

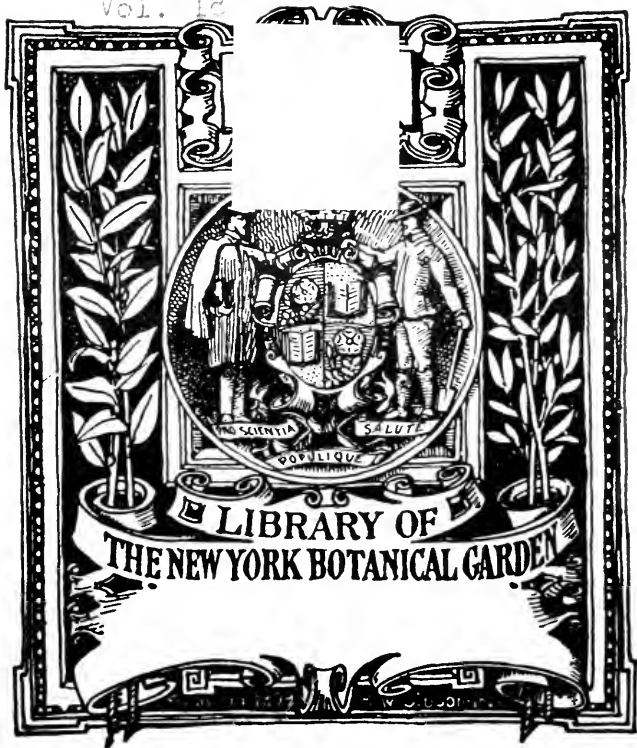

Vol. 18













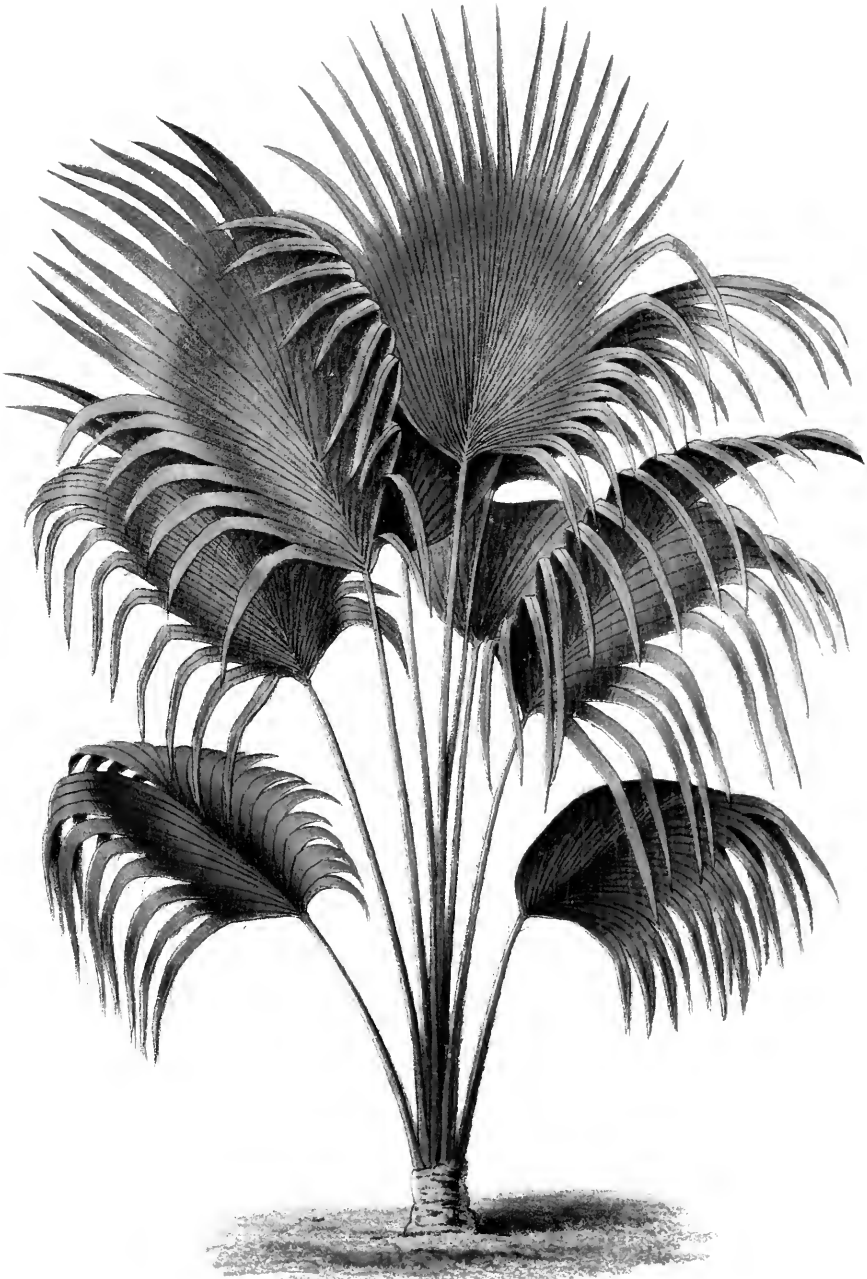

PRITCHARDIA FILIFERA.

TSINCLAIR & SON, LITH. PHILA.

ENGRAVED EXPRESSLY FOR THE GARDENER'S MONTHLY.



# *The Gardener's Monthly*

AND

## *Horticulturist,*

DEVOTED TO

HORTICULTURE, ARBORICULTURE AND RURAL AFFAIRS.

---

EDITED BY

THOMAS MEEHAN,

*Formerly Head Gardener to Caleb Cope, Esq., at Springbrook, and at the Bartram Botanic Gardens near Philadelphia; Graduate of the Royal Botanic Gardens, Kew, (London,) England.*

*Member of the Academy of Natural Sciences. Author of "American Hand-Book of Ornamental Trees." &c.*

LIBRARY  
NEW YORK  
BOTANICAL  
GARDEN

---

VOLUME XVIII. 1876.

---

PHILADELPHIA:

CHARLES H. MAROT, *Publisher,*

No. 814 Chestnut Street.

1876.

# ILLUSTRATIONS.

Frontispiece—Chrono .....	PRITCHARDIA FILIFERA.	
<b>A</b>		
Academy of Natural Sciences, Philadelphia.....		31
Arbor vitæ, Globe.....		101
Auricula .....		296
<b>B</b>		
Beecroft's Wheel Hoe.....		4
Bouvardia Humboldtii corymbiflora.....		40
Brodiaea coccinea.....		340
<b>C</b>		
Chickory (Witloef) for Salads.....		209
Cineraria maritima.....		10
Cowan's Compensating Heating Apparatus.....		43
Croton spiralis.....		361
"    volutum .....		359
Curves, Measuring.....		229
<b>G</b>		
Gilliflower, Paris.....		236
Grafting, Orange and Lemon—two cuts.....		104
Grape, Lady—Chromo.....	facing page	80
Greenhouse Heating—Small.....		135
<b>L</b>		
Liatris pycnostachya.....		294
Lilium auratum.....		184
<b>O</b>		
Orange and Lemon Leaves—two cuts.....		105
<b>P</b>		
Pear, Marshall.....		51
Pelargonium, Ivy-leaved—Konig Albert.....		267
"    Zonale—Wonderful.....		237
Polyanthus, Double.....		296
<b>S</b>		
Sarracenia Drummondii.....		323
Saxifraga Huetii.....		11
Standard Gooseberries and Currants—Method of Grafting.....		270
<b>T</b>		
Tea Rose, Duchess of Edinburgh.....		231
Tree Ferns, Australian.....		347
Trellis for Melons.....		206
Trietelia laxa.....		278
<b>V</b>		
Van Houtte, Louis, Portrait of.....		249
Violet Victoria Regina.....		76

PHILADELPHIA, Jan. 1st, 1876.

TO THE LATE SUBSCRIBERS OF  
"THE HORTICULTURIST."

Having purchased the above magazine from Henry T. Williams, its late Editor and Proprietor, it ceased to exist as a distinct publication with the issue of its December number of the year just closed.

I have prepared an extra edition of the January number of "THE GARDENER'S MONTHLY AND HORTICULTURIST" for those subscribers of the late publication who may desire to renew their subscriptions for 1876.

This number which you receive is a copy of the same, and is sent to you on the presumption that you were a subscriber to the late Horticulturist, up to the close of 1875; its publisher having furnished us a list of that year's subscribers, of which your name is one.

We hope you will, on reception of this initial number of the combined publications, inform us of your pleasure as to a renewal or discontinuance for the year 1876, as our editions are limited to our subscription list, with very few *over copies*; and a postponement of renewal to a later date might find us *unprepared* to supply the whole series for this year, including the back numbers from January.

Those whose subscriptions are now current entitling them to one or more numbers within 1876, to complete their credits, will please advise us at once, informing of the time paid up to, so that we may revise their account on our mail list.

The terms of subscription are, for one year, including postage, **\$2.10**; for six months, **\$1.05**; for four months, **70** cents; for three months, **53** cents.

Or, send us your own name and that of a new subscriber for **\$3.20** the two.

We would particularly thank those who wish to *discontinue* to kindly drop a line to that effect, and accept the present number for their trouble in so doing; as it will be a great favor to know early how to limit our edition to the probable demand. Hoping an inspection of the current number may inspire you with a desire to try us one year longer, or that we may, at least, hear from you, *pro or con*, for reasons above stated,

I am very respectfully yours,

CHAS. H. MAROT.

Address CHAS. H. MAROT,

Publisher of "The Gardener's Monthly and Horticulturist,"

814 Chestnut Street, Philadelphia, Pa.



THE  
GARDENER'S MONTHLY  
AND  
HORTICULTURIST.

DEVOTED TO HORTICULTURE, ARBORICULTURE AND RURAL AFFAIRS.

Edited by THOMAS MEEHAN.

VOLUME XVIII.

JANUARY, 1876.

NUMBER 205.

FLOWER GARDEN AND PLEASURE GROUND.

SEASONABLE HINTS.

In the North, with the great body of vegetation still shrouded in snow and the usual habiliments of winter, little can be done in this department; but in the Southern States gardening operations will be about commencing actively. Pruning should be completed as soon as possible. Some judgment is required in pruning flowering shrubs, roses, &c., although it is usual to act as if it were one of the most common-place operations. One of the most clumsy of the hands is commonly set with a shears, and he "goes through" the whole place, clipping off everything indiscriminately. Distinction should be made between those flowering shrubs that make a vigorous growth, and those which grow weakly; and between those which flower on the old wood of last year, and those which flower on the new growth of next season, as the effect of pruning is to force a strong and vigorous growth. Those specimens that already grow too strong to flower well, should be only lightly pruned; and, in the same individual, the weakest shoots should be cut in more severely than the stronger ones. Some things like the Mock Oranges, Lilacs, and others, flower on the wood of last year—to prune these much now, therefore, destroys the flowering: while such as Altheas, which flower on the young wood, cannot be too severely cut in, looking to that operation alone. We give below a full list of the shrubs in most common cultivation, of the different classes.

Ornamental shrubs that flower chiefly from the wood of the preceding year: Snowy Mespilus, Dwarf Almond, the different kinds of Andromedas, Azalias, Kalmias, Rhododendrons, Calycanthus, Corehorus, Cornelian Cherry and the other Dogwoods; Philadelphuses, Deutzias, Mezereon, Leather-wood, Fothergilla, Golden Bell, Hydrangeas. Itea Virginica, Jasmynes, Privet, Upright Fly and Tartarian Honeysuckles, Pyrus japonica; the Missouri and other ornamental currants; most of the early flowering Spiræas, Dwarf Pavias, Snow Berries, Guelder Rose, Wiegelia rosea, Persian and other Lilacs, Annual Roses.

Shrubs that flower from the present season's growth: *Amorpha fruticosa*, *Ceanothus Americana*, Bladder Senna, Coronillas, Burning Bushes, Genistas, Scotch Broom, *Althæa*; *Hypericums*, such as *Kalmianum*, *Prolificum*, &c.; *Greenfringe*, *Flowering Locusts*; the Fall-flowering *Spiræas*, *Tamarix*, *Vitex agnis-castus*, &c. These lists also embrace the most desirable of ornamental shrubs in cultivation, from which the amateur may select when the planting season arrives.

In pruning roses, the Fall-blooming kinds, which flower on the new growth, may be pruned as severely as we wish—in fact, the "harder" they are cut in the better. In this class are the *Noisette*, *Bourbon*, *Tea*, *China*, and *Hybrid Perpetual*, and *Perpetual Moss*. Without considerable experience it is difficult for the amateur to distinguish these classes. The best way to get over the difficulty is to obtain the catalogues of the principal rose-growers, in which each kind is

OCT 23 1959

usually classified. Amateurs should pay more attention to the scientific—if we may so term it—study of the rose, and its classification and general management; no class of flowers is more easily understood, and no one affords so rich a fund of perpetual interest.

Wherever any part of a tree does not grow freely, pruning of such weak growth, at this season, will induce it to push more freely next year. All scars made by pruning off large branches should be painted or tarred over, to keep out the rain. Many fruit trees become hollow, or fall into premature decay, from the rain penetrating through old saw cuts made in pruning. Also, the branches should be cut close to the trunk, so that no dead stumps shall be produced on the tree, and bark will readily grow over. Many persons cut off branches of trees in midsummer, in order that the returning sap may speedily clothe the wound with new bark, but the loss of much foliage in summer injures the tree, and besides, painting the scar removes all danger of rotting at the wound.

### COMMUNICATIONS.

#### A PLEA FOR PLANTING PYRUS CORONARIA.

BY MR. W. T. HARDING.

I was much pleased with Mr. Stauffer's remarks, in the March number of last year, on our native *Pyrus coronaria*, the American or Garland Crab Apple. He, Mr. S., is an excellent writer,—good, sound logic always seems to flow from his pen,—and, that he loves the beautiful, is also evident. He lets us know his heart is where it ought to be, and feels "as happy as a king" when beholding a crab tree.

It occurs to me, that when a boy, and reading of a traveler (Waterton, I think), returning home, after a long absence, observing, that "of all the beautiful or wonderful sights he had seen, at home or abroad, nothing pleased him so much as the sight of an old crab tree, blossoming in a hedgerow at the margin of a wood."

"O happiness, our being's end and aim,  
Good, pleasure, ease, content, whate'er thy name."

I endorse every word the genial Stauffer and other æsthetic writers say about the crab apple. To quote his language, "A more beautiful object cannot be found when in full bloom, together with its delightful fragrance (early in spring)." He may well ask, "Why is it that we do not find

it in cultivation?" "There's the rub." His description of its merits, I assure the reader, is no exaggeration, and it ought to be in every garden or lawn. It would be the glory of the greenhouse in winter, and would seem, either in groups or as isolated bushes, the loveliest of the lawn. In many respects it far surpasses the favorite *Cydonia japonica* as an ornamental shrub. It flowers more freely, and is as sweet as a Bon Siline rose. In the Southern forests, the blending odors of the Carolina jasmine *Gelsemium sempervirens*, and *Pyrus coronaria*, are as exquisite as any floral perfumes can possibly be, and are far more refreshing to inhale than frankincense and myrrh.

I think the reader, ere this, will have discovered the writer loves pretty things, and they may feel assured that he would willingly sign a round robbin, vote in person or by proxy, hold up his right hand, or both hands, in favor of doing justice to the Garland Crab Apple.

Before, and during the war, it grew abundantly in South Carolina, Georgia, Florida, and Tennessee. I met with it in the neighborhood of Columbia, Beaufort, Daufuskie Island, Savannah, Saint Augustine, Fernandina, and Knoxville. I presume it grows there still, unless the indignant people living in those parts grubbed them all up when it was suggested to "hang Jeff Davis on a sour apple tree." Why "a sour apple tree" instead of any other, I cannot imagine. I shall never forgive Mr. Doggerel, who first hinted at putting such a beautiful tree as *Pyrus coronaria* to so base a purpose as to make a gibbet for any one. It would have been equally as consistent to have advised smothering the unfortunate man with flowers.

As Mr. Meehan observes, "It is singular that in all the botanical excursions of the editor, he has never ran against this tree." No doubt he will some of these days, and (providing he does not break his shins when doing so), will say something pleasant about it. In the meanwhile, I will tell the editor how I "ran against this tree."

When in charge of Wade Hampton's estate, in South Carolina, during "the piping times of peace," I was often amused with the exciting narrative of a coon hunt, one of the chief delights of a darkey. So, "just for the fun of the thing," I proposed to join the sable "Nimrods" in the hunt about to take place that night. About nine o'clock I heard a negro quartette approaching, and as they advanced from a copse of magnolias

and evergreen oaks, I heard them singing lustily the celebrated coon-catching epic, "Sittin' on a Rail." The hero of the poem, it seems, was a daring darkey, who fearlessly, bravely, and stealthily, regardless of consequences, crept up to—

"De raccoon sittin' on a rail, an' sleepin' berry sound,

Den he catch him by de tail, an' pull him to de ground."

But, as the sequel will show, in this instance, he was not "sleepin' berry sound." He was "a wide-awake coon." The night was more than usually pleasant, so calm and cool, and almost as light as day. Nature seemed to be at rest all serenely.

"The moon was bright, 'twas a shiny night,  
In the season of the year."

I honestly believe we all felt as merry, if not as brave, as did either Earl Percy or Douglass, of "Chevy Chase" renown, as we filed off along the forest path. "With axe or brand, no braver band, advanced to face"—a coon.

The chief hunter rejoiced in the name of Long John, while his henchman was equally proud of Bogus. The next name on the roll was Festus—"most noble Festus"—followed consecutively by the valiant Soger; then, yours respectfully, W. T. H., and lastly, though not less famous, Vinegar, and whom all acknowledged to be "de best dog dat eber treed a coon."

Now, in many respects, Vinegar was a remarkable canine, and I say it advisedly; he was the leanest and mangiest pup that ever ran before a tail. Indeed, he seemed to be a "cur of low degree," and to have, as his looks indicated, a very dogged way of his own. Notwithstanding, he was, to his credit be it said, in possession of more than ordinary dog talents in circumventing rats, rabbits, 'possums, and coons, and was honored accordingly. Bogus and Vinegar were bosom friends by day and bed-fellows by night, and had for several seasons lived and loved together. Long John was considered a good man, and I believe he was; he was (what I believe they call), a Gospel expounder on the plantation. In some respects he resembled Saul, who, "from his shoulders and upwards, he was higher than any of his people." He was also a man of might in his way, having had some desperate encounters, as he described them, when "wreslin' wid de spirit, befo' he was 'ligeous." When I remarked that I thought the spirit must have been a

plucky one that durst attack a man like him, he replied, "De dibble wusn't half so plucky as he 'peer'd to be, wen he wus well tackled; he mostly got de wust of de scrimage." Just fancy Long John and the other black fellow in a tussle. Well, he was just as good and useful on the coon-path as he was terrible when on the war-path.

After wandering about some time, through bogs and swamps, until I was weary and wet, in fact, I was in a shocking plight, Vinegar had the credit of treeing a coon. Bogus, approvingly and with much gusto, remarked, "Binegah am de most cummin' ole man dat eber wag a tail, shuah." Then was heard such a hubbub, yelling, hooting, howling, and barking round the tree as was never heard before from four men and a dog. All the time the chips flew fast and furious, as they vigorously applied their axes to the butt of the tree. Poor blackamoor! how much they seemed to enjoy the sport, and how I laughed to hear them cracking funny jokes at "de gemman up de tree," whom they invited to come down "an' 'zamin' massa Binegah mouf, case he got de toof-ache, shuah!" I really pitied the poor creature, and hoped he would escape. It did not seem a fair fight—five to one. The rotten tree soon yielded to their efforts, and began to lean over. The excitement seemed to increase as it fell, when to the astonishment of all hands, three coons scampered out of a hole, and together fell foul on Vinegar. Thus beset, the beleaguered "Binegah" seemed to be getting the worst of it, until Festus interfered. Aiming a blow at one of the coons, he missed it, and buried his axe in the dog's side, and disemboweled poor Binegah.

"Great Goddlemighty!" exclaimed Bogus, and looking at Festus, said, "See what you niggah fool dun, you murdid poo' Binegah shuah!" In an instant Bogus was down by the dog, vainly attempting to close up the frightful gash in his companion's side. The big tears flowed copiously from the master's eyes, and fell fast upon the face of his dog, whose life-blood was welling away.

In the mind's eye I see the picture now, and a more pitiful sight I seldom have seen, than the poor weeping negro rubbing his rugged cheek on the dog's, and sobbingly commiserating with his dying friend, and exclaiming, "Poo' Binegah! ole man, you dun fo' now! No mo' rats, no mo' possum, no mo' rabbit, no mo' coon, no mo' nuffin,—an' no mo' Binegah! Dis chile will miss de poo' fellow! Sally, miss de poo' fellow!

and de chill'n miss de poo' fellow! Eberybody miss de poo' fellow! Goddemighty, bress us all!"

After gently patting his dead friend for the last time, and throwing some leaves and grass over him, he looked steadfastly at the most ignoble Festus, and pointed at the blood-stained grass, but never a word said he. Festus only laughed, which stirred up the hot blood of the tamed savage, and ended in a passage of arms, or rather heads, or more correctly, butt and counterbutt. Quick as thought, Bogus ran his head butt into the stomach of Festus, and sent him sprawling in the grass, who, on gaining his feet, returned the compliment, and staggered Bogus. Then stepping in between, as seconds are supposed to, Long John supported Bogus, while Soger did the like service for Festus; when it was decided, according to the *code duello*, their wounded honors had been redressed in a chivalric and noble manner, be-

State, New Jersey, she remembers when a girl, in the neighborhood of Mount Holly, seeing quantities of the Garland Crab Apple. So it is probably nearer Philadelphia than you are aware.

### EDITORIAL NOTES.

**WATERPROOF PACKING PAPER.**—Dissolve 1.82 lbs. white soap in 1 quart water. In another quart water dissolve 1.82 ozs. troy of gum arabic and 5.5 ozs. glue. Mix the two solutions, warm them, and soak the paper in the liquid, and pass it between rollers, or simply hang it up to drip.—*Scientific American*.

**BEECROFT'S WHEEL HOE.**—Man is a pretty smart sort of a creature, and has managed in various ways to evade the primeval curse with tolerable success. The old-fashioned hoe we have, how-

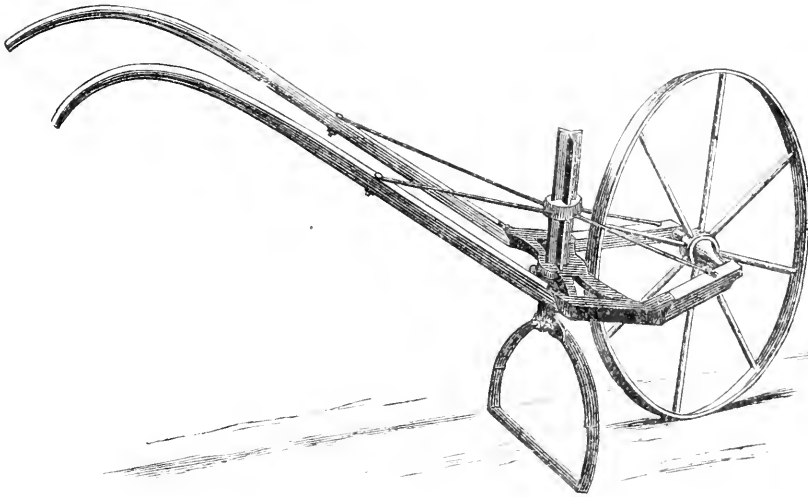

coming to gentlemanly combatants, they shook hands, feeling assured their fair fame was untarnished.

After all, it was a more sensible manner of deciding nothing than white fools usually take, when they run a muck at each with knives or swords, or try to shoot bullets or buckshot into each other's hides.

The raccoons had stampeded, as might be expected, while "the moon with her sober countenance" placidly looked down at the scene where the jasmynes and crab apples bloomed profusely.

In conclusion, it only remains for me to say that my better half informs me that in her native

ever, regarded as just about the same as it was in the days of Adam, and we have an absolute surety that when he went out to fight the thorns, thistles, and noxious weeds with one of these back-achers, he must, more than at any other time, have felt that his rank disobedience, or giving way to feminine persuasion, which ever it was, did not pay at all.

We have watched continually for some good thing to supersede this abominable implement, and have from time to time given sketches of wheel hoes of various kinds. The present one (see illustration) is certainly the best of all we have seen. It indeed reduces hoeing to an amuse-



ment, and might be sent to gymnasiums, or to dyspeptic clergymen, as a means of gentle exercise in the garden, of benefit both to body and mind. The machine has been introduced to us by Mr. Thomas Jackson, of Portland, Maine, who is doing good service in distributing it.

**AN AUTOMATIC GATE.**—We have never seen a gate of this character that did not in time get out of order to an extent that caused an early abandonment. The idea of a self-opener is too good in a gate to be wholly given up, and we are glad to note that among those who are working on it is our ingenious friend, Dr. Weed, of Des Moines, as we find by the following in an Iowa paper:—

“We visited the farm of Dr. James Weed, yesterday, and inspected his self-opening gate. It works like magic. As you approach in a buggy the gate suddenly parts in the middle (being double) and the two parts turn over backwards, leaving the way clear to drive in, without slackening speed, even though your horse should be on the trot, and as you drive along, the gate as suddenly closes and latches as snugly as it was before you came to it. The principle on which this gate operates is difficult to describe on paper. All the machinery visible above ground is two pieces of rounded iron in the road, one on each side of the gate, about thirty feet from it. This must be run over by the buggy, its weight pressing the iron down and causing certain motor springs connecting with rods to throw the parts of the gate upward. These parts are steadied by “tortion” springs, which counteract the weight of the gate, so that there is no slam or jar as it comes down to the ground. The return of the parts of the gate is caused on the same principle by the buggy running over the other piece of rounded iron inside the enclosure. The machinery is so adjusted that the principle works precisely the same whether going in or out of the enclosure. It is not only a novelty, but a pleasure and convenience to ride along and, without moving hand or foot, have the gate open and close for you by some unseen power. Dr. Weed has been experimenting on these gates for several years, and his latest improvements are substituting motor springs for gearing, and “tortion” springs for the former method of balancing the gates with stones of equal weight. He claims that it is now perfect in every particular, and not liable to get out of order in any kind of weather. He secured a patent last year. These gates are rather expensive—\$200—but what is that to a man who is able and willing to pay for the thing

that suits him? We wish the Doctor success after his long years of patient study in perfecting his invention.”

**THE TULIP TREE IN ENGLAND.**—A correspondent of *Gardener's Chronicle* says: “There is in Lord Llanerton's grounds, Woolbeding, near Midhurst, Sussex, ‘a very fine Tulip tree,’ which was acknowledged by the late Sir Wm. Hooker to be the finest specimen in the kingdom; and it certainly is a magnificent tree, being one mass of foliage from its summit to the ground. Its measurements in 1871 were as follows: Height, 91 feet 5 inches; girth at 3 feet from the ground, 17 feet 2 inches; circumference round the branches, 79 yards. It is in perfect health, and has doubtless increased somewhat in size since the above measurements were taken.”

**WINTERING ECHEVERIAS.**—Echeverias which have served for borders, beds, or floral inscriptions during summer, if potted to pass the winter, are liable to rot or spindle up. A method of preserving them, which occupies practically no room whatever, and which avoids the above mentioned inconvenience, is to shake out the earth from their roots when taken up in autumn, and suspend them heels up or anyhow, in small bunches, on strings stretched horizontally, like linen hung on a line to dry, beneath the roof of a cool greenhouse, which just keeps out the frost.—*Gardener's Chronicle*.

**ARUNDO CONSPICUA.**—Vietch says it is very similar in habit to the well-known Pampas Grass (*Gynerium argenteum*), but blooming about two months earlier than that variety, and lasting much longer in beauty.

## NEW PLANTS.

**PHYSIANTHUS ALBENS.**—The *Garden* says:—“Those of your readers who are in want of a quick-growing summer climber, for covering a wall or trellis, should procure this interesting Asclepiad. A small plant of it, little more than a foot high, with a few laterals, was turned out against an ordinary wall, with a warm exposure, about the end of May, and now covers five or six square yards of surface, every joint being furnished with a raceme of pure white flowers. A month hence the shoots will be pruned back, and the plant potted up for wintering in a warm greenhouse. I have yet to learn what degree of cold it will survive, but probably it would endure mild winters in the southern counties of Eng-

land and Ireland. An easier plant to cultivate can hardly be imagined." And we notice it here to say that it is even a better plant for American gardens than for English ones. Last autumn the writer of this saw it in Ellis Park, in Chicago, more handsome than he ever saw it before, covering trellises eight feet or more high with hundreds of its large, waxy, white flowers. It is of cruel tastes, however, the flower catching insects without any use whatever, so far as is at present known.

**PENTSTEMON HUMILIS.**—One of the prettiest of the dwarf Pentstemons of the Rocky Mountains, forms the subject of a handsome colored plate in the *Florist and Pomologist* for November.

**NEW HARDY TREES.**—From various sources we make up the following, that will probably all prove hardy in our climate:

**Maackia amourensensis.**—We had a specimen of this from the collection of Alfred Cope. The flowers are in close white bunches, and the leaves have much the appearance of a *Cladrastus tinctoria*. It will be a good acquisition to our list of hardy trees.

**Corylopsis spicata.**—We have before given some account of this beautiful Japan shrub, one which will probably prove hardy in our country. The *Gardener's Magazine* has recently given a wood cut of it, and with the following description: "This interesting hardy Japanese shrub is regarded by hasty observers as a hazel or a near relative of the nut tribe, but as the seed is a hard capsule, those who watch it through its course learn that in one respect at least it is far removed from the hazels. It is, in fact, a member of the Liquidambar family, and its generic name of *Corylopsis* refers to the striking resemblance of its leaves to those of a hazel, not to its flowers or fruit.

"*Corylopsis spicata* is a free-growing shrub possessing considerable beauty, and especially handsome in the spring when its flowers appear, as they bear some resemblance to the elegant inflorescence of *Garrya elliptica*, being produced in drooping racemes in the greatest profusion. They appear before the leaves, and are of a pleasing greenish yellow color, pleasantly fragrant, and attractive to the bees. The leaves which follow are large, subcordate, and of a full green color, like those of the hazel. Those who are now planting will do well to include this useful shrub in the list of desiderata for the shrubbery."

**Othera japonica.**—The English papers say of this, which will perhaps prove hardy in at least our Middle States: "A new and beautiful evergreen shrub. One of the most distinguished Japanese travellers says this is perhaps the prettiest evergreen they have in Japan; it grows about twenty feet high, has dark green leaves and a profusion of bright red fruit; it is very effective and perfectly hardy."

**A NEW STRAIN OF DRACENAS.**—Mr. Bause, who was the first to break up the old-fashioned *Coleus* into so many beautiful kinds, and without which our gardens would make now but a poor show, has done the same thing now for the *Dracæna*. The new strain is said to be among the most beautiful of leaf plants, quite as striking as the *Coleus*. No doubt some of our enterprising florists will soon offer them in this country.

**PYRACANTHA JAPONICA.**—We have not noticed before that there is a *Pyracantha* under this name in Europe. It appears there are a number of good Japan trees and shrubs in the Old World awaiting introduction here. The *Garden* says: "In town gardens, *Pyracantha japonica* is now one of the most attractive of all wall plants. In the Royal Horticultural and also in Kensington Gardens, this plant is now the admiration of all who see it. *Crataegus Aronia*, in Kensington Gardens, is also just now strikingly beautiful, as is likewise the crimson-fruited *Cotoneaster frigida*, which, as a town tree, ought to be more extensively planted than it is.

**SYRAX JAPONICA.**—This hardy deciduous shrub is of dwarf compact growth, with elegantly spreading branches, furnished with bright green elliptic leaves, and gives a profusion of white flowers, somewhat resembling snowflakes. It will be a very useful plant for early forcing along with *Deutzias*, *Spireas*, &c., and an exceedingly pretty and useful shrub for borders in the open air. It is a native of Japan.—*W. Bull.*

**DEUTZIA CRENATA CANDIDISSIMA PLENA.**—An exceedingly free-flowering variety, producing fine large, very double, pure white flowers. It is a very useful winter and spring-blooming plant, and looks extremely elegant when covered with its large bunches of pure white flowers.

**WEIGELA LAVALLEI.**—The flowers of this attractive variety are of a rich purplish red color, with yellow centres, and are very freely produced in exceedingly long bunches. It is a distinct and handsome variety of robust growth, and is also an excellent plant for forcing.—*W. Bull.*

# GREEN HOUSE AND HOUSE GARDENING.

## SEASONABLE HINTS.

Many of our readers have only a few window plants. These are often kept too warm, too wet, have too little sunlight, and have too many insects. In towns, in addition to all these, they have often too much of the fumes of burning gas. Leaks or escapes from the gas pipe are well-known to be an injury to plants, but it is not so well known that plants suffer, though in a less degree, from the common burning of coal gas. The trouble with most room cultivators is to know when plants get too much attention. Too many insects are easily known, one—a single one—is by far too many. We still think there is nothing like coal oil to destroy all kinds of insects. A very little, just enough to make a colored scum on the surface of a tub of water, is sufficient, and in this the insect covered plant may be dipped, inverting the pot and plunging only the plant, and not the pot of course. If too much oil is used the plant may be injured. Too wet, is when a plant seldom gets dry—a healthy plant should get dry, and have light dry looking surface soil, every too or three days. As to heat, a temperature of about 55° or 60° is best for room plants; below that they do not flower freely; above they grow weak, especially if they have not a great deal of sunlight. Indeed heat should be in proportion to direct sunlight on the plants.

Roses, when they are forced, do much better when the pots are plunged in some damp material. When no better plan offers, they may be set inside of a large pot, with moss between the space around. All plants that come into flower through winter should have those positions afforded them that have the most sunlight, especially the early morning light.

Fergeries are now so deservedly popular, that we must have a word to say for them at times, though their management is so simple, there is little one can say. It is probably their ease of management, and the great results obtained for the little outlay of care, that has rendered them so popular. It should not, however, be forgotten that the cases in which they are enclosed are not

to keep out the air, but to keep in the moisture, as ferns will not thrive in the dry atmosphere of heated rooms. A few minutes airing every day will, therefore, be of great benefit to them. Decayed wood (not pine), mixed with about half its bulk of fibrous soil of any kind, and a very small proportion (say a tenth of the bulk) of well-rotted stable-manure, makes a good compost. Most kinds particularly like well-drained pots. This is usually effected by filling a third of the pots in which the ferns are to grow with old pots broken in pieces of about half an inch square, on which a thin layer of moss is placed, before filling the pots, to keep out the soil from choking the drainage.

Many very pretty fergeries are made up entirely of native ferns, some species of which are within the reach of every one. Of the exotic ones, however, that are now general in most florists' establishments, and are remarkable for their elegance and beauty, we may name, *Selaginellas* (formerly *Lycopodiums*) *S. stolonifera*, *S. densa*, *S. Mertensii*, *S. denticulata*, *S. cordifolia*, *S. flabellaris*; *Adiantum concinnum*, *A. pubescens*, *A. cuneatum*; *Pteris longifolia*, *P. serrulata*, *P. hastata*; *Polypodium Sieboldii*, *P. glaucum*; *Doodia caudata*, *Gymnogramma chrysophylla*, *Platyroma rotundifolia*, *Nothoclæna nivea*, *Pteris geraniifolia*, *Hemionites palmata*. This will form a good and easily obtained collection to commence with. Ferns are easily raised from seed. Shallow pans of very sandy soil should be procured and filled within an inch of the rim. The seed, which is obtained from the brown lines or spots (called by botanists, Sporangia) on the under surface of most mature fronds, should be sown on the surface of the soil, well watered with a very fine rose, window-glass placed closely over the pans, to keep in the moisture and keep out small insects, and the pans themselves set in a heat of about 50°, when the spores will germinate in about two months.

Where the air is dry, if in rooms or greenhouses, frequent syringings are of much benefit to plants. Besides, cleanliness keeps down insects and checks disease in plants as in animals. Most old-

fashioned lady gardeners (and may we ever bless them for the many lessons they have taught us!) take every opportunity to set their window-plants out of doors when a warm shower happens to occur. In winter a rain at a temperature of 40° or 45°, which often occurs, might be called a "warm shower." Cold water does not have half the injurious effect on plants that cold air has. When plants get accidentally frozen, the best remedy in the world is to dip them at once in cold water and set them in the shade to thaw.

It is better to keep in heat in cold weather by covering, where possible, than to allow it to escape, calculating to make it good by fire-heat, which is, at best, but a necessary evil. Where bloom is in demand, nothing less than 55° will accomplish the object; though much above that is not desirable, except for tropical hot-house plants. Where these plants are obliged to be wintered in a common greenhouse, they should be kept rather dry, and not be encouraged much to grow, or they may rot away.

After Cyclamens have done blooming, it is usual at this season to dry them off; but we do best with them by keeping them growing till spring, then turning them out in the open border, and re-pot in August for winter flowering.

Mignonette is much improved by occasional waterings with liquid manure.

In managing other plants, where there are several plants or varieties of one species, and command of different temperatures, it is a common plan to bring some forward a few weeks earlier than others in the higher heat, thus lengthening the season of bloom. This applies particularly to camellias and azalias; the former are however, not so easily forced as the latter, being liable to drop their buds, unless care be taken to regulate the increased temperature gradually.

## COMMUNICATIONS.

### ÆSTHETICS IN CONSERVATORIES.

No. 2.

BY F. W. P.

The London Crystal-Palace, of 1851, designed by the then only Mr., afterwards Sir Joseph Paxton, the gardener to the Duke of Devonshire, was a clever structure, meeting the requirements imposed by the government on the architects better than any other plan proposed, and as

unique as it was in its conception, grand in its dimensions, but imposing only on vulgar minds or coarse and uncultivated tastes, as quantity and size always do, it never was a beauty nor ever claimed to be by its own originator. It was at the beginning intended to serve but a temporary purpose, and the permission for its erection was granted upon the special condition, that it should be removed immediately after the World's fair was over. Its re-erection for permanency was an after thought; but the idea that it might serve as a plant-house never entered the mind of Paxton. He knew too much for that, and what he might have done in this direction, if afforded an opportunity, may be surmised after a careful and intelligent study of the Conservatory at Chatsworth. The mistaken adoption of the style and the leading features of the Crystal Palace for horticultural structures, only proved a gross ignorance of the fundamental and indispensable requirements of contrivances for the maintenance and the proper display of plants.

To intrust the construction of them, if not *carte blanche* to engineers, at any rate with too much unwarranted faith in their superior genius and skill, is a great mistake. We ought to remember that engineers are technicians, more or less scientific mechanics, and as a class have never shown much of an artistic turn of mind, nor anything like infallibility. When in the construction of our parks and conservatories, they are invited to furnish just as much and as little of their peculiar skill and ingenuity as is wanted or indispensable, they may prove very useful; but to make them the directing minds and final authorities in matters of science and art, for which they never had sufficient time nor opportunities to qualify themselves, is a mistake which is sure to bring about such results as are already visible in but too many places, and the repetition of which ought to be discontinued.

Horticulturists and landscape gardeners may easily add to their stock of knowledge what little is required of engineering, to get along without them; and before engineers can undertake to supersede the professional gardeners, they have to be initiated in mysteries beyond the power of screws and levers.

That monstrous bubble of glass in Kew-garden (constructed by a man whose legitimate business was to build railroad depots, and who knew well enough how, with iron and glass, to arch over wide spaces for the accommodation of several locomotives abreast), is, as a plant-house, about

as suitable and useful for information as a race-horse is in its line, and Mr. Jeffreys in one of his criticisms on the "Horticulturist" calls it "a costly royal toy," adding that it is "a luxury of which I cannot well see the utility in so much expense." Well, would it be English if it were not costly? Only think of it—sixty thousand pounds sterling, to "dome" over only half an acre of ground, for the exhibition of more iron, tubs and pottery, than foliage and flowers, serving more to satisfy the vulgar curiosity of the London sight seers, than the scientific thirsts of students. For, what it is smaller in size and inferior in efficiency than the Chatsworth conservatory, covering an area of more than an acre, it makes up in useless, costliness and ostentation, like some people's books, of which the bindings cost more than the books themselves are worth.

The celebrated Palm-gardens, at Frankfort on the Main, originally built for the Duke of Nassau on his place at Biborich were, after his mediation, acquired by a society and removed to Frankfort. They have since been considerably increased in extent, and a richer collection of tropical and sub-tropical plants in large and fine specimens could not well be found in any other establishment. In this enterprise the society has expended up to this day the snug sum of about half a million of florins (200,000 dollars), and has the flattering satisfaction of realizing, together with a universal and enthusiastic approval of an appreciating public, an encouraging financial return on the outlay, by charging only half a florin (.20 cents) admission fee.

Here, an arrangement of the plants, more natural and thus more beautiful, than that in the Kew Palm-house, forms one of the chief attractions, but, as in all the older structures of this kind, the too great length in proportion to the width and the uniform level of the ground or floor, made full, or at least a better success in this direction, impossible. We also miss the aquatic plants and, besides a puerile, though larger than usual, "rockwork with cascade," we notice incongruities, such as vases with a yucca or a dracæna stuck into them; palms, over forty feet high, in tubs, which are by no means improved by being coated with bark; but what is decidedly most objectionable is the circumstance, that even here some genius, delighting in small things, has been permitted to intrude the paltry product of his talent for rag-quilting into this assemblage of the floral aristocracy of the tropics. (When will

both gardeners and amateurs learn to understand where ribbon or mosaic planting, and how much of it, is proper?)

The roof of this, in every essential respect, admirable conservatory, is appropriately simple and unpretending, not forcing itself unduly and first of all upon the visitor's eye. It is, what it always should be,—the mere shell of a sweet and delicious kernel.

### EDITORIAL NOTES.

CALLA ÆTHIOPICA.—Our lady readers will value the following little hint from a correspondent of the *Gardener's Magazine*:—With a comparatively small number of plants, I have been cutting blossoms nearly every week for the last twelve months (not less than two hundred in all), and from the appearance of the plants, as to buds and luxuriant foliage, I may expect a succession during the coming winter months, when other white flowers are so difficult to procure, especially for church decorations. I must add that I give the Callas very little rest, some of them none whatever. By this system of culture the old roots do not die, and the plants certainly produce much finer blooms.

BUTTON-HOLE ROSES.—Mr. Radclyffe must have written in fun when he recommends Madame C. Joigneaux and Charles Lefebvre as button-hole Roses; but he might as well have "gone the whole hog" and recommended a full-expanded Paul Neron. He omits many beautiful button-hole Roses—*e.g.*, Madam Falcot, Madam F. Janin, La Boule de Neige, and Prince Camille de Rohan (in bud). There are several fine Teas, too, of late introduction that he does not mention; for instance, Anna Ollivier, very fine in bud for button-holes, and Amazone, the same. I do not think we shall find many rosarians recommend Abbe Brammerel, Maxime de la Rocheterie or Baron Chaurand for any purpose.—*P.*, in *Journal of Horticulture*.

TREATMENT OF ORANGES.—The small Otaheite Orange, so useful for winter flowering, should, when out of bloom, have its growth pushed on in a little warmth. This plant is subject to scale, and before any young growth is made they should be thoroughly cleansed with insecticide, using the sponge in preference to the brush, the latter being liable to scratch the leaves. Plants of varieties of large growth that have flowered should be similarly treated. Oranges of all

kinds, whilst making their growth, must be well supplied with water, especially overhead, and be also slightly shaded from the sun. The orange is a plant of comparatively easy growth, and naturally able to withstand a good deal of bad treatment without being killed outright; and to this, no doubt, may be attributed the indifferent condition in which they are often seen. When in a bad state the roots are generally few, and almost dormant at a time when they should be ramifying in all directions; when thus stunted and unhealthy the best course is to turn them out of their pots, reduce the balls considerably, put them in smaller pots, and place at once in moderate heat with a close moist atmosphere until the roots are unmistakably active and the growth is made: plants in such condition will be much benefited by a moderate bottom-heat of about 70°.—*Gardener's Chronicle*.

**VERBENAS FROM SEED.**—Those who are limited or room in their greenhouses, and still like to make as good a show of bedding plants as possible during the summer months, will find it by far the best plan to raise their stock of Verbenas from seed. This can be easily done in the following manner:—Take a few seed pans, and if these be not at hand, a few shallow boxes will suffice quite as well (if the latter be selected, some holes must be made in the bottoms), cover over the bottom with some broken crocks, and fill in to within about half an inch of the top with a light mixture of rotten loam, leaf mould, and a good dash of silver sand, make the surface level, and press it a little, so that when watered it will not sink. On this surface the seeds should be evenly sown, and then covered over with a light sprinkling of the same soil that they are sown on; they should be watered with a pot that has a fine rose, and then placed in the greenhouse close to the glass, and if put so that they will receive a little bottom heat so much the better. They should not be allowed to get dry, but still never over-water them, as that would be much more fatal. When strong enough the plants should be potted off, and so grown on till it is time to stand them out to harden off before being put out into the beds, in which they are to bloom. When Verbenas are about to be raised in this way the seed should always be purchased of some good seedsmen, to ensure the varieties being good. Petunias can also be raised in a similar manner.—A HASSARD, in *The Garden*.

**EUPHORBIA JACQUINÆFLORA** almost stands alone

for the incomparable beauty of its cerise-scarlet flowers, arranged in such elegant wreaths, at this season of the year. At an evening party not long since, where the beauty of flowers, among other pleasant agencies, ministered to the delight of the company, this beautiful stove Euphorbia was singled out for especial praise. Such a warm glow of color as the flowers present appears to be especially acceptable when snow and ice and frost of unusual severity hold Nature in a state of repose. The flowers, though small, are individually very exquisite in form and color, and being produced with much profusion on the elongated branches the plant throws up at this time of the year, and the leaves being also of elegant form and of a transparent green, it has come to be much used by ladies as wreaths for the hair. The flowers are set on at the base of the leaves in short spikes of three or four to a dozen buds, and as all regularly face in an upward direction, they form a wreath of great natural beauty. It is a grand plant for stove decoration at mid-winter, and it can be met with as specimens 6 to 7 feet in height, with from twelve to twenty leading branches, each starting from the base, and at the blooming season crowded with flowers. For winter decoration the Euphorbia, when appropriately managed, is scarcely second to any other plant known to gardeners.—*Gardener's Chronicle*.

## NEW PLANTS.

**SILVER-LEAVED PLANTS.**—A. L. S., writes, "Will you give me, please, a list of such silver-leaved



plants as will grow in the open ground of this climate (Maryland), and make borders for beds, such as I have seen about Boston? I should need

enough to make, if in one straight line, say 100 feet."

[*Artemisia stellaris*; *Centaurea rebusina*, often called *C. candida*; *C. gymnocarpa*, and *Cineraria maritima*, are generally used. The last is often known familiarly as the "Dusty Miller," and is so easy to increase and manage, that it is very popular. We give an illustration of it herewith when allowed to flower. For large beds, where there is no necessity to have the leaves sheared, as is sometimes desirable in this class of bedding, the *Glaucium corniculatum* is used.—Ed. G. M.]

**SAXIFRAGA HUETII.**—Most of the Saxifrages in cultivation are perennials,—the best known, perhaps, being the *S. sarmentosa*, one of the most useful of plants in hanging-basket culture. The present species is an annual, and is represented as being a remarkably good thing for early spring



flowering in pots. It does not appear to be known much in England yet, but has been introduced on the continent by the old and well-known firm of Vilmorin, Andrieux & Co., of Paris, who are prominent in the enterprise of introducing good and substantial things.

### QUERIES.

**DISEASE IN PALMS.**—E. H., New Bedford, Mass., writes:—"I enclose to you two samples of Palm-leaves affected with a disease which seems to be spreading over the entire plant; my gardener is at a loss to know how to deal with it. One of the Palms is *Latania Borbonica*, a large thrifty plant, growing well, but this threatens to destroy

it. Your opinion would be esteemed a great favor. I have for years been a subscriber to your *Monthly*."

[This disease is caused by a small fungus which feeds on the interior tissues of the leaves. It is not known how it enters the structure, but probably through the roots. Wood ashes, water with a little salt, just enough salt in the water to be perceptible to the taste, or even warm water itself (say 130°) will often destroy fungoid matter at the roots of plants,—and the Palms generally stand these doses better than other plants. If, however, the plant is not too large, it would be best to re-pot entirely in fresh earth, washing the roots clean in water with wood ashes. The diseased leaves should be cut off at once, as soon as the injury is perceived.—Ed. G. M.]

**TOBACCO AS MANURE.**—H. L. says:—"Should be glad to know through the *Gardener's Monthly* or otherwise, what the value of decayed tobacco is as a fertilizer."

[It is not probable there is any more value in tobacco, as manure, than in any other vegetable substance. As decayed vegetable matter it would have a value, no more.—Ed. G. M.]

**THE DOUBLE LOBELIA.**—S. This is simply a dwarf form of *L. erinus*, the common blue Lobelia, and has no "native country." It is a garden variety only. It was, we believe, raised in England, but introduced into this country first by Mr. Henry Chitty, of the Bellevue nursery. It is a very desirable thing.

**CULTIVATION OF ERICAS.**—An Ohio correspondent speaks in high terms of the value of Mr. Munroe's article on the Cape Heath, published in our last volume. These plants are among the most beautiful in the world. They are supposed to be more difficult to raise in our climate than they are in England,—and we believe they are, and hence there is the more credit due to the skill of those who, like Mr. Munroe, produce such good results.

**COLEUS CHAMELEON.**—Mr. T. Ottway, Middlebury, Ohio, says:—"I saw it stated in last *Monthly*, that it was necessary to pot *Coleus Chameleon* in poor soil, to make it hold its colors. It makes no difference with me, rich or poor. At first I had some little trouble in getting good sporting stock. This year I have a beautiful lot, the most brilliant colors, and old plants breaking back very fine."

## FRUIT AND VEGETABLE GARDENING.

### SEASONABLE HINTS.

In getting ready for spring vegetables do not fear to pile on the manure. It is the rank rich growth which gives the agreeable tenderness to them, and without an abundance of manure this cannot be done. Deep soil is also a great element of success. Though we do not favor sub-soiling and underdraining for fruit trees, we regard it as very profitable in vegetable growing.

Asparagus beds may have the soil raked off them a little, if it was thrown up from the alley-way in the fall. It allows the sun to get to the roots earlier, and the crop is forwarded thereby. If the beds are poor, they may have a dressing of guano, or superphosphate, which has been found very beneficial to this crop. It has become almost a stereotyped recommendation to have "salt applied," but there is a good deal of the humbug about it. In dry, sandy soils it does a little good, and a little in whatever manure is applied is acceptable to them, but more has been made of the salt theory with Asparagus than it deserves. Asparagus beds may be got ready as soon as the ground is sufficiently dry to admit of working. A deep soil is all-important; two feet, at least, and a situation should be chosen that is warm, and yet not too dry. The roots should be set about four inches under the surface, twenty inches or two feet from each other, and the rows eighteen or twenty inches apart. Large, fine Asparagus cannot be obtained by crowding the plants; strong two and three year old plants are the best; although in good, rich soil, one year old plants will often bear a good crop the year after planting. The length of time Asparagus requires to come into bearing depends much on the soil. It is useless to attempt raising it in poor ground.

This is generally supposed to be the pruning season. Orchard trees generally get too much pruning. In young trees only thin out so as not to have the main leaders crossing or interfering with one another. Or when a few shoots grow much stronger than the rest, cut these away. Insist on all the branches in young trees growing only on a perfect equality. On older trees which

have been in bearing a number of years, it will often benefit to cut away a large portion of the bearing limbs. By a long series of bearings, branches will often get bark bound and stunted, preventing the free passage of the sap to the leaves. In such cases the sap seems to revenge itself by forcing out vigorous young shoots a long way down from the top of the tree. It is down to these vigorous young shoots that we would cut the bearing branches away. One must use his own judgment as to the advisability of this. If the tree bears as fine and luscious fruit as ever of course no such severe work need be done, but if not, then now is the time.

In young orchards some species of scale insects are likely to be troublesome. These should be killed by washing at this season. If the trees be very badly infested, cut back the young shoots, and the stouter branches can then be more thoroughly done. Some people use weak lye for washing, with good results; we do not object to some lime and sulphur going in with it. Old trees are very much assisted by having the rough bark scraped off of the trunk and main branches, and then coated with a similar wash. Never mind what people say about stopping up the "breathing pores." Try it once, and you will always want to repeat the practice.

And above all look after the nutrition of the trees. Some people say that land which will raise good corn will grow good fruit trees, which is all right; but they should add that like corn they require regular and continuous manuring. There are some parts of the country where corn can be successively taken for a half a life time without manure; on these soils we need not manure fruit trees, but in all others we must, to have good results. This is particularly essential where trees are grown in grass, as both the trees and the grass require food. Where trees are grown in grass, we prefer top dressing in June or July, but if it has not been done then, do it now. Where trees are kept under a clean surface culture, the manure is of course ploughed or harrowed in with the crop in the spring of the year. To know whether trees require manure or not ask the leaves. If in July they are of a dark



rich green, nothing need be done to them, but if they have a yellow cast, hunger is what is the matter. This of course is supposing they are not infested by borers, in which case they will be yellowish in the richest soil.

## COMMUNICATIONS.

### FREE AND CLING-STONE PEACHES.

BY H. M. ENGLE, MARIETTA, PA.

In the September number of the *Monthly* you compared several of the new early Peaches with mine (the Downing), which was quite favorable to the latter, but closed by calling it a cling-stone. Please define what you consider a cling-stone. In my experience in peach growing, we have three classes, viz: free, cling, and half or semi-cling. In the latter we class Hale's, Early York, Early Rareripe, Walter's Early, and others, all of which part from the pitt, but not freely. My Early Seedlings are of this class. My experience is, that in some seasons they adhere to the pit more than in others, but are never true cling-stones.

A few years ago I shipped to a friend a few crates of true Old Mixon free. He wrote back that he wanted no cling-stones. That season our free-stones were about as much clings as the Hales and its class generally are. On the other hand, we have had seasons when the latter were received without objection to their being clings.

Am I wrong in classifying as above? Or is the experience of peach growers different from mine? Please explain.

[Mr. Engle is right. Peaches are divided into two classes, free and cling. There is another, which is generally free, and yet often clings considerably to the stone. We have never thought so much about this, as since Mr. Downing's note in regard to the Alexander. There should be three recognized classes.—Ed. G. M.]

### BLACK WALNUT.

BY THE REV. J. H. CREIGHTON, COLUMBUS, O.

Almost every man and boy thinks he knows all about gathering and cracking and eating Walnuts—but may be not. Our native Black Walnut (*Juglans nigra*) is hardly ever treated right, and is when rightly preserved one of the best of all nuts. It is commonly left too long in the hull after it is ripe. Sometimes it is allowed to

lay for a long time on the ground in its thick moist hull till the kernel goes through a kind of change that makes it not only unpalatable, but unhealthy. Hence, a great many persons have an idea that this nut is strong, and hard to digest. But it should be gathered immediately after it is ripe, and not allowed to remain in the hull. It should not even be allowed to remain on the tree till it falls itself, but as soon as the kernel is ripe take it off and *dry it quick* and it is a very different nut from what is commonly found. The kernel is white and delicious, no strong flat taste, and has a delicate flavor that is hardly surpassed by any nut. And then when thus treated there are little cracks in the hard shell that make it easy to crack out the kernel. These little cracks are formed by the sudden drying.

There are great differences in different trees as to the size and quality of fruit. There is a tree near Duncan's Falls, Muskingum County, Ohio, that bears fruit of uncommon size and quality. We have thought it worthy of propagation.

### GRAPE GROWING AT GALVESTON, TEXAS.

BY J. FALCONER.

Many kinds of American Grape vines are grown in the gardens in and around Galveston, and although some sorts of them do well, the more experienced gardeners (I apply this term to those people interested in and doing their own gardening) are of opinion that it is a waste of room, time and means to grow the American grapes, when the finest European kinds can be as easily grown, besides being so very much more remunerative. At Mr. Stringfellow's gardens, some two miles southwest of the city, I saw the European grapes in as healthy and fruitful a state as I ever did under glass. His gardens are near the sea beach, and like all the south coast of Galveston, subject to most devastating south winds that do more harm than north ones. To guard against these winds he has his gardens fenced in with a wooden fence, just inside of which, is a high "sea-cedar" and oleander hedge; oleander hedges some eight feet high and fifty feet apart run east and west through the grounds to act as wind-breaks too. In these sheltered plots Mr. S. has the Black Hamburg, Canon Hall Muscat, Bowood Muscat, Muscat of Alexandria, several kinds of Chasselas, and other sorts that he has fully attested, and is satisfied that they are decidedly better adapted for Galveston than the Amer-

ican grapevines. They ripen and color well, produce large bunches of fine flavored fruit, and the berries adhere well to the clusters and are not so liable to rot as the natives. He grows his vines on three barred wooden trellises three feet high, for should they be higher the vines would be blighted and prostrated by the winds sweeping over the oleanders. As in hot-houses, so are these grapes out of doors, they require thinning, and this the grower considers an objection, but it is a small one, for when we see plainly the great good thinning out grape berries in the clusters does to the appearance, quality, and value of the crop, we can hardly grudge the trouble and time spent in it. The vines are subject to mildew but Mr. S. tells me that he keeps them effectually clean by using powdered sulphur three times a year, viz., before they come into bloom, after stoning and before coloring. Ten dollars worth serves him a year, for how many vines I cannot say, but he estimates his crop this year at 5,000 pounds. He applies the sulphur through a fine wire sieve.

Mr. Stringfellow considers the Delaware the best of the Americans for Southern Texas, and particularly for Galveston, where it ripens early and well, colors beautifully, and bears heavily. He is very hard on the Scuppernon, and asserts that it will grow like a weed, but with any amount of coaxing he cannot get it to bear and ripen. I may mention that Mr. S. is giving the Golden Champion a fair trial. This is its first bearing year, and now (April 29th) it has several very solid bunches of flowers, and is withal in a most promising and healthy condition.

Lawyer Tucker, a gentleman who grows grapes for pleasure and profit, has the finest collection of kinds that I know of in Galveston or in Texas. He has now in admirable vigor and fruitfulness forty-two distinct sorts of European grapevines, all three years old, besides several one year old plants and cuttings from California and elsewhere. He, too, is of opinion that the European kinds are by far the best for Galveston, and places great stress upon the different kinds of Chasselas as being the best. He tells me that he sells his fruit for \$1 a pound in Galveston and that they retail in the same city for \$1.25. His mode of culture is almost a fac simile of Mr. Stringfellow's, but his garden is further from the sea-coast and better sheltered with big trees than Mr. S's, and the soil is older and deeper. Mr. Tucker places much weight, and I think justly too, in surface dressings, and for this purpose he keeps under cover heaps of fresh earth, decomposed organic

manure, wood-ashes and charcoal, and leaf soil, so as to be able to mix it and apply it as he considers necessary, and his whole garden bears ample testimony of this efficacious practice.

Mr. Chappell, a farmer some five miles west-the-island showed me an immense Scuppernon vine that he has trained on a trellis over his water cistern at the north side of the house, and from which he says he cut 310 pounds of grapes, besides what the folks about the house had eaten off it. He prunes off a good deal of old wood annually, shortens the ends of the remaining shoots, and as the vines begin to grow he leaves only every third or fourth bud along the shoots, rubbing off the rest. Mr. C. showed me several other fine Scuppernon vines, all of which promised well for a heavy crop, but seeing the clusters in flower and in ripe fruit are two different things. Just observe the difference of opinion existing as regards this grape between Mr. Stringfellow and Mr. Chappell.

Mr. Shrader, a German farmer some distance north-west of Mr. Chappell's place, and a thirty years' "residenter" on the island has the most tastefully kept garden I saw amongst the farmers in that district. He is a most polite and entertaining old gentleman, and in his fruit trees and flowers he takes great pride and interest. He has Concord grapevines, but he does not like them; they bear regularly and heavily and have large clusters and berries, but should there come a rain at ripening time they are sure to rot. He has the Isabella too, and it does well with him and he never found it to rot. This gentleman has many other very fine grapevines, but having lost their names and not keeping a written record of them he does not know what they are.

### COMET PEACH.

BY D. O. MUNSON, FALLS CHURCH, VA.

I send you by to-day's mail a plate taken from the same kind of peaches sent you, only the ones sent to Dewey were larger than the ones sent you. I also sent some to Chas. Downing, who says it is a new peach. Rivers, of England, has sent out a yellow peach called the Comet, and it will therefore be necessary to give this one a new name, and I have decided to call it the Billier's Comet. It originated with a Mr. Billier, in Kent County, Md., and has been known in that county for several years as "Billier's Comet." The buds I received from R. G. Hanford I learn are from the yellow peach sent out by Rivers of

England, which he named the Comet, which is described as ripening about the same time as this. On account of the wet, cold weather during the past summer, the peach was not so highly flavored as in previous years; still it sold for a big price in Washington, D. C. market. It is from two to three weeks later than the Salway. This peach originated in Kent Co., Md.

[We have before given our opinion of this excellent Peach, under the provisional name of Comet.—Ed. G. M.]

### ELDRED CLING PEACH.

BY W. FALCONER, BRENHAM, TEXAS.

A year ago last June, Mr. D. R. Eldred, a farmer and enthusiastic fruit grower of this (Washington) county, Texas, brought a basketful of these peaches to Mr. Watson for his opinion regarding them. It was in the first week in June, just as Hale's Early began ripening, and as a cling at that season is a rarity, it may be considered one of the best additions to our peach list in Texas, where clings are so much more in demand than free-stones, and it is a decided cling. The fruits are as large as Crawford's Early, somewhat oval in shape; pale yellow skin, with a beautiful red cheek; flesh, whitish, very juicy and rich. Mr. Watson says it is the earliest cling of his knowledge, and decidedly a first rate fruit, and in compliment to its raiser. Mr. W. has named it Eldred Cling. This year the fruits sold at a higher price than any in others Brenham.

### EDITORIAL NOTES.

**STRAWBERRY FERTILIZER.**—A Lancaster correspondent of the *Farmer* says: "An experiment made last year by myself may not come amiss at this time with those who grow Strawberries. I procured half a hogshead, filled it with rain water, and put into it  $\frac{1}{2}$  lb. of ammonia, and  $\frac{1}{2}$  lb. of common nitre. When the Strawberry plants were blossoming out, I gave them a sprinkling of the solution at evening twice a week until the fruit was nearly of size. The result was double the amount of fruit on those where the liquid was applied, to what was obtained from those alongside, to which none of the liquid was applied."

**PROFITABLE BEE-KEEPING.**—One of the most profitable speculations in Bee-keeping that we ever knew, was by a young lady in Illinois, until

recently, Miss Ella Dunlap. But two Californian girls seem to have gone ahead of her. A correspondent of the *Rural Press* says "that they kept on teaching till they got money enough to buy two hundred stands of bees. They then bid good-bye to school and took possession of their bee-farm. Their accommodations were not palatial, but they answered the purpose, and I will wager anything I have in the world that no weary traveler passing the Smith-Linden rancheria would say that the inmates were 'keeping bach.'"

Last week the senior partner came up by steamer with the first 2,500 pounds of white sage honey. She has another 1,000 pounds coming. She found the honey market depressed on account of the financial collapse, and put it in store-until things looked brighter.

I have no business to be telling this story, but I think it ought to be told for the encouragement of girls tired to death of sewing and teaching. And I think it ought to be told to prove that one student of the University has taken to agricultural pursuits. And I think that every pound of honey should be sold to the good housekeepers of San Francisco at prices which will pay the producers fairly for their creditable undertaking.

Miss Smith is taking advantage of her leisure to collect information about honey secreting plants. She sowed all the mignonette seed she could get last year, and now intends putting in a crop of two acres."

**DREER'S LIMA BEAN.**—Mr. Geo. Paist, of Reesville, Chester Co., Pa., reports that he finds this variety a remarkably prolific bearer, and in his opinion it is much superior in every respect to the common Lima bean.

**REMEDY FOR THE CELERY FLY.**—One of the worst enemies to the celery is a small fly, which deposits its eggs in the leaves, and the young eat their way under the skin, and in this way materially affect the growth of the plant. The *English Gardener's Chronicle* says:—"I can fully concur with what has been stated by Mr. Tillery as regards soot being beneficial to the growth of Celery, and also a preventive to the celery fly (*Tephritis onopordinis*), having experimented with the same with satisfactory results, though instead of selecting a fine day for the operation I selected a showery one. I intended to have written to you before on this subject, as I consider it an easy remedy and of great importance where fine heads of celery are in requisition."

**DWARF APPLES.**—On my *Pommier de Paradis* stock, Apples may be planted eighteen inches apart each way, and when they begin to touch each other may have each alternate tree removed, leaving the plantation at three feet apart each way. At this distance they will do to stand many years. I had nearly 1,000 sorts in the season of 1868 in fruit, many of them bearing six to twelve Apples, the trees being twelve inches by eighteen inches apart, and most of them only one foot to one and a half in height. The great thing with this stock is that all the large Apples, which are generally strong growers and slow bearers, bear abundantly in two or three years, and produce fine handsome fruit, generally better flavored than when from the Crab or Doucin stock. The management of these trees is very easy and simple—that is, if any of them should have an inclination to grow too luxuriant, merely lift them out of the ground, *tread down the place firmly*, and then place the tree on the part so hardened, covering its roots with a few inches of the surrounding soil, thus raising the tree on a little mound, which will prevent the roots striking too deep into the cold crude soil; and as a consequence, the wood will be well ripened and a fruitful tree be formed. Little pruning is necessary; a few over-luxuriant shoots pinched back slightly once in summer, and a neat and thin regulation of its branches in autumn and winter, is all that is required. Avoid too much summer pinching and pruning, otherwise your trees will become ugly little stunted scrubs, with their skins so tight that the life is strangled in its ascent, and deformed abortions will be all you will have. Be generous to your trees; do not overpinch, overprune or overload them, and they will repay you with interest.—*Scott's Orchardist.*

### NEW FRUITS & VEGETABLES.

**THE NORTHAMPTON APPLE.** The Horticultural Editor of the Lebanon Valley (Pa.) *Standard*, an accomplished and intelligent horticulturist by the way, giving a list of Winter Apples suited to that section says: "Baldwin, Newtown Pippin, Lady, Fallawater or Pound, Bellflower, Rambo, Vandevere, White Pippin, Seek no further, Romanite, to which list may be added an Apple peculiar to Lebanon, bearing with us the name of "Northampton" from the locality whence it was introduced many years ago by Abraham Light, deceased, and which is not described in

any of the books. We sent a specimen of the books. We sent a specimen of the fruit to Charles Downing last May, and received the reply, in answer to our request for a name, that he had never seen the variety before, and requested us to send him a specimen for trial this fall. It is not procurable from any nursery and yet its many excellent qualities of flavor, size, appearance and bearing, coupled with the long period in which it can be used, from October to May, entitle it to a prominent place in the smallest collection or orchard."

**LUCY GRIEVE PEAR.** We have from Messrs. E. G. Henderson, of London, a beautifully executed colored lithograph of this new English Pear, which is attracting much attention among English Pear growers. The description which they send us, and which we give below, is from the pen of Dr. Hogg, the Downing of England:—

"Fruit large, above the average, upwards of three inches long, and two and a half wide, oval in outline, combining the features of Glou Morceau and Swan's Egg. Its complexion lemon-yellow, with a red blush towards the sun, and the whole surfaced with cinnamon-colored russet dots. Flesh white, very tender and melting, very juicy, and richly flavored. It is a delicious Pear, having the texture of flesh found in Marie Louise, and ripens in October."

"The seed of this Pear was sown in a flower-pot by the daughter and only child of Mr. Peter Grieve, gardener at Culford Hall, near Bury St Edmund's, who carefully tended the plants till they were large enough to be planted out; but ere the first of them bore fruit, in 1873, the little maid was in her grave. The first-class qualities of this fruit will perpetuate her name, and as a living record become at once a professional souvenir and 'forget-me-not.'"

### QUERIES.

**PETITION.**—J. H. C. says:—"The form of petition in the *Gardener's Monthly*, page 347, is well timed and should be copied extensively, and signed by thousands and in good time sent to Congress. If this be done we surely will have the desired change. Let all our horticulturists attend to it in good time.

"Our request is so evidently right, that we will be almost certain to succeed."

[This did not reach us in time for our last. We trust the petitions will go in, if not already gone,

We believe at this moment of writing, as we have already said, that in this fight the Express companies will prove stronger than the people. We suppose the newspapers will be strong enough to have the law altered, as it affects printed matter; but seeds, plants and such things will remain. We shall be glad to find that we are mistaken, and trust no effort will be lacking to prove that we are wrong.—Ed. G. M.]

PHYLLXERA ON THE ROOTS OF GRAPE.—G. A. F., Waltham, Mass., says:—"I send in this package a few Iona Grape roots and wish you would be kind enough to inform me if the knots on the roots are caused by the Phylloxera. Please answer through the columns of your valuable magazine."

[Yes, it is the Phylloxera, and a very bad case. Generally, as we have seen, only the fibres are attacked. In these, many of the main roots are suffering also. Such Grapes should not be planted until every swollen part be cut away.—Ed. G. M.]

WILD CELERY.—M. L. says:—"In Baltimore recently, and dining with a friend, I was struck with the excellency of some duck, and was told that it was through the bird having been fed on Celery. Is it generally known that Celery has this effect on the flesh of the duck."

[We examined this matter some years ago, and gave the results in the *Gardener's Monthly* at that time. It is not *Celery*, but a wild pond weed with long grass-like leaves, known to botanists as *Valisneria spiralis*, and which the sportsmen call wild Celery. It does not impart any of its own particular properties to the duck, but is favorable to the bird's nutrition—just as corn would be, in making flesh in an ox superior to hay or fodder.—Ed. G.M.]

GRAPES FOR A COLD GRAPERY.—B., Lebanon, Pa., asks: "What are the best grapes for a cold grapery?"

[The best of all kinds for a cold grapery is the Black Hamburg. Perhaps for an amateur who takes pleasure in their growth, some variety would be preferable. In this case a vine or so of some of the forms of Chasselas for earlier, and the West; St. Peters for later, might be desirable. These are very old, but standard kinds. If one is particularly fond of the subject, of course some of the newer kinds, as Golden Hamburg, Muscat Hamburg, Trentham Black, &c., may be introduced; but still looking to the Black Hamburg as the leading stand-by.—Ed. G. M.]

THE HIGHLAND HARDY RASPBERRY.—A correspondent from Ulster Co., N. Y., sends us the following. We may say that we know nothing of the variety personally:

"This variety, though surpassed, perhaps, in some respects by others more widely known, has nevertheless valuable qualities that commend it to the attention of fruit growers throughout the land. A short description of its qualities, habits of growth, and manner of cultivation will probably be of interest to amateurs and others who may be giving their attention to the cultivation or testing of new varieties of fruits.

"Originating in this county several years ago, it has rapidly gained such a popularity that large plantations have been made of them, superseding other well-known varieties. The plant is of vigorous growth, from 4 to 6 feet in height, which affords an abundance of wood for the support of the fruit. The canes are perfectly hardy, and have withstood a temperature of 16° and 20° below zero during the past winters without injury. I give them no protection whatever, nor do they require it, as the canes bear fruit in abundance to their very tops. This valuable trait of being entirely hardy is the chief cause why they have supplanted so largely the Antwerps and other kinds previously grown, that required winter protection. To such an extent are they superseding the well known Hudson River Antwerp, that the time is probably not far distant when they will supplant them almost entirely in the River Counties which supply so largely the markets of New York city.

They seem adapted to nearly all kinds of soil, such as corn and other hoed crops are usually grown upon, with the exception of clay flats, or low, poorly drained fields. For the purpose of experimenting, I have planted them on a diversity of soils, and find that they can be grown with profit even upon a heavy clay soil, if well drained, either naturally or artificially, though they do best on a gravelly soil, or light loam.

"The berry is a bright red, unusually firm, which makes it of great value for shipping to distant markets; flavor very good, comparing favorably with other kinds; size of fruit, medium to large, surpassed in this respect by other sorts, such as Herstine, Brandywine, or the Antwerps. The plants ripen their fruit considerably earlier than most of the red varieties, coming into market or upon the table a little before the Kentucky, Jucunda or Col. Cheney strawberries disappear.

"The Highland Hardy may be classed under the head of "very productive," giving with ordinary culture from 40 to 60 bushels to the acre, the crop selling in New York at from \$400 to \$600 per acre. Under very favorable circumstances the fruit from small plots has sold at the rate of from \$1500 to \$2000 per acre. These latter figures are rare exceptions, but still they show what success has been reached.

"As to their cultivation, the ground should first be well ploughed, giving a good coat of barnyard manure. After harrowing, the ground can be marked out with a plow or otherwise, placing the plants 4 feet apart each way, or by making the rows 6 feet apart, and the plants  $2\frac{1}{2}$  or 3 feet distant in the rows. The first method permits of better culture, though the yield does not differ materially either way. The ground should be kept well cultivated, except when the fruit is ripening. Manure the land well late in the fall or in the spring of each year; not too liberally, if the soil is naturally very rich.

"Plantations may be made in the fall or spring, and usually the young shoots may be set out with good success as late as the second week in June. The second season from planting will generally give a paying crop, though full returns should not be expected until another year. This raspberry has been widely disseminated throughout the land, and those who have received them, as well as others, will be interested, no doubt, in knowing with what success they are grown on this their native soil."

THE NEW EARLY PEACHES.—T. T. A., Comorn P. O., King George Co., Va., asks: "Please inform me how the early Beatrice, Louise, and Rivers peaches have succeeded this year, and would you advise the planting of them with us? [From all we can gather, they are desirable varieties, and think you would be safe in planting them in your part of the country.—Ed. G. M.]

APPLES FOR SOUTH-EASTERN NEW JERSEY.—A correspondent from S. E. New Jersey asks: "Can you give in the *Gardener's Monthly* a list of late keeping apples of good quality and production? I have the Winesap, but would like several other varieties, suited to our soil and climate, which will keep till March or later."

[We have "official records" at hand that would enable us to answer this question in a manner that ought to be satisfactory. We under-

took to answer a question like this in regard to Northern Ohio, from similar "authorities," and our readers may remember the trouble we got into. Of course, not residing in these sections, we have no other sources of information to fall back on as regards these local affairs. We have an idea what kinds we should plant in that part of the world, but would prefer that some one on the spot should answer. In case no one responds, we will then give a list that we should recommend.—Ed. G. M.]

RED-FLESHED APPLE.—A Henry Co., Ills., correspondent says: "I have received from Michigan an apple which I think is worthy of notice. The skin is yellow, with a slight blush, medium size, juicy, good flavor. The remarkable feature about it is the color of the flesh, which is similar to that of a red-cored watermelon; it is bright rose-colored, and I am told makes a cider very much like wine.

Have you ever before heard of this apple or anything like it. I will try and have a specimen of it sent you. The man who owns the farm where it grew says that the tree was on the place when he bought it; and I understand that he does not know whether this is the original tree or not. My impression is that it is a seedling, and that it has not been disseminated."

[Red-fleshed apples are not uncommon. The old-fashioned Quarrenden is often as red all through as the heart of a watermelon, and so is the Black Detroit and others. The specimen did not come to hand.—Ed. G. M.]

WINTER GRAFTING OF THE PLUM.—A New Jersey correspondent writes: "I have a few hundred plum stocks which I wish to graft, and could I not saddle graft them successfully during any pleasant weather this winter? Should I tie and cement?"

[Grafting of anything can be done all through winter, if the scion and grafted part be protected from frost. You must tie and wax, if whip or saddle grafted. We are partial, however, to cleft grafting, as when well done waxing only is required.—Ed. G. M.]

PLUM GROWING.—O. M., Ottumwa, Iowa, writes: "I am interested in plum growing, but am at a loss to know how to proceed, or what plan to adopt, and appeal to you for advice. This subject has not been tried much in this country, and I am desirous of learning the best plans. As you are aware, the great obstacle is the

curculio, and this is what troubles me. I have been thinking of a plan on which I ask your opinion, viz., to plant an orchard, cultivate the ground, sow lettuce under the trees, then with a tight fence, and furnished with a pond of water, pasture ducks and geese thereon. This idea is original with me, and if you will be so kind as to favor me with your opinion, also any other ideas or hints which might be useful, I will submit the same to our State Horticultural Society, and thus, no doubt, be a source of valuable information to others also."

[This letter reads as if a reply was desired by letter; but, as we often get similar requests, we take occasion to say that we have no time to write private letters on public topics, but are always willing to speak of them through these columns. The members of the Iowa State Horticultural Society are readers of our magazine, and it will do the same good, and probably interest numbers of others, by being answered here.

That plum growing would be profitable, if successful, is true. We may say it is profitable where successful, for many succeed in keeping clear of the curculio, and that is almost the only serious obstacle. The insects are kept down by jarring the trees, when the insects fall into sheets and are destroyed. Ellwanger & Barry have a snag made by sawing off a branch a few inches from the main stem. They hammer on this, and thus the bark is saved from bruising. Dr. Hull had a sort of wheelbarrow, with a sheet spread on a frame,

and a pad so fixed as to save the bark when the barrow was run forcibly against the tree. Both these methods of jarring are followed by considerable fruit.

Keeping trees in chicken yards has been tried with some, but not great, success. It cannot be applied on a very large scale, and only to a score or so of trees. The curculio is hard to catch, even by one of the feathered tribe. Still sometimes it is very successful. One of our subscribers in Philadelphia tells us that a half dozen trees in a chicken yard are every year laden with plums. We suppose, in this case, the chickens destroy the curculio.

This is all we can say of our correspondent's proposition from experience. It *may* do, but it is a matter wholly to be worked out by an experiment. It is worth the trial, as good plums are as profitable as any fruit can be.—Ed. G. M.]

A SEEDLESS PERSIMMON.—B. says: "I send a small box of *seedless* persimmons. My reason for sending is, I never heard of another tree of the kind north of Texas, and the seedless feature is, in my opinion, a valuable one. The fruit this year is not as large as usual. The owner of the tree propagates from sprouts."

[Rather smaller than the average persimmon, but only three small seeds in a hundred fruit—a considerable variety. It can be grafted on seedlings, of the ordinary kinds, and in this way might be increased rapidly.—Ed. G. M.]

---

## EDITORIAL.

---

### THE GARDENER'S MONTHLY AND HORTICULTURIST.

A PIECE OF HISTORY.

As will be known to most of our readers before their eyes meet this, the *Horticulturist* has now become a part of the *Gardener's Monthly*. Personally we regret the fact. We have never felt any rivalry in regard to our old friend, or that we had anything whatever to gain by its absence from the field. On the contrary, we have ever

been ready, earnestly and sincerely, to lend it a helping hand; and not only to it, but to all enterprises of a similar kind. Mr. Williams resigns it, primarily, because of his connection with so many other works; but, of course, it would not have come into our hands had other people felt encouraged to continue it in an independent form; and the impression from these considerations by the outside world must be, that horticultural taste cannot be very wide spread on this

continent if there is room for only a single horticultural magazine, and that a monthly one. It is because we know that this view is deceptive that we offer these remarks now. We have been abundantly satisfied with our own success. Nothing was more surprising to every one than the immense circulation, for a purely horticultural paper, achieved by the *Gardener's Monthly* before the war. Though not equalling its original strength, the course has been steadily onward since the end of the great struggle. The intelligent and the refined, to whom horticulture was among the highest pleasures, were the chief sufferers by the war; and an entirely new class came to the surface, with whom the taste for horticulture was in a measure no more enjoyable than an unknown tongue. This has been, however, annually improving; and we have been quite satisfied with our share in the good work. We know the taste will continue to increase, and we firmly believe there was no reason why any of the horticultural magazines that have disappeared from the field should cease to be.

Let us review for an instant our own course. *Hovey's* magazine had the field in the writer's younger days. In some departments of gardening it did immense service, especially in fruit culture, and Pomology generally. The present high position of Pear growing in this country is mainly due to its labors. The *Horticulturist* followed. It chose a higher field. It was the embodiment of the best intellectual culture in this beautiful department of art. Its sphere was all its own. There was still room for another in a different line, and the *Florist* appeared. The young editor was abundantly fitted for the work. It was a brave and worthy effort; but what could be done by one without a dollar in the world? With its departure the field was still open. The highest taste and pomological gardening were fully ministered to; but there was nothing for the thousands with slender purses and small yards and grounds, and others who, in numberless ways, could be benefitted by little hints of a practical caste. This was our time. Unfortunately our good neighbor, "The *Horticulturist*," came down from the position it was so ably filling, working in a measure in our own line. We are satisfied it lost a great advantage by the change. The *Hearth and Home* folks saw the opportunity, and it was indeed a grand one. Why they failed was perfectly clear to those who understood the needs of horticulture in this country. It might have been to-day the exponent of the highest culture in our beautiful art—

a leader equal to some of the best in the old world—and a good paying investment instead of the heavy sinking fund it was to the projectors. As for the *American Gardener's Chronicle*, the *American Journal of Horticulture*, and the *American Garden*, the very fact of the adoption of these names betrayed a want of originality, and invited a comparison so unfortunate for themselves that no one acquainted with business, in its relation to horticultural literature, ever had the slightest hope of their success.

The *Gardener's Monthly* is left the sole survivor, but indeed it is not because there is no room for more. The work which so many have tried to do is really better done by the numerous excellent agricultural papers of which our country may well be proud. There is one agricultural phase of gardening which, while not ignoring aesthetics wholly, yet looks mainly to profit; and there is one which places the mental and the beautiful a long way before the monetary and the material, though still bordering on the mere agricultural, and this is the work which we have to do. It commences just where their's ends. No attempt to build up a paper which is simply in competition with the horticultural departments of our excellent agricultural serials can possibly succeed. They ought not. There is no need of them. But those who can comprehend what true horticulture is, and what it needs with us, need not fear to find abundant patronage.

Truly we had no desire to involve our elder brother. Earnestly do we desire to see more of our family keeping house for themselves, and it is because we sincerely wish to have them do so, and because we believe there is plenty of reason why they should, that we have candidly given our views on the situation.

In the meantime, we bespeak sympathy for the *Gardener's Monthly* and *Horticulturist* in its lonely condition. If we make any new friends by the change we shall try to treat them well, while we trust our old friends shall have no cause to feel jealous of any attention we may give to the newcomers in our household.

We cannot close these remarks without thanking our *Weekly Agricultural*, and other exchanges, for their kindly notices of our new situation, for many are coming to hand while we are writing this. Our relations with them have always been kind and cordial, and we do not know of one that we may not call our friend. We are, indeed, co-operative in the same task, and no one can appreciate their good will as well as we.



# NATURAL HISTORY AND SCIENCE.

## COMMUNICATIONS.

### ABIES MACROCARPA—A NEW CONIFEROUS TREE.

BY DR. GEO. VASEY, WASHINGTON, D. C.

In the fall of 1874, Mr. F. M. Ring, of San Geronimo Pass, California, sent to the Department of Agriculture some cones and twigs of a coniferous tree, of which he desired to know the name. The striking resemblance of the cones to those of *Abies Douglasii* was very apparent, but their great size and weight were remarkable. I requested from Mr. Ring more detailed information of the characteristic marks of his tree. In reply, under date of Nov. 25th, 1874, he wrote as follows: "The tree in question is called here a fir tree; it is the first pine tree met with in ascending from the plain to the mountains, growing in the canons of the foot hills, and in this locality is the most common of the evergreens. As you ascend in the mountains it becomes scarce, and is not found higher up than about five thousand feet. It attains a large size, from two to three feet in diameter, and from sixty to eighty feet high; the usual size, however, is about a foot and a half in diameter, and fifty feet high. Its appearance is peculiar, different from the other pines found with it. This is caused by its manner of growth, the limbs extending straight out from the trunk without bending up or down. It is a fine spreading tree, even when growing thickly together, and I think would make a highly ornamental one if planted singly or in groups in open ground."

The leaves had all dropped from the twigs sent by Mr. Ring, and as it appeared too late for more specimens that year, I deferred the matter until the coming year. In the meantime the cones were seen by Dr. Gray and Dr. Engelmann. Dr. E. was particularly interested in the matter, and desired more information and specimens. I accordingly applied again to Mr. Ring last summer, and under date of September 14th, 1875, he writes as follows:

"I have endeavored to find some cones of the fir tree, but have not succeeded so far. This year

there appear to be very few cones formed; last year the trees were loaded with them, but now I can find none but the old ones which still hang upon them. The cones that I sent you came off separate trees, and were of the average size; all the trees of this sort bear cones of about the same size; there are none intermediate in size as far as I can discover. If by the *Abies Douglasii* you mean the Douglas spruce of the northwest coast, I should say that the tree in question is not the same. It has not the same general appearance, and grows under quite different circumstances. It is not nearly so large as the Douglas spruce, and the branches are much longer in proportion to the height of the tree. The branches appear to me to be singularly long and spreading, in marked contrast with the other cone-bearing trees. The bark of the old trees is quite deeply furrowed; in the young ones not so much so, but it is never smooth."

In addition to the information sought for from Mr. Ring, I also instructed Dr. Ed. Palmer, who was making collections in Southern California, to search for the tree, and to get specimens and a section of the trunk. He was successful in finding the tree in San Felipe Canon, in the mountains northeast of San Diego. The section of wood has not yet come to hand, but the specimens of twigs and cones have. The twigs seem to be longer and slimmer than those of *Abies Douglasii*, and the leaves are rather more acutely pointed, but otherwise there is no apparent difference. But the cones hold out in entire accordance with those sent by Mr. Ring. They are old cones, Dr. Palmer stating that no new cones were to be found. They are five inches long by two and one-half inches in diameter, composed of about 60 scales, which in the centre of the cone are one and a half to one and three-fourths inches wide. The bracts can hardly be distinguished from those of *Abies Douglasii* except that they do not project so far beyond the scale. The difference in the cones of the two kinds is most strikingly shown by their comparative weight. Five average sized cones of the San Geronimo specimens weighed 202 grammes, equal

to six and one-third ounces; while five cones of the average size of the ordinary form of *Abies Douglasii*, weighed but thirty-eight and one-half grammes, or less than one-fifth as much. The seeds are triangular, brown outside, and white on the under side, with a wing twice as long as the seed, together being seven-eighths of an inch to one inch long. The seeds are much heavier than those of the ordinary *Abies Douglasii*.

In recent investigations of the collections of the Department, a cone was found marked *Abies Douglasii*, var. *macrocarpa*, collected at San Felipe, Cal., Nov. 16th, 1857, with the note, "cone five inches long, I. S. N. Ives' Colorado Exp." On referring to the report of Ives' expedition, we find *Abies Douglasii* var. *macrocarpa* referred to from the mountains near San Felipe. The cone corresponds exactly with those obtained by Dr. Palmer. Further examination of the range of this form, and of the permanence of the peculiar characteristics stated is desirable, but it would seem from what we now know of it, that it deserves to rank as a new species, in which event no more appropriate name could be found than *Abies macrocarpa*.

### DO PLANTS NEED WATER?

BY W. T. BELL, FRANKLIN, PA.

"Thomas Meehan, editor of the *Gardener's Monthly*, answers this question by saying that "if any one thinks plants need *water*, he can try by stopping up the hole in the bottom of a flower pot, in which a plant is growing. This will be one of the best ways of learning that the essence of all good culture is to get rid of the water in the soil as soon as possible. This is the great principle that underlies the practice of underdraining land. We want *moist air* in the soil, not water. 'Firm potting' favors a large amount of air spaces. If soil is moderately dry, the more we 'pound' it, the more we pulverize it, and pulverization means dividing into minute particles. The more particles the more spaces—the more spaces the more porous is the mass. Every pore contains air, and this air is moist air, and it is on this moisture that the plants draw. There is no difference in the manner by which a root draws moisture from the atmosphere under the ground, and that by which the root of an air plant draws moisture above the ground. If you take the earth in which a healthy plant is growing, and handle it, you will find no *water* in it; but you will perhaps find it *moist* enough to dampen a piece of paper. We do not know that any amount of pressure would squeeze *water* out of some soils in which plants grow healthy, though possibly moist air might be so compressed as to make *water*. Indeed, the matter seems so clear to us, that we supposed it would be ne-

cessary only to state it to insure conviction. And we wonder very much that writers still continue to use the word *water*, when they speak of the necessary conditions in the food of plants."

I clip the above item from the *Lancaster Farmer*, and must dissent from the views therein. Stopping up the hole in the bottom of the flower pot is scarcely a fair way to test the question. You might as well say that a man does not need water, and to prove it plunge him head and heels in a water tank and keep him there. Plants need water and men need water, but more than they need is hurtful to both. You say "we want *moist air* in the soil, not water." Why not say also that man wants *chyle*, not food? Man needs food to form chyle, and plants need water to make moist air in the soil about their roots. Nay, more, plants must have water supplied to them in such quantities that they can absorb it, and appropriate at least some portion of the quantity absorbed together with the other food which it holds in solution.

[Our correspondent is in some measure right. The comparison by stopping up the hole in the pot is hardly a fair one, and scarcely meets the case; still it seems as good a way as any of illustrating what we mean. The difference between water and mere vapor is not great certainly, and there can be little or no humid particles in the soil unless water is given. In this sense plants need water of course. That is, water must be given to the earth in order to create this humidity: but after giving the earth this water, the good cultivator must draw it away again as rapidly as possible.]

Our correspondent kindly adds: "Two features in the magazine strike me as particularly commendable. 1st. You offer no chromos or other useless premiums, and are not continually blowing your own horn, and 2d, you exclude advertisements (cloaked or otherwise) from your reading matter. My introduction to the *Monthly* was made in the Nov. No., but, from appearances, I think the acquaintance will be continued for some time to come."—Ed. G. M.]

### EDITORIAL NOTES.

DISEASE IN THE LARCH.—It is known that the plantations of Larch in Scotland suffer much from disease, and the planting has received a check in consequence. At a recent meeting of the Scottish Arboricultural Society, Mr. Gorrie, Rait Lodge, read a paper on "The Failure of the

Larch." This subject, whether considered economically or scientifically, was, he said, the most important which forced itself on the attention both of forest owners and foresters, for the failure of the Larch had involved vast pecuniary loss in many districts of Britain. The principal causes of the Larch failure he classed under the following heads:—(1) Heart-rot, dry-rot, or pumping; (2) surface-rot, cancer, cankering or blistering, and top-rot; (3) the Larch bug or blight. The first was caused by excessive droughts, occasional saturations, and fungoid attacks on the roots, and the prevention was to avoid planting Larch in places that were likely to favor these causes. Surface-rot, cancer, and blistering, and top-rot were due to the effects of late spring frosts occurring after the sap flow and growth were in full progress, and to autumn frosts setting in before the growth of the season was fully matured. The prevention here was a more judicious selection of soils in which to plant young Larch. They should avoid warm southerly exposures that excited a too early spring growth, and more especially all low, flat, moist districts that were subject to cold ground fogs or hoar frosts. The bug which attacked the Larch did not appear to be a native of this country, but had been imported with the tree. It was found most prevalent in low, hollow, sheltered situations where thinning had been neglected. No perfect preventive of the ravages of the bug had been discovered, and the society should offer prizes for the best "steep" that would destroy the insects or their eggs.

**IMMEDIATE EFFECTS OF CROSS FERTILIZATION ON FRUITS.**—Everyone knows that whenever Indian corn is fertilized by strange pollen there is an immediate result on the grain of corn, but it has been contended that this is not a fruit, as pomologists understand it. Some think there is an immediate effect on melons and squashes, but just how much of the change seen is due to a natural tendency to vary and how much to fertilization is not quite clear. The following is a contribution to this subject, from the pen of Prof. C. E. Bessey, as we believe:

"C. W. Garfield, foreman of the Michigan Agricultural College Gardens, reports as follows: We made ten crosses, employing ten specimens in each cross—one hundred in all. Perfected fruit was obtained in all but three instances. In only three did we observe any variation in the specimens, save that which would come as an ef-

fect of the gauze employed to prevent the ravages of the codling moth. These cases were: 1st. Wagener upon Tallman Sweet. There was a modification of flavor quite noticeable, the fruit being sub-acid. 2nd. Tallman Sweet upon Astrachan. In this instance there was a manifest change in color, flavor and shape. The apples were quite mild to the taste; the color was very much modified, and the form was that of a flat apple. 3d. Tallman Sweet upon Wagener. The modification here was noticeable in all the specimens, in flavor and color. Two of these had no gauze on them, and the difference was quite as noticeable in these samples as in the remainder.

**FUNGUS CRACKING THE PEAR.**—At the meeting of the American Pomological Society at Chicago, the editor of this magazine was called on somewhat unexpectedly to deliver an address on fungi and fruit diseases. Without notes or memoranda, he stated that the peculiar black fungus, which develops on the leaves of Prince's St. Germain and some other pears, finally leading to that peculiar form of cracking, might be from some one of the polymorphic forms of *Roestelia cancellata*, the fungus which causes the leaf blight in young seedling pears. It appears, however, to be another kind, with the rather hard name of *Helminthosporium pyrorum*. As Mr. Meehan's remarks may be reported by the secretary for the proceedings, this correction may be made in the volume by those who are interested.

**TOUGHENED GLASS.**—We have already noticed this invention. When it becomes cheap it will be one of the best insurances we can have against hail storms for our glass-houses. The *Boston Journal of Chemistry*, referring to it, says:

"Essentially, the process consists in heating glass nearly up to the softening point, and then plunging it into a bath of oil or grease. But to bring it to perfection has needed the patient experience of seven long years. M. Bastie, who is a gentleman of fortune, is said to have made his discovery first some seven years ago. This was after many years of investigation. But though he seemed to have succeeded for the moment, it took two years more of continual experiments before he could repeat his success. The invention has been patented in all European countries, and soon will be throughout the civilized world."

**RAPIDITY OF GROWTH IN TIMBER TREES.**—At one time it was supposed that it took almost a long life time for a tree to grow to any considerable size. Of late years people come to under-

stand differently. At a recent meeting of the Scottish Arboricultural Society, Mr. McCorquodale said he had measured recently two specimens of *Abies Douglasii*, which were 41 years of age. One contained 99½ cubic feet of timber, and the other 132 cubic feet. That was a rapidity of growth in coniferous trees that was seldom seen. *Douglasii* was suited by a dry soil remarkably well.

### QUERIES.

DEPTH OF ROOTS.—J. B. says: "You remark that the roots of trees which run deep are not for food, but for moisture. Is it a recognized truth in vegetable physiology that some roots can only take up moisture, while others can take other kinds of food?"

[We have never said that some roots can take up moisture *only*, but it is tolerably certain that young active *fibres* supply the plant with nutritive matter, while *roots*, that is (speaking of trees), fibres that are more than a year old, do so only with difficulty. Trees that lose their fibres by rotting, or by fungi, have but yellow foliage, and weak growth. They can take something from the soil through these main roots, but not what the fibres can. As to the fact, Mr. Darwin says that *Drosera* roots can take in only water; and then we know practically that the roots of the trees which go deep down into the subsoil do not take up more than moisture, because there is nothing else often in the poor subsoil to take. Plant food is chiefly at the surface.—Ed.]

APONOGETON DISTACHYON.—"Please let me know, through the *Gardener's Monthly*, the botanical family and native place of the water plant called by the gardeners "*Aponegeton distachyon*."

A [native of Cape of Good Hope, and, let us say, one of the most interesting flowers to have, and one of the easiest to cultivate. Last year we had a flower given to us by Mr. W. T. Foust, of Philadelphia, from a plant that was raised simply in a tub of water—it being an aquatic. It is of the natural order *Juncaginaceae*. The white flowers are curiously formed, but the indescribably sweet odor is its chief charm. It would, we think, be hardy in any water where the ice did not reach the bottom.—Ed. G. M.]

THE POTATO DISEASE.—M. says: "*Dear Sir* :—Since my return from Europe, where I spent the

summer, I have been looking over some of the back numbers of the *Gardener's Chronicle*, and find that the potato rot continues to excite speculation. You have doubtless often seen a lot of English gooseberries, with a mild spring make some nice young wood of several inches long, when one night's frost would come, which would not only check up the growth of the young shoots, but in a few days you would find both the shoots and the young berries covered with a leathery fungus which enclosed them as a coat of mail, and which you, sir, knowing well what was the cause for that fungus being there, would count it idle to inquire further whether it was a spore or a fungus. During my several crossings of the Atlantic I have always spent a few weeks in fatherland (north of Ireland), where, in answer to my many inquiries as to the potato rot and its cause, I was always invariably told that the rot was preceded by a heavy fog, that approached the land from the east, and that as soon as the fog passed away, the potato leaf would be limp, and get discolored, and should the sun come out strong, would throw off a very disagreeable odor. I was in Ireland during the potato rot fog last August (1875). For some days afterwards you could have smelled the potato fields at a considerable distance. The fog passed over the north of Ireland about the 15th of August, and in a conversation with a friend who plants 12 to 15 acres potatoes annually, he told me that he had passed through his potato fields at early morn, before the fog had passed away, and that every leaf *was frozen stiff*."

"Since my return home I passed one evening a beautiful flat of Dahlias belonging to my sons. Two days afterwards, upon passing the same flat of Dahlias, it reminded me of an Irish potato field stricken with the potato rot, and there was no perceptible difference in the smell. Frost did it. M."

[Nothing is more clearly proved than the fungoid origin of the potato disease. An examination of the evidence given in back volumes of the *Gardener's Monthly* and other magazines shows this. The potato disease will often rot a whole cellar full of tubers, when certainly no frost entered there. The point made by our correspondent that last year the disease appeared with most virulence in Ireland after a heavy fog, is a good one, for it has been shown by the observations of Worthington Smith that the form of fungus so destructive last year requires considerable moisture for its development.—Ed. G. M.]

FEMALE WEeping WILLOW.—M., Newcastle, Del. says: "I have heard that the willow in this country has but one sex. Is this correct, and how is it?"

[This probably refers to the common weeping willow, which, up to quite recently, was represented only by the female form. The original willow probably came from China, and as it is increased by cuttings, the plants are all, both in this country and in Europe, of the sex of that original tree, which chanced to be female. Of late years, however, the male form, under the name of *Salix japonica*, has been introduced. We have now the two sexes, but the male is not so pendulous or so graceful as the old one. The female will therefore continue to be *the* weeping willow.—Ed. G. M.]

EMBLEMATIC DESCRIPTION OF THE PASSION FLOWER.—Mrs. R. T. W. asks: "Can you inform me where I may find the Emblematic description of the 'Passion Flower,' and greatly oblige."

[An apology is due to this lady for overlooking the question last month, for which it came to hand quite in time.

The Spaniards when they first entered Mexico, associated everything possible with their religious faith. This flower came in for its share of this attention. It was taken to illustrate the passion of Christ. The three nail-like pistile were emblematical of the three nails by which he was attached to the cross, and the five stamens the five wounds, four on the hands and feet, and one in the side. The singular narrow processes which characterize the passion flower, and form the course below the stamens, is the crown of thorns which covered the Saviour's head. The ten petals and sepals are the ten apostles, two being absent, one, Peter, being afraid and having run away to hide himself; the other, Judas, having in a spirit of remorse, gone and committed suicide. The fancy is much more perfect than that which identifies the Holy Ghost in the form of a dove with the *Peristeria elata*, and is, perhaps one of the best that the Spanish Americans have given us.—Ed. G. M.]

THE CHARTER OAK.—We have the following letter from Dr. G. W. Russell, of Hartford: "I sent you last year some of the leaves of the Charter Oak, which you thought to be those of the *Quercus discolor* or Swamp White Oak. As controversy has arisen lately as to the true name of the Charter Oak, some contending that it was *Q. alba*, others *Q. discolor*, I write again:

"Genuine leaves of the Charter Oak taken from

it after it was blown over, are very variable; those on the upper branches are like those usually delineated and described as the *Q. alba*. Those which I sent you were probably from the lower branches.

Upon examining several trees of the *Q. alba*, I find that universally the leaves upon the upper branches are deeply lobed and of the usual form, whilst those upon the lower, and near the trunk, are quite different, being broader and not deeply lobed.

"Those which I sent you were genuine, and probably from the lower branches, and were of this description.

"I am inclined to think that we made a mistake in calling the Charter Oak tree *Q. discolor*, and that it should be the *Q. alba*, as has always before been supposed.

"I send you specimens of leaves of an oak which I think to be *Q. discolor*, very unlike those of the Charter Oak in either form; the tree is *ragged* in its appearance, bark loose, in large plates, and upon the whole presenting much the appearance of a man 'out at the elbows.'"

[The oak on the grounds of Mrs. Colt, shown to the writer as a seedling from the Charter Oak, is certainly *Q. discolor*. The leaves sent us from the original tree, were very small, and on a cursory examination we took them to be *Q. discolor* also. Since receiving this letter of Dr. Russell we have re-examined the little leaves critically, and with numerous specimens of *Quercus alba* and *Q. discolor* before us, and find that there are always constant characters distinguishing the two kinds quite independent of the outline of the leaf, (which indeed is very variable) and which enables one to fix the species even though only a portion of the leaf should be under examination. We have now no hesitation whatever in deciding that the original Charter Oak was of *Quercus alba*, the common white oak.]

ROCKY MOUNTAIN SILVER SPRUCE.—H., Quincy, Ill., asks: "Will you be kind enough to give us the botanical name of the 'Rocky Mountain Silver Spruce?' We are often asked to give it, and cannot do so. We enclose a paragraph clipped from a description by a well-known writer."

"*The Rocky Mountain Silver or Blue Spruce.*—This we consider the most beautiful evergreen of America. A well-known writer speaks of it as follows:

. . . 'But the Silver Spruce is the one gem of the trees, a sort of first cousin of the evergreen

we call the Balsam Fir in New England yards, but more richly endowed with beauty of shape and color. . . . It looks as if a delicate silver powder had been strewn over its deep green needles, or rather as if a light white frost had fallen all upon and enshrouded it; and you cannot help wondering why the breezes do not shake the powder off, or the sun dissipate the frost, so ever present is the one illusion or the other. A soft white, blue-green combination."

[The description suits *Abies Menziesii*, and *A. Engelmannii*. As the latter is not common in those parts of the Rocky Mountains frequented by "well-known writers," the doctrine of chances will make the tree *Abies Menziesii*. It is to be hoped that the time will come when a fair knowledge of botany, so as to be able at least to write intelligently, will be regarded as part of the education of "well-known writers." As it is, they know so little of what they describe, as to

make it a waste of time to puzzle out their meaning. *Abies Menziesii*, if this is the "most beautiful evergreen of America" referred to, has been under cultivation in most leading American nurseries for a quarter of a century, and is generally a mean and miserable looking thing. Now and then we have seen a fair specimen, and if some care was taken in finding out what particular soil and situation just suited it, it might do its wild character, as once in a while seen, some credit. It seems also in our Eastern nurseries to be an especial favorite of the red spider, and this is against its chances of securing admiration. The writer of this paragraph grew one once to the height of 20 feet, which kept itself very beautiful. It grew on bottom land, which seemed to suit it very well, but one extra wet spring was too much for it in that situation, and it died. It seems to want some rather difficult and exact conditions to do well.—Ed. G. M.]

## LITERATURE, TRAVELS & PERSONAL NOTES.

### COMMUNICATIONS.

#### POISONING BY RHUS.

BY H. C. BEARDSLEE, PAINESVILLE, OHIO.

I notice, in *Gardener's Monthly* for December, a communication in regard to the poison of *Rhus*. I have suffered many times from the poison of *Rhus toxicodendron* (L.) and *Rhus venenata*, (D. C.) In New England there were many popular remedies for this poison. Among these were a strong infusion of white ash bark *Fraxinus Americana* (L.), of sweet fern *Comptonia*, and of the common everlasting *Gnaphalium polyccephalum*. (Mich.)

The most speedily effective remedy I know, is a solution of the bichloride of mercury—corrosive sublimate—used as a wash. The only effective vegetable remedy I have ever seen used, is a cold infusion of the roots of *Nabalus albus* (Hook.) var. *serpentaria*, *N. altissimus* (Hook.) and *N. fraseri*, (D. C.,) all of which have similar properties.

The tuberous roots should be bruised and infused in cold water—and this infusion should be used as a drink—compresses wet with it should be applied to the affected part and kept wet. It is really a safe and effective remedy.

Corrosive sublimate is a very active, and perhaps, if used strong, not always a safe application.

#### GARDENERS AT GALVESTON.

BY W. F.

Gardeners, with the view of getting employment at their trade, should not come to Galveston or, indeed, to Texas, unless pre-engaged, as no one employs professional men of their class—a negro or common laborer does all the work necessary. I would not advise those who would wish to start in business for themselves, however, to stay away, but merely remind them that everything is at the highest figure on this island. Land near the city is worth from \$300 to \$1000 an acre, and two miles out of the city, along the island, from \$50 to \$200. Unless it is old cultivated land it is poor and hungry, requiring much manure, labor, and wind-screens. There is no mode of transit on the island but by wagons, unless the goods are being shipped out of the island, when the railroad affords the desired facilities. Galveston itself is a good market for vegetables. There is a good road

(for a Texas road) along the middle of the island, and it is not impassable with mud in winter as many of the inland roads are.

### EDITORIAL NOTES.

**LAW OF PURCHASING PLANTS.**—A trial has taken place in England in which an employer refused to pay Mr. B. G. Williams for plants purchased by the gardener. Some of these plants were expensive, one of them being \$150. It was shown that it had been the custom on the estate for the gardener to purchase plants, as it had been that of the cook to purchase the meat, and the bill was ordered by the ruling of the judge, and the verdict of the jury, to be paid,—with some sharp comments on the practice of Mr. Williams in giving five per cent. of the amount of the bills to the gardener for ordering the plants of him. The objection to the bill was that these particular plants were not ordered, but the decision is that if the gardener had been permitted to order before, the employer was bound by subsequent orders, unless notification had been given to the contrary.

**THE BAOBOB TREE.**—*Adansonia digitata*.—Before the discovery of the mammoth Sequoias of California, the baobob tree of India used to be the greatest wonder among large trees. We have read of it taking thirteen men spreading arms and touching fingers to span one tree. An English government paper on Forests, thus speaks of some:—In Upper India, especially, the growth of this tree is extremely slow. Two trees planted at Etawah, in 1824, are at this date only 50 and 55 feet high, with a girth of only 9 and 10 feet respectively at 6 feet from the ground; and the largest of a number of trees planted in the same station, between the years 1859 and 1864, by Mr. A. O. Hume, the magistrate and collector of the district, has now only attained a height of 24 feet, with a girth of 2 feet 2 inches at 6 feet from the ground. At Lucknow, also, the largest of some trees, locally reported to have been planted in the reign of Asaf-ud-dowla, or between ninety and a hundred years ago, is not more than 13 feet in girth at 5 feet from the ground.

**DR. C. C. PARRY.**—This well-known botanical explorer, has been spending the summer in Central Utah, and will winter in Southern California. Few men have added so much to the knowledge of American plants as he has. He has now been

many years engaged in various parts, with no great profit to himself, but has placed us all under great obligations for what he has done.

**PERSONAL.**—*The Country Gentleman*, one of whose editors recently made a visit to Mr. Meehan's nursery, at Germantown, has a kind reference to the fact that in the seventeen years of Mr. Meehan's editorship of the *Gardener's Monthly*, no one would gather from anything in its reading columns that he had anything to sell. This arises from the fact that Mr. Meehan has no ownership in the *Gardener's Monthly*. He is simply engaged by the owner and publisher to edit it in the interest of Horticulture, and it would be manifestly improper to use his position for his own personal ends. *The Country Gentleman* has our best thanks for its generous notice of the fact.

**BILLIEU'S COMET PEACH.**—Since D. O. Munson's article was printed in first form of present No. (see page 14) we have the following from him by way of correction:

"I still find there is a mistake in the name of the Comet peach. The correct name is Billieu's Comet. When first heard from the parties, the name was not written plainly, and I had to partly guess at it."

**AGAVE VIRGINICA.**—We are in receipt of the following striking circular from Tennessee:

"NEW FLOWER—*Agave virginica*.

This plant was discovered a few years ago in one of the beautiful valleys of East Tennessee, and is well worthy of cultivation for its curious structure and delicious fragrance.

Foliage large—some plants during this season having reached two feet in diameter. Some of the leaves are fluted and of a deep green color; others of a pea-green shade; others variegated, spotted with blood red drops. The stalk grows from three to six feet in height, having on each from thirty-five to fifty flowers. It remains in bloom from six to eight weeks. Its fragrance is very sweet, peculiar, and unlike any other flower known to the discoverer. The arrangement of the flowers upon the stem reminds one more of a group of Chinese characters than anything else. It has improved wonderfully under cultivation.

The soil for its cultivation should be a rich loam. When the bulb is potted *in the fall*, and kept in a hot-house or conservatory, its beautiful foliage contrasts strongly against other plants, and blooms early in the spring. When potted *in the spring*, it flowers early in July, continuing into September. It can also be propagated from the seed, flowering the second year.

I can furnish a limited number of these bulbs at 50 cts. each, or \$4.00 per dozen. Seeds, 25 cts.

per package, postage prepaid. Those ordering by express must pay charges.

Being the original discoverer and cultivator of this plant, it can only be purchased from me."

It illustrates well how one may tell the truth and not convey a good idea. There is nothing that one can object to, in fact, in what is said, and yet those who bought would be disappointed. The flowers are sweet and curious but not showy. It bears culture very well—some we have had for several years in our garden thriving under all vicissitudes. So far as the writer of the circular is the first to make an effort to introduce it into general culture, he is the "discoverer," nothing more. It is however worth growing.

**BINDING THE ADVERTISEMENTS.**—A correspondent of the publisher's, from Saratoga Springs, New York, sends his year's numbers to be bound, directing the advertisements to be inserted; "for," says he, "in years to come it will remind us of old friends and stand-by's in the trade that are gone." It is a good thought, and we wonder more do not think of it. The editor has his personal copy bound in that way.

**THANKS.**—The publisher hands the editor a batch of letters from many who are renewing their subscriptions, telling him of their satisfaction with the magazine, and their intention to send on a few more subscribers. These kind words are encouraging, and go a good way towards making hard editorial labors light. It is indeed only by the kind efforts of friends that a magazine like this can increase its circulation. Lovers of horticulture are scattered, and no ordinary advertising can find them. Once in a while are some valuable suggestions. One thinks that if there were more about fruit and less about flowers, it would be an improvement, and another thinks he would have some of the fruit department cut down and given to the flowers. Another tells us he does not know anything about "oospores" and "peronosporos" in potato, but likes to read all that we sometimes write about practical potato culture. Another thinks we give too much attention to the scientific part of horticulture, and would like to see more of the practical details, while still another thinks that the "mental pleasures connected with horticulture are its highest charms," and hopes we will give still more of it. All of them, however, speak kindly of the attention given to their several departments by the editor, who is fully determined to do all for every one that he possibly can. That author felt badly who, when he asked read-

ers to criticise, found that not one solitary sentence in his book escaped censure; but when he tried the other plan and asked for praise, and found all was honored, he took heart again. We do not ask for either praise or blame, but take either kindly when it comes. By the criticisms we often profit, and the words of praise encourage to renewed effort to deserve all we get.

**ALFRED COPE.**—Horticulture suffers a great loss in the decease of this gentleman, which occurred on the 4th of December. He was in his 70th year, fifty of which he had been more or less of an invalid. He was particularly fond of hardy trees and shrubs, and endeavored to grow all that would endure our climate. In this and in all other tastes that he inherited, he was ever anxious to share his enjoyments with others. Fond of gardening, himself, he was an advocate of public parks for the people, and Fairmount Park, Philadelphia, really owes its existence to him, he and his brother having purchased the Sedgely estate, and presented it to the city as the commencement of the enterprise. The Zoological Garden, one of the attractions of the Park, and a source of much intelligent amusement to the people, received \$25,000 from him not long since. He was ever a friend to the poor and the oppressed, but so averse was he to letting his right hand know what his left hand did, that the many thousands of dollars he has given away in his long lifetime will be known only to a few intimate friends. His great aim always seemed to be not so much to hold others up, as to help them to hold themselves. He loved, therefore, to aid the cause of education in its most solid and useful phases. For the operatives of Germantown he established a free library in which an immense collection of books have been gotten together, excluding frivolous kinds. Though a devout and earnest Christian, he was also a deep inquirer into the mysteries of science, fearing no antagonism between truths. He leaves three children—one of them, Prof. E. D. Cope, standing at the head of certain branches of science in this country.

**DEATH OF DR. HULL.**—This excellent gentleman died at his residence, near Alton, Illinois, during the last week of November last, of inflammation of the bowels, in his 59th year. Mrs. Hull, heart-broken by the blow, died four days after. This is a truly great loss to Western horticulture, as few there had so great a knowledge both of the theory and practice of horticulture. He was



indeed a continuous student, and to the day of his death was always in the van of progress. Mrs. Hull was also an excellent botanist and entomologist, and had a general love for all that was intelligent. A day spent at their beautiful home, along the Illinois river, some years ago, is so pleasantly seated in the writer's memory, that it forces itself into notice in this paragraph, lamenting their deaths.

R. BUIST'S CATALOGUE.—With a remarkably full list of plants, Mr. Buist makes the announcement that this will be the last he will issue. The next will be that covering the sale by auction, in June, 1876, when the whole of this famous establishment will be finally closed out.

BOTANICAL BULLETIN.—Mr. John M. Coulter, a well-known botanist, has commenced the publication of a small monthly serial under this name. It is only \$1 a year, and single numbers 10 cents. Address Dr. John M. Coulter, Hanover, Indiana.

THE AMERICAN NATURALIST.—The Peabody Institute, of Salem, Mass., has made over this publication to O. H. Houghton & Co., of Boston, by whom it will be published as heretofore. Price, \$4 per annum.

THE AMERICAN AGRICULTURIST.—This well-known agricultural monthly is now entering its thirty-fifth year, and with all the evidences of its old time prosperity. Prof. Thurber, the chief editor, is so well known for his many intelligent accomplishments, that this alone is sufficient to account for the prosperity of the *Agriculturist*.

THE SCIENTIFIC MONTHLY.—This is a new magazine, devoted to the natural sciences, and published and edited by E. N. Fitch, of Toledo, Ohio. Price, \$3 a year. It is a healthy sign that there is room for intelligent magazines of this class. We wish it every success.

THE ANNUAL REGISTER.—We have just received an advance copy of the *Annual Register of Rural Affairs* for 1876, published at Albany, N. Y., by Luther Tucker & Son, and mailed to any address for the nominal sum of 30 cents. It is the oldest (and now the only) publication of the kind, and contains 150 pages of practical matter, interesting to every resident in the country, illustrated with no less than 164 beautiful engravings, almost all original. Elaborate almanac pages are prefixed, and a very useful feature is the *Farmer's Register*, which gives the addresses of all the reliable dealers in everything a farmer needs to buy—live stock of all kinds, seeds, implements,

nursery stock, &c. The cover is quite a work of art, and altogether the little book is a gem in its way. J. J. Thomas is the editor. We know of no better almanac for the cultivator of the soil to have ready to hand.

GARDENING FOR PLEASURE. By Peter Henderson. Published by Orange Judd & Co., New York.

When man first looks to nature, it is for support—what he shall eat and what he must wear are among his first thoughts. This is all in order. It is the condition of animal nature. But the mental soon calls him to an upward field. The mere animal knows no difference between the flowers of the field and the blades of grass. All alike are food to him. Man alone sees the beauty and admires it: and the extent of his culture in this line is the full measure of the distinction between him and the beast.

Mr. Henderson has worked in a truly natural way. He knows man must first have the material, and he gave us "Gardening for Profit." Having learned folks how to make the money, he now proceeds to show them how to spend it in a rational way, and "Gardening for Pleasure" comes regularly in its place. It is a good idea, and the work is welcome.

Mr. H. tells us all about preparing ground for gardens—drainage, making walks and roads, of manures and fertilizers for making things grow. Then there are designs for gardens, and full instructions for planting, propagating and potting. Window gardening has a share of attention, with notes on baskets, plant cases, greenhouses, conservatories. Graperies, fruits and vegetables, and all adjuncts to a good garden, have a fair share of attention.

The work is just such an one as should follow "Gardening for Profit." It is not a treatise on the higher branches of gardening. There is little in it in common with such good things as *Scott's Suburban Home Grounds*, or *Downing and Sargent's Landscape Gardening*; but it places a link in between the high and the low, and it is a link much wanted, and will, we think, be highly appreciated by the gardening public.

### QUERIES.

GLADIOLUS.—*The Pronunciation*.—A correspondent writes:—"Vick accents the first syllable; Webster, the second; and those not favored with the perusal of either, the third. Among those who

wish to be governed by authority, the question arises: 'Under which king?' We were inclined to follow Webster, but examination reveals the fact that he has not followed his own analogy. For he has *glad'-iator* and *glad'-iole* both from the same root as *gladiolus*. So that apart from the consideration of whether Vick is not *the higher authority* in such things, he certainly has followed what seems to be correct analogy. We surrender to Rochester, while awaiting the decision of the Editor.

GLADI'-OLUS."

[The analogy is not with its root but with the class to which it belongs. Diminutives have their penults short, in this respect differing from adjectives which have their penultima long. The classical pronunciation therefore is *gladi'-olus*, that is, "a little sword."—Ed. G. M.]

HIDDEN ADVERTISEMENTS.—A. P. P., Peoria, Ills.

writes: "Send me some samples. Gardening here is carried on extensively for market purposes. We have been so often fooled in agricultural papers that we have sworn to only take such as are known to us as reliable and truthful in advice to us, and not praising up every new fangled tool or variety, and misleading us into all kinds of misfortune and loss."

[We thank our correspondent for his good opinion. We regard it as about the meanest feature of journalism that under the guise of "reading matter," sneaks in a paid for advertisement. We can hardly think it is common with respectable journals. At least we have been asked to do it only once in seventeen years. True, we have often been requested to give "notices" as a condition of advertising, and have once in a while lost a good advertiser by refusing.—Ed.]

## HORTICULTURAL SOCIETIES.

### EDITORIAL NOTES.

THE CENTENNIAL EXHIBITION.—Horticulturists will be anxious to learn what is going on in this department of our coming Centennial. We suppose there will be special exhibitions of various classes of fruits and flowers during the several months that the exposition will continue, but, with the exception of fruits in September, in a measure backed by the American Pomological Society, and which goes into the agricultural department, nothing definite is decided on, at this moment of writing. All effort so far has naturally been centered in the completion of the permanent arrangements. The great conservatory designed by Mr. Swartzman is finished, and is the largest ever built in the United States. It is a very imposing structure, and well calculated to attract the popular eye during an exhibition of this kind. In case there should be any large collections of hot or greenhouse plants on exhibition, as illustrations of superior skill in plant growing, it is remarkably well adapted to the purpose. We have not, however, heard that any of these are offered—this particular department of gardening not having made as yet much headway in our country. The building is to be permanent—as long as a large structure with so much of

wood will remain permanent—and will be an excellent place for the winter storage of large palms, oranges, aloes, tree ferns, and other articles suited to the summer decoration of the Park grounds. The two curvilinear wings are well adapted to plant growth, and will be a permanent attraction for rare plants. Already many valuable plants are stored in them, the contributions chiefly of Mr. W. R. Smith, of the United States Botanical Garden, and of the Hon. Frederick Watts, of the Department of Agriculture, through Mr. W. Saunders, the Chief Superintendent of that division.

The huge building is heated by eight large hot water boilers, and four miles of iron pipes.

Exhibitors in the out-door departments promise to be numerous. Trees, flowers, fruits, annuals, bedding plants, bulbs, &c., are to be planted out in beds arranged on a plan around the conservatory, each exhibitor selecting a bed from the plan for his own particular articles. These beds are all now completed, and are ready for planting by the exhibitors as soon as the spring opens. The whole labor of arranging these things has fallen on Mr. C. H. Miller, the Chief of the Horticultural Bureau; and horticulturists may congratulate themselves that the commission was able to command the services of

one whose practical knowledge was equal to the task of harmonizing such details with the more popular features which must of course actuate the leading commissioners of such an exhibition.

ACADEMY OF NATURAL SCIENCES OF PHILADELPHIA.—The natural sciences are in so many ways the handmaids of horticulture, that we are all particularly interested in their prosperity. The Philadelphia institution has the finest collections, taken as a whole, of any in America; and its printed proceedings take a high rank all over the world. The old building, though very large, was completely inadequate to the collections, and its large botanical department had to be kept in what was contemptuously styled by those familiar with more favored buildings, a "dust bin."

Some ten years ago a move was made to put up the building we illustrate, and the hope entertained by some that it might be effected before the Amer-

ican "one hundred years" should arrive. It may be that the good President, Dr. Ruschenberger, who, with a few devoted friends, have worked towards the accomplishment of what has been done, with an energy and determination against obstacles that very few know of, many not live to see the final building finished; and yet it is not at all impossible that when the great public see how much has been done with a few talents, may be tempted to aid the workers soon with a good deal more.

From the Proceedings we take as follows:—*The Apple Hair worm.*—It will be remembered by our readers that last year we called attention to a long slender hair worm found in an apple at York, Pa., and which was supposed by some to be the common Hair worm, *Gordius Aquaticus*, but which was found by Dr. Leidy to be an old acquaintance of his of quite a different character. In the *Proceedings* of the Society just issued, we find the following additional note:—

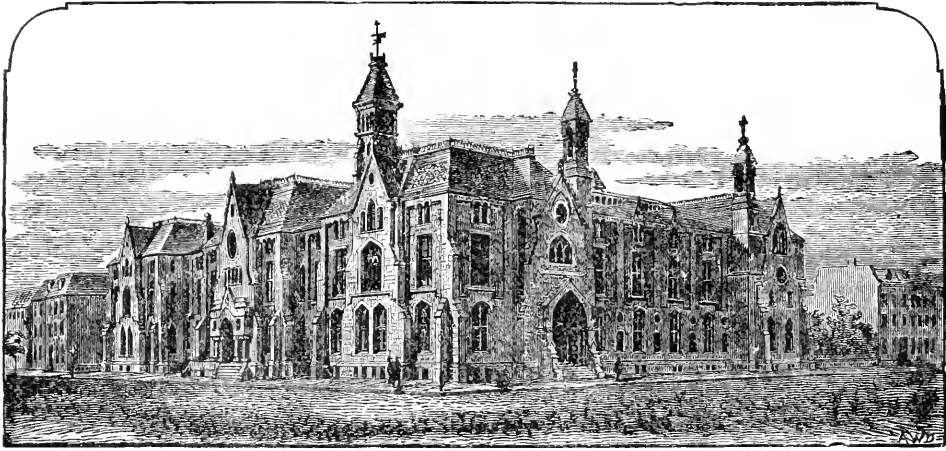

ican "one hundred years" should arrive. Money was subscribed from friends continuously from that time to this, and only as much work done as could be paid for. About a quarter of a million of dollars has been raised in this way, and one wing of this building—this much larger than the whole of the old building—has at length been completed, and the collections removed there, though not yet arranged. Considering that this has all been done without any remarkable legacies and bequests, that have so often aided similar institutions, and in this way a whole city get the credit of what is really due to the generosity of one or two individuals, it speaks very well for the general interest felt in science in Philadelphia. The main hall and south wing will yet

Prof. Leidy exhibited a living specimen of *Mermis acuminata*, which had been sent to him for examination, the 8th of last August, by Mr. P. H. Foster, of Babylon, Long Island, N. Y. It was one of two specimens which Mr. Foster had taken from apple worms found concealed in a woolen rag tied around the trunk of an apple tree in his garden. The *Mermis* is  $7\frac{1}{2}$  inches long and had been retained alive in a box with moist sphagnum. It exhibits a condition which Prof. L. had observed on several previous occasions in other species of *Mermis*. An intermediate portion of the body, apparently from injury, had died and was decomposed, while the extremities, held together by the integument, were still alive and active. This condition has been observed to

be maintained for some time, that is to say, for some weeks."

We also extract the following from the same publication:—

"*Variations in the Stipular Spines of Robinia Pseud-acacia*.—Mr. Thomas Meehan referred to the thorns of the yellow locust, which, as usually seen, were about a quarter of an inch long, and nearly as wide at the base; triangular in shape. At the meeting of the American Association at Detroit he collected specimens, one of which he exhibited, with slender spines, about three-quarters of an inch long. Since then, in the vicinity of Chicago, he had noticed that there was considerable variation in the direction of long and slender spines. In his own vicinity he had since noted a large number of trees, and some variation, but only to-day had he found one with long, slender spines, and that was even longer than the case from Detroit, being in some cases a full inch in length. The fact of this great variation was probably new; but it was also interesting from its bearing on a physiological question of importance. The first suggestion made by most of his botanical friends, to whom he had mentioned these facts, and he believed the first that would occur to the minds of most botanists, would be that these extra strong spines would be found in connection with extra strong shoots. If these were true spines—that is to say, abortive branches—the inference would be a fair one; but these thorns were the analogues of stipules, as we look for in allied leguminous plants, and would, therefore, be most likely to follow the laws which influenced stipular productions. One of those laws was, at least so far as his own observation went, that stipular development was in inverse ratio to ordinary growth force. For instance, we say that the scales which cover the buds of trees in winter are metamorphosed leaves; but this is, in many cases, certainly not strictly true. Bud scales are, in many cases, but modified stipules where leaves have these appendages, and dilated petioles where they have not. This peculiar development of the stipules, of course, only commences with the decline of growth force in the axis in the fall, or before it has achieved great power in the spring.

"The specimens of *Robinia* exhibited illustrated the same law. In the one from Detroit—the three-quarter inch slender stipular spines—it would be seen by the members, were not from a very vigorous branch, but from a very slender one; but the best illustration was on the strong branch

which he exhibited, cut to-day, and with the inch spines before referred to. This was from the upper portion of a branch of this year's growth, 6 feet long. On the lower portion of the part exhibited, produced when the growth force would be at its maximum, the spines are of the normal size, about one-quarter of an inch in length; and these spines increase in length gradually to an inch, in proportion as the season's growth becomes weaker. But there is a still stronger illustration in the secondary branchlets which have grown from the main one. These are no thicker than straws, but the spines are about three-quarters of an inch in length, and slender, and much larger in comparison with the axis to which they are attached, than the largest on the strong main branch."

NEW YORK HORTICULTURAL SOCIETY.—After numerous failures, some of the leading horticulturists of New York have organized a Horticultural Society. We are glad to see it. Baltimore, which had also often failed, has now succeeded at last—and so may New York. There is about New York the material for a first-class society, and from the character of the gentlemen now moving, we think there will be no failure this time.

WINTER MEETINGS OF THE STATE HORTICULTURAL SOCIETIES.—Notices often come to hand of forthcoming meetings, but too late to insert in our columns. We would gladly aid these bodies by publishing their dates and programmes, if they would give us a chance to do so.

THE AMERICAN POMOLOGICAL SOCIETY.—We hope our readers will not forget that the American Pomological Society will hold an ad-interim meeting in Philadelphia next September. Exhibitions will be held continuously, of course, all the year, but an especial attempt will be made to have an extra exhibition at the time of the visit of the society. There will be no discussonal meeting. It will be strictly Centennial business.

PENNSYLVANIA FRUIT GROWERS' SOCIETY.—The Seventeenth Annual Meeting of "The Pennsylvania Fruit Growers' Society" will be held in Lenape Hall, Doylestown, Pa., commencing on Wednesday, Jan. 19th, 1876, at two o'clock p. m. Essays will be read and addresses delivered by prominent horticulturists and fruit growers, and a full and interesting meeting is expected.

EDWIN SATTERTHWAIT, President,  
W. P. BRINTON, Cor. Sec.,  
E. B. ENGLE, Rec. Sec.

THE  
GARDENER'S MONTHLY  
AND  
HORTICULTURIST.

DEVOTED TO HORTICULTURE, ARBORICULTURE AND RURAL AFFAIRS.

Edited by THOMAS MEEHAN.

VOLUME XVIII.

FEBRUARY, 1876.

NUMBER 206.

FLOWER GARDEN AND PLEASURE GROUND.

SEASONABLE HINTS.

The problem of perfect roads is yet unsolved. As every place, large or small, has to have pathways of some kind, it is a topic that interests every reader of our magazine. As we cannot have perfection, we must approach it as near as we can; and we may approach much nearer than we do, if we will give our thoughts to the principles that underlie success.

There is but one enemy to a good road, and this is water. Some would say frost, but frost does no injury whatever where water does not exist. If we can get any kind of material so tight and compact that it will not absorb water, it is entirely frost-proof. This is the real secret of the value of asphalt, which is simply bituminous limestone. The rock is first broken in small pieces, then crushed fine, and rolled under heat. The crushing makes innumerable small spaces, into which the melted bitumen penetrates. Every air space is thus effectually closed, and of course it is entirely water-proof. No frost can therefore affect it in the slightest degree. The danger is from high temperatures. The dark color favors a rapid absorption of heat, and the heated mass expands, and as it cools makes numerous small fissures that permit water to follow. This freezes, and the disruption of the whole commences, imperceptibly at first, but in time to a serious extent. Lime alone will make a tolerably good path, if slacked before using, and put down in the form of plaster; trusting to

continuous rolling to press out the air cells. Its particles are too soft to stand against heavy, sudden blows, such as from horses' feet, but for steady travel it is excellent, and very cheap. For cellar floors nothing better can be desired. It takes a couple of weeks or more to harden, but is then perfect rock. We were astonished recently to see the cellar floors of a very large public building in Philadelphia being asphalted, as if they were for a tremendous traffic, when the great expense might have been avoided by a lime floor. The lime floor we have described, it must be particularly noted, is not a mortar floor, but a plaster floor made of well-slacked lime and rolled.

There is not, however, much gained by these patent attempts to get over the road-making difficulties of the time. None of them are equal to a first-class Macadam road, made of the best flint rock. Rarely is a road, said to be "Macadamized," really so. To make one we must first provide for thorough drainage. Any coarse, heavy stone that will lay solid will do for a foundation. As we near the surface it must be smaller, but that on the top should be no larger than almonds, and the whole compactly rolled. The reason why they must be so small and no larger is this: If a stone moves ever so little under a heavy wheel, it is bound to be more or less broken; or if it does not move, if it bears the whole weight of a wheel without any support from its neighboring pieces of stone, it will be crushed to dust. But if the pieces are so small that each is compactly wedged in by the others, so that any displacement of the piece is utterly impossible, it

receives the heaviest weights with perfect indifference. A well made road of this character will bear public travel for a hundred years, provided a facing of the half-inch material is added occasionally, as the little wear that takes place needs. So far as public roads are concerned, loads of this stone might be hauled to the yards of penitentiaries, and broken by heavy machines worked by convicts; and with a view to just such useful labor these buildings might very often be erected convenient to stone of this character. We trust that these hints on roads will be useful at this season of the year especially.

In many parts where our magazine goes it will be necessary to bring up the preliminaries for active spring work.

Many delay pruning shrubbery until after severe weather passes, so as to see what injury may be done,—but with March all should be finished,—taking care not to trim severely such shrubs as flower out of last year's wood, as for instance, the Wiegela—while such as flower from the spring growth, as the Althæa, Mock Orange, &c., are benefited by cutting back vigorously.

Those which flower from young wood, cut in severely to make new growth vigorous. Tea, China, Bourbon and Noisette roses are of this class. What are called annual flowering roses, as Prairie Queen and so on, require much of last year's wood to make a good show of flowers. Hence, with these, thin out weak wood, and leave all the stronger.

To make handsome, shapely specimens of shrubs, cut them now into the forms you want, and keep them so by pulling out all shoots that grow stronger than the others during the summer season.

Graft trees or shrubs where changed sorts are desirable. Any lady can graft. Cleft grafting is the easiest. Split the stock, cut the scion like a wedge, insert in the split, so that the bark of the stock and scion meets; tie a little bast bark around it, and cover with Trowbridge's grafting wax, and all is done: very simple when it is understood, and not hard to understand.

If flowers have been growing in the ground for many years, new soil does wonders. Rich manure makes plants grow, but they do not always flower well with vigorous growth. If new soil cannot be had, a wheelbarrow of manure to about every fifty square feet will be enough. If the garden earth looks grey or yellow, rotten leaves—quite rotten leaves—will improve it. If heavy, add sand. If very sandy, add salt—about

half a pint to fifty square feet. If very black or rich from previous year's manurings, use a little lime, about a pint, slacked, to fifty square feet.

If the garden be full of hardy perennial flowers, do not dig it, but use a fork, and that not deeply.

Dig garden ground only when the soil is warm and dry. Do not be in a hurry, or you may get behind. When a clot of earth will crush to powder as you tread on it, it is time to dig—not before.

If perennial plants have stood three years in one place, separate the stools, replanting one-third, and give the balance to your neighbor who has none.

Box edgings lay well now. Make the ground firm and level, plant deep, with tops not more than two inches above ground.

Roll the grass well before the softness of a thaw goes away. It makes all smooth and level.

In planting trees remember our repeated advice to use the pruning knife freely.

The rule for pruning at transplanting is to cut in proportion to apparent injury to roots. If not much the worse for removal, cut but little of the top away. Properly pruned, a good gardener will not have the worst case of a badly dug tree to die under his hands. In a nursery, where these matters are well understood, trees "never die."

## COMMUNICATIONS.

### TOUCHING THE HARDIHOOD OF CONIFERS.

BY F. R. ELLIOTT, CLEVELAND, OHIO.

Your comments, friend Meehan, in the December number of the *Gardener's Monthly*, are just to the point, in so far as my own experience, in practice and observation, proves. It has been my study at all times to use new and untested varieties touching hardihood, to place them where they could be protected from the winter's sun, and at the same time relieved measurably from the severe cold winds of winter. I have found among those Mr. Hoopes classes as tender, that the *Abies Smithiana* and *A. Douglasii* only needed the protection from winter's sun; so also *Cupressus Lawsoniana*. I have in mind a tree of this latter planted on the north side of a building, but in a bleak exposure, on the border of Lake Erie, which has for six years borne the winter without a blemish. Similar exposures

with the Chinese Arbor Vitæ have proved only a suffering of one or two inches of the ends of twigs or branches, an item easily corrected by shearing in the spring. The Oblong Weeping Juniper, *J. oblonga pendula*, I have had for years in full exposure, except of the sun in winter, and it has only had to have here and there a twig cut back.

The *Pinus excelsa*, while not generally successful, yet with a little protection from other evergreens, stands well. I have, as I write now, in mind a tree at Newburgh, N. Y. It is a beautiful tree, as all acknowledge who see it; ten to twenty feet high.

[It is a pleasure to have the endorsement of Mr. Elliott on this matter of shelter. The writer has had a chance recently of examining the forests of Mississippi, and is more than ever convinced that all we need for many things is protection from winds. In Mississippi, in some parts where the thermometer falls to *ten above zero*, the writer found the *Palmetto*, *Sabal Palmetto*, flourishing! But with the cane and other thick masses of vegetation as wind breaks, it laughed at the thermometer. Fancy a *Palmetto* stuck out on a bleak Illinois prairie! It would die before the freezing point was reached, to say nothing of 22 degrees below.—Ed.]

### CELASTRUS SCANDENS.

BY J. F. M. FARQUHAR, EAST PROVIDENCE, R. I.

This native climber, better known, perhaps, by its popular name, *Stufftree*, presents a grand appearance long after king frost has robbed our fields of their summer beauty. It blossoms early in June, and its greenish colored flowers are produced in clusters along the sides of the branches. The leaves are of a rich green color, oblong in shape, and slightly serrated. The berries are roundish or three-cornered in form. When frost appears, the outer covering of the berry opens, showing the shining scarlet pulp surrounding the seed. Here this climber has taken possession of some dead cedar trees, and at this late season their branches are wreathed in beauty by the long lines of scarlet woven round them. The nook is much admired by all who see it, and the berries retain their color, and do not fall for many weeks. This climber is worthy of cultivation, and might be used with good effect in many positions in gardens, cemeteries, &c. It is easily propagated from seeds, cuttings, or suckers.

### TREES IN CITIES.

BY J. C., CHELSEA, MASS.

As you are well aware, much has been said and written about shade trees, both for and against them.

I believe it is well understood that even the most handsome and rare trees would be out of place in a city or town where it is densely settled, but still there is occasionally a small square or triangle occurring where a tree or two would be a great relief to the eye in the midst of so much brick and mortar. And when nearing the suburbs of a city, what is more enlivening and attractive than to see the sides of the streets lined with handsome trees, say about fifty or sixty feet apart, or what can please the eye of the traveller better than the different shades of green in the family of maples, not saying anything of their rich autumn tints, and, where a variety of sorts is wanted, the elm of different kinds, tulip tree, &c., and many others that might be named. Many are averse to seeing trees anywhere but in an orchard or a forest. All such have never studied the beauties of nature. Still I would say with the old Scotch laird: "*Aye keep plantin' a tree, Jock, it will be growin' whan ye're sleepin'.*"

There is a good illustration given of the value of shade trees in cities, in the wide-spread conflagrations which have taken place frequently in Virginia City, Nevada; they have often been averted solely through the agency of shade trees, in preventing the burning embers from flying through the air, and thereby preventing distant buildings from taking fire. They also break the force of the wind, so that, by taking advantage of any open space as above stated, a community which acts on these suggestions not only ministers to the refinement of taste, but promotes a love for the beautiful, and the blessing of the traveller is sure to descend on him.

### EDITORIAL NOTES.

PREPARING TIMBER.—Mr. Saltonstall, of Massachusetts, has known birch to be used for railroad sleepers, and to last ten years when kyanized.

FOREST PLANTING IN MASSACHUSETTS.—HON. B. PERLY POORE some years ago made a forest of oaks in Massachusetts. We understand it is quite successful, but have no particulars.

**SPIRÆA SORBIFOLIA.**—This plant is not uncommon in American gardens, and is usually rather long legged, but otherwise striking. A correspondent of the *Gardener's Chronicle* treats *S. Lindleyana*, a species of similar habits, to an annual cutting down, as if it were an herbaceous plant—a practice that would no doubt improve our commoner one.

**HARDY BEGONIAS.**—The well-known old *Begonia Evansiana*, often known by the absurd name of Beefsteak geranium, is hardy in our part of the world. A companion for it is probably *B. Vietchii* and varieties, which is said to have lived out several years near London and may do so here.

**PINUS CEMBRA.**—This is one of the hardiest and most beautiful of pines. It is rather slow of growth, but just the thing where there is not much room to spare.

**WILD GARDENS.**—These might be a cheap and pleasant adornment to many a farmer's home. Many plants cannot be grown in our climate when exposed to cold, dry winds. If these plants were set in the borders of blackberry patches, or among similar wild bushes, they would do well. There would always be something to interest one in such a clump as that. The chrysanthemum, which is often killed outright in our open borders, would live out safely in such wild clumps as these.

**AN ELECTION FOR ROSES.**—The *Journal of Horticulture* gives the result of an election for roses. Twenty-four of the most distinguished rose growers of England gave in a list of 25, naming their first choice first, and the others in successive order. There were votes:

- 16 for Louis Von Houtte.
- 15 Countess of Oxford.
- 12 Marquis of Castellane.
- 11 Francois Nicholson.
- 10 Ferdinand de Lesseps.
- 8 Captain Christy.
- 6 Catharine Mermet.
- 6 Etienne Levet.
- 4 Paul Neron.
- 4 Mlle. Eugenie Verdier.
- 2 Ed. Morren.

And one for each of the following: Auguste Neuman, Hippolyte Jamin, Depuy Jamain, Perle des Jardins, Duchess of Edinburg, Rev. J. B. Camm, Mary Turner, Baron Bonstettin, Miss

Hazzard, Auguste Rigotard, Gen. Von Moltke, Chestnut Hybrid, Mad. Lacharine, Mad. La Comtesse de Monssac, Mlle. Marie Finger, Princess Beatrice.

The first five we may therefore take as certainly the best roses grown in England.

The electors were Mr. Robson, Rev. H. Dombrain, Rev. F. H. Gale, Rev. E. N. Pochin, Rev. J. B. Camm, R. G. Baker, J. Hinton, Rev. Allen Cheales, J. Scott, Rev. E. Handley, R. W. Beachey, J. Burrell, H. Blandford, B. R. Cant, Ewing & Co., George Cooling, Charles Turner, Mr. Bennett, H. Curtis, Mr. Cranston, George Prince, S. Wheeler, Richard Smith; all rose celebrities.

**ACER STRIATUM**, or, as it is more correctly called, *A. Pennsylvanicum*, though more common farther northward than in that State, is an interesting tree in winter by its peculiar striped white and green bark. Its twigs are of a bright red, and in this way the tree possesses an additional attraction. It is rather a fast grower. We have seen trees the past year make a growth of four feet. The large tri-lobed leaves give it a distinguished appearance in the summer season.

*Acer spicatum*, or *A. Montanum* of some, the mountain maple, somewhat resembles this species, but is but a bush, besides having other botanical characters to distinguish it.

**ACHILLEA UMBELLATA FOR WHITE EDGINGS.**—So far as we know the plant referred to in the following has not been introduced into our country, but is worth bringing in. The *A. tomentosa* is somewhat hoary, and makes a very good edging. This one is now common in American gardens: "If I were asked to name the most useful, and, at the same time, the most lovely of the dwarf white edging plants now in use, I should say *Achillea umbellata*. It is perfectly hardy, and certainly requires less manipulation than the dwarf *Cerastium tomentosum*. The latter requires renewing every year, whereas the former will be as effective the second and third year as the first. For carpet bedding it is a gem in every way, and only requires to be known to be appreciated. It is easily increased by cuttings taken off in September or October, and dibbled in very thickly under a wall. We have thousands planted under the foot of a west wall, and they give no more trouble than this—after a severe frost—in spring, to sprinkle a little sifted leaf mould over the cuttings, and with the hand press into the soil those that have been forced out by



the frost. The few leaves falling from the fruit trees give sufficient covering now until rooted, after which they will take care of themselves."

**MAMMOTH ROSE TREE.**—Mr. O. D. Dryden, near Gilroy, informs us that he has a rose tree, twelve years old, of the Cloth of Gold variety, the stock of which is seventeen inches in circumference. It branches one and a half feet from the ground, and stands about ten feet high, with a spread of top ten feet across. If it were not kept closely pruned it would be much larger.—*Pacific Rural.*

### NEW PLANTS.

**DAHLIA GRACILIS.**—This is a new species. The common dahlia is improved from *D. coccinea*, a single scarlet flowered kind. But it has simply pinnate leaves. The leaves of this one are bipinnate.

**GLADIOLUS CRUENTUS** is a new species introduced into England from Natal, and has the advantage of flowering late in the fall.

**RHUS PANACIFORMIS.**—A close-growing shrubby plant of elegant character. It has alternate pinnated leaves, with about six pairs of leaflets, which are rounded and unequal-sided at the base, elliptic oblong in outline, and on the young plants about two inches long. The rachis is puberulous, and the leaflets hairy beneath. It is apparently a plant of stocky habits.—*W. Bull.*

**RHUS RUFÆ.**—A fine pinnated-leaved shrubby plant of ornamental character. It has erect rusty-barked stems, pinnate leaves a foot long or more, and consisting of about eight pairs of leaflets, which are from 3 to 4 inches long, and from an inch to an inch and a half broad, hairy beneath, oblong-acute, with the base rounded and unequal-sided. The leaves are alternate, the rachis tomentose, of a reddish hue, and the whole plant of a free-growing and elegant habit.—*W. Bull.*

**FRAXINUS LONGICUSPIS.**—A slender deciduous Japanese tree, with tetragonous branches, whose bark is marked by lenticular warts. It has pinnate leaves, with two or three pairs of leaflets, which in the mature state are lanceolate with a long acuminate point, but in the young plants are blunt, and sometimes rounded. The inflorescence forms an erect terminal or lateral panicle. According to Siebold, this is one of the plants on which the wax insect feeds.—*W. Bull.*

**WISTARIA MACROBOTRYS.**—This variety, introduced from Japan, is of vigorous growth, and exceedingly free flowering, producing fine large full bunches of flowers, of immense length. The foliage is dark green; the flowers are white, tinted with bluish purple, and very large and fine. It is a most attractive and ornamental plant.—*W. Bull.*

**MAGNOLIA CAMPELLII.**—"The *Magnolia Campbellii* was discovered by Dr. Griffith in Bhotan; it is a large forest tree abounding on the outer range of Sikkim, at elevations of 8,000 to 10,000 feet, appearing on the road above Pacheem, and thence ascending to the top of Sinchul, 8,000, and Tonglo, 10,000 feet; though occasionally seen on the central ranges at the same elevations, it is much less frequent. The flowers are produced abundantly in April, at the end of all the branches, when the tree is as yet perfectly leafless; they vary from white to deep rose color, or almost crimson, and in size from 6 to 10 inches; the scent is faint. In May the tree is in full leaf, and the fruit ripens in October, when a few small and often deformed flowers are sometimes produced. The flowering branch drawn in Mr. Cathcart's collection is nearly twice as large as that represented here. Young plants have the leaves perfectly glabrous; those of older trees are more or less silky on the under surface."

**GYMNOTHRIX LATIFOLIA A GOOD CENTRE PLANT FOR FLOWER BEDS.**—Those who want a good plant for the centre of a bed should use this Grass, not so handsome in its flowers as the Pampas Grass, but much handsomer in its foliage and manner of growth. Here it grows over six feet high, with broad deep green leaves, and reddish-brown knotted stems. It is a more compact grower than the Pampas Grass.—*H. N. Ellacombe, Bitton Vicarage, Bristol, (in Garden.)*

**VIBURNUM AWAFUKI.**—This beautiful hardy Japanese shrub is now in splendid condition at Belgrove, Queenstown, the seat of W. E. Gumbleton, Esq., who describes it as the most brilliantly colored autumnal plant he has ever seen. Many of its leaves are now of a bright rose color.—*Record.*

**TAMARIX PLUMOSA.**—Of this plant, M. Carrière writes as follows in the *Revue Horticole*: "Nothing can be finer or more graceful than this species, which is still so rare, in spite of the readiness with which it can be propagated. Its numerous, slender branchlets, of a glaucescent green hue,

bear a certain resemblance to the curled plumes of the ostrich (or the white stork), whence its popular name of 'Marabout.' It flowers in August, about the same time as *T. indica*. The flowers, which are disposed in dense erect panicles, have an airy lightness, which adds much to the elegance of the foliage. Isolated on a lawn, or in a large park, *T. plumosa* forms a compact mass of the most pleasing appearance. It is quite as hardy as *T. indica*, and propagated and grafted in precisely the same manner."

**DAPHNIPHYLLUM ROXBURGHII.**—A deciduous tree, belonging to the natural order Euphorbiaceae. It has an extensive geographical range; the plants here offered are from Japan. It has an erect twiggy habit, with oblong-ovate or ovate opposite deep green leaves, and axillary racemes of minute flowers.

### QUERIES.

**RARE EVERGREENS IN MARYLAND.**—W. G. A. says: "A friend brought me from Maryland, near Gunpowder river (or creek), these evergreens which grow beautifully at that place. I was not able to name them. The Spruce is very abundant, about 30 feet high, and beautiful. What spruce is it? The black and white belong to the north; the arbor vitæ, I take to be our own. What is the cedar? These trees are *supposed* to be indigenous in that locality."

[It is surprising to get specimens like these with the suggestion that they might be *indigenous*. One is the American arbor vitæ from the northern part of the continent; another the deodar cedar of the East Indies; another the Japan cedar, *Cryptomeria japonica*; and the other *Libocedrus decurrens* of the Pacific coast. The remarkable health of these specimens, shows that they are excellent kinds for our Maryland friends to cultivate.—Ed. G. M.]

**DISEASE IN EVERGREENS.**—B. T. B., Carlinville, Ill., says: "My evergreens are dying 'piece-meal,' that is, they die in spots; a little branch here, and another there; sometimes on one side of the tree, and then again on the other; and then again, all through the tree you will see little dead branches or twigs. What can be the matter with them? Can you, and will you if you know, tell me? I would not bother you if it was the busy time of the year. But now, I thought

you had time, and would, perhaps, give me the desired information. My trees stand just as they have grown, never having been trained a bit or a branch broken if I could prevent it, and consequently grow down to the ground. I hate to lose them now, they are 20 or 30 feet high; and should like it very much if you would tell me what to do for them."

[Evergreens, especially pines, are liable to the attack of a small fungus, which comes out in spots like small pin heads all over the leaves, and soon injures them, severely affecting in time very seriously the health of the trees. This is known as the *Æcidium abietinum*. In addition to this, pines often suffer from insect attacks; some kinds bore into the young branches and kill them. This is probably what is the matter with these trees; slit some of the injured branches lengthwise and see. If so, their traces will be seen, and the only remedy is persistent watchfulness, to cut off and burn all injured branches as soon as they are seen.—Ed. G. M.]

**CHOCOCOA RACEMOSA.**—M. C. & Co., Atlanta, Ga., say: "A lady of Cedar Keys, Fla., sends us the enclosed branch and fruit of a vine that is indigenous to that part of Florida, and says it blooms three times before fruiting, once flowers yellow, twice white, and very fragrant. We do not recognize it. Can you tell us what it is? Also, seeds of flowering potato—so called there; can you locate it?"

[We give the name above. There were two kinds of seeds in the letter, one of some malvaceous plant; and the other, perhaps, a convolvulus.—Ed. G. M.]

**RAISING THORN SEED.**—J. C. T., Farber, Mo., writes: "I have tried to get information of the *American Agriculturist* how to manage thorn seeds like this I enclose. I cannot find out why I have failed two different times to get these seeds to grow. I froze them all winter and planted in good soil, but as yet not a single plant appears. It grows abundantly here, a natural hedge plant; stocky, hardy, dwarf, very thorny, and so thick naturally that small birds make their nests in it with perfect safety from large ones. I have lost several years in trying, and now appeal to you. Please tell me all the details of treatment, as I have a lot of seeds now buried with some crab-apples also, with which, I am going to make some hedges, if I have to dig up the roots. I have had the same luck with these as with the others. I am greatly dissatisfied with

the Osage, on account of its rampant growth and its baneful influence on the crops contiguous to it. I believe nature furnishes us, right at hand, a hedge plant far better in many ways than the osage."

[The seeds were of *Crategus crugalli*, the cockspur hawthorn. Many attempts have been made to make a hedge out of it, which it will do in from 10 to 15 years—entirely too slow for the

average American. Then it is liable to mildews and moulds, and blights and borers, so that after all their waiting, it does not please our posterity. The seeds grow easily if you keep them one year in a barrel of wet earth, and sow them the following spring; at the end of that season they will be an inch high. When you get a good hedge from your own sowing, we should be pleased to be alive to look at it.—Ed. G. M.]

## GREEN HOUSE AND HOUSE GARDENING.

### SEASONABLE HINTS.

Window plants are as much appreciated at this season as at any time of the year. There are few things more beautiful than the old classes of roses—the Borbon and China. We have seen some beauties in windows recently, and wonder they are not more grown. In another case we saw a handsome *Chorozema cordata*. Usually, Australian plants do not thrive in our climate, but this plant was simply plunged in partial shade in summer, rewarding the owner with its pretty brown and purple butterfly-like flowers all winter. This, and many other window flowers, are liable to suffer from the minute insect known as red spider. Very minute whitish green spots on the leaves usually indicate the insect's existence. It is best to lay the plants on their sides, in the open air, and treat them to a powerful syringing with strong soap-suds, and, while still damp, sprinkle a little sulphur on them from a pepper box. Red spiders do not hanker much after sulphur. Sometimes window plants suffer from mildew, and sulphur is a good remedy for it also.

Look out for a good stock of bedding plants in time; by striking cuttings of such things as grow rapidly, and sowing seeds of such annuals as may be advanced to advantage.

Fuchsias may now be readily struck from the young growth of the old plants, which will make excellent blooming plants for the next summer season.

Dahlias should now be brought forward. A good plan is to shorten the extremity of the roots, put them in six-inch pots and place in a

warm greenhouse. In a few weeks they will sprout, when they should be shaken out, divided with a piece of root to each sprout, and separately potted in four-inch pots.

Pansies are coming now into flower. They like an airy frame, where they will not be roasted in mid-day nor exposed to drying winds, and yet have a free circulation of air and plenty of light. Planted out in such a frame, and the old shoots cut away as soon as the plant has done flowering, the plants will keep healthy over till the next season. Superior varieties can be raised from seed. Choose those with the roundish petals, best colors, and the first flowers that open, to raise seed from.

Camellias will require rather more water while growing than at other times. Just before they grow is a good season to graft. Cut down the stock, cleft graft in the crown, wax, and plunge in a bottom heat of 70°. A great many kinds may be had on one plant by the bottle system—a shoot about to grow is obtained, and attached to the stock as in inarching, the end of the shoot being put in a small phial of water suspended beneath it. This plan does best, however, with half ripe wood in July.

Geraniums, Pelargoniums, Cinerarias, and Chinese Primroses, must be kept as near the glass and light as possible; they do little good in shady places. Keep off the green Aphis;—for this, on a small scale, there is nothing like hot water; on a large scale, tobacco-smoke, in several successive light doses, is still the best remedy.

Azaleas succeed well by grafting with the half ripe shoots of the present season's growth on plants raised either by seeds or cuttings. Old wood does not take readily.

Auriculas, Carnations, Pinks, and Polyanthus—the prettiest of florists' flowers, must be kept cool, just free from frost, with plenty of air, if the best results are desired.

Chrysanthemums should now be raised from cuttings for fall flowering. They make better blooming plants than offsets.

New Holland and Cape plants, such as *Epacris*, *Acacia*, *Heaths*, &c., are now the glory of the greenhouse; hot bursts of sun on them should be avoided, as it lays in them the seeds of "consumption," which frequently carries them off the following summer.

## COMMUNICATIONS.

### GROWING THE POINSETTA.

BY JOHN HOOD, SOUTH AMBOY, N. J.

The Poinsetta is a little difficult to grow satisfactorily in pots, being somewhat irksome to maintain the proper degree of moisture, which seems requisite to its well being. How we have obtained the most satisfactory results with least trouble, is to plant them out in the open ground, in May, or as soon as there is a fair prospect of settled weather. When the weather begins to get hot and dry, we give them a good mulching of well-rotted manure, if procurable, if not, with short grass, which keeps the ground cool and moist. By the end of the following month, if they have been growing vigorously, the young shoots will have attained the length of fifteen to eighteen inches. This we cut back to four eyes, from which it started in May; in all likelihood those four eyes will push simultaneously, which rarely happens when grown in pots, or nipped off as soon as they have made four or five leaves. The strongest of this growth is cut back again about the first week in August—cutting with a view to equalize the flow of sap and form a compact head. Near the end of this month, select a cloudy day, and, with a spade, cut around the plants thoroughly, not underneath. Pack the soil firmly around them again, and replace the mulching. The distance from the stem they require to be cut must be regulated by the size of the plants and pots you intend they shall occupy. This should be done three weeks previous to their removal. In that time they will make numerous fibrils, which can be removed without injury—which is very essential

to successful transplantation. After being lifted and staged for some time they require to be carefully shaded, and, if kept in a close, humid temperature of 65°, they will lose few of their leaves, will quickly become established, and, in the course of six or seven weeks. We opine that, under good cultivation, as a winter flowering decorative plant it has few competitors. Some, however, prefer growing them in pots, and assert they should not be cut back, as it impairs the size of the bracts. Recently we saw an illustration of this method at a commercial establishment, credited with having well-grown plants. In outline they reminded one of the common Sumach (*Rhus glabra*), as seen in the fall of the year—shoots over three feet in length, nude, except very near the top. Tortured in this way, it is, undoubtedly, more queer than beautiful.

### BOUVARDIA HUMBOLDTII CORYMBIFLORA.

BY W. H. BAILEY, PROVIDENCE, R. I.

Having for a long time grown and flowered the *Bouvardias grandiflora* and *jasminoides*, of which species the *Humboldtii* is a member, and knowing their faulty character as bloomers, though prizing them for their purity and fragrance, I had just cause for many misgivings, when *this* variety was flatteringly announced and introduced to public notice. But the experience I have had with it justifies me in awarding it a very high place among the many new things of the past few years. The drawing I send you gives the natural size, without exaggeration, but one can form from it but a meagre idea of the plant as flowering upon my grounds last season. I had a large bed containing some thirty-five or forty plants, from thumb pots, and planted in May, which in July was a sight worth a journey to see. Each plant grew most vigorously, sending up from eight to one dozen shoots, which, after attaining a foot or more in height, began budding, and were soon densely loaded with the large jasmine-like blossoms, of the purest white, with a fragrance not unlike the delightful *Stephanotis*, and nearly as powerful as the *Tuberose*, which, wafted about by the breeze, particularly at evening, was the delight and wonderment of all persons within its odorous range.

The first flowers opened in July, at which time my beds of *Vreelandii*, *Hogarth*, *leantha*, and *elegans* had not the appearance of a bloom, though the plants were the same size when put



out, and received equally careful attention. From the time Humboldtii commenced flowering, we were able to cut generous clusters of flowers until frost, and such plants as were carefully lifted with earth adhering to them, and potted, continued to blossom several weeks in the greenhouse. For winter blooming, I think it very valuable, but the plants for this purpose should be grown in six-inch pots, plunged in the border, and not allowed to bloom during summer. This treatment I find the best for all varieties of Bouvardias when required for winter use, as they do not generally transplant into pots very well from the open ground. All the Bouvardias are desirable,—we could hardly dispense with any,—but the Humboldtii opens certainly a new era with this family. Having succeeded in crossing it with the leiantha, a scarlet sort, I may have something interesting to report at some future date.

### TAR IN GREENHOUSES.

BY PETER HENDERSON, NEW YORK.

You will be doing many a poor fellow a great kindness if you will again warn, and keep warning, against the common and fatal mistake of painting hot-water pipes in greenhouses with gas tar.

I have done so several times in the *Monthly*, but as you know that we are getting scores of new and inexperienced men every year into the business who keep falling into this error, it is well to keep on. Already two of my customers report this season that they have so blundered, and the effect has been ruinous in each case. As you are aware, if the mischief has been done, there is no other remedy but taking the pipes out and burning them thoroughly until the gas is entirely expelled from the iron.

### NOTES ON A SUMMER'S TOUR.

BY WILLIAM SUTHERLAND, PHILADELPHIA.

The country seat of Matthew Baird, Esq., situated at Darby, Delaware County, Pa., under the skilful management of Mr. James McAdams, the gardener, is one of the neatest kept places in the vicinity of Philadelphia.

The flower garden is tastefully laid out in different shaped beds, which were planted with a variety of tropical and bedding plants calculated to produce the best effect, while in the background were some fine specimens of choice evergreens.

Adjoining the mansion house was a small conservatory, well arranged with a choice collection of begonias, ferns and ornamental plants, the ends of the conservatory being glazed with looking-glass, giving the interior the appearance of being three or four times as large as it really is. In the middle of the house was a very fine aquarium, filled with a variety of plants and fish, while in two smaller ones I noticed some of the largest specimens of *Cyperus alternifolius* that I ever saw. Adjoining the conservatory is a small vinery, from which the fruit had just been cut. Mr. McAdams remarked that the vines had borne well, and, judging from their appearance, I saw no reason to doubt the statement. Descending a flight of steps, and crossing the carriage road, I entered another range, consisting of stove and orchid house, palm house, and two large pits for forcing tomatoes, cucumbers, beans, and other vegetables. At the time of my visit (in September), one of the pits had just been started with cucumbers, and the gardener complained bitterly of the depredations committed by the ants, and would like to know how to effectually get rid of them. For want of a better remedy, he lays down raw meat bones, attached to short wires, which as they become covered with the pests are dipped in scalding water. By this means thousands are destroyed, but their number does not seem to be diminished.

In the palm house I noticed some fine specimens of *Dracenas*, *Crotons* and *Allamandas*; and one of the finest grown plants of *Dracæna umbraclifera* it has been my good fortune to see. It must be fully six feet in height. There were also some fine specimens, well marked, of *Hydrangea speciosa*, *Croton aucubæfolium*, and *Duranta Baumgartnerii*. The old *Aspidistra lurida variegata* seemed better marked than in common. Among the palms I noticed some magnificent specimens of *Areca rubrum*, *Lantania borbonica*, *Seaforthia elegans*, *Cocos plumosa*, and *Caryota excelsa*, many of them so high that, although the tubs were sunk in the floor, the tops barely escaped the glass. Mr. Baird will have to raise the roof of the house or donate his large palms to the Centennial conservatory, for certainly their present quarters will not accommodate them another year.

The benches around the house were bright with specimen *Coleus*, which gave a very cheerful appearance. In the stove, adjoining the palm house, there was a fine collection of *Orchids*, principally on blocks, all looking very

promising, as was also a fine collection of *Selaginella*, grown in pans of no mean dimensions. Leaving this range, I next entered the green-houses. Here I noticed a very neat specimen of *Cycas revoluta*, and quite a number of magnificent *Ficus elastica* and *Oleander* plants; also a very healthy collection of *Camellias*, so thickly set for flower that thinning out the small buds was necessary. The *Azaleas*, of which there were some fine specimens, all looked very promising. One house was devoted to bedding plants, and

variegation being in the middle of the leaf, and a broad belt of deep green around the edge. This variety, I think, will make quite a stir when it gets into commerce, and will, no doubt, be the parent of a new class of variegated geraniums.

Mr. McAdams informed me that they were about to introduce Cowan's new compensating system of heating, Mr. Baird having had an agent in Europe all summer for the purpose of examining the apparatus before bringing it out to this country.

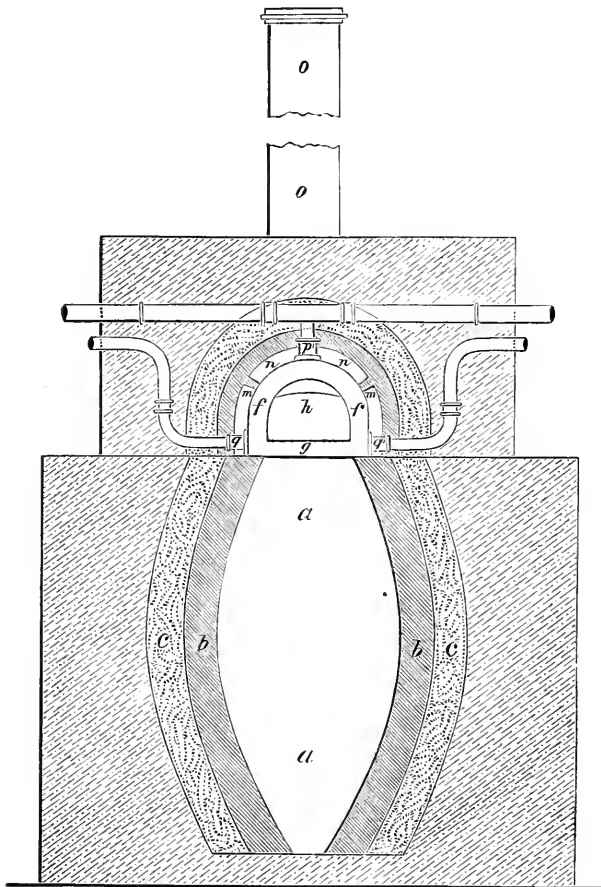

another to winter flowering plants, such as *Stevia*, *Heliotrope*, *Cinerarias*, *Bouvardia*, and various kinds of winter flowering geraniums and roses, from which to supply bouquets, &c.

Among the *Zonale* geraniums I noticed one called "Happy Thought," which Mr. Baird has recently imported from England. This variety is quite distinct from any I have ever seen. The

Knowing that you are always on the lookout for novelties to lay before the readers of your valuable journal, I determined to pay another visit after the first hard frost—when they hoped to have the apparatus in full working order—and open to the inspection of those who wished to examine it.

I accordingly paid a visit about the beginning

of December, and found the apparatus to consist of a limekiln and an improved boiler.

The cut taken from Cowan's circular will give the reader a better idea than pages of description.

This establishment formerly took three furnaces, and a like number of boilers, to keep up the heat in the different ranges. Without removing the old boilers, these have now all been connected by passing four-inch hot-water pipe, laid in eight-inch terra cotta pipe, from one range to another, under ground, and the whole apparatus seemed to work admirably.

It is claimed for this system that it is compensating, because the lime drawn from this apparatus can be used for different purposes, also that it requires no night attendance, and is adaptable anywhere that lime-stone and coal are procurable. It is in general use in most of the large establishments of the United Kingdom, both public and private, and in one place, near Liverpool, England, four miles of four-inch pipe are heated by one kiln, which formerly took the united aid of sixteen boilers.

To Mr. Baird belongs the honor of introducing this system into this country, and I think it does not require a prophet, or the son of a prophet, to predict that this system will eventually revolutionize hot-water heating in all large establishments.

[There are figures for reference in the cut, but we have not the copy to correspond. We presume, however, the cut is explanatory, in so far as the main principle is concerned.—Ed. G. M.]

### HOT-WATER HEATING.

BY J. M. JORDAN, ST. LOUIS, MO.

Having had considerable experience with heating greenhouses with hot water, I wish to give a few suggestions.

I have learned that water pipes should be so arranged as to facilitate the rapid motion of the water, and any change in the size of pipe tends to diminish the flow of water. A large stand pipe, or expansion tank, where one pipe enters into and another leaves it, retards the motion; or where a large pipe is contracted or enlarged also retards the motion.

All steam generated in the boiler should be used to move the water, but the pipes should be so arranged that the water could not boil out of the exhaustion tank. On the question of boilers, as new designs are being introduced every year,

we should be very cautious, and consider well the essential points, before we adopt them. The vital points about a good boiler are: 1st, to be capable of burning all kinds of fuel; 2d, have plenty of heating surface; 3d, the boiler should be so constructed as to give a rapid motion to the water, thereby carrying off the heat from the furnace, so as to save all its heat generated from the fuel.

Rapid circulation is the very essential thing at present, as many cultivators of plants build greenhouses from one hundred to four hundred feet long, and many times other additions to greenhouses attached, so the water has to pass through five hundred to eight hundred feet of pipe before it can return to the boiler to take on a fresh supply of heat. We should consider that all heat is generated in the furnace, and the moment the water leaves the boiler, it begins to radiate its heat, and when it moves slowly, and has parted with the high temperature, it is of but little value in repelling the sharp arrows of frost on a cold winter's night, with the thermometer marking below zero; therefore, I would say, that the boilers are very few that can heat the water and give it a momentum through more than five hundred feet of pipe, boiling until it comes back to the boiler to take on a fresh supply of heat. So a boiler that heats one thousand to three thousand feet of pipe should have separate attachments and very rapid circulation, or that portion of the greenhouse over one hundred feet away from the boiler will not be evenly heated with that near by.

### EDITORIAL NOTES.

ROSES FOR WINTER BUDS.—The *Garden* says Niphotos, Isabella sprunt, and Safrano, are found to be the best to grow for Covent Garden Market.

TACSONIA INSIGNIS.—The *Tacsonias* are closely allied to the passion flowers, and in many respects superior to some in beauty. A new one under the above title is among the novelties announced in England. The flowers are large, and of a crimson color.

HARDINESS OF THE COFFEE.—The coffee seems a hardier plant than we have been accustomed to regard it. A writer speaks of it as sometimes under snow in coffee countries; and that it makes a good plant for room culture.



LILIES OF THE VALLEY, are the most charming of forced flowers. To be very successful with them, they should be grown a year in boxes before being forced.

BOUARDIA JASMINIFLORA is becoming popular in London for cut flowers. It is not as floriferous as our popular *Vreelandii* or *Davisonii*, but has the advantage of fragrance.

NAMES OF FERNS.—*L. Puffer, Mass.*—Your fern is *Aspidium falcatum*. The fern from our correspondent at Guelph, Canada, is *Cheilanthes pilosa*.

VIOLET VICTORIA REGINA.—We have from Mr. Chitty a bunch of flowers of this excellent violet. It is strong stemmed, large and sweet.

GERANIUM, *Happy Thought*, also from Mr. Chitty. The deep edge of green around the central white portion makes it one of the most distinct and pretty of the variegated kinds.

OLEA FRAGRANS.—It will be seen by the following from the *Journal of Horticulture*, that this very sweet and popular plant can be grafted on the privet:

"*Olea fragrans* is flowering in the Economic

house, at Kew, and possesses a perfume of the most delicious description. The flowers are small and of a pale yellow color, but grow many together in numerous clusters. They are used in China for scenting teas. That called pekoe is a green tea much prized for the scent imparted to it by these flowers. The species is well worth growing in conservatories for its perfume. It is easily grown and succeeds on its own roots, but is perhaps hardier grafted on privet. A plant so grafted has withstood the last two or three winters against a wall."

### QUERIES.

DISEASED GERANIUM LEAVES.—F. R. & Son, Denver, Colorado.—The leaves sent are not affected by red spider, but by mildew. Syringe them well with warm soap-suds, and then sprinkle them with sulphur. Sometimes this trouble comes from having the roots colder than the atmosphere. When plants are growing the roots should be at least as warm as the leaves and branches.

## FRUIT AND VEGETABLE GARDENING.

### SEASONABLE HINTS.

In managing the vegetable garden the highest excellence should be aimed at. This is the chief source of pleasure in a garden. If one can take no pleasure in his garden,—if the watching of the beautiful processes of nature in furnishing him food—and the many lessons they teach him, which he in a thousand ways can so pleasurably and profitably apply, have no charms and attractions for him, he had better give up gardening; for assuredly, in most cases,—even to 99 in 100 instances,—the market gardener will bring the vegetables to his own door cheaper than he can grow them. Amateur gardening should primarily be pursued for the lessons it teaches, and the pleasure it affords; when it ceases to do this it should be abandoned.

In the Middle States the work for February will, for the most part, consist of preparations

for future operations, and particularly for dealing with the manure question. All those kinds that are grown for their leaves or stems require an abundance of nitrogenous manures; and it is useless to attempt vegetable gardening without it. To this class belong Cabbage, Lettuce, Spinach, etc. The other class, which is grown principally for its seeds or pods (as Beans, Peas, etc.), does not require much manure of this character; in fact they are injured by it. It causes too great a growth of stem and leaf, and the earliness—a great aim in vegetable growing—is injuriously affected. Mineral manures, as wood ashes, bone-dust, etc., are much better for them. For vegetables requiring rich stable manure, it is better that they have it well rotted and decayed. Nothing has yet been found so well fitted for the purpose as old hot-bed dung: though to the smell no trace of "ammonia" remains in it.

One of our most interesting parts of a vegeta-

ble garden is a hot-bed for starting seeds early. The end of the month will be time enough for those who have not command of a large supply of stable manure, as the very low temperature we often get at the end of the month soon absorbs all the heat the hot-bed possessed. It is in any event best to put up the beds in the warmest and most sheltered spots we can find, and to keep cold winds from the manure, by covering it with branches of trees or mats; and the glass should always be covered with mats at night. Tomatoes, Egg-plants, Peppers and Cucumbers, are the first seeds to be sown this way. Cooler frames can be got ready for Cauliflower, Lettuce, Beets, Celery and Early York Cabbage, a little of which may be sown about the end of the month for the earliest crop. The Cauliflower is a particularly valued vegetable, and no expense spared to get them in perfection will be regretted when one's efforts are successful.

In the open air, should the weather prove favorable, as it often is about the end of the month, Peas and Potatoes may be planted. Frost seldom gets deep enough in new dug ground to injure them after this date.

In the more southern States, the gardener will lose no time in getting in his Potatoes, Beets, Carrots, Parsnips, Peas, Spinach, Radishes, Lettuce, Onions, and Salsafy. These should be the first crops put in after the season breaks up for good. The earlier they are in the better. Asparagus, Rhubarb and Horse-radish beds may now be made. Asparagus roots are generally planted too thickly to produce fine shoots,—they starve one another. A bed five feet wide should have three rows, and the plants set about eighteen inches apart. A deep soil is very important, as the succulent stems require every chance they can get for obtaining moisture. About four inches beneath the soil is sufficient to plant them. Rhubarb also requires a deep, rich and moist soil. Horse-radish beds are best made by taking pieces of strong roots, about one inch long, and making a hole about a foot or fifteen inches deep, with a dibble, and dropping the piece to the bottom of the hole; a clean, straight root will then rise up through the soil. Crowns or eyes are better than pieces of roots,—where they can be had—and a rich clayey soil better than a light, sandy one.

About the middle or end of the month, or still later in the North,—say the middle of March,—Celery and late Cabbage may be sown. Here, we usually sow the second week in March.

In the Northern States, Broccoli, and Cauliflower when sown in March as recommended, do not head early enough in Fall. It should be sown about the time of Early York Cabbage, in the hot-bed, during this month.

Pruning of fruit trees, when required, should be proceeded with at favorable opportunities. We write *when required*, for in our climate more injury is done by the knife than by the neglect to use it. Gooseberries, for instance, are usually ruined by pruning. In Europe, it is customary to thin out the centre well to "let in the sun and air." Here it is the sun and air that ruin them, by inviting mildew; and so the more shoots, the better. Our country farmers are the best gooseberry growers, where weeds run riot, and grass and gooseberries affect a close companionship. Wherever, in fact, the gooseberry can find a cool corner, well shaded from the sun, and with a soil, which is never wet, nor yet by any means dry, there will gooseberries be produced unto you. The English kinds mildew so universally as to be almost gone out of cultivation south of the St. Lawrence. Nor, indeed, is it to be so much regretted, since the improved seedlings of large size and fine quality, raised from the hardier American species, are becoming known, and their merits appreciated by growers.

The rule, in pruning grape-vines, is to shorten the shoots in proportion to their strength; but if the advice we have given in former summer hints has been attended to, there will be little disproportion in this matter, as summer pinching of the strong shoots has equalized the strength of the vine. Those who are following any particular system will, of course prune according to the rules comprising such system. As a general rule, we can only say, excellent grapes can be had by any system of pruning; for the only object of pruning in any case is to get strong shoots to push where they may be desired, or to increase, with the increased vigor of the shoot, which pruning supposes will follow the act, increased size in the fruit it bears.

All fruit trees like a rather dry, rich soil. On a cold, clayey bottom, diseases are usually frequent. Do not plant deep; cut off tap roots, and do all you can to encourage surface fibres. Surface manuring is the best way of doing this after the tree is planted. Do not allow anything to grow vigorously around your trees the first year of planting, nor allow the soil to become hard or dry. Let trees branch low, and prune a little at transplanting.

Manuring of grapes should be regulated by the nature of the soil. If it be damp—in most cases a bad condition for grape growing—stable manure in great quantities means diseased vines. In dry ground, it has a beneficial effect. Many persons of small places have grapes in damp ground, or can have none. They must take care to keep the roots near the surface; never crop the ground about them to destroy the small fibres, if it can be avoided; and even good may often follow, when the vines seem failing, to carefully follow up the roots, lift near the surface, and encourage, as much as possible, those remaining there. Wood-ashes, bone-dust, and such like fertilizers are best for grape-vines in low ground.

In order to grow good fruit, we need only repeat in a general way, that trees require as much food as a crop of corn, or potatoes; but it is very important to keep the feeding roots at the surface, and therefore that the very best way to mature fruit trees is by surface dressing.

---

## COMMUNICATIONS.

### THE ICING WATER-MELON.

BY IRA J. BLACKWELL, TITUSVILLE, N. J.

Having grown the above melon the past summer, and thinking it a good variety for family use, I endeavor to speak a word in its favor. We grew the past season the mountain sweet, ice cream, and the icing water-melons, all good varieties. With us the icing ripened first, and produced the most; all the melons were of good quality, even the small ones ripened up good, and it continued bearing until the frost killed the vines. It is one of the new things that is good, or probably best, here. It is not very large. Green skin, red flesh and white seeds, form round. I think it a cross with the imperial, or most probably a seedling. The dark green variety is much the best.

---

### MANAGEMENT OF THE BARK OF FRUIT TREES.

BY P., OF MISSISSIPPI.

I notice your tilts at those who do not believe in opening the bark. I have seen in an orchard of the best fruit, splendid trees, split in the bark of

the trunk and larger limbs. In a place, fence between, same soil, same trees in variety, scant fruit, bad quality in comparison and no thrift. I have split tree bark; saw it done sixty years ago; then the careful men always did it. I have scraped the rough bark off, and cleaned the trunks.

A friend here uses linseed oil, to an extent as if house painting, on 1, 2, 3 and 4 year old pear trees, trunk and limbs, and has stopped the blight, no increase of disease and tree apparently unharmed. I saw the trees, had my hand on them, and he says, he did this before and will continue.

---

### DON'T USE THE HATCHET OR SAW.

BY REV. J. H. CREIGHTON, COLUMBUS, O.

Of all the blunders that the common farmer, and some others, make with trees, none is so common, or so hurtful, and which he is so long finding out, and of which he might know so certainly, as the practice of cutting off *lower limbs*. All over the country nothing is more common than to see mutilated trees on almost every farm. Big limbs cut off near the body of the tree, and of course rotting to the heart.

This is a *heart* sin against nature. The very limbs necessary to protect the tree from wind and sun, and just where limbs are *needed most*, they are cut away.

But the greatest injury is the *rotting* that always takes place when a big limb is sawed off—too big to heal over it must rot, and being kept moist by the growing tree, is in the right condition to rot, and being on the body, the rotting goes to the *heart* and hurts the whole tree.

It is common all over the country to see large orchards mutilated in this way. We often see holes in the trees where big limbs have been cut away, where squirrels and even raccoons could crawl in. Perhaps the only reason these trimmers would give is, that the lower limbs were easiest got at, and some would say they wanted to raise a crop under the trees.

[To the good suggestion made by our correspondent we would say also, Do not hack with hatchet and saw; but when you do, paint the surface of the part exposed by the saw, to keep out water. Common paint is quite as good as wax or plaster made from the most approved recipes.—Ed. G. M.]

### THAT LITTLE TURK.

BY GEN. W. H. NOBLE, BRIDGEPORT, CONN.

How got our curculio this heathenish name? Comes it of that wreck and waste marking alike the bivouac of this Little and the Grand Turk? Most likely it was hinted by that Moslem signet, the little crescent lip, gashed by his snout upon our fruit. It is there he nests the tiny worm that eats into its heart.

Not the plum alone suffers from this foe. The grape and the apricot, and many think the apple, pear and cherry show his marks. The question is, how to defend our fruits against his raids. Plainly, we must fight the little rascal, by tactics and strategy fitted to his heathenish ways. His weakness then shall be our strength.

I have no faith in most of the "sure cures." Hens and hogs in the plum yard, traps and entanglements for his footsteps, he laughs to scorn. Stenches viler than Chinese stinkpots are his joy. Hunting him in the cool of the morning, about the time of the "early bird," while our little Turk naps late, under chips and stones and rubbish, is a waste of time and a delusion. Early risers are not very plenty. Besides, such fuss will only cut off some outlying posts of a foe, whose hosts swarm among our neighbors.

The truth is, appearances deceive us. A device this year seems to give a full crop, which the next don't work worth a cent. A few years since, a friend of mine thought he had saved his crop, by dusting sulphur on blossoms, leaves and fruit. He made sure, and went straight for that grand prize which somebody out West offered. But by the next year the little Turk had got a liking for sulphur, and didn't care a snap for the cure. For reasons past finding out by our philosophy, one year, a tree matures a crop, every fruit on which the next, drops stung by the curculio. This season our trees may be loaded to breaking, while our neighbor's not a hundred yards off, cannot show a plum. Such results and their seeming cures and causes, are often illogically linked. No remedy deserves our faith, which will not, year by year, fulfill with a crop the promise of the bloom.

Now the curculio can fly. Every remedy must count on this. If we kill them, our neighbors who don't, can furnish plenty of recruits. But our little Turk has a weak spot in his mental make-up. Like Major Bagstock, he thinks he is "cunning and deevlish sly." Besides he is more timid than a hare. He is a coward, and plays possum. That smart rap, by which Ellwanger

& Barry, have for so many years saved their plums, startles him. At the first blow he gathers his feet and snout and body into a ball, at the next he tumbles to the ground for dead. There the wide inverted umbrella or a sheet, gathers him for a scald or a scorch, or some lively fowl devours him.

Now this timidity of the little Turk, and some observation of his ways and of some results, lead me to think, that a very slight jar or rap upon the tree, kept up through the season of fruiting, will put a stop to our curculio's work. For years my crop has never failed, nor do I have any stung fruit, on trees trained on my barn. There—in some years were stabled horses, &c. On others only emptiness, yet each year alike, they bore. Why this, unless "the rapping and the tapping" of the twigs, and the rustling of the leaves against the barn, startled the timid creatures with some sense of danger. You cannot of course train all plum trees on buildings, but you can run, from tree to tree, slight iron rods or stout wires fastened thereto, and by striking them on end with a steady and slight automatic blow, send through all the needed jar or shock. Some little wind-mill tapper, some strong coiled spring, or other slight propulsive force, perhaps would do the work. A trellis of iron posts and wires, vibrating under a gentle blow, would do well for the grape or the plum.

A few years since, some one took out a patent for doing this work by an automatic machine. Right away there came to him from far and near a demand therefor. He only thought of its use to save the plums. But to his great surprise, the loudest call came from Delaware, where the curculio sadly trespassed on the grapes. The problem has been, to get a cheap machine, by wound up weight, or spring compressed, or other stored power, to run twelve hours; often and gently rapping on some pin or rod fastened to the trees. No cheap machine could be made, to give more than a gentle rap every few seconds through that time. The slight expenditure of power, in a smart rap, often repeated during twelve hours, counts up heavy in the pounds. The storing of the needed force would call for stronger and more costly and bulky machinery than would pay. If anybody can get up one cheap and durable, costing to buyers not more than \$5, he had best hunt up the patentee; there is money in it, if not, as Col. Sellers has it, millions. Meanwhile the plan of Ellwanger & Barry will hold the front as the best and cheapest remedy out.

### GRAPES—TRAINING AND MILDEW.

BY "MYSTIC," MEDFORD, MASS.

In the summer of 1874, a large portion of the leaves on some of my grape vines (out-doors), were badly mildewed and dropped off. The mildew followed cold, damp nights. My vines are mostly trained on the southerly side of a tight board fence, with southeast and southwest exposures to the sun. Those with the southeast exposure, were *very* much the most affected by the mildew. Those parts of the vines on, or near the ground were not perceptibly affected—the heat of the ground (sandy loam), keeping warm the lower stratum of the atmosphere and counteracting the deleterious effects of the cold night air.

How near the ground, and why upon the ground, were the vines? The vines are planted midway between the posts of the fence (nine feet apart), cut back yearly close to the ground, and allowed to take their own course in growing (except pinching off the weaker shoots), until four years old, then narrow strips of boards are nailed horizontally from post to post, a foot from the ground, and laths are nailed vertically to the strips and the top rail of the fence, and the vines are tied to them. This brings the vine six inches from the fence, which leaves a space for the circulation of the air. I first tied the vines to vertical wires instead of laths, but found they slipped down under the weight of the leaves and fruit. The strongest shoot is selected, trained perpendicularly and cut off even with the top of the fence. Four arms on each side are trained horizontally and cut off at the posts—the arms being one foot apart, and the lower one a foot from the ground. Short fruit spurs (which should be renewed), are left at the joints of the arms. If the shoot selected for the upright stock has not the requisite number of branches for arms, I train up shoots from the ground to supply the number wanted; and then cut off all the others, and also cut off, from time to time (oftener the better), the runners and superfluous shoots, unless I leave some vigorous ones to layer for new plants the next year. The new wood on the spurs is kept pinched back to about four leaves of the fruit—more fruit on the spur requiring more leaves. In handling the vines, care should be taken not to break off the buds of the arms; for a new bud (except at the end), seldom starts without more skillful treatment than is commonly applied. From vines, of

varieties suitable to the climate, trained within the above-named limits, large, well-ripened fruit is generally obtained, if too many bunches are not allowed to grow.

Those arms of the vines (Concords as well as others) on which the leaves were badly mildewed and dropped off early in the season, were mostly winter-killed; while all the lower arms but one survived. The main stocks of two Concords were killed down to the lower arms; but none of the vines left on the ground were killed. The leaves on the lower arms, and on the vines lying on the ground, had not been injured by the mildew. A vigorous Eumelan, four years old (which lost nearly every leaf by mildew), received such a shock that what wood was not killed made scarcely any growth in 1875. Remedy—cut back to the ground and try a new growth. The partially killed Concords made a good growth—furnishing plenty of new wood to supply the place of that winter-killed.

My vines are mostly Concord, eight years old—the best variety yet for out-door cultivation in this region. Let no one who is limited to a few vines, be deluded into trying other highly praised or *very promising* varieties (often brought into market for a speculative purpose), but stick to the tried and reliable Concord for the present.

This experience of mine tends to show that vines trained on, or near, the ground, are not perceptibly affected by the mildew, and that vines badly mildewed are liable to be winter-killed. As the lower arms of the vines were protected by the snow, a part of the winter, it might be reasonably maintained that this prevented their being killed. But of the arms unprotected by snow, only those were winter-killed that had been badly mildewed; and a healthy Concord vine is believed to be hardy enough to withstand, unprotected, the coldest winter in this region. The winter-killing may have been the joint effect of mildew and the severity of the winter—the winter of 1874-5 being a very cold and trying one for vines and fruit trees.

[We have much pleasure in publishing this excellent practical communication. The point in regard to the comparative tenderness of wood in cases where the leaves fall early from mildew, or any cause, accords with numerous observations recorded in our columns in regard to raspberries and blackberries, and even the grape; and then as regards protection, it is also known that though a raspberry cane that prematurely loses its leaves is killed by severe frost—it yet is per-

fectly safe when covered with earth. It is safe, therefore, to say with "Mystic," that it is both mildew and frost that destroys the grape wood.

It is worthy of further remark that all methods of culture seem to have their peculiar diseases. It has been noted that grape shoots trained or growing near the ground, are less liable to mildew than when growing higher up—but on the other hand the fruit maturing in these lower vines are more liable to the disease known as the grape rot. This has been often observed, and it came again particularly under our notice at Mr. Bassett's vineyard, at Hammonton, last year.—Ed. G. M.]

### EDITORIAL NOTES.

**FRUITING OF HICKORY TREES.**—It does not take so long for nut trees to come into bearing as many suppose. Mr. Manning of Reading, Mass., has had a hickory to bear in fifteen years from planting.

**PRESERVING GRAPES FOR WINTER USE.**—We have on various occasions noted that the English preserve their fine hot-house grapes for winter use, by cutting them with pieces of the branch, and inserting in a vial of water. So popular is the plan, that contrivances for holding bottles are numerous.

**PLANTING HICKORIES.**—The Hon. Leverett Saltonstall, of Massachusetts, reports that he finds no more difficulty in transplanting hickories than any other trees, if they have been transplanted when young, and this is the experience of nurserymen.

**GOOD OLD STRAWBERRIES.**—It is a remarkable fact that while in this country the Hovey's Seedling now and then turns up, conquering all popular favorites, Myatt's British Queen often does the same in the old world, though now near forty years old. The very old favorite, Keen's Seedling, seems, however, to have gone out entirely. Its name is never heard.

**THE WILDER PEAR.**—This one of Fox's new California Seedlings, and described in our Magazine, was referred to by Mr. Saul at the American Pomological Society's meeting in Chicago, as an excellent variety, which he had eaten in good condition on the 19th of April.

**TRAINED GOOSEBERRIES.**—The *Florist and Pomologist* tells us of the great skill of Mr. Henderson,

the gardener at Moresby Park, in England, in raising fruits. Among other things, he has a wall twelve feet high, the northern fence of which is covered by gooseberries, all trained artistically, and fastened to the wall. The branches are all trained vertically, each four inches from the other. The increase in the number and quality of the fruits on this plan is represented to be enormous. Independently of this, it must be worth going miles to see.

**THE EUROPEAN SPARROW AND THE FRUIT BUDS.**—We have given our opinion in these pages, that the sparrow does not injure fruit buds. This was the result of our own observations in connection with such evidence as we could gather from other sources. It is but proper to note that the editor of the *Gardeners' Chronicle*, whose opportunity for observation is much better than any one's here, is of opinion that they do eat buds. He speaks of it as a well ascertained fact that "sparrows and bullfinches injure fruit buds to a serious extent, even to the destruction of the crop sometimes."

**THE THREE EARLIEST PEACHES.**—The experience of this season confirms the opinion I had previously formed on the respective merits of Mr. Rivers' three earliest seedlings. As the matter concerns growers for the market, as well as amateurs, it is worth recording. Early Beatrice, I see others recommend as the best early. I cannot think so after six years of careful observation, made on about a dozen trees, trained variously and exposed differently—under glass I mean. It is a fine Peach; carries a splendid color, and is of good flavor, but it is generally too small here. If others had mentioned the circumference we might have compared notes. Early Rivers has so far been the very earliest; this season it ripened without fire-heat, on diagonal cordons, by June 14. It is a very fine Peach, of large size, exquisite flavor, prolific, and to be relied on as a setter. All these are cardinal virtues in the Peach for the purpose of sale, and it is for market growers that this notice is intended. But the stone too often decays within, allowing passage to insects. This defect is owing to some tenderness of habit, or some imperfection in the fructification, which is inexplicable to me, considering its healthy foliage and general vigor. Some artificial means might be adopted; these might well form the subject of consideration, for the Peach is a most valuable one. Early Louise is the third of the very early Peaches, and on the whole,

I am inclined now to give my vote for its being the best in its season. It is of a great size here, well colored, and healthy, flavor excellent, and altogether a telling market fruit. It is about a week later than Early Rivers and Early Beatrice. This is, of course, an advantage. Had Early Rivers been of a constitution equal to Early Louise, it would have proved the greatest acquisition made to the Peach grower during the last twenty years; as it is, I like it extremely. We want a very early Nectarine, not too small. Hunt's Tawny is our earliest here, but it is extremely

superior quality, that has not been pushed into notice as its merits deserve. It originated in Cambridge, Washington Co., N. Y., on the farm of Wm. Marshall, some forty years ago, and at present is only known on Long Island. I have grown it a few years, and fruited it this summer; find it in every particular to correspond with the description given it by my friend, whose language I will give:"

DEER PARK, L. I., December 13, 1875.

MR. P. H. FOSTER:—Dear Sir: As you request I will give you a bit of the history, and my opinion

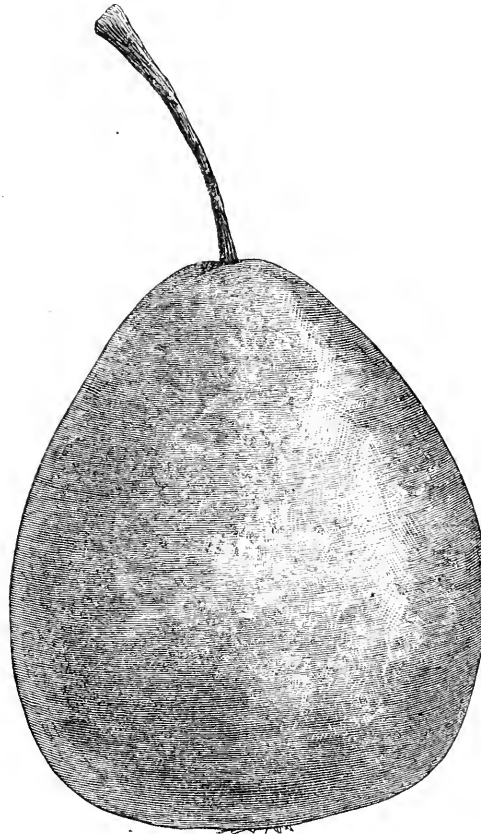

subject to mildew, which dwarfs the foliage and renders the fruit small, unless carefully watched and thinned.—*Thomas Bréhaut, Guernsey, in Gardener's Chronicle.*

### NEW FRUITS.

MARSHALL PEAR.—*See cut.*—By P. H. Foster, Babylon, L. I.—“The Marshall pear, is not a new candidate for public favor, being an old fruit of

of the Marshall pear. While in Washington Co., I procured some grafts, which I have had growing for a number of years. Since they have come into bearing, have cropped them three years in succession. The tree is a moderate grower, forming a top much like an apple; fruit above medium, bell-shape, greenish russet becoming yellowish when ripe, thin skin; flesh white and buttery; flavor neither sweet nor sour; ten days after the Bartlett; juicy; is as good a bearer, and a better

*fruit.* I consider it the best pear for general cultivation. Tree perfectly hardy; fruit smooth and fair, does not crack or canker, is universally admired by all who have seen it growing, or tasted when ripe.

Respectfully yours, &c.,

J. T. WHIPPLE.

### QUERIES.

PLUM CULTURE.—O. W., Ottumwa, Iowa, asks: "Will you please tell us something relating to the best curculio proof plums to grow?"

[The American varieties of the Chickasaw and common red plums are less liable to injury from the curculio than the finer kinds of the European race. They are, however, much inferior in general qualities, and if with a little extra trouble you could succeed in growing these finer kinds, the profit would be considerably larger. Of the foreign kinds—or rather the kinds of the foreign race—there is no one that resists the curculio more than another, though some think they find differences, but a "proof" variety in one place becomes just as bad as others elsewhere, showing that it is rather some congeniality to the situation, giving it more power to resist, than anything of a constitutional character—Ed. G. M.]

VARIATION IN APPLES.—H., Oberlin, O., writes: "By a recent reference in the *Gardener's Monthly*, I see you refer to the Rhode Island Greening producing sweet apples in California and sour in the Atlantic States. Is the authority undoubted for this statement? It is so remarkable that I think it ought to have confirmation."

[The authority for the statement is our own.

We have eaten sweet Rhode Island Greenings from California. If the authority requires strengthening, perhaps the following, from the pen of Charles Downing, may help our good friend to believe. He does not, to be sure, speak of his variations being sour or sweet, but still it goes so far as remarkable variations: "As to the two varieties being found on the same tree, it reminds me of a remark made by a celebrated pomologist, viz.: that he could select twelve apples from a R. I. Greening tree, which any fruit committee would decide to be twelve different kinds, so you may select both Yellow and Green Newtown Pippins from the same tree, but the general crop of the yellow variety will be yellow, and so of the green."—Ed. G. M.]

GRAPE BORDERS.—B. M. D., Spring Garden, Pa., writes: "Wanting to make a vinery for foreign grapes under glass, I went to considerable trouble to dig out a border three feet deep in the clay, and fill in with good earth, with bones and other rich matters to feed the vines, in accordance with the directions in the best works I could obtain on the subject. An English gardener whom I have taken to look after my place says this is all wrong, and that it is more hurt than profit. He says that in England they do not let the grape roots go deep, but very often put a mortar floor under the ground about eighteen inches from the top, so as to prevent them. The gardener seems to understand his business, but how about this advice of the books?"

[Burn the books and listen to the gardener.—Ed. G. M.]

THE BLUSH PIPPIN APPLE.—A correspondent speaks of an excellent apple grown in Western New York under this name. What is it?

## NATURAL HISTORY AND SCIENCE.

### COMMUNICATIONS.

#### "DO PLANTS NEED WATER?"

BY W. H. BLANCHARD, WORCESTER, VT.

I wish also to dissent from the opinion of the editor, and say that they do. Air plants are no more fair examples than fresh water Algae

would be; but let us take common agricultural and garden plants.

If moist air, or the vapor in it, is enough for plants, how can they obtain any of the ash constituents, nitrogen or hydrogen? *Perhaps a little* of the two latter from the air, but none of the ash. These must be in solution in *water* in its *liquid* state.



But it is a question if vapor of water is taken up at all by the roots. Sachs and Knop, in their experiments, found roots would not absorb, but rather exhale, vapor. Free water injures the roots of most plants if they are long confined in it, it is true, but when drained off there is left capillary and hygroscopic water, and with this the plant grows in the most healthy manner.

This is the principle of underdraining land, and there is, of course, moist air in the soil, because it is then open, with air circulating in it; and this air, if there is sufficient water in the soil, will be *moist air*—so that it is true that plants need moist air, but this only as a necessity from having a well-drained soil with water in it, not bottom water, but capillary and hygroscopic.

So keep the hole open in the bottom of the pot and let the plants have a chance to have moist air, but do not keep the soil as an old lady of my acquaintance advised—"a muddy wet."

While the editor says we want moist air in the soil, not water, I say we want moist air in the soil *and* water, and the water furnishes nearly all the food of the plant, save carbonic acid.

For the highest authority in the world on this subject, I refer the reader to "How Crops Feed," by Prof. S. W. Johnson, pp. 36 and 200.

[We do not know that we have any objection to make against this statement. We are reminded of the good minister who objected to dancing, but who was opposed by a gay young parishioner who thought she had Scripture to justify her, and she quoted that "David danced before the ark." "Ah!" quoth he, "David danced singly and alone. If you want to dance as David did, go on." Now, there is water in every thing. In every one hundred pounds of wheat flour there is sixteen pounds of water, but it appears quite dry to us, and we suppose there is no earth that the gardener ever handles so dry but contains "water." But the water we refer to is of another kind. *Wet* and *dry*, horticulturally, are technical terms. To the gardener, when the earth "smears"—makes a paste when he presses it—it is *wet*, contains water; when it rather powders under pressure, it is *dry* to him. There is water there, of course, in a chemical sense, but not in the horticultural one.—Ed. G. M.]

### THE POTATO DISEASE.

BY M.

Permit me to make a few remarks in answer to your and Mr. Worthington Smith's conclusions

respecting potato rot. You are aware, I suppose, of the very marked difference between the old potato *rot* of 1846, '47 and '48 and what is termed the potato blight of to-day. The rot commenced with the potato, the blight with the leaf. In 1848, in Ireland, potatoes rotted everywhere, with one exception, and that was where they were put in ridges by the spade. Those ridges were generally from five to seven feet wide, and I was assured by a correspondent that wrote me at the time that while the potatoes in the centres of the ridges always rotted yet the rows upon the brows of the ridges, alongside the trench, where no water could lie, were always sound and good. In those days, in this country, I could tell by the thermometer what prospect we had for a crop of potatoes. If we had a succession of warm, showery weather in August, so much that the water would lie between the rows, and when tried by the thermometer it would stand from 80 to 85 degrees, and this state of weather continued for three or four days without dry, windy weather setting in, so as to absorb the heated moisture the potato was enclosed in, the crop was gone. If the weather blew up suddenly dry, only such potatoes as the water sat around would go to rot. All others were safe. Many is the stalk of potatoes that I have pulled up, and always found the points of such potatoes as were imbedded in the heated moisture going to decay. I have spread many and often stalks of potatoes partially rotted along the tops of the rows to dry, and always found that as soon as perfectly dried that the rot extended no farther, and that such portions of potatoes kept perfectly sound during winter. Such was potato rot; but potato blight is a horse of another and very different color. It attacks the leaves and tender tops. I have never seen the appearance of a more promising crop of potatoes in Ireland than was last year until, one day a cold, chilly fog came floating along, and which was so cold that by the next morn potato leaves were frozen stiff, so that as soon as the sun came out upon them they began to blacken and afterwards to smell, destroying all the late crop. Now, what was it that killed those potato tops?—for at this time examine the tubers and you can notice nothing wrong with them. Mr. Worthington Smith says that it was fungus. The conclusion that I came to was that a frost that would freeze a tomato, a snap-bean or a potato *stiff* was enough to kill them without asking any aid from a fungus to help. A few days later—26th of August—Isailed from Rothsay, Isle of Bute,

up the Clyde to Glasgow, and found that where the fog, in place of floating, covered its banks like a blanket, and where there was no frost, of course, that not a potato was injured. 27th of August I strolled up past old Bothwell Castle to near to Corrie Lynn and still no potato blight.

It is certainly true that put diseased potatoes in a cellar they will rot, but that has nothing to do with what made them diseased. I once dumped into a covered cave 800 bushels of sound potatoes. The weather was wet, and a good deal of clay stuck to them. About mid-winter I found them heated and half rotten, which I certainly never would have thought of charging to fungus. The same with 200 or 300 bushels of sound turnips that after being carefully topped were piled away in a corner of the cellar that soon began to grow and then to heat, and which, if they had not been immediately scattered, would all have been lost. I was lazy, Mr. Mechan, about sending you my last communication, and as much so this time, but having written, and my conclusions about potato rot thought to be wrong, I want you and your correspondents to pitch into me, as it is only facts that I am after.

[Can our correspondent explain why no "frosts," "heats," "damps," or "fogs," had these destructive effects previous to 1846?—Ed. G. M.]

### TOBACCO AS MANURE.

BY W. H. BLANCHARD, WORCESTER, VERT.

H. L. can best see the value of Tobacco waste by comparing its nitrogen and ash constituents with other plants, as meadow-hay, and wheat-straw and grain, as given by Prof. Wolff, of Hohenheim :

	Water.	Ash.	Nitrogen.	Potash.	Phos. acid.
Tobacco,	180	197.5	46	54	7
Meadow-hay,	144	66.6	13	17	4
Wheat-straw,	141	42	3.2	5	2.3
Wheat-grain,	143	17	20.8	5.5	8

The table shows the number of pounds of water, nitrogen, total ash, potash, and phosphoric acid in 1000 lbs., air dry.

It will be seen that tobacco is the most valuable plant we raise for manure, being worth three times as much as meadow-hay. In practice, farmers consider tobacco-stalks and waste of great value, and apply it to the land, some directly by plowing in, and others by composting it with stable manure and allowing it to decompose; which latter is the better way.

### RESTING SPORES OF THE POTATO FUNGUS.

BY J. G. HUNT, M. D., PHILADELPHIA.

In accordance with your request, I send you the following :

There are three diseases, apparently, afflicting the potato. First, the potatoes may be gathered apparently sound, but after being housed a short time, many of them and often the entire crop, are found soft and in a condition of decay.

Secondly, many tubers are nearly or entirely filled with hard concretions, while only a small part is seemingly healthy, but the entire potato remains dry.

The third diseased state—if it be really distinct from the other conditions—I have more carefully examined. The potato presents many irregular excavations on the surface, extending often deeply into it. These excavations on carefullest examinations present no trace of insect ravages. The sides and entire circumference of each pit are bounded by shrunken, irregular cells destitute of starch granules. On making very thin sections entirely across these excavations and properly treating the sections, a careful microscopical examination reveals the following facts :

In many of the empty cells next the boundary of the excavation are beaded filaments of a fungus, two or more round cells, with the terminal one often presenting a point. Mycelial filaments obscurely septate creep all among these cells, and extend back into and among the more normal cells, in which the starch is still in a natural state. On many of these mycelial threads in the still full cells are oval or round bodies, about the one eight hundredth of an inch in diameter, each containing one or more distinct nuclei. The cells containing these bodies—which, probably are resting spores or oogonia—are generally destitute of starch, though a few grains often remain, but are altered in structure, being rough and broken into fragments. It is apparent, that no insect could produce ravages similar to these, I am, therefore, convinced that a fungus is the cause of this form of disease, and that the plant is *Peronospora*, and that the resting spores are placed where they are in order to get nutrition through their resting stage in order to perpetuate the fungus in the coming season when the new crop shall be planted in the spring.

[At a recent meeting of the Academy of Natural Sciences, Philadelphia, Dr. J. Gibbons Hunt announced the discovery of what he believed to be the resting spores of the potato fungus in

potato tubers. These resting spores had never been seen till last spring, when they were discovered in England by Mr. Worthington G. Smith, and found to be the cause of what was supposed to be a new potato disease. It was, however, but a new phase of the same old species of *Peronospora*, the peculiar season having favored the development of these resting spores, and hence leading to their discovery.

We believe, however, that Mr. Smith's discovery extends no further than the open ground; and that Dr. Hunt's finding them on the tubers and actively at work, is new and important. His remarks will, no doubt, be given in full in the Academy's proceedings; in the meantime, at our request, Dr. Hunt has kindly given the above abstract to us. Ed. G. M.]

### EDITORIAL NOTES.

**PINUS ARISTATA.**—Many American botanists believe that this is the same as one collected by Jeffrey, in California, and named by Mr. Murray P. Balfouriana, and if so, the name of *P. aristata* will have to be dropped, in accordance with the recognized botanical law of priority. It must be confessed, however, that no trees of *P. aristata* have been found that have the cones quite so much narrowed out as those figured from Jeffrey's collection as *P. Balfouriana*. Neither, so far as we know, have any more of this form been collected since Jeffrey's time, though California has been pretty well explored. We would thank any of our readers who may live in those districts, and may find very narrow-coned forms of *Pinus aristata*, to send us specimens. Mr. Jeffrey's cones came from near Mount Shasta, in Northern California.

**UTILIZING THE RAIN.**—Where land is of a hard, rocky character, the rains are liable to run rapidly to the streams, very little penetrating beneath the surface. In such soils forests are of immense service by checking the rapid flow, and giving time for the water to sink in the ground. Little of this water, however, goes to aid springs, but is held by the soil for the trees' own use. The farmer is a much better aid to the water reservoirs of the earth than nature ever was. He loosens the soil by his various methods of culture, so that absorption takes place very rapidly. More rain will penetrate the earth in an acre of well cultivated corn or potatoes, or even in an ordi-

nary timothy sod, in one year, than there would be in the same land, naturally hard and tree covered, in double the time. Art will beat nature in these matters.

**ROFIA FIBERS.**—In many of our seed stores *Rofia* is introduced in competition with Linden bark for tying plants. It is not quite so low in price, but is sometimes thought to go further. It is simply the split leaves of a palm of Madagascar—*Sagus Ruffia*.

**PRONUNCIATION OF DE CANDOLLE.**—A. J. S.: The accent is on the second syllable,—not *De Candolle*, but *De Candolle*. The letters or abbreviations after plants' names are for the names of the botanists who gave the name to the plant. Thus *Fuchsia, Lin.*, signifies that Linnæus gave the plant that name. The reference is useful as furnishing a clue to the original description, and then it sometimes happens that the same name will be given to different plants, when the author's name is almost essential to distinguish one from another.

**NEW COLORADO AND CALIFORNIA PLANTS.**—Dr. Asa Gray contributes to the January number of the Proceedings of the American Academy, notes on various American plants, many new. Some will be of interest to florists when they once get into the seed trade, as quite a number belong to families that have already furnished us with well known favorites. When new Western plants are found, the Asteraceous order is nearly sure to be found among them, as many of these are. A new genus, *Palmerella*, is described,—it is allied to *Lobelia* and another, a shrub from Guadalupe Island, off Lower California, named *Hesperelwa*, of the Oleineous tribe, to which our *Chionanthus* belongs. There are several *Gilias* and allies, a tribe that gives us many ornamental annuals; some *Convolvuli* and *Pentstemons*. The genus *Mimulus*, also containing many interesting plants to the florist, has undergone a complete revise.

There is a genus of plants of the *Chenopodiaceous*, or, to make ourselves understood by the general reader, we may say the order the *Spinage* belongs to, named by Hooker, *Grayia*, in honor of Professor Asa Gray. It is interesting to note that one of the discoveries of Prof. Gray, as recorded in this paper, tends somewhat to weaken this genus and place it nearer the old one, *Atriplex*; at the same time the discovery induces him to elevate an older species to generic rank. *Atriplex*, or *Obione Suckleyana*, is hence-

forward *Suckleya*. It would be annoying to the numerous friends of the distinguished botanist if, after honoring so many others, his own name should fail. There is, however, another genus called *Asa-Graya*, so named by Lindley, allied to *Helonias* in the Lily tribe, and which we believe yields a famous Mexican drug known as *Sabadilla*.

**FERTILIZATION OF CAMPANULA.**—As our readers know, many flowers cannot fertilize themselves, but depend on insects to help them. In this way the pollen is often brought from other flowers than the ones fertilized, and this constitutes what is known as “cross fertilization by insect agency.” In the January number of the *American Agriculturist*, Dr. Asa Gray has an article, written in the clear and happy manner he is noted for when he chooses to write to the popular mind, showing that *Campanula*, the well-known Bell flower of our gardens, is another addition to this miserably helpless class of plants.

**VARIABILITY OF CONIFERS.**—Our English friends give specific names to numbers of forms from our country that we regard scarcely as varieties, not seeming to be aware how variable this class of plants is, and yet facts before them often seem to teach this lesson. For instance, a correspondent of the *Garden* says: “Of this some striking examples may now be seen in Mr. Methven’s Nursery, Edinburgh, among Lawson Cypresses raised from imported seed. Among those plants possessing the most diverse habits and colors, I noted the following forms, viz.:—1. *Cupressus Lawsoniana*, the dark green type, with drooping leaves, and a rather lax habit. 2. *C. L. erecta viridis*, a dense-habited bright green Thuja-like shrub, of erect, almost rigid, habit. 3. *C. L. nana*, a very dwarf glaucous form. 4. *C. L. flaccida*, a greenish glaucous variety, almost pendulous. 5. *C. L. glauca*, a variety nearly like the type in habit, but of a distinct bluish color. Besides these there were many other forms more or less intermediate between them, but those numbered are quite as distinct as are many of the so-called species of *Abies* or *Pinus*.”

**AUSTRALIAN GRAPE FUNGUS.**—Mr. Berkeley tells us in the *London Gardener's Chronicle* about a fungus on the grapes of Australia that may interest our people to know about. He says:

“In the *Gardener's Chronicle*, June 8, 1872, p. 762, I gave an account of a disease which had proved extremely formidable to vines in Australia, where it is known under the name of the

“black spot.” The specimens were not so perfect as might have been wished, but it seemed highly probable that it was due to an obscure fungus belonging to the genus *Gleosporium*. This, like many allied fungi, is probably a mere form of some more perfect organism, connected possibly with it by an alternation of generations. I have now numerous specimens of live shoots sent to the editors by Mr. Edwin Rice, from New Senack, near the seaport of Poti Caucasus, which are affected apparently in the same way, and in a most disastrous condition. Varieties received from England three years since equally with a large quantity of vines from the Crimea, have fallen a prey to the destructive malady, the former having not at present produced a single bunch of grapes. ‘The malady first shows itself at the latter end of June; the leaves begin to shrivel round the edges, diminish in size, and partly curl up from the contraction of the edges; all the young shoots wither as soon as they appear, the first appearance of the disease, as observed under a good lens, being a small blister or bladder containing liquid exactly like a scald in the human flesh; this blister darkens gradually, till it becomes almost black, and turns to a scale, which extends and destroys not only the bark of the shoots, but penetrates a considerable distance into the wood. The bunches of grapes are likewise affected with black spots, which eventually entirely destroy them. The vines at the end of the season have the appearance of plants nearly scorched to death, all the young wood being consumed, and none left for the next year’s training.’ It is curious that the American Catawba is not affected, a circumstance agreeing with the fact that American varieties are in great measure unaffected by the oidium. On examining the shoots I cannot find any perfect *Gleosporium*, though there are plenty of minute tubercles which, from their internal structure, I should conceive to be their early stage, as I find perfect sporophores; but, on the contrary, on one of the specimens there is a *Sphæria*, which appears to be identical with *Sphæria acuminata*, Sow., or, at least, is identical with what is figured under that name by Mr. Currey in the *Linnean Transactions*. It is quite possible that this may be the perfect form of the *Gleosporium*. It is greatly to be hoped that the disease may not visit us after the fashion of the *Puccinia malvacearum*.”

**THE PEAR** (*Pyrus communis*) **AND APPLE** (*Pyrus malus*) are found in their wild state in the

mountain woods of the greater part of Europe, and from these indigenous species have been raised the whole of our orchard and garden varieties. Their amelioration by cultivation, and the perpetuation of varieties by grafting, have been celebrated by poets from the time of Ovid, and continue to the present day. Pliny enumerates thirty-nine different pears known to the Romans, several of them being also mentioned by Virgil, Cato, Columella, Juvenal, Macrobius, &c. Fée has endeavored to identify some of them with modern French varieties, and Galesio with Italian ones, as in the following examples:—

PLINIAN NAMES.	SUPPOSED CORRESPONDING MODERN NAMES.
Amerina serotina . . .	San Tommaso.
Lactea . . . . .	Perle or Blanquette.
Dolabelliana . . . . .	Winter Bon-Chrétien.
Falerna succosa . . . .	Bergamot.
Favoriana rubra . . . .	Large Muscat.
Superba parva . . . . .	Little Muscat.
Hordearia . . . . .	Common Muscat.
Mustea . . . . .	A variety of Bon-Chrétien.
Picena or picentina . . .	Spina.
Pompeiana mammosa . . .	Campana.
Viridis . . . . .	Spadona vernina, considered by Galesio as a most ancient Italian Pear.
Myrapia . . . . .	Guignoline .
Volema . . . . .	Another Bon-Chrétien.

In Tuscany, under the Medici, we find, in a manuscript list by Micheli of the fruits served up in the course of the year at the table of the Grand Duke Cosmo III, an enumeration of two hundred and nine different varieties of pears, and another manuscript of that time raises the number to two hundred and thirty-two. Among them, grafts of the Dorice Pear of Portugal were introduced by the same Grand Duke, at a cost of one hundred golden doubloons, whence it received the name of Pera cento doppie, by which it is still known, as well as by that of the Ducal Pear.—*Gardener's Magazine*.

**SPECIES OF AMERICAN PLUMS.**—So many of our readers fail to distinguish the species of American plums that the following, prepared for Mr. Curley's recent work on "Nebraska," by Prof. Aughem, will help them.

"There are three type species of plums in the State, namely, *Prunus americana*, *P. chicasa*, and *P. pumila*. Of these there is an almost end-

less number of varieties. In a plum thicket in Dakota County, covering only a few acres, I counted, while in fruit, nineteen varieties of *Prunus americana* and *P. chicasa*, varying in size from a fourth to 1½ inches in diameter, and in color from almost white and salmon, to many shades of yellow, tinged with green and red, and from a light, dark, and scarlet red, to purple tinged with different shades of yellow. Such instances are frequent over most portions of the State, the plums being common in almost every county, especially along the watercourses, and bordering the belts of timber. These plum groves in spring time present a vast sea of flowers, whose fragrance is wafted for miles, and whose beauty attracts every eye. The varieties of *Prunus americana* have oval or obovate leaves (broader at the tip than where the stem is attached), with saw-toothed or doubly saw-toothed edges and very full of veins. The fruit is globular or oval, and ranges from half an inch to 1½ inches in diameter, the latter being an exceptionally large size. The color is all shades of yellow, with some red and crimson. Its juice is pleasant, but its skin is tough and acerb, and its stone is sharp-edged or margined. The shrub varies in height from 6 to 25 feet. The fruit ripens in August and the first half of September. These are the prevailing characters, but they vary greatly, some of the varieties producing fruit which is a great improvement in size and taste on the type species, while others again, have deteriorated. Still more subject to change is the *Prunus chicasa*, which grows from 4 to 12 feet in height, sometimes thorny, and always with long, narrow, almost lance-shaped, acute leaves, whose edges are set with very fine teeth. The fruit is globular, of all shades of red, and from half an inch to an inch or more in diameter, of pleasant, some varieties of delicious, flavor, thin-skinned, and containing an almost round and entirely marginless stone. The dwarf or sand-hill Cherry, so famous on our western plains, is really botanically a dwarf plum, *Prunus pumila*, and therefore we speak of it last. The stem is smooth, depressed, trailing or semi-erect, from 8 to 24 inches high. The leaves are obovate lanceolate, tapering to the base, sometimes a little toothed towards the apex, and pale underneath; the flowers numerous, two to four in a cluster. The fruit varies greatly, but is generally about half an inch long and three-eighths broad, ovoid, dark purple, brown purple, brown, reddish, or nearly black, generally sweet, sometimes delicious and occasionally almost in-

apid. It is enormously productive. In one of the plates is represented a specimen of this fruit, natural size, taken from a shrub 13 inches high from the root, and found south of Lowell. The shrub has a spreading habit, forming dense masses, sometimes covering from 30 to 60 square feet of ground, but usually the tufts are not more than from 15 to 25 feet in area. It suckers abundantly from the roots, and propagates in this way as well as by seeds. It is found over the greater part of the western half of the State, and while it is not excluded from the richest soil if dry, it seems to be partial to sandy localities rich in alkaline earths. As this plum is nearly related to some of our cultivated varieties of cherries, and the stamens and pistils of the flowers are large in both, it will require no great skill to produce a cross between them; and as Fuller has remarked (*Small Fruit Culturist*), a cross between the dwarf plum and a bigarreau or morella variety, retaining the dwarf habit, vigor, and productiveness of the former, with the flavor of the latter, would be an acquisition of incalculable value, and would completely revolutionize cherry culture. However this may be, the best varieties of the dwarf cherry are valuable, as they come from the hand of Nature. Many an explorer and traveller in the unsettled regions has been refreshed by them, and the day is not distant when this fruit will, as it deserves to, have a place in the gardens of all the people."

### QUERIES.

**DROSELA ROOTS AND WATER.**—At p. 24 we endeavored to show that deep roots take in only water, because there is nothing more that they can take, and referred to a similar experience of Mr. Darwin's in regard to Drosera. The following is Mr. Darwin's:

"The absorption of animal matter from captured insects explains how Drosera can flourish in poor, peaty soil,—in some cases where nothing but sphagnum moss grows, and mosses depend altogether on the atmosphere for their nourishment. . . .

"We can thus understand how it is that Drosera roots are so poorly developed. These usually consist of only two or three slightly divided branches, from half to one inch in length,

furnished with absorbent hairs. It appears, therefore, that the roots serve only to imbibe water, though no doubt they would absorb nutritious matter if present in the soil, for, as we shall hereafter see, they absorb a weak solution of carbonate of ammonia."

A correspondent calls our attention to our statement, and so we give Mr. Darwin's own words. The Drosera roots cannot, in the sense in which we said deep roots of trees could not, "because there is nothing else to take." If, however, the expression "cannot" were to be taken as "absolutely powerless," it would be an interpretation not warranted by Mr. Darwin's words.

We used Mr. Darwin's observation merely to illustrate our own point in regard to deep roots not having anything to take but water, without any regard to its application to Mr. Darwin's case. But since our attention has been more particularly drawn to it by our correspondent, we are led to ask whether the peaty or boggy places in which many Droseras grow are really so "poor" as Mr. Darwin's language would seem to imply?

**CROSS FERTILIZATION OF FRUITS.**—"Justice to Mr. Garfield impels me to say that I had nothing to do with the very interesting experiments made by him upon cross fertilization of fruits, noticed on page 23 of the January number of the *Monthly*. So far as I know he is entitled to the full credit of the work. C. E. BESSEY."

CAMBRIDGE, MASS., Jan. 7th, 1876.

**PLANTS' NAMES.**—M.—All generic (the first) names are spelled with a capital letter. No specific names (the second) begin with capitals unless they are proper nouns or their genitives. Thus we write *Abies alba*, the white spruce, but *Abies Douglasii*, the spruce of Mr. Douglas.

**FUNGI.**—A knowledge of these minute plants is of great use to the gardener. The following was not sent to us for publication, but we give it in the hope it may help the study.

Dear Sir:—I beg to call your attention to some collections of *Fungi* which I have made. They are put up in sets of 100 species each; *correctly* named, and represent all the principal orders. Price, \$8.00 per set. Should you feel interested in such plants please write for any further information. Should you wish some nice specimens of *Marine Algæ* I could furnish them.

Yours, very truly,

B. D. HALSTED,

Bussey Institution, Jamaica Plain, Mass.

# LITERATURE, TRAVELS & PERSONAL NOTES.

## EDITORIAL NOTES.

ACKNOWLEDGMENTS.—The letters of appreciation of the *Magazine*, and the kind notices of our newspaper contemporaries are so numerous, that we have to return our thanks in one general acknowledgment. While, however, conscious that some of the success of the *Magazine* has been owing to the efforts of the Editor and the Publisher, we cannot forget how much is really due to the numerous correspondents who have helped us through so many years. The whole of this mass of information has been the *free will offering* of friends of the *Magazine*. Occasionally we have well studied and carefully elaborated papers offered for sale, well worth all that is asked for them,—but we have to confine ourselves, in view of our limited space, to the short newsy class of matter, which enables us to touch upon a vast variety of topics that go to make up general gardening.

A WEDDING IN IOWA.—The "Editor of the *Gardener's Monthly*" was made happy by the receipt of an invitation card to attend the marriage ceremony between Miss Jennie Wright and Mr. Alex. E. Patton, of Ennis & Patton, of Lyons, Iowa, on December 27th. It was pleasant to be thus kindly remembered, and though it is twelve hundred miles away, we advise our good friends not to tempt us in that manner too often, or we may be there one of these times. We represent so many who esteem the firm of which Mr. Patton is a member, that as "Editor," we feel that in a sort of representative capacity we can offer a host of congratulations at this new evidence of happiness and prosperity.

WHERE PLANTS CAN BE PURCHASED.—We often have inquiries as to where the plants noticed in our columns are to be obtained. This is a matter that wholly concerns our advertising columns, and out of place in this department. As a general rule, however, the leading firms who advertise in our columns either have the plants or can obtain them; and a line to them will generally get the needed articles. Sometimes the plants are only as yet in England; but most of these

firms have European connections, and if an order is given, should they not have them on hand, they will get them if a little time be given. For instance, we have some inquiries now where things can be had referred to in our January No. Turning to the advertising pages of that number, we see that rare flowers and trees are dealt in by Parsons, Ellwanger & Barry, Saunders, Meehan, Miller & Hayes, E. M. Wood, H. A. Dreer, Sked, Paddock & Co., John Saul, and Geo. Such. These especially mention *new plants*. There are others who do not specially mention them, and the list may be increased by looking over past numbers. In this way almost anything noticed in our columns can be obtained.

LATIN NAMES FOR GARDEN VARIETIES.—The *Gardener's Chronicle* says, "As a general principle we should prefer that Latin names should not be given to artificial productions;" this is the ground we have taken.

POTTSVILLE, PA.—A correspondent tells us that on December 9th, the thermometer was 44° in the shade at Pottsville. This is pretty mild for a mountain climate, this city being 900 feet higher than Philadelphia. Gardening is slowly progressing in that great coal centre, though just now suffering somewhat, as it is in all other parts of the country.

LOW PRICE OF AMERICAN NURSERY STOCK.—The celebrated nurseries of Luccombe, Pince & Co., of Exeter, England, have recently been sold at public sale. The apple trees are regarded as having been sold low,—at an average price of 75 shillings a hundred. People often have an idea that trees are much higher in American nurseries than in English ones,—but our nurserymen would think themselves in "clover" if they could get an average price of \$20 per hundred at a public sale.

RESPONSIBILITY OF SEEDSMEN.—At a meeting of the Seed Trade, held at the Astor House, in the City of New York, on the 6th day of January inst., at which were represented the principal houses of New York, Boston, Philadelphia and Albany, the subject of the liability of Seedsmen for damage by failure of crops

from seed sold by them, was fully discussed—and thereupon after much consultation, it was considered by the meeting that, in view of recent decisions in the States of New York and New Jersey, holding Seedsmen liable for all damages happening to their customers by reason of failure of their crops, which could be traced to the Seed sold, it was imperatively necessary for them to adopt such measures as should protect them from the claims of designing or ignorant parties.

The meeting therefore adopted a resolution that the Seedsmen print upon their packages, bill-heads and circulars, a notice similar to the following:

“While we exercise the greatest care to have all Seeds pure and reliable, it is hereby mutually agreed between ourselves and the purchaser of this package, that we do not warrant the same, and are not in any respect liable or responsible for the Seeds sold by us, or for any loss or damage arising from any failure thereof in any respect.”

It is unnecessary to add that the dealers, without dissent, disclaimed any idea of selling poor or imperfect Seed; they propose as heretofore and always, to use their best efforts in good faith to furnish their customers with the best, and while they do not doubt that this will be well understood and accepted, they feel confident that their customers will at the same time approve and justify them in their efforts for self-protection.

**FLOWERS IN CEMETERIES.**—A cemetery is most certainly the right place for a profusion of flowers. Of all out-door monumental decoration these are by far the most beautiful and appropriate. Those who have money to spend upon the last habitation of their friends and relations, and who piously desire to show their love and sorrow by some sort of outward sign, will act more wisely in paying some annual fee to the cemetery gardener to keep churchyard flower-beds trim and pretty, than in laying out a vast amount of money among stonemasons, resulting in ill-executed angels, or trophies of cannon-balls and swords and cocked-hats, and other such insignia, hinting at the professional career of the deceased. The sums of money spent on these great ponderous symbolical monuments are often very large. But who that has groaned in presence of some hideous specimens of sepulchral bad taste, some terrible combination of cherubs and skeletons, of scythes and hour-glasses, of broken columns and ponderous marble clouds, and who has felt the

beauty of one of these flower-begirt graves, will not testify to the superiority of the gardener's work over that of the stonemason? There is, too, a symbolism in the introduction of flowers here which makes them specially fit. These plants have come up from a root which itself was buried in the earth in order that the flower which we admire might bloom. They were put into the ground in the form of seed or bulb with no beauty about them to win our admiration, but they come up in due time arrayed in such splendor of decoration as cannot fail to fill us with admiration first, and then, as we think longer, with hope. They are grasses of the field whose perishable nature has been made before now to typify the insecurity of human life. Moreover, they suggest, at least, a certain continued supervision, a daily tending and care, which favor the idea that those to whose memory they are sacred are still held in recollection by their friends.—*All the Year Round.*

**ANNUAL REPORT OF THE PENNSYLVANIA FRUIT GROWER'S SOCIETY FOR 1875.**—This excellent report is beautifully illustrated with plates of various Pennsylvania fruits, and has numerous essays, and reports from many of the leading horticulturists of the State, besides brief notes of the discussions. It is given free to all members of the Society, which we are pleased to see by the list printed herewith is quite a full one in comparison with that of some other States, though not as full as a great State like Pennsylvania ought to have. Mr. W. P. Brinton, Christiana, Pa., is corresponding secretary; and Mr. E. B. Engle, of Marietta, the recording secretary.

**SIXTH BIENNIAL REPORT OF THE BOARD OF TRUSTEES OF THE IOWA STATE AGRICULTURAL COLLEGE. 1874-1875.**—This institution seems to be very successful, nearly three hundred students annually availing themselves of its advantages, a large number being young women. Among the reports of departments, that of horticulture and forestry is full of interesting matter. A large number of experiments have been tried on various subjects,—and although many of the matters sought to be proved have long since been decided, it does not detract from the value of the observations. Indeed, it is one of the weaknesses of our profession, that too much is taken on trust. We can only wish that more would follow the example of Prof. McAfee and go over things as he has done. Some of the expressions seem strange to “old stagers.” In an account of preserving tree



seeds, for instance, we are told that white oak, red oak, burr oak and others, kept better in layers piled on the surface all winter, than in the less economical rot heap. A nurseryman who would put such seeds as these in a "rot heap" would be thought crazy. A "rot heap," in nursery phrase, is a spot where hard bony seeds lie for a year before sowing. We opine further that some of the failures or successes in some of the experiments are due to deeper causes than those supposed,—and we think that repeated experiments, to prove some of the points, would not always end the same way. Prof. Bessey has an interesting chapter on smut in Indian corn, and some other plants.

MR. DAVID WEBSTER.—This gentleman, well known in connection with landscape gardening, and a contributor to our pages, is at present on a tour through California. We notice, by the California papers, that his lectures on ornamental gardening are well received there.

MR. JOHN ELLIS—Well known to horticultural readers of ten years ago as "Fox Meadow," is now engaged at the University of California. He is planting an arboretum of all plants that will stand that climate.

TEXT BOOK OF SCIENTIFIC AGRICULTURE.—By E. M. Pendleton. M. D. Professor of Agriculture and Horticulture in the University of Georgia. 2nd Edition. Published by A. S. Barnes & Co., New York.

This is one of the most useful works of this class, published in this country,—and should be in the library of every intelligent farmer and gardener. It treats of the anatomy and physiology of plants; of meteorology; of soils in their relation to physics; chemistry of the atmosphere; chemistry of plants; chemistry of soils; fertilizers, and animal nutrition. Not the least interesting is the appendix, which gives a complete history of all the leading agricultural plants including cotton and other Southern staples.

The author has drawn on foreign investigators chiefly for his facts. Prof. Kedzie, of Michigan, and President Clark of Amherst, and Mr. Ravenel have each a single reference; and Prof. S. W. Johnston is quoted in a few instances. The main reliance is chiefly on the results, often contradictory, of foreign workers. We doubt very much whether some of the positions assumed would find unhesitating support in this country; and consequently, the practices deduced from these principles sometimes become questionable. In

the present state of our knowledge, however, no person can write a book like this and have its teachings as unquestionable as a work on geometry would call for; and the weak points we have referred to, do not in the least detract from the value of the book, which we hope will find itself in the hands of all our readers.

LANDRETH'S RURAL REGISTER; VICK'S FLOWER AND VEGETABLE GARDEN—deserve more than a passing notice, on account of the immense amount of useful information they contain. The latter is an especially beautiful production, and is a great credit to the American trade.

CENTENNIAL HISTORICAL CALENDAR.—Philadelphia, published by T. W. Price & Co., for 1876.

This little *almanac* will be of immense service to any one visiting the Centennial. There is a map of Fairmount Park with references to the leading points of interest, with addresses of the hotels, directions of the street cars, and many matters that will interest the stranger. No price is named, and it is probably for gratuitous distribution by the firm above named.

THE AMERICAN NATURALIST.—As announced in our last, this magazine appeared in January, under the protection of Messrs. Houghton & Co., of Boston. The popular character of the magazine has been immensely extended, and we shall be surprised if it does not soon become one of the most widely circulated of American periodicals.

THE RURAL JOURNAL.—This is a new candidate for public favor, published by H. Young, and edited by Prof. S. B. Heiges, of York, Pa. The editor is well known to the farmers and Fruit Growers' of Pennsylvania, as one of the most intelligent gentlemen connected with their interests; and he is also known to our readers by an occasional contribution from his pen. He was one of the best presidents the State Fruit-grower's Society ever had, and our editorial brethren receive in him an honorable addition to their ranks. It is a very cheap agricultural paper—only 50 cents a year.

THE GARDEN.—This English weekly, now in its ninth year, has been a great success. The publisher is now emboldened to add a weekly colored plate, raising the price of the magazine one-fourth more than it was before.

THE PRACTICAL FARMER.—This well-known agricultural paper, which, for seventeen years was published by the late Paschall Morris, in Philadelphia, continues to prosper, and will hereafter be issued as a weekly.

## QUERIES.

PRONUNCIATION OF GLADIOLUS.—A valued correspondent writes in regard to the paragraph at page 29: "We say *Gladiolus*, because the penult is short, and the rule is that when the penult is short the accent falls on the *ante-penult*."

"Now, if it be asked why the 'i' is short, the answer is given in the first rule in prosody in my Latin grammar: 'A vowel before another vowel, or a diphthong, is short;' to which follows a string of exceptions, none applicable to *gladiolus*.

"Then the case is hit by another rule: 'Diminutives in *ulus*, &c.,—shorten the penult.'

FORESTRY.—A correspondent asks if we cannot

give attention to this important branch of culture. We have done so—sometimes placing the matter under our "Fruit and Vegetable Garden," because it seemed a matter of profit—or as incidents, under some other department. But we will in future, give it a head of its own.

REPRINTING THE FIRST VOLUME.—E. S. W. Berlin, Mass., writes, "I wish you would reprint the first volume of *Gardener's Monthly*, and make it uniform size with the rest, (I have all) and I will take one copy."

[It would cost as much as an ordinary book of that size, and take at least a thousand subscriptions, and perhaps more of them at \$2.10 to make expenses.—Ed. G. M.]

## HORTICULTURAL SOCIETIES.

### COMMUNICATIONS.

#### KANSAS STATE HORTICULTURAL SOCIETY.

BY H. E. VAN DEMAN, GENEVA, KAN.

The ninth annual meeting of this Society was held at Manhattan, Kansas, on the 14th, 15th and 16th of December past. The most of the regular and reliable members of the Society were present, except Dr. Wm. M. Howsby, who has grown gray and become almost superannuated in the labors of the cause; and Mr. S. T. Kelsey who within the last year has removed from the State to North Carolina, where he is now prosecuting the business of practical fruit growing.

Upon recommendation of the Committee on Constitution and By-laws, the Constitution was so altered that all ladies attending the meetings were permitted to all the privileges of membership without admission fee, and each of the District Horticultural Societies were entitled to two delegates, and each of the other auxiliary Societies of the State reporting to the Secretary of the State Society were entitled to one delegate, who should be admitted to annual membership free of the usual fees.

H. E. Van Deman, of the standing Committee on Botany and Vegetable Physiology, called the attention of the Society to the same matter to

which reference was made at the previous meeting at Fort Scott in June last, viz.: The death and injury to trees and plants in Kansas during the last two years.

As before stated, the two prime and chief causes were the drouth of the summer of 1874 and the defoliation by locusts the same season. These so weakened their vital force that nearly all kinds of trees and plants were not able to resist the evaporating influences of the following dry, cold weather without injury. Many died outright even before the winter set in, which was unusually dry, and when the spring came many more were either dead or seriously weakened by evaporation. The past summer has been further witness to the same causes of injury, which was shown by the feeble growth of many trees and plants when the season just past was most favorable to growth. The same causes he thought might occur again, and if the true physiological principles were understood, the horticulturists of Kansas might be able to prevent or ameliorate in a degree, the natural results.

Mr. Cutter, of Junction City, spoke of the damage sustained in 1874 by the parched condition of the earth killing the surface roots, and so cutting off the supply of moisture usually taken from the soil. Mulching he had found to counteract this influence.

Dr. J. Stayman, of the Committee on Vegetable Gardening, read a report or an essay giving directions to all engaged in either market or home gardening. They did not differ from those usually given for the more Eastern States. During the evening of the first day an address of welcome was given by Mr. R. A. Parker, from the citizens of Manhattan, and responded to by H. E. Van Deman, on the part of the Society.

It is a noteworthy fact that since its first organization, the members of this Society have been most freely and generously welcomed to the homes of the citizens of every place in which its meetings have been held. Indeed, we think, for the State and the Society, this method of circulatory meetings is far better than a permanent location.

The officers elected for the ensuing year are: President, E. Gale, of Manhattan; Vice President, Robert Milliken, of Emporia; Secretary, G. C. Brackett, of Lawrence; Trustees, H. E. Van Deman, of Geneva; D. B. Skeeles, of Galesburgh; and Geo. Y. Johnson, of Lawrence; Treasurer, F. Wellhouse, of Leavenworth.

Following the report of the standing Committee on Arboriculture was a long discussion on windbreaks, their uses and construction, the best trees to plant in them, &c. The cottonwood seems to be one of the most available and suitable. Lombardy poplar, the ash and elm in their native species, the silver maple, and better than all for a quick growth, good fuel, besides a quantity of fruit, the common seedling peach, that can easily be obtained and grown by the people.

We had a most instructive talk, as he called it, from Prof. Wm. K. Kedzie, of Kansas State Agricultural College, on the experimental stations of Europe, based upon his recent tour of observations among these institutions. He thought America should not be blind to the value of such great instructors as similar stations would be in this country. Private individuals cannot afford the time and means to properly carry out this grand idea, and the general government or the States should each foster it. We of Kansas propose to see first what can be done without money, and hope to inaugurate a series of experiments that may never stop short of untold good to the fruit growers of this region. With such a live, willing, working chemist as our young Kedzie, and such an entomologist as Biley, of Missouri, to aid us, we may hope to reach some sound conclusions.

This latter enthusiastic worker favored us with his presence, and in his quiet, plain, sensible way gave us much instruction. He who rides a bug for a hobby certainly has a lively time if he keeps his seat, but Riley comes as near it as the next one. The grasshopper from the Rocky Mountains gave him a rough jolting this last trip, and indeed this whole Western country has felt the effects of the ride. We want the government to order a survey of the region from whence they came and to which they have gone, which lies in the Rocky Mountain plateaus of Northern United States. Perhaps we can then be able to effectively combat the devastators. You see that we, from necessity, are horticulturists of the rough and ready pioneer sort, who can scarcely yet get to even *discuss* the more æsthetic and elaborate departments of the subject. We have aspirations, but must needs first lay the foundations for what are as yet but our air-castles.

Let me say that the tree act of Congress, granting lands to those who should plant and cultivate a certain per cent. of the acres taken, has proved entirely abortive in Kansas.

---

### EDITORIAL NOTES.

THE SOUTHERN STATES' AGRICULTURAL AND INDUSTRIAL EXPOSITION.—It is sometimes said of Southern people that they lack energy and "push." The managers of this society are not open to this charge. There never was an enterprise better advertised. This is to be held for ten days from Feb. 26th. It happened recently that we had the pleasure of going through these fair grounds at New Orleans, and can conceive of nothing more beautiful to a Northern eye. If any of our readers would like to know how it feels to walk down an avenue of Orange trees, and see the Banana, the Pomegranate, and similar things flourish in the open air, he could not do better than take a trip to New Orleans, and do it at the time of the holding of this great fair. If he wishes to take his horticultural products along for exhibition he can do so, and get a schedule, with a colored lithograph of the beautiful grounds, from Sam'l Mullen, Esq., New Orleans.

THE CENTENNIAL EXHIBITION.—The exhibition was looked on rather coldly in England for awhile, and, perhaps, considering the superiority of English gardening over ours, it was but na-

tural that it should appeal but little to the sympathies of English horticulturists. The following from *The Gardener's Magazine*, however, shows that it may not prove wholly unattractive to our English friends:

The International Exhibition of 1876, which will be held in the city of Philadelphia, will in all probability constitute as distinct an epoch in the history of international exhibitions as did the first of the series, held in the lovely palace of glass in Hyde Park, London, in the year 1851. Since then the experiment has been repeated in many of the great cities of Europe, London included, and, though it cannot be said that failure was felt anywhere or any when, until a *permanent* exhibition was organized at South Kensington, yet there has always been wanting the freshness, the surprise, and the completeness of the first venture, while the partial successes achieved have been more or less prejudiced by a pervading sense of weariness. If any such thing as a great international exhibition is wanted now, the Western continent is certainly the proper place for it. For the present, and for some time to come, the old world has had enough of these things, and it is well that our cousins on the other side of the Atlantic have taken the subject out of our hands, and intend to rehabilitate it in their own thorough and original way of managing such affairs. The description of the scheme, which will be found in another part of this sheet, will show that the scale is vast and comprehensive, and comprises features now for the first time attempted. All the industrial arts will be fully represented, while agriculture and horticulture will obtain a prominence they have never enjoyed before in similar undertakings, a course of procedure consistent with the requirements of the age as well as with the characteristics of American enterprise and taste.

One of the necessary consequences of the location of the exhibition will be that the old world will visit the new world in considerable force in 1876. Hitherto the traffic across the Atlantic has been chiefly determined by business considerations, for although Americans visit Europe in considerable numbers, very few Europeans visit America, except in obedience to calls of duty or the temptations of commercial advantage. In matters intellectual the people of the States have always had to subsist for the most part on the products of the old world, and the influence on them of European thought has of necessity developed an interest in European scenery and

memorials and manners. The playful sarcasm, that "rich Americans when they die go to Paris," represents fairly enough the joyous curiosity with which our Western cousin starts on his tour of Europe, which may be said to begin at Stratford-on-Avon, to culminate at the mosque of St. Sophia, and to end somewhere in the neighborhood of the Tuileries. Between us in respect of such matters the reciprocity, thus far, has been quite partial; for few Englishmen, and in proportion, fewer Continentals, have visited the States unless they were impelled by motives of interest or that conviction of duty which makes the sea as dry land, and converts danger and strangeness into delights which fill the soul with agreeable expectancy. But a change is coming, and, indeed, has come. The active spirits of the old world are on the move. Philadelphia is the universal goal of the reflective, inquiring, and adventurous ones of Europe, and in an especial manner of all possible English visitors to any possible exhibition. It is early as yet, perhaps, to make the trip, but many whose ruling motive is curiosity are already on their way, and the completion of the exhibition buildings will be witnessed by many nationalities.

The spring of 1876 will see a vast exodus westward, and it is certain that thousands of brave Britons will obtain a glimpse of the United States in a very agreeable way, who would never have sought such a pleasure except through the persuasions of an international exhibition. All will be done that can be done on both sides of the Atlantic to facilitate the movement; but the sea that divides will take its toll of our time, however otherwise it may be disposed to help us. The great Napoleon abolished the Alps by marching over them, and the only way to abolish the Atlantic is to take the fastest ship, and consider the feat of crossing it a nine days' wonder. Some time early in the summer of next year, some great excursion parties will be organized for doing the thing cheap and sociably, and even now various kinds of accommodation are being prepared for the very many who will make the exhibition an excuse for a good look round at the wealthiest cities and most renowned scenes of the western continent; so that many who begin at Philadelphia will have Lake Superior, and Niagara, and Quebec in the programme, and will be wiser when they return than when they went out; or, if not really wiser, certainly richer in observations, and reflections, and comparisons that the "memory will not willingly let die."

THE  
GARDENER'S MONTHLY  
AND  
HORTICULTURIST.

DEVOTED TO HORTICULTURE, ARBORICULTURE AND RURAL AFFAIRS.

Edited by THOMAS MEEHAN.

VOLUME XVIII.

MARCH, 1876.

NUMBER 207.

FLOWER GARDEN AND PLEASURE GROUND.

SEASONABLE HINTS.

One would suppose that with all that has been said in our pages in regard to deep planting, we should not see much of it done; but it is very common, and we have to note the evils continually in our travels. If the land is dry and sandy, or the trees with a few heavy roots of a thick "tap" like character, it does not matter so much. In the sands of New Jersey one may set trees deeper without injury than in Pennsylvania, and one would find much less injury in the dry earth of Colorado, than in the moister climate of Iowa. The Oak or the standard Pear does not suffer much from deep planting, but it is best to set them but little deeper than they grew before. Fibrous rooters like Maples and Ashes must be kept tolerably near the surface, while hair-rooted things, such as Rhododendrons and Azaleas, if not growing in almost open sand, must be set on the surface or not at all. We note these remarks through having recently seen the attempts of a friend, and we are sorry to say, a reader of the *Gardener's Monthly*, to grow the Rhododendron on quite an extensive scale, a comparative failure from deep planting. They were not very deep either; an Apple would not have rebelled at the treatment. The balls of roots in a Rhododendron should be set, as a general rule, on the ground, and the earth drawn up about the roots, and pressed very firm.

What we say of deep planting for trees, applies also to deep planting of flower or other seeds.

We may put a Walnut or Chestnut several inches under ground, or six inches under ground if sown in sand; but for our ordinary seeds, we want them as near the surface as we can get them. Suppose we actually take our readers to the garden, and show them practically how to sow their flower seeds.

The day is warm, and the surface soil just dry enough to powder when struck with the back of the trowel. We should not ask their company otherwise, for when the soil is sticky it won't do to sow seed. The ground has been dry several days before. The surface is now powdered and about the thickness of the trowel blade scraped off. The seed is then sown, the soil drawn back and beat firmly down on the seed. You see how near the top we sowed the seed, and how firmly we beat the soil over it, and we spoke about a "first principle." This principle is this:—Seeds want moisture to make them grow, but they must also have air—one is an evil without the other. If deep they get only water, in which case they rot. If entirely on the surface they get only air, and then they dry up. "But, Mr. Hintsman, why beat the soil so firm?" Another principle, dear lady, lies there. Large spaces in soil enable the earth to dry out rapidly; small spaces, on the other hand, hold water. Crushing earth, when dry, gives it these small spaces, or as gardeners call it, makes it porous, and thus you see we have set our seeds where they will be near the air, and fixed them so that they shall be regularly moist.

While caring for the flowers, forget not the

lawn—that great charm—without which a garden is not worthy of the name.

Our readers all know that the soil should be made as deep as possible, because a deep soil is generally a reservoir of moisture, from which is replaced the waste from the drying surface, under the summer heats, and thus the grass is kept from burning out. But this is not all. Lawns soon become impoverished by exhaustion of the soil, and by continual mowing,—and this has to be provided for. Mowing machines particularly injure lawns, by their very close and continuous cutting. But this must not be an argument against the machines. We cannot do without them. One should be on every lawn of any extent. But we must in some way provide a counter advantage to check the weakening influence which they undoubtedly exert. One of the troubles of close mowing is, that the grass is so weakened in vitality that little, low, vile weeds soon advance their forces, and choke out the grass. Allowing the grass to grow up without mowing for a year will give renewed vigor to the grass, and be death to the little pests; but in a year or two the old sod will be as bad as ever, and it is doubtful whether the advantages of the plan compensate for the untidiness. It is, perhaps, better to follow the suggestions of previous volumes, to set the machine so as not to cut so low as we did on the first introduction of mowing machines, where it has not been done.

The hints we offered in our last number are in general applicable to this also.

### COMMUNICATIONS.

#### FOREST HILL CEMETERY, UTICA, N. Y.

A correspondent sends us the following from the pen of a citizen of Utica,—and we have from Mr. Roderick Campbell the favor of photographs of the buildings. The idea is excellent, and promises to be very popular.

When the Mort chapel was erected in Forest Hill Cemetery by the late Mrs. Silas D. Childs, the trustees of the cemetery thought that a suitable place had been secured for holding the final services over the remains of the dead. Experience proved, however, that it was unsuited to this purpose in winter. As the building is constructed of stone, its temperature is very low in winter, and as during this season bodies are kept

in the catacombs till spring, the application of heat is out of the question. On many days it was colder in the building than out of doors. The trustees therefore determined to provide a building which could be used at all seasons of the year.

The conservatory is constructed in the form of a triple arch, the middle arch being the highest. The side arches, or lean-tos, join the main arch just beyond the highest part of their curve. The conservatory proper is 80x36 feet in size, and constructed almost wholly of glass. In front of the building is a porch, or *porte du chaise*, 12x13, supported by two pillars, under which the funeral parties alight without exposure. On entering, the visitor finds himself in a vestibule, 20x16 feet, separated from the rest of the building by glass partitions. From the vestibule a door opens into the auditorium and conservatory. This part of the building is 60 feet in length.

The auditorium is 16 feet wide, and directly under the main arch which is 25 feet high. The floor is laid with alternate strips of ash and black walnut, sufficient space being left between the strips to allow the heat to rise from below. On either side are benches, of the same material, for those attending funerals. Under the side arches, which are 13 feet high, are flower beds, 10 feet wide, extending on either side the whole length of the building. Hot-houses are divided off by a glass partition in the front part of the building on either side of the vestibule, where tropical plants, requiring a higher temperature, are kept. From the vestibule a stairway leads to a gallery of the same size as the vestibule, and from which a very good view of the interior can be obtained. On the west of the conservatory, and about the centre of it, is the tower and observatory, 40 feet high. In the basement of this are two large boilers, which supply the building with heat. The heated water from these boilers flows through 2,000 feet of three-inch pipes, laid under the floor beds, and when cooled returns to the boilers to be warmed over again. Twenty-five tons of coal were used in heating the conservatory during the past winter, which is only one-quarter of the amount first estimated.

It is the only building of the kind in the world, and reflects great credit on its originator and designer, Thomas Hopper. Roderick Campbell, a genial son of Scotia, has been engaged as florist. For the past five years he has had charge of a private conservatory in Brooklyn, and for fifteen years before that time, was en-

gaged in the same occupation in his native country. He is familiar with the common and botanical name of every plant in the building.

The cost of the whole has been in the neighborhood of \$13,000, which includes the fitting up of the gardener's cottage, just east of the conservatory.

Death is always an unwelcome visitor, whether he comes to the aged or the young, the high or the lowly. On the death of a friend or relative, the mind is instinctively lifted from things earthly to the world beyond. At such times the stern realities of life grate harshly on the finer sensibilities of human nature, and add to the sufferings of those already deeply afflicted. Not many years ago it was customary for relatives and friends to gather around the grave at the time of burial. As the beloved form was lowered into the dark, damp earth, it seemed as if all hopes of ever seeing it again went down with it. The heavy clouds which rattled on the coffin lid, fell with equal weight upon the grief-stricken hearts of the mourners. It mattered not if the winter's wind moaned drearily through the treetops, and chilled the forms of those in waiting till they seemed to feel the coldness of the grave; or if the summer's rain fell thick and fast like their tears. Death is no respecter of times or persons, and the sad duties were performed under circumstances which made one shudder at their recollection.

Now all this is changed. When a body is brought for interment, it is first taken to the conservatory, which is in itself a paradise. Though life may have been darkened with shadow, here all is bright. The turmoil and bustle of life may have broken the heart worn with care; here the silence is only broken by the glad songs of birds and the music of the fountain. Rugged, desolate and dreary the paths of life often are; here all is beautiful as a fairy scene, beautiful beyond comparison with other earthly scenes; carrying the thoughts with those who have gone before, to that Eden where sin, and sorrow, and suffering are unknown: "Where the wicked cease from troubling, and the weary are at rest." The coffin is placed in the centre of the auditorium, when the final services are held, and a last look at the face of the loved one is taken. None can regret leaving their dead in such a place. On either side are beds of blossoming flowers, beautiful camellias, calla lilies, pelargoniums, azaleas, acacias, rhododendrons, geraniums, and other hot-house plants. Here is also a large lemon tree in

bud, flower and fruit. Overhead are rustic hanging baskets, magnificent in their variegated colors. Ivies and other creeping vines twine around the pillars and arches supporting the roof. To these will be added a variety of tropical trees and plants, such as palms, palmettos, orchids, passion flowers, and the finest of tropical plants.

Comes winter, with its cold chilling the earth and wrapping it in a winding-sheet. The windows of the lodge look out from under its snow-capped gothic gables as if half asleep. The thick branches of the fir bend beneath the weight of the fleecy substance which falls on mound and monument alike. It is the sleep of nature, cold and cheerless as death itself. But under the shining arch of the conservatory, life and perpetual summer reign. Here, in warmth and light, surrounded by beautiful buds and blossoms, amid the cheerful songs of birds and the murmur of the fountain which flows as ceaselessly as time—here we leave our dead, and our last thoughts of them will always be associated with this place. The seasons may come and go, but in this spot made sacred by hallowed recollections, will be perennial spring. Here too, in after days, we will love to sit and call up memories, sad, but full of holy joy, and hold sweet communion with those who have been transplanted to the great garden above.

#### RHODE ISLAND BENT GRASS.

BY DR. WM. F. CHANNING, PROVIDENCE, R. I.

In a note to the editor, which strayed into print, in the *Gardener's Monthly* for October, 1875, I spoke of Rhode Island Bent Grass, pure and simple, as the best Lawn Grass, in the estimation of many persons living where it is supposed to have originated, and where alone it is extensively cultivated.

There had been a previous lament in the *Monthly* over many of our Lawn Grasses destroyed by the intense cold of the preceding winter. The Rhode Island Bent had stood this extreme test without injury.

I have since received numerous letters enquiring where the seed of this grass can be obtained; and the *Country Gentleman* has asked: "What is Rhode Island Bent? and in answer to its own question has conjectured that it is probably *Agrostis vulgaris*—the Red-top of New England and New York, and the Herd's Grass of the Southern States.

A somewhat extensive examination enables me now to say, and I hope to be able to show, that the Rhode Island Bent is a distinct and valuable grass which, by a curious fatality, appears to have hitherto escaped recognition and description. I am well aware that these light grass seeds may blow from one end of the Continent to the other, and it is not impossible that Rhode Island Bent may be locally grown elsewhere under a different name; but I find no record of the cultivation of any similar grass.

At this season it is impossible to furnish a botanical analysis of the plant, but I send to the editor, for his comparison, two bundles, one of Rhode Island Bent and one of Red-top,—winter specimens—furnished me by Charles H. Potter, of Prudence Island, Narragansett Bay, an extensive cultivator of Bent.

The following paragraph from Flint's admirable Treatise on Grasses and Forage Plants, is perhaps responsible for the confusion between these two grasses :

"This grass (*Agrostis vulgaris*) is known by various names, and is greatly modified by soil and cultivation. On a moist rich soil it grows larger than on a poor, thin soil; and not only larger but has a darker, purplish color, with a stem varying from eighteen inches to two and two and a half feet high; while on poor gravelly soils, it seldom grows over twelve inches, and often not over five or six inches high, while it has a lighter color. In the latter situations it goes by the name of Fine-top, and is universally seen in old, dry pastures. In some sections where it is highly esteemed, it goes by the name of Burden's or Borden's Grass; in others, of Rhode Island Bent; but I am unable to discover any difference between these and Red-top, except that produced by varieties of soils; and on enquiring of some of the largest dealers in seeds, I find that orders for all these are supplied from the same seed."

With this authority before them, it is no reflection upon American seedsmen to say that, whenever a demand has grown up in any locality for the real Rhode Island Bent, it has been met with a dispensation of Red-top seed, and the genuine grass, therefore, has soon lost whatever footing it has acquired. I shall endeavor to state the points of difference between these grasses as they appear in cultivation, side by side, in Rhode Island, so that this confusion may be no longer possible.

Both these grasses, as well as Fiorin and English Bent, belong to the genus *Agrostis*, of which

BENT GRASS is the synonyme; but, for convenience in this paper, the word Bent will be used exclusively to designate the Rhode Island grass.

Both the Bent and Red-top have perennial, creeping roots; but, while Red-top does not spread rapidly by the root, the Bent rivals, in this respect, the Couch grass (*Triticum repens*), forming very soon a densely matted sod. But the stoloniferous roots of the Bent are as numerous and fine as those of the Couch grass are coarse.

Under the same culture the Bent grass is hardly more than two-thirds the height of Red-top, but is heavier bottomed, owing perhaps to the denser sod, or to more numerous or longer leaves. A field of Bent which appears much lighter than one of Red-top, will often give an equal weight of hay. This may be due in part to the greater solidity of the stem of the Bent. Still the average hay crop of Bent is probably less than Red-top.

The stems of the Bent are also more numerous, as well as more slender, than Red-top. Indeed the Bent is one of the finest, most delicate grasses, in leaf and stem. It makes up for size by number of stalks and blades.

The blossom of the Bent is softer, more silky, and lighter in color than Red-top, sometimes nearly white. One of its names in Rhode Island is Furze-top.

The seeds of the Bent are soft and silky to the touch, while the Red-top is comparatively harsh. An experienced dealer informs me that he can distinguish between the varieties, or detect an intermixture of Red-top with Bent, by simply putting his hand into the sack. This is a distinction which may be useful to seedsmen and purchasers.

In Rhode Island, Red-top has no aftermath. The Bent grass, in wide contrast, starts as soon as cut. This is one of its qualifications as a lawn grass. The beauty of the Newport lawns are proverbial. I have heard this ascribed by more than one person to the prevalence of Rhode Island Bent, though the climate, resembling the English, must be taken into account.

The Bent has the reputation of standing drought better than other grasses, and of furnishing even then good after-feed, differing in this widely from Red-top. This may be a result of the fineness of the grass and closeness of the sod, preventing evaporation.

Rhode Island farmers claim much greater sweetness for Bent than for Red-top. The gen-



eral testimony is that horned cattle pick out and prefer Bent to other grasses in the same field. A farmer assures me emphatically that Bent is the best grass for cows. This, as well as its readiness to start after close cropping, bears on its value as a pasture grass.

Another farmer, whose testimony is reliable, tells me he has extirpated Couch grass by plowing, manuring, and sowing with Bent. He gives it as his opinion, that Bent, on a soil sufficiently rich, will, at any time, crowd out Couch grass.

One bushel of Rhode Island Bent seed, well sown, is sufficient to plant an acre. For Lawns twice that amount should be used. The market price of Bent in Rhode Island is from \$2.50 to \$3.00 per bushel, according to weight and quality. Genuine seed can always be obtained of Wm. E. Barrett & Co., Providence, or of Thomas G. Potter, East Providence, both well-known seedsmen.

To sum up, in Rhode Island Bent we have a Lawn Grass, perfectly hardy, forming a close sod, fully occupying the ground and holding its own against coarser grasses, fine in texture, and beautiful in all its stages, starting as soon as cut, and withstanding drought.

As a pasture grass it is sweet and perpetual. For hay, deficiency of crop, if any, is made up by luxuriant after-feed.

[Dr. Channing deserves the thanks of all horticulturists for his investigations in this important matter. The poor specimens sent for Rhode Island Bent grass, appear to be what is known in some parts of the country as "Hair Grass," *Agrostis scabra*, a very different species from "Red-top" or *A. vulgaris*. Its fineness should make it a much more desirable grass than "Red-top." Besides, in our experience, we find the latter chiefly in heavy land, and the "Hair grass" in high and dryer places, which will give it an advantage for lawns, which are generally on dry land.—Ed. G. M.]

### THE ENGLISH SPARROW.

BY GENERAL W. H. NOBLE, PROVIDENCE, R. I.

In some respects this little foreigner deserves our welcome. But his distant origin and his cheery, home-loving ways, blind us to his betters at our doors. Before him we had native birds, greedy for worms, more pretty of plumage, and sweeter of song. We feed and pet this immigrant, but our own birds we shot and stoned, till they found neither pluck or numbers to fight the worm. Then the crawling pests so stripped

to wintry barrenness the garb of "glorious summer," that in pure despair we took on trust this sparrow's boasted appetite for worms, to war against our petty foes.

He breeds so fast that if each one only ate a few, their numbers would make havoc among the creeping tribes. A little colony of eight settled here four years, have filled the town. But as "early birds" after the worms, they don't eat a cent's worth. Enough sparrows have squatted on my two acres to eat all the worms off an hundred, and cry for more, yet the tormenting pests still strip my currant bushes right under their noses. Nor does the sparrow hunt other worms any better. In fact, as help against our foes on leaf and fruit, I set down the English sparrow as a failure and a fraud. But worse than this, I fear we may find him as big a pest as the worms be promised to eat.

Sad stories come to me of his picking out the fruit buds in the winter, and of his raids on the opening bloom of spring. Last year, near New Haven, a flock swept off in a day the promised crop of a whole orchard. Last winter the squatters on my ground stripped my currant bushes of half their buds. They served a large strawberry bed in the same style. Hunger could not be plead for such vandalism. They shared with my fowls plenty of small grains, and garbage always within reach. These sorry habits, in such swarms of them as must soon fill the land, will by and by demand a premium for their scalps.

These sparrows, too, are mighty exclusive in their ways. Fellowship for other species is not one of their virtues. They are a plucky and fighting crowd, and more than a match for any small bird, except the little bully wren. I find the sparrow drives away many of his kind, more pleasing in plumage and in song, who formerly spent their summers at our door. The blue bird no longer tarries with us after his Southern winter tour. The Northern mocking bird has deserted the pear tree top, whence for years at early dawn he filled the morning air with apt and gleeful mimicry of song. Not half so many kinds of birds spend their summers with us now, as before the coming of these sparrows.

But perhaps this visitor does better elsewhere, and will mend his ways. It would be hard to condemn him on so short a trial. He is a hardy, cheery, home-loving little fellow. He sticks close to the crannies and nooks and little resting spots around the house. In the gloom and storm of winter, when pretty much all his kind

desert us for the Southern skies, his chirp and lively flitting cheer away the gloom of a murky sky and chilling blast. Though he is not a pretty bird, or a sweet singer, nor fills the measure of his promise in the line of worms, yet, like the teaching of a friend when the clouds and storms of fate hang o'er us, his lively chirp close to our door steps, in face of the chill and glower of winter, binds him to our hearts despite his faults.

I hope to hear from others a more welcome record of his ways. In the meantime, is there no bird who will eat the hairy and thorny coated worms, which are as bad as any?

There is another English bird whose cheery notes I would like to hear, defiant of the wintry blast and storm—the English robin, the true robin redbreast. Our robin is not truly a robin, but a species of thrush. Is not that so? Yes. I do not know his habits or his food. But if he never eats a worm, the reality at our doors of his picture, singing from the snow-clad, red-berried holly, under a murky sky, gleesome, defiant and hopeful, would well pay for his passage and his feed. Wont some enterprising bird man get us the English robin redbreast?

### EDITORIAL NOTES.

**RATTAN TRELLIS.**—One of the neatest of trellises for training strong growing vines on, we saw last summer in the yard of Mr. Isaac Burk, of Philadelphia, made of Rattan.

**THE HOLLYHOCK.**—So far as we know this has quite disappeared from our vicinity during the past few years, through the operations of a fungus that destroys the leaves. If any of our friends have any this summer with diseased leaves, we should be glad of some specimens for examination.

**ARALIA PAPYRIFERA, HARDY.**—We were astonished recently to meet with a specimen of this popular greenhouse leaf plant which had stood the severe winter unharmed.

**AN AVENUE OF ORANGES.**—The head-quarters of the Jockey club, at New Orleans, was a private residence before the war, and is one of the most beautiful and tasteful buildings in the vicinity of the city. The gardens are very elaborate. The main path to the garden is lined by two long rows of orange trees, forming a beautiful avenue.

**A HEDGE OF GERANIUMS.**—The *Gardener's Chronicle* says, that on the Scilly Isles, which receive the full force of the warm gulf stream as it dashes against the coast of England, there is rarely frost, and it speaks of a garden there in which there is a hedge of scarlet geraniums fourteen feet high.

**THE MISTLETOE** grows on the Norway spruce and Scotch pine in some parts of Europe. It is supposed the seeds do not grow in many cases, through not being properly fertilized. It can be propagated by grafts inserted just under the bark.

**CHIMONANTHUS FRAGRANS.**—This old-fashioned shrub is not near as common in gardens as it deserves to be. The buds are formed in the fall and grow larger with every warm winter's day. If these branches are cut off and placed in water in a warm room, they will expand in a few days, and fill the room with their delightful fragrance. A new branch so treated every week, will keep up a succession all winter.

**THE UMBRELLA PINE (SCIADOPITYS VERTICILLATA).**—It does not appear to be generally known that this fine Japanese Conifer, so distinct in habit and yet so beautiful, is hardy in sheltered positions on well-drained soils, as far north as Edinburgh. Two healthy little specimens of it in the Botanic Gardens there, planted out some four years ago, are thriving most satisfactorily. There are, at least, two distinct forms of this plant in cultivation, one being dense in habit, and the other more lax and luxuriant."

The above is from the *Garden*. We believe it is one of the hardiest of coniferous plants, but of remarkably slow growth. We know of one plant that has stood 17° below zero without the slightest injury, but it is not yet much over one foot high, though now very branchy, and it is over fifteen years old. Besides the above, we give the following from the *Gardener's Chronicle*:

"Indigenous to Japan, from whence it was introduced by Mr. Fortune in 1861. It is described as a large pyramidal tree, with horizontal spreading branches, attaining from 100 to 150 feet in height, and from 3 to 4 feet in diameter. Dr. Siebold, who previously discovered it, described it as a large bush or small tree, from 12 to 15 feet in height. Judging from the progress making, and the specimens to be seen in this country, Dr. Siebold's description is likely to prove correct. It is very satisfactory to know that this very distinct, indeed unique, tree, has

generally proved quite hardy, although of slow growth, at least in its young state. Its branches are alternate and verticillate, with numerous branchlets; its leaves are from 2 to 3 inches in length, linear, leathery, and of a yellowish green color, spreading out horizontally like the ribs of an umbrella, hence its name of Umbrella Pine. Dr. Siebold considers the Umbrella Fir the finest Conifer of Japan, and one which presents an appearance as strange as elegant, in consequence of its innumerable ramifications, which always end in a parasol-like tuft of leaves.

"We have not yet had sufficient experience to speak very positively as to its merits and culture, but have seen enough to satisfy us that it will require a warm situation to induce growth, and a good deep soil on a dry subsoil. It will probably be found to be better adapted for the Southern than the Northern parts of these islands.

"Wherever there is any chance of its succeeding as an ornamental tree, it should be experimented with, on account of its unique and elegant appearance. At Castle Kennedy, and numerous other places in Scotland, it has stood the severity of our winters unscathed, but seldom makes more than 2 or 3 inches of growth in a season.

"Messrs. Veitch report that their largest plant (4 feet in height), in their rich collection of Conifers at Coombe Wood, near Wimbledon, last year grew 9 inches."

---

## NEW PLANTS.

**ABIES ALCOQUIANA.**—This Japanese species proves as hardy in our country as the Norway spruce. The under surface is as silvery as the Menzies spruce, while the upper surface is of a deep green. A correspondent of the *Garden* regards it as the handsomest of the spruces.

**IMPROVED PETUNIAS.**—The Petunia thrives better in our climate than in that of the old world, and hence has improved faster. *Hender's strain* forms the subject of a beautiful illustration in the *Florist and Pomologist* of London, and are much like those we have seen of Vick, and others of our leading seedsmen.

**XANTHOCERAS SORBIFOLIA.**—We have from time to time had notices of this new tree. A recent number of the *Garden* gives a colored illustration, and shows it to be more beautiful than one

would suppose from the description. The flowers are as large as an apple blossom, white on the upper portion of the petals, but of a purplish crimson at the base, and they are borne in upright clusters, like those of the horse chestnut. The leaves are like the mountain ash, whence its specific name *sorbifolia*. As it grows in its native wilds in China, together with the Kolreuteria, which is one of our hardiest trees, we may look on this as something well worthy of, introduction into our own country.

**PENTSTEMON PALMERI**, Gray.—This handsome Utah species is of robust habit, attaining, in good soil a height of from 3 to 5 feet. The lower leaves are petioled, varying in form from ovate-lanceolate to spatulate, coarsely and sharply toothed; those of the stem broadly ovate, entire, and semi-amplexicaul, or sometimes even connate, all being of a fleshy texture, and, like the whole plant, smooth and glaucous. The flowers are borne in a many-flowered naked panicle, from 18 inches to 2 feet long; the corolla, which is peach-colored, being remarkable for its short inflated tube and gaping mouth, as well as for the long reflexed lobes of the lower lip, each marked by a central reddish line, and the conspicuous projecting yellow-bearded sterile filament. It is quite hardy, and will succeed in almost any well-drained soil.—*Garden*.

**BRODIAE VOLUBILIS**, Baker (Stropholirion Californicum, Torrèy).—This Californian species is remarkable for its twining habit, the flower-scape often reaching the height of 7 or 8 feet or even more. The flowers are produced in terminal umbels of from fifteen to thirty each, the perianth being of a light rosy-purple color, nearly 1 inch long, of a tubular ventricose form, contracted below the mouth. The foliage is linear, somewhat fleshy in character, and from 12 to 18 inches in length. It is perfectly hardy, and of the easiest cultivation in any soil, but will probably succeed best in sandy loam. Seedlings will bloom the third year of their growth.—*Garden*.

---

## QUERIES.

**THE CHARTER OAK.**—E. says: "This, many years since, was discussed and decided to be *Q. alba*. At one time I resided in Hartford, Conn., and visited the tree many times in company with others."

ROCKY MOUNTAIN SILVER SPRUCE.—An Ohio correspondent says: "I am not a little surprised that any one conversant with this tree should class it as *Menziesii*—but perhaps I have never seen a true *Menziesii*—but of this *Abies*, with its silvery blue green foliage, I have gathered thousands from the forests or wilds of the upper lakes, grown and sold them. In damp—not wet—soil, of a light loamy or sandy nature, it grows freely, and its gently drooping branches, with its usually perfect sharp conical form, makes it one of the beauties among ever-greens."

[Our correspondent evidently refers to *Abies alba*, and a beautiful tree.—Ed.]

An Illinois correspondent who has paid much attention to the Rocky Mountain conifers, writes that *Abies Menziesii* is undoubtedly the tree referred to. He also adds that Colorado seed produces hardier and better plants every way, than seeds of the same trees from the Pacific. He regards this species as one of the handsomest to cultivate. He has had plants of *Pinus ponderosa* from Californian seeds killed, when those from the Rocky Mountains were quite unharmed.

RAISING CLEMATISES.—N. Y., Rochester, New

York: Clematises are generally raised from seeds; but they mostly take one year to grow. The hybrid kinds are grafted on roots of the *Clematis flammula*, or perhaps other kinds. The improved clematises have been a long time in this country, having been introduced soon after the appearance of *Clematis lanuginosa*, which is one of the parents of the great hybrid race: it being a very free seeder. The hybrid clematises have not, however, made much headway with us, owing, we believe, to some root injury, apparently of a similar nature to that produced by the phylloxera on the grape. Where they do well there is nothing more beautiful, and you may safely "experiment in their propagation with a view to selling them."

TAR WALKS.—Very good walks are made by mixing gas tar with gravel. It softens somewhat in summer, but is an admirable winter path. They fail sometimes—and a correspondent of the *Country Gentleman* suggests that this is often through employing professional "walkers," who boil the tar, and in this way make a very little tar go a great way. There is not enough tar to make a lasting walk under such circumstances.

## GREEN HOUSE AND HOUSE GARDENING.

### SEASONABLE HINTS.

Visiting the greenhouse of a lady at Doylestown recently, who keeps no gardener, but does all her own work, it was interesting to note that the pots were not only full of earth, but it was mounded up so that the plants seemed to be growing on a small hill in the centre of the pot. The first impression of the good gardener would be that this practice was wrong. There is no place for the water. It would all run off. And this indeed was remarked by a gentleman of the company. The lady did not defend the practice against recognized horticultural rules, but timidly remarked that she was so ignorant about watering plants, and found in practice that she always gave them too much, she had made a mound as an insurance against over-watering. To us, however,

the plants made no objective response. The great health they presented showed that they were quite satisfied with the treatment. The little fibres peeped through the surface as happily as the little chickens under their mother's wing. Now we are often asked by window gardeners how often they should water their pot plants, for every one seems to know over-watering is an injury. It is always hard to give an answer to this question, but in the light of this lady's experience we would say, fill up the pots full, mound it, and then you may water every day or as many times a day as you please. It will always do good.

In most places where our readers are, March is a busy greenhouse month. For those who live in Labrador or Australia of course we have no March hints to give. But they understand that what we say here must be sooner or later for them.

Our readers are so widely extended that for the benefit of the most favored, we rather advanced our hints as to season, last month. To the bulk, they will still be in order.

## COMMUNICATIONS.

### A FEW FACTS ABOUT CALLAS.

BY W. T. HARDING, COLUMBUS, OHIO.

Excepting the Rose, I know of but few plants having more admirers, or of which so much has been said or written, as the well-known Calla *Æthiopica*—or, more correctly, *Richardia Æthiopica*. Of all plants, it seems the one with which everybody excels their neighbors in cultivation, and on that account is so justly popular. The first essays of amateurs generally begin with them, and then follows, as is very natural, their initial communication "to the editor," to announce their success. When we take into consideration the combined beauty of flower and foliage, and admit the fact of no one ever failing to produce the finest flowers that ever grew, there is no wonder why in every window stands a stately Calla. The latest remarks I quote from the January number of the *Monthly and Horticulturist*, in which a writer says: "I give the Callas very little rest; some of them none whatever. By this system of culture, the roots do not die, and the plants certainly produce finer flowers."

A more liberal supply of fair flowers, healthy green leaves, or sturdier plants, I never saw under any system of cultivation than which grew in the basin of a water fountain in a Cleveland conservatory. For seven long years, through all seasons, the pots stood up to their rims in water. Were never dried off, had no rest—as they were never weary of well-doing, did not require any—and so they went on blooming without ceasing. More fortunate than poor Ponce de Leon, they had found the fountain of life; and while enjoying a perpetual spring, with all the vigor of immortal youth, they freely imbibed the life-giving water.

Years before, at the junction of the Black and Yellow rivers, at the Cape of Good Hope, the writer saw untold millions of them growing in the swamps, lakes and lagoons. I believe they never dry up there, in that particular region, during the hot and droughty seasons peculiar to Africa, but are at all times submerged. Who knows but what the *Arundinarias*, *Imperatas*, *Cyperus*, *Arun-*

*dos*, *Papyrus*, *Nymphias*, and *Callas*, overshadowed the ancient crocodile and hippopotamus many thousands of years before Vasco de Gama doubled the Cape.

There are but few plants capable of existing under such dissimilar conditions as the Calla. Treated as an aquatic, a terrestrial, or sub-aquatic, it readily adapts itself to the situation, and flourishes finely. Chilly winds and frosty weather are more fatal to them than any other causes. Notwithstanding they succumb to zero's icy touch, they will endure considerable cold, and live, if preserved from frost.

It may be argued, for argument's sake, perhaps, that, as they are tuberous plants, nature intended them to have a period of rest, and it would be folly to attempt to change such immutable laws. Such views may accord with the ideas of those who consider nature's laws as austere and rigorous as were "the decrees and statutes," right or wrong, "of the Medes and Persians, which altereth not." As regards vegetation, I honestly entertain a contrary opinion, and candidly believe, *kind* nature is neither so unyielding or inflexible as the Solons insist, but is, to a certain extent, governed by circumstances. That nature often deviates from accustomed ways, and seems none the worse for the change, is obvious to all intelligent observers. In corroboration of my assertion, I will cite but one more instance, which came under my notice in South Africa, namely the *Erica*, which is a very interesting and elegant genus, always considered so difficult to manage under cultivation. Of all the plants which come under a gardener's care, Cape Heaths require, probably, a higher order of floricultural skill than most other plants do to insure success. No mere novice, or pretender, should be allowed to meddle or tamper with them, as disappointment and loss will inevitably follow. It is well said, "These plants are among the most beautiful in the world." Such a gentleman as Mr. Munroe deserves all the success he obtains with them, as well as the hearty thanks of every Heath grower for his pains.

At the Cape of Good Hope, *Erica imperialis*, *E. pellucida*, *E. grandiflora*, *E. viridiflora*, *E. vestita alba*, *E. mirabilis*, *E. princeps*, *E. blanda*, and many others, the writer saw springing from slight cracks and openings in the rocks, and growing amazingly, with apparently little or no soil to support them, and where the sun's rays literally blazed upon them. The same kinds,

with numbers of other species, were equally happy and vigorous on the mountain sides, beneath shady, broad-leaved forest trees, near the sea-beach, in the snow-white sand, and in boggy hollows. With such a variety of soils and conditions, they flourished, as if to show the different ways "Dame Nature" had of doing things.

Returning to the Calla question. However much cultivators may differ about the right method of treating them, they all agree that plenty of old rotten cow manure is a pabulum they most delight in. Soot-water is also an excellent stimulant; in fact, is one of the best for pot plants generally. For vegetables it is equal to guano—especially for onions, celery, cabbage, turnips, asparagus, &c. As a fertilizer, to sow on the lawn, or green pastures, I have used it with good results for many years.

If the heart's Utopia is among Callas, why, in the name of all things flowery, let the good folks enjoy it. Certainly the joys of floriculture, either in this or any other land, are equal to any other pleasures, and far surpass most of the trivial ones which tempt us to follow. Yet, the cold-blooded cynic may live unmindful of the Creator's goodness in strewing flowers along the waysides, which he refuses to see or appreciate. He may pass through the forest, cheery with the hum of insect life, and merry with the music of birds, without hearing them, or knowing there are glorious old trees around and above him. He may be in the midst of fields bearing the bending golden grain, without heed or pleasure. But, he is not "one of us"; being utterly incapable of feeling, he does not know the world is full of beauty when the heart is full of love.

Boston is as famous for Callas as it is for Lilies, Violets, Tuberoses, Pinks, and Roses; and Mr. W. C. Strong was much noted for successfully cultivating the same. Callas were a specialty, and were grown in immense quantities, both in pots and in the borders of his mammoth greenhouses, to the profit and pleasure of the worthy proprietor.

#### MYRSIPHYLLUM ASPARAGOIDES.

BY F. R. FITHIAN, WEST CHESTER, PA.

This beautiful plant, commonly known as Smilax, is from the Cape of Good Hope; the word *Myrsiphyllum* means myrtle-leaved. It is now used in the cities for decorating, and as

greens for bouquets, to such an extent that there is a great demand for it by our city florists. It is very easily cultivated, the seed being sown in boxes of light but rich soil in August and placed in a close and shaded greenhouse. I saw at one time seed sown in two boxes, one box being placed in a close house, the seed in it germinating very well; the other box was put in a hot-bed, the heat being 95°; there it remained for eight weeks, only five or six seeds germinating; supposing the balance of the seed had decayed, the box was taken out of the hot-bed and placed with the first box—in less than a week every seed germinated, and grew at a rapid rate, soon outstripping the first box. When large enough they should at once be potted off in two-inch pots and placed in a warm house, and kept growing until early spring, when they want a rest, for, it must be remembered, they belong to the Lily family; after gradually drying them out, place under the bench, turning the pots on their sides. The first of August they will begin to show life by throwing up long slender shoots, of a light purple color, and looking somewhat like asparagus. They are now just one year old, and want planting out or potting; if they are desired for "cut flowers," by all means plant them out, they are tremendous feeders, want plenty of room and plenty of water to bring them to perfection. Plant in soil composed of two parts rich manure, two parts good loam, one part old sods, and one part sand; give plenty of water, never allowing them to become dry; their two greatest enemies are drought and red spider, either of which causes them to drop their leaves, and then they are worthless for cut flowers. Each plant will throw up six or eight shoots, and will want strings to hold them up; twine three or four shoots to one string, and when they have grown to the height of five or six feet they are ready for market, each string being worth at wholesale about twenty-five cents. After they are all cut, dry off gradually, and give a slight top-dressing of fine but strong manure. Each following year they will increase in value, throwing up more and stronger shoots. While growing, they should be often syringed, and occasionally watered with liquid manure, after being diluted. The second winter from seed they will flower and produce seed. The flowers are greenish white and very fragrant, though small. The berry grows to the size of an English pea, and when ripe—in August—is a light red color, containing three or four seeds, which are hard and black.

**RICHARDIA ALBA MACULATA.**

BY W. PULLEN, PENN YAN, YATES CO., N. Y.

Can you give me some information in regard to the above-named plant? Having seen in Peter Henderson's Catalogue that it was deciduous, and required the same treatment as the Dahlia, I procured a tuber and planted it out in summer, lifted it in the fall, and have it in the house now. It is in a six-inch pot and has twelve large handsome leaves and one flower on, and is the admiration of all who see it. This plant bloomed last summer, and from a flower I saved seed which produced one hundred and twelve plants, all as truly variegated as their parent. What I wish to know is—does this plant really require to remain dormant awhile as represented? Many ladies and gardeners hereabouts have been interested in my plants, and I propose to have them photographed, a copy of which I will send to you.

[The great success achieved by our correspondent answers his own question. It does not appear to be a necessity that it should be dried off like a dahlia.—Ed. G. M.]

**EDITORIAL NOTES.**

**THE CHRISTMAS ROSE.**—This—the *Helleborus niger*—is popular as a winter forcer in England. Recently some sold in London for half a dollar a dozen—a good price for English cut flowers.

**VARIEGATED SAGE.** *Tri-color.*—This is becoming rather common now, but there are few things more beautiful as a leaf plant. It does well in windows, and is very tractable in many respects.

**UNHEALTHY CAMELLIAS.**—One of the best methods of restoring to health sickly Camellias, is to cut them in severely, and plant in the open ground. They will push into new growth of an excellent character. They must be put into pots again in September. They can be set out in the full sun.

**WINTER-BLOOMING FUCHSIAS.**—The Fuchsia is an excellent plant for window culture, but, unfortunately, does not bloom well in the winter season, when window flowers are the most desirable. Some, however, have a decidedly winter-blooming tendency; and of these, *Speciosa*, *Coccinea major* and *Speciosissima* are, probably, the best.

THE LOVE OF CUT FLOWERS is increasing in England as well as in this country. The floral establishments that make this branch a special line are amongst the most successful of any in horticulture; and they vie with each other in the introduction of new and special features.

**A FINE POT ROSE.**—The *Gardener's Record* says: "The *Gardener's Chronicle*, of Saturday last, gives an illustration of one of the splendid roses in pots, exhibited by Messrs. Paul & Son, at Manchester, at the Great Whitsun Exhibition held there last spring. The variety was Paul Ricaut, and it was seven and a half feet in diameter in one way, by five and a half feet in another; and it was from four to five feet high. The group, of which it formed a part, was considered by Messrs. Paul & Son to be the finest they had ever grown; and the thirteen plants occupied in transit two large railway trucks, which they thoroughly filled."

**EUCHARIS AMAZONICA.**—This is essentially a lady's flower, both for hair and dress, combining purity of color with delicate fragrance. Some can scarcely command a bloom of this plant at all, others flower their plants twice a year, and some four times, which means never-out-of-bloom. Some force them into flower with bottom heat, and others starve them—that is, they rest them in a pit or greenhouse, and flower them in a stove. When there is such a diversity of opinion, how is any one to decide correctly?

"There are at least two, if not more, varieties of *E. amazonica*, or the species are confounded. There is a kind which commences growing in December or January, and this has very much stouter petioles, and very much shorter, with considerably broader and thicker leaves, deeper in color, and has larger heads of bloom, and more numerous blooms than a variety which commences growing or flowering in May, and which is remarkable for its long leaf petioles, its thinner-textured, smaller and paler-colored leaves, and smaller flowers with a paucity of them. Is not the former *E. grandiflora* syn. *amazonica*, and the other *E. candida*? I think so.

"In January the bulbs are to be shook out of the soil or the soil removed, and four or five of the largest potted in a 10 or 11-inch pot, and draining well, using a compost of three parts turfy loam and one part each of well-rotted cow dung and fibrous peat, and pot so as to just cover the bulbs. Three bulbs may also be placed in an 8 or 9-inch and one in a 6 or 7-inch pot. Place

in a warm stove—60° to 65° at night, 70° to 75° by day—and keep very moist, and in March or April they should flower; and for blooming they may be placed in a cooler house, and afterwards be returned to the stove, when the plants not unfrequently flower again in July. It is better, however, to rest the plants for a time after flowering, say six or eight weeks, in a cool stove or a cold pit after May, which by judicious air-giving is a stove, watering only to prevent the leaves flagging, and

when the growth is complete, to place them in a house of about 10° less heat than that in which they are grown, but light and airy, and by no means so dry as to affect the foliage; and with ten weeks of this cool treatment to return them to heat, giving plenty of it, for they enjoy strong moist heat and liberal watering during growth, and after flowering and completion of growth rest in a cooler house.—G. ABBEY.”

[We give the above from the *Journal of Horti-*



VIOLET VICTORIA REGINA.

introducing to heat again, when the plants will flower in August or September. Plants may be had in bloom at almost any time by growing them in brisk heat and affording abundant air-moisture and water; and when the growth ceases rest them near the glass in a warm greenhouse (55°–50° min.) with water only to keep the foliage from flagging, and with a syringing overhead once a day they will scarcely need water until required for starting. The rest should not be less than six weeks. Another mode of culture is not to dry the plants at all, but, after flowering, or

culture, as supplementary to an excellent article by Mr. Taplin in one of our former numbers. Few people here seem to grow it well.—Ed. G. M.]

### NEW PLANTS.

VIOLET VICTORIA REGINA.—Recently we received some fresh flowers of this beautiful new violet from Mr. Henry Chitty of the Bellevue



Nursery, and now have the pleasure of giving our readers an illustration of the same.

**NEW VARIEGATED FERN:—**DICTYOGRAMMA JAPONICA.—Variegated ferns are very rare. Mr. Williams of England has introduced this. The yellowish green variegation is "herring boned" along the centre of each leaflet as in some of the marantas. There is a wood cut of it in January *Florist and Pomologist*. It is a hardy greenhouse kind.

**DAHLIA MAXIMILLIANA.**—This is a new species from Mexico, with flower of a peach-blossom color, seeds of which are being offered by American seedsmen. It may be the parent of a new race.

**ZONALE PELARGONIUM, DISTINCTION.**—Mr. Chitty says this is a very interesting variegated leaved novelty. The leaves are dark green, having a narrow band of jet black near the margin. There is a cut of it in the advertising columns.

**CLEMATIS LIGUSTICIFOLIA.**—This is a remarkably strong and vigorous growing, hardy clematis. A neighbor to the well known *C. Virginiana* of the Eastern states, and will at least be as popular. We note that it is now being offered in several of our seedsmen's catalogues. It grows from Colorado westward. A good thing for covering walls of houses or outbuildings.

**ALOCASIA ODORATA.**—The common *Caladium esculentum* is well known. Some years ago we noted a fine plant in the garden of Mr. Mitchell, of Milwaukee, as stated in our columns at the time. Since then we have noted it of immense size in Southern gardens; for which it is a very striking object. Mr. Hanford thus speaks of it:

"This noble plant while young, slightly resembles the well known *Caladium esculentum*, but grows to really gigantic dimensions as it attains age, and while the latter dies down annually to the bulb, this grows into a stem or trunk, which retains some of the foliage through the winter, if kept in the conservatory or sitting room. The leaves are of enormous size, of a bright glossy green, with thick fleshy mid ribs and nerves, standing stiff and upright on a stout stem. Plants under good culture frequently attain eight and twelve feet in height.

A remarkable plant and well worthy of a place in every collection of plants, for garden, conservatory, or sitting room decoration.

## QUERIES.

**RUBUS ROSÆFOLIUS.**—S. D., Oxford, Pa.—The above is the plant referred to in the following: I send you by mail a box with a flower of a seedling that came of itself in one of our pots. It is new to me, although it may be an old flower. Is it a raspberry rose?—or what is it?

[It is commonly known as the Bramble Rose. It produces no seeds, but propagates by pieces of the root. A piece was in the soil of your pot.—Ed. G. M.]

**DISEASE IN VIOLETS.**—J. McB., Boston, Mass., says: "Would you be so kind as to let me know through the columns of your valuable periodical what has caused the failure of a bed of Neapolitan violets, which I had planted last fall in a compost of maiden loam, decomposed manure, one-fourth leaf mould, and a small proportion of sand?"

"The house in which I planted them is a span roof running east and west. Parallel and to the south of this house runs another house of the same size and shape. So it was always partially shaded by the house south of it, thereby preventing excessive heat from the sun. When I brought the plants in from the open ground, they appeared to be in a very healthy condition, and continued to appear so for a few weeks afterwards.

"Some time in December I discovered they had become sickly, and, upon examination, I found formed on the fibrous roots small tubercles resembling diminutive *Gladioli* bulbs. Now, sad to relate, my violets are all dead. I am at a loss to know the cause of their death. Enclosed I send you a sample of their roots.

"What I should like to know is, have the tubercles caused death? If so, what caused the tubercles? Relying on your authority, I trust you will give your opinion in the next number, as you would confer a favor upon me as well as perhaps others who may have similar experience."

[We have never seen this disease before. It is evidently caused by an insect similar to the *Phylloxera* in the grape vine. Send a few fresh specimens in damp moss to Prof. C. V. Riley, St. Louis, Mo. They will be of great interest to him.—Ed. G. M.]

**PROPAGATING BEGONIAS.**—T. H., Bridgeport, O.—The dwarf kinds are raised from leaves, or portions of the leaves, from any portion of which buds will push. Many people divide the nerves

and ribs of the leaves, and then peg down the leaf on sand or light soil, and little plants will form from the severed portion. It is best to have the sand of a temperature of 60° or 70° to have the best success. The more shrubby kinds are raised from cuttings of the stems.

## FRUIT AND VEGETABLE GARDENING.

### SEASONABLE HINTS.

There is nothing so worries the editor of a Magazine like this, as questions as to what varieties of fruit it is best to plant; for every locality has a favoritist of its own. The editor of this *Magazine* has had a wide experience, there being few localities over this great country that he has not had some personal knowledge of, and yet he would not dare to give a list for any one place without feeling sure to raise up a host of observers, who would be sure they would not plant such a list on any account. We may say, however, that we believe there is not near as much "adaptability" required in varieties, as people think for.

A very imperfect trial, perhaps with weak plants, or under bad treatment, or perhaps some exceptional unfavorable seasons or circumstances, have given a variety a bad name, that really deserved a better fate. We know how very local the *Triomphe de Gand* strawberry was supposed to be, and yet it became a good stand-by, and the *Jucunda* was actually discarded by some of our best cultivators, before the late war. Knox found good in it, a decision that has been abundantly confirmed. If the plant be healthy and the system of culture not an exhaustive one on the constitution of the plant, we would not hesitate to try in most localities kinds that had been found reliable in others.

In fruit growing, remember that fruits are like grain and vegetable crops, in this, that they must have manure to keep up fertility. Unlike vegetables and grain, however, their feeding roots are mostly at the surface. It is best, therefore, annually to top-dress fruit trees. If manure cannot be had, any fresh earth from ditches or roadsides, spread half an inch or so under the trees, will have a wonderful effect. Indeed, we do not know but that for the pear tree a thin layer of

road sand is one of the best manures. We have seen apples thrive amazingly with a coating of coal-ashes.

Whitewashing the stems of orchard trees has a very beneficial effect in clearing away old bark and destroying the eggs of innumerable insects. The white color is bad; throw in a little soot or some other matter to make it brown. In greenhouses sulphur has been found of benefit in keeping down mildew. Possibly, if mixed with the whitewash in tree-dressing it might do good against fire-blight, and such like fungoid troubles.

In planting fruit trees aim to have them so that the hot, dry sun will not have full effect on the ground about the roots. The great heat in this way injures the trees. Many who have trees in gardens, plant raspberries under them. The partial shade seems to be good for the raspberries and helps the trees. Blackberries would, no doubt, do well in the same situation; and strawberries it is well known, do not do badly, grown in the same way.

This is a busy season south of Pennsylvania in the vegetable garden. Here we must wait till the end of the month, and northward still later. The crops noted will, of course, be dependent on the arrival of the *season*, which is rather indicated by the ground becoming warm and dry, than by the almanac. It is very important to have crops early; as soon as the ground is, therefore, in good condition put in the seed. Possibly a cold rain might come and injure them, and you may lose, and have to make a new sowing. Even so, it is but the loss of the seed and labor, while if the seed do *not* die, the early crop will more than repay that risk.

Deep, rich soil, now so generally condemned for fruit gardens, is of the first importance here. Soil cannot be too rich or too deep, if we would have good vegetables. It is, indeed, remarkable, that in many respects we have to go very differently to work to get good fruits than we have to

perfect vegetables. While for instance, we have to get sunlight to give the best richness to our fruits, our vegetables are usually best when blanched or kept from the light. So, also, as we keep the roots as near the surface as we can in order to favor the woody tissue in trees, we like to let them go deep in vegetables, because this favors succulence.

In the open ground, peas and potatoes receive the first attention. Then beets and carrots. Then lettuce, radish, spinach, onions, leeks and parsley. Beyond this unless in more favored latitudes than Pennsylvania, little can be done until the first week in April. There is nothing gained in working soil until it has become warm and dry.

Celery for the main crop will do about the end of the month, but a little may be sown now. We have never been able to make up our mind whether there is such a thing as an absolute *solid* variety of Celery; and whether pithiness in any degree depends on soil or culture. Certainly we buy all the most improved "solids" every year, and never yet found one satisfactory throughout. We cannot say which is the best of the many candidates.

In the hot-bed, pepper, egg-plant, tomato and cucumbers may be sown,—and in a cooler hot-bed frame, Early York cabbage, cauliflowers and celery. Those who have not got a hot-bed, can sow a few pots or boxes, and keep them near the light in a warm room.

In addition to sowing of the above, onions, leeks, parsnips and parsley must be sown at this season—not for the main crop, but to have a few in advance of the rest. To keep over the winter, almost all kinds of root crops become tough or coarse if sown too soon.

---

## COMMUNICATIONS.

---

### JUNE PEACH BUDDING.

BY H. E. VAN DEMAN, GENEVA, KAN.

My chief reason for writing this note is that myself and others may be enabled to successfully perform what is commonly termed *June budding* of the peach. I will first say what I have done. Last year, 1875, knowing that others had made it a success, I began by setting a few buds in that year's peach stocks about July 1st. The stocks were less than the size of a lead pencil, the buds

were the nearest developed that could be found. Every one united with the stock, and in about eight days after setting I cut the stock off close to the bud, which was inserted some three inches above the ground. These died—root and all—within two weeks from being cut off, although the season was very favorable and some of them showed signs of starting.

July 12th I set sixty buds, which all united, and part of them I cut off to the bud in about ten days. The buds in those cut off made a growth of from six inches to a foot.

About June 15th I set a dozen peach buds taken from the new growth in stocks of the previous year's growth. These united and I cut off the stocks, and the buds made a growth of some two feet.

Now my inferences from this experience are, that these last mentioned buds set in the old stocks succeeded, and that one might save stocks that way in which buds had failed that were set the fall previous. That the first buds and stocks both of the new growth, were, when tried (July 1st) too green or tender.

That those set July 12th made only a poor growth, although the season was all that one could desire.

I desire that Mr. Bilyeu, and others of experience, may give the readers of this journal the benefit of their experience, so far as they can, by written directions in this matter.

---

### SELF OPENING GATES.

BY J. H. PEIRCE, DAYTON, OHIO.

I observe your remark about self-opening gates, or rather gates opened by the wheels of the carriage passing over them. I have had in use one made by Messrs. Cottom, of this city, for three years, and never in any respect out of order, or working otherwise than satisfactorily. Many others of same make have been in use here for five or six or more years, and give perfect satisfaction. My single gate cost, put up, \$40; the price of double gates I think is \$50 and \$60. It is the best I ever saw, and see no use for further attempt at improvement.

Sunday, 9th January, ther. 58°. A bush honey-suckle in the garden in full bloom, from which we have the flowers now in the house. 10th, Monday, 7 A. M., temp. 16°; 11th, 10°; this morning, 21°.

### EDITORIAL NOTES.

**THE LADY GRAPE.**—In our advertising pages Mr. Geo. W. Campbell, of Delaware, Ohio, has a beautiful lithograph of his Lady Grape. We can say from our own experience that it is a free, healthy grower, and the fruit, which we have had before us on several occasions, indicates it to be one of the best yet introduced.

**THE SOUTHERN RED RASPBERRY.**—A year or more ago Mr. Stearns furnished us a note in regard to this variety, which attracted some attention. A correspondent from St. Mary's, Indiana, furnishes us with the following note in relation to its history.

"I have no reliable history of its origin. I received it five years ago from Moses J. Stearns, of Cobden, Ill. After I had grown it a few years and found it to be far superior to anything in the raspberry line that I had ever tried, I wrote to him for a full history of it. It was some three or four months before I received an answer to my letter, and it was then from a man by the name of Crandall (his first name I quite forget). He stated to me in his letter that Mr. Stearns was dead, and that he was his administrator. He also stated that as to the raspberry he was not posted and could give me no correct history of it."

**BORECOLE.**—While on a trip through the State of Mississippi recently, we had occasion to note how extensively this was grown and appreciated under its old fashioned name of "Coleworts," pronounced down here *collards*. They do not head as the cabbage does, but have short tender green leaves, which push out from buds all up and down the stem as the Brussels sprouts do. These and other vegetables were in full condition for use at McComb City, a settlement chiefly of Northern men, who are prospering remarkably well in this far off region. In our northern regions we could not grow this as our winters are of course too severe. Col. Hillyard, the enterprising secretary of the Mississippi Valley Company, informed us that at McComb City the thermometer rarely falls 12° below freezing point and then only for a little while, which is of course very favorable to winter vegetables.

**GRAPE, GOLDEN QUEEN.**—The *Gardener's Chronicle*, referring to grapes for cold vineries, says this continues to be one of the highest excellence.

**PRESERVING FIGS.**—While along the Gulf coast recently the writer noticed that the fig, though in

a climate exempt from frost, seemed determined to keep to its deciduous proclivities, and was in a perfectly leafless state. We can, therefore, say nothing about southern figs, but by the way the southern people talk of them they must be something to tempt even an anchorite. But we were told that no one has been able to dry them so as to compete with those of Europe. So far as we could learn no one seemed to know the process by which they were dried in Europe. We therefore give the following account. It may be remarked that even in raisin making the Europeans make free use of lye to open the pores and hurry up the drying.

The preparation of figs for market is given as follows: Sheets are held under the trees—clear of the ground—and the fruit is shaken into them. They are then placed into baskets and dipped in a bath of strong potash lye for about two minutes, and then dipped into clean water. This is to remove the gum on the outside of the fruit and to improve the color. They are then placed upon hurdles to dry in the sun, or in a dry-house, and when soft enough to pack closely are pressed tightly into wooden drums or boxes. The drums hold about fifteen pounds and must not be made of pine, as it injures the flavor.

**THE WALBRIDGE AND EDGAR RED STREAK APPLE.**—A correspondent of the *Prairie Farmer*, says these have been proved identical, the last being the prior and therefore the proper name. He gives the following history of it:

"The Edgar Red Streak was originated in this country by my father, Joseph Curtis, of Paris, Ill., in the year 1818, and was named by the Indianapolis Horticultural Society, of Indiana. It was one of three varieties named from twelve new seedlings which he presented to that Society (of which he was a member) about the year 1840. Was grown from the same planting of seed that produced the Illinois Greening and Belleflower Pippin. Has been noted here for vigor and hardiness of tree, full bearing and bright color of fruit. Keeps through winter, but is only second rate in quality, and rather small to become a popular market apple."

**THE LETTUCE MOULD.**—This terrible disease of the English salad grower has not been hitherto very destructive in America, but Prof. Burrill, excellent authority, reports it as being very destructive in the vicinity of Champaign, Ill., last year.



LADY.

*From a Photograph by C. Bodurtha.*



**THE WILD GOOSE PLUM.**—It is very hard to get at what is meant by the true "Wild Goose Plum." We had some sent to us for our opinion last summer, some from Delaware, and some from Lebanon, in Pennsylvania, as the true and genuine kind. On these we gave our opinion at the time. We thought them fair cooking plums. Referring to these lately, the editor was told that the genuine kind was as large as a black walnut. If so we have certainly never seen a true one. Now comes the meeting of the Western New York Horticultural Society, and it seemed to be by general consent regarded that Mr. Willard had the true "Wild Goose," and he describes it as a very good thing "an inch wide and an inch and a half long." Now this is an *oval* plum, and no larger than the ordinary copper plum, and very different from a black walnut in size. To make our troubles worse come Messrs. Hance of Red Bank and they tell us the true Wild Goose is perfectly round, and a whole two inches in diameter; now here we get near the black walnut.

As to the quality, the meeting of the fruit growers referred to developed various opinions. A Cincinnati gentleman who seemed to be very familiar with the "right" kind, thought it good when, like a persimon, it was taken at the right time, otherwise, still like a persimon, it was bitter and astringent.' J. J. Thomas' experience was that it was pretty good to his taste. As reported, however, there is a mystery about his opinion. He seems to have fruiting trees, "not grafted." "fruit thin skinned, but the curculio failed to sting them;" but the fruit on which he based his opinion were not these, "but came from Georgia." We know how brief reports do injustice to speakers, and it is doubtless the case here. In the meantime we are confounded with this wild goose chase. We have an idea that there is a real bird somewhere, but whether its merits are a "matter of taste," or something on which there can be no difference of opinion, we do not know.

**THE PROFIT OF FILBERT NUTS.**—A correspondent of the *Garden* says:

"If, in America, an enterprising man were to get the grant of 1,000 acres, and at once clear and plant it with Cob Filberts, he would find it one of the most remunerative transactions of his life—their transit to this market is easy, and they are not injured from being two or three months in tubs, a circumstance which renders them as easy of carriage by land or sea, as flour."

It shows how ill calculated one at a distance is

to offer advice; though we can appreciate the good intention which moves the suggestion. Our good friend is evidently unaware that this bush is extremely liable here to a terribly destructive fungus, which would sweep off a whole thousand acres in two or three years. We would rather take our chances on a thousand acres of plums than a thousand acres of filberts, and every American knows what that means.

**FERTILITY RESISTING FROST.**—We have repeatedly called attention to the fact that a half starved tree, or one dried out in summer, is the first to die in a severe winter. An abundance of rich nutritious food is favorable to hardiness.

Under the heading of this note a correspondent of the *Country Gentleman* has an excellent article confirming this position. Clover and grass where well manured were green and healthy long after those under poorer circumstances were killed.

**EARLY CABBAGES AND TOMATOES.**—A "practical gardener of many years experience," hailing from Janesville, Wisconsin, is issuing a circular in which we are told that the tomato, except in few instances, does not ripen in that latitude till September, but he possesses a "secret" by which he can have them ripe by the 4th of July, which is Independence day. By his "secret," cabbages will mature "from two to four weeks earlier" than any body else's cabbage. By virtue of "said process," these "two important articles of food," cabbages and tomatoes, may be had "in bloom," when "the proper weather arrives for their transfer" from the hot beds.

What special advantage there is in having a cabbage in bloom we do not know, but this we suppose is part of the "secret," which we are told, "is not patented," and therefore can only be disposed of for a "valuable consideration." We are further told that "the method applies to nursery stock as well," which, we suppose is to be made to produce fruit on the fourth of July.

We do not know that any of our readers will be particularly anxious to "go in," on these "secrets," but if there are, there can be no objection, provided they pay all their debts first. It is their own business.

**LATE APPLES.**—There ought to be a good field for the exporter, with our late keeping apples, to England. The London *Garden* says that early in January their two best keepers, Ribston Pippin and Cox's Orange Pippin, are beginning to decay. We could certainly keep the English market in apples till the strawberry season comes in.

**THE MANDARIN ORANGE.**—This is one of the luxuries of New Orleans. It is a much superior fruit to the ordinary orange, but, decaying easier, is not suited to transportation, hence we do not get it in our markets. Those who have gardens in Louisiana should plant this delicious variety.

**BROCKWORTH PARK AND BONNE D'EZEE PEARS.**—The new English pear, Brockworth Park, is said to be the same as the French Bonne d'Ezee.

**CLAPP'S FAVORITE PEAR** is regarded by a distinguished French pomologist, as one of the best three August pears for that part of the world.

**AMERICAN POTATOES IN ENGLAND.**—It has been long known to us that English varieties of potatoes soon degenerate when planted here. It now appears that it is exactly so with our varieties in England. They produce wonderful crops the first year, but soon go backward.

**AMERICAN APPLES.**—In a notice of a collection of apples from Ellwanger & Barry the editor of the *Garden* observes that the flavor of American apples is far superior to that of English apples, even the Ribston pippins from Rochester, and which is the king of all apples in England, is pronounced "firm, juicy and delicious." Our climate seems to have such an effect on the juices, that to the taste of the editor, our class of sweet apples seemed like eating a new race of fruits. The pears sent with the apples by E. & B., were not regarded as equal to the best English fruit.

Talman's Sweet is the variety of apple which especially struck the editor of the *Garden* as of so fine a flavor among all apples. This may be a good hint to exporters.

**THE BEST ENGLISH PEAS.**—Kinds that prove best for the English climate, are not necessarily the best here. Still it is good as a matter of information to know what are regarded as the best in the old world. A correspondent of the *Garden*, gives the following list and we believe he regards them as best in order as named. It is a pretty good list for "the best," and will indicate the enormous number of varieties they must have in England.

"I will name the following as among the very best Peas in cultivation:—First crop—Kentish Invicta, Blue Peter, Carter's First Crop, William the First, and Laxton's No. 1; the last a very early blue wrinkled Marrow Pea. Second or main crop—Ne Plus Ultra, Dwarf Ne Plus Ultra, Laxton's Alpha, Auvergne, Veitch's Perfection, Nutting's No. 1, Williams' Emperor of the Mar-

rows, Laxton's Supplanter, Champion of England, and Burbridge's Eclipse. For late cropping—Ne Plus Ultra, Veitch's Perfection, Moss Podded, M'Lean's Best of All, James' Prolific Marrow, British Queen, Victoria Marrow, Knight's Tall and Dwarf Green Marrows, Laxton's Omega, Yorkshire Hero, Champion of Scotland; and for the last sowings in August, First and Best and Laxton's No.1 and Alpha.

**PROTECTING TREES FROM RABBITS AND MICE.**—This is a very simple matter. A piece of paper tied around the stem near the ground, and tarred, is sufficient. Pine tar should be employed, gas tar often contains creosote in sufficient quantity to penetrate the paper and injure the bark.

**PROFITS OF FORCED PEACHES.**—We believe all attempts to make any very great profits from early peaches have failed in the vicinity of Philadelphia. We do not know why it has been abandoned. It would seem that it *ought* to pay. We give the following which we find as a "floating" paragraph, observing, however, that nothing of *profits* can be deduced from fancy prices, as competition soon pulls them down.

From a single tree planted in a tub, and kept in his hot-house, C. S. Holbrook, of Holbrook, Mass., has sold in 18 years, no less than \$2,300 worth of peaches—some of them at \$36 per dozen; many at from \$24 to \$28 per dozen, and all at an average of \$18 per dozen. They were sold mostly in the months of February and March.

**THE WILDER PEACH.**—Mr. H. M. Engle, of Marietta, Pa., has got out colored lithographs of this, which we favorably noticed last year. Mr. E. is very sensitive about having his name connected with any unworthy thing, and hence is modest in pushing anything of his own. We feel quite safe in saying that hundreds of new fruits have been widely advertised on much inferior merit to this. We would not be at all surprised if this "Wilder" peach should distance *all* the early ones yet brought out. Of course a careful test would be necessary to give this as a positive opinion, but we really think the facts point *that* way.

## NEW FRUITS & VEGETABLES.

**LARGE MONTMORENCY CHERRY.**—Mr. Ellwanger says in Report W. N. Y. H. Soc.: "We have fruited this fine acid cherry for several years, and consider it one of the most valuable in cultivation. The tree is very hardy and a great bearer; fruit large



and of a shining, dark red color, and of a very good quality. Ripe about a week after the Early Richmond."

**PAUL'S IMPROVED CRAB.**—Illustrated in January *Florist and Pomologist*. This is highly colored and a little early, and it is therefore regarded as a hybrid between the common Siberian and Red Astrachan, but our Western Pomologists have obtained numerous seedling crabs of this character, as simple seedings, without any idea of hybridization.

**SOUVENIR DU CONGRESS PEAR.**—At the recent meeting of the Western N. Y. Horticultural Society Mr. Geo. Ellwanger said: "After several years' fruiting, we can say that for large size, beautiful form and color, as well as good qualities, it is without a rival among recent introductions."

**TWO NEW FRENCH PEARS.**—*President Drouard, and Belle de Beaufert.*—Under these names we have from Mr. J. De Saint Ange colored plates. They are large greenish "Duchess" looking fruits, and both winter varieties.

**DR. McLEAN PEA.**—An immense number of new peas appeared in England last year. This is thought to be one of the best. It is a dwarf blue wrinkled marrow, large pods, and a great cropper.

### QUERIES.

**MUSHROOM CULTURE.**—A "*Subscriber*," has started a small bed of mushrooms, as described in "*Henderson's Gardening for Profit*," but says he "don't know how to cut, pack and sell them, which Henderson omits to mention, and much other minutiae perhaps necessary to be known by the producer for profit."

[Mr. Henderson will perhaps oblige by furnishing us with the desired supplement to his useful work.—Ed. G. M.]

**BLACK'S EARLY PEACH.**—H. E. Van Deman says: "Who knows to a certainty about this peach? Where did it originate? What is its season of ripening? What of its productiveness and quality? Any one who can answer these questions will confer a favor upon the writer and perhaps upon other readers of the *Monthly*."

**WATER AT THE ROOTS OF GRAPE VINES.**—M. N. C., Chicago, Ill. You are right. It will not hurt the roots of your vines to be near water. The celebrated vine at Hampton Court is said to be so superior because *some* of the roots get to a cess-

pool, and one of the best growers of native grapes in Pennsylvania, Mr. Jacob Garber, finds some vines do best where a *portion* of the roots get to a spring. Still it is also true that if *all* the roots are damp, grape growing is a failure. Perhaps the explanation is, that where some of the roots are employed in taking up water only, others are engaged in taking up other food, and the division of labor is an advantage.

**FRUIT CULTURE.**—A Cincinnati correspondent says: "I am a great admirer of the *Gardener's Monthly*, but think you give too much space to small fruit growers and others whose grounds are rather farms than gardens. In a recent issue I noted that *one-fifth* of the whole space was occupied in that way. Can you not give us a horticultural paper, pure and simple and let these farm topics alone."

Jupiter once sat in the heavens, and opened his trap door to listen to the supplications of the inhabitants of the earth. He who was blind asked to be deaf instead, the lame man preferred to be blind, the deaf man wanted to be lame. No man had anything he wanted, and wanted everything he had not. Whereupon Jupiter waxed exceeding wroth, and shut the trap door down with such a bang that it has never been opened since.

However we shall have less temper, and are quite willing that the "fruit" men have their say in turn if they wish.

**HIGHLAND HARDY RASPBERRY.**—J. A. N. St. Josephs, Michigan, says: "Who sells the 'Highland Hardy Raspberry?' If what your Ulster Co. correspondent says of it in January number is correct, the purchasers would be many. Please ask him to verify his statements, then advertise his *bushes*."

[As we stated in our note when inserting that communication, we know nothing whatever of that raspberry. We suppose if it is all that is claimed for it, some one will have it for sale before long.—Ed. G. M.]

**OYSTER SHELL LIME.**—W. M., Plainville, Conn., says: "My garden is a light sandy soil, and this spring I think of using on it oyster shell lime. Am I right in doing so, and what will be the result? I also intend to apply it around my fruit trees. Please note in March No. and oblige."

[Oyster shell lime is better on sandy soil than ordinary lime, which on the other hand is best for clay lands,—but beware of overdosing; much less lime to the acre has to be used on sandy than on clay lands.—Ed. G. M.]

# FORESTRY.

## COMMUNICATIONS.

### RAPIDITY OF GROWTH OF TIMBER TREES.

BY F. R. ELLIOTT.

Your note of the *Abies Douglasi* suggests to me that, perhaps, it would be admissible in your journal to state that twelve to sixteen years in this country has grown the cottonwood to a height of over forty feet, and of size sufficient to make from half to three-fourths of a cord of wood. The black walnut, butternut, chestnut, soft maple, willows, poplars, all are rapid growers. The Norway spruce, white, and yellow, and Scotch pine have grown to a height of thirty to thirty-five feet in twelve years.

But, while we have many rapid-growing trees, promising of profit and beauty, much depends upon the soil in which they stand, and also the distances apart. Many a piece of ground, now vacant, and too low to cultivate without great expense, might be cultivated with forest trees, that in ten to twelve years would be found of greater profit than if planted in the ordinary way or left to its natural grasses. The destruction of our native forests is yearly rapidly increasing, and, perhaps, no better move could be made than to petition the controllers of public funds to apply a certain amount yearly in premiums to those who plant.

### THE FORESTS OF MICHIGAN.

BY PROF. W. T. BEAL.

Within my recollection a large part of Southern Michigan, which is now in the form of arable land, has been cleared of timber. Our grandfathers, at great labor and expense, cut down, rolled into heaps, and burned the timber from thousands of acres in New York, because they must have room for corn and wheat and meadow. Our fathers did and are still doing the same thing for Michigan. Educated in this way, brought up in the woods, where timber is too plenty, as a people, we have been taught to undervalue timber. There are now living, men who can see no

beauty in a tree, except for the cords of wood or loads of lumber, or the hundreds of rails it will make. The lovely elm, with all its grace and beauty, well styled the queen of American trees, shades the border of his meadow, and is a nuisance. He cuts it down. Our large, grand old trees have not been saved, partially because of this lack of love for them. In many places it would be impossible to save them. They would not stand the storms alone when their fellow trees were cut away. In 100 or 200 years it is likely our successors will have and care for large samples of trees which have grown more stocky in exposed places. One of the interesting things now to do is to save what we can and make a record of the size and position of any large trees in Michigan.

The largest hemlock I ever measured was at Hersey, in Osceola county. At the stump it was thirteen feet in circumference. I know there are larger specimens, and I am ready and anxious to record and publish the figures. At Hersey, also, I measured a black birch ten and a half feet in circumference. I hear of an arbor vitæ white cedar about twelve feet in circumference on Cedar river. I hear of a buttonwood tree, four miles below Grand Rapids, thirty-three feet around. In Saginaw county I hear of a butternut tree three feet nine inches in diameter. I am anxiously waiting to get dimensions of more native trees.

The largest apple and largest pear trees I ever saw or heard of in Michigan are at Monroe. The pear tree is ten feet in circumference in the smallest place; the apple tree is ten feet in circumference six inches from the ground. Near Adrian is a weeping willow about four feet through, and a grape vine twelve or thirteen inches in diameter. In Branch county stand two trees, twelve feet apart, each about twelve inches through. They run up twelve feet, when one starts off horizontally and strikes the other, when they grow together in one body. I heard of a specimen, perhaps not now standing, two pines, about four feet apart, diameters twenty-six and twenty inches respectively. About sixteen feet from the ground they are joined by a pine

six inches in diameter. Above the point of union the smaller tree becomes the largest. In Oakland county are twin beeches, much like the pine trees just mentioned.

On Little Salt river I hear of a white oak twenty-five feet in circumference. At Lansing we have tamaracks about nine feet around. In Lenawee, near Deerfield and on Little Prairie Ronde, I hear of sassafras trees six feet in circumference. At Grand Ledge and at Tecumseh are coffee trees four feet in circumference. At Adrian and near Kalamazoo are honey locusts about six feet in circumference. At Northport is a red cedar about nine feet around. In Otsego county there is a sugar maple said to be eighteen feet in circumference; one in Ionia county seventeen feet four inches around. At Clam Lake an old lumberman can furnish spars of pine 175 feet long and only two feet through at the butt. In Reading, Hillsdale county, I hear of a black walnut nine and a half feet in diameter. As a boy I remember one in Rollin, Lenawee county, which, I think, was equal to the one in Reading. In Dearborn I hear of a swamp oak twenty-three feet around, an American elm at Manistee twenty-four feet around. In Vevay, Ingham county, I learn of a white wood eighteen feet around.

In Farmington, Oakland county, I hear of an ailanthus thirty years old six feet three inches in circumference. In Flint I hear of an oak tree nearly three feet in diameter. About ten feet from the ground is a huge knot which is sound and goes nearly around the tree. The wart, or knot, strikes out nearly three feet each way from the tree.

Some trees prove of great value because of the peculiarity of the grain. If I am rightly informed, a walnut tree at Potterville sold for \$1,000 as the wood was in beautiful waves. It was made into veneering. Doubtless many a valuable log has been destroyed by ignorant people not knowing its real worth.

A thorough survey of the State, with a full illustrated report of the forest trees and other plants, would be of great interest and value in many respects. Trees indicate soil. Massachusetts has a good report.

At the Agricultural College we have begun in a small way to raise some of our native trees, some foreign ones also, to see which will prove of most value for future generations to grow for profit. It may seem strange to hear of raising trees for timber in Michigan, but our people will soon begin to raise some kinds, and some of us

will live to see it in all probability. So far as we can judge now our best trees to raise for timber are white ash, hickory, black walnut, white pine, white oak, European larch. An acre of timber raised, cultivated and properly cared for is of much more value than an acre of forest trees of the same species.

Considering the great prominence of Michigan forests when compared with any other states, it is well worth while for our citizens, through the Centennial, to show specimens of them, and also sections of some of our oldest cultivated trees, as fruit trees and ornamental trees, to show how fast they grow, to show how well they endure our climate. Of such, we are preparing to exhibit locust, catalpa, European larch, apple trees, cedars, maples, &c.

---

### EDITORIAL NOTES.

---

**FORESTRY IN IOWA.**—Mr. Suel Foster tells the *Country Gentleman*: "Forest timber, wind-breaks and ornamental trees," was a subject of much interest in our meeting. No man in our State has done so much in this line as Hon. C. E. Whiting, of Monroe county, on the west line of the State; and no man in the State is doing so much to instruct and encourage tree planting as H. H. McAfee, Professor of Forestry and Horticulture at our Agricultural College. He is a man who puts his hand to the work; knows how to do it, and when it is rightly done. His department at the farm has not been enlarged, as the interests of our State require, but so far it is progressing in the right direction.

**CALIFORNIAN CHESTNUT.**—At a recent meeting of the Californian Academy of Natural Sciences, Dr. Kellogg said he had just returned from under the shadow of the finest evergreens ever grown. He hoped the secretary would record the fact that there were in California GOLDEN CHESTNUT TREES (*Castanea chrysophylla*) from 100 to 200 feet high, 4 to 6 feet in diameter, and with an unbranched trunk of from 50 to 70 feet.

**ENGLISH OAK TIMBER.**—We have before us a statement of an English planter that he has two acres of oak timber planted in 1845 now with trees fifty feet high. This is not two feet a year. We have seen English Oak do better than that in this country, and believe the timber, from some few observations we have made, to be better than any of our own species. We believe the time

will soon be when a plantation of English Oak will be one of the most profitable parts of one's farm. In less than ten years it would play no mean part in fencing.

**GUM TREES.**—At a discussion in New York, a gentleman observed that one of the family of Australian gum trees, the sweet gum, was already prolific in the South. The Sweet Gum is the *Liquidambar styraciflua*, almost useless for anything but poor fuel we believe. The gum of Australia is the *Eucalyptus*, of a family having no relationship to the sweet gum. It shows the danger of confusion in the popular mind of popular names.

**THE BLACK SPRUCE.**—An admirable and exhaustive paper appears in the recently published transactions of the *Albany Institute* of New York, by Professor Peck on the Black Spruce. Not only are its botanical relations considered, but its history as a timber tree, and its position in American Forestry are very fully treated of.

**CAROLINA POPLARS.**—English writers, and they are followed by some in this country, speak of this as the "Black Italian Poplar." There are two very distinct species. Both are cultivated in leading American nurseries.

**VIRTUES OF THE EUCALYPTUS.**—It seems to be now conceded that the chief value of the *Eucalyptus* resides in its rapid growing and numerous roots, which absorb so much moisture as really to dry up ground but moderately marshy, and indeed to prevent in this way the material action on animal life. As the tree cannot be grown where the thermometer shows a lower temperature than the freezing point, we might at least profit by the hint to the extent of extensive planting of other fast growing trees in marshy places that have an unhealthy reputation. We fancy a grove of cypress would be as health giving as though of *Eucalyptus*.

**VALUE OF AUSTRALIAN GUM WOOD.**—The *Rural Press*, of San Francisco, thus speaks of *Eucalyptus* wood:

"It will be of much interest to our gum tree growers to know some of the uses and qualities of the wood in the region where it has reached its best estate. In Australia ship builders get keels of blue gum timber 120 feet long; they also use it extensively for planking and other parts of the ship. It is considered superior to American rock elm. A test of strength made between some blue gum, English oak and Indian teak, showed that the blue gum carried fourteen pounds weight

more than the oak and seventeen pounds four ounces more than teak upon the square inch. It is extensively used by carpenters for all kinds of out-door work, for fence rails, shafts and spokes of drays, and a variety of other purposes. For railroad sleepers it lasts about nine years. The wood is of a yellowish grey tint, with a close, straight grain.

"Nor is the red gum tree wood of less value and utility. The specimens shown by Mr. Mackey show its qualities clearly. Baron Von Mueller gives the following careful description of the wood: It is a hard, dense wood with a handsome curly but rather short grain. It is almost entirely free from the tendency to longitudinal shrinkage which is the invariable characteristic of all the other eucalyptii. It is of extraordinary endurance under ground, and is, therefore, highly valued for fence posts, piles and railway sleepers. It is extensively used by shipbuilders for main sterns, stern posts, inner posts, dead wood, floor timbers, futtocks, transoms, knight heads, hawse pieces, cant, stern, quarter, and fashion timber, windlass, bow rails, &c. It should be steamed before it is worked for planking. Next to the jarrah, from Western Australia, it is the best wood for resisting the attacks of the sea worms and white ants. Its possible uses are almost too various for enumeration; as an instance of which it may be mentioned that it is used with great advantage and economy for the bearings of machinery, the cost being almost nominal as compared with brass, whilst the material is equally serviceable and almost indestructible.

**CATALPA TIMBER.**—We believe people are not generally aware of the great value of the *Catalpa* for enduring timber. We find the following in an exchange:

"This familiar tree, says Landreth's *Rural Register*, indigenous to the greater portion of the Union, has been long known to a limited number to possess wood of an enduring quality for posts; as lasting, it is claimed, as the black or yellow locust—*Robinia psued-acacia*—but, fortunately unlike it, exempt from insect attack—indeed, so far as our observation has extended, it is not liable to disease direct or consequential; and as the tree grows readily from seed, there need be no impediment in propagating it to any extent desired. Fence rows, boundaries, lanes, the roadside, impracticable plats of ground, inaccessible knolls, might each be seized upon for planting this useful and ornamental tree."

Dr. Lamborn once told the writer of some gate posts of Catalpa that were sound after fifty years. Our own personal experience is limited. We know of some fence posts of Catalpa, we think seven years old, which appear as good as the day they were put in, and see no reason why they should not last fifty by their present appearance.

THE RANGE OF AMERICAN FORESTS.—Prof. Brewer, in discussing the distribution of American woodlands, says, that though Maine is the great source of Pine and Spruce lumber, the hardwood species predominate in that State. The wooded area of New England is not diminishing, but the amount of sawed lumber is lessening—an indication that the trees are cut younger. In the Middle States the wooded area is sensibly and rapidly becoming smaller. The New England and Middle States furnish hardwood trees; in the Southeastern States, from Virginia to Florida, is a belt of timber which supplies the hard and yellow pine; and the Northwestern region contains immense areas of common pine. From the Gulf of Mexico to the Arctic Ocean stretches a treeless area 350 miles wide in its narrowest part, and 850 miles wide on our northern boundary. West of this region is the narrow

wooded Rocky Mountain region, and west of this is the barren region of the Great Basin. On the Pacific coast are some of the noblest forest regions of the world, and official government reports say that the forests in some parts of Washington Territory are heavy enough to "cover the entire surface with cordwood ten feet in height."

SLOW TREE GROWTH.—At a recent meeting of the St. Louis Academy of Science, Dr. Engelmann exhibited a section of the trunk of *Juniperus californica* var., which was not quite four inches in diameter and yet showed an unmistakable age of 127 years, each ring being on an average about one-fifth of a line wide. The largest growth in ten years had been about 4 lines, the smallest during a similar period about 1½ line.

### QUERIES.

WORK ON FORESTRY.—B. M.—One of the most beautiful and complete works on forestry that we know of in our language, is an English work by a Scotch gentleman: "Forestry," by James Brown. If you read French "Cours Elementaire Culture des Bois," by M. Lorentz, is a still better one.—Ed. G. M.

## NATURAL HISTORY AND SCIENCE.

### COMMUNICATIONS.

#### POTATO ROT.

BY M.—

You asked me in last month's paper, "*why* no frosts, &c. had these destructive effects previous to 1846," which I might honestly answer by asking you another question. Is it a *fact* that previous to 1846 potatoes were not affected by both *water* and *frost*, so as to produce those diseases known as potato rot and potato blight? But in place of that I will answer you to the best of my recollection. I was born in Ireland, where, when a boy, I had often seen frosts in May cut down to the ground acres of potatoes that had made six, eight, and even ten inches of growth,—such destruction being mostly upon low, boggy ground. I came to this country with father and family in 1820, and in 1831 was settled upon the farm on

which I still reside. About 1841 or 1842 I broke up a piece of old meadow which I planted with potatoes. The summer and fall being wet, so that water for days would lie upon parts of it, I found at lifting time that wherever the water lay, that all the potatoes were rotted; while on the dry knolls they were sound. Several miles of under-draining was commenced about this time. It is about twenty-five years since I planted some two or three acres with Neshanock potatoes, upon a piece of boggy, coal formation soil. Something prevented, so that the planting was kept back till July. One day, early in September, I was passing by my potatoes, when I found that a blight had passed over my beautiful patch, leaving it exactly like fields that I saw this summer blighted in Ireland. Now, sir, being entirely ignorant (and I confess it) of all the mysterious workings of funguses and spores, and the telegraphic manner in which they destroy fields of potatoes, I

will tell you the conclusion that I came to respecting this blight. I said to myself—here is a bad job—these potatoes were too late planting. The slight frost last night and the hot sun to-day has fixed them—must plant so early after this that they will be ripe before the first chance of frost. Which conclusions I have carried out, and believe that that was the first and last potato blight that I ever saw upon the farm. While your scientific readers may prefer the microscope, I would advise your practical ones to keep an eye open upon Old Prob.

[1846 was the date fixed by our correspondent himself for the first appearance of the "frosts" so injurious to the potato. It is not uncommon to have frosts in *September* sufficient to destroy potato plants. These cases have no doubt existed for many years,—but the potato disease, as we all now understand it, was not observed till 1845 on the British Isles, though we believe a year or so earlier on the Continent.—ED. G. M.]

### EDITORIAL NOTES.

SPONTANEOUS COMBUSTION.—The matter of the origin and prevention of fires, is a question of particular interest to horticulturists. The following, which we find in the *Journal of Chemistry*, is to the point:—

"This seems a queer notion, but it is made quite plausible by a recent English writer, who says: "When oxide of iron is placed in contact with timber, excluded from the atmosphere, and aided by a slightly increased temperature, the oxide parts with its oxygen, is converted into very finely divided particles of metallic iron, having such an affinity for oxygen that, when afterwards exposed to the action of the atmosphere from any cause, oxygen is absorbed so rapidly that these particles become suddenly red-hot, and, if in sufficient quantity, will produce a temperature far beyond the ignitable point of dry timber. Wherever iron pipes are employed for the circulation of any heated medium (whether hot water, hot air, or steam), and wherever these pipes are allowed to become rusty, and are also in close contact with timber, it is only necessary to suppose that under these circumstances the finely-divided particles of metallic iron become exposed to the action of the atmosphere (and this may occur from the mere expansion or contraction of the pipes), in order to account for

many of the fires which periodically take place at the commencement of the winter season."

PICEA PARSONSIANA.—The history of this variety, as recently given by Mr. Parsons in our pages, has stirred up some of our English friends, and several letters have appeared. Though Mr. Parsons himself tells us that it is only a plant selected from a lot of others, and that it can be kept distinct only in that way,—that is to say, it is but a valuable variety. The discussion turns on what *species* it really is. It is hard to understand what rule our English friends have for distinguishing species from varieties.

In this case the distinction is of much consequence; for as a good garden variety it has the name. Parsonsiana has the right of priority, and Mr. Gordon is not justified in naming it in his book *P. Lowiana*. If it be a good *species*, the rules of Botany require that the botanical *description* as well as the name should be published, in order to entitle the name to stand. Even though the plant had not been *described*, and Mr. Gordon were the first to *describe* it, common courtesy would dictate that a name common in nurseries, used in the *Gardeners' Monthly*, and in such a prominent publication as Barron's Catalogue, should have the preference over an entirely new one,—especially when that name—Mr. Low's—only comes in as the receiver of the plant from Messrs. Parsons. It may be right in the abstract, and botanists would have to fall in,—but with their own opinion of the fairness of the author taking such a course.

Those botanists, however, who are familiar with the variable character of conifers, and especially of *Picea grandis*, know well that this is but a variety of that species, and Mr. Parsons' name should and probably will be the name finally adopted to designate it.

BOTANIC GARDEN OF HARVARD UNIVERSITY.—Very few know how widely useful this celebrated garden has become. In the hope that our readers may aid or profit by it to a still further extent, we give the notice of Prof. Sargent's recent report of its doings and condition the past year.

#### IMPROVEMENTS.

The preparatory work, having in view the proper re-arrangement of the hardy plants in the Garden, has been continued during the year. The permanent labelling of all plants, as soon as determined, has been pushed forward as rapidly as possible, and is now, with the exception of the

Grasses and some other *Monocotyledonous* orders as nearly completed as this difficult and constantly recurring operation can be.

The small north glass shed behind the small Orchid-house has been fitted with benches and heated, and will be devoted to the cultivation of *Dionæa*, *Sarracenia*, and other insectivorous plants, cool-house Ferns, &c.

The brick wall dividing Greenhouse No. 2 from the large potting-shed behind it has been removed; the wooden roof of the latter changed to a glass one, and the whole converted into a span-roofed cool-house, which will be devoted to the cultivation of Australian shrubs and other half-hardy plants.

The principal range of glass-houses has been, for several years, heated by two boilers, placed at the two extremities. The smaller of these has been discontinued; an arrangement which, it is hoped, will lead to a considerable economy in fuel, as it certainly will in labor.

This range of houses, though in excellent condition, is entirely inadequate to contain the various collections of exotic plants now cultivated in the Garden, and the plants are beginning to suffer for want of sufficient room. The magnificent Palm in the Central Compartment, probably the finest specimen in North America, must be cut down the coming year, if new accommodation is not provided for it.

The small greenhouse in the rear of the principal range is in miserable condition, and the collection of Succulent plants grown in it has already suffered for want of proper accommodation. This house is so old that it does not seem expedient to make any great outlay on it.

For want of sufficient room and proper accommodation for its operations, the propagating department of the Garden has been transferred from Cambridge to the greenhouses of the Bussey Institution, now temporarily devoted to the uses of the Arnold Arboretum.

Materials for the botanical classes during the winter, which were formerly raised at the Garden, are now either raised at the Bussey Institution or purchased. This arrangement is cheaper than the former method, and it also admits of the cultivation at the Garden of plants of scientific interest in the space which must otherwise have been devoted to a great number of individuals of a few common species.

#### EXCHANGES.

The total interchange of plants and seeds with

other Botanic and Horticultural establishments has more than doubled; while the number of plants and packets of seeds distributed from the Garden is more than six times as great as that of the previous year.

They were distributed as follows: To Great Britain, 487 plants and 878 packets of seeds; to the Continent of Europe, 76 plants and 449 packets of seeds; to the Governor of Bermuda, 2 packets of seeds; to all parts of the United States, 6,492 plants and 685 packets of seeds.

Total, 7,055 plants, and 2,014 packets of seeds.

1,609 plants and 2,195 packets of seeds, from 71 donors, have been contributed to the Garden during the year. Of these, 187 plants and 754 packets of seeds have been received from Great Britain; 46 plants and 536 packets of seeds from the Continent of Europe; 11 packets of seeds from the Cape of Good Hope, and 7 from Algeria; 66 plants from the Island of Bermuda, and 1 from Australia; and from all parts of the United States, 1,310 plants and 887 packets of seeds.

The principal foreign contributions are: A set of rare Orchidaceous plants and many European and Australian seeds from the Royal Garden, Kew; a large collection of seeds, from the North of Europe and Northern and Western Asia, from the Imperial Botanic Garden, St. Petersburg; many seeds, especially of Mexican and Australian plants from the Royal Botanic Garden, Palermo; a large collection of seeds from the Musée d'Histoire Naturelle, Paris; and seeds of Alpine plants from the Royal Botanic Garden, Edinburgh. Besides the above, the following foreign donations require especial acknowledgments: A collection of the Ferns of those Islands from Major-General Lefroy, Governor of Bermuda; a fine collection of Orchids and other plants and seeds from Messrs. Veitch, the eminent London nurserymen; several collections of seeds from Mr. William Thompson, seed merchant, Ipswich, England; a magnificent Tree-Fern trunk from Australia, by the Baron Von Mueller; seeds and rare bulbs from Herr Leichlin, Baden-Baden, and collections of seeds of ornamental plants from the late M. Thuret, of Antibes, and Messrs. Huber & Co., nurserymen, Hyères.

Among the many contributions to the Garden from the United States, the following are of especial value: Seeds and plants from the Sierras of California, by J. G. Lemmon, Esq., California; plants and seeds by H. B. Bolander, Esq., of San

Francisco; a collection of seeds made in Southern Florida by Dr. Edward Palmer, and another made by the same collector on Guadeloupe Island off the California coast; a collection of seeds made in Colorado and Utah by Dr. C. C. Parry; a fine collection of plants and seeds from P. J. Berckmans, Esq., of Augusta, Georgia; a collection of exotic Orchids by General Rathbone, of Albany, N. Y., and many rare seeds by Dr. George Englemann, of St. Louis, and Dr. J. H. Mellichamp, of Bluffton, South Carolina.

It is again my duty to call attention to the fact, that to the very generous annual grant made to the Garden by the Trustees of the Massachusetts Society for Promoting Agriculture is due its increasing usefulness as a means of illustration for Botanical instruction, and as a scientific establishment, through whose agency many useful and beautiful plants are annually introduced into this country; and from this country into all parts of the world.

C. S. SARGENT, *Director.*

RHODE ISLAND BENT GRASS.—Dr. Channing's article in another column came to hand as we were sending that department to press; and the imperfect specimens sent, appeared to be *Agrostis scabra*, as we said in the appended note. Since then we have a perfect specimen from Dr. C., and find that the real species is *Agrostis canina*. It seems to vary a little from the European specimens of that species, but is, no doubt, specifically the same.

BOTANIC GARDENS.—Some of our larger cities are now turning their attention to the forming of botanic gardens, for the amusement and instruction of the people. There is no reason why these gardens may not be artistic as well as botanically useful, and we take pleasure in introducing to our readers the following from the *Garden*, with which we entirely agree:

"There is a phrase in last week's *Nature* which well illustrates the ideas of a certain school of botanists as to design in botanical gardens. The writer, speaking of the proposed changes in the Oxford Botanic Gardens, deprecates 'transforming a botanic garden into a pleasure ground, *in which the needs of study must once more be subordinated to artistic effect.*' With reference to the words in italics, as well might it be said to young artists, 'It is wrong to learn painting under the influence of a noble gallery of pictures!' If anything is wrong and foolish, it is the suggestion that botanical study cannot be pursued in a garden artistically beautiful. The greater the natu-

ral beauty in a garden the more likely is the student to become a lover of plants and a good botanist. Who, for example, would not rather study plants on Mr. Backhouse's beautiful rock-garden than on many ugly excrescences that we need not name in public gardens? Is not the study of trees more attractive as they stand in groups round a glade in a beautiful park than in some narrow old botanic garden where their naturally stately forms are crammed into narrow beds, as in many old-fashioned botanic gardens? Are the plants in Glasnevin, which is, in parts, a picturesque and beautiful garden, any the less interesting or attractive than in the old Chelsea Garden, which consists of a series of squares, and beds, and walks? Surely the herbarium and not the garden is the place for packing plants closely together in a 'systematic' manner."

### QUERIES.

PLANTS FOR NAME.—Mrs. Norton, Iowa.—The numbers have been mislaid. The purplish grass was *Agrostis scabra*, the very small bit some *Sporobolus*, the pretty little Iris like flower *Sisyrinchium Bermudianum*, and the other, with numerous small, fine, head-like flowers, one of the wormwoods—*Artemisia dracunculoides*.

MIXING OF POTATOES BY POLLEN.—H. says: "I send you a potato of a pink tint, which I am positive grew on a plant of the Peach Blow variety. Not far from where these grew were some Early Rose. Does not this prove that the pollen of the Early Rose reached the flowers of the Peach Blow, and that this cross fertilization influenced the sap, and in this way had an immediate effect on the tuber?"

[Not that we see. The editors of the *Prairie Farmer* sent us some years ago some red sweet potatoes on the same root with white ones. As the sweet potatoes never flower, how did the "pollen" act in that instance? All of this discussion originates with people who have not kept up with the progress of the times, and have no idea of the plants' innate powers of change, quite independent of any external influences.—Ed. G. M.]

THE TOMATO DISEASE.—The "*American Gardeners' Monthly*, in quoting our account of the tomato disease around London, says: 'So far as we know there has been nothing of this character seen in the United States. Occasionally we



have seen tomatoes suffer, however, from the fungus known as *Verbena rust*. It is instructive to know that the tomato fungus does not thrive in the drier climate of America. Would Mr. Meehan kindly tell us to what extent the potato disease exists in America."

[The potato disease is rarely virulent of late years in our country. It seldom takes the form

of destroying the haulm—blackening them in a few days. The most usual course is rotting of the tubers in the ground when about mature, or in the cellar soon after storing. For some years past the disease has been comparatively slight all over the Union, until last year it was rather severe in California, taking the most virulent form in the destruction of the growing foliage.—Ed. G. M.]

## LITERATURE, TRAVELS & PERSONAL NOTES.

### COMMUNICATIONS.

#### THE CHARTER OAK.

BY C. M. HOVEY, BOSTON, MASS.

In your January number you have some remarks in regard to the species of oak to which this famous old tree belonged. I now send you leaves and acorns gathered this day, Jan. 31, the leaves from the tree, and the acorns from the ground beneath it, by which you will know the species even without seeing them; as Michaux states that the *Quercus alba* is "the *only* oak on which a few of the dried leaves exist till the circulation is renewed in the spring; one tree is just now covered with leaves but they continue to blow off with every wind, and by April 1 only a few remain.

You may possibly inquire what tree, when we say we gathered them from the tree, and how it is known to have any relation to the Charter Oak? We will tell you.

About the year 1836 or '37, the late Dr. E. W. Bull, of Hartford, who was well known for his love of and deep interest in horticulture and arboriculture, and who had a beautiful residence in that city, on a visit to us, stated that he had reared two young trees out of several acorns he had planted, which he gathered with his own hands from the old tree, and he kindly offered to give us one of them if we would accept it. We, of course, were too glad to do so, and he said that at the proper season he would bring it himself to Boston. His promise was fulfilled, and he put the tree, which was one year old, in his carpet bag, and brought it to Boston. It was so small, and for fear of its being injured or dug up by carelessness, we planted it in a pot, and kept it in

the greenhouse and cellar in winter for two or three years. It was then placed out in the open ground, but grew slowly, and was only five or six feet high in 1845 or '6, when it was removed to its present position on the lawn in front of the conservatory. It is now about 30 ft. high with a handsome head.

This is the history of our Charter Oak, and the tree from which we gathered the leaves. We understood from Dr. Bull some years later, when he visited us for the last time before his sad death, that there were only two seedlings in existence, the one we had and one in his own grounds, and we believe, if our recollection serves us, that after the destruction of the old oak itself, Dr. Bull's specimen was planted out in the identical spot where the old tree stood for so many years before its destruction. Dr. Bull had a real affection for the old oak. He never failed to speak of it, and he sent us two or three engravings of it, one of which he desired us to present a copy of in the Magazine of Horticulture; but the drawing was on so small a scale it would not give a very good representation of the tree, and we laid it aside for the time.

We at one time thought it could not be the *Q. alba*, but for some years since it has developed itself we think there can be little doubt about it.

[The leaves sent by Mr. Hovey are undoubtedly *Quercus alba*, the common white oak. It is clear, from all the evidence, that those who have *Quercus* discolor under culture as seedlings from the original Charter Oak are mistaken. Ed. G. M.]

### EDITORIAL NOTES.

ADVERTISEMENTS.—WHY will people send advertisements and other business matters to Mr.

Meehan, the *Editor*, in *Germantown*, who has nothing to do with it, instead of to the *Publisher* in *Philadelphia*. Among other evils, it makes several days delay, and thus advertisements are often too late!

W. H. BAILEY.—We found an article on our table, simply signed "W. H. Bailey," and having Mr. Bailey, of Providence, in our mind, so made it. It will appear from the following note that it was not that Mr. Bailey:

"I regretted to see that you printed over my article in the *Monthly* my address as *Providence, R. I.* Now, though I feel every confidence in all the works of Providence, I am satisfied I must work out my own salvation *here* at Plattsburgh, N. Y., where I am growing plants and seeds. I mention this matter, as many of my friends and customers may notice the address given and think that I have changed my location. If the same could be corrected in your next issue I would esteem it a favor. Very truly yours,

W. H. BAILEY."

THE HORTICULTURIST.—Mr. Downing's name is so closely identified with the history of the *Horticulturist*, that the public are apt to forget it was to the enterprise of the late Luther Tucker, of Albany, that the magazine originated, and that it was financially sustained and published by him till Mr. Downing's death.

THE CUT FLOWER TRADE OF BALTIMORE.—The *American Farmer* says: "The cut-flower business during the holidays and since seems to have been satisfactory, notwithstanding the cry of hard times. Mr. Pentland's handsome store at the corner of the new building of the Young Men's Christian Association seems especially adapted for a flower business, and has been exceedingly well patronized. The same is true of his neighbors, Messrs. J. Edward Feast, and R. J. Halliday."

PRIVATE GARDENS ABOUT BALTIMORE.—We learn from the *American Farmer* that Mr. W. W. Spence, at Bolton, his beautiful place, which is a charming bit of country almost entirely surrounded by city walls, has recently put up probably the most modern and attractive greenhouse in or near the city. President Perot has annexed to his other structures, at his finished seat on the Charles St. Avenue, quite a large fern and orchid house. Mr. Rasin has added a third to his two already well-stocked houses. Captain Snow, of Harford, is contemplating an enlarged plant-

house to replace his present ones, which do not give room for flourishing palms and other plants of tall stature. Numerous other alterations have recently been completed, or are in progress.

FLOWERS IN NEW YORK.—The *New York Times* says that the money expended in New York for flowers exceeds \$2,000,000 annually, and \$3,000,000 more for plants, &c.; but we suspect that this is only a guess, and not the result of any carefully kept figures. In this amount is included \$400 invested by "an excellent amateur florist of thirty years standing" in blue roses, spotted roses, black roses, and such other "novelties" that seem to be a flourishing success on Broadway.

NOT A NEW CANDIDATE.—In Mr. Foster's note on the Marshall pear, he said it was "a new candidate." From the context we supposed the word *not* was accidentally omitted, and so we inserted it. Mr. Foster desires us to say he meant what he said, "It is a new candidate."

BLUE ROSES, STRAWBERRIES ON TREES, &c.—One man in New York has invested \$700 in the speculation, and thousands of dollars are being taken by a set of swindlers. These men have flourished for generations back. A correspondent says we should "warn" the public against them. But the best "warning" to your neighbor whom you would save from such swindles, is to ask him to subscribe to a good horticultural paper. No reader of such papers buys such things.

TREES FOR NOTHING.—A Western nurseryman advertises "That he has growing on his premises spontaneous seedlings. Large amounts of seedlings of different sizes, and some ten or a dozen different varieties, which he will give away in any quantity to any person for his planting only, by his removing them at his own expense. He will furnish full information regarding sizes, varieties, cost of removing, &c., to any person addressing him as above, with stamp to pay return postage." It reminds us of an old "almanac" story. There was a man who was "too lazy to live," and his neighbors determined on burying him. On the way one charitable soul took pity on him, and offered him a bushel of corn. He looked out of the coffin in which they were taking him to the grave, and asked, "Is it shelled?" Finding it was not, he sadly exclaimed, "move on," and went to his rest! It is hardly to be expected that people who are will-

ing to get something for nothing will "send a postage stamp, &c." They may do so out West, but that class have long since left here.

**KANSAS AGRICULTURAL REPORT. 1875. FOURTH VOLUME.** From Alfred Gray, Secretary. A fine volume of 750 pages, filled with information as regards the agricultural resources and natural history of the State.

**THE WABAN GREENHOUSES OF E. A. WOOD & Co.**—A Boston paper gives the following information about this establishment: "These greenhouses are conveniently situated to Boston on the Boston & Albany Railroad, within a few minutes' walk of Natick, the nearest station to Boston, however, being 'Lake Crossing,' which is about the same distance from the grounds, and at which numerous trains stop during the day. The houses for the growth of flowers are 25 in number, and from 100 to 117 feet each in length, built in the most substantial manner, and the most approved methods of heating and ventilating are used, thus giving every facility for growing young plants and flowers to the highest perfection, and in the most abundant quantities. The increasing popularity of the concern is apparent from the fact that ten additional houses, each 117 feet long, have been built the past season, and are filled with blooming plants, of roses, carnations, lilies, etc.; 15 houses are devoted exclusively to the culture of roses, both for cut blossoms and young plants, the more celebrated varieties, Maerchal Neil and General Jacqueminot, are made great specialties, while numerous (in fact *all*) the good European novelties are being added to the collection as soon as they are introduced."

**MR. DARWIN.**—This distinguished gentleman has brought out a new edition of his climbing plants, and has in the press a new work on cross fertilization by insect agency. We doubt very much whether any one man has been of so much service to the world of science as Mr. Darwin. All the world does not agree with some of his deductions. It is more than likely Mr. Darwin himself does not expect them to do so, but no one has given more facts of importance than he has.

**EDWIN SATTERTHWAIT.**—The Bucks County *Intelligencer* gives an account of one of its neighbors well known to our readers, from which we extract the following:—

"One of the most energetic and successful of

the farmers and truckers who regularly supply the Philadelphia market is Edwin Satterthwait, of Abington, whose establishment is about a mile east of Jenkintown, not far from the Friends' meeting-house. Mr. Satterthwait is also an extensive florist and nurseryman. When a young man he was engaged in a store in the city, but having a natural taste for agriculture and horticulture, he moved out to his native neighborhood again and began operations in his present line of business about twenty-five years ago. He then had a small place of a little over thirty acres. By taking the best care of this, he was enabled to obtain more, and his property now contains about 150 acres, of which all but ten is arable land. He has always attended market, standing along the curbstone to sell his produce for a number of years until the modern market-houses were erected. Since the great market-house at Market and Twelfth streets was built Mr. Satterthwait has occupied stalls there, and is one of the most regular frequenters. Every week day in the year a large wagon-load of articles from his place in Abington is sent to the city for sale. Mr. S. himself remains in the city most of the time to attend to sales, and affairs on the farm are looked after by his son, assisted by several foremen. He goes down and up by the North Penn. trains, while the marketing is taken down the pike. The scale on which business is transacted is enough to surprise an ordinary farmer. He usually raises 20 acres of potatoes, an acre each of carrots, ruta bagas and parsnips, several thousand bushels of turnips, thirty or forty thousand cabbages, and as many plants of celery, which altogether furnish an enormous bulk of produce. From his 20 acres in potatoes he has usually obtained six or seven thousand bushels, worth as many dollars in market.

Mr. Satterthwait also deals largely in fruit. His immense collection of pears has made him famous among fruit growers all over the country. He began taking an interest in this direction fifteen or twenty years ago, and now has over five hundred different varieties of pears growing on his premises. Among so many kinds there are of course some of no great value—and there are very few which he considers better for general purposes than the Bartlett and Seckel and the Lawrence. He is generally the largest exhibitor of pears at fairs held in this part of the State. He has also a large collection of apples, but has settled down on Smith's cider as the most satisfactory market fruit. Four years ago he planted

100 cider apple trees, and last fall he gathered about 100 bushels of the finest fruit. From some older trees, which came from the original stock near Pineville, he had an average of 40 bushels each.

On the property are nine large green houses, filled with ornamental and flowering plants of all kinds. The plants in pots are sold mostly in the spring and fall, for bedding-out and other domestic uses. In winter, and especially during the holidays, a large business is done in cut flowers, and to produce these there are special houses for roses, carnations, camellias, &c. The hard times have interfered considerably with the cut-flower trade.

Mr. S. takes a warm interest in horticultural improvement, notwithstanding his busy life; and at present he is President of the Fruit Growers' Society of the State, which held its annual meeting in Doylestown on Jan. 19th.

### QUERIES.

ELLIS PARK, CHICAGO.—W. H. P., Chicago, Ill., writes: "It was very gratifying to me as well as to many others, to find that Mr. Meehan was pleased with some things at Ellis Park. We value the place very much, not merely for the positive enjoyment we have while there, but because it shows how much may be done in the gardening way to make a city delightful, even though space

and means are limited. The space is but three acres and the total appropriation for all purposes is only \$2,500."

NAMES OF FERNS.—S. G.—It is not easy to name fragments of ferns, especially without fruit. 1, appears to be some *Doodia*. 2, *Adiantum* perhaps and *concinnum*. 3, *Cassaberia hastata* in fruit. 4, *Pteris longifolia*. 5, Probably a fragment of *Aspidium spinulosum*. 6, *Nephrolepis bulbosa*. 7, *Cassaberia hastata*, piece of a barren frond. 9, piece of some *Davallia*.

NOT IN THE TRADE.—The following card explains itself.

NEAR LOUISVILLE, KY., February 11, 1876.

DEAR SIR.—I have for several years past been in regular receipt of trade lists and wholesale catalogues from numerous nurserymen in the United States and in Europe. Upon inquiry I find some directory has my name down as a nurseryman. It is quite a mistake as I am only an amateur and have never been engaged in the business, either as florist or nurseryman. How shall I have the error corrected, for while I could find many persons who would be glad to get and read a good descriptive retail catalogue and thereby be induced to buy, I know of no one in this vicinity who cares to have a trade-list and wholesale catalogue, while they are perfectly useless to me. Will you mention this matter for me in the *Gardener's Monthly*, and oblige,

Yours most Respectfully, THOS. S. KENNEDY.

## HORTICULTURAL SOCIETIES.

### COMMUNICATIONS.

#### PENNSYLVANIA FRUIT GROWERS' SOCIETY.

BY M.

The annual meeting of this society was held this year, and for the first time at Doylestown.

Mr. Edwin Satterthwaite, the well-known fruit-grower, and president elect, presided, his past experience in our Legislature well fitting him, in addition to his horticultural eminence, for this responsible position. He was elected for another term, as indeed were all the old officers, except the treasurer, for which office Mr. Geo. B. Thomas, of West Chester, was chosen. As the funds of the society were in a prosperous condition,

the membership fee was reduced from two dollars to one dollar a year, and this is to include a copy of the annual proceedings to every member.

In the more practical business of fruit culture, Mr. H. M. Engle, of Marietta, for the General Fruit Committee, made a report on the condition of fruit culture the past year in the State. The pear seems always more or less of a success, never an entire failure, in Pennsylvania. The apple crop was fair, but not equal to former years. Plum culture seems on the increase, and injuries from the *curculio* not so prevalent. The knot on trees, which injured the cherries so badly in years gone by, is not near as bad as formerly,

With these facts before us, the Kansas State Horticultural Society has created an experimental commission, the purpose of which is to organize and peach culture, which once was hardly thought of as a Pennsylvania crop of any importance, is now on the increase in many of the southern counties. The president's annual address took in for its chief topic the profits of the fruit-growing business, in which he took the ground that it seemed to be somewhat overdone—that much more was being raised than there was a good market for, though he thought the present general depression pervading all classes of the community had much to do with this overstocked market, and brought about more sellers than buyers. There was a discussion as to whether the popular impression that a new fruit appearing in any given locality was better than varieties brought from abroad was correct in principle, and the drift of the discussion seemed to be that there was no such rule; sometimes they were and sometimes not. The popular Bartlett pear is an English variety, while the Jucunda strawberry is French, and Triomphe de Gand French is Belgian. On the other hand the Seckel pear is a Philadelphia seedling. There was no rule as to nativity—only “try all things” would show the local adaptations.

A discussion on “cheap refrigerators for fruits” elicited nothing practical.

The raising of new fruits by design as hybrids produced an interesting discussion, the essayist opening it taking the ground that a selection of kinds and raising from these, trusting to natural laws of evolution for improvement, had done more towards producing our best fruits than cross-breeding had done or could do. The dissent from this view was emphatic on the part of many of the most intelligent members.

The cultivation of the apple, and the best varieties to plant for the various seasons and for profit, seemed the most popular topic introduced, and took up a good part of the time at the society's disposal. The Codling moth, which produces the “wormy fruit,” is the worst foe to the apple-grower. Persistent gathering of fallen fruit, and collecting the eggs by hay bands round the trunks of the trees, will destroy the whole crop of insects in one year, and all for the next year's operations will be only those that may fly from one's neighbors' grounds.

In plum culture the interesting fact was brought out that the wild American plum had been so improved as to approach the old-fashioned

the chance to taste one. These American plums seem to make themselves at home in our gardens.

In grape culture it seems that the finer varieties, which grow weak and liable to disease, can be grafted on Concord and Clinton roots, and then grow as well and as strong as these popular varieties. The French have found this out, and are importing largely of these American kinds for grafting their own kinds for their vineyards.

[In addition to what has been furnished above by our correspondent we may add that it is one of the most difficult things in the world to give even a synopsis of what takes place at a three-days' meeting of such societies as this. In endeavoring to condense, the speaker's real point is often lost, and frequently distorted. But one of the best attempts at this condensation was made by the *Buck's Co. Intelligencer*, from which most of the notices given in the papers have been made, but without fair credit. Though in its six long columns only the briefest heads of the remarks are given the true point is rarely lost.—Ed. G. M.]

GERMANTOWN HORTICULTURAL SOCIETY—BEGONIAS.—THOMAS MEEHAN ESQ., DEAR SIR.—In your notice of the fall exhibition of The Germantown Agricultural Society, published in the *Gardener's Monthly*, there was an error in the name of the exhibitor of the eight Foliage Begonias which received the first premium. At the time I did not think it worth while to call your attention to what I supposed to be a typographical error, but I find that you are still under the impression that they were exhibited by Miller & Hayes. The plants were of my growing and were not from Miller & Hayes as reported. They were rooted 18 months previously, and were shown in 8-inch pots. The best one covered a circle of twelve and a half feet in circumference and the others were nearly as large. Yours Respectfully,  
ROBERT J. SIDDALL.

KANSAS HORTICULTURAL SOCIETY.—E. G. says: “Many questions relating to the culture of forests, orchards and gardens in Kansas are yet unsettled. We have learned that forest and fruit trees suited to the southern part of Kansas, are not always a success in the northern portion of the State. We know that trees which promise well south do not succeed in the vicinity of Manhattan even. We have to accept the fact that the experience of the eastern counties will not avail for western, or even central, Kansas.

garden plums in value, but which, from various causes, have so disappeared from cultivation that many persons now-a-days have never had a system of experimental stations at the most feasible points throughout the State. The commission have organized and commenced their work in securing the promise of individual co-operation from different portions of the State. The work already done gives gratifying evidence that we shall be able to very largely utilize the work of individual enterprise, at really little expense to the society, at the same time making it as available to the interests of horticulture as though owned by the State.

It is the design of this commission to thoroughly organize its work, by making these several stations the points of systematic and regular observations and experiment, with Manhattan, for the present, as the common centre. By this course the commission hope to collect a large amount of valuable facts which would not otherwise be made available; and propose to report the same to the State Society at the close of the year.

### EDITORIAL NOTES.

**THE CENTENNIAL EXHIBITION.**—It is difficult to find out exactly what is being done in the various States in regard to the agriculture and horticulture of the Centennial. From most of our exchanges we learn that everywhere "something" is being done, but we cannot tell exactly what. Of Indiana the *Indiana Farmer* tells us:

"Thanks to the efforts of Prof. E. T. Cox, our State Geologist, and a few other enterprising and public-spirited citizens, our mineral resources, agricultural productions and educational facilities will have a fair representation. It is a matter of regret that our last Legislature did not make a more liberal appropriation for this purpose, but it is gratifying to know that all will be done that the moderate allowance made, and the too limited subscription fund can accomplish toward giving us a good showing in the eyes of the world."

Instead of reporting what people talk about doing we have thought best to wait till we see what is done, and about this we shall probably be able to tell a little next month.

**ORGANIZATION OF THE NURSERY BUSINESS.**—At a meeting of Nurserymen, Florists and Seedsmen, at Crystal Lake, Ill., Jan. 25th, it was decided to hold a Centennial meeting of all engaged in the trade, in the city of Chicago, on the 2d Wednesday of June.

It has always seemed strange that enterprises of such vast importance have not as yet made any special effort for a national organization. It is hoped that a large attendance can be secured and means devised to better organize and strengthen these great interests.

**A BOTANICO-HORTICULTURAL CONGRESS** is to meet at Brussels, Belgium, on the 30th of April in connection with the International Horticultural Exhibition to be held there at that time. A leading topic will be to arrange for a *Hortus Europæus* or catalogue of the correct names of all plants cultivated in Europe, of which there is much need.

The *Gardener's Monthly* acknowledges the kind invitation of President d'Hamale, of Malines, to be represented on the occasion.

**THE CENTRAL HORTICULTURAL SOCIETY OF FRANCE** is one of the most active in Europe. We have a circular from Mons. A. Lavalle, the general secretary at Paris, in which the advantages of membership are fully and freely detailed.

**ALTON HORTICULTURAL SOCIETY.**—**APPLES FOR PROFIT.**—At a late meeting Mr. Pearson said that his most profitable apple was Smith's Cider; and next to this is the Benoni. No other sorts approach these. Dr. Long had made more money out of the Romanite than any other. The Early harvest and Red Astrachan had done well. Northern Spy and Yellow Bellflower were worthless on his grounds. He found it best to cultivate his orchards, and to apply lime, ashes, and stable manures. Young orchards he found most profitable; orchards generally through the country were not profitable to the owners, simply because proper cultivation was not given, and insects destroyed.

**WESTERN NEW YORK HORTICULTURAL SOCIETY.**—The annual meeting held in January at Rochester, but very full reports have been given in the *Rural New Yorker*, *Country Gentleman*, *Rural Home*, and other agricultural weeklies, so that details in a Monthly like ours would be rather out of date. It appears to have been more than usually successful. Mr. Barry presided with his usual excellency.

**MASSACHUSETTS HORTICULTURAL SOCIETY.**—No Horticultural Society in America at all nearly equals that of Massachusetts in wealth or in the amount awarded in premiums. For 1876 the prizes will amount to \$6,800, of which \$3,200 are for plants and flowers, \$2,100 for fruits, \$1,200 for vegetables, \$300 for gardens, greenhouses, etc.

THE  
GARDENER'S MONTHLY  
AND  
HORTICULTURIST.

DEVOTED TO HORTICULTURE, ARBORICULTURE AND RURAL AFFAIRS.

Edited by THOMAS MEEHAN.

VOLUME XVIII.

APRIL, 1876.

NUMBER 208.

FLOWER GARDEN AND PLEASURE GROUND.

SEASONABLE HINTS.

April in the South is Spring, and the early flowers have long since been in bloom; but April in the North scarcely finds the Violet in flower. What should we do if we were to write a "Calendar of Operations" for our readers? However, this we never attempt. What we give as "Hints," are not so much intended for the *month* as for the season. We speak now of the early spring season, and each must apply it as he finds to suit the latitude. Of course the trees and bushes are all pruned, litter cleared up, grass rolled, walks edged, and vegetation is pushing along. Evergreens may be set out till after the growth has been made. Deciduous trees also may be still set out, if any leaves they may have made are plucked off. They will make new ones. The main business of this department will be in setting out garden flowers.

Of flowering plants which thrive well in our climate, we have a good selection. The Geraniums are amongst the best, although botanically they are not distinct from Pelargoniums; yet it serves a good purpose to retain the name as a popular designation of an useful class in flower gardening. There are now double varieties; but for flower gardening purposes, double flowers are inferior. These varieties do not flower as freely as the single ones. This has proved to be the case with the Petunia, the Pansy, and other things, and we suppose the rule will hold good here. The Rose Geraniums flower somewhat steady throughout the year, and are indispensa-

ble for their delightful fragrance and elegant foliage. The Verbena used to be the main reliance for bedding—but the great ravages of the verbena rust, have made it somewhat unreliable; and, although it is indispensable yet, it does not take the front rank as formerly. Of double flowers we may say, however, that the Double White, and perhaps Asa Gray, a bronzy salmon, flower much more profusely than some of the older kinds.

In the class of scented flowers, the Heliotrope, the Mignonette, and the Sweet Alyssum, command a prominent place. The last is liable to suffer much from the cabbage-fly. A syringing with water, in which a few drops of coal oil has been spread, soon settles his business. There is a variegated Sweet Alyssum which is very pretty.

The Golden Feverfew is admirable for edgings. Lantanas are very desirable; but to have the best results from them, they should be planted in *poor* soil. Mr. Harkins' new variegated Lantana is said to stand the sun well. A very pretty species, trailing like a Verbena, but not much known, is *L. Sellowii*. The varieties of Lobelias make fair bedding plants if not put in too dry a soil, or too warm a situation. The Cuphea hyssopifolia sent out by Messrs. Hoopes is a good border plant.

The old *double white* Feverfew is one of the most desirable of bedding plants. White flowers can be cut from it all summer, and yet have plenty left to bloom. The Petunia, though of no account for cutting, keeps up a brilliant show the whole season. They do also very well in hot

places where little else will do. The singles give the most flowers. For cutting purposes, the Monthly or Tree Carnations are lovely things, though they are ugly growing plants, and do not make much show on the grounds. The blue *Ageratum* is not very showy, but blooms so profusely, that every one likes to have it. The old *Nierembergia gracilis* is another not very showy plant, but flowers so well, and is so satisfied with indifferent treatment, that one cannot let it go. The *Gazania* is curious, and makes a brilliant show of orange and black on a fine day, but is not well adapted to a hot place. The little *Cuphea platycentra* has rather too much green for a show plant, but if the soil is not too rich, gives fair satisfaction.

The *Othonna crassifolia* is perhaps one of the best vase succulents ever introduced for sunny places. The new hybrid *Dianthus*es are beautiful bedding plants, about which see an article in another column.

## COMMUNICATIONS.

### POSTSCRIPT TO ARTICLE ON R. I. BENT GRASS.

BY DR. W. F. CHANNING.

Since the article in last number was written I have obtained specimens of Rhode Island Bent grass from Charles H. Potter, which were cut sufficiently young to retain and show the characteristic inflorescence. On submitting these to Joseph W. Congdon, Esq., of East Greenwich, an accomplished botanist, he reports as follows:

"After a thorough and careful examination, I am satisfied that the species is *Agrostis canina*, L., or Brown Bent of the books. The flowers when carefully examined with a glass, show that there is only one husk or palea, wrapped around the grain. On the back of the palea you find a long bent awn, growing out of it near its base. This usually projects more or less out of the flower, but is hardly noticeable to the naked eye. It usually disappears, being very fragile, after the grass has blossomed."

These observations which I have confirmed, seem to leave no doubt as to the species. There are one or two varieties of *Agrostis canina*, native to the grassy mountains of New England. Whether the Rhode Island Bent is one of these, or different, remains to be ascertained. It is certainly an upland grass, and is in thorough

possession of the soil in Rhode Island, as if to the manor born. Horticulturally and agriculturally at least, it seems to have been hitherto unrecognized, except in southeastern New England.

[As stated in a brief note in our last, this excellent lawn grass is certainly the *Agrostis canina*. Ed. G. M.]

### REMONTANT PINKS. (CARNATION.)

TRANSLATED FROM LA CULTIVATEUR, LYONS, FRANCE,  
BY MISS B.

The culture of the Carnation is believed by certain horticultural writers to have been for upwards of 2000 years. We know nothing of what was practiced at that time, and horticultural Science as well as some others, dates but little in the first century, so that we can only trace the present history of the Monthly Carnation. The Remontant Carnation originated in Lyons. Mons. Dalmais, gardener to Mons. La cure, (the zealous patron of Horticulture in Lyons, and formerly of our Horticultural society) obtained the first true one nearly 36 years ago.

It was sent out in 1844. Atim was the product of artificial impregnation of a kind known by the common name of Mahon or St. Martin (because it flowered almost regularly towards the middle of November) with the Carnation Bichon. This first result was afterwards impregnated with the fancy and produced in 1846 numerous varieties of different colors.

Mons. Schmitt one of the most earnest and intelligent Horticulturists of Lyons, followed Mons. Dalmais in the track which he traced and increased the collection to several remarkable varieties, such as Arc en Ciel, and Polar Star, which were cultivated for a few years but are lost now, being replaced by better sorts.

Towards 1850 a malady broke out amongst these. Mons. Schmitt was discouraged and abandoned them. It was at that time that Mons. Alegatiere applied himself to their culture, and in a short time made great progress, and it is to this able and persevering Horticulturist that we are indebted for the numerous Remontant sorts so esteemed in England, Germany and Italy, and also for the best means of cultivating them, which we will describe. Mons. Alegatiere is not contented to increase the Carnation so extensively as to put it on a level with the old Florist's Pink (in the culture of which the Belgians and Hol-



landers excel) but he imposes upon himself the task of giving us Remontant Carnations with stiff flower-stems, which he obtained in 1866. And it may also be said that Mons. Alegatiere has produced a race which will be continued by seed.

"A permanent race is almost a race which we have created," (Henri Lecoq.) This kind has the same merits as the *Carnation Flon*, and the advantage of having large flowers and various shades of color. Certain authors have said that the culture and propagation are very easy. At a time not very distant it was said and published of the culture of the *Carnation*: "Grafting, considering the few chances of success which it offers is seldom employed; therefore it is recommended to split the bottom of the graft and introduce into it a grain of wheat, oats, barley or a small pebble, to keep it apart." Without doubt, this means of grafting offers fewer chances of success, as one of the grafts rots, and if the plant coming from this graft does not die, it remains weakly. Grafting was therefore condemned, and layering, which was in its infancy, was extolled. Now the routine yields to observation, and by the intelligent student of facts it is generally admitted that grafting is the best means of multiplying all plants.

Thus it is admitted that grafts can be made of a plant when layers cannot. The graft cut, the plant seeks to replace these cuts, to repair the damage to which it has submitted, and reproduces new branches, whilst the plant that has been layered nourishes its half cut branches without replacing them. It has been said on this subject, that shoots take root very easily; it is quite certain that cuttings make better plants than layers.

These can be made (says my friend Alegatiere,) at all seasons, but for those who have a greenhouse and wish to propagate largely, the best time is winter, that is to say, January and February, and they will have plants that can be potted in April and May, will be strong in the course of the summer, and flower in the autumn. If you have no bell-glasses the sash of a greenhouse will suffice to strike these cuttings. It is not necessary to tell how to prepare these cuttings,—every gardener knows that. An essential point towards success is to remove every day the leaves that become yellow and not to fear to lift the cuttings; on the contrary the undertaking is more sure, for changing the place and soil from time to time hastens them in rooting. And why? Because the earth around them becomes mouldy and if the cutting does not die the development

of its branches is retarded. Frequent waterings are indispensable, as excess of moisture is better for Carnations than dryness. Cuttings made in winter, take root generally in 3 or 5 weeks, according to the variety. As soon as the cuttings are rooted they are put separately in small pots and brought gradually to the air, and the further treatment is like A, B, C, to the workman.

The cuttings having rooted it is best to put them in the ground during April or the beginning of May, (according to the season and climate,) in a place well aired, as the *Carnation* loves air and dreads to be confined between walls and trees.

The nature of the soil is not difficult; however, it prefers fresh earth provided it is well drained, as stagnant moisture is very destructive to it.

Copious waterings, not too often repeated, it likes, provided these waterings are of liquid manure and free of foul materials. These last can easily be disinfected by sulphate of iron.

To preserve Remontant *Carnation* dwarf it is better to take off each flower-stem immediately after the flowering, to 2 or 3 inches above the base, the plant will then branch out more and send forth new flower-stems. Carnations resist the cold perfectly and can be left in the ground, unless they are desired to bloom in winter. In this case a good precaution to take is to shelter the plants after a strong frost from the rays of the sun by some covering.

If they are to flower in winter, pot the plants in October, at least those that show buds, and let them be as late as possible (so that the buds do not freeze) in an Orangery greenhouse, shed or any other temperate shelter, and give them air every time the exterior temperature is fit. The amateur who has not a greenhouse for propagation should graft them in September, against a northern wall in the open air. The striking of them is then almost certain. This culture is within the means of everybody. These same rules will apply to many plants, especially those which are called soft-wooded. Many horticultural publications contend that certain plants are difficult to multiply by grafting. Why difficult? Because we are ignorant. Every plant grafts easily if we know how to do it. It is to hide our ignorance that we say a thing is difficult. "Seek and you will find," says Jesus Christ, and it is and always will be true. What man knows not how to do he declares impossible. Pride! What he cannot comprehend or what is above his intellect, he decides to be impracticable. Pride!

JEAN SISLEY.

## TIME TO PRUNE SHRUBS, AND OTHER HINTS.

BY F. R. E.

All know me as an old foggy soon to pass away to, I hope, a land where trouble or doubt has no abiding place—but while here among my fellow men I cannot rest, without now and then pencilling down my thoughts as I read their teachings.

In your general directions, page 34 of February number, you are correct, but as you are now the only Horticultural Magazine Editor for all except California or southwest thereof, should you not occasionally tell novices as to the time or period of the budswelling; when to prune, please? "With March all should be finished"—will not quite pass in our more Northern sections, and it is too late for the South. I suggest that you tell us how to prune, and then give touching the breaking of buds, etc., as to the location of your readers.

Perhaps you will reply to me as follows: "We write for those who are educated, not for those who have had no knowledge either of books or practice." All right, but here let me object to your item of how to make shapely specimens. I would not pull out the strong shoots, but I would shorten them, and cut in close the weak one, and then as the buds on the strong shoots struck but laterals, I would pinch them back, here an inch and there three inches.

But you need not publish this of mine; for in this article I have been picking at, you have so complimented the ladies, and told so many truths of what we should and what we should not do, in the use of spade as compared with fork, or the hoe as compared with the rake.

Right again, and keep it before your readers until after the April number, "That no good gardener loses a tree in planting, because another has injured its roots." As you say, the experienced hand in tree planting keeps always in mind the old motto, "never say die."

Now I am along when you have been putting "Sam Slick" on me, but I forgive; yet am afraid it will make somebody try to throw me out of office should I ever gain another berth, and so I——. Well, well, no matter, let me turn over to the few words of *Pinus Cembra*, please; for the planting in grounds when space is restricted, we have nothing superior to it, in hardness, beauty of form, color of foliage, and compactness.

*Wild Gardens.* Let us have more of them. Who is ever afraid to gather a flower of the wild

*Azalea*, or the common *Kalmia*, or who hesitates to pluck a fern leaf when wandering in our wild, wild woods. If you have any of that kind on your list, take them into some of the rocky woods of Connecticut, etc. Let us have more of the old shrubs and perennial flowers. Why should we continue to dress and decorate in gaudy colors, when simple blue and rosy white, are the shades that tinge on green so sweetly in nature.

*Spiraea sorbifolia.* Once more I must call attention. Never cut it clear down, except when first planted, then do it and cut out the poor puny stems, shorten the strong shoots and take out the laterals that tend to thicken too much the centre, and shorten back the laterals that come out, to assist you in giving the shrub a cone or round head, etc., as you desire.

## EDITORIAL NOTES.

*JASMINUM NUDIFLORUM.*—This is one of the best hardy plants to put under the windows on the walls of houses. It is a trailer and needs a trellis or wires to keep it up. It grows in a dense mass, and the flowers open on the slightest taste of warm weather. The season has been rather mild in Germantown, and a beautiful block of it on the house formerly occupied by the late Miss Elizabeth Morris, the well known Botanist, has been in full bloom since Christmas, and has given pleasure to hundreds who have stopped to look at it. It has the good merit of getting along under the roughest treatment; even in the driest places under trees it will grow and do well.

*THE LIVE OAK—QUERCUS VIRENS.*—In our recent trip to the far South, we know of nothing that so impressed us with its rare beauty as the Live Oak, and we feel a grateful remembrance of Col. Hardee of New Orleans, for a drive to where these beauties were. The general aspect of these trees is that of huge apple trees,—that is to say, they branch comparatively low down, and spend their remaining efforts in producing immense heads. In this way the trees, tall as they are, are wider than high? The branchlets are rather slender for an oak, and hence in spreading become somewhat pendulous, and this favors the spread of the "moss" (*Tillandsia usneoides*). This moss does not increase much from seed, but by pieces blowing on the other branches, and

thus new colonies are formed, and of course a sub-pendulous habit is an advantage to the spread of the *Tillandsia*. With yards in length of this "moss" hanging in every direction from a grand Live Oak tree, it seems to make the perfection of arborescent beauty.

**GARDEN EDGINGS.**—Those who do not like box, or are in climates too cold for it, should by all means use the *Globe Arbor Vitæ*. It can be laid just as box is laid, and bears trimming just the same as box if not better. We recently saw some beautiful edgings at the nursery of Geo. Achelis, at West Chester. When full grown it is a beautiful ornament. Here is a sketch of one as growing on the grounds of Wm. R. Mercer, Esq., of Bucks Co., Pa.

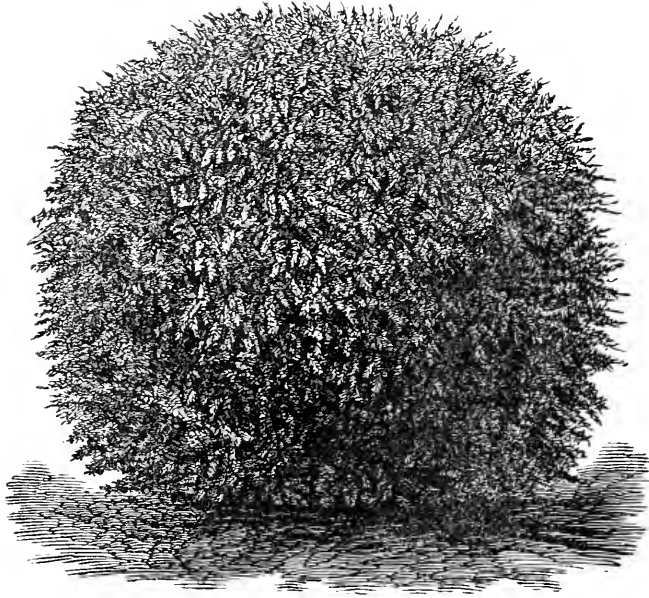

**SCHIZOSTYLIS COCCINEA.**—A few years ago we saw this beautiful plant in flower in a garden near Philadelphia, but have missed it lately. We suppose it is yet in some of our gardens. We are reminded of it by the following sketch in the *Gardener's Magazine*.

"This is one of the most valuable of plants, either for conservatory decoration or for growing in any warm sheltered nook, for supplying cut flowers during autumn, and no garden, however small, should be without it. In order to have strong plants, it should be planted out early in the spring, in beds specially prepared for that purpose, as it grows much more vigorously treated in this way than it does when confined in pots. The beds should be formed of some rich

**ABIES ENGELMANNI.**—On the grounds of W. R. Mercer, Esq., of Bucks Co., Pa., we recently saw two fine specimens of Engelmann Spruce. One was about three feet high, and probably larger than Mr. Gray's at Boston, which we had supposed hitherto, was the largest in cultivation. As is well known, there is a remarkable tendency to vary among coniferous plants, and hence our readers will not be surprised to learn that there was much difference between these two plants in habit and other characters. This beautiful Colorado spruce seems well adapted to eastern culture, and we hope to see it become common.

vegetable material, such as leaf soil and good fresh loam, or any refuse peat that has been cast aside as unfit for potting purposes. If either of the above materials can be spared to form a bed from 6 to 10 inches deep, there will be no difficulty in growing such plants of *Schizostylis* as will produce an abundant supply of its rich scarlet *Gladiolus*-like blossoms during the greater part of the winter. Where supplies of leaf soil or peat are not to be had, it may be grown tolerably well in any ordinary soil that has been well enriched with rotten dung previous to planting. Its flag-like leaves are rather subject to red

spider, but this may always be prevented by keeping the plants well supplied, when necessary, with water, as it is invariably over-dryness, either in the atmosphere or at the roots, that favors the existence of this pest; both may, therefore, be guarded against by sprinkling the plants overhead two or three times a week, or as often as the weather renders such a course necessary or desirable for the health and well-being of the plants. If treated in this way, they will be found to produce flower-spikes early in October, when they may be taken up and placed in pots according to the size and strength of the tufts. They should then be placed in a close, moist frame for a week or so, to give them a chance of becoming established before being placed in the comparatively dry atmosphere of a greenhouse or conservatory."

### NEW PLANTS.

ROMNEYA COULTERI.—A new and peculiar flower, belonging to the Poppy family, which we did not meet in California, but of which we often heard. The plant was represented to us as two feet or more in height, with white, fragrant flowers quite five inches in diameter. The petals are pure white, stamens bright yellow, foliage pale green, somewhat glaucous. Flowers fragrant, and often from forty to fifty adorning the plant at one time.—*J. Vick.*

[We believe this plant has somewhat the face of the well known Argemone Mexicana, or Mexican Poppy.—Ed. G. M.]

DELPHINIUM NUDICAULE.—Mr. Vick says of this: "Among the beautiful flowers that adorn the California mountains, we saw nothing really more decorative than the bright scarlet Larkspur, *Delphinium nudicaule*. Every mountain-top, especially in the neighborhood of the Geysers, seemed covered with these brilliant little flowers. We filled our hands with the flowers, and our pockets with the seeds; and though often warned that rattle-snakes abounded, we saw nothing more formidable than the pretty little lizards, that seemed as lively as crickets."

BRODLEA CALIFORNICA.—Of all the pretty flowers that abound in California, we know of nothing prettier than the twining Hyacinth. The flowers are a very fine pink, or deep rose. It grows in the mountains and twines over every bush it can reach, and the flower-stem goes to

the top of the bush to which it is attached, no matter if it is five or ten feet. After it gets to the top of the bush and rests awhile to be sure it has got a good hold, it lets go of the earth and goes on blooming and seeding for weeks and months, regardless of the burning sun by day or the cool mountain air by night. The leaves are long, narrow and grass-like. The roots are very deep, and being entangled with the roots of shrubs and bushes, it is next to impossible to get them up. This plant is in flower at all times from May to September. The flower-stem breaks off near the ground, and the flowers are left swinging in the air without any connection with earth or root, supported by the bush about which it twines.—*James Vick.*

SPIREA PALMATA.—In a description of this plant given in the *Botanical Magazine*, No. 285, Dr. Hooker says: "By far the handsomest species of the genus hitherto imported, and certainly one of the most beautiful hardy plants in cultivation; the deep purple red of the stems and branches, passing into the crimson purple of the glorious broad corymbs of flowers, contrasts more exquisitely with the foliage, which in autumn assumes beautiful tints of brown and golden yellow." It is a native of Japan, and was discovered and introduced by Mr. Fortune.—*W. Bull.*

### QUERIES.

CRATEGUS PYRACANTHA HEDGES.—A Kentucky correspondent writes: "I take the liberty of writing you regarding *Crategus Pyracantha*, which is now exciting a good deal of attention in these parts, though very little is known of its merits as a hedge plant. Do you believe it would be hardy down here? That is, hardy to the extent of carrying its foliage throughout the winter. I am glad your *Monthly* is getting along finely."

[The common *Pyracantha* is a rather straggling bush, and has to be kept in order by the shears. The White-Berried *Pyracantha* is a dense close grower, and makes a beautiful close hedge without trimming. It is rather a slow grower, but as there is nothing lost by cutting back, as in most fast growing things, it comes up in about the same time. The white-berried kind is very much the hardiest, and keeps green all winter. It must be raised from cuttings.—Ed. G. M.]

# GREEN HOUSE AND HOUSE GARDENING.

## SEASONABLE HINTS.

In this part of the world window plants are not given their summer airing until May, but every opportunity is taken to let them have all the open air possible, by opening windows and sashes wherever practicable. People often complain that plants from greenhouses are too tender to stand the open sun, but it is only because they have been too much confined. If any plants growing in pots are yellow, or in any way sickly, it is as well to prune them severely and plant for a year in the open ground. If they have insects on them these should be cleaned off before planting out, or they will increase under our dry summer sun. The red spider is best treated to a syringing of warm soap suds, and then to be dusted with sulphur; and the scale insects should have a painting with whale oil soap, and some say linseed oil. Many plants will have to be kept in pots all summer, and these are best set in partial shade. There are few more desirable room plants than the Ivy and Periwinkle in their numerous varieties. These should be potted now, and grown all summer. There are many things nearly, or quite hardy, that are not often kept in pots, but which would make good things for room culture, and these should be potted now. Of these we may name Cotoneasters, Mahonias, Berberis, Euonymus. These are very easily managed, and it seems to us that for those who have had little experience in plant growing, or whose conveniences are limited, it is just as feasible to have beautiful things *easy* to grow, as beautiful things that are *difficult*.

During the summer one may have rooms prepared for winter window-plants, and much may be done by arranging shutters so as to make double windows, to keep out the cold. In this connection read the following good hints from the *Builder*:

"Nothing is more effective to keep out cold than double windows; the layer of air between two panes of glass is a good non-conductor of heat, and can only transmit it from the inside outward by convection, that is, by a circulation

of the inclosed air, which will descend along the outer cold window pane and ascend along the inner warm pane. The radiated heat, which, at temperatures below 100° Fah., is very weak through glass, is of course smaller still through double glass; then the inconvenience of glass becoming covered with frost during cold weather, is done away with, if the inclosed air is dry.

"Some time ago we communicated a suggestion, made by some builder, to insert two panes of glass, one on the outside and one on the inside of the same frame, having rabbets on both sides; this may do for economy, but is subject to the objection that the inside cannot be cleaned without taking the glass out, and the fact is that in the course of time it will in some way or other get into such a condition as to need cleaning; then, when the glasses are so close together, the protection against the outer cold is less effective than if a greater mass of air is included.

"In very cold countries, like Russia, Sweden, or Canada, the need of such protection is more felt than with us; but even here it is often adopted in exposed localities, when the parties can afford the luxury. Thus all the houses on Brooklyn Hights, enjoying the magnificent view of New York harbor, and those on Washington Hights, enjoying the view of the Hudson river and the Palisades, are fully exposed to the strong and cold blasts of the northwest winter winds, and are all provided at the west and north sides with double windows, the absolute necessity of which has become more and more evident for the comfort of the inmates. Such a double window may serve another purpose, and be used as a little greenhouse; when exposed to the sun, the solar heat is stored up in them, and in France some parties grow different plants and even grapes in them in winter."

## COMMUNICATIONS.

### ORANGE AND LEMON TREES AND GERANIUMS.

BY WILLIAM SUTHERLAND, PHILADELPHIA.

A lady, writing from Maryland, says that last spring a year ago I proposed in the *Monthly* to

tell something about raising Orange and Lemon trees, and wishes I would redeem my promise. She says she and her lady friends followed my instructions for growing the Calla lily with very favorable results, and adds that she is quite successful in raising seedling Geraniums, but has great difficulty in getting them to flower before they are very large plants. Now, I think this letter ought to have been sent to Mr. Meehan, as all letters of inquiry should be; but as she says I promised, I must, of course, perform. The first thing to be done is to procure the lemon seed (as both orange and lemon are generally grafted or budded on the lemon stock); this can easily be accomplished by saving all the perfect pips they find in the lemons when next they make lemonade; these should be dried and sown in light sandy soil in a pan or shallow box, and when two or three inches in height should be

Suppose the stock to be one foot high, or as high as your fancy may dictate; with a sharp knife carefully cut the bark and outer wood down as shown in Fig. 1, then prepare the graft as shown in the same figure; insert the graft in the stock, carefully bringing the edges of the bark together so that the bark of the graft fits the bark of the stock (it is not necessary that the graft fit the stock exactly, if the bark of the graft meet the bark of the stock on one side it is all-sufficient); tie them in their place as shown in Fig. 2 with some soft tying material, such as cotton strings, matting, &c. After tying them smear the grafted part over with soft clay, shorten the stock back, place it in a glass jar, and stop the mouth up with moss, cotton or soft paper, so as to exclude all air during the time that the union is taking place. Shade the plant, and when the graft has taken, gradually harden

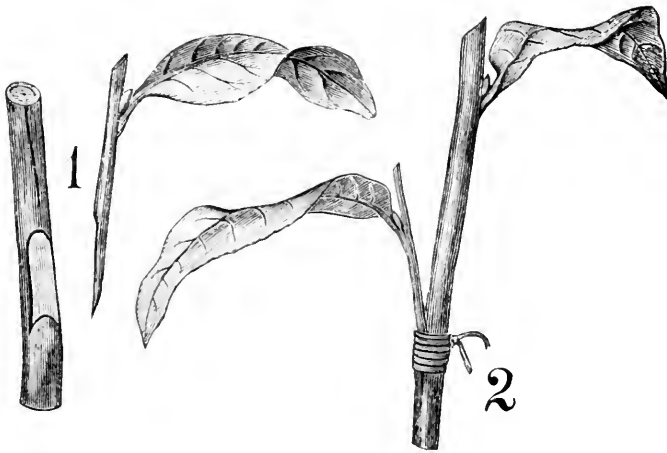

potted singly in small pots or planted out in the open ground. If the weather be warm, and all danger from frosts be over, these seedlings when as thick as an ordinary lead pencil may be budded with orange or lemon buds in the same way as peach trees, and about the same time of the year—July, August, September. For my own part, I prefer grafting, as it forms a specimen much quicker than the slower process of budding, which causes us to wait until the next season before we can hope to get a growth. The only difficulty in the way of grafting is to keep the stock and graft, or rather that part which is operated upon, in an air-tight chamber during the process, which can be readily done in the following manner:

it off by removing the material from the mouth of the jar for two or three hours each day, extending the time until it is thoroughly hardened, but in no case allow the graft to droop from too long exposure. In selecting the grafts be careful to take only such as have plump eyes on the half ripened wood, as the older the wood is the slimmer the chance of success. The orange is generally distinguished from the lemon by its leaf stalks having wings, as shown in Fig. 4, while the lemon has a plain stalk as shown in Fig. 3. Both plants grow well in almost any rich sandy soil, and when growing require an abundance of water. The pots should be well drained with oyster shells, broken pots, or small stones, and the

plant shifted into larger pots, as the old one becomes filled with roots.

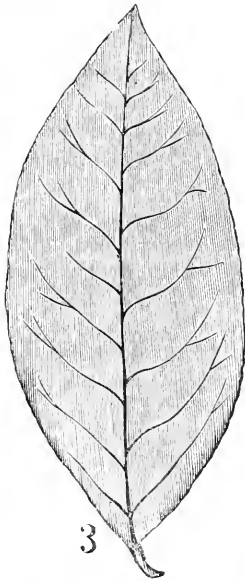

The principal varieties of oranges and lemons are—

- |                |                        |
|----------------|------------------------|
| Sweet Orange.  | Varieg. leaved Orange. |
| Bitter Orange. | Sweet Lemon.           |
| Finger Orange. | Sour Lemon.            |
| Blood Orange.  | Citron.                |

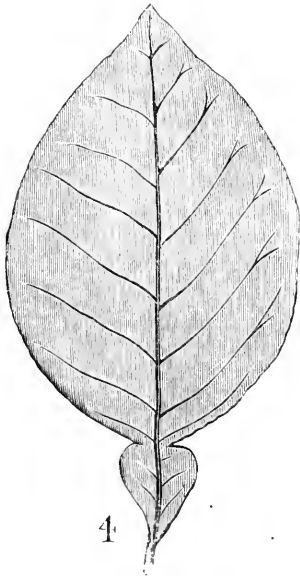

- |                       |                   |
|-----------------------|-------------------|
| Otaheite Orange.      | The Lime.         |
| Myrtle-leav'd Orange. | Californian Lime. |
| Mandarine Orange.     | Dwarf Lime.       |
| Fr. Hybrid Orange.    | The Pummeloe.     |

In regard to flowering seedling Geraniums the process which I generally practice after the plant has grown some eight inches is as follows: I make a six-inch cutting of the top, dry it in the shade for a day, and insert it in sand or sandy soil, keeping it moderately dry until rooted, when it should be potted and shifted, as it requires, or planted out in the ground.

By this means it will be found that seedling Geraniums flower much quicker and grow dwarfer than on the seed roots, and where room is no object, and stumps are kept, you get two plants instead of one, which is a great advantage if the seedling be worth preserving, &c.

### COAL TAR.

BY J. F. M. FARQUHAR, EAST PROVIDENCE, R. I.

A few years ago I had some experience with the use of coal tar in two forcing pits, which may be interesting to some of your readers.

The wooden frame-work of the beds having become decayed, it was necessary to renew them. In order to make the new frames last as long as possible, the inside of the planks were given a coating of coal tar. The work was done in summer, so that it had time to dry and harden before the soil was put in. I had recommended to my employer pitch tar in preference to the cheaper article, fearing that bad effects might result if the high temperature in the pits should melt the coal tar. But in the fall, when the soil was placed in the beds, so hard and dry had it become that I thought the work could not be done better, or more cheaply, and my earlier apprehensions were removed. Winter-flowering plants and early vegetables occupied the beds, and all did well for about three months after being planted.

The weather having become intensely cold, the heating apparatus had to be kept at work night and day. Just at this time the plants seemed to lose their healthy look; Roses and Bouvardias began to sicken, their leaves to turn yellow and fall off. I at once suspected what the trouble was, and in order to remedy the evil as far as possible, I removed these plants out of the beds and potted them. I found that their young roots were black and lifeless from being poisoned by the tar. The continual heat from the pipes immediately under the beds had melted it, and the gases being absorbed by the soil poisoned it. In other parts of the pits, Carnations, Helio-

tropes and Stocks were planted in the same manner, and they did not appear to suffer in the least. Lettuces, however, didn't seem to like their quarters any better than the Roses and Bouvardias. Parsley grew quite as well as if nothing unfavorable touched its roots. I had no satisfaction from these pits that season, and when summer came round again, I took the first opportunity to remove all traces of what had given me so much trouble, and refitted the frames with hard pine planks; after which I had no trouble. Experience is often a hard teacher, and this mishap taught me that a gardener cannot know too much about anything that relates to his business.

### HEATING WITH HOT WATER.

BY THOS. OTTAWAY.

I have had thirty years' practical experience in heating plant houses with flues, steam and hot water, and do not hesitate to say that hot water is by far the best for plant growth. The best boilers are those of Hitchings & Co. and Weathered of all I have had in use. My advice is to use plenty of pipe for heating to produce healthy plants. I don't like the water to exceed 160 degrees. My advice is to keep pipes 4 to 6 feet above the boiler, and to connect the feed pipe with the flow, to take away the steam generated in the boiler. Many suppose the hot water drives the cold, but it is just the reverse—it is the balance of power. Cold water being the heavier, the more the pipes are elevated above the boiler the quicker the circulation.

### EDITORIAL NOTES.

FLORAL DECORATIONS AT TUNBRIDGE WELLS.—The floral decorations at the exhibition of the Tunbridge Wells Horticultural Society, held on the 2nd inst., exhibited a marked improvement upon those of last season, both as regards number of entries and taste in arrangement. In the class for a group of three pieces for table decoration (flowers or fruit), strange to say not one group staged contained fruit. The first prize in this class was awarded to Mrs. Seale, London Road, Sevenoaks, for a charmingly-arranged group of three March vases, decorated with white Water Lilies, scarlet Geraniums, the scarlet spathes

of the Flamingo plant, Orchids, scarlet Begonias, pale blue Larkspurs, mixed varieties of Ferns and wild Grasses, while from the trumpets trailed long sprays of *Lygodium scandens*. The arrangement of the flowers in these stands was much more effective than that which Mrs. Seale exhibited at the Crystal Palace on the 26th of last month; indeed, I quite agree with one of our oldest judges, who, when he saw Mrs. Seale's group of March vases at Tunbridge, said it was the prettiest arrangement he had ever seen. The second prize in this class was awarded to Mrs. G. Smith, Hurstley, for a group of three vases, consisting of trumpets rising out of flat tazzas, the centre piece being the tallest, but had it been about 6 inches taller still it would have been a great improvement. The principal dressing of these stands consisted of blooms of *Tacsonia Van Volxemii*, sprays of *Spiraea* and *Copper Beech*, and light grey-tinted foliage furnished by *Centaurea* and other grey-leaved plants. The third prize in this class was awarded to Mr. John Beech, for an effective group consisting of a March stand for the centre piece, and at each side trumpets rising out of tazzas, all three being dressed with much taste. In the class for a single piece for table decoration the first prize was awarded to Mr. James Bolton for an elegantly-arranged vase, in which Orchids, blue Corn-flowers, *Stephanotis*, and other flowers and Ferns were charmingly intermixed. The second prize fell to Mrs. Seale for a March vase, very similar to the others exhibited by that lady; and the third prize was awarded to Mr. Fennel for a pretty design; and an extra fourth was awarded to Mr. G. Hubbard. The hand bouquets were good, nearly all exhibited, with few exceptions, being lightly put together, and free from that packed appearance too often to be observed in those exhibited for competition at flower shows; the prizes were awarded (in the order in which the names stand) to Mr. John Staples, Mrs. Staples, Mr. G. Hubbard, and Mrs. Fennel. For button-hole bouquets, which were plentiful, the first prize was awarded to Miss Jane Hollamby, and the second to Mr. R. A. Boesseer. Again, as last season, in the class for arranged groups of wild flowers, there was a keen competition. The first prize was awarded to Miss Cox, the flowers in whose stands consisted of Poppies, Dog Daisies, Forget-me-nots, yellow Bird's-foot, Trefoil, and Grasses; the second to Mr. Charles Noble, for a large-sized March vase, in which, in addition to wild flowers, Grasses were extensively employed. In the



class for a single piece for table decoration (for gardeners only), the prizes went to Mr. Richard Downing and Mr. James Bolton, both of whose arrangements were much admired.—*The Garden*.

ANNUALS FOR BOUQUETS.—People often want to know what to sow to get flowers for cutting all summer long. The following list is recommended by Messrs. Thorburn:

LIST OF ANNUALS SUITABLE FOR BOUQUETS.

Abronia umbellata.	Gypsophila acutifolia.
Ageratum Mexicanum.	Heliophila araboides.
“ album.	Heliotropium grandiflorum.
Alyssum maritimum.	Iberis odorata.
Amaranthus tricolor.	“ umbellata.
Aquilegia cærulea.	“ sempervirens.
Aster chrysanthemiflora.	Leptosiphon densiflorus.
“ alba.	Lobelia gracilis.
Balsams Camellia flowered.	“ erinus.
Centranthus macrosiphon.	Mimulus moschatus.
“ dwarf.	Phlox Drummondii.
Clintonia pulchella.	Reseda odorata (Mignonette).
Collinsia bicolor.	“ verna.
“ verna.	Silene Schafta.
Cuphea ocymoides.	Smilax asparagoides (Myrsiphyllum).
“ miniata.	Sraguea umbellata.
“ purpurea.	Stocks, (Ten Weeks.)
Dianthus Chinesis.	Viola tricolor, <i>finest</i> .
Didiscus cærulea.	Viscaria oculata.
Gilia tricolor.	“ Dunnettii.
Gypsophila paniculata.	Zinnia, all the double varieties.

NEW PLANTS.

MACLEYA YEDOENSIS.—This charming ornamental-leaved plant has been recently introduced from Japan. It is a vigorous grower, and attains in one season a height of from four to five feet. The leaves are very large, of a glaucous green, with rosy yellow nervoses on the upper side, and are deeply and elegantly cut.—*R. G. Hanford*.

NEW VARIEGATED LANTANA—Harkett's Perfection.—This has been proved the past two summers and is undoubtedly the best variegated bedding or pot plant to stand the sun. The leaves are golden yellow, blotched and marbled with dark green; having rich rose colored flowers with orange centre, beautifully harmonizing with

the foliage. It obtained a diploma at the Northwestern Exposition held in Dubuque, in September, 1875.—*W. A. Harkett*.

OTTHONNA CRASSIFOLIA.—This pretty plant is but little known. It has a dwarf, creeping, or pendulous habit, with slender, round, fleshy, light green leaves, and small axillary, yellow flowers. As a plant for hanging-baskets, flourishing in a cool temperature, it is the gem of all similar plants. Its numerous graceful stems droop over the sides of the pot or basket, and its Sedum-like foliage glistens under the bright sun; also suitable for carpet-bedding among succulent plants. It is a perfect gem in the full sun.

BEGONIA FRÖBELI.—This new species was first exhibited in this country by its introducers, Messrs. Fröbel & Co., of Zurich, on August 4th, 1875 (see *The Garden*, Vol. VIII., p. 121), when it received a first-class certificate. In habit it is quite distinct from all others, having large obliquely cordate, hairy leaves, hoary beneath, and very variable in size, the largest being 6 to 12 inches in length, and from 3 to 8 inches in width. It has crimson-scarlet flowers, which are borne in erect panicles from 10 to 15 inches in height. The male flowers are four-petaled and nearly 2 inches in diameter, while the female flowers are five-petaled, and about 1 or 1½ inches in diameter. The peduncles themselves are of a bright red color spotted with crimson. This species has been used with success for bedding purposes on the Continent. It is a welcome addition to our hardy tuberous-rooted species, and will be invaluable to the hybridiser, the panicles of vivid flowers being borne well up above the tufted radical leaves on separate stems, as in *B. Veitchii* or *B. roseiflora*, only we have here many-flowered branched panicles instead of a few-flowered scapes. This, one of Mr. Roetz's discoveries on the Andes of Ecuador, where it luxuriates at altitudes varying from 8,000 to 10,000 feet, or in a temperature where the Strawberry seems perfectly at home, is well figured in the January number of the *Illustrirte Garten-Zeitung*, t. 1. We believe Mr. B. S. Williams has made arrangements to distribute it in this country.—*B., in London Garden*.

QUERIES.

NAMES OF PLANTS.—J. I., Newton, Mass.—The little leaf No. 1 appears to be a variegated leaf of

*Eranthemum pulchellum*. No. 2, variegated  
*Vinca major*.

MACHINES FOR FLOWER POTS.—F. G., Memphis, Tenn.: "You will confer a favor upon a constant reader of your *Gardener's Monthly* by letting me know where I can get a machine to make flower pots."

[These are made in Baltimore, we believe, but are unable to give more precise directions.—Ed. G. M.]

FLOWERING OF *COMBRETUM GRANDIFLORUM*.—J. B., Cuyahoga Falls, Ohio: "Could you give me some information, please, how to make blooming *Combretum grandiflorum*. We have one plant of it; been about 15 years on the place: never did anything but grow."

[This plant and its allies often take these contrary humors, but when they do bloom usually make up for it. The best advice that we can give is to keep it under potted, and let it have all the light and sun it can get.—Ed. G. M.]

VARIEGATED LANTANA.—Mr. Harkett writes:

"I send you to-day a plant of my new *Lantana*, which I think you will find a valuable plant for bedding, especially where exposed to the sun, where few variegated plants can succeed. I also enclose a few remarks in regard to training trees and fruit bushes to walls for late crops, which may be both valuable and interesting to some of your readers in the large Eastern cities, where walls abound that can be made to do service.

"In regard to the *Lantana*, the leaves get a little green when they are shaded too much or get old, but while growing, exposed to the sun, it is excellent, and I think will prove the most valuable addition to the class yet obtained. I have also a very fine scarlet *Geranium* of dwarf habit and very free bloomer that holds its petals well and produces large flowers and trusses which is fully equal in quality to the latest imported varieties, although flowers are not as large as *Rienzie* or quite as perfect, but better bloomer and has larger trusses."

[The *Lantana* did not come to hand.—Ed. G. M.]

## FRUIT AND VEGETABLE GARDENING.

### SEASONABLE HINTS.

The Apple is our standard fruit, and may always be relied on with reasonable care. The first care is good food. Some talk about too rich soil. We never saw the soil too rich for the apple. Where any trouble arises in apple culture, it will be safe to attribute it to other causes than rich soil. Kitchen ashes, in which table refuse is thrown, is an excellent top-dressing for apples. We like top-dressing better than any other system of manuring apple trees. Even nice ditch scrapings are good to top-dress with, where nothing else offers. Apple trees are often starved in other ways than by neglect to manure. The apple borer leads to starvation oftener than poor soil. The supply of food is cut off by every move the borer makes. They work at the surface of the ground. Look for them now. If you have no time, set the boys and girls to work. Say they shall have no apples for

Christmas or birthday presents if they do not. However, get the borers out somehow, even if by wire and jack-knife. If not soon done they will soon get out themselves, and give you more trouble in the future. After they have left, whether by your invitation or otherwise, keep them out; even though you have to lock the door after the horse is stolen. There is nothing like tarred paper to keep them out. The paper must be put an inch or more below the ground, and two or three above. We have used gas-tar for years; but find that if the tar contains creosote, as it sometimes does, and the newspaper be very thin, it will once in awhile injure the bark. Pine tar will therefore be better.

In grape raising people seem to go to extremes in management. A few years ago the poor plant was in leading strings. It dared not make one free growth, but it was pinched and twisted into all sorts of ways. Now the "prune not at all" maxims are getting headway, and this is as bad, if not worse. First, grape growing was such a

mystery it took a life time to study it, and the "old vigneron" was an awfully sublime sort of a personage. He is now among the unfrocked and unreverenced. But there is great art in good grape treatment; and yet this art is founded on a very few simple principles. For instance, leaves are necessary to healthy growth; but two leaves three inches wide are not of equal value to one leaf of six inches. To get these strong leaves, see that the number of sprouts be limited. If two buds push from one eye, pinch out the weakest whenever it appears. The other will be strengthened by this protective policy, and the laws of trade result in favor of larger and better leaves on the leaf that follows. Allow no one shoot to grow stronger than another. If there are indications of this, pinch off its top. While it stops to wonder what you mean by this summary conduct, the weaker fellows will profit to take what properly belongs to them. There is little more science in summer pruning than this; but it takes some experience, joined with common sense, to apply it. This, indeed, is where true art comes in.

South of Philadelphia, the more tender kinds of garden vegetables may now be sown—beans, corn, cucumbers, squashes, etc.—that it is not prudent to plant in this latitude before the first of May; and tomato, egg-plants, etc., may also be set out in those favored places. Cucumbers, squashes, and such vegetables, can be got forward as well as tomatoes, egg-plants, etc., by being sown in a frame or hotbed, and potted off into three-inch pots. They will be nice plants by the first week in May. Rotten wood suits cucumbers and the squash tribe exceedingly well as a manure. Tomatoes and egg-plants that are desired very early are best potted, soon after they come up, into small pots. They can then be turned out into the open air without any check to their roots. Of course, they should be gradually inured to the open air—not suddenly transferred from a warm and moist air to a very dry one.

Early York cabbage for early use should be set out early in this month. An excellent plan is to make the holes with a dibble first, where the cabbage is to be set; then fill the holes with manure-water; and after the water has soaked away, set in the plants. It is rather more laborious than the old way, but the cabbage grows so fast afterwards that it pays pretty well.

Celery is an important crop, and should be

sown about this period. A rich moist spot shaded from the mid-day sun, should be chosen; or a box in a frame, if convenient.

Bean-poles may be planted preparatory to sowing the Lima bean in May. Where bean-poles are scarce, two or three hoop-poles, set into the ground, and tied together at the top, make as good a pole, and perhaps better.

Dwarf beans should have very warm and deep soil—sow them only two inches apart. The Valentine is yet the best early, take it all in all.

Peas should be sown every two weeks for a succession—do not make the soil very rich for them.

---

## COMMUNICATIONS.

---

### A VISIT TO COVENT GARDEN MARKET.

BY MANSFIELD MILTON.

Being long anxious to visit this world-renowned place for a display of vegetables, I accordingly paid it a visit one Saturday morning, in January last. With the produce which the market gardens around London brought to this market I was astonished at its excellence; but with the place they have for selling it in I was disappointed. It is far too small for the immense traffic, and, together with the narrowness of the streets leading into it, make it altogether a very mean place for the purpose. The business is mostly done in the morning between 6 and 9 o'clock, when but little traffic of any other kind is being carried on, especially during winter; but, at the same time, the large wagons used for conveying the produce are so closely packed together it is very difficult for those on foot to push their way through; and very disagreeable for those having the work to do, getting their vegetables off the wagons, and properly disposed of.

The flower market is much superior to the vegetable department. It is a large building so arranged that one can move about and examine the plants and flowers with a good deal more comfort than in the vegetable market, and, undoubtedly, with a good deal less of rebuff to the stranger than in the latter place. The buyers and sellers appear to think they have an exclusive right during the early hours of the morning, and that strangers should stand outside and

under no pretense whatever ask any questions about what they see, except the prices of the different vegetables. In the flower department every one appeared very anxious to inform us what we asked them.

Upon the whole, I really think London—the Empire City of the world—should possess a vegetable market something in keeping with her great size and immense wealth. For the benefit of the readers of the *Monthly*, I shall give a list and the prices of some of the principal vegetables, plants, and cut flowers which were in the market at the time of my visit.

Turnips were in large quantities and of good quality, but not very large in size; they sold for 4d. per bunch. Carrots were splendid, not extra large, but clean and free from canker; 6d. per bunch. Rhubarb, at 1s. 6d. per bundle, was finely colored, although forced, which is what is not always seen, and what many gardeners do not deem requisite to have in forced rhubarb, but what is not well colored is not well flavored. Plenty of air and light are necessary in obtaining color. Green peas, at 1s. 6d. per lb., were not very plentiful. Considerable quantities of new potatoes were in the market, and for about 1s. 6d. per small basket. A good many tomatoes I saw, but of a quality which would not be much relished by Americans, who are so much accustomed to such fine fruit at home; they brought from 1s. to 2s. per dozen. Seakale was in splendid condition, thoroughly blanched and, therefore, very tender; sold for about 2s. per punnet. Asparagus was plentiful, and of excellent quality; home-grown brought from 8s. to 10s. per bundle. There were also cucumbers, onions in large quantities, leeks, celery (mostly red varieties), lettuce, endive, cabbage, Brussel-sprouts, and cauliflower, which all sold at good, fair prices. Taken altogether, the vegetables were the best and in larger quantities than I had previously seen anywhere.

The fruit was also very good and in large quantities; some excellent grapes of Lady Downe's and Black Alicante varieties. These are the two best kinds we have for hanging late, but it appears to me the true Alicante is not always seen bearing the name. It is a fine keeping and good looking, but not an extra flavored grape. They ranged in price from 2s. to 6s. per lb. Plenty of foreign grapes at much lower prices.

There were some good specimens of *Ne Plus Meuris*, Easter Beurre and Beurre Rance, pears, large lots of American apples, plenty of oranges, figs, nuts, melons and pine-apples. The plants

were mostly growing in six-inch pots, but were well grown and free from insects; those in flower appeared as if their blooms had just opened, so as to be in their best that very day. The plants of Azaleas were grown mostly as standards, and the smallest of the plants full of blossoms, both single and double varieties; they sold for from £2 to £3 per dozen.

Bouvardias were not in such good condition as I have often seen some of the American gardeners having them; they sold for about 12s. per dozen. When visiting the large plant establishment of Messrs. Hugh Low & Co. I saw a great quantity of the different varieties of bouvardia growing in pots flowering very freely, but what drew my attention most was the large size of trusses they had. *Primula sinensis* astonished me to see the excellent strains of some of the lots exposed for sale here. It is very strange some of the enthusiastic florists throughout the United States have not got into the cultivation of some good strain of *Primula* and raise seed for home demands. As it is, gardeners in want of fine kinds have to import from England, and although the highest price is paid for it, far superior strains are seen for sale in Covent Garden than any I have ever seen raised from any of our "imported" seed.

The plants have foliage of fine substance, the flowers, which are very large, are produced in large trusses, and raise above the leaves just high enough to make them look well. The fine strains brought 12s. per dozen.

*Poinsettia pulcherrima* is grown in six-inch pots. The plants are very dwarf, and the bracts very large. Some of the white one—*alba*—are for sale, but not nearly so abundant as the red one; they brought about £1 per dozen. Tulips were in variety and very fine. They are planted five bulbs in a pot, and sell from 9s. to 18s. per dozen. Hyacinths are grown singly in pots, and bring about the same price; except Roman Hyacinths, which sell for as much as 30s. per dozen. There was a great show of the different colors of Cyclamen, selling for from 12s. to 18s. per dozen.

Besides the above, there were large lots of Heaths in variety, *Begonias*, *Echeveria retusa floribunda*, *Cyperus alternifolius*, *Epiphyllums*, *Dracenas*, *Mignonette*, *Pelargoniums*, and *Ficus elastica*. Cut flowers were not so plentiful as are seen in the florists' establishments in the United States. I have seen in a single establishment there more flowers at one time than there were in all Covent Garden Market. Some of the prin-

cipal were Carnations, 12 blooms, 2s. to 4s.; Gardenias, 12 bl., 12s. to 18s.; Eucharis, 12 bl., 6s. to 18s.; Stephanotis, 12 sprays, 9s. to 18s.; Tuberoses, per dozen, 4s. to 9s. Such kinds as Cyclamen, Heliotropes, Mignonette, Pelargoniums, Primula, Spirea, Violets, and Roses sold a good deal cheaper.

### A NEW CULTURE FOR ASPARAGUS.

BY GEN. W. H. NOBLE, BRIDGEPORT, CONN.

The horticultural observations and experience you so wisely invite, have worth just in proportion as they come tested and sifted from mere notions and whims. What others tell us they have tried or seen, gains value only through a like ordeal. No one matter with which the human has to do is fuller of humbugs told as truths than horticulture. I, therefore, sift well all new ways put out as betters of the old. Under this rule, asking for what I am about to tell only the trust deserved by well weighed words, I relate a new mode of asparagus culture, told me by the venerable Elias Fairchild, whom all here know to be truthful and exact.

Just over our New York boundary, a hotel-keeper, who was also a garden-lover, planted on good, level soil an asparagus bed of some 12 by 20 feet. When its growth became strong he year by year covered it with some two or three inches of good rich mould. Up through this shot the stalks and crept the roots. The method was followed up every season, with the result of larger growth and product, till the bed became an oblong mound of some 2 or 3 feet in height, and a perfect wonder in the quality and quantity of asparagus furnished for the table. That yearly blanket of soil was, my friend thinks, the only culture or enrichment given. *The bed was never dug with fork or spade.*

Have we not in this a new and better method for this toothsome and healthful vegetable? To many it may not be new. It was to me. A slight experience of mine, the last season, gives me faith in its value. By sheer accident, some two or three inches of good loam was spread over a portion of my asparagus bed; I noticed there, a much more vigorous growth of the vegetable as well as weeds than elsewhere on the bed. The question is, if such results come simply from this heavy dressing of good mould, may we not hope for greatly larger when we spread on new earth, full of absorbed richness from cattle yards,

the bottoms of old stalls, or taken where the wash of house or barn have soaked the soil.

If others have known of such results from like causes, I hope they will not fail to tell your *Monthly*, to which we look for sound views and new light on all horticultural matters.

### EDITORIAL NOTES.

JUNE BUDDING PEACH TREES.—H. C. S., Green Tree, Pa., says:—"Gardeners, be so kind as to inform me through the columns of the *Gardener's Monthly*, whether peach trees, budded in June, are budded from wood of the previous year's growth, or of the present year's growth; and if the former, is there any advantage in budding the peach in June? For I see peach trees budded in June recommended by several nursery-men in their catalogues."

[By June budding, if the proper time and conditions are secured, a season is saved in getting a tree. The plants are not as large as those which take two seasons—not half as large,—but we have seen very good trees so raised, quite good enough for extensive planting, and we know no reason against the practice.—Ed. G. M.]

THE LADY APPLE.—There are two varieties of Lady Apple, viz.: Pomme d'Api rose and Pomme d'Api noir. The black one is really black, if we may term a blackberry black, and has a very peculiar appearance on the dish in company with its rosy-cheeked companion. Both are worth growing, but I have had no experience of them in this country.—*Chevalier, in The Garden.*

FOREIGN FRUITS in England cannot compete with the native grown. Grapes, pines, bananas,—none are so good as the English raise in their forcing houses. The American Newtown Pippin apple is, however, the most popular in the English markets of all apples. English pears are said to be superior to any. Glout Morceau and Winter Nelis, are the favorites at Christmas time.

AMERICAN SEEDLING POTATOES continue popular in England, on account of their immense productiveness,—but are produced very inferior in quality to the standard English kinds.

TWO SETS OF ROOTS TO A GRAPE VINE.—The *Gardener's Chronicle* speaks of the great success of a grape grower in obtaining fine fruit, who bent the top of the cane down so that it could root in the ground. There were thus two sets of

roots, one at the bottom in a natural way, and one at the top. The result was extremely favorable to vigor and health, and the fruit was extra fine.

**FORCED FRUITS AND VEGETABLES.**—It is said the taste for varieties is increasing, and prices rather on the advance for them in England.

**THE EARLY OLIVE RADISH** is the most popular early kind now in England, having completely displaced all others where a first-rate kind is desired.

**THE PROFITS OF ORANGE GROWING.**—There has been some discussion as to the relative profits of fruit growing north, and orange growing in the far south—the advantage being thought to be with the southern oranges. We are inclined to doubt this. The *Semi-Tropical*, of a recent date, says:—

“Mr. F. Hudnall has sold for shipment 35,000 oranges from his grove on the river opposite Jacksonville, which averaged but one hundred and thirty-eight to a barrel. Mr. Tuttle, owning a grove of eleven-year-old trees near Mandarin, has marketed seven hundred oranges, which for quality cannot be excelled. One hundred selected from the lot weighed over one hundred pounds.”

When the writer of this was in New Orleans, last December, Florida oranges were being brought in by the boat load, and were selling on the levee for \$1.50 per hundred,—and these were thought to be good prices. The “grove” of Mr. Tuttle is not given as to its size,—but if these seven hundred are the first products of “eleven years,” a northern apple orchard will go a long way ahead of this. If we have to wait so long, and we think we have, what signifies \$400, and from this are to be deducted shipment to New Orleans.

Here is another paragraph:—

“Mrs. Bryan, an old resident on Lake Santa-fee, Alachua county, Florida, has an orange tree, planted by herself sixteen or seventeen years ago, which produced last year five thousand oranges.”

At a cent and a quarter a piece, it is not much to wait sixteen years for. Better set out oak timber.

**THE BIG RAMBO APPLE.**—In regard to the note of our Ohio correspondent, we find the following in the *Galena Press*:—

“J. H. Creighton, of Pataskala, Ohio, gives the

supposed origin of the Big Rambo Apple which, with many aliases, has grown to be a very popular fruit. He says that nearly sixty years ago Wm. Cummins, of Pickaway county, Ohio, purchased half a dozen of the trees from a sale, at the residence of Mr. Bogart, in Fairfield county, Ohio, and that these trees are still alive, and in full bearing. His son recently informed the writer that one of his neighbors took sprouts from the roots of these trees which produced the same kind of fruit, hence he concludes the Bogart farm must have produced the original seedling.

“Now it seems to us there are just two serious objections to this theory. First, if it proves anything it would prove too much, namely: that all the half dozen trees were seedlings, else why should sprouts from these produce the same fruit? Yet again if they were all seedlings, it would also go far to prove that an apple was at last found which perpetuates itself from the seeds. We have grown more than a dozen varieties of plums in our garden from root sprouts which were true to the variety of the grafted stock, including every one of the Gage varieties, yet we know the trees from whose roots the sprouts were taken were grafted stock, some of them being grafted by us. How then were the sprouts the same as the grafted stock? Simply by deep planting, and striking roots from the grafted stock so that the tree gets to stand upon its own roots. All the sprouts from these roots will be the same in kind as the grafted stock. We never thought of mentioning this before, because we supposed the process familiar to all whether nurserymen or amateurs. It is quite common in such cases to have two kinds of sprouts from the roots of the same tree; one set with the same leaf as the tree, the other, that of the seedling on which it was originally grafted.”

**LARGE ENGLISH PEARS.**—A correspondent of the London *Journal of Horticulture*, thus braves American pear growers as to the size of their fruit:—

“We have from time to time read in the newspapers surprising accounts of the enormous size pears and apples have reached in California and other favored places in the United States, but I had no idea that we possessed in England either a climate or a soil sufficiently fertile to produce pears rivalling the fruits of our brother Jonathan. A few days ago I received from Carmarthenshire a box of specimen pears of such unusual size

and beauty, that I think they are worthy of being noticed in the pages of our Journal.

Easter Beurré, 1 lb. 1 oz.; Beurré Superfine, 1 lb.  $\frac{1}{2}$  oz.; Durandean, 14 $\frac{1}{2}$  ozs.; Beurré d'Anjou, 12 ozs.; Marie Louise, 12 $\frac{1}{4}$  ozs.; Winter Nelis, 10 $\frac{1}{2}$  ozs.; Gansel's Seckle, 8 ozs.; Zephirin Gregoire, 6 $\frac{3}{4}$  ozs.; Doyenne du Comice, 1 lb. 6 $\frac{1}{4}$  ozs.

This last magnificent specimen measured 13 $\frac{1}{2}$  inches every way. These pear trees were not delicately nurtured under glass in an orchard house and fed with stimulants, but they grew in the open air, and carried full crops of fruit. The Marie Louise last year produced upwards of 640 fruit, and has yielded another very large crop this year.

### NEW FRUITS & VEGETABLES.

**THWACK RASPBERRY.**—A Louisiana, Mo., correspondent says: "This berry so far is only locally known, for I have purposely held it back till I could propagate a good supply of plants, and thoroughly test in ordinary field culture without protection. The upright cane sorts, Turner, Herstine, Brandywine and Philadelphia, killed to the ground last winter, while the Thwack leaved out to the very tips, and bore an enormous crop of fruit last summer. These other sorts have usually been hardy, but last winter with us was unusually hard on small fruits, and they all failed. The Thwack is a cross between the Herstine and Brandywine.

**THE STERLING STRAWBERRY.**—Mr. Bateham sends us a private letter, evidently not intended for publication, but in which he says he is annoyed by parties writing to him about it, and he desires us to say to all without any further correspondence, that he regards it a first-class variety, superior in many respects to the Jucunda from which it may, perhaps, be a seedling. He gives the following account of its origin, which we think he will have no objection to our extracting:—

"The *Sterling*, with several other seedling strawberries, was first exhibited to the public at a fruit and flower show at East Cleveland, in June 1870, when I was present, and in common with other fruit growers was very favorably impressed with this variety. I learned that it was grown from seed by Matthew Crawford, a market berry-grower of that place. The seeds taken from several large varieties, including Jucunda and

Triomphe de Gand. About this time, Mr. F. R. Elliott had fruit of the *Sterling* presented to him, and wrote a flattering notice of it for the *Rural New Yorker* and the *Cleveland Herald*.

### QUERIES.

**HUMAN HAIR AS A FERTILIZER.**—A New York correspondent says: "Do me the kindness to inform me what you would think of the application of human hair as a special manure to pear and plum trees in orchards. It occurred to me to-day that it must be full of the phosphates, and might have some value. Will it decompose readily without the use of some acid with it? Any light you can give will be gratefully received.

[Clippings of barbers' shops are found to be very indestructible unless treated first to a dose of sulphuric acid. We should suppose it would be an excellent fertilizer so treated.—Ed. G. M.]

**GAS LIME.**—D. D. & Sons, Allegheny City. "Will you please inform us if lime, after being used in the gas works, is better than fresh lime for land for cabbage?"

[Gas lime is no better than other lime, but is cheaper. Sometimes it is dangerous from the amount of creosote it contains. Ed. G. M.]

**HARDY MARKET RASPBERRY.**—"A *subscriber*, J. S." near Crosswicks, N. J., "about to commence the cultivation of raspberries for market," asks, "What is the best kind for the purpose, and whether *the best kind for market is hardy* or requires any special treatment?"

[So far no better kind for the purpose indicated has been found than the Philadelphia. It is the only kind not needing any special treatment, though somewhat inferior in quality to others which have to be covered by earth in winter. Ed. G. M.]

**DO PERSIMMONS CHANGE BY GRAFTING?**—E. H. C., Shepherdstown, Pa., says: "Your advice to a correspondent in regard to propagating the persimmon has suggested this question.

"More than twenty years ago I procured grafts from an adjoining county of a large and almost *seedless* variety, and grafted them on a non-bearer. The result has been large, fine fruit but very seedy. I have heard of similar 'freaks' in grafting this fruit. Who can tell more about it?"

[This is an extremely interesting fact, and

though we have never known anything of the kind before, it accords with what we have placed before the public in regard to the laws which regulate the production of the sexes in plants, and also in relation to fertilization. We have shown that in regard to fertilization, what is known as the doctrine of "cross fertilization by insect agency" is defective in this: that it assumes an actual purport or design, a practical separation of the sexes in order to obtain some supposed benefits from cross fertilization. Thus the first crop of clover produces few seeds, but the second many, and the assumption is that the plant can only seed by cross fertilization, and the insect necessary to this act is not abundant till the second crop is in flower; but the truth in all probability is, as has been shown by the writer of this, that it is from some peculiarities of nutrition which at some seasons, or at some times in some seasons, now favors the male organs at the expense of the females, or the females at the expense of the males, or now makes an exact balance of advantages which results in a hermaphrodite flower truly perfect in all its functions. Thus we see why clover may fail in one month, and succeed in another, and after its first course of nutrition has been interfered with by the mowing.

We note further how nutrition interferes with the sexual organs of plants, in what has been written by the writer of this on the laws of sexes, and putting all these facts together, it is perfectly explicable how a persimmon, seedless on one stock, should perfect seed on another. Nutrition and the root system of a tree are intimately connected, and one tree may easily communicate to a set of branches an impulse favorable to the perfection of pistils—conditions necessary to perfect seeds—which another set of tree roots would be unable to do. Ed. G. M.]

PEACH SEEDLINGS.—B. W. H., Bloomingdale, Ind., writes: "I have seen in catalogues reference to peach seedlings and grafting. What are they grafted on? How are weeping trees propagated?"

[We are not clear that we quite understand our correspondent. We will, however, say that peaches in nurseries are raised first from the stones, and when four months old are budded. That is, the sprouting kernel of April is budded in August. In the case of weeping peaches the stock is, however, suffered to grow two years, so as to get it 6 or more feet high, so that the branches may have room to hang down. In the

Southern States peaches are crown grafted in the winter time, and stowed away in boxes till spring, as we do apple grafts, and this is more popular than our Northern systems of summer budding. Peaches are often grafted on plum stocks, and do very well on some kinds, especially on the Mirabelle, but do not do well on the Myrobalan. There are often discussions on these points, some praising, some discouraging plum stocks, but the kind of stock makes all the difference.

Perhaps our correspondent is referring to the use of seed of seedling trees for stock raising, about which there is some difference of opinion among nurserymen. The question, *per se*, we should decide in favor of seedling seed. We believe that seeds of fruits of any kind are more likely to be better from ungrafted trees than from grafted ones, but there are many practical circumstances to interfere with this abstract good. In the case of the peach it is liable to many diseases arising from culture, and it can transmit disease to its progeny. This is the case with seedling as with grafted trees, and one will have more success with seed from healthy grafted trees than from unhealthy seedlings. In fact no nurseryman finds any difficulty in getting as good trees as any one wants, in spite of the abstract question, if the seed be only from healthy trees, grafted or not. On the other hand much injury results from this seedling idea in that it opens the door to frauds. There are some few places where people are satisfied with small, inferior peaches, which, of course, have small stones, and the impression has become general that a seedling peach must have a small stone. There are some kinds of peaches that will reproduce themselves tolerably pure from seed. Of these we may mention the Columbia and the Smock. We believe that orchards are once in a while planted with seedlings of these, and they would make excellent vigorous stocks, but no purchaser of "seedling" stones would touch them, because the stones are not small. To cater to this impression, seeds of Early York, Hale's Early, and similar kinds, are saved, and passed off for "seedling." But they are really worse than the average of good grafted seed, because they are less vigorous, and, as is well known, more liable to disease. The quantity of seedling orchards in the country is very small, but there are stones enough of "seedling" sold every year in the United States to an astonishing extent. This is where the practical evil of a good abstract idea comes in.—Ed. G. M.]



## FORESTRY.

### COMMUNICATIONS.

#### THE GROWTH OF THE CORK TREE IN THE UNITED STATES.

*Read before the Germantown Horticultural Society by the President, Mr. John Jay Smith.*

It was a witty reply—and wit keeps for a long time—which Mathews gave when asked if he had ever been to Cork: “No, but I have seen many drawings of it.” Our theme at present is not the city of Cork, but the growing of cork trees from acorns. Whether this will become, in the Southern States, a new industry or not, further experience only will test; more probably than not, a cork tree plantation will prove of equal if not greater value than a sugar orchard; the profits from the latter, from Canada to Virginia, are not inconsiderable.

From official statements it appears that the value of cork imported into the United States in the year ending June 30, 1874, was \$435,909, and in the year ending June 30, 1875, \$381,959. No weight is given. Surely here is inducement enough to make us to render ourselves independent of foreign countries\*. The countries which supply us with cork are Spain, principally, and Barbary; we pay in two years, if we calculate the above sums in gold, three-quarters of a million of dollars for a useful substance proved, as I shall show, to grow successfully in our Southern climate, and where thousands upon thousands of acres are to be bought for a few dollars an acre! The emancipated slave looks upon to-morrow as futurity, and is happy if he can see his way to the next Saturday. The statesman should look with forecast to the future of our country; while he fosters manufactures by high tariffs, he should look to every portion of the products from the land, and encourage new industries.

About twenty-four years ago this was attempted, as regards acorns of the cork oak. A great flourish was made, and a few bushels of nuts were distributed to cultivators in the South—this by

\* It is said tea culture is at last becoming successful in Georgia. Why not also cork?

the Patent Office, there being then no Agricultural Bureau; the latter came into fashion, and one would have thought the cork acorns would have been looked after. Upon writing to Judge Watts on the subject I received the following letter, and this would seem to be all he knows:

“DEC. 13, 1875.

“JNO. JAY SMITH, ESQ., GERMANTOWN, PHILAD’A.

“Sir:—In reply to your letter of the 10th inst. I send you the experiment of J. H. Rion, of Wimsborough, S. C. He says—‘In 1859 I planted acorns of the cork oak sent me from your Department (meaning, no doubt, the Patent Office). All came up, producing healthy plants. I gave away some, and transplanted others to my backyard. Those I gave away are doing well where planted, and I now have three flourishing trees. One of them is twenty-three feet high, and twenty-seven inches in circumference. I send you the bark of one, which you see is good cork, three-quarters of an inch thick.

‘The trees are evergreen, resembling somewhat the live-oak; they are of slow growth, and very long-lived. Spain is the home of the cork oak, but the largest tree known grows in England. Besides the cork, this tree produces enormous acorns, which are fine food for stock, and when roasted are much relished by the Spaniards. Spanish Black is simply the charred bark of this tree. There is no reason why this tree may not be profitably grown in any part of the United States.’”

(The writer should have said in any part where the live-oak will flourish. It would not succeed at the North. He could have added that the mast gives a peculiar and delicate taste to the lard of hogs fed upon it.)

I had said to Judge Watts that two trees at least were in flourishing health at Orangeburgh, S. C., and he asks: “The Department would like to hear further of the success of the two trees in Orangeburgh, S. C., that you mentioned in your letter.

Respectfully,  
“FRED’K WATTS, *Commissioner.*”

Accordingly I forwarded to the Department the following copy of a letter from Judge Thomas

W. Glover, of Orangeburgh, S. C. Under date of Dec. 21, 1875, he says: "About 24 years ago I planted six acorns of the cork tree. All germinated, but grew slowly, as the soil was barren, and the location exposed them to the sun. They were not cared for; but wishing to test their adaptation to our climate, after four or five years I removed two of them to a more favorable soil, and where they enjoyed the shade of a house. Since their removal the trees have advanced in height and increased in diameter. My trees are about twenty feet high, and thirty-one inches in circumference—and nineteen inches at five feet from the ground. The leaf resembles that of the live-oak, but the branches are not so extended. My trees have never yet borne any acorns. I am satisfied that the tree can be successfully cultivated here. I enclose pieces of the bark."

All this is satisfactory and to the point. The specimens of the bark no one can mistake; they are true cork. (Specimens were shown.)

We come now to the facts of European cultivation, and give presently a few particulars from Michaux, and the exhaustive account of that expounder of botanical matters, Loudon, in his great work, the *Arboretum Britannicum*. As long ago as 1845 I visited one of the largest cork trees in the world, at Ham House, England, which was planted by Dr. Fothergill, and is still in tolerable condition, not having ever been stripped. I have taken pains since to examine single trees in various parts of Italy, especially at Isola Bella in lake Como, one of the Borromean isles, where the *Quercus suber* flourishes admirably alongside of the Camphor tree, and many botanical curiosities I have rarely met with elsewhere.

"Aye be planting, Jock," applies emphatically to our America. Suppose at the Revolution in 1776 every member of Congress from the South had planted only a peck of cork tree acorns! Would we not bless every "signer" and his memory, for his forethought. Suppose we try the experiment in 1877, and record the names of our patriotic cork men.

Let us see now what Michaux and Loudon say. Taking the first authority and condensing his information we find that—

The cork oak grows naturally in the Southern parts of France, in Spain, Portugal, Italy, and the States of Barbary, which are comprised between the 44th and 35th degrees of latitude; that it rarely exceeds forty feet in height and three feet in diameter. (The trees already mentioned

as growing in South Carolina are 23 and 20 feet high, attained in a little more than 20 years.)

Its leaves are evergreen, but the greater part of them fall and are renewed in the spring; they are ovate, thick, slightly toothed, of a light green on the upper surface, and glaucous underneath. The acorns are rather large, oval, and half enclosed in a conical cup, and being of a sweetish taste, are eagerly devoured by swine.

The wood is hard, compact and heavy, but less durable than the common European oak, particularly when exposed to humidity. The worth of the tree resides in its bark, which begins to be taken off at the age of twenty-five years. The first growth is of little value; in ten years it is renewed, but the second product, though less cracked than the first, is not thick enough for bottle corks. It is not till the tree is forty-five or fifty years old that the bark possesses all the qualities requisite for good corks, and from that period it is collected once in eight or ten years. Its thickness is owing to the extraordinary swelling of the cellular tissue. It is better fitted than any other substance for the use to which it is appropriated, as its elasticity exactly adapts it to the neck of the bottle, and its impenetrable structure refuses exit to the fluid.

Had my edition of Michaux's great work been deferred till this date, (it was published in 1857,) and two editions issued, I should have added that gutta percha and gum elastic have been tried with some success with a view of superseding cork, but the heavier cost and imperfect adaptability are so great that as long as the true cork is obtainable all substitutes yet tried will be found greatly inferior. It may here be added that a vast portion of the cork imported in America is refuse, declined by European users. The best is taken by the champagne bottlers abroad. The bottled wines of this country are remarkable for their inferior corkage, and Mathews would have found very often a difficulty in taking drawings of them.

July and August are the seasons for gathering cork. Two opposite longitudinal incisions are made through the whole length of the trunk of the tree, and two others, transverse to the first, at the extremities; the bark is then detached by inserting a hatchet-handle like a wedge. Great care must be taken not to wound the albumen, as the bark is never renewed upon the injured parts. After being scraped, the bark is heated on its convex side and laden with stones, to flat-

ten it and render it easier of transportation. It should be from fifteen to twenty inches thick.

Michaux, who is an authority, asserts that this tree would be an important acquisition to the United States, and would grow wherever the live-oak subsists. This region may be said to commence about the latitude of Fortress Monroe, Virginia, and extends to the Gulf of Mexico. In much of this region land is only worth, say, from one to three and five dollars the acre. If a man was desirous of founding a family, he should plant these acres, or some of them, with cork, walnut, locust, larch, catalpa, and other trees; if he selects his land with judgment, his children and grand-children can and will supply the great demand which is to come for railroad ties, furniture, car builders, and the thousand artificers who are always demanding more wood. The bark of the cork tree will always be in demand. We have quotations every week of the Quercitron used by tanners; it is within the possibilities that quotations of cork oak bark will hereafter be made at one hundred times the value of the "tanners' bark." Though the time for receiving returns for planting cork seems a long one, let us remember that the black oak has taken quite as many years to produce its bark, and that when stripped the tanners' bark is never renewed.

Both outer and inner bark, according to London, abound in tannin, and the former contains a peculiar principle called suberine, and an acid called the suberic. The wood of the tree is stated to weigh 84 lbs. per cubic foot, but is never found of sufficient size to be of much consequence; its outer bark was applied to useful purposes even in the time of the Romans. Pliny speaks of a buckler lined with cork, and the Roman women lined their shoes with it; both Greeks and Romans appear to have used it occasionally for stoppers to vessels, but it was not extensively employed for this purpose till the 17th century, when glass bottles began to be generally introduced. Besides the above uses, bungs are made of it, and it is employed by fishermen for buoying their nets, in the construction of life-boats, so-called life-jackets, &c. The Venetian ladies employed it for their high-heeled shoes, and the poor people of Spain lay planks of it by their bed-side to tread on, as rugs are employed. Sometimes the insides of houses built of stone are lined with this bark, which renders them very warm, and corrects the moisture of the air. Bee-hives are also made of the bark of young

trees; even furniture of the lightest kind is made of cork.

If we add to its compressibility and elasticity, that it is the best non-conductor, flexible, its adaptability to life-preservers either in the form of boats, its imperviousness to liquids, and its great durability, we have an article readily produced, of the utmost importance, and well worthy of cultivation in our country; its commerce extends throughout the civilized world.

Recent efforts have been made with cork shaved thin to adapt it for the soldiers' knapsacks, belts, and even his canteen, the object being lightness and dryness; and it is understood these efforts have been successful. Who can say that the huge trunks now employed may not be made of slabs of cork?

When the cork tree has attained the age of about 15 or 20 years the bark is removed for the first time, but the first bark is found to be cracked, and is therefore only fit for burning or being employed in tanning.

The largest cork tree is in England, says the same valued authority just quoted, in Devonshire, at an elevation of 450 feet above the level of the sea, in a soil of fine rich red loam, on a substratum of stone conglomerate. It is only three miles from the sea, and is exposed to the sea breeze from the east, a situation not unlike the long reach of our eastern Florida coast.

Byron has alluded to this tree thus:

"The cork trees hoar that crown the shaggy steep;"

and Southey speaks, in Roderick, the Last of the Goths, of

"The cork tree's furrowed rind, its rifts and swells."

In conclusion, this Centennial period is a very proper one to inquire what we can do for the next hundred years. For one thing, I would say, plant cork acorns, and don't depend upon Patent Office or Agricultural Bureau for encouragement.

Since all the parade of government patronage was made, we have obtained California, with a climate in places no doubt admirably adapted to the Evergreen or live oak and the cork oak. Whether it will succeed there is a question to be decided, and how far irrigation will be required remains for the future to ascertain. Doubtless there are situations wherein both these important aids to civilization will flourish. We recommend a trial; and if acorns are wanted Messrs. Vilmorin, Andrieux & Co., Quai de la Messagerie, Paris, will gladly supply them in any needed quantity.

Parties reading this article will confer a favor on the public by communicating to the editor any further facts in relation to the growth of these trees in the United States. I may add that I have succeeded in getting part of a trunk that grew in South Carolina, for the Centennial Exhibition.

Since this was penned my friend D. Landreth, Esq., suggests that the limit of Fortress Monroe is not sufficiently far South. Even in the south of England, though the bark is true cork, as it is in South Carolina, the trees are never turned to account by stripping. It is probable that a warmer latitude is necessary to perfect the bark for commerce.

### EDITORIAL NOTES.

THE CORK TREE.—In reference to the article by Mr. J. Jay Smith in another column, we give the following piece of information from the *Semi-Tropical*, a new magazine from Florida.

"The cork tree, (*quercus suber*), is a most beautiful shade tree; an evergreen oak much resembling the live oak of the Gulf States. It is a native of Spain and has been cultivated in many parts of the world. It flourishes in England and Ireland; one tree, near Cork, in Ireland, having obtained a diameter of over three feet, while some in England are still larger. Large orchards of it have been planted in California, and many trees are found in other parts of the United States. It is admirably suited to the Southern States; will withstand, as in England, exceeding cold. It should be cultivated, not only for its cork, which is its bark stripped off every few years without injury to the tree, but as a shade tree for the Middle States, where it would equal the live oak in beauty. Its acorns are very plentiful and make one of the best masts for hogs, and its cork may be stripped every few years for several hundred years, as experience has shown."

THE PECCAN.—This kind of hickory, *Carya oliviformis*, is considered by a correspondent of *Prairie Farmer* to promise well as a timber tree. It grows faster than other hickories, but is rather slow we think in comparison with some other trees. For its nuts it is of little value north. They do not perfect in Philadelphia.

OSAGE ORANGE TIMBER.—When in Texas a few years ago, the writer saw large quantities of Osage orange sawed into joists for buildings, and was

told that it was one of the best possible for indoor uses, but not of so much when used for open weather purposes. We have heard however that it was extremely durable as stakes. From the following, which we find in a California paper, we think it must be of more use for general purposes than one would suppose, and should be glad of any facts that our correspondents may have respecting it:

"We have been shown at the carriage manufactory of William P. Miller a set of buggy wheels, the spokes of which were made of Osage orange wood. The timber was cut from Capt. Weber's premises, on the peninsula, and the place formerly owned by Smith Whiting, corner of American and Lindsay streets, and has been seasoning for about three years. A specimen of the wood shown us was a trunk six inches in diameter and showing sixteen concentric circles. The wood is susceptible of a high polish; and while it is not probably as tough as hickory, it is not so liable to shrink in dry weather or swell in wet weather. This latter quality makes it peculiarly adapted to our climate, although there is not enough grown here to manufacture extensively. In Arkansas and Texas, where this wood grows plentifully, it is commonly used in the manufacture of wagons."

HARD NAMES.—There would be some force in the objections made against hard botanical names, if those who prefer common ones would properly identify the plants they mean. The *Scientific American* gives us the following. By "black dogwood, or berry-bearing alder," we suppose *Prinos verticillata* is meant, but surely that does not make wood large enough for extensive charcoal uses:

"The black dogwood or the berry-bearing alder makes the best charcoal, willow is next, and the common alder third in rank. Small wood of about ten years growth is in all cases to be preferred for charcoal for making gunpowder. Alder and willow at this age will be probably 4 or 5 inches in diameter, dogwood about 1 inch."

THE ENGLISH MAPLE.—This, the *Acer campestre*, or cork-barked maple, though affording good wood for cabinet making, does not grow to a very large size. Sometimes it seems to attain considerable dimensions, as appears by the following from the *Gardeners' Chronicle*. It may make a larger tree in the United States, where it seems perfectly at home. It may be noted, however, that the tree varies very much, and some forms

seem more tree-like than others. The Austrian Maple, *Acer Austriacum*, is hardly different botanically, but grows to a large size. This is what the *Chronicle* says:

"Strutt, in his *Sylva Britannica*, gives an etching of a Maple growing in Boldne churchyard, within the New Forest, that Gilpin considered the largest (and probably the oldest) in England; and here, under the shade of this tree, and amidst the scenes he so much loved, he elected to be buried. Close to the ground this tree is stated to have been 12 feet in girth, and at 4 feet from the ground 7 feet 6 inches, and 45 feet in height. I have, however, met with several Maples, in Worcestershire equal in magnitude to this "Boldne Maple;" and on the banks of the river Teme, near Powick, 3 miles west of Worcester, is one much larger, the trunk dividing into three huge arms, supporting a multitude of lesser branches and dense foliage. This wide-spreading tree measured 15 feet in girth near the base at the time when it was sketched, and would be much more higher up from the divarication of the boles. It was rather more than 40 feet in height, and must be of very considerable age."

RUSSIAN TIMBER.—The *Gardeners' Chronicle* says: "As evidence of the traffic in Pine Timber, (whether simply sawn or dressed) between foreign ports and this country, we may mention that an official return shows the town of Memel to contain fifteen steam mills and twenty wind-mills, all employed in sawing timber. The wind-mills, once a characteristic of this port, are gradually disappearing, the new establishments being all provided with steam-power."

## QUERIES.

LARCH TIMBER.—A. B. C., Ottawa, Ill.—The timber of the American Larch is of little value, it is the European which is so popular. Even this varies considerably in the quality of the timber. In some localities it is liable to the attack of a small fungus which causes the tips of the leaves to decay before their natural time, and it is probably this which makes the difference in the quality of the timber. The Larch will grow on rather wet ground, but it only really thrives to best advantage on ground that is rather dry. It is on the whole one of the most valuable timber trees we have.

WHITE CYPRESS.—A correspondent inquires which kind of Cypress it is that produces the white kind. There is but one known species, the *Taxodium distichum*. But there is some difference in the timber that does not show itself in characters that botanists can take hold of for scientific purposes. It is the same with other trees. The Liriodendron is an example. There is the white poplar and the yellow poplar of the cabinet makers. The wood is very different one from another, but the Liriodendron that yields the one or the other, seems exactly the same to the botanist.

RATE OF GROWTH IN THE OAK.—M.—You are mistaken. There are some trees that grow faster than oaks truly, but most oaks grow faster than you think. Faster than some maples. We have no doubt that under most circumstances many oaks would beat the sugar maple.

# NATURAL HISTORY AND SCIENCE.

## COMMUNICATIONS.

### THE ROOT-CAP.

BY BYRON D. HALSTED, BUSSEY INSTITUTE, MASS.

The idea held by the earlier botanists, that the tips of all roots consisted of spongy masses of tissue, by means of which plants were enabled to soak up their food from the soil, has, with the aid of the microscope, been entirely discarded. The term *spongiolæ*, which was given to these the-

oretical bodies, is a land-mark of departed ignorance, and furnishes a striking contrast with the *known* structure (viz.: the *root-cap*), with which the tip of every growing root is covered.

With the leading botanists of to-day a root is considered to be an outgrowth protected by a cap. This definition seems very short, but if anything further is added, there comes with it a number of exceptions.

The name which this covering to the root-tip has received is in itself very descriptive, as it is

truly a cap, consisting of a number of layers of quite dense cells surrounding the extremity. These root-caps vary in size in different species of plants; sometimes they are so small that only with the high powers of the microscope can they be seen, while on the other hand they may be readily observed with the naked eye. It is now generally understood that a root does not elongate throughout its whole length, as is known to be the case in the young and growing stem, but its growth in length takes place at a single point a very short distance from the extremity. The stem usually grows in the open air, with plenty of room on all sides, while the root generally penetrates the much denser substance of the soil, where elongation would prove fatal to the delicate root hairs which are thrown out from them on all sides for the absorption of nourishment. Growth in length by elongation of the whole root might also cause twisting and breaking of the roots themselves, and a general disturbance of the soil.

The "growing point" of a root is situated just back of the root-cap, and forms the dividing line between the root and its cap. The position of this point of growth, as related to that of the cap, suggests the use of this latter structure. All young formative tissue is very delicate, and easily destroyed by any external influences. Should this layer of thin-walled, newly formed cells be situated at the very extremity, then, as growth proceeded, these cells of great delicacy would come in direct contact with the rough and sharp edges of the grains of the soil, and soon be broken down and destroyed. It is plain that the important role which the root-cap plays in the vegetable economy is that of protection to the tender growing within, and which it always so completely surrounds. As these outer cells of the cap are worn away, there must be a source of supplies for the protective department, and this is found in the formation of new layers of cells on the inside of the cap, and from the protected tissue.

The growing point, situated near the tip of every root, then, has a double office to perform: the laying down of new tissue for the growth of the root, and the meeting of the losses by wear and tear of its protecting cap.

It may be said, then, that it is not the root-tip which does the work of absorption. Neither do plants "sponge" for a living, but take in their food in a different way, which will be left until another time to describe.

## EDITORIAL NOTES.

**TYPOGRAPHICAL.**—After the proof left the office last month, the printers had to make some altering in the setting, and the consequence was a running together of ideas in the Kansas and Pennsylvania notes at the heads of the columns. The first three lines on p. 95 belonging to p. 96, and *vice versa*. The intelligent reader no doubt saw and corrected as he read. Accidents happen in the best regulated families, and we suppose the printers are no exception.

**THE PHYLLOXERA.**—We find the following in the *London Journal of Horticulture*: "Owing to the disastrous effects of the Phylloxera in the French vineyards, the desirability of importing stocks from America was urged on the ground that the vigorous character of the American varieties were by that insect invulnerable. This appears, however, to be simply 'tall talk,' for a correspondent in the *Prairie Farmer* reports that he has recently taken up 2,000 vines in nearly twenty varieties, and that every sort was infested; the strong growers, however, being the most free from the pest, but all were attacked. The 'little villains were found on the roots by millions.'" Our cotemporary has not clearly seen the point of the case. The report of Mr. Planchon, and on which the demand—not exactly for American kinds, but for two of them, Concord and Clinton,—was brought about, showed, not that these two were not attacked, but that their rapid rooting and fibrous character enabled them to resist the attacks of the insect more successfully. Professor Planchon was well aware that the phylloxera attacked these two varieties, and yet their value as stocks is much more than "tall talk," and for the reasons given.

**SUNKEN FORESTS.**—Near all bodies of water, especially near old lakes, or the mouths of rivers, are forests under the surface, which show how ages ago trees grew where now nothing of the sort is found, or where other features of quite a different character exist on the surface. In Southern New-Jersey quite a trade is done in wood of the white cedar, mined from many feet beneath the surface. In digging wells in Illinois, it is by no means uncommon to come on large trunks of Red Cedar, and New Orleans is over a complete Red Cedar forest, one hundred and sixty feet below the surface. According to *Nature*, a forest is also under the city of London. It tells us that an interesting geological discovery has been recently made during excavations for a

new tidal basin at the Surrey Commercial Docks. On penetrating some six feet below the surface, the workmen everywhere came across a subterranean forest bed, consisting of peat with trunks of trees, for the most part still standing erect. All are of the species still inhabiting Britain: the oak, alder, and willow are apparently most abundant. The trees are not mineralized, but retain their vegetable character, except that they are thoroughly saturated with water. In the peat are found large bones, which have been determined as those of the great fossil ox (*Bos primogenius*). Fresh-water shells are also found. No doubt is entertained that the bed thus exposed is a continuation of the old buried forest, of wide extent, which has on several recent occasions been brought to the day-light on both sides of the Thames, notably at Walthamstow in the year 1869, in excavating for the East London Waterworks; at Plumstead in 1862-3, in making the southern outfall sewer; and a few weeks since at Westminster, on the site of the new Aquarium and Winter Garden. In each instance the forest bed is found buried beneath the marsh clay, showing that the land has sunk below the tidal level since the forest flourished.

### QUERIES.

DIERVILLA.—A Flushing correspondent asks: "May I trouble you to tell me where the name of Diervilla was given to Weigela, and when?" [Diervilla was never given to Weigela. It is just the other way. The original name is Diervilla; Weigela is a newer name. It was thought to constitute a new genus, and was separated from Diervilla, but as our knowledge of the genus increased, it was found that there was not sufficient character to found a separate genus and so the name Weigela has to be dropped, and the indi-

viduals composing it go back to Tournefort's older name of Diervilla, in accordance with botanical laws of priority in nomenclature.—Ed. G. M.]

ROCKY MOUNTAIN SILVER SPRUCE.—Mr. J. T. Lovell says: "says Permit me to say the Rocky Mountain Silver Spruce and *Abies Menziesii* are one and the same. Some years ago Messrs. Hargis and Sommer, Quincy, Ill., who were the first I noticed to advertise or offer for sale "Rocky Mountain Silver Spruce," sent us a few specimens, stating they knew the tree by no other name. They since collected for us, among the mountains of Colorado, 1,000 plants of the same, and are all precisely the same as the *Abies Menziesii* received from different European nurseries, answer the description of *Abies Menziesii*, and I know are *Abies Menziesii*."

"If your correspondent has collected other plants than *A. Menziesii* for Rocky Mountain Silver Spruce, I am very sure he has made a mistake."

[There seems no doubt but that the tree meant by the "celebrated writer" is the *Menzies Spruce*. It is a pity he had not a little more knowledge of these common things, or took some pains to find out, before he published his book. It would have saved us and our correspondents much trouble in finding out his meaning. But now that it is found, we trust the misleading name of "Rocky Mountain Silver Spruce" will be dropped. There are firs and spruces in the Rocky Mountains quite as "silvery" as this, and then this particular one is not confined to the Rocky Mountains, but is far better known in connection with the Pacific coast. Above all it is already well known in all the nurseries of the world as the *Menzies Spruce*, a name short and convenient.—Ed. G. M.]

## LITERATURE, TRAVELS & PERSONAL NOTES.

### EDITORIAL NOTES.

HORTICULTURE IN NEW ORLEANS.—Last fall the writer chanced to get to New Orleans, and the temptations to visit that section again when the spring should start vegetation into new life was so great that he took another run in February

last especially to look at things. The most striking horticultural feature on entering the city is the use of the *Stillingia sebifera* as a shade tree. It is called here tallow tree. The leaves are very much like those of the common aspen, but the dense, twiggy growth is very peculiar. It is very much valued for its rapid growth when young,

but does not grow to a size ultimately that would render it out of character in a narrow street. It moreover bears trimming as well as the Linden trees of Germany. It is deciduous. The Fig grows to a fair size, but not near so large as they do in the south of Europe. The largest reached about to the second story windows. They are without leaves six months in the year and yet bear two good crops a year. No attempt is made to dry them as in Europe. The Pomegranate and Grape Myrtle also take a long repose, and though of large size do not seem so much at home as we have seen them in Kentucky and Virginia. The most striking tree at the end of February is the Loquat or Japan plum, as it is commonly known here, botanically, the *Eriobotrya japonica*. It grows to about 20 feet high, with a large round head, the leaves and general character reminding one of the large *Rhododendron arboreum* of the East Indies. The fruit is borne in large clusters at the ends of the branches, each fruit about the size of a small fig, and of a golden yellow color now when ripe. The fruit varies very little in shape or size, but there is a great difference in the quality of the fruit on different seedling trees. Some are hardly worth eating, while others have a subacid flavor peculiarly agreeable. The Banana fruits in the open air abundantly, but the leaves have a battered and torn appearance by the winds, very different from the noble character they present in our hot-houses. The kind usually grown is the *Musa paradisiaca*. The Papaw tree is rather uncommon. This grows up with a single stem like a Palm, though belonging to a very different tribe of plants. The male trees of course bear no fruit, but the female trees have the fruit of several pounds weight, touching each other for a considerable space up the stem, like a lot of oval-shaped melons. The tree is the *Carica papaya*, and is quite ornamental in addition to its valuable fruit. The great feature of New Orleans is, however, its orange trees. Every small yard and garden has its orange trees, under the fragrant shade of which the people sit at even. Large orchards of them exist in some places, some of them evidently of great age. Near the old Spanish Fort, now nearly two hundred years old, was a plantation, the trees set 20 feet apart and the branches nearly touching each other, and the stem of one of which measured three feet in circumference. There was no fruit on these trees, but myriads of blossoms; and as we sat under the shade of one, with the little rippling waves of Lake Pontchartrain whispering at our

feet, and the balmy spring breeze coming up south from the Gulf of Mexico, it was easy to understand the poetic exultation with which such scenes and circumstances have so often been described. In various parts of the city were trees many feet high of the Myrtle-leaved orange, the fruit no larger than pigeons' eggs, and making a very striking appearance. On the grounds of Dr. Richardson were trees of the Shaddock, with three generations thereon. There were the large ripe fruit, fruit just forming, and flowers. Dr. R. is a lover of rare plants, and his greenhouses are filled with Orchids, Palms, and other plants of the most valuable character.

Perhaps the most striking evergreen of New Orleans is the *Pittosporum*. These grow to the size of an ordinary log cabin, and will bear any amount of shearing and still keep their foliage vigorous and healthy down to the ground. It is extensively used for topiary work, as the yew is in Europe. The Chinese *Viburnum*, as well as some others, are used also for this purpose, but none is so charming as the *Pittosporum*. Sometimes the winters kill the oranges even here, but not often, and never so thoroughly but what some escape, as in the case of those referred to at the Spanish Fort; but this season has been remarkably open, and even the tender *Salvia splendens* was in full scarlet feather, making everything look gorgeous with its gay beauty. The immense bushes of *Lantanas* in full flower were also exceedingly attractive. Roses, both Hybrid Perpetual Chinas and Teas were everywhere in full blossom, and would excite the envy of the bouquet makers North, who at the same time would be buying the "buds" at immense prices. Our party bought large bunches of them made into tolerable bouquets for 50 cts. each.

We were fortunate in meeting at New Orleans with Col. M. B. Hillyard, the Secretary of the Mississippi Valley Company, which has at McComb City made a very prosperous settlement, already claiming a population of nearly 1500. Col. Hillyard has, perhaps, done more than any other person in the South to draw the attention of Northern men and others to the great natural advantages which the South possesses; and whenever this section of the country shall have risen to that prosperity which we feel in time will be its just fate, this gentleman's name will stand prominently forward as having been one of the pioneers in the good work. Under his guidance our little party visited the markets, the Fair



grounds, and other prominent points calculated to give us a good view of the horticultural advantages and products. The vegetable and fruit markets were particularly attractive, all our spring vegetables being in great abundance, and charming the heart of the writer's good wife, who regards herself as a particularly good judge as to what is perfection in that line. The new potatoes really did look excellent. The strawberries were not abundant, and though they are often spoken of as among the great achievements of the Southern winters, neither in quality or appearance were they equal to our Northern fruit.

The great Southern exposition, which has been so extensively advertised, was being held, but there was not much to interest the horticulturist, though in agriculture and the mechanic arts it was particularly attractive; but this was more than made up in the horticulture of the Fair ground itself, which gave us a treat which, had we seen nothing else, it would have paid us well alone to see.

Here were specimens of rare plants, which for years we had known only as rare things, coddled up in pots and tubs in hot-houses, growing to majestic proportions in the open air. There were also greenhouses with plants which thrive better there than in the open ground, though, perhaps, hardy in the main, forming small trees of large size. The curious *Carolina princeps* and the *Astrapæa Wallichii*, which now and then flower in our conservatories, were here in magnificent blossom. Huge *Raphiolepis* and other winter-blooming shrubs were covered with blossom, and among the out-door things, *Cupressus torulosa*, and others of this class, tender with us, made pictures of beauty we shall never forget. Best of all here was to find in the gardener, Mr. Müller, one of whom the profession may be proud. We so often meet with "gardeners" who are mere pretenders, and who get into good places by mere luck, while real sound men of modest worth are left out in the cold, that it was a real treat to find so intelligent a gentleman in charge here, and we cannot help making a note thereof.

Our limits are too cramped to make any extended notice of our long trip in this formal way. From time to time we hope to benefit our readers by what we have seen. We will only offer our best thanks to our numerous Southern friends, by whose urgent invitations we were tempted to take the trip, and to whose generous and warm-hearted attentions we are indebted in

so many States for pleasures we shall not soon forget. We cannot, however, close these notes without a brief reference to the beautiful grounds of Mr. Nelson, of the Magnolia Nurseries, on which the Deodar cedars, Torreya, Cupressus, and many other plants, were grown into specimens of more than striking beauty.

A FEW SUGGESTIONS ON TREE PLANTING, BY PROF. C. S. SARGENT, OF HARVARD UNIVERSITY.—This is a plea for forest tree planting, and a plea urged with great ability. He gives an account of the plantations of Mr. Richard Fay, near Lynn, in Essex Co., Mass., of two hundred acres, in 1846, mostly European Larch. There are now some of them fifty feet high and fifteen inches in diameter. Seven hundred cords of firewood have been cut at various times, besides all the fencing material for the vast estate. Thousands of dollars worth could be cut to-day. The land was excessively poor when planted.

Another gentleman, J. S. Fay, Larch and Scotch pine set out in 1853 are now 40 feet high, and 10 to 12 inches in diameter one foot from the ground, and this in the poorest kind of huckleberry ground.

Mr. Sargent then goes into a large number of facts and figures to show that even from the earliest stages of forest tree planting in most places a profit may be made, and that one need not feel that in planting trees for posterity nothing is to be made at once for oneself. We are sure many will be startled by the good case for tree culture made out by Mr. Sargent, and yet we are sure that he has rather under than over stated the case, and that if anyone who truly understood the business of forest tree culture, and united with this knowledge, ordinary tact and business prudence, he could make even considerably more out of the business than Mr. Sargent puts it, favorable as his statement is.

The contribution to arboriculture is timely, and we are sure will do an immense amount of good.

"SUBSCRIBER" ON MUSHROOMS.—We have from Mr. Henderson the article on Mushrooms desired, and hope to be able to give it in our next.

PROCEEDINGS OF THE WESTERN NEW YORK HORTICULTURAL SOCIETY, January, 1876—from R. C. Reynolds, secretary, Rochester, New York. This is the earliest in the field, most of these documents not appearing till near a year after the time of meeting. We notice that Mr. J. J. Thomas corrects the published report of his re-

marks on the Wild Goose Plum. He does not regard it as of high quality, and says it is coarse in texture, but values it because it will make a good market fruit.

TRANSACTIONS OF THE MASSACHUSETTS HORTICULTURAL SOCIETY, for 1875—from E. W. Buswell, secretary. Part II. The Massachusetts Society is now the most prosperous one in the United States, and is doing excellent service to horticulture. Its annual volumes of transactions are among the most interesting of this class of literature, and are full of matter that must of itself make the members feel that in their connection with the Society they are receiving the full value of their annual dues. The Society has a good herbarium for reference, and one of the best horticultural libraries in the world. A catalogue of the ferns in the herbarium is given in this volume. The *Flora Danica* was purchased for the library last year at an expense of \$600. The prize essay on the *Culture of Cauliflower and Cabbage*, by Mr. W. H. White, is given in full in the volume. Another awarded to Mr. James Cruikshanks in *Landscape Gardening* also appears. The third prize essay is awarded to Mr. D. D. Slade, and is on *Principles of Landscape Gardening as applied to Small Estates*, a department of gardening that needs a good deal of looking after just now. The reports of the various committees are very interesting. Mr. J. G. Barker is chairman of the Floral committee; Harvey Davis on Fruits, and C. N. Brackett on Vegetables.

BAD ADVICE AND WORSE CONSEQUENCES.—As the Editor sat in his well-worn chair, the Publisher, with a look of horror, threw him the following card, and demanded an explanation:

"My subscription to the *Gardener's Monthly* expired with the February number. Do not wish to renew, as I have lost about \$10 in Silver Thorn plants, owing to the Editor's directions as to their management. J. D. LEE, Athens, Ill."

We have looked through all our back numbers where any mention is made of the Silver Thorn, and see nothing calculated to have led J. D. Lee astray. It is a pity he was not more explicit and did not point to the page and volume from which he derived ten dollars worth of ruin; as however he seems lost to us forever, it is of no use to ask him now. The loss to our friend would sit very heavy on our conscience did we not feel that in the seventeen years he has been a reader, he derived profit enough to overbalance this loss.

It is said that when Barney was reprimanded for hoeing off the carnations, he pleaded that his master ought to be thankful that he had not hoed out the geraniums also! We trust our correspondent had some good from the geraniums at any rate, and that after his desperate remedy his Silver Thorns will live.

For the benefit of those who will read these remarks, let us say that the Editor does not profess to hold all knowledge in the palm of his hand, and is not infallible. The advice he gives is only to the best of his knowledge and belief, and even when he gives advice, it must be remembered that very much depends on the applicant's application of it.

RECLAIMING DAMAGES.—It will be remembered that recently a vegetable grower of New Jersey obtained damages in court from a New York seedsman for having sold him late turnip seed, when he supposed he was buying an early kind; and there have been some other verdicts of a similar character, and so unjust in a general way, that the seedsman of New York have been driven to a measure that will not help them in the slightest degree, while it may subject them to charges by those whose natural inclinations lead them to blame somebody but themselves when things go wrong. This class of persons are now especially jubilant over these curious legal decisions, and are already casting about for good "spees" out of them, and one of these is recorded by the *Detroit Free Press* as follows:

Six or seven days ago an old man entered the store of a Detroit hardware man, who also deals in seeds, and, inquiring for the proprietor, soon stood face to face with him.

"Want to see me?" asked the dealer.

"Yes, sir, I do! Seven years this coming Spring, I bought a paper of seeds of you."

"I presume so."

"I'll swear to it, sir! Seven years ago, sir, and not one of those seeds came up."

"Well, that's funny," laughed the dealer.

"You may think it was," said the old man, "but I'll make it cost you ten thousand dollars! When you sold me those seeds, sir, you did not know that you were dealing with a lion!"

"Well, you stop your blowing and get out of here."

"Give me a package of cabbage seeds, sir?"

"I won't!"

The old man went away, but in an hour returned, and said in a loud voice:

"Seven years ago this coming spring, I bought

a package of seeds at this store. Not one of those seeds arose from the silc!"

He was ordered out, and he went out. He was there the next morning as soon as the proprietor was, and he said:

"Seven years ago this coming spring you sold me a package of seeds. Not a single seed matured to manhood!"

He was put out that time, but returned in the afternoon, when the store was full of customers, and exclaimed:

"Seven years ago this coming spring I was swindled by that man there! He sold me a package of garden seeds, not one seed of which ever thriv!"

When he went out something hit him three or four times in the back. He went down the street for awhile, and then returned and stood in front of the store, and said to the people who passed:

"Seven years ago this coming spring this store here sold me garden seeds that never sprouted!"

He repeated the words over and over, until a crowd began to gather, when he was called in and given a dozen papers of seed, and told to forgive and forget.

"Six papers of onion seeds to pay for the choking!" he said as he buttoned his overcoat.

They were given him, and when stowed away he remarked, "Six papers of cucumber seeds to pay for four kicks!"

After some argument these were handed him, and as he backed out of the doors he said:

"It's all right! You've acted like a man about it, and if you want any vegetables next fall I'll make a discount to you."

**THE GARDEN.**—We have a notice from the *Garden* that it will in future discontinue its exchanges with American publications—the *Gardener's Monthly* among the number. It seems to us that most, if not all, of the success which the *Garden* has met with in this country, is due to the free, and, we think, cordial notices of the American press. Still it has a right to decide its own course. It is a little strange, however, at the same time that we are politely shown the door, to be asked to say a good word for the inmates! However, we will say, in finally parting with the *Garden* from our exchange list, that it is a credit to horticulture, and in every way worthy of the success it has earned.

**MR. ROBERT DEMCKER.**—This gentleman, well known by his former connection with Central Park, and one of the most intelligent gardeners

in America, has just concluded a series of admirable articles in the *Pen and Plow* on "Floral Decorations." In regard to the form of flower-beds he gives this good advice:

"We will now ask an important question. Which is the best and most advisable form of flower beds for all kinds of gardens? This question could be easily answered if fashion, human desires and caprice, could always be ruled or governed by good taste. In compliance with good taste, the oval form for flower beds seems to have been adopted, but it will be wrong to use this form as a rule. When used too freely and too frequently its sameness defeats the object in view; for there are also other good forms. In gardens laid out in geometrical style, the form of the flower beds should correspond with the style of the garden itself, as well as harmonize with the buildings, and other structures, such as bridges, terraces, fountains, statues, &c. For parterres a composition of Arabesques, or a large circular form of rosettes, with its divisions, allowing a variety of single groups as a display of flowers, may be used with the greatest success. In small gardens, only a few beds of a simple shape are to be recommended, as ovals, circlets, reniform, or trifolium-shaped beds."

**HOOPES BROS. & THOMAS, WEST CHESTER, PA.**—Catalogue of Alpine and perennial plants. The number of horticultural catalogues that pour in on a horticultural magazine is so great that we found it took up several pages of our limited space to notice them, and so had to give up all such notices in common fairness, unless there were some special points of public interest. This catalogue is just such an exception. We doubt whether such a catalogue has appeared from any nursery in the world, and this well-known firm deserves this notice for its enterprise.

**GOULD NURSERY CO., BEAVER DAM, WISCONSIN, ANNUAL CATALOGUE OF GREENHOUSE PLANTS.**—The publisher desires to return thanks to this company for a kindly notice of the *Gardener's Monthly* on its title page. It says, and we believe truly, "each number during the year furnishes some new idea that is useful and instructive, and very frequently worth more financially than the price of a year's subscription."

**THE EVERGREEN.**—This is a valuable monthly serial, devoted solely to the growing interests of tree culture, and published by Mr. Geo. Pinney, of Sturgeon Bay, Wisconsin, for the low figure of 60 cts. per year.

# HORTICULTURAL SOCIETIES.

## COMMUNICATIONS.

### POTOMAC FRUIT GROWERS—FEBRUARY MEETING—GALA DAY.

BY GEO. F. NEEDHAM.

As at this meeting the officers elect were to be installed, arrangements were made, at the last meeting, for a social re-union to-day, and a good time generally.

On entering the rooms, your reporter was struck with the tasteful and profuse ornamentation with evergreens. On the sample tables, there was a good collection of fruits; while on other tables there was a sumptuous entertainment prepared by the ladies.

But I must let your readers draw upon their imaginations as to how the four pleasant hours of the meeting were spent; what with addresses by the inaugurated, presentation of a symbolical gavel to the retiring President, with an address full of telling points, a poem by the Secretary, readings, speeches, songs, *bon mots*, etc., a large attendance and an abundant refreshment.

On the sample tables were fruits as follows:

*Of Apples.* Abram, Albemarle Pippins, Cart-house, Limbertwig, Rawle's Jenet, Spitzenburgs (growth of Va.), Lady Apples (pronounced by Judge Gray the Queen of apples), Roman Stems, Willowtwigs, and Winesops.

Most of the fruit was grown in Virginia; Maryland and the District furnished each a variety.

*Of Pears.* Vicar of Winkfield, Lawrence, Glout Moreceau, and Beurre Easter.

Maryland had the finest pears, though Virginia the most varieties.

A jar of persimmons, "preserved in sugar," were tasted by all present, and pronounced to be "good."

Mrs. John Saul also sent to the exhibition a beautiful stand of lovely flowers.

The discourse of the President elect was well-timed and pertinent to the occasion. I reproduce one paragraph, which just now is of great interest.

"*The want of the day* is organized and systematic co-operation among fruit growers. Especially is this so in regard to all fruits that are des-

ignated perishable. The past season having been one of unusual productiveness in this middle region, has left on its records important lessons; which, being dearly learned, should not be soon forgotten. I allude to the hap-hazard way of shipping fruits to particular points, without knowing the condition of the market there, in regard to supply and demand.

"You may remember that on a certain day last summer Early Peaches were selling in New York city for \$2.00 per basket. That later in the day a telegram announced one hundred car-loads to arrive early next morning. As the market would not bear more than half of this supply, the result of this avalanche of fruit was that prices fell to a figure less than freight commissions, and remained demoralized for the entire season; and thus the goose that was to lay the golden egg was sacrificed.

"There were probably one hundred shippers owning these car-loads of peaches, and not one of this number knew what was to be the extent of the day's shipping. Each was anxious to crowd *his* product on the market; all failed to realize anything, and many had to pay balances against themselves. These men were not novices, but were practical and sagacious men, competent for successful business; but each did not know what the other ninety-and-nine were doing. *They had no concert of action, no organized plan that embraced the common interest.*

"Now, let us suppose that these growers had previously agreed that they would report to 'a board of direction,' or a single shipping agent, the quantity of fruit they would send forward on a given day, and had given to this board or agent full power to direct to the place of destination. This agent could have learned by telegraph the exact condition of the several markets; which the one hundred could not know. He would have been informed just where to ship, and how much, and these car-loads could have been distributed in destitute markets between Boston and Chicago and sold at satisfactory prices, and opened to the producers new markets for the entire season.

"Is it not clear that co-operation would have saved millions of dollars the past season? And

that for lack of it these hundred producers destroyed their hopes of fair compensation for their labors? And that we will do so year after year if we do not learn wisdom from the past?

"Let us remember that if the article be perishable, the greater is the necessity for system in selling.

"I ask you to give this subject your careful consideration; that you will inaugurate the movement suggested, by calling a convention of the fruit growers of New Jersey, Delaware, Maryland, and Virginia, to meet at some central point to consider the subject; and that this Centennial year may open to us a more enlightened and fraternal intercourse with our brethren of the other States."

### EDITORIAL NOTES.

NEW YORK HORTICULTURAL ASSOCIATION.—Officers of the Association, for 1876: President, John Henderson, Flushing, Long Island. Vice-Presidents, George Such, South Amboy, N. J.; James M. Patterson, Newark, N. J.; William C. Wilson, Astoria, Long Island; Robert B. Parsons, Flushing, Long Island. Recording Secretary, W. J. Davidson, 322 Fulton Street, Brooklyn, N. Y. Corresponding Secretary, Peter Henderson, 35 Cortlandt Street, New York. Treasurer, Isaac H. Young, 12 Cortlandt Street, New York.

MINNESOTA STATE HORTICULTURAL SOCIETY.—The hard times reduced the attendance on our winter meeting very much, but we not only had a goodly number present, but a very interesting and profitable meeting; showing a very decided improvement in the interest taken in our calling. We have thus far found fruit-growing, especially apples, pears, &c., rather up-hill business in our State. Grapes and small fruits have done better. I myself raised over 6,000 pounds of grapes last year, and think there must have been over 10 tons raised in this county. I wish I could drop in upon your city about next September, and attend the meeting of the Pennsylvania Horticultural Society, Re-union of American Pomological Society. We will try and have our State and Society represented there by some one, if possible. Probably Prof. Chas. Y. Lacy, of the State University, being our Secretary, may represent us, and we hope two or three others. I would like to be among the number, if circumstances will permit; if not, we shall all look to you, through the columns of the *Monthly and Horticulturist*, to give us a just and full account of the

display, and what there is new in our line worth noticing. Excuse this hurried letter, and accept it in the fraternal feeling it is written, and with which horticulturists are wont to greet each other; and should you wish, I will endeavor to send you the proceedings of our Society, when published, as the State publishes 2000 copies annually, part of which is handed over to the Society for distribution.

Officers for 1876—

Truman M. Smith, St. Paul, President.  
 Prof. Chas. Y. Lacy, Minneapolis, Secretary.  
 A. W. Lias, Rochester, Treasurer.  
 E. H. S. Duet, Owentown, 1st Vice-President.  
 T. G. Carter, St. Peter, 2d " "  
 J. G. Grimes, Minneapolis, 3d " "

Executive Committee—

Norman Buck, Winona, Chairman.  
 Wyman Elliott, Minneapolis.  
 P. A. Jewell, Lake City.  
 O. F. Bland, Faribault.  
 John S. Harris, La Crescent.

MEETING OF AMERICAN NURSERYMEN.—At a Meeting of the Nurserymen, Florists and Seedsmen, at Crystal Lake, Ill., January 26th, it was decided to hold a Centennial Meeting of all engaged in the trade, in the city of Chicago, on the second Wednesday of June, 1876. It has always seemed strange that enterprises of such vast importance have not as yet made any special effort for a national organization. It is hoped that a large attendance can be secured, and means devised to better organize and strengthen these great interests.

*Object of Meeting.*—1st. Relaxation from business.

2d. The cultivation of personal acquaintance with others engaged in the trade.

3d. Exhibition of any new Fruits, Flowers, Plants, or any Manufactured articles, such as Labels, Wire Goods, Berry Baskets, or implements used in the business.

4th. Exchange, purchase or sale of Surplus Stock.

5th. To perfect better methods of Culture, Packing, Grading, and Sale of Stock.

This will present a favorable opportunity for the exhibition and sale of new varieties of strawberries, new and rare plants, wooden and metallic labels, lithographs of fruits and flowers, berry baskets, wire goods, florists' requisites, and the various implements used by nurserymen. It is expected to obtain reduced rates from all the railroads and hotels in Chicago. Any further information can be obtained by addressing,

Dr. John E. Ennis, Clinton, Iowa; J. S. Stickney, Wauwatosa, Wis.; Edgar Sanders, Chicago, Ill.; L. K. Scofield, Freeport, Ill.; A. R. Whitney, Franklin Grove, Ill.; D. Wilmot Scott, Galena, Ill.; Lewis Ellsworth, Naperville, Ill., Committee of arrangements.

**HORTICULTURAL DEPARTMENT OF THE CENTENNIAL.**—At the last meeting of the Advisory Committee on Horticulture, there were present: John J. Smith, Chairman, W. L. Shaffer, Thomas Meehan, J. G. Mitchell, Robert Buist, S. B. Parsons, Secretary.

It was advised, That the signs expressing the location of each out-door contributor be in the form of a shield twelve inches wide and fifteen inches high; that they be uniform in shape, and placed with the bottom of the shield not exceeding two inches above the ground.

That there be issued a special catalogue of horticultural articles exhibited.

That the Horticultural Societies and individuals, throughout the United States be requested to offer medals for special exhibitions of plants and cut flowers.

That the judges on horticulture be composed of men well known as experts; and who are not exhibitors.

That the Centennial Commission be requested to appoint a committee of men skilled in the nomenclature of plants, to name plants which are new and unknown.

That the plants of contributors be kept in order by the commission at the request of the contributors who so desire it.

It was especially recommended to the Centennial Commission to set apart a room for the use of the Chief of the Bureau of Horticulture, and the Advisory Committee, and for the reception of Horticulturists from the different parts of the world.

That a special recommendation be sent to the Horticultural periodicals of the world to have their issues placed on the tables of the Horticultural Rooms.

We believe the recommendations have been endorsed by the Chief Commissioners.

**ADMISSION TO THE CENTENNIAL.**—It has been decided to charge fifty cents for admission to the Centennial, and each person must be provided with an exact fifty cent note, so as to save time in making change, or counting of fractional parts.

**HOTEL RATES AT THE CENTENNIAL.**—To avoid all misunderstanding as to the probability of increase in the rates during the Centennial, the "Continental," the leading hotel, charging \$5 per day for its best rooms, as other leading hotels in the country do, has announced that under no circumstances will this rate be advanced. The \$2 and \$3 hotels have made similar announcements.

**ENGLAND AND THE CENTENNIAL.**—A London paper tells us: "In the lists of exhibitions announced for 1876, the International gathering at Philadelphia is necessarily the most important. It should prove the most powerful and brilliant demonstration of its class hitherto accomplished, for it has the advantage of new ground and of enormous and long-considered preparations. It is well for international exhibitions in general that our American cousins have taken the matter in hand, for they will break through European traditions, bring new ideas, on what at least to us, is new soil, to an undertaking characterized by new features, and will promote their great work with an energy all their own, untrammelled by the conventionalities of courts and coteries. The strong temptation the exhibition holds out to the more adventurous spirits of the old country will take many of the British westward in the coming summer, although, so far as we can judge up to the present time, there is greater interest felt in the undertaking on the Continent than in this country."

**FRUITS AT THE CENTENNIAL.**—A space five hundred and twenty-five feet long, and one hundred feet wide, will be devoted to a *continuous* exhibition of fruit, so that any one at any time may send anything they have. The opening day will be May the 10th, and it is expected that tropical fruit will then be at once on the tables. Certain periods will be set apart for distinctive exhibitions. July 1st will be devoted to a special display of Southern fruits, and September 11th will be given up to the American Pomological Society. The Bureau of Agriculture, of which Mr. Burnett Landreth is Chairman, has made arrangements for providing 10,000 dishes to exhibitors, should that number be necessary. The Bureau will also furnish table room, all free of charge. Premiums will only be offered by individuals or societies. Of fruits, so far, premiums have only been arranged for apples, but it is hoped others will come in.

THE  
GARDENER'S MONTHLY  
AND  
HORTICULTURIST.

DEVOTED TO HORTICULTURE, ARBORICULTURE AND RURAL AFFAIRS.

Edited by THOMAS MEEHAN.

VOLUME XVIII.

MAY, 1876.

NUMBER 209.

FLOWER GARDEN AND PLEASURE GROUND.

SEASONABLE HINTS.

Most of our readers know that evergreens can be transplanted with considerable success at any season of the year if certain precautions be taken. But perhaps the best time is just as the buds are about to burst. The roots are very active just then, and soon recover from any injury done them. They can be moved long after the buds have pushed, if the young growth be pinched back. It is enough to pinch off half the length of the growing shoot, though in cases of poor roots nearly all may be taken away. In like manner deciduous trees may be planted long after they are in leaf, if a good portion of the young leaves and branchlets are cut out. In this kind of pruning the custom is carelessly to cut away anything; and as the stout, strong end branches come first to hand, these are the ones sacrificed,—but this should be reversed. It is the poor, slender, half-dried-up stuff that should be cut out. The healthy, luxuriant wood, full of life and sap, is just what we want to depend on. Watering at transplanting is poor policy. It is much better to have the earth dry, and broken in well about the roots. They will get all the moisture they need if only in contact with the earth. This is just what thorough beating does. Some people fear injuring the roots by this tremendous beating process. But far more injury results from open air-spaces, loose holes, and such like, than from all the injury the most severe pounding with heavy hammers is ever likely to inflict. The depth to be planted will depend on

the kind of tree, and kind of soil. In light sandy soil, there is seldom injury from deep planting, —and especially from woody rooted trees like oaks and poplars—but fibrous rooted trees suffer very much, especially in heavy clay soils. If land is rather wet, elevate the plants somewhat above instead of putting them below the surface. There are a few things with poor ferny roots which must always be set deep. *Pyracantha* is one of these. The plant may be half buried to advantage. Amongst evergreens the singular *Thuja ericoides* is another example.

Flowers in pots and tubs, for adorning roads and gardens, now spring like lovely butterflies from their winter's hiding places. Cellars give forth their treasures, and barns, pits and green-houses bring forth their lovely things each after its kind.

This branch of gardening has not been enough valued. There are many things which do not well endure our winter, that are truly beautiful when a little protection is afforded them; but because they are only half hardy, are not grown at all. The following are well worthy of being grown in this way:

*Magnolia fuscata*, *Pittosporums*, *Clerodendron Bungei*, *Hydrangea*, *Figs*, *Oleander*, pink and white; *Pomegranate*, single for fruit and double for show; *Bignonia Capensis*, *Bouvardia triphylla*, *Oranges*, *Lemons*, *Laurel*, *Bay*, *Laurustinus*, *New Zealand flax*, *Mahonias*—particularly *M. Darwinii*—*Euonymus japonicus*, *Aloes*, *Agaves*, and others. In very cold climates, *Peaches*, *Nectarines*, *Apricots* and *Plums*

might be grown in this way, and would not only charm the eye during the flowering season, but add their mite to more material pleasure, in a way agreeable to most persons of taste, if not of refinement.

Mow lawns very early the first mowing, or at every subsequent mowing the lawn will look brown. A thin sprinkling of salt is good for the lawn, just enough salt to see the grains on the surface, about a quarter of an inch apart. An overdose will destroy the grass. Frequent rolling is one of the best ways to get a good close sod. When coarse weeds get in the lawn, hand weeding is the best remedy.

Tuberose, Gladiolus, Tigridias, Dahlias, and other bulbous things which cannot be put out till the ground gets warm, ought not to be kept out of the earth any longer than necessary. It was once supposed they thrive best in poor soil—an error; they love rich food.

## COMMUNICATIONS.

### DISEASE IN VIOLET ROOTS.

BY DR. S. W. UNDERHILL, CROTON POINT, N. Y.

In the March number, "J. McB.," of Boston, Mass., inquires about a disease affecting his Violets.

I have been quite familiar with this disease for four or five years past, and believe it exists to some extent in nearly every greenhouse in the country, generally in such a mild form as not to be noticeable.

Since discovering it, I have always carefully examined all plants received, and in most cases, have found it prevalent to some extent. Have received plants affected by it from Boston, New York, Philadelphia and Baltimore, besides other places. I have frequently thought it very singular it had not been noticed by gardeners before. A person not familiar with it, would not notice it, except in bad cases.

The violet is the only plant, I have observed, it killed outright; but it will attack many kinds of greenhouse and bedding plants, such as Verbenas, Petunias, Torrea Asiatica, Tea rose, &c., but these plants are not as seriously injured by it as the violet.

This disease is owing to the attacks of an exceedingly small insect, with the habits of the Phylloxera, but not more than one third the size. Although I was confident from the first it was

caused by an insect, yet it was a long time before I was able to find one, for whenever I examined the roots, there were none to be seen. After repeated examinations, I found one running across the field of the microscope, and with considerable difficulty kept it in view long enough to see that it resembled the Phylloxera, much smaller, with longer legs and slimmer body, and much more rapid in its movements. I afterwards found them feeding on the roots, but they will run away as soon as disturbed.

It appears to be difficult to destroy them by applications to the soil, and I find the best way to get rid of them is in being very careful in selecting soil for potting, and to grow all stock from seed or slips, and not from division of the roots, and to keep the stock plants in a different house from the slips or young stock; also, to destroy all stock plants affected by them as soon as they can be spared.

I find it is not safe to use soil from the vicinity of the greenhouse, where I have found them attacking the tomato, several kinds of weeds, and even the tobacco plant; although I think any rich soil taken from near the greenhouse, is as good as soil taken from the field if properly treated beforehand. Heaping it in the spring and covering with a sufficiently heavy coat of mulch, to entirely prevent a growth of weeds through the summer, will effectually destroy them by fall.

Killing all plants by hoeing or storing the soil dry under a shed during the summer and autumn will also answer the purpose.

I think, from my experience, the good qualities of fresh soil from a pasture is very much owing to the absence of these insects. Where the soil is rich and the plants can get an abundance of nutriment, the effects of these insects are seldom noticed on the growth of the plants; consequently it is best to supply all affected plants with plenty of nourishment. By this means most plants, except violets, can be grown successfully, even where they are very numerous.

If they are very abundant on the violet, they will, in the autumn, eat the bark from the main roots or body of the plant, and cause it to rot off below the surface of the ground.

This trait is similar to one of the Phylloxera, the effects of which on the different varieties of grape vines I have been studying for several years past—probably being one of the first to notice them in this country—having discovered them with a microscope, on some diseased grape-vine roots, in the autumn of 1869. My observations



on this subject I propose to send to the *Gardener's Monthly* at some future time.

[In addition to the above, we have the following from Mr. R. Linsley, West Meriden, Conn.]

"I notice the enquiry of J. McB., of Boston, on page 77, March number, and send you a sample of a plant lifted last fall, the old roots 'clubbed,' as we call it—the young roots grown quite recently showing the same thing,—the ground occupied is a fine loam, well underdrained. Some of the plants died in the garden, others after we lifted, and others in the same plot showed no disease, but have not flowered as well as usual. The disease affects them much as 'club' does cabbage, but the process is not the same at all, and is much longer in destroying the plant. I have forwarded a sample to Prof. C. V. Riley, St. Louis, Mo. There is at the same time a fungus on the leaf."

### EVERGREENS.

BY MR. E. MANNING, HARRISBURG, O.

I have been much interested in looking over our friend Hoopes' selection of ornamental trees, &c. Although I regard his selection as a very good one, and his opinion and experience as of the first importance, yet I think a few more additions might be safely made.

I would add to his list of twelve deciduous trees of large size as very choice, Weir's cut-leaved Maple, very beautiful; *laciniata* or eagle's claw; and *gold-leaved Maple*, both very fine, and also *purpurea*. To his twelve medium sized trees I would add *Betula laciniata pendula*, and *Alnus imperialis laciniatus pendula*, both good and distinct; *Glyptostrobus sinensis pendula*, perfectly hardy here and nothing more beautiful, Kilmarnoch Weeping Willow—grafted high—and *Salix buria variegata*, which is much more charming than the common variety. I would add to his twelve small sized deciduous trees, *Exochorda grandiflora* and a variety of *Althæas*, blooming as they do so late in the season; and by all means *Hydrangea paniculata grandiflora*, if thought large enough to come into this class. For twelve conifers of large and medium size, let me put first, *Picea Parsoniana* as the most beautiful and faultless of all. My largest specimen is eleven feet high, and has proven hardier than the famed *Nordmanniana*, which is frequently browned and has even had its leader killed by severe weather. I fully endorse all Mr. Parsons

says of its beauty and am glad to find Prof. Sargent speaks of it in high terms. *Pinus excelsa* all should have for its great beauty. *Abies Canadensis macrophylla*, I should judge, will never make more than a moderate sized tree; it is much more beautiful than the common variety, having leaves of a dark green, and it is more hardy. It is one of the very best and should be better known.

When we come to small sized evergreens we must not forget *Juniperus glauca*, from Japan, beautiful and hardy, also *J. glauca Americana*, and *J. viridis pendula*. The *J. drupacea aurea* does very well with me, but I fail to see how it differs from *J. Japonica*. I have three distinct kinds of variegated forms, all entirely hardy.

*Biota semper-aurea* is with me the very best of its class—it has stood out for four years. It is of spherical form and of the brightest yellow color, and is more beautiful than *elegantissima*, and holds its color better in winter than any other. You could pass it every day for months, and see some new beauty in it every time. Louis Van Houtte, of Ghent, speaks in the highest terms of this little gem. *Buxus latifolia*, *B. glauca*, *B. aurea variegata* and *longifolia* should be in every collection. So should *Cephalotaxus Fortuni*, which is the only thing of the Yew family that has succeeded here. *Picea Numidica* and *P. cili-cica* are two comparatively new Firs, and should they prove hardy, will stand in the front rank, particularly the former. I have great hopes of this, and of *P. amabilis*. We all have our pets, and these are mine.

### RHODODENDRON ARBOREUM.

BY WALTER ELDER, PHILA.

The scarlet *Rhododendron arboreum*, was first introduced into British gardens in 1820, from Nepal. The late James Cunningham, nurseryman in Edinburgh, found it in a London nursery, bought it for a high price and took it home. The peculiar comeliness of its foliage attracted his love for the plant. When it bloomed, he was transported with joy. The leaves are of a delicate green on the upper sides, and richly silvered on beneath. The blossom is of rich scarlet crimson, of great brilliancy, and of the finest texture. The plant was a model of perfection. During its season of blooming, other species were set around it, to be impregnated by it, to originate new varieties. I had the care of it from the autumn of 1831, to the late spring of 1834. During that time

the nursery was like a fair with numerous visitors to see it when in bloom (May). A dozen of other species were set under and around it to be impregnated by it; but as the flower-bells were three inches in diameter and deep, the trusses immensely large, it was feared the pollen might not flow beyond them freely, artificial impregnation was resorted to, and was fully successful.

In the morning much honey was in every bell, and was sucked out by bog-reeds to prevent the pollen from being clogged. The plant bore seeds plentifully, and increased the original species. The impregnated plants also were prolific in seed-bearing, from which numerous new and superior varieties were produced. During my time a new greenhouse was erected for their growth. It was one hundred and fifty feet long and sixteen feet wide, with an elevated bark-pit (bed). The plants were all grown in pots and plunged in the bark-pit. By the descriptions of the original species and the choice varieties in the magazines, Comely Bank Nursery became celebrated all over the United Kingdom, and also over the continent of Europe. The demand for them was far beyond the supply. I never saw such a splendid plant as is the scarlet *Rhododendron arboreum* when in bloom, and never knew of a plant so universally admired and sought for.

Since my time, by the works of others, (the Waterers &c., of England, and Houttes of Belgium,) the *Rhododendron* has been made by new superior species, the most valued and beautiful genus of ever-blooming shrubs all over Europe. Many are hardy, and grown in large masses in open pleasure grounds. Others more tender, are grown in greenhouses. Large houses are filled with them. No wealthy estate there is without its collection of *Rhododendrons*.

### EDITORIAL NOTES.

PLEASE THE GARDENERS.—HE (*imaginative*): I always think it a pity to be in London when the country and gardens are so lovely. Your flowers must be splendid just now?—SHE (*practical—taking tea*): Yes, mamma says some of us ought to go down for a day or two, just to please the gardeners.—*Punch*.

GRASSES FOR INDIANA.—In Dr. Coulter's interesting little *Botanical Bulletin* for March, there is an account of the native grasses of Jefferson Co., Ind., by Mr. A. H. Young. The

Red Top (*Agrostis vulgaris*) seems to be remarkably well suited to that part of the country. There are many suggestive observations on other grasses.

NAMES OF VARIETIES.—Our readers may remember that when our friends Maxwell and Barry introduced two varieties of *Arbor vitæ*, and named one George Peabody, and the other Tom Thumb, and we supported them in the excellent innovation, the English nurserymen flatly refused to have these varieties under these names, and re-christened them with Latin names of several feet in length. We cannot see how Latin names are to be obviated in Botany,—but for garden forms there is no necessity, and it seems inexpressibly absurd. Here before us is a list of garden forms of holly. One is *Ilex aquifolia aurea angustimarginata*, another *Ilex aquifolia serratifolia alba marginata*, and so on. Even in Europe as in this country there have been attempts at rebellion. Mr. Waterer having named one holly Golden Milkmaid, but he seems to have been subdued, and the kind is declared to be *Ilex aquifolia aurea medio picta*,—only this and nothing more!

WEeping HEMLOCK SPRUCE.—The *Garden* says: "Mr. Samuel B. Parsons writes to us from Flushing, Long Island, praising the beauty of the Weeping Hemlock (*Abies canadensis* var. *pendula*.) The ordinary form of the Hemlock is a very graceful tree, and this new one will prove a welcome addition to our pleasure grounds. We have never been able to understand the reason why the hemlock tree, which does so well in the cold regions of North America, thrives so poorly in our gardens. With us it is frequently surpassed in stature by the Western *Arbor vitæ*, which is naturally a much smaller tree, inhabiting the same regions as the hemlock."

The reason the hemlock does so poorly in England is probably the presence of limestone. The best soil for the hemlock is that overlying granite. Even in America it does poorly in limestone soils.

### NEW PLANTS.

LILIAM PARKMANI. — This magnificent Lily, raised by Mr. Francis Parkman, between *L. auratum* and *L. speciosum*, and to which we have referred in our pages, is the subject of a beautiful colored plate in the London *Florist and Pomolo-*

*gist* for March. We may give some idea of it by saying that it looks like a highly colored *L. lanifolium rubrum*, only *double the size* of any ordinarily seen.

There seems to be a fatality about the spelling of the name. The *Gardener's Chronicle* in first describing it accidentally made it Packmani, — and now the *F. and P.* has it Parkmanni. It should be Parkmani.

**LIGUSTRUM CORIACEUM.**—Is a new species of Japan privet, introduced into English gardens, and which will probably prove a desirable thing for out door culture in this country.

**ZINNIA DARWINI.**—Under this name a new race of Double Zinnias has come into existence through the skill of the hybridizer, and is illustrated in the February number of the *London Florist and Pomologist*. The habit is much better than the old race of Double Zinnias, and they will be no doubt great favorites. We believe our seedsmen will soon be able to offer them to American cultivators.

**THE PURPLE-LEAVED MAPLE.**—This, known in catalogues as *Acer polymorphum atropurpureum*, is one of the loveliest ornamental maples imaginable. The winy purple tint is peculiar among all the purple-leaved plants,—and it has the property rare among purple-leaved things of keeping a dark tint far away into the fall. It is as yet rather scarce in our collections, through a difficulty in propagation. In England some trees have reached a height of ten feet, and must be very grand.

**PANCRATIUM ROTATUM.**—This native bulb is quite as handsome as many of the imported Lilies and other grand plants from abroad. Our enterprising friend who has taken in hand to push the *Agave Virginica*, might do a similar good work by working up this, which also grows wild in his region. It is not at all abundant in cultivation, and, practically, it has yet to be introduced. Still not to excite the ire of those of us who love to have things correctly expressed, he had better not, in his *Pancreatium* circular, claim the honor of a "first discovery."

---

### QUERIES.

---

**INSECT INJURY TO THE ELM.**—The elm, and especially the English elm, is "skeletonized" every year by an insect which it has been taken for

granted is the larva of a *Scolytus*, which is reported to be destructive to the elm in France. A correspondent called Prof. Packard's attention to the prevalent opinion, and this is his response. It seems the matter has not yet been made clear. It is certainly no Campsidean that injures our elms.

PEABODY ACADEMY OF SCIENCE,  
SALEM, MASS., JAN. 29, 1876. }

My Dear Sir:—I wish I could give a satisfactory answer to your inquiries. I have not noticed whether the European elm suffers more than the native species or not. We have as you know but few European elms about here. I would like to see some specimens of the *Scolytus*. Is it not possibly a true longicorn borer, Campsidea? I know of no *Scolytus* or allied beetle particularly injurious to the elm in New England, and know the Campsidea is very injurious at times in New York and New Jersey. The Canker worm is not found in the Middle States so far as I know, though common in Illinois and Missouri. Yours, very truly,

A. S. PACKARD, Jr.

**FAILURE OF CAMELLIAS IN FLORIDA.**—A Jacksonville correspondent calls attention to her Camellias in the open ground, the buds of which never fully expand but dry up while opening. While in New Orleans, recently, we saw the same in Camellias there growing in the open air. We might say in brief that the *Camellia* never did like heat, and therefore these climates are too hot for it. We might put the fact in other words, and say the evaporation from the petals is too great for their permanence. Even in glass culture it is found the *Camellia* does best in a rather low temperature with a regularly moist atmosphere. Those who would grow Camellias in Florida or Louisiana, must plant them in the coolest spots possible, and where there is a regularly humid atmosphere.

**FAILURE OF PÆONIAS.**—A Rochester correspondent says: "Do you know why it is that in the South, California, and South-west, *Pæonias* so generally fail to bloom—the buds blasting? We have constant complaint. Is it the heat and drouth? I have been asked scores of times to write an article on the subject, but know too little, although I have paid some attention to the matter in my travels."

[The answer to Florida Camellias, doubtless applies here also.—Ed. G. M.]

**NEW DOUBLE DEUTZIA.**—A correspondent sends us for name, a specimen, which proves to be the new double *white* *Deutzia crenata*,—which we did not know before had reached our shores, though announced in Belgium. This will be a good companion to the double rosy one now becoming well known. It will be a capital forcing plant, pure white flowers being always in demand.

**YELLOW VIOLET.**—A Bloomington, Ill., correspondent says: "Is there a yellow Violet? Would you regard one as a choice plant, or worthy of propagation?"

[There are yellow Violets in abundance among the botanical species,—but we have never known of any one likely to compete in cultivation with our blue and white kinds.—Ed. G. M.]

## GREEN HOUSE AND HOUSE GARDENING.

### SEASONABLE HINTS.

About this time of the year people will prepare hanging-baskets, for suspending from trees and half-shaded places in piazzas, so as to get them to grow well and be established against next winter, when they will have to adorn rooms and small conservatories. It is of course well understood by this time that these baskets when made of pottery or metal must have a hole to let out the water. This note seems necessary, however, because we often see things offered for sale as flower-baskets that have no provision of the kind. The best baskets are wire ones that have a coat of moss on the inside to keep in the earth. These never get too wet, and with proper care never too dry. Plants do not require changing in these baskets near as often as people think, for a lady of the writer's acquaintance has baskets that have been undisturbed for several years, but manure is occasionally given to them, and the plants thrive charmingly. Among the plants in them we note the *Abutilon vexillarium pictum*, a really delightful thing with its half-pendant habit and profusion of orange and crimson flowers. The old green-leaved *Mesembryanthemum cordifolium*, or ice plant; *Senecio scandens*, or parlor ivy, one of which plants from the basket had some of its branches twelve and fifteen feet in length, and was wreathed about picture frames and other ornaments on the walls of the room; the old red *Mesembryanthemum spectabile*; several ferns, as *Onychia japonica*, *Platyloma hastata*, *Pteris serrulata*, and *Adiantum cappillis veneris*; *Oxalis multiflora*; *Oxalis floribunda*; variegated Periwinkle; and there were actually some "weeds" growing among other

things, which the lady thought too pretty to pull out. A very large lemon tree was in the room that had been blooming all winter, the picture of health. The room was heated by a common anthracite coal stove, and all the plants as healthy as we see in any greenhouse, and much better than in many—but the deadly foe to the plant-grower, illuminating gas, was absent—the room being lighted from coal oil lamps. We are satisfied, from such little experiences as these, that lists of plants for room or basket culture are superlative—for any thing will do well if properly treated. The baskets are hung out under trees in summer. In fact almost all plants do better in the open air in summer than under glass; but with what are called hard-wooded plants, like Heaths and Epacrises, the dry heat of our climate does not seem to agree. A partially shaded place is best for most of them, but not under the drip of trees, though many persons put them out under trees, as such shade with drip is better than the hot sun. Plants are better also with their pots plunged into the soil, but they ought to be twisted around or taken up and reset about once a month, or roots will so many go through the bottom of the pot as to injure the health of the plant when taken up, and so many broken off at once in the fall. Azaleas usually flower better when plunged in the full sun.

There are some things which do well kept under glass all summer, as *Achimenes*, *Gloxinea*, *Begonias*, *Ferns*, &c., but it will be best to try to get as much as possible in the open air; in the first place, because they are more enjoyable thus in summer, and, in the next place, because they usually keep hardier, and clearer from insects, which are very hard to contend with, under glass, in hot weather.

## COMMUNICATIONS.

## HEATING SMALL GREENHOUSES.

BY H. LUMBARD, OAK PARK, CHICAGO, ILLS.

I think there must be a great many readers of your paper that heat their houses with furnace heat that would be pleased to know how to heat a small greenhouse by the same fire.

I know that I should have been very much pleased to be informed how the thing could be accomplished last fall. Now I know by practical experience, and if you think it will be of use to any one you are at liberty to use it.

My greenhouse, or perhaps it might be better named pit, is a lean-to, adjoining the house, about 12 feet square, facing south, about 3 feet of it being under the piazza. The heating arrangement is what I intend to refer to principally, as follows:

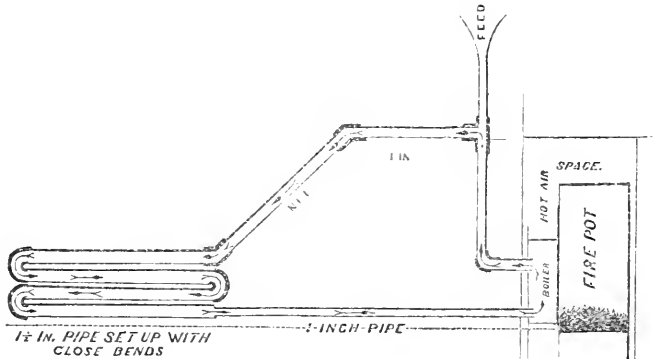

I procured a copper boiler, holding, perhaps, 2 gallons, made to fit a section of the fire-pot of the furnace. From this I led the flow pipe (1-inch gas pipe) to the ceiling of the basement, thence to the greenhouse, about 20 feet from the boilers, along the side to the front, where I connected with a coil of  $1\frac{1}{2}$ -inch gas pipe, which passes four times across the front of the greenhouse, then returns to the boiler with a 1-inch gas pipe, to be heated and go over the same ground again. It requires no care, about one-half pint of water per week, and works perfectly; and if flowers could say anything they would say that it suits them perfectly, too; not having the gift of speech they do the best they can by looking their very prettiest. At the present writing I have in bloom Auriculas, Azaleas, Roses, Hy-

cinths, Pansies, Cyclamens, Camellias, Chorozemas, Abutilons, &c., all in perfect health, which plants never have when heated by stove or furnace heat.

If you conclude to publish the above, you will have to dress it up a little. If there is anything that you cannot understand, and think it worth a letter of inquiry, I will answer it. If I was to wait till I had time to write in shape fit for publishing I am thinking my plan would never reach you; and if on reading the above scrawl, you think that the best place for it is in the basket under the table, I shall offer no objection.

One thing I really forgot, which is essential to the working of hot water—keep all the pipes above the level of the bottom of the boiler. This I learned by experience. I tried to have my return pipe lay on the floor of the basement, which was about 18 inches below the bottom of the boiler, but the water would not flow properly; did not work at all satisfactory until I changed it to have all the water used a trifle higher

than the bottom of the boiler. The expense of the whole heating arrangement was about twenty-five dollars. The boiler must be made to fit the fire-pot of the furnace very close; and I think, probably, 2-inch pipe for the front pipe would be better than  $1\frac{1}{2}$ . This winter has been a very mild one, but I have no fears but that with a few mats for covering I shall be able to keep frost out in a severe winter. If the pipe has to be carried far before entering the greenhouse, it will be necessary to cover it with a coating of asbestos or sawdust, or some good non-conducting material, otherwise a considerable amount of heat will be lost by radiation. With such a covering it can be carried quite a long distance without much loss of heat. Probably two 4-inch pipes across the front of greenhouse would be

much better than four 1½ ones. This is only suggested; I have only written as I have it in operation. I hope some one will give you something better before next winter for heating small houses.

### PEERLESS ROSE.

BY E. HOLLY, HUDSON, N. Y.

Or, as most catalogues have it, Bourbon Rose Peerless. I also notice it under the head of Ever Blooming Rose. I do not wish to say anything against the rose, having purchased a half dozen plants the first season they came out, and have grown them ever since in pots and in the open ground; have had plants eight feet high, with canes an inch through or more, covered with hundreds of clusters of beautiful blossoms in June. I have cut the plants back and tried them in different ways, and have never seen a rose on any of them, except the spring bloom on them in pots and the June blossom on those in the open ground. If it had been called a Hybrid Perpetual I would not have been disappointed. I think the general mass of people who grow roses expect a Bourbon Rose to be one which gives more or less blossoms through the season and a fine bloom in the fall. Peerless with me grows more like Prairie Queen than any rose I grow—not as tall growing, but the same strong, thorny wood as the Prairie Queen. I think this rose should have been called a Hybrid Climbing June Rose. I hope others will give their experience with this rose in the *Gardener's Monthly*, and have this rose pushed into its proper place if it is not there at present.

### EDITORIAL NOTES.

**EUPATORIUM LIGUSTRINUM.**—This is the correct name of the white sweet-scented Eupatorium now becoming so popular for winter cut flowers. It has eight or more names given to it erroneously.

**THE RICHARDIA (CALLA) ÆTHIOPICA**, which our people have learned to call "Calla Lily" and "Easter Lily," goes by the name of "Trumpet Lily" in England.

**PRESERVING CUT FLOWERS.**—If we fill a tumbler with water, and invert it, the water remains

therein. A correspondent of the *Florist* or *Pomologist* has taken advantage of this fact to get bouquets of flowers under water in bell glasses, and he says if exposed to light in this condition the flowers keep perfect a wonderfully long time.

**NAME OF PLANT.**—Mrs. E. J. B., St. Louis, Mo.—*Bryophyllum calycinum*.

**PLANT-SELLING AT AMHERST COLLEGE.**—We find the following in the *Detroit Farmer*: "We recently visited the Durfee Plant House at Amherst, established by a fund given the Agricultural College by Dr. Nathan Durfee, of Fall River. We found it under the charge of Prof. S. T. Maynard, a graduate of that college, who reports that the house now contains between seven and eight thousand plants of fifteen hundred species and varieties. Twenty thousand bedding plants were propagated the last season. The sales of plants and flowers during the year amounted to \$758.32, while about a third of the grapes in the vineyard were sold for \$265.16, the balance having been destroyed by frost. The nursery at the college now contains more than six thousand fruit and ornamental trees, including a large number of species. The vineyard contains about 2,000 vines of 32 different sorts.

**THE PLANT HOUSE AT THE AGRICULTURAL COLLEGE.**—The plant house at the Agricultural College at Lansing is a success, an honor to the institution and to the State. But it is just in its infancy and should be extended. We strongly recommend that this department be placed on a paying basis. The experiment to be tested is whether the growing of plants will pay. This is a narrow, low and selfish view of the case, but it is a lesson to be taught. Will it pay? Will flowers pay in dollars and cents? Not socially, intellectually, morally, aesthetically or hygienically? Will they pay like potatoes, corn, pigs or eggs? There are plenty of people in Michigan that will favor the plant house just as soon as they see the shinplasters and greenbacks growing out of them.—*Michigan Farmer*.

**ROYAL BOUQUETS.**—Mr. Wills, of the Royal Exotic Nursery, Onslow Crescent, had the honor of receiving the commands of H. R. H., the Duke of Edinburgh, for the Floral decoration of the Royal Albert Hall and the Royal Box, on the occasion of the recent State concert there. Mr. Wills also supplied the bouquets presented to Her Majesty, H. R. H. the Princess of Wales,

and H. R. H. the Princess of Beatrice. Her Majesty's bouquet was composed of Roses, Eucharis, Odontoglossum Alexandrie, the chaste and beautiful *Cœlogyne cristata*, Violets, and Lilies of the Valley; that of H. R. H. the Princess of Wales was quite unique, and contained Neapolitan Violets, the lovely *Dendrobium Wardianum*, Lilies of the Valley, and various other gems; the Princess Beatrice's was composed of various Orchids, Lilies of the Valley, Roses, Eucharis, Lilac. All were surrounded by Brussels lace holders.—*Gardeners' Chronicle*.

**FLOWER POTS.**—We learn from the *Hamburger Gartenzeitung* that the fabrication of Flower-pots from a mixture of cow-dung and earth is now extensively practiced in North Germany. As many as 16,000 were used last year in one establishment. For forcing they are highly recommended, though they will not bear plunging in a hot-bed; and they are admirably adapted for nursery work, for plants raised in pots and afterwards turned out, in this case pot and all. Even standing dry the roots of plants will penetrate the sides of the pot, and extract some nourishment from them. They are made by machinery, and one man can make from 700 to 900, or even 1,000, in ten working hours. There are machines for three sizes—2 inches by 2 (price 8s), 2½ inches broad by 2½ high (price 10s). Since the first introduction of these pots by Mr. MacIvor some years ago we have heard little of their use in this country.—*Gardeners' Chronicle*.

**FORCED DEUTZIA GRACILIS.**—The *Gardeners' Chronicle* says: "Deutzia gracilis that has been forced through the winter and has done flowering will now be pushing growth. The best way of treating this plant, and by which it may be kept in a healthy, useful condition for a number of years, is to cut out the old wood after it has flowered, depending for next year's bloom upon the young shoots that push up freely from the collar when the plant has plenty of roots. To ensure its blooming satisfactorily every year when forced it should, after flowering, be kept in a little heat, such as a vinery at work, until the growth is made and flower-buds formed. If in small pots give them a moderate shift; if they do not require more room they will whilst growing be benefited by manure-water twice a week or so."

**FUCHSIAS.**—Fuchsias appear to be grown more extensively than in any previous year, for sev-

eral houses are filled with plants of various sizes, ranging from the smallest to be sent out from rooted cuttings to those sold as established plants. The collection comprises nearly 150 varieties, and as some of the most popular are grown by the hundred, some idea may be obtained of the number of plants comprised in the stock. Several new varieties are in course of distribution, amongst them being *Cannel's Gem*, a very beautiful dwarf and compact growing variety with white corolla. The flowers are of fine form, nearly equaling in this respect the very best of the dark varieties. *Cannel's Favorite*, a pretty light-flowered variety of the Oriana type, but of course quite surpassing that variety, which in its time was deservedly held in high esteem. *Resplendent*, a fine dark-flowered variety in the way of Lord Elcho; *Mrs. J. Lye*, a pretty light flower; *Stupendous*, a very large double flower in the way of Champion of the World, but possessing a better habit. Mr. Cannel is also distributing four hardy hybrid fuchsias, but as they were not in bloom nothing can be said about them beyond mentioning them as worthy of a trial in gardens in which hardy fuchsias usually do well. These are said to be hybrids between the hardy species and the best of the show varieties.—*Gardener's Magazine*.

**STANDARD PYRACANTHAS.**—The old evergreen thorn, *Crataegus pyracantha*, which is usually grown as a wall-tree, and is certainly one of the finest wall-trees of its class, makes an equally effective standard or free-branching bush, and in this shape bears berries profusely, and from the end of September to the end of March is without any question whatever the most splendid berry-bearing shrub in the English garden. In the *Gardener's Magazine* for December 6, 1862, I directed attention to the importance of berry-bearing shrubs for winter furnishing, and in the issue for December 16, 1865, I explained how I had employed pyracanthas as pot plants to light up beds of evergreens during winter on the plunging system. It is therefore no new freak with me to have standard pyracanthas, and my only regret is that I have not room to employ them largely, for they are equal to any evergreen shrubs when the berries are gone, and are brilliantly beautiful all through the autumn and winter, if the thrushes will but leave them alone. Give this notion room for expansion in your sunny shrubbery borders, and in a few years you will see the way to do winter promenade garden-

ing in a way to beat all attempts hitherto made, excepting, of course, those of your obedient servant.—*Gardener's Magazine*.

A HINT TO TABLE DECORATORS.—A splendid subject for table decoration, hitherto (so far as I know) unused, may be found in every garden, but its season of perfection is nearly past. It has stared me in the face for years and years, but I never thought of using it until lately, when "stern Necessity's supreme command" led me to hunt for every scrap of suitable stuff on the premises. The new subject is our old friend of the kitchen garden and salad bowl, the Common Sorrel, *Rumex acetosa*, which now presents huge, ugly, club-like spikes of purplish red inflorescence of a comparatively coarse and unattractive nature. But, unpromising as it looks, it needs but to be judiciously used, and it becomes a most valuable aid in the light filigree work which is so much needed in the dressing of vases, and will take its part admirably with grasses and ferns to make a delicious cloudy atmosphere around and above gay flowers. Try it and be convinced. Every one of the great ugly bunches will furnish fifty light sprays of grass-like inflorescence of a peculiar color, differing from, yet harmonizing with all kinds of flowers, and so distinct it is when set off with bright green that it might be employed as the dominant furniture in some instances.—*Gardener's Magazine*.

POINSETTIA.—Passing by these old friends, not without a word of hearty welcome be it well understood, we come to another plant which has been of late years an almost indispensable adjunct of Christmas decorations, be they of church or hall—the brilliant Poinsettia pulcherrima, the bright scarlet bracts of which give the head of blossoms a flower-like appearance, and serve admirably to lighten up the somewhat sombre masses of evergreen. Not only in England is this beautiful plant regarded as a Christmas flower; in the North of Mexico, where it finds a place in almost every garden, it is called *Nochebuena* from its blossoming about the time of the Christmas festival, for which *noche buena*, "the good night," is the Spanish name. In the South of Spain it is a very popular flower, and there too, it is connected with a Church festival, being known as *Flor de pasqua* or Easter-flower. Its name commemorates a French traveler, M. Poinsette, by whom the plant was introduced to cultivation. He brought specimens to Charles-

ton from Mexico in 1828, whence they were taken to Philadelphia; and specimens sent from the latter place to Edinburgh flowered in 1835, since which date it has become increasingly popular and plentiful in our stores. There is a variety with white bracts, and a so-called "double-flowered" variety has just made its appearance amongst us, and which will, we believe, shortly be illustrated in these columns. With us in England the plants of the Poinsettia attain comparatively but small size; but in India, on the Neilgherry Hills, where it is grown in gardens, it attains the size of a large bush.—*Gardener's Chronicle*.

## QUERIES.

WORK ON GREENHOUSE CULTURE.—W. M. G., Niles, Mich., writes: "Will you have the kindness to inform me which is the best authority and most extensive work on greenhouse culture, and where obtained, and the price. I have Henderson's Window Garden, and some other small works, but none of them answer my purpose. I want something that covers more ground, alphabetically arranged, so that I can refer to at least the majority of plants usually found in a greenhouse collection, their culture, time of taking cuttings, and general management of each and every plant. I would prefer an American work, as the treatment in different countries is different. I notice by your advertisements in the *Gardener's Monthly* that you are a greenhouse man, and being an editor I presume you know what is best for my purpose."

[Buist's work is the best, and it will probably be the only work of that character for some time to come, as there has been so much progress made of late years in practical floriculture that minute directions, for propagating and managing each particular plant is not called for. Practice has so simplified propagating especially that a first-class propagating house strikes anything and all things equally alike. The delicate Heath, or the coarser Camellia, Geraniums, Azaleas, Cactuses, Roses, everything, all are done for in one and the same bed. There is no mystery any more about these things. Good sound sense, with an educated experience, is all that is needed, and when one can do this with one plant he will do with most all. For a knowledge of plants



specially, as to whether they are from hot countries or cold, and similar matters, that will aid a good propagator, Lindley & Moore's *Treasury of Botany* is a good helper.—Ed. G. M.]

SCALE ON OLEANDERS.—J. P. S., Winterset, Iowa.—“Please inform me through the columns of the *Gardener's Monthly* (of which I am a subscriber) what is the best means of destroying scales on Oleanders; also, can alcohol be used to any advantage, and how much does it require to be diluted? By so doing you will much oblige.”

[Gardener's generally use for the scale on Oleanders strong whale-oil soap.—Ed. G. M.]

NIPHETOS TEA ROSE FOR CUTTING.—Dallas Bros., Bridgeport, Conn., with a very beautiful rosebud, say: “We noticed in the *Gardener's Monthly* a paragraph headed *Roses for Winter Buds*. We send you two buds of the first-named (and perhaps least known), Niphetos, cut from a plant imported last fall. By all appearance it is a very free bloomer, and the quality you can judge by the buds sent.”

## FRUIT AND VEGETABLE GARDENING.

### SEASONABLE HINTS.

Fruit culture for profit has had to contend with over-abundant crops the past year or two, and the trees in such cases are weakened. Now, this may be remedied by thinning out fruit in infancy. This prevents a glut, gives finer fruit, and saves the trees.

Besides thinning the fruit, we should thin the young branches. Handsome forms are as desirable in fruit as in ornamental trees. No winter pruning will do this exclusively. It may furnish the skeleton—but it is summer pinching which clothes the bones with beauty. A strong shoot soon draws all its nutriment to itself. Never allow one shoot to grow that wants to be bigger than others. Equality must be insisted on. Pinch out always as soon as they appear, such as would push too strongly ahead,—and keep doing so till the new buds seem no stronger than the others. Thus the food gets equally distributed.

Fruit growing primarily for pleasure, to follow with plenty of good fruit, has been much encouraged by the greater success of the grape of late years. There is much more interest in having collections of varieties than there used to be.

As to the best system of pruning grapes, there are several “schools,” all contending that their views are “decidedly best.” In such cases, we have generally found there is much to admire in them all—situations and peculiar circumstances deciding the point in each individual instance.

There are a few points incontrovertible to insure success, and it matters little what system of pruning is followed, so that they are secured. First, a healthy set of roots of the previous year's growth is essential to produce vigorous start of growth the year following. Secondly, after starting, these roots can only be kept vigorous by encouraging an abundance of healthy foliage, to be retained on the vine as long as possible. Thirdly, the leaves of the first growth are at least of double the value to the plant than those from secondary or lateral shoots; they should, therefore, be carefully guarded from injury. Fourthly, checking the strong-growing shoots strengthens the weaker ones, equalizes the flow of sap to every part of the vine, and insures regular and harmonious action between all the parts. Any system that secures this does all that is necessary for the general health and vigor of the vine; and where some special objects are desirable, such as dwarfing, particularly early bearing, productiveness at the expense of longevity, special means must be employed to bring them about.

In the cultivation of garden crops, the hoe and rake should be kept continually at work. Weeds should be taken in hand before they are barely out of the seed-leaf, and one-half the usual labor of vegetable gardening will be avoided. Hoeing or earthing up of most garden crops is of immense advantage in nearly every case. One would suppose that in our hot climate flat culture would be much more bene-

ficial; but a fair trial, say on every other row of a bed of cabbages, will show a great difference in favor of the earthed-up plants. It would be easy to explain the reason of this, but in this column we try to confine ourselves to "hints," and leave reasons to our other departments.

Cabbage, Cauliflower and Broccoli are now set out for fall crops, and Endive sown for winter salad. Lettuce also for summer and fall use. This, however, must be sown in very rich soil and in a partially shaded situation, or it will go to seed. Peas, beans, and other crops should be sowed every two weeks. They do much better than when a large crop is sown at one time, and then have too many on at one time to waste.

Melons, cucumbers, corn, okra, squash, beans, sweet potatoes, Lima beans, pepper, egg-plants, tomatoes, and other tender vegetables that do well till the sun gets high, and the ground warm, should go into the soil without delay.

Bean poles should be set before the beans are planted; and near cities where they are comparatively high priced, their ends should be charred. This will make them last some years. Try also short stout poles for cucumbers and tomatoes. They do remarkably well this way.

---

## COMMUNICATIONS.

### MUSHROOMS.

BY PETER HENDERSON.

In reply to "Subscriber," in the March number, who complains that in my work, "Gardening for Profit," I omit to say how to "cut," "pack," and "sell" the product of his mushroom bed that my instructions have enabled him to obtain. Though these instructions do not necessarily belong, I think, to such a work, no more than the telling of "how to catch a hare" should be followed by the information of how to cook it, yet I will endeavor to help him. In most cases when mushrooms come up thickly in clumps or clusters, they are best gathered by twisting off carefully, so as not to injure those not yet fit to gather; but when that cannot be done without injury, they may be cut as asparagus, by slipping them off with a knife below the surface. In packing, the same rules apply to them as in anything else, that is, use the size of the package according to the season of the year.

In February or March, a package holding a bushel may be used, while in May or June, when the temperature is higher, the package should not be more than one-fourth, or one-sixth of that size; for the reason that a larger package would then heat. In all cases be sure that the package is filled *full*, so that its contents will not shake or jolt. About "selling," much will depend upon where "Subscriber" is located. If in the vicinity of any of our large cities, the principal hotels will be the purchasers. There is not yet demand enough for mushrooms in our common markets to command prices high enough to justify their culture, though the prices paid by the first-class hotels and restaurants in New York are such as I believe pay well. A gentleman called on me the other day from Canada, who informed me he had some 10,000 square feet of cellar space, which he had for three years devoted to the forcing of mushrooms and rhubarb, all of which he sold in the New York hotels at remunerative prices. Your correspondent states that he has a *small* bed. He will find that he will have more difficulty in selling his mushrooms, or anything else, than if he had enough to sustain a regular supply to the purchaser. All articles of a perishable nature that are products of the garden or greenhouse, we find are always sold to better advantage when the supply is regular. Our large growers of cut flowers, for example, in the vicinity of New York, who have enough to send in daily to their customers, realize at least one-third more than those who can only send in occasionally; and such as a general thing is equally true of fresh fruits or vegetables.

---

### BILYEU'S COMET PEACH.

BY RANDOLPH PETERS.

In December number of *Gardener's Monthly*, p. 368, your correspondent, D. O. Munson, Esq., of Fall's Church, Va., says, "I send you by express some peaches which have been sent to the Washington market for two or three years, under the name of Comet, from the eastern shore of Maryland. This fruit brings from \$4 to \$5 per bushel. You describe this peach as a white flesh peach. Again I find in January number, 1876, pages 14 and 27 same number, two more communications from same correspondent. On page 14 he says, "I send you

a plate of same kind of peach I sent you. I also sent same to Chas. Downing, who says it is a new peach. Rivers, of England, has sent out a yellow peach called Comet, and it will be necessary to give this one a new name, and I have decided to call it Billiers' Comet, as it originated with a Mr. Billiers, of Kent Co., Md." Again, on page 27, Mr. Munson says, "I still find there is a mistake in the name of the Comet peach—name is Billieu's Comet." Now, Mr. Editor, I think there is no good to come of having too many names for one fruit. This peach was originally put out by S. G. Bilyeu, of Littleton, N. C., and he named it Bilyeu's Late October. Now I find it under the following names: Billiers' Comet, Billieu's Comet, Bilyeu's Sweet October, and further, it has taken premiums under other names, which can be corrected at another time. Your correspondent says it originated with a Mr. Billiers, of Kent Co., Md. No one of that name ever lived in Kent Co.,—at least fifty years back; this I know of my own knowledge, as I am well acquainted with all the prominent fruit growers of Kent Co. The Peach was found by Mr. Bilyeu in Caroline Co., Md., and has been planted extensively in Kent, Caroline, and Dorchester Co's., Md., and where soil is dry and light loam, or sandy, does finely. As I wished to have the above corroborated by good authority, I wrote Col. E. Wilkins, of Kent Co., Md., calling his attention to the matter, as he planted largely of the Bilyeu's Late October, and from the first lot that was propagated from the original tree. The Colonel planted on different kinds of soil, and I propose to give here an extract from his letter in answer to mine, for such information as he could give in reference to this peach. To save confusion, I am anxious it should have but one name. Col. F. W. writes as follows:

RIVERSIDE, KENT CO., MD., Feb 4th, 1876.

RANDOLPH PETERS, ESQ.:

Dear Sir:—Yours of the 2d inst. received. Some people in Kent Co., Md., as well as the correspondent in the *Gardener's Monthly*, have got things not a little, as you say, but I think a good deal mixed up. I know but one peach called the Comet, the one sent out by Thos. Rivers, a yellow-fleshed peach, ripens with me about with Smock. The peach you allude to is known to me as Bilyeu's Late October, and was propagated by Bilyeu from what he supposed to be a natural tree, which he found in Caroline Co., Md. With the owner's permission he obtained

specimens of the fruit, and secured buds to propagate from the next season, and in due time he planted them on land that he got on shares, both in Caroline and Dorchester Co., Md. I succeeded in getting quite a large lot of him. Several parties propagating peach trees in this county for sale, got buds from me of this peach, and every fellow seems to have thought he had a right to give it a new name. Some of these parties called it Comet. Sherman calls his Sherman's October. Now about the peach. It is not a shy bearer, but sometimes, when most other varieties are full, these will have none on them, but most generally when there is a crop this variety is well loaded. This is not the only peculiarity. I do not know any peach that is so much influenced by soil and situation as the Bilyeu's Late October. When grown upon high, dry, sandy soil of good quality, you obtain a valuable peach for market and for table use. They are large size, fine color and fine flavor, but when grown under other circumstances are small, and inferior in quality. There are only a few spots where I have them planted that suits them. I have sold this fruit after the 20th of October at \$4 per box, when the ruling price during the season for peaches was less than \$2.

Respectfully yours,

EDWARD WILKINS.

### TRAINING GOOSEBERRIES.

RY W. A. HARKETT, DUBUQUE, IOWA.

In your editorial notes for February, I notice an extract from *Florist and Pomologist* in regard to training gooseberries on north side of a wall, and would say that the writer of this has spent many hours training not only gooseberries, but red and white currants, plums, cherries, and pears, near London, England, where it is done to obtain late fruit fresh for the table long after the main crop is over, and economize space on costly walls. Currants and gooseberries were trained as described in *Florist and Pomologist*; pears, horizontally; plums and cherries in the fan-shaped style.

Also in regard to preserving grapes, a little charcoal finely broken is usually put in the bottles to keep water pure, and that chloride of lime is used in the fruit rooms to absorb the moisture evaporated by the fruit, and which may be dried and used over again indefinitely.

## EDITORIAL NOTES.

**PEACH GROWING.**—The Ohio peach growers have a bad time with their peach orchards. In 1869 and 1874 they were ruined by abundance. In '70, '73, and '75 they were ruined by scarcity. So far as abundance is concerned, it ought to be an easy matter to regulate it. Mr. Bateham says full crops exhaust the tree. Why not thin out the fruit? Peach growers generally co-operate in various things. As soon as it is known that a large crop is set, why cannot co-operation reduce the crop to mature by one-half? The trees will be benefited, the fruit will be increased in size and flavor, the prices for fine fruit will be double that of poor fruit, and, better than all, the ruinous abundance would be prevented.

**MEXICAN EVER-BEARING STRAWBERRY.**—A correspondent says: "You seem to have a suspicion of the merits of our seedling fruit, and yet you spoke well of the Mexican ever-bearing strawberry, though it did no good on our grounds." We never saw the strawberry on our correspondent's grounds. We saw it on the grounds of Mr. J. B. Whiting, some miles from Detroit, and everything we said of it was strictly true in every particular. So full was the field of fruit, that the field had a red tint for a long distance away, and we saw a large milk pan filled with fruit by the picker from a space so far as he could reach out around him, without moving his feet away. The strawberry was an *Alpine*, and failed in other places simply because it was planted where nobody would plant an *Alpine* that knew what he was doing. It is the same class of people that failed with the Mexican ever-bearing strawberry who are making plantations of *Eucalyptus globulus* in Maine.

**PEACH RAISING IN MISSISSIPPI.**—Col. W. B. Hillyard has the following account of Gov. Brown's grounds in a recent number of the *Indiana Farmer*:

"Some of the land on Gov. Brown's farm brought over a bale and a half of cotton to the acre, and it had only been 'cow-penned' several years ago. This land is called the 'peach land' of Western Mississippi, as it enjoyed for several years a monopoly in growing that fruit—people supposing that there was some mysterious virtue in the soil, and paying enormous prices comparatively, for it. Here peach growing had, so to speak (its origin as a business on this line of

railroad, and here are the pioneers who, some years ago, derided as visionaries by their neighbors, lived to get incredible prices for their fruit; to have given the impetus to what is going to be one of the most profitable and beneficent industries in the south; and to turn the laugh on their scoffers. Here there are twice as many peach trees planted in bearing as there are on the whole line of railroad, besides, perhaps. It is, in fine, the peach station, and no one need take any risks in buying, for peach raising, or, indeed, any fruit and vegetable adapted to the climate. In this vicinity there is plenty of cane, and cattle will keep beef-fat all winter through, without any other food whatever. The Governor told me that his cane would keep fifty head of cattle fat all winter. He has on his farm over 1,300 acres of land, with miles of fence, a large gin-house, a large number of dwellings, many out-buildings, a magnificent grove of natural growth in the rear of his house, with a considerable growth of the same in the front. Besides, his wife, Mrs. Brown, has a superb collection of flowers, and gardens arranged with all the fondness and care of a most cultivated taste. I judge the buildings could not be put there under ten thousand dollars, and what think you he asks for the plantation? Well, \$12.50 per acre would buy the place, which is about giving one the superb land. The houses could be so divided as to make residences for five or six families, with out-houses, enough left for kitchens, &c.

"I had like to have forgotten to say that there was a peach orchard on the farm in very fine condition once, which might be considerably resuscitated. Opening for a colony. Why would it not be a good plan for some one to undertake to organize a colony there?"

**NEW APPLES.**—As a general rule, we favor no new addition to the two thousand list of apples, unless they are in some respects superior to old ones. But Mr. Chas. Downing, in a recent report to the Fruit Grower's Society of Western New York, speaks so very favorably of some new ones, that we rather reluctantly make a place for an account of some of the best of them in our columns:

*Reeds' Golden Pippin*—received from Thomas J. Pullen, of Hightstown, N. J., who states that it is of unknown origin, is not surpassed in flavor by the Newtown Pippin, and is a late keeper. The tree is vigorous, making a large round head, bearing annually, and setting its fruit evenly

over the tree. Fruit medium, roundish-oblate, golden yellow; flesh yellow, half fine, tender, juicy, mild, rich sub-acid, slightly aromatic; core small.

*Pyle's Red Winter*.—A promising new winter apple, from Wm. C. Burk, Glen Mills, Pa., who states that it was a chance seedling on the farm of B. Pyle, Thornbury township, Pa. Tree vigorous, spreading, an early and abundant bearer of large fair fruit, of excellent quality, and keeping well. The fruit is large, roundish-oblate; skin pale yellow, shaded with light purplish red, and some obscure splashes and stripes of a darker hue; flesh whitish, half fine, crisp, tender, juicy, sprightly, sub-acid.

*Piedmont Pippin*.—Origin on the farm of Jas. Woods, Rockford township, Virginia, and is supposed to be a seedling of the Albemarle, or Yellow Newtown Pippin, and by some regarded as equal to its parent, and in some respects superior. Tree a strong, upright, forky grower, bearing large crops alternate years, ripening the latter part of winter. Fruit large, roundish-oblate, slightly conic, angular, sometimes oblique; skin greenish yellow, flesh whitish yellow, half fine, tender, juicy, mild, rich sub-acid, slightly aromatic.

*Mellinger*.—This originated on the premises now owned by Dr. Mellinger, Manor township, Pa.; and although not a new apple, is but little known out of its locality, where it is esteemed as one of the most valuable and showy apples of its season—October and November. The tree is a healthy, strong grower, with spreading branches, producing large crops alternate years, and a light one the intervening ones. The fruit is medium to large, roundish conical, with stripes and broken splashes of light and dark red nearly over the whole surface—some of the splashes are purplish red; flesh quite white, half fine, tender, juicy, sprightly, sub-acid.

*Smith's Seedling*.—A new Mississippi apple, raised by Hiram Smith, Woodville, Miss., from whom we received specimens, and who informs us that it is one of the best grown in that latitude, and is popular where known, ripening the last of July. Fruit large, oblate, slightly angular; skin pale greenish yellow, flesh whitish yellow, a little coarse, tender, moderately juicy, mild, sub-acid, rather rich, with pleasant flavor.

*Picket*.—This was received from W. M. Samuels, of Clinton, Ky., and originated with Wm. Picket, Arlington, Ky., where it is esteemed a valuable acquisition, keeping as late as the

Winesap. Tree a strong and upright grower, bearing early and abundantly; fruit large, roundish oblate, slightly oblique, flattened at the ends; skin pale yellow, nearly covered with pale purplish red; flesh whitish yellow, a little coarse, half tender, juicy, mild, pleasant, sub-acid, very good.

*McIntosh Red*.—Originated with John McIntosh, Dundela, Ontario, some seventy years since, but is not widely known; the tree is said to be very hardy, long-lived, vigorous, with a spreading head; a good annual bearer of fair, handsome fruit of excellent quality, and valuable for home use and market. Fruit medium or above, roundish oblate, regular; skin smooth, whitish yellow, nearly covered with rich red or crimson, almost purplish in the sun, moderately sprinkled with light dots; stalk rather short, small, cavity medium; calyx closed, basin rather small, slightly plaited; flesh white, fine, very juicy, mild, sub-acid, refreshing, with a peculiar slight quince-like flavor; core medium. November to February.

CLASSIFICATION OF THE APPLE.—If a person is already acquainted with the flower and seed vessels of a cabbage or turnip, and come across a wall-flower or a stockgilly for the first time, he sees at once a similarity of general appearance and analytical characters, that tell him at once almost the page in his botanical manual where he will find it, and learn all about it. This is the result of what is known as the natural system of botany. It takes no one character on which to make a system, but considers all the characters and comes down from that. Before this system came into vogue, Botany was a fearful study. Single characters, or nearly so, made the divisions, and the result was that the most heterogeneous forms were found in company with one another, and as these characters were not constant, the system was of very little use. It was pretty much as though we should take all white flowers, red flowers, and blue flowers, and put them, every color by themselves; or sweet flowers, or inodorous flowers, or spring flowers, or summer flowers, and make separate classes of these. It was not exactly like this, of course, but not far different.

Fruit classification is in about the same straits just now. We name sweet fruits and sour fruits, winter fruits and summer fruits,—long fruits and short fruits,—and the consequence is no one can make anything out of the systems. It is not too

much to say *no one* could take Downing, Thomas, Barry, or any of our best authors, and with a strange fruit before them, certainly fix the name by the description alone; and the only use of these descriptions is to tell us what any thing is not. If a man has a tree which he plants for a Baldwin apple, and when it bears it proves a Rhode Island Greening or a Porter, he will soon find by examining his books that it is not a Baldwin, but he will be extremely acute if he can fix it as Porter or R. I. Greening. He may come so near as to fancy it may be one of these, but not till he finds some one who knows these kinds would he dare to say it was one of them.

We have pointed out often in these columns that some one who makes varieties of fruits a special study, would do a famous thing to arrange fruits as plants are arranged. It only requires to take some fruits as types or centres of the circles, bringing together those that are near like each other, and naming each little circle after some well-known one among them. When some one does this for us, Pomology will be a real science and a pleasure to study it.

In the mean time our pomologists try their hand from time to time with artificial systems. The following is the latest classification of Apples by Dr. Hogg, of the *Journal of Horticulture*, and is perhaps the best of the artificial systems so far:

"The characters which I have adopted as the basis of this classification are the eye, the seed-cells, the calyx-tube, and the stamens. These supply the primary and most important divisions; but they may be extended and broken up into fruit round, roundish, or oblate, and fruit conical, oblong, or ovate, and these for convenience may be further divided into pale, colored, and russet. I will now treat of the leading characters.

1. *The Eye*.—This is the pomological term used to signify what botanists call the sepals or limb, and mouth of the calyx. In French it is called *œil*.

If we examine a great number of varieties of Apples we find that in some the eye is wide open, and the segments quite-reflexed, in some cases so much so as to be quite flat on the surface of the fruit. This is very apparent in Blenheim Pippin, Wyken Pippin, and Court of Wick. In many cases the segments are erect and spreading or reflexed at the tips, and this form of structure also leaves the eye open though not so much so as in the previous examples. Between the spread-

ing and the erect open eye there are many gradations which will be remarked by any observer who examines the different varieties.

The other form is the closed eye. It will be observed in this case that the segments are erect and connivent at the tips, forming a small cone. In some cases of this form of closed eye the tips are spreading; but there is another very distinct form of the closed eye in which the segments are quite flat and convergent, closing in the eye like a trap-door in five divisions, as is seen in Trumpington. These two characters of eye open, and eye closed, I propose to employ as my primary divisions.

2. *The Seed-cells*.—These constitute what is popularly called the core of the Apple, and contain the seeds or pips. They are usually five, but they vary in number, and are occasionally three, four, and even six. They differ very much in structure, and are either open to the axis of the fruit or closed; and between the closed and the wide-open cells there are as many gradations as in the closed and open eye. Some have perfectly closed cells; some have them open, and in others again they are wide open. In the last are to be found all the Codlins, and varieties having the Codlin character.

The seed-cells form the second great divisions of my system, which are distinguished as cells open, and cells closed.

3. *The Calyx-tube*.—In making a longitudinal section of an Apple in a line through the centre of the eye to the stalk a more or less deep cavity will be observed under the segments of the eye and between them and the core. This is called the calyx-tube, or *kelchrohre* of the Germans. It is of very varied form, but all of these are modifications of two, or perhaps three, which may be regarded as distinct, and these I have called the conical and the funnel-shaped. As in the cases of the open and the closed eye and the open and closed cells these run into one another, and there are instances in which it is difficult to distinguish to which of them the individual belongs. In the examples of the conical tube, some are wide and deep, and others narrow and short. The funnel-shaped tube also assumes various forms. The third form is the cup-shaped, which very rarely occurs.

The calyx-tube is the character on which the third division is based, and is divided into calyx-tube conical and calyx-tube funnel-shaped.

4. *The Stamens*.—These are little bristle-like bodies which are found forming a fringe round

the inner surface of the calyx-tube, and it is on the position they occupy that the fourth character of this system is founded. On examining a number of different varieties of Apples it will be seen that the stamens are not always in the same position. Some will form a fringe immediately under or near the base of the segments, and these I call marginal. Others occupy a midway position between the margin and the base, and these are called median; and a third are situated near the base, which are termed basal.

Taking the position of the stamens as my fourth great division, we have,—1, Stamens marginal; 2, Stamens median; and 3, Stamens basal.

To prolong the subdivisions even beyond this point to which we have arrived, we can have,—1, calyx-tube short conical, and deep conical. Then we can have short funnel-shaped, and long funnel-shaped. These may again be further divided into—1, Fruit round, roundish, or oblate; and 2, Fruit conical, oblong, or ovate.

I have already called attention to the changeableness of the characters in some varieties; how in the cases of the eye and the cells some exhibit them open or closed, or intermediate between the two; also in the interchangeable form of the calyx-tube and the positions of the stamens. In my classification I have provided against any confusion arising from this cause, and have given additional references when a variety is to be found in more than one division. For example, in Scarlet Nonpareil the eye is sometimes open and sometimes closed, though the calyx-tube is always short funnel-shaped, and the stamens marginal. This variety is therefore placed in class 1, section 2 (??), and division 1 (†); but to provide for the case of the eye being closed, it is entered thus—"Scarlet Nonpareil iii., ??, †," showing that it is also found in class iii., section 2, and division 1.

It is important that perfect specimens of fruit be used when the classification is applied, and especially that the eyes be perfect; and to observe the calyx-tube correctly, the longitudinal section should be made directly through the centre."

## NEW FRUITS & VEGETABLES.

**PITMASTON DUCHESS PEAR.**—This is the subject of a colored plate in the February *Florist and Pomologist*. As represented, it is narrower than

the ordinary Duchess, and of a peculiarly pleasing orange color. It is a seedling from the Duchess.

**ALEXANDER PEACH.**—Messrs. Silva & Sons, of California, excellent judges of peaches, write that the Alexander ripens with them two weeks earlier than Early Beatrice, and is one-third larger.

**BRIGGS' RED MAY PEACH.**—This is becoming the popular early Peach in California, and is found superior to Early Beatrice.

**THE WEALTHY APPLE TREE**—is a native of Minnesota; raised by Peter M. Gideon, from seed obtained at Bangor, Maine, and planted by him about thirteen years ago; has stood the winters of Minnesota uninjured; as hardy as Siberian Crab; growth thrifty, and good shape; the apple a large red; pleasant tart; late fall and early winter.

Mr. O. F. Brand, of Faribault, Minnesota, says: "The Wealthy is undoubtedly the most valuable tree that has been produced the last half century."

**THE NORMAN STRAWBERRY**—is reported to us by some friends in the West, to be a new seedling of promising character.

## QUERIES.

**STERLING STRAWBERRY.**—Mr. Elliott says: "Your April number has just come to hand, as usual full of practical, as well as scientific matter. I note that I have been quoted as having written a *flattering* notice of the *Sterling Strawberry*. Please, I herewith send you the copy of what I did write, touching that and one or two more Strawberries. I am oft accused of praising varieties, but just here, let me say, the man who can prove that I have favored any one new fruit, without a qualification, or remarks touching its success, has got to look sharp over my notes on fruits.

"*New Strawberries.*—I am indebted to Matthew Crawford, East Cleveland, Cuyahoga Co., O., for samples of seedling strawberries, that are in themselves truly beautiful in form and color, and superior in quality. Of their productiveness I have only to give Mr. Crawford's statement, which is that they equal any other sort. The three best, Mr. Crawford has named, respectively, Mary White, Sterling, and Margaret.

\* \* \* \* \*

"*Sterling*.—This is a berry somewhat after the style of Golden Seeded, or a full colored, well ripened Triomphe de Gand. It is of size of Triomphe de Gand but more uniformly conical or obovate conical; of a rich glossy vermilion red, thickly studded with golden yellow seed on the surface; the flesh is quite firm, of vermilion red, having a white rim around the cone, which is in some, not all, partially hollow; it is rich, sprightly and brisk, but a little acid. The calyx is large. It has all the points of a good and desirable market sort if it prove abundantly productive. The leaf is broad, almost round, with broad yet sharp-cut lobes.

"Mr. Crawford writes me: 'It has taken two first premiums—one for the best seedling, and the other for the best flavored berry.'

"I have no knowledge of who the committee were that gave the premiums. I wrote from the specimens sent me. F. R. Elliott."

THE PEAR SLUG.—"Waverly," Baltimore Co., Md.—"My Pear trees were attacked last June by a slug about a quarter of an inch long, he has a broad flat head, body tapering to a point at the tail. They left my trees in a very unsightly condition. Please let me know in the next number of the *Gardener's Monthly* how to prevent or destroy them."

[*Quick* lime powdered, not slacked lime, will finish them. Have a culinder on a long pole, and sift it over them.—Ed. G. M.]

FRUIT PROSPECTS IN KENTUCKY.—A. N., Breckenridge Co., Ky., under date of March 21st, tells us: "Our early-blooming cherries, peaches and plums were in full bloom two weeks ago, but we have had winter for about one week; freezing nights last week, snow on Friday, and nearly all gone by 12 M. Sunday, and at dusk on Sunday snowing commenced and continued 24 hours, or until a fall of about one foot of snow, and this morning it is cold, and a west wind. Heavy west winds most part of last week. Some farmers have their oats sown and they were up and the frost cut them down. Tobacco plants that were up, or sprouted, were killed by the frost, before the snow of last week. Leaves on the apple trees and cherry trees that were out look black and dried this morning. I enclose you bloom of the pear that you may see how disappointed we are for Bloodgoods, also of leaves of the gooseberry. You can judge how forward our season has been up to the last set-in of winter of last week. The last fall of snow continued for about 24 hours. I fear many of the fruit trees are injured by the condition which the sap was in at the time this cold spell set in."

## FORESTRY.

### COMMUNICATIONS.

#### THE CORK OAK IN WEST VIRGINIA.

BY JOSEPH HARRIS, MOUNDSVILLE, W. VA.

I see by the *Gardener's Monthly* you desire information about the cork oak. I think about 1868 I obtained a can of cork oak acorns through the Patent Office, with the understanding that they came from France.

I planted them and they grew pretty well. I protected them the first winter, after that let them take their chance with a covering of pine branches over them. They were killed a little at the tops. I kept them for three or four winters, but the subsequent winters injured them so much that they died at last.

My place was near St. Clairsville, Belmont Co., Ohio, in latitude about 42°, altitude 495 feet above low water mark, on the Ohio river, the ground a strong limestone. I think this is too far north for the cork oak to grow—that it cannot be protected in the winter on the high lands of this place. I have no doubt from the description given in the *Monthly* that I had the true cork oak.

[Mr. Harris had the true cork oak. It belongs to the evergreen section, none of which flourish where the winters are cold and dry. A good rule for the cork oak is that it will flourish wherever the live oak (*Quercus virens*) flourishes, and no where else to any advantage. It is a tree for the South only.—Ed. G. M.]



## EDITORIAL NOTES.

**TIMBER OF DELAWARE.**—It is very much to be regretted that in the efforts of the various States to display their resources at the Centennial so many of them have lacked the ability to discover those in their midst of whom to take intelligent counsel. Here is a scrap reported to be the Centennial "discovery" for Delaware:

"There are twenty-nine varieties of wood grown in this State, as has been discovered by Colonel H. B. Fiddeman, of the Centennial Commissioners. These are: Chestnut oak, white oak, red oak, black oak, Spanish oak, peach oak, hickory, poplar, sassafras, chestnut, sweet or white gum, yellow gum, black gum, white cedar, red cedar, maple, walnut, wild cherry, yellow or long-leaf pine, spruce, holly, ash, persimmon, dogwood, sycamore, birch, mulberry, locust, and beech. They will all be exhibited at the Centennial."

If such an able botanist as Mr. Wm. N. Canby, Col. Fiddeman's neighbor, had been consulted, he would no doubt have doubled the list to the credit of Delaware, and made no charge we are sure for such able service. We can say of our knowledge of Delaware, thinking merely just as we write, that, besides the trees named, there is the water oak, the post oak, scarlet oak, black jack oak, shingle oak (supposing that by peach oak the willow oak and not this is intended), pin oak, swamp white oak; besides there are several kinds of walnut, ash, hickory, locust, pine, and so on, while the "long-leaf pine" does not grow there at all. The most common pines of Delaware are *Pinus inops*, *P. mitis* and *Pinus rigida*.

**TREE-PLANTING IN MASSACHUSETTS.**—To encourage arboriculture within the State, the Trustees of the Massachusetts Society for Promoting Agriculture have voted to offer prizes to the amount of \$3,000 for plantations of different trees of not less than ten acres in extent, to be awarded in 1887. The white ash is the only native tree for which prizes are offered, as the trustees have in view the advantage of devoting to sylviculture the large tracts of barren waste land now so common in the New England States, and which can only be made profitable and productive by covering them with such trees as the European larch and the Scotch pine, which are well suited to the New England climate, and flourish on the poorest soils and in the most exposed situations.

The trustees have also voted to print 8,000 copies of Mr. Sargent's Essay on Tree Culture, which we have noticed elsewhere, for distribution among the farmers, in the hope that its perusal will excite in them an interest in this branch of agriculture.

This is not the first time that the public are placed under obligation to the managers of this old society. Three quarters of a century ago the Botanic Garden at Cambridge was founded through their liberality, and the increased public usefulness of the same establishment is due to the annual grant made to it from the funds under their control.

**SUB-HARDY EUCALYPTUS.**—An Eucalyptus, supposed to be *E. viminalis*, has been found in a garden at East Lothian, in Scotland, that has been out for thirty years, though somewhat injured in severe winters. This is hardier than *E. globulus*, and we should say might perhaps do out as far north as Southern Virginia. It is well worth the trial.

**DOGWOOD CHARCOAL.**—A correspondent suggests that the writer in the *Scientific American* must mean a Buckthorn (*Rhamnus frangula*), not a Dogwood, and further suggests that this Buckthorn would be well worth planting extensively for gunpowder charcoal.

**ORIGIN OF SERICULTURE.**—Whence came this silk-worm? What is its country and that of the mulberry—for the tree and the animal seem to have always travelled side by side? Every thing seems to indicate that China—Northern China—is its point of departure. Chinese annals establish the existence of industries connected with it from those remote and semi-fabulous times when the emperors of the Celestial Empire had, it is said, the head of a tiger, the body of a dragon, and the horns of cattle. They attribute to the Emperor Fo-Hi, 3,400 years before our era, the merit of employing silk in a musical instrument of his own invention. This date carries us back 5,265 years. They are said to have employed the silk of wild caterpillars, and to have spun a sort of floss. At that time they knew nothing of raising the worm or of winding the cocoon into skeins.

This double industry appears to have arisen 2,650 years before our era, or 4,515 years ago, through the efforts of an empress named Si-ling-Chi. To her is attributed the invention of silk stuffs. You will not be surprised to see that the

fabrication of silks should have a woman as its inventor.

Si-ling-Chi, in creating this industry, which was to be so immensely developed, enriched her country. Her countrymen seem to have understood the extent of the benefit, and to have been not ungrateful. They placed her among their deities, under the name of Sein-Thsan, two words that, according to M. Stanislas Julien, signify the first who raised the silk-worm. And still, in our time, the empresses of China, with their maids-of-honor, on an appointed day, offer solemn sacrifices to Sein-Thsan. They lay aside their brilliant dress, renounce their sewing, their embroidery, and their habitual work, and devote themselves to raising the silk-worm. In their sphere they imitate the Emperor of China, who, on his part, descends once a year from his throne to trace a furrow with the plough.—A. DE QUATREFAGES, in *Popular Science Monthly* for October.

AN ARGUMENT FOR TREE-PLANTING. — MR. Northrop, Secretary for the Connecticut State Board of Education, makes the following patriotic argument for tree-planting :

Tree-planting is fitted to give a lesson of forethought to the juvenile mind. Living solely in the present and for the present, too many youth will sow, only where they can shortly reap. A meager crop, soon in hand, outweighs a golden harvest long in maturing. As short-sightedness is the danger of youth, they should learn that forecasting the future is the condition of wisdom. Arboriculture is a discipline in foresight, for it is always planting for the future and often for the distant future. To do something in this centennial year which may live on in 1976 will be a healthful aspiration to any youth. Washington Irving well says of tree-planting, "There is a grandeur of thought connected with this heroic line of husbandry. It is worthy of liberal and free-born and aspiring men. He who plants an oak looks forward to future ages and plants for posterity, exulting in the idea that the acorn which he has buried in the earth shall grow up into a lofty pile and shall keep on flourishing and increasing and benefiting mankind long after he has ceased to tread his paternal fields." It would be a grand achievement for this centennial year, if a genuine interest in arboriculture can be awakened in all our towns. To this end our pupils should observe all the common trees so as readily to recognize them by any one of the six most distinctive marks. If fit lessons were early

given on the varieties and value, the beauty and grandeur of our majestic trees, our youth could hardly fail to admire and enjoy them, and then to plant and protect them. The planting of one hundred thousand trees by the wayside (and that would be forty thousand less than one for each pupil and teacher) would ultimately make the roads and streets of Connecticut by far the most beautiful in America. If private taste, public spirit, town pride and the sentiment of patriotism to our State could be duly enlisted in connection with the certainty of pecuniary profit and the manifold personal advantage of every citizen, our streets would become bowers of beauty and verdure. Nothing can add so great a charm to our country roads or village streets, as long and magnificent avenues of stately elms and maples, such as may already be seen in many beautiful towns in Connecticut. But there remain some desolate, neglected, repulsive, leafless villages, where taste and trees, and shrubbery, hedges, creeping vines and a park or green, would make the wilderness blossom as the rose.

Among the memories of my boyhood, while under thirteen years of age, no day has recurred with more frequency and satisfaction than that devoted to tree-planting. The maples then set out before the homestead, in Litchfield County, are now beautiful and stately trees. They have paid me a thousandfold for the work they cost, and added new attractions to the cherished spot to which I count it a privilege to make an annual visit. This personal incident is given to suggest how easily our youth may now provide for a like grateful experience.

A single fact out of many which might be given will be enough to illustrate the economic bearings of tree-planting. New Haven owes its beauty and growth largely to the taste, liberality and foresight of James Hillhouse. The Public Green Association, which he organized in 1799, raised and expended a little over \$1,500 for planting elms and grading the Green. One of the donors gave five gallons of rum, then apparently as good as legal-tender. Next to the location of Yale College, nothing has contributed so much to the growth and enrichment of New Haven as its elms. It is celebrated in this and other lands as the City of Elms. Its magnificent avenues of stately trees, surpassing even the famous *Unter den Linden* of Berlin, have enhanced its reputation for taste, beauty and elegance, and thus attracted many wealthy and desirable residents, and greatly increased the taxable value of all the

property in the city. New Haven virtually receives an *annual* income from her elms far greater than their entire original cost.

**RAPID GROWTH OF TIMBER TREES IN MASSACHUSETTS.**—Mr. J. W. Manning says in *Boston Cultivator*:

I will here record my own experience: In 1858, 3-foot trees of Norway spruce and Scotch larch were planted. In 9 years the spruce reached 15 feet in height and spread 12 feet broad, and was then successfully transplanted. The larch in 1872 had reached 30 feet, and had a spread of branches full 20 feet, and a circumference of 4 feet at the base. One larch had attained 40 feet from 5 feet, in 17 years, and this on the dry, sandy loam, that was distinguished for barrenness 20 years ago, so that only a medium crop of rye could be grown once in 5 years. I have grown rock maple trees from the seed on the same sort of land in 6 years to 15 feet high and 2½ inches in diameter. The white maple excels many others in rapid growth. From 6-foot trees, 3 years from seed, planted in the fall of 1864, they now stand 35 feet, and are from 7 to 10 inches in diameter at base. All these are on

naturally poor soil, that has been kept free of weeds and grass. I planted elms in 1856 that were easily carried on my shoulder, and now they stand 30 to 40 feet high, with a girth at base of 6 feet. Rock maples planted in 1855 stand now 30 feet high and 15 inches in diameter. The bass and white ash I then planted have done as well in the race of life. So with such living examples to behold, and as good or better examples in all towns, an enthusiasm could be generated that would shortly line all our streets and country roads with comforting shade. I know of a farm in Lisbon, N. H., Leonard Bowles's, on which were planted, 30 years ago, rock maples on the roadside as far as his land extended, and the result is, that hill on which these trees stand is memorable in the life of the planter. Those trees are distinctly visible from the top of Mount Washington, which is more than 20 miles to the east. It is very strange that more land owners do not appreciate such examples often seen in communities, and plant miles of trees, leaving a growing monument, instead, as is frequently the case, leaving a more desolate aspect to the land than they found.

## NATURAL HISTORY AND SCIENCE.

### COMMUNICATIONS.

#### TREES OF SOUTHERN FLORIDA.

BY DR. GEO. VASEY, WASHINGTON, D. C.

During the months of October and November last, Dr. A. W. Chapman of Apalachicola, Fla., made a journey along the western coast of Florida, examining the Keys and running up several rivers into the interior. The journey was made by schooner for the purpose of obtaining specimens of the trees of that region, for the display of forest trees which is to be made by the Department of Agriculture at the approaching Centennial.

It is pretty well known that the vegetation of Southern Florida is of the West Indian type, and is not found in any other portion of the United States. What knowledge we have of that region is recorded principally in Dr. Chapman's Flora

of the Southern States which was prepared some years ago, and as that region has been little visited by botanists, our information has been little extended since. I made out a list from Dr. Chapman's Flora, of such plants as were recorded as trees, amounting to about forty species.

The result of Dr. Chapman's investigation will best be stated by quoting from his Report. He says:—

“The number collected exceeds your estimate by ten species and falls short of my own by the same number. I believe I obtained all the native trees known down there except *Simaruba*, and perhaps *Calyptanthus*, if it is a tree. I found several trees which I supposed to be shrubs and *vice versa*. I made a thorough exploration of the whole western coast from Anclote Keys to Cape Sable, wherever we could find smooth water for safe anchorage. At Charlotte Harbor I diverged from the coast and

ascended Caloosahatchie river, in order to get such woods as do not grow in the influence of salt air. This was really the most interesting part of the route. Gigantic *Acrostichums* ten feet high covering acres, Epiphytes loading the trees, and the entire vegetation tropical. A peculiarity of these tropical trees is that for miles they occur to you as mere shrubs, when at some other locality you find them lofty trees. I was much disappointed in the size of most of the forest growth in that region. On the Keys you can scarcely anywhere find a large, (or rather a tall) tree. Some of these were large enough at the base, but we generally found such hollow, and of some we never did find a sound one. You will be disappointed, as I was, to find the growth so small. I do not remember to have seen a tree, during the trip, two feet in diameter, with the exception of the live oak, and on the Keys none of them get to be more than thirty or forty feet high. The Mahogany is not found in Florida, and should be erased from the Flora. My authority for introducing it was a pod picked up on the beach by Dr. Leitner. *Hibiscus tiliaceus* was not seen by me, and I think Dr. Blodgett must have got it from cultivation. In Jamaica it is a shrub twelve to fifteen feet high. *Terminalia* is not a native, and is, I believe, local along the St. John's or near St. Augustine. The others mentioned I did not meet with on any of the Keys I visited. Whether they become trees I cannot say, for I forget the sources of my information regarding them when writing my book. It was of course impossible to visit all of the hundreds of Keys along the reefs, and it is probable that these omissions may occur on more westwardly ones than those I visited."

I append Dr. Chapman's list of trees obtained (modifying the arrangement) believing that it will be found very interesting.

*Anona?* (Custard Apple). No flowers or fruit, fifteen to twenty feet high. The fruit is said to be egg-shaped, one and a half inches in diameter, and eatable when fully ripe.

*Capparis Jamaicensis* (Caper tree). A low tree.  
*Canella alba*.

*Guaiacum sanctum* (Lignum Vitæ). Only found, if I am rightly informed, on the "Lignum Vitæ Keys," and quite rare there.

*Xanthoxylum Pterota* (——). 15 to 20 feet high.

*Bursera gummifera* (Gumbo Limbo, Gummer

Limmer). The largest of South Florida trees abounding in gum.

*Amymris Floridana* (Torch-wood). Mostly shrubby.

*Ximenia Americana* (Hog Plum). 2 to 20 feet high.

*Schafferia frutescens?* (Crab-wood). A small tree.

*Sapindus* (White-wood). This is scarcely the tree of the Southern States and of my Flora; I suspect it is *S. saponaria*.

*Hypelate paniculata* (Madeira-wood). This wood is very like Mahogany and is highly valued. It is not abundant and was only found on Metacumba Keys.

*Rhus Metopium* (——). 20 to 30 feet high. It is very poisonous and we all got peppered by it.

*Piscidia Erythrina* (Dog-wood). A rather large tree.

*Pithecolobium Unguis-Cati*. Rarely a small tree.

*Rhizophora Mangle* (Red Mangrove). Commonly a low spreading tree. On the Thousand Islands it attains its largest size, forty to sixty feet. All the low Keys are formed by this tree.

*Conocarpus erecta* (White Button-wood). It comprises almost the only fuel used in Southern Florida, and extends north as far as Anclote Keys.

*Laguncularia racemosa* (Black Button-wood). A small tree everywhere, or a mere shrub except among the thousand Islands and north of Cape Sable, where it forms a large tree.

*Eugenia buxifolia* (Iron-wood). 25 to 30 feet high.

*Eugenia monticola* (——). South Florida, about 20 feet high.

*Eugenia* ——.

*Eugenia* ——, near *dichotoma*, but probably distinct. This was only seen at Caximbus Bay, and was called "Naked Wood."

*Eugenia* —— (Stopper-wood). A small tree, in fr.

*Guttarda Blodgetti*. Mostly a shrub.

*Randia clusiaefolia* (Seven year's Apple), with fl. and fr.

*Sideroxylon pallidum* (Mastic). A middle-sized tree.

*Sideroxylon pallidum*, var. *sphaerocarpum*. A small tree.

*Sideroxylon* ——. A large tree.

*Chrysophyllum microphyllum*. Six to twenty feet high.

*Mimusops Sieberi* (———). A large tree. We found the trunk invariably hollow.

*Bumelia parvifolia* (———). A shrub or small tree.

*Jaquinia armillaris*. A rather small tree with most curiously grained wood.

*Myrsine Floridana*. Mostly a shrub, rarely a small tree.

*Ardisia Pickeringii*. Mostly a shrub, but on the Keys a small tree.

*Citharexylon villosum* (Fiddle-wood). Rarely a small tree.

*Avicennia oblongifolia* (Black Mangrove). Only a tree among the Thousand Islands.

*Avicennia tomentosa* (Black Mangrove). At Cedar Keys only.

*Pisonia obtusata* (———). With male flowers. *Coccoloba Floridana*. 20 to 30 feet high. In fruit.

*Coccoloba uvifera* (Sea-side Grape). In fruit.

*Persea Catesbæi* (———). No flowers or fruit.

*Drypetes crocea* (———). A small tree.

*Ficus aurea* (Wild Fig). A large tree, full of milky juice. It is also called Gum Tree, and the juice forms a kind of India Rubber.

*Ficus* ———. Perhaps the same as the preceding.

. . . . (Silver Palmetto or Silver Cabbage Tree.) The berries are white, but in the absence of flowers the genus is doubtful. It attains a height of 30 to 40 feet. It occurs first at Cape Romano, and is found sparingly on the mainland southward. It is more common on the Keys, but I never heard of it before.

*Yucca aloifolia?* (———). I found this from Manatee southward, 15 to 25 feet high.

*Pinus Clausa*, *N. sp.* At Apalachicola. Dr. Engelmann is doubtful. Perhaps it may be a variety of *P. inops*.

### EDITORIAL NOTES.

**TWIN MUSHROOMS.**—Mr. Worthington Smith figures a twin mushroom in a recent *Gardener's Chronicle*. One with two stems and a single head was exhibited some years ago at a meeting of the Philadelphia Academy of Natural Sciences.

**A NEW AGRICULTURAL GRASS.**—In the Isle of Borbon, they have found a grass—*Reana luxurians*—of which wonderful things are told. Our Southern friends who are just now watching for

some good grasses suited to their soil and climate should look after it.

**OSMUNDIA CINNAMOMEA.**—This is the name of the fern sent by R. P., Indianapolis. "Will Mr. Meehan be kind enough to give the name of the enclosed Fern in the next number of *Monthly*. It grows in this State. Fronds near 2 feet. I send part of barren and fertile fronds.

**MOTION OF TENDRILS.**—Ever since Mr. Darwin's little work, the motion of tendrils has become an interesting study. In *Scientific Farmer* for March, Prof. Penhallow gives some account of observations made on a squash. The tendrils soon after development commence motion—searching for something to cling to. The revolutions continue for two or three days, at no regular rate, when, if no support is found the tendrils die there. Often about the fourth day they will fall to the ground exhausted, and, after a few hours start up again, make a few more revolutions and fall back again. It will often do this several times before giving up finally. How much these act like animated things!

**OZONE.**—This element is considered a purifier of the atmosphere. Where there is a deficiency there is disease. A Dr. Mantogazza of Pavia, finds that odoriferous flowers throw off ozone largely on exposure to the sun, and therefore this is the great mission of odor in leaves and flowers. It is at any rate a new argument for flower culture in cities.

**GROWTH OF PLANTS AS AFFECTED BY LATITUDE.**—A Prof. Hoffman states that from numerous observations in Central Europe, he may conclude that as an average, one degree of latitude is equal to 3¼ days in the development of plants, especially in their spring blossoming. That spring advances at the rate of 3¼ days for every seventy miles may be true, but it is not true as to the direction of the degrees of latitude on the map.

**CAUSE AND EFFECT.**—How difficult it is to trace the relations between cause and effect is frequently illustrated by everyday occurrences. A chemical factory started in England in the vicinity of a market garden where leeks were a staple crop. The same season the leeks failed disastrously, and of course the factory was associated in everybody's mind with the fact, and a suit against the factory resulted. Fortunately in this case, science saved a rank injustice from being perpetrated. It was shown that the leeks were

suffering from the attacks of a small fungus—the *Uredo alliorum* or onion rust,—with which the factory had nothing whatever to do.

PRONUNCIATION OF BOTANICAL NAMES.—We have had several inquiries lately about this matter. Unless one is very well versed in the ancient languages, it is best not to look for any “rules,” but go at once to authorities. In regard to our native plants, Dr. Gray’s Manual gives the pronunciation, and Loudon’s *Encyclopædia* most of those in general cultivation. The matter has excited the same attention in England recently as in our own pages. We give from the *Gardener’s Chronicle* the following extract from its correspondence:—

“I note the remarks of your correspondents, ‘W. P.’ (p. 179), and ‘Ebor’ (p. 212). I had not forgotten to mention how the correct pronunciation of names is to be decided; there was no need for me to mention it. Obviously it is to be decided in the same way that correct spelling is decided at a spelling bee—so far, that is, as pronunciation can be communicated through the medium of the eye; namely, by reference to some great and recognized dictionary. In England, for pronunciation, we have Loudon’s *Encyclopædia of Plants*, published in 1829, a supplement following in 1840, and a second supplement in 1855. This massive and manifold book—contained, I should suppose, in all good reference libraries—has 3,337 generic names, and describes considerably over 21,000 species of flowering plants and Cryptogamia. Every name, both generic and specific, is accented, and though, possibly enough, there may be typographical mistakes, after making allowance for these it may be depended upon implicitly. I think it will be found that the typographical errors are all or mostly corrected in the general index to the whole work. Individual botanists, erudite scholars, may, perhaps, find an accent here and there which they would dispute; just as at a spelling bee there are differences of opinion, even among the best informed, in regard to the orthography of certain exceptional words of doubtful etymology, upon which nobody can pretend to insist. But over 999 out of every 1,000 accentuations in Loudon all scholars and authors are willingly agreed upon—those, I mean, who abide by the system of pronunciation observed in England at the present day. Foreigners would probably object to a good many; with that we have nothing to do, in the absence

of an absolute, immaculate, and unimpeachable standard of right and wrong, such as we can never hope to possess. For all the everyday and really useful purposes that a pronouncing bee would care to promote, we may reasonably be content with Loudon, and be glad of it. I thought that every one who took the slightest interest in botanical nomenclature and pronunciation would be perfectly well aware of the existence of Loudon’s *Encyclopædia*, or I should have mentioned it in my little article. That article, in some of its utterances, as all would see, was half playful. It was half playfully that I suggested the pronouncing bee, never supposing that any one would seriously set one on foot, though if anybody would take the trouble there can be no doubt that it would render good service. I proposed it, not for the learned, but for the sake of the scores of people who do not know how to pronounce ordinary and accustomed names; those, for example, who say *Podophyllum* and *Tragopogon*. Just as the spelling bee, in the eyes of all sensible and practical people, is not got up to decide on the orthography of—

‘Spermagoraiolekitholakapotides,

Words that should only be said upon holidays  
When we have nothing else to do.’

—but to show young men and young ladies the importance, if they would pass for ‘educated,’ of correctly spelling *Fuchsia*, *aeronaut*, *acquiescence*, and the rest of the common words in which so many at the bees fail miserably, so the pronouncing bee would address itself to *Epacris*, *Polypogon*, and the like.”

## QUERIES.

POISON-VINE.—(*Rhus toxicodendron*).—J. H. C., writes: “Be it known after all that has been written on the remedy for this poison, that hot water is a speedy and certain cure. Let it be applied as hot as can be endured without blistering—*probatum est*.”

ROCKY MOUNTAIN SILVER SPRUCE.—Mr. Siler, Osmer, near Ranch P. O. Utah Territory, writes: “In the *Gardener’s Monthly and Horticulturist* for January, current year, on page 25, I find a question in regard to the Silver Spruce of the Rocky Mountains. I am not able to answer H’s question as to the name, but with due respect, I

would differ with the Editor's suppositions that the Silver Fir is either *Abies Menziesii* or *A. Engelmanni*. It is neither, it is in appearance distinct, resembling more the *Abies concolor*, for which I have often mistaken it before I became well acquainted with both trees. The Silver Fir grows only in one location that I have found in Kane county, and that is very near the east line, at the head of Peter's Cup Creek, at the east foot of the Pine Valley mountains.

"The 'well-known writer' quoted in the article above referred to, gives so good a description of the Silver Fir that I will not attempt to describe the tree, only saying that the tree grows 60 to 80 feet high, with long, straight, horizontal branches, and cone shaped. I have never found this species in fruit, but I will watch more closely for cones than I have done before and if I find them, you shall have a share of them.

"I am led to believe that the Silver Fir is *Abies grandis*, Lindl., but in this I may be mistaken as I have not had an opportunity of seeing the trees growing together, and as I remarked before, I have not seen the Silver Fir in fruit."

[The "well-known writer" will have enough of his attempt to give a well-known tree a new common name before he gets through. Mr. Siler however, does not distinguish between a "Fir" and a *Spruce*. His tree is quite likely to be *Abies grandis* which has a silvery stem, and is readily distinguished by this alone in Colorado, as it keeps this silvery character to quite old age. *Abies concolor*, also growing in the Rocky Mountains however, has the same character, and is probably but a form of the same species.—Ed. G. M.]

VERBENA RUST.—R. P., Indianapolis, Ind., writes: "Since I have been a reader of the *Monthly* I don't recollect to have seen anything about the fungus known as Verbena Rust. Is there no remedy for it? I planted out over thirty varieties of verbenas last spring; we had a very wet summer; rust attacked them, and I lost the whole lot. I procured seed and sowed early this spring; when the plants had formed the second pair of leaves I could see traces of rust. Where did that rust come from? From the soil, the atmosphere, or did it inherit it from the parent? I had nothing in the house affected with it, as I throw away every plant as soon as I can see a trace of it. I have talked with some of the florists here about it, but they differ as widely as the poles; and what says the Editor of the *Monthly*?"

[The Verbena Rust is a fungus, a very bad fellow. What particular kind it is, or its general history, has not been worked up yet to our knowledge, but we will try and put some of our mycologists on the track as soon as we can get some good specimens.—Ed. G. M.]

FERTILIZATION OF CLOVER.—A. T. L., Whitehall, Mich., writes: "A Swede in my employ is quite an expert pianist, reads music readily at sight, even if it is quite difficult, etc. After a twelve months practice at odd tunes I 'fiddle' my violin with surprisingly moderate ability; in other words what he sees at a glance I have to look twice to discover, but I love anything in the shape of music so well that almost every evening I coax him over to the house and we get at it,—result, difficulty on my part to get him to play the 'Old Hundred,' 'Hail Columbia,' and 'Star Spangled Banner,' pieces that I am trying to learn, and desire on his part to go rambling and scrambling up among the sharps, flats and minors of some opera that I can't understand at all yet. Now, as yours is the only horticultural monthly, I want to urge you not to forget the 'old hundred' readers who have neither the learning, ability nor opportunity to profit by the horticultural 'operas' which to you older heads seem so simple.

"About the idea you advance in connection with the persimmon sport mentioned by E. C. in April number. I do not believe that it is a difference in the substance, chemically considered, with which the clover plant feeds itself at the first and second blossoming which makes the difference in the amount and perfectness of the blossoms and seeds, but the operations of the well known law of nature that whenever a plant is checked in its growth it at once puts forth an effort to perfect its seeds to perpetuate its kind. Where the first crop is cut this cause obtains; if it is not, and the plant dies down of its own accord, the new plant springing up, as it does, from a partially exhausted root, and generally under the check of a dry soil, produces the conditions requisite to make a 'case,' as the lawyers term it, under the 'aforesaid' law. How much the blighting influence of the hot mid-summer sun affects the flower, as it does too early sown buckwheat, I do not know, but some I suspect."

[Such suggestions as these are always welcome. The musical illustration is a happy one, for the opera has the same meaning to all when all understand it, and our correspondent has only said

in another form, what was said in our last number in another way. It has been the object of the writer of this, to show that different phases of growth force, depending on different powers of nutrition, affect a plant's ability to fertilize itself; and further, to suggest that much of what is written by some botanists about the plant's abhorrence of self-fertilization, proves no such abhorrence, but is to be referred to these vary-

ing phases of growth force. While a plant is growing vigorously it has little to spare for waste or reproduction. As the growth force declines, the reproductive force increases. In the reproductive condition there are still degrees of force, the highest conditions resulting in the female and the lower in the male flowers. This is our interpretation of growth, and accords with the observations of our correspondent.—Ed. G. M.]

## LITERATURE, TRAVELS & PERSONAL NOTES.

### EDITORIAL NOTES.

LETTER FROM THE LATE HON. J. C. CALHOUN OF SOUTH CAROLINA.—We present to our readers a letter, never before published, from John C. Calhoun, of South Carolina, to Col. George Gibbs, of New York, an enthusiastic horticulturist and disseminator of the grape, fifty years ago.

WASHINGTON, March 29th, 1824.

DEAR SIR:—I received your box of cuttings in excellent order, and will give the several varieties a fair trial of our soil and climate.

I am delighted with the growing attention to the vine, and look forward with confidence to the period when we shall add wine to our staple commodities, to the great improvement of our health and morals. Is the vine cultivated in China? No two countries occupy positions on the globe so nearly the same as ours and China; and the climate of the two accordingly is almost in every respect the same. I feel confident that all of the fruits and productions of China would flourish in corresponding latitudes of our country, and that without going through the process of being *acclimated*. Our climate and that of Europe, on the contrary, is in every respect the opposite as the positions which we occupy on the globe. There are certain powerful causes, rising out of the relation which a country has to the ocean that greatly affect its climate. All over the globe countries lying on the eastern and western shores of the ocean, or even of deep and extensive lakes, will be found to have very different climates in the same latitude. The west-

ern coast of our continent is as warm as Europe, and as moist too, in the same latitude.

With great regard, I am, &c.,

J. C. CALHOUN.

COL. GEORGE GIBBS.

OUR EARLY BOTANISTS.—Letter of Dr. Muhlenberg. (Copy of original in Library of Academy of Natural Sciences, Philadelphia).

LANCASTER, Oct. 29, 1814.

Dear Sir:—Your letter of the 20th of October arrived safe and gave me much pleasure. Probably Mr. Michaux's letter will contain some news of what we can expect from him in a future day on American *Shrubs*. He has deserved well of trees: will the English translation appear as promised and can you not persuade him to add a few *Synonyma*? At least his father's *Synonyma* should be added, *Tilia*, *Nyssa* and a few others are still doubtful.

After examining the *Prunus pygmæa* of Willdenow's Specimen I have no doubt he means our Long Island Beach Plum. My son mentions they have two varieties on the New York market: the small one agrees entirely with *pygmæa*, the larger one is hardly more than a variety; can this be the *maritima* Willdenow? I have put both in my garden, but shall hardly live to see the difference. As *P. sphaerocarpa* Mich. must change its name the former name can remain for *maritima* or *pygmæa*.

The *Prunus cerasifera*,—Willd, I have seen several years without knowing it. It is not our common wild yellow and red Plum, the *Americana*, Marshall, although the description of Ehrhart agrees very well. It is a round, red Plum with a compress drup—"caule biorgeali, ramis



glabris foliis ovatis utrinque acutes *obtusè* serratis venenis basi subglandulosis floribus odoratis solitariis." It stands in Mr. Matlack's (now Gundacker's) garden at Lancaster. Mr. Matlack had it by the name of *South Sea Plum* grafted. I have no doubt it is a North American Plum, and wish to hear more of its native place. Mr. W. Hamilton thought he knew it. Will you favor me with your opinion. At Baltimore they have another wild Plum on market which was named to me *Mountain Plum*, but the specimen sent to me was not different from the P. Chicasaw Mx. The P. acuminata and hyemale Mx. are still uncertain to me. If I could get a sight of P. nigra Bot. Mag. 1117, I would be much pleased.

Of Mr. Bigelow I have heard nothing since, nor of Mr. Green, nor of my Southern friends Elliott and Baldwin. The mournful news of the departure of Lyons, I have mentioned to Mr. Elliott.

If Mr. Correa returns by the way of Lancaster I shall be extremely glad to see him, and if I could then persuade him to take charge of my Catalogue with a few specimens to Messrs. Person and Beauvois or a few seeds for Thouin I would be much pleased.

Forgive me that I trouble you so often with my trifling letters and let me hear very often that you are in good health. I remain with great esteem, Sir, your sincere Friend

HENRY MÜHLENBERG.

I enclose a specimen of P. cerasifera (Willd.) from Gundacker's formerly Matlack's Garden.

To Zaccheus Collins, Esq., Philadelphia.

[The letters of those identified with the early history of botany and horticulture in our country are extremely interesting. We find in the above that there was as much trouble about the native Plum among the early botanists, as among the fruit growers of the present day. John Lyon was an English nurseryman of much intelligence, and greatly esteemed by the botanists of Pennsylvania. In July, 1814, he left Philadelphia on a long journey of exploration for seeds and plants into Virginia and over the mountains into Tennessee, thence into North Carolina. The journey, which was performed on horse-back, was very arduous. He was taken ill in Tennessee, and died at Ashville, N. C., early in September. The other names mentioned in the letter are all well known in the history of botanical science, and one of them (Dr. Bigelow) still survives.—Ed.]

"RINCATON," INDIANA.—We have before said in these pages that there is no place of the above name in Indiana. Those who address "James Ford, Princeton, Ind.," any other way, throw away both time, paper, printing, and "stamps," besides annoying our good friend Ford, who must hate to see advertising agents make dunces of themselves.

COMMON NAMES OF PLANTS.—If one is really convinced that "language was given to man for the purpose of concealing his thoughts," he would no doubt commence to exercise that faculty on giving common names to plants. For instance, a friend called our attention to the "shrubby trefoil," lately (*Ptelea trifoliata*). He was "corrected" and told it was not a trefoil, but the "Hop tree." Our young friend was confident he was right,—so we turned to the Botanical authorities and under "trefoils" found nothing but clovers, trifoliums—trefoils. He was discomfited, and we pitied his annoyance,—but shortly he pointed out the place right in that book, where *Ptelea* was also a "trefoil." Now if *Ptelea* is to be a "trefoil," and *Trifolium* a "trefoil," we must submit to the popular dictum,—but really we should prefer the hard names to such a mixing, if the dear people will only let us.

TO THE "MANOR BORN."—A correspondent using Shakespeare's expression, "to the manner born," was made by the proof-reader to say "manor." The proof-reader has many authorities for this, and is excusable. But we sympathize with our correspondent, when we say "poets are born not made"—we mean that they are born in that manner,—and this is clearly what Shakespeare meant. To the manner born,—that is born in that manner—a manner natural to one.

BOX IN WASHINGTON'S GARDEN.—The box edgings in the garden of Washington at Mount Vernon are still in a healthy condition, though over one hundred years old. They are well kept and cared for. The estate was named Mount Vernon by Washington, out of respect to Admiral Vernon, a distinguished officer, who commanded the West India squadron of the English fleet.

EXPLORATIONS IN JAPAN.—The Flora of Japan is so remarkably well adapted to the Atlantic portion of the United States, that we feel a particular interest in a paper kindly communicated to us by Mr. Louis Bohmer, an excellent gar-

dener and botanist. The exploration of the Island was ordered by General Horace Capron, who is chief agricultural adviser to the Emperor of Japan, and the document we publish is in the nature of a report addressed to him.

POSTAL LAWS on seeds and plants.—We warned our friends that unless they exerted themselves much more than we expected they would, the express companies would hold all the advantage they had gained, and the rates would not be lowered. Now, as we write, it looks as if they are to be *increased*—not only is the obnoxious one cent per oz. rate to be continued,—but for “over 1000 miles 2 cents.”

ARTIFICIAL HEAT IN HORTICULTURE.—We may form some idea of the rapid progress in horticultural buildings from the fact that one hundred and fifty years ago, even dwellings in England had not begun to be artificially heated.

THE FIRST ENGLISH NURSERY.—The earliest nursery worthy of the name of which we have any record seems to have been that of London & Wise, founded in 1684.

MR. CHARLES DARWIN.—This distinguished naturalist was born with the coming in of the century, and has recently passed his 76th birthday.

MISCELLANEOUS PUBLICATIONS.—We have received Helmick's Counterfeit Note Detector, Dreer's Garden Calendar, Long Bros.' Illustrations, Home Florist, Briggs Bros.' "Tomato Race" and Catalogue, Bull's New Plants, Annual Report of the Chicago Bot. Garden, by Prof. Babcock, showing good progress, Manual of Co-operation, by Hon. Thos D. Worrall of Louisville, Ky.

THE LANGUAGE OF FLOWERS, and floral conversation, by "Uncle Charlie." From James Vick, Rochester. This is gotten out in a small beautifully bound volume three inches square,—and will make a very attractive article on any lady's parlor table.

FIRST BOOK OF ZOOLOGY.—By Prof. Ed. G. Morse. We have only a notice from Messrs. Appleton that they are publishing a book as above—we have not seen it,—but can say from what we know of Prof. Morse's knowledge of the subject, and abilities as a teacher, that no man in America is capable of giving us a better book on this subject.

THE SHEPHERD'S MANUAL.—A practical treatise on sheep, by Henry Stewart, New York, Orange

Judd & Co. This little manual takes into consideration everything connected with sheep management, and must be a useful helper to the class for whom it is intended. A very interesting chapter is that devoted to the anatomy and diseases of sheep. Referring to the favorite food of sheep, Mr. Stewart notices that they are particularly fond of those worthless weeds, the ox-eye daisy, and the yarrow. He speaks of the "bunch grass" of the plains, as *Festuca*, "scabrella," and as being something different from the ordinary sheep *Fescue*, *Festuca ovina*. Only that we note the remarkable accuracy of the botanical references—remarkable for works of this character we should be disposed to query this. As it is, we presume it may be as Mr. Stewart says.

THE AMERICAN LAWN.—By Thos. McClunie, Landscape Gardener, Hartford, Conn. This is an excellent essay, by one who is a master of his art. It can probably be obtained from the author.

FOREST CULTURE IN MINNESOTA.—Published by The State Forestry Association. Nothing shows more the growing attention given to forestry than the increase in the number of essays and papers like unto this, which is an address by Leonard B. Hodges. As is well known, we do not agree with much of the abstract theory thrown round forestry, and which Mr. Hodges adopts in common with so many others. But on the practical points, as developed by undoubted facts and figures, there can be no difference, and the publication of the address will on this account alone be of great value.

AN EGG FARM.—By H. H. Stoddard, published by Orange Judd & Co., New York. From J. B. Lippincott & Co., Philadelphia. This small paper covered work, tells what it is by its comprehensive title. The management of fowls for their eggs chiefly. It is cheap and useful,—two excellent qualities in these times.

MANUAL OF SMALL FRUITS.—Mr. E. P. Roe tells us in a letter that he has issued a small work under the above title, and that he has "read the advanced sheets to Charles Downing." All such works are valuable, as fruit culture is continually progressing, and there is, or ought to be, something new in all new books of this kind.

PHONETIC MAGAZINE: a monthly magazine, edited by W. Geo. Waring, Tyrone, Pa. Shorthand writing, and the many interests involved in his department of literature, command general

attention; and we are quite sure that horticulturists especially, who value this department of study, will welcome this serial conducted, as it is, by one of their number, and one who is so widely known and respected as Mr. Waring is.

THE BOSTON CULTIVATOR.—In a recent issue we find the following:

"The Gardener's Monthly and Horticulturist, an excellent journal, in giving the condensation of an article of ours, credits it thus indefinitely—'A Boston paper gives the following,' etc. There are several papers published in Boston; hence it might not be easy for the reader to determine which one was referred to."

We did not know this was an original contribution to the columns of our good neighbor, or should certainly have given it credit. We supposed it to be made up from some Boston daily. The moral obligation to "credit" is confined to

"exchange" ethics we believe,—though it is our custom to credit for information, even if we pay for it the full subscription price.

FARMER'S HOME JOURNAL.—Mr. W. Duncan, well known in past times as a contributor to the *Garden*, *Gardener's Chronicle*, and *Gardener's Monthly*,—and who, for some time past, has been editing the *Farmer's Home Journal* of Louisville, is now part proprietor as well as editor of this excellent weekly agricultural paper.

REVEU DE L'HORTICULTURE BELGE.—This new Belgian venture, which we have before noticed, appears to have been quite successful. The first number of the second volume, now before us, starts with a beautiful colored plate of some new Chrysanthemums. Those of our readers who understand French, and love flowers, will find it a good thing to subscribe to. It is published at Ghent, for one franc a number.

## HORTICULTURAL SOCIETIES.

### COMMUNICATIONS.

#### SOUTH-EASTERN KANSAS HORTICULTURAL SOCIETY.

BY H. E. VAN DEMAN.

Although this society was organized one year ago it has not yet been reported to the readers of the *Monthly*.

We are not asleep in this corner of the vineyard, but in our weakness and ignorance are striving to cultivate the field lying in this corner of Kansas. Indeed we think that we have a very fruitful field too.

On the 26th and 27th of January, 1876, there was a meeting of this Society, at Chanute, Neosho Co. It was its first annual meeting. The exercises consisted of reports of the officers and standing committees; reading and discussion of essays; adoption of fruit list for the district, and election of officers, together with other and smaller matters.

Any one who undertakes the organization of such a society, except the people are first thoroughly awake to its need, will find it an uphill business. Great credit is due Mr. D. B.

Skeeles, of Galesburg, and Capt. G. W. Ashby, of Chanute, in particular for their untiring energy in carrying this nurseling Society through its early life. These gentlemen have acted as President and Secretary with energy and patience.

President Gale and Secretary Braskett of the State Horticultural Society, have lent their aid also, and now we hope to proceed to active life-work. After an essay by Capt. Ashby upon Flower Culture, there was some discussion which resulted in making plain the fact that tender flowers may be protected *at once* by planting hemp or castor beans, or both. To the settler upon the prairie, this is a matter of necessity if he or she would grow flowers where not a tree or a bush stands to oppose the sweep of the winds. What we need is a protection or wind-break available the first year, and until something more substantial can be grown: One of the best exercises of the meeting was a lecture or black-board talk, by Prof. Knox, of Baker University, on the Elementary Principles of Vegetable Growth. Plain, practical, easily understood lessons, like this one, are the kind that take root in the mind.

Dr. Bailey, of Chanute, offered a resolution declaring "That fruit culture in Kansas had

been, and always would be a failure." This brought to their feet many persons of experience and observation, who denied the declaration of the resolution, and gave positive testimony against it. This sort of shells is the kind to rouse the sleepers and provoke discussion and elicit facts. We are glad it was offered, and indeed it was presented to bring out facts. Although the mover bravely stood his ground, it was lost in a vote with only one on the affirmative. Another fact demonstrated was, that apple and pear trees trained with high heads, or rather with tall trunks, are badly sun-scalded on the south-west side. They must be headed very low in this climate—say 1 to 2 feet above ground and the trunks kept protected by the shade of the branches. Also plant with an inclination to the south-west.

The officers elected for the present year are, President, H. E. Van Deman, Geneva; Vice-President, W. W. Tipton, Burlington; Secretary, G. W. Ashby, Chanute; Treasurer, M. Bailey, Chanute; Directors, A. Shinn, Ft. Scott; H. A. B. Cook, Blue Mound; and Frank Bacon, Chanute.

During both evening sessions we were delighted and cheered by songs from a select company of singers, belonging to the city of Chanute, accompanied by the music of the cabinet organ. We think this accompaniment of music a decided help to a horticultural gathering, and indeed a most lawful outgrowth of the spirit, we, as a society, strive to awaken. Let others copy. There was no show of fruits, for it was not expected by the members who might have brought them. Then there are very few specimens to exhibit this year, and more especially in this newly settled section of Kansas. There are, however, a very few orchards now nearly twenty years old.

Of house-plants we had a small, but handsome display from the window-gardens of Chanute. The next meeting will be held in Burlington, Coffey Co., in the month of October, 1876.

#### NORTHERN IOWA HORTICULTURAL SOCIETY.

BY X.

We had a very pleasant, and I trust profitable, meeting of the Northern Illinois Horticultural Society, at Crystal Lake, Ill., the last week in January. Although the place of meeting did not suit many who reside near the west and

south border of the district—it being on the extreme northern line—yet we had an increased attendance, with more interest manifested than at any meeting of the Society I have attended in the past five years. Most of the veterans were there, and some new faces, who were gladly welcomed to our ranks. Notably absent, and occasioning universal regret, were Douglass, Edwards and McAfee. The papers presented were of more than ordinary interest. One by Tyler McWhorter, on Landscape Gardening, illustrated by drawings, was remarkable for its clear perception of beauty combined with utility in arranging ordinary farm dwellings and grounds. This paper deserves a much wider dissemination than it will receive in the State Reports.

Mr. Cochrane, of Blue Island, near Chicago, gave us an interesting familiar talk on orchids, their habits, treatment, &c., and the influence of flowers in home life. The great attention shown to his remarks, and applause at times, demonstrated the growing interest in all classes of a higher estimation of floriculture. By a vote of the Society he will at our next annual meeting continue the subject and illustrate his subject with specimen plants of this unique and beautiful family. Steps were taken to have an arbor day appointed for the State, and every exertion will be made to make the Centennial year celebrated by a wonderful increase in the number of trees planted. Delegates were in attendance from Indiana, Wisconsin, Iowa, and other States. The next meeting was appointed at Franklin Grove, Ill. Much interest was manifested by other towns to secure the meeting, but a few things turned the scale in favor of the Grove. First, A. R. Whitney is one of the most active horticulturists we have, always lending his time and means to the various Societies in the North-west, and so modest that up to this time he has never asked or received a favor. Second, we all want to see the elder Whitney once more. He is now in his 84th year, yet stands erect, and will walk his mile as fast as even his grand-children. It being Centennial year both of the Whitneys are set down for speeches. Your *Monthly* being our organ in the West as much as it is in the East, we feel a little like demanding your presence next winter. Please come and see what rapid strides we are making in horticulture. The West has passed the pioneer age, and a taste for the beautiful is rapidly developing. At the Crystal Lake meeting, it was decided to hold a convention of nur-

serymen, Florists and Seedsmen in Chicago, on the second Wednesday of June next. It being on the route of our friends from all sections of the West and South-west many will stop at such a meeting on their way to the Centennial. This meeting cannot fail to result in great benefit to our trade. We extend to all the Nurserymen, Florists and Seedsmen of the East a cordial welcome to be present.

### EDITORIAL NOTES.

**THE GREAT CENTENNIAL.**—Our papers are full of what is to be at the great Centennial, which is to open on the middle of the present month, and continue all summer. We wait till we see what comes, before saying anything, except that the promise of a great exhibition is very good indeed. At the time of our writing, a shipment of Rhododendrons from Waterer, of England, had arrived, but much too soon for our climate, and so are temporarily under a wooden shed. Mr. Buist has a few evergreens deposited, but the season is hardly safe. We expect to have our note-book busy for our next number.

**STATED DISPLAYS.**—At the Centennial the following Stated Displays, under their respective dates, will be held during the International Exhibition. Applications for entry may be now made, on forms which will be supplied by the Chief of Agricultural Bureau:

Pomological Products and Vegetables, May 16th to 24th. Strawberries, June 7th to 15th. Early Grass Butter and Cheese, June 13th to 17th. Early Summer Vegetables, June 20th to 24th. Honey, June 20th to 24th. Raspberries and Blackberries, July 3d to 8th. Southern Pomological Products, July 18th to 22d. Melons, August 22d to 26th. Peaches, September 4th to 9th. Northern Pomological Products, September 11th to 16th. Autumn Vegetables, September 19th to 23d. Cereals, September 25th to 30th. Potatoes and Feeding Roots, October 2d to 7th. Autumn Butter and Cheese, October 17th to 21st. Nuts, October 23d to November 1st. Autumn Honey and Wax, October 23d to November 1st.

**DR. WARDER.**—Among the pleasantest incidents of the Centennial, we anticipate the universal meeting of friends. Among the first to come in on Centennial business we had the pleasure of meeting Dr. Warder, of Ohio, re-

cently. His numerous friends will be glad to know that he seems in excellent health.

### FRUITS AND LODGING AT THE CENTENNIAL.—

ASHEVILLE, N. C., March 21st, 1876.

Thos. Meehan.—Dear Sir: I take the liberty of troubling you a moment (as hundreds are doubtless doing at this time), with reference to space for exhibition at the Centennial. A letter from Prof. W. C. Kerr, Geologist of this State, in whose charge was placed the exhibition of North Carolina products, mechanism, &c., at the Centennial, informs me that there will not likely be any representation in this way from this State, for the reason that there are no funds raised for that purpose, and none will likely be raised. I, therefore, as an individual, without representing any one but myself, ask information as to how I may place on exhibition 100 varieties of apples next October 1st? My section of the State (the mountain country), is, in my opinion, the finest apple section of the Union, and although but little attention has been given the subject, I am anxious to show the world what we can do in this way, and that, too, off old and neglected trees, and from hands uneducated in the business. Will you put me on the right track? And if I get under headway, bound for the exhibition, will you aid me in getting a cheap but comfortable place of lodging for a few weeks? Any documents explaining everything connected with the Fair will be thankfully received.

[We have many letters like this. Burnet Landreth, Chief of the Agricultural Bureau of the Centennial, has charge of the fruit. They will be on exhibition, we believe, during any time people choose to send them, but there will be special shows for special fruits, all of which can be learned by application to Mr. Landreth.

Letters in regard to boarding are so numerous that we thought best to ask the Centennial Board. There is abundance of room for all, but the difficulty would be to a stranger, where to find the places. Arrangements are made by all the railroad companies with boarding houses, and when the visitor comes to Philadelphia, he will have no more trouble than with his baggage. Boarding tickets will be sold by an authorized agent.

But many people will like to know of these arrangements before they start. The Centennial Commission, in answer to our inquiry, referred us to Sydney, Smirke & Co., 3829 Lancaster avenue, Philadelphia, who publish a complete "guide to visitors" in regard to hotels, boarding

houses, horse-cars, and so forth, and which they mail to any one for 20 cents.

INTERNATIONAL EXHIBITION.—

BUREAU OF AGRICULTURE,  
PHILADELPHIA, March 28th, 1876. }

Sir:—The Centennial Commission are erecting a special annex for the exhibition of fruits; the dimensions of the structure, situated on the east of the Agricultural building, and connected with it by a covered way, are one hundred and eighty by two hundred feet, affording room for the display of eight thousand dishes of fruit at periods of special displays. Although the exhibition of pomological products will extend over the entire term of the exhibition, affording most marked manifestation of the wide range of our soils and climates, still there will be certain periods especially designated for the display of particular fruits, which have special seasons, under the influences that more immediately pertain to the States near to Pennsylvania, and which from their proximity to the point of display, will afford the material for large and expressive exhibits.

The periods decided upon for these special displays are as follows, though any of the fruits enumerated will be received for exhibition either preceding or subsequent to these dates:

Pomological Products, May 16th to 24th. Strawberries, June 7th to 15th. Raspberries and Blackberries, July 3d to 8th. Southern Pomological Products, 18th to 22d. Melons, August 22d to 26th. Peaches, September 4th to 9th. Northern Pomological Products, 11th to 16th. Nuts, October 23d to November 1st.

The Pomological annex will also be used for the exhibition of vegetables continuously, and at the stated dates of June 20th to 24th for early summer vegetables; September 19th to 23d for autumn vegetables; and October 2d to 7th for potatoes and feeding roots.

Tables and dishes for both fruits and vegetables will be furnished by the Commission free of charge, producers being simply requested to pay the charges for transportation.

You are respectfully requested to advance the display of fruits and vegetables as much as possible both at terms of stated displays and at all intermediate dates.

Yours respectfully,  
BURNET LANDRETH,  
Chief of Bureau of Agriculture.  
per C. HENRY RONEY.

STRAWBERRIES AT THE CENTENNIAL.—Arrangements are made to have fruits on exhibition at

all times, whenever people send them, but special exhibitions will be held at various times. The great Strawberry show will commence on the 7th of June.

MARYLAND HORTICULTURAL SOCIETY.—*Orchids*.—At the March monthly meeting, Captain Snow exhibited twenty species of orchids in flower.

ATTRactions AT HORTICULTURAL SOCIETIES.—We are apt to complain that so many of our horticultural societies have to introduce music and various other outside attractions in order to make horticultural exhibitions popular enough to pay expenses,—and we are often told they do things differently in England. But the *Gardener's Chronicle* tells us it is the same there as here. The real floral exhibition, it says, is thrust into the background,—expensive bands are engaged, athletic sports, sensational performances, pyrotechnic displays, and so forth. The general public, it thinks, are not attracted by the mere love of floral cultivation. The time was when the remarkable heaths, Pelargoniums, and other things like this really attracted thousands, but it seems there, as well as here, there has been too much sameness, and people have tired.

ROYAL HORTICULTURAL SOCIETY OF LONDON.—Mr. Thos. Andrew Knight suggested it. It was founded—its first meeting—March 7th, 1804. April 2, 1805, Mr. Knight read the first paper, followed by one May 7th, by Sir Joseph Banks, on the introduction of the potato. It was chartered April 7th, 1809, with Earl of Dartmouth, President. In 1811 Mr. Knight became President, which he held till his death, in 1838. The published transactions commenced in 1812. In 1815 it commenced the practice of sending plant collectors abroad by sending Reeves to China. He sent the first *Wistaria Chinensis*, *Spiræa Reevesia*, and other things. Mr. Geo. Don was sent to the west coast of Africa; David Douglas to North America, and McRae to the Sandwich Islands. In 1840 Hartweg was sent to Gautemela, and, 1842, Fortune to China. After Mr. Knight's death, the Duke of Devonshire became President in 1838, dying in 1858, and succeeded by Prince Albert, since whose death the Society has declined, till now it is becoming a question whether it has not fulfilled its mission. It has done an immense work in making horticulture what it is in England. It made the splendid horticultural press of that country a necessity, and now the very existence of that press enables the horticulturist to do without the society.

THE  
GARDENER'S MONTHLY  
AND  
HORTICULTURIST.

DEVOTED TO HORTICULTURE, ARBORICULTURE AND RURAL AFFAIRS.

Edited by THOMAS MEEHAN.

VOLUME XVIII.

JUNE, 1876.

NUMBER 210.

FLOWER GARDEN AND PLEASURE GROUND.

SEASONABLE HINTS.

A lady says, "The first thing I always read in the *Gardener's Monthly* is the 'seasonable hints.' The rest of the Magazine seems just the thing for those who are already advanced, and who must keep pace with the progress of horticulture. The hints suit us beginners, and encourage us to follow after those who know more. Now please tell us in your next how we babies in floriculture, as it were, can propagate roses. Some easy and cheap rule; for most of us have no hot-beds or hot-tanks as the florists have." One of the most successful rose raisers that we ever knew, was the late Charles J. Wistar, of Germantown. He took half ripe wood of roses, and rose wood is half ripe just about the time the flowers are fading,—and he would put them in pots of sand,—the sand full to the brim, and even rounded. These pots were set on his garden walk—a gravel walk—in the open boiling sun—and well watered every day,—we are not sure but they had water several times a day—for the good old man spent the most of his old days in his garden,—and, if we are not mistaken, they had saucers of water under them besides. At any rate every cutting always grew;—and we can imagine nothing more simple, or suited to the wants of "floral babies."

And, speaking of roses, we may add that towards the end of June propagation by budding commences. This is very commonly employed with the rose; but ornamental trees and shrubs

may be increased in the same way. Closely allied species must be chosen to work together.

The Prairie Roses have been found excellent stocks. Other roses take well on them, and they do not sucker much. It is old, very hardy, and it promises to be a very popular stock for rare roses.

The Rose bugs are apt to be very annoying at some seasons. The best remedy is to shake them off into a pail of water. The Rose slug is often very injurious to the leaves—completely skeletonizing them. All kinds of rapid remedies have been proposed—whale oil, soap, petroleum, &c., but the best thing of all is to set a boy to crush them by finger and thumb. It is astonishing how rapidly they are destroyed by this process. This is true of most of the larger insects. Hand picking or crushing is by far the best remedy.

Peg down Roses where a heavy mass of flowers is desired. The side shoots push more freely for this treatment.

Cut off the flowers of roses as they fade,—the second crop will be much better for the attention. Seeds of all flowering plants should be also taken off; all this assists the duration of the blooming season.

Propagation by layering may be performed any time when strong vigorous growing shoots can be had. Any plant can be propagated by layers. Many can be readily propagated no other way. Cut a notch on the upper side of the shoot, not below, as all the books recommend, and bend down into, and cover with rich soil.

In a few weeks they root, and can be removed from their parents. Stakes for plants should be charred at the ends before using, when they will last for years.

Flower-beds should be hoed and raked, as soon as the ground dries after a rain. Loose surface soil prevents the under stratum drying out. Peg down bedding-plants where practicable. Split twigs make the best pegs. In dry weather do not water flower-beds often; but do it thoroughly when it is done. See that the water does not run off, but into and through the soil.

### COMMUNICATIONS.

#### THE GLORIES OF GARDENING; OR, "THE GOODLINESS OF TREES."

BY W. T. HARDING, COLUMBUS, OHIO.

"'Twas when the world was in its prime,  
When the fresh stars had just begun  
Their race of glory, and young Time  
Told his first birthdays by the sun;"

And THE BOOK informs us that soon after creation's early dawn, Beneficent Providence gave to the man the care of a garden, and lovingly enjoined him "to dress and keep it." Assuredly, then the charge was of grave importance. It was designed as a labor of love, conducive to happiness of the purest kind. Although "summer and winter, spring-time and harvest" have come and gone many thousands of times since then, we naturally opine, it is so, even now. Thus, it is recorded of the first created of our race, that to fully enjoy the blessings of life, he was to dress, and keep a garden. And his first pursuit was Horticulture.

The good gardener, of those days, was not only the first of men, but the most honored of mortals. And while he faithfully followed that ancient occupation, manifested the highest state of civilization the world has ever seen. Alas! poor man, his circumstances changed; and like many of his unfortunate successors, now-a-days, was wearied with labor, and saddened with toil, while earning his bread by the sweat of his brow. Notwithstanding the old Gardener's misfortunes in after life, it is to his credit recorded that he began well, and no doubt did much good work in his better days. He not only conducted the first operations in that model of a goodly garden, but when he ceased from his labors therein, happily bequeathed to posterity an

enduring and appreciative taste for the gentle art he loved so well. The legacy he left us has found claimants in all civilized communities and countries, from that remote age until now.

Richard Hooker, good soul! was a "fine old English gentleman:" one of the Elizabethan worthies, who, with a delicacy of feeling, penned many a prosy and pleasant line. He was, moreover, a philosopher of the highest attainments. In the quaint language of those days, he sagely remarks, "that the goodliness of trees, when we behold them, delighteth the eye." The happy aphorism, so well expressed, unmistakably proves that the "one touch of nature" had left an impression on his kindly heart, such as we can feel.

The good folks who peruse the '*Monthly*,' will unanimously admit that trees, viewed either as ornamental or useful, whether "pleasant to the sight or good for food," are always objects of much interest, and are valued accordingly. I have ever cherished a love for them, and during an extensive practice, have planted many thousands; numbers of which are vigorous and hale green trees, most beautiful to behold. I will venture to say, no man living has passed happier hours than the writer, beneath the sylvan shades of the primeval forest,—the cultivated copses,—and park lands,—or, where more thinly scattered over the plains.

If circumstances permitted, how pleasantly time would pass while picturing woodland Elysiums, and referring the reader to arboreal scenes in other lands,—delightful spots,

"Studded with old sturdy trees,  
That bent not to the roughest breeze."

How marvellous their structure, and dissimilarity of habit, and contrast in form. For example, see the slender light Bamboo, the massive Oak, the mighty Sequoia, peculiar Kauri, magnificent Palm, sombre Cypress, beautiful Araucaria, wonderful Banyan, grand Magnolia, ponderous Eucalyptus, graceful Willow, strange Sterculia, elegant Cedrus, dapper little Spruce, Abies pygmæa, mammoth Baobab, and curious Mangrove. Without further allusions to them at present, I will endeavor to draw the reader's attention to matters at home; and as it is presumed they intend to plant something, let us enter the garden together, and see what can be done.

Let us hope when planting trees, cultivating fruits and flowers, or otherwise adorning the



landscape, no one does so for mere ostentation, or outward show, but simply for the love of doing a good and proper thing. It is well for us, "the pomp and vanities of this wicked world." do not often, if ever, appear in the guise of gardening. Its purpose is to refine and elevate society; and as that is its aim and end, there can be nothing meretricious, sordid, or spurious about it. Then by all means plant and sow. Improve the surroundings, and make home attractive, without and within; and then it will, in every sense, be the happiest spot on this side "the land o' the leal." And when the heart enjoys the scenes so charming, Hooker's truism will be fully realized, and we shall then feel that "the goodness of trees, when we behold them, delighteth the eye."

In the suggestions I offer, it occurs to me that fruit trees might be more generally used on, or about the lawn or shrubberies. If judiciously done, the effect would be equal to, if not superior, to many things often seen there. Why not plant a clump of dwarf Pears, another of Quinces and Plums? With here, a group of Peach, Almond, Nectarine, or Apricots. And there, a grove of Apples, belt of Cherries, or border of Gooseberries, or Currants, red, white and black. The same of Figs, and Pomegranates, where the climate is favorable; as it is in California, and most of the Southern States. The Guava, Orange, Lemon, Loquat and Olive, also flourish there. In less favored spots they may be wintered safely in cellars; and when danger of frost is over, brought out and planted.

If there is sufficient space, the various kinds of nut trees will be found useful. Their form and foliage will materially assist in preserving the general characteristic features of landscape gardening. Omitting the Hickory, with the exception of the Pecan, I would propose the European Walnut, which is a handsome spreading tree, and bears excellent fruit. There are some dwarf kinds very prolific and of good quality. They are proper trees, either to group or isolate. The same may be said of the Chinquapin, or dwarf Chestnut, and the Hazle-nut, or, what is still better, the Filbert.

The Sweet Chestnut is a noble tree of rapid growth, both ornamental and fruitful, and should not be forgotten. Neither should the Mulberry be passed by. Than this handsome tree there is nothing better deserves a place on the lawn or elsewhere. The Persimmon must not be overlooked. When quite ripe, it is really a palatable

and wholesome fruit. Some people may perhaps have a taste for Papaws, and Passion-vine fruit, and Prickly Pears. If so, set some out, by all means.

On neat trellises, verandas, stakes and arbors, Blackberries and Grape-vines may be trained. Or the latter may be left in suitable places to wander at will over large trees, and the rich ripe clusters of fruit will give additional charms to the leafy festoons.

Raspberries, Barberries, Huckleberries, Blueberries, Cranberries, and Bilberries, will be found very useful; in fact, indispensable, in the arrangement of an ornamental fruit garden. On account of their shrubby nature, some of which make beautiful bushes, they are well adapted for low clumps and clusters, or, to margin groups of larger growth.

The last, though not the least luscious in the list, is the Strawberry. Beds or borders of them may be planted on the lawn; and if alternated with Tigridias, Gladiolus, or Tuberoses, they will be quite as attractive, and much more useful than a bed of Potentillas.

Make the garden gay with flowers. Let the Rose, Heliotrope, Salvia, Ageratum, Mignonette, Verbena, Violet, Geranium, Petunia, Pink, Pyrethrum, and such like pretty things, have proper places; as they should in all good gardens grow.

Fancy the charm of spring bulbs, whose colors "blend like the rainbow that hangs in the skies," blooming at our feet, and sweet blossoms bursting above us; what an Eden it would be! While meandering among "trees loaded with beauty and promise," we should feel as happy as the old "Gardener Adam," and his good wife did, before they barely escaped being choked with bad fruit, *the meanest trash* of apple kind.\*

And as "the golden hours on angels' wings," go gently by, and bring on sunny summer days, unveiling fresh beauties, and diffusing exquisite perfumes, while unfolding fair flowers, how much like "Paradise Regained," it would seem! And as "Flora" gracefully surrenders her loving care of the glories of spring time and summer, in favor of "Pomona;" the foretaste of

\* By consulting such Pomological guides as Downing, Barry, Elliott, Warder, or Thomas, the reader will run no risk of getting to the wrong tree, when he wants a good apple: such as befell the first tasting committee, at the Primal Pomological Society—long ago. They are all reliable gentlemen, and would not offer or recommend a worthless fruit to anybody, if they know it. That assertion I can vouch for.

bliss we enjoyed with the former, will be fully realized with the latter, in the rich profusion of mellow autumn's ripe offerings.

From the opening of the first blossom buds in early spring, to the ripening of the first fruit of the season, the enjoyment will augment with each coming day, until the last languishing flower sheds its fragrance and fades away. But the joys of the garden will not be all gone by, nor will they even cease, when wintry blasts draw us round the cheery fire, to discuss the merits of the remaining mellow apples or juicy pears; and crack the last nuts that are left us.

### DAHIA MAXIMILLIANA.

BY MR. E. LONSDALE, GERMANTOWN, PHILA.

Respecting *Dahlia Maximilliana*, noticed amongst "New Plants" in the *Monthly* for March, Mr. Haeltel, foreman to John Rock, Esq., Nurseryman, &c., San Jose, Cal., writes me as follows:—

"Last summer Mr. Roezl brought with him from Mexico a species of *Dahlia* under the above name, which he described as being a *tree* *Dahlia*. Mr. Rock procured plants of it. They were dormant. The roots differ from the old species, being less tuberous. They were potted and placed in a greenhouse, where they soon commenced to grow. The young shoots appearing from the old wood. In due time they were planted in the open ground. By Fall some of them had attained a height of about 6 feet, when they were lifted and potted and again placed in the greenhouse where they have continued to flower the whole winter. The flowers are single, of a deep lilac color."

This may interest some of the readers of the *Monthly*.

### BEAUTIFUL SHRUBS OF S. UTAH.

BY A. L. SILER.

*Shephardia rotundifolia*, Parry, presents to the beholder, on first sight, so bright and silvery an appearance, that it is with persons of taste the universal exclamation—oh, how beautiful, how much like silver! The leaves of this shrub are covered with short soft hairs that give it its silvery appearance; they are very thick and round in shape; the flowers are small and inconspicuous, being of a dull yellow; and the female

flowers, which are borne on separate plants, are almost apetalous; but the greatest beauty about this plant is its flower buds, which are full sized in December, although it does not flower until early spring. The buds are about an eighth of an inch round on the male, oblong on the female plants. These buds are truly, to all appearance, little balls of silver; the fruit, which ripens in June and July, is about  $\frac{1}{2}$ -inch long by  $\frac{1}{4}$ -inch wide, and is covered with stinging hairs, which, when examined under the glass, look like stars. This shrub is an evergreen. Another nice shrub for rocks and rock-work, as it will grow in any crevice of a rock where it can hide its root, is *Cercocarpus intricatus*, Parry. Is an evergreen, and grows only about a foot high. It is often seen growing several hundred feet up the face of a sand-stone ledge, where, if it has soil at all, it must be only the least particle.

### HARDINESS OF ARALIA PAPYRIFERA.

BY C. W. S., HULMEVILLE, BUCKS CO., PA.

I wrote you about this time last year asking if *Aralia Papyrifera* was hardy. You replied that it was doubtful and I took mine up. Sometime in September, of this year, I found a fine young plant growing in the spot from whence I had removed the old plant, evidently coming from a piece of root left in the ground. Had remained dormant almost a year, and had survived one of the severest winters we have had for many years. I think, with a little rough litter thrown round it, the *Aralia* could be left out all winter.

### WHO SHALL LAY OUT OUR ORNAMENTAL GROUNDS?

BY B. S. OLMSTEAD, LANDSCAPE GARDENER, RYE, NEW YORK.

From time to time, during the last one or two years, allusions have been made in the horticultural magazines to the employment of civil engineers in the laying out of our public parks and other ornamental grounds. It has been claimed that this work should be done by gardeners, and by gardeners only.

Now I have not the least doubt that a good gardener, because he is a good gardener, is better qualified to plant a tree and make it grow, than a civil engineer, because he is a civil engineer;

neither would I hesitate for one moment to aver that a clever gardener is also better qualified to make a good lawn, arrange a parterre of flowers, prune trees and shrubs—some engineers whom I know would make sad work of this—and to do a hundred things among the almost numberless operations which a *landscape gardener* is called upon to perform.

But on the other hand are there not some things for the engineer to do? Some things which he, from the very nature of his training, is better fitted to perform than any gardener as a gardener can possibly be? Does the education and training of a gardener—I am speaking now of good gardeners—better prepare him to locate and construct a drive, form a terrace, build a wall, arrange a system of drainage, than a well educated and experienced engineer? Why, my dear Mr. Editor, I have known a gardener, than whom there was none superior in his line of work, to try persistently to make water run up hill, at the expense of both the money and patience of his employer. I have known others to utter wise prophecies—wise in their own eyes—concerning the alleged instability of certain work done under the supervising care of a competent engineer; work which stands to-day, after a good many years of trial, proving how very *unwise* those prophecies were. As I write, I have in mind a place not many miles away, which was possessed of great capabilities, and which might have been made one of the most beautiful seats this side of England; but which, if not utterly spoiled, was at least shorn of a large share of its natural beauty, and its great capabilities were frittered away by the “lay out” of one who was thoroughly competent in all the work of a gardener, from the management of the orchid house, down to the operations of the potato patch.

And again, I have known men who were thoroughly conversant, both in theory and practice, with all the abstruse problems of railroad building, who were never so happy as when an obstinate skew arch called for their best powers, who were competent to plan and build the East River Bridge, and they would have built it too, before this, if they could have had their way about it; but who were no more fitted to design a plan of ornamental grounds than—well, than some of the gardeners I have known. And to their credit be it said, none knew this as well as they did.

Hence, I claim that it does not follow that

*because a man is a clever gardener he must of necessity be a competent Landscape Gardener, any more than because he is a skillful civil engineer. Sometimes, in my journeyings, I have had the suspicion thrust upon me by the wording of signs, and cards, and circulars, that some of these men, of both classes, perhaps, in their honest and laudable ambition to become landscape gardeners, were actually ashamed of the term gardener. They had themselves printed and called landscape architects, landscape engineers, rural architects, artists in grounds, etc., etc.; anything but landscape gardeners.*

And here, by way of parenthesis. Let us stick to that good old name, landscape gardener, worn and honored and elevated by Repton, Loudon, Kemp, Downing, Daniels, Bauman, Copeland, and some living men who are not ashamed of it.

But to return. Suppose we combine the two professions. Putting aside all jealousies, suppose we try the experiment of training, for the future adornment of our common country, a race of men who shall be both well educated, and well trained gardeners and engineers; to say nothing now of other more artistic qualifications. Is there anything inconsistent in this idea? *Cannot* one man be *both*? It seems as thoughtless to say “No” to these queries as it would be to assert that an architect is not a skillful architect, because he knows all about carpentry, and painting, and stone cutting, and plastering, and masonry; or, to insist that, because a merchant is well versed in the law of contracts, therefore, he cannot be a prosperous merchant. One of the most successful clergymen I ever knew was educated as a lawyer, and he used to say that what little success he might have had in the management of the affairs of his parish, and his friends know that it was anything but little, was due, in a large measure, to his legal training. Of course it is not practicable that all clergymen should first be bred as lawyers; and yet, if it were so, perhaps it would be no detriment. The thought I would emphasize by these illustrations is this: *A landscape gardener cannot be too well educated.* There is no danger of his knowing too much. Let him be chemist, botanist, farmer, gardener, architect, engineer, artist, it will not impair his usefulness. He will have need of all he knows, and with it all, he will find himself wanting; or if he does not, others will.

Landscape gardening with us Americans is in its infancy. It is where architecture was twenty or thirty years ago. Not only the artist, but those

who employ him, ought to be educated up to a higher level. The relation of lawyer to client, physician to patient, clergyman to parishioner is well understood and obeyed. The engineer and the architect have their recognized place, and even the land-surveyor, whose processes and methods can be learned in a year, can assert his right to control his work, and be heeded; but the position of the landscape gardener is wherever the caprice or whim of the hour may place him. His employers often have their own notions about the laying out of grounds, and it is right that they should have them, as they would have of what is lawful, or healthful, or righteous; and the wise landscape gardener will note and incorporate them into his own designs whenever he can do so in justice to his client and himself. But, "shall I not do what I will with mine own," is too often the exponent of the treatment both he and his work is destined to receive. All who have ever practiced the profession have suffered in this way. Repton wrote, "Of many hundred plans, digested with care, thought, and attention, few were ever so carried into execution, that I could be pleased with my own works." Loudon complains of the nurseryman and jobbing gardener pretending to improve the plan of the landscape gardener, "and having, by dint of perseverance and talking got the ear of his employer, the latter is prevailed on, for quiet's sake, to yield to the proposed alterations, and to admit trees and shrubs in such quantities as, in some cases, entirely to destroy the effect which the landscape gardener intended to produce."

But this opens too wide a field for the close of an article. Suffice it now to say, that the only way through the consequent embarrassments and discouragements, which at times weigh so heavily upon those men who have dedicated their lives to the work of adorning the homes of our beautiful land, seems to be such thorough education and training, as shall enable them to command such respect and confidence from those who would avail themselves of their professional aid, as will secure to their advice and plans that deference which is now paid to the opinions of men who are in what are called the "learned professions." This process must, of necessity, be slow. "Taste, as it is called, is so universal that every one sets up as a connoisseur." In England this confidence is better established, but it has taken nearly a hundred years to secure it. Let us hope that our next Centennial will find that our calling has taken

its place where it belongs, among those "learned professions."

[We commend this excellent article to the attention of our readers. After all, the same trouble occurs in all professions; there are plenty of architects, lawyers, doctors, and what not that are mere botches in their professions,—and yet "get along" very often better than the most deserving. In our profession the only remedy is to educate people as to what good gardening is,—and then educate landscape gardeners to supply the cultivated taste. Even then the educated and talented landscape gardener must have business tact to make his abilities known, and able to "keep that knowledge before the people."—Ed. G. M.]

### EDITORIAL NOTES.

THE POMEGRANATE.—The *Home Journal* of New Orleans, tells us: "The pomegranate is one of the most profitable fruits grown. The trees bear fruit in three years from the cuttings, and will grow on the most ordinary soils without irrigation. The pomegranate is a delicious fruit, and possesses medicinal qualities of great value. It will bear shipment better than any other fruit. It may be barreled up and sent around the globe in good order."

The pomegranate is nearly hardy so far north as Philadelphia, and is easily preserved in cellars. The one usually grown is double, and does not fruit. The single one, however, is often seen in northern gardens, and the fruit will often perfect.

CHIMONANTHUS FRAGRANS.—The *Petersburg Messenger*, noticing a bouquet sent by Mr. Bryant of that city in the depth of winter, refers to this remarkably interesting shrub, and it moves us to repeat what we have before said, that it is astonishing so sweet a thing should be so little known. The buds, cut off and put in water, will expand in a warm room and fill it with fragrance.

FESTUCA VIRIDIS FOR EDGINGS.—"This pretty herbaceous grass is recommended for edgings, and I can fully endorse all that is said in its favor for that purpose, as I have employed it in that way, and find it most valuable. It is very dwarf, not exceeding 4 inches in height, and is dark green in color. Small pieces of it, put in a line about 2 inches apart, early in the spring, will expand and form a compact line by the autumn, and if not required to be lifted may

remain for several years. Early in the summer it throws up flower-stalks, and if they are at once cut off with a pair of shears there will be no more growth to need trimming until the next year. I believe it to be quite as ornamental as box, and it neither entails as much labor to keep it neat, nor is it so liable to get out of order as this much used edging plant."

In addition to what the *Garden* says above, we may add, that it is entirely hardy in our climate, and may be made to do good service in our ornamental gardening.

**THE ORIGINAL GOLDEN YEW.**—The original plant of the Golden Yew is in the Royal Botanic Gardens, at Glasnevin, and a remarkably good specimen it is. It is known to have existed there from about the beginning of the present century, and it need hardly be added that vast numbers were propagated from it both in Dr. Moore's time and in that of his predecessors.—*R. in Record.*

**A GOOD TEA ROSE FOR MARKET PURPOSES.**—"I was told the other day" says a correspondent of the *Garden*, "that from one dark apricot-colored Tea Rose Madame Falcot, worked on a standard briar stock, out-of doors, roses had been cut every year to the value of between 30s. or 40s. a year. It is evident, therefore, that this is a useful rose for furnishing cut bloom for market."

**QUERCUS FASTIGIATA.**—The *Gardeners' Chronicle* says: "According to M. Petzold, in the *Deutschen Reichsanzeiger*, the original tree of the upright oak, *Quercus Robur fastigiata*, near the village of Haareshausen, by Aschaffenburg, is 100 feet high, 3 feet 4 inches in diameter breast high, and about 280 years old. The first branches are given off at about 30 feet from the ground. The first descendant of this fine tree adorns the grounds of Wilhelmschohe, near Cassel. It stands near the castle, and is 92 feet high, and a foot less in diameter than the parent tree. The age of this specimen is estimated at 90 years, and it is a very vigorous, healthy tree, branched to the bottom, so that it may be expected to exceed the parent tree in height and size as it does already in beauty.

---

## NEW PLANTS.

---

**PERAPHYLLUM RAMOSISSIMUM.**—Mr. Siler says: "While writing upon the vegetation of Southern Utah it will probably be interesting to you for

me to notice a few other plants that are either new or but little known.

"*Peraphyllum ramosissimum*, a low growing shrub with its masses of white and sometimes pink flowers, and waxy fruit in July, is probably the handsomest flowering shrub in Utah. The fruit, like the flowers, differ very much in appearance. Those plants that produce white flowers yield white waxy fruit; while those producing pink flowers have fruit with bright flesh colored skin and a beautiful red cheek. This shrub is perfectly hardy, growing usually on clay soils and in the driest localities. It is destined to become a favorite shrub for hedges in all northern localities."

**VICTORIA MIGNONETTE.**—New mignonettes continue to be introduced, but to the general observer do not appear very different from old sorts. The *Victoria* is now said to be the best.

---

## QUERIES.

---

**PROLIFEROUS HYACINTH.**—Mr. Dreer hands us the following from a correspondent:—"I have sent you by express one or two clusters of flowers from the hyacinth I named to you. The clusters grow something as shown in sketch. I have never seen anything like this form of hyacinth before. I shall keep the bulb."

[Each single flower produces numerous small ones. Proliferous flowers are not rare. The geranium, and others, often have these proliferous flowers. We never saw it in the hyacinth before, and if the bulb continues to reproduce this peculiarity, it would be a good addition to garden curiosities.—Ed. G. M.]

**LIME FLOORS.**—E. S. M., Amherst, Virginia, asks: "Can you give me the *modus operandi* for making the lime floor for cellars mentioned in the February number of the *Gardener's Monthly*. By so doing you will greatly oblige."

[It must be remembered that though it is a lime floor it must not be a mortar floor. Lime, as mortar, crystalizes and is then too brittle for good floors. The lime for floors is "drawn," as plasterers say,—that is, it is dissolved in water, not merely slacked as the masons do. Mortar dries very rapidly, but when drawn through water lime takes a long time to harden. The drawn lime must be rolled heavily to make a good hard stone-like floor.—Ed. G. M.]

# GREEN HOUSE AND HOUSE GARDENING.

## COMMUNICATIONS.

### CULTURE OF COMBRETUM.

BY MR. ALEX. MESTON, ANDOVER, MASS.

Having been successful in flowering some of this genus, a few remarks may be of interest to some who grow it. *C. grandiflorum*, which J. B. asks about, is one I never had anything to do with, and which I believe is a shrub, also *nanum*; all the others being climbers.

One in particular of the climbers I consider well worthy of cultivation—it is *C. atropurpureum*. This ought to have a pocket built for it and planted out, allowing it to run up a pillar or rafter; fill the pocket with a compost of sandy peat and loam, one part of the former to two of the latter, adding a little sand. Planted in this it will make very vigorous growth, which ought to be well exposed to the sun, so as to ripen the wood well before winter. Give plenty of water when growing, and use the syringe freely, as red spider is a great enemy, and the mealy bug delights to sport amongst the leaves. As the wood ripens in the Fall, give less water, but never allow it to get dry at the root, as it is an evergreen. When growth commences in spring, the branched panicles of reddish purple flowers will begin to show themselves, and by May will be gorgeous. It often flowers twice a year.

[A correspondent some months ago made inquiry about the culture of these beautiful plants, and we are therefore especially obliged to Mr. Meston for his contribution.—Ed. G. M.]

## EDITORIAL NOTES.

THE AUSTRALIAN OR PARLOR IVY.—Under the names of Parlor Ivy, Australian Ivy, and German Ivy, *Senecio scandens* is now very well known to

our readers. A new species, *Senecio macroglossum*, has been recently introduced, and the *Gardener's Magazine* introduces it to its readers as "Australian Ivy."

PINKS FOR SUMMER FLOWERING.—The whole family of *Dianthus*, and its neighbors *Armeria* and *Silene*, which includes Indian Pinks, carnations, "Ragged Robins," and so forth, are among the best of border plants in our climate for early summer flowering, making capital stuff to cut from. A correspondent of the *Journal of Horticulture* refers to a little known kind in the following paragraph:

Growers for this purpose will do well to note the large-flowered Thrift, *Armeria alpina grandiflora*, as one of the most useful and effective of hardy red-blooming plants to cut from all through the month of June. The plant is strong and robust, and should not be used for edgings, but ought to be planted well in beds or in long lines, as the flower-stems are from nine to ten inches in height, are stiff and straight and carry heads as large as the flowers of the White Pink. The plant increases rapidly in size during the summer, and thrives better in drought than in moisture; it is increased by pulling the roots to pieces in the autumn, when every piece will soon get established and start into growth. This Thrift blooms simultaneously with the *White Pink* and autumn-sown plants of the *Blue Corn cockle*. Immediately following this is that beautiful rosy-red Pink *Lord Lyon*, a fine double smooth-edged kind that is a most attractive flower and delicately perfumed. I look upon this as one of the very best pinks ever raised, as amongst the varieties of this useful flower light colors so largely predominate. It is quite as free as the old white kind, but a little later; is perfectly hardy, and propagates freely from pipings. It should find a place in the herbaceous border of every garden.

CARBOLIC ACID FOR HOUSE PLANTS.—Several of my nice geraniums began to look sickly, and upon examination I found little worms at the roots. I applied a solution of weak carbolic acid

quite freely to the earth, and found it restored the plants to health and beauty in a very short time. It will also kill lice upon the stalks, if applied with a swab or feather to the plants, without injuring the foliage.—*Country Gentleman*.

**IVY AS A DECORATIVE PLANT.**—Gardeners are beginning to appreciate more fully than they used to do the value of Ivy for a variety of purposes. Connoisseurs, too, have begun to collect, study and classify the many varieties. Mr. Shirley Hibberd has written one of the most pleasant and valuable garden monographs concerning them. Town squares are largely decorated with them, a practice we borrowed in great measure from our French neighbors, and one we hope to see extended and improved upon, as few plants do better in confined spaces and dirty atmosphere than the free-growing sorts of Ivies; in fact, the Ivy is a most accommodating plant, as our French friends have discovered. We give an illustration of a movable tent, or sun-shade, formed of Ivy, and which we copy from a recent number of the *Revue Horticole*. Patience and time are required to make such a veritable "umbrella" as this. It was exhibited at the Paris exhibition of 1867, and has now a straight, clean stem more than 6 feet in height. The spread of the branches, if fully extended, would be about 10 metres (between 32 and 33 feet), but they are trained in an arching manner so as to leave an opening about 7 metres (about 23 feet) in diameter. The branches are well furnished with leaves, and, as the plant is grown in a tub, it can be removed from place to place, as may be required, and may be made to serve as a most agreeable summer-house. The facility of transport is still further increased by the fact that the branches are trained over wires which can be folded up umbrella-fashion.

The plant is now in the possession of M. Rousset, landscape gardener, 16 Chaussee du Maine, Paris, but we are not informed to whose patient skill we are indebted for this work of art. It is obvious that our decorators might take many a hint from this *tour de force*.—*Gar. Chronicle*.

**HOW TO DYE MOSSES, GRASSES, FLOWERS, &c.**—It may interest some of our readers to know how the Germans dye grasses, &c., in a great variety of unnatural colors; but we have our hopes that few people will follow them in the use of blue moss and other equally tasteless artificial

productions. The following notes are from the *Neueste Erfahrungen und Erfindungen*.

**To Dye Moss.**—Green: Boil  $\frac{1}{2}$  lb. of alum in 4 quarts of water, and dissolve  $\frac{1}{2}$  lb. of finely triturated mineral blue in it, and a dark green dye is the result. Or a very beautiful green dye may be made with indigo—carmine and picric acid, adding water to reduce it to the desired hue. As picric acid is rarely to be had of uniform strength the exact proportions cannot be given. The same dye may be used for grasses.

Black: Two ounces of logwood in 1 quart of water,  $\frac{1}{4}$  oz. of alum, and 3 oz. of copperas, the whole boiled together and the moss dipped into it while hot. Or two parts of logwood and one of Fleabane, thoroughly boiled together, and a little green vitriol.

Red: The best way to make this color is to boil as much red aniline in rain-water as will produce a pretty red. The dye should be hot when the moss is dipped.

**To Bleach and Dye Everlasting Flowers.**—Bleaching: Put a number of flowers, which have previously been placed in a warm chamber to cause them to open, in a vessel containing a solution of chloride of lime,  $\frac{1}{2}$  oz. of soda, and 2 quarts of water. Cover the vessel and leave it as it is in a moderate temperature for four or five days. During this period the flowers first change to an orange color, and afterwards to a blueish white. As soon as these changes show themselves take the flowers out and pour off the fluid, and fill it up again, using this time only 1 oz. of chloride of lime and no soda. Let the flowers remain in this until quite white, subsequently drying them in a warm oven.

Dyeing.—Carmine:  $\frac{1}{4}$  loth (about 2 drachms) of Munich lac,  $\frac{1}{4}$  pint (about  $\frac{1}{2}$  drachm) ultramarine blue, dissolved in 12 loth (about 6 ounces) of warm water.—Rose:  $\frac{1}{4}$  quint of extract of safflower, dissolved in 1 quart of cold water.—Dark blue: 1 loth indigo extract in a quart of water.—Cornflower blue:  $\frac{1}{2}$  loth blue aniline, 2 loth spirits of wine, in 1 quart of water.—Violet:  $\frac{1}{2}$  loth violet aniline, with the same proportions of water and spirit.—Light blue:  $\frac{1}{2}$  loth Prussian blue, dissolved in a quart of water.—Dark blue: 1 loth of catechu, boiled in a quart of water.—Light green:  $\frac{1}{4}$  loth picric acid, and  $\frac{1}{4}$  quint of indigo in 20 loth of alcohol.—Black: as given above.—Orange: 3 loth of borax in 2 quarts of hot water, leaving the flowers to steep for some time.

The dyes for grasses, &c., are made in the same way.

*To Preserve Asters.*—Place a vessel containing muriatic acid and sulphur in a suitable air-tight box, and hang the Asters in it.

*To Bronze or Gild Grasses, &c.*—Take a solution of equal parts of oil of turpentine and copal lac, and immerse the grasses, such as Anthoxanthum, Briza, &c., and, before they are quite dry, strew them over with gold, silver, or copper bronze. All other colors for grasses are put on as follows: Dip the grasses in a very thin solution of gum arabic, and, when they are partially dry, lay on the color with a soft pencil.

*To Dye Asters, &c.*—Take a pint of water and add an eighteenth part of sulphuric acid, and dip the newly cut flowers into it singly, afterwards hanging them up to dry in an airy, shady place, when they will assume a beautiful red color. Zinnias, Pansies, Pelargoniums, Fuchsias, &c., may be dipped in a very thin gum and afterwards dried, care being taken that the leaves retain their natural position. Where the leaves happen to stick together they may easily be parted with a penknife.—*Gardener's Chronicle.*

PROPAGATING ROSES.—“A. Rose” says: “Please inform me what mode of treatment would be best to adopt with spring prunings of roses, in order to make them strike. They are tied in bunches, labelled, and buried in damp sand. I beg you not to advise me that the Fall is the best time to propagate roses from cuttings. I have noticed this question asked frequently, but the answer is never satisfactory. I can and do grow roses from cuttings wintered over in a cold frame, but cannot succeed with spring cuttings. It seems a pity that so much wood should be wasted, and I think there must be some plan to utilize it. (1.) Can roses be successfully grafted on pieces of the root of other roses (like apples are grafted)? If so, please detail the process. (2.) Can Spring budding of roses be successfully performed, and if so, is it to be done when the buds of the stock are pushing, or earlier? (3.) I don't find satisfactory information on these points in any of the authorities on roses (Parsons, Parkman, &c., &c.), and am therefore impelled to ask you to enlighten my ignorance.”

[1. Old wood, if taken off in the Fall, kept in moss in a place cool enough not to encourage mould, and planted out in a place that is par-

tially shaded, and will keep just damp without watering, will root very well. Cuttings taken off in Spring will not root.

2. Roses can be and are grafted in Winter on pieces of roots, as apples are. The Prairie roses make good roots for this purpose. Manetti roses are also used, but it is objectionable through its suckering propensities. Splice or whip grafting is employed. It is immaterial what plan, so that the edges of the bark of scion and root meet, at least on one side.

3. Good sound wood, kept over winter, buds easily on healthy stocks. The buds are to be put in as soon as the bark runs in Spring.—Ed. G. M.]

## NEW PLANTS.

NEW HYBRID GLOXINIAS.—Mr. Alex. Newett, gardener to H. P. McKean, Esq., of this city, has flowered some of Messrs. Veitch's new hybrid Gloxinias, and they prove to be very handsome things indeed. On the continent of Europe as well as in England they are turning their attention to this new race. The *Illustration Horticole* thus describes some new ones raised in France:

“*Madame Duval*, flowers nearly 2½ inches in diameter, with obovate lobes, waved at the margin, of a velvety carmine-red or crimson, passing into pink at the circumference and shaded with dull red in the throat, which has a white ground spotted with red; a superb variety, of perfect shape; perhaps the finest red in the group. *Phedre*, flowers perfect in shape, about 2 inches in diameter, of a violet-blue, paler towards the margin of the lobes, with a darker ring suffused with fiery red at the mouth of the tube. *Colore Nova*, flowers nearly 2½ inches in diameter, of a deep brown-red or claret color, paler towards the centre; throat white; a new color in Gloxinias. *La Rosière*, flowers beautifully formed, about 2 inches in diameter, pure white with a half-circular ring of delicate pink in the centre, radiating in lines corresponding to the lobes, and bordering the lobes; a handsome and free-flowering variety. *Papillon*, flowers large, of a beautiful lavender-blue, rayed, dotted, and veined with a deeper tint, forming a new design, which recalls the markings on certain butterflies with blue wings.



These five fine varieties were raised from seed by Mr. Duval, of Versailles, and upon every occasion, and at every place where they have been exhibited, they have attracted general admiration. They show that these charming Gesneriacæ have not yet attained their highest degree of perfection. From year to year there has been an advance in purity of form, in the size of the flowers, and in the marvellous diversity of rich coloring they display. We think they very closely approach perfection, though doubtless crosses with new species would bring further improvements.

THE LILAC-FLOWERED FUCHSIA.—Referring to *Fuchsia syringæflora*, Mr. Porcher, President of the Orleans Horticultural Society, writes as follows to the *Revue Horticole*: "When grown in small pots, the effect of *Fuchsia syringæflora* is indifferent, but, when grown in large pots, or in the open ground, it forms splendid bushes 3 or 4 feet high, of fine shape, and bearing an abundance of flowers all the summer, and for some time on into the winter. This plant was introduced in 1849, by M. Van Houtte, of Gand, who considers it to be a variety of *F. arborescens*."

### QUERIES.

BRYOPHYLLUM CALYGINUM.—A correspondent from Plainville, Conn., says: "I send with this a plant by mail for you to examine and name if you can. It is commonly called air plant. The leaves taken off and hung up in a room will root, and numbers of small plants will spring forth from the edges of the leaf. I have kept them for a year, but have had no flowers as yet; hardly think they flower."

[Nearly every month we get this thing to name from somebody. It is a plant no one can kill, and perhaps this is why it comes here so often.—Ed. G. M.]

GRAFTING DOUBLE CAMELLIAS.—J. S., Baltimore, Md., writes: "In article 'Grafting,' Appleton's *Encyclopædia*, reads: 'The fine double camellias will not grow from cuttings, but are propagated by grafting upon the single kinds which readily do so.' Is not this wrong? I have a fine double white camellia, and I have always understood that it is growing on its own roots."

[The *Encyclopædia* is wrong. As a rule double flowering plants are not as vigorous as single flowered kinds of the same species, and it is best to graft the double ones, therefore, on single stocks. But it is an error to say "double camellias will not grow from cuttings."—Ed. G. M.]

SUMMER TREATMENT OF CAMELLIAS.—H. L., of Oak Park, Ills., writes: "Will not some one write an article on this subject, and oblige me and probably a great many others?"

[Camellias in this part of the world are generally taken out of the houses about the middle of May and are placed under a shade made of lattice-work, or if that is not to hand, the partial shade afforded by a large tree. They want light in summer time, but not the full blaze of the mid-day sun.—Ed. G. M.]

GREENHOUSE FURNACES.—W. H. L., (post-office indistinct) writes: "Will you please give explicit direction for building furnace and flue to heat small or large greenhouses, in *Gardener's Monthly and Horticulturist*? or if such directions have been given in previous numbers will you please give their numbers and volumes that I may procure them, as I desire to build a furnace to heat a small greenhouse? Please state the price of the numbers also. I never saw *Gardener's Monthly* until this month's number fell accidentally into my hands, and as a lover of flowers am much pleased with it. I intend to become one of its regular subscribers."

[No particular directions can be given, because how to build will vary with each one's particular circumstances. In a general way one may say that it pays to have a furnace well built. The heat soon uses up a poor thing. Double doors are good. Single doors warp, crack, and soon loosen from their holdings. Good fire brick should form the sides and roof of the furnace. convenient the roof is best arched. The frame inside supporting the building arch can be burnt out. The mouth of the furnace, if possible, should be outside the greenhouse. Besides avoiding dust it is a saving of fuel, as when inside the fire is fed from the warmed atmosphere of the house. Where flues are made of brick, these should be soaked in water when about to be used, and the mortar should be of the best quality. The flue should be elevated from the ground, in order to keep the flue dry, which favors draught, as well as to save heat, as when the flue is in contact with the earth much is lost by conduction.—Ed. G. M.]

# FRUIT AND VEGETABLE GARDENING.

## COMMUNICATIONS.

### WILD GOOSE PLUM.

BY A. HANCE & SON, RED BANK, N. J.

We notice thee says in the March number of the *Monthly*, that we say the Wild Goose Plum is "perfectly round and fully two inches in diameter." The true Wild Goose Plum, we have found a handsome, rather large, oblong, crimson variety, with a fine bloom. It is an inch to an inch and a half wide, and an inch and a half to two inches long.

We regret to say that the possessor of the original tree, and who first disseminated this fruit, sent out a number of worthless Chickasaw plums, some of which bear small, round fruit, similar in shape and size to the Damson. This, we conclude is the cause of the general and vast difference of opinion regarding this plum, which thee will find more fully set forth in the *Country Gentleman* of Dec. '2d. Thee will also find a few comments on this gentleman's character, under the head of "Scalawag Record," in G. W. Campbell's Catalogue for Spring, 1876.

In regard to our describing the Wild Goose Plum as *round*—it is true that the illustration in our "Retail Price List of Fruits for Spring of 1876" depicts it as such. This illustration we purchased of Fish, of Rochester, and sent it to our printers. It is scarcely necessary to add that we experienced a feeling of mingled surprise and vexation, on receipt of the price lists, and finding the illustration so incorrect. By turning to page 6, of said price list, thee will find the Wild Goose Plum described as "medium to large, oblong; deep crimson with a blue bloom; juicy, sweet and good."

[In addition to the above we have the following from Mr. D. O. Munson, of Falls Church, Virginia.—Ed. G. M.]

"I notice in the March number of the *Gardener's Monthly* an article in relation to the Wild Goose Plum. As there seems to be a difference of opinion in relation to the size and quality of said plum, I thought I would write you my experience in the matter. Six years ago I sent

to Nashville, Tenn., for 30 trees of the Wild Goose Plum and last year was the first they fruited. Two or three bushels of the fruit from six of the trees were sent to the Washington, D. C., Market, and brought from \$9 to \$10 per bushel. I took a sample of the fruit to Mr William Saunders of the Agricultural Department, who pronounced it a good eating plum and ordered 50 of the trees. Mr. Saunders stated that he had received trees of this variety from two or three parties which had proved to be worthless. Several parties who purchased the fruit in market liked it so well that they have ordered trees from me. Mr. John Saul had them in bearing last year and the fruit was identical with mine. The plum is deep red in color, with a blue bloom, and is sweet and juicy; it is a little over an inch in diameter, and an inch and one-half in length. Very Respectfully,

D. O. MUNSON. per J. M. T.

### A FEW APPLES THAT DO WELL IN NEW JERSEY.

BY I. J. BLACKWELL, TITUSVILLE, N. J.

*Early Flat Top.* Medium size; color, pale yellow. This is a local apple as far as I know, not finding it among our list of named varieties in bearing. Tree low-headed, needs considerable thinning and rich soil to produce good fruit, one of the earliest apples, and is in market before peaches.

*Red Astrachan.* Too well known to need description. This is a promising variety, quality and color are good, and size large, and comes before peaches. If this variety proves to be productive, it will be the best early apple for New Jersey.

*Sweet Bough.* Good bearer, fine apple. Only limited quantities of this variety should be set, as they sell only on the fruit stands, and peaches are plenty at this time.

*Woolman's Long.* As known in Trenton, and I think, in Philadelphia, is profitable. Rather poor quality, ripe in August.

*American Summer Pearmain.* Best of its season.

*Porter.* Only fault, time of year that it ripens.

*Cornell's Fancy* and *William's Favorite.* For all practical purposes either will take the place of both, good growers, productive, September.

*Hagloe.* Very fine apple, tree slow grower.

*Fall Flat Top* (or *Henry Young*). Another local apple, which stands at the head of the list of September and October apples, should be planted in the family orchard especially. This apple does not ripen as evenly as is desirable for market; tree strong grower, fruit large, color green, nearly covered with red stripes, quality best.

*White Doctor.* Strong grower, productive, fruit large, quality medium, color white.

*St. Lawrence.* Good grower and bearer, quality good, too small and apt to be knotty; only for home use.

*Leland Pippin.* Good grower, fruit large, quality good, to be recommended, ripe 1st of September.

*Fallwater.* Strong grower, productive, very large, fair quality, drops badly unless picked early, profitable.

*Rhode Island Greening.* Good grower, productive, quality best, ripens here in September.

*Baldwin.* Strong grower, productive, quality best, must be picked early, and will keep here until Christmas.

*Nero.* Another Jersey apple, good grower and productive.

*Cooper's Market.* Good grower and productive, keeps well.

*Jersey Russet.* Good grower and productive, drops badly before ripening on sandy soil.

*Monmouth Pippin.* Strong grower, fruit large, and quality good, not a long keeper as a general thing.

*Ladies' Sweeting.* Very good keeper.

*Smith's Cider.* This we place last, thinking that in most orchards in this section for market apples, every hundred trees ought to have ninety of them of this variety, as it fills the bill for all the season when apples are most in demand. It is ready to market from September 20th, until the first of March. Tree grows about as well as any other variety in the orchard, bears young and abundantly. It will produce more bushels, and bring more money to the acre of trees, than any other of our one hundred varieties now of bearing age. The objections to this apple are, that is not so high flavored as some other varieties, especially when the trees are overloaded with fruit, and this tree is a heavy cropper, often year after year.

## GRAFTING THE FEATHERY WEEPING CHERRY.

BY GEN'L W. H. NOBLE, BRIDGEPORT, CONN.

This weeper—"Cerasus pumila pendula"—many nursery catalogues name "as always scarce and difficult to work." If I do not mistake the tree which answers to this name, the only trouble is in the method of your working. Its delicate vine-like grafts and buds of one season's growth are too frail and feeble readily to unite with even vigorous stocks. But thrifty scions of two years' growth or more, cleft grafted therein, will surely take, and soon give us a fine graceful tree. An old grafter has proved this on my grounds repeatedly. If his plan is not new to you it must be to many who find this cherry "difficult to work."

## THE APPLE BORER.

BY B. F. TRANSOU, HUMBOLDT, TENN.

I have been a careful reader of your *Monthly* a long time, and I think with profit. I entertain the highest regard for your judgment and plain practical suggestions you generally make on all subjects you write about. Of course the varied soil and climate of the United States must produce a considerable difference upon the vegetable as well as upon the animal kingdom. What will hold good in your State may not exactly in our State; not so much difference, however, with us (except late fruits and vegetables) as with other States differing greater in climate. The pests we have in our orchards also may differ. We beg leave to differ with you at least about the apple tree borer, as given in the *Gardener's Monthly and Horticulturist*. April No., "Seasonable Hints," you say (or the inference is) the borer does his work at or near the surface of the ground—"remedy, tarred paper, an inch or more below the surface and two or three above." This would not protect our trees in Tennessee, as we often as otherwise find the borer from one to three feet above the surface.

The first and second year after planting in orchard, particularly if the soil is thin, and, as you say, "starved," the borer is likely to commence his depredations, and if not destroyed bores into the pith or heart of the tree, going up or down, killing the tree. Strong soap applied to the body of the tree Spring and Fall, or strong or thick paper tarred, is the best preventive we know of.

[The "flat-headed borer" operates in any part of the stem, and this is the one probably that Mr. T. refers to. So far as we know this species

is injurious only in the West. It was the other species we referred to, and which, so far as we know, enters only at the ground. We have to thank our correspondent for his timely suggestions, and we hope to hear from him again.—Ed. G. M.]

### HUCKLEBERRIES.

BY WILLIAM JOHNSTON, QUITMAN, MO.

I will try to write a few lines on the subject of huckleberries. I think there is no doubt but it can be domesticated and raised so as to pay in a majority of gardens, especially when the fruit cannot be picked on the wild bushes or bought in the market, which is the case in the western prairies.

Mr. Hammond, in the August number of the *Horticulturist*, speaks of the different varieties of huckleberries, that no one had given a description of the different kinds.

Professor Gray, in his *Field Botany*, describes ten varieties *Vaccinium corybosum*. The blueberry of New England States, growing from 3 feet to 10 feet in height, answers the description of the kind described by Mr. Hammond. That there is a great difference in the quality of the berries of this same variety there is no doubt, and if we go into the cultivation of the berry let us begin with the best, and by a course of reproduction the fruit will be very much improved. Of the different native fruits of our country the grape has had the most attention, and the result has been very satisfactory. The same may be done with the native plum, persimmon and the native berries, all better fruits in their wild state than the apple or pear was.

All fruits and flowers that have been brought into cultivation have been much improved. All flowers in their wild state are single. Cultivation and reproduction makes them double; equally as great changes can be made in the quality of our wild fruits.

### ASPARAGUS CULTURE.

BY W. D. M., FAYETTE CO., TENN.

Your correspondent, Gen. W. H. Noble, in the April number, wishes to hear more on what he calls "the new culture for asparagus." It is not new to me—my father planted a bed about thirty years ago, and his culture was nearly like the gentleman's referred to by Gen. N., with this difference: hen and stable manure, mixed

with good garden soil, were used freely, and the bed dug as deep as the asparagus roots would allow every spring. For fourteen years I have kept up my father's mode of culture, and the old bed continues to yield, from year to year, a good crop of fine large asparagus. I also grow radishes, &c., on the bed, as my father did, which does not seem to injure the asparagus.

Having changed the plan and size of my garden, I wish to start a new bed, as the old one is now out of place, and looks odd with no walk leading to it. Please tell the best time and method of doing it.

The peach crop here is nearly a failure—none worth talking about. Apples, pears and small fruits look promising.

### ASPARAGUS CULTURE.

BY A. T. I., WHITE HALL, MICH.

The manner in which — cultivates asparagus by annually adding a layer of fresh dirt is a success. If these layers are made alternately of clay loam and sand loam, I suggest that it would be an improvement. There is a mulching power in clay on sand and in sand on clay that is not half understood nor but very little practiced to what it should be on our light sandy soils where clay knolls abound so plentifully. Fruit prospects here are good without exception.

### PEAR TREES—FROZEN-SAP-BLIGHT.

BY MYSTIC, MEDFORD, MASS.

Late, rapid growth of the pear tree, when the vitality of the leaf is not sufficient to effect a perfect assimilation of the sap, produces immature wood, which is very apt to be injured, if not killed, by freezing, and especially by freezing and thawing, in the winter. The next spring, "the bark of the trunk and principal limbs exhibit black spots, and, on cutting into them, the bark and wood, for some distance beneath, are found quite dead and black. The only remedy is to cut away at once all of the tree that is affected—cutting below the lowest spot."

The winter of 1874-5 was a trying one to the pear trees in this region. The frozen-sap-blight showed itself in many gardens. I had two Bartlett's (standards) six years old, strong, vigorous and beautifully shaped—the result of deep, thorough cultivation and careful training. The branches on one side of one showed the blight

early in the spring, and were immediately sawed off close to the stock. New branches soon put out, which I let grow three feet—as long a growth as I think prudent for pear trees to make in this climate. In a few years, by pinching back the branches of the other side and allowing them to bear fruit freely, and by manuring more heavily on the side of the new branches, and allowing them to bear no fruit, I shall restore the symmetry of the tree.

The blight struck the main stock of the other tree where it was three years old. I hesitated a week or two—harboring a lingering hope contrary to the advice and experience of horticulturists—and then resolutely amputated the stock of this cherished tree below the blight. The tree having plenty of strong branches below the point of amputation, I shall train it by spreading them in the vase form, which is preferable in some important respects to the natural form.

A handsome Duchess d'Angouleme (on Quince) was so affected by the blight that I cut it off within six inches of the ground. There are a plenty of good shoots—four of which I shall select for the base of a vase form top; three would answer.

A Buffum (standard) of the same age was killed outright.

My soil is a sandy loam, with pebbles interspersed and a porous subsoil, trenched two feet deep. The growth of the year before the blight was not large, but my treatment of the Bartlett's and Duchess, I am apprehensive, was erroneous. It happening to be peculiarly convenient, I gave them a heavy top dressing of new stable manure in the latter part of the summer. Early in the spring, or late in the fall (after the leaves are off), are the proper times for manuring. Unrotted manure I prefer to have forked in in the fall. After manuring these trees I watered them copiously with the hose, and, as the season was dry, repeated the watering into September. No extra growth followed. I submitted the case to one of the leading pear cultivators in Massachusetts, and he said the blight was not occasioned by my treatment of the trees. Yet I have my doubts. To be sure, some of my neighbors' trees, starving in the same kind of soil, with not six inches of growth that year, neither manured nor watered, were affected, and a part of them killed, by the frozen-sap-blight. It is safest never to encourage a fall growth.

In all the cases I noticed in this and the neighboring towns, every spot of blight, with one ex-

ception, was on the south side of the wood blighted—showing pretty conclusively that it was the freezing and *thawing* which caused the blight.

The blight poisons the sap—hence the importance of amputating immediately, on its discovery, below the affected spot, to prevent the poison from entering into the general circulation of the tree, and thereby injuring, if not eventually killing, it.

I carefully protected the spots of amputation in the cases above stated by covering them with mortar composed of clay and green cow dung, using a larger proportion of the latter. If this mortar is carefully spread and firmly pressed on, lapping over well, it will remain a year or more. When it comes off it can easily be replaced. Where clay is not accessible, loam can be substituted.

#### GRAPE CULTURE—THE WILD GOOSE PLUM.

BY B. F. TRANSOU, HUMBOLDT, TENN.

Your remarks on grape pruning we like very much. We cultivate the scuppernong grape with more profit than any other (for home use), and that you may let "rip," needs no pruning whatever after you get it overhead on a trellis. While I am writing I have a mind to say something about the wild goose plum you spoke of in the March No. Think I can solve the difficulty. This noted plum originated in Tennessee, and is as "thick as blackberries" all over our country. The practice has been, and still quite common, to plant stone fruits without grafting or budding. No wonder there is such a difference. Thus it is (now and then) we get a "very good thing," or something that will "pay." The goose plum, "true," will compare favorably with any of the other so-called "finer" varieties—Coes Golden Drop, Jefferson, Washington, &c.—in point of flavor. The average size one and a half to two inches in diameter; round shape, very productive, and almost, not quite, free from the curculio—the only trouble we have with other varieties. The comparison with a "green persimmon" is good before ripe. No green plum is fit to eat. It has another good quality—for shipping. To gather when colored and firm will keep several days or a week. In the St. Louis, Chicago, Cincinnati, and other markets, we usually get, if handled right, from 5 to 8 dollars per crate of 24 quarts.

[We thought that it was well settled by the letters of Mr. Hance and others in our columns, that the wild goose plum was not a round plum, but an oblong or oval one. So clear did we all think this that Mr. Hance even went so far as to deprecate the Rochester firm that sent him the illustration representing it as "round" and an "inch and a half or two inches in diameter." Now Mr. Transou, whom we should look on as among the best authorities on a question of this kind, takes us back to that identical thing! All we can say is that perhaps after a while we shall see what we shall see.—Ed. G. M.]

### QUERIES.

**NATURAL PEACH STONES.**—A correspondent from South-eastern Tennessee confirms our remark in regard to the rareness of *true* "natural" stones in market,—and says that though three-fourths of the peach trees of that section are seedlings, there is no trade in the stones. Some are dried, but for the most part hogs are turned into the orchards, and "Sambo with a long pole beats off the fruit, while piggie picks it up." He thinks it strange they should still plant these things, fine grafted fruit, bringing two dollars and a half a bushel, while the "natural" bring only from fifty to seventy-five cents,—and all within a few days of the appearance of each in market. We should be glad to know from our correspondent if these seedlings have always very small seed, all of an uniform size,—or whether there are large and small ones,—various sizes—as we should suppose. We should suppose that those who intended to depend on seedlings, would at least save from the largest and best, and these would give stones of a fair average size. What we have seen as "naturals" were of

small size, and we are almost sure were early York or small fruited peaches of some kind.

**AMERICAN APPLES IN ENGLAND.**—We are very much indebted to Mr. Robinson, for the following correction.

"There is a mistake in the *Monthly* as regards what I said of the fine collection of American apples sent us by Messrs Ellwanger & Barry. I did not say that Talman's sweet had the finest flavor of all. I described it as very sweet, but a great many sweet things are very sickly too, and I should much prefer a French Crab to any of those 'sweet' apples. It was among the so-called 'sour' apples that we found the high pine-apple-like and delicious flavor, that makes a good American apple one of the finest fruits ever ripened by the sun.

"I fancy America is destined to supply the world with good apples. If you now send them in quantity to us, who are supposed to grow good apples, and from whom you originally obtained your parent kinds, you ought in the future to send them in greater numbers to countries where the apple does not grow well, or is badly cultivated. Only tell them not to put all the little and bad Newtowns in the middle of the barrel. There was a good deal of grumbling about this during the late apple season in Covent Garden. The practice most hurts the packer and his fellows in the end."

**SMALL FRUITS.**—A. B. C. The article did not appear, because, while there were here and there an item that might interest some people,—on the whole it was a bare-faced advertisement. We might have selected the news, and let the other go, only for the request to "publish as written." We regard it as an injustice to those who pay honestly for their advertising, to allow another to get in a free advertisement under the guise of an "article."

## FORESTRY.

### COMMUNICATIONS.

#### THE FOREST TREES OF DELAWARE,

BY W. M. CANBY, WILMINGTON, DEL.

A brief item in the *Wilmington Commercial* shows, that at least one member of the Centen-

nial Commission of this State is alive to the advantage of having one of the most important resources of Delaware properly displayed at the approaching exhibition. I allude to the statement that Col. H. B. Fiddeman has found that we have "twenty-nine varieties" of native trees,

and that "they will all be exhibited at the Centennial."

If sections of *all* our trees could be prepared so as to properly show their qualities for various useful or ornamental purposes, our wealth in this respect, would, I think, astonish some of our own citizens and be of interest to those from other States and countries. For if Col. Fiddeman had been able to extend his researches throughout the State, he would have found that we have at least sixty-six distinct *species* of trees that are native to Delaware soil. In this number are included four species of the Ash, two of the Elm, two of the Walnut, five of the Hickory, thirteen of the Oak, three of the Birch, three of the Poplar or Aspen, (not the Tulip Poplar,) and four of the Pine, besides other genera which are each represented by a single species.

In the list below, all trees which attain a less diameter of trunk than six inches are excluded as are also all such as are natives of other portions of the United States, but of recent introduction here, though gradually making themselves at home, as, for example, the Catalpa, Honey Locust, &c. A single tree in the list is to me very doubtful as a *native* of Delaware, viz., the common Locust; but as Mr. Tatnall (in his "Catalogue of the Plants of New Castle County,") and Col. Fiddeman think otherwise, I have acquiesced.

It may not be inappropriate to say that Dr. Geo. Vasey, the Government Botanist at Washington, will exhibit at the Centennial, specimens of about four hundred and fifty of the native woods of the United States.

The Latin names as well as the English are here given, for the reason that the former are stable and recognized all over the world, while a single one of the latter is often applied in different sections of the country to two very distinct species. Thus, what is called "Red Oak" in Delaware, is called "Spanish Oak" in Pennsylvania, while the Spanish Oak of Delaware is scarcely known in Pennsylvania:

## LIST OF TREES.

Swamp Magnolia,	Magnolia glauca.
Tulip Tree, Tulip Poplar,	Liriodendron tulipifera.
Linden, Bass Wood,	Tilia Americana.
Sugar Maple,	Acer saccharinum.
Silver Maple,	Acer dasycarpum.
Red Maple,	Acer rubrum.
Box Elder, Negundo,	Negundo aceroides.

Locust,	Robinia Pseudacacia.
Red Bud, Judas Tree,	Cercis Canadensis.
Wild Plum,	Prunus Americana.
Wild Cherry,	Prunus serotina.
Wild Crab Apple,	Pyrus coronaria.
Sweet Gum,	Liquidambar styraciflua.
Common Dogwood,	Cornus florida.
Black Gum, Sour Gum,	Nyssa multiflora.
American Holly,	Ilex opaca.
Persimmon,	Diospyros Virginiana.
Fringe Tree,	Chionanthus Virginicus.
White Ash,	Fraxinus Americana.
Red Ash,	Fraxinus pubescens.
Green Ash,	Fraxinus viridis.
Water Ash, Black Ash,	Fraxinus sambucifolia.
Sassafras,	Sassafras officinale.
Slippery Elm,	Ulmus fulva.
American Elm, Drooping Elm,	Ulmus Americana.
Hackberry, Hoop Ash,	Celtis occidentalis.
Red Mulberry,	Morus rubra.
Seyamore, Buttonwood,	Platanus occidentalis.
Black Walnut,	Juglans nigra.
Butternut, White Walnut,	Juglans cinerea.
Shellbark,	Carya alba.
White heart Hickory,	Carya tomentosa.
Red Hickory, Pignut,	Carya porcina.
Small fruited Hickory,	Carya microcarpa.
Bitter Fruited Hickory,	Carya amara.
White Oak,	Quercus alba.
Water Oak,	Quercus aquatica.
Swamp White Oak,	Quercus bicolor.
Scarlet Oak, Black Oak,	Quercus coccinea, and varieties.
Willow Oak, Peach Oak,	Quercus Phellos.
Spanish Oak (Delaware),	Quercus falcata.
Bartram Oak,	Quercus heterophylla.
Shingle Oak, Laurel Oak,	Quercus imbricaria.
Black Jack Oak,	Quercus nigra.
Post Oak,	Quercus obtusiloba.
Pin Oak,	Quercus palustris.
Chestnut Oak, Rock Chestnut Oak, &c.,	Quercus Prinos and varieties.
Red Oak, (Delaware),	
Spanish Oak, (Pennsylvania),	Quercus rubra.
Chestnut,	Castanea vesca.
Beech,	Fagus ferruginea.
Hop Hornbeam, Ironwood,	Ostrya Virginica.

Red Birch,	Betula nigra,
Swamp Birch, White Birch,	Betula alba, variety.
Cherry Birch, Black Birch,	Betula lenta.
Black Willow,	Salix nigra.
American Aspen,	Populus tremuloides.
Long toothed Aspen,	Populus grandidentata.
Downy Poplar, Cottonwood,	Populus heterophylla.
Loblolly Pine, Old field Pine,	Pinus Taeda.
Pitch Pine,	Pinus rigida.
Jersey Pine, Scrub Pine,	Pinus inops.
Yellow Pine,	Pinus mitis.
Hemlock,	Abies Canadensis.
White Cedar,	Cupressus thyoides.
Cypress,	Taxodium distichum.
Red Cedar,	Juniperus Virginiana.

Respectfully,

WM. M. CANBY.

[Our readers will remember the criticism we made on Delaware trees. Since then Mr. Canby has contributed the above to the *Commercial*, and we are pleased to be able to add that the Commission has had the good judgment to avail itself of Mr. Canby's knowledge in getting the Delaware wood together.—Ed. G. M.]

### EDITORIAL NOTES.

**NURSERYMEN AND TREE PLANTERS.**—There will be held at the Palmer House, in Chicago, on the second Wednesday in June next, a meeting of the nurserymen of the Northwest, for the purpose of organizing a nurserymen's association. Dr. Ennis, of Clinton, Iowa, will preside, and J. Wilmot Scott, of Galena, will act as secretary. The object of the association will be to promote the general welfare of the tree-growing interest.

**ABIES MENZIESII.**—The fine specimens of *Abies Engelmanni*, noted in our *Magazine* three years ago, as growing on the grounds of Mr. Gray of Boston, proves to be the *Abies Menziesii*. The seed was from Colorado. It is on the strength of these specimens that the idea has started that the Colorado plant is much better for Eastern culture than those from the Pacific coast, and if all the plants from Colorado seed are to be like these, we heartily endorse the idea.

**PRIZES FOR TREE PLANTING.**—We call the particular attention of our readers to the schedule of premiums for tree planting issued by the Massachusetts Society for the Promotion of Agriculture. Tree culture can be made a success. It only needs a few examples to illustrate it. Such example premiums of \$1000 and \$600 ought to bring forth. Schedules can be had of E. N. Perkins, Jamaica Plain, Mass., up to December 1st, 1876. Prof. Sargent's essay is distributed with the Schedule.

**SUBSTITUTES FOR WOOD.**—What shall we do when the forests are no more, and the coal all used up? This is a question which those who look many centuries ahead, are continually asking themselves. Some reply, Providence will take care of us, something will be invented when the time for it comes. Already they are preparing for this good time. By a chemical process and great pressure, paper can be made equal to wood, and paper buckets are already a "fixed fact."

THE AMERICAN FORESTRY ASSOCIATION was organized at Chicago, Illinois, on the 10th of September, 1875, by the election of John A. Warder, of Ohio, President, and H. H. McAfee, of Iowa, Secretary. The objects of the Society are mutual improvement in the art, the diffusion of information upon the subject of Forestry, and the fostering of all interests of forest-planting and conservation on this continent.

*The following gentlemen were appointed a Committee on correspondence and statistics, with J. T. Allan, of Nebraska, Chairman:*

- J. T. Allan, Chairman, Omaha, Neb.
- W. H. Brewer, New Haven, Conn.
- Bernard Fox, San Jose, Cal.
- Wm. M. Byers, Denver, Col.
- Jno. Saul, Washington, D. C.
- P. J. Berckmans, Augusta, Ga.
- A. G. Humphreys, Galesburg, Ill.
- W. C. Flagg, Moro, Ill.
- J. C. Ratliff, Richmond, Ind.
- J. Hussey, Lafayette, Ind.
- C. E. Whiting, Whiting, Monona Co., Iowa.
- G. B. Brackett, Denmark, Iowa.
- J. L. Budd, Shellsburg, Iowa.
- E. Gale, Manhattan, Kan.
- Jas. Truitt, Quincy, Ky.
- Geo. B. Sawyer, Wiscasset, Me.
- Wm. T. Breckenridge, Baltimore, Md.
- G. Emerson, Boston, Mass.
- T. T. Lyon, South Haven, Mich.



E. Y. Lacy, Minneapolis, Minn.  
 Geo. Husman, Sedalia, Mo.  
 Wm. Parry, Cinnaminson, N. J.  
 J. G. Knapp, Mesilla, N. M.  
 E. Moody, Lockport, N. Y.  
 Franklin B. Hough, Lowville, N. Y.  
 S. T. Kelsey, Horse Cove, Macon Co., N. C.  
 J. J. Harrison, Painesville, O.  
 Leo. Weltz, Wilmington, O.  
 Thos. Meehan, Philadelphia, Pa.  
 Josiah Hoopes, West Chester, Pa.  
 J. W. Rosamond, Gadsden, Tenn.  
 Judge Richards, Hagan, Utah.  
 J. Harvey, Richmond, Va.  
 Thos. B. Vanhorne, Ft. Vancouver, W. Ty.  
 Jas. S. Stickney, Wauwatosa, Wis.  
 J. C. Plumb, Milton, Wis.

*Points to be investigated and reported on by this Committee.*

1st. Estimates of the area of woodland, in square miles or acres, and average ages of the trees.

2d. Estimates of their productiveness per acre in cubic feet of lumber and cords of fuel.

3d. Lists of native trees and woody plants, with local and botanic names, and their special value in the arts.

4th. Location of species, relatively to elevation above the sea, to soil, etc.

5th. Natural grouping and consociation of species, etc.

6th. Numbers, kinds and acres of artificial forests planted, and areas protected from cattle in order to encourage the natural reproduction of trees.

THE PROFITS OF TREE PLANTING.—In a notice of Prof. C. S. Sargent's paper on timber culture recently we said that we thought that the profits of timber culture could in many cases be made much greater than he had presented them. On the whole we believe he under estimated rather than exaggerated what one could make. We dearly love, however, to present both sides of all questions and particularly this one of tree culture and its profits, for, if we make an error in our calculations on such subjects it is one which cannot be remedied in our lives. It is a matter on which it is better to be right than to be President of the United States. A correspondent of the *Country Gentleman* from Connecticut, makes the following objections to Mr. Sargent's figures, and not to head off what any one may have to say about the paper, we give it without comment:

"I observe in your last journal an article strongly commending the late report of Professor Sargent upon arboriculture. Referring to the table

on p. 195, I observe that the profits on ten acres in European larch are rated, for a period of fifty years, at 13 per cent. per annum. Will you excuse me for thinking there must be some exaggeration in such an estimate?

"The charges for land, fencing, plants and labor are perhaps fair enough; but the credits seem to me to be very 'rose-clored.' Thus, the cutting, after 20 years of growth gives a thousand posts to the acre, worth 20cts. each—or two posts to a tree. I cannot help doubting the certainty of such developments. As a case in point, I may mention that I have a European larch, just 20 years planted, growing in a very favorable locality, where it receives wash from a hill-road, and I find by actual measurement that it has scant nine inches of diameter at the butt, and would make at best only one merchantable post.

"At the end of 30 years, the table printed gives a second thinning of about 2,000 merchantable sleepers (railroad ties) to the acre. This is an exceptionally good cutting for our average woodland that has had no previous thinning. At the end of 50 years the table shows credit for 3,800 piles, worth \$5 each.

"Now, admitting that the best of exposure and well adapted soil would secure such growth, what is to be said of cost of cutting and carting?

"The figures given represent prices on delivery, but the cartage of such heavy masses of timber from any of our average farmlands, would represent at least one-third, if not one-half of its market value. It must be a very superior pile tree which in our latitude, and in any ordinary situation, will command more than \$2 as it stands in the wood. Trees contiguous to a railway will naturally command more. In fact the consideration of locality, and costs of getting to market, make up so important an element in the calculation, that no table with a uniform scale of figures can be relied upon.

"There are live oaks contiguous to water courses in Florida which are worth \$20 per tree, but place them at a remove of eight or ten miles, with interlying canebrakes and jungles, and they would not be worth \$3 per tree.

"I do not make these remarks in any hypercritical spirit, but only through fear that a very good cause—to wit, that of arboriculture—may be injured by exaggerated statements. Is there not reason to ask, in this case, further explanations?"

"There is no branch of agriculture at once so pleasant and so productive of possible gains as farming *on paper*. It is a dangerous pastime however, and often leads into grave errors and great dangers, as the agricultural population has learned to its cost."

RATIO OF TREE GROWTH IN IOWA.—The *Western Farm Journal* furnishes the following figures:

"Mr. H. H. McAfee, of the Iowa Agricultural College, and also now Secretary of the American forestry association, gives the following as results obtained in twenty years with the trees named below:

	Diam. of trunk in.	Hight in ft.	Cord ft. in fuel.
Cottonwood ( <i>monilifera</i> ).....	24	50	5¼
Cottonwood ( <i>angulata</i> ).....	28	50	6
Lombardy Poplar.....	23	60	4¼
Elm ( <i>Americana</i> ).....	17	44	3¼
Elm ( <i>fulvia</i> ).....	18	39	3
Maple ( <i>dasy carpum</i> ).....	18	39	3¼
Maple ( <i>nigra</i> ).....	11	37	1
Walnut ( <i>cinerea</i> ).....	20	38	3¼
Walnut ( <i>nigra</i> ).....	14	37	2¾
Honey Locust.....	14	40	3
German Pine.....	14	33	2

Thus, actual tests show that cottonwood will make three-fourths of a cord; that even the slow growing black maple will make one-eighth of a cord; while the ash leaved maple (*negundo*) will make five-eighths of a cord to the tree in twenty years' growth.

The same trees if grown in groves thickly, would probably not make more than half the quantities named, which would in time come nearer to the figures as given above.

The following will, we think, be a safe estimate for groves or broad belts, in twenty years, planted, say four by four feet, and thinned out as their good deserves, to a maximum distance of sixteen by sixteen feet for the fast growing varieties, and eight by sixteen feet for the slower ones:

Cottonwood.....	70 cords.
Ash-leaved Maple.....	60 "
White Walnut (Butternut).....	50 "
White Maple.....	44 "
Elm.....	43 "
Honey Locust ( <i>Gladitschia</i> ).....	35 "
White Pine.....	32 "
Black Walnut.....	30 "
Black Sugar Maple ( <i>nigra</i> ).....	20 "

## NATURAL HISTORY AND SCIENCE.

### COMMUNICATIONS.

#### GENERAL OBSERVATIONS ON THE FLORA OF HOKKAIDO.

BY M. LOUIS BÖHMER,

*Horticulturist to the Kaitakuska, Yedo, Japan.*

On my arrival at Hakodate, in the end of May, I at once proceeded to investigate the neighboring districts. The weather, however, proved so unfavorable that I was for some time unable to collect specimens.

The first plants that struck me as most remarkable were the Azaleas and Diervillas, which were growing on Hakodate Head in great profusion, and with their pink and scarlet flowers produced a magnificent effect. Amongst other flowering trees and shrubs I observed more particularly the common Pear (*Pyrus communis*), the double flowering wild Cherry (*Prunus pseudo cerasus*), a wild Plum (*Prunus*), and a shrub looking

like a wild Apple (Japanese "sansashi," which I afterwards found to produce clusters of small red fruit, very likely a *Pyrus toringo*. Of the latter a great number were collected at the time (although I recommended that this operation should be deferred until the proper season for removal had arrived), and in consequence nearly the whole of them perished.

Another most remarkable climbing shrub, the "Kokuwa," a species of *Actinidia*, I found in flower on an excursion to Hakodate Head, the only time I saw it in that condition; unfortunately the specimens which I then collected were lost through the inclemency of the weather. I was fortunate enough to secure afterwards specimens in fruit which I preserved carefully. In the Appendix 3, I refer more fully to this valuable fruit.

The only large timber trees I saw were *Cryptomeria japonica*, evidently planted there, and the absence of all native timber trees, with the

exception of a few small oaks, struck me as very remarkable.

Among the herbaceous plants I must mention *Placidium palmatum*, a beautiful Ranunculaceous plant, also found in the mountains of "Nikko," and never yet introduced into foreign gardens. The Lily of the Valley, covering many acres of meadows, was the most charming sight I ever beheld. I also found in the hills several varieties of Solomon's Seal (*Polygonatum*). In some places where water collects frequently, I found a fine *Arum*, bearing flowers more than 12 inches long, resembling the *Calla Æthiopica*, but of larger size, which would form a valuable acquisition for our ponds; as it will no doubt prove hardy there, because I found it growing in company with *Caltha palustris*, a plant which is so very common in our northern latitudes. For many of the spring plants, which make their appearance soon after the snow leaves the ground, I was too late, or else no doubt I should have had a rich harvest. I remarked some good looking grasses in the neighborhood of Hakodate, but as they were not in flower at that time, I had no opportunity of ascertaining their value for the purpose of feeding cattle, horses, etc. The small white clover is seen growing in many places, not, however, I think, indigenous, but probably escaped from cultivation during former attempts to introduce foreign farming into the Island of Yesso.

Ferns are very abundant on the hills, and amongst them I remarked as growing very luxuriantly the *Adiantum pedatum*, a kind of Maiden-hair fern commonly grown with us in hot-houses. It is seen in large patches under the shade of shrubs, the effect when young and producing pink fronds on black stalks is very pretty. *Asplenium*, *Polypodium* and *Pteris* are also abundant.

In sea-weeds, the bay of Hakodate is very rich, and I secured a great collection during my stay there. They are now in course of preparation by the students at the farm.

Nanai, the farm of the Kaitakushi, within ten miles of Hakodate, I visited for several days on my journey to the west coast. Here I saw the first good sized trees, although not frequent. They consisted of Horse-chestnut, edible Chestnut, Walnut, Magnolias, beautifully leaved Maples (*Acer palmatum*), Alder, Birch, and an Ash. There is no remarkable vegetation on the road to Nanai. The farm itself presents no features of any consequence beyond the fine range

of buildings for the purpose of stock-breeding, and I found very little to repay my researches there. The few thousand fruit trees planted there seemed to do better than those I had seen growing in Hakodate, and are as yet free from the attacks of the butterflies, which are so disastrous to the trees in the latter locality. The orchard and nursery are not planned as well as they might be, but only a radical change in the laying out could remedy this defect.

On my way to Volcano Bay, going through the mountains at an elevation of about 1000 feet above the level of the sea, I found a beautiful climbing shrub, called by the Japanese, *Matatabi*, which I recognized as *Actinidia polygama*. At first sight the points of the leaves appear to represent the flowers; and are often mistaken for them by casual observers. On close inspection, however, the flowers are under the branches, resembling those of the Tea shrub. They are sweet scented, and belong to the same family as Tea and Camellia. (? Ed.) The appearance of the shrub is elegant, and would well repay introduction into our shrubberies. It is more frequently found growing in company with and climbing on *Magnolia hypoleuca*, which grows there to a size of 2 to 3 feet in diameter, and to the height of at least 60 feet. A very remarkable tree, and valued much for the sake of the timber it yields, is the Japanese *katsura*, the scientific name of which is *Cercidiphyllum Japonicum*, only lately classified under the family of Magnoliaceæ. There are recorded two species in this country of which I only found one. It grows to a large size, and attains a height of over a 100 feet, with a diameter measuring sometimes 6 to 8 feet. The vegetation becomes more dense in the mountains, presenting no new features, but descending towards Volcano Bay, the growth of the trees gradually diminished on account of the pumice of the extinct volcano.

My destination being Sappora, and the road skirting the sea-shore, at first little of interest occurred in the way of plants as far as Oshamanbe, from whence, again entering the interior, the vegetation was more profuse, caused by the increase of the depth of the soil, and the neighborhood of fresh water ponds, which counteracts the fatal influence of sea-air. In the ponds a diminutive water-lily (*Nymphaea teragona*) is found, the undeveloped leaf-buds of which are considered a great delicacy by the Japanese, and eaten by them with vinegar. The leaf-buds present a peculiar appearance, being covered with a

mucilage resembling fish spawn. The flowers are white, like a small *Nymphæa*. Leaving the sea-shore we struck and followed the valley towards Kuromatsunai. The valley is remarkable for its rich growth of plants, Maple, Alder, Chestnut, deciduous Oak and Ash, forming the principal timber trees; less frequent are Birch, Elm and *Aralia*. The undergrowth is composed of a close growing *Arundinaria*, which is commonly called Bamboo grass, and gives a favorite food for horses and deer. Among climbing shrubs I more particularly remarked the magnificent *Schizophragma hydrangoides*, which I do not think has as yet been introduced into foreign gardens, but which I dare to point out as one of the future leading novelties for our parks. The general appearance of this creeper is striking, and with its white sterile flowers resembles much a white *Clematis* at a distance, although it is a true *Hydrangea*; the rich green tint of its foliage is one of its great attractions. Among other climbing plants, I found *Euonymus radicans* a plant now well known, which covered the trunks of trees in the same manner as Ivy, and is evergreen like its rival. *Taxus cuspidata* is frequently found in shady places, and is the only Conifer growing in these districts. The soil here is black mould, the substratum of which is a dark brown loam.

The Japanese had several settlements here, and seemed to do well. They cultivated various grains and vegetables, especially wheat, which grows here of superior quality: barley, millet and buckwheat are also produced in small quantities, but must be remunerative to the growers as their general appearance leaves an impression of their doing well. *Lilium Thunbergianum* was here cultivated to a great extent, in company with *Dioscorea batatas*, for the sake of their edible bulbous roots. The settlers are all Japanese; very few Ainos are met with here, but these do not represent a fair type of this singular people, as they are entirely dependent on the good will of the Japanese settlers. Their huts and their way of living cannot be compared in any way with those of the same tribe living at what may be considered their head-quarters.

On the pretty stream, on which Kuromatsunai is situated, I found on the stones a singular Lily, which is new to cultivation, named by Professor Gray, *Lilium medeoloides*, from the collections in 1862. It is a singular Lily, and resembles much a *Fritillaria*; and is called by the Japanese; "Kuruma yuri," on account of its leaves

being verticillate—"kuruma," wheel—"yuri," Lily. It bears flowers, generally single, with petals much recurved, of a scarlet color. There was nothing of any marked interest beyond what I had observed hitherto, until I reached Otashuta, excepting magnificent trees of *Magnolia hypoleuca*, which, being in flower, presented a beautiful appearance.

The formation of the ground from Otashuta by Iwanai and Tomari to Otarunai seems to me not very favorable for agricultural purposes, if I may judge from the general vegetation. At Iwanai there is a plain of some extent, but even there, although the position of the ground seems to be favorable, nothing but plants growing on a soil of a poor description could be seen, such as the *Pteris aquilina* (Brake fern) a few shrubby Oaks and others. The young shoots of the Brake fern, Jap. "Warabi," are much prized by the natives as an article of food; the fronds are gathered when still undeveloped and used in soups, etc.

It struck me that sheep would thrive well in this valley, as I have seen similar grounds used for that purpose in the north of Germany, at a latitude of about the same degree.

At Tomari, going up to the coal mine at Kayanoma, I discovered the *Hydrangea spicata*, remarkable in its appearance on account of the large spikes of white flowers, entirely different from any *Hydrangea* I ever saw; another *Hydrangea*, I fell in with, was of a beautiful sky-blue color, not shrubby like the former, and of a much smaller size, growing in shady situations. It is as far as I can ascertain, *Hydrangea acuminata* of Siebold and Zuccarini. Among the rocks I observed two different kinds of Clubmoss, growing side by side, like those well known in America, and always used by the bouquet makers of New York and other large towns in the United States.

A fern called *Lomaria Japonica* is frequent here, and makes a very pretty effect with its variously and delicately tinted fronds; they consist of the sterile ones growing close to the ground, eight or ten in number, out of the centre of which two or three fertile fronds rise perpendicularly.

Shakotan is a place famous for the production of a peculiar kind of Bamboo (*Arundo*), used by the Japanese for stems of pipes and writing brushes. The place where the reeds grow is situated five miles up the stream from the village. It grows abundantly round the stream, and no

traveller, who stops at this place, leaves without securing some of the peculiarly colored reeds. The coloring the Japanese frequently declare to be characters of their own language, written as they believe by their gods.

In the hills near Otanunai there is a fern growing with variegated fronds. Variegated fronds among ferns are very unusual, especially in northern latitudes.

At Sapporo, which I reached the 28th of July, I remained for about two weeks. As it is the Capital of the Island, I thought it important to gain a knowledge of the plants and trees which are more frequently to be met with there. The town is situated in a large plain under a range of mountains, and the soil consists of a deep yellow loam, covered in most places with about a foot of rich black mould, which I had no doubt, judging from the vegetation, might be easily worked to produce rich crops of grain, fruits and vegetables.

[To continue in next number.]

### EDITORIAL NOTES.

**NEW CALIFORNIA PLANTS.**—In the February part of the proceedings of the American Academy, Mr. Sereno Watson gives us three articles; one on the Flora of Guadalupe—a small island of the coast of Lower California; another, a list of plants collected on the same island by Dr. Ed. Palmer; the third, descriptions of new plants, chiefly Californian. The last contains many things that cultivators will be on the look-out for. There are three new Lupines, all blue flowered. Four new species of clover gives Mr. Watson a chance to revise the whole of North American Trifoliums. He makes 39 species in all. *Sophora Arizonica* and *Parkinsonia Torreyana* should make valuable shrubs for the Southern States. The beautiful family of annuals, *Mentzelia*, receives a new addition in *M. dispersa*. A new dogwood from California is *Cornus Torreyi*; it has loose cymes of white berries, with the stones curiously crowned with tubercles. Reference is also made to a curious Palm, with leaves as thready as the well-known *Yucca filamentosa*, and of which we have had specimens sent us by Mr. Rock and others. Mr. Watson says it is a *Brahea* and “introduced into cultivation as *B. filamentosa*.” He describes two allied species—one from Guadalupe Island as *B.*

*edulis*, the other, if a real *Brahea*, as *B. armata*, from 80 miles below San Diego. A *Cyrtopodium*, collected by many botanists in past years, and near *C. parviflorum*, is now made *C. occidentale*.

A small white-flowered shrub from Southern Arizona, allied to *spiraea*, is made *Vauquelinia Torreyi*.

Guadalupe Island is 26 miles by 10, and is 100 miles west of the coast of Lower California. One would suppose from its southern latitude that the plants would be of a tender character, corresponding with that on the mainland, but a glance at the list of 119 given here shows a comparatively hardy class. But this is accounted for when we read that the island is in the midst of the current, which on that side flows down from the North seas; and this should make the flora of a somewhat similar character, as regards hardiness, to that of England, which receives the warmth of the northward flowing or gulf stream. Still the winters are not quite as severe as the English, and the summers are often hot and dry. The Palm, *Brahea edulis*, grows 40 feet high. Only six grasses are in the enumerated list.

**NOMENCLATURE.**—It has always been a mystery what rule our English friends had for their choice of names. Mr. Barron, whose name is closely associated with evergreens, says that in that “old-fashioned country we have been taught that the best name is one somewhat descriptive of the plant.” In this country we hold that the best name is the one which was given with the first description in a recognized botanical work, and we leave to the one authorized to name it all consideration regarding the fitness of things. By following this law of priority we avoid all wrangling about “the proper name.”

**BEES AND FLOWERS.**—The relation between bees and flowers is one of increasing interest. A London paper says:

“An interesting experiment is being made in the shipment of two nests of humble bees, which have just left Plymouth for Canterbury, New Zealand. The principal object aimed at in the introduction of these insects into the antipodes is the fertilization of the common clover, the pollen of which the common bee is generally unable to collect, while the ‘humble bee,’ having a larger proboscis and being much stronger, is able to reach sufficiently deep into the flower to collect the fertilizing dust. It is hoped that by this means the plant will be more generally fertilized, and its cultivation largely extended in the

colony. The bees which have just left England for the antipodes were in two separate nests, which had been procured by Mr. Frank Buckland, and packed in a suitable box, where they were supplied with everything necessary for the voyage, including honey, farina, water, &c. They are very fine specimens of the humble bee. The exact number is not known, as many of the eggs are not yet hatched. They are placed under the care of Mr. John Hall, a member of the Council of New Zealand, who takes a stock of ice for the purpose of keeping down the temperature of the nests while passing through the tropics."

**FREEZING OF THE SAP OF PLANTS.**—Our readers know that we have furnished innumerable evidences that the juices of plants do not freeze, and the plants so frozen continue to live. And how strangely some of our friends quite distinguished in science persist in ignoring these facts. One of them, President Clark, when the observations referred to were brought to his notice, deeming them of no further importance than the short reply, "Of course the sap freezes." In spite, however, of these contemptuous expressions, we hope to be pardoned for continuing to place on record such facts as seem to prove the point.

In the *Gardener's Chronicle* of March 25th a correspondent, B. Piffard, records an experiment made with the juice of the cabbage leaf. Two glasses, one filled with pure water, the other with water and the juice of cabbage leaves, were placed side by side in a frosty atmosphere. At the point where the pure water froze the solution of cabbage juice remained liquid. And he goes on to infer, as we have often done, "that if a plant survive a degree of cold at which other plants perish, their preservation is attributable to the non-congelation of the sap." Does it not occur to the reader that something more than "Of course not" is required from President Clark and our other friends to set aside such reasoning as this?

**FERTILIZATION OF LILIES.**—Those who are interested in the fertilization of flowers would do well to watch how Lilies behave in nature, as well as to experiment with them under culture. Mr. Parkman found the pollen of some kinds had potency for fertilization, but with very little power to stamp its own characteristics on the progeny. The cases of this power were very few, and *Lilium Parkmani* was the chief result. In nature

some species show a very prolific character—*L. superbum*, for instance, usually producing seeds from every flower. On the other hand, *Lilium Canadense*, even when the flower is crossed by foreign pollen, for which much is claimed by some physiologists, is very often barren.

When the *Lilium auratum* (a sketch of which accompanies this) was first introduced much was expected in the way of hybrids, but so far little has been done except in the case of *L. Parkmani*.



**EFFECT OF WEIGHT ON TENDRILS.**—A remarkably interesting paper has recently been contributed to the *Gardener's Chronicle* by Mr. D. T. Fish, showing how weight influences the production of fruit in the grape-vine. We leave out what Mr. Fish says about the nature of grape-vine tendrils, because morphologists now know that a bunch of grapes is nothing but a set of transformed branches, and that a tendril is the same thing in a lower stage of development. We also leave out Mr. Fish's explanation, because that has been better explained by the author of "Waste Force in Vegetation." The interesting facts of Mr. Fish are, however, worthy of careful thought. He says:

"Having charge of a large vinery at the Messrs. Tattersalls', Hyde Park Corner, London, between thirty and forty years ago, he found that though he could command good shows of

grapes by means of the genial atmosphere provided by a stock of fermenting manure within the house; hardly had the flower peduncles grown to anything like their full length when, probably in sympathy with dormant and diseased roots, they began to twist round any branch or twig they came in contact with, and to run into tendrils. He soon found that when the twists were removed the tendency to run into tendrils was arrested. This was one step gained. Partly to better the lesson thus learned, and with a view of confirming the dependent position, small weights were attached to the bunches. The result was as gratifying as it was at first unexpected. The untwisting and the weight together soon checked the formation of tendrils, and forced the sub-peduncle into its proper character of a bunch of grapes. When I lived with my brother at Putteridge Bury, there was an old vinery with the roots in a bad state, or very deep. The grapes in this were always in danger of bolting off into mere tendrils, unless weighted into fruit bearing, and we used to weight each with small pebbles as soon as they fairly showed. If any were missed, or if the pebble or other weight slipped its tie, these bunches ran off into tendrils, while I do not remember an instance of one sufficiently weighted doing likewise. Since then, during more than twenty years' practice, I have weighted many suspicious-looking bunches, and always with the result of checking the degeneration of a fruit branch into a mere tendril. In this reversion or degradation of parts there is often a great variety of structure. The flower-stalks, soon after they are formed, often branch off into a number of hooked semi-tendrils, resulting, of course, in a fruitless state; on the other hand, true tendrils that show flowers on the extremities or other parts—for these flowers are by no means confined to the extremities—set and swell their fruit better if also weighted.

“It is well also to note that the weighting of the sub-peduncles is not nearly so effectual, unless the twist is carefully undone. There can be no doubt that that single revolution dominates to a large extent the character of the entire branch beyond, and confirms in a powerful manner its tendrilward tendencies; in fact, unless that circle is undone, it is comparatively useless to attempt to lure back the runaway bunch into fruitfulness. I have even seen such sub-peduncles weighted above the twist suddenly snap off and the remaining portions run off into true tendrils.

More wonderful still, perhaps, as showing something akin to a sympathy of parts, and like dominating like, the success of weighting is enhanced by removing the tendril. I have also noticed that the tendency of the sub-peduncle to form a tendril is increased in proportion to the strength and length of the tendril, and would, therefore, strongly recommend the removal of all tendrils at the earliest possible moment.

“The effect of weight in promoting fruitfulness is further seen in the fact, that as soon as any fruit sets and begins to swell on the sub-peduncle, the formation of tendrils ceases. The natural weight of the berries brings back the wayward branch, as it were, to its proper business—that of fruit bearing. So strong is this check that I have seen tendrils on the fruit-bearing branch attempt to form flowers after the berries began to swell. The same fact is strikingly illustrated by the second flower on Muscat grapes. I never remember to have seen one of these sub-peduncles run into a tendril; on the contrary the tendril is often wanting, or changed into a part of the bunch, thus converting it into a cluster. Another singular fact has often been observed in regard to these, and that is, that however imperfectly the first crop may have set or swelled off, the second or third successional crops invariably set and swell well. It would be interesting to prove what effect the weight of the first crop had on the freer setting and more rapid swelling of the second.

“That weight has something to do with it is almost demonstrated, else how can the facts already advanced be explained?—or the additional one that by weighting the blossoms of cucumbers and melons we promote the setting, and stimulate the swelling of the fruit? I have adopted this course with cucumbers hundreds of times, and always with uniform success.

“Now, in almost every case the weighted fruit only will swell, and if some of the others attempt to follow its lead it will nevertheless outstrip them all. Pressure is as potential as a weight suspended, and I have often covered over shy setting melons with an inch or two of warm soil at the period of fecundation, and the progress they have made has been quite astonishing and not to be accounted for by the increase of heat or humidity, to which the buried fruits were subjected. The stimulus to the growth was so great, that if the fruits were carefully exposed to the light afterwards, they receive such a stimulus as to ripen a week or more in advance of

those not covered, and sorts difficult to set freely did so by either weight or covering."

**ANNUAL ROOTLETS.**—At a recent meeting of the Academy of Natural Sciences, of Philadelphia, Mr. Thomas Meehan called attention to the many varying hypotheses in regard to the eccentricity of the annual layers of wood in plants, which is sometimes so great that, as recently shown by a writer in *The American Naturalist*, the pith (in the common Poison Vine), is wholly on one side, and once in a while seems like a little ridge running along just beneath the bark. In the Poison Vine the greatest thickness of wood seems generally on the side between the pith and the object the vine clings to, and the writer referred to surmises that the rootlets coming out on that side may have something to do with this interior thickening. Another gentleman, Dr. Hickok, of Poughkeepsie, thought only those trees which sloped a little thickened chiefly on the under side. These hypotheses were inconsistent, and Mr. Meehan thought the true cause of the thickening of woody layers more on one side than the other had yet to be explained. The rooting on the under side could not cause the thickening of the wood, as *Wistaria* and many others which he mentioned, rooting on the ground as they ran, did not thicken in consequence; while *Ampelopsis* did, as well as the Poison Vine. The rootlets by which the Poison Vine attached itself to the trees had been referred to as being of some age; but this was a mistake, as in most cases save some orchideæ and a few other plants aerial rootlets, like rootlets beneath the earth, were mostly annual. The whole root system of plants was, indeed, but the analogue of that system which existed in the atmosphere. Morphology had made a great stride when it pronounced all the parts of the inflorescence but modified leaves.

Botanical science had yet to go further. The whole plant was but a modified leaf, roots as well as branches. The same general laws that we found in the aerial system, therefore, had their correspondence in the terrestrial one. In the terrestrial system we generally saw a marked difference in the leaves and branches; but in some cases, as the arbor-vitæ and deciduous cypress, the two were so blended together that at the annual "fall" season branchlets and leaves all fell together. In these cases we saw that some of these compounds of leaves and branches—those the most favorably situated as regards nutrition—maintained a hold on life, and, once passing this critical time, had an indefinite lease of life thereafter. It was precisely the same with the rootlets of trees. They were the representatives of leaves, and myriads died every year. Only here and there one endowed with greater vital privileges escaped the annual "fall," and then it became a "root," with various terms of endurance. Aerial roots, used by some creeping vines, were under the same laws. Now and then one would find itself in a soft crevice of an old wall or in the decaying hollow of an old tree, and thus become a permanent feeder to the vine. In England the Evergreen Ivy had been cut down near the ground, after running for years over old ruins, and had continued to live on. But in these exceptional cases it was found that some of the rootlets, as the rule, annual, had found some soft place and taken on a permanent character—had become real feeding woody roots. He exhibited some old stems of *Ampelopsis Virginiana*, which for many years had been hanging unattached from the branches of a tree, and which had eccentric wood, as in the attached Poison Vines, and the surface was covered with aerial roots, which were produced and died annually.—*Independent*.

## LITERATURE, TRAVELS & PERSONAL NOTES.

### EDITORIAL NOTES.

**AMERICAN POMOLOGICAL SOCIETY.**—Transactions for 1875. Chicago meeting. Edited by the Secretary, W. C. Flagg, Moro, Ills.

There have been no issues of the transactions of this Society that were not a credit to the Society and to the country. It will be no discredit to them to say that, in real value, we regard this one as the most valuable of all; for horticulture is expected to be progressive, and its literature



should travel the same way. A great advantage to the Society on this occasion is that the whole will be fresh to the reader. In former years the matter had mostly found publication before the volume appeared.

Mr. Flagg has had a great deal to do in getting together the matter for the volume. The bulk of oversight of the printing has fallen on Mr. P. Barry, who thus earns an additional claim to the consideration in which he is already held by American horticulturists. The volume is free to members, and four dollars sent to Mr. P. James, Cambridge, Mass., renders one eligible to membership.

INDIANA HORTICULTURAL SOCIETY.—Transactions for 1875. From W. H. Ragan, Secretary.

We do not know that we have ever been more pleased with any "annual address" than that of President Gilbert, as reported here. In speaking of the objects of the Society, he refers to its duty in furnishing the fruit growers of Indiana with reliable lists of fruits, and in the "broader field of inculcating a love of the beautiful in nature, landscape gardening, arboriculture, and floriculture, not forgetting vegetable gardening, and all that pertains to the kitchen and dining-room." It is eminently practical in going into the details of the horticulture of public buildings and grounds, where above all in a country like this we should expect to see good gardening. It is strange reading. The Blind Asylum at Indianapolis is "surrounded by delightful grounds, fountains, beautiful shade-trees, green lawns, beautiful flower-beds, and well-kept walks, while the Normal School at Terre Haute has no trees, no grass, no flowers—a bleak, barren place, with a tumble-down fence." The same queer anomalies prevail through the whole report.

It is to be regretted that "delegates" to other societies should do no more than hand in as "their" reports, clippings from the local columns of the daily papers where the meetings are held. The reporters of these papers know nothing of horticulture, and are very often young men, ignorant of short-hand, and who can but just manage to write down the first part of a sentence, and omit the last part for want of time before getting at the next. Every speaker knows the horrible work these gentlemen make. They do the best they can, and we are all thankful, but we expect *delegates* who undertake reporting to do better, and not lazily take newspaper

reporters' work and palm it off as their own. Here we have a delegate reporting that "Mr. Meehan said a hop vine growing over a pear tree would keep pears from cracking," in his remarks at Chicago. This was perfectly excusable on the part of the young man who reported for the *Chicago Tribune*, and it received at the time the compliment of a good laugh; but it is a very absurd statement for one who heard Mr. Meehan's remarks, to make in a report to the Indiana Horticultural Society.

NEUNZEHUTER JAHRES-BERICHT DES GARTEN-HAW-VEREINS FÜR BREMEN. 1875. (Nineteenth annual report of the Society of Horticulture of Bremen, 1875.) Pamphlet form just received, containing, besides the annual reports of the officers, many useful articles on greenhouse and hot-house plants. Illustrated.

COL. WILDER.—It must be gratifying to this distinguished gentleman to receive in his old days so many testimonials of regard for his services to his fellow-men—services which have already extended far beyond an ordinary life time. But a few weeks ago, the New England Historic and Genealogical Society, of which Mr. Wilder is President, had his portrait, painted by Marchant, presented to it, which was acknowledged in the following complimentary resolutions:

*Resolved*, That our cordial thanks be presented to Mr. Edward D. Marchant, of Philadelphia, for the original portrait of Hon. Marshall P. Wilder, recently executed by his hand, and generously presented by him to be placed in the gallery of this society.

*Resolved*, That we cherish this gift both as a memorial of our President, whose long years of valuable service have placed us under lasting obligations, and likewise as an exhibition of the extraordinary power of the artist, whose genius has transferred to the canvas, with marvellous life-like expression, the features of one whom we respect, venerate and love.

*Resolved*, That these resolutions, with the note announcing the gift, be placed upon the records of the society, and that a copy of the resolutions be forwarded to Mr. Marchant, at Philadelphia.

Then a few days since the Massachusetts Horticultural Society have presented to him a large picture representing the grand opening of the United States Agricultural Society in 1855. A Boston paper says:

"The scene represented by the artist is the opening of the exhibition. The grand cavalcade

is on the track, headed by President Wilder, on a splendid white charger, supported by Gen. John S. Tyler, Chief Marshal, on the right, and Gen. Wm. S. King, Secretary of the Society, on his left, with twenty-five marshals, all mounted, following in succession. Most of the figures are real portraits. On the left are representatives of celebrated breeds of cattle and sheep, and on the other side the immense stage crowded with thousands of spectators. The precise moment which the artist has chosen for illustration represents Col. Wilder with raised hat and extended arm, announcing the opening of the exhibition."

Mr. Wilder must feel highly gratified at these evidences of esteem, and the more so from the consciousness of having fairly earned them.

JOHN T. NORRIS.—This distinguished individual, whose dealings with nurserymen render him an object of their tender solicitude, has recently received the following notice from the daily papers:

"A man named John T. Norris, who lives in Springfield, O., is carrying on a systematic and very extensive swindling business. He advertises his headquarters at Springfield and Cincinnati, and orders goods and products of various sorts from firms in all parts of the Union and Canada, referring them to bankers and other business men. When the goods arrive they are immediately taken from the express office or freight depots, and transferred to other parties for any amount Norris or his confederates can get for them. Norris was in the Ohio penitentiary for swindling nearly a year but was discharged through a legal technicality, and has been carrying on his business since on a larger scale than before."

BURNETT LANDRETH.—This gentleman, to whom the Agricultural Department of the Centennial Exhibition owes so much of its great success, has been appointed by the Scottish Arboricultural Society its leading representative in the great exposition.

AGE OF MR. CHARLES DARWIN.—In a note recently, it was stated that this gentleman was born on the 12th of April, 1800. This is on the authority of Shirley Hibberd's Almanack for 1876. A correspondent points out that Lippincott's Biographical Dictionary gives the date as February 12th, 1809, which strikes us as being more likely to be correct.

HAND BOOK FOR FRUIT GROWERS, by F. R. Elliott. Published by D. M. Dewey, Rochester, N. Y. What comes of all the fruit trees raised and sold annually in the United States? This question is often asked, and the response is, most of them die. There is a sad want of knowledge among the people, notwithstanding the great number of fruit books and agricultural magazines. As for the general fruit books, they are mostly too expensive and too elaborate for just the class who lose the most trees. A first-class book, yet cheap, touching on every branch of fruit culture, ought to be immensely salable, and of great use, and we think this little attempt "fills the bill" exactly. There is often much grumbling about the bad doings of tree agents and tree peddlers, but if they could be induced to take around with them a little book like this to sell while taking orders, we think it would balance accounts with a world of sin.

SECOND APPENDIX TO DOWNING'S FRUITS.—This has just been published by, we suppose, Wiley & Co., and, like the others, is from the pen of Charles Downing. It brings pomological knowledge down to date.

ORCHID CULTURE. By E. S. Rand, Jr., New York; published by Hurd & Houghton. From Claxton, Remsen & Haffelfinger, Philadelphia.

Mr. Rand's works are put out in the most beautiful style known in horticultural literature, and this is equal to any that have gone before. The typographical execution is nearly perfect, and this is a good feature in a work with so many "hard names" as orchideæ possess.

As regards the matter of the book, we suppose Mr. Rand does not want to claim much on the score of originality. 272 pages out of 472 are made up of descriptions of the best known species, taken from various sources. Why he has given no description of the genera as well we cannot explain, unless it be that the botanical works in which they are described are not so convenient of access to copy from. There are lists of orchideæ for cool-house culture, similar to those which have appeared in the *Gardener's Monthly*, *Gardener's Chronicle*, *Garden*, and other publications.

Indeed, it is Mr. Rand's weak point that he hardly does justice in his works to his cotemporaries. He, for instance, professes to give a "History of Orchid Culture in the United States," and what he knows of this subject, as it relates to Philadelphia, he tells in the following words:

"In Philadelphia, Robert Buist, one of our oldest florists, has a small orchid house. Mention should also be made of a small assortment grown by Caleb Cope, in Philadelphia, about 1850, which was dispersed after his death!"

It will be strange news to the flourishing young family of our good friend, Caleb Cope, to hear of his death in this sudden manner. We hope and believe, however, that this esteemed and honored gentleman will yet live many years, and that when in the fullness of time he shall be called away from us, his great services to horticulture and to orchid-growing horticulture will be recorded by a more intelligent pen. In the great collection at Glen Ridge—his own collection—which in his "history" Mr. Rand so much glorifies, there are but 269 species,—a list we are quite sure the "small collection" of Caleb Cope equalled, if it did not excel. There was nothing of consequence known at that day, that was considered worthy of culture, that was not purchased; and the collection was continually being weeded out, and the places filled by the kinds on trial. Besides the orchid house, the large Victoria lily house, and other houses, were made to do duty to contain the plants of this superb collection.

Then there were the magnificent collections of James Dundas, Mrs. Rush, and Matthew W. Baldwin, about which Mr. Rand seems to know nothing at all, besides smaller collections by other persons,—and at the present time surely the collections of Mr. Pratt McKean, and of Mrs. Baldwin, under the management of those excellent gardeners, Messrs. Newett and Joyce, are worthy of some note in a "history."

We confine our criticism to the Philadelphia part of this so-called history. Baltimore may ask why Captain Snow has been overlooked, and other cities may have each its own grievances. We regret to have to make these remarks. In many respects we regard Mr. Rand as one of the best friends of American horticulture, and he is capable of much better work than this. But American cultivators have great difficulties in making themselves known. The Old World like a wealthy firm in business, has a perfect machinery for advertising its doings. It is extremely difficult to run against established channels. Even our own people, who ought to know better, are prone to think there is no horticulture at all in America, and look to Europe for the supply of every little trifle they want, and for every scrap of informa-

tion they need. Those of us who are laboring for American advancement, are anxious, not that we shall have a reputation before Europe for what we do not deserve, but that we should get credit for what we have; and it is therefore peculiarly mortifying to these workers to have books like these go forth to the world as the best that America can do.

Amidst all this to regret, there is one comfort: nothing is really so simple as orchid culture—nothing in floriculture more fascinating. Mr. Rand's book is a beautiful one, and with all its shortcomings, is calculated to increase the taste for these curious plants. It is far from doing justice to the subject, but it will aid in a good cause.

MANUAL ON THE CULTURE OF SMALL FRUITS.  
By E. P. Roe.

Small fruit culture is much further advanced in America than in Europe, but we think comparatively in its infancy here. All engaged in it continue to find something new, and every writer who honestly gives his own practical experience, is helping small fruit culture to a healthy and vigorous growth. Since we wrote our last paragraph in reference to Mr. Roe's little book, we have the volume itself. It is just of the character we have referred to, and will have its good use. We fancy some cultivators would do things differently, and that is well enough. Mr. Roe simply tells what he has done and what he would do, and on the whole what he says commends itself to our judgment. He is not extravagant in praise of varieties. Of the Highland Hardy raspberry, for instance, he tells us that it is "infinitely better than none," and after all this may be, at the option of the reader, great praise; for the best any one ever ate may claim just such a character.

Mr. Roe is a successful raiser of seedling fruits. His gooseberries received high praise from Prof. Thurber, who is usually careful and discriminating in his judgment, and if Mr. Roe's practice in small fruits prove as good as his varieties, the little tract will be well worth the 50 cents asked for it.

THE MILL STONE.—A monthly journal of practical science. Richmond, Ind. No. 6. Above the average of "family papers," as the Western magazines generally are. We are pleased to note that a good friend of the *Gardener's Monthly*, Mrs. Helen V. Austin, takes excellent charge of the department of "boys and girls." She treats them

to articles on natural history, in a style the youngest can understand.

THE RURAL NEW YORKER.—Mr. Moore, so long and so agreeably known in connection with the *Rural New Yorker*, has had to retire by reason of failing health. The paper comes into the hands of many of the former associate editors

who have formed the "Rural Publishing Co." Mr. A. S. Fuller is chief editor. Mr. Fuller, to excellent literary abilities, has the additional advantage of a thorough practical education. He knows what the American farmer wants, and what they ought to have in order to progress; and with the ability to supply, the *Rural* must continue in its own successful path.

---

## HORTICULTURAL SOCIETIES.

---

### EDITORIAL NOTES.

---

OPENING OF THE CENTENNIAL EXHIBITION.—The Horticultural Department is hardly yet in a condition to do justice to the exhibitors, and a critical notice must be deferred till the future. In the meantime the following sketch intended for the mass of the people not well versed in Horticultural matters, from Forney's *Daily Press* of May 11th, giving an account of appearances at the opening, may serve as an introduction to more solid matter which will probably follow:

#### HOW HORTICULTURAL HALL LOOKED.

*Thomas Meehan's Description—Features of the Exhibition already in Place.*

The rain, so dampening to the well-wishers of the great opening, provoked so monotonous a series of remarks all around that I was glad to meet the cheery face of Mr. John Stevenson, the landscape gardener of the Centennial Grounds, for surely, thought I, here is one who will like to be congratulated on the timely rain, and so we ventured on that strain. But no! It was all right, he thought, for bringing out the bright green grass and the shiny foliage of the deciduous trees, but of what use was that if the people could not enjoy it? The trees and vegetation, both those natural to the beautiful grounds as well as those furnished by the exhibitors, seemed really to enjoy the timely gift from

heaven, and I entered fully into their thankful spirit. But there are few natural flowers as yet. The dogwood, which the wits tell us is known by its bark, as well as by its beautiful white flowers, was ready for the occasion; and the red bud, which is the American representative of that tree which, according to the Book of Gerard the Herbalist, and which in the "ancient writings" of the Horticulturist, is "ye tree whereon Judas did verilye hang himself," was covered with its rosy blossoms. The weather, after all came out just right. English weather in the morning—American in the afternoon, just fair and right for an international exhibition.

The Horticultural Grounds are not yet quite completed by the exhibitors, but so far as the work is done it is a marvellous success. In the exhibitions of the Old World the plants were removed just as ordinary nursery trees are—with the usual result—a deplorable appearance the whole summer after. But our American exhibitors have improved on this. Many of them have had their trees growing in tubs and pots for a whole year ahead, and now that they are set out, they are leafing out and blooming as if they were "to the manor" as well as to the "manner" born. There is little doubt the outdoor Horticultural Department of the Centennial Exhibition will be the most successful of that class ever held in the world. Most of the exhibitors have their plants plainly and tastefully labelled, thus making the collections to the highest degree

educational. It was said in an English horticultural periodical that some of the English nurserymen intended to come over with their goods and astonish the Yankees. It is astonishing that their plants have arrived in such good condition, but it seems just likely that the astonishment will be mutual, and do good all round. It was pleasant to meet on the grounds so many representatives of foreign firms: Benary, of Erfurt; Court, of the celebrated firm of the Veitche; Waterer, the rhododendron man; and Williams, famous for the introduction of new tropical plants, were on the grounds. Waterer, with his rhododendrons, was first on here. They are not displayed yet, but if superior to those of the American firm of Parsons & Son, of Flushing, they will be very fine indeed. The leading exhibitors, who have in a measure completed their plantations, are S. B. Parsons & Sons, R. B. Parsons & Co., of New York; Asher Hance & Sons, of Red Bank, N. J.; Hoopes Bros. & Thomas, of West Chester; Veitch & Sons, of Chelsea, England; and in azaleas, Waterer, of London; Robert Buist, of Philadelphia; Miller & Hayes, of Mount Airy; Verdier, of Paris; and Ch. Pohl, of Austria. The last has a collection that will astonish Americans by its novelty. It is a collection of gooseberries and currants grafted on the stem of our wild Missouri currant, which is a strong sort, growing four or five feet high. These are already in front of Horticultural Hall, in flower, and when the red fruit matures they must make very striking objects.

The Japanese have a small collection of dwarf evergreens in front of their building. The kinds, however, have for the most part been already introduced by our enterprising nurserymen, and are found in their collections. It shows that the celebrated skill of the Japanese in dwarfing evergreens is fully matched by our own horticulturists. They simply select the dwarf forms—the Tom Thumbs of the vegetable kingdom—and propagate from them. The trained fruit trees of some of the European exhibitors are greater monuments of skill.

Horticultural Hall is yet but partly filled. Plants cannot travel long distances in cold weather, and the more tender kinds must yet wait a while. It is wonderful that so much is already here. Mr. B. S. Williams, of Holloway, near London, has been very successful in bringing over a nice lot of rare hot-house plants. These are in the northeast conservatory. The plants are, of course, small in comparison with

what our home florists can contribute, but it is a remarkable collection for so great a distance. The several varieties of Bornean pitcher plants attract much attention from the curious visitor. In this house there is a small but very choice collection of those tropical curiosities, known as orchids or air plants. Many more are expected later in the season, when the weather is safer for their transportation. These few are from Mr. Sturtevant, of Bordentown, N. J. Among these flowers are mimic representatives of the ornithological and entomological worlds. S. B. Parsons & Sons, of Flushing, N. Y., have a collection of ferns in this division, which is pronounced exceedingly choice by those skilled in pteridology. The centre of the house is occupied by Australian tree ferns, contributed by Miller & Sievers, of San Francisco. In the northwest house we found Mr. Taplin, the well-known superintendent of Geo. Such's fine collection at Amboy, N. J., with what is so far the most valuable collection of tropical plants in the Exhibition. There is a plant of the snowy wax palm, some twelve feet high, of which small specimens are valued at \$100 each. Usually, palms have a graceful look, but the devil palm, *Daemonorops hystrix*, is horrible to look upon. The usually humble fern gives us here a representative with a stem five feet high. This is the way they grow in Australia. There are plenty of sago palms in the hall, but here is one in flower. It looks as if nature had simply placed a crown of oak leaves on the head of the palm. The flowers, however, come to nothing, as among sago palms marriage is necessary to perfect happiness. A new kind of sago palm is in Mr. Such's collection, called *Cycas circinalis*. The sago is made from rotting the stems—expensive sago at the figures at which these plants are held. The whole collection of palms is perhaps one of the most valuable ever seen at any great exposition, and surprises those of our English friends who fancied Americans far behind in these tasteful luxuries. The flamingo plant drew numbers within its brilliant circles. It is somewhat allied to our well-known calla lily, but few but botanists would suspect the relationship. There are about fifty expanded flowers on it. The florists call it *Anthurium Scherzerianum*. Not fit to associate with respectable vegetation, and therefore, confined in a small glass case, is a collection of those savage little things known as insectivorous plants. They have cut loose from the simple habits of their forefathers, Mr. Darwin tells

us, and have taken to eating bugs and flies, not refusing pieces of beefsteak when they get a chance. There is one kind from New Holland, another from Java, and one wretched little fellow was found in our own country, near Wilmington, North Carolina. They are all here safely guarded by the box, and in imprisonment together. And those oddities, the cacti, have some choice representatives in this superb collection. The visnaga, or Mexican tooth-pick cactus, is among them. This one is only about the size of an ordinary football, though it would hardly do as a substitute, but in its own country it grows to the size of a sentry-box, and the writer has helped to handle one that weighed over a ton. Nature must have been in a strange mood when she made these things. Just beside these is the table-formed house-leek, looking for all the world like a cabbage rolled out flat. Perhaps Nature, tired of the labor involved in cactus-making, sat on these plants to rest, and thus these flattened results. Across the hall, in the southeast conservatory, is the Cuban contribution of Mr. Lachaume, of Havana. The good old gentleman was personally attending to the placing of his pets, many of which have suffered severely from the long voyage to a cooler clime. Very appropriate to the Centennial occasion is his collection of century plants, embracing over forty kinds. In one corner he has several blocks of plants cut from the forest giving a better idea of these tropical wood-growths than all one could read about them in a lifetime. Here are orchids and cactuses and ferns, and "preacher in the pulpits" of a decisively tropical countenance, all seemingly as happy together as a bunch of soup-herbs in our Eastern Market-house. Among the curious plants in this collection are numerous forms of the "Dutchman's pipe-vine." The American forms are shabby fellows in comparison with these. They throw out a long lip-like petal, veined precisely like a piece of flesh, but the mimicry does not stop here. The plant has become too lazy to work, and seems to have studied out a plan to make insects slave for it. Instead of fertilizing itself it depends on insects for carrying the fertilizing pollen to the pistil, and in order to lure them to this thankless task, besides the flesh trick above referred to, it creates a stench to which that which the fiend introduced about the good Saint Anthony was incense itself. The insects are enraptured with the prospective carrion, rush in, and in this way

fertilize the flower, but find, alas! when too late, that they have entered their tomb, and in a few days wholly disappear in the form of food for the large ants that have their home in great abundance in these parts of the world. Capital texts for sermons, these Centennial experiences afford, but these matters I shall leave to our clerical friends.

But we must not linger long in any one place to-day. The Hall itself, under the direction of Chief Miller, is quite as forward as any other department: but new attractions will now appear every day. In a hurried look we noted the great sago palm owned by Robert Morris, which has a stem now, perhaps, four feet high; and there is another remarkably beautiful one from Mr. De Puy, of Cuba, with the leaves so regular and close that it is the envy of those having a passion for these things. There is a small plant of the sacred fig of the Hindoos which will catch many an eye when it gets a label on. Several plants are here of the now famous Eucalyptus globulus, a competitor in growth with Jonah's gourd; with the "brave old oak" of England in the solidity of its timber; with Jayne's, Helmbold's, and all other antidotes combined as a febrifuge; and with everything under the sun—so a French professor tells us—for securing sleep to one's mother-in-law, soundly in spite of dullest sounds from mosquitatorial pipes. There are also Acacias in great numbers, but too late in the season to see them "wave their yellow hair;" a fine camphor tree, some twenty feet high, and a great number of kinds of banana plants. A large plant marked "Chocolate tree," is unfortunately not that celebrated plant; but there are guavas, Japan plums, mangoes, Indian rubbers, and many similar things which we often read about but seldom see. Many visitors missed the side rooms, but there are nice things to see from Peter Henderson, H. A. Dreer, Françoise Huss, who has some remarkably well-arranged skeleton leaves; Charles H. Marot, with a set of beautifully-bound volumes of the *Gardener's Monthly*, in a beautiful case to match, and Hewes & Co., of Boston, Mass., have some remarkably beautiful specimens of horticultural pottery ware. For Waterer's Rhododendrons, a house to be covered by a muslin shade has been started, in which the plants are to be arranged as in a tasteful piece of landscape gardening. Only for the immense conservatory near it, the Rhododendron house would be thought a mammoth structure.

THE  
GARDENER'S MONTHLY  
AND  
HORTICULTURIST.

DEVOTED TO HORTICULTURE, ARBORICULTURE AND RURAL AFFAIRS.

Edited by THOMAS MEEHAN.

VOLUME XVIII.

JULY, 1876.

NUMBER 211.

FLOWER GARDEN AND PLEASURE GROUND.

SEASONABLE HINTS.

New sown lawns are liable to be crowded with weeds. There seems no better remedy than to hand-weed, filling the holes made with earth in those cases where the roots are large. In some cases this hand-weeding will have to be done for two or three successive years. The seeds of the common Plantain, for instance, do not all germinate the first. It is often three years before they all grow. The greatest labor is during the first year of sowing, however. The increased encouragement of the grass helps to keep down weeds.

Ornamental hedges that are thin at the base receive much encouragement from cutting back the strong top shoots. Indeed, this applies to all growths, trees and shrubs, evergreens included. Any check to the more vigorous shoots while growing encourages the weaker ones. Remarkably beautiful specimens of anything may be had by noting this. The branches are rendered uniform in vigor by this sort of watchfulness, and can be made regular from bottom to top.

Plants set against walls and piazzas frequently suffer from want of water at this season, when even ground near them is quite wet. Draw away the soil around each plant so as to form a basin; fill in with a bucketful of water, allowing it time to soak gradually away, and when the surface has dried a little, draw in loosely the soil over it, and it will do without water for some weeks. This applies to all plants wanting water

through the season. If water is merely poured on the surface, it is made more compact by the weight of water, and the harder the soil becomes, the easier it dries; and the result is, the more water you give the more is wanted.

It must, however, be borne in mind that much injury often results to the newly planted trees from summer watering. The cold water cools the ground, and we need some warmth in the soil to encourage new roots to push. Still, trees must have some water when the ground is dry, but it must be used with caution.

Amateurs may have some rare or choice shrub they may desire to increase. They may now be propagated by layers. This is done by taking a strong and vigorous shoot of the present season's growth, slitting the shoot a few inches from its base, and burying it a few inches under the soil, or into a pot of soil provided for the purpose. The young growing point of the shoot should be taken out in the operation. By the English mode of making the slit, a great number of the shoots will be broken and spoiled. Anything can be propagated by layers; and it is an excellent mode of raising rare things that can be, but with difficulty, increased by any other.

COMMUNICATIONS.

ROSE—DUCHESS OF EDINBURGH.

BY MR. E. LONSDALE, GERMANTOWN, PHILA.

I send a flower—though it is a little past its best—of the new tea rose, Duchess of Edinburgh. If you have not already seen it, I

thought it might interest you. I am disappointed in the color, as according to descriptions and colored plates, it should be a "deep glowing crimson." It is, as you will see, very little darker, and not so bright, as the good old, and deservedly popular, Bon Silene. Location and soil may make some difference; but the plants here have been fully exposed to the light, and no plants could look more healthy. I think this is one of its characteristics, for not a sign of mildew has been observed during the six months I have had the plants in my possession, but have worn a dark, luxuriant green, making it very readily distinguished from any other variety.

### ARBORETUM AMERICANUM.

*List of One Hundred and Seventy-five Specimens Ornamental Deciduous Trees, in the Grounds of Messrs. Hovey & Co., Boston.*

BY C. M. HOVEY.

Long ago, in the *Magazine of Horticulture*, I urged upon all lovers of trees the importance of employing a greater variety in the formation of pleasure grounds and parks, and the very great addition such variety would be to our landscape scenery; abundant as the material was, and rich also, giving not only variation of outline, but diversity of foliage; not only the verdure of summer, but the glorious autumn coloring which no other country can claim; not only the formal, round-headed horse-chestnut, but the pyramidal oak; not only the maple, beautiful as it is, but the massive grandeur of the magnolia; not only the flowing grace of the elm, but the exuberant richness of the weeping beech; not only the stiffness of the Linden, but the fringing exquisiteness of the Kentucky coffee tree; not only the gaudy berries of the mountain ash, but the golden panicles, set in feathery foliage, of the *Kolreuteria*.

Gilpin (whom Loudon so often quotes as his best authority), in his classic volume on *forest scenery*, remarks, "If a man was disposed to moralize, the ramifications and spray of a thriving tree afford a good theme." And he devotes several pages to descriptions of the spray of the oak, beech, ash and elm, illustrating his remarks with engravings. In fact, to a real lover of trees, a winter view is a study, and almost as gratifying as that of the summer fullness of foliage. An elm forming one of a long row, near our

daily walk, is a never-failing source of pleasure the year round. It is what I might justly call the zig-zag, or, perhaps, serpent elm. The outline of the head, which is 60 feet high, appears quite symmetrical; but the branches which form it run in every possible direction, like huge boa constrictors curled beneath the leaves. Yet these limbs contort and twist in a regular order of their own, and only in winter, except by close examination show their peculiar character.

Besides the spray, which is so varied and pleasing, we have the lightness or heaviness of foliage; the early or late leafing as well as the early or late fall of the foliage; the roughness or smoothness of the bark; the light or dark color of the same; the yellow, brown or scarlet autumn tints of their leaves; the beautiful flowers of some, and the conspicuous fruits of others; each possessing some wonderful characteristics which make variety, and add to the expression of every landscape or ornamental plantation.

Long since impressed with the importance of such variety, I have endeavored to procure every tree which would be likely to prove hardy in our climate, and in 1844, when abroad, I selected from the leading nurseries of England, Scotland, and France every tree of this character then to be had. The quantity was very large, but quite a number did not survive the voyage, and many succumbed to the first very severe winter. Several were cut down and burnt, not being distinct, and others not specially noticeable served in the same way for want of room; yet we find, to our very great surprise, on counting them up, that we have nearly two hundred species and varieties left. The oldest trees were set out in 1844, and the others from year to year up to 1865, since which time the trees are too small to deserve the name of specimens, several of which are thirty to sixty feet high, and a number twenty to thirty feet in breadth.

For convenience, as well as for reference to authentic descriptions and engravings, I have arranged them according to Loudon's "Arboretum," the most complete work ever yet written upon trees, and perfectly astounding in regard to the information he gathered together about every tree. Descriptive, geographical, historical, useful, poetical and legendary; soil, situation, insects, diseases, propagation, &c. That Mr. Loudon should have accomplished this great work while editing the magazine, is simply amazing. The late Dr. Lindley, we think, called



him merely a compiler; but the original ideas and criticisms scattered through the "Arboretum," as well as all his books and magazines, would fill a dozen ordinary volumes, and they have moulded and formed the present English taste for landscape art, as they have also influenced to a great degree the taste in our own country.

## MAGNOLIACEÆ.

1. *Magnolia tripetala*, The three-petaled *Magnolia*, 15 feet.
2. *Magnolia acuminata*, Pointed-leaved, 40 feet.
3. *Magnolia acuminata*,  
*Hoveyi variegata*, Hovey's new golden variegated, 12 feet.
4. *Magnolia cordata*, Heart-leaved, 15 feet.
5. *Magnolia conspicua*, Chinese, 10 feet.
6. *Magnolia conspicua*,  
*Soulangeana*, Soulanges, 10 feet.
7. *Magnolia conspicua*,  
*speciosa*, Showy, 15 feet.
8. *Magnolia conspicua*,  
*Norbertiana*, Norberts, 12 feet.
9. *Magnolia conspicua*,  
*Lenné*, Linnæus', 8 feet.
10. *Magnolia Thompsoniana*,  
*Thompsons'*, 8 feet.
11. *Liriodendron tulipifera*,  
The Tulip tree, 35 feet.
12. *Liriodendron variegata*,  
Variegated-leaved, 20 ft.

## TILIACEÆ.

13. *Tilia Americana*, American lime, 25 feet.
14. *Tilia Europæa*, European lime, 40 feet.
15. *Tilia Europæa platyphylla*,  
Broad-leaved, 25 feet.
16. *Tilia Europæa laciniata*,  
Cut-leaved, 18 feet.
17. *Tilia Europæa aurea*, Golden-twiggèd, 15 feet.
18. *Tilia Europæa rubra*, Red-twiggèd, 17 feet.
19. *Tilia Europæa, alba pendula*,  
Weeping, 25 feet.

## ACERACEÆ.

20. *Acer Tartaricum*, Tartarian maple, 15 feet.
21. *Acer spicatum*, Spike-flowered, 12 feet.
22. *Acer striatum*, Striped-barked, 25 feet.
22. (bis.) *Acer eriocarpum*,  
Silver-leaved maple, 60 feet.
23. *Acer platanoides*, Norway maple, 45 feet.
24. *Acer platanoides variegatum*,  
Variegated-leaved, 20 ft.

25. *Acer platanoides laciniatum*,  
Eagle's claw, 22 feet.
26. *Acer saccharinum*, Sugar, 40 feet.
27. *Acer saccharinum nigrum*,  
Black sugar, 30 feet.
28. *Acer pseudo platanus*,  
Sycamore, 20 feet.
29. *Acer pseudo purplea*,  
Purple-leaved, 18 feet.
30. *Acer pseudo rubra*, Reddish-leaved, 10 feet.
31. *Acer opulifolium*,  
Guelder rose-leaved, 12 feet.
32. *Acer rubrum*, Scarlet, 50 feet.
33. *Acer campestre*, Common English, 15 ft.
34. *Acer campestre Austriacum*,  
Austrian, 20 feet.
35. *Negundo fraxinifolium*.  
Ash-leaved *Negundo*, 30 feet.

## ÆSCULACEÆ.

36. *Æsculus hippocastanum*,  
Common horse-chestnut, 25 feet.
37. *Æsculus hippocastanum florepleno*,  
Double-flowered, 25 feet.
38. *Æsculus hippocastanum Memmingeri*,  
Memmingeris, 12 feet.
39. *Æsculus hippocastanum maculata*,  
Spotted-flowered, 12 ft.
40. *Æsculus hippocastanum hybrida*,  
Hybrid, 12 feet.
41. *Æsculus rubicunda*, Red-flowered, 20 feet.
42. *Æsculus rubicunda variegata*,  
Variegated-leaved, 15 ft.
43. *Æsculus rubicunda laciniata*,  
Cut-leaved, 10 feet.
44. *Æsculus Ohioensis*, Buckeye, 20 feet.
45. *Æsculus flava*, Yellow-flowered, 20 feet.
46. *Æsculus flava Whitleyi*,  
Scarlet-flowered, 16 feet.

## SAPINDACEÆ.

47. *Kolreuteria paniculata*,  
Panicked-flowering *Kolreuteria*, 15 feet.

## XANTHOXYLACEÆ.

48. *Ptelea trifoliata*,  
Shrubby Trefoil tree, 12 feet.
49. *Ptelea trifoliata variegata*,  
Variegated-leaved, 8 ft.

## AQUIFOLIACEÆ.

50. *Ilex opaca*, American Holly, 18 feet.

## RHAMNACEÆ.

51. *Rhamnus catharticus*, Buckthorn, 12 feet.

## ANACARDIACEÆ.

52. *Rhus typhina*, Sumach, 15 feet.  
53. *Rhus Cotinus*, Smoke tree, 10 feet.

## LEGUMINACEÆ.

54. *Virgilia lutea*, Yellow wood, 25 feet.  
55. *Cytisus Laburnum*, Scotch laburnum, 15 ft.  
56. *Cytisus Laburnum Wateréri*, Waterer's, 15 feet.  
57. *Cytisus Laburnum pendula*, Pendulous, 18 feet.  
58. *Robinia pseud-acacia*, Locust, 15 feet.  
59. *Carragana arborescens*, Siberian Pea tree, 15 ft.  
60. *Gleditschia triacanthos*, Three thorned acacia, 15 feet.  
61. *Gymnocladus Canadensis*, Kentucky Coffee tree, 30 feet.

## ROSACEÆ.

62. *Cerasus vulgaris*, Cherry tree, 25 feet.  
63. *Cerasus vulgaris, flore pleno*, Double flowering, 30 ft.  
64. *Cerasus avum flore pleno*, New double flowering, 16 feet.  
65. *Cerasus semper-florens*, Ever-flowering, 18 feet.  
66. *Cratægus oxyacantha*, English Hawthorn, 15 ft.  
67. *Cratægus oxyacantha punicea*, Scarlet flowering, 15 feet.  
68. *Cratægus oxyacantha punicea flore pleno*, Double pink, 20 feet.  
69. *Cratægus oxyacantha punicea, Paul's new*, New double scarlet, 6 ft.  
70. *Cratægus oxyacantha flore pleno alba*, Double white, 15 feet.  
71. *Cratægus oxyacantha pendula*, Weeping, 15 feet.  
72. *Cratægus oxyacantha stricta*, Erect growing 15 feet.  
73. *Cratægus punctata*, Dotted fruited, 15 feet.  
74. *Cratægus crus galli*, Comum thorn, 12 feet.  
75. *Cratægus coccinea*, Scarlet, 10 feet.  
76. *Cratægus cordata*, Washington thorn, 15 ft.  
77. *Cotoneaster frigida*, White-flowered, 18 feet.

78. *Amelanchier botryapium*, Snowy amelanchier, 10  
79. *Pyrus communis (?) pendula*, Weeping pear, 12 feet.  
80. *Pyrus spectabilis*, Double-flowering apple, 20 feet.  
81. *Pyrus coronaria*, Garland flowered, 8 feet.  
82. *Pyrus Aria*, White beam tree, 25 feet.  
83. *Pyrus aucuparia*, Mountain ash, 15 feet.  
84. *Pyrus aucuparia pendula*, Weeping, 10 feet.

## CORNACEÆ.

85. *Cornus Florida*, Florida dogwood, 14 ft.  
86. *Cornus alternifolius*, Alternate-leaved, 10 ft.

## HALESACEÆ.

87. *Halesia tetraptera*, Snow-drop tree, 20 feet.  
88. *Halesia diptera*, Two-winged, 10 feet.

## OLEACEÆ.

89. *Chionanthus Virginicus*, Fringe tree, 15 feet.  
90. *Fraxinus excelsior*, English ash, 25 feet.  
91. *Fraxinus excelsior pendula*, Weeping, 25 feet.  
92. *Fraxinus excelsior crispa*, Curled-leaved, 10 feet.  
93. *Fraxinus Americana*, American ash, 30 feet.  
93½. *Fraxinus Americana aucubæfolia*, Gold spotted-leaved, 15 feet.

## LAURACEÆ.

94. *Laurus sassafras*, Sassafras tree, 18 feet.

## SANTALACEÆ.

95. *Nyssa biflora*, Tupelo tree, 25 feet.  
96. *Nyssa villosa*, Hairy-leaved 15 feet.

## ELÆAGNACEÆ.

97. *Elæagnus argentea*, Wild olive tree, 18 feet.

## ULMACEÆ.

98. *Ulmus campestris*, English elm, 20 feet.  
99. *Ulmus campestris cornubiensis*, Cornish elm, 10 feet.  
100. *Ulmus campestris viminalis*, Twiggly elm, 40 feet.  
101. *Ulmus campestris pendula*, Scampston weeping, 40 feet.  
102. *Ulmus suberosa var.*, Huntington elm, 40 feet.  
103. *Ulmus suberosa pendula*, Weeping, 20 feet.  
104. *Ulmus effusa*, Spreading-branched, 25 feet.

105. *Ulmus montana*, Scotch elm, 40 feet.  
 106. *Ulmus montana purpurea*, Purple-leaved, 40 feet.  
 107. *Ulmus montana superba*, Superb-leaved, 20 feet.  
 108. *Ulmus montana crispa*, Curléd-leaved, 12 feet.  
 109. *Ulmus montana pendula*, Weeping, 35 feet.  
 110. *Ulmus montana pendula*, Camperdown weeping, 12 feet.  
 111. *Ulmus montana laciniata*, Cut-leaved, 10 feet.  
 112. *Ulmus Americana*, American elm, 60 feet.  
 113. *Ulmus Americana horizontalis*, Spreading-branched, 18 feet.  
 114. *Celtis occidentalis*, American nettle tree, 20 feet.  
 115. *Celtis Australis*, European nettle tree, 20 feet.

## JUGLANDACEÆ.

116. *Juglans regia*, English walnut, 10 feet.  
 117. *Juglans nigra*, Black-wooded, 18 feet.  
 118. *Juglans cinerea*, Butternut, 25 feet.  
 119. *Carya alba*, Shell-bark hickory, 20 ft.  
 120. *Carya porcina*, Pig-nut, 18 feet.

## SALICACEÆ.

121. *Salix Babylonica*, Weeping willow, 15 feet.  
 122. *Salix rosmarini-folia*, Rosemary-leaved, 12 ft.  
 123. *Salix lucida*, Shining-leaved, 10 feet.  
 124. *Salix alba*, Common white, 15 feet.  
 125. *Salix vitellina*, Yellow willow, 15 feet.  
 126. *Salix tricolor*, Variegated, 10 feet.  
 127. *Salix Americana pendula*, American weeping, 10 ft.  
 128. *Salix caprea pendula*, Kilmarnock, 10 feet.  
 129. *Populus alba*, Silver-leaved abele, 50 ft.  
 130. *Populus tremula*, Aspen, 18 feet.  
 131. *Populus tremula pendula*, Weeping, 16 feet.  
 132. *Populus monilifera*, Black Italian, 25 feet.  
 133. *Populus canescens*, White, 25 feet.  
 134. *Populus balsamifera*, Balm of Gilead, 45 feet.  
 134. (bis) *Populus Hoveyi*, Hovey's blue poplar, 40 feet.

## BETULACEÆ.

135. *Alnus glutinosa*, English alder, 25 feet.

135. (bis) *Betula nigra*, Black birch, 20 feet.  
 136. *Betula alba*, White birch, 20 feet.  
 137. *Betula papyracea*, Canoe birch, 40 feet.  
 138. *Betula lenta*, Pliant birch, 30 feet.  
 138. (bis) *Betula Hoveyi*, Large-leaved, 20 feet.

## CORYLACEÆ.

139. *Quercus pedunculata*, English oak, 40 feet.  
 140. *Quercus pedunculata heterophylla*, Cut-leaved, 50 feet.  
 141. *Quercus pedunculata fastigiata*, Pyramidal, 30 feet.  
 142. *Quercus pedunculata fastigiata viridis*, Green pyramidal, 30 ft.  
 143. *Quercus cerris pendula*, Weeping Turkey, 20 ft.  
 144. *Quercus alba*, White American, 40 ft.  
 145. *Quercus alba Hoveyi*, Hovey's bronze oak, 15 feet.  
 146. *Quercus macrocarpa*, Over cup white, 15 feet.  
 147. *Quercus obtusiloba*, Post oak, 30 feet.  
 148. *Quercus lyrata*, Lyrate oak, 15 feet.  
 149. *Quercus rubra*, Red oak, 18 feet.  
 150. *Quercus coccinea*, Scarlet oak, 30 feet.  
 151. *Quercus macrophylla*, Large-leaved, 18 feet.  
 152. *Quercus palustris*, Swamp white, 20 feet.  
 153. *Fagus sylvatica*, English beech, 25 feet.  
 154. *Fagus sylvatica purpurea*, Purple, 25 feet.  
 155. *Fagus sylvatica cuprea*, Copper, 26 feet.  
 156. *Fagus sylvatica heterophylla*, Cut-leaved, 20 feet.  
 157. *Fagus sylvatica pendula*, Milton weeping, 40 feet.  
 158. *Fagus sylvatica pendula*, Fountain weeping, 25 ft.  
 159. *Fagus Americana*, American beech, 25 ft.  
 160. *Fagus Americana latifolia*, Broad-leaved, 20 feet.  
 161. *Castanea Americana*, American chestnut, 30 ft.  
 162. *Ostrya vulgaris*, Hop hornbeam, 25 feet.  
 162. (bis) *Ostrya Virginica*, Virginian hop hornbeam, 20 feet.  
 163. *Carpinus Betulus*, Common hornbeam, 15 feet.  
 164. *Carpinus Betulus pendula*, Weeping, 20 feet.

165. *Carpinus Betulus*  
variegata, Variegated-leaved, 10 ft.
166. *Carpinus Americana*,  
American, 20 feet.
- BALSAMACEÆ.
167. *Liquidambar styraciflua*,  
Sweet gum, 18 feet.
- TAXACEÆ.
168. *Salisburia adiantifolia*,  
Ginkgo tree, 20 feet.
- CONIFERÆ.
169. *Larix Europæa*, Scotch Larch, 30 feet.
170. *Larix Americana*, American, 25 feet.
171. *Larix Kämpferi*, Japan, 12 feet.
172. *Taxodium distichum*,  
Deciduous cypress, 20 ft.

Of the above list the following are very splendid specimens, some of them as broad as they are high, and branched to the ground, viz.:

Cut-leaved Beech, twenty feet broad; Purple Elm, twenty-five feet broad; Pyramidal Oak, so broad and dense at the base as to hide the stem—a superb tree; Eagle's Claw Maple, very distinct; *Quercus macrophylla*, leaves ten inches long; Tupelo Tree (from seed); variegated Tulip Tree, clothed to the ground with bright, golden-blotched leaves; *Quercus laciniata*, spreading fifty feet; *Ulmus viminalis*, very distinct; Double Horse-chestnut, thirty feet, and branched to the ground; *Æsculus rubicunda*, v. *variegataflora* and *Whitleyi*, covered this year with thousands of their showy blossoms; Scampsten Weeping Elm, fifty feet high and forty broad; Weeping Beech, fifty feet broad, every limb dropping at a right angle, and touching the ground; Weeping Beech, the Milton variety, not so novel and beautiful a variety, but gracefully drooping; White Beam tree, a broad cone of silvery foliage; Kentucky Coffee tree, twenty feet broad, a mass of glaucous pinnate leaves.

As new and somewhat remarkable trees, not so large, because new, are the *Magnolia acuminata Hoveyi aurea*, with leaves as brilliantly golden as *Sanchezia*; a Bronze-leaved oak, the young leaves as bronzy crimson as some of the new Japan maples; a new poplar, with large leaves of a dark blue-green, with pinkish nerves; a Sycamore Maple, with no petioles, and the leaves tinged with red on the under side; an elm of the habit of a rock maple, and a birch with very large leaves, seven inches long, precisely like the beech; all seedlings selected from

time to time. Also *Æsculus Memmingeri*, from Belgium, the leaves of which have the appearance of being covered with a silvery dust; and *Ptelea trifoliata variegata*, with very bright golden variegated foliage. Also, Shellbark hickory, a seedling raised by the late Mr. Dana (the raiser of the Hovey pear), from some of the largest and finest nuts he could get. The leaves are of immense size—a magnificent specimen.

To the lover of beautiful trees, these specimens offer an agreeable and interesting study, and give a good idea of their relative beauty for parks or ornamental grounds. We hope to preserve most of them as long as possible; but in the neighborhood of large cities this is no easy task, and in turn, no doubt—some of them at least—will fare no better than hundreds of others, which have been sacrificed to make room for bricks and mortar.

#### NOTE ON THE GARDENS OF GERMANY. \*

BY O. NURTINGEN, WURTEMBERG.

The taste for rare trees is not as wide-spread here as in other parts of the world.

I have found considerable difficulty in getting together all I wanted. In fruit trees I had no trouble whatever; the pear trees especially are splendid, and there are plenty of places where you can get them near home.

The demand for ornamentals, however, is much smaller, and hence the opportunity of getting a good assortment not very good. While you can get at Stuttgart (12 miles from here) splendid specimens of *A. Nordmanniana* 7 to 8 feet high, perfect beauties, with ball, for \$2.50 (retail), I could not find a single specimen of Irish or Swedish Junipers, very few dwarf *Thuja*s, no *Retinospora* (or, as they call them here, "*Chamœcyparis*"), excepting *ericoides*, which does here splendidly. *A. Pinsapo* is here perfectly hardy. So is *Well. gigantea*, Cedar of Lebanon, *Deodar Cedar* and *Cryptomeria jap.* I even saw an *Araucaria imbricata*, some 24 feet high, entirely uninjured; it was, however, well surrounded and protected by other evergreens. Strange to say, the common *Am. Arbor vitæ* suffers more or less every spring; no entire limbs perish, but nearly all the ends of last year's growth are dead. *A. Nordmanniana*, *Pinsapo*, *Cupr. Lawsoniana* (perfectly hardy), *Thujopsis borealis*, *Well. gigantea*, *Taxus baccata*, White Pine, *Hemlock Spruce*, White Spruce, *Biota aurea* and *B. compacta*, English Holly, you can find in the

nurseries around here in the largest quantities and generally of very good size. Magnolias are extremely scarce.

We had, what they called here, terribly cold weather; every one was complaining; the cold was 10° below zero, and that only one day, without any air stirring. January was beautiful, generally 20°-24° above zero. February and beginning of March was mostly wet, and now for weeks we have had no frost; we are sitting in the garden every day; thermometer ranges during the greater part of the day between 50°-65°, and sinks to about 42°. Most fruit trees are now blooming or beginning to. The nurserymen have been through selling their dead stock for a week or more.

This delightful climate, the most excellent beer, the splendid and very cheap wine, the cheap and good cigars, the jolly society we have—how can a man long for America, with local option and all its blessings? and women writing and preaching against smoking? as I read of in your papers. Three cheers for Germany!

### EDITORIAL NOTES.

**PARKS IN BOSTON.**—Boston is in a fair way to have a chain of magnificent public parks. The commission to inquire into the matter reports favorably.

**ANEMONE NEMOROSA.**—This beautiful spring-flowering native plant has a great tendency to produce rosy tinted flowers. If closely looked after a real pink native Anemone might be obtained.

**HOW MARECHAL NIEL ROSE GROWS.**—Mr. Harrison, of Darlington, mentions in the *Gardeners' Magazine*, that a plant of the Marechal Niel Rose in his nursery "has attained the immense growth of 500 yards, and is now (Feb. 22) making nearly 2 yards of wood per day." Mr. Harrison continues: "We have people coming from all parts to see it. It is now beginning to bloom, which will stay its growth. Splendid blooms have gone to Covent Garden to-day at 1s 6d. each. What a pity to have to destroy such a plant! as I must, because the place has been sold over my head, and I shall have to move this spring to Catterick."

**GUN-BARREL BUDDING.**—This kind of budding is now much practiced by rosarians. In all rose

gardens where the amateur buds his own roses there will be found many strong suckers rising from the roots of dead briars. On account of the severe frosts last winter, many fine, strong suckers may be found at the present time. Take a strong sucker, about 3 feet high, dress all the spines and side shoots off for about 2 feet from the ground, the young wood will be found in about the same state of greenness and ripeness as the side shoot of the briars which you are budding on the top part of the stock. Instead of waiting till next season, bud at once, just above one of the leaf rings, gun-barrel fashion—put the point of the knife in just above a bud, draw it upwards gently for about an inch in length. Here you have the incision which must receive the bud, at the top of which make your cross cut. Use good, strong, plump buds, which can always be obtained in abundance during August, which is the best time for gun-barrel budding. About two eyes above or below you may insert another bud. There is such an immense flow of sap in these shoots from the root that, when tying up the bud, the sap flows out and runs down the stem. The briar and the bud are thus both of one age, and may be said to begin the world together. The junction is rapid and complete. All below the inserted buds must be cut away, but all growth above must be suffered to remain until about the middle of November. The reader will naturally ask, "How do you get this sucker up when the head is formed? How do you separate it from the parent stock?" I let it grow for two seasons, after which a good head is formed, and the sucker has become as thick as the thumb. In November, grub up the whole of the old root, and separate the stem from it; it is generally full of fibres, and may be removed to its proper quarters with safety. On this plan, instead of suckers being a nuisance, they may be turned to good account, and your roses multiplied into dwarfs and standards at pleasure. I generally bud these suckers last, and they have often been of the greatest service to me, when a friend has sent me some buds of very choice new sorts late in the season; all my briars having been worked, I should have had no stocks to bud them into, had I not preserved these suckers. Gentlemen occupying land can bud into the suckers arising from old roots growing in the hedgerows; but, before inserting the buds, the sucker must be carefully examined at its base, in order to see whether it can be taken up when the head is formed, and removed to the rose garden.—*Garden.*

IMPORTANCE OF FORESTS.—At the nineteenth annual meeting of the Scottish Arboricultural Society, held recently, the President, in his inaugural address, alluded to the beneficial effects of the maintenance of a due proportion of forest land in every country, from the shelter it gives in spring and protection from high winds, as well as to the common belief that malaria and flights of locusts and noxious insects, &c., are often arrested by belts of forest. He then proceeded to sketch the evils that have followed the reckless cutting down of indigenous wood in many countries, where, only when it was too late, have measures been adopted for preserving the forests. He urged the necessity of prudence and caution in all operations which, on a large scale, interfere with the primeval arrangements of the organic and inorganic world.

ANDROMEDA ARBOREA.—We seldom see in pleasure grounds the *Andromeda arborea* (sometimes called *Lyonia arborea*), and yet it is one of the prettiest of deciduous trees of moderate growth, and when in blossom it forms an object of singular elegance. The tree is somewhat erect in its habit of growth, and is clothed with largish oblong serrated leaves, which have an acid flavor, whence it has been called the Sorrel-tree. But its chief interest is to be found in its flowers, which are so much like the bells of the Lily of the Valley in outward aspect, that the branched panicles might almost be imagined to be made up of a loose cluster of Lily spikes. The resemblance of the horizontal one-sided racemes is, indeed, so striking, that the name of Lily-of-the-Valley Tree might not inappropriately be applied to the species, the more so as it inhabits the valleys of the Alleghenies. This is one of the choice, old-fashioned, neglected plants one meets with in such collections as that at the Knap Hill Nursery.—*Gardeners' Chronicle*.

### NEW PLANTS.

NEW DOUBLE WHITE CLEMATIS.—In Lucie Le-moine we have a new double-flowering white Clematis which is destined to take high rank among these beautiful garden flowers. It is a Continental variety, as yet but little known, for, as we have had so many introduced of late by the English raisers, it has been well nigh overlooked. Hence the necessity of directing prominent attention to it. It is an early-flowering variety, and the flowers, which are of the purest white,

are produced very freely; they are rather larger than those of John Gould Vietch, and more double. It can be strongly recommended for pot-culture, as a conservatory climber, and for outdoor decoration generally. It now appears to be in the hands of all the principal nurserymen.—*Gardeners' Magazine*.

FRITILLARIA PUDICA.—A beautiful yellow-flowering bulb of Utah and California; is finding its way into general culture. Unlike so many of these far western things it seems to be adapted to eastern culture. The flower much resembles the snowdrop in form, and flowers a little earlier than that well-known favorite. It might be called yellow snowdrop.

FRITILLARIA RECURVA, Benth., with flowers worthy of being described as scarlet, is in flower at Kew, and, it is needless to say, is a striking novelty. It grows to a height of from one to two feet, though the present example is less than six inches, from the fact of the bulbs having been somewhat weak, and without sufficient time to get established. The leaves are very narrow, and of a greyish green tint. The flowers number from three to eight, are narrowly campanulate, and from an inch to an inch and a half in length, but in this case they are smaller. No other known species can approach this in color. On first expansion it appears most brilliant, being afterwards apparently toned down with an increase of yellow, which would seem the ground color. The tessellation is somewhat obscure, though evident on close examination. On the inside the perianth is distinctly yellow, and is covered with numerous usually linear scarlet spots. It is a native of California, and will doubtless prove one of the most interesting bulbs recently introduced from that or any other country.—*Gardeners' Chronicle*.

### QUERIES.

DISEASED BRANCHES ON OAKS AND MAPLES.—J. H. McH., Pikesville, Md., writes: "I forward some branches cut from diseased trees, and shall be glad to have your advice as to the proper remedial treatment of the trees.

"The knots on the English oak appear principally on the lower branches on the north and west sides of the tree. The branches of the maple seem to have been killed after the blossoms were thrown out, and several maples of this

variety are looking badly. The trees have been set out about twenty years, and have until within a year or two looked healthy and thriving."

[The burr on the oak may be of fungoid origin, once formed the burr continues to increase in size every year, often attaining considerable size. It was not clear what was the matter with the maple branches.—Ed. G. M.]

DOUBLE WHITE DEUTZIA CRENATA.—Mr. David Saunders, Whitneyville, New Haven, Ct., furnishes the following additional note: "I notice in the May *Monthly* that you mention the Double

*White Deutzia crenata* as a novelty. Six years ago I purchased a plant of Olm Bros. (then doing business in Springfield, Mass.) marked *Deutzia crenata purpurea flora plena*, which on flowering proved to be a *pure white double*. I have since then propagated and disseminated it considerably, so that in this locality it is no novelty. I presume it is the same variety you allude to. Please accept of a plant which I send by express."

[It is pleasant to know that this beautiful variety has found its way so extensively into the trade.—Ed. G. M.]

## GREEN HOUSE AND HOUSE GARDENING.

### SEASONABLE HINTS.

If we take a look through most greenhouses, we see with regret that the cultivation of plants with the view to make fine specimens of skill has not kept pace with general gardening progress. The demand for cut flowers causes a general crowding—and thus we see at horticultural exhibitions only in rare cases plants of more merit than could be bought for a few cents at any street corner. Even in the cases where large specimens are on exhibition they are chiefly plants which time and not skill has made. It may perhaps be the Sago Palm owned by Robert Morris of the Revolution, or it may be some other thing that has been the hero of a hundred shows, still the same old plant and nothing more. In view of this falling off or perhaps indifference to garden skill, it is a pleasure to find ourselves once in a while in some old farmhouse or cottage by the way, where magnificent specimens of the commonest things are found in the highest perfection. It was our privilege to see early the past spring, growing in an old iron-bound bucket, a specimen of the common Indian *Daphne*, several feet high, and with hundreds of sweet blossoms over every part of it; and yet this person had not even a greenhouse of any sort to grow the plant so well. Where is the greenhouse that can produce such *Daphnes*

as this? More recently we have seen old Scarlet Geraniums and Rose Geraniums not cut down and made into small bushes from time to time, but kept on growing from year to year, making grand specimens, clothed with foliage from bottom to top, and covered with flowers—truly magnificent sights to see. This is the sort of skill we like to see encouraged. A new or rare plant is all very well, but a good specimen of an old thing is equally new or rare and well worth the trying for.

Most of the plants are set out for the summer, as formerly recommended—little care will be required beyond seeing that they are not over or under watered. Some will be yet growing; and may be full of roots. If growth will probably continue for a while longer, pots a size larger may be furnished such. Whenever a shoot appears to grow stronger than the rest, so as to endanger compactness or any desired shape, pinch it back, and any climbing vines should receive due regulation as they grow over the trellis, or they will speedily become naked below. A good, stiff trellis is a desideratum hard to be obtained by the uninitiated.

In training vines, so manage that there shall be a due proportion of branches hanging loosely about the trellis,—as it is this flowing gracefulness that adds half the charms to this tribe of plants which they so profusely possess.

## COMMUNICATIONS.

## POINSETTIA CULTURE.

BY JAMES M'PHERSON.

On page 40, February number, is a good article on the culture of the above plant. I have long practised a method differing somewhat from the one referred to, and described by me in last year's *Country Gentleman*. It is not a new method, but is not often practised in this country. The dormant plants are planted in the open ground about the middle of May and encouraged to make a good growth. About the latter end of August cuttings of the young wood are taken about nine inches long, and at once inserted in four-inch pots in rich sandy loam, placed in heat, and kept well shaded until struck, they will with good management retain their leaves from the rim of the pot and give splendid bracts.

## ORCHID CULTURE.

BY MR. MANSFIELD MILTON.

The increase in the culture of this class of plants throughout Europe and America within the last few years is really astonishing, and the great perfection which is attained in the cultivation of such kinds that used to be considered almost impossible to manage. The high, moist, and almost unbearable temperature which used to be thought indispensable in the successful culture of orchids, has been greatly abandoned, and a more airy and natural temperature adopted and with marked success. The plants are healthier, flower more abundantly, and kept easier free of insects than when the extreme high temperature system was employed. The great rage throughout England, just now, appears to be for what are called "cool orchids," which comprise some of the finest treasures in the floral world, such as some of the species of *Cattleya*, *Odontoglossum*, *Masdevallia*, *Disa*, *Barkeria*, *Lycaste*, and many others which can be grown in any house when a cool, steady, moist temperature can be maintained free from cold draughts of air passing through amongst the plants. The numerous varieties of *Odontoglossum Pescatori*, *O. Alexandræ*, and *O. Grande*, give them an attraction, making them worthy of a house specially devoted to their culture. The *Odontoglossum* house being a specialty about a good many places in England and Scotland. Of course it is not to be supposed when a *cool* temperature is mentioned that a *cold* temperature is meant, and

that a general collection of orchids will, with impunity, bear a low temperature for any lengthened time is erroneous; from such treatment such plants as *Phalænopsis*, *Saccolabium*, a good many of the *Vandas*, and other genera from the East Indies may look for a short time in a healthy condition, but spot is eventually sure to make its appearance, and if once this worst of all orchid diseases, gets a commencement in a collection of orchids, it is difficult to stop, and can scarcely be cured. The most devastating case I ever witnessed of this disease was in a valuable collection of orchids in the North of Scotland. The plants had been growing vigorously for several years, when a change of gardener, who was a strong advocate of the cool treatment system, changed the temperature, keeping it too cold for the welfare of the plants, the result being spot of the most malignant kind upon *Phalænopsis*, *Vandas*, *Ærides* and *Saccolabium*, completely destroying this once beautiful collection. I visited a collection of orchids, a short time ago in this country, composed of East Indian and Mexican orchids, which have been kept for some time back very cool, and although previously in excellent health, I could observe upon some of those which are natives of very warm countries strong indications of spot making its appearance, while such kinds as are natives of Mexico and other parts of Central America, are in excellent condition, fully substantiating what experience has always taught me, that while orchids from the highlands of Central America do best and keep in the healthiest condition when grown in a cool steady temperature, when sufficient air is admitted to prevent a stagnant atmosphere, such plants as are natives of Moulmain, and other parts of Burmah, require a much warmer temperature at all seasons, especially when making their growths.

One of the most fatal mistakes in growing cool house orchids, is keeping them too dry at all times, which is just the opposite of what they should be, more especially in this country, where evaporation is so rapid.

Mr. Rand, in his excellent work on *Orchid Culture*, says: "Orchids must have a house for themselves." This I do not altogether agree with, as the fine specimen plants I saw of some of the most difficult kinds in cultivation at some of the places I visited during my stay in England this winter, which were growing in houses mostly devoted to the culture of other plants, testify that they can be grown, and with success associ-



ated with other plants. Where there is a large collection of orchids, or of any particular class of plants, it is unquestionably the better way to devote a place for themselves; but no collection of plants in the country, whether greenhouse or hot-house, can be considered complete without a few orchids in it. Some of the finest orchids we have are of much easier culture than plenty of the hot-house and greenhouse flowering plants.

I have seen some excellent specimens of ornamental-leaved plants and good plants of orchids in fine flower, exhibited at the different horticultural exhibitions in Boston, but very seldom have I seen a good specimen of *Stephanotis*, *Ixora*, *Franciscea* or *Dipladenia* exhibited. Horticulturists are not needing, therefore, to be deterred from having in their collections a few orchids, because they cannot set aside a house for their particular culture. Bestow the same care upon orchids which other plants require, with which they can be associated, and they will amply repay the trouble.

The following is a list of a few kinds suitable for culture in the greenhouse:—

<i>Dendrobium nobile</i> ,	<i>Lycast</i> , <i>Skinnerii</i> .
<i>Cattleya citrina</i> ,	<i>Odontoglossum grande</i> .
<i>Cattleya Mossiæ</i> ,	<i>Odontoglossum Alexandræ</i> .
<i>Cœlogyne cristata</i> ,	<i>Phajus grandifolius</i> .
<i>Cypripedium barbatum</i> ,	<i>Phajus Wallichii</i> .
<i>Cypripedium venustum</i> ,	<i>Zypopetalum Mackayai</i> .
<i>Cypripedium insigne</i> ,	<i>Zypopetalum Maxilan</i> .

### THE AQUATIC BOUQUET.

BY MRS. C. S. JONES, MONROE, MO.

A novel and most charming floral arrangement will be found in the "Aquatic Bouquet;" and whether for the drawing-room bracket, the stand of the sick-room, or as an epergne for some elegant dining or supper table, it is an imposing object. But to describe this lovely creation:—It consists of flowers, leaves, buds, sprays, grasses, ferns and moss, — or indeed any treasure of the floral kingdom,—in a state of perfect beauty, and in an upright position, surrounded, covered,—yes, buried as it were, beneath the limpid element. A singular, yet, after all, a most simple phenomenon, merely one of Nature's laws beautifully demonstrated, viz.:—the power of atmospheric pressure, and the old rule of our school lesson—"two elements cannot occupy the same place at the same time," in this instance proved by following the subjoined directions:—

Have ready a glass-shade, such as we use for covering fern-cases, wax-flowers, statuary, or other delicate objects, of any size convenient; or substitute any plain glass chamber, such as a tumbler, jar, or bell-glass — though these are only suitable for small bouquets—a glass or china dish, with flat bottom, sufficiently large to admit the shade, and with a deep rim (such as a soup-plate for instance),—a selection of flowers, of even ordinary species, such as *Dianthus*, *Abronia*, *Verbena*, &c., with the other floral treasures before mentioned; a piece of stone one-half as large as diameter of the shade, some fine but strong green thread, and a tub filled with clear cold water. Now commence, by arranging the flowers and leaves tastefully into a graceful bouquet-form; using judgment and artistic skill, in order that, by contrast and pleasing combinations, the most satisfactory results may be obtained. Fasten this when completed to the stone, by tying the stems to it (for which reason the stone might better be rather rugged in character). The stone itself must then be entirely hidden by tying moss and colored leaves around it (commencing at the top, and covering the stems of the bouquet). For this, the leaves of *Coleus*, *Achyranthus*, *Alternanthera*, and variegated *Geraniums*; contrasted with moss and emerald-green fern-fronds, will present a charming appearance. The stone so covered is placed in the centre of the dish, and around it (if space intervenes between it and the side of the dish) arrange pretty stones, moss and bright leaves, with graceful vine sprays.

Now immerse this dish, arranged as it is, in the water contained in the tub; then taking the shade in the hand, place one side of it beneath the water, just over one side of the dish, and slowly sinking it until entirely filled; all the time turning it over the bouquet, until finally it is placed down on the dish; then raise dish and all up slowly from the water, and you will find that the atmospheric pressure will keep the shade firmly fixed, while before you will be one of the most lovely objects you ever beheld.

Do not disturb the water around the rim of the dish, as it aids in making the shade air tight, and for this reason it might better be renewed from day to day as it evaporates. Around the outer rim of the plate or dish place pieces of stone, shells and coral, prettily dressed with *Tradescantias*, *Ivies*, or other delicate plants that will grow in water. We have said this was a beautiful object, but "the half hath not been

told," until after standing for twenty-four hours, or less time perhaps, each tiny leaf, every feathery spray, the crimson of the gorgeous foliage plants, and soft velvety petals of the blossoms, have become—encrusted with a glittering coat of diamonds—draped and festooned with tiny ropes of shimmering spangles—gemmed and studded with sparkling jewels, and opalescent pearls in the form of hundreds of minute air-bubbles, so iridescent and transparent that every shade and tint of the rainbow is reflected; and the star-like incrustations give the bouquet the appearance of some wonderful piece of fairy-work, arising from a sylvan grotto covered with white frosty gems, far more brilliant than any cut and polished by human hands.

This wonderfully beautiful object is well-suited for adorning the sick-room, where flowers are generally so acceptable, yet frequently inappropriate on account of the odor; but for table decoration it is specially elegant, and capable of surprisingly beautiful effects. Thus we have seen a most imposing supper-table epergne arranged thus; an unusually successful aquatic bouquet, filled a shade eighteen inches in height, placed on a moss-covered stand, one foot in height, around which were four gold-fish globes, of the half gallon size; arranged in the same manner, but with only white flowers; below these was a circle of white cut-glass, finger glasses, alternated with small shades, only six inches in diameter, with bright flowers in the one, and only ferns in the other; as an edging, a circle of plain, cut-glass tumblers, each containing four rose-buds of many varieties surrounded by moss. Each dish was surrounded by shells, stones, and delicate vines, and having been constructed the day previous, it was by the following evening in that perfect state of frosty loveliness that is the greatest charm of these exquisite creations. The magnifying power of the globes and round shades is also another special wonder in these beautiful arrangements, so that very small blossoms appear quadrupled in size. They will continue perfect for four or five days in summer, and from six to nine in winter. Sea-weed also is charming arranged in this manner with a shell to anchor them.

### EDITORIAL NOTES.

ODONTOGLOSSUM CIRRHOSUM.—New orchideous plants continue to be introduced,—adding to the variety and interest of collections, but seldom

surprising by rare beauty. The subject of this paragraph, as well as *Odontoglossum Alexandræ*, are exceptions to this; of the former, a recent *Gardener's Chronicle* says: "A plant of this extremely handsome new introduction has just flowered for the first time, and was exhibited at the Royal Horticultural Society's Meeting on Wednesday, the 5th inst., when it elicited unusual admiration, and was unanimously awarded the First-class Certificate it so justly merited. The flower-spikes are branched, bearing from twenty to thirty pure white, purple-spotted flowers; the sepals and petals have undulated margins, and their apices are drawn into long tapering points. The lip is yellow at the base, boldly streaked with rich dark brown, and the crest is whitish and two-lobed. The flowers may be likened to those of 'O navium,' but are fully three times larger than those of that species."

KALMIAS FOR WINTER BLOOMING.—The following hint from the *Gardener's Chronicle* may be of value to our "winter bloomers:" "One of the best hardy plants for forcing is *Kalmia latifolia*. Plants should be selected well filled with buds, and potted up in the ordinary way, and brought on in heat. Not only do the plants flower with great freedom, but they remain for a long time in bloom, and the cultivator can "cut-and-come-again" in a liberal manner. When associated with *Rhododendrons*, *American Azaleas*, and other plants in a warm greenhouse, the *Kalmia* has a very pleasing effect."

And here is another hint from the same source: "The Sweet Briar can be forced in order to have its young growths for use at this season of the year. We recently saw some plants that had been raised from seed, and forced the winter following the second year. The plants should be planted out in the open ground during summer, and lifted in October and November and potted in medium-sized pots, and placed in a warm greenhouse. During March and April an abundance of young shoots will repay the labors of the cultivator."

MONEY VALUE OF ORCHIDS.—To show the value of orchids we give the following from the *Gardener's Chronicle*, advertised as "unprecedentedly low prices:"—"Pleione humilis, good flowering bulbs, 3s. 6d. each; if a dozen are taken, 3s. each; if 50 are taken, 2s. 6d. each: a dozen would make a good specimen. The usual price of this hitherto rare Orchid has been 2 guineas each.

"Pleione maculata, same prices as the above.

"*Cœlogyne corymbosa*.—This is probably the first time this handsome species has ever been seen in England in a living state. 10s. 6d. each, 4 guineas per dozen.

"*Dendrobium marmoratum*, 7s. 6d. each, £3 per dozen.

"*Dendrobium Cambridgeanum*, 7s. 6d. each, £3 per dozen.

"Some splendid plants of the rare *Odontoglossum Lindenii*, only a few plants of which previously existed in this country, 15s. each, 6 guineas per dozen."

### NEW PLANTS.

*CHEILANTHES FRAGRANS*.—A pretty dwarf Cystopteris-like Fern, forming dense tufts in vertical fissures of rocks fully exposed to the sun. Fronds bright green, two or three times divided, with deep brown bristly-scaled stalks: highly fragrant with the scent of new-mown hay. A native of the mountains of Corsica and Switzerland. Probably hardy in favorable situations.

*PHORMIUM COLENSOI VARIEGATUM*.—This beautiful plant has narrowish, erect, pointed, dark-green leaves, scarcely an inch in width, elegantly banded at the margin with one or sometimes two narrow stripes of creamy white. It has the same distichous mode of growth as *P. tenax*, but is altogether a smaller and more elegant plant, while its more erect habit and narrower leaves give it quite a distinct appearance from that of the variegated *Phormium tenax*. It is a native of New Zealand.

*CORYNOSTYLIS HYBANTHUS ALBIFLORA*.—The genus *Corynostylis* belongs to the family of the Violets, and consists of semi-scandent shrubs,

with alternate leaves and long-stalked flowers, the lower petal of which is produced behind into a long horn or spur. The present species was found on the banks of the Amazon. It is a shrubby and remarkably free-blooming plant, of a trailing or climbing habit, bearing ovate-acuminate leaves and lovely, white, horn-shaped or trumpet-shaped flowers, about two inches long, suspended on long, thread-like peduncles. These interesting flowers taken in profile present the appearance of some long-spurred *Tropæolum*, while on the front view they bear a resemblance to those of a gigantic Violet.

### QUERIES.

*SUN RAY FUCHSIA*.—A correspondent from Watertown, N. Y., desires to know who originated the Fuchsia "Sun Ray."

*NYMPHÆA CÆRULEA*.—"Ignoramus," Sing Sing, N. Y., writes: "Will you please be so kind as to let me know in the next number of the '*Gardener's Monthly*' about the aquatic plant, *Nymphæa cœrulea*, how soon will it bloom from the seed? and how large a plant is it? would it be suitable for a small aquarium? Pardon the liberty I take, but as I understand you like to have subscribers inquire about what they do not know, I take you up by asking these questions. If you see fit to answer them, you will confer a favor on a new subscriber, who is young and green. IGNORAMUS."

[This will bloom the second year from seed. It is hardly the plant for an aquarium, as it needs sun and stagnant water to thrive well,—and this is not the conditions aquariums are usually treated to. We are always glad to answer inquirers.—Ed. G. M.]

## FRUIT AND VEGETABLE GARDENING.

### SEASONABLE HINTS.

We often wonder why so little pride is taken to have the vegetable garden beautiful as well as useful. To some extent this is owing to a desire to save labor. As often arranged with box edgings and flower borders all the garden has to be dug

with a spade or fork. This will not do for many. They want to plow, not dig the ground. But this can be arranged by having a long narrow garden instead of the old-fashioned square one. The plow can then work up and down the back, while through the middle may be a walk with box edgings or other edge plants. Then much

may be done in the way of training or arranging the plants to make them look pretty, without much labor, time or cost. Training vines on stakes has a beautiful effect. Even on simple stakes a tomato or cucumber looks more beautiful than when left to run at random over the ground. Fancy melons trained over a neat trellis. And these trellises can be made with any ordinary small sticks tied together. We note a case of this kind in Vilmorin's Illustrated Catalogue, which we here reproduce, and suppose this mode of culture must be common in France.

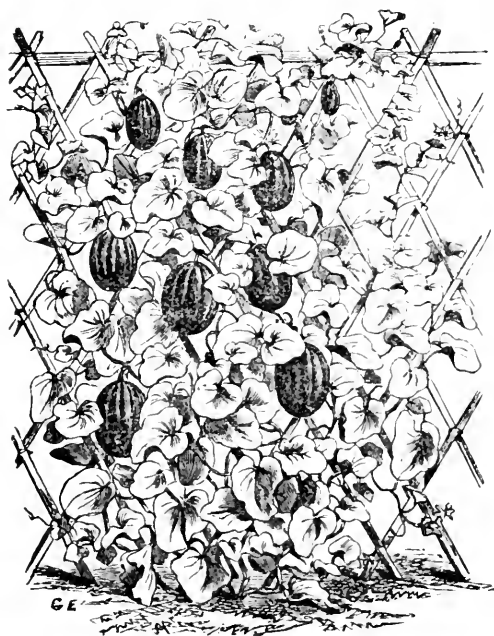

It is a pretty custom, and we might grow things the same way here.

People will soon begin to be worried about fungi and insects on fruit trees. We have gained considerably in our knowledge of these things from year to year, and those who have followed our pages closely will have little trouble. In regard to the white scale we may remind our readers of an article that appeared last winter from a Mississippi correspondent, who recommended to wash the stems with linseed oil. The writer's orchard was particularly bad last year. It had been a growing trouble for years. Last year they had in many cases the appearance of being whitewashed, and the writer felt a little bad when John J. Thomas, who has not much of an idea of growing trees in grass, came to see them, lest he should regard the insect as the

direct result of "neglected culture." Everything recommended in the books and suggested by our own experience had been tried in vain, or with trifling results. In March and April a boy was put to painting all the bark of the trees with linseed oil, though with some promises on the part of friends that the oil would "stop up the breathing pores," and the trees die. To-day there is not a cleaner or more beautiful lot of trees in the county. The correspondent modestly withheld his name. We feel that the simple idea is of such inestimable value to orchardists that we take the liberty of saying that the thanks of those who read that article are really due to Dr. Phillips of the Oxford University, who was the author of the paper, and who has been quite conspicuous through a long life for his devotion to the agricultural and horticultural advancement of that part of our country in which he lives.

As for the plum knot and pear slug we have had so much of interest in our pages lately that we do not suppose that they are to be feared enemies much longer.

## COMMUNICATIONS.

### HOW TO DESTROY THE PEAR SLUG.

BY MR. W. SAUNDERS, ONTARIO, CANADA.

In your May number, in reply to the inquiries of a correspondent on this subject, you recommend the use of powdered quick lime (not slacked lime) sifted over the trees by means of a suitable sieve fastened to a long pole. There are several objections to the use of this material. The powdering of quick lime is a difficulty which but few could overcome; the mechanical appliances necessary for the purpose not being available. Then the unpleasantly caustic action of the lime on the eyes and skin of the operator is such as to interfere seriously with a second application of the remedy.

Having had to contend with frequent swarms of these insects on my pear orchards, I have found nothing so good or so easily applied as powdered hellebore; one pound of the powder mixed with a barrel of water has been found strong enough. My mode of operating is as follows. The barrel of Hellebore and water is placed on a one-horse cart, and on the cart is erected a suitable platform for the operator, who is supplied with an ordinary watering can. From his elevated position on the platform he showers

the death-dealing liquid on the foliage, driving from tree to tree as the sprinkling is effected; a light shower is all that is needed, and effectually cleans the trees. Passing up one side of a row and down the other side where the trees are not very large, an active man can easily operate on from two hundred to three hundred in a day. Where the trees are too large to admit of their being entirely reached in the manner described, the liquid can be effectually applied with a garden syringe.

### PROGRESS OF PLUM CULTURE—A THOUSAND ACRES PLANTED WITHIN THREE YEARS.

BY M. B. BATEHAM, PAINESVILLE, OHIO.

It will no doubt be a matter of interest, if not of surprise, to most readers of the *Monthly*, to learn of the amount of Plum-tree planting that has been done in Ohio within the past few years. If there has been anything like the same amount done in other States, it is pretty certain that our city markets will, in a very few years, be abundantly supplied with Plums, in spite of the persistent opposition of the curculio.

In the Report of our State Horticultural Society for 1872, some account was given of the orchards of about 8,000 Plum trees, part of them in bearing, near Chillicothe, and from what we then learned we supposed there were about 7,000 trees in orchards elsewhere in the State, of Damson, Chickasaw, Lombard, and other varieties, only one-fourth or one-third of them of bearing age. The Report for 1874 gave an account of an orchard of 5,000 trees of Lombard and other varieties, 2,000 of them in bearing, and very successful, in Huron Co. That year we learned of quite extensive planting, and that there were probably in all about 50,000 trees in orchards in the State.

Last spring the planting was still more active, and was only checked by the scarcity and high prices of trees. By recent correspondence, I find that about 50,000 Plum trees were set last spring, and that the estimates for the previous two years were below the reality; so that there are now not less than 125,000 Plum trees set in orchard form in the State; and from present indications, at least 30,000 more will be planted the coming spring!

Of the present orchards, Hamilton county (in

the south-west), has the largest amount—about 50,000 trees—of these 30,000 are in the single township of Columbia. They are mostly of the blue Damson, and have commenced to bear. There are also orchards of Wild Goose, Lombard and finer varieties in that and other townships. The adjoining county of Clermont is reported as having 15,000 or more trees, mostly Wild Goose, Chickasaw and Damsons. In Ross county the planting has now extended to about 35,000; full three-fourths of these are of the Shropshire Damson, which is found best of all for distant markets. The trees are grown very rapidly and cheaply in home nurseries, by budding on seedling peach roots, and transplanting the next year as with peaches. They are found to grow and bear well, especially on good dry loamy soils, having a friable subsoil. Some of the planters say they prefer the Peach root to the Plum, as producing more thrifty trees. I think the question of their durability has not yet been sufficiently tested. Of course these trees can be grown for one-half the cost of those on Plum roots.

Huron county has about 10,000 trees, mostly of Lombard and other large kinds. The first planted trees of Lombard were injured by over-bearing, four or five years after planting, when they gave over a bushel each of fruit that sold for \$6 per bushel.

In Warren county the Shakers and others have orchards of a good variety of the Chickasaw plum. It is a native of the south-west, and similar to the Wild Goose, but smaller. It is much used for cooking and canning, and escapes the curculio better than the finer sorts. There are said to be 5,000 or more trees of this and other sorts in the county. Then there are at least ten counties that I have not named, having an average of 1000 trees each; so that the aggregate for the State is not less than 125,000.

FIGHTING THE CURCULIO has not as yet been found necessary for the Damson, Wild Goose and Chickasaw orchards. The trees are naturally inclined to bear too full, and where there are many in bearing the insects do not seem to be sufficiently numerous to cause more of the fruit to drop than ought to come off. It may be that as the trees grow older the insects will increase so as to make jarring or other means of defence necessary. Lombard and finer varieties are protected by jarring and the use of "Catchers" on the well-known principle of Dr. Hull and others, of which I need not now speak.

## EDITORIAL NOTES.

**IMPERFECT REPORTS.**—There is a vast amount of trash going the rounds of the papers professing to represent the opinions of the *Editor of the Gardener's Monthly*. This is especially true as regards what he knows of fruit culture. It is useless to follow up these misapprehensions. Their correction involves as much risk as the original statement. We may say in brief that when one reads that we advocate either neglected orchards or expensive manuring, he may at once conclude to doubt the information.

**THE ENGLISH SPARROW.**—The English sparrow abundant about our trees, do not eat the buds—but it may be that they find enough of other preferable food. Mr. William Tillery, one of the most prominent and respected of England's many intelligent gardeners, in a recent number of the *London Gardener's Chronicle*, says "during the late severe weather" they were very destructive to the buds of his currant and gooseberry bushes, and then, quoting the article of General Noble in our columns recently, adds:

"This correspondent expresses a wish, as Burns did of the 'Deil,' that the sparrow might 'tak' a thocht and mend,' but there is little chance of this from what we know of his habits in this country. Our farmers know to their cost the ravages sparrows make on their ripening corn near the hedges, and to the grain in their stacks in the winter time, and it will be the same in other agricultural countries abroad where they have been introduced. We gardeners, like the farmers, likewise get blamed if we take means to keep their numbers within bounds, and the number of their scalps taken must not be counted for 'Mr. Punch' to get hold of. The evil of acclimatizing sparrows and rabbits in America as well as in our Australian colonies was pointed out at the time when these exportations were being made, and the results now show the soundness of the advice."

Our own impression is that in our country the sparrow will not wander off to the country until it becomes more thickly settled than it is now. There is nothing for it to eat in winter; but this bud-eating habit has a bad look for the fruit growers near towns.

**FIGHTING THE CODLING MOTH.**—That hay bands wrapped around the stems of apple trees afford an enticement to the codling moth to

"stay and be killed" when in its larval condition is well known. Whether the plan will stand the test of the profit and loss, account is now a point raised by Ohio fruit growers. An Ohio paper tells us that several of our extensive orchardists, at the Toledo meeting, objected to the hay-band remedy proposed by Prof. Cook, as involving too much labor. One, who had three thousand apple trees, and was quick in the use of figures, said the plan proposed would require of him three thousand bands to be put on and taken off and the worms crushed, eight or nine times during the season. It was a bigger job than he was willing to undertake. He thought hogs and sheep could do the work about as well and much cheaper. Another member referred to the extensive apple orchard of Mr. Wilson, near Toledo, which was inspected by the committee of the State Horticultural Society two years ago, and which had been observed by him for a number of years past, and is noted for the excellence of its fruit, being almost entirely exempt from injury by worms, the owner attributing this exemption solely to his keeping a large drove of hogs in the orchard during summer, and supplementing this with a drove of sheep turned in for a day or so at a time, once or twice a week, when there is more wormy fruit falling than the hogs can quickly consume.

**SNYDER RASPBERRY.**—An Illinois friend tells us that this variety proves very hardy and well adapted to that region. The fruit is not so large as some well-known kinds, but it is of first-class quality and yields in immense profusion.

**THE WEALTHY APPLE.**—Among the interesting fruits in the Iowa collection was the Wealthy apple, a seedling of Minnesota, from seed brought from Maine by Peter E. Gideon of Bangor. It stands the severe climate of Minnesota when so many others succumb. It is very large, red, somewhat inclined to be striped, of a pleasant tart flavor. In a climate that will give little else than Siberian crabs, it must be not only an "acquisition" but a positive luxury among the apple kind. Its parentage is uncertain, but from its hardiness and appearance we should suspect a relationship to Alexander.

**THE ART OF MAKING WINE.**—A system prevails, more or less, in all wine-producing countries, but especially in Spain, of what is known as "Plastering" the Wines. In some notes on the chemistry of tartaric and citric acid, in a recent number of the *Journal of the Chemical*

*Society*, Mr. R. Warington gives some interesting particulars relating to this plastering. It consists of treading in with the grapes a kind of plaster known in Spain as "yeso," about 10 lb. being added to the quantity of grapes required to make a butt of wine (108 gallons). The "yeso" reduces the acidity, and "is used equally for red and white wines, but is not employed in the preparation of the sweet wine 'vino dulce,' made from over-ripe grapes for the purpose of tempering sherry." Besides plaster other substances are sometimes added to wine, and affect the composition of the lees. A substance known as Spanish earth is commonly employed in Spain for fining the wines. This earth is also occasionally used by English wine merchants for a similar purpose. This so-called Spanish earth has a somewhat soapy feel, easily impressed by the finger-nail, but containing sometimes fragments of slates. "When rubbed in the hands under water the earth is resolved into an unctuous paste, and it is in this condition applied to the wine which it is destined to clarify."

**VERSAILLES CURRANT.**—In the *London Gardener's Chronicle* Mr. Barron makes this a synonym of the cherry currant. In this country there are two distinct kinds. La Versaillaise has a long bunch; the cherry is a comparatively short bunch. The berries are darker, sweeter and smaller than the cherry. He also gives the following notes in regard to some other synonyms, about which we would be glad to have the experience of some of our American growers, as we are under the impression some of these synonyms are really distinct:

"*Gondouin* [syns., Raby Castle, May's Victoria, Imperiale Rouge, d'Hollande à grappes longues].—This a remarkably strong-growing late variety. The bunches are very long. Berries large or above medium, of a bright red color with a sharp acidity. As a bearer it is only medium. The plant is of a most robust growth, soon forming large bushes. Shoots strong, reddish. Leaves large, dark green, with reddish veinings, flat, deeply cut, very showy, and very distinct. The flowers have also a reddish tinge. This is one of the latest currants to ripen and hang well on the plants afterwards. The plant, from its strong vigorous growth, is very suitable for growing as a standard or large bush.

"*Red Dutch* [syns., Fertile, Fertile d'Angleterre, Fertile de Palluau, Fertile de Bertin, La Hative, Hative de Bertin, Bertin No. 9, Belle de St. Gilles, Chenonceaux, Grosse Rouge de Boulogne, Queen

Victoria, Red Grape].—This is one of the best varieties in cultivation. A most abundant bearer, and ripening early. The bunches are long and the berries large, full and juicy, of a bright red color. The plant is of a dwarf and somewhat slender habit of growth, never attaining a large size. The leaves broad and flat, deep green, having a sort of metallic glaucous hue, which renders it in appearance quite distinct. The synonyms here given are all referable to this one variety, and which is the one generally grown and known in this country as the Red Dutch."

Mr. Barron reduces all currants to sixteen varieties. Since the above was written we note that Mr. Fuller agrees with Mr. Barron that the two are identical.

**PLUM CULTURE IN OHIO.**—Mr. Bateham says that plum culture is considerably on the increase in Ohio. Small growers cannot care for a few trees, but in large orchards it pays to keep a man with shaking machines to knock down the curculios.

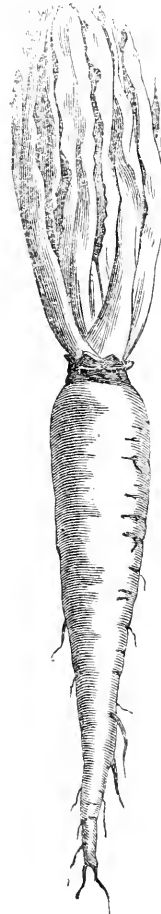

**CHICKORY SALADS.**—In our country we know chicory simply as a root used in the adulteration of ground coffee. In Europe they use both the roots and leaves as ingredients in salads, and the demand for them has increased as many varieties as we have of peas or cabbages. In looking over the catalogue of Messrs. Vilmorin, Andrieux & Co., of Paris, we note that one whole page of their closely printed catalogue is devoted to varieties of chicory. Considering how hardy the plant is, and how much Americans value salads it might be well to try these more extensively than they have been. We give with this an illustration of one which they seem to speak highly of under the name of Witloef, or great chicory root of Brussels.

**THE PLUM AND CHERRY KNOT.**—The cause of the plum knot—a fungus working from the outside of the bark inwardly—has been so clearly developed by Professor W. G. Farlow that there is no longer any excuse for knots in a good orchardist's grounds. Washes must certainly destroy them. We fancy that no tree annually white-washed would suffer from plum knot. Of course one may put clay or soot into the whitewash to destroy the glaring white.

### QUERIES.

**FIRE BLIGHT IN THE PEAR.**—An Elyria, (Ohio) correspondent says that the fire blight has been so destructive there that pear growers are much discouraged.

Since it has been demonstrated that this disease is the work of a fungus operating from the outside, washes in early spring ought to be an "infallible cure." Indeed, Mr. Saunders, of the Agricultural Department at Washington, made this fact tolerably clear long ago, and before Dr. Hunt explained so lucidly how the fire blight fungus operated.

**PEAR DISEASE.**—A Frankford (we believe Pa.) correspondent says: "Enclosed I send you a piece of bark from a twig on a Bartlett pear. Will you in the *Gardener's Monthly* please to explain the nature of the disease if disease, it is; and the cure, if cure there is? I find that it causes the smaller limbs to die slowly, and gives the tree a stunted or premature appearance. My trees are much injured by a short, green, big-headed slug that eats away the tender portion of the leaves from the upper side, and leaves only the woody fibre. Can the ravages of this vile thing be prevented or stopped? By causing the trees to put out a second growth of leaves, I have blossoms in the fall and no fruit next year."

[The disease shows itself in blackened leaves, and in black splotches in the growth of the past year, as the leaves are growing in spring. We have always identified it with what is known in the books as "Frozen sap blight," though we are quite sure frost has nothing whatever to do with it. As our correspondent says, it is very likely to appear on branches that have had the leaves prematurely destroyed by the leaf blight of the summer previous. As leaf blight is a fungus, it is quite likely the "frozen sap blight" is a phase

of development of the same fungus; but of this we have no certain evidence. For the leaf slug see article in another column.—Ed. G. M.]

**PEAR TREES AND UNDERDRAINING.**—There is nothing in the following to show where it comes from. It appears to be from some place in Ohio. Correspondents should be careful to note their localities, as it is half the interest of inquiries through the *Monthly*.

"Can you tell me something about underdraining, the price per rod for drain tiles, and where to procure them. A correspondent of the *Ohio Farmer* recommends the tiles manufactured in Drake County, O., and says underdraining pays on the capital invested in tiles, in one ordinary season, from twenty-five to one hundred per cent; and that one should always use the genuine drain tiles, with oval cavity. There is not a garden or orchard in this section of country underdrained. Now, if you will suggest something that will make our lands more productive, and reclaim the worn-out hill-sides, how much greater benefactor would you be than "he who causes two blades of grass to grow where but one grew before." Fruits of almost every variety do well here, pears, however, do better than peaches or apples, and but little subject to the blight; there are pear trees on my place nearly forty years old, planted by my father soon after settling here in 1836, and some of them, standing in the yard, were never cultivated. Do you think it would pay here (six miles from a railroad), to grow pears for market? Would you plant standards or dwarf trees? Are the former less subject to blight than the latter. They have proven to be so with me. The dew-berry is found here in our old fields, sending out runners ten feet in length, and ripens nearly as early as the strawberry, and by some considered about as good a berry—can you say anything in its favor!"

[Underdraining is not profitable in ordinary land, unless one proposes to hold it for a number of years. Americans seldom feel sure of this. In orcharding we prefer planting on the ground surface, drawing the soil up about the roots to cover with, that is, making ridges or hillocks, in wet ground rather than to underdrain it. A few dwarf pear orchards have been profitable, but those who have made most on pears did it by standards.—Ed. G. M.]

**VANILLA CULTURE.**—Some friends went from Philadelphia a year or so ago to engage in



Vanilla culture at Greytown Nicaragua, and now send us a sample of their fruits in the shape of some Beans six inches long. They undertook the culture with some misgivings, but the quality of production is excellent, and the enterprise will doubtless prove a success. What a luxury it must be to walk around among an orchid orchard, and enjoy the sweet perfumes and delicious profits!—well, we suppose there is some drawback to all this happiness.

PEACH YELLOWS.—Col. Wilkins, of Maryland, is sure that an aphid causes the yellows in the peach. The peculiar process by which this

cause was traced to this effect, we have not had described to us.

POLYGONUM AMPHIBIUM FOR TANNERS.—Paragraphs have been going the rounds that this plant is found to make first-class leather. We should be favored if any of our readers can tell us what sort of leather it will make? We have heard that the Illinois factory where it was worked up is being offered as a woolen mill, "because the Polygonum cannot be had in quantity," but that is a poor reason, when the plant could be so easily cultivated. What is its value?

## NATURAL HISTORY AND SCIENCE.

### COMMUNICATIONS.

#### GENERAL OBSERVATIONS ON THE FLORA OF HOKKAIDO.

BY M. LOUIS BÖHMER,

*Horticulturist to the Kaitakuska, Yedo, Japan.*

[Continued from page 183.]

The forest trees principally consist of large Elms, which have much the appearance of the *Ulmus campestris*, so very common in the north of Europe. This tree attains a large size, averaging about 4 feet in diameter, and is most valuable for building purposes. A large area is covered with deciduous oak, consisting of *Quercus serrata*, a narrow serrated-leaved species; the beautifully leaved *Quercus dentata*, whose leaves generally are 5 to 6 inches long and 3 inches wide; the acorn, which is always single, is enclosed in a scaly cup, much resembling some of the North American species; and another species which has a much smaller and sharper dentated leaf. The third kind bears leaves of middle size and more deeply dentated than those of the former ones. The proportion in size and the number of trees seen growing seems to be equal in all three. A large Ash, growing about 100 feet high, is a striking feature. I further remarked numbers of a large Walnut, which, cut up into boards, is used for the inside of houses, where it produces a good effect. On the foot of the mountains the large Magnolias and *Cercidiphyllum*, already mentioned, grow abundantly and in good sized specimens. A curious tree, of a

smooth white bark, bearing racemes of flowers almost the size of the Elderflower, is a gigantic representative in this country of the Snow-ball family, *Viburnum phlebotrichium*. *Sophora Japonica*, in company with another tree resembling very much a *Syringa*, were in flower at the time of my visit, and I was fortunate enough to secure both living and dried specimens of them, which in some cases were difficult to obtain from other trees.

At a distance of about twenty miles from the capital, having ascended the mountain range, I found an Elm with smooth bark and tripinnate leaves, very remarkable on account of the use to which the Ainos (the natives of the island) put the bark, and it is called by them *Ohiyo*. After being stripped from the tree, the bark is thrown into water, and the strong fiber, which separates after some time from the bark, is made into strings, and woven into a kind of cloth, which is in general use with them. For the purpose of dyeing this cloth they have been ingenious enough to discover materials in other plants. A yellow dye is furnished by the cork-like bark of a tree resembling an Ash (Aino name: *Chikerepeni*). The bark of an Alder (Aino name: *Ke Ni*), furnishes them another dye, which is of a red color. There are three kinds of Birch, the bark of two of which is employed for domestic purposes, one used as torches (Aino name: *Chitachi ni*), the other (Aino name: *Kariba ni*), for fastening together boards of boats. Two kinds of Linden are very conspicuous among forest trees. One a large heart-shaped leaved one is

*Tilia cordifolia*; the other smaller, with flowers more erect, is *Tilia mandschurica*. The inner bark of both is used for making strong ropes (Aino name: Nibesh ni). It is equally used by Ainos and Japanese. Coniferous trees only grow in the higher elevations. They consist of two kinds, "Yesso matsu," *Abies Yessoensis*, and "Todo matsu," another long-leaved *Abies* with a white bark, growing taller than the former, and much used for timber in the saw-mill of Sapporo. On the borders of streams I noticed three different kinds of shrubby *Viburnum* growing in great abundance. A large lily of peculiar appearance forms together with the *Lilium giganteum* a separate section of this genus, as it differs from other lilies. It is frequently found near water, and in swampy places around Sapporo. It bears large heart-shaped leaves of a dark green color, and its flower stalks very often attain a height of 10 feet and more, bearing large flowers of a greenish white color outside; the inside is pure white, with purple spots at the base of each petal. It seems to differ from other lilies in propagating solely from seed. My observations in this respect were confirmed by my Japanese companions, who, I have reason to believe, possessed some knowledge of vegetable life. It flowers only after the bulbs have attained a considerable size, from three to four years; and when it is done flowering it dies with the stock. According to Siebold's *Flora Japonica*, Tabula 14, it is *Lilium cordifolium*. Siebold hardly can have had an opportunity of having seen this lily in its native habit, or his figure would have been of much larger dimensions. I also noticed several handsome herbaceous *Spiræas*, one bearing red berries, which, when mature, turn black; another I found with white flowers about 6 feet high. Here also grows in the grass under the shade of trees a *Campanulacea* of climbing habit, with flowers resembling a diminutive *Cobœa*: *Campanulæa lanceolata*. In the mountains I found a number of terrestrial orchids *Cypripedium*, *Epipactis*, *Liparis*, and other small, evidently interesting species. In ferns the woods abound, and more particularly I was struck with a large smooth leaved *Scolopendrium*. A climbing *Hydrangea*, the *Schizophragma*, the *Ampelopsis* a kind of Virginian creeper, and *Vitis labrusca*, the wild grape, as well as an *Actinidia* with edible fruit (*Kokuwa*) are here frequently met with.

From Sapporo I started for the east coast on the 14th of August. The road leads through a

well-wooded country skirting the foot of a range of hills. All along the road, and wherever horses have been travelling, I noticed an herb very common in these latitudes, a *Plantago*. The seeds of this *Plantain* if boiled forms a mucilage which has been found to act as a remedy in cases of dysentery. The forest trees principally consist of maple trees, of which I noticed and collected three kinds. One of them resembles the American sugar-maple, and attempts have been made with some success to produce sugar from them. I saw crude samples of it during my stay at the capital, but have no doubt that with proper manipulation it could be made available for domestic purposes. Another of them is remarkable for its curious leaves, resembling more a *Cratægus* than a maple; and, if it had not been in flower, I should have mistaken it for one. It never attains more than 25 feet in height and 1 foot in diameter.

From Shimamappu, descending gradually towards Chitose, the formation of the ground changes from the rich loam hitherto met with into a mixture of black soil and pumice of an extinct volcano. As the soil changes the vegetation also presents different appearances. Deciduous oak trees form the principal feature on the more elevated ground. The Mistletoe is found growing abundantly on these trees. The lower ground sloping towards the rivers is occupied by a shrub resembling, at first sight, a wild apple. It bears red fruit, and is called by the Japanese, "Sansashi" *Pyrus toringo* of Siebold. I found an excellent engraving of it in the "Kwawi," a celebrated Japanese botanical work published a hundred years ago. Among plants of smaller growth I noticed several kinds of *Spiræa* which were in flower at the time, and a shrubby *Aralia* with small green flowers and black berries. Three terrestrial Orchids are found growing in the grass under the shade of forest trees. One, the universally known *Spiranthes australis*, a pretty *Liparis*, and another peculiar looking Orchid with large leaves and flowers, probably a *Bletia*. Shallow ponds of some extent are formed in the woods, and possess a vegetation of their own. Rushes and small ferns and the blue flowering *Pontederia* are the principal occupants of these moist localities. The deeper ponds are covered with the leaves of *Nymphæa tetragona*, already noticed before at Oshamambe. Birch and Alder are found of all sizes in the more rugged localities.

(To continue in next number.)

### ROOT HAIRS.

BY BYRON C. HALSTED, BUSSEY INSTITUTE, MASS.

That the largest portion of the liquid used by the growing plant makes its entrance through the roots, from the soil, is a well-established fact; but those parts which are the most active in the absorption of this food material in solution were for a long time not so clearly understood.

By careful experiments and microscopic investigation, it is found that the extreme tips of young roots are about the only portion which take little or no part in this work. A short distance back from the growing points, on nearly all growing roots, may be seen with the aid of a microscope a large number of minute, slender bodies extending out in all directions from the surface of the root. These thread-like structures are not unaptly called *root hairs*, and consist of sac-like protuberances, as outgrowths from the epidermis or surface cells of the root. With the naked eye they are not easily seen, but their presence may be inferred from the manner in which they cling to the particles of the soil when a young root is lifted carefully from the earth in which it was growing. This power which they have of fixing themselves to the grains of earth is very great; so that when a plant is taken violently from the soil, a large part of these delicate hairs are broken from the roots and retain their attachment to the soil. As the root grows along in the earth new hairs are produced while those behind perish as the root becomes woody, and a dense, non-absorbing, protecting epidermis is formed; so that the active life of a single hair is of short duration. The office of these hairs must have already suggested itself to the reader. By means of these prolongations the greater part of the absorption takes place, though the newly formed surface cells are also active. But the surface which they expose is small in comparison with that of the hairs. It is hard to conceive of a more thorough and economical means of exposing an absorbing surface, at the same time keeping in view their method of apical growth, required strength, and a means of rapid transfer of its liquid through a tube to the root to which it is attached.

In a poor soil roots run rapidly in all directions, and are often very long; so, with the hairs, they are put out quickly, take in what nourishment they find and soon die. While on the other hand, in a rich soil the roots are not required to be long, and the hairs are of greater duration. Here is a saving from the use of manure and other fer-

tilizers which, because below ground and out of sight, is apt to be overlooked.

A consideration of the root hairs involves a question about which there has been much theorizing and speculation, viz:—how do these root and root hairs take in the liquid from the soil?

Putting aside these various *notions*, perhaps it will not be amiss to state very briefly the view now generally held, though still thought by some investigators not to explain every point. It is a well-known fact that solid, porous bodies have the power of taking up liquids to a greater or less extent, according to their nature and surrounding circumstances. A dry cloth hung so that one corner will dip into water will in a short time become saturated. This is sometimes called capillary attraction, and has a part in the root absorption. From an extended study and knowledge of the properties of liquids the law of diffusion has been established, viz:—when two or more misible liquids of different degrees of density are placed in contact, interchange will take place until, when the diffusion is complete, the whole liquid will be homogeneous. Instances of partial diffusion are too familiar to warrant space for illustrations. This property of liquids will account for the movement of the absorbed sap to any part of the same cell—from the tip of the hair to the basal portion. But there is another kind of diffusion, first nicely pointed out by Dutrochet and afterwards largely experimented upon by Graham, which has received the name of *osmose*, or membrane diffusion. When liquids differing in density are separated by a thin membrane, as a bladder, diffusion takes place through this septum with a rapidity depending on the nature of the liquids and separating membrane, the greater flow being towards the denser fluid. This intercepting membrane often greatly accelerates the diffusion, but just how it acts, and the chemical and other changes which take place in it, or on its surface, are not well known; still the fact is very striking when, with the proper adjustment of the apparatus and materials, liquids can be made to rise through a tube to the height of many feet. The cell wall of a root hair is such a membrane, separating the denser liquid within the cell from the weaker one without, and this membrane is a living, growing one, and may for that reason be much more effective for osmotic action.

It is difficult to state what portion of the work is done by each of these forces, but combined, they seem to answer the questions concerning

the flow of liquids through the plant, as well as the initial step, the entrance of the solutions into the root and hairs. Where these liquids flow after passing into the plant can not be considered here. Suffice it to say, a growing plant is always in a state of unstable equilibrium, with materials in solution continually changing place.

The amount of absorption by the root hairs is often very great, as careful estimates have shown. When rapid evaporation is going on from the leaves, a demand for fluid from below is created which must soon reach the hairs, and they make good the loss.

From the function, position and delicate structure of the root hair at least one important practical conclusion can be drawn—that of the importance of their preservation, when plants are undergoing transplanting, potting or other like change, thus often saving the life of the whole plant.

There are many other plant hairs besides those which grow from the superficial cells of roots, and they may furnish the subject for a few remarks in a future number of the *Monthly*.

### EDITORIAL NOTES.

"PEACH AND APRICOT HYBRIDS.—H. M. Engle says he has cross-fertilized the peach with the apricot pollen, and had produced several new varieties, two of which are acquisitions, being highly colored, and of excellent quality."

The above is on the authority of the *Boston Cultivator*. Mr. Engle gave us a very different account. He cross-fertilized the peach with an apricot, and though the peach perfected fruit under this apricot pollen, there was no other evidence of potency in the apricot pollen. There were no characteristics of the apricot in the progeny. The progeny were simply good, bright colored peaches, and Mr. Engle does not regard them as hybrids of the apricot.

'NUTS FOR THE SCIENTIFIC TO CRACK.'—"At a late meeting of the Massachusetts Horticultural Society, the Secretary read a very interesting letter from the venerable Prof. Jared P. Kirtland of East Rockport, Ohio, giving an account of a curious hybrid between the Western hickory and the black oak. Externally they resemble hickory nuts, in every particular, and on cracking they split longitudinally into two equal parts, exhibiting in place of the usual hickory kernel or meat, perfectly formed acorns of excessively bitter taste, together with well-defined stems,

such as attach the acorns to the limbs of the oak. A quart of these hybrid nuts were collected under a hickory tree overspread by a larger black oak, two of which were sent to Dr. Kirtland, and were deposited by him in the cabinet of the Kirtland Natural History Society at Cleveland. Such a hybrid leads one to suspect the possibility of unions which had previously been deemed impossible, and Dr. Kirtland goes into some speculations as to the possible results to horticulture by crossing the apple with the wild crab; the apricot and the plum; the quince and the pear, etc."

The above is from the *Boston Cultivator*. It is to be regretted that our good friend Dr. Kirtland did not submit his paper to some one who has made hickories a study, before sending it to Boston for publication. As a general rule, the kernel of the walnuts are rough, as everybody knows,—ruminated, as a botanist would say,—but in *Carya amara*, the bitter-nut hickory, it is very often quite smooth, as in the acorn, and occasionally so in the pig-nut hickory. It is simply an abnormal condition in no way related to hybridism.

CALLIRHOE INVOLUCRATA.—The following from a Marysville, Kansas, correspondent refers to this beautiful plant: "It has been very hard times in Kansas the last two years, but crops look well. I send a flower and leaf of a plant that I found on the overland route to California, and should like to know the name of it. It is a beautiful running plant, root like a parsnip."

SEEDS FROM MALE PLANTS OF AUCUBAS.—They are having the same "bother" over the male Aucubas in England that we used to have over our barren strawberries till we learned better. A strawberry that usually has its stamens abortive, and thus be known as a "pisifillate" variety, under some circumstances will perfect its stamens, become hermaphrodite and bear fruit. Berries are sometimes found on the male Aucubas, and so some assert that "male Aucubas bear fruit." It is a play upon words, and hardly worthy of the serious discussion it is receiving. Of course, if a plant usually bearing only stamens, produces a fruit, it can be only by the occasional development of a pistil among the stamens or on the plant—just as every American farmer knows an occasional productive flower will be produced and bear a grain in a male tassel of Indian corn. It is a simple thing to make so much mystery out of.

## QUERIES.

INSECTS, BOTH NIGHT AND DAY FLYERS.—As there has been some curiosity to know in the supposed necessity many flowers have for cross-fertilization by insect agency how it is done in early spring, before winged insects are common, the writer of this made notes of the earliest seen. The first night flyer caught was on the 10th of May—*Heliothrips Harveyi*. These were in great abundance up to near midnight, and perhaps longer. A few days after the same insect was caught abundantly at mid-day, sucking honey from flowers, in company with the bees. Mentioning the matter to Mr. Wm. Saunders, the distinguished editor of the *Canadian Entomologist*, produced the following note:—

“We have very much yet to learn regarding the voluntary activity of insects. It has long been observed that many night flying species which usually rest during the day will, if disturbed by man or other enemies, fly about with considerable activity, even in the middle of the day. The common mosquito is a day flying insect, but is also very active during most of the hours of the night. While sugaring recently with the view of capturing moths, I have found my bait almost every night being fed on by swarms of mosquitoes actively buzzing about in the darkness at least as late as midnight, and I presume longer. Several species of ants, too,

which are active during the day, are very abundant and lively at sugar during the same hours. One of the species of *Plusia*—*simplex* is, I know, a day flyer, another species closely resembling it, *precatonis*, I believe usually flies at dusk. It would be well to record all observations of this kind. We have all been too ready in times past to accept as established facts many things which have never been satisfactorily proven.”

FERTILIZATION OF LILIES.—In regard to some observations on lilies, made to the Philadelphia Academy of Natural Sciences by Mr. Meehan, Mr. Parkman writes:

“The facts which you notice about the fertilization of lilies by the pollen of *L. auratum* is equally established in regard to fertilization by several other species. In hybridizing *L. umbellatum* by *L. lancifolium*, the only effect produced was to render the resulting flower a complete mule, being in some instances without stamens and with imperfect pistils. The corolla showed no decided effect from the influence of the foreign pollen.”

GRASS FROM GENESEO, ILL.—If you please, the name of this grass? Twelve or fifteen inches high; spreads rapidly from seed; stools wide. None of us saw it until three years ago.

[*Alopecurus aristulatus*, the “water foxtail grass.” It is a lake-region grass, and has been found in Northern Illinois before.—Editor G. M.]

## LITERATURE, TRAVELS & PERSONAL NOTES.

### EDITORIAL NOTES.

LAWS FOR NURSERYMEN.—A nurseryman of Germantown, Philadelphia, took pear and other trees, and having marked them found them in a garden owned by a notorious character who had already been several times in prison. The evidence that he had stolen them was so conclusive that the nurseryman did not hesitate to pull the trees up and take them home. The case was heard before a magistrate, who committed the thief to answer at the criminal court for larceny. The trees were pear trees, and had been bought to sell again, and were bedded in temporarily to

being re-sold; and with this view the magistrate held the trees to be merchandize, and hence that the man had committed larceny. The case came up before His Honor, Judge Thayer, of the Criminal Court, who charged the jury that if there was ever so small a quantity of earth over the roots of the pear tree, so that the tree might possibly strike out new roots and grow, the man had not committed larceny, and the jury under the charge of the learned judge discharged the prisoner.

The question then arose as to what should be done with the prisoner. It was found that there were four ways of catching such rogues.

Larceny, which did not work. Malicious mischief—but this only holds where a man does an injury when the main element is not the benefit to himself; but here the man wanted pear trees, so that would not do. Then there was “trespass”—but a nurseryman’s ground was a place of business, and it is no trespass to be found there. Then “damages” were considered, but the trees were worth only four dollars, and besides the nurseryman had regained possession. The whole range of law was examined by a careful lawyer, and the result arrived at that at common law a nurseryman had no redress for trees stolen from his grounds, unless such trees were lying on a brush heap ready for the bonfire, or in some other way disconnected with the earth. The conclusion was so remarkable that the writer of this addressed a letter to the District Attorney of the City of Philadelphia, and received the reply we give below, noting however that in the letter to Mr. Sheppard there was no reflection on the decision of Judge Thayer, as the answer would seem to imply. Judge Thayer is himself an excellent horticulturist, and no one would suspect him in any case of giving a decision he did not honestly believe in, while his legal learning is of too high a character to doubt the soundness of what he decides to be the law.

“PHILADELPHIA, May 19, 1876.

Mr. Thomas Meehan.

DEAR SIR:—I have read your letter of the 17th very carefully, but I must say that I think the law was correctly laid down by His Honor Judge Thayer. There are many instances, however, in which things which were not the subject of larceny at common law have been made the subjects of larceny, or have otherwise received protection from positive legislation. I would suggest that you continue to give the subject your attention, and frame a clause, and submit it to the Legislature, which will cover the class of cases to which you refer. It will doubtless receive the favorable consideration to which its merits entitle it, and which a sense of justice should prompt. Very respectfully yours, &c.,

FURMAN SHEPPARD.”

We hope this will receive the attention of our legal friends who are interested in horticulture. A law such as the District Attorney suggests would require more talent to frame than the editor of this journal could bring to bear on it. It takes a very smart man to beat a rogue at law in these days.

ADVISORY COMMITTEE OF THE BUREAU OF HORTICULTURE OF THE CENTENNIAL.—A “member” asks us to say, and it seems but justice to do so, that the committee was never called together but once, and that the results of the exhibition, creditable or otherwise, in the Horticultural Department, does not rest with said committee.

LINNEA BOREALIS.—A lady writes: “I inquired in vain at the Centennial Exhibition in the Egyptian Department for the Papyrus, and in the Swedish School Room for the *Linnaea borealis*. Now I suppose both plants are there, only not in conspicuous positions, where I hope they will be placed. Also, I hope some one, or ones, who live near the Centennial Grounds will wreath that beautiful likeness of Linnæus in the Swedish School Room, with Laurel and the *Linnaea borealis*, which my Botany tells me is now in bloom. I will add what Mrs. Lincoln says: “Kalm, a pupil of Linnæus, whose name is given to the *Kalmia* (American Laurel), spent three years in America, and returned to Europe laden with botanical treasures. The sight of the American plants brought by his pupil, many of which were entirely new to him, is said to have produced such an effect upon Linnæus, that, although lying ill of the gout, and unable to move, his spirits were re-kindled, and in the delight of his mind he forgot his bodily anguish, and recovered from his disease.”

ABOUT HYBRIDS.—A correspondent calls our attention to the following from Sachs’ Text book:

Mr. Sachs says: “According as the union takes place between (1) different varieties of one species—between (2) different species of one genus, or between (3) two species belonging to different genera—the resulting hybrid may be termed a variety-hybrid, species-hybrid, or genus-hybrid. When a hybrid is made to unite with one of its parent forms or with another parent form, or with a hybrid of different origin, the product is termed (4) a derivation-hybrid.”

As a matter of scientific precision, and this in a work intended to go the bottom of things, like this of Sachs’, is of some consideration, the terms may do; but for every day use we prefer the common term “cross” when a mixture of varieties is intended. The Albany seedling and the Hovey seedling are varieties of one species of strawberry, and the progeny of the two we should say was the result of a “cross.” Horticulturists at least would understand us better

than if we said "hybrid." How far we should carry this term "cross," and where we should drop it and take up "hybrid," would depend on the idea we formed of "species." What is a good species to one botanist is simply a variety to another, and while there is this room for doubt there can be no rule that shall be infallible in the use of the terms.

**HOOPE'S BOOK OF EVERGREENS.**—A Mississippi correspondent writes: "I do not see *Cerasus lauro-cerasus* among the evergreens in Hoopes' book. It is a grand thing for these parts." Mr. Hoopes confines himself to the resinous plants—*coniferae*.

**THE GRAPE PHYLLOXERA.**—Those grape growers about Kelley's Island, who were for so long a time sure Mr. Riley must be mistaken about the ravages of the Phylloxera, seem to have reconsidered the matter more favorably. One gentleman now writes to the *Ohio Farmer*:

"Some twelve years ago I set out a vineyard of ten acres, mostly Catawbas, with Cincinnati vines. These vines had some knots on the roots, but I then did not know any better than to set them; now these Catawbas have all failed. From personal observation and experience I am forced to believe in the theory of some grape-growers of much experience, that the Phylloxera is the cause of leaf mildew and grape rot; for certainly, if during the summer the new grape roots are consumed, there is nothing to sustain and mature the leaf and fruit. It is very natural to suppose that this insect, like many others, after a certain period will disappear, but experience is against this theory."

But our friend must not go too far in the other direction, for there is often mildew and grape rot independent of Phylloxera.

**SALE OF THE ROSEDALE NURSERIES.**—We have only a line or so at command as we go to press, to say that the sale of Mr. Buist's plants is now going on. We note among the buyers friends from Milwaukee, Cleveland, New York and other places. The larger plants appear to us to go much below their real value, while the smaller ones bring fair prices. We conclude from the experience here, that the love for rare plants is by no means declining.

**TEST OF A GOOD GARDENER.**—Mr. J. Paget, gardener to J. Donald Cameron, Esq., of Harrisburg, Pa., sends us a brace of cucumbers that reminds us of the good old times of England's

gardeners, when skill was measured by what a gardener could do in the way of forcing fruits and vegetables at any season of the year. These were 22 inches long, slender and as delicate and crisp as a cucumber could be. Many people cannot eat cucumbers, and no wonder when the strong, seedy things so often used are set before them. Such as these—and the first week in May—the most delicate would not refuse.

**GEOLOGICAL SURVEY OF TEXAS.**—Texas is wise in prosecuting her geological survey. It furnishes just the kind of knowledge people want who are disposed to emigrate,—and Texas, beyond many States, has room for thousands. This is the second annual report of the State Geologist, Prof. S. B. Buckley, and besides the usual scientific matter, has much in relation to the agricultural and horticultural features and capabilities of the State. Prof. Buckley describes a "cactus-looking" shrub as *Forsythia splendens*, which we do not recognize. The old *Forsythia* of American authors, *Decumaria sarmentosa*, has not "trumpet-shaped" flowers like this, nor is there any accordance with the genus *Forsythia* of Japan, of which the common Golden Bell of our gardens is a well-known representative. Mr. B. describes it as a good fence plant, known as "Ocotea" to the Mexicans. Perhaps it is a misprint for *Foquiera*?

**TRANSACTIONS OF THE MASSACHUSETTS HORTICULTURAL SOCIETY FOR 1876.** Through the kindness of Mr. Robert Manning, we have part first of this always interesting serial. It is made up of the essays and discussions of the monthly meetings. Among the papers which will particularly attract general attention, are that on grape culture, by Mr. W. N. Barnett, of West Haven, Conn., and that on Herbariums, by Professor Robinson.

Mr. Barnett has been very successful in the culture of the grape, and these are the men who can give good advice. It is not always clear that the reasons for certain practices as given are correct, and hence those who attempt another's practice often fail. It is here that discussions arise, and Mr. Barnett's paper appears to have been warmly debated.

The conclusion of Mr. Robinson in regard to the proposition to establish a Herbarium by the Massachusetts Horticultural Society, commends itself to our judgment. One or two Herbariums is enough in a large city. Every citizen interested in botany should do his utmost to make these

perfect. The Massachusetts Society is now proudly pre-eminent in its library, which is the best one of a horticultural character in the Union, if not in the world. If it has any money to spare, let it take up a horticultural garden next. Its members would learn more in a week among living plants than in a life-time among dry specimens—and the herbariums of the botanists, and the botanists will settle disputed points better than the members of the Horticultural Society would ever do for themselves. And then the horticultural experiments of such a garden, detailed in the transactions, would do good over all the world.

REPORT OF THE AMERICAN POMOLOGICAL SOCIETY.—The following kind notice from the *Gardener's Chronicle* shows the high appreciation of the Society's work in intelligent European cities:

"We have received, through the kindness of Colonel Wilder, a report of the last meeting of the American Pomological Society, held at Chicago, 1875. The perusal of this report gives us a vivid idea of the magnitude of the Society's operations, and the zeal with which its work is carried on. We know of nothing to approach it in Europe. The report before us contains the summary of the business of the meeting, attended by delegates from most of the States of the Union; various essays on certain points of fruit-tree culture, to some of which we may hereafter refer; and last, not least, a most valuable (for America) catalogue of fruits, authentically named, with their synonyms, a brief description and indication of the value in which the particular fruit is held, as judged by a committee, in the several States, grouped under a northern division between 42° and 49°, a central division between 35° and 42°, and a southern division between 28° and 35° lat.

MR. RAND'S BOOK ON ORCHIDS.—The following letter from Mr. Rand is addressed to Mr. Meehan personally, but as it relates to matter which appeared in the *Gardener's Monthly*, we presume it was intended for the Editor, and so give it a place in our columns:

"Boston, June 5, 1876.

Dear Mr. Meehan:—This morning my attention was called to your notice of my book on orchid culture. May I say that if you had found time to reply to either of my letters written in February last, asking for information as to any collection of orchids now or formerly existing in Philadelphia, the omissions of which you complain would not have occurred. I regret to have

killed off Mr. Cope. My impression always was that his decease was the cause of the dispersion of his collection of plants.

I thank you for the faint praise. Perhaps if you were an orchid culturist you would find more to commend.

Now may I ask you a question which I heard one gentleman ask another—both well-known to you—at the horticultural rooms, and to which I have for years been unable to give an answer? "What is the reason Mr. Meehan can see no good in anything that comes from Boston; he is as bitter as gall, and lets some unaccountable prejudice run away with him. Nothing from Boston can expect fair treatment at his hands." While personally I have ever experienced courtesy from you, I cannot but be of our friend's opinion.

Sincerely yours,

EDWARD S. RAND, JR."

It is remarkable that with the knowledge that "nothing from Boston gets fair treatment," "Boston" should expect a "reply to two letters;" still more remarkable, that while "regretting" one's errors, it should be thought unfair treatment to have these errors pointed out. More remarkable still is the fact that two letters written to Mr. Meehan in February should never have reached him; and the climax of all these remarkable events is that because one gentleman writes letters to another gentleman who in courtesy is not bound to answer them unless he feels inclined to, that should afterward be offered as an excuse for errors in a book, which even the author himself "very much regrets."

FLORA OF CALIFORNIA.—The first volume is now ready, and may be had for \$6 of Mr. Sereno Watson, Cambridge, Mass. The proceeds are to bring out the second and concluding volume.

GUIDE TO THE PACIFIC COAST.—A circular announces that Mr. Williams, formerly editor of the *Horticulturist*, will soon have a Pacific guide book ready for the press.

D. D. T. MOORE.—Our old friend of the *Rural New Yorker* cannot be idle since he gave up his paper, and here before us is a circular of his advertising agency. It always struck us that a knowledge of agriculturists and of agricultural literature should be essential to a good advertising agent, and it is singular that no one saw the force of this till Mr. Moore took it up.

NEW PLANTS.—Mr. W. Bull, of Chelsea, London, makes a specialty of new and rare plants,



and we have now before us his annual catalogue of near two hundred pages, affording a chance for any one to find some novelty to his taste. And here we take up another catalogue of a similar class from the well-known firm of James Vietch & Son, also of Chelsea. But we must stop, for here is another from Linden, of Brussels.

MR. W. T. HARDING.—We are gratified to learn from some friends at Upper Sandusky, Ohio, that our excellent contributor, as skilled in practical work as he is intelligent behind his pen,

has been spending the spring and summer in designing and laying out a cemetery at that place, and that the result is "very beautiful and acceptable work, at a comparatively low cost." This is after all the true test of a skillful master of the art of gardening. There is nothing so dear as a cheap "bungler," and nothing more unsatisfactory when the work is done. We hope Mr. Harding will get more of the same sort this fall, to the profit of his own and to the interest of those who may employ him.

---

## HORTICULTURAL SOCIETIES.

---

### EDITORIAL NOTES.

FLORA AT THE CENTENNIAL—MAY.—The great floral feature at the Centennial for May was Mr. Waterer's Rhododendrons. A house was built for these by the Centennial authorities, like a huge curvilinear conservatory, only covered with canvas instead of glass. Mr. Waterer arranged the ground inside in what is known to gardeners as the "Regent's Park style." In some places the earth was raised so as to be several feet above the natural level, forming a "bluff," around which a walk would be led, and then again were levels and rises, with narrow grass verges and broad, sanded walks, the Rhododendrons thickly planted in the beds, and the whole forming a delightful piece of landscape gardening. There were fifteen hundred plants in about eighty varieties in the collection, and we think it is safe to say that nothing ever exhibited in a floral way in the United States attracted so much attention or received such unqualified admiration. The house was crowded from morning to evening, and many visitors who found themselves unexpectedly among so much floral beauty telegraphed to their distant friends to come right on, and see the glorious sight. It was evident that although all the leading American nurserymen have been for years endeavoring to introduce Rhododendron culture, not one in a hundred of the thousands of visitors here ever saw one before, and the influence on their introduction will be immense.

But not only to the great multitude was this a great lesson, but all of us found much to learn

from the great exhibit of so many varieties all blooming here together. We fancy that few ever took into consideration how great is the diversity of form and habit among these plants, as well as in the form, color and markings of the flowers; yet to those making collections of these beautiful things such points will enter largely into the system of selection. Some make long straggling growths, while others have a dense, compact habit. Some kinds perhaps making specimens four or five feet high would have but a dozen or so of heads of flowers, while other varieties would have half a hundred in plants of the same size. Then there is a great difference in the shape of the heads—some kinds having them as round as an orange, and others cone-like, as in a pine-apple. Some kinds have rather short pedicels to the flowers, and then the head is compact, while others are long, and then the head is loose. So in number. There are kinds which will have nearly double the quantity of flowers in a head that others will. All these and similar points enter largely into the sum total of pleasure to be derived from a collection of Rhododendrons, and no doubt many of them were noted in the memorandum books of the visitors, which we were pleased to see in common use.

It is generally known that the Rhododendron is an "American plant," and people wonder why Americans cannot grow one of their own articles as good as Europeans. It is not as generally known that these garden forms are hybrids between the American species and the Rhododendron ponticum, and perhaps in some cases *R. arboreum*, which have a much tenderer consti-

tution, and hence where this "sap" predominates, the plants are not hardy enough for an average North American winter. The American *R. maximum* is found wild as far north as Nova Scotia. The Catawbiense flourishes in the cold mountains of North Carolina. If these two alone were concerned in these hybrids we should have a true stock of "American plants." The seed of the *Rhododendron* is as fine as dust; and only those skilled in seed raising can grow the plants in this way. It has to be strewn on or very near the surface, and the atmosphere kept so moist that very little watering to disturb the seed will be required. After getting the plants, if peculiar kinds are to be perpetuated, they have to be grafted, and this adds to the expense. Seedlings not grafted, are generally beautiful enough for the average grower. They have a good variety of color and form among them.

As a matter of culture it may be noted that the roots are extremely delicate and hair-like; and as roots must have air, the plants must be kept very near the surface in the average heavy soils of our country. Where the soil is of a loose, sandy, stony, or peaty character, full of air spaces, this precaution is of no consequence. The *Rhododendron* seems also to have an antipathy to lime. Those varieties which are of the hardiest are still much benefited by a shelter of trees or bushes from the windward quarter. If they have this protection, and the precautions we have suggested be taken in regard to keeping the little roots near the surface and in cool, open soil, it makes little difference whether they be grown in the sun or the shade.

These and similar questions were plied us while we were taking notes in Waterer's tent, so we thought we might just as well incorporate the answers we had to give in this notice here. Often it was observed to us, "So many look alike; which are the most distinct?" In answer we give the following, without, however, being able to say that they are the best selection for standing our severe climate. That can be only a matter for experiment, though some, as for instance *Everestianum*, are known to do well.

*Album grandiflorum*—very large dense heads of lilac and white.

*Everestianum*—a dense grower, free bloomer; flowers rosy pink, with crimped edges.

*Archimedes*—rose white, small, but numerous heads.

*Album elegans*—rosy white; heads not numerous, but large and conical.

*Titian*—rose shaded white; rather loose habit of growth, but very showy.

*Lady Eleanor Cathcart*—one of the most attractive, rosy flowers, with dark spots on the upper petals; heads compact and numerous.

*John Waterer*—deep vermilion rose; one might say as good as some *Rhododendron arborcumis*. Rather diffuse in habit.

*Queen*—delicate rosy white. The great charm of this is in its rounded lobes of the corolla; almost as perfect in this respect as the *Camellia*.

*Mrs. Halford*—has very large heads, with diffuse habit.

*Vandyke*—small dense heads of purple crimson flowers.

*Minnie*—small heads, rosy white, with yellowish green spots on the upper petal; an easy, free, rapid grower.

*Lady Cathcart*—a superb variety, looking as if the heads of flowers were made up of the old-fashioned *Pelargoniums*, before we had to mix up *geraniums* with them.

Then we noted as possessing points of special merit as distinct *Archimedes*, *Pastuosum pleno*, *Michael Waterer*, *Lady Armstrong*, *Mrs. John Waterer*, *Stella*, *Lady Cleremont*, *Concessum*, *King of the Purples*, *John Marshall Brooks*, and *Mrs. John Chitton*.

Desirous of knowing how far those we selected, as the most distinct of the collection as we saw them in bloom, would come out in a contest with the whole of the collection as *Mr. Waterer* knew them, we asked him for a list of six of those he would consider the most distinct, whether in flower are not, and these are they: *Everestiana*, *Mrs. John Chitton*, *John Waterer*, *Lees Purple*, *Charles Dickens*, and *Titian*. It was a great pleasure to note that one who came so far to exhibit at this great exposition did his part so well, and that his efforts were so highly appreciated.

We went from here to the open grounds, where the two firms of *Parsons*, of *Flushing*, had made grand exhibitions of *Rhododendrons* also. If they had had a house given to them as the commission gave one to *Mr. Waterer*, or if only a part of the house had been given to *Mr. Waterer* and a part to the two *Parsons*, there would have been a fair chance of a competitive comparison. The *Parsons'* collections in the open ground had apparently a greater number of fine specimens than the *Waterer* collection, and perhaps as many varieties, but of course had no competitive chance whatever with those in the house to make a public impression. In fact not

one in a thousand who saw and admired the Waterer collection know now that the Messrs. Parsons had any at all on the grounds. It is pleasant to be able to say that, notwithstanding the immense disadvantage the American Rhododendron firms were placed under, we have not heard one word of complaint from the Messrs. Parsons—nothing but pleasure that our English friends who came so far with their productions should be treated so well.

It was our intention to do these excellent firms some justice by making notes of their good things. On getting to their department we were astonished at being ordered away by the guards, and we found by further experiment that this was the "law." We made an effort to examine the collection of Messrs. Hoopes, the Roses of Mr. Buist, the Geraniums of Peter Henderson, and finally the Arboretum planted by the writer of this, and was ordered away from all! On suggesting to the official seraph, who held the flaming sword at the gate, that surely one had a right to enter his own Eden, we were told that he "was not supposed to know exhibitors from other people." But we were fighting rather for "other people" than ourselves. We addressed a letter to Director General Goshorn, pointing out that the exhibitors in the open ground planted *their allotments* for people to examine the varieties, and not as mere masses of flowers and foliage for the landscape adornment of the Centennial grounds, and expressing a hope that the wrong would be remedied. We had not the honor of a reply from any one in authority, but just as we go to press with this find by experience that the guards have been withdrawn, and that the public now are as free to examine the Horticultural collections as any other on the grounds.

These remarks are necessary in order to explain to our readers why we are unable to give any account of the out-door flowers, and to correct the impression carried naturally through the country by those Horticulturists who during the first month were ordered away, that the collections can only be seen from a distance varying from 10 to 50 feet off. *This difficulty does not exist now*, and we hope to have a clear field for reporting in the future. *Any one can go on the grass to examine the collections.*

**INTERNATIONAL EXHIBITION—POMOLOGICAL REPORT.**—We have the pleasure of giving to our readers the following, the first report on any-

thing exhibited at the great Exhibition, so far as we are aware.

PHILADELPHIA, May 25, 1876.

HON. A. T. GOSHORN, Director General U. S. Centennial Commission.

Sir:—In consequence of the Pomological Board of International Judges not being at this date completely organized, and the temporary exhibit of Fruits presenting points of great merit, we have been invited by Mr. Burnet Landreth, Chief of the Bureau of Agriculture, to examine it, and do most respectfully submit the following report.

The exhibit embraces Lemons from Messrs. Vicari & Spragusa, of Milazzo, Italy, very fine and of extraordinary size. Onions, Potatoes and Tomatoes from Bermuda, exhibited by J. C. McNaughton, of Philadelphia, the two former remarkably fine productions, the latter small and wrinkled, but valuable for their earliness. Two hundred varieties of Potatoes from Messrs. Bliss & Son., of New York, embracing every known kind of value.

A collection of Roots for feeding cattle from Messrs. D. Landreth and Sons, comprising a great variety of Beets, Mangolds and Carrots, showing how well these can be preserved far into a new season by pitting.

A few Apples and Potatoes, from Geo. A. Foote, of ———, the best of the popular variety Peerless. A very good collection of Apples from the Iowa State Horticultural Society.

Remarkably well kept Apples, from the fruit-house of N. Hellings & Bro., of Battle Creek, Michigan, and a superior collection from the Michigan State Horticultural Society, embracing forty varieties of kinds that have been kept in the ordinary farm-house cellar of some of the members of the Society. As the season is very late for good keeping Apples, the Committee made notes of those varieties which seemed to them meritorious, taking as a standard of character the actual condition of each variety with the best known specimens of its own kind, as well as of actual good quality. In the Iowa collection they note as among them, Tewksbury Winter Blush, Ortle, Rawles Janet, Newtown Pippins, Jonathan, Winesap, and two not well known out of the West, Hoover and Minkler as having much to recommend them. In the collection of the Michigan Pomological Society, the finest were the Roxbury Russet, Rock, Willow Twig, Smith's Cider, Rhode Island Greening, Jonathan, Fallwater, Esopus Spitzenberg, both

kinds of Newtown Pippins, and Red Canada. The last seems remarkably fine for this part of the country. Steele's winter, as exhibited by Mr. John Waterman, of Plymouth, Michigan, was so nearly alike with Canada Red, that if there is any difference, the Committee failed to detect it.

Among the kinds little known East, but presenting points of interest at this season, the Committee noted Detroit Red, Emerson, Well, and Brooks' Keeper. The collection from Messrs. Hellings, embraced forty dishes of ten varieties, all high colored, and large and well-grown fruit. They are all grown in Michigan, 1875, and by the method adopted by them in their fruit-house, had even the stems as green and firm as when plucked from the trees. The Rhode Island Greenings, and Northern Spy's were fully equal to the best average specimens known. Newtown Pippins, Baldwins, Jonathans, Westfield, Seek-no-farther, were very good; Red Canada, Spitzenberg, and the others not quite equal to those preserved in the common way.

Signed, { THOMAS MEEHAN,  
W. L. SHAFFER,  
A. W. HARRISON,  
THOMAS P. JAMES,  
WM. PARRY.

PHILADELPHIA, June 1st, 1876.

To the COMMISSIONERS of the U. S. Centennial Exposition.

Gentlemen:—By request of Mr. Burnet Landreth, Chief of Bureau of Agriculture, the regular jury not having fully organized, I have to-day examined the collection of Tropical Fruits, exhibited by Mr. Robert Thompson, of Jamaica, through the British Commission, and respectfully report that it comprises the following fruits and vegetables: "Cho-Cho," (*Sechium edule*) of the Cucumber family; the fruit is used in soups and pickles to a great extent.

"Cocoa nuts," mature and immature, on the stalks, as gathered from the tree. The young fruit is boiled and used as a food for infants, also as a mild form of domestic medicine. The young fruit is from the same tree as the mature. The tree when once in bearing producing continuously successive crops.

"Jack Fruit," (*Artocarpus integrifolia*) a fruit of the size and form of an average watermelon, but with a rough coat similar to an unripe mulberry. The fruit has an uninviting appearance, but is said to be palatable to most tastes in its natural conditions. It transports with difficulty and was beginning to decay.

The "Bread Fruit," (*Artocarpus incisa*) similar to the last, unfit to eat in its natural condition, but more useful and popular. It is cut in slices and fried or toasted as bread; transports very badly, and only when preserved in water. This specimen was too far gone to exhibit.

"Sapodilla," (*Sapota achras*) a round rough brown fruit, the size of a medium apple, insipid in its present condition, but said to be palatable when ripened by keeping in some slightly damp material for a few days.

"Mammee Apple," (*Mammea Americana*), also called South American Apricot, from the orange color of the flesh; the large seeds occupy most of the interior. The flesh is not of superior quality in natural condition, but is highly esteemed when cut in slices and steeped in wine.

"Mango," (*Mangifera indica*). This was the most delicious of all the fruits exhibited; it resembles a large flattened papaw, the flesh yellow and fibrous like a mature persimmon, and exceedingly juicy and refreshing.

Of the better known fruits and vegetables were fine specimens of Sweet Potatoes, Yams, *Caladium esculentum* (allied to the American Indian Turnip, the roots being boiled or roasted). "Bananas, Plantains, (a longer and narrower variety of the common Banana), Pine-apples (three kinds), Oranges, Citrons, Shaddock, Limes and some stalks of Sugar cane.

Since the last report of the Special Committee, Messrs. Bliss & Sons, of New York, have deposited four varieties of Potato of this season's growth, among their great exhibit, and grown for them in Florida. The varieties are Snow Flake, Hundred Fold, Snow Ball and Lapstone Kidney, a kind celebrated in England for their extra earliness. The specimens were larger than the average of the very early varieties of potatoes.

THOMAS MEEHAN.

PHILADELPHIA, June 9th, 1876.

HON. A. T. GOSHORN, Director General U. S. Centennial Commission.

Sir:—The undersigned special committee, acting at the request of Mr. Burnet Landreth, have this day examined the fruit on exhibition, and respectfully report that the collection of Strawberries is very fine, though in many districts they are not yet ripe; the latter ones are expected next week. Of those examined to-day, a fine collection came from Mr. John Saul, of Washington, but the distance and the lateness of

the season for that latitude, had passed them beyond a condition for fair judgment. This was also the case with several dishes from Robert H. Gilman, of Milford, Del. The appearance indicated that both of these collections had been in a very creditable condition. Rev. C. F. Weld exhibited some very fine fruit marked "Dr. Warder," which the committee believed misnamed; they could detect no difference between them and the "Jucunda." Edw. N. Wright, of Phila., exhibited four varieties, all, especially "Boydens 30," remarkably well grown.

Jas. S. Jones, Germantown, had "Albany Seedlings" and "Boydens," the last named especially fine.

E. Burroughs of New Jersey, some "Chas. Downing" of very superior size for even this fine variety, but over-ripe.

Wm. Parry, of New Jersey, made the finest display. There were a large number of dishes, embracing 15 varieties, among these "Black Defiance" was conspicuous, resembling "Albany Seedling" in general character, but less acid. "The Monarchs" of this collection were also very attractive by their size and good flavor. "Cumberland Triumph," a new kind with white flesh was the highest flavored of any on exhibition but rather soft for a market fruit. "Star of the West," a fine looking fruit, but not equal to some others in flavor. "Col. Cheney," of very irregular shape and sour, but said to be an abundant bearer. "Matilda," a new kind coming into notice but appeared unripe. "Cowing's Seedling" was small but of fair flavor.

E. T. Steel, of Germantown, showed "Boyden's 30," very large and fine, and regarded by the committee as the best dish of Strawberries in the Exhibition so far.

C. F. Abbott, Falls of Schuylkill, some remarkably fine "Monarchs."

Mrs. Gearey, of Trenton, N. J., several dishes of good fruit.

David Peltz, Falls of Schuylkill, good "Monarchs."

"Fields Excelsior," said to be a new seedling, the berries were very fine, but the committee believe them to be only well grown "Jucundas."

Scattering plates of fair fruit in several popular varieties, some from E. C. Bell, Camden, N. J., Dr. H. K. Whitney, S. C. Decou, Moorestown, N. J., and H. P. Grant, Gloucester, N. J.

A remarkably fine display of "Albany Seedlings" was made by J. H. Withington, of South Amboy, N. J., which, in the opinion of the com-

mittee, were equal to the best "Albany Seedling" ever grown.

Of Strawberries in pots, the only exhibition was made by Wm. Parry, this was of "Golden Defiance," a seedling of Mr. Parry's and had the appearance of being an abundant bearer.

J. H. Purnell, of West Point, Georgia, exhibited some early "Beatrice" Peaches, grown in Alabama, they were of excellent flavor, and about six inches in circumference. A single specimen being 8½ inches.

Signed,

THOMAS MEEHAN,  
EDWIN SATTERTHWAITE,  
A. W. HARRISON,  
JOSIAH HOOPES,

PHILADELPHIA, June 16, 1876.

HON. A. T. GOSHORN, Director General U. S. Centennial Commission.

Sir:—During the week since our last report, the following fruits and vegetables have been submitted for our examination.

*Strawberries.* David L. Peltz, Phila., a seedling strawberry grown from Wilson's Albany, with points of excellence, but on the whole appears hardly equal to the parent. The same exhibitor had very fair fruit of "Monarch," "Albany," "Chas. Downing," and "Golden Queen," a round berry, rather soft and not of high flavor.

Jas. S. Jones, Germantown, "Jucunda." These have been generally fine this season. Mr. Jones' were very good, but not quite equal to others which have before come under the committee's notice.

G. N. Mumma, near Harrisburg, Pa., "Cumberland Triumph." These were much finer fruit than came previously, before the committee, but not quite so high in flavor; it is a promising fruit. Also by the same, "Springdale," another seedling raised by Amos Miller, of Carlisle, darker than the other, a good solid berry of fair flavor, also a promising new kind.

E. Satterthwaite, Jenkintown, Pa., 9 kinds, all of fair average growth, and the "Jucundas" and "Boyden's 30," particularly fine.

Chas. Dickens, through his gardener, Wm. Smith of Hunterspoint, N. Y., plates of two seedlings. "President Lincoln" was very varied in shape, long, oval, flat, and irregular, crimson-scarlet and of fair flavor.

"Smith's seedling," resembling the other, but averaging much flatter, a little brighter in color, and of a brisk, good flavor. These both appear to be seedlings of good promise.

H. W. Whitney, 3620 Baring street, West Philadelphia, very good "Jucundas."

Edward S. Handy, Philadelphia, "White Pine Apple," (Lennig's White) remarkably good fruit of this shy bearing but excellent variety. Also "Jucunda," very high colored, and on the whole the best of this variety that has so far been exhibited.

A. L. Felten, Phila., 3 seedlings, "Alliance," "Continental," and "Beautiful." These seedlings are not as large as some popular kinds exhibited, but are above the average in flavor of most that have come before the committee, and on the whole were promising varieties, the first named perhaps the best.

H. R. Grat, Gloucester, N. J., very good "Monarchs."

S. C. Decou, Moorestown, N. J., sends several kinds of good fruit.

H. Jerolamon, of the Seth Boyden's farms, Irvington, N. J., makes a very handsome display in 5 kinds. Of "Boyden's 30," he had 3 crates of 45 quarts each, with extra fine fruit of this popular variety. He had also a box with plants proving the healthy, free growth of this kind, and also that it will bear a long succession of fruit, a good character in a strawberry.

E. M. Durand, Irvington, N. Y., nine new seedlings called "No. 14," "Great American," "No. 33," "No. 23," "Essex," "No. 12," "Pioneer," and "Giant." They were mostly of extra large size and very beautiful in color, making the best collection of seedlings so far exhibited, none of them of the highest flavor. "No. 14" is in the opinion of the committee the best. The raiser regards the "Great American" as the best, taking growth and all points into consideration.

Rev. E. P. Roe, Cornwall, N. Y., made a very fine display of eleven kinds.

Of these "Kerr's Prolific," "Champion," and "Damask Beauty," are on the exhibition tables for the first time, and are equal to the average of other good kinds; the whole collection is creditable.

Peter Henderson, New York, exhibits "Boyden's 30," to show what can be had from plants set out last August. They are not as large as some of this kind that have been before us, but still superior to many.

E. Burroughs has a dish of superior "Charles Downing."

Rev. E. P. Roe has a gooseberry, a seedling of the European race, which so far has shown no tendency to mildew, which is so common with foreign varieties.

A. L. Felten, cherries, "Black Tartarian," and "English Morello."

A. Outerbridge, Philadelphia, Burmuda Potatoes, and remarkably fine Burmuda Tomatoes, equal to the best American production.

Special Committee of Judges,

Signed, 

{	W. L. SHAFFER,
	A. W. HARRISON,
	JOSIAH HOOPES,
	THOS. MEEHAN.

THE INTERNATIONAL JURY UPON MISCELLANEOUS FRUITS, has at length been appointed, consisting of Messrs. W. L. Shaffer, Thos. Meehan, A. W. Harrison, Josiah Hoopes, Wm. Parry, Edwin Satterthwaite, and will meet in Agricultural Hall, every Tuesday at 1 P. M., and every Thursday at 3 P. M., for inspection of all fruits on exhibition. Commendatory reports will be made and published upon all displays of high merit, and the various reports collected at the end of the exhibition for publication in pamphlet form. At the time of the Grand Pomological Displays, July 18th, and September 11th, the work of the Judges will be divided up under the classes of Apples, Pears, Peaches, Grapes, &c.

MASSACHUSETTS HORTICULTURAL SOCIETY.—Special prizes for Essays offered:

For the best Essay upon the Culture and varieties of Roses, \$25.

For the best Essay upon the Culture of Flowers and Foliage for Winter Decoration and the Market, with a list of the most desirable varieties, \$25.

For the best Essay upon the culture of the Squash and Melon, with a list of the best varieties, \$25.

For the best Essay upon the Ripening and Marketing of Pears, \$25.

For the best Essay upon the Improvement and Ornamentation of Suburban and Country Roads, \$25.

The Essays to be sent to the Committee on Publication and Discussion, Horticultural Hall, Boston, so as to be received by the first of November, in sealed envelopes, unsigned, but accompanied by the name of the writer in a separate sealed envelope. Notice will be given to successful competitors of the time for reading their Essays.

All the Society's prizes are open to general competition.

WILLIAM C. STRONG,  
Chairman of Committee on Publication and Discussion.

THE  
GARDENER'S MONTHLY  
AND  
HORTICULTURIST.

DEVOTED TO HORTICULTURE, ARBORICULTURE AND RURAL AFFAIRS.

Edited by THOMAS MEEHAN.

VOLUME XVIII.

AUGUST, 1876.

NUMBER 212.

FLOWER GARDEN AND PLEASURE GROUND.

SEASONABLE HINTS.

In the last generation the effort of the wealthy citizen was to have a home in the country, with business in town. If very well off he had a town house and a country seat—the one for his summer enjoyment, the other to pass the winter time away. The introduction of railroads has altered all this. It is so easy now to “get away,” that the summers are not spent in the country, on the farm, or in the garden; but in the mountains, at the springs, or by the sea shore. There is, therefore, not the same want as there was, and in consequence that class of gardening which was called for in the olden times of country life, has by no means kept pace with the increase of wealth and population. The best gardens are now for the most part those which are comparatively close to large cities, attached to residences convenient to business by steamboat or rail, and where the families are at home winter and summer, all the year round. Those who have now their town house for winter, and country seat for summer, are among the rarest of American citizens. Gardening at country seats is almost of the past. There is little demand for that high class of horticultural talent that this system called for. On the other hand it is a pleasure to note that suburban gardening is largely on the increase. The small places, from one to ten acres, are more numerous, we think, than they used to be, while the love of flowers is certainly on the increase. It will do no harm to our gardeners to think over these things. The

ornamentation and horticultural comforts of small places are the great things for them to study.

It should not be forgotten that beauty can often be acquired without great cost. By studying the character of a piece of ground, and adding to that which already exists, we can often make a place as attractive as if we attempt wholly to imitate at great cost some pleasant garden scene that exists elsewhere. And not only cost of improving, but the future should be studied.

In all suggestions for the improvement of grounds, the subsequent cost of keeping in order should be studied well. This is the rock whereon so many strike. Walks and roads are particularly expensive to maintain, and should never be made without there is an evident necessity for them. Shady grass walks, with masses of flowering shrubs on each side, and kept mown a few times a year, are as pleasurable parts of a pleasure ground as can well be provided, yet we very seldom see them employed.

The great fault with our gardening is, that we follow too much after foreign styles. In England, for instance, they have fine evergreens, but deciduous shrubs do not do well. They have, therefore, to make their places gay by bedding plants. Our country is the paradise of flowering shrubs, and foreigners, when they come here, are amazed at their beauty. Most beautiful effects can be produced by massing them—beautiful effects that can succeed each other from spring to fall, and indeed continue to give interest

through all the year. But we blindly ignore our own advantages, and persist in following English styles of bedding. We cannot put out a flower till May. We have to water and water to make them grow. By August, when it is too hot to enjoy them, those which have fought their way through the summer heats are tolerable; and then the first September frost takes them off. We have their blackened leaves till Christmas, and bare ground the rest of the time.

We are quite sure that much more satisfactory gardening than this can be made out of nice green grass and comfortable shade trees—clusters of clematises and other flowering vines that defy our heats, and masses and designs of shrubs and dwarf, colored-leaved plants, with hardy herbaceous plants mixed. And then there is the great American idea underlying all this—most beautiful grounds maintained at little cost.

It is a very good time to think of these things. Autumn will soon be here, when they can be put into shape for the next season.

---

## COMMUNICATIONS.

### LANDSCAPE GARDENING.

BY E.

The remarks of B. S. Olmstead I read with pleasure, for we want no more of jobbing gardeners, who work physically, and claim to be landscapists; nor do we want engineers, who perhaps are capable of running a straight line, but know no more of a graceful curve than the mule Nebuchadnezzar recently poetically described and published in over forty papers in the States. I have never yet met an engineer that could drive his stakes to a rolling line of grade, but every time it would be like the quarter or half pitch roof of a house; and the generality of jobbing gardeners know no more of a gentle, irregular rolling surface upon a long line than the common laborer. Again, please, in making of croquet grounds, I have beaten an engineer, by my eye, three inches in his grade, and made him confess it. A landscape gardener must be capable of going upon a place, and after carefully studying the architecture of the house—of which he must or should know—then he should have an eye to give, first, the lines of paths and roads; second, by eye to stick grade stakes every six feet, so that 20, 40, or 80 men could,

under one foreman, go right ahead with the work. I speak knowingly, for, having studied carefully ere I offered my services to the public, I can prove that I have had 80 men at work grading a lawn for a public ground, per day, and two hours time given by me, with one man to drive stakes, another to carry them, secured the day's work, so that it had not to be done over.

Let us trust and hope that the time will come when those who made their money (vide Halleck) "in the cotton and sugar line," will learn that a man must be taught to form a beautiful landscape place in conformity to the surrounding lay of the country, the style of architecture, whether it be Gothic, Italian, Grecian, Roman, Doric, &c., and know just what trees and grades to place and make in it. If he cannot do that, he should be discarded from the list.

---

### DESTRUCTION OF THE ROSE SLUG.

BY W. T. BELL, FRANKLIN, PA.

Under the head of "Seasonable Hints," in June number, speaking of rose slugs, you say: "The best thing of all is to set a boy to crush them by finger and thumb."

Hand picking for rose slugs is now out of date, as you must admit after trying the following: Dissolve one tablespoonful of powdered white hellebore in two gallons of boiling water. When cool enough to use, apply to the roses with a whisk broom, bending the tops of the plants over, so as to reach the under as well as the upper side of the leaves, dashing the liquid upon the plant in a fine spray.

One application is usually sufficient for a season; it is thoroughly effective, cheap, and quickly applied. It is also sure death to the currant slug.

I was much pleased with your very readable article on the Horticultural Department of the Exhibition, and hope you will furnish us more in the same vein.

---

### A HAPPY HOME.

BY E. P. POWELL, CHICAGO, ILLS.

I have had one hour of real pleasure with old Mr. White, of Ellis Park. Fresh as a lark, and full of enthusiasm, he was turning out his greenhouses into the park, and his own lawns. It is such a pleasure to find a plant-lover and a horticultural scholar, that I feel five years



younger for my visit. Mr. White's hobby is the geranium. Now that this plant begins to approach perfection in symmetry and color of both leaf and truss, it is worthy of devotees.

I found in friend White's collection the excellent home seedlings of Mr. Desmond, of this city, one of our thorough workers; also the admirable results of the skill of John Goode, as well as the importations from Dr. Dean and others whose names are famous abroad. The best bronze in the collection was *Marechal McMahon*. Close beside it stood that marvellous affair, *Happy Thought*. Whose happy thought it is I have forgotten; but it is probably a quiet conception of nature in one of her happy moods. Flaming grandly in orange scarlet stood No. 1, Royal Horticultural Society prize, *Sautry*. Near it *Richard Dean*, *Daniel Webster*, *Pliny*, *Brindley*, *Master T. Hammer-sley*, *Crujan*, *Charley Cusbon*, *Adalina Patti*, *Mrs. George Smith*, *Ianthe*, *Ephraim*, *Sir John More*, *Mercy Grogan*, and many more, including all the newer and the best of the older names. "Nothing for sale," so that it will do to advertise and praise a good thing for once.

Chicago never can become really a floral city, owing to its short seasons and its constant winds. We need flowers that come rapidly into show, and do this best while they have a chance. The geranium does well by us, and deserves to be a favorite. But in Mr. White's collection of plants there are some very rare and choice specimens, over which he broods with paternal care. Our happy hour drew to a close with a wish that we had more such genuine sons of Flora in Chicago.

### LILIES.

BY JOSEPH COBB, PEEKSKILL, N. Y.

How often is the question asked, "Why is it my lilies do not bloom, but produce a cluster of small setts round the old bulb?" To which I would reply, that you must first learn what is the cause, and then endeavor to remedy it. It may have been bruised at the crown in the transfer, or what is more likely, to have rotted at the nose after planting. Knowledge is power, and so it must be admitted that we cannot produce flowers of any kind without knowing the peculiar character of seed or bulb which produces them, and the exact treatment it requires. Now the general cause of the lily failure is, they are planted without a proper provision for them to be kept constantly moist, without suffering

from lying in cold, damp, undrained ground, so that if you have a soil that is made good by annually manuring, you are not certain of success on lilies, for the under soil may be hard pan clay, or churly, tight-bound gravel, which is so unsuited for them. We will suppose, then, you intend to put in a small group of lilies (any variety), from one foot to two feet square, or circle; get out the good soil larger than you intend the group to be; lay that aside by itself. Then dig out at least two feet deeper the raw soil; haul it away and fill the hole with half bricks, old plaster, stones, &c.,—a few broken bones mixed in would help the lilies too. When filled to within a foot from the surface, a few shovels of chips from the wood-pile, or leaves, or a covering of stable manure put on, would prevent the soil from going down through. Then take your good soil which you first took out, mix a little chicken manure and wood ashes with it, fill up rather above the level of the bed, and plant your lilies, taking care to have them three to four inches from the surface to the top or crown of the lily. If your lilies are sound when you plant them, they will keep so, and you will not regret the extra pains you have taken with your lily bed. In the fall cover well with dry leaves, and put brush on to keep them there.

### CURVES.

BY B. S. OLMSTEAD, LANDSCAPE GARDENER, RYE, NEW YORK.

I think it was Hogarth who first designated the curving line as "the line of beauty." Whoever it was, he enunciated a far reaching truth. Ruskin gives utterance to very much the same thought when he says, "Nature is all made up of roundness, not the roundness of perfect globes, but of variously curved surfaces. Boughs are rounded, leaves are rounded, stones are rounded, clouds are rounded, cheeks are rounded, and curls are rounded; there is no more flatness in the natural world than there is in vacancy. The world itself is round, so is all that is in it, more or less, except human work, which is often very flat indeed." This, in nature's gentle developments, is obvious at a glance. In her sterner moods, angular lines and sharp surfaces occur; but they are blended with and softened by the more flowing lines and smoother surfaces, so that it is doubtless true "there are no sharp lines in nature."

Now it may have been that the landscape gardeners of the last century, in their strivings to get away from the constraint of the artificial lines so prevalent then in the arrangement of walks and terraces, and high walls which hampered and confined the ornamental grounds of those days, were led—more than they were aware, perhaps,—by this universal law which they saw and *felt* in their communings with nature, to adopt the more natural methods of arranging grounds, which a little later on so almost entirely suspended the former style. For a time at least, a line of drive or walk was hardly admirable unless it curved. Straight lines were out of fashion. Curves, and curves only, were in vogue; and there is enough of evidence to make us believe that this undue preference still exists; for the landscape gardener of to-day will hardly have practiced his profession a year before he will have come in collision with this notion in the minds of some of his clients. They will have a horror of straight lines, as nature was once said to have of a vacuum. They will want all their walks to curve, if only for the sake of curving. He will, of course, know that this is wrong, for he will have learned, among the first axioms of his art, that straight lines still have their place, and that they cannot be laid aside without, at times, violent incongruity; yet he will often find it "hard work" to get this notion safely at a distance.

And yet, after all, it would not be difficult to prove that, as sometimes applied to the arrangement of ornamental grounds, *all* curves are not lines of beauty. A glance at public grounds within easy distance would convince any practical eye that better arrangements were possible than those which have been made. There seems to have been too great a use of the circular curve. This has its place, of course; but it is not universally applicable, as in some places seems to have been attempted. It is often stiff, and formal, and hard. It *reverses* badly, does not always fit well to the surface, and, although these faults may in a measure be modified by skillfully combining different radii, still, there is a degree of artificiality which cannot always be overcome. It has indeed proved so arbitrary and obstinate, that many have discarded the idea of laying out their roads and walks by any known law. They have preferred instead to trust to the eye altogether, and they have often secured better results by doing so than any which the circular curve could give them. And

when this trusted member (the eye) has failed, other expedients have been called into use. A cart loaded with stones, and drawn by oxen around where the much sought curve was wanted, has answered the purpose. Others have made a raid upon the nearest drying ground, and brought thence the clothes-line to their aid. But there are difficulties in these methods also. A clothes-line will not always lie exactly in the right place, especially on rough ground, through bushes, or over as yet unremoved stone walls; and in some cases it would take a large family to supply a clothes-line long enough. And so with the ox-cart. It cannot be regarded as a convenient instrument, nor one always available. It would certainly be troublesome to carry one around from place to place, no matter how well trained the oxen; and some places come back to my memory now over which drives were required to be laid out, where it would have puzzled the most sure-footed ox to have made his way, nor would the wheels' track have been exactly the curve wanted, even if he had got safely through.

And to all these methods there is one very strong objection, viz., the difficulty of mapping the grounds after they have been so laid out, or of transferring, in any of these ways, a plan already drawn, to the ground.

Is there not, then, some method which can be devised to overcome these difficulties? I do not know, but I suspect that "it is always dangerous to assert anything as a *rule* in matters of art." I have, however, for some years been a good deal helped in this part of my work by the use of a curve, which is very easily laid down either on a plan or on the ground. It is one which is far less stiff and formal than a circular curve, is better fitted to uneven ground, leaves a tangent line more slowly, and therefore reverses much more gracefully; and it can be laid off from tangents of unequal length, which is often practically of great convenience. This curve is the *Parabola*. Its name need not alarm any one by its apparent abstruseness; for, analytically considered, it is one of the simplest of all curves, and a very short acquaintance with its good qualities will convince us that it is a very graceful and obliging one, not willingly to be rejected after a little practice has made obvious its easy application.

This is not the place for a mathematical discussion of the parabola. Reference to any analytical geometry will furnish full information of

its several properties; but a single diagram will suffice to show one way in which it may be located.

Tangent or straight lines are first located upon the ground, approximating as nearly as may be to the final location of the drive or walk. In ornamental work it is better to lay out one side rather than the centre. These straight lines and their angles of intersection are measured; or, if no instrument of measuring angles is available, auxiliary lines are also measured, by the help of which they may be mapped, if need be, and which will also furnish the necessary elements for constructing the curve. These tangent lines are then connected by means of some kind of curve; and it is here where the parabola is so available.

Tangent points at which to start and end the curve are selected when most convenient. In circular curves the tangents must be of equal length, unless we take the trouble to introduce a *compound curve*—that is, a curve of two or more centres; but a parabola can be introduced between either equal or unequal tangents, although in most cases *the longer tangent should not exceed the shorter by more than one-half the length of the latter*. The length of the tangents and their angles of intersection are all that are wanted to compute the elements of the curve; but if we do not have the means of measuring the angle, our tape-line will do very well, for all we will have to do will be to measure the straight line across from one tangent point to the other, instead of the angle. These remarks are elementary, but they may help further on.

Let us now suppose that we find it necessary to join two tangents, that is, two straight lines by means of a curve, which are at present connected by an angle, and that all we have to work with is a tape-line, some pegs, and a hatchet.

Measure the tangent AB—80; BC—120, and the chord AC—184 feet. Find D, the middle point of AC; then measure BD—44.8 feet, and find its middle point E. E is a point in the required curve, and BE of course equals 22.4 feet. Now one property of the parabola is this: If we divide its tangents AB and BC into any number of equal parts, the distance from any one of these points to the curve is as the square of the distance of that point from its tangent point A or C. Thus, the distance from the point marked (2) is four times the distance that (1) is from the curve; at (3) the distance is nine times, and at B it is sixteen times that of (1) to the curve.

Now we know the distance BE, because we have measured it. It is the half of CD, that is, 22.4 feet. Hence, if we, for the sake of convenience, call the distance from (1) to curve *a*, we have  $16a = 22.4$ , and  $a = 22.4 \div 16 = 1.4$  feet. The distance at (2) will be  $4a = 5.6$  feet, and at (3) it will be  $9a = 12.6$  feet. Then divide each of the tangents AB and BC into four equal parts, numbering

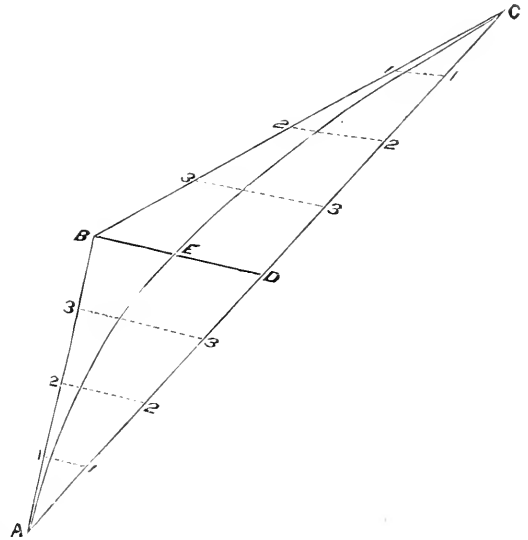

them (1), (2), (3), &c., counting from each tangent point, and at (1) set a peg 1.4 from it, at (2) set another at 5.6 feet from it, and at (3) one at 12.6 feet from it, and the curve will be located at these points. If more points are wanted, we must increase the number of points into which we divide the tangents, always remembering that the distance of the point nearest the tangent point from the curve is found by dividing the distance of the intersection of the two tangents from the curve by the square of the number of parts into which we have divided the tangents, and that each succeeding distance is found by multiplying the first distance (which we called *a*), by the square of its number from the tangent point. Thus, if in the example given we had divided our tangent into six equal parts instead of four, *a* would have been found by dividing 22.4 feet by 36, instead of by 16, and the other distances would have been  $4a$ ,  $9a$ ,  $16a$ ,  $25a$ .

But there is one thing which we have not yet considered, and which we must not forget, and that is the *direction* in which the distances are to be laid off. *They must all be in one direction, parallel to that middle line BE, and therefore parallel*

to each other. As we have only a tape-line to work with, the best way to secure this condition is to divide each half of the chord A C into just as many equal parts as we divide the tangents, numbering them (1), (2), (3), &c., from each tangent point. Then from (1) on the tangent range to (1) on the half chords, and lay off  $a$ . Set off  $4a$  from (2) on the tangents to (2) on the half chords, and so on to the end.

This is one of the several ways of locating a parabola.\* It is the one which I have found most convenient in my practice, and it has proved so available that I have felt a desire to make others acquainted with it. Of course it will be understood that there is nothing new or original in it, and most civil engineers are familiar with it, but perhaps others who may have occasion to draw the "line of beauty" upon their grounds, and possibly some professional landscape gardeners may not be; they will find it applicable in many ways. As already stated, it reverses well; and it forms one of the most pleasing ovals either for carriage-sweep or flower-bed that I have met with.

\* "Vide Henck's Field Book for Engineers."

### EDITORIAL NOTES.

**LILIES.**—*Lilium canadense* is well worth cultivating. It is admirably suited to our climate, and is the first to bloom. In Germantown its first blossoms open about the first of July. Others follow through the season.

**RHODODENDRONS AND ROSES.**—Rhododendrons are beautiful while they last, and uninteresting the rest of the year. Hybrid Perpetual roses, and *Gladiolus* should be planted among them, and there will be flowers all the year.

**THE ELM SLUG.**—It is well known that throughout a large part of the United States the elms are skeletonized by a small slug, which renders the trees very unsightly after midsummer. We could find no account of this in the works of the leading entomologists, so set the writer of this at work to observe this season, and this is what he saw: About the middle of May the leaves are seen to be eaten into small holes, and a small beetle, about one-third the size of a potato beetle, is found to do the work. It is green, and has a dark olive-colored line running down each wing. It is an extremely active insect, but

"plays 'possum" at the least suspicion that anybody is after it; and when more frightened, drops as if dead to the ground. It appears to be a species of *Galeruca*. After two or three weeks the eggs hatch, producing the "slugs" which skeletonize the already riddled leaves. Our entomologists would do good service by working the matter up more precisely.

**LAWN FROM SEED.**—The *Germantown Telegraph* has a well merited compliment to the lawn grass around the government buildings at the Centennial Exposition, made under the direction of Mr. William Saunders, from seed sown this spring. There is plenty sown "with oats" in the usual way by others, and with the usual wretched appearance. Why do people sow oats with spring sown lawn grass? Do they know themselves?

**HEMLOCK IN LIMESTONE SOILS.**—From circumstances that had come before us, we were led to believe that the hemlock did not do well in some parts of England and elsewhere, because of limestone land. The *Country Gentleman* notes instances of perfect success with the hemlock in limestone land in Western New York. The poor success of the hemlock at Rochester was one of the reasons for our original conclusion. It would be singular if it should turn out that not even the rhododendron objects to limestone, in spite of the prevalent impression.

### QUERIES.

**LILIUM AURATUM.**—You speak of this lily in your last number, and remark that with the exception of *L. Parkmani*, nothing has been done in the improvement of this superb lily. Did you ever read the *Magazine of Horticulture*? If not, please turn to the volumes for 1866-67 (vols. xxxii, p. 242, and xxxiii, p. 248).

As this lily is now in splendid bloom, it occurred to us that it would be better to refresh your memory by this reference than to say in plain words—you must have been living in the woods.

Respectfully yours,

C. M. HOVEY.

Boston, July 4, 1876.

### NEW PLANTS.

**NEW TEA ROSE, DUCHESS OF EDINBURGH.**—It is to the Messrs. Veitch that we are indebted for

this valuable acquisition. I believe it is now sufficiently well tested in this country to establish its merits, and that it will be found to sup-  
 gives a fair representation of the bud and flower when well grown. When forcing for its buds, this variety should be grown as near the glass as pos-

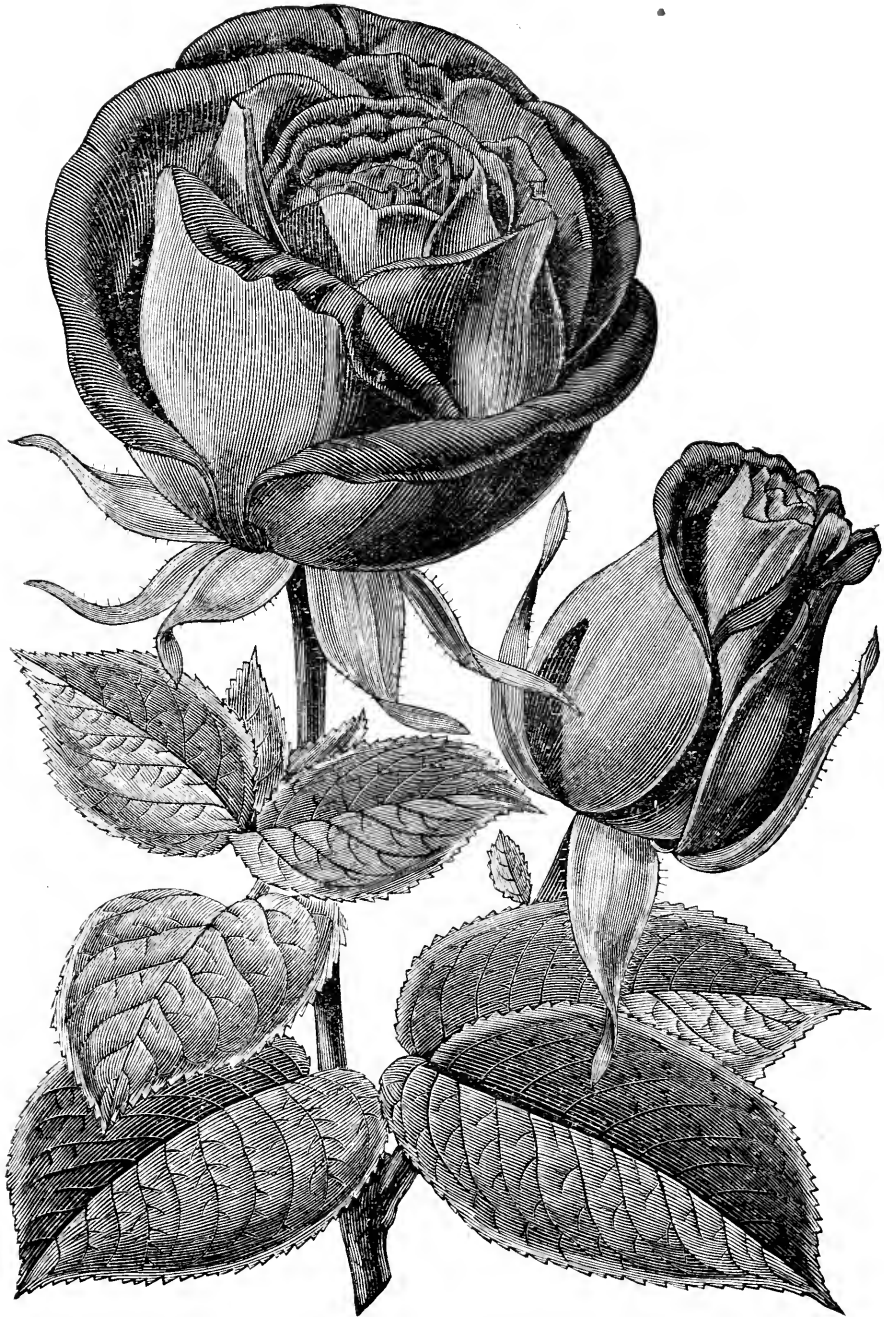

ply a want long felt by florists—a free-flowering tea rose, producing handsomely formed buds of the richest velvety crimson color. The drawing is  
 sible, to bring out its richest tints; otherwise its brilliant crimson merges into an undefined pink.  
 H. E. C.

# GREEN HOUSE AND HOUSE GARDENING.

## SEASONABLE HINTS.

August and September are often taken as the time to repair plant houses and build new ones. A few hints in connection may not be out of the way. Summer heat shrinks wood, and very often loosens glass, and makes leaks, through which water drips in fall and winter most annoyingly. This is worse when there is putty. This is used now only to lay the glass in. The glass is pressed down on it, tacked down by brads, and only painted on the outside. The laps of the glass should be as narrow as possible and white—not dark—paint used. Never use dark paint or dark material about the house if possible, and most positively avoid tar.

Water tanks, collecting rain from the roof, can often be introduced to advantage. Where the earth is solid no stone or brick need be used. Put on a thin coat of mortar, say a quarter of an inch, and on this a coat of cement about as thick as a sheet of brown paper. The thinner the cement coat the more chance of its being waterproof. We have known one barrel do for one thousand square feet of surface, and be as impervious to water as glass. For large ranges of glass there is nothing that equals hot-water pipes for heating. For small greenhouses well-constructed flues answer. Flues should be near the ground but never touch it. If there are cracks in flues, permitting the passage of smoke and gas, it is no use to plaster over it. Work out the whole mortar near the crack—that is, make the hole larger—and fill in with new mortar. Never paint or whitewash flues. A flue of any length, even on a dead level, can be made to draw by building a fire at the end of it. By this we rarify the air, making it lighter, and the heavier air rushes in at the furnace end to take its place. A close reflection on this fact will always enable one to build a flue that will, to a dead certainty, draw well. There is no excuse whatever for a badly drawing flue. In small bay windows, fitted up for plants, close curtains may be drawn across to cut off the atmosphere of the room; and if double glass be used for the windows, or the

window itself be in a sheltered place, a good oil lamp or two will generally suffice to keep out frost.

## COMMUNICATIONS.

### GREENHOUSE FURNACES.

BY W. T. BELL, FRANKLIN, PA.

Your directions to W. H. L. on this subject, in June number, are scarcely explicit enough to enable a person without experience to build a good furnace and flue, and having had something to do with flues I will, with your permission, supplement your article with a few additional directions, which shall at least have the merit of being practical.

If convenient, W. H. L. should make a cellar or pit adjoining the end of his greenhouse, and five or six feet in depth. The furnace should be built within the greenhouse, but the door should be open into the cellar, so as to exclude the dust and smoke from the plants. The cellar may be made large enough to answer for a coal house.

Furnace fronts and fixtures, consisting of a heavy casting, with two doors, metal grate-bars, &c., should be used; and the ash-pit of the furnace may be raised about a foot from the floor of the cellar.

The foundation and walls of the furnace should be strongly built, not less than eight inches in thickness; and all that portion exposed to the fire, as well as the first ten feet of the flue, should be built of the best fire-brick.

The size of the furnace will depend on the size of the house to be heated, and the fuel to be used. If the latter is to be wood mainly, the furnace should be larger than if coal or coke is to be burned.

For a greenhouse of fifty feet in length, where coal or coke is to be the fuel, a good size to make the furnace will be three feet long, eighteen inches wide and twenty inches high, above the bars. The arch for the top of the furnace may be built on a core of soil, rammed firm and trimmed to the shape desired.

The flue should rise from the back of the furnace to the level of the greenhouse floor, with a steep slope, and be built from thence to the foot of the chimney with a gradual rise. The steeper this rise is the better the draught will be; but care must be taken not to interfere with doors and benches.

The instructions for building flues, usually met with, were evidently written by persons who have used anthracite coal, or coke—as they speak of carrying them one hundred and fifty feet, with two or three bends, and but little rise, and no mention is made of any method of cleaning the flue.

In many parts of the country the fuel must necessarily be bituminous coal; and unless some provision is made to remove the soot and ashes from the flue, the destruction of the plants by gas will inevitably occur.

If the flue is built straight, with a uniform rise, and a door is made in the base of the chimney, opposite the entrance to the flue, the soot may be brushed into the furnace by a close-fitting swab.

The flue should be raised from the ground sufficiently to keep it dry, and should be built of good size, not less than eight inches wide and twelve inches high inside.

The bricks forming the side may be set on edge, but are better when laid flat, and the top may be covered with narrow tile. The whole should be laid with good thin mortar, and the joints should be thoroughly plastered.

Build the chimney not less than twelve feet high, and let it rise six feet above any object near it.

Such a furnace and flue, if well built and kept clean, should do good service; but if W. H. L. intends to make floriculture a business, he will never be satisfied until he procures an efficient hot-water apparatus.

I began with flues, and many a cold night I have slept beside them, with no bed but a board, waking as the heat began to decline to replenish my fires.

My next step was to a simple form of boiler, but I made a mistake common to young florists who are struggling along with little means. I bought a boiler too small for its work, and that winter my wife and baby occupied a sleeping-room with me, improvised in the potting-shed, directly over my little heater, and every two hours I wakened to fire up.

The next summer I put in a large boiler of the

best construction, capable of heating twice the amount of glass I had in use. This I could leave without attention for twelve hours at a time, and I consider it the best investment I ever made.

### MR. SARGENT'S AZALEA SHOW.

BY BOSTON.

Towards the end of May Prof. C. S. Sargent, Esq., of Brookline, Mass., exhibited his famous Azaleas, and they were grand. The plants, some large and others of various sizes, were well grown and densely flowered, and tastefully arranged in beds on the lawn under a very spacious tent. The pots being plunged out of sight, the fresh, grassy carpet and the presence of a few Palms and Rhododendrons set off to advantage these floral pyramids, umbrellas and cushions. Chief amongst the varieties were *Decora*, *Exquisite*, *Bride of Abydos*, *Ierzana*, *Beauté de L'Europe*, *Variiegata*, *Flower of the Day*, *Daphne*, *Criterion*, and *Marquis of Lorne*. These Azaleas in order to be retarded as late as convenient are wintered at the lowest possible temperature above the freezing point, and they appear to bear such treatment with impunity. The spring had fairly opened, out-door vegetation was approaching its prettiest, the weather was pleasant, neither too hot nor too cold; in fact, everything we could wish for, to make a visit enjoyable was in our favor. The gardens of Mr. S. are extensive and picturesque and undergoing considerable improvement. They too contain many fine specimen deciduous trees and handsome conifers. The greenhouses are well stocked with plants, most remarkable amongst which are the gigantic specimens of such Agaves, as *Coccinea*, *densiflora*, *Glaucophylla*, *Angustifolia*, *Verschaffeltii*, *Uncinata*, *Grandidentata*, *Ghiesbreghtii*, *Horrida*, *Xylacantha*, *Unirittata*, *Recurvispina*, *Besseriana*, *Arovirens*, *Jacobiana*, and many others.

### MR. HUNNEWELL'S RHODODENDRON SHOW.

Now, June 10th, is the season of Mr. Hunnewell's Rhododendron Show at Wellesley, Mass., and such a display Waterer, Veitch or Lane might be proud of—yes, Waterer went to see them, was surprised at their excellence, and now admits, "Well, you can grow some things in America after all!" It is not the quality that is so surprising, it is the quantity. The finer and more tender kinds are arranged in beds, and some as isolated specimens under a very large tent near the greenhouses. Evergreen hedges

act as sides to the tent, and they together with the carpet of grass add greatly to the relief and advantageous display of this wealth of flowers.

Amongst them are also a few Indian Azaleas in bloom and some only in bud and a specimen of *Rhynchospermum jasmuinoides* that would do credit to the stages of the Crystal Palace or the terraces of Regent's Park. The finer and more tender *Rhododendrons* are wintered in a large cellar purposely constructed for their accommodation, and, judging from their appearance,—well they seem to have enjoyed their quarters. The heavy mulching around the roots of those permanently out-of-doors bespeak the care evinced for them. Some of the most prominent sorts were *Atrosanguineum*, very deep, dark red, trusses and blooms large and substantial, a very hardy and fine-leaved kind; *H. W. Sargent*, dark crimson, large truss and substantial foliage, a splendid *Rhododendron*: *Mrs. Milner*, fine dark red; *Prince Albert*, deep lilac red; *Stella*, one of the best and freest bloomers, rosy lilac with chocolate blotch; *Lady Armstrong*, spotted rose; *Scipio*, dark rose, very fine, grown as a standard; *James Bateman*, dark rosy red, blooms of fine form; *Brayanum*, dark rosy scarlet, paler in the middle; *Giganteum*, a very long trusser, blooms rose-colored; and *Purity*, one of the prettiest of whites. It is curious to note that all these, the cream of Mr. H.'s exhibition, were raised by Waterer of England. We must not omit, however, *The Queen*, one of the most lovely of whites, with sometimes a tinge of pink.

Throughout the pleasure grounds, which are uncommonly extensive, there are nooks and banks all a-blaze with the rose tree, but they are not alone in their glory, this, too, being the hey-day of the hardy Azaleas, of which there are dense and gorgeous masses. The open and sweeping lawns, the clumps of pines, spruces, purple beeches, maples, magnolias, and other trees, and the natural location are excellent features of this princely domain. Tropical and semi-tropical plants from the greenhouses are much used in the out-door embellishment of rockeries, flower gardens and borders. In the greenhouses are some very fine *Dracenas*, *Alocasias*, *Crotons* (including the fine new *C. Disraeli*), and many other specimens of the finer tropical subjects. Here, too, we notice an *Allamanda Schottii* with stem and spread of branches like an old *Wisteria* and densely bloomed. The

conservatory, we believe, is particularly grand and well furnished with fine foliage and floriferous plants, but from it visitors are debarred. In the fruit houses are grapes ripe and being cut, and others in every stage of advancement—peaches, plums and apricots.

Three days after we were there the Emperor of Brazil and suite visited these gardens and were entertained by Mr. H.

### FORCING ROSES.

BY BENJAMIN GREY, GARDENER TO E. S. RAND, JR.,  
DEDHAM, MASS.

Although much has been written on this subject, still as there are so many failures made yearly, in what is really an easy matter, I venture to offer a few suggestions. Many growers prefer a three-quarter, or hip-roofed house, facing south, but in my experience I find a span-roofed house, facing about east and west, better. With such a house we get the sun early and late, and keep the temperature moderate in the middle of the day with less ventilation, thereby lessening the risk of mildewing the roses by the cold draught, which it is almost impossible to avoid with the other style of house.

It is an important matter to have the border properly made: the drainage should be perfect; if this is not attended to the soil soon becomes soured. Roses require frequent syringing to keep down the "red spider," and plenty of water at the roots when growing, but it must have a chance to pass off quickly. If the subsoil is gravel or sand nothing more is needed but to make the soil, which should be good turfy loam, of the depth of about fifteen inches, adding two or three inches of *well-rotted* stable manure, and thoroughly mixing it with the loam. With a clayey subsoil it would be necessary to strip off the top soil and form a drainage of rough stones or other material at hand answering the same purpose, covering it with straw, or better, sods with the grass side down, after which proceed as above.

The application of a large quantity of green manure before the plants are established is probably one of the most fruitful sources of failure, and the use of a greater quantity than that before mentioned I would not advise.

For planting, bushes which have grown in eight or ten inch pots are preferable, the extra cost of such plants being amply repaid by having stronger bushes. If these are not to be had plants will do which have been propagated in February or March and kept growing until they



are established in five or six inch pots, which they will be by the middle of June, and this I consider a good time to plant, or as soon after as convenient. When strong plants are used, I plant them about two feet and one-half apart in the row and three feet between the rows. If the plants are small, plant half the above distances, thinning out every other row, and every alternate plant in the remaining rows, after the first season. When planted the house should be shaded by painting the glass with turpentine with a little white lead and oil added. This does not destroy the paint on the woodwork, which is the case when lime is used for shading. Give plenty of air for a month or six weeks, leaving the sashes open at night, until the plants are well rooted in the new soil, which ensures a stronger "break" of young wood than if the house is kept close at first. After this, syringe, and close the house early every evening. The border should now have a good mulching of stable manure, and after a time frequent waterings with liquid manure. When the nights get cool, start a gentle fire to keep off the mildew, and in winter the thermometer should be kept up to fifty-five or sixty degrees by fire heat.

No pruning will be required the first season, except to cut out the scrubby, blind shoots near the bottom which are apt to harbor "red spider." In fact, a rose bush, which has been forced into a soft, pithy growth, should never be headed in or cut back in the manner in which we would cut a hardy rose, as it never breaks strong. Whole houses of fine bushes have been thus destroyed, and I find it best when a house has been treated in this way, to dig up the bushes and replant with young vigorous plants at once. In pruning, the shoots which have ceased to give flowering wood should be cut clean out at the bottom, and the shoots of the later growth left entire, and if bent over and pegged down they will break finely from the latent eyes, on the lower part of the canes. I have practiced this method, which is an old one, for years, and find it works well, especially with old plants, which many growers throw away, to make room for young ones, while these at best take one year before they give as good a crop of buds as old plants treated in this way.

The varieties suitable for marketing are Saffrano, Bon Silene, Isabella Sprunt, Yellow Tea, Marechal Niel, Souvenir de la Malmaison, Niphotos, in about the order named, and a few others, which, however, are not grown largely by Flo-

rists, and are, perhaps, more suited to the wants of amateur cultivators, where variety is more the object than market qualities.

All of the above-named varieties may be successfully grown in pots, if potted, in three parts turfy loam and one part well-rotted manure, and shifted as the pots become filled with roots, with an occasional watering of liquid manure.

Should you deem the above worthy of insertion in the *Gardener's Monthly*, and care to hear from me again, I may drop you a few lines on some future occasion. [Please do.—Ed. G. M.]

### HISTORY OF THE DOUBLE LOBELIA.

BY HENRY CHITTY, PATERSON, N. J.

I selected a plant in a London greenhouse, and carried to this country in my hand, as it were. In fact, we had the Double Lobelia in our nursery as early as June, 1873, and was getting a nice stock of it. During my visit to your city in September of that year, Mr. Buist asked me if we had it, and made me promise him an early plant. I promised him the first plant we sold, which was October 1st, 1873. Our plants were all set out among a lot of Double White Chinese Primroses which were planted out in a bed in one of the houses. On the last night of September the slugs, or snails, made an attack on them and eat off every one of them even with the ground. Not one of them ever grew the least bit afterwards. It appeared to have poisoned them. To say that I was disgusted and discouraged only partially describes my feeling at that time. From that time to the first of last June we imported about 30 dozen plants without getting one alive. I even hired a man to bring out some plants, telling him how to manage them, but he not knowing the importance of the plants had them packed in a box, and they were lost. At last, upon leaving London, I selected three fine plants, and I landed in New York with them in full flower, from which we soon had a stock. The plant varies in color of flowers from a very light sickly blue to a deep, rich, dark blue. The latter are worth having, and with the opportunity at my command I did not select the former.

### EDITORIAL NOTES.

WALL-FLOWERS AND GILLIFLOWERS.—These old-fashioned flowers do remarkably well under culture for greenhouse adornment in early spring, and may be sown now for that purpose. There

have been great improvements made in form, color and habit. One of the best we have seen was sent to us by Mess. Vilmorin, of Paris, and of which we give an illustration. They call it the



Paris Gilliflower. We are not sure that this special kind is offered by our seedsmen, but it could be inquired for, with instructions to send other good kinds if that one was not on hand.

The whole family of Wall-flowers and Gilliflowers, or "Stocks," as they are sometimes called, are capital things to try one's skill on as plant cultivators. A poorly-grown stock is still a good thing to have, but a well-grown plant is charming. Horticultural societies should offer premiums for such things as these.

ROYAL PATRONAGE OF CUT FLOWERS.—The *Gardener's Chronicle* says: "The floral decoration at the Guildhall on the occasion of the reception of the Prince of Wales was entrusted to Mr. B. S. Williams, of Holloway, who also supplied the bouquet presented to the Princess, 200 other bouquets for the ladies, and 350 "button-holes" for the gentlemen. The Princess' bouquet consisted principally of *Phalenopsis grandiflora*, *Odontoglossum Alexandrae*, *Vandas*, &c. Between thirty and forty van-loads of decorative plants, such as Tree Ferns, Azaleas, Palms and Orchids, were required on the occasion. The ball-room and the approaches to it were decorated by Mr. Wills."

TO PREVENT HYACINTHS HAVING SHORT STEMS.—Get some stout brown paper and cut it into squares of a suitable size, and then roll them up into funnels similar in form to the pointed bags in which grocers put moist sugar. They should be from six to nine inches long, and as soon as rolled into shape pasted up the edge to keep them firm; if for plants in pots, the base of the

funnel should be large enough to go over the bulb and a portion of the soil; if for glasses, it should fit the outside of the upper rim of the glass. The pointed end should be cut off, so that when placed over the plants, the light will come in at the top only; the flower-stem will rise up rapidly to reach it, and as soon as it is as long as you desire, take off the funnel and allow it to bloom. After a little practice with this method, you will be able to grow them all of a height, which very much enhances their beauty where a number of them are arranged in a window.—*Gardener's Magazine*.

### QUERIES.

FLOWERING OF THE HOYA CARNOSA.—Mrs. C. C. P., Aledo, Mercer Co., Ill., asks, "Can you tell me how to flower the wax plant (Hoya)? I can make it grow like a bad weed, but cannot, as yet, make it bloom. Or must it have a certain age to bloom? If you can give me a hint in your excellent magazine perhaps others will be as thankful as I know I shall."

[Set it out in the full sun during summer. It will in all probability flower freely after that.—Ed. G. M.]

KILLING THE MEALY BUG.—A correspondent sends the enclosed and asks our opinion.

"For exterminating mealy bug, writes a correspondent in the *Rural New-Yorker*, I have never found anything so good as alcohol; or even common high-proof whisky will do. With a small soft brush one can soon clean the bugs from a hundred plants, no matter how badly infested. Dip the brush into the alcohol, and then let a drop or two fall upon a cluster of mealy bugs, and they will disappear. There are some very delicate kinds of plants which the alcohol will injure if used too freely; but there is not much danger in its application to the ordinary kinds cultivated in greenhouses."

☞ We believe it is good advice. At any rate try a little first, and if effective, and no injury results, use it extensively.

### NEW PLANTS.

NEW DOUBLE ZONALE PELARGONIUM WONDERFUL.—Mr. Geo. Smith, of Hornsey, London, who raised this variety, says it is remarkable for the persistency with which it retains its petals, the unusually large size of its trusses, as well as the

great substance and intense brilliancy of its flowers, and when we reflect that the Royal Horticultural Society awarded it a first-class certificate of merit last season, we may justly infer that its

abundant bloom, and other qualities of that variety as well as its intense brilliant orange-scarlet color. Our plants when only three or four inches high—mere slips, commenced throw-



merits were well considered.

This variety is a sprout from the well known and popular single flowering Zonale Pelargonium "Vesuvius," and retains the dwarf free growth,

ing up their flower trusses, which would seem to indicate an unusually free flowering habit, which will give it great value as a market or bedding plant.

H. E. C.

# FRUIT AND VEGETABLE GARDENING.

## SEASONABLE HINTS.

Many kinds of fruit trees that have arrived at a bearing age, may perhaps be growing very vigorously and producing very little or no fruit. Those who have read our remarks in past numbers, will understand that whatever checks the wood producing principle, tends to throw the plant into a bearing state. For this purpose, summer pruning is often employed, which, by checking the most vigorous shoots, weakens the whole plant, and throws it in a fruitful condition. The same result is obtained by root pruning, with this difference, that by the last operation the whole of the branches are proportionately checked, while by pinching only the strong growing shoots, the weak ones gain at the expense of the stronger ones. Presuming that the branches have been brought into a satisfactory condition in this respect, root pruning may now be this month resorted to. We cannot say exactly how far from the trunk the roots may be operated on, so much depends on the age and vigor of the tree. In a luxuriant, healthy tree, one-fourth may be safely dispensed with. In a four year old standard pear tree, for instance, the roots will, perhaps, have reached four feet from the trunk on every side. A circle six feet in diameter may then be cut around the stem, extending two feet beneath the surface. It is not necessary to dig out the soil to accomplish the result; a strong post spade, or strong spade of any kind, may be driven down vigorously describing the circle, and doing the work very effectually. Of all trees, the peach is as much benefitted by root pruning as any.

August and September are favorite months to plant out Strawberries, with those who desire a crop of fruit the next season. In making a strawberry-bed a warm, dry spot of ground should be chosen, with, if possible, a good loamy or clayey subsoil. A moist wet situation is very unfavorable. It is best to subsoil at least eighteen inches deep, and if the soil is poor, let it be moderately enriched with well decayed stable manure. In

setting out, take care that the plants do not become dry from the time they are taken up till they are replanted, and see that they do not wither afterwards. Many persons cut off the leaves, if they are afraid of their wilting under hot suns, but a much better plan is to shade. Inverted 4-inch flower-pots are excellent for this purpose; they may be taken off at night. The dews will so invigorate them, that the shade will only be required for a few days. Sometimes in September they may need a good watering; but this should never be attempted unless a thorough saturation of the bed be given; and in a few days after, the hoe and rake should be employed to loosen and level the surface, which the heavy watering will, in all probability, have caused to bake and become very crusty.

The Grape vine at this season will require attention, to see that the leaves are all retained healthy till thoroughly ripened. It is not a sign of healthiness for a vine to grow late; on the contrary, such late growth generally gets killed in the winter—but the leaves should all stay on, to insure the greatest health of the vine, until the frost comes, when they should all be so mature as to fall together. Frequent heavy syringings are amongst the best ways to keep off insects from out-door grapes, and so protect the foliage from their ravages.

Towards the end of the month, a sowing of Spinach may be made in rich soil, which will come in use before winter. That desired for winter and early spring use, is usually sown in September in this region. A few Turnips may be also sown for an early crop, but will be hot and stringy unless the soil is very rich.

As fast as endive is desired for salad, it should be blanched. Matting thrown over is the best for this purpose, as the plants are not so liable to rot as when pots or boards are employed. In cold or mountainous regions, Melons are hastened in the ripening process and improved in flavor by a piece of tile being placed under the fruit.

Celery will require earthing up as it grows, to get it to blanch well. It is not well, however, to

commence too early, as earthing up tends in a slight degree, to weaken the growth of the plants. Take care also, not to let the soil get into the heart in earthing, or the crown is apt to rot.

At this season of the year, more than perhaps at any other, it is important to hoe and rake between the rows of growing crops. A loose surface soil not only admits the various gases that the roots luxuriate in, but it also prevents evaporation and checks a too great absorption of heat, and then, besides all this, the weeds are kept down, and neatness and order reigns. After every heavy shower, if the time can at all be spared, the hoe, and the rake should be freely employed.

---

## COMMUNICATIONS.

---

### ONION AND SEED GROWING IN CALIFORNIA.

BY A. MCML., SAN JOSE, CAL.

No country in the world produces finer onions than are grown around the Bay of San Francisco. The rich alluvial soil and the peculiarity of the seasons and climate in this part of California seem to be specially adapted for growing both the bulbs and the seed of the onion in the greatest perfection. Great quantities of the Yellow Danvers and Yellow Dutch are raised chiefly by Portuguese for the city market. I have been in Egypt and Holland, as well as in Spain, but in none of these lands, the native home of this ancient deity of the kitchen, have I ever seen onions to excel our California bulbs, either in beauty of form or fineness of flavor. One who has great experience in onion culture, both in the Eastern States and in California, writes in *The Pacific Rural Press*, that "the onion bulbs produced in California are much more perfect in every particular than any grown elsewhere on this continent. Californian onion seed, when planted in the same field with seed of the same kind of Eastern and European growth, produces larger and finer onions than the latter, having less scallions and ripening earlier."

This fact is of especial interest to onion growers, and is, no doubt, to be accounted for by the circumstance that the crop of onion seed usually ripens here about a month in advance of seed grown in the East. To test these points, California onion seed has been planted along with the best Connecticut and English grown seed of the same kind, at Rochester, N. Y., and

Detroit, and the result was such that the seed of California growth was acknowledged to be superior to the seed of Eastern growth, even by those who were considerably prejudiced against it. Our mild winters and genial spring and summer allow the seed vessels of plants to be fully developed and all seeds to be perfectly formed and ripened; our cold nights rendering them also quite hardy. Then, the long, dry summer, without rain, permits of the thorough drying of the seed in the open air. These are advantages which ought to give onion and other vegetable seeds grown in California the same preference in the market that our wheat (seed) now enjoys. The seed farms in the vicinity of this city are carefully cultivated, being owned by reliable individuals of intelligence and experience.

From the large quantity of onion and lettuce seed sent East last year, and the extensive orders received from several of the leading seed establishments of America, it is evident that vegetable seeds, particularly onion and lettuce seed, grown in this State, will soon come to be in great demand as its superior excellence comes to be more generally known. The cost of suitable lands, the expense of labor and freight, and the destructiveness of the "gopher," which is the pest of this fertile land, however, seriously curtail the profits of the seed grower in California. But against these he expects to place the superior quality of his seeds, and a rapidly increasing demand for them, both in the Northern and Southern States. The onion growers of California prefer seed of native growth to any other, for the most part growing what they require themselves.

San Jose, Santa Clara Co., Cal., June 3, 1876.

---

### THE WILD GOOSE PLUM.

BY E. S. N., CHATTANOOGA, TENN.

I see you noticed my letter in the June number, referring to the Peach seed, and desire to know from me "if these seedlings have always very small seeds, all of a uniform size, or whether there are large and small ones, various sizes, as we should suppose."

You are correct in your supposition. As some of the fruit is large and some small, so also the seeds are in like proportion, large and small.

A word about the wild goose plum. Mr. Transou, of Humboldt, Tenn., thinks he can solve the difficulty, and says: "This noted plum originated in Tennessee, and is as thick as blackber-

ries all over our country. The practice has been and still quite common to plant stone fruits without grafting or budding. No wonder there is such a difference," and goes on to say: "The average size, one and a half to two inches in diameter, *round shape*, very productive," &c. I beg leave to differ with the gentleman when he says "they are as thick all over the country as blackberries." On the contrary, there are but few of them planted through the State. I mean the genuine, for when reproduced from seed there is no certainty of their being so. It is true, we have got plums growing all over the country like blackberries, and they can usually be bought at fifty cents per bushel in their season, and while they belong to the Chickasaw family, are not by any means genuine wild goose plums. In fact, I never heard any such claim made for them. They are round (as the gentleman says) and about one-half to two-thirds as large, while the wild goose is large and oval, and can be told by the leaf and wood as well as by the fruit.

The genuine wild goose can be procured at any nursery in the State, most generally budded on peach stock.

### EDITORIAL NOTES.

ROE'S SEEDLING GOOSEBERRY.—We have before us some specimens of Mr. Roe's Seedling Gooseberry, and a marked copy of circular stating that it "is as large as the best English varieties, and has never mildewed for fifteen years." Professor Thurber's opinion of it is also quoted, but we note that he simply says "it is much larger than our native sorts," which is correct, for with Professor Thurber's botanical knowledge he could not call this a seedling of the native species. Unfortunately, the fact that it has never mildewed for fifteen years is no proof that it never will. All experience has shown that the foreign class of gooseberries are unreliable in this respect. We hope it may never mildew. Nothing would please us better than that Mr. Roe had been fortunate to find just this mildew-proof foreign kind. But our duty to our readers will not allow us to hold out this hope.

LINSEED OIL FOR PEAR BLIGHT.—We have noted the remarkably beneficial effect on pear and apple trees by washing with linseed oil, but we find a place for the following from the *Rural Home*:

"Two or three years ago, a paragraph went

the rounds of the agricultural press to the effect that Mayor Ludlow, of Norfolk, Virginia, had treated the pear blight with remarkable success by applying linseed oil to the diseased parts. It was copied into the *Rural Home*, and read by D. P. Westcott, of this city, among others. That same season Mr. Westcott had a tree attacked with blight, the bark of the trunk, below the branches, presenting that blackened, burnt appearance, so indicative of what is called 'fire blight.'

"By cutting through the bark Mr. W. discovered that the inner bark and sapwood were black and apparently dead. Remembering the oil prescription, referred to above, he washed the diseased parts thoroughly with raw linseed oil. This was in the autumn. The next spring the tree leafed out, and commenced growing, and upon cutting into the diseased bark, he found that a new inner bark had grown, and the tree is now alive and flourishing.

"Last summer his trees commenced blighting again, some of them very badly, and he applied the linseed oil again. The blight was arrested, and the trees have put forth their foliage in good condition this spring, and the new bark under the dead exterior, is alive and apparently healthy. We have just called, at his request, to see the trees, and find them as reported above.

"Although Mr. Westcott lives in a densely settled portion of the city—39 Stone St.—he has a liberal lot well stocked with ornamental trees of the smaller kinds, shrubs, fruit trees, grapes, raspberries, strawberries, and quite a variety of garden vegetables, all so well cultivated and pruned as to be really ornamental. His pears are of a number of varieties, both dwarf and standard, and both kinds have been attacked by the blight.

"Although Mr. Westcott does not claim to have fully demonstrated the fact that linseed oil is an infallible remedy for pear blight, he will be very likely to try it again should his trees be again attacked, and we would advise the readers of the *Rural Home* to do the same, and see what its effects may be in their cases."

THE PEACH BIRD.—We regret to state that these birds have made their appearance in our county. One of our fruit growers informs us that he first discovered them on his place last Sabbath; he described them as being larger than our sparrow, yellow in appearance, and beautiful singers. They do not confine themselves to peaches, but are feeding upon pears, or any

other fruit that they can swallow.—*Centreville Record*.

**THE EARLY PEACHES.**—The desire of the public to know about the early peaches, now closely rivaling each other for superiority, is intense. It is very difficult to settle contending claims, and among so many friends it is not pleasant to be the referee; but it is our misfortune to be in this position, and we have no choice but to decide to the best of our ability. We have had the chance to test this season the following, all grown within sixty miles of each other, and without going into details, must say that for earliness we believe them to stand as follows: 1. Downing; 2. Saunders; 3. Alexander; 4. Musser; 5. Amsden; 6. Beatrice; 7. Wilder; 8. Hales' Early. We believe these will ripen in the order named if growing all near each other.

Now as to quality, we would put first No. 4, then as follows in order, No. 3, 2, 1, 6, 7.

In size we should put the numbers in the following order, 7, 4, 3, 2, 1, 6.

All this is subject to future revision, but it strikes us this way at present.

**COLORADO CABBAGE.**—The *Saguache Chronicle* gives some interesting facts regarding Mr. Stollsteiner's farming operations in the upper valley of the Rio Grande in Southwestern Colorado. Last year he raised Marblehead mammoth cabbages that weighed thirty-five pounds each.

## NEW FRUITS & VEGETABLES.

**BRIGGS' RED MAY PEACH.**—From John Rock, San Jose, Cal., June 22d.—Round, very white skin with red cheek, 7 to 8 inches in circumference, rather tart in flavor, probably from the distance requiring them to be gathered before quite ripe, but very juicy and refreshing; flesh and stone greenish white. This was as large as any of our best peaches, and equal to the average in general qualities. It was the largest early peach we have ever seen, and if in this climate it should prove as large, and as good, it would soon put all those we have aside. The actual value, however, of course depends on how it compares with our popular kinds, when grown side by side in this latitude, or with others in California. Of this last point Mr. Briggs says:

"I have been requested by John Rock, of San Jose, Cal., to send you by mail specimens of

the Red May peach. It originated with me, and is fully twenty days earlier than Hale's Early. We have had a remarkably wet season and the peach on that account is not as well flavored as usual. The Red May has been placed on the San Francisco market for the last four years, on from the 27th to the 30th. There have been at the date of this over 5,000 bushels of the Red May placed on this market. Last season they were all gone on the 18th of June."

**THE HAMNER PEACH.**—Mrs. M. E. H., Galveston, Texas, gives the following account of this variety: "Hoping that I have something new in the way of a very fine late peach, I thought I would give you its history thus far, and see if you could give me any light upon its name or merits, if not a new peach. It being very late here, and hardy and large, I think it is just the peach for a very late, large, good sort for market when all others have become scarce; and as it is very showy, I think it would command a good price.

"It is a seedling of the cling variety. It came up in my garden voluntarily three years ago last April, and from its thrifty and vigorous appearance, I allowed it to remain. It bore two peaches at two years of age, but my little ones being able to reach them, they were not allowed to ripen. Last year it had about five pecks of the finest peaches it has ever been my pleasure to see or taste. When very green, some two months before ripening, they were exhibited at the Texas Horticultural and Pomological Society, at Houston, where they were universally admired, and had honorable mention made of them. When ripe, I could have sold them readily at twenty-five cents a piece. I had one dozen picked promiscuously, and weighed on a druggist's scales, and they weighed from 6 to 10 ounces each. They are very oblong when young, with a very decided neck, and tip on the end, but are almost round when matured. Very slightly pinkish in color, sweet and very juicy. Another very strange circumstance in regard to this tree is, that whilst six others in the yard, and not over 40 feet from it, some of them younger, and some older, all as well, or better protected from the September storms were killed, this tree survived, and is in vigorous growth, but with very few peaches on it this year."

**CUMBERLAND TRIUMPH STRAWBERRY.**—"We gave a figure of this new variety, last year, showing its large size, and from a personal examination of

the beds, were enabled to judge of its productiveness. Colman's *Rural World* (Mo.) states that fourteen of them have weighed a pound, and that paper publishes a communication from a Texas correspondent who obtained berries weighing half an ounce on plants received through the mail forty days before. This variety was raised by Amos Miller of Carlisle, Pa., and resembles *Green Prolific* magnified nearly double its usual size."

The above is from the *Country Gentleman*, to which, we will add that some on exhibition at the Centennial impressed us favorably. They were the best flavored of many on exhibition that day.

**DURAND'S GREAT AMERICAN STRAWBERRY.**—Those exhibited at the Centennial attracted much attention. They are similar in size to Jucunda, as Knox used to raise them, and are equal in quality to that capital variety. There is a greater tendency to flattening than in that. It is one of the most promising seedlings we have seen.

**SMITH'S PRESIDENT LINCOLN STRAWBERRY.**—Exhibited at the Centennial, is among the best seedling strawberries of the season. The fruit averaged as large as any exhibited at the great Centennial show. Very firm solid berries; of a brilliant dark scarlet color, and of excellent flavor. Most of them were inclined to flatten. This is another of the most promising seedlings that have come before us this season. Raised by Mr. Smith, gardener to Charles Dickens, Esq., of New York.

**PROUTY'S STRAWBERRY.**—A Western seedling, has been tested by Mr. Bassett, of Hammonton, on whose grounds the writer saw them in June last. It bears out here all its Western friends have said of it.

**SOUTHERN RED THORNLESS RASPBERRY.**—We have from Mr. W. Bassett, Hammonton, N. J., some boxes of this variety, which proves to be an excellent traveler, and as superior a keeper. It appears to belong to the same class as the *Philadelphia*. We cannot speak of its bearing qualities from our own experience, but in all others we can say it is a superior fruit. It is rather darker than the *Brandywine*, which is also a favorite with our market men.

**THE BARNHARDT CHERRY.**—R. D. Barnhardt, post-marked West Newton, Pa., sends us a seedling cherry. He does not say it is his own, but that it "originated with some fruit grower of this locality." As it is a valuable cherry undoubtedly,

and it is no use to notice things without name, we give it the name above. It is of the Biggarreau class, above medium, very solid, and very sweet, long slender stem. Fruit bright red, mottled with scarlet, and a shade of black on the sunny side. It strikes us as a valuable market fruit.

## QUERIES.

**SEEDLING STRAWBERRY.**—J. R. S., Catawissa, writes: "I take the liberty of sending you to-day per Reading Express (expressage prepaid) one small box of a seedling strawberry of my own raising for examination. With me they are much larger, better quality, much more productive and very much better growers than any other kind. I would like Mr. Meehan to see them, and have his opinion of them, but as he lives in Germantown, I thought likely he would not get them until spoiled. The season is very wet with us, and the fruit consequently not so firm and good flavor as usual. This is the second week's picking and the berries are from  $\frac{1}{4}$  to  $\frac{3}{4}$  smaller than the first week."

[These should have been sent to Germantown. It would have saved time and twenty-five cents to the editor. Still they came to Germantown from Philadelphia in fair condition after their long journey, and enabled us to form a high opinion of their merits.—Ed. G. M.]

**RICHLAND PLUM.**—G. & S. B., Norwalk, Ohio, say: "Can you tell us anything about the Richland plum?"

[It is a small copper-colored plum—indeed often confused with the *Copper* plum—much planted by the Germans of the interior of Pennsylvania. It is not of first-class quality, but is very hardy and prolific, and seems more free from injury by curculio and disease than other kinds. It is very well suited to heavy clay lands.—Ed. G. M.]

**THE EARLY PEACHES.**—Mr. H. M. Engle, Marietta, Pa., says: "The question, which is the earliest peach, has been considerably agitated the last few years, and it is still undecided. Would it not be for the public interest to arrange to have them exhibited and tested at the Centennial? We know that latitude, soil and situation, and other circumstances, will prevent a positive fair test, but the period of ripening, size, appearance and quality may be approximated by a competent committee, which would certainly be some criterion until they can all be grown side



by side. The prospect for my seedlings, *Wilder*, *Downing* and *Saunders* is fair, and I expect to show them at the proper time. There is also an early new seedling in Cumberland Valley of fair promise, that fruited for the first time last season, which shall be on hand if it comes to time. Let us hope the *Beatrice*, *Louise*, *E. Rivers*, *Amsden*, *Alexander*, *Honeywell*, and all other candidates for honors of earliness will be on hand.

My first impulse was to write an article for the Monthly, but have concluded that it would be more effective in the shape of an editorial, if you approve of the suggestion.

[Mr. Engle's suggestion is a timely one. We hope those who have early peaches will send them. No application for space is required, as requested of the permanent exhibitors. If they are sent, express paid, to Burnett Landreth, Agricultural Bureau, Centennial Buildings, Phila., they will be properly taken care of, and placed on exhibition. The early kinds exhibited should of course come from the same localities for comparison. On the 9th of June some fine *Early Beatrice* were on exhibition, but they were from Alabama, and there were no other kinds from that region to compare them with. One of these was *eight and a-half inches round*, and the flavor better than any we had tasted before of this kind.—Ed. G. M.]

CORNELIAN CHERRY.—An Indiana correspondent, evidently supposing this to be a *cherry*, inquires "what stock it is budded on." It is not a true cherry, but a dog wood—*Cornus mas*—also called male *Cornel*, but why, we never knew. The fruit is cherry-like, and employed to make rather tame preserves and tarts. It has great beauty as an ornamental shrub to recommend it. It is grafted on no stock, but raised by nurserymen from seed.

WHITE ALPINE STRAWBERRY.—J. H. C., Columbus, O., says; "I once had a white Alpine strawberry, twenty years ago, that bore a long time after the strawberry season and bore abundantly. I see no account of such a berry. Who can tell about it? It was about the color of pale buff paper and very delicious. I would like to know if any one can tell about such a berry. I regret very much that I neglected to keep it."

[There are white varieties of the Alpine strawberry, but most attempts to keep the Alpines in cultivation prove futile, from ignorance as to the proper culture of Alpines. When treated as ordinary strawberries they are small, and hardly

worth growing. They need reclaimed bog land or some other cool soil to do well.—Ed. G. M.]

LEECHEE NUTS.—Miss G. writes, "My niece, Mrs. Wm. C. Heacock, U. S. N., when in San Francisco, about three years ago, was presented by a Chinaman with some nuts containing, as near as I can make out, an edible pulp covering a stone. The nuts are about the size of the largest button balls of the Buttonwood or Plane tree, are of a brown color and look as if all particles were joined into one and hardened to a crust. I find by crushing it a little I can enclose a broken one. If it should be new to you so far that you desire more, I will send you some perfect ones and will ask you to name it.

[This is the fruit of the *Nephelium Leechee*, a Chinese tree that would be hardy south.—Ed. G. M.]

DISEASE IN CABBAGE PLANTS.—A Felton, Kent Co., Del. correspondent, says: "I send by mail to-day in a small box, packed in moss, two cabbage leaves of Jersey Wakefield variety. They are spring grown, in a gentle hot-bed; the bed has been only moderately warm at any time. I have observed lately that the leaves have looked yellow, but paid very little attention to them, thinking it was the effect of frosts during the late cold nights. To-day finding them looking worse than ever, I examined the plants and found the leaves thickly covered on the under surface with a white insect, about the size of red spider that infests hot-house plants, perhaps somewhat larger than these. The bed of plants has the appearance of having been scalded. At first they appear in small patches and some leaves have but very few on them, others have, as you see by the specimens I send you, the under surface thickly studded. In the same bed of about 4000 plants are about 1000 of Fottler's Early Drumhead, and these are but slightly, if at all affected. I have failed to find any reference to such an insect in Henderson's books, the *Gardener's Monthly* or other Agricultural papers, and I take the liberty of sending you these specimens, hoping they may arrive in good order, and that you may enlighten myself and the many other readers of the *Gardener's Monthly* in regard to this, to me, singular insect, which I fear may prove a serious hindrance to the already risky business of growing cabbage."

[This is *Peronospora parasitica*, near relative of the *Potato fungus*, and likely to prove a dangerous customer.—Ed. G. M.]

# NATURAL HISTORY AND SCIENCE.

## GENERAL OBSERVATIONS ON THE FLORA OF HOKKAIDO.

BY M. LOUIS BÖHMER,

*Horticulturist to the Kaitakuska, Yedo, Japan.*

[Continued from page 212.]

Leaving the forest towards Yubuts we struck several rivers running in an easterly direction and found large numbers of the *Lilium tigrinum*, the bulbs of which are a favorite vegetable with Japanese. A *Lychnis*, with much lacinated petals and of a bright red color grows here among the grass; it looked so handsome that I collected a number of living plants. Yubuts is situated on the sea-shore, and vegetation naturally becomes less varied. A large leaved creeping *Rubus* (Raspberry), bearing clusters of large red fruit grows everywhere in the neighborhood. The fruit at first sight looks very tempting, but has little flavor to recommend its cultivation.

Following the coast on our way to Akkehi I found little of interest until I reached Saru. The sandy levels on the sea-shore are frequently covered with a wild rose, *Rosa rugosa*. It has large dark-green leaves and single purple flowers measuring 3 inches in diameter, and bears a red round fruit which is much relished by Ainoes and Japanese. If preserved in sugar they would make a fine desert fruit. *Vitis labrusca*, the wild grape, is also found growing near the sea-shore. It has long dark-green leaves which are of light-brown color underneath, and bears bunches of fruit which are dark-blue when ripe. The growth of the vine is not as luxuriant as it is in the woods near Sapporo and other places, but this can be accounted for by the soil which here is of a much poorer description. Small oaks with an undergrowth of *Lespedeza* (a leguminous plant), much prized by the Japanese and often mentioned in their poems under the name of Hagi, and a grass, *Eulalia Japonica*, growing about 5 feet high together with an *Artemisia*, are all I remarked. The latter three are cut together and made into hay, which is used by the natives for feeding their horses in winter. A pretty looking fern is growing on the branches of the oak trees.

Near Saru is one of the head-quarters of the Ainoes, consisting of seven villages with a population of about five hundred inhabitants. Their occupation is principally fishing and hunting; but I found some traces of agriculture, or rather

garden culture, along the banks of the river on the good rich soil. Millet and beans formed the principal crops. Wild Hops grow frequently in this soil; the specimens I saw looked very much like foreign ones, and I think would improve by cultivation. Foreign hops imported there would certainly succeed well if the Ainoes could be induced after proper instruction to devote themselves to this profitable article of commerce. Of all the localities I have seen during my stay in Hokkaido, none seems, in my opinion, more favorable to the cultivation of hardy foreign fruit as far as both position and soil are concerned.

I was much surprised to find even in this remote locality some small traces of ornamental gardening. These gardens are only found at the government stations, and planted by officials in former years. The plants consisted principally of those growing in the neighboring mountains, such as *Rhododendron*, small firs, and the dwarf growing *Taxus cuspidata*, which is often trained into different shapes. In some of these gardens I even found some of the favorite trees imported from Yedo, the Plum Cherry, Pine, *Cryptomeria*, and among herbaceous plants the *Chrysanthemum* was most conspicuous.

On the road to Urakawa I met with an apparently leafless Orchid. It had pink flowers at the time, but I could not ascertain from my traveling companions whether it ever made leaves, nor could I find any traces of them. At the same place I found a number of Lilies which were pointed out to me as the "black Lily;" unfortunately the flower had already passed, and I had no opportunity of identifying this plant. Mr. Lyman, who started earlier for the east coast, had seen it in flower, and tells me that the flower is of a dark-blue color. The plant which generally goes under the name of "black Lily," in Yedo, and of which I have seen drawings, differs materially in the structure of the leaves, and I am inclined to think that the Yesso Lily is a species as yet unknown. I therefore collected a large number of bulbs to be sent to Yedo, in order to see whether it really is a novelty or not.

Here I had to leave behind the artist who had been attached to our expedition; he fell sick and had to return; a great disappointment to me, as I had counted upon him to preserve in drawings

such plants as I was unable to preserve by drying. I am all the more sorry as he gave proofs of considerable ability, although he took a long time over the few drawings which he really finished.

From here the road becomes almost impassable for travellers on horseback. It is nothing but a path, and never seems to have been laid out or repaired properly, and even becomes dangerous in some parts. Gradually ascending the mountains at Samani the vegetation becomes alpine, and coniferous trees which I had to my great surprise seen very little of up to this time formed the forest to a great extent. *Abies Yezoensis* with a pine which I believe to be *Larix Kaempferi*, but which for want of cones I could not well determine. The undergrowth was formed of a large leaved *Rhododendron*, and *Zanthoxylon*; the fruit of the latter is used by Japanese as a medicine. The seeds have a peculiar flavor.

In the moss underneath the fir trees a small Orchid, a *Goodyera* is found growing; also the handsome creeping blue *Campanumæa* (*Gentianeæ*) is to be met here in the clearings.

*Monotropa uniflora*, a species of *Ericaceæ* is found growing here among stones near rapid flowing streams under the shade of trees. It is parasitical on the roots of trees, has a scaly stem about 8 inches high, bearing only one flower of a whitish pink color. It resembles much a *Monotropa* which grows in North America, and is called there commonly "Indian pipe." It is very curious that the Japanese also have a similar name for it, viz.: "Gankubiso," meaning herb like the bowl of a pipe.

(To continue in next number.)

### PEAR OR APPLE: WHICH?

BY R. J. BLACK, BREMEN, OHIO.

The strangest thing in my pomological experience of twenty-five years has come under my observation recently.

Some years ago, for want of a more convenient stock, a *Sops of Wine* apple tree was grafted with several new varieties: *Snepps*, *Celestia*, *Muster*, &c. All are in bearing now, as the May frost which swept off the pears and thinned out the cherries, injured the apples but little—many varieties not at all.

Examining this tree lately, I was attracted by the fine appearance of the fruit on the lower branch, which had not been grafted. Pulling off

some of the less perfect apples, as it was very full, and coming to a shoot hanging down with two fruits on the point of it, to my surprise one of them—the larger of the two—proved to be a finely shaped pear! It is distinct pyriform, dull red, and green like the unripe *Sops of Wine* apples; and of fair size—large indeed for the time of the year, July 1st.

One rod south of it is a *Kirtland* pear tree, which, though large enough, has never borne; and not having observed it closely last spring, I am unable to say whether it bloomed or not. But the *hybrid* (if such it be) has no resemblance to *Kirtland*, which is a roundish, yellowish russet pear, with the stem "inserted in a small cavity;" while the former has its stem inclined and joined to the neck by an enlargement and without depression, after the manner of *Louise Bonne de Jersey* and some others.

One of the interesting questions connected with the subject time may determine: whether the seed will be perfect or not.

[There is a similar case illustrated in plaster in the Government Department of the Centennial Exhibition, and to which our attention was kindly called by Mr. Seaman, of the Agricultural Department. In these cases it would be worth while trying by the microscope whether there was any other approach to the pear than the mere aberration of form indicated. The pear cell is very different from that of the apple in general character.—Ed. G. M.]

### PALMS OF SOUTHERN CALIFORNIA.

BY SERENO WATSON, CAMBRIDGE, MASS.

In your note upon my last "contribution" in June *Gardener's Monthly*, I see that you have misunderstood me in regard to the South California palms.

*Brahea* is a genus of Central Mexico, of a single species so far as I know, *B. dulcis*, Martius. The palm of South California, before much was known about it, was referred by Cooper, and in the Botany of the Mexican Boundary, doubtfully to the same species. When seed was sent to Europe a few years ago, and it began to be cultivated, Wendland named it *Brahea filamentosa*, and it was so known by the few who had it, but it was never published or described, and the reference to *Brahea* was probably merely a guess on the part of Wendland.

When the Guadelupe specimens came (flowers, fruit and foliage), I studied them up as well as

opportunities permitted, and was disposed to call it a *Livistonia*, but sent it to Wendland who named it *Brahea edulis*, as I have published it. I still think, however, that I was more nearly right, but with deference to Wendland's authority named the second species from the Tantillas mountains in Lower California, *Brahea armata*, as it was certainly of the same genus with the Guadalupe species.

But if these two are *Braheas*, what is the old San Diego species? If you had represented me as saying that it is *not* a *Brahea* you would have hit it exactly, for in describing the differences in the fruit I intended that that should be inferred. And, in fact, since my paper appeared I learn that Wendland has transferred it to *Pritchardia*, and that the plant is now for sale under the catalogue name of *P. filamentosa*, or as some have it, *P. filifera*; see May number of the *Garden*, with a (made up) figure.

Both Dr. Parry and Dr. Palmer are looking into the matter of the palms of our Western coast, and I trust that we will have more perfect knowledge of them by the time that the second volume of the *Flora of California* is ready for publication.

### EDITORIAL NOTES.

THE ELM SLUG.—We find this enemy has been fully recognized by the ever watchful Prof. Riley, who detailed its operation in the *New York Tribune*, for Aug. 7, 1873, as follows:

"The elm is a favorite shade tree here, as well as in New England, and we seem doomed to have them all killed by an insect. One of my neighbors thinks that the eggs are deposited by a bug (see sample inclosed), which flies up into the branches; but others believe that the female ascends by crawling up the body of the tree? Can't you refer this note to some competent person, and publish the simplest known remedy—suitable for poor folk to practice. Tobacco juice will drive them, but it is expensive, and in case of large trees, impracticable."—[Thos. S. Watson, Louisa Co., Va.]

Reply by Prof. Charles V. Riley, *Entomologist*.

"The specimens inclosed in the above letter were badly smashed (all correspondents who send entomological specimens should enclose them in a stout box, or other receptacle, and not loosely in a letter), but were, nevertheless, easily recognizable. There were several specimens of the

perfect beetle, and a few of the larvæ of one of the most injurious insects of the elm, viz., the striped elm leaf-beetle (*Galeruca Calmariensis*, Fabr). Almost every one is familiar with the common striped cucumber-beetle (*Diabrotica vittata*) which infests cucurbitaceous vines, and this little elm-leaf beetle bears a close resemblance to it both in size and markings; but instead of having a smooth larva inhabiting the root like its cucumber-feeding congener, the elm species has a brown larva, ornamented with short, stiff hairs springing from polished warts, and feeding externally on the leaf. In this respect it resembles some of the flea beetles, e. g., the common grape-vine flea-beetle (*Haltica chalybea*, Illiger), from whose larva it would hardly be distinguished by the ordinary observer.

The striped elm-leaf beetle is winged in both sexes, and the female consequently flies into the trees with the greatest facility. Those who believe that the female ascends by crawling, confound it with another serious enemy of the elm—the common canker-worm—which produces a moth which in the female sex is apterous, and consequently must climb up the tree to deposit her eggs. The same blunder was once committed by the city fathers of Baltimore. This same little beetle was skeletonizing the leaves of, and doing great damage to, the elms planted for shade and ornament in that city, and the authorities, aware that the elms in Philadelphia had been effectually protected from certain defoliators (in this instance genuine canker-worms) by the use of leaden troughs fastened around the trunks and filled with oil—went to a good deal of trouble and expense to furnish their elms with similar troughs. They found to their sorrow that their efforts were futile, since it was the leaf-beetle, and not the canker-worm they had to deal with. Had they, instead of blindly jumping to conclusions, sought the advice of some entomologist, both time and money would have been spared.

*Galeruca Calmariensis* is—like so many of our worst insect enemies—an importation from Europe, and I have known elms in France to wear a sad, blighted and scorched appearance from its ravages. Fortunately, it does not yet occur in the State of Missouri, and in suggesting a remedy I cannot speak from personal experience. Nor do our transatlantic friends help us much with their experience, for though the species has swarmed during certain years on the elms in Paris and other large French cities, the French

writers confess that they know no remedy. Indeed the insect is not so easily managed as the canker-worm, and has heretofore defied man's efforts to counteract its ravages. The similar larva of the grape-vine flea-beetle is brought to grief by a thorough dusting of the infested vines with dry lime, while an application of any mixture having Paris green as its basis, deals rapid death to the striped cucumber beetle. I would consequently advise your Virginia correspondent to dust his trees with lime by means of a perforated vessel attached to the end of a pole, or to syringe them thoroughly by means of a garden syringe, with water in which Paris green is stirred—one pound of the green to 15 or 20 gallons of water. The proper proportion of green and water to be effectual will depend on the quality of the former, and should first be ascertained by a few experiments on a small scale. The first remedy will prove most expedient if the trees are small—the last, perhaps, if they are large.

They are oval, fixed on the small end, and arranged in rows along the ribs of the leaves. The larva which eats only the parenchyma of the leaves, descends when full grown, and enters the earth to transform; while the beetle hibernates under whatever shelter it can find. As preventative measures, therefore, I would advise a good sprinkling of lime on the ground under the infested trees, as soon as the larva is noticed on them, and a careful collecting and burning of all leaves and rubbish late in the fall of the year.

### QUERIES.

CEPHALANTHUS OCCIDENTALIS.—A. F. S., Moline, Ills. "The above is the name of the specimen sent. It is a beautiful, hardy shrub, and it is a wonder it is so seldom cultivated. Though naturally found in swampy places, it is much improved by culture in ordinary garden ground. In some parts it goes by the common name of swamp button ball.

## LITERATURE, TRAVELS & PERSONAL NOTES.

### COMMUNICATIONS.

#### "LAWS FOR NURSERYMEN."

BY PETER HENDERSON, NEW YORK.

In the July number of the "*Monthly*" an article headed as above has special interest for me, as I had some time ago a similar experience. In May of 1875, we had a large bed of Tuberoses flowering in one of our greenhouses, and had been picking a thousand or more daily, when all at once the supply began to diminish so as to attract the attention of the man in charge, and it became evident that some one was stealing them at night. A watch was set and the thief captured, who proved to be a young workman who had left our establishment a few days previous, and whose knowledge of the premises made his stealing the flowers an easy matter. On being caught, he plead so piteously that we let him go, but the ungrateful scamp came right to the spot again the next night, and got safely off with another lot. Watch was again set, but the sentinel slept, and once more he was successful. I now brought in the aid of the police and he was again caught; this time he asked no quarter, nor got any, and I had him duly com-

mitted before a magistrate. But when the case came up before the grand jury, the District Attorney advised them that there was no case, as there was "no law on the Statute books against stealing flowers." The consequence was that he was discharged, and, incredible as it may seem, the first use he made of his freedom, was to again pay a nocturnal visit to my Tuberoses bed, and he got off scot free with another basketful! The thing was now getting serious; Tuberoses were worth \$3 per 100, and he took 500 at least at every haul. The law had shown itself powerless to punish; the fellow had found this out and was determined to make the most of his "rights," as he evidently held to the principles of Robin Hood and other rievvers who believed in

"The good old rule—the simple plan  
That he may take who has the power,  
And he may keep who can."

But on the next night of his foray he came to grief in a way that has induced him to leave our Tuberoses undisturbed since.

Now the perfect absurdity of having such valuable interests, as are now owned by the horticultural community, unprotected by law is almost beyond belief. This man had stolen nearly \$100

worth of my flowers that were as much my property, and had probably cost as much to produce, as the same value of flour or beef, and yet, the thief was set free and virtually told by the court to go and help himself again, of which privilege, as has been stated, he was not slow to avail himself. This immunity from punishment of the flower or tree thief is not generally known, and this ventilation of it in your columns will not certainly make our property any safer, unless it be the means of stirring up our legislators to the great necessity for a remedy.

### EDITORIAL NOTES.

M. LOUIS VAN HOUTTE.—This distinguished horticulturist died on the 9th of May last. Next to the late Prof. Lindley, we regard Mr. Van Houtte as having exercised more influence on the elevation of horticulture than any man of the past age; and anxious to show our appreciation of his services, we sent to Europe for a portrait before making any note of his decease. Having now secured an engraving especially for our readers, we give it with the following account of his life and services, and for which we are indebted to the *London Journal of Horticulture*. We have selected this account to go with our engraving, as it seems to us one of the fullest accounts that we have seen:

"A GIANT in horticulture is gone—Van Houtte is dead. On the 30th ult. we held converse with him at the Brussels Show, and on the 3rd inst. we shared the hospitalities of his table in his home at Ghent, regretting his sinking frame, but admiring his energetic horticultural spirit, and enjoying his sparkling wit over the social meal. We know somewhat of the habits of this remarkable man, having sojourned with him in response to the following invitation:—'Come and see me. You dine with us, you sleep with us; you go into my nursery and into my house when you like; you have all you want; you stay as long as you like;' and then with definite earnestness—'you stay a month.' That is an example of the heartiness of the welcome which he gave to strangers—a specimen of the hospitality for which he was proverbial. Of that visit which occurred three years ago the following was written:—M. Van Houtte is a gentleman of robust physique and vigorous intellect, and subjected to his penetrating vision a nervous man might feel himself the subject of stock-taking and being read all through. He has not much time for polished ceremony or to press courtesy to an unpleasant extreme. Like many another eminent man he is a great listener, and seems content for the friends around him to do the conventional talk, himself sitting and speaking only to the point. His characteristic is soon seen to be matter-of-fact exactitude, which is one of the greatest acquisitions any man can in-

herit or acquire, and which in the end will serve him the best. Van Houtte's is a house of work. Each one has his or her duties in conducting this great business. Even the daughters of the household—of charming manners and genial—have their share in foreign correspondence, their maternal parent being chief cashier. Van Houtte spends his whole time in his business bureau. He has not been all round his nursery for three years, yet is cognizant of everything in every part of it. From five to eight every morning is occupied in arrangements with different foremen, and if it is never seen, still the governing head is felt in every corner of the establishment. Surrounded by a large staff of clerks every detail of management is arranged in the bureau, the chief himself commencing work between one and two o'clock every morning, and working incessantly until 8 P. M. with less than one hour's intermission, and this not in any particular season, but constantly from one year's end to another. What a lesson it teaches, that there is no royal road to success, and is one more example that those who have won have worked—worked with rare zeal and perseverance irresistible in pressing to the goal of success. That is a brief sketch of his character and position *then*, but *now* he is dead.

This excellent man and highly skilled horticulturist died at his residence in Gendbrugge-lez-Gand on the 9th of May. He was nearly sixty-six, being born at Ypres in the June of 1810. The mere enumeration of the offices and honors conferred upon him are a sufficient testimony to his great merits. He was Director of the Royal Botanic Gardens, Brussels; Director and Founder of the Horticultural School at Gendbrugge; Administrative Member of the Royal Agricultural and Botanical Society of Ghent; Member of the Royal Botanic Society of Belgium, and of a great number other horticultural and scientific societies, &c.; Mayor of Gendbrugge; Knight of the Royal Order of Leopold of Belgium; of the Imperial Order of Saint Anne of Russia; of the Royal Order of Portugal; of the Imperial Order of the Rose of Brazil; Commander of the Spanish Order of Charles III., &c. At the recommendation M. Alexandre Verschaffelt, M. Van Houtte settled at Ghent in 1839, and commenced the publication of the "Flore des Serres" in 1845, and continued without any interval its editor as well as proprietor until the time of his death.

He was the son of a military engineer who was engaged on the fortifications of Antwerp, and dying when his son was young the training of the latter was confided to his mother, but, as is very usual, had an inclination for studies very different from those of his father. He was devoted to floriculture, and being a good botanist was engaged as a botanical traveller to search for new plants worthy of cultivation in South America, the coast of Central Africa, and elsewhere. He was subsequently Curator of the Royal Botanic Gardens of Brussels, and afterwards joined an Englishman with a view of establishing a business in Britain. To this en-

terprise he was too confiding, entrusting his capital to his colleague with the result as expressed in his own (Van Houtte's) words—'I have not seen that man or that money ever since.' In continuation of the narrative of his life and

work. But,' continued the man who had so much respect for his assistants. 'I did not make it all myself; my men did it, my good men. I have foremen on my place who have been here from twenty to thirty years. My plan has been



business he further remarked—'I came back to Belgium to start clear. I had little money but plenty of health. I bought the little plot of ground where you saw my porter's lodge. That was all I had thirty-five years ago, and now you have seen my place. It has all been done by hard

this: mark it—When I have a good man I keep him, I do not part with him for any money. When I have a bad man I will not keep him if he will pay me, for a good man makes other men good; a bad man makes other men bad.' Those are true words worthy of being reproduced. In

them is embodied a policy which has proved to be a sound policy and successful, and which in the third part of a century has resulted in one of the most extensive businesses in the world. In the conduct of that business—'this,' once said M. Van Houtte, 'is my plan: I do the best I can for my friends abroad, and the best I can do for my friends at home and my men in my nursery, and when I do the best I can for all these I do the best for myself.' These are 'words of wisdom,' uttered by a man who had proved their worth—a man who was a 'tower of strength' in his generation, and whose memory will be cherished in all civilized countries where it has so long been a 'household word.'

The funeral took place at Gendbrugge on the 12th inst., attended by a large concourse of the population. Among those who were present were Comte de T'Serclaes, Governor of the Province; Comte de Kerchove, Bergomaster of Ghent; General Baltia; M. Dumont, Counsellor at the Cour de Cassation; Professor Morren of Liege, M. Crepin of Brussels, M. Yobert, Director of the State Railways; M. Oswald de Kerchove, M. Kickx, M. Rodigas, M. Pynaert, M. Ambroise Verschaffelt, M. J. Verschaffelt, M. Charles Van Geert, many public functionaries, and about two hundred workmen connected with M. Van Houtte's establishment. This vast crowd could not be accommodated in the house, and they therefore congregated outside in the nursery, surrounded by the brilliant achievements of their departed friend; and here Comte de Kerchove took the opportunity of addressing those assembled in feeling terms on the brilliant career of the renowned horticulturist. After an address from M. Pynaert the funeral cortege moved off in the following order:—The Corps d'Harmonie of Gendbrugge, a detachment of infantry, the clergy, the coffin covered with the burgomaster's uniform and the decorations of the deceased. The workmen of the establishment placed upon it a magnificent crown, and immediately behind was a deputation from workmen not connected with the deceased, who carried another crown as their last homage to their patron. The pallbearers were Prof. Morren, M. Ambroise Verschaffelt, M. Seymortier, Alderman of Gendbrugge, and M. Gust, Guilmot. The funeral service was celebrated at the church of Gendbrugge, which was far too small to admit the crowd, consisting of 1500 persons.

At the grave three *éloges* were delivered; the first in Flemish by M. Guchteneire, the two others in French by Professor Morren and M. Aug. Van Geert.

A notice of M. Van Houtte would be incomplete without some reference to his nursery, even if it embraces but an outline glance and includes but its salient points. The business connections of the establishment extend not only to every nation in Europe, but also to North and South America, China and Japan. The nursery, which we recently visited, is situated about two miles from Ghent. There is no external show of grandeur, no parade of wealth which

those who are truly rich and great—the aristocracy of nature—never display. Yet if men of great requirements and substantial resources do not revel in show, they work with perseverance in every honorable and legitimate way to achieve success; and above all they take care that what they have for the world the world shall know about.

M. Van Houtte not only availed himself of the agency of the press, but his catalogues were distributed with a liberal hand. These catalogues were not merely trade lists, but have long been manuals of reference and guides to many readers. The correctness of the several issues is generally admitted, and both the information and the manner in which it has been conveyed have been instructive and entertaining. But numerous and extensive as have been these issues, they are small in comparison with the great work published periodically of the "Flore des Serres et des Jardins de l'Europe." This work is a monument of its late proprietor's and editor's taste and industry. It has reached its twenty-second volume, and contains 2261 colored plates, 2300 woodcuts, and 4500 articles relating to horticulture. Specimens of these plates adorned one of the walls at the late centenary exhibition at Brussels, and were awarded the first prize for horticultural publications—the large silver-gilt medal. M. Van Houtte also published a serial work on fruits—the "Pomona"—also with colored illustrations. In the issue of these works, and the energy displayed in producing the colored plates as truthful and as perfect as possible, the art of chromo-lithography was considerably advanced. No more striking sight is afforded in the nursery than the preparation of these plates. In a long corridor-like building are fourteen or fifteen presses, and the entire process from the first sketching of plants to the final coloring by hand of the several plates is conducted. That may be termed the fine art department of the nursery, and has long given employment to several workers. It is a wonderful feature of a wonderful place, and is probably—in connection with the nursery—unequaled by any establishment of the same nature in the world.

M. Van Houtte was not only a manufacturer but also a raiser of plants, and he is worthily commemorated in one of the sections of the genus *Gesnera*. *Houttea* includes the species of which *G. pardina* is a type. Of this family of plants, in their various sections, more new and valuable varieties have been raised here than in any other establishment; and when the collections are flowering their rich velvety foliage, elegant habits, and variously colored flowers demonstrate how superior they are, and how effective for summer, also winter decoration. The *Gloxinias* are worthy of especial mention. We have seen fifty thousand of these plants flowering in the nursery, seedlings planted in leaf mould and protected by glass lights. Of this number raised annually it is seldom that more than a dozen are selected to add to the catalogue list, the remaining combs being classed in cat-



egories and sent by the hundred to different parts of the world.

It was in this nursery that the splendid *Berltonia Van Houttei* was raised, which caused such a flutter of sensation by the wonderful combination of glistening colors playing on the foliage—a plant which won gold medals wherever it was exhibited. It is impossible, however, to enumerate a title of what has been raised here, but we must not pass silently the *Azaleas*, of which many of the finest varieties extant of *A. indica* have been raised in this nursery. Some of these were noticed in our report of the Brussels Show, but one, a charming semi-double white *C. Van Eckhaute*, was omitted. It was from this nursery that *A. mollis* was first distributed, and nowhere else can such fine and striking varieties be found. *Azaleas* of all sections are planted out during the summer, and are potted or mossed in the autumn, and sent by thousands to all countries.

*Camellias*, too, are another staple of this nursery, and in the autumn of last year probably 500,000 plants might be seen and all grown in pots, some being plunged in brick pits and others placed in the avenues formed by Lombardy *Poplars* where the plants could enjoy shade without drip. *Tuberous Begonias* are here seen in brilliant array and in the foremost varieties of the day; they are also planted out in leaf soil during the summer.

The glass department is very extensive, the structures being mostly plain brick pits with span roofs. There are also some very large houses, one being about 100 yards in length, resembling a railway tunnel; another is quite circular, having been originally erected for the *Victoria regia* and other aquatics, but now occupied with *Palms*. Altogether there are upwards of forty houses, with pits and frames innumerable. These are all filled with plants of almost every genus usually cultivated under glass, which are propagated and sold in a wholesale manner.

The nursery grounds are also very extensive, and are now intersected by a line of railway. The different quarters are divided by hedges of evergreens, the enclosures forming bulb gardens; gardens of herbaceous plants, in which the establishment is very rich; hardy fruit gardens, *Rose* gardens, enclosures for deciduous trees, and evergreens. Such is an outline of this great nursery.

Shall we enter the large white family dwelling? No need to speak of the hospitable welcome which has been so long accorded to all and every wandering horticulturist. But we may briefly sketch the business bureau where its owner for so many years labored with indomitable energy and herculean strength. Alas! that the central point of interest should be now the "empty chair!" There the great man sat, spurning a coat, even a vest, when in the discharge of his duties. Without rising from his chair he could by a system of wire communication summon whom he wanted from any part of his nursery. There he sat with his several

clerks before him engaged in correspondence in every European language, himself guiding, directing and transacting his large business, and conducting his literary work. There he was surrounded by his fine library of horticultural books, amongst which, of course, a long series of volumes of the *Journal of Horticulture* and *Gardeners' Chronicle* were arranged and referred to. But now he is gone. An united family have lost an honored head, and horticulture has lost one of its best ornaments.

As the best biography and greatest memorial of a man is written in his work, we have given this sketch as faintly shadowing the character of him whom many friends of many nations mourn. *M. Van Houtte* has left behind him a rare example of industry; he was a man of great botanical and literary ability, and his memory will be cherished at home and abroad, and his name will be mentioned as one both honored and illustrious.

He has left a widow, two daughters and a son, who will continue the management of his nursery. This son, *M. Louis A. Van Houtte*, has attained to manhood. He is a gentleman of activity and an accomplished linguist."

#### HORTICULTURAL JUDGES AT THE CENTENNIAL.—

It is not to be wondered at that in an affair of such tremendous magnitude as the Centennial, things should not all go right. It is indeed amusing to hear of this or that one body, or even individual, who feels himself or his cause has been "snubbed." By what we can learn, everybody in every sort of way has been "snubbed." They have all "snubbed" one another. It is at least a satisfaction to find that the authorities are willing to repent when convicted of wrong. Among their slips was the overlooking of judges for horticulture and pomological products. The last has been some time remedied, and now we have for horticultural judges Messrs. *Thurber*, *Breckenridge*, *Saunders*, and *F. Pentland*. It strikes us as fortunate that the omission occurred at first, for it is very doubtful if so able and honorable a jury would have been selected in the first instance.

"PALMS" ON PALM SUNDAY.—The English papers are trying to find out why their people use willows for "palms" on Palm Sunday, and fancy they find Scripture for it: "Ye shall take you on the first day the boughs of goodly trees, branches of palm trees, and the boughs of thick trees, and willows of the brook." The Catholics in this part of America use box branches, but do not search Scriptures for authority. The most rational explanation is, that the willow was used because they could not get "palm," and the box

was taken here because neither "palm" nor willow was to be had.

**BELGIUM HONORS HORTICULTURISTS.**—The *Journal of Horticulture* says: In no country in Europe are the representatives of horticulture held in such honor as they are in Belgium. It is not on some solitary occasion only that they have experienced this, but whenever there is an opportunity offered for their assembling together they meet with a recognition which they receive nowhere else.

On this occasion no sooner had the representatives of the different nationalities arrived in Brussels than a warm reception was accorded to them by the Burgomaster at the Hotel de Ville; but the greatest honor was reserved for the opening day of the Exhibition, when the delegates from the different governments and societies, members of the jury, and some of the leading exhibitors, were invited to a banquet by the King and Queen at the royal palace. Nothing could be more kind than the reception their Majesties gave their guests, with each of whom they entered freely into conversation; and to the British representatives the banquet had an additional interest from the whole of the service, which was solid silver, being the wedding present to the Princess Charlotte by her father George IV. on her marriage with Prince Leopold of Saxe-Coburg, afterwards King of the Belgians. Every plate was marked with the royal arms of Great Britain. What gave especial importance to this occasion was that their Majesties remained in Brussels for the event, and departed for Germany late at night after the entertainment was over—an act of courtesy and condescension such as horticulturists are not familiar with at home.

Tickets for the opera were provided for all the guests who after the banquet were disposed to avail themselves of them. Another banquet was given by the Société Royale de Flore on the evening of the 1st of May, and numerous other attentions were offered, leaving nothing to be desired to render the visit of foreigners agreeable and memorable.

**FORSYTHIA SPLENDENS.**—Prof. S. B. Buckley desires us to say that the name as above given in his Texas geological report is a misprint for *Fouquieria splendens*, as we supposed.

**PROCEEDINGS OF THE NEW JERSEY HORTICULTURAL SOCIETY, 1876.**—Prof. Thurber is President, and a large list of well-known horticultural

names make up the officers. This is the report of the first annual meeting, and much good work appears to have been done. The President's address will bear reading over several times. Seldom is an "annual address" given with so much food for thought. Then there are highly instructive essays from W. Parry, on Raspberry Culture; the Huckleberry, by C. W. Idell, especially interesting because as yet this is not among cultivated fruits; the Geranium, by P. Henderson; Hybrid Strawberries, by E. W. Durand; Horticultural Entomology, by A. S. Fuller; Gladiolas, by Geo. Such; Promising New Fruits, by E. Allen; Keeping Pears, by W. H. Goldsmith; Hedges and Screens, by S. W. Thompson. All articles that are really *Horticultural*, and valuable.

**MINNESOTA STATE HORTICULTURAL SOCIETY.**—Proceedings for 1876, from Charles Y. Lacy, Secretary.

We have always had an idea that for genuine gardening Minnesota was destined to become in time the best State of the Union, and delight in watching her progress in this direction. A great deal of this report is taken up with fruit culture for market and for profit, which it is quite right and proper should be considered; but there is quite enough of the finer matters to show that the Minnesotians fully understand that man is not to live by bread alone.

**BOTANY OF CALIFORNIA.**—By W. H. Brewer, Sereno Watson, and Asa Gray.—We briefly noted the appearance of this in our last. The work is now before us, and we take occasion to say that only for the liberality of a few gentlemen of San Francisco, botanists and horticulturists would still be without any work of reference to the flora from this interesting part of the world. What we have hitherto learned of the flora of California has had to be gathered from numerous tracts or memoirs scattered through the proceedings of various scientific societies, or the reports of various government exploring expeditions; and even this information was often inaccurate and incomplete. During 1860-'64, in the progress of the Whitney geological survey, Dr. W. H. Brewer took charge of and mostly made the botanical collections, and since that time additional collections have been made by Dr. Bolander, Dr. Cooper, Mr. Lemmon and others, and the hard work of getting this material ready for the press was undertaken by the three eminent botanists whose names are given above.

Unfortunately the Legislature of California refused any further appropriations to the survey

in 1873, without making any provision for bringing before the world the results of the other portions of the survey already in course of publication, and nothing for botany whatever.

Fortunately some liberal and public-spirited citizens already referred to, came forward with the means. Their names are as follows, and we are glad to place them on record in our pages, that all may know to whose liberality in the the failure of their own representatives we are so much indebted for this valuable contribution: Leland Stanford, D. O. Mills, Lloyd Tevis, J. C. Flood, Charles McLaughlin, R. B. Woodward, Wm. Norris, John O. Earl, Henry Pierce, Oliver Eldredge, and S. Clinton Hastings. This volume covers but half the work. It is sold by Mr. Sereno Watson, Cambridge, Mass., at \$6. As soon as enough has been sold to warrant it, the sum so received will be used to issue the second volume. So many of our most beautiful cultivated flowers are Californian, that horticulturists as well as botanists will be glad to secure a copy.

FRUIT GROWERS' ASSOCIATION OF ONTARIO.—Proceedings for 1875, from D. W. Beadle, Secretary, St. Catharine's, Canada.

This volume has colored plates of Mr. Arnold's hybrid raspberries, and has many essays and discussions of great interest to Canadian horticulturists.

INSECTS OF THE STATE OF MISSOURI.—Eighth Annual Report of Prof. C. V. Riley, State Entomologist.

Unfortunately the "Insects of the State of Missouri" are the insects of most of the Union, and yet it is fortunate that this is unfortunately so, for Missouri is the only State that goes to work in a creditable way to make these terrible enemies known, and we are all benefitted by Missouri's labors. We never feel so much enthused for Missouri, and to do her some good by voice or pen, as when we read these annual reports. May she continue to be prosperous, and the great and powerful State in the Union she is to-day!

WILLIAMS' PACIFIC TOURIST AND GUIDE ACROSS THE CONTINENT.—A notice of this appeared in our last—the work itself is now before us. The writer of this, having been over some of the ground described, can testify to the interest attached to the places noted, and the accuracy with which they are detailed. The tide of travel to the *great West* of the present day is but just setting in, and this guide is just the thing to

help along and guide it. Henry T. Williams, of New York, the former publisher of the *Horticulturist*, is the editor and publisher.

LIFE HISTORIES OF BIRDS. By Thos. G. Gentry. Vol. I. Published by the author, at Germantown, Pa. Price \$1.75.

Mr. Gentry is a comparatively young man, Principal of one of the public schools in Philadelphia—an educational system which contains amongst its teachers a large number of ladies and gentlemen who for high intelligence and worth are perhaps not excelled in the world. There are but few Philadelphians who do not feel pride in the teachers of their public schools. Among these Mr. Gentry has been particularly successful as a teacher, and it is no mean tribute to his ability in this respect, that though natural history is not one of the branches of public education, a large number of his students have acquired tastes for this delightful pursuit. It is pleasant to find a gentleman endeavoring to extend his sphere of usefulness by a work of this kind. With much that is old, there is a great deal that is new. It is good reading, especially for young people, and ought to find a place in every rural home.

Mr. Gentry is his own publisher, and if supported, as we hope he will be, in this effort, a second volume will follow.

---

## QUERIES.

---

PROTECTION FROM TREE THIEVES.—A Philadelphia correspondent says: "The tree thief (referred to in the July number of the *Gardener's Monthly*), should have been held for Malicious Trespass. The law reads as follows:

"Malicious Trespass. The wilful taking and carrying away of fruit, vegetables, plants, fruit or ornamental trees, vines or shrubs,\* whether attached to the soil or not, shall be deemed, and the same is hereby declared a misdemeanor, and may be prosecuted and punished as such under the laws of this commonwealth, and on conviction thereof shall be fined not exceeding fifty dollars and imprisoned not exceeding sixty days,' &c.

"You give the name of the Judge and of the District Attorney. Who was the 'careful lawyer?'"

\*This law was originally confined to seven counties, but was afterwards extended throughout the State.

# HORTICULTURAL SOCIETIES.

## EDITORIAL NOTES.

HORTICULTURE AT THE CENTENNIAL.—Before proceeding with our notes we may say that it does not seem to be well understood that the plan of awards at this great exhibition is essentially different from any that has gone before, and in our opinion is far superior. In the old style there is a premium of a few dollars, or a medal of equal value, awarded to a mere handful of successful competitors. No one knows why he got that premium. It is all a matter between him and the judges. After he has the premium it is of no use to him unless he advertises it; unless perchance the recipient of the premium be one of those rare philosophers to whom the possession of the secret within his own breast that he has something superior is a reward in full for all his merit. Those who get no premium are absolutely unknown to the world, and yet very often the success of an exhibition is as much or if not more dependent on the nine who get nothing as the one who gets all. There is no one who has had experience as an exhibitor and has given any serious thought to the question but who would cheerfully give up his "premium" if the society would instead do the advertising for him. The Centennial Commissioners are the first to make the departure. The plan they have adopted will in future be known distinctively as the "American plan." *Everyone's* exhibit will be noticed in the final report and its actual merits—not comparative merits—detailed. These final reports, going all over the world, and into the hands of every intelligent man, form the best possible advertisement, and worth to the business man a thousandfold more than any premium would be. Yet, and in the pomological department especially, we have heard people say they do not care to exhibit because there is no inducement. The inducements are even greater to them than to any other class of exhibitors. They not only have their names with the meritorious nature of their products with whatever medals may be awarded, not to them as competitors, but as marks of distinction, recorded in the final reports, but have the advantage of the publication of the preliminary reports of the committees upon which the final ones will be

founded. Surely this is far better than any ordinary system of competition? Under the old system no report could be made at all until the close of the exhibition. Judges could not to-day award a premium for the best strawberry or other fruits, when to-morrow a superior one might be before them. We can only say that they who do not exhibit for "want of inducements" are the most strangely obtuse people we have ever met with. Not only do we approve of this American system, but we look upon it as the only system that can rejuvenate many of our tottering societies. In these days the best business men care much more for the advertising than the premiums. There are many cases where the premiums will be advantageous. There always will be some to whom cash is worth more than an advertisement, and especially will this be so with gentlemen's gardeners, so many of whom are badly underpaid for their services; but what we have said is in view of general principle rather than of special exception.

The main exhibitions of fruits promise to be a great success, though little may be done with continuous shows. At the time we write Horticultural Societies from Iowa, Michigan, Kansas, Indiana, Massachusetts, Ohio and Canada have asked for space for *ten thousand plates* for the 12th of September exhibit. Surely some of the other States will want to come in! It will no doubt be the most wonderful sight ever seen in this world, with the fruits at the Agricultural, and the Horticultural department with its plants and flowers. The annual exhibition of the Penn. Society is to go on as usual in their hall in Philadelphia. Philadelphia ought to be the great central point for horticulturists in September, 1876. Independent of this we believe the Horticultural Department of the Centennial will hold a special exhibition, but no details have been resolved on up to this time.

The grounds around the Horticultural Hall on the Centennial Grounds are becoming daily more beautiful. We notice in a leading paper some criticisms on the way the whole is laid out. It is easy to criticize when the reasons are not known. In a tremendous effort like this no one man is able to have his own way, even in his own department, and yet before the public he seems responsible for all. In regard to the horticultural grounds it must

not be forgotten that the allotments belong to the exhibitors, and that their views had to be in a great measure consulted in the laying out. Our only astonishment is that with so many varied interests to serve and so many difficulties in executing the Horticultural Department should have turned out so well. The flowers will be better as the season advances. To-day we will glance at the trees and shrubs. Few of these are large specimens. They would have been failures if they had been. Some few of the large ones have died, but very few on the whole. European nurserymen are not in strong force. The leading ones are from Holland. R. Van Ness, of Boskoop, has Hollies, Rhododendrons, Roses, Magnolias, and similar plants popular in European gardening; the trained fruit trees attracting much attention. W. C. Boer, of the same town, has a similar collection, with some very good *Retinispora leptoclada* among them. The grafted currants and gooseberries of Chas. Pohl, of Austria, attract universal attention. Grafted on the Missouri currant they seem free from the mildew which is the bane of the foreign gooseberries here. Messrs. Vietch, of England, have some very nice plants, as well as choice kinds of plants. These have been given to the City of Philadelphia. Some are too tender for our climate without some protection, but are so beautiful that protection should be cheerfully given them. Of these there is *Veronica Traversii*, with myrtle-like leaves and an abundance of white flowers like spikes of Privet, and a *Raphiolepis ovata* about 2 feet over. The leaves are like those of a *Pittosporum*, and the flowers like the common Indian cherry. It is tolerably hardy. One of the best specimens of *Prumnopitys elegans* is here. It may popularly be likened to a conical-growing yew tree. It is a native of Valdivia. The Umbrella Japan Pine, *Sciadopitys verticellata*, is represented here by a specimen about 2 feet high. This is a remarkably beautiful and very hardy evergreen, but slow in growth while young. Of the rare pines there is *Pinus koraiensis*, from the Corea. It is a five-leaved pine, as dark as an Austrian, but with fine delicate leaves. There are several interesting spruces, for instance *Abies Hookeriana*, one of our Pacific hemlocks, with dark, blackish leaves not half the size of our ordinary hemlock, and *A. Hanburyana*, from Japan, also like our Hemlock, but with very broad leaves. Then there is the Japan white spruce, *Abies Alcoqui-*

*polita*, and a capital specimen of *Retinispora filicoides*. This is one of the most interesting of all hardy evergreens, having foliage like some *Cheilanthes*, or other fine-leaved fern.

Most of the remainder of the collection are various forms of Hollies and Rhododendrons, of rare species, and some trimmed into fanciful forms.

Of American nurserymen Mr. R. Buist has a choice collection, mostly evergreens. Among these a *Retinispora pisifera aurea* about 5 feet high is very attractive. This proves so hardy that it is becoming very popular. There is here an *Euonymus aurea marginata*, which lessens one's regrets that golden Hollies do not thrive in our climate. And then there is the beautiful variegated white dwarf, *E. radicans variegata*, of which much more might be made in our garden work than is made. Mr. Buist's collection is well massed and very effective.

Messrs. Hoopes Bros. & Thomas, West Chester, Pa., have a collection of 40 kinds of ivies, with flat trellises of wood and wire. It is a good chance to note the merits of the various kinds, and if the mass of judges did not decide that the old sorts are better than the improvements we should be surprised—a little delicate form called *Conglomerata* we might except. It is very neat, and as few would regard it as an ivy at all at first glance is, perhaps, why it seems to be an exception in beauty.

The same firm have a collection of Coniferous evergreens which does them much credit, each tree neatly labeled. A *Sciadopitys* here is nearly as good as Vietch's. The most beautiful pine in the collection is, perhaps, *Pinus insignis*, from Lower California, but unfortunately it is not hardy in these Middle States. The collection affords an excellent chance to study differences. Here is *Pinus Ayacahuite* approaching *P. excelsa*; *Abies nobilis*, and *A. magnifica*, appearing much the same; and *Abies Albertiana*, which will puzzle any one to tell from a common hemlock. Then the student will find kinds like *Pinus Elliottii*, and others that he could perhaps see nowhere else, and well worthy of examination.

R. B. Parsons & Son have also an excellent collection, mostly Rhododendrons and other evergreens. The Rhododendrons, as well as those of S. B. Parsons & Son, are admirable specimens, and make one regret that some one had not thought to make an effort to get a tent for them as well as for Mr. Waterer's. Perhaps they will

know better "next time." Among the good things is an admirable specimen of the curious gray *Retinispora squarrosa*. It is about 6 feet high and proportionate in width. Also an admirable specimen of that best of all firs, the *Picea Nordmanniana*.

S. B. Parsons & Son have a special bed for the Japanese plants of Mr. Hogg's direct introduction. There are many varieties of the Japan maple—*Acer polymorphum*—among them, the best perhaps being the *A. p. atropurpureum*. There is among them a very singular maple with leaves like a Hornbeam and appropriately named *A. carpinifolia*. It seems somewhat allied to the well-known Tartarian maple, and will no doubt serve the same purposes in landscape gardening. Then there is the variegated *Planera Japonica*, and *Daphne gwenkwa*, a light blue flower, which will probably become a very popular hardy, early-flowering shrub. In their general collection of rare plants is the blood-leaved Norway maple—*Acer Schweidleriana*—and a beautiful purple-leaved *Daphne mezereon*.

Mess. Asher Hance & Sons, of Red Bank, N. J., have a small collection with some very good things in it. Especially one of the finest plants of the beautiful Japan Sumach, *Rhus Osbecki*, we have ever seen. It is a new idea and a good one to graft the dwarf *Catalpa Kaempferi* on our stronger native one. There are also here among other things that will well repay tree lovers a good blood-leaved birch, weeping yellow elm and a *Taxodium pendulum*.

Miller & Hays make an exhibit intended to illustrate arrangement and taste in landscape gardening. The whole tract is of a rather oblong shape, and at the two ends are clumps made up chiefly of rare and choice evergreens. In about the centre of the plot is a light mound containing in the centre an *Aralia spinosa*, a capital thing for effect in American gardening. Around this is a circle of cannas, then one of pampas grasses, then var. bamboo. Around these taller things then follows a circle of *Irisine Herbstii*, a circle of *Centaurea gymnocarpa*. Then there is a slope of a few feet of grass, and finally a frame of *Coleus* on the natural level around the whole. Between this central and the end clumps are beds, some with palms, some with succulents, and others with colored-leaved plants. The whole makes a very elegant design, and is much appreciated by lovers of good gardening.

Besides this Mahlon Moon, of Bristol, has a

collection of hardy trees and shrubs, and there are one or two other collections on the grounds that are well worthy of the visitor's examination.

The flowers we hope will be in condition for a notice next month. In the meantime let us say to our readers and the correspondents of agricultural and other intelligent papers that this *out-door department* may be as worthy of attention as anything in *buildings*. They rarely receive any attention from newspaper men, as the plants seem to be a part of the grounds, and not the work of *exhibitors*. Immense praise is given to some exhibitor *in a building* for enterprise which really cost him but little, while here in the open ground are *thousands of dollars* expended, and no little amount of loss and anxiety to accomplish, that few people stop to think about. It is natural in the daily papers to pass these things over. The city folks have little ideas of gardening, but we look for more encouragement from "our own" people.

PHILADELPHIA, June 29th, 1876.

GENERAL A. T. GOSHORN, Director General U. S. Centennial Commission.

Sir:—The undersigned jury on special pomological products respectfully report that during the week ending with this date, the season for strawberries being past and that of raspberries hardly commenced, the exhibits have been light.

Mr. A. L. Felton, of Philadelphia, exhibited on the 27th a plate of a raspberry named "Felton's Early Prolific."

Mr. Chas. Finger, dealer, exhibited water-melons from Georgia of excellent quality and in good condition after their long journey. And to day Mr. Felton had on the tables plates of "Northern Wonder" raspberry, and of the "Hornet." The last named kind is the largest variety yet known, and these of Mr. Felton were of good average size, some of the berries measuring seven-eighths of an inch in diameter. Mr. Felton has also two kinds "Seedling Cherries," the best one in quality equalling and very much resembling the well-known "Black Heart." Mr. Van Zant, of Chesnut street, Philadelphia, exhibited a few "Hale's Early Peaches" and four apricots received in excellent condition from California.

Signed,

{ W. L. SCHAFFER,  
A. W. HARRISON,  
JOSIAH HOOPES,  
WM. PARRY,  
THOMAS MEHAN.

THE  
GARDENER'S MONTHLY  
AND  
HORTICULTURIST.

DEVOTED TO HORTICULTURE, ARBORICULTURE AND RURAL AFFAIRS.

Edited by THOMAS MEEHAN.

VOLUME XVIII.

SEPTEMBER, 1876.

NUMBER 213.

FLOWER GARDEN AND PLEASURE GROUND.

SEASONABLE HINTS.

With September we think of the bulbs which flower in spring. We have an idea that as soon as the bulbs from beyond the Rocky Mountains come into culture and under improvement, we shall have races that will vie in beauty with those of Europe.

In most of the countries of Europe, summer gardening is the most attractive, and most that is done there is with that view. With us the spring and autumn are more enjoyable, and if American gardening is ever to have a distinctive feature of its own, it will be from efforts specially directed to one or both of these. Our summers are usually hot and dry, and people are either "away," or very much indisposed for out-door enjoyment, except such as may be found in shady woods, or on some heights where the cool breezes blow. At any rate we shall not go wrong by doing our best for good effects with spring flowers, and it is time to think about these things now. There is scarcely anything more beautiful in spring than a bed of Hyacinths and Tulips well intermixed. The Hyacinths go out of flower just as the Tulips come in. In the spring Gladiolus and Tuberoses can be placed between these; or if desirable, some flowering bedding plants, and in this way the gaiety and interest can be preserved from spring to fall. Crown Imperials are capital things for the centre of small beds, and the regular bedding plants can go around them. Narcissuses keep their foliage too long after flowering, as does the Snowdrop. These

can hardly be made available where regular bedding is desirable for summer. They are best in odd patches by themselves. Crocus does well anywhere. It may even be set in the grass about the lawn, as it is generally over before the first mowing takes place. But it would not be admitted into our best kept lawns. The vast tribe of lilies come in rather late for spring gardening, but few will care to be without them. Besides these there are many little items which are noted in almost all bulb catalogues, from which many interesting spring blooms can be had. No one will go amiss in looking well to this class of plants. The best time to plant is from now to frost. Mice and vermin are very liable to attack these roots. Poisoning is the best remedy.

Spring gardening, however, need not be confined to bulbs. There are other spring flowering things.

Shrubs for this kind of gardening we have alluded to, should of course be of free flowering character. Of those which can be made very effective, the following may be used: *Pyrus japonica*, the red and white; *Spiraea prunifolia*, *S. Reevesii*, *S. Billardii*; *Deutzia gracilis*, *scabra*, and *crenata pleno*; *Weigela rosea* and *W. amabilis*, *Philadelphus coronarius*, and *P. Gordonianus*; *Forsythia viridissima*; *Hypericum prolificum*; *Althea* in variety; Persian, and even the common Lilacs; Tartarian and Fly Honeysuckles; Hawthorns, Double Almonds, and perhaps some others. But all these are common in most nurseries; are very easy to grow, and very pretty effects may be had at a small outlay.

Many persons who have but a few of these plants, will like to raise some more. The end of the month is a good time to take off cuttings, unless the weather be very warm. Of those we have named, all but the *Pyrus* and Almond will grow by cuttings. These two grow by pieces of roots. Cuttings should be made about four or six inches long, and planted out in rows, and set two or three inches below the surface of the ground. In spring planting we put them right level with the surface.

In many parts of the Northern States the leaves will have changed color previous to the incoming of winter, and the planting of trees and shrubs will commence as soon as the first fall showers shall have cooled the atmosphere and moistened the soil. Further south, where the season will still remain "summer" a while longer, the soil, may, at any rate, be prepared, that all may be in readiness when the right season does come. What leaves remain on should be stripped off, and the main shoots shortened. They will then do better than if planted very late. In fact, if planting cannot be finished before the beginning of November in the Northern and Middle States, it is better, as a rule, deferred till spring. In those States where little frost occurs, this rule will not apply. The roots of plants grow all winter, and a plant set out in the fall has the advantage over spring set trees, that its roots in spring are in a position to supply the tree at once with food. This is, indeed, the theory fall planters rely on; but in practice it is found that severe cold dries up the wood, and the frosts draw out the roots, and thus more than counterbalance any advantage from the pushing of new roots. Very small plants are, therefore, best left till spring for their final planting. It is, however, an excellent plan to get young things on hand in fall, and bury them *entirely with earth*, until wanted in spring. Such things make a stronger growth the next season, than if just dug before transplanting.

## COMMUNICATIONS.

### CENTENNIAL RHODODENDRONS.

BY S. B. PARSONS.

The Editorial Notes of the *Gardener's Monthly* are always interesting, because the Editor is also a connoisseur. His admiration of the colors in Mr. Waterer's tent was very natural and just, for

they were worthy of it. I would like to supplement them by giving our experience of the varieties he names. Of the twenty-four he names, there are "just four, no more," which will endure our summer and winter. The remaining twenty, however beautiful in tent or in greenhouse, are utterly worthless when planted in the open ground. All who try them will have a poor opinion of Rhododendrons.

I once saw on the mountain sides back of the town of La Guayra some five acres of Scarlet Cactus in full bloom. The colors were magnificent, but I did not incline to transfer them to Flushing soil, nor would I incline to transfer the contents of Mr. Waterer's tent to the same locality. There are Rhododendrons, however, which are perfectly hardy in American climate, and doubtless Mr. Waterer has them. These high colors are, however, not found among them, but belong to sorts which are adapted only to greenhouse culture.

### MR. HOVEY'S ARBORETUM AMERICANUM.

RY J. M.

I am a great lover of trees, and was interested in reading the list of what specimens Mr. Hovey has. One hundred and seventy-two species and varieties on one's grounds must be a source of great pleasure to the fortunate possessor. I must, however, confess to a disappointment in not finding among his list many an old favorite of mine; the more so as Mr. H. says he has endeavored to procure every tree which would be likely to prove hardy. Surely very many of our native *Quercus*, *Carya* and *Fracinus*, which are wanting in his collection would live with him. I would name the *Quercus bicolor*, *Q. imbricaria*, *Q. Prinus*, *Q. nigra*, *Q. falcata*, *Q. tinctoria* and *Q. castanea*, and perhaps even *Q. Phellos* as being entirely hardy and quite easily procured. The *Q. bicolor*, *Q. falcata* and *Q. imbricaria* are especially beautiful trees, the former growing to magnificent proportions, with leaves of the most glossy green.

I miss, too, the *Carya microcarpa*, *C. amara*, *C. oliviformis*, *C. tomentosa*, *C. sulcata*, the most of them the commonest of our grand forest trees, and all of them of easy procurement. And there are the *Fracinus sambucifolia*, *F. quadrangulata*, *F. pubescens* and *F. viridis*, all hardy and common; and perhaps even the *F. platycarpa* would live there. With those above named others could readily be added to make perhaps forty species of American trees not on his list. If to



these we add varieties—of which Mr. H.'s collection largely consists—we should perhaps have double or more of them. On running over the list given of the specimens he has, I find of the one hundred and seventy-two, about one hundred are kinds not native to the United States. Besides the gratification missed by such an admirer of trees as Mr. Hovey in not having in his collection the beautiful native trees I have named, it seems hardly justice to give his list forth to the horticultural world as the result of his endeavors “to procure every tree which would be likely to prove hardy in our climate.”

### THE RHODODENDRON AND AMERICAN YEW.

BY J. A. NELSON, INDIAN RUN, PA.

It is said Rhododendrons should not be overhung by trees, as the roots of trees would be injurious. It is also recommended to use charcoal liberally. Growing in their native places, they do not get charcoal; neither do trees or roots appear to injure them, being found under trees and in thickets. In the beginning of the month of June, 1873, I was on a rambling excursion on what is called the Seven Mountains, near the central part of Pennsylvania. My visit was partly to see and study the native habits of several evergreens, seldom found elsewhere; then try to imitate them as near as possible. I took up a lot of small Rhododendrons from two to six inches high and packed them in damp moss. They were out of the ground one week before I got them home. I prepared a bed for them, planting them rather shallow, imbedding their roots well in wet moss, with a covering of moss and a mixture of sand, with some light loose loam over all as a mulch. Above the bed, some two feet high, was placed a partial shade made of evergreen boughs; the first summer when dry weather came an occasional watering was given. Every plant lived and made a growth of from six inches to one foot annually. The third season several bloomed; the fourth season—this year—they all bloomed, and a more beautiful sight was seldom seen. For the two last summers I transplanted on our lawn, close up under evergreen trees, in the shade among their roots. They all did finely. They need some protection, particularly in the winter, from the noon-day sun and winds.

The American Yew is another evergreen shrub that is but little known. I have succeeded very

well in growing this from cuttings. It will grow upright from cuttings. It requires near about the same mode of treatment when permanently planted as the Rhododendron. These two American evergreen shrubs I consider the best amongst all our foreign and native trees and shrubs. Last spring I potted several Rhododendrons and placed them in the greenhouse. About the 1st of July and for several days when in bloom we had no plants to compare with them in beauty.

### RHODODENDRONS.

BY C. M. HOVEY.

It is gratifying to learn from your last number that the grand display of Rhododendrons brought out by Mr. Anthony Waterer has been so satisfactory, and attracted, as it ought, so much attention at the Centennial Exposition. It will, no doubt, bring this comparatively little known native shrub, with its superb varieties, into more prominent notice, and accelerate its more general introduction into our gardens. Certainly it must show how safely they can be transplanted, when it is recollected that the plants, some of them quite large, were out of the ground at least three weeks, and yet produced a magnificent display of flowers.

Your remark that “not one in a hundred of the thousands of visitors has ever seen one before,” reminds me of the article on the Rhododendron in *Appleton's Encyclopædia* (first edition). Who prepared it I do not know; but its value or correctness may be estimated when it is stated “that in the Northern United States the great Rosebay (*R. maximum*), will alone endure the winters.” As this was written before Alaska was purchased, I do not know what Northern States are intended; for the *R. Catawbiense* and its varieties are the only kinds that are generally grown in the gardens of Massachusetts; *R. maximum*, although a native, being far less common than the former. For forty years in our grounds they have not suffered from the winters, and have outgrown in the same time the *maximum*. If the writer had seen or even heard of Mr. Hunnewell's fine collection at Wellesley, he must have known the *Catawbiense* endures our winters as well as the *maximum*.

Such authority is, of course, not of any importance to intelligent cultivators; but to those unacquainted with the plants, it helps to retard their introduction into our grounds. In fact, beyond

a mere enumeration of the species, from Loudon's *Arboretum*, more information can be obtained from any nurseryman's catalogue. After nearly half a century of experiments in hybridization, the grand results of which you have given in your notices, and the details of many of which have been published, it would seem that an instructive and very valuable paper might be prepared, showing the gradual progress made in the improvement of this truly regal shrub. It would be a great incentive and encouragement to follow up this advancement, at the same time adapting them to our more severe climate.

It is really astounding to find that the Rhododendron, Azalea and *Kalmia* are so little known. At least one-half of the many hundreds of visitors who have come to look at our collection, just going out of bloom, did not know "which was which;" the Azaleas and Rhododendrons being in bloom at the same time, and the *Kalmias* also, for about a week before the former were gone. Our reply was that the shrubs with the large evergreen-looking foliage were the Rhododendrons, and the small-leaved ones the Azaleas, or sometimes that those with the yellow, orange, salmon, buff or scarlet flowers were the Azaleas; and quite a number made the remark that the *Kalmias* looked a great deal like the Laurels that grow wild in some parts of the State!

The predominating "sap," as you term it, of the *R. ponticum* and *arboreum*, in most of the splendid varieties so far produced, precludes their cultivation in our climate north of Washington, and it illustrates the fallacy of what is termed "acclimatization," for with the intermixture even of the "sap" of *arboreum* in the fourth and fifth generations, the tender character of the Asiatic species still continues to crop out, and although the plants rarely die, their foliage is disfigured, and the flower buds partially or wholly destroyed by our severe winters. Unfortunately this is not generally known. The English and Belgian catalogues describe them as hardy, as they are in their climate, and the brilliancy of the colors as compared with *Catawbiense* is so charmingly beautiful that a choice selection is made accordingly. The plants are imported, and planted out with all due care, but at the end of two or three years nothing is left but the stock upon which these superb kinds are grafted.

Twenty-five years ago, when the late Mr. Standish first began the hybridization of Rhodo-

dendrons, and raised that beautiful variety, Minnie, with others which were said to be very hardy, I imported ten of the best seedlings, two plants of each, but up to this time they have never produced a single flower, and only two or three are alive; these grow up every year a foot or two high, and are killed down again by the winter; and just ten years ago (1866) we imported one hundred of the hardy varieties from Belgium, including Lord Clyde, Minnie, Baron Osy, Mooreænum, and other fine sorts. The first year, while small, they were wintered by placing a frame over them, filling in with dry leaves, and covered with sashes. They kept well and flowered, but soon grew too tall to be covered. We then planted them out, to give them a trial, in our Rhododendron bed: now we have not even one left.

In time I don't doubt we shall obtain very dark-colored Rhododendrons perfectly hardy, but all the experiments so far show how difficult is the work. The Indian blood which carries color also carries with it a perfect bar to hardihood of white, blush, pink, rose, rosy lilac, rosy purple, and rosy crimson. We have as fine hardy sorts as can be desired; but of fancy colors, and deep red and crimson colors, we have none. It is to the production of the latter that the efforts of our hybridizers should be directed.

Forty years' experience in the cultivation and production of Rhododendrons and Azaleas has enabled us to learn something of their character. Under the right treatment no plants grow more freely, none transplant more safely, few require less care, and none give so grand a display of blossoms.—Many of our specimens, now forty years old, have been transplanted but once; one twelve feet high and twelve broad, and producing every year thousands of flowers. Some seasons the bloom is more abundant than others, but out of an acre of Rhododendrons, Azaleas and *Kalmias* we have never known a plant to be seriously injured. This year the snap of bloom has been simply magnificent.

I regret that I could not find the time to visit the Centennial, and see the great display of Mr. Waterer, as well as those of the Messrs. Parsons. It was no little labor to bring 1500 plants across the Atlantic, and the thanks of all lovers of beautiful shrubs are due to him for his commendable efforts to place before the American people these superb varieties, the parents of which cover the mountain regions not many miles from Philadelphia.

## HARDY RHODODENDRONS.

BY X.

I would remark with regard to your list of probably hardy kinds of Rhododendrons, that out of eleven there mentioned, commencing with *album grandiflorum* and ending with Minnie, not half are hardy. In this I speak what I know. The remainder will surely disappoint those who plant them. And so of the other lists, and of Mr. W.'s entire collection; while there were very many grand, hardy plants in it, it must in its future results end in disappointment.

I could know this by glancing at the leaves while walking around, for the *ponicum* and *arborcum* show through the whole collection. I could say more, but add only that the unfortunate feature is that the sight of so many beautiful flowers will lead many in their ignorance to plant those half-hardy sorts, and after the first winter they will condemn the whole tribe; whereas, if they had planted such sorts as *roseum grandiflorum*, *album elegans*, *Everestianum*, &c., they would have had continual enjoyment from them.

## HARDY HERBACEOUS PLANTS FOR JULY.

BY WILLIAM FALCONER, BOTANIC GARDEN, CAMBRIDGE, MASS.

May and June are the hey-day of hardy herbaceous plants, but underneath I mention those only that are in bloom now, July 10th, in the gardens here, and which have been wintered without any protection whatever beyond in some cases a light mulching of leaves. Of course, having confined myself to what are actually growing here, I have omitted several valuable seasonable plants, and at the same time I have carefully avoided mentioning any that are not the very cream of our collection; everything of the "botanical" nature being strictly omitted.

*Aquilegia chrysantha*, the finest of all known yellow Columbines, and keeps blooming some weeks after the other kinds have ceased.

*Campanula rotundifolia*, or common Harebell, flowers, blue and pretty, dwarfish, and in the rockery or border equally at home. *C. Carpathica*, a very fine species, in compact clumps, blooms blue, widely open, and many. Not yet at its best.

*Viola cornuta*, blue; in free, rich, moist ground, with a little thinning or cutting, blooms un-

ceasingly from June till October. Much used in Europe as a summer "bedder." Not so apt here.

*Dicentra eximia*, charming for borders or rock-work; has rosy purple flowers and fern-like leaves; nine to fifteen inches high. Amongst the earliest plants to bloom in spring, and even now is only at its best.

*Pentstemon barbatus*, a Mexican plant, with long wand-like panicles of drooping scarlet flowers. It needs staking, otherwise it looks ragged. *P. argutus*, two to four feet, flowers purplish and blue, on long paniced stems that, if not timely tied up, become prostrate. Both fine border plants.

*Tradescantia*, or Virginian spider-wort, of which there are blue, purple and white kinds, all equally hardy and showy. The white is the scarcest. They are pretty, and will grow almost anywhere, and become naturalized in rough places.

*Aconite* or Monkshood, blue, and showy border plants, also *Delphiniums* in variety. Amongst the finest *Delphiniums* are *Belladonna*, pale blue; *Hendersoni* and *formosum*, deep blue, and *nudicaule*, red. They last well as cut flowers.

*Saponaria officinalis*, or common soap wort, 18 to 24 inches, with dense paniced bundles of large white or pink-tinged flowers. Showy, and a good border plant. There are variegated-leaved and double-flowered kinds of the same quite as hardy.

*Lychnis chalconica*, two to three feet, with corymbose clusters of scarlet flowers. There are single and double-flowered varieties of this old-fashioned border plant, varying in color from white to scarlet, but scarlet is the best.

*Dianthus Seguieri*, single pink, 12 to 15 inches; makes a compact and pretty clump, but not so pretty as some of its predecessors.

*Funkia ovata*, the blue day lily, makes fine clumps for borders or shrubberies; flowers bluish, arranged unilaterally, and freely borne.

*Hemerocallis fulva*, the common day lily, is suitable for borders, shrubberies, or for naturalization under trees, or in waste places.

Hollyhocks are at their best. Of course we have only single sorts, and for ornamental purposes the intensely colored double sorts are the most appropriate, and quite as hardy.

*Yucca filamentosa*, a common but noble plant, with tall, tree-like flower, stem laden with yellowish white blooms. I lately saw a pretty effect produced on a sunny slope by having

these *Yuccas* planted some three to four feet apart, and interplanted with low-growing, red-flowered *Cannas*, banded with white variegated grass.

*Antirrhinums*, or Snap-dragons, treated as self-sown annuals and transplanted. The dark and intensely colored ones I think the prettiest, though the striped ones are the most sought for.

*Callirhoe involucrata*, the common *Malva*; a procumbent and spreading plant, with a profusion of showy crimson flowers. Suitable for rockwork or border.

*Malva moschata*, vigorous; flowers rosy lilac, and freely borne on tall, branchy stems. Shrubberies and mixed borders if staked.

*Betonica grandiflora*, a pretty border plant with whorls of purple flowers.

*Physostegia Virginica*, a purplish labiate with terminal racemes of crowded blooms. Wants lifting, dividing and transplanting every second or third year.

*Dracocephalum peregrinum* makes a fine border clump, 12 to 18 inches; flowers blue, in loose whorls on arching or decumbent racemes.

*Erigeron speciosus*, bluish, two feet; handsome as a border clump, or naturalized in wild places. *E. glabellus*, one foot, flowers pretty, and, like *speciosus*, a fine border plant.

*Coropsis lanccolata*, two to three feet, bearing a profusion of bright yellow flowers; a desirable border plant. *C. tripteris*, tall and handsome, flowers showy, yellow with dark centre; *C. palmata* and *C. delphinifolia*, good enough in their way, in roomy borders and amongst shrubs, but too rough for the select border.

*Lathyrus latifolius*, the everlasting pea, of which there are pinkish-purple and white-flowered kinds; particularly pretty, and keeping in bloom a long time. The white kind is very fine. In clumps, on supports, or depending over rock work they are very appropriate.

*Spiraea venusta*, a handsome and very fine perennial, with rosy-carmine flowers in terminal compound cymes; two to three feet high. Also *S. Kamtschatica*, pretty white flowers, in the way of *S. umaria* which is also in bloom, and *Astilbe chinensis*, two feet, with paniced clusters of pinkish flowers; fine.

*Lythrum salicaria* or Loosestrife, two to five feet; flowers reddish-purple and in whorls on long terminal spikes. A handsome and desirable plant for borders or water margins. The variety known as *Roseum superbum* is the best.

In addition to the above are many *Salvias*, *Scutellarias*, *Nepetas*, *Veronicas*, *Lychmises*, *Asters*, *Achilleas* (*A. millefolium roseum* is the best), *Chrysanthemums*, *Anthemises*, *Centaureas*, *Convolvuluses*, &c.

Chief amongst shrubs in bloom are *Spiraea Douglasi* with dense terminal panicles of rosy-pink flowers; *S. Menziesii*, not unlike *Douglasi*; *S. callosa*, with thick terminal corymbs of pinkish blooms; *S. salicifolia*, the American Meadow Sweet, dull white, in crowded panicles; and *S. corymbosa*, with showy flat compound corymbs of white flowers. There are likewise *Itea Virginica*, with racemes of pretty white flowers; double *Deutzias*, *Hydrangea arborescens*, *radiata* and *hortensis*, the Smoke tree *Rhus cotinus*.

*Calycanthus floridus*, or Sweet Shrub, locally known here as Pine-apple Shrub; and, *Rubus odoratus*, a free-blooming shrub, good enough for rough places, but not sufficiently attractive for choice shrubberies.

## EDITORIAL NOTES.

PUBLIC ADORNMENTS OF CITIES.—Americans often wish that their public servants were "intelligent," and would attend to parks, squares, and other public places "as they do in Europe." But it appears they are no better off than we, and "societies" and outside pressure have to be brought in to aid the public officers to walk in the way they should go. This is an illustration:

"Mr. George Dawson, in a recent lecture at Birmingham, England, said that the office of a man's house was not only to give shelter, food, and meat, but also to surround his children with those fair sights and sounds by which the sense of beauty might be developed. There were houses in that town in which not a poem was read nor a song sung throughout the year, and yet the people wondered why their children were vulgar. Attention to the beauty of towns was one of the most neglected duties and one of the most deserving. If a town was beautiful, the people took pride in it, like to live in it, and were sorry to leave it. In Birmingham they wanted a new society, to be called 'the Beauty Society.'"

THE RHODODENDRON.—Mr. Waterer with his Centennial Rhododendrons has stirred up the folks with a vengeance. Four Rhododendron articles in one number! The subject is well

worthy of the space. Ignorant Rhododendron culture is a costly thing in America, but intelligently pursued, nothing is more delightful.

*LIATRIS PYCNOSTACHYA.*—This magnificent plant stood the dry and hot weather most triumphantly. By the 1st of August it was in full bloom, continuing the whole month. It will be a fit companion to the *Gladiolus* when it becomes well known. It flowers after it is one year old from the seed, and is easily raised.

---

### QUERIES.

---

PROTECTION OF TEA ROSES IN WINTER.—L. F., Belleville, Ills., asks: "Having heretofore failed to find the proper method to keep my Tea Roses during winter, I propose the coming sea-

son to fasten the branches to a stake and surround them with straw, making a mound of coal ashes over the roots. Would not such a plan keep the plants dry, and protect them from freezing? If you will give your valuable opinion on that subject, you will much oblige me indeed."

[The putting on and taking off of earth or coal ashes in fall and spring is troublesome where there are many tea roses. It is better to take them up late in the fall, cut away the immature parts, choose a spot where water will not lie, and then bury roots and tops in earth till early in spring, when take up and replant. If there are but one or two plants, and it is desired to have handsome specimens, the branches may be packed in with dry leaves, and a box placed over the whole to keep the leaves dry and from blowing away, just as in these parts we do Pampas grass and some other things.—ED. G. M.]

---

## GREEN HOUSE AND HOUSE GARDENING.

---

### SEASONABLE HINTS.

---

Those who have greenhouses, pits or frames, will now see to having any necessary repairs attended to. White-washing annually is serviceable, destroying innumerable eggs of insects, in the war against which the gardener should always take the initiative; sulphur mixed with the whitewash is also serviceable. Powerful syringing is a great help to keeping plants clean, and should be frequently resorted to.

One of the worst foes is the red spider, an insect so small that few persons know of its existence till they are educated to it. With a small lens they can be seen, living, red, dust-like dots, very active, and usually traveling with great rapidity over the leaves. But they are very destructive. Their presence is always indicated by grey or whitish spots on the green leaves. Whenever they are seen the leaves should be carefully examined, and syringing with water and sprinkling with sulphur employed.

Propagation of bedding plants for another season will now be progressing actively. Geraniums, and other things with firm wood, do best

in sand spread on the open ground, with a glass frame partially shaded spread over it. A great benefit will be found in most cuttings if they are placed for a short time in slightly damp moss for a few days before inserting the same, so that the wood at the base of the cutting may be partially healed or calloused over. Verbenas, and such cuttings, can be kept but a few hours, unless the wood is very hard. The harder the wood the longer they will do to keep so. Ripe wood of some things will be benefitted by keeping two weeks. All this must be found out by each propagator himself.

It is a very good time to look around for soil for potting purposes. The surface soil of an old pasture forms the best basis, which can be afterwards lightened with sand, or manured with any special ingredients to suit special cases, as required. The turfy or peaty surfaces of old wood or bogs also come very "handy." A stock of moss should also be on hand for those who crock pots, in order to cover the potsherd; moss also comes in useful for many purposes connected with gardening, and should be always on hand.

People not in the secret are often puzzled over the terms used by gardeners in potting. *Soil* they regard as the earth—earth of any kind that is ready to receive the plant or seed. A heavy soil is that in which clay preponderates over sand. A sandy soil is that in which sand is abundant with the clay. *Loam* bothers some people—generally it is used as the equivalent of “soil,” writers often using “sandy loam” when they might just as well say “sandy soil.” But strictly it is the upper surface of clay land which has become black by contact with the air and culture. A loamy soil would be understood as a rather heavy earth lightened by culture.

Plants intended to be taken from the open ground and preserved through the winter should be lifted early, that they may root a little in the pots. A moist day is of course best for the purpose, and a moist shady place the best to keep them in for a few days afterwards. Anything that is somewhat tender had better be housed before the cold nights come. Some things are checked without actual frost.

Ornamental annuals for winter-flowering should be at once sown, not forgetting *Mignonette*, to be without which will be an unpardonable sin. Chinese Primroses, *Cinerarias*, *Calceolarias*, Pansies, *Polyanthus*, &c., should be sown. Winter-blooming Carnations and Violets should not be forgotten. They are now essentials in all good greenhouse collections. *Calla Ethiopica*, old as it is, is an universal favorite, and should now be repotted, when it will flower through the winter finely. *Oxalis*, *Sparaxis*, *Cyclamens*, and such Cape bulbs that flower through the winter, should be repotted now. They are an easily grown tribe of plants, and should be in more favor.

---

## COMMUNICATIONS.

---

### REMEDY FOR VERBENA RUST.

BY ROBERT PALMER, INDIANAPOLIS, INDIANA.

Some three months since I asked through the pages of the *Monthly* if there was a remedy for the fungus known as *Verbena rust*. No one having offered a remedy I now give one. Pulverized charcoal applied to spots of rust removes them in a short time. I have tested its merits on some pretty hard cases and always with success.

Mr. Meehan, I have forwarded you the above remedy, thinking it would be of service to the readers of the *Monthly*.

---

### PITTOSPORUM TOBIRA.

BY WALTER ELDER, PHILADELPHIA.

A plant of *Pittosporum tobira*, four and a half feet high, and three feet in diameter of its spread branches, was planted in the open garden of James C. Smith, Esq., 2104 Walnut street, Philadelphia, in June, 1875 (last year). It stood out all last winter without injury, and now, June 5th, 1876, it is in a flourishing state, and covered with its white, sweet-scented blooms. If it should prove always hardy in this latitude, it will be a charming addition to our evergreen blooming shrubs. It diffuses the fragrance of its blooms for a large distance around it, and is then very ornamental, with broad and dark foliage.

David Landreth, Esq., seedsman, who has successfully cultivated the hardy hybrid *Rhododendrons* for a quarter of a century back at Bloomsdale, has had the greatest profusion of blooms by them this year that he ever had, and the same with his hybrid Belgian *Azaleas*.

---

### CULTURE OF PRIMULA SINENSIS.

BY BENJAMIN GREY, GARDENER TO E. S. RAND, JR.,  
ESQ., DEDHAM, MASS.

This very desirable winter-blooming plant may be propagated from seeds, which should be sown in a pan on a light sandy compost about the beginning of August for early spring bloom, or sooner, say May, for fall or winter flowering. The pan of soil should be well watered, and the seeds sown on the surface, covering only by laying a piece of paper over the top of the pan; in fact, we find this mode of covering excellent for all small seeds, as it maintains a uniform moisture, with less frequent waterings, should the soil seem to be getting dry. The pan may be dipped nearly to the edge in water, and let it soak in through the holes in the bottom. The plants will be up in three or four weeks, and as soon as large enough may be potted off singly into small pots, or pricked out in a frame or old hot-bed in sandy loam and leaf mold, and in the fall they may be put into five-inch pots, in which they will bloom, and may be kept in the frames shaded from the mid-day sun as late in the sea-

son as they can be with safety from frost. As the plants come into flower, all the best ones should be marked and kept for stock for the following year. After a good strain has been obtained we never resort to seedlings again, except for new varieties, but divide the old plants about the latter part of May, and plant in a frame, and shade until the first of October, when they may be potted and left in the frame until established, after which move them to a cool house for winter. They do well in a house with Camellias, and plants of a like nature.

When large specimens are desired, cut the old leaves off around the bottom of the plants, turn them out of the pots, and cut off the lower half of the old ball, re-pot into pots one or two sizes larger, sinking the plants so as to cover the old stems.

When treated in this way, or by dividing as above, they will flower finely throughout the whole winter and early spring. Pot in sandy loam, with leaf mold or well-rotted stable manure, and avoid giving too much water during the short, dull days in winter.

---

### EDITORIAL NOTES.

---

**BOUQUETS OF THE PHILADELPHIA BELLES.**—The correspondents of the different papers, writing from the Centennial Exhibition, ought to find enough of facts to write about without serving up fiction as truth. We have seen in leading English papers some astounding narratives—all news to us at home. In the horticultural line the following is one of these specimens. It is strange that a man cannot see when he is hoaxed. It all comes from people writing of what they hear, instead of working up what they actually see.

“We have also recently learned that in some towns of the State, Philadelphia for example, the number of bouquets carried by a lady at a ball is considered to be indicative of the number of her actual admirers of the other sex. A lady without a bouquet confesses herself without an admirer sufficiently interested in her to have given her even a simple flower. On the other hand, if a lady has several admirers and each has sent her a bouquet, she appears with the whole number. No donor is more favored than another. This may give rise to a sense of equality, and of levelling of the claims of the admirers, but it is,

to say the least, inconvenient to the lady and her partners. We have heard of a lady who appeared at a ball with ten huge bunches of flowers, some of which she had to trust to her partner, while she carried the remainder herself. We are told that “the whole of them would have filled a wheelbarrow, and the effect was awkward in the extreme.” This is easily to be believed.

“The carrying of the bouquets is like the bearing by the Indian brave of the scalps of those he has killed—a token of victory. It is a fashion that we think is hardly likely to be imported from America by our belles who visit the exhibition.”

**VIOLETS FOR WINTER BLOOMING.**—We have at present, says a correspondent of the “*Garden*,” a row of Czar Violet, in patches about 400 feet long, at the bottom of a south wall. These flower freely and long in Spring and early Summer. The runners are chopped off with a spade several times during the season to keep the shoots vigorous, which get a good size in a single season, and about November and onwards we take up a number of patches at a time, pot them in eight-inch pots, and put them into the Vineries or Peach-houses, or anywhere convenient, where there is a gentle heat. Thus treated, flowers quickly make their appearance, large and sweetly scented; and, though the plants do not continue to bloom for a very long time, we have plenty of them to fall back upon, and, therefore, introduce another batch.

**CUT FLOWERS.**—The *Gardener's Chronicle* says: “We read in the London papers of whole congregations carrying large bouquets of flowers to church on some particular occasion, and in the country parishes in Scotland spinsters may be seen carrying Lad's Love to church, along with some sweet-smelling showy flower to scent the white cambric handkerchief, neatly folded on or around the gilt-edged Bible; for the holiday dress alone, without the adornment of the flowers, would be reckoned wanting in the finishing stroke. Bridals require flowers. The Orange blossom, whether natural or artificial, is always given away with the bride, whatever else may be her dowry. In the theatre the successful actress gets applauded, not only with shouts and clapping of hands, but with a very shower of bouquets as she gracefully retires. The decorations of the dinner-table owe much to flowers tastefully disposed, and the drawing-rooms, dressing-rooms, and ante-chambers in the best family mansions

are all set off with gay and sweet-smelling flowers. It is, moreover, a Continental custom, fast gaining ground in this country, to drop flowers into the graves of departed friends, as though we owed some loving tribute to their memories.

"In order to meet these demands and many others, we have our 'flower girls,' who deftly handle the cut flowers, and construct some very quaint devices. Taking a leaf of a Zonal Pelargonium, for instance, she bores a hole in the centre and inserts some gaudy flower belonging to another genus, thus making a button-hole bouquet, the smallest size, good 'home made,' quite a marketable article, and sold in thousands. The flower orders for wedding bouquets is quite a commercial affair in the London season, and cost a good round sum. Occasional *fêtes*, such as those got up for the Shah, are red-letter days for bunting and bouquets."

**CHRYSANTHEMUMS AFTER FLOWERING.**—Many amateurs who have grown chrysanthemums for conservatory decoration are in doubt as to what should be done with them now that they are out of flower; and a word or two on the subject will be of service. They are, it must be said, very accommodating, and may be kept in a properly-constructed pit or under a covering of long litter. As pit-room is not often very abundant in such gardens, and the chrysanthemum, although reputed hardy, is likely to suffer from severe frosts, stand the pots on a layer of coal-ashes at the foot of a wall or other sheltered place, and when there is any appearance of frost cover them with a thick layer of long litter or newly-collected leaves, and place a few boards on the top, especially if leaves are employed, to prevent them blowing about. Here they can remain until all danger from severe frosts is past, and then they can be uncovered. In the early part of the spring turn them out of the pots, knock away all the soil, and select the strongest suckers with a few roots attached to them, and then put them singly in small pots. This will save the trouble of striking the cuttings, and a little time will also be gained. When established in the small pots they can be shifted on in the same manner as those raised from cuttings.—*Gardener's Weekly*.

**SOFT-WOODED GREENHOUSE PLANTS.**—*Veronica Andersoni* and *salicifolia* are amongst the most useful autumn flowering plants for conservatory decoration, when grown in pots and properly prepared. To keep them dwarf and bushy, as also to induce a free disposition to flower, the

pots should now be plunged in coal-ashes in a sunny situation, and well supplied with water. When they get filled with roots give them manure-water once a week.—*Gardener's Chronicle*.

## NEW PLANTS.

**RUDGEA MACROPHYLLA**, producing a large head of pure white flowers, is blooming in the stove. The leaves are of large size and have been compared to *Medinilla*, with which in habit the plant has some similarity, though from so small a plant much cannot be said. It is about a foot high, and the inflorescence in size is quite out of proportion. The flowers are very beautiful, and have been used in the bridal bouquet of a Royal marriage. Individually they last only a short time, but a large number of buds open in succession, and these alone are of great beauty. The corolla is funnel-shaped and about an inch in diameter. It was figured in the *Botanical Magazine* of 1867, where it is described as "a magnificent plant, and belonging to a genus which, though containing many species, had never previously, so far as I am aware, been introduced into European gardens." It is yet quite rare. The specimen from which the portrait was drawn was sent by Mr. Henderson of Pine Apple Place. It is a native of Rio Janeiro, and is described as attaining a height of 6 feet. Hitherto it has not been tried with different soils or temperatures, but has succeeded in the stove, using a soil of peat and loam as for the generality of stove plants.—*Kew Novelties in the Journal of Horticulture*.

**PINK MARECHAL NIEL ROSE.**—A pink Marechal Niel rose appears to have been secured by our excellent coadjutor Mr. Thomas Trussler, of Edmonton, and should it prove to bear the test of criticism it will add to the series of illustrations recorded of the reciprocal influence of stock and graft. A bud of John Hopper was entered on a brier in the usual way, and afterwards a bud of Marechal Niel was entered on John Hopper. The result is apparently a pink Marechal Niel. The flower before us is smaller than the type; it is pale lemon-yellow without, with a diaphonous tint of pink within, very pleasing, and in some degree resembling *Devoniensis*. Should it prove permanent it will be peculiarly interesting.—*Gardener's Magazine*.



THE NEW DOUBLE FLOWERING IVY-LEAVED PELARGONIUM.—This plant originated as a chance seedling in the garden of Herr Oscar Liebmann, the single flowering varieties of *Pelargonium*, *luteipes*, and as now flowering with us it produces medium sized trusses of flowers, which are



of Dresden, and is a valuable addition to this class of plants; it has the trailing habit of growth, and the semi-succulent glossy leaves, peculiar to of a pinkish lilac color, veined and feathered with carmine and white. The flowers are abundantly produced, and endure as long as the

double flowering Zonal varieties, which gives it a value for bouquets, &c.,—a value which the single forms do not possess. The plant has been introduced under its German name *Pelargonium König Albert*, but presume that we shall be understood if we henceforth call it King Albert. The cut conveys a good idea of size of truss, foliage, &c., but does not give the feathered markings of the petals.

H. E. C.

**CROTON UNDULATUS.**—This is one of the most beautiful varieties ever introduced. It is of the usual free Croton growth, the edges of the leaves being beautifully undulated and wavy, and the variegation consisting of numerous markings and blotches, which in the matured leaves are of the brightest crimson on a dark green ground, and in the young leaves, at first yellow, gradually changing to pink and crimson, the base of the petiole being a very light green. It has been introduced from the South Sea Islands.—*B. S. Williams.*

**ANTHURIUM CRYSTALLINUM.**—This fine species is in the style of the well-known *A. magnificum*, having large, ovately heart-shaped leaves of deep emerald-green ground, with beautiful silvery veins radiating from the base to the extreme point. The secondary nerves have also broad bands of silver, which glitter in the sunbeam like veins of crystal, presenting a brilliant contrast

with the intervening rich-green leaf-spaces. The young leaves show a purplish-violet tint.

## QUERIES.

**HYBRID FERNS.**—W. B., Delaware, Ohio, writes: "I send you this day a box, by mail, containing three fern fronds. Nos. 1 and 2 are seedling crosses of *Pteris serrulata* and *P. elegans*, they somewhat resemble the *Pteris longifolia*; they are very strong growers. Are they worth disseminating under a new name? If so, I will have to send them east to be introduced. Our people understand *corn best*. No. 3; please give me the correct name; the frond I am aware is not perfect, but I selected it because it contained ripe seed which you can sow if you desire.

[It is often hard to distinguish between a variation in obedience to some innate law and a hybrid. Numbers of instances of the latter really belong to the former. These look as if they may be hybrids, and are in any case beautiful forms. The other fern is *Aspidium falcatum*.—Ed. G. M.]

**SUN-RAY FUCHSIA.**—J. P. S., says: "Sun-ray Fuchsia was raised by Mr. G. Smith about the year 1870. It was introduced into this country also under the name of Sunset."

# FRUIT AND VEGETABLE GARDENING.

## SEASONABLE HINTS.

Trees that have long stems exposed to hot suns, or drying winds, become what gardeners call "hide-bound." That is, the old bark becomes indurated—cannot expand, and the tree suffers much in consequence. Such an evil is usually indicated by grey lichens which feed on the decaying bark. In these cases a washing of weak lye or of lime water is very useful; indeed, where the bark is healthy, it is beneficial thus to wash the trees, as many eggs of insects are thereby destroyed.

We would, however, again refer to linseed oil as

a wash, as far more effective for insects, and would, perhaps, do as well for moss and lichen. After all, these seldom come when trees are well cultivated. It is neglect makes poor-growth, and poor growth, lichens.

The planting of the pear, apple, plum and cherry will soon be in season; peaches, apricots and grape vines, except south of the Potomac, being for the most part left till spring. Choose a dry piece of ground. If not naturally dry, it is best to throw the earth up into banks or ridges and plant on them. This is cheaper and better than underdraining. In planting, if the roots appear deep, cut away some of the deeper ones, and shorten some of the top of the tree at the

same time. This is particularly true of dwarf pears which are often grafted on rather long quince stocks. Cut all away of the quince root but about six inches, and if this should be found to leave few roots, cut away the top correspondingly. Most of the failures with dwarf pears come from bad quince roots, so deep in the ground the lower parts decay, and this decay gradually communicates upwards until the whole system becomes diseased. The more tenacious the sub-soil the more necessary is it to attend to this matter. We spoke of pruning in proportion to injury. It will be found that all trees are a little injured by removal, therefore all trees should be a little pruned at transplanting.

The vegetable season is almost over, though some care may be used to advantage.

Tomatoes will still repay care bestowed in keeping them in shape. Those grown on stakes should be tied up, and will continue bearing for some time yet. Where the ground is very dry waste water from the kitchen will benefit them.

Egg plants like plenty of moisture, with sun and air. If the ground be dry, give them abundant manure water; they will bear until frost.

Potatoes, as soon as the tops are well decayed, are best taken up at once, as they appear less liable to rot afterwards, than if left long in the ground.

Turnips also may still be sown. In fact, if the soil be rich, a better quality of root for table use will be obtained than if sown earlier.

The main crop of spinage should now be sown. Properly cooked, there are few vegetables more agreeable to the general taste, and few families who have gardens will wish to be without it. It is essential that it have a very well enriched soil, as good large leaves constitute its perfection as a vegetable. As soon as the weather becomes severe, a light covering of straw should be thrown over it. A few radishes may be sown with the spinage for fall use.

Cabbage and cauliflower are sown this month for spring use. The former requires some care, as, if it grow too vigorous before winter, it will all run to seed in the spring. The best plan is to make two sowings—one early in the month, the other at the end. The rule is, get them only just so strong that they may live over the winter in safety. Many preserve them in frames; but they should have wooden sashes or shutters instead of glass, so as not to encourage them to grow much.

Cauliflower, on the other hand, cannot well be too forward. Most persons provide a pit of stone, brick or wood, sunk five or six feet below the surface of the ground, into which leaves, manure, or any waste vegetable matter is filled. When quite full it is suffered to heat a little, when it will sink somewhat and have more material added to it; about six inches of good rich loam is then placed on it, and early in November the cauliflower is planted out. The object in refilling the leaves so often is to insure the plants remaining as near the glass as possible, which is very essential in the growth of cauliflowers. Lettuce is treated in the same way, and seed should be sown now to prepare for the planting. The cabbage lettuce is the kind usually employed.

## COMMUNICATIONS.

### THE STANDARD CURRANTS AND GOOSE-BERRIES.

BY KUHN & CO., ROCHESTER, N. Y.

It is now about twelve years since this method of growing the Currants and Gooseberries has become general in Europe; since then it has rapidly assumed large dimensions, so that now they are quite an article of commerce with the nurseries there.

I first saw them at the Pomological Institute of Dr. Ed. Lucas, at Reutlingen (where I spent two years), in the autumn of '69; being immediately taken up with the idea, I wrote Dr. Siedhof, my kind patron, about them.

He wrote, "Send me a dozen," and since has largely increased the number—now having about fifty in all.

He has imported about one hundred more for special friends of his in different sections of Hudson Co.; N. J.; so they have been thoroughly tested. Not a speck of mildew during seven years.

This method of grafting naturally does away with and supersedes the old and tedious method of trimming up the plants on their own roots to the standard form and then have it ruined by the borer, as *Ribes aureum* is exempt from the attacks of the borer.

The stocks are grown by stooling, removed and potted in fall and placed in a frame till about the holidays, when they are brought into a cool house—say from 45° to 50°.

In about three weeks they have started sufficiently for grafting to begin. The methods employed are the common whip graft, without

Previous to grafting they are kept shaded well. After grafting, however, they are given the full light and a little more heat.

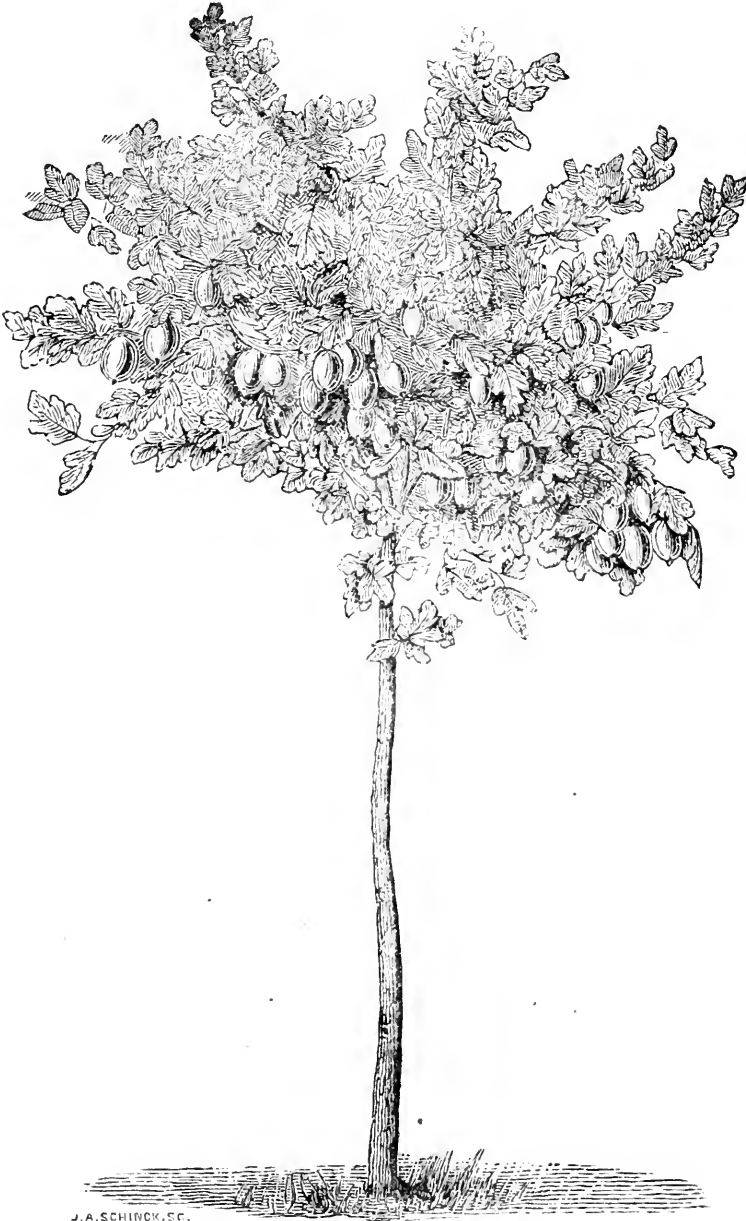

cutting the tongue, and the cleft graft for larger stocks.

Only perfectly well-hardened, woody stocks should be selected, all others rejected.

Bottom heat is not absolutely necessary, but of course, in a measure, is very beneficial.

Frequent sprinkling after starting from the graft is also very beneficial.

By pinching the tips of the stocks we obtain branched heads, and so are enabled to set several grafts on one plant.

Instead of potting, some firms just envelope the roots in a ball of moss fastened with wire. These are very handy for shipping.

They must at no time be kept too moist. Are saleable next fall as one-year olds.

The fruit we exhibited at the Centennial were *not show berries*, as the English grow them, for the plants were *literally loaded with fruit*.

We have measured berries  $5\frac{1}{2}$  by  $3\frac{3}{4}$  inches in circumference, weighing from  $1\frac{1}{4}$  to  $1\frac{1}{2}$  oz.

These statements are actual facts and may be relied on. If these notes will be of any use to you we shall be glad to have you use them.

### LINSEED OIL FOR SCALE.

BY DR. M. W. PHILIPS.

This morn Prof. Wheat asked me if I had seen the *Gardener's Monthly* for July, stating that "Mr. Meehan pays to you a very high tribute." I read it, and said, "I would rather have it than the praise of officers and courts of our country." My business for forty years has been farm life. I love it. I love trees and flowers, stock of all kinds; even prefer the "caw!" "caw!" to all your "harps with a thousand strings," although I am devotedly fond of music, the voice or instrument; yes sir, the praise of such a man is incomparably sweet to me. But, please, only give me due praise; I would not pluck a leaf from any man's laurel. I have been a learner since I was sent on earth, 1806, January. When I know of a good thing, or if even it can be, and trial can only prove, to this extent only have I done duty.

Settle the vexed question—the blue hen laid the eggs, the black hen had the hatching, which has the credit?

J. J. Wheat, D. D., Prof. of Greek, painted his trees with linseed oil, trees 1, 2 to 5 or 6 years old, limbs of any size, and stem to the earth.

I saw the fact one or two years after the first, and three to six months after the last painting. Dr. W. opened the bark where the blight was, and the wood was healthy. My opinion was, and is to this extent confirmed, that the insect, or something depositing eggs (insect or vegetable), the latter as yeast or "beer seed," is destroyed. I know the blight, have fought it; seen as splendid trees in orchard ruined by blight; seedlings, in a

yard where no culture, earth only removed for trees; old trees in a garden where manure, green and rotted, was applied liberally, yet all died in one year, destroyed, I say, by the fungi, whether spores deposited by atmosphere, stung by an insect, or what, I know not. The rot in cotton bolls, I believe, I first suggested to Mr. Townsend Glover at my house was caused by an insect, and I sent to Patent Office the little bug, as scary as the curculio. Why not poison from an insect on the bark of the pear? At all events, mine offence was telling what I saw, believing, hoping it would prove worth millions to my fellow citizens in America. Thanks to you, my friend.

Let me say, Dr. J. J. Wheat is an expert in the garden, small fruit, and the orchard. I heard a Bishop of the Episcopal Church for two hours or more. I remarked to one of his brethren, a Gen'l, "Why did you spoil such a speaker in making a Bishop?" I say now as to Dr. W., one of the rare men for farm, or garden, or fruit, was spoiled in making of him a Greek Professor. Upon my word I would prefer his talent for the practical to all Greek lore from Thucidides, Xenophon, Euripides down to—well, all the ancient lore. I have been a student, of books and the practical, for near fifty years. I ought to know what is success, whether in a cabbage or in pear culture.

### CLASSIFICATION OF FRUITS.

BY W. H. SEAMAN, WASHINGTON, D. C.

In the last number of the *Gardener's Monthly* you allude to the need of a classification of apples, number of "fruits as plants are arranged." Now, are you sure the thing is possible? In these days when all species are declared "*varieties* of types," "whose boundaries cannot be certainly defined," what characters will you select in, say the apple, which shall remain so unchangeable under the influence of varying soils and climates, as to enable any variety to be unerringly detected by even an experienced man? I have seen two sets of apples handed to a competent fruit grower, who was utterly at a loss on one—though well acquainted with the other—both grown on the same graft and exhibited by the grower. Now, I have received apples from Missouri, said to be seedlings. In appearance and taste they were identical with the Pound Sweet. *A priori*, there is no reason why a second seedling should

not resemble a previous one. Would you call it Pound Sweet?

Many Europeans have tried their hands at pomological taxonomy, notably the Germans, as Lucas, for example. They have carried their divisions to a fine point; how far are they in actual use? I hope to learn this summer. Among us, Thomas and Warder, especially the first, have presented simple and apparently reasonable systems, but the great majority of cultivators don't know of their existence, and Downing, chief of all, declares such an attempt visionary.

[The difficulty our correspondent presents is no more than the botanist meets with in his studies. If he were to take oak leaves alone, or acorns alone, he would never get along! He does not dream of classifying on one character alone, but considers all. Why must a pomologist be restricted to a fruit? There are quite as striking differences in the leaves, in the branching, in the flowers, and other parts, as in the fruits. There is no apple varies more than the Red Astrachan. By the fruit alone we can never be positive, but if we begin with the tree, follow to the flower, and finish with the fruit, one need never mistake in the Red Astrachan; nor indeed in any other variety treated in the same way.

Let us say that few persons in this country have given more attention to varieties of fruit than the writer of this, but he has not been ambitious to achieve a "name" as a "pomologist" because of the absurdity of the endeavors to establish systems on single and variable characters. It is amusing to note even first-class "fruit men" wrangling over the proper name of a plate of fruit at a fair. The scene can only be paralleled by looking at a party of hucksters higgling over the price of a fish. We have no liking for this sort of guess-work.

We have great respect for the opinions of Warder, Thomas, Barry, Downing, and others. We should prefer their opinions on many questions in relation to pomology to our own. But when they assert that any better system of classification than that of a heterogeneous mass of descriptions of fruits alone, is visionary, if attempted, we beg to differ from them.

Visionary or not, this writer would certainly make the attempt had he the time. There is little doubt in our mind that some one will not only try it some day, but try it and succeed. This we have said often before in these pages,

and see no reason to change our views.—Ed. G. M.]

### EDITORIAL NOTES.

NECTARINE PRODUCED FROM A PEACH.—A valued correspondent sends us an account of a nectarine produced from a peach tree on the grounds of Mr. E. Wilkins, of Maryland. It is thought to be a case of "reversion." But the first nectarine that was ever known was raised in that manner—not by reversion, but by a sport from a peach. What is called "reversion" by animal physiologists is generally of the same character. Nature is prolific in her powers of varying form, and the resemblance to predecessors is but an incident in the progress, and with little or no regard to that which has gone before. It is, in fact, just such illustrations as this of the relationship of the peach to the nectarine which proves how untenable much of this reversionary theory is.

RASPBERRY FROM MR. ROE.—On the 18th of July came to hand samples of a seedling raspberry—but in one decayed mass.

THE AMSDEN PEACH.—Mr. J. Wampler, Carthage, Mo., says: "As the unprecedented freeze of 15th March last destroyed the peach crop here, when they were just coming out in bloom (mercury fell almost to zero), we hope to hear from more favored localities of the success of the new early Peaches this year. So far as we can learn none of the new peaches escaped here, except three specimens of the Amsden in the garden of Mr. Lewis, in Carthage. These were all taken from the tree very ripe, on the 27th of June, the largest measuring  $7\frac{1}{2}$  inches in circumference. This is the fourth year the Amsden has borne fruit here. The few specimens this year being a little earlier than in any former year, we think it safe to conclude that the Amsden is at least eight or ten days earlier than Beatrice, as in former years it was ripe eight days to two weeks before Beatrice growing by its side. We had hoped to see Amsden and Alexander side by side this year, but the great freeze disappointed us; and we hope others will report, if any have ripened the two varieties.

THE ALEXANDER PEACH.—We have seen some letters addressed to Messrs. Jabez Capps & Sons in regard to this peach, from California, which compare it very favorably with Briggs' Red May,

and show it to be far superior to Early Beatrice. The latter seems going out of favor in California. The following we find in an Illinois paper:

"The question is now who shall produce the early peaches. English and American horticulturists have been vying with each other in this matter. First our Hale's Early was far ahead of the English Early York; next Mr. Rivers of England, leads with his Early Beatrice, now Logan county has the honor of leading in the race with the Alexander, a peach that for earliness and excellence is ahead of all competitors. In California, that land of fruits, the Alexander is attracting much attention. The season is very late and fruits are generally two to three weeks later in ripening than usual. C. M. Silva & Son, of New Castle, Cal., say that it ripened with them on the 12th of June; could have been shipped several days earlier; ripened ten days earlier than Beatrice, and were fully twice as large. Messrs. M. T. Brewer & Co., wholesale fruit dealers at Sacramento City, who received a box of Alexander by express, were surprised at seeing such fine flavored, large sized and bright colored peaches so early in the season, and pronounce it a very desirable peach for shipping, and say that the Beatrice will stand no comparison with it,—that while Alexander peaches would sell in the market at 15 cents per pound the Beatrice would not sell for one cent."

MANURE & STRAWBERRY INSECTS.—Dr. Phillips, Oxford, Miss., writes:—"I do not know whether I communicated to you, or whom, that Dr. J. J. Wheat, professor of Greek in our University, requested me to examine with him what should have been his strawberry patch. He dug at each hill, plants dead, and found one or more of the grub worm, and where the plants were in a dying condition, we found the worm and the root eaten up to the very plant. This proved, that manure where the black beetle deposits eggs is improper for the strawberry, as some one, I forget now who, wrote some years ago. Dr. Wheat concluded to make a new patch and use no animal manure, and to-day he informs me that the worm is in the new patch, but younger and smaller than last year. He used cotton-seed meal, I think. I know the bug will use oat meal to roll his ball. I saw it done, but cannot suppose meal applied last fall or this spring could be used in the earth, and that the egg was deposited before plants were set.

A STRAWBERRY GROWER AT BOULDER, COLO-

RADO.—Mr. William Newland has one of the most valuable tracts of land in the suburb of this city, one-half mile to the north. Its chief attraction now is its 1½-acre strawberry patch. They were now just ripening fast, the first fruit, 700 quarts, having been gathered in the few last preceding days. The crop for the season is estimated at six thousand quarts. They were first sold at fifty cents per quart, but had fallen to thirty cents.—*Colorado Farmer.*

## NEW FRUITS & VEGETABLES.

HAME'S APPLE.—Messrs. Cole & Co., Atlanta, Ga., write: "We send you by express to-day a few Hame's Seedling Apples—a seedling that originated in Western Georgia in about 33° 30' N. latitude. It ripens with Red Astrachan, and the specimens sent should have been gathered ten days ago, and their condition is partly due to the unfavorable season. Our apple trees in this section are all blighted—the presence of insects and improper handling. The fruit is only one-half to two-thirds its usual size; the heaviest sent you weighing only 7½ oz., while last year specimens weighing 13½ oz., were weighed by us, and good authority represented they were not the largest on the trees,—not grown with view to obtaining size but large trees with bushels of fruit on them. We have been watching the apple for several years and send these very poor specimens, hoping they may reach you in condition to enable you to form an opinion of its merits; promising to substantiate the statement as to size by better specimens another year.

"The apples were not raised by us, but shipped 70 or 75 miles."

[This apple has very much the appearance of Summer Hagloe, but this is a month later, instead of a month earlier than Red Astrachan. Unquestionably it is a desirable variety.—Ed. G. M.]

MARYLAND EARLY PEACH.—W. L. M., Frederick City, Md., writes, July 11th: "I send you to-day by express, specimens of a new peach, which originated in this county, and which may prove a valuable acquisition to the pomological wealth of the country.

"It is said, by the gentleman with whom it originated, to be a seedling of a yellow peach, which was itself a seedling. The tree is now five years old and in perfect health, fruited last year bear-

ing five; this season it bore thirty; the first were ripe on the fourth of July, the balance are ripe at this date.

"The largest were taken off and given away before I saw them, two of them measuring 8 and 8½ inches in circumference respectively. Those I send you were taken off the tree yesterday forenoon, the 10th inst., and were the largest that were then on, but I think little if any more than a fair average in size. The smaller one, I fear, will be rotten before it reaches you, as it was bruised while on the tree, and the juice has been weeping from it.

"Please let me have your opinion of them as

compared with the Amsden, Alexander and other new varieties."

[Not having Amsden, Hale's Early, or other fruits from the same locality, we cannot speak *comparatively*, but can say it is one of the best early peaches we have had this year, and we have had some first-class ones.

We do not know but the peach is playing some pranks on us this season. On the writer's own grounds, Hale's Early, Troth's Early and Early York all came in together, no difference whatever between them. The trees seem all equally healthy. Last year, in the same trees, Hale's Early was much in advance.—Ed. G. M.]

## NATURAL HISTORY AND SCIENCE.

### PRAIRIE FLOWERS.

BY L. J. TEMPLIN, HUTCHINSON, KAN.

Every one has heard of the beauty of our Western prairies when decked in their floral robes of summer. And every one has tried, at some time, to form, in the imagination, a picture of a landscape, sweeping away in the distance as far as the eye can discern. But to one who has never seen such a sight a true conception of the real scene is impossible. To a mind in sympathy with nature there is something in such scenes to elevate it and excite the most lively emotions. There is something almost sublime in the grand stretch of these vast plains as they sweep away to the distance, at times almost as level as the bosom of the sleeping ocean, then rising in the most gentle and graceful undulations, and again ascending in bolder but beautifully rounded, or occasionally breaking into the abrupt bluff or precipitous cliff, but everywhere impressing and almost oppressing the mind with a sense of vastness and immensity of space that is almost overwhelming, till to the mind, as to the sight, in the misty distance heaven and earth seem to meet and mingle into one. But while this sense of vastness may elevate, if not awe, the beholder, I apprehend most minds in contemplating these scenes would find their greatest pleasure in the varied forms and colors of the vegetable world with which these plains are so profusely covered. The prevailing vegetation is composed of grasses, but generally of strange forms and species to the emigrant from our east-

ern States. But after all the flowers that wave in the breezes and blaze in the sunlight will be objects of greatest interest. Many of them will suggest old, familiar kinds, while many by their novelty of form and brilliancy of colors, will impress the mind in the radical difference of vegetable forms in different parts of our country. Two species of *Allium*, one with purple and the other with white flowers, spread a carpet of bloom over acres of land early in the season, before the taller plants have grown enough to obscure them from sight. Then comes a Mallow that to casual observers has the leaf of the Verbena and the flower of the Portulacca, spreading its branches on the ground, radiating from the base as a centre, and spreading its brilliant crimson flowers to a distance of a yard in every direction. Similar to this in manner of growth, but entirely different in form, is the Sensitive Briar, that often produces, from a single root a perfect bed of beautiful rose-colored bloom, from five to eight feet in diameter. Large patches of dwarf Helianthus, with their yellow rays expanded in the sunlight, look like fields of glittering gold. Dwarf roses as fine, in both form and color, as many that are cultivated with care, expand their petals and shed their fragrance in countless profusion. But time and space would fail me to speak of the countless species that, with their white, blue, crimson, and gold, join with the many shades and forms of foliage to bedeck the plains, while they perfume every passing breeze with their balmy fragrance. It must be seen to be appreciated.



## GENERAL OBSERVATIONS ON THE FLORA OF HOKKAIDO.

BY M. LOUIS EÜHMER,

*Horticulturist to the Kaitakuska, Yedo, Japan.*

[Concluded from page 245.]

Descending towards the seashore, a pink and a white *Scabiosa*, in company with a *Platycodon* (*Campanulaceæ*), is growing in sunny places. Approaching the vicinity of the seabeach, the rocks are studded here and there with a small *Compositæ*, of which the flowers are sometimes red and sometimes white. I also noticed several different kinds of *Sedum* and *Saxifraga*. From here we ascended again the mountains where I found some trees I had not seen before. Foremost among them is *Styrax abassia*, a tree peculiar to the Japanese islands, with large round leaves and clusters of fine white flowers. It grows about 15 feet high, and has a smooth light red bark. A *Carpinus*, with flowers like those of a Hop, almost three inches long, was in full bloom. *Kalopanax richinifolium* (*mig.*), a large species of *Aralia*, which is often found in the forests, attains here its greatest size. It is a handsome tree, especially when in flower, and has almost a tropical appearance. The trunk sometimes has a diameter of from three to four feet, and as the wood is easily worked it is used for various purposes, especially by Ainos for their canoes, which are made by hollowing out a portion of a trunk about 20 feet long. The Japanese name is *Sen noki*, or *Harigini*. The Ainos call it "Yoshi-ni."

*Clerodendron trichotomum*, a shrub with large leaves and racemes of white flowers relieved by a red calyx, grows here with great vigor, although I did not expect to find it so far north. It is really a handsome shrub, and would form a valuable addition to foreign parks, as it is perfectly hardy here. A pink-flowering *Andromeda*, which I had not seen before, grows in patches in stony ground. A pretty flowering herbaceous plant with blue flowers, which I believe to be a *Lysimachia*, frequently occurs here; and the beautiful *Primula Japonica* I found for the first time in its wild state on the sides of small mountain streams. Four years ago this plant was introduced into England, and on account of its elegant habit has sprca through foreign gardens with great rapidity, and promises to be one of the leading plants for open air cultivation. The mountains rise here to about three thousand feet, and those facing the sea are generally

scantly supplied with vegetation, while those more inland are covered with thick forest up to their summit. On the former Birch and Alder of small size are met with, and also small Oak. A species of *Arundo*, a favorite food of the deer, covers large spaces of the open ground. The deer are said to collect here in large numbers during the winter season, and are killed by the natives for the sake of their skins. I was informed that no less than thirty thousand deer were killed last winter at Hore-idzumi, where large plains covered with this reed occur.

Following the road, we had again to descend to the seashore, and on the way we passed through most luxuriant vegetation. There must be a considerable amount of moisture in this neighborhood, as I found no less than three different ferns growing on trees. *Hydrangea*, *Actinidia*, *Euonymus* and the wild grape grow luxuriantly, and give the forest almost a sub-tropical appearance.

From Berufune to Kusuri the road leads through a plain about a hundred feet above the level of the sea. This plain is much intersected by small rivers, on the banks of which a gigantic umbelliferous plant was in flower, a species of *Angelica*, similar in habit to those found so frequently in Siberia. They often attain a height of 15 feet, with a hollow stem of at least 6 inches in diameter; some of the white umbels measured 18 inches across. Apparently it has a preference for moist localities, as I only found it growing in places where water is abundant. It is the largest representative of this widely-spread family that I have ever seen.

*Polygonum cuspidatum* is frequently met growing in company with these umbelliferous plants. It is a beautiful species, of tall growth, whose fertile flowers, which are of a light pink color and produced in large clusters, have a very good effect, and would form a valuable addition to park scenery in Europe or America. It sometimes grows to a height of 10 feet, and the stems are often used by Ainos as walking-sticks, probably because they are hollow, light and comparatively strong. This plant belongs to the buckwheat family, another remarkable instance of the size herbaceous plants sometimes attain to under favorable circumstances. The plains contain very little of interest, excepting a number of vigorously growing *Aconitum*, the roots of which are used by the Ainos for poisoning their arrows in order to kill wild beasts. They make a decoction of the root, and soak in it their arrow-heads,

which they use in traps for catching bear and deer. *Gentiana Buergeri*, which grows sometimes to the height of three feet, is very frequent, and has a magnificent effect with its clusters of blue flowers. At Ohotsunai, two small *Vacciniums*, one with red, the other with black berries, occur abundantly. A greenish white Lichen grows between them, of which the deer are said to be fond in winter. Several rivers run here into the sea, and the plains through which they run would afford good opportunity for cultivation. The soil is a rich loam, and of a dark brownish color. The black Lily mentioned before grows at Kusuri in quite large quantities.

From here to Akkeshi the road leads through mountains of not very great elevation. The deciduous trees give way here to Conifers. They were represented by the Tode and the Yeso Matsu before mentioned, with an undergrowth of *Taxus cuspidata* called by the Ainos "Unco." It is held in great estimation by them, as they use the tough wood for making their bows. A great deal of moisture must collect in these districts, as a white Lichen is met with everywhere hanging from the trees. Here I found a wild Raspberry and a red Currant covered with fruit, of which the bears are said to be very fond. The Raspberries favorably compare with those cultivated in foreign countries. The Currant grows about 10 feet high, has large leaves and bears large red fruit, which is rather sour. A shrub which I think to be *Philadelphus coronarius* was past flowering, and I only saw it in fruit, and was therefore doubtful as to its identity. An Actinidia, with red leaves which seem to differ materially from the two kinds already mentioned, I only met in this neighborhood. Around Akkeshi, on the foot of the hills, a Rubus resembling a Blackberry, except in the color of its fruit, which is red, grows among the shrubs. The flavor although sweet leaves a bitter taste in the mouth. Wild Strawberries grow abundantly here, and are said to be of fine flavor. As they were past bearing on my arrival I had no opportunity of testing their merits. The leaves look much like those of the European wild Strawberry.

Opposite Akkeshi there are two islands, which I visited, but I found nothing different from the mainland; in fact they were too near and too small to have a flora of their own.

It was my intention to proceed as far as Nemoro, but the Japanese objected, because they said that the frost would interfere with our in-

vestigations, and I was reluctantly compelled to return to Sapporo by the same road.

I left Akkeshi on the 28th of September, taking with me from the different stations on the road the plants which I had collected.

At Chitose I met again with *Lilium medeoloides*, and as it is scarce in other places I procured a large supply of it.

I reached Sapporo, with all the plants I had collected, on the 28th of September, and after making an additional collection of trees and seeds in that neighborhood, to be forwarded to Tokio, I started for Ishcari.

This road leads through a fertile and well-wooded country. On the road well-cultivated farms are seen, and the wood is composed of a great variety of beautiful timber trees. It is difficult to say which tree is the most abundant, but near Shinoro the Chestnut and the Walnut are decidedly the most prominent. In the woods around Ishcari, Maples are found more abundant. They are generally large trees, but I noticed one of smaller growth with leaves colored dark blood red, which had a magnificent effect. All the trees already mentioned, such as Magnolia, Tilia, Aralia, Quercus, &c., seem to flourish and do well here.

The "Kokuwa," a fruit which had been described to me as a great delicacy, I here had an opportunity of tasting for the first time. It has a peculiarity of not being eatable before it has had a certain amount of frost. Its flavor is delicate, and resembles the taste of a fig combined with that of the grape. If taken in large quantities it acts as an astringent medicine. A number of fruits were gathered and preserved in sugar, which I believe have been sent to Tokio.

On the 5th of October I returned via Sapporo, Tomakomai and Horobets to Tokarumui, and collected on the road all the living plants which I had observed before, but which at that season could not be removed.

At Tokarumui I was especially fortunate in securing a great variety of trees and shrubs. Among other shrubs I found a *Lindera*, always employed in Japan for making toothpicks, which are a household necessity in this country. *Clerodendron trichotomum* grows here to an enormous size, sometimes attaining a diameter of one foot and a height of thirty feet. Sanshio (*Zanthoxylon*) also grows to good sized trees of about the same dimensions. I am convinced that this place is very rich in its vegetation, and it would repay a closer investigation another season.

I returned to Tokio on the 26th of October, leaving the plants in charge of the Japanese officers who accompanied me. The plants have now reached Tokio. The living ones are planted in the gardens at Aoyama, and the dried collection is undergoing classification.

### RING FORMING FUNGUS.

BY J. STAUFFER, LANCASTER, PA.

C. B. Grubb, Esq., residing on Lime street, in the city of Lancaster, inclosing an entire block, between Lime and Shippen streets, called my attention on the 23d of June, 1876, to a remarkable feature in his fine grass plot in the rear of his mansion. This was a well marked ring from six to ten inches wide, as if drawn by a radius of five feet from a common centre. The blades of grass within the ring seemed fresher and more luxuriant than those on the outside of the ring. On inspection the ring itself was found to be the result of an incrustation on the slender blades of grass chiefly from their centre to the tips; under the lens they seemed like a conglomeration of globular, ovoid or kidney-shaped bodies, of a purplish-gray color, slightly roughened, serrile; some were ruptured at the apex, and revealed minute bodies like sporules. As a whole, they appeared much like the sori or fruit dots on fern leaves—the sporangia, the membrane like an indusium—evidently, however, a parasitic fungus, analagous to the puff-balls. The diversified modifications of this parasite completely baffles my endeavors to reconcile it with fungoids—known in the production of what are known as “Fairy Rings.” Allow me to quote from a dictionary of science, literature and art (Brande and Cox) on this subject:—“The green circles or parts of circles sometimes seen in pastures. They are produced by a certain fungi, chiefly species of *Agaricus*, in this way: a patch of spawn spreads in every direction, and produces at its edge a crop of its particular fungus; the spawn exhausts the inner portion of soil, so that the spawn there dies, but the crop of fungi meanwhile perishes, and supplies a rich manure to the grass, which in consequence becomes of a vivid green. The spawn progresses outwards, and the process of exhaustion and renewal goes on, so that the ring increases in diameter year after year, till it is sometimes several yards across.”

*Agaricus oreades*, *gambosus* and *arvensis*, are some of the principal species which give rise to

these mysterious looking rings. I have met with rings formed in the soil in manner here referred to. But the term *Agaricus* is very vague. The *A. gambosus* is now the  $\frac{1}{2}$ *Tricholoma* of *Fries*. *A. oreades* to  $\frac{1}{2}$ *Galarhæus*. These are all stiped and regular mushroom-like fungi. Another authority states that the *Lycoperdon bovista* is known to cause such a ring. The *L. pratense* is a smaller species, it is said. These are roundish tuber-like plants when ripe, exploding and emitting the sporules in the form of smoke, whence country people call the species puff-balls. The genus *Leangium* are small, wart-like plants resembling a minute *Lycoperdon*. The *L. Trevelyani* are scattered, of a pale brown, and found on the leaves of mosses. *Sporangium* sessile, *peridium* splitting into many regular reflexed segments; *columnella* very minute; sporules pedicellate. This latter accords more closely than any other of this extensive class or tribe of fungi.

Fungi are divided. 1st—into two great sections those that have simply the terminal joint or joints of the component threads or cells, altered in form from those which precede them, and at length falling off and reproducing the plant, in which case they are called *spores*. In the other they are formed from the contents of certain sacs or asci, and are usually definite in number, in which case they are called *sporidia*. Both *spores* and *sporidia* may be multicellular, and in germination give rise to as many threads of spawn as there are cells. They are again ranged in six principal divisions, variously regarded as natural orders or tribes, namely:—*Hymenomyces*, of which mushrooms and sap-balls are well known examples; *Gasteromyces*, represented by the puff-balls; *Coniomyces*, of which the rust and bunt of corn afford ready instances; *Hyphomyces*, to which belong the naked-seeded moulds; *Ascomyces*, of which morels and insect *Sphaciæ* are examples; and *Physomyces* represents the common bread mould.

It seems desirable to become better acquainted with those causes of blight, mildew, rust and brand, and those that induce the dry rot, &c.

Berkeley's Introduction to Cryptogamic Botany and outlines of British Fungology, is an excellent work, but we need an American work as well—but alas! we find nothing systematic, that I know of.

My co-worker, Prof. S. S. Rathvon, of this city, found a fungus which in one night grew around the stem of a geranium (*Pelargonum*) about two inches from the ground; externally, mealy of a

cream yellow color; inside, spongy and black; the centre, dull rose or brick color, and slimy; the globular mass about two inches in diameter. This was on the night of June 21st, 1876. This evidently belongs to Class II., *Pyrenomyces*, Div. 1, *Sphariacei*, in the second tribe of *Gasteromyces*. My readers will excuse these hard names—I did not name them—but thus these plants are classified into separate classes and sections grouped together; and yet, there seems to be such a diversity of forms in the same plants that, viewed at different periods, they are as readily referred to one genus and then to another; and yet it is well to have some general knowledge of these insidious plants.

*Trietelia laxa* belongs to the natural order of Liliaceæ, the famous lily family. In shape it resembles the *Agapanthus* or *Lilium longiflorum*, being trumpet shaped; the flowers are from two to four inches in length, and, at the mouth, from one to two inches in diameter. They are borne in clusters at the end of the stem, there are from ten to fifty flowers in each stem, according to size of bulb. I have often picked ones with twenty to thirty flowers, all in bloom at once, and with as many buds. The bulb is rather small to bear such large flowers, but every one knows that nearly all our finest flowers come from very fine seed. The bulb is found from five to six inches below the surface.

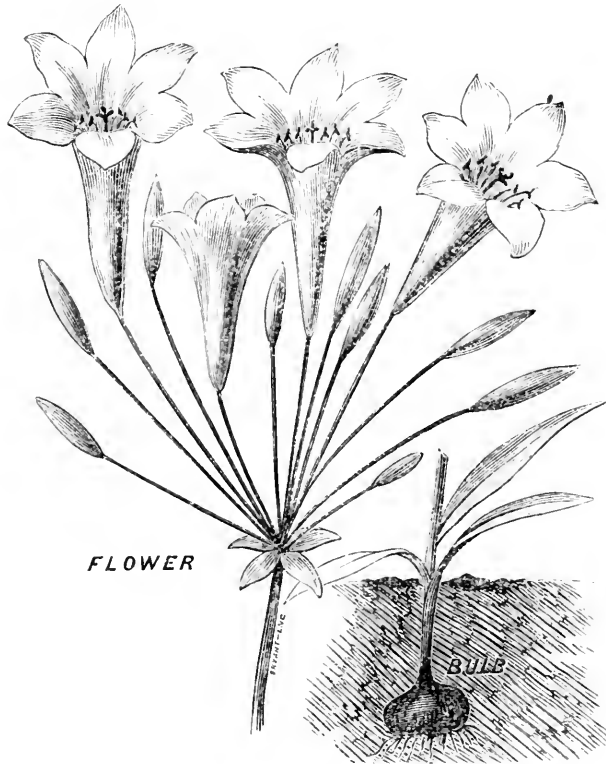

### TRIETELIA LAXA.

BY W. C. L. DREW.

That there are found in California many gems of the first water in the floral line, is no new information to the thousands of readers of the *Gardener's Monthly*, therefore I will proceed, without comment on this point, to describe one of the very finest of them, and whose name heads these lines.

The leaves are few in number, generally two; are very narrow, about one-half inch wide, and are from one to one and a half feet long; they are of a dark green color and of a drooping habit, often lying flat on the ground.

The stem is long, small in circumference, generally about one-sixteenth inch only in diameter; very rigid and brittle, being easily broken over, but hard to separate; is generally as straight as a

line, and is without any leaves in its whole length; it grows from sixteen inches to two feet in height.

The flowers are of various shades of blue, varying from pure Victoria blue to deep purplish blue. They are slightly fragrant and altogether magnificent.

#### CULTURE.

The *Trietelia lara* improves wonderfully by cultivation. The bulb should be planted in the fall of the year, about October; it should be planted in good, rich soil, which should be in good condition, for, although they will do well in any situation, a little favor makes them wonderful. Set the bulb from four to five inches deep, never less. Never water them, only what nature gives them. Plant in as dry a place as possible.

### ECCENTRICITY IN WOOD GROWTH.

BY MR. T. S. GOLD,

SECRETARY OF THE CONNECTICUT STATE BOARD OF AGRICULTURE, WEST CORNWALL, CONN.

I notice in the *Gardener's Monthly* the subject of eccentricity in wood growth. I have had two remarkable illustrations on my grounds.

A choke cherry sprang from seed in front of my piazza, close to it, and could only be moved by the winds laterally. The section of the trunk was elliptical, the longer diameter being nearly double the shorter. Since the tree has grown above the roof of the piazza the trunk is becoming less elliptical.

A young plum tree standing close by the side of an out building was killed by mice, and the sprouts were allowed to grow. These were all elliptical like the cherry, and made most wood on the two sides. It appeared to me that the trees made wood where it was most needed, on the sides where the strain of the wind came.

Sometimes the eccentricity is produced by large branches or large roots on one side of the stem, and in other cases these seem to have little influence.

[In connection with Mr. Gold's interesting observations it may be noted, that the celebrated horticulturist, Thomas Andrew Knight, believed that the winds often had an influence in the way suggested here. In regard to the influence of large branches or roots in particular cases, the red cedar affords familiar illustrations.—Editor G. M.]

### EDITORIAL NOTES.

SEEDING OF THE TRAILING ARBUTUS.—The Boston *Cultivator* says: "What we would like to learn from our readers in the sections of New England where it abounds, is, does it fruit? Who will send specimens to Prof. Asa Gray, of Harvard University, Cambridge, Mass., as he desires? In collecting and preserving fruiting specimens, care should be taken not to detach the style. Prof. Gray is studying the heteromorphic condition of this plant. Whoever will help Prof. Gray to settle what is supposed to be abnormal will aid in advancing botanical science.

MITE PARASITES OF THE COLORADO POTATO-BEETLE.—Prof. Riley exhibited a specimen of *Doryphora 10-lineata*, that was so completely covered with a mite parasite belonging to the *Gamasida*, and apparently the *Gamasus coleopterorum* that the point of a needle could not be placed on any part of the beetle's body without touching one of the parasites. He estimated that there were over eight hundred of the mites, and they had killed their victim. Aside from the toad and other reptiles, the crow, rose-breasted grosbeak and domestic fowls among birds, which prey on the potato pest, he had, in his Reports, figured or described no less than twenty-three insect enemies that attack and kill it. Only one of these is a true parasite, and the mite exhibited made the second, or just two dozen insect enemies in all.—Proceedings of the St. Louis Academy of Science, June 19th.

THE BERMUDA GRASS.—This grass, which was brought to our attention by Col. Hillyard, of Mississippi, as one of the most valuable of all introductions for that State, is also attracting much attention in Australia, as we find by the following notice from Dr. W. R. Guilfoyle in his annual report of the Melbourne Botanical Garden:

"The Donb Grass (*Cynodon dactylon*), often erroneously called 'Doob,' is a native of Bermuda, and in my opinion ranks next to Buffalo Grass (*Stenotaphrum glabrum*) as a hardy pasture grass for arid climes, though as a lawn grass it is inferior, presenting in the winter a brown and rusty appearance. I can state from experience, however, in New South Wales and Queensland, that where it has been introduced round a station hut horses and cattle, when left to feed as they chose,

have collected round it eagerly, refusing the native grasses in luxuriant growth near them, so long as a blade of Doub grass remained. As to the nutriment contained in these two grasses there can be no doubt, as many squatters across the Murray could testify. Respecting their durability the same may be said, as during seasons of excessive drought, when scarcely a blade of them could be seen, so tenacious of life were they, that when the weather broke they sprang up in rich luxuriance, and when native grasses were totally destroyed by the drought these two species were the only ones that withstood it."

---

### QUERIES.

---

**FREEZING OF THE SAP OF PLANTS.**—W. B. says: "I would like to take the Editor of the *Gardener's Monthly* out in Massachusetts when the mercury indicates 20° below zero, and help cut down some trees frozen so as to be brittle." [Our correspondents forget what has been said of this subject in our past pages. We have seen plenty of frozen wood, without going to Massachusetts to find it. There is no reason that we know of why liquid that has not been prepared for plant life should not freeze. Trees in these parts often freeze so that they split by frost. But this is from the moisture in the *dead wood*. What is called heart wood in plants can absorb moisture. In winter there is not much in this wood; sometimes there is, and if it freezes, it expands. In most trees the living cells are those in the few

outer woody circles. It is these living cells which prepare their peculiar material, the leaves at certain seasons assisting, and it is these living cells that do not freeze; or, when they do freeze, they die.—Ed. G. M.]

**POPULUS CANESCENS, AIT.**—E. P., Delaware County, Pa.—"I enclose leaves of a species of *Populus* which is planted in Philadelphia a good deal, to ask if thee would name it for me through the columns of the *Gardener's Monthly*. I have none of the aments, but they (the staminate) are very similar to those of *P. alba*, appearing a couple of days before them, stamens about twelve, scales lacerate-fringed. The leaf-buds are not viscid, and the leaves, later in the season, become smooth on both sides. The bark is similar to that of *P. alba*, but rather more yellowish than that. I have puzzled over this a good deal, and concluded that it must be a variety of *P. alba*; but at the Centennial the other day, in the Swedish school-house, I saw dried specimens of *P. tremula* which resemble this considerably; but I think young leaves were present with the catkins, which is not the case with this."

[*Populus canescens*. It is not uncommon as a street tree in Philadelphia, but is a worse sucker than *P. alba*.—Ed. G. M.]

**WESTERN TANNIN PLANT.**—N. N., Louisville, Ky., says: "Can you give us any information of the so-called Western Tannin Plant, and whether the same is in practical use in this country?"

[The plant is *Polygonum amphibium*, abounding in the East as well as the West. Our opinion, from all we can learn, is that it is a fair substitute where bark is scarce; but we cannot learn that much is being done with it.—Ed. G. M.]

---

## LITERATURE, TRAVELS & PERSONAL NOTES.

---

### COMMUNICATIONS.

#### NOTES UPON THE GROUNDS OF SMITH & POWELL, SYRACUSE, N. Y.

BY F. R. ELLIOTT.

Recently, in the absence of other occupation, I visited the nursery grounds of the Messrs. Smith & Powell, at Syracuse, N. Y. They have

in real estate about 1,240 acres, of which say 540 are used as nursery grounds. Ere I write more of the trees, &c., that I saw in the grounds, I shall speak of Mr. Wm. Brown Smith's labors. As near as I can learn, without too pertinacious and impudent questions, it is something over 30 years since he joined Mr. Thorp, who had established a nursery on four acres of ground, issued a hand-bill catalogue of trees for sale, &c. Time has

passed, and this energetic, industrious man has also passed through trials and tribulations which so many experience. Thanks to the Great Giver of all good, Mr. Smith has now a son-in-law as partner, and from four acres his nursery has grown to over five hundred, most admirably filled with a collection of all the best varieties of trees and shrubs, arranged in a most systematic manner, and grown healthy and stocky. His residence is in the city limits, but most of the nursery and farm proper is outside thereof. Mr. Powell, now his son-in-law, and partner in business, we found a gentleman of intelligence, industry and perseverance. His leading fancy, however, is the improvement of stock—as neat cattle, horses, &c.—and so by his fancy the firm are working up ground that it embraces in different localities somewhere near 1,250 acres.

As it may interest some of the readers of the *Gardener's Monthly*, we will say that the landed property of Smith & Powell embraces one tract of 120 acres, one of 16 acres, one of 50, one of 53, one of 700, one of 100, one of 18, &c., acres. These have the lands best suited to a healthy growth of trees, and are given specially to them, the balance being used for pasture or farm purposes. Upon the old homestead, as it were (16 acres), are not only the residence, but many good things in the way of ornamental trees. There is a Kentucky coffee tree 50 feet high, and 20 feet broad in its branches; also a *Magnolia tripetala* of a rounded form in branches of 20 feet each way. This concern has given special attention to trees for street or ornamental planting, and the show of maples, elms, &c., is too great to write of. Of fruit trees, a great variety and of all ages are in blocks on land suited to their healthy vigor, and all are treated so that the buyer can have a stocky tree with low branches if he so desires. Passing along we noted Louis Phillippe cherry, a variety which the writer imported from Le Roy in 1854, and which has no equal as a preserving fruit. Again as I passed a stake labelled "*Elliott's Favorite*," Mr. Smith said, that of all the sweet cherries this was the *best* in flavor and quality. I found many new features of value in the management of this concern, and of them I will first mention the practice they have of taking up, the varieties of fruit trees, and re-planting them in blocks, so that any one, needing an orchard at once, can take these trees, plant them with their fibrous roots, and the following year obtain fruit.

Next, I noticed among evergreens that every

other row was of a more stocky and compact nature than its associate. I asked the how and why? The answer: We root-prune them by the use of an underground plow, which with a horse attached on each side cuts under the tree and at the same time cuts the side roots without in the least disturbing the tree, yet it at once forms new fibrous roots, and when removed a hedge of four feet high can be made as perfect as if it had been planted at one foot high and yearly trimmed. While we note this, we must not forget to say that this concern keeps up a full stock of all the best evergreens and other ornamental trees of all sizes. Neither should we neglect to tell the readers of the *Monthly* that we found the true *Corsican* pine in these grounds. Those who know of the Corsican know that among the long-leaved pines it is one of the best. It is between Austrian and Scotch, compact, hardy and beautiful as a specimen tree, or as a hedge. Ere I leave my readers let me say that I saw a mile of Honey Locust hedge that four years since was started with two-year-old seedling plants from the grounds of Smith & Powell, and that was now four feet high, and so thick and perfect that not a bird or animal could pass through it. Again I must note the fact that S. & P. make plantation belts of evergreens to check the forces of winter winds, and in the making they have alternated the black American Spruce with the Norway, and its silvery, glossy foliage contrasts most beautifully as well as gracefully. Passing over the grounds we noted seedlings of varieties of trees, located as our own as well as their judgment told that the soil was suited to their healthy growth. We asked if they should use all. The reply was, we expect to do so, but while we make no pretension to grow stocks for sale, we are ready to sell to an honest and reliable man who desires to grow trees healthy and true to name. To close these random remarks, let me say that every person who visits Syracuse, N. Y., should go over Smith & Powell's nursery and farm grounds.

[Since this letter was in type, we believe we have seen it in another publication. It ought therefore to be credited to the publication in which it first appeared. We have therefore to say to our co-temporary that it was received by us supposing it to be original. We have to make this explanation as we would not have the *Gardener's Monthly* even suspected of using the property of its neighbors without proper credit. We are glad, however, to insert the article, for

we know of no firm in the Union whose efforts deserve more praise than the firm of Smith & Powell.—Ed. G. M.]

### OBSERVATIONS IN NORTHERN TEXAS.

BY H. E. VAN DEMAN, GENEVA, KAN.

Owing to the call of business, I have been spending the greater part of the past two months (May and June, 1876) in the northern counties of Texas. It is possible that a short sketch of the horticulture of this region as it appeared to a Kansan may be somewhat interesting to the readers of the *Monthly*. The soil is principally of two classes called "black land" and "sandy land." The *black land* is a composition of the richest alluvium, and lies in hills partly prairie and partly timbered. Since the wild fires have been checked by settlements, the timber growth is greatly increasing and will soon obliterate many of the smaller prairies. This *black land* is the natural home of the Osage orange or Bois d'Arc, pronounced *Bo-dark* by the natives. This tree furnishes the most durable wood that I have seen. Even the oldest trees lying dead in the forest are not decayed. The elements slowly wear away the particles of wood, but there are no signs of rot as in most kinds of timber. Fence rails made 30 years ago show no signs of even rotten splinters. Another species of elm called there the *Cork Elm* grows on both black and sandy lands, and extends north quite half-way through the Indian Territory. The leaves are only one to one-and-a-half inches long, and of the usual shape of the other elms. This foliage is very neat, and with the graceful weeping habit of the branches makes a charming ornament. There are two narrow ridges of corky bark  $\frac{1}{4}$ -inch high, opposite each other on the two-year-old branches that look very odd and give it the name *Cork Elm*.

The almost exclusive timber growth of the sandy land is the Post Oak.

In no country have I seen the Pear growing with such vigor and freedom from blight, except the "grand traverse region" of Michigan. It is true that I saw slight indications of blight on both pear and apple, but in such small degree that nothing serious may be looked for. Pear trees 30 years old are sound as a silver dollar, and (although this year prevented from bearing by a spring frost) since coming into bearing have not failed to produce abundant crops of fruit. Upon the black land the apple does not seem to

flourish. The cause is not apparent to me; some say it is excess of lime in the soil. There is a great abundance of this mineral in the soil in places where the apple does poorly, but whether or not the lime hurts the tree is a puzzle to me. I might have stated before that the whole area covered with this *black land* is underlain with a sort of magnesia limestone (?) that is sawed into blocks for chimney building, &c., as easily as if it were wood. Exposure hardens it, and by heating gradually will stand in fire-places for a lifetime. Its color is gray, and in some quarries almost white. Where this rock is nearest the surface, and in decomposing fragments in the soil the apple seems to prove the most unsuitable. Some of the geologists and chemists ought to look up this matter. The farmer and fruit-grower may have very mistaken ideas of the causes of failure. Some that have tried it say that by digging large holes and putting sandy soil in them, brought from some neighboring sandy country, the apple will grow, if planted therein, although the surrounding soil be ever so black. Another character of the black soil is that it is very waxy, and when dry weather comes on, in August and later, great cracks appear that will admit of a fence rail being thrust in endwise its entire length. It is dangerous to ride a horse across the country then, they tell me. Under such circumstances, the soil dries in some cases to the depth of ten feet. And yet these same persons tell me that crops on this same soil withstand the drouth two weeks later than on the sandy land.

Although the sandy land seems far better for the apple than the other, yet the pear, peach, quince, grape and all the berries seem to do equally as well as on the former, in fact, excluding the apple and the currant, I never saw a better soil and climate for fruit-raising than the counties of Texas along the Red River.

Oh, such roses as they grow in Texas! The old-fashioned town of Bonham, in Fannin Co., has been one grand rose garden all the month of May, and the perpetuals were yet in bloom when I left, the last of June. The tender Tea roses, like Marechal Neil, glory in the balmy air, and with common treatment yield a profusion of flowers almost the whole year. The carnation thrives admirably. A gentleman there (Mr. Peters) has growing some splendid seedling carnations that would grace Horticultural Hall at the Centennial, were he able to show them there.



The delicate passion flower adorns the old fences and waste fields, and is a great pest as a weed, being hard to exterminate. Perhaps I have found a novelty; if not, I will expose my ignorance (which is real) by saying that near an old fence I found growing wild the passion flower of the purest white and much larger than the common purple species. Old citizens said they had never seen another of like character. Another beautiful flower that grows wild in abundance on the black land only, is the *Ipomopsis elegans* or standing cypress of common fame. Its brilliant scarlet spikes glow in many a grassy, weedy nook, where the sun finds ready access. Taking it all in all the people of northern Texas have a glorious country in which to grow fruit and flowers.

---

### EDITORIAL NOTES.

---

THE POSTAL LAWS AS AFFECTING HORTICULTURE.—Many of our friends were hurt that we should say the Express companies would hold their own. They now see that it is so. It was never the intention to double the rates on printed matter. It makes no difference to the Express companies what these rates are. It is the transmission of merchandise which hurts them. It was a bad blunder of Mr. Hamlin's to include printed matter. It raised the whole newspaper press, and so they have been only too glad to have it repealed. Merchandise, seeds, cuttings, and things of that class, are now just as the express companies desired, and we suppose it will thus remain; and we must submit to the rule of these corporations with as much grace as we can.

We are not of those who think governments should carry on a postal service wholly irrespective of profit or loss. It seems to us that a wise statesmanship should manage the post-office so that on the whole it should be self-supporting, or if with a deficit, yet with some prospects of an early self-sustenance. It is, therefore, a perfectly fair question as to whether this merchandise pays, or is likely to pay. We presume it does pay, and did at the old rates. At any rate that should have been considered well before the attempt was made, and thousands of firms had adapted themselves to the new circumstances. If it was not statesmanship to enter on so great a charge without fair facts or figures, or laws of

sound political economy, it was still less to take a backward step, and especially in so sudden a way. The bare idea of statesmanship in connection with it is laughable. It is not statesmanship, it is robbery!

FLOWER THIEVES.—A thief in Jersey City did not read the papers. He did not steal the flowers direct from the plants, but he stole them from a messenger who was taking them to a customer. He is to stay two years in jail. Serves him right. He should have studied the laws a little more. It shows, however, that flower thieving is a risky business unless intelligently pursued.

PHYSALIS EDULIS.—Of this the *Gardener's Chronicle* says:

"*Physalis edulis* is receiving the attention it deserves from some French horticulturists, and M. de St. Quentin, writing in the *Bulletin de la Société d'Acclimatation*, declares the fruit to be superior to the best flavored tomatoes. With us it is still very little grown, and usually more as a novelty than for the sake of its crop of fruit, but doubtless it will sooner or later come into favor in this country, just as the tomato has done. Within the last ten or fifteen years the demand for tomatoes in England has increased to an enormous extent, though few persons like them on the first trial; but after the taste for them is once acquired nothing is more palatable. The same remark applies to the beet-root, which is now rapidly superseding the less wholesome and more expensive indigestible pickles."

THE LEMON VERBENA.—Very few of our readers, we suppose, ever fancied there were medicinal virtues in the Lemon Verbena, but this is what the London *Gardener's Chronicle* says:

"The Lemon plant, or sweet-scented Verbena of our English gardens (*Aloysia citriodora*), holds a foremost place among Spanish herbs. Every leaf of it is treasured and dried for winter use, and it is regarded as the finest cordial and stomachic in the world. It is taken in two ways—either made into a decoction with hot water and sugar, and drank cold as a *refresco* and tonic; or, better still, with the morning and evening cup of tea. 'Put a sprig of Lemon Verbena, say five or six leaves, into the teacup, and pour the tea upon it; you will never suffer from flatulence, never be made nervous and old-maidish, never have cholera, diarrhoea, or loss of appetite. Besides, the flavor is simply delicious; no one who has once taken his Pekoe with

a sprig of Lemon Verbena will ever again drink it without.' ”

**VISITORS TO KEW GARDENS.**—On August 2nd, 1875, 61,133 persons visited Kew gardens. It was the highest number for any day in the year. Gardening must be popular to attract such crowds in England.

**LANDSCAPE GARDENING.**—Mr. F. R. Elliott is engaged on a hand-book, similar in character to his recent hand-book for fruit growers.

**EXCHANGES OF SEEDS AND PLANTS.**—Amateurs often have seeds and plants of their own raising that they would like to exchange with others similarly situated. Organizations for this purpose materially assist the idea. A valued correspondent, Mr. Theo. Shuster, of Brooklyn, tells us that there is one in Ohio in very successful operation.

**COLORED PLATES.**—Mr. John Saul sends us a colored plate of the Duchess of Edinburgh Rose, of which we recently gave a wood-cut in our pages, and Mr. A. Rolker & Sons, of New York, one of Rose, Duchesse de Vallambrosa. This is a salmon color shading to a blush, and if the flower comes out in this country just as represented here, is rather novel in tint. It appears to be a Hybrid Perpetual.

**THE FLORIST AND POMOLOGIST.**—Edited by Mr. Moore, and published at the office of the London *Journal of Horticulture*, has a beautiful colored plate of our Hale's Early Peach; a variety first brought to notice in our columns, and

which seems to have given a good account of itself in Europe. There is also a similar kind figured under the name of Early Victoria. It has also a colored plate of a buff rhododendron, Prince Leopold. It is one of Vietch's hybrids. The magazine always has excellent colored plates of fruits and flowers, and is remarkably cheap at 12 shillings a year.

## QUERIES.

**CORRECTIONS IN THE ARTICLE ON CURVES.**—Mr. Olmsted writes: "In the article entitled 'Curves,' in the August number of the *Gardener's Monthly*, some errors have crept in which, if corrected, would make my meaning more evident. Page 228, 1st column, for 'suspended the former style,' read 'superseded,' &c.; for 'hardly admirable' read 'hardly admissible'; for 'practical eye' read 'practiced eye.' On page 229, 1st column, second paragraph, for 'when most convenient' read 'where most convenient.' Same column, last paragraph, for A B=80, B C=120, &c., read A B=80, B C=120, &c. And in second column, for  $a=22.4-16=1.4$  feet, read  $a=22.4$  divided by  $16=1.4$  feet.

"In my quotation from Ruskin in the article entitled 'Curves,' in the August number of the *Monthly*, I am made to say 'there is no more flatness in the natural world than there is in vacancy.' What I meant to quote, and what Ruskin wrote, is 'there is no more flatness in the natural world than there is vacancy.'"

# HORTICULTURAL SOCIETIES.

## COMMUNICATIONS.

### MASSACHUSETTS HORTICULTURAL SOCIETY.

BY B.

The exhibitions held on each Saturday in January have been very interesting, as all the impromptu exhibitions are, owing partly to the discussions which take place at the same time. The subject of the first discussion, January 10th,

was the Native Grape, the essayist being W. N. Barnett, of West Haven, Ct. The discussion was continued the following Saturday, and was long and animated. On the 22d of January E. S. Rand, Jr. made some interesting remarks on the orchids exhibited by him. January 29th W. H. Halliday read a paper on the growing of plants in Wardian cases, and that subject and the forcing of lilacs was discussed by various members of the Society. The principal plants

exhibited have been the Orchids of E. S. Rand, Jr., who has shown the following fine varieties: *Cypripedium insigne*, an old well-known species, with thirty flowers. *C. Harrisianum*, a fine hybrid variety, with five flowers. *Calanthe vestita rubra*, with four very fine spikes of flowers, a very striking variety. *Cattleya pumila*, on a block of wood, a charming species from Brazil which remains some time in bloom. *Cirrhopetalum Medusa*, a remarkable orchid, of which Williams, in his manual, says, "The flowers, though not large, are very numerous, and part of the sepals are very much lengthened, so that the spike looks like a head with long hair hanging down, from whence its name has been derived; it is a dwarf growing plant, with thick fleshy leaves." *Laelia anceps*, a superb plant, with five fine spikes of bloom; this is one of the best of orchids, it lasts a month or more in perfection if kept cool. *Saccolabium giganteum*, a very beautiful species, deliciously fragrant, and also very valuable on account of keeping in bloom a long time. This plant was in splendid order; it had been in bloom six weeks, and the flowers were apparently as fresh as when they were first expanded. *Cattleya amethystoglossa*, this is also a beautiful species, and as yet somewhat scarce; the flowers are very rich colored and attractive, and the specimen is the first exhibited. Mr. Rand has also shown very fine sprays of *Thunbergia Harrisii* and *laurifolia*, well-known stove climbers; also *Aphelandra fascinator*, recently sent out by Messrs. Veitch; the flowers are very bright and showy, and seed as freely as a morning glory. James Comley has exhibited a new *Amaryllis*, *Hendersonii*, the beautiful *Lapageria alba*, *Dendrobium nobile*, *Dracena metallica* (new), *Lycaste Skinnerii*, very fine specimens of lily of the valley in boxes; *Cymbidium aloifolium*, an old but choice species. C. M. Atkinson—Neapolitan and Maria Louise violets, good specimens, grown in pots. Although in color Maria Louise is the finest and best, the florists here say that it does not pay as well at \$1 a hundred as Neapolitan at 50 cents. Cut flowers arranged in stands, dishes, and vases have also formed quite a feature of the exhibitions.

In fruits, a very fine display of winter pears was made by J. H. Fenno, who received prizes for Beurre Langelier, Easter Beurre, and Josephine de Malines. The first prize for Winter Nelis was given to J. L. Bird, and the second to J. H. Fenno, for Uvedales St. Germain; and the second prize to C. E. Grant for Catillac. Charles

Bird exhibited an extra fine dish of Beurre d'Anjou. James Comley has shown some very fine forced rhubarb; the variety was Prince of Wales, and it was grown in a mushroom house.

The Society has appropriated for the present year \$6,800 for premiums, divided as follows: For plants and flowers, \$3,200; for fruits, \$2,100; for vegetables, \$1,200; for gardens and green-houses, \$300.

---

### EDITORIAL NOTES.

---

HORTICULTURE AT THE CENTENNIAL.—Notwithstanding the terrific heat of July, this first week in August finds the floral department of the Centennial Bureau of Horticulture a blaze of glory, and receiving applause from all quarters. Our remarks of last month, calling attention to the fact that this is mainly the work of exhibitors, have been appreciated, and both the press and the public have been led to notice what the florists and nurserymen are doing, in a way gratifying to both. The *Public Ledger* of Philadelphia at once had a very full notice of the exhibits in the department, and it is to be hoped that our rural papers, which above all we should expect to do justice to such affairs, will have once in a while a little to say about it, as well as of the striking features in French ribbons, or the novelties in a Japanese parasol. To-day we make a few notes on the floral features, aiming chiefly to give such information about them as will interest those engaged in flower gardening, whether they get the chance to visit the exhibition or not.

In the laying out of the grounds for exhibition purposes there were some plots not taken up, and these the Centennial Commission has had to fill up themselves. All this has been arranged under the direction of Mr. C. H. Miller, the Chief of the Bureau, and makes one of the most beautiful floral features ever seen. Usually the forms of flower beds amount to nothing. Their real outlines can be seen on a piece of paper, but not on the grounds. A circle, or a parallelogram with rounded ends, is nearly as good as anything else when seen sideways, but here the beds can be looked down on from considerable elevations, and the harmonies of color and form be seen and appreciated. The beds are planted on the massing and ribbon styles, and the greatest success is that not one single variety has

failed—and this failure often steps in to spoil a gardener's efforts in this climate. The principal plants employed by Mr. Miller in producing his effects we note to be *Geranium Lucius* and General Grant, *Coleus Verschaffeltii*, *Irisene Herbsti*, *Glaucium corniculatum*, *Artemisia stellaris*, *Cineraria maritima*, *Centaurea gymnocarpa*, *C. candida*, *Pyrethrum aureum*, *Vinca major*, Petunias, Variegated Arundo and Cannas. The various varieties of dwarf Achyranthus also enter largely into the work.

Mr. Thomas J. McKenzie, of Philadelphia, has a circular bed with four small semi-circular projections. The style of this bed is remarkably well adapted to effective results. The wings are set with Scarlet Salvias and other fall flowering plants, so that full effects aimed at will not be seen till next month.

Messrs. A. Hance & Son, of Red Bank, aimed to make a star out of Geraniums in a circular bed, using white variegated leaved kinds for the ground color, and different kinds of colors for the limbs of the star, but the heat kept some varieties from doing well, and interfered with complete success.

Peter Henderson, of New York, makes some admirable floral displays; exhibiting one hundred different varieties in one bed, all named. We were about to make a note of those which seemed to stand the sun best, but we noted that in some corner, or in some one part, all the varieties did well, and in other places all did poorly. It is clear, therefore, that it is not wholly the sun which causes some varieties to do well or ill; but in addition, there is something in the irregularity or regularity of manure, or some other little thing which, when known, may make success out of almost any kind. One of Mr. H.'s beds is a large circle with the plants arranged in the following order:—Centre, dark leaved Cannas, then var. *Arundo*, *Caladium esculentum*, *Coleus Verschaffeltii*, Golden Coleus of some kind, apparently Queen Victoria, *Irisene Herbsti*, *Cineraria maritima*, and finally near the grass, *Alternanthera versicolor*. This was a very effective combination, and would have been better if *Glaucium* had been used for the *Cineraria*, which was too weak for a heavy circle.

C. H. Wilson, of Montgomery Co., Pa., has a circle with the following combination:—Centre, of Cannas; next, of scarlet Geraniums; then of Coleus Queen Victoria; then silver Artemisia, and finally a ring of *Alternanthera versicolor*. For such a combination very large plants of scarlet

Geraniums should be used. Here they are much too small. The other plants outgrow them.

Mr. Robert Scott, of Philadelphia, has a magnificent rectangular bed of General Grant Geranium, and another of Tea Roses. These were blooming charmingly, and show that with a proper selection of kinds for massing, a regular *parterre* of Tea Roses would be one of the most charming scenes in summer decorative gardening.

Mr. W. F. Boyle, of Philadelphia, has a very pretty circular bed. The centre is *Irisene aurca reticulata*; then *Coleus Bausei*; next *C. Verschaffeltii*, *Centaurea gymnocarpa*, *Irisene Herbsti*, *Centaurea ragusina*, and finally *Alternanthera amœna*. All these seemed to come up well in their order as intended. He also has an attempt at a star of Coleus, and somewhat successful. The head and tails are of *Coleus Verschaffeltii*, while the tails or points are shaded off by varieties of a lighter color.

Mr. W. C. Wilson, of Astoria, has an irregular bed, but the plants arranged in belts and ribands regular and irregular. The general effect is very fair. There are many plants here not in general use, but would come in well in places. There is a pretty *Gaura*, perhaps *G. Lindheimeri*, a *chamæpene*, a narrow-leaved silver *Gnaphalium*, the *Santolina incana* and some nice Petunias.

Gibson & Bennett, of Woodbury, N. J., in a very pretty circle, make good use of dark Verbenas inside a circle of Golden Feverfew. We never saw anything set Verbenas off better.

Mr. Zeller's Perpetual Carnations, suffered fearfully from the heat.

Mr. John Dick, of Philadelphia, makes a very large display, and is chiefly interesting for the great amount of information one may glean from it, as to the rarer plants that may be used to advantage in summer gardening, but are not often seen. Here, doing remarkably well after this dry and hot season, we noted *Festuca glauca*, *Euonymus radicans variegata*, *Abutilon vexillarum variegatum*, *Alternanthera* of many varieties, *Muhlenbeckia platyclada*, *Salvia coccinea*, *Talinum patens variegatum*, *Plumbago capensis*, and a very dwarf *Eupatorium colæstinum*. The effects, too, of his beds of Echeverias, Aloes, and succulents generally, in comparison with other flowering plants, are beautiful in the extreme.

Mr. Siebrecht, of New York, has a specimen of rock-work. It has the great disadvantage of being surrounded by highly ornate gardening, under which circumstances rock-work never

looks well. The critics as they come on generally want to know what that pile of building stone does to improve the landscape, forgetting, as we have said before, that this piece of land is for special exhibits, and not to show off a grand illustration of perfect landscape gardening. It is indeed astonishing that so very little to offend critical taste in landscape gardening occurs in the management of so many special exhibitors' tastes, and the result speaks highly for the talent which secured so much unity. Mr. Seibrecht's rock-work is a very good piece of mechanism, and when in that part of a garden landscape where rock-work tells well, would have a good effect.

Mr. Geo. Such has a collection of plants illustrative of tropical gardening, a branch too much neglected with us where our hot summers suit these plants so well. Here are rare Palms, Iago, Bananas, Agaves, and other things, all in absolute perfection.

The Pacific Guano Company have a very large exhibit of plants, large numbers very rare and valuable. They have not been planted with any view to make gardenesque effects, but rather to show the results of the article they deal in. But still the many luxuriant blooming plants make the exhibition grounds in that part very attractive.

Mr. A. Felton and Mr. Maginly, of Philadelphia, and Mahlon Moon & Son, of Morrisville, have beds of various articles which attract visitors.

Mr. H. A. Dreer has *Gladiolus*, *Verbenas*, *Petunias*, and other standard plants for which this firm has long been celebrated; and Mr. W. K. Harris, the *Geranium* raiser, has a bed of his most approved seedlings.

Mr. Thos. Robertson, of Philadelphia, makes a very good exhibition of many varieties of *Coleus*.

The German and French exhibitors make very fine shows in their several departments. The *Gladiolus* of Eugene Verdier, of Paris, was undoubtedly the finest thing of the kind ever seen in this country; and the *Roses* of M. Soutert and Notting, of Luxembourg, elicited high praise. Charles Verdier also shared his brother's honors in the *Gladiolus* line.

Krelage, of Harlem, Holland, contributed many beautiful collections of bulbs, and amongst other things shamed Americans by sending back for exhibition here a very large bed of *Asclepias tuberosa*. Thousands who saw it no doubt suppose it is from China or Japan, or some other

far-away place, and no doubt orders will flow to Holland for the roots. Mr. Krelage deserves all the orders he will get.

Mr. Lachaume, of Havana, carries off all the honors for *Agaves*, *Succulents*, &c., but these we have already noted.

The amount of space devoted to the out-door horticultural department is about 40 acres; the amount of space available for exhibitors, exclusive of walks, borders, buildings, and reserve space for ornamental gardening, is a little over eight acres, or 282,673 square feet. The amount of space occupied by American exhibitors is 239,173 square feet; by foreign exhibitors, 43,500 square feet. Of these England occupies 8,000; Spain, 8,500; France, 15,000; the Netherlands, 6,700; Germany, 4,500, and Austria, 800 square feet. There are 56 exhibitors in the American section (not including those in-doors), and 27 in the foreign section. The number of plants or other objects exhibited in the American section is 59,500, and in the foreign section, 10,233, divided as follows: England, 1,801; Spain, 2,088; France, 4,164; The Netherlands, 1,000; Germany, 1,200, and Austria, 80.

#### NEW YORK HORTICULTURAL ASSOCIATION.—

This Society seems entering on a successful career. The last exhibition is reported as having been well attended. Among the exhibitors were W. L. Fisher, John Thornhill, Isaac Buchanan, S. B. Parsons & Sons, James Riddle, Charles Zeller, Henry Bird, Wm. Ball, Peter Henderson, Ekirsh & Wilson, A. M. Connell, F. Gordon, Walter Reid, S. Henshaw, Robert Casey and W. Walsh. The only item of general interest that we can gather from the newspaper report before us, is that the premium for the best strawberry of any kind was awarded to Wm. Burgess, for *La Constante*.

**THE NURSERYMEN AND TREE GROWERS.**—The regular semi-annual meeting of the Nurserymen's and Tree Planters' Association of Chicago and vicinity was held July 11th in the office of the *Western Farm Journal*, at Chicago. The President, Mr. Jonathan Periam, occupied the chair.

The association indulged in a long discussion regarding fruit and fruit prospects, the conclusion of which was that in general the fruit crop promises to be good.

A resolution was adopted that the association exhibit as an organization, and that there be a

conference with the managers of the Inter-State exhibition with a view to having a series of monthly exhibitions with them. It was also voted that the association exhibit as an organization with the American Pomological Society in Philadelphia, at the Centennial Exhibition, at which space for fifty plates has been secured. The exhibition will be from the 10th to the 15th of September.

The nurserymen present signified their intention to exhibit at the Inter-State exhibition, if suitable arrangements could be made.

PHILADELPHIA, August 4th, 1876.

HON. A. T. GOSHORN, Director General U. S. Centennial Commission.

Sir:—The Judges on Pomological products beg respectfully to report that during the past week the following articles have been added to the Exhibition:

From Gibson & Bennett, of Woodbury, N. J., a large number of plates of early apples, including 13 varieties, but as a collection of early maturing kinds, the exhibition is instructive and commendable. The varieties are Sweet Bough, Bevan's Early, Summer Queen, Tatem's Early Red, Strawberry, Red Astrachan, Red Juneating, Starr, Primate, Gardiner, Gravenstein, Summer Rose, and Clonmell Sweet. The same firm had a collection of pears and plums in an immediate condition.

W. Dun Rogers, of Moorestown, N. J., had a small collection of apples and pears. Of these the Red Astrachan deserves especial mention, being nine inches in circumference and perfect in form. The Early Strawberry was beautifully colored, and measured  $7\frac{1}{2}$  inches around.

Mr. Abraham Barker, of Philadelphia, Pa., pears—the Bloodgood, Dearborn's Seedling, and Beurre Giffard. The last were extra fine specimens of this variety, measuring four inches long and three inches wide, and four weighing over one pound.

Col. Mears, of Bermuda, through Mr. Outerbridge, of Philadelphia, exhibited a remarkably fine "Californian" squash, rivaling some of our largest pumpkins in size. Its weight is said to be 115 pounds.

Judges of Special Pomological Products. { W. L. SCHAFFER,  
A. W. HARRISON,  
JOSIAH HOOPES,  
THOMAS MEEHAN.

POMOLOGY AT THE CENTENNIAL.—An exhibition of Fruits will be held in the Pomological Annex to the Agricultural Building, September 11th to 16th inclusive.

Tables and dishes will be furnished by the Centennial Commission free of charge, exhibitors being only required to pay the cost of transportation.

Products, as soon as received, will be classified and arranged for exhibition.

Large fruits may be exhibited in dishes of not less than five specimens of each variety, except in the case of varieties exhibited for the first time, when three specimens will be sufficient.

Fruits that are especially perishable should be sent in excess of the number, so that the dishes may be replenished from time to time.

The displays of nurserymen, fruit growers, and societies will be considered separately.

The Judges will report upon exhibits according to their merits, having regard both to the perfection of the individual specimens and to the variety of the display in each class, and in combinations under each division. The Awards will consist of a Special Report by the Judges, and a diploma and bronze medal from the United States Centennial Commission.

Fruits will be arranged for examination by the Judges as follows:

Division 1. *a* Summer Apples. *b* Autumn Apples. *c* Winter Apples.

Division 2. *a* Summer Pears. *b* Autumn Pears. *c* Winter Pears.

Division 3. *a* Free Stone Peaches. *b* Cling Stone Peaches. *c* Apricots. *d* Nectarines. *e* Native Plums. *f* Foreign Plums.

Division 4. *a* Native Grapes. *b* Foreign Grapes.

Division 5. *a* Strawberries. *b* Raspberries. *c* Blackberries. *d* Currants. *e* Gooseberries. *f* Cranberries. *g* Water Melons. *h* Citron Melons.

Division 6. *a* Oranges.

Division 7. *a* Almonds. *b* Filberts. *c* Walnuts. *d* Shellbarks.

The right to alter or amend this circular is reserved.

A. T. GOSHORN,  
Director-General.

BURNET LANDRETH,  
Chief of Bureau of Agriculture.

PHILADELPHIA, August 15th, 1876.

THE  
GARDENER'S MONTHLY  
AND  
HORTICULTURIST.

DEVOTED TO HORTICULTURE, ARBORICULTURE AND RURAL AFFAIRS.

Edited by THOMAS MEEHAN.

VOLUME XVIII.

OCTOBER, 1876.

NUMBER 214.

FLOWER GARDEN AND PLEASURE GROUND.

SEASONABLE HINTS.

The great exhibition of flower gardening at the Centennial Grounds must have taught our people how beautifully they can adorn their grounds at a trifling expense, and, as thousands on thousands are visiting the Exhibition from all parts of the Union, the result must be favorable to our general horticultural education. There is one feature which we think must strike every visitor. The gardening that is fitting for a quiet stroll on foot should be of a very different character from that along a carriage drive. In the first case we have to keep in view that which looks well in the immediate surroundings, while the distant glimpses are of far more importance in a carriage ride. Another matter one may learn from the Centennial exhibit, is the advantages of studying appropriateness in arrangement. Much of beauty comes from the harmony of relations. As noted in our last the piece of rockwork on exhibition is very well, if it had been where a piece of rock-work ought to be, but out of place among the many artificial specimens of gardening about it. On the other hand the sunk garden shows admirably from the footwalks made along the heights above. There is, however, one feature, an accidental one, which affords us a good lesson. The space for garden work is bounded by a piece of natural

forest on one side, and the great conservatory or Horticultural Hall on the other. Next to the conservatory are the brightest flowers, and the best kept beds. The plots devoted to shrubbery come next, and then the natural woods. The beds between the shrubs and the flowers were not taken up by exhibitors, and hence had to be filled up by the Centennial Commission with something; so shrubs, evergreens, castor oil plants, petunias, and all sorts of things are mixed together, and the effect of introducing the gay flowers to the green leaved shrubbery is beautiful in the extreme. Any one who studies this little incident will have a good lesson for home gardening. Another matter is worthy of thinking about. We see here how few are the plants that can certainly be depended on for summer gardening. We have to make up our flower beds of fewer items than any other people. Half the things common in European flower-beds will not do here, yet we follow too much those plants which have European reputations. There is little doubt but we have large numbers of things that will not do in Europe, and which would suit us exactly, and this would not only add largely to our bedding plant variety, but give American gardening a special character of its own. This is especially the season to think of these things, as the stock has to be propagated through the winter, in order to have them ready when spring comes.

## COMMUNICATIONS.

## LANDSCAPE GARDENERS.

BY J. C. CHELSEA, MASS.

MR. EDITOR:—In the June number of the *Monthly* I found an article headed "Who shall lay out our Ornamental Grounds," wherein queries are put and suppositions made, many of which I submit has very little to do with the subject in hand.

Any one who appropriates to himself the name of Landscape Gardener, must be aware that he assumes a profession of no mean pretensions; and as your correspondent justly observes, many that are known to be good gardeners in the general acceptance of the term, would not pretend to class themselves with "landscape gardeners." Nevertheless, if a gardener has taken a pride in his profession, and has had an opportunity to study it in all its branches, I can see no reason why the services of an engineer should be required in locating and constructing a drive, forming a terrace, building a wall, or arranging a system of drainage.

Through a lengthened experience in conducting such work, I have uniformly done my own engineering, and in some instances on places of great extent. In my opinion no one should undertake the duties, and incur the responsibilities of the "landscape gardener," without first having a good, general knowledge of civil engineering.

Again, if we are not to apply to the gardener to make a lawn, arrange a parterre of flowers, and to prune trees and shrubs, to whom can we go for assistance? This is surely supererogation, it being part of the duty of the gardener, and with which the engineer is not expected to be conversant.

Your correspondent also says: "I have known a gardener than whom there was none superior in his line, to try persistently to make water run up hill," &c. What secret is there in making water run up hill if you have a good supply at the foot of the hill? With a good hydraulic ram properly placed you can send water up hill any reasonable distance, and in any direction you choose.

Again, he says: "I have known a gardener, thoroughly competent in all the work devolving on him as a gardener, from the management of an orchid house to a potato patch, that ruined the natural beauty of a place through his inex-

perience of the principles of taste." In such a case the employer was more to blame than the employee. This reminds me of the assertion of a "landscape gardener," now deceased, who seemed to take pleasure in undervaluing all gardeners, whatever their abilities or qualifications, that the most of them might be good enough for sodding a bank, planting cabbage, or hoeing a potato patch; but I presume there are as good fish in the sea as has yet been caught, and that men qualified for their duties as landscape gardeners will make their appearance when required.

Your correspondent states: "By the wording of signs, cards and circulars, many seemed ashamed of the term gardener, and hence called themselves Landscape Architects, Landscape Engineers," &c.; but he justly remarks that a name that was good enough for Repton, Loudon, Downing, Kemp, &c., is good enough for their followers.

I have exceeded what I intended to say, but I may be excused for stating that, as I give designs for laying out grounds, and also for horticultural buildings, I do not hesitate to style myself Landscape Gardener and Horticultural Architect.

Chelsea, 22d July, 1876.

## RHODODENDRONS.

BY H. W. S. WODENETHE, FISHKILL ON HUDSON, N. Y.

Mr. S. B. Parsons, in your September issue, in his article on Centennial Rhododendrons, while criticising the plants exhibited by Mr. Waterer under the tent, as being too tender for this climate, concludes by saying: "There are Rhododendrons, however, which are perfectly hardy in our American climate, and *doubtless* Mr. Waterer has them. These high colors are not, however, found among them, but belong to sorts which are adapted only to greenhouse culture."

Surely Mr. Parsons must have forgotten that the finest collections in this country, Mr. Hunnewell's, at Wellesley and Mr. Rand's, at Dedham, besides many others around Boston, such as Mr. Sargent's, at Brookline—all came from Mr. Waterer. Some of these collections consist of several thousand plants in many varieties, all doing under the heavy mulch treatment of eight to ten inches of dead or decaying leaves, quite as well as the same plants do in England.

I have for many years grown the annexed list, with only the slight protection in winter of evergreen branches on the northwest side, and



though many of my plants suffered from the severe winter and summer droughts of 1872-73, yet I am not aware they have ever suffered from cold many degrees below zero.

Among the varieties I have grown here with success are the following, imported from Mr. Waterer many years ago:

<i>Everestianum</i> ,	Charles Bagley,
Mrs. Milner.	<i>Purpureum elegans</i> ,
Mrs. McClutton,	Lady Armstrong,
<i>Blandyanum</i> ,	<i>Atrosanguineum</i> ,
<i>Album Grandiflorum</i> ,	<i>Onslowianum</i> ,
<i>Album elegans</i> ,	<i>Delicatissimum</i> ,
<i>Roseum Grandiflorum</i> ,	John Waterer,
Old Port,	Titian,
<i>Andersonii</i> ,	Minnie,
<i>Towardii</i> ,	Purity,
<i>Scipio</i> ,	Stella,
<i>Caractacus</i> ,	Mrs. Halford,
<i>Cataubiense Album</i> ,	

Mr. Hunnewell, certainly the best grower of Rhododendrons in this country, writes me to-day on the subject:

"I do not think the difficulty arises from the cold, but from the drought, which is undoubtedly the case with most evergreen failures. If you will give Rhododendrons a good depth of soil in the first place, say at least eighteen inches of one-third peat or leaf soil, one-third sand and one-third the top soil of an old pasture well-rotted and in a place where they do not get the mid-day sun, and mulch very thoroughly—*twelve to twenty inches*—of well-rotted leaves. The earth under them is always moist and cool in our hottest weather."

Of course, if one had great facilities for watering Rhododendrons there would be less necessity for heavy mulching. This, however, has another advantage,—the annual decay of the lower leaves of the mulch forms an admirable pabulum or food for the plants.

Mr. Nelson's idea in your September number, that the roots of overhanging trees do no harm to Rhododendrons is a great mistake, for if nothing else they absorb the moisture and food, which, did they not exist, would go into the Rhododendrons. A wood or mass of trees on the south side of Rhododendrons is very well, but the roots of this wood should be always kept out of the Rhododendron bed by annual cutting back.

I presume Mr. Nelson is praising our native Rhododendrons having but one color, and could he but see the collection at Wellesley of perhaps

fifty or more colors from "Old Port," almost black, to "Purity," nearly white, and every intervening shade, he would be astonished. There are many better evergreens than the American Yew.

#### KILLS AND CURES IN THE GARDEN.

BY GEN. W. H. NOBLE, BRIDGEPORT, CONN.

After each new pest and ail, follow lots of sure cures therefor. But much of their value is lost by not telling plainly the method of their use, and their exact make-up. These are just the things wanted. For that which in one way and proportion will cure an ail, in another will kill us and the ail too. Our friends therefore who would help us in the garden, should not leave anything at the mercy of a guess; but give us "measure for measure" of each thing which makes up the remedy, and should tell us, too, just how to apply.

Now, almost everybody knows that kerosene and carbolic acid are grand helps against many petty foes and ails; but just how much of either and how much of water make up a proper "solution," "that is the question." At page 168 of your June number we face this trouble, in "a weak solution of carbolic acid" "for house plants." "About as large as a piece of chalk" is quite as definite, on size, as is a "weak solution," regarding the quantities therein. Now if you know how much carbolic acid of certain proof, and how much water, make a safe solution, tell us, please.

#### HARDY HERBACEOUS PLANTS FOR AUGUST

BY WILLIAM FALCONER, BOTANIC GARDEN, CAMBRIDGE, MASS.

The following comprises the cream of the hardy herbaceous plants in bloom here at the Botanic Gardens on August 19th, "botanical" plants being strictly omitted. Some of our best reckoned-to-be hardy plants that were wintered in frames raised from seeds last spring or otherwise obtained and transplanted out-of-doors here this year, and that are now in "season," I have not mentioned, having only referred to those unquestionably hardy, in so far, that they survived unscathed our last winter. Many plants, too, that have bloomed earlier, are owing to timely cutting over and the late rains, coming quite prettily into flower again, such as *Delphiniums*, *Coreopsis lanceolata* and many *Labiates*. Antir-

rhinums are still as gaudy as Petunias, and of the pretty little *Dicentra eximia* some plants in leaf and flower are now better than ever, whereas others in the same border are done for a season.

It is not on our altogether-hardy plants, however, that we are to look for a show at this season, when we have annuals of every color, amongst which as blues *Wahlenbergia gracilis* and *Browallia viscosa* are particularly floriferous, fresh, lasting, and handsome; also, the mass of everybody's plants as Dahlias, *Daturas* (*D. meteloides* especially), Cannas, *Caladium esculentum*, *Gladioli*, *Tigridias*, *Salvias*, *Verbena venosa*, Marvel of Peru, Coral Plants, Century Plants, and many others that may be wintered in a dry cellar and transplanted thence to the open ground on the approach of summer. Besides, our gardens are all aglow with Morning Glories, Man-of-the-Earth Creepers, Cypress Vines, *Calystegias*, Wild Balsam-Apple Vines and Clematises, that need neither protection nor care beyond thinning and training.

*Phlox paniculata* and *vars.*, perhaps the finest plant of the season. From two to four feet high, of every shade of color, from the purest white to the deepest red, and thrives almost anywhere but in bogs—in the field or the garden. Considering the great perfection of some of the improved varieties now in cultivation, surely amateurs generally might give them place to the old purple. They propagate easily by dividing the old stools just as they begin to grow, when a little leaf-soil or light, rich earth helps them greatly.

*P. Drummondii*, a Texas annual and a perpetual bloomer. Sown in the open ground towards the end of May or raised under glass and transplanted thence it thrives equally well. In the South it self-sows itself. It is hard to fix the true species, colors, as I have seen as many varieties of it growing wild in Texas as I ever saw cultivated in Northern or European gardens. The Texans are fond of the brilliantly colored and variegated-flowered kinds which they permit a place in their yards, but the others they ruthlessly chop out.

*Lilium speciosum*, a Japanese lily, from two to four feet high, often grown in pots, but perfectly hardy. The flowers are rosy-white, spotted with purplish red, from three to twelve on a stem, and sweet-scented. Amongst dwarf shrubs, in the borders or choicest flower-beds it is equally applicable and deserving. On Craigie street, close by, is an old neglected garden round a

"house to let" with a large bed of these lilies all ablaze amongst the weeds, a splendid sight.

*Funkia subcordata*, the White Day Lily is now in its hey-day. It has long, funnel-shaped, pure white, fragrant flowers, and large, pale green leaves. It likes a free, well-drained soil.

*F. ovata albo-marginata*, somewhat like a medium-sized blue day lily, but blooms later.

*Lobelia cardinalis*, a most beautiful late-blooming native perennial, some two feet high, in erect racemes of brilliant red flowers. Our plants are in a very damp, shady spot, where they do well, but they would also thrive in an ordinary moist border. They are best divided and replanted every year.

*L. syphilitica*, also a native, nearly as tall as *L. cardinalis*, blue-flowered, on a leafy raceme. Requires treatment like the preceding.

*Aquilegia chrysantha*, that best of all of Columbines—the Rocky Mountain Yellow, is still in bloom. Some of the old plants are densely flowered and well-leaved, whilst others are sparsely bloomed and shabbily foliaged. This year's plants and those early cut back are good and fresh.

*Euphorbia marginata*, a western annual two to three feet high and very showy. The leaves are margined with white, and those crowded amongst the flower-cups are very broadly white, and the corolla-like appendages are purely white. It seeds freely and grows so readily from seeds that it self-sows itself.

*E. corollata*, a perennial and a little dwarfier than the preceding, also a native. The leaves are linear and green and the flowers in corymbose umbels are surrounded with five pure white corolla-like appendages. A very showy plant.

*Campanulas* are past their best, still *C. Carpathica* is very fine; *C. rotundifolia* moderately good; *C. rapunculoides* blooming wherever it can get a chance to exist—as a weed anywhere; and the *C. persicæfolia*, blue and white, that were transplanted last spring. In reference to *C. Carpathica*, Mr. Patterson, of Watertown, tells me that it is one of the best pot plants for conservatories in early spring, he having grown it for that purpose for many years.

*Staticee*,—*S. latifolia*, the great sea lavender, from twenty to thirty inches high, in tall, broad panicles of greyish-blue flowers, arising from a rosette of deep green leaves; *S. incana*, the hoary sea lavender with broad corymbose panicles of red and grey flowers; and *S. Limonium* var. *Carolinianum* about fifteen to eighteen inches

high, with blue flowers; are now very fine. The *Statice*s are worthy of a choice position and like a light, well-drained soil.

*Trawetteria palmata*, a ranunculaceous plant, the only species, a native of the United States and Japan, and has white flowers somewhat like a *Thalictrum* on a loosely corymbose cyme. It grows from 2 to 3 feet high, has large palmate root-leaves, and smaller ones on the flower stem. It is as hardy as a columbine and a persistent grower.

*Tradescantia pilosa*, a species with somewhat short lanceolate acuminate and pubescent leaves and blue flowers, about the same size as, and blooming later, than *T. Virginica*, which is still more or less in flower.

*Pentstemon argutus*, has reclining stems from two to three feet long, with a wealth of purplish flowers now in full beauty.

*Reseda Durieuana*, a hardy biennial or perennial, from North Africa, that blooms all summer, but not to be compared to our annual Sweet Mignonette.

*Lysimachia clethroides*, one of the best of the genus, from eighteen to twenty-four inches high, with terminal racemes of densely-set small, white flowers. It grows thriftily, blooms freely, lasting a long time; is very hardy, and propagates readily by division.

*Polygonum cuspidatum*, a noble plant, better fitted for isolated specimens and sub-tropical gardens than anywhere else. It is eight feet high with arching branch-like stems and a profusion of slender axillary clusters of white flowers. It dies down in the fall and comes up in spring like stalks of giant asparagus; indeed, the English gardening journals suggest its use as asparagus.

The composites are now quite showy, but the bulk of them are too tall and coarse for general use other than amongst shrubs, in large borders, or out-of-the-way places. Certainly the asters deserve a conspicuous position; *A. corymbosus*, *macrophyllus*, *patens*, *prenanthoides*, *ascendens* and *comixtus* are now in bloom. Amongst the other genera of this family are *Silphium*, *Coreopsis*, Golden Rods, *Vernonias*, *Echinops*, *Cnicus*, *Centaureas*, *Rudbeckias*, *Eupatoriums*, &c., now at their best. The *Labiates*, too, continue to furnish many flowers such as *Monardas*, *Nepetas*, *Lopanthuses*, *Scutellarias*, *Pycnanthemums* and *Salvias*.

Amongst shrubs the *Altheas* take the lead, single and double, and of every tint from white to red. *Hydragea paniculata*, with its dense panicles of whitish flowers, is very showy; and the *Kerrias*, single and double, are blooming more

or less. *Neviusia Alabamensis* has pretty white flowers in terminal peduncles, and its near relative, *Rhodotypos kerrioides*, is also well furnished with large white flowers at the ends of its arching branches. The *Oxydendrum arboreum* or sorrel-tree is just going out of bloom as are likewise the *Clethra sabnifolia* and *acuminata*, both native, still beautiful shrubs. *Vitex incisa*, or the cut-leaved chaste tree, is still shrouded with its lavender-colored flowers, which, together with digitate sub-pinnatifid and fragrant leaves constitute a pretty ornament. The *Vitex* is cut down considerably by our winters. The shrubby Cinquefoil (*Potentilla fruticosa*) with silky leaves and showy yellow flowers, and the *Hypericum pyramidatum*, another yellow-bloomed plant also in flower.

## EDITORIAL NOTES.

PUBLIC PARKS.—These are just now receiving particular attention in every populous town. In a recent visit to Buffalo, we were especially delighted with their public grounds. Mr. F. Law Olmstead is the designer, and Mr. McMillan has the general superintendence. We doubt whether so much has been accomplished in any town for so little money, and that much done so tastefully, and in a general sense, so well. It would be a great treat to our readers if Mr. McMillan would give them some leaves from his experience in these lines.

PATENTS FOR NEW PLANTS AND FRUITS.—We see this subject, which has been so impartially discussed in our pages, is still the theme of writers in the agricultural press. There is a deal said about "regarding the brain work of the introducer or raiser of new plants," which we all sympathize with. The "Whereas" are all right enough. None of the writers show the connection of the "Therefore" with the preambles, and this is just what is the matter with the argument.

SILVER-THORN AND PYRACANTHA HEDGES.—The *Country Gentleman* speaks of the Silver-thorn or Pyracantha as if they were one and the same thing. Silver-thorn is the *Elæagnus parvifolius*, and has no relationship whatever to the Pyracantha. As a rule we seldom note the errors of our co-temporaries; that is their own business, but such an error as this our neighbor will pardon us, we are sure, for pointing out.

**FLOWERING OF THE PAULOWNIA IN ENGLAND.**—If our summer heats do not permit some of the gardening enjoyments of England, it vouchsafes us others which are denied to them. It favors the maturity of some trees for which the cool summers of England are inadequate. Mr. Edward Meehan, the father of the writer of these lines, has recently flowered the Paulownia in England, and the event is made quite noteworthy by the *Gardener's Chronicle*. Americans have enjoyed its delicious fragrance for 20 years. It is a pity so sweet a thing has so ungainly a habit.

**AMERICAN FOLIAGE IN EUROPE.**—When in Edinburgh, a week or two ago, I noticed several trees, in the Botanic Gardens there, remarkable for their handsomely-colored leaves. A *Paria flava* and one or two others were bright orange in color, relieved here and there by great splashes of vermilion and russet. The Sugar Maple (*Acer saccharinum*) and the Scotch Laburnum were also beautifully colored, but the handsomest of all were the Liquidambers, some branches of which were literally crimson and gold. Such vivid colors intermixed with deep green-leaved Oaks, Conifers, and Planes, are strikingly effective, and should not be overlooked by planters.—F. W. B. in *Garden*.

### NEW PLANTS.

**LIATRIS PYCNOSTACHYA.**—We made a note of this beautiful hardy flower last month; since then the effect of the drouth on summer flowering plants has been counted up, and the result in favor of this is so striking that in the hope of a more general introduction, we have had a sketch made of one as an illustration. Through the greater part of the month of August it was in full blossom, as if the heat, so destructive to many plants, was a matter of no consequence to it.

The plant is found wild abundantly throughout the States of Kansas and Texas, and in the Indian Territory, and though long known to botanists, and now and then sent east by correspondents during the past dozen years or more, no attempt to introduce it to general notice has been made that we are aware of. During the past summer we saw a whole row of it in the garden of a florist, and the effect of so large a quantity was beautiful in the extreme. The plants were raised from seeds brought origi-

nally from Southern Kansas, in 1873. If sown in the fall, the plants bloom the next year, but the best success follows when sown in the spring, and the plants have a season's growth before flowering the next year. The roots are somewhat bulbous, and when once had will bloom

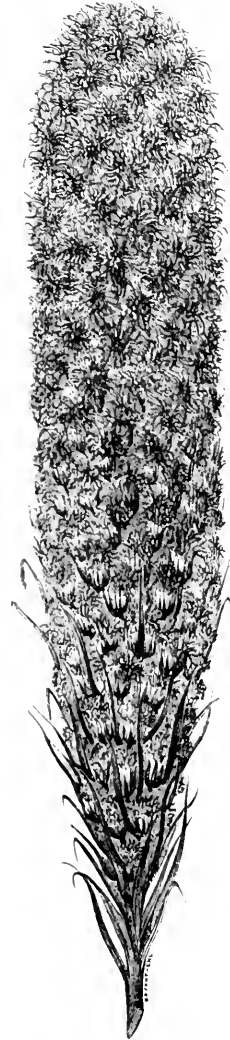

LIATRIS PYCNOSTACHYA.

well for several years. There are some twenty species of North American *Liatris*, but this is perhaps, the handsomest of the whole. The flowers are rosy purple; spike about one foot long, as shown in the engraving. They commence to flower at the top of the spike, and the blooming progresses downwards. In the illustration the lower blossoms have yet to open.

Like so many beautiful plants from the West this has not been known long enough to get an English name, and we suppose the Greek one will be considered "hard" by the dear ladies, and "pedantic" by the average man. The settlers call it "Fire-weed" and "Sky-rocket Plant," but as these names are already given to scores of things, and will be to as many more, it is hardly worth holding on to them. The Eastern *L. scariosa* is known as "Gay Feather;" suppose we all agree to call this the "Kansas Gay Feather." there are other species of *Liatris* in Kansas, but as this is the best let it be *the* one.

HYBRID PENTSTEMONS.—As the Pentstemon thrives so well in American gardens, it is worth notice that the Germans are improving some species remarkably. The best strains are hybrids between *P. Hartwegi* and *P. gentianoides*. But these species require a little protection in our severest winters.

RETINOSPORA LEPTOCLADA.—It should not be forgotten by purchasers is the same thing as the *R. squarrosa* of some English catalogues.

ASPERULA ODORATA.—This pretty, hardy herbaceous plant, says *L' Hort. Belgique*, enters into the composition of the German perfume, known as "maitrank."

HYDRANGEA, "THOMAS HOGG."—This beautiful pure white variety of *Hydrangea hortensis* we un-

derstand is now ready for sale, and has been sent to England for distribution. It will no doubt be one of the most popular plants sent out from the English nurseries, and is expected to yield the parties concerned an immense sum, which their enterprise and industry well deserve.

VIBURNUM Plicatum.—This, the Japan Snow-ball of our gardens, is becoming well known in our country, where it thrives well. Its hardiness and great beauty will long ensure popularity for it. It does not seem to be so well and favorably known in England. It forms the subject of a full page engraving in the *Gardener's Chronicle*.

NEW TREES.—An English gentleman writing to a horticultural magazine, says, "he has only one life to live, and hence he gives a high price if he cannot help it, for the first chance of a new tree, in order that he may enjoy the full beauty of its form before he dies."

A NEW HARDY TREE, CEDRELA SINENSIS.—In 1862, a tree was introduced to France, supposed to be a kind of *Ailanthus*. It has now been found to be of a different genus, and is *Cedrela sinensis*.

QUERCUS ANDERSONI, a new species of oak from the Sikkim Himalaya, was the subject of a paper by Dr. G. King at the last meeting of the Linnean Society. It is the "Katoos" of the Nepaulese, and one of the very finest of Indian forest trees. It is closely related to *Q. spicata*, but is met with at higher altitudes.

## GREEN HOUSE AND HOUSE GARDENING.

### SEASONABLE HINTS.

The great anxiety will be at this time to preserve those things that have been growing in the open ground during summer, for, though when they were set out, we had no thought of anything more than summer decoration, we hate to let things go to destruction that have afforded us so much pleasure. The feeling is commendable, and yet it is to be kept in check or we overburden ourselves with material which becomes a tax on time and space to care for. Still there are always some to be lifted, and those who have not the advantage of professional gardeners to

assist them, may find a few hints serviceable to them.

In taking up things from the ground for potting, care should be taken to have the pots well drained, with pieces of potsherds over the hole. The more rapidly water passes through the soil the better plants will grow. Pots could be made without holes, and the water would all go through the porous sides in time; but that is too slow a way, so we make a hole to admit of its more rapid escape, and we place the broken pots over the hole to make a vacuum, which assists the objects of the hole. In very small pots, or with plants which have strong

enough roots to rapidly absorb all the moisture they get, and speedily ask for more, "crocking" is not necessary.

After potting, the plants should be well watered and kept in the shade for a few days. If they still show signs of keeping a wilted appearance long, it may be as well to pick off a few of the leaves. Some things of not too tender a nature can be kept in cellars for spring. The bedding geraniums are often treated in this way. The leaves and softer parts are cut away, the whole tied in bunches, and hung up. At times the cellar is rather dry for this, and then some moss is packed in among the roots, and kept a little damp.

Plants for blooming in windows or conservatories are looked after soon. The Chinese primroses are among the best for this purpose, and indeed the whole primrose family is excellent, provided the rooms in which they are to flower are not too warm. They are all nearly hardy, and would sooner have some frost than great heat. The old Auricula is a great favorite with English plant growers for early spring flowers, but has to be kept in sunk pits in the cool over summer in our climate. Few care to take this trouble, but it is worth all it costs. It belongs to the primrose family, and we give an illustration in order to make it better known.



AURICULA.

There are some very pretty additions to the old primrose family of late years in cultivation, of which the *Primula japonica*, *P. involucrata*, and *P. farinosa* are now well-known examples. After all there are few prettier things in this class than the varieties of the old English primroses under the names both of Polyanthus and Oxlip; of these there are singles and doubles. The white ones especially are in great demand by florists. The double ones known are generally of the old single stem or primrose class. Mr. M.

Vilmorin, of Paris, who was on a recent visit to the Centennial Exhibition, tells us that they have in France a peculiar double one. It is of the "Hose in Hose" class, and must be very beautiful and give an increased interest to this tribe of plants. He gave us the following sketch of it.



DOUBLE POLYANTHUS.

Hanging-baskets which have been in piazzas or under trees all summer, will need to be taken to the parlors soon. Many take out and reset at this season under an impression that the soil is exhausted; but a much better way is to let them alone, and sprinkle a little very well decayed manure among them.

There are but few things in the greenhouse that will require special treatment at this time. Camellias and Azaleas, as they cease to grow, will require less water; but it is now so well known that moisture is favorable to growth, and comparative dryness favorable to flowering, that we need do no more than refer to the fact.

Bulbs for flowering in pots should be placed at once. Four or five inch pots are suitable. One Hyacinth and about three Tulips are sufficient for each. After potting, plunge the pots over their rims in sand under the greenhouse stage, letting them remain there until the pots have become well filled with roots, before bringing them on to the shelves to force.

## COMMUNICATIONS.

### DESTRUCTION OF GREENHOUSE PLANTS BY GAS.

BY E. MASON, DETROIT, MICH.

During the winter of 1874-5, a large number of valuable plants were destroyed or damaged by gas in the greenhouse of Taplin & Davis of this

city. A gas main leaked in a sewer, which communicated by a tile-drain with the greenhouse. The presence of the escaping gas was detected by the smell and by the drooping and withering of the plants; and the Gas Company were notified to take immediate steps for preventing further damage. They were unable to find or to stop the leak until after extensive damage had been done. Taplin & Davis then sued the Gas Company for damages, and after some litigation the matter was decided by arbitration, and the plaintiffs were awarded \$2,900. The sum was not the full value of the plants destroyed or damaged, as it was considered by experts that many of them would recover from the effects of the gas.

[We are very glad to learn that T. & Co. recovered something. They were more fortunate than some Philadelphia florists who were awarded nothing in similar suits.

If one looks at men laying these pipes, it is only a wonder more damage does not occur. The pipes are covered before they are tested, and if the gas leaks nobody cares. Philadelphia loses largely in the item "leakage," as seen in the annual reports of the gas companies; and when we see beautiful shade trees killed, as we often do, we think it a pity she does not lose more.—Ed. G. M.]

### ECHEVERIAS FOR BEDDING.

BY B. GREY, GARDENER TO E. S. RAND, JR.,  
DEDHAM, MASS.

Probably few plants of late have attracted so much attention for this purpose as those of the genus *Echeveria*, and deservedly so; as they may be used in a variety of ways, either as carpeting, where larger plants, such as Agaves, Aloes, Cactuses, &c., are used in the bed; or for mounds and pyramids; or geometrical figures on nearly flat surfaces. This being the case, perhaps a few remarks on the mode of "getting up a stock" of plants will not be amiss to beginners. Although easily propagated, either from seeds, suckers, or leaves, yet such a large number are required for effect in any of the above mentioned modes of planting, that it is well to begin as soon as possible. *Echeveria metallica* and varieties are best grown from seed, as they make few suckers. *E. secunda* and *E. secunda glauca*, the latter being the best, make offsets freely from the old part of the stems, and these may

be taken off and pricked into shallow boxes. *E. sanguinea*, as the plants get large, has a tendency to drop its leaves; these, if cut into pieces and placed on a surface of damp moss, will make plants quickly. This variety, however, seeds as freely as most others.

The above modes of propagation would be applicable only when the grower had already some plants on hand. For a start, seeds would be the easiest and cheapest. These should be sown in pans as soon as ripe and dry enough to rub out of the capsules, and under favorable circumstances would be up in about a month. The seed should be sown on the surface of the earth, covering with a piece of paper until the plants begin to come up. In watering, care must be used so that the surface shall not wash, which causes the seedlings to come up in thick patches, thereby increasing the risk of "damping off," which they are liable to do if watered carelessly before they gain considerable strength. As soon as the young plants have made the second pair of leaves proper, they are fit to transplant. If this should be in spring, which would be preferable, a frame or old hot-bed makes a capital place to grow them in, as they can be protected from the fall frosts, and they should be kept out as late as possible, as they winter better when grown cool, late on. The soil should be forked up and left quite light. The plants need only to be dropped on the surface at a distance of two or three inches apart, according to the size of the variety planted, watered with a light rose watering-pot, and covered with a mat until they are established, after which the mat may be gradually removed. They will make fine strong plants by December, and should then be taken up and stored away in a light potting-shed, around the path of the greenhouse, or any convenient place where they can get light without much heat, thus preventing the plants being in a great measure spoiled by having the centres "drawn," which is apt to be the case if kept dark. They should be kept *perfectly dry*, if cool, until spring, when they may be removed to the frames again until wanted for bedding.

### EDITORIAL NOTES.

SEEDING OF *ARACAUREA EXCELSA*.—By artificial application of pollen, an *Aracaurea excelsa* at Hauva, in Algiers, has been made to produce seeds—a rare thing in the old world.

WINTER-FLOWERING CARNATIONS AND BOUARDIAS.—As winter flowers are so much in request here, we grow a very considerable number of carnations, which are known as perpetual or tree carnations. These during the winter season are grown in a span-roofed house, provided with side stages, which admit of the plants being placed near the glass, so that they may enjoy a fair share of light. The temperature is maintained at or about 60°, which appears to suit them admirably, as well as the Bouvardias, of which we grow a few dozen plants of the most useful sorts. The carnations are now in fine trim, and the supply of flowers for button-holes, bouquets, and vases well-nigh unlimited. In gathering a few dozen flowers to-day I made note of the following being especially good, and in every way desirable for a limited collection, namely, *Avalanche*, white; *Beauty*, white and scarlet; *Boule de Feu*, scarlet; *Congress*, scarlet; *Duke of Wellington*, dark scarlet; *Herbert*, rose; *Hermione*, white; *Jean Bart*, bright scarlet; *La Belle*, white, large, very full and fine; *Novelty*, buff and red; *Oscar*, yellow; *Purity*, white; *Souvenir de la Malmaison*, blush; *The Dragon*, scarlet. The perpetual-flowering *Picotees*, *Ascot Giant*, white ground with heavy red edge; *Ascot Yellow*, yellow with crimson edge; *Prince of Orange*, yellow with bright crimson edge, are also exceedingly good in their season. The Bouvardias which appear to be the most useful for private growers for winter work are *Davidsoni*, white; *Vreelandi*, white; *Elegans*, scarlet; *Bridesmaid*, flesh-pink, and *Longiflora*, white. The last-mentioned is a straggling grower, but its flowers are so deliciously fragrant that it cannot be dispensed with. The flowers of the other varieties enumerated possess but little fragrance, and are in consequence not so popular amongst the ladies.—*Head Gardener, in Gardeners' Magazine.*

BOUARDIA.—These are hard-wooded plants, but associate best with soft-wooded plants, and should only be grown in a house that is kept well heated during winter. Those employed for bedding purposes make nice pot plants, but the best of the family is *B. longiflora*, which produces a profusion of most elegant and sweet-scented white flowers during the winter. It is a troublesome plant, but worth any amount of trouble. Strike cuttings of the young wood in a brisk moist heat in March. Pot off as soon as rooted in five-inch pots, in a mixture of equal parts loam and peat, and a sixth part of the whole

bulk of silver-sand. Put them into the warmest place you have, but they must not be closely shut up, and the foliage must be frequently syringed. A fortnight after this potting pinch out the points of all the shoots to promote a bushy habit. Winter them in a temperature of 50°, and in February shift them into eight-inch pots, and after this potting put them in a good growing temperature, and as the season advances move them to cooler quarters, so that by the middle of August they may be in a light airy house, to ripen the wood and prepare them for flowering. As soon as flowers appear put them into a temperature of 60°. Keep them very clean, and they will continue to flower for four or five months.

The bedding varieties of Bouvardia are more hardy than the lovely *longiflora*, and may be prepared for the embellishment of the conservatory by a very simple course of culture. In the middle of May secure a sufficient number of plants of the sorts required. Newly-made plants from spring cuttings will not do, but old scrubby ugly ones will answer perfectly. Cut them rather close, so that when they make new shoots they will become neat round bushes, and plant them out in a sunny spot. Give water as required. In the first or second week of July pinch out the points of all shoots, and give no more water. About the middle of September take them up carefully, and pot them in a light loamy mixture, taking care to injure the roots as little as possible. Give them a good watering, and then put them near a wall out of doors where the sun will not shine on them, and keep them regularly sprinkled and watered. In the early part of October take them into the greenhouse, and very soon they will begin to flower and make a splendid show. *B. Vreelandi*, which is a capital bedding plant, is also one of the best for this rough-and-ready course of culture for the production of winter flowers.—*Gardener's Magazine.*

TUBEROSES IN MIDWINTER.—To have Tuberoses in at Christmas, and on New Year's Day, the following course is pursued in the United States, where Tuberoses are admirably grown:—By the 20th of August they are potted into 4-inch pots, containing a composition of two-thirds strong loam and one-third old rotten manure. They are then planted out of doors in a frame, as close as they will stand until the end of September, when the centre-table of a span-roof house is bored with a number of holes to let up the warm



air from underneath, and the Tuberoses are planted out on this. It is necessary to have three or four hot-water pipes underneath the table, and the compost ought to come, if possible, from an old pasture. To every two barrows, one barrow of old hot-bed manure is added, the whole being well mixed together, and then placed upon the table to a depth of 5 inches, and well pressed down with the feet to give solidity. The Tuberoses does best on a heavy rich soil. The bulbs are then turned out of the pots, and planted in rows 6 inches apart, and 6 inches from plant to plant, and thoroughly watered with the hose. The plants are well syringed, and, on the first appearance of frost, a moderate night temperature of, say, 60° should be maintained. By the 6th of November, the plants will be well established, when the night temperature may be increased to 70°, and abundance of moisture used, the path of the house being flooded at night. Sulphur, worked into the consistency of thick paint, is put on one of the hot-water pipes, as a preventive against red spider, the great enemy of the Tuberoses. If the plants have been managed properly, they will commence to flower by the middle of December. At Christmas, they command from £1 to £1 12s. per hundred florets, each plant or bulb producing from thirty to forty florets at these prices. The following practice is usually adopted, and is, I think, the most practicable for the spring crop:—A hot-bed, or better still, a pit, is prepared in a similar way to those for Melon and Cucumber growing in England. As soon as the rank steam is off, 3 inches of coal ashes are put on, and the bulbs potted as previously directed, selecting those that are thick at the neck. Some think a very large bulb is best; but I think those of medium size are preferable. First-class bulbs sell at £10 per thousand; those of second quality, £7 per thousand. The pots are plunged to the rim in the bed, and there is no danger of their rotting from the heat, which they will bear well. Linings are added as soon as the surface heat declines, the night temperature being kept at 60° and the pit covered up well at night, mats and shutters being used; in a month or five weeks, they will have their pots well filled with roots, have dense foliage, and they are then ready for the house. The first crops by this time are gone. Having planted out as before recommended, plenty of water must, as the spring advances, be given to the plants in the bed. Morning and evening a syringing must be given with the hose to prevent

red spider. Should the plants come near the glass, they must be tied down. Thus treated, they will in part commence to flower by the end of April. The florets sell from 12s. to 16s. per hundred, and, by June 1st, they are down to 8s. per hundred. Even at these prices I have known £200 made of the plants grown on the centre table of one house, the table measuring 88 feet long by 6 feet wide.—*John Howatt, in Garden.*

*EUPHORBIA JACQUINÆFLORA.*—This being one of the most useful winter-flowering plants, it is now deserving of special attention. Plants struck in the beginning of June should now have made growth at least four feet in height and strong in proportion, with plenty of laterals. If the plants have hitherto grown amongst other stove subjects which required shade, they should be removed at once to a house or pit where they can be fully exposed to the light and sun, and kept as near the glass as possible, with plenty of air admitted during favorable weather, so that the wood may get thoroughly matured, as on this depends chiefly their successful flowering. The watering of this plant is also a point of importance, for if it is allowed to suffer for the want of this element, it will lose all its bottom foliage, which would greatly diminish its effect when in flower.

One rarely sees this beautiful plant occupying the position it should hold in our stoves. We not unfrequently find it grown amongst the general collection of stove plants, and sometimes at the north side of the house, and consequently very much shaded. What is the result? A weak, drawn, and not half-ripened growth, with a few miserable flowers at the points instead of fine racemes of orange scarlet, from fifteen to eighteen inches in length, which would be the result under better cultivation.

To grow the *Euphorbia* well the principle batch of cuttings should be put in, not later than the first week in June. Another batch may be put in later for a succession. The cuttings should be taken off with a heel, and inserted round the edges of pots filled with peat and sand, plunged in a gentle bottom heat, and kept close and shaded until well rooted, when they should be potted off, "either singly or three or four in a pot," in a compost consisting of fibrous loam, peat, and leaf mould in equal parts, with the addition of some silver sand. The plants should then be well-watered, and again kept close and shaded, till they take root in the fresh soil.

When they commence to grow they should be gradually exposed to the air and sun, and no shade used afterwards except for a day or two after re-potting. The plants may be re-potted up to the end of August or beginning of September, but not later.

The back wall or the spare end of a succession Pine pit will be found a most suitable place for the successful growth of the *Euphorbia*. A wreath of *Euphorbia*, intermixed with some neatly wired bells of Roman Hyacinth, has a charming effect in a lady's hair at a ball or dinner party.—*Gardener's Record*.

**ASTILBE.**—The well-known *Astilbe japonica*, which is, perhaps, better known as "*Spiraea japonica*," is eminently valuable to furnish greenhouse flowers early in the spring, though it is a cheap hardy herbaceous plant. When forced slowly in a damp pit, close to the glass, it is one of the loveliest plants in the world, and well worthy to be made a feature of in any private garden where beautiful plants are valued by some other scale than their money value in the market. They should be potted in September or October, in a mixture of turfy loam, leaf-mould, decayed manure, and sand, and started in a temperature of about 55°. From this allow the temperature to rise gradually to 75°. They should be supplied liberally with water when growing freely, and may be placed in pans of water to advantage. It is a matter of no consequence what sized pot is employed, but for ordinary decorative purposes, five, six, and eight-inch pots will be most serviceable; the two former for the drawing-room jardinets, and the latter for the conservatory. Strong clumps ready for forcing may be purchased at nurseries and seed houses. Those who prefer growing them for forcing in after years may do so with but little trouble. Early in May or June they may be planted out in an open quarter previously well prepared for their reception. They should have two or three liberal waterings and a mulch of short litter, or partly-decayed leaves, placed between the rows if it can be spared. They will then require no other attention, and by the autumn will have formed strong crowns and be in grand condition for forcing. If considered desirable, they may be divided into single crowns in May, each of which will form a nice little plant by the end of the summer. Those who have not convenience for forcing may have a fine display early in the season by simply keeping

them in the greenhouse from the time they are potted until they come into bloom. Of course they should be placed in an out-of-the-way corner until the young growth begins to push, and then they should be placed in a position near the glass.—*Journal of Horticulture*.

**A VASE OF SIMPLE FLOWERS.**—A few days since I arranged a vase of flowers for the breakfast table which was much admired by several friends, indeed, so much so, that I am induced to give a description of it, as the effect was produced by the arranging of the flowers not the quality, for they were only common garden varieties. The shape of the vase was a flat tazza, out of the centre of which rose a tall glass trumpet, and from the base of the trumpet sprang three curved branches; round the edge of the trumpet were fronds of the Lady Fern, and in the tazza were grouped white Water Lilies, Scarlet Geranium, leaves of Dells Beet, Ribbon Grass, hardy Ferns, and Wild Grass. In the three curved branches were yellow Roses and Delphiniums, the latter a very pale shade of blue. In the trumpet was a yellow Rose, some scarlet Geraniums, white Honeysuckle and blue Lobelia intermixed; with these were wild grasses and a few blades of Ribbon Grass; round the mouth of the trumpet drooped a few fronds of the Lady Fern, while twined amongst the glass branches were a few young shoots of the variegated Periwinkle. As will be observed on reading the above, the flowers themselves are only common kinds, such as are to be found in almost any garden, but if a little trouble be taken in the arranging of them, few I think will feel disappointed with the effect produced. Other effective arrangements could be made in different colors with the same class of flowers, say for instance the light blue Delphiniums used in place of the Scarlet Geraniums; pink Christine Geraniums in place of the Delphiniums in the curved branches, and the same in the trumpet; again, mauve-colored Clematises might be used in the tazza, and Violas in the curved branches and trumpet; by the change of these few flowers quite different stands could be produced, though the principal flowers and foliage would remain the same all through. It is in this way that variety can be produced where there are few flowers to cut from. A great mistake often made is, that because the flowers at hand may not be perhaps of very choice kinds they are not worth arranging, but most effective decorations can be made with very simple ma-

terials; indeed, nothing is more charming than wild flowers if well arranged. Just at present, too, these are in their full beauty, so those living in the country who have not hitherto enjoyed them will do well to give them a trial.—*A. Hassard, in Gardener's Record.*

### NEW PLANTS.

**NEW AMPELOPSIS**—*A. incisa*—*Vitis incisa* of Nuttall.—We received this from Mr. Thomas Meehan, by whom it was introduced quite recently, and who describes it as follows: "This beautiful climbing vine was first discovered, described and named by the distinguished botanist, Nuttall, but only now, for the first time it is believed, introduced to cultivators. The leaves are trifoliately cut and divided, and have a thick texture similar to that of the well known *Hoya carnosa*, or Wax Plant, with a glossy surface, and so peculiar in appearance as to attract even the commonest attention. Like all the Ampelopsis family it is a rapid grower, extending many feet in a season—climbing by tendrils as in *Ampelopsis bipinnata*. The flowers, as in most of the general family of *Vitis*, are not striking, but the small black berries are an attraction. It is a native of the Indian Territory and southwards. How hardy it may be is not yet known, but it has been known to endure a temperature of zero, without injury."

It is also a very desirable plant for florists and others, as it can be used to great advantage in hanging-baskets, vases, flower stands, &c.—*Ellwanger & Barry.*

**CROTON WEISMANNI**.—A remarkably distinct, ornamental-foliaged plant, in habit somewhat resembling a *Dracæna*, with long, narrow leaves, striped and mottled with gold of the brightest

possible hue. It is of very graceful habit and of free growth, the leaves attaining ten to twelve inches in length, and about three quarters of an inch wide, very acute at the apex, the upper surface, dark shining green, with gold blotches, the mid-rib and margins golden yellow; under surface similar, but paler green.—*Vitch.*

### QUERIES.

**KEEPING LARGE LANTANAS**.—W. H. L., Brockport, N. Y., asks: "Permit me to ask you or some of your readers, through the *Monthly*, how I may keep Lantanas through the winter without the aid of a greenhouse or conservatory. I have kept small ones in the sitting-room, but I have some fine large ones which I wish to keep over the winter for bedding out next spring."

[Though easily touched by frost, the Lantana can be kept well in a low temperature, and no doubt if the leaves are cut off, the plants could be kept in an ordinary cellar, as Pomegranates, Crape Myrtles, and other things are.—Ed. G. M.]

**BROWALLIA ELATA**.—M. This is one of the prettiest of all blue-flowered plants for "cutting" through winter. It is an annual, and flowers soon after sowing. It does not like high temperature; one about 50° to 60° suits it best. It likes a rather damp soil, but yet one in which the water passes rapidly away.

**MIGNONETTE**.—M. This does not want much heat to bring forward. It grows when the thermometer is well down towards the freezing point. Indeed cold frames are better than greenhouses for it. It is late to sow in October, but still we have no doubt that plants "sown in a window" would flower in spring.

## FRUIT AND VEGETABLE GARDENING.

### SEASONABLE HINTS.

The past season in most parts of the country has been one of very abundant bearing, and unless the food has been kept up by a liberal supply of manure, there will be many weak and exhausted trees, and short crops next season. We prefer to manure in such cases as these in midsummer. The cells of trees are like honey

combs, and store up matter for use the next season. They have of course to do this while growing. Whenever this has not been done, matter for a surface dressing should be got ready during autumn and winter. Much injury has been done to fruit culture by the expressed dread some cultivators have of a "too rank growth," and a consequent advice not to manure. A fruit tree never suffers from too

much manure, if the roots are healthy. If a tree seems to suffer after a heavy manuring, it is only that it was in a bad way before this. Of course, if one were to empty a cesspool, a cart load of fresh lime, or some other inordinate mass of food under a tree, it would suffer; but our meaning is that no amount of manure that would be found of benefit to any regular garden, will be otherwise than beneficial to a fruit tree, *if the roots be healthy.*

Celery as it grows will require earthing up, and Endive successively blanched; but the main business of the month will be preparations for housing the root crops for the winter. Beets are generally the first thing attended to, they being the most easily injured by frost; Carrots, Salsafy and Parsnips following. The latter are never really good until they have been well frozen; and many leave them entirely in the ground, taking them up as wanted for use. We prefer taking them all up and packing them in sand or half-dried loam, in a shed or cellar, which can be kept just above freezing point; yet the cooler the better. If suffered to be in heaps they heat and soon rot. In the same situation Endive and Cape Brocoli may be preserved to the end of the year—they are taken up with a small quantity of earth adhering to them, and placed side-by-side together. Tomatoes, if dug up also, and suspended, roots upward, in such a situation, will keep good a long time; but this must be done before the least frost has touched them. It is a wise plan to sow a little more Early York Cabbage early in the month, as in fine mild winters the September sowing grows too forward when protected. A very slight protection is better for them than any elaborate affair, the sun principally injuring them. The same remarks apply to Lettuce intended to be kept over winter for spring use, though the sun is less destructive to them than to the cabbage.

Forcing vegetables, wherever the least command of heat can be had, is the most interesting and useful part of gardening. It is not by any means what it is often considered, an operation by which you pay a dollar for a mouthful. The Asparagus, Sea Kale, Lettuce, Radish and Cauliflower can be had for months earlier than in the open ground, wherever a regular temperature of 55° can be obtained, with, of course, the proper amount of air, moisture, &c. Asparagus can be had under a greenhouse stage, though of course the tops will not be so green, nor will it be much else but indifferent under

such circumstances, as it would be in full light.

Radishes require an abundance of air, and Lettuce light. Cauliflowers, if kept for some months with all the light and air possible, at a temperature of 50° or 55° may have it gradually raised to 60° or 65°, and even 70°, and thus come into use in February, when there is no vegetable more desirable.

Cucumbers, Tomatoes and Beans require a temperature of at least 65° to begin with. If a temperature of 70° can be maintained in the coldest weather, a few of these might be sown by the end of the month, which will produce some very acceptable dishes about New Year's day. Rhubarb, if carefully taken up at the fall of the leaf and potted, or put into boxes, will also come forward well if put under the stage in a house of the last temperature.

### COMMUNICATIONS.

#### HAS THE PEAR A NEW ENEMY.

BY A CONNECTICUT READER.

I send you some tips and branches from my injured pear trees. I hope you can tell me what ails them. The ends of branches, new growths and fruit buds look very much like those of the buttonwood, which of late years has been subject to some such trouble. Unless our books on the pears are very loose and meagre about its pests, the hurt to my trees seems that from a new foe.

Is the *Scolytus* guilty of this harm? I cannot trace on my trees the marks of his work named in the books. I have carefully searched but cannot find *him*. That "small beetle" has not been seen. Neither do I find that small hole as of a pin or needle, at top or base of any bud, for him to go out or in. Nor have I struck any gallery of his boring around the pith of limb or bud. No leaves wither after starting, as they do where he cuts their sap conduits.

On some of the last year's growths, every leaf-bud fails, and the shoot shrivels and dies down to the old wood, whence a new one starts out to try its chances. On another of last year's growing, only the end bud lives. There, right beside this you may find shoots from whose sides at intervals, one or two buds start, while all the rest are dead. In like manner the fruit buds are served. Some die clear down to the branch, others only to their base, whence pushes out a thrifty growth for a new struggle with its foe. Some trees, and some parts of the same tree, suffer more than others. The tops are most exempt

from harm. This year a tree may hardly yield a fruit, while the next bears superbly in quantity and quality. The wood of two years growth rarely shows injury, and then it comes from a starved growth, or from the sensitiveness and annoyance which few think trees suffer, when their thrift or freedom is molested.

Now I am at a loss to know what ails my trees. I find on those injured most, a squad of small brown lice, clustering around the buds and roots of leaves. These are visited by lots of ants, who seem to feed on some sweetness distilled from them or from the wounds they make. Around such buds and leaves a black mold or mildew spreads and closely clings.

I have long held a lurking suspicion that the roots of evergreens, dead or alive, were hurtful to the pear. The ground where my pear trees stand, was some years since, well filled with Norway Spruce, which I cut down when 12 to 15 feet high. I have no fixed theory about this, but only make a query. Perhaps the living leaves and fronds work just as much, if any harm, to this favorite fruit. Your counsel is asked as to the cause and remedy.

[The appearances were quite novel to us. Some of the specimens were sent to one of the most distinguished mycologists, who acknowledged himself completely puzzled. This is all we can say at present.—Ed. G. M.]

### EDITORIAL NOTES.

**THE THWACK RASPBERRY.**—Notwithstanding its uncouth name, is said to be a very good thing by some who have seen it. The growers say it "eclipses all other sorts" in eight several particulars, which we should regard as doubtful, as also that it is a "cross between the Herstine and the Brandywine." We think loose statements tend rather to prejudice a variety really good in itself rather than "help the cause along."

**ORCHARDS IN GRASS.**—One of the most impartial discussions of the relative merits of the different plans of cultivating orchards that we have read for some time is in the *Rural Home*, of Rochester, N. Y., of August 26. The advantages claimed for grass culture and clean culture are fairly stated, and it concludes with the following, which is the pith of the whole subject:

"How to keep up the fertility of orchards at

the least cost is, perhaps we may say, the most momentous question that confronts the orchardist, and one to which we purpose to give further attention."

**ORCHARD OF GODFREY ZIMMERMAN**, Pine Hill Nursery, Buffalo, N. Y.—We had an opportunity to examine this beautiful orchard recently. It embraces pears, dwarf and standard, cherries, apples, and other fruits. The trees stand on ridges ploughed up before planting, after the manner so well known to those who have seen the late M. L. Dunlap's orchards, at Champaign, Ills. The orchards have been now many years in green grass—not "neglected grass," but occasionally top-dressed. Mr. G. is proud of his successful orchards, and no one who visits but must envy him. A very successful Honey Locust hedge surrounds the property. The few hours spent in Mr. Zimmerman's grounds, and the personal acquaintance of the members of his excellent family, are among the pleasant recollections of the Editor's hurried trip to Buffalo.

**WILD GOOSE PLUM.**—Mr. D. S. Myers, Bridgeville, Del., says: "I send you by mail this day one wild goose plum. I notice in *Gardener's Monthly* that there is some question about the true wild goose. I hope you will have a number of these plums sent you, so you can form an opinion about them. The fruit I sent you last year and this are grown on trees I purchased five or six years since from a nursery in Mississippi. Late frosts cut off all early-blooming fruits with us, including the plum, or I would have sent you a sufficient quantity for better inspection. In an old number of *Journal of Horticulture* (now discontinued, was published at Boston) you will find a long article on plums of the South and wild goose plums. This article in *Journal of Horticulture* is from a leading horticulturist of standard authority. I think if it was republished it would do much to settle the question about the true wild goose plum. The wild goose plum cannot withstand any more frost when in bloom than the budded peach. The tree on its natural roots grows very rapidly on land in sod, where the peach tree will die in a few years if not cultivated. The fruit is subject to injury by the curculio, but not so much so as other firmer varieties of Northern plums. Grown on peach stock the trees are very rapid growers, and can be better cultivated if desired; or if not desired to be kept under clean culture like a peach orchard, should be on their natural roots,

or budded on plum; but on their natural roots will no doubt do better on all the thin, sandy land of the South.

[This was a very good plum, but we do not want any more "wild goose plums." Everybody has the "true one," and yet we get no two alike. The only way out of this snarl is to drop the name "wild goose," and re-name the whole lot over again from grafted plants, with a proper pedigree to each stock. This seedling business has mused the whole race.—Ed. G. M.]

PEASGOOD'S NONSUCH APPLE, is the subject of a colored plate in the *Florist and Pomologist*, and is represented as one of the handsomest autumn apples they have. As figured, it is 13 inches round, and of a deep orange color, with crimson stripes on the sunny side. It is said to be "an apple of good quality."

DR. BOYNTON'S PEAR ORCHARD.—Some years ago the most beautiful pears "in the world" came to the exhibitions from the pear orchard of Dr. Boynton, of Syracuse. The trees at last failed, and went fast to destruction. Dr. B. had reason to believe that it was due to the system of ploughing and other deep cultivating practices then popular and prevalent, and gave up the surface-stirring practice. We met the doctor recently, and he reports that since that time the trees have done all that he can expect of them, and are in every way satisfactory.

THE APPLE CROP IN MASSACHUSETTS is very heavy, and although the pear trees are loaded with fruits, the pears are not as a rule so large and fine as they were last year. The pear-blight played sad work amongst some orchards near Boston.

ANOTHER WILD GOOSE.—A. Hance & Son write: "By to-day's mail we send a couple of specimens of wild goose plum. These were taken from a tree selected as a genuine *wild goose* out of a lot sent us by Sam'l A. Baker, Davidson Co., Tenn., the disseminator of the wild goose plum, and who claims to own the original tree. They are not quite up to the usual size, owing perhaps to the very dry weather we are having. There is also a beautiful bloom on the fruit as it hangs on the tree, but which was rubbed off those we send in picking. It may be seen about the stem, however."

[Please don't any correspondent write any more about wild goose plum. This is a good enough plum for a native plum, but no more

like Myers' than a damson is like a prune. They must be all named over again—then they will be "genuine."—Ed. G. M.]

---

## QUERIES.

---

CLASSIFICATION OF FRUITS.—In reference to note in our last, though not intended for publication, our friend will, we are sure pardon our giving the following:

UNION SPRINGS, N. Y. September 6th, 1876.

MR. EDITOR:—Please allow me to make a slight correction of the remark in the last number of the *Gardener's Monthly*, page 272, where I am included with those who "assert that any better system of classification [of fruits] than that of heterogeneous mass of descriptions, is visionary." The first revised edition of the *American Fruit Culturist*, issued twenty-seven years ago, had a distinct classification, entirely my own for most of the fruits, and nearly the same has been continued in all the editions since published. When Dr. Warder was preparing his work, he courteously asked me to allow him to adopt my plan, which he did with some modifications and additions. It is quite probable that important improvements might be made, as my chief object was to employ a simple one, readily understood by every cultivator, and readily used or applied at the time of the maturity of the fruits. I have not written this for publication, but it may be well to give its substance. Very truly,

"J. J. THOMAS."

FORCING RHUBARB.—"Reader," Bridgeport, Ind., says: "Will you please give us an article in the *Gardener's Monthly* on the forcing of Pie-plant; the plans and appliances to do the same in a *small* and also *large* way, the *ins* and *outs* of the work in detail and oblige an old reader."

[Rhubarb is so easily forced that there is really no art about it. Any one who has a greenhouse or warm cellar can have rhubarb any time in the winter by getting the roots from out of doors, and planting in these warm places. They require no light, but sprout and go on as do potatoes. Some put barrels over them in the open ground, and then a little strawy manure or leaves around the barrels, and this brings the stalks forward a few weeks before they would naturally come. So little heat starts the growth that forcing rhubarb is very easy.—Ed. G. M.]

THE RICHLAND PLUM.—Hoopes, Bro. & Thomas, West Chester, Pa., say: "We notice in *Gardener's Monthly* for August, in reply to G. & S. B., Norwalk, Ohio, you describe 'Richland plum' as a small copper-colored plum, &c., whereas the one we grow and 'Downing' describes is purple. covered with a thin blue bloom. Flesh, greenish yellow, juicy, sugary, good; last of August. Originated in Bucks Co., Pa. Is evidently a seedling of Blue Damson."

[The kind is the same as we referred to as seen in our markets, the "blue bloom" is rubbed off, and we take it to be as much "copper" as purple. But our correspondents have paid close attention to plums, and we are quite willing to adopt the term they prefer.—Ed. G. M.]

SUMMER HAGLOE.—G. W. says: "Please tell us whether you meant to say in September number of *Gardener's Monthly* that the Hame's apple, or Hagloe, is a month later than Red Astrachan. Grammatically it is Hagloe; but Elliott says the Hagloe is a month earlier. We have an apple which resembles 20 ounce pippin, and is known as Pennington Red Astrachan, but has been pronounced by Dr. Warder to be Hagloe, although it is a month later than Red Astrachan. Who is right?"

[We meant as it reads, that Hagloe is *later*. If we are not correct in this, we shall be glad to be corrected by those who have the kinds together.—Ed. G. M.]

## FORESTRY.

### EDITORIAL NOTES.

THE AMERICAN FORESTRY ASSOCIATION.—This society, preliminarily organized last year at Chicago, met, pursuant to resolution, at Judges' Hall, Centennial grounds, during the great Pomological week. The numerous attractions diverted attention from the meeting, and although some seventy persons attended the session, the meeting seemed small in so large a room.

Dr. Jno. A. Warder, President, with Mr. MacAfee, Secretary, called the meeting to order. Dr. Warder delivered the opening address, showing the great importance of the timber question to the nation, and to individuals, and how well calculated such a society was to help the cause along.

Dr. Hough, of Albany, New York, gave an address, showing that the constitution of the United States, and of most of the States, gave the right to interfere for the preservation of forests; that other countries had taken the matter in charge, and that forestry was progressing well under such national care. He made various suggestions calculated to aid the cause of timber culture, and thought that a journal of forestry,

out of the range of trade influences, should be established, if possible. Dr. Hough's address exhibited considerable research into meteorological and other classes of literature, and was delivered in a pleasing and intelligent manner.

Professor MacAfee reported on the condition of forest culture in the West, showing how the planting of trees had been going on to an immense extent, and that it was found the old notions about the slowness of timber growth had been derived from the hard struggle with nature, that wild timber had to make. Cultivated trees had grown so much faster than was expected, that people had been surprised at the growth, and it was now becoming generally known that wood came into profit much sooner than was thought possible years ago, and forest culture was much more popular in consequence. In his State at least 80,000 acres of timber had been planted during the few past years, and the work was still going on. He gave figures as to the growth of individual species, chiefly from facts within his own observation. The report was one of the most practically useful it has ever been our good fortune to listen to, on the subject of forest culture.

A proposition was made to unite the association with another body, called the Forest Council. Mr. Meehan inquired whether the objects of the two societies were the same. Mr. Geo. May Powell, Secretary of the Forest Council, said it would take too long to read the constitution of that society, but would say briefly that the objects were the same. Mr. Meehan said the object of his inquiry was an account of the notice of a meeting he had seen of the Forest Council in the newspapers. That report seemed to show that little business was transacted, except to endeavor to induce government to take hold in an especial manner of the forest interests of the country. The American Forestry Association, he thought, was working in a different field. It wished to make forestry popular by showing the profit there was in it—in short, by diffusing forest knowledge through the land. Mr. Powell then read two clauses of the Forest Council constitution, to show that they considered these matters also. A committee was appointed to consider the question of union.

Several members made remarks giving valuable information in regard to various trees they had experimented with in various parts of the country.

Mr. Meehan remarked on the pleasure it had given him to listen to the remarks of the different members, and especially to the papers of Dr. Hough and Prof. MacAfee, which two papers, taken together, he thought particularly instructive. He confessed to a fear on the organization of the society, that it might be drifted away from its legitimate purpose, and become little more than a mass meeting to urge on the government to do the work which itself was organ-

ized to do. It was all very well to know what the paternal governments of other countries were doing with timber culture, but he thought we needed no paternal government to supervise us here. He thought it a blessing that our government did not stand in the light of a parent to us, but was rather our servant, and he trusted he should never live to see the day when he might be ordered by a paternal government to plant a tree, or having planted one, be forbidden to cut it down. The two papers together, however, showed that we were doing very well. Dr. Hough had shown very clearly what the paternal governments did for their child-like people. Prof. MacAfee had shown what the people were doing without this fatherly interference, and surely the picture was everyway satisfactory. Those who clamored for government interference evidently had no practical knowledge of what was going on. 80,000 acres in one State made up for a great deal cut away in others. But this was nothing to what was going on elsewhere. A gentleman then present in the meeting had planted thousands of trees in Virginia, and in five years would have five thousand acres under timber culture. These people had faith that timber would pay, and as old timber grew scarcer, their faith would increase, and originate new faith in others. This was the proper plan, and he congratulated the society that it was taking this path. Individual effort, encouraged by State laws and agricultural and horticultural societies, would soon replace the decaying forests of our land.

Dr. Warder was re-elected President, Mr. MacAfee, Secretary, and Dr. Hough, Treasurer.

## NATURAL HISTORY AND SCIENCE.

### COMMUNICATIONS.

#### ON GRAFT HYBRIDS.

BY THOMAS MEEHAN, GERMANTOWN, PHILADA.

(Read before the American Association for the Advancement of Science, at Buffalo, August, 1876.)

Of late years an impression has prevailed that hybrids may be obtained by grafting as well as

by seeds. Sachs makes no mention of this in his text-book, but it has had a place in the literature of horticulture for over a hundred years. Bradley says that a variegated jasmine grafted on a common green stock infused the variegation throughout the whole plant; and there is an idea among some horticulturists that an intermixture in apples can be obtained by



uniting two halves of different buds and grafting them together. Thousands of people have laughed at these notions. No one has tried them. But only a few years ago it was found that Bradley was right; and we have in cultivation new variegated forms of *abutilon*, as well as some other things originated by the graft process. During the past few years it has been asserted that new varieties of potatoes have originated in this way:—a tuber is taken and all the eyes cut out. A wedge with an eye of another kind is then inserted into the eyeless mass and planted. The results are said to be true hybrids. Many of our best physiologists doubt this. I have not seen these cases; but I must say the evidence offered is much stronger than much of that on which some popular theories have been built. I tried the split and grafting process, not believing it would result in a hybridity. I merely wished to test the popular notion. I am pleased to be able to say now that it is correct. New varieties can be obtained in that way. I took the Rhode Island Greening and the Red Astrachan—two very distinct varieties of apples in every respect. The grafts with a single bud were split as near through the centre as possible, and a piece of each kind fitted together so as to appear one complete scion. Twelve of these were grafted; three grew; two of these have fruited; neither are Rhode Island Greening, and the two are unlike each other; one of these has a flower like the Rhode Island Greening, and the flower of the Red Astrachan is rosy and in many ways distinct from the large white one of the Rhode Island Greening; but the fruit is, in many respects, similar to that of the Red Astrachan. The second variety has the flower similar to that of the Rhode Island Greening, and the fruit somewhat the color of the Red Astrachan, ripening about the same time, but is but half the size, very much flattened, and with a slender stem near two inches long, and as much like that of a Siberian Crab as can be. There is no doubt but two varieties, distinct from their parents, and distinct from each other, have resulted from this graft process. Some may suppose that the union of a Red Astrachan and a Rhode Island Greening apple should result in producing an exact intermediate, and that the union of buds in several graft cases should each produce identically the same, and therefore the two distinct varieties from the same process be a surprise. But no two children of the same parents are exactly the same; and this is the experience of plant hybridists.

Our fellow-member, Mr. W. Saunders, of London, Ontario, crossed the American gooseberry (*Ribes Cynobasti*) with the red Warrington, an English variety, but both with hairy fruit. The hybrid product has smooth fruit, thus introducing a character not extant in either parent. And as regards variety, I have myself, from one single berry of a fertilized *Fuchsia*, produced several score of plants, among which no two were alike. I do not know that there is any pomological value in the new varieties of apples I have raised, but I am delighted with the scientific results, proving that hybrids by bud-grafting is more than a popular delusion.

---

#### NOTES ON THE AMERICAN GRAPE VINE MILDEW.\*

The grape vine seems to afford special inducements for the growth of fungi; Curtis, in his list, enumerating no less than eighteen species which grow upon it. "The grape disease, properly speaking, that which proved so disastrous at different times to the vines in Europe and Madeira, is caused by a fungus to which Berkeley has given the name of *Oidium Tuckeri*." It is a form of a fungus which has not yet been recognized in its perfect state, and is supposed to occur to some extent on this side of the water; but as many fungi have this *conidial* form, and some so nearly identical with it, and also growing on the grape, there may be some doubt as to our vines ever being attacked by the true grape disease of Europe.

The disease which most interests the grape growers of America, is the fungus called *Peronospora viticola* by Berkeley and Curtis. It is quite common, appearing on the under surface of the leaves about the first of August, and continues to flourish until the dying leaf will nourish it no longer. It can be most easily seen on the smooth leaves of *Vitis cordifolia*, as small frost-like spots, which rapidly spread, and soon cover the whole leaf, frequently extending down the petiole to the stem. This fungus, like the potato rot and other closely related species, thrives best in moist, warm weather.

Under the microscope, the tissue of the grape leaf is seen to contain an abundance of minute

---

\* An abstract of an article on this subject by Dr. W. G. Farlow, in the last issue of the *Bulletin* of the Bussey Institution.

threads, which force their way in all directions between the cells of the leaf, thrusting their suckers into the cells to rob them of their contents. When the time for fruiting comes, some of these threads push through the stomata of the leaf-branch considerably, in a definite and peculiar manner, bearing the conidial spores on their tips.

Under the head of the germination of these asexual bodies, Dr. Farlow has several interesting experiments. They germinate equally well in the dark as in the light. Those sown in the morning germinate more quickly and abundantly than those sown in the afternoon. It was not possible to keep the conidia which were produced in the night until the afternoon, as they generally fell from their attachments in the morning, and began to germinate. In all cases the germination took place with surprising regularity. At the end of an hour the conidia were slightly swollen, and their contents had begun to segment, each segment having a light-colored nucleus. At the expiration of an hour and a quarter, the segments had resolved themselves into a number of oval bodies, which collected at the distal end of the conidia, and which, before long, succeeded in rupturing the cell wall and making their escape from the mother cell. They passed out rather slowly, usually one at a time, and paused for a moment in front of the opening, where they remained as if not yet quite free from one another. In a short time each segment began to extricate itself from the common mass, moved more and more actively, and finally darted off with great rapidity, a full-fledged zoöspore, furnished with two cilia. The average number of these rapidly moving spores is from six to eight. Their movement gradually grows slower, and in fifteen to twenty minutes come to rest. Soon an outgrowth proceeds from one side, and rapidly develops into a new plant.

The *oöspores*, which are the result of sexual action, are found in autumn within the tissue of the shrivelled leaves as spherical, thick-walled bodies. They escape by the breaking up of the dry leaf, or through the decay of the surrounding tissue.

The fungus under consideration is common on *Vitis æstivalis*,—*Michx.*, *V. labrusca* L., and their cultivated varieties; *V. cordifolia*,—*Michx.*, *V. vulpinata*, and nearly all varieties of cultivated grapes. The statement is often made that it does not grow on *V. vinifera*. By carefully conducted experiments in the laboratory, Dr.

Farlow found this mildew could be made to grow on the leaves of this European species, and with the usual luxuriance.

It is quite gratifying to know that so common a disease as this one upon the grape does no real damage, but on the contrary is beneficial to the grape crop. It makes its appearance late in the season, when the large leaves have finished their work. By shrivelling up the leaves, the *Peronospora* enables the sun to reach the grapes without loss to the vines, as is shown by the fact that the vines continue to live on from year to year without apparent injury.

In Europe, where the "winters are warmer, the springs earlier, and the summers much moister than here, it is quite possible that the advent of the *Peronospora*, by reason of the greater warmth and moisture, would be some weeks earlier than here, before the vine had attained its growth, and at a time when the leaves are needed for the work of absorption and assimilation." Should this be the case, the disease which with us gives little cause for alarm, might prove very disastrous in the vast vineyards of Europe.

---

### THE SOUR AND SWEET APPLE.

BY W. S. W., PHILADELPHIA.

I have just read in the newspapers your speech at Buffalo on "Grafted Hybrids."

Some thirty years ago there stood in my uncle's orchard in Stafford, Conn., a small apple tree which bore fruit, one side of which was sweet and the other side sour. I was told that this result was brought about by inoculating a young tree with a half of two buds taken respectively from sweet and sour apple trees, and firmly joined together before the inoculation. I do not know what the varieties were that were joined together for the inoculation, but the hybrid product was of no account except as a curiosity. Indeed, so far as I remember, the fruit was apt to be imperfect in form, and not *always* possessing the characteristic of "one side sweet and the other side sour." A few years since I visited the place, hoping to procure a specimen apple for a scientific friend, but found that the tree had gone to decay. I have, therefore, to rely upon the impressions of my boyhood, and do not know that I could substantiate these statements by any one now living. Still I

have very distinct recollections of frequently experimenting with the fruit, principally, I must confess, to see whether it was good for anything at all to eat, and feel sure that my general impressions regarding its characteristics are correct.

[Because an apple is part sour and part sweet, is no evidence that it was produced by grafted buds. It is known that the Rhode Island Greening will be sometimes sweet, and sometimes sour. We know now that buds can be united, and the result is the blending of characters, forming a new individual kind—a true hybrid—but the experiments so far made do not favor the idea, that two distinct characters can be made to run along separately in one tree, so that the flowers, fruit, and so on, on some branches shall be of one sort, and on other branches of another. We know of no experiments which prove anything like this.—Ed. G. M.]

### FRUIT VARIATIONS.

BY T. T. LYON, PLYMOUTH, MICH.

I enclose you an account of a deformed specimen of Carolina June apple, which was brought in as a curiosity at a recent meeting of the South Haven Pomological Society.

The specimen is one of six apples, which were exhibited attached to the branch upon which they grew. The other specimens were of the usual form, and all were of the usual color of this variety. I add an outline of one of them also for comparison.

In color and flavor the abnormal specimen is not distinguishable from its fellows. Its core is slightly deformed nearest the stem, which is very short; and the usual fibrous connection of the stem and core is entirely dis severed. The larvæ of the codling moth had attacked the calyx and core, which possibly may have increased the malformation of the core. The seeds were plentiful, although partially destroyed by the larvæ.

The only apparent difference between this and the other specimens, so far as outward appearance or arrangement upon the branch are concerned, and aside from the change of form, consists in the fact that this was nearest the base of the branch, and grew upon a spur four or five inches in length, while the others grew upon spurs of about an inch in length.

This specimen is so perfectly and unmistakably

pyriform, that I at first suspected it to be a case of "spur grafting;" but a very careful examination of the spur and branch determines that nothing of this character had to do with the case, but that it is clearly an unusual "lusus naturæ."

[There is little doubt, we think, that these cases of pyriform apples are in no way connected with hybridization through pear pollen. It is in consequence of some as yet unexplained inherent law of growth. We call them mere lapses of nature,—sports, but it is worthy of note that these "lapses" are in an uniform direction when they do occur. The "monstrosity" does not resemble a peach, a pine apple, or a pomegranate—it is always the pear. This shows that it is not mere accident—it is law even in the aberration from law. Bearing this in mind, we can readily understand that a law which makes a pear in form and appearance out of an apple, and as a temporary production, can just as well make an actual pear out of an apple as a permanent existence, and it is just such experiences as these which prepare the mind for what are termed evolutionary doctrines. We are always glad to hear of these doings of nature.—Editor G. M.]

### PRAIRIE FLOWERS.

BY L. J. TEMPLIN, HUTCHINSON, KAN.

(*Callirrhoe involucrata*.)

Among the earliest flowers that may be seen on these plains is the above member of the Malom family. The general form of the leaf is round, but it is parted or cleft and cut-lobed. The root is thick and fleshy, resembling a parsnip in form, and frequently reaching an inch in diameter. It is a perennial, being perfectly hardy here, and extending into Nebraska, and far up toward the mountains. Several stems grow from one root, and these spread out on the surface of the ground, and are thus rendered rather inconspicuous after taller vegetation has advanced somewhat. But, though humble in its manner of growth, this plant compels the attention of all who come near it by the brilliancy and beauty of its numerous flowers. The flowers grow on axillary peduncles that are from two to five inches in length. The flowers are about two inches in diameter, and vary in color from a brilliant scarlet to a dark mauve, excelling in size and rivaling in brilliancy the most

splendid varieties of portulacca. Beginning in May, they continue to bloom in great profusion throughout the whole season. Where several of them grow near together, they cover the surface with their branching stems, and make a bed of dazzling beauty throughout the summer. It seeds freely, and the seed is easily procured by a little attention. It is quite tenacious of life, and it is readily transplanted, so that it is an easy matter to have a fine bed, or even a whole yard or lawn covered with these rich colored flowers. Occasionally we see them transplanted to the garden or yard here, but on account of their commonness but little attention is given to their cultivation. This is certainly worthy of more attention in the States further east than it is receiving.

---

### EDITORIAL NOTES.

---

**POISONING BY LABURNUM.**—The leaves, and especially the roots of Laburnum, are poisonous. European papers often have accounts of injury to the health of animals that have eaten it.

**TREES, RAIN-FALL, AND THE LAKES.**—M. Faribault, Minnesota, desires "to know whether the lowering of the water level of some lakes is not an evidence that the rain-fall is diminishing by the cutting away of the forests?" We have no wish to revive this controversy. We will only say that if it is evidence to him, it is not to us. Lakes sometimes rise as unaccountably as they fall, and we are inclined to think no one knows why. Never mind the lakes, however. Plant trees. We shall need all for timber, whether the lakes rise or fall or not.

**AGE OF THE MAMMOTH TREES.** *Sequoia gigantea.*—Professor Gray has steadily combated the popular notion that these trees are several thousand years old. Mr. J. G. Lemmon, one of the most esteemed of California botanists, has recently sent a long account of a visit to the trees, to the *Pacific Rural Press*, from which we take the following extracts:

"The stump of the very large tree which was bored off with pump augers in 1852 to form the floor of a house, affords a fine opportunity for counting, since it is so evenly smoothed off; but still more time is necessary to do it accurately than most observers allow themselves. This tree should certainly be considered a fair sample of

the oldest of the present generation, for it is one of the largest ever seen. Its circuit at base is 97 feet by my tape line, held at one end by a Puritan and master builder from Boston. Longest diameter without bark, five feet above the base, 24 feet 10 inches. Shortest diameter, 22 feet eight inches. The bark averages 18 inches in thickness, making the entire longest diameter of the tree at five feet above base, over 27 feet. A few other trees are met with measuring as much or more at base, but they are generally swollen outward, and hollow like the shaft of a light house. This monster tree was as straight and sound as a candle, hence it was undoubtedly the largest perfect tree ever yet seen.

I spent nearly a day counting the rings of this stump, and of the butt cut of the tree lying near it. I counted carefully both ways, putting in pins to mark the place of hundreds. The stump being a little irregular in consequence of its near roots, I counted in three places along three equidistant rays. The first count was 1,260 rings, the second count was 1,258 rings, and the third count was 1,261 rings—average age, 1,260 years. Counting on the butt, cut 24 feet from the base, the rings were of course a few less, 1,242 in number, but all very plainly discernible, and presenting exact uniformity in their decrease in thickness from heart to bark. I availed of this uniformity of decrease by establishing, after many counts of different trees, a rule for determining the mean number of rings to the linear foot, and fixing the locality on a cut across these trees where the rings are of average thickness. That point is just one-third of the distance from the bark to the heart. At the heart the grains are often three-eighths of an inch thick, at the bark as thin as paper. The average, as determined by countings of all the logs in the grove which have been cut across, some half dozen or more, clearly established the rule that the rings of average width are found one-third of the way from the bark to the heart. This rule proved very useful afterward in estimating age of broken trunks.

As late as February last the writer saw a specimen of Sequoia in the Central Pacific railroad collection at San Francisco for the Centennial exhibition, which was sent from the Calaveras Mammoth Grove, and is marked "four thousand years old."

Now I firmly believe with Dr. Gray that this is an "over-statement," and, as I said, I am glad that it is such. Let India with her banian tree

—which by the way is a mass of trunks, not a single one—take the palm for growth of 4,000 years; let African baobab trees reach back still nearer to the Garden of Eden; let Palestine boast of her cedars of Lebanon growing since Moses' time, and let Australia present upon every exploration by the close observer, trees of undeterminable ancient origin; all these trees of the old world almost, without exception, are slow-growing, fine-grained, stunted, gnarled, decrepit, unsightly old relics of past ages—only interesting because of their great age.

The famous baobab, *Adansonia digitata*, is the largest in circuit at base of any tree yet known, but it is only 70 to 80 feet high. The cedar of Lebanon, with annual layers, so fine that a lens is necessary to distinguish them, is similar in shape, the trunk an abruptly tapering spike.

Now all observers admit that the California Big Trees, with their vast straight-fluted columns, 200 to 300 feet high, and their immense crowns of finely divided, evergreen branches, are the most symmetrical and magnificent in form, the tallest and actually the largest in dimensions of any yet known in all the world. How satisfying to the pride of a true American, to reflect upon the inference derived from this comparatively new fact—formerly a most unwelcome one to the thoughtless, inasmuch that loyal Californians prove their loyalty by declaring their belief in the great age of the Big Trees; hence the warfare to which Dr. Gray refers, and the great but pardonable assistance given to the erring side by eminent writers through their praiseworthy love of country.

But Science always searches for the truth. Sooner or later the facts will come to be believed, and they are always best. And the truth, in this case so long repressed, is most welcome, because it gives foundation for the most reasonable and enthusiastic loyalty. Why, these grand giant trees are mere vigorous saplings yet, only 1,200 to 1,500 years old! Ages hence full-grown trees may be seen 50 feet in diameter and 1,000 feet high, only limited by the proximity of brother trees and the depth of the valleys where found. We can't expect them to be so unneighborly as to choke their brothers to death, nor to rise above the leveling winds that sweep over the canons of the Sierra. So let the old world pride itself upon old things, old nations, old creeds, old arts, old customs, old monuments; we of America rejoice that this, a new, unfinished

world, with young yet colossal vegetable growths, strange yet beautiful animal forms, modern yet matchless peoples, adolescent yet full-fruit-bearing institutions, unprecedented yet unimaginable destinies!

“For still the new transcends the old,  
In deeds and wonders manifold.”

COCOANUT PALM (*Cocos nucifera*, LIN.) is very widely distributed between the tropics, generally affecting the neighborhood of the sea, and especially abundant in India and the Pacific Islands, where its tall and cylindrical trunk, from 60 to 100 feet in height, crowned with many gracefully waving feather-like leaves, fringes every islet and forms one of the most striking beauties of the scenery.

Almost every part of the tree, as in a few others of the palm tribe, is applied to important uses. The wood, imported into Europe under the name of *porcupine wood*, is employed for building purposes, the construction of chairs and fancy articles. From the leaves, besides their general use as a thatch and in hut-making, baskets and screens are made, while those young and tender are cooked and eaten. Of the well known nutritious fruit, the coconut, several bunches of a dozen or more are borne by each tree. From the shell of the mature nut, various useful or ornamental vessels, spoons, &c., are cut and carved, and from the fibrous rind or husk which envelopes it is prepared the “coir” of commerce, so extensively used in the manufacture of mats, carpets, brushes, cables, bags, &c. The fibre is prepared from the husk by steeping and beating.

From the kernel, boiled and bruised or grated, is obtained the coconut oil largely employed in the manufacture of excellent candles, and also of soap. Of this oil, in 1870, 197,788 cwts. were imported.—*Pharmaceutical Journal*.

## QUERIES.

CLASSIFICATION OF THE MINUTE FUNGI.—Prof. Bessey, Ames, Iowa, says: “I must enter a protest against friend Stauffer's article, ‘Ring Forming Fungus,’ in September *Gardener's Monthly*. Had the writer thereof consulted Dr. Farlow, Dr. Peck, or any one else versed in mycology, he would not have inflicted upon us those hard names, while he was guessing for one to fit his wonder. He probably had, judging from his description, one of those curious organ-

isms known as the *Myxomyceta*, and it is more than likely that it was *Spumaria alba*, as I have found this species presenting an appearance exactly like that noticed by Mr. Stauffer.

And while I am about it, I may as well say that Mr. S. might have as properly given us the old 'Linnæan System' for our flowering plants as the one he outlined for fungi."

## LITERATURE, TRAVELS & PERSONAL NOTES.

### COMMUNICATIONS.

#### LAWS FOR NURSERYMEN.

BY GEO. HASKELL, IPSWICH, MASS.

I see by recent statements in the *Monthly* that land-owners in Pennsylvania and New Jersey are still living under the old common law rule, "that there can be no larceny of the freehold or of anything annexed thereto." Ninety years ago Massachusetts, by statute, limited the application of that rule, and at several times since then statutes have been passed for the protection of the soil and its products, so that now we are annoyed but little by intruders.

Under existing statutes it is provided that:—"Whoever by a trespass, with intent to steal, takes and carries away anything which is parcel of the realty or annexed thereto, the property of another, against his will, shall be guilty of such simple or aggravated larceny as he would be guilty of if such property were personal property."—Gen. Statutes, Chap. 161, §25. By Section 81:—"Whoever wilfully commits a trespass by cutting down or destroying any timber or wood standing or growing on the land of another, or by digging up or carrying away any stone, ore, gravel, clay, sand, turf or mould from such land, or any root, fruit or plant there being, without the license of the owner thereof, shall be punished by imprisonment in the jail not exceeding sixty days or by fine not exceeding fifty dollars.

By Section 83:—"Whoever wilfully enters any orchard, nursery, garden or cranberry meadow and takes away, mutilates or destroys any tree, shrub or vine, or steals, takes and carries away any fruit or flower, without the consent of the owner, shall be punished by a fine not exceeding one hundred dollars or by imprisonment in the House of Correction not exceeding three months."

By Section 84:—"Whoever wilfully commits a trespass, by entering upon the garden, orchard or other improved land of another, without permission of the owner, and with intent to cut, take, carry away, destroy or injure the trees, grain, grass, hay, fruit or vegetables there being or growing, shall be punished by imprisonment in the jail not exceeding thirty days or by fine not exceeding twenty dollars; and if any of the offences mentioned in this or Section 81 are committed on the Lord's day, or in disguise, or secretly in the night-time, the imprisonment shall not be less than five days, nor the fine less than five dollars."

It will be seen that these sections are applicable to different acts of offence. I have not copied the statute with literal fulness; but the foregoing are correct abstracts of our laws, and they may afford aid to those who desire similar protection in other States.

### LET US PROFIT BY THE EXPOSITION

BY RAMBLER.

The Exposition has (Sept. 10) but sixty days more to live, and how many gardeners have seen it?

Such, Mr. Editor, were the objects of my reflections while coming home from the fruit show yesterday, and well might every man of an observing nature cogitate on the above questions, for fully one-half of the gardeners I come in contact with, have not visited our "glorious Centennial," and the other half not more than once or twice, the last being a rare exception.

Now, what I wish to call attention to is this: that some of those who make a great "blow" and noise about their "loyalty, independence and liberty," are first to patronize and aid any undertaking connected with this Centennial celebration that will bring their name into

prominence before the public as generous and liberal, while the same men have not offered their gardeners a day this summer for recreation and enjoyment, and to witness this mighty show. Not only would the gardener be benefitted, but his employer would also be, for the lessons to learn are numerous—if only to study the landscaping, the Horticultural Hall and the beds around it, which speaks highly for the taste and judgment of the "Horticultural Bureau," and a keen observer will pick many a valuable "wrinkle" in the gardening line.

I have been waiting patiently to see if the veteran Harding or some other "able genius" would have a plea through your valuable journal for the working gardener; and not only for the gardeners, but for those also who have the dignified position of helping the cook and Bridget, the scullery maid; whose temperaments are so well balanced as to be able to hold the offices of gardener, coachman, boot-black, errand boy and God knows what, combined! Those who hold the position of gardener, in the literal sense of the word, are very few and far between, and let the gentlemen who employ both classes study the matter. Let those who employ the first, and treat them as such, give them a few days between this and the end, with a few fifty-cent pieces in their fists; and let those who employ the others, whether they are peanut venders or insurance agents, give their men a day, without a murmur, and without a fifty cents. It will not only give new energy, but it will be an indebtedness the servant will owe his master, and an object for which he can retaliate by a more faithful, industrious and grateful future.

#### CHARLES READE ON FLOWERS.

Father Leonard is eloquent and Mrs. Gaunt listens to his church discourses with rapt attention. He lives in a sort of monastery with another seminary priest and an old servant of Mrs. Gaunt's, now a widow, Betty Gough, is the house-keeper. Her little kitchen is a glorious place compared with the parlor, for it is illuminated with bright pewter, copper vessels, brass candlesticks and a nice clean woman with a plain gown kilted up over a quilted petticoat.

Betty sees Mrs. Gaunt driving by one day and asks her to come in and see her place. The priests are abroad until supper time and so Mrs. Gaunt smiles and goes in. She shivers in the cold gloom of the parlor, but she says he preaches

so divinely, doubtless, angels come and brighten the place for *him*.

"Not always," says Betty, "I do see him with his head down on his hands by the hour, and hear him sigh ever so loud."

"Betsy Gough!" says Mrs. Gaunt, "let you and me sit down and see what is wanting, (for she pities him whom she has long revered). "First and foremost methinks this window should be filled with geraniums and jessamine and so forth. With all his learning perhaps he has to be taught; the color of flowers and golden green leaves with the sun shining through, how it soothes the eye and relieves the spirits! yet every woman born knows that. Then do but see the bare table. A purple cloth on that, I say."

"Which he will fling out the window," says Betty.

"Nay, for I'll embroider a cross on the middle with gold braid."

"Oh, bless your heart! he's all for mortification."

"Well, we must begin with the flowers; God made them, and so, to be sure, he won't spurn *them*."

"Ay, ay," said Betty, "the flowers first."

They plan other improvements, and Mrs. Gaunt sends her gardener with a load of flowers in pots, which Betty helps to arrange in the window and on the outside.

Brother Leonard comes with his eyes down and does not see the flowers. But when he enters his room Betty hears a profound "Ah!" She bustles in and finds him standing in a rapture.

"Now, blessed be the heart that hath conceived this thing and the hand that hath done it. My poor room is a bower of roses—all beauty and fragrance."

One day he found two watering pots in his room marked with a cross. "That means nobody's to use them but you, I trow," said Betty, rather crossly. But our extract is already long enough.

The *Gardener's Monthly* is eminently practical, and we seldom find much on the *sentiment* of flower culture. Indeed this is perhaps too efflorescent a thing to be appreciably considered by our ordinary senses—it is a mere blossom *of the blossoms*, and yet it meets real spiritual needs and is relishable now and then, like nonsense—e'en by wisest men.

The following items may serve to illustrate this:

"A Flower Sermon" is preached every year at St. Katharine Cree Church, Leadenhall street, London, on Whit Tuesday evening. On the last occasion all parts of the edifice were crowded, chiefly with young people, most of whom brought nosegays according to request. The charity children in the front gallery had all been supplied with bouquets, and they presented a pretty sight. But for the high pews the parterres would have been as regular and conspicuous below.

It is now twenty-five years since Dr. Whittemore preached the first of these annual flower sermons, thinking thus to interest the hearts of his youthful parishioners. There is always a bouquet in the pulpit, which the preacher never fails to smell before beginning his discourse. It was first presented by a little girl who is now a grown up woman with children. At the close of the service when the congregation were dispersing, it was interesting to see the gutter children clustering around the doors, begging eagerly for flowers, which were freely bestowed upon them by their little friends to whom Providence had been more kind.

The holiness of flowers. They are everywhere over the earth, evidently given to remind us that there *is* an Eden, and that we may regain it. During the cholera visitation of 1866 an unknown man walked from bed to bed in the London hospitals laying a flower on every pillow, with the words, "For Jesus' Sake." His gift, inspired by a thought, in the night had sublime effect. In 1874 a snow-drop, a primrose and two or three violets were sent in the early spring to a sewing circle of poor widows. They were passed around two hundred hands for their fragrance and freshness to be enjoyed, and then divided among three dying persons, one of whom passed away clasping them.

Still we hear—and often hear—the sneering question, What's the use of flowers? you can neither eat them nor wear them.

---

### EDITORIAL NOTES.

---

PATENTS FOR PLANTS AND FRUITS.—Lex.—It is extremely rare that we decline to admit articles to our columns that are not of a personal character, and never for the reason that the writer differs from our views. Any respectful article is admitted to our pages, provided it tells anything

new, or is not evidently written under a misapprehension. "Lex" wants to know why we did not publish an article of his. It was for the last reason. He tried to show that the *Gardener's Monthly* is wrong in maintaining that there "should be no laws protecting the originators of fruits and flowers." On the contrary we believe there should be such laws. But the laws proposed by some people are so thoroughly impracticable that we decline to have our space wasted in discussing them. The "laws" are about as good as they can be now. We know of a person who has been some six years working on a new plant, and who will probably realize \$20,000 for his "labor and skill" next year. This is as good as he would probably do under any "patent law." Indeed, there are plenty of ways by which the originator of any good thing can be "protected" now, provided he *has* a good thing, and has the proper judgment to make use of these ways. If he has not this, not even a "patent law" will help him. "Lex" misunderstands us; that is why the paper did not appear.

THE JUDAS TREE.—The *Cercis canadensis*, our "Red Bud," is known as one of the Judas trees, on one species of which, it is said by Gerard, Judas hung himself. But popular tradition in the East makes the Elder tree the one. Our American Elder is but a weak shrub, but the European and the Pacific representatives of the genus grow to the dimensions of small trees.

THE FONT GROVE GREENHOUSES.—At Slingerland's, 7 miles from this city, on the Albany and Susquehanna railroad, are the Font Grove greenhouses, belonging to James Hendrick, Esq. There are in all about 1,500 running feet of roofs, part of which are similar to those of Peter Henderson, in Jersey City. One of the houses, however, is widely different from anything we have before seen. It is in the shape of the Geddes harrow, having wings branching off from the central house at an angle of 45 degrees. The heating apparatus is placed in the central building, and as this is on the lowest ground, the wings are readily heated, partly by flues and partly from a saddle boiler placed over the furnace. By this arrangement an unsightly hollow is utilized, and the several greenhouses are heated at a minimum cost for pipes and flues. An \$85 Albany boiler is found ample to heat 680 feet of pipes. The central building is double the height of the others, and was intended for camellias, azaleas, &c., and proves well suited to



that purpose. Notwithstanding the great height, the gardener, Mr. Whittle, has found no difficulty in keeping up the necessary temperature—the thermometer never falling below 45°, even when several degrees below zero outside.—*Country Gentleman*.

ROSES IN ANCIENT FESTIVALS.—Lovers of roses are bound to be shocked if you tell them that their favorite flower was at one time intimately identified with convivial customs; so that to talk in one's cups was to talk *sub rosa*, and the nice nonsense about Harpocrates and the sublimity of silence is the nonsense that it looks. The Bacchanals, who made piety a pretext for licentiousness, dedicated the ivy to their luscious god, but the more profane revellers of old time preferred the rose, and with it crowned themselves and their lady-loves, and as a matter of course steeped its petals in their wine. It may be information to some lovers of roses who are inclined to be shocked at this association of the flower with the flowing bowl, to be told that the wine of the ancients was sorry stuff, badly made, and badly kept, and that some of the choicer sorts had a decided flavor of turpentine. Hence the steeping in it of rose-leaves and ivy-leaves and other balsamic herbs was in some degree necessary, as at this day the Germans steep the flowers of Woodruff in their Rhine wine, and the manufactures of sparkling Moselle flavor that exhilarating liquor with herbs the names of which they carefully keep secret. If any one doubts about roses having a convivial history, he may turn with advantage to Anacreon, and afterwards to Horace, and he will not long remain in doubt. In the famous fifty-third ode of Anacreon we are told how the rose originated and became an emblem of merriment and gallantry.—*M. in Gardener's Magazine*.

MONUMENT TO M. LOUIS VAN HOUTTE.—Nearly a thousand francs had been raised by the 1st of August for this purpose, by the horticulturists of Northern Europe and America.

FOURTH ANNUAL REPORT OF THE KANSAS STATE BOARD OF AGRICULTURE.—From Alfred Gray, Secretary, Topeka, Kansas.—If one desires to know just what Kansas is, we know of nothing which gives so clear an idea of the State as this admirable report.

TRANSACTIONS OF THE WISCONSIN STATE HORTICULTURAL SOCIETY.—From F. W. Case, Secretary, Madison, Wis.—This is the report chiefly of the

annual winter meeting at Madison last February. The apple, which is the great fruit of Wisconsin, receives exhaustive attention; but there is much notice taken of grape culture, flowers, cranberries, small fruits and ornamental trees. The Report is neatly bound, and gotten out at the expense of the State. It has 64 members.

ORCHIDS.—F. L. Ames, Esq., of North Easton Mass., has bought the entire orchid collection of Mr. Edward Rand. Mr. Ames' collection of stove and greenhouse plants and orchids is one of the most extensive and select and best kept in the country.

BOTANICAL PARTY.—Dr. Engelmann, W. M. Canby, John H. Redfield, Dr. Asa Gray, of the Botanical Gardens, Cambridge, have returned from a botanical tour in the Carolinas.

---

### QUERIES.

---

HABITS OF VAN HOUTTE.—“A Reader,” Geneva, N. Y., says:—In your account of L. Van Houtte it says he begun work between one and two in the *morning*, continuing until 8 P. M., with less than one hour's intermission. Is there not a mistake here, or is it usual for European horticulturists to begin work in the middle of the night, and eat only one meal a day?

[We do not know much of the habits of European nurserymen, but we have known of many American ones, whom the necessities of their business often compelled to be up till near daylight before they could go to bed. The writer of this paragraph, in the earlier days of his business life, had often enough to be up by “one or two in the morning”—not occasionally, but as a tolerably regular thing. We doubt whether there is any body of men who work so hard and get so little, in Europe or America, as the nurserymen. Our school books used to tell us, “if you are industrious, you will be rich;” but it is a well known fact, that after all these long hours of industry, nine-tenths who start the business fail. It seems to a looker-on a very simple thing to plant a nut and wait four years only to sell it for a dollar. Scores are misled by these appearances every year, and sink money. Success in the nursery business means “early and late,” and then the chance is often ten to one against you. This experience of American nurserymen is the best help we can give our “Reader” to understand Van Houtte's case.—Ed. G. M.]

# HORTICULTURAL SOCIETIES.

## COMMUNICATIONS.

### INTERNATIONAL HORTICULTURAL EXHIBITION, OF 1877, AT AMSTERDAM, IN THE PALACE OF INDUSTRY.

BY H. GROENEWEGEN, SECRETARY, AMSTERDAM,  
NETHERLANDS.

His Majesty, the King of the Netherlands, has deigned to accept the patronage of this Exhibition and to express sincere sympathy with the aim the Commission has in view. In consequence, the Exhibition finds itself powerfully supported, and the chances of success have considerably increased.

The Board of Directors of the Exhibition, now constituted, have been duly empowered by the Commission for the regulation of National and International Horticultural Exhibitions in the Palace of Industry and by the deputies of the co-operating horticultural societies and similar associations and establishments in this country.

It is intended to establish Correspondents in all the provinces of Netherlands, to whose care the promotion of the interests of the Exhibition will be entrusted.

Though the duration of the Exhibition cannot be fixed at present, it may be safely relied upon, that it will be opened in the month of April 1877.

The Programma of the Exhibition of Horticultural Products (not to be mistaken for the Exhibition of Vegetable Produce, of which the projected programma has been inserted in Bulletin No. 2) will be distributed simultaneously with the present Bulletin. This Programma is only provisional, as it will shortly be followed by a statement of the prizes to be awarded, and of the regulations for the contribution of articles and subsequent competition.

Applications have been made to the Directors of Railway, Steamer and other Companies in order to obtain lower freights and thereby to reduce the expenses on the expected packages.

The Board is happy to state that it has not been disappointed in its expectation of obtaining the moral and material aid of the Dutch Government.

On application to the Minister of the Interior, His Excellency has graciously expressed his readiness to realize the wish of the Board, that official Committees may be constituted in foreign countries, in order to promote the interests of all who contribute.

The Minister of Colonies, on being solicited to have the Programmes and Bulletins spread among colonial establishments, corporations, officials, and all those who might be judged competent to further the aim of this International Horticultural Exhibition, has readily complied, and forwarded the documents, relating to this matter, to the parties concerned.

In conformity with the request for free conveyance of products from Dutch Colonies and Possessions, His Excellency has invited the Governor-General of Dutch India and the Governor of Surinam, to facilitate as much as possible the free transmission to Dutch harbors of packages, intended for the Exhibition.

On application to the Minister of Foreign affairs, soliciting his aid to promote the contribution of products from foreign colonies and from countries beyond Europe, His Excellency has been pleased to inform the Board, that the Dutch Embassies and Consulates have been invited to lend their support towards the promotion in foreign parts of the aim and interests of the undertaking, by distributing programmes and giving information on the subject, when desired.

In consequence the Board have already received copies of dispatches from the Consul-General at Bern and the Minister-Resident at Rome, containing some observations and particulars, which were read with great interest and acknowledged with thanks.

On application to the Minister of Finances, His Excellency has decided, that, subject to certain formalities to be made known afterwards, the custom-house examinations are to take place on the grounds of the Exhibition, and that freedom of duty will be granted to dutiable goods, which may remain unsold and be re-exported.

Amongst various communications, all manifesting the greatest sympathy with the under-

taking, the Board begs to make mention with particular pleasure of a letter from Mr. Otto Blanck, Consul at Stockholm, in which this gentleman not only expresses his readiness to contribute to its realization, but also informs the Board, that he has already commenced operations by distributing the projected Programma of Vegetable Produce, after translating it into Swedish.

As already observed on a former occasion, the Press has shown by its co-operation its warm sympathy with the undertaking; and the editors of the most accredited Dutch and Foreign periodicals and newspapers, wishing to lend their valuable aid, have inserted the Programmes and Bulletins in their publications, of which the Board have received copies.

To be had on post-paid application:

a. The programme of the Exhibition of Vegetable Produce.

b. the programme of the Horticultural Exhibition.

Both a and b, not only in Dutch, but also in French, German and English.

Please direct all letters and communications, connected with the Exhibition, to the General Secretary of the Board, Mr. H. Groenewegen, 5, Oetewalerveg, Amsterdam.

[It is very pleasant to us to be able to lay this letter before our readers, showing as it does, how deep is the interest in horticulture in the old world. Horticulture does not mean there as it often does here, the growing of a few fruits and vegetables for market, but it is a tasteful art, cultivated by all to as great an extent as painting or music, and we hope to see it so here some day. —Ed. G. M.]

#### POTOMAC FRUIT GROWERS.

BY G. F. NEEDHAM, WASHINGTON, D. C.

JUNE.—On the sample tables were fruits as follows:

*Strawberries*.—C. Downing, Dr. Hexamar's seedling, Mountain Beauty a promising plant of the Potomac region; seedling Eliza Fillmore, Monarch of the West, Star of the West, Boyden's 30, Triumph de Gand, Wilson, Agriculturist, Champion, Jucunda, Napoleon III., President Wilder and Col. Cheeney.

*Cherries*.—E. Richmond, Empress Eugenie, Black Eagle, White Heart and Belle de Choisy.

*Apples*.—Tukesbury Blush, well preserved specimens from last season's fruitage.

The tables were ornamented with a rich and extensive show of roses, peonies and penstemons.

JULY.—Flowers again garnished our tables, conspicuous among which was a fine display of gladiolus. The fruits entered to-day were:

*Peaches*.—E. Beatrice, Louise, Rivers and Hale's. The two first-named were well nigh out of season, as they had been put into the market some two weeks previous (the last of June). The Hales were not matured.

*Apples*.—Astrachan, Harvest, Rose, June, Strawberry, Hagloe, Edward, Summer Pearmain, &c.

*Pears*.—D. d'Ete, B. Gifford and Honenschenk, all of which lacked a few days of maturity.

Downing's Mulberries, Long Branched Red, R. and W., Dutch, Victoria, Prince Albert, W. Grape and W. Bologna currants, Utah seedling, Houghton's and Downing's gooseberries.

Prof. Howland exhibited and explained a working model of "The Regulator" wind-mill, one of which he had recently erected on his farm at an expense of \$250. He considered it the *ne plus ultra* of wind engines, it being automatic, so that the harder the wind blows the more it don't go. Manufactured at Marshall, Mich.

Prof. Brainard, of the Patent Office, read an interesting paper on "The Food and Diet of Plants."

The key-note is in the concluding paragraphs, as follows: The sources of plant food may be gathered from some analyses and contrasts. Plants feed on carbonic acid, animals give it off. Plants give off oxygen, animals consume it. Plants decompose carbonic acid, water, ammonia, etc., animals produce them. Plants produce nitrogenized compounds—albumen gluten, casine, etc., animals live upon them. Plants also produce non-nitrogenized compounds—starch, sugar, green oil and acids, animals consume these. Plants endow mineral matter with properties of life, animals deprive them of these properties. Plants impart to chemical atoms the power to nourish animals, these reduce organic matter to a condition suited for the support of plants. Plants convert simple into complex forms, animals convert complex into simple. The plant is an apparatus for deoxidation; the animal an instrument of oxidation. The plant is a mechanism of construction, the animal a mechanism of reduction. The plant absorbs heat and electricity, the animal produces them.

From these observations we infer that animal excretions, especially urine, afford most valuable and appropriate food for plants. And our cities are impoverishing the country by emptying their sewers into the rivers. The time will come when this wanton waste will be stopped, and the wasted matters will be utilized.

A convenient method of saving this liquid manure is to collect it in a cask and deodorize with dry earth or coal ashes.

A recent number of the *Scientific American* states that two ounces of kerosene oil and six gallons of water make an excellent fertilizer, as also an antidote to the ravages of insects. It is to be applied with a watering pot between the rows of plants and round the trees.

---

### EDITORIAL NOTES.

---

**THE CENTENNIAL EXPOSITION.**—It is but fitting that with the maturity of the exhibition fruits should pour in with great abundance. It has indeed been the great feature of the month. No such an exhibit of fruits was ever made on this earth; and Americans had reason to be more than ever proud of their country, as the foreign visitors showered encomiums on the great exhibit. Among those who have especial reason to be proud is chief Landreth. There is no department of the exhibition that has had so difficult a road to travel as the Agricultural. It is no secret that the plan as originally drawn out and partially acted on almost ignored Agriculture and Horticulture. At the eleventh, or, more properly, near the twelfth hour, the subject was taken up. Horticulture had an early recognition from Philadelphians, and the great conservatory became a part of the original plan; but the commission never seemed to know what to do with it, and instead of its having any bearing on the great central idea of the exposition—the giving of the people an idea of how horticulture has progressed in America during the last century—it became a mere deposit for a few palms and economic plants, chiefly from the United States Botanic Garden and the Department of Agriculture. Fortunately the Bureau fell into the charge of an excellent practical landscape gardener, who succeeded admirably in showing what good summer bedding plants can be brought to in our climate. That branch has not

shamed America; but there was no place at all for fruits in the Horticultural Department, where all over the world it would naturally be placed, and so pomology was turned adrift to the cold charity of the world till Agriculture ran against the little child and took the foundling in. Thus it has been with Mr. Landreth. He has had to work without time for any well-digested and uniform plan, and hence has had to make all things work in together as they came up as best he could. In spite of all this the Agricultural Department has been one of the most successful of the whole exhibits, and we are satisfied that if the visitors could be polled by the Finance Committee, to know where the dollars came from, the vote would be that more came attracted by the Agricultural Department than by any other—the Government building, perhaps, excepted.

But just now we are dealing with the fruits. We will pass over with a mere reference to doubts, annoyances, and innumerable difficulties which surrounded the agricultural chief—especially at the hands of those who would no doubt have been assistants instead, if they could have understood the exact situation of things. The only honest critics of the department are those who have had only a partial knowledge of the surroundings. Yet, in spite of all these difficulties, nothing could be finer than the show.

The fruit was arranged in long, narrow tables of three shelves each. The real magnificence of the whole, as seen at one glance, would have been better appreciated by flat tables, but this would have seriously interfered with the examination of the fruit by the judges, and the facility for reading the names and studying the fruit by the visitors. One or the other idea had to be sacrificed, and we think the management acted wisely in preferring instruction to mere general effect. The chief exhibitors were the Massachusetts Horticultural Society; Worcester County Society, of Mass.; Benj. G. Smith, of Cambridge, Mass.; John Cummings, of Massachusetts; J. W. Manning, of Reading, Massachusetts; A. S. Sheller, of Lewisburg, Pa.; Berks County Agricultural Society, of Pa.; J. A. Nelson, of Indian Run, Pa.; H. M. Engle & Son, of Marietta, Pa.; Ellwanger & Barry, Rochester, N. Y.; Mr. Ricketts, Newburg, New York; Minnesota Horticultural Society. The State Society of Iowa, James Smith, Des Moines, Iowa, and the individual entries from Iowa, were quite numerous. Of these we noted some fine fruit from E. H.

Calkins, R. S. Willett, W. W. Carhart, G. Hollingsworth, David Leonard. Michigan had excellent representatives in J. W. Humphrey, of Plymouth, H. Dale Adams, and the Michigan State Pomological Society. Canada received great praise. She has made continuous exhibits from the opening, through the Fruit Growers' Society of Ontario, and on this occasion excelled even herself. The plums especially attracted universal praise. Mr. Dougall, of Windsor, and Arnold, of Paris, were conspicuously prominent by instructive items in the exhibit. Indiana did very well through her secretary, W. H. Ragan, as did Connecticut through Mr. Augur. Among those from the State whose contributions attracted observation, we noted General Noble, B. H. Atwater, C. P. Augur, David Williams, T. C. Austin, P. M. Augur, P. H. Ashton, S. D. Bradford, W. B. Gear, S. Hoyt & Son, Nathan Hart, T. S. Gold, S. S. West. Ohio had a very fine collection of fruit, but we understood that the State would pay no one to properly exhibit them, and so no one knew names of fruit, or of parties who sent them, which was unfortunate. In like manner unfortunate was California. The fruit appeared to be fine, but the chance of turning an honest penny by selling to a centennial visitor for a dollar the same article he could buy on Philadelphia streets for a quarter was too strong on those who had charge. The very plate under the Judges' noses would be sold off before they could make an entry in their notebooks, and after many attempts to do justice as between the growers and the centennial visitors, the judges gave up California in disgust. Wisconsin did very well, as did Kansas and Nebraska, as indeed these States always do. Virginia, through the Potomac Fruit Growers' Society, did remarkably well in peaches; and among the individual exhibits of Ohio, J. C. Anderson, of Dayton, had some good peaches, and Mrs. McGregor, of Wilmington, Ohio, some fine peaches also. Delaware was represented by Wilson Green with a few very fine peaches; and Mrs. G. W. Carpenter, Daniel Smeych, A. S. Felten, E. A. Davis, and Frederick Seitz, represented the peach interests of Pennsylvania. Minnesota sent her plums and crabs, in both of which she is justly famous.

Among other exhibitors of very superior articles we may note Geo. Hussman, of Sedalia, Mo., grapes; W. N. Barnett, West Haven, Conn., grapes; Gibson & Bennett, Woodbury, N. J., various fruits; O. J. Tillson, Ulster County, N. Y.,

grapes; Chas. B. Horner, Mt. Holly, N. J., grapes; Geo. W. Campbell, Delaware, O., grapes; Egg Harbor City Agricultural Society, N. J., grapes; W. Dunn Rogers, Moorestown, N. J.; Merrick & Coleman, Geneva, N. Y., grapes; M. J. Mitcheson, Cambridge, N. J.; Jacob Steigleder, Shelburne Falls, Mass.; Marshall P. Wilder, Dorchester, Mass.; Hovey & Co., Boston, Massachusetts; E. G. B. Hatch, Cornwall Bridge, Conn.; W. R. Johnson, Waterbury, Conn.; F. Trowbridge, Milford, Conn.; Jones & Palmer, Rochester, N. Y.; H. E. Hooker, Rochester, N. Y.; Theo. J. Beaur, Moorestown, N. J.; J. S. Linderman, South Haven, Mich.; A. H. Richards, Hammonton, N. J.; W. F. Bassett, Hammonton, N. J.; B. Smith, Meriden, N. Y.; J. B. Seelye, Vine Valley, N. Y.

There were of course many other Exhibitors, making up in all over *fifteen thousand* plates of fruit. We can only give the names of those whose collections we personally examined. It was impossible for one man to do all in the time. Only the full report of the Commission will do justice to all. The acting judges were Mr. Yellowley, of Miss.; Mr. Lyon, of Michigan; Mr. P. Earle, of Illinois; Messrs. Harrison, Schaffer, Satterthwaite, Hoopes, and Meehan, of Pa.; Parry, of New Jersey; Foster, of Iowa. Three from other States did not appear.

THE PENNSYLVANIA HORTICULTURAL SOCIETY. —The annual meeting took place Sep. 12th to 14th, according to announcement. It is the 48th annual meeting. These are always looked forward to with great interest all over the land. The interests of the Centennial were of course overshadowing, and many friends of the Society thought it had better be deferred altogether. But other friends had faith, and the result proved a much greater success than could have been anticipated; and the result shows how very strong is the Institution in the popular affection. The plants exhibited were even better grown than usual, and the variety of many of the species in many cases, shows that the taste for beautiful novelties is strong. Fruits were particularly beautiful and abundant. The designs and ornaments of cut flowers were tasteful and fully up to the standard. A ship made of cut flowers took well with the people. Usually, these "harps," "crowns," and other articles of floral work, seem like playthings, yet are tolerated from their associations even by persons

of highly cultivated taste, but it is seldom safe to go beyond these. Mostly, "designs" at floral exhibitions are horrible things. On this occasion, the sails being made of the white flowers of the Pampas grass saved it from condemnation by even the most fastidious, while to the vast majority it was "beautiful," as we had abundant evidence all round.

The reception given by the Horticultural Society to their pomological brethren in their hall, was a remarkably pleasant affair. President Schaffer received the guests, and all were made to feel perfectly at home. It was a great occasion for those in kindred pursuits to become acquainted with one another; and while the Horticultural Society evidently felt gratified that so many had responded to the invitation, we know that none of the guests but felt it was an occasion to be remembered. The Philadelphia fashion of "no speeches" we believe was particularly appreciated.

**ROOTS, BULBS, AND TUBERS AT THE CENTENNIAL.**—An exhibition of roots grown for cattle feeding, onions, potatoes, &c., will be held in the Pomological Annex to the Agricultural Building, October 2d to 7th, inclusive.

Tables and dishes will be furnished by the Centennial Commission free of charge, exhibitors being only required to pay the cost of transportation.

Products, as soon as received, will be classified and arranged for exhibition.

Roots, bulbs, and tubers may be exhibited in lots of nine specimens of each variety. Larger quantities, may, however, be shown upon special application.

The judges will report upon exhibits according to their merits, having regard both to the perfection of the individual specimens and to the variety of the display in each class, and in combination under each division. The awards will consist of a special report by the judges, and a diploma and bronze medal from the United States Centennial Commission.

Tubers and roots will be arranged for examination by the judges, as follows.

Division 1. *a* White Skinned, Round Potatoes. *b* Colored Skinned, Round Potatoes. *c* Colored Skinned, Kidney Potatoes. *d* White Skinned, Kidney Potatoes. *e* Yellow Sweet Potatoes. *f* White Sweet Potatoes.

Division 2. *a* Sweets or Ruta Bagas. *b* Globe Turnips. *c* Flat Turnips. *d* Long Beets. *e*

Round Beets. *f* Mangolds, Globe. *g* Mangolds, Long. *h* Kohl Rabbi.

Division 3. *a* Carrots. *b* Parsnips.

Division 4. *a* White Globe Onions. *b* Yellow Globe Onions. *c* Red Globe Onions. *d* White Flat Onions. *e* Yellow Flat Onions. *f* Red Flat Onions.

The right to alter or amend this circular is reserved.

A. T. GOSHORN,

*Director-General.*

BURNET LANDRETH,

*Chief of Bureau of Agriculture.*

PHILADELPHIA, August 15th, 1876.

PHILADELPHIA, September 7th, 1876.

HON. A. T. GOSHORN, Director General U. S. Centennial Commission.

Sir:—During the week ending with this date, we have received the additional exhibits. Miss Anna Gillingham, 1510 Poplar street, Philadelphia, 12 early "Newington" Nectarines. Nectarines are now so rarely seen from open air trees, and these were of such excellent size and flavor, that we especially commend them. A. B. Colgrove, Middletown, Connecticut, a large quantity of seedling pears, five kinds, but mixed together so that the kinds could not be separated. They were good fruit, but not equal to other named and well-known kinds of the season.

H. S. Cochran, Cecilton, Md., "Reeve Favorite" peach—five specimens of this popular Delaware variety, 9 inches in circumference.

W. F. Bassett, Hammonton, N. J., Bassett's American Plum. The improved native plums have been recently derived from the native plum of the North-Eastern States, but whether from the beach plum or the common red plum is not quite clear. The fruit is of medium size, good flavor for an American plum, and, as exhibited by a branch with fruit on, apparently abundant. In addition to these the Fruit Growers' Association of Ontario, the State of Connecticut, and the Potomac Fruit Growers' Association, have placed on the tables a large portion of a very large exhibit, but as they are intended for the special exhibit to be in order next week, we refer to them here only for the purpose of fixing the week of their appearance here.

Signed,  
International Jury on  
Pomology.

{ W. L. SCHAFER,  
A. W. HARRISON,  
JOSIAH HOOPES,  
THOS. MEEHAN,  
WM. PARRY.

THE  
GARDENER'S MONTHLY  
AND  
HORTICULTURIST.

DEVOTED TO HORTICULTURE, ARBORICULTURE AND RURAL AFFAIRS.

Edited by THOMAS MEEHAN.

VOLUME XVIII.

NOVEMBER, 1876.

NUMBER 215.

FLOWER GARDEN AND PLEASURE GROUND.

SEASONABLE HINTS.

With the appearance of winter there will be anxiety about the protection of tender trees; and when we speak of tender trees we may as well understand that the list of those things that will stand exposure to keen winds is very small, indeed. There are very few things that will stand a severe winter when both roots and branches are encased in frost, and the winds dry out all the moisture. After the trees get large and the roots push below the general frost line, the list of "hardy" things is increased; but even this list may be doubled by protecting the tree from severe wind. A large number of trees and shrubs, thought rather tender, want nothing more than shelter from wind. Even grass is better for protection.

Leaves are the natural protectors of grass; clearing them from lawns has a tendency to impoverish the vegetation. Mowing of course also weakens a lawn. This makes an occasional top dressing advisable,—any decaying matter will do. This is the season to apply it. We would not, however, use stable manure when other can be had. It is so disagreeable in color all winter,—and there are other objections besides. Sometimes lawns, after frequent mowings, become so weak, that not even manurings will bring them up again; for, as we have often taught our readers, cutting off green herbage weakens vitality. When this is the case, small Veronicas and other minute weeds, which the

scythe does not cut, grow strong enough to crowd out the enfeebled grass. We have seen resort made to weeding in such cases with little beneficial results. The best plan is to break up the lawn at this season, let it lie all winter, and seed it again anew in spring. The Blue Grass of Kentucky or Green Grass of Pennsylvania—botanically *Poa pratensis*—is better than any "mixture" for making a first-class American lawn. For reasons we have given, lawns run out faster when a mowing machine is used, than when scythe cut, but the advantages of a machine are so great, that we wonder that they are not in more general use. There are many good ones now, all excellent for the purpose.

As soon as the ground gets caked with the first real frost, herbaceous plants should be protected. Though hardy, they will repay this extra care,—mostly natives of woods or grassy places in their native state, they expect a covering of leaves or dry grass. We find dry leaves the best material for the purpose, a few inches is a sufficient depth,—a little soil being thrown on to prevent the leaves blowing away. Where such material is not at hand, the common garden soil may be drawn over them, as before recommended in these pages.

There is some danger of Pampas Grass rotting by moisture getting down in the hollow of the leaves into the heart of the stem. A friend tells us he guards against this by burning off the old leaves of the Pampas before putting the dry leaf covering on. Last year we kept them remarkably well by turning the whole plant over on its

side, and then covering leaves and roots with a foot of earth. It was a severe winter, but the plants were in good condition in spring.

As soon as the first white frost has awakened *Dahlia* leaves, the stems should be cut back to a few inches of the ground, the label securely fastened, and the root placed away in a cool place secure from frost till next March, when it should be "sprouted," divided and again set out. Most of the tender plants that we desire to preserve over the season, have now been lifted from the borders, and removed to winter quarters,—and in a few weeks the beds will present a rough and forsaken appearance. It is too often the practice to leave the borders just in this neglected condition till spring time returns.

## COMMUNICATIONS.

### THE CULTURE OF PITCHER PLANTS.

BY S. B., NEWBERN, N. C.

While reading the English catalogue of Mr. Wm. Bull, which an English friend has sent to me, I was interested in noting that our common pitcher plants were not only cultivated there, but seem to be generally appreciated. Of the kind common all over the country, *S. purpurea*, he says:

"This remarkable plant, a native of peat bogs in North America, bears the popular names of Side-saddle flower and Huntsman's Cup. It is a most remarkable evergreen perennial plant, and is so nearly hardy that it is sometimes cultivated in the open air. The plant is stemless, while the leaves which spread around the crown are pitcher shaped, and furnished at the end with a roundish heart-shaped hood, which stands erect, like the open lid of a pitcher. These curious leaves are of a deep green, veined with purplish-red. The flowers grow on scapes about a foot high, the dark purple petals arching over the greenish-yellow styles."

The Southern kinds are more beautiful than this, and I think that if it were generally known how easy it is to cultivate them, there would for them be a great demand.

I have had the *S. Drummondii* growing very well by the following plan:—I put it in a mixture of about one-half sand and bog moss, pressed in as tight as possible about the roots. Then I get a vessel that will hold water, and put a stone, or piece of brick in, and stand the pot with the

plant on it, so that about a quarter or even half the pot is under the water. So you see, all the water the plant gets is what comes up through the hole at the bottom of the pot. The plant itself is never watered, but I find it is always damp. The moss draws up moisture enough. When the water in the outside pan evaporates so as to be below the pot, of course more is added. I know of nothing that grows so easily, or gives more pleasure. I enclose an illustration of this pretty species.

### GRAFTED ROSE ACACIA.

BY GEN. W. H. NOBLE, BRIDGEPORT, CONN.

I wonder why nurserymen do not send out small trees of this plant grafted on the varieties of the locust. It takes and grows thereon as vigorously as does the apple on its kind. On a stock, anywhere from one to six feet high, it forms a graceful head of lovely bloom and foliage. There are two, perhaps more, varieties. The old, with flowers of a dull purplish pink, and the major, much the finer in flower and foliage, blooming in long racemes of bright, clear and most delicate pink, very pleasantly fragrant.

It blossoms at the same time with *Laburnum* and *Wistaria*. A group thereof in grace, in tint, in fragrance and entire loveliness, would have no rival. For some reason the dwarf nature of the *Rose acacia* seems to stay the rambling, suckering propensity of the locust roots. At any rate, I have never been troubled by this habit under *Rose acacia* grafts. To have a compact head and fine blooms, cut in pretty boldly in the early spring. It blossoms on the shoots of this year. After the first flowering a like treatment will give you a late bloom. If possible, give to this plant, the *Wistaria*, and the *Laburnum* a plentiful supply of water when in flower, thereby their bloom is finer and holds longer.

### OUR CENTENNIAL MAGNOLIA TREE.

BY M. B. BATEHAM, PAINESVILLE, O.

Near the boundary of my lawn, on a sandy slope, is a native *Magnolia acuminata*, which is remarkable for its size and productiveness, and is, no doubt, at least a centennarian in age. At four feet from the ground the trunk is 16½ feet in circumference, and as usual with the species, is very round, with but little diminution of size



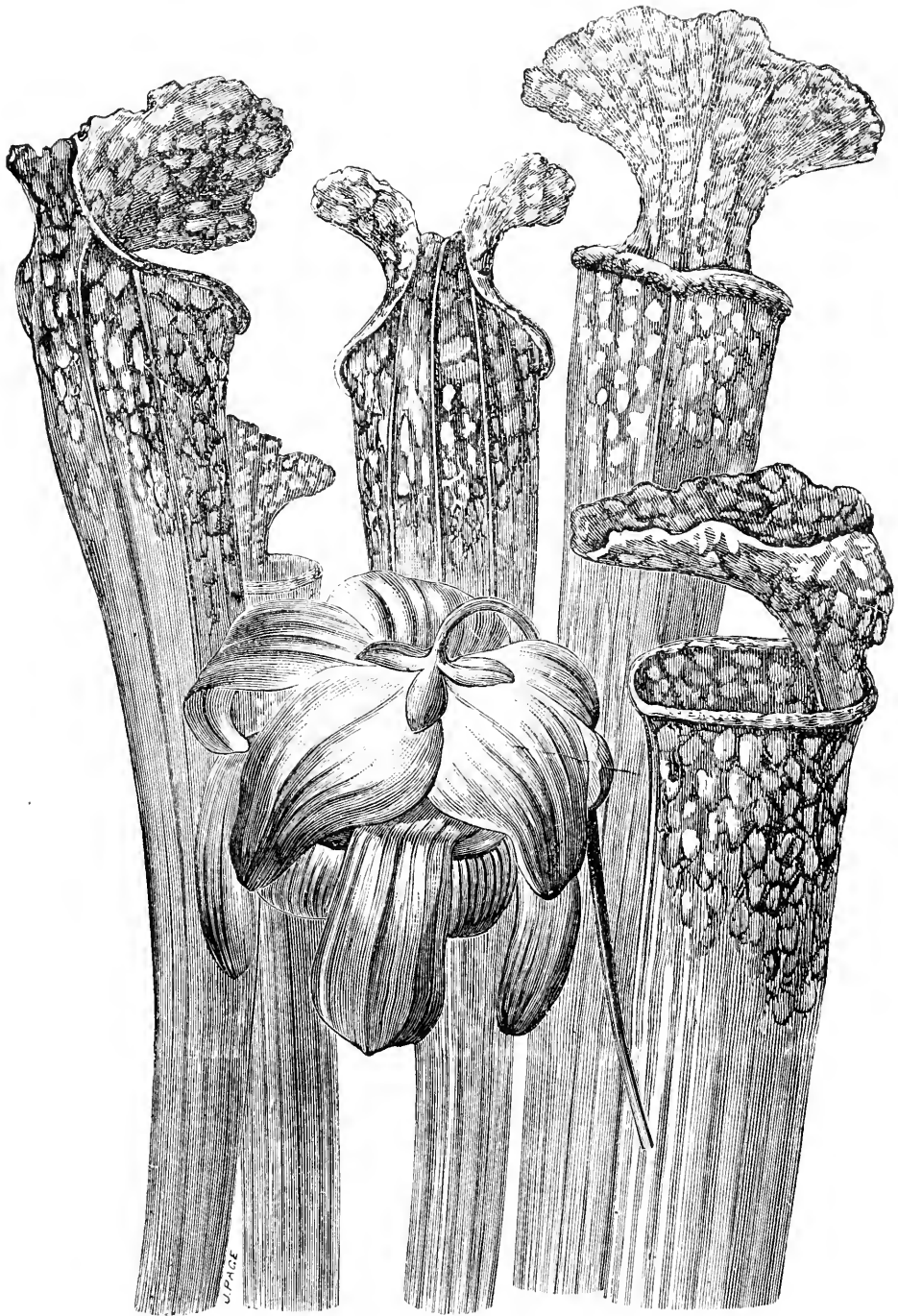

SARRACENIA DRUMMONDII.

till the first branches are reached, which are about 30 feet from the ground. The top is large and spreading, and the entire height about 80 feet. A few of the branches show signs of decay, but still it bids fair to live for at least another quarter of a century. It was originally surrounded by forest, but has been standing nearly alone for fifty years.

As stated above, this tree is remarkable for its productiveness as well as size. In fact it is more profitable than any two or three orchard trees in the neighborhood. For the past ten years it has failed but once of producing a crop of fruit, yielding from twenty to eighty pounds of seed, which has been sold to nurserymen for 75 cents to \$1 per pound. When ripe the seeds fall out of the cones while on the tree, and are picked up by our three youngest children, who are given the proceeds annually as their Christmas money, with which to buy presents for one another and for cousins. So it may well be believed that our Centennial Magnolia is an important feature of the homestead, as well as a conspicuous one. Is there a larger tree of the kind in the Union?

#### LARGE LEMONS.

At the nurseries of Storrs, Harrison & Co., of this place, is a lemon tree which is quite remarkable for the size of its fruit. It ripened over twenty specimens the past year, and six of them gathered the past week weighed just six pounds, the largest weighing nineteen and a half ounces. The tree was left in charge of S. H. & Co. some years ago, by a family who moved away and never called for it; so that its origin is not known, nor the name of the variety, if it has any name. Can you, Mr. Editor, give us the names and descriptions of the varieties of lemons usually grown where this fruit is extensively cultivated, or in the greenhouses in this country?

#### LIATRIS PYCNOSTACHYA.

BY C. E. B., AMES, IOWA.

*Liatris pycnostachya*, of which you speak on page 263, grows abundantly here. It is truly a magnificent plant, and when seen waving its blazing head in the prairies, it never fails to commend itself to the flower lover. As our summer climate is hot and dry, it ought to endure anything you ever have of dryness in the East.

#### EDITORIAL NOTES.

**AKEBIA QUINATA.**—This has fruited for the first time, as far as we know, on the grounds of Mr. W. Canby, of Wilmington, Del. It is as large, and very much resembles in external appearance, a papaw. The seeds are in a juicy, slightly sweet pulp. It is said to be eaten by the Japanese, but unless something be added to it the flavor has little character to make it sought after. It might grow even "near a college where young men are being educated for the ministry," as Mark Twain would say, without many disappearing.

**WIER'S CUT-LEAVED SILVER MAPLE.**—Few "cut-leaved" plants please us, and we had not much of an idea of this. But a specimen in the Centennial collection of Messrs. Hance & Son, shows that it is a very desirable tree.

**EUONYMUS AMERICANUS.**—An Ohio correspondent calls our attention to the beauty of this native shrub. It is more beautiful than *Euonymus atropurpureus* and *E. Europæus* and varieties, the two in cultivation, and should be grown. It would probably graft on the other strong kinds, and make pretty heads in this way.

**WEIGELA AMABILIS LOOYMANSI AUREA.**—This long name means a golden-leaved *Weigela amabilis*. It is figured in *L'Horticulture Belge*, and ought to be worth introducing here.

**ON NAMING FLOWERS FOR PERSONS.**—The *Pall Mall Gazette* remarks: "The practice of naming flowers after private friends or public characters is very pretty; but it may be suggested that a little care in the selection of epithets bestowed on such names would not be amiss. Otherwise it is difficult to say whether poetical compliment or covert satire of the sponsor is intended. What shall we say, for instance, of the descriptions appended to the names given to three new roses, just 'sent out' by a leading nurseryman, which we find in the advertising pages of last week's gardening papers? First shall come a lady, and, if the language is rather glowing, we trust that it is not on the whole displeasing to the fair prototype:—

"*Miss Hassard*:—Beautiful delicate pinkish flesh color, large, full, and fine form, very sweetly scented. First-class for either exhibition or general purposes.

"But the next is so ludicrously inappropriate

that we only reproduce it in the assurance that the original bearer of the name would have smiled at the incongruity of the epithets:—

"*John Stuart Mill*:—Bright clear red, large, full and beautiful form, of great substance; well adapted for exhibition purposes, being also of strong constitution and free habit. Quite distinct.

"Last comes a clergyman, himself a distinguished rosarian, and we hope his parishioners recognize the portrait:—

"*Rev. J. B. M. Comm*:—Very bright rosy pink, most pleasing color, large, very full, and fine globular form; very sweet, constant, and thoroughly distinct; growth vigorous.

"The moral touch, 'very sweet and constant,' is peculiarly appropriate to a clergyman, and will perhaps reconcile his admirers to the allusion to what some might deem the physical defects of a rosy pink complexion and a too globular form."

WHITE BEDDING PANSIES.—In my trial bed of bedding pansies this year I find that Hooper's Great Eastern and Dean's Snowflake carry off the palm from all others, both in purity of color and continuity of blooming. In the white section a tendency to blue is very observable, especially amongst kinds that are qualified to rank amongst show Pansies, and where this defect is apparent the usefulness is greatly detracted from. There is, too, a common notion prevalent that any Pansy will do for a bedder if it be of the required color, but that is a greatly mistaken notion. Bedding pansies are none the more useful or effective for having large flowers. It is rather the quantity that is desired, and plants that produce medium-sized blooms and maintain a constant succession by continually throwing up young growth from the base are best suited for bedding purposes. The purest white flowers are got out of the German strains; but they are very thin and uneven, and the growth is long and straggling. I am, however, this year using blooms of some of the best of these to fertilize Snowflake, in the hope of throwing even greater purity into that variety, and should I succeed in that respect, and still keep its excellent robust habit, we shall then get a most valuable variety.—*D. B., in Gardener's Weekly.*

## NEW PLANTS.

DOUBLE-FLOWERED LILIUM AURATUM.—At a meeting of the Central Horticultural Society of

France, held on the 11th of last September, M. Duchartre read a letter from M. Boisgiraud, of Tours, in which that gentleman stated that, amongst the plants of *Lilium auratum* in his garden, one had produced double flowers. This makes the fourth species of Lily which has produced a double-flowered variety, the others being *L. tigrinum*, *L. candidum*, and *L. Thunbergianum*.

EUONYMUS FLAVESCENS.—Introduced by Veitch from Japan; the best yellow bedding plant, hardly for winter gardening.

PELLEA ORNITHOPUS.—An interesting and distinct Fern from California. Fronds glaucous-green, rigid, erect, from 9 to 12 inches high, bipinnate; the secondary pinnae all trifoliate, except the ultimate ones, which are simple and solitary. The pinnules are so formed and arranged in the trifoliate pinnae as to resemble the claws of the foot of a small bird, each terminated with a distinct mucro. Stipes and rachis dark purplish. Received direct from collector, and exhibited by us under the name of *P. mucronata* before the Royal Horticultural Society, when it was much admired, and was awarded a first-class certificate.—*Veitch.*

MR. LEE'S NEW VIOLET, PRINCE CONSORT, surpasses in size, depth of color, and fragrance, all the varieties we are acquainted with in the valuable section of violets it represents. A boxful of the blooms were in our office a fortnight, and at the end of the term were still recognizable as noble violets, though time had robbed them of their freshness. Their unusually large size and great substance are strikingly characteristic, and justify Mr. Lee's declaration that his Prince Consort is "the finest violet out."—*Gardener's Magazine.*

BAMBUSA ARGENTEA STRIATA.—This handsome Japanese plant has been received from Dr. Regel, of St. Petersburg, under the name above quoted. Like all the Bamboos, it is of an extremely graceful habit, and, in this instance, the elegance of the plant is very much augmented by the fine silvery glaucous hue of the under side of the foliage. It is of a moderately vigorous habit, and the leaves, which are three to four inches long, and about three-quarters of an inch broad, are of a full green on the upper surface, glaucous beneath, and striped in a varying degree, but usually freely with white, forming an elegant variegation. It is a strikingly ornamental hardy decorative plant.—*W. Bull.*

STANGERIA SCHIZODON.—Of this interesting Cycad, which has been imported from Natal, only young plants are yet known in this country. These have, as in the original *Stangeria paradoxa*, a bluntly rounded or napiform stem, the crown of which is slightly elevated above the soil, and from which the pinnate leaves arise. These leaves (in the plants before us, evidently immature) consist of three pairs of pinnae or leaflets, which are of an ovate-lanceolate form, and irregularly inciso-serrate at the margin, the larger teeth being irregularly cut down into a variable number of smaller teeth, thus forming a deeply but irregularly toothed margin, instead of the single spinulose serrate margin of *S. paradoxa*.—*Wm. Bull.*

ARNEBIA ECHIOIDES.—Of the many beautiful plants in flower on the Rockwork at Kew, *Arnebia echioides* is by far the rarest. It is allied to *Lithospermum*, of which it has much the habit, and the bright yellow flowers are perhaps the prettiest of the color in the order to which it belongs. There are sometimes five purple spots on the corolla, alternating with the lobes, but these are absent in some flowers while present in others on the same plant. It forms a neat tuft, and the flower-stems grow to a height of from six to eight inches.

GALACTITES TOMENTOSA, Mönch.—Among plants remarkable for their ornamental foliage, the *Galactites tomentosa* deserves honorable mention. It is a Composite, indigenous to the shores of the Mediterranean, growing from two to three feet high, of erect branching habit, with spiny divided foliage, prettily blotched with white, in the manner of *Silybum Marianum*, nearly smooth above, but very cottony and

white on the under surface. The stems and branches are terminated by solitary flower heads of a lilac-purple color. If sown as early as February, the plant blooms the first season, but stronger specimens are obtained by sowing in autumn. It succeeds best in good loamy soil.—*Garden.*

NEW GOLDEN POPLAR.—We have received from Mr. Charles Van Geert, of Antwerp, a colored plate representing a shoot and foliage of his new Golden *Populus canadensis*. It is very beautiful, and those who know Mr. Van Geert are certain that he would not circulate any representation of it which was an exaggeration of the truth. Our forest scenery is destitute of golden tints, except in the autumn, and this new gain of Mr. Van Geert's will add a beauty and variety to it which has hitherto been lacking. In his prospectus Mr. Van Geert says—

“Its leaves are quite as large as those of the common Poplar, and the yellow hue, instead of looking sickly, has a warm and vigorous tint. The better nourished the tree is, and the more it is exposed to the sun, the more vivid is the golden hue. The stalks and the bark of the shoots become then dark red, which adds greatly to the beauty of the coloring.

“This variety, or rather this freak of nature—for it was spontaneously produced on a single branch of a large tree—has been observed by ourselves for more than five years, and during all this time it has never shown any tendency to alter its golden character.

“This novelty will be ready for sending out in March, 1876, and the finest specimens will be forwarded to the first subscribers.”—*Journal of Horticulture.*

## GREEN HOUSE AND HOUSE GARDENING.

### SEASONABLE HINTS.

A year ago we called attention to the success of a lady who filled her flower-pots to the brim and even mounded the earth in the centre.

This plan will not please skilled gardeners, nor ought it to do so. They will get along better in the old way. But an extended experience with window gardening teaches us that the pot plants almost always fail from too much rather than too little water, and we feel, therefore, that there

is virtue in the full pot plan. It is almost impossible to over-water a pot when it is packed quite full of earth. Saucers must of course be kept under window plants, in order to guard the carpets from water. But the water must not be allowed to stand in the saucers; when it has all passed through the pot, the saucers should be emptied.

Hanging baskets, on the other hand, are generally too dry. Besides the daily waterings, about once a week they should be immersed in a bucket of water.

Window Plants should not be kept very warm at this season. They should have all the sun and air, and as little of the artificial heat of the room as possible. These remarks apply especially to Mignonette, which is very impatient of in-door confinement. Succulents, such a Cacti, are excellent window plants in this respect, as the dry air does not affect them. To keep the air about the plants moist, is one of the secrets of window-culture. Some who have very fine windows well stocked with fine plants, make glazed cases with folding doors of them, by which, when the room is highly heated and very dry, they can be enclosed in an atmosphere of their own. In such cases, ferns and mosses can be grown to perfection, and pendant plants in hanging vases give a Brazilian forest appearance to our happy Christmas homes.

The greenhouse will now begin to look more natural, after having had the stock housed last month. With many plants having probably been taken up out of the open ground, dead leaves will daily appear, requiring frequent removal. Neatness is one of the chief beauties of a greenhouse. Acacias, and Australian plants generally, with hard wood and delicate roots, should be placed at the coolest end of the house, where little water will be required. These plants should not be watered often; but when they are, it should be thorough. Frequent waterings soon render the roots of these plants unhealthy, when it is very difficult to restore them to vigor. Whenever the foliage becomes of sickly yellow hue, the best plan is to plunge the plant in a larger pot, filling the space with moss,—and when the plant requires water, give it only through the moss, unless the plant seem to become so dry as to suffer, when it should receive one thorough watering. Very little fire should be applied to a greenhouse,—just sufficient to keep it at about 45°. Unless very far north, but little fire-heat will be required this month.

## COMMUNICATIONS.

### VERBENA RUST.

BY W. T. BELL, FRANKLIN, PENNA.

Robert Palmer (in September number) calls this a *fungus*, and may be correct, although some good authorities say it is occasioned by an insect. In my opinion, it is of more importance to grow verbenas well. There should never be any rust to remedy. It is better to throw rusty plants away, and get others that are young, clean and vigorous, and keep them so, and there will not be need to doctor them for the rust.

[We should be glad to have an article from our correspondent as to "growing Verbenas well," for we must confess to seeing rust on plants, that in old times we should have thought were under the best treatment.—Ed. G. M.]

### RHODODENDRONS UNDER GLASS.

BY MR. GEO. MOORE, WABAN CONSERVATORIES, MASS.

Noticing Mr. Parsons' article on Centennial Rhododendrons, I observe that all which are not hardy here he condemns as only adapted to greenhouse culture, but why could not means be adopted for their protection by housing them in the winter in cold houses or cellars? As another correspondent remarks, they can be kept out of ground a long time with safety, and all familiar with them know that from the nature of their roots, removal is practicable and easy at all times. If Gladioli, Dahlias, and the like are worthy of the *annual* care they receive, surely such superb shrubs as these under consideration will as well repay the effort to thus protect them. While admitting that those who plant Rhododendrons without regard to soil, situation and subsequent care will be sure to meet with disappointment; I do not think that it is fair to discourage lovers of them, by condemning them as "utterly worthless when planted in the open ground," without stating that many fine varieties besides the "four" alluded to will flourish if proper attention is paid to the locality in which they are planted, &c. Mr. Nelson took the right course by following nature, as stated by him in his common sense article in your Magazine, p. 259, and if your other correspondents had given some directions as to the best method of planting and protecting, instead of consigning all, or nearly all of this beautiful

tribe to oblivion, I think the interests of horticulture would have been better served.

I have the good fortune to live in the neighborhood of the superb collection of Mr. Hunnewell, and I think that any one visiting that gentleman's grounds in the Rhododendron blooming season, if they had tried to grow them and failed, would attribute their failure, not to the want of hardiness in the plants, but to want of skill or attention in their management.

Mr. Hovey who writes somewhat in the same despairing style as your other correspondents, seems to have got himself, or his words rather, a little mixed, when he says: "The Indian blood which carries color, also carries with it a perfect bar to hardihood, of white, pink, rose, rosy lilac, rosy purple, rosy crimson." Now where did we get all these crimson tints if not from Indian blood? And if it carries a "perfect bar to hardihood," what is the use of hybridizers attempting an impossibility? How was one of the very kinds recommended as hardy by your other correspondent, X, (*Roseum grandiflorum*) produced if not by a cross with *Arboreum* and *Catawbiense*? We all know that the latter is purplish lilac, and where could the rose color have originated otherwise than by hybridization or (more properly) impregnation with a variety possessing the crimson color so much desired. I am glad to find that you as Editor of the *Monthly* take the same view of this subject as I do, when you say that nothing is more delightful than Rhododendron culture intelligently pursued. I have been deeply interested in it for the past 35 years, and if my practice and views will be of service to your readers, I shall be glad to give them at any time you may wish to open your columns.

[Our readers will be glad to hear from Mr. Moore at any time.—Ed. G. M.]

### EDITORIAL NOTES.

**DRYING WHITE FLOWERS.**—Mr. Wernig's instructions, published in *The Garden*, from time to time, in reference to drying flowers and Grasses, have so much pleased me that I am induced to ask a few questions respecting the preservation of white flowers. In some cases I have succeeded very well with these; but, in others, I have failed. The floral leaves, or rather petals soon curl and turn yellow, especially those of Roses, when dried in sand. Is there any

chemical agent which could be used to bleach them after being dried? By what process can I preserve white Camellias, Tuberoses, Pinks, Roses, &c., so that they will retain their original whiteness and form? I have failed to dry white Camellias without being spotted. In drying the Immortelle with borax ought the flowers to be bleached first, or remain in their natural yellow color?—*L. F. Sanderson, River Bank Nursery, San Jose, California.*

[To the foregoing Mr. Gustave Wernig, to whom this letter has been sent, furnishes the following reply:—If Mrs. Sanderson did not succeed in preserving white Camellias, white Roses, Tuberoses, and similar flowers, she has not had a worse result than the most experienced preservers of flowers have. Up to this time I do not know a single instance in which I have seen a dried specimen of the above-mentioned flowers, and of many others—as, for instance, all the Orchids, and most flowers of Monocotyledonous plants. White flowers, especially, are very difficult to manage, as they nearly always become spotted with a shade of yellow, which gives them a rather dirty appearance. The only flowers which are pure white in bouquets of Everlastings are to be found among the true Everlastings, viz., the pretty little *Ammobium alatum*, white Immortelles, *Xeranthemum annuum album*, &c. How to preserve these well, I described in my former articles. Even among dried white Asters, although much used and, if well done, pretty looking, I never could find one which was pure white; every one had, more or less, a shade of yellow. It may be that, with the aid of chemistry by-and-by, we may succeed in preserving a greater number of flowers in their natural colors; but, up till now, we must be contented with a limited number. Referring to the other question in the above letter about the coloring with borax, Mrs. Sanderson may, without hesitation, take the Immortelles in their natural state; yellow as they are, they turn to a beautiful scarlet if managed in accordance with the directions which I gave in a former number of *The Garden*. I must add, however, that flowers colored with borax become paler in the course of time, especially if exposed to the sun; while those colored by aniline keep their color much longer. Borax, however, is cheaper, and gives the finest scarlet.—*The Garden.*]

**STANDARD CUPHEAS.**—Admirers of the old-fashioned but extremely pretty Cuphea platycen-

tra, so popular about a quarter of a century ago, will be much pleased with *C. Hillfieldiana*; for whilst possessing the neat habit of the older form, it is of more vigorous growth and has larger and more richly-colored flowers. It has a branching habit and usually attains a height of ten or twelve inches, and is densely furnished with rich glossy green leaves. The flowers are trumpet-shaped, about an inch in length, and of a rich crimson color. It may be had in bloom during the greater part of the year, and although its usual period of flowering is from spring to autumn, it may, by a proper course of culture and genial temperature, be had in bloom during the winter months. Small bushes are remarkably attractive, but, like *C. platycentra*, it will probably appear to the best advantage in the form of standards upon stems from fifteen to eighteen inches in height.

I have for many years grown standard specimens of the species last mentioned, and as they are usually much admired during the time they are in the conservatory, it is not unreasonable to suppose that a few particulars of the course of culture by which examples with well-furnished heads are obtained will prove useful to some of the numerous readers of the magazine. A batch of cuttings are struck in the usual way in the spring, and after they have been potted off and made sufficient progress to show which are likely to grow with the greatest vigor, the strongest plants are put on one side to receive the special training necessary in the production of standards. The others are simply stopped, and in due course planted in the borders or shifted on to form neat bushes for the conservatory. The first matter to be considered is the formation of a stout stem, and, as in the case of fuchsias and other plants required for standards, the shoot of which the plant consists must be trained to a neat stake fixed in the pot, and the side-shoots be nipped off as fast as they make their appearance. When the desired height is attained the top must be nipped off and all the side-shoots that push from four to five inches below be allowed to remain. These in their turn will want stopping at the fourth or fifth joint, and unless extra large heads are in request there should be no further stopping.

A vigorous growth must be maintained by shifting the plants on as becomes necessary until they reach pots eight inches in diameter. Very neat standards may be had in six-inch pots. A rich and rather light compost is necessary, and

this can be prepared by well mixing together three parts mellow turfy loam, one part each of powdery manure and leaf-mould, and half a part of sand. The plants may be kept in excellent condition for several years by simply repotting them annually, and reducing the ball of soil at each shift, sufficiently to allow of their being returned to pots of the same size.

*Cuphea Hillfieldiana*, it remains to be said, was introduced by Mr. Wilson Saunders, and grown for some years in his gardens at Hillfield, before it found its way to trade collections.—*Flower Gardener, in Gardener's Magazine.*

A GERANIUM PYRAMID.—Different people have different ways, but I shall suppose my way to be the best, and I am quite sure it cannot be the worst, because we have perfect pyramids solid throughout with leaf and flower. I first of all make a mound of good loam, not over steep, but rising in nicely rounded form. Mine are ten feet in width, with another border, slightly sloping off towards the walk, of three feet wide, making the width of the whole affair sixteen feet.

The plants are of course sorted in lengths, and there are of course plenty of poles and sticks and good bast at hand. Now, I must say, first of all, that to do the pyramid well, you ought to plant early. I generally get mine made up by the end of April, and build up a wattled fence to protect the plants until the middle of May. If they got a little punished by frost, I do not much mind, for they soon come right, and it is a grand thing to get them well-rooted before hot weather sets in, for, as a matter of fact, the plants have a lot of work to do. However, seasons differ, so do climates, and mine happens to be a particularly good climate, which is a matter of some importance.

It is necessary to bear in mind that when your pyramid is in perfection in the month of July, it may be blown to pieces and scattered all over the parish by a thunder-storm, for the gales that occur in the thunder season are to be thought of in time by the prudent gardener. For this reason, then, we make our work secure in the first instance, and the first step is a stout ash pole well driven into the centre of the mound, to serve as the centre-piece of the scheme. The length of this pole must of course be proportionate to the height of your tallest plants, but it may be a foot taller out of the ground than your tallest plants, because they will soon

make a growth to cover that much. My ten-foot pyramids require centre poles twelve feet long; which, when planted, are nine feet out of the ground, and my plants are so large that I could take them considerably higher. When the centre pole is fixed, drive in half a dozen more in a slanting direction and tie them at the top firmly to the centre. These should not be more than two feet and a half from the centre at the base. Now, make up a tent-like frame with slighter poles between, and plant your tallest geraniums and train them in carefully, having in view to furnish the upper part of the pyramid only. It matters not how leggy they are, so long as they are inclined to grow at top, and have good roots to begin the season with.

The next work is to build again with shorter and slighter poles two feet and a half from the last. They must be driven in only slightly aslope, and be bent to bring their tops to the inner framework, and of course they must be notched to prevent the ties slipping, and must be well tied like the last with tarred rope. Now plant again with shorter plants and tie as before. As regards the tying of the plants, you cannot be too severe. Train your pyramid to the stiffest outline possible, but take care that every tie is loose enough to allow for the swelling of the wood. In my first attempts I trained my plants so as to ensure—as I thought—a rather soft outline, but this was a mistake. I found that the tying in should be in the style of those gigantic pyramid azaleas that startle us at the great London exhibitions. If you do not make a sharp, hard, precise pyramid in the first instance, you will be in a precious muddle before the season is out, for the growth will floor you thoroughly. But make your outline severely correct, and you will scarcely have to touch the thing all the season through; the natural growth will soften the outline beautifully, and by the time the flowers are showing freely all the hardness of the outline will be gone, and your pyramid will satisfy the eye of taste.

I had almost forgotten to say that before I plant I nip out all the flower trusses that are visible, and shorten back any shoots that appear to be superfluous or misplaced.

The finishing of the scheme is of course accomplished by planting circles of proper bedding geraniums, &c. I find a good circle of old bushy plants of Flower of the Day, and a broad margin of blue lobelia next the gravel, a capital finishing to a scarlet pyramid; but tastes differ,

and I shall say no more about the finishing touches.

When the drizzle of October begins, we lift our plants carefully, slightly disroot them, and pot them in as small pots as possible without distressing them, and house them in a cool vinery where they cover the back wall, and being too tall for the house are tilted all aslant like a lot of drunkards; only, perhaps as they all lean one way, and give no trouble, the comparison is unfair. As a matter of course, they get very little water all winter, and are kept as cool and airy as possible to be safe.—*W. Kemp, in Gardener's Magazine.*

### QUERIES.

ROSE, TEA DUCHESS OF EDINBURG.—Mr. J. S. Lovett, Red Bank, N. J., writes:—"By this mail I send you a leaf and flower of 'Duchess of Edinburgh Tea (?) Rose,' figured in the *Gardener's Monthly* of August. If it is not too far gone when it reaches you—particularly the leaf—I think you will agree with me in calling it a Bourbon. When I first saw this new rose in bloom at the Kissena Nurseries, nearly a year ago, it struck me as strongly resembling the Bourbon class, which I remarked to Mr. Trumpy. His reply was, that he had noticed the same, and was of the opinion that it would turn out to be a Bourbon. Having since watched it closely, I am now satisfied from its habit, appearance of leaf and flower, that it is a true Bourbon, though the handsomest one I have yet seen. It possesses much merit, and is worthy a place in all collections, yet those who buy it for a crimson Tea Rose, will, I am satisfied, be disappointed."

[The habit is much of the Bourbon, but how about the fragrance? Bourbons are only beautiful; Teas are sweet.—Ed. G. M.]

GLADIOLUS BRENCHLEYENSIS.—B., S. E. Central O., says:—"Some bulbs of this fine old variety, planted deeper than usual (four or five inches), were overlooked in taking the others up last fall. The past winter was mild, and they seemed to suffer no injury, as they started early and have grown well. They have been in bloom for a week or more, and are finer than ever before, rivaling even Meyerbeer in splendor of coloring."

COMPARATIVE VALUE OF BRONZE BEDDING GERANIUMS.—Mr. Geo. Moore, Waban Conservatories, writes:—"I enclose herewith leaves of what are considered the three best Bronze Geraniums—



Black Douglass, McMahon and Earl Roslyn, all grown together and under the same circumstances, and find that for brilliancy of color, dwarf but vigorous habit of growth, and ability to bear ex-

posure to the hottest sun, Earl Roslyn bears the palm. Will you please add your opinion of the leaves enclosed."

[They were very superior kinds.—Ed. G. M.]

## FRUIT AND VEGETABLE GARDENING.

### COMMUNICATIONS.

#### NOTES ON NEW FRUITS.

BY WM. F. BASSETT, HAMMONTON, N. J.

Southern Thornless Red Raspberry has more than sustained the promise of last season. Considerably resembling the Brandywine in appearance, it is decidedly better in quality, and customers who would not have the Brandywine, were satisfied with the Southern Thornless Red.

Norwood Prolific does not appear to be adapted to this section.

Prouty's Seedling Strawberry I consider worth all the new varieties of the last ten years, for this section. The foliage is healthy, growth strong, it bears abundantly, and the fruit is very firm and the best in quality of some dozen varieties I fruited.

Snyder Blackberry is a very vigorous grower, and from reports of it from other sections I hoped to find it a good thing for home use at least, but the quality of the fruit was not satisfactory. Probably it requires a heavier soil.

Hoosac Thornless does not succeed on our sandy soil—growth rather light and fruit small.

#### BLODGETT'S SEEDLING PEACHES.

BY MR. LORIN BLODGETT, PHILA.

I decided to-day to put some of my seedling peaches on exhibition, and took nine varieties out, placing them in Division J., No. 6, of the Pomological Annex to Agricultural Hall, making eighteen plates. I hope you will see them on Saturday and find them worthy of notice.

My seedling peaches have now borne six successive full crops, the yard 25x150 feet, yielding on twenty-five trees from thirty to one hundred bushels each year, last year being the great crop. They give us a full and continuous supply from August 15th to October 20th, the latest being the best and most valuable to propagate; but this

year the continued cold weather leaves them less bright in color, and less perfectly sweet than in all previous years.

I have very reluctantly concluded to give some of them to the public, at least so far as to name them, and announce that they can be got of me in the form of cuttings, unless some one chooses to propagate them.

I hope you will allow me to name the large October freestone No. 3, (yellow) the "Meehan." It is the finest peach when perfect that I have ever seen. On at least three occasions some of them have weighed half a pound each; the best were in 1872 and 1874. In 1872 they were sold on Chestnut street by Bilyeu at \$12 a crate (basket and a half) and retailed at 15 cts. to 25 cts. each. Last year the tree bore nearly fifteen bushels, and was much broken then and still more by the storms of July 10 and September 16, this year. There are four plates of these on the exhibition tables. No. 12 is a magnificent golden yellow clingstone; No. 13 is almost identical with No. 12—both perfectly sugary and rich; Nos. 14 and 15 are very fine yellow freestones, differing very little, but 14 the most prolific; in most years it is scarcely distinguishable from No. 3. No. 11 (exhibited) is the latest, and not yet ripe; it is a very rich yellow cling, but not equal in quality to Nos. 12 and 13.

It is too late for the white melting peaches, of which I have some very valuable. No. 1 is the best (poor specimens are on the plate). It is very large, a freestone, perfectly white, and perfect as a melting peach. I have put two other whole freestones on the stand—Nos. 22 and 24—but they are not worth propagating.

In September two very fine white clingstones ripened which I have never shown. Both are very large, heavy, rich and melting; but still, being clingstones, are not so much in favor.

Of the small white melting freestones—most delicious peaches—coming from September 1st to 20th, I have five different seedlings closely resembling each other. These are the Willow

Class, and breed true from seed, at least have almost always done so with me.

I have been engaged in raising seedling peaches now for more than thirty years, and although always producing good and even excellent peaches in reasonable frequency, have never until now got peaches of permanent value. These are of four or perhaps five classes; first, the August red peaches, similar to the New York "Rareripes;" second, Early September blush and white; third, the white melting "Willow," all freestones; fourth, the blush and white free and cling, late September, and fifth, the yellow October peaches, free and cling. Of each of these I have four to six trees, distinct seedlings, yet perfectly identifiable as a class. Of the fifth class there are eight trees, four cling and four of freestones, all worth propagating, and without exception very large in size, rich in quality and the most prolific in bearing.

I have so often sent you specimens of these since 1870, that both last year and this I refrained, though the crop was conspicuously fine.

#### NOTES FROM TENNESSEE.

BY B. F. TRANSOU, HUMBOLDT, TENN.

With your permission I would like to reply to Mr. E. S. N., of Chattanooga, in August number. He objects to our *round shape* of the genuine Wild Goose Plum. We consider Chas. Downing good authority as a pomologist. In his forms or shapes of pears, says globular or ovate, both of which will apply to the *true* Wild Goose Plum, as you will find both those forms on the same tree, perhaps a majority ovate. Mr. E. S. N. says oval. If we take Webster's definition—oval, egg shape, we protest, as the true Wild Goose Plum is not egg shape. I am at a loss to know how the above gentleman can infer from my article I claimed or said, "our common old field plum was the Wild Goose," or that "we did not graft or bud." No respectable nursery man would send out a seedling as genuine. He also objects to our statement—"thick as blackberries." So they are in West Tennessee at least; may not be, however, in his section.

In speaking of peach pits you inquire, if of different size. Mr. E. S. N. replies: "Some of the fruit is large and some small, so also the seeds are in like proportion, large and small." We would also call your attention to the fact, that it is not always the case that the largest

peaches have the largest seed; for instance, the Heath Cling is a very large peach, and has a very small seed, less than many peaches, not of half the size.

#### FRUIT IN MICHIGAN.

BY E. D. MASON, DETROIT, MICH.

The fruit crop of Michigan for 1876 is fair. Small fruits, which are now nearly out of season, have done well, but there is not enough raised in the State to supply the local demand, and large quantities are annually imported from Ohio, Illinois and other States. Strawberries were abundant this season on account of the frequent showers, and raspberries produced well and were much cheaper than usual. The currant and gooseberry caterpillars have been very destructive this year, destroying the foliage and damaging the fruit. The apple crop is fair, but will not be heavy, as the fruit did not set very well, and a considerable part of the crop is already damaged by the apple-worm, the larva of the codling-moth. Early in the season there was a prospect of a fine crop of pears, as the trees blossomed profusely and set well, but blight has set in and is unusually destructive. The peach crop will be fair throughout the State.

#### NEW GRAPES.

BY MR. GEO. HASKELL, IPSWICH, MASS.

It will be recollected that a few years ago I expressed in the *Monthly* a desire to have my seedling grapes tried farther south, in a climate where they would attain perfect maturity. Nothing, however, was done to secure such a trial, and I am, therefore, unable to send to the Exhibition, in Horticultural week, ripe specimens of these fruits. I regret this exceedingly, for I think the varieties I have raised ought to be known—to be seen and tasted—especially so, as I see the Pomological Society's Report states that only the Clinton and Concord succeed, generally, and they are only tolerable in quality; certainly they are not hardier nor so good or early as many of my seedlings.

I am on the sea coast, about midway between those cool summer resorts, Cape Ann and Hampton Beaches, and the fruit will not generally ripen here before the last week in September, and many varieties still later.

I have put sashes over some varieties, and

they may be well colored by the 10th of September, and if they are, I can bring some of them to the Exhibition, in case, only, it should be worth while to expose them *to view*; for a fortnight more upon the vine will be needed to enable any one to form a correct opinion of their qualities.

I shall try to send an assortment of thirty to fifty varieties about October 1st, and regret that the members of the American Pomological Society cannot examine them when mature.

I will remark that during the last five years I have sent some ten or a dozen varieties to the most prominent horticulturists in this country, and last autumn I sent ten varieties to Dr. Robt. Hogg, of London, the highest authority in such matters in Great Britain; and all to whom they were sent have expressed the opinion that they possessed desirable qualities. If this opinion is correct, it is a public misfortune that they are not known and distributed in all parts of the country.

[We may explain to our readers that Mr. Haskell's position is that, as the raiser of a desirable fruit, he should have his reward by a patent right. But why wait for that? They who have good articles raise large numbers, and then advertise them for sale. It may be said that every person who raises a good fruit does not want to go into the nursery business. In that case, sell the stock to one who is. But again it may be objected, "but they will not give near what we think it is worth." This may be quite true, and yet we do not see how a patent right would help it. As a nurseryman the writer of this would not give one cent more for a "patent right," with a new plant, or fruit, than he would give for the whole stock itself; nor do we know of any one who would.—Ed G. M.]

### THE STRAWBERRY GRUB.

BY G. WRIGHT, ROCK FALLS, WHITESIDE CO., ILL.

We are much troubled here with "grubs," which eat the roots of strawberry plants in certain localities, whether the ground has been manured or not; and I think the larvæ found in manure heaps is entirely distinct from that which destroys our strawberries and other roots. The latter is more slender and hairy than the other, and does not increase in size so rapidly; besides I have never found the young ones earlier than the middle of July, while full grown grubs are found in the manure in June. If the smallest

grub touches a root of strawberry the leaves wilt in the sun, and we search the rascal out and save the plant.

I have a plot of ground two rods wide and ten long, which I have been salting in March for several years, using a bushel of salt broad-cast on the strawberries, and have no trouble with "grubs." The next plot, separated by a row of peach trees, has only been salted twice, and I have taken out with the aid of the chickens, over a thousand grubs, while the next plot is literally filled with grubs, and I have scarcely saved a plant for two years. None of this ground was ever manured, but has been a garden since the prairie sod was turned. Salt does not kill the larvæ, for I have kept them in brine for ten minutes, and they crawled away as smart as ever; but I think it must be unhealthy for the little ones.

### EDITORIAL NOTES.

ANALYSIS OF THE ONION.—By Messrs. Wellington & Bragg, under the direction of Prof. Goessman, at the Massachusetts Agricultural College chemical laboratory, being the first authentic analysis of this plant on record.

1,000 parts, air dry, contain:

Water,	892.000	Lime,	0.354
Organic matter,	103.638	Magnesia,	0.159
Nitrogen,	2.120	Iron (Fe <sub>2</sub> O <sub>3</sub> ),	0.027
Total ash,	4.362	Phosphoric acid,	0.689
Potash,	1.680	Sulphuric acid,	1.153
Soda,	0.083	Silica,	0.145

—*Scientific Farmer.*

AMERICAN GRAPES IN EUROPE.—At a recent meeting of the French Acclimatization Society there was an interesting discussion on the value and prospects of the American varieties of Grapes which have been largely planted in some of the districts where the ravages of the Phylloxera have been greatest. In the Herault alone some fifteen million American Vines have been planted, and great hopes of success are entertained. The variety called the Clinton has been extensively planted, and, whilst some members stated their experience with it as a shy bearer, it was stated that as many as 180 bunches had been gathered from one cane. The wine produced by it is said to be highly colored, and without the unpleasant flavor commonly attributed to it, and almost as rich in alcohol as Roussillon. The unanimous opinion was that the American var-

eties suffer less from the Phylloxera than the French ones, and, if not so valuable for their fruit, they are at least of great use as stocks.

**INFLUENCE OF THE STOCK ON PEARS.**—One of the richest of Christmas Pears is Josephine de Malines, and it is also one of the hardiest, ripening here—a very exposed situation in Norfolk, not far from the coast—on bushes in the open ground. It seems, however, to be a Pear peculiarly susceptible of influence from the stock on which it is worked. It is here on the Quince, grafted on the common Pear stock, on the Hawthorn, and on its own roots, a pendent bough, which touched the earth, having become layered and thrown out roots. In the first form (on the Quince) it bears early; but the fruit, luscious, is somewhat under-sized. The wasps attack it first of all. On the ordinary Pear stock at ten years old it has not fruited. On the Hawthorn the shoots are thinner than on either of the preceding; it has had fruit twice, but they did not become soft; so far it is not a success. On its own roots it has fruited three times (same age as others) and the fruit is very unlike that of the parents from which the bough rooted. The fruit is somewhat larger, less covered with russet, greener in hue, more vinous, and less honey-sweet. It is also later in ripening. This day (March 2) I have been examining the trees: on the ordinary Pear stock, if there be blossom buds, they are so backward that they cannot be easily discerned; on the Hawthorn, ditto; on the Quince the knots of bloom are very perceptible—as forward as Doyenne d'Été, the earliest Pear on its own roots; but the blossoms are almost ready to expand—the forwardest in a collection of about thirty kinds—very abundant too, which is the first time they have been so. In the previous nine years of its separate existence, the blossoms have been sparse, but have set fairly. Our trial goes to show Josephine de Malines is best left to itself—*i. e.*, on its own roots—but is a good Pear on the Quince.—*G. G., in Garden.*

**CARTER'S ROUND-LEAVED BATAVIAN ENDIVE.** **EARTH-BLANCHING.**—This is a winter-salad vegetable of great excellence. Sown in July it has afforded a supply for winter use which is especially esteemed. In growth it is particularly compact, less leafy than many other Batavian Endives, and consequently more edible in heart and midrib. Dug-up in November when perfectly dry and the outer leaves carefully folded, it was buried, root uppermost, in the south slopes

of Celery ridges, and a month afterwards, and onwards, it turned out in fine condition, white as milk, crisp as anything could be, sweet as a nut, and with no decay saving in the very outside leaves. By this simple mode of blanching, any one having a garden may have a salad at Christmas that will add to the appearance of any festive table, and be as good as it looks. Of course, it is equally good under Mushroom-house and other modes of blanching, but the main object of this note is to recommend a plan, far from new, but easy and effective.—*W., in Gardener's Magazine.*

**THE ESKBANK BUNCH OF GRAPES.**—In answer to enquiries made of Mr. Curror respecting the treatment of the vines at Eskbank that produced the 26 lbs. bunch of grapes, recently shown by him at Edinburgh, he has kindly furnished us with the following:—The vinery in which the large bunch of Raisin de Calabre grew that I staged at the international fruit and flower show at Edinburgh is a small lean-to house with a southern aspect. It measures 20 feet in length by 14 in breadth, and 11 feet in height at the back, and is heated by four rows of 4-inch hot-water pipes. The vines were planted in 1868, and produced four bunches each, the third year after planting. They are planted 3 feet apart in the inside of the house, with an outside border 13 feet wide and 4 feet deep, the soil of the border being composed of one-half yellowish clayey loam and one-half light gravelly soil strongly impregnated with iron. With this soil are mixed a few half-inch bones and a small quantity of manure. The border is top-dressed every year, inside and out, with 3 inches of cow or horse manure, and gets no protection from rain during winter. There are five vines in the house besides the Raisin de Calabre, viz., two Black Alicantes, one Lady Downes, one Bowwood Muscat, and one Mrs. Pince, all of which carry bunches above the average size. The Raisin de Calabre which bore the 26 lbs. bunch produced three other clusters, one of which weighed 6 lbs., another 10 lbs., and one that still hangs on the vine is calculated to weigh about 18 lbs. This gives just 60 lbs. of grapes for one rod about 14 feet long. The vines are usually started about the 15th of February, when the house is shut up for two weeks without fire-heat. The third week they are assisted by a little fire-heat, and are also syringed several times each day until they break into leaf, after which the syringe is never used. I leave

from 2 to 3 inches of air on all night, both at back and front, according to the state of the weather, and give very little fire-heat, except when the vines are in bloom, until the grapes begin to color. The inside border gets a thorough soaking with water three times a year—at starting with clean water, again after the berries have set, and, finally, just before they begin to color, with guano-water. Under this treatment the leaves grow large and leathery, which, with well-ripened wood, I consider to be the secret of getting large bunches of grapes of good quality.—*John Curror, of Eskbank, Dalkeith, in Garden.*

**PRUNING FRUIT TREES IN JAPAN.**—The *Garden* reports a conversation with an intelligent Japan gentleman, as follows: “The pruning of fruit trees is considered a matter of very great importance, and exact rules are laid down for the pruning of each particular kind of tree. For instance, in the case of pears, which are largely cultivated between Yokohama and Yeddo, and which in the commoner kinds sometimes form large trees, the stems are grown to something over the height of a man, at which point the branches are trained in a horizontal position on bamboo trellises, so that a whole orchard will be covered with a flat roof of branches, under which one may walk and gather the fruit with the hand. The fruit is almost spherical in shape, about the size of a child’s fist, and is covered with a greenish-yellow skin, spotted like a Reinette apple. It is very juicy, but abounds in stringy threads like an old radish, and is far inferior in flavor to any of our good kinds of pear. The Japanese, however, think they are superior to our pears—a matter of taste. The Kakis require a special mode of culture. The principal object aimed at is to have large trees, and, to this end, they cause them to rest every other year, that is to say, they allow them to bear fruit one year, and hinder them from doing so the following year by twisting the fruit-bearing shoots. Moreover, it is requisite that the trees should produce deep-searching and strong roots. To obtain these, the principal roots are surrounded with a coating of clay mixed with stones, which prevents the formation of small lateral rootlets. The soil also must be of such a nature that the roots will not meet with water until they have descended to a considerable depth. In pruning plum trees, the branches are allowed to retain their natural mode of growth, but they are always pruned so

as to allow the wind to pass through them readily. A free circulation of air through the branches is particularly insisted on.

## QUERIES.

**FIRE BLIGHT IN THE PEAR.**—J. McP., writes: “I have had quite a good deal to do with the fire blight on the pear this year, and I have to say that Mr. Meehan’s friend would require a very powerful instrument to detect fungi on the affected branches. Quite a number of people believe that the trees are struck by lightning; and certainly the so-called blight of this year became evident almost immediately after one of those peculiar storms of thunder, lightning and rain, during which the whole atmosphere seemed charged with electricity. Now, the fungus may require that condition of the atmosphere to galvanize it into growth—who can tell? But if the ‘blight’ is the effect of the lightning alone, then I would certainly suggest to some scientific amateur the use of cheap bar iron lightning rods, set well in the ground and rising above the trees. This idea was patented in England some years ago as a preventive of mildew in French vineyards, and it would, if applied here, very likely clear up a fallacy.”

[We believe microscopists generally have powerful instruments. Certainly electricity *may* have something to do with the disease, and so *may* lots of other things. When we come to what *may be* causes, one man’s guess is quite as good as another’s. The lightning rod suggestion does not amount to much, as every branch of a tree is already a rod, and each leaf as good as a platina point. Already houses and barns with rods are often destroyed by lightning.—some say just as often as those without rods. This being the case with buildings, what would the rod prove in the tree? Dr. Hunt is too good a microscopist to be deceived in his observations that fungi caused the fire blight; still it is proper to add that Prof. Farlow, who has been studying fire blight this season, does not find any fungus, but cannot imagine any adequate cause for the appearances. On the other hand it may be noted that the Editor of this magazine stood alone once in showing from *analogy* that the plum knot could not be the work of an insect. It has now been demonstrated by Prof. Farlow to be a fungus, as we showed it must be,

and we know of no intelligent fruit-grower who thinks otherwise.

In like manner we are prepared to say from similar analogies with all we know practically of vegetable life, that the fire blight can only be by fungoid agency; unless there is some entirely new agency at work in the world of which no one has yet had a suspicion. But this new agent is not necessary, because fungoid growths are quite equal to the emergency, and do similar things in hosts of instances.—Ed. G. M.]

ELVIRA GRAPE.—Messrs. Bush & Son send us the following from Bushberg, Jefferson Co., Mo., dated September 9th: "We send you to-day by mail a sample of our Elvira grape. It is hardly ripe enough, but we thought it would carry better thus. We shall be pleased to hear your opinion of it."

[Our western friends make a difference between wine grapes and table grapes. It is, perhaps, as of the former class that this is esteemed. The true test of a wine grape is in the ultimate product,—we can only say that this has characters which we suppose entitle it to distinguished consideration.—Ed. G. M.]

FRUITING OF PYRUS JAPONICA.—T. S. & M., Nashville, Tenn., write: "We send you to-day by mail a specimen of the fruit of 'Pyrus Japonica' grown on our grounds. The 'bush' bore two of this size and shape, and five smaller specimens about the size and shape of a small-sized nectarine, bearing no resemblance in shape to the one sent you."

[This has come to hand. They were probably sent to note their size, as the fact of this plant fruiting often is generally known. It might be worth while to select the largest and best in other respects. It is possible an improved and useful fruit might be obtained. The perfume is delicious; if only the fruit was not quite so tough it might be useful.—Ed. G. M.]

MOTH IN A GRAPERY.—Mr. H. Hannam, Wilmington, Del., writes: "Through the columns of the *Gardener's Monthly* or otherwise you would greatly oblige me, also my employer, if you could afford us some information regarding the moth and grub I enclose in a small box, mailed at same time with this letter. The pest is in our graperies, and has prevailed for three years, but this year to an alarming extent, occupying one-third of the time every day, while there is foliage on the vines, killing by hand, grubs and

moths, and with all the time and labor bestowed on them, we cannot begin to keep them under. The moth makes its appearance in the spring, inserts a germ on the foliage, from which comes the grub, which curls the leaf around it more and more as it grows in size, till it quite cripples the leaf, and if not attended to by killing, the pest would ruin every leaf on the vines before they had ripened their fruit. I have fumigated with tobacco (strong), syringed with Quassia chips, Geshurst's compound, and Paris green, but all to no purpose. The moths and grubs this season increase by thousands every day. I never saw the pest till we had it here, and it is not prevalent around here.

"I hope you will be able to advise us with respect to exterminating the pest."

[This seems to be a new enemy. Send samples to Prof. Riley, St. Louis, Mo., who will probably be glad to see it, and to tell our readers all about it.—Ed. G. M.]

THE EARLIEST PEACH.—A correspondent of Palmetto, Ga., who is fond as an amateur in experimenting with all the peaches he can get, says he "shall not be surprised to find from present appearances that, all things considered, the Alexander will prove the best early peach for that section."

BRIGHTON GRAPE.—Under date of September 9th, which is early for Rochester, Mr. Hooker writes us with a bunch of Brighton grapes. It is impossible to judge in these days of the comparative merits of grapes, when good ones are so numerous. But we can say that the Brighton is an excellent grape, and will, we think, satisfy the demands of even persons of taste in the art of grape culture.

JAPAN PERSIMMON.—O., Bucks Co., Pa., writes: "Some ten or fifteen years ago I read in some periodical a description by a traveller in Japan of a fruit resembling very much our persimmon, which he described as being very good, but have not heard anything of it since. This week I attended the Centennial, and saw some fruit made of wax in the Japanese department which looks very much like our persimmon. There are specimens in their different stages of growth. I tried to learn more about it, but had very poor success. No doubt you might be more successful than I would be. I was strange, and it did seem as if they did not care to bother with me. Is there no way that I could get a few grafts at a

reasonable rate? I feel very desirous to see the persimmon improved, if it can be done. Would our climate be suitable to work them on our native persimmon?

"The above is on exhibition in the Main Building, and on the south side near the wall. If not too much trouble, please let me know more about the above, and oblige."

[We fear our good correspondent is a better reader of "some periodical" than he is of the *Gardener's Monthly*, or he would know that the Japanese persimmon is not unknown in this country. Moreover, if he had been as good a student of the nurserymen's collections on the Centennial grounds as he was of Japanese wax work, and as we suppose the nurserymen hoped tree lovers would be, he would have seen Japanese persimmon plants in several collections. There was the place to find out what was in the country, and we fancy our correspondent, like a good many more people, has not profited the half by the Centennial that he might have done. We have no doubt that the leading nurserymen near our large cities can soon, if not now, supply Japanese persimmons.—Ed. G. M.]

A NEW GRAPE.—A correspondent says: "I mail you to-day sample cluster and foliage of a new grape we have not named. It is an accidental seedling of Fox parentage, grown a little north of New York. The berries first showed color this year July 19th, and first cluster was picked, and good eating, July 31st. To-day, Au-

gust 8th, all the clusters on the vine are ripe and picked. Hartfords in same locality, and with as good exposure, only just show color to-day for the first. This grape is fifteen to twenty days earlier than Hartford, and will prove of great value on account of its earliness, vigor, health and productiveness. The original vine, five years old, trained as an arbor last year, yielded two hundred pounds of grapes, which readily sold at home for 12½ cents per pound. Unlike Hartford, the berries adhere firmly to stem, and do not drop at all, even if left on vine a month, as has been repeatedly tried."

[We do not remember that the grape above referred to came before us. It may be, however, as well to say to those who send us grapes, that good varieties, so far as flavor and appearance are concerned, are now so numerous, that other qualities must go to make up a successful grape, and of these the editor with but a bunch before him cannot judge.—Ed. G. M.]

CALIFORNIA ONION SEED.—A correspondent says: "I have tried California and Oregon grown onion seed but one year. It did better than I supposed it would do, but not as well as eastern grown seed, and certainly one year's trial is too brief a test to warrant such unlimited claims to superiority. If onion seed grown in a warm, dry climate will tuber as well as seed grown as far north as it will possibly ripen, it is something new, and will upset some old notions."

## FORESTRY.

### COMMUNICATIONS.

#### AMERICAN ARBORETUMS.

BY WM. WEBSTER, LANDSCAPE GARDENER,  
ROCHESTER, N. Y.

Since my return from Philadelphia, where I had the pleasure of examining Mr. Meehan's Arboretum, in the Centennial grounds, an idea has presented itself to my mind in connection therewith, that the more I reflect upon, the more convinced have I become of its feasibility and its importance. The plan which I propose is sim-

ply the formation of collections of trees or shrubs by private individuals, and so arranged as not only to be a pleasure to themselves, but a source of profit and enjoyment to their friends.

So long as Arboretums in their true sense must in this country be confined principally to institutions of learning like our Universities or large public parks, or belong to the government like the one at Washington—just so long will the majority of our people learn but little about the culture, growth or value of many of the trees, the timber of which is used in the arts. Any one who has paid even the slightest attention to the fine exhibits of the various kinds of

wood, the production not only of our own, but of other countries at the Centennial, cannot fail to appreciate my remarks. Hence what is really required to render this interesting subject more popular with the masses is a diffusion of more general knowledge of the proper culture and use of trees, through the establishment of private collections, containing one or more of the natural orders, with genera, species and varieties. Having made the culture and science of trees a study, I feel that the importance of such collections cannot be too strongly urged upon such gentlemen as not only have the means but the taste and ground requisite to form such collections. Some men will spend thousands of dollars in forming a collection of antique china, or of old coins or minerals. If such things become interesting and valued, as they generally are by the collector and his friends, surely a fine collection of trees, which are yearly growing in beauty, must to a lover of nature, become infinitely more so. For instance, Mr. A. may form a collection of willows like the Woburn collection in England. Willows are simple appearing things in themselves, yet when planted in the aggregate, are highly interesting. In the collection just named, there are one hundred and fifty-nine kinds, which are described and named in the *Salicetum Woburniensis*. Or suppose Mr. B. desires to make a collection of oaks; he will be astonished at the vast number of species and varieties that will be brought to notice, and so of other, through the long list of natural orders to the end of the catalogue. Thus, if a number of these collections, each different in itself, be started in any one place, like the suburbs of a large town or city, they would in the aggregate form an Arboretum of grand proportions, that if scientifically arranged would afford instruction and amusement to a large number of people.

Being called in consultation a short time since in regard to some improvements now in progress on a large estate situated in the midst of some of the grandest scenery in the State of New York, I suggested among other things to the proprietor, the formation of an Arboretum. The idea pleased him much, and it was decided that as there were a great number of large and beautiful pines growing on the place, to add to these all the different kinds of hardy conifere and form a *Pinetum*, scientifically arranged, properly labelled, and catalogued with a description of each species and variety, so that any

friends visiting the grounds could be presented with a catalogue, from which they could learn the name and use of each tree, thus making the collection as complete in its character as possible. The location of the place just mentioned is on a branch of the Erie Railroad, where it crosses the Genesee River by an iron bridge which is raised 235 feet above the bed of the river. Immediately below the bridge there is a fall in the river of 66 feet, and a short distance beyond there is another fall of 110 feet, where the water is so broken in its descent as to give it the appearance of fine lace. The improvements which are being made are on a level piece of land along the river bank, between the two falls, and from whence the bridge above, appears so light and airy that a passing train seems as it were gliding through the air; truly a charming spot,

Down in the glen where laughing waters play,  
And stately Pines lift up their heads in light of day;  
There graceful Spruces spread their branches wide,  
That with the odorous Fir the magic of the scene divide.

No one need imagine from the foregoing description that it is one of those places kept up in the highest style of art, with the accessories of hot-houses, graperies, and numerous flower beds, for it is nothing of the sort; everything being plain but neat; simply Nature, assisted by Art, only to such an extent as becomes necessary in the arrangement of the various objects, and in such a way as to harmonize with the surroundings; nothing incongruous but everywhere showing the hand of taste of the proprietor. And this is a style which must obtain to a great extent in this country in the future. Trees are both beautiful and interesting objects for study. They are the glory and delight of nature, and yet how few there are that understand anything about arranging them when planting, in such a way as to produce anything like a pleasing effect, an error which it becomes the province of the initiated to correct, and a knowledge of which it is also designed that a study of these private collections shall impart.

---

### EDITORIAL NOTES.

---

MEEHAN'S ARBORETUM AT THE CENTENNIAL GROUNDS.—We have not noticed in these columns the arboretum planted by the editor of the *Gardener's Monthly*, as naturally he would prefer them to be judged by his cotemporaries rather than



by a magazine, of which he is himself the editor. It was a much greater effort than most persons imagine to place in first-class condition and properly name on large labels so large a collection of trees, and no other person attempted it. We have, however, much pleasure in placing on record that the London *Gardener's Chronicle* complimented them highly; the New York *Tribune* regarded them as "offering an opportunity of study and comparison rarely to be enjoyed in this country;" and the *Rural New Yorker* had a good word for them as "750 kinds of deciduous trees, &c., mostly hardy," which was kindly intended, but they are not all "deciduous"—one-third being evergreens. Other newspapers have kindly referred to their existence and commercial worth.

**HISTORY OF THE CATALPA.**—*Field and Forest* for August, a very interesting scientific serial of the more popular type, published by Mr. C. R. Dodge, of Washington, has an article on the Catalpa, to prove that it is not an introduced tree. We have read the arguments carefully, but think it does not take in the point fully. There is no doubt it was here when the white man found the country, but there are many reasons for doubting it is an aborigine, in the sense that other trees are. The probabilities favor the idea that it and the Honey Locust are wanderers in the far away past from Asia. How they got here we have as yet no means of knowing.

**THE CATALPA TIMBER.**—As sound, solid, durable timber, there seems to be no doubt of the value of the Catalpa. But it must be borne in mind that in the Northern and Western States, it is liable to have its terminal bud destroyed in winter, and then the stem grows crooked—a defect in a timber tree. This may be remedied by cutting a seedling down when it is three years old. A new

tall strong stem results. In Virginia we learn it proves very satisfactory.

**THE LOCUST TREE SLUG.**—The Yellow Locust through large districts of our country is being "skeletonized" as bad as the Elm. Prof. Rathvon says it is done by the larvæ of *Hispa suturalis*, a small beetle.

**THE GERMAN FORESTS.**—If the accounts we hear of the change in the climate of Germany during the last fifty years be true, it cannot be on account of the disappearance of the forests. The *Department of Agriculture* says:

"In the distribution of the kinds of wood the pine and fir are found in the south of Germany, oak and beech in the west and south-west, and the Scotch fir in the north and north-east, while Central Germany, to a greater or less degree, contains all these varieties.

"Since 1831 the forest area of Prussia has diminished about 5 per cent.; in most of the other German States a barely appreciable diminution has taken place, while there has been a steady increase in Bavaria, Baden and Saxony. On the whole, Germany has wood enough to meet domestic demand for many years to come."

**TREE-PLANTING.**—A correspondent in Livingston, Illinois, reports that the planting of trees in groves and shelter-belts, and for ornamental purposes, has become very general in that county. Ten years ago 95 per cent. of the area of the county was treeless; but now a farm without a grove is an exception to the general rule. Black walnut has the preference for profit and ease of cultivation; but elm, soft maple, willow, cottonwood, European larch and ash are common, while evergreens are popular for ornamental purposes, and occasionally are planted in groves and shelter-belts.—*Dep. of Agriculture.*

## NATURAL HISTORY AND SCIENCE.

### COMMUNICATIONS.

#### TRITELEIA LAXA;—OR SEUBERTIA LAXA;—WHICH?

BY MR. W. WEBSTER, ROCHESTER, N. Y.

The communication by W. C. L. Drew in the September number of the *Monthly* is not only timely, but an exceedingly interesting one to me. The

flower which he introduces to your readers by the name of *Triteleia laxa*, is a very familiar one to me. The plant but not the name. And it recalls to my mind very vividly, the great delight I experienced on first discovering it growing in all its perfection of bloom on the hillsides in California.

Some time during the month of May last,

while in company with a friend, we determined on taking a ramble among the hills which so nearly environ the beautiful town of San Rafael, of which place the gentleman was a resident; and while ascending one of them our eyes were greeted with a fine display of this, the finest of California's floral gems. In ascending to the summit of one of the highest hills, the flowers became more profuse and beautiful, and I cannot refer to any previous botanical excursion that ever gave me such genuine delight as I experienced on this occasion.

That it improves by cultivation was very apparent, for near to where it was growing in great profusion a piece of ground had been enclosed for the purpose of growing the Eucalyptus. The ground on which the trees were planted had been pretty thoroughly broken up a year or two previous, and the bulbs which had remained in the ground at the time of the breaking up of the soil, had thrown up flower stems over two feet high, with umbels as large as those of *Agapanthus umbellata*, and of dark blue or violet, very striking indeed. The plants on the inside of the enclosure being twice as large as those on the outside where the ground had not been broken up.

A short time subsequent to making this discovery, I met Prof. Bolander, of San Francisco, and to whom I introduced the subject, at the same time asking him to favor me with the correct name, which he did in writing, and the name as he gave it is now before me—*Seubertia laxa*—and that there may be no mistake of identity, I enclose you a small bulb which I dug from one of the hills in the vicinity of San Rafael. Please give us the true name.

[The name *Seubertia* which Kunth gave to this is more properly appropriated by a genus of composites nearly allied to the well-known *Bellis* or English Daisy; hence Hooker's name of *Trieteleia* prevails.—Ed. G. M.]

### BRODIAEA COCCINEA.

BY W. C. L. DREW.

Among the many wonderful plants found in the vegetable world of our State, California, there are few, if any, that are more curious and interesting than the various *Brodiaeas*, foremost among which is the *B. coccinea*, an idea of which I shall attempt to give the readers of the *Monthly* in this article.

*B. coccinea* was first discovered by Gray a few years ago; it belongs to the Natural Order Liliaceæ; in its native home it is not so well known under its botanical name as given above, as by its common and popular name, Vegetable Fire-Cracker, which name is far more appropriate than that borne by many flowers.

The flowers are borne in immense clusters or umbels, each cluster having from twenty to fifty, and often more, blossoms in it; and are often found from six to eight inches across the cluster.

The single blossoms are about the size of a Chinese fire-cracker, which every one has seen on the Fourth of July; in shape they are also

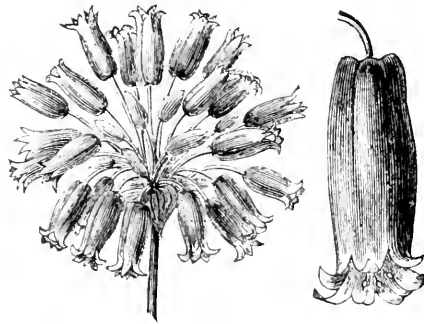

similar; in color they are of a very bright scarlet, and very brilliant, and produce a dazzling appearance when seen swaying to and fro in the sunshine, it is to this resemblance to the fire-cracker it owes its name "Vegetable Fire-Cracker," and at a distance its resemblance to a pendant bunch of fire-crackers is very remarkable. The flowers remain fresh for a very long time, often three or four months, which point will make the plant valuable. The stem grows two feet high, is straight and slender, but very strong; the leaves are from two to four in number, and are of a drooping nature; they envelope the part of the stem under ground, but above ground they are almost always found lying flat on the surface.

The root is a bulb of small size, found very deep in the ground, never less than five inches. It abounds in a mucilagenous or starchy substance, and is relished by the Indians, who seek it, and consider it a dainty.

It is found in gravelly and rocky soils, on mountain tops and along the northern part of California, and always in partial shade, being under oaks and conifers or in half open woods. These points will give persons cultivating it a hint as to treatment.

## RAIN-FALL AND THE LAKES.

BY J. JAY SMITH, GERMANTOWN, PHILA.

I was very much pleased with your paragraph on page 310, of the October Magazine, regarding "Trees, Rain-fall and the Lakes." Writers on these subjects often run away rapidly with what appears a *good and new theory*. But has it been proved by lengthened observation, carefully carried out, that cutting down the trees prevents rain-fall? I observe in some recent foreign publications that it is doubted, and they bring, in confutation, observations on the summer drying up of the Arno, to show that Florence has *always* suffered, though it is but lately that the mountains which feed the river have been in the course of destruction, or the denudation of their trees.

Let us try. Have the Falls of Niagara decreased in volume, or has the flow of the Mississippi diminished in any material degree? What is wanted is "observation with *extensive view*," and *facts* that science can recognize.

[It is a great pleasure to have this brief but pithy note from so intelligent a source as this. The Editor of this magazine has had to stand almost alone in opposition to the deductions of the celebrated author of "Man and Nature," and these too backed up by the full force of the influential American Association, which adopted a report of one of its committees in favor of Mr. Marsh's views. We do not say Marsh's theories are not true, but we do say that the reasoning ought not to satisfy a truly logical and scientific mind.—Ed. G. M.]

---

 EDITORIAL NOTES.
 

---

VERNACULAR NAMES.—As we grow older we get out of all patience with what are called common names. It has been the writer's luck to be a juror in several departments of the Centennial Exhibition,—amongst others "Legumes" and grains from foreign countries—in cases where it was thought his botanical knowledge might be of some service in determining what the different peoples were talking about. We all know, for instance, that the English "common" name of the *Anagallis arvensis*, is "Pimpernell," but there are Austrians and Hungarians in abundance who will stick you out in an argument that "Pimpernell" is *Poterium sanguisorba*. "Algaroba" we all

thought was the *Ceratonia siliqua*,—and which receives from our people the common name of "St. John's bread,"—but our experience at the Centennial teaches us that if you send to Spain or Portugal for "Algarobas" you may get a dozen different things. One thing we noted that whatever they were they were always Legumes—and perhaps the word is a generic—a common name, and not a specific one, as we have always believed. Again we find among Spanish leguminous products "Lupins" that are not of the genus *Lupinus*; and large numbers of Beans with very different common names by different growers. In fact we found to our sorrow that the "common" names of the world were entirely too common for us,—and it was a great comfort to find in the magnificent collection of Baron Angelo Porcari of Palermo, that he had the botanical names to his labels, as well as the common ones. It enabled the judges to do full justice in tracing out the origin of the articles exhibited, and thus understanding from what they were "improved," and was thus regarded by the jurors as one of the most sensible and instructive of all the world's contributions.

We have a suspicion that "common" names made all that great trouble at the tower of Babel.

HOW ERROR IS PROPAGATED.—It is more than probable that much of the supposed differences of opinion which prevail on scientific subjects, between distinguished men, come from their imperfect understanding of each other's statements. The writer notices this frequently in his own case, and it is doubtless so in those of others. A very distinguished English author quotes some "observations of Mr. Meehan *on trees all growing together in his garden in Germantown*." By reference to the paper itself it will be found that nothing was said as italicised. They were not all growing together, and any one knowing that fact, but not reading the original paper, might infer that "Mr. Meehan was not particularly exact in his facts."

Again in the English edition of Sach's Text Book of Botany, Meehan is given as authority for the statement that the various species of *Rubus* rarely perfect seed in America. As everybody knows the Blackberries seed freely, they must have a poor opinion of Meehan's facts. But if they will turn to the original they will see that what he really said was that plants from seed in the natural state are of

the rarest occurrence. And so gentle reader, when you read of something attributed to some favorite whom you believe in generally, but which seems very absurd on this particular occasion, be merciful to him and think that per-adventure he did not do that foolish thing. So may charity claim you for a client, when your trial day comes round.

**TROPICAL FLORA AT THE POLES.**—As every intelligent person knows, the remains of tropical plants and animals are found as far as explorations have yet reached, and puzzle philosophers to account for their appearance there. Some have thought that through the long course of ages the earth has gradually, and perhaps may be still gradually, shifting its axis, so that what is now the north may have been under the line. The following from a recent lecture by Mr. Blandet before the Geographical Society of Paris, if true, might account for it in another way,—for if the Sun was so large every part of the earth would be warmed about alike. We cannot of course decide between these theories. The student must take his choice.—

“Our earth went, during its course in space, through six periods: 1st. The chaotic period—absence of all vegetable and animal life. 2nd. Carboniferous period—the era of the immense vegetable growth, which absorbed the carbonic acid from the air, and the products buried during successive convulsions of the earth, extended through various zones, as well under the equator as near the poles. 3rd. The cretaceous period. 4th. The oecene period. 5th. The miocene period—the primitive vegetation leaves the poles, which cool down to below the temperature necessary for life; at the same time nature, more choice in its products, gives birth to animals more and more perfect. 6th. The last or quaternary period, is that in which we now live.

“The continuous condensation of the sun is alone sufficient to explain how it has been able to furnish the prodigious quantity of heat which it has radiated into space. The calculations have been made: if it condense only enough to diminish its apparent diameter one second of an arc, it generates an amount of heat equivalent to that which it emits in 18,000 years.

“In the beginning of our earth's existence, it rolled through a space of fire, the sun's heated gases were extending beyond her orbit.

The sun had then, as seen from the earth, a diameter of 180°; this slowly became reduced to 47°, next to 22°, next to 8°, and finally to 2° apparent diameter.

“Then the quaternary period began; the poles commenced to cool, and only the tropics received heat enough to sustain the luxurious vegetation of the former periods.

“The miocene period, or the time when the tropical flora prevailed on the tops of the Pyrenees and Alps, and at the poles, when the sun was 3°, or 180 minutes, or 10,000 seconds larger, we go back 194,000,000 years before 244,000,000 years. Paris had, even later still, a tropical temperature, and the eocene period existed 250,000,000 years before that time, or about 500,000,000 years previous to the present day.

“But the carbonaceous era consists of 777,000,000 years more, making together about 1,500,000,000 years.

“The earth separated from the contracting planetary nebula some 4,300,000,000 years before, making, as a total for the time of its independent existence, about 6,000,000,000 years.

**VITALITY OF SEED.**—When a new form of plant appears, the Botanist refers to all that has been known about it before. We should like to see this sort of knowledge attended to in other branches. Mr. W. H. Seaman of Washington, has been doing this good work for us in relation to the question of vitality of seeds. In *Field and Forest*, he has given references to all he can find on the subject. There seems to be little evidence worth considering that seeds will live for ages in the ground.

**COURSE OF THE SAP.**—Prof. Karl Koch says in *Gardeners' Chronicle*: “Among practical gardeners and pomologists not only does this error respecting a rising crude sap or raw food prevail, but many of the current notions as to the real nutritive substances are equally at fault; more particularly that with regard to the direction of assimilated sap, which goes wherever it is needed—that is to say, where it can nourish, as a rule and for the greater part upwards, and in a less degree downwards. In the first place, nobody appears to have attempted to answer the question, When do the leaves become active or begin to assimilate the nutritive substances, the carbon-hydrates? Nor, so far as I know, has it been taken up from a scientific standpoint. As the leaves are already green when they unfold, it has been tacitly admitted that assimilation commences then. But such is by no

means the case. The leaves only become active after the shoot has attained its full development. Until this point is reached, the leaves themselves, as well as the axis of the shoot, need nourishment, in order to enable them to reach their natural size, and finally fit them for the work of assimilation."

[The writer of this can confirm Professor Koch's views. In experimenting years ago, he would pick off the leaves of the pushing young branches of Ashes, Horse-Chestnuts, and Maples, as fast as they could be discerned. Nevertheless the shoots would become wood to a considerable portion of the whole length. The material for the organization must have been partly stored up the previous year, and partly drawn from other parts of the plant.—Ed. G. M.]

#### THE WARFARE OF PLANTS ON ONE ANOTHER.—

Mr. Lester Ward in the *Popular Science Monthly* for October, has the following good piece of reasoning:—

"The most frequent and prominent cause of these disturbances of the natural fixity of vegetation is the influence of man. The results of this influence may be said to be the products of agriculture, horticulture, and floriculture, on the one hand; and, on the other, weeds. But there may be many other causes of disturbance besides that produced by man, such as the appearance of new animals, geological revolutions, or climatal and meteorological vicissitudes. Anything which destroys the stability which the perpetually-operating vegetal forces impose upon the plants of any region is certain to reveal a latent vitality, which, when liberated, proves itself capable of profiting by conditions far different from, and superior to, those under which it is originally found. The willow, the alder, the elm, and the sycamore, hug the banks of streams because lashed and beaten back at every attempt to invade the drier ground. The wild-columbine and the saxifrage are driven into their rocky fastnesses by more powerful rivals for the rich forest loams. The thistle and the chamomile flourish in lawns and commons, because their human foes are less formidable than the enemies of the plain. The fruit-trees, the cereals, and the roses, reach those wonderful heights of development under man's care, because he not only proves their friend, but wards off all their enemies. And just here it should be remarked that the alleged tendency of cultivated plants to relapse, when neglected, into their original state, upon which Prof. Agassiz

laid so much stress as an unanswerable argument against transmutation, becomes, under the law of mutual repulsion, the necessary result of remanding them to their old conditions. As man's care and protection were necessary to enable them to advance, so, when these are withdrawn, they must be expected to again yield to hostile forces, and fall back to the level of their original state."

[We have long known that cultivated plants do not necessarily go back, as Agassiz urged against Darwin, when left to themselves. Varieties raised under culture reproduce themselves from seed just as well as true species, and we believe that so far as any inherent law is concerned, would go in with the ages just as well. They are crowded out by more powerful rivals.—Ed. G. M.]

ADAPTATION TO THE ENVIRONMENT.—It has long been regarded as a law of life, applicable alike to animal and vegetable forms, that each species is exactly adapted to the particular habitat where it occurs; and naturalists, assuming this law, have sought to solve the problem how this remarkable adaptation has been brought about, instead of pausing to question the alleged law of adaptation itself. And yet there have never been wanting numerous and obvious facts, especially in the vegetable kingdom, which, if interpreted at all, must be conceded to be incompatible with such a law, at least unless materially modified and greatly enlarged.

Mr. Thomas Meehan has remarked the fact that "almost all of our swamp-trees grow much better when they are transferred to drier places, provided the land is of fair quality. He referred, among others, to sweet-bay, red maple, weeping-willow, etc., as within his own repeated observations growing better out of swamps than in them." He further observes that "plants as a general rule, even those known as water-plants, prefer to grow out of water, except those that grow almost entirely beneath the surface."

A great many facts are at hand to prove that those plants which are found habitually growing in wet ground may be easily made to grow in dry ground. The *Iris versicolor* (blue flag), which, in a state of Nature, grows universally in marshes, and keeps perpetual company with *Nuphar* (pond-lily) and *Sagittaria* (arrow-head), is a common occupant of the driest gardens. The *Lobelia cardinalis* (cardinal flower), which I have found below tide-water mark, is also a common garden-flower, and not difficult to cultivate.

Almost as much may be said for *Lobelia siphilitica* (great lobelia). The calla, the caladiums, and the anthuriums, belong to this class, and the list might be indefinitely extended.—*Lester J. Ward, in Popular Science Monthly for October.*

**THE SELF FERTILIZATION OF PLANTS.**—Mr. Thomas Meehan, one of the most acute and thoughtful of American Botanists, has, several times during the present year, brought before the Philadelphia Academy of Natural Sciences, the subject of the fertilization of plants. He has observed that there are plants with conspicuous and attractive flowers, which are as much adapted to secure self-fertilization, as other flowers are for cross fertilization. One of his examples is the greenhouse annual *Browallia elata*, belonging to the order Scrophulariaceæ, having an attractive blue flower.

Another phenomenon, the "sleep of plants," or closing of the flowers at night-fall, has been found by Mr. Meehan to result in self-fertilization in *Claytonia Virginica*, and some buttercups which seed abundantly in the absence of insects.

In *Ranunculus bulbosa*, in the evening following the first day's expansion of the flower, Mr. Meehan found the immature anthers, and the young pistils covered with pollen grains. On examining the flower he found that the outer series of anthers mature on the first day of opening, scattering the pollen on the glazed petals which, on closing for the night, drop it on the immature stamens and pistils as before noted. Another remarkable instance of self-fertilization occurs in *Ranunculus abortivus*, which does not close its petals at night, but the slender pedicels droop, inverting the flower, and thus allow the pollen to drop on the stigmas. Mr. Meehan concludes that some deeper purpose than has yet been conceived, governs the fertilization of plants. In view of these examples Nature cannot abhor "in and in breeding," and it can hardly be that color, fragrance, and honeyed secretions in flowers have been developed solely to secure cross fertilization. Evolutionists will await with interest, further researches by Mr. Meehan, and confirmatory evidences from other inquirers.—*Nature.*

### QUERIES.

**SEEDS TWO THOUSAND YEARS OLD GROWING.**—A correspondent sends us the following from the London *Examiner* and asks what we think of it:

"A most interesting observation, referring to the power of germination in seed which is hun-

dreds and even thousands of years old, is said to have been made by Professor Hendreich in Greece. In the silver mines of Laurium, only the slags left by the ancient Greeks are at present worked off, in order to gain, after an improved modern method, silver still left in that dross. This refuse ore is probably about two thousand years old. Among it, the seed of a species of *Glaucium* or poppy was found, which had slept in the darkness of the earth during all that time. After a little while, when the slags were brought up and worked off at the melting ovens, there suddenly arose a crop of *Glaucium* plants, with a beautiful yellow flower, of a kind unknown in modern botany, but which is described by Pliny and others as a frequent flower in ancient Greece."

[We do not "think of it" much. *Glauciums* with "a beautiful yellow flower" are common enough in Greece. Why do not people who are anxious to know "what to think" about these things, put a few *Glaucium* seeds in a bottle, seal the bottle air tight, and bury in the earth. We would give the "silver mines of Laurium" if we owned them against the seeds remaining vital five years, to say nothing of twenty hundred years. Some day when the Grecians get as many railroads as we have, and as active scientists to investigate, we fancy plenty of things "unknown to modern Botany," will be found all around them. We know of *no* evidence satisfactory to us, that any seeds have been found vital under the extraordinary circumstances claimed. The whole theory of great vitality through long periods when buried in the earth, is at best founded on nothing but shrewd guesses, and, in the main on the evidence of persons of no more importance in a scientific point of view than those who believe wheat is transformed from chess.—Ed. G. M.]

**ORTHOGRAPHY OF BOTANICAL NAMES.**—J. S. O., Cincinnati, Ohio, asks: "Will you please give us the rule for the terminal *i* in botanical names? For instance, should we write *Smithi*, or *Smithii*?" [It should in Smith's case be *Smithii*. It is no use to give you the rule unless you are acquainted with the Latin language. We can only say that in Latin the form of the genitive depends on its nominative. When the nominative ends in *us*, the *us* changes to *i* to form the genitive. *Smithius*, the Latin of Smith in the nominative case thus makes *Smithii* in the genitive. There are two *i*'s only because one is already there.]—Ed. G. M.]

# LITERATURE, TRAVELS & PERSONAL NOTES.

## EDITORIAL NOTES.

THE THWACK RASPBERRY.—We never go out of our course to notice what people say in advertisements; but in relation to the Thwack raspberry, the circular was brought to our immediate attention, and we were asked to say what we thought of it. We thought we spoke very well of the fruit, as far as we could speak of a thing we had never seen, and we coupled our praise with a little friendly advice—friendly as we thought—about extravagant expressions. In this, as well as in most advertisements, we really think that over-praise injures a good thing. Mr. Foster, who is President of the Pike County (Mo.) Horticultural Society, and, as we believe, every way a highly honorable and estimable gentleman, does not seem to see our point. He imagines the object was to injure and not to help his fruit, and so he sends us the following letter:

“The Thwack is not ‘said to be very good’ by some, ‘but is said to be best by all’ who have tested it, and the number is large. Our statements are not ‘loose,’ unless the best men in the State of Missouri and Illinois are wholly untrustworthy, and have loaned the sanction of their names to palm off a swindle upon the public; and besides our raspberry is not a ‘very good thing’ but a choice new fruit. Sorry you consider it a thing!”

We think there cannot be many who interpreted our remarks unfavorably of the raspberry, as Mr. Foster himself has done; and that it is hardly necessary for us to “rise to explain;” but lest there be, we beg to say that we had not the remotest idea of condemning the raspberry. Our remarks had reference to the manner in which advertisements are often worded. We thought they would be better if worded differently, and we hoped to be thanked rather than blamed for the suggestion. It was but an opinion; but if our good friends think differently, we have no objection, only please do not ask us for an opinion of a circular, and then feel badly because we honestly give it.

POSTAL LAWS.—A correspondent writes that we are wrong about the postal laws on seeds and plants; that the obnoxious express rates of last

season have been repealed, and that his post-master receives things from him at the rate of one cent for two ounces.

Notwithstanding all this, we assure our correspondent that the Express companies’ law of last season is not repealed, and that post-master of his his may get him and himself into trouble one of these days. More than this, we do not believe the people are strong enough to defeat the Express companies in this matter. They can afford to keep men at Washington to explain their side of the case; the People have no representative. We do not believe the stories of the sensational newspapers that members of Congress are bought up to vote in these and other instances. These men, many of whom we know, are as honorable as any other body of men, and such charges are as a rule, but the outpourings of spite and evil dispositions; but we mean that plausible arguments and representations on one side against little or nothing, on the other, are bound to tell in the long run, and this is the advantage the companies have over us all. Even more, it may after all be good national policy, as well as to the advantage of the Express companies, to have the law as it is, but so far as we understand, it does not seem so. If any of our readers have undoubted facts and figures to bear on this question we would willingly publish them, and we think a good tempered article in our columns would have weight at Washington. We do not want mere newspaper statements or newspaper figures; these can be made to prove any side. But what is wanted is to show that mailing seeds, cuttings, plants, &c., is not merely a benefit to horticulture, but is no serious loss to the Post-Office Department.

THE GARDENER’S MONTHLY.—An Iowa correspondent says:—“The September number of the *Gardener’s Monthly* is a fine number. I am glad to see by the continued improvement of the magazine, that it is in a prosperous condition. It certainly deserves it.”

[All such kind notices please the publisher, who is very grateful for the encouragement. We may say that there has been a gradual increase of subscribers since the war, but nothing near to the extent there would be if the magazine were agricultural instead of horticultural; for where

there are a thousand people who farm for a living, there may be but one who gardens for pleasure. For the same reason it is very hard for the publisher to find out where the garden-loving folks are, and he has therefore to depend on the good services of friends about subscription time, when two can often be sent on as well as one. As our correspondent remarks, such encouragement comes back at last to these friends, for we endeavor to improve with increased encouragement.—Ed. G. M.]

CRITICISM.—A highly valued friend writes:—"On page 295, in mentioning the new hydrangea, 'Thomas Hogg,' you give it as a variety of 'H hortensis,' when you know very well that it was named in honor of Queen Hortense, and should be *Hortensia*, with a capital H. But then we can't all be perfect. Why don't you insist on having a good proof-reader? Such things as 'celler' for cellar, 'mallorn' for mallow, and a lot of others *you* of course are not responsible for, but some one should be. While I am poking good-natured criticism at you, I will add that the Germans will laugh (p. 295) to learn that 'Maitrank' is a 'German perfume.' Bless your innocent heart, the word means may-drink, and the thing itself is wine, in which the leaves of *Asperula* have been infused. The Germans have been calling the plant 'Wald-meister,' and insist that it grows wild in this country, but they mistake for it one of our own *Galiums*. I don't at this moment recollect which species it is, but one of them has quite the same melilot perfume as *Asperula*. It is singular that *Anthoxanthemum* among grasses, *Melilotus* and *Dipterix* (tonqua bean), in *Leguminosæ* and *Asperula* and *galiums* in *Rubiaceæ*, to which we may add *Liatris odoratissima* in *Compositæ*, should, though so unlike botanically, have almost precisely the same odor. But this is preaching. The October number is a good one, in proof of which I admit to have read it all through."

In addition to this we have another from an equally esteemed correspondent:—

"I was quite amused on looking at the *Gardener's Monthly* the other day to see a quotation from a Belgian journal, saying that the *Asperula odorata* was used in making the German perfume called Maitrank. In New England, perhaps, it might do to call it a perfume; but in Germany, where there is no prohibitory law, there is no hesitation in drinking what the Belgian journal calls, facetiously perhaps, a perfume. In plain En-

glish, Maitrank, as the name implies, is a sort of punch, made of some light white wine, into which is put the meistrkraut, or *Asperula odorata*, apple-blossoms and such things; clover-flowers are even said to be used, and I have known *Oxalis* leaves to be found floating in the Maitrank. In short, the ingredients are as indefinite—although somewhat higher-toned—as in the root beer of New England. Wine is indispensable; then, if it can be obtained, *Asperula* and in addition any number of other flowers. The Maitrank is a favorite spring beverage in the valley of the Rhine, particularly in Baden and Alsace. The traveler will easily find a chance of tasting it in Frankfort, Heidelberg or Strasbourg. Amongst other places at the Molkenkur in Heidelberg it is offered for sale about the first of May, when if one does not fancy the somewhat weak and acid beverage, he can, at any rate, enjoy the magnificent view of the neck and the more distant Rhine. The *Asperula odorata* is common all through the Vosges mountains, and it always seemed strange to me that so pretty a plant was not cultivated. One of the prettiest species of *Peronospora*, *P. calothea* grows upon it."

[Another friend sends us a postal card, much to the same effect. We return our best thanks for these favors. It has been ever our ambition to make the *Gardener's Monthly* as near absolute perfection as possible, and it is a great pleasure to us to find our friends as jealous of its accuracy as we are ourselves. Such corrections are always very welcome.—Ed. G. D.]

THE TOMATO.—Nothing is more remarkable than the way in which nations will year after year shut themselves up in their prejudices, and keep deaf to evidence that would help them to facts of great value to themselves. It is within the time of the present writer that the tomato was in use only in England by the very select few, and then merely as sauce. All this time, and for three hundred years before, the Germans, to whom we are indebted for its extensive use, were luxuriating in it. The mass of the people of England believed the tomato to be "poison," and many believe so yet. We are reminded of this by the following paragraph:—

"Several interesting statements are made by 'Science Gossip' (English), showing the centuries since the culture of the tomato was known in gardens. Galen, who lived in the second century, uses the name *Lycopersicum*, now applied



to the tomato, but it is not known to what plant he alludes. But an Italian writer, in 1561, thinks Galen meant the tomato. Dodoens, a Dutch botanist, describes it as growing in his time (in 1583), and as eaten dressed with pepper, vinegar and oil. Gerard mentions it in his 'Herbal' in

extensive use on the table, cooked and uncooked, about the year 1825."

MILLER & SIEVERS.—*Australian Tree Ferns*.—We see by the public papers that for the very fine collection of Australian tree ferns, which

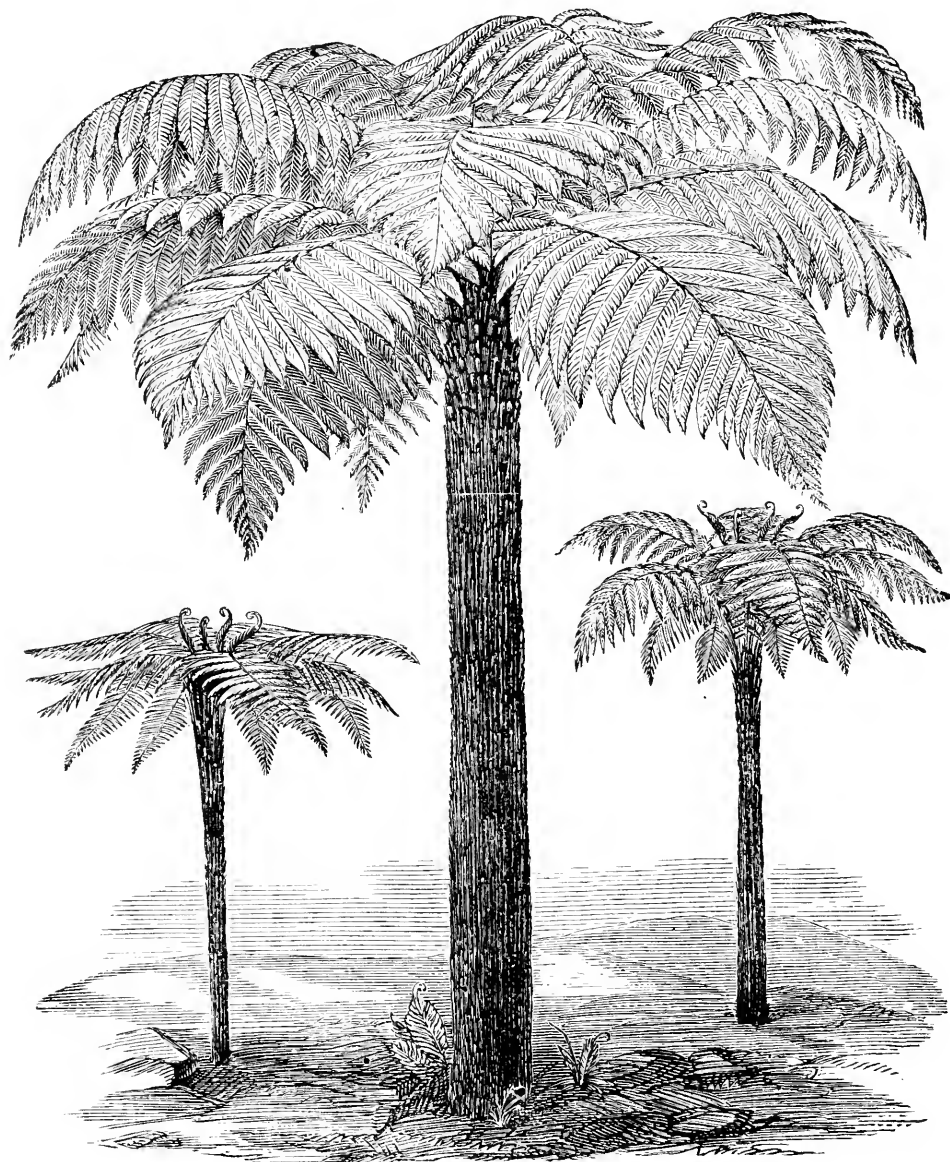

1597, and calls it *pomum amoris*, and describes red and yellow fruited sorts. Parkinson, in 1656, says it is cultivated only for curiosity, and 'for the amorous aspect or beauty of the fruit.' A century afterwards Miller states it was used in soups. Coming down later, we remember its

formed one the leading attractions of Horticultural Hall, at the Centennial, these gentlemen have had deservedly an award of honor. That those who may not have visited the Exhibition may have an idea of these remarkable trees, we give the accompanying sketch. The reader

must imagine the central stem in the picture to be about ten feet high.

**THE EARLY HISTORY OF THE VINE AND POMEGRANATE.**—The *Independent* of Oct. 5th, notices the researches of Dr. Birch on "Monumental Egypt," and that there is in the work an account of a Botanical collection made by Thotmes III., on the pylons of Karnak. The sunflower, vine, pomegranate, and a kind of Arum, are recognized, which we are told were found "on the upper Rutennu or Northern Syria, and from there brought to Egypt." This brings the authentic history of these fruits back to a much more remote period than we have reached before, and towards the spot where Noah had "that high old time," after his miraculous escape from drowning. It is more than likely that when the countries east of the Caspian and across the Himalayas shall have been explored, both in their botany and ancient records, as Egypt is now being done, much that is obscure in the early history of our fruits and vegetables will be cleared up.

**W. FORSYTH.**—This old writer on Gardening, *The Journal of Horticulture* tells us, was born in 1737, at Old Meldrum, in Scotland. He succeeded in wheedling the Government of England into giving him \$9,000, for mixing cow dung, lime, wood ashes and sand together, in order to make hollow trees fill up with sound living wood. A "commission" was appointed to report. A Dr. Lettson and a Dr. Anderson composed it, and they testified that it was "nothing more than the truth." History says Mr. Forsyth was "mistaken." A modern writer would say he was a "dead beat," and consider even such slang more than politeness required.

**I. E. ILGENFRITZ.**—Among the many personal features that give interest to the Centennial, Michigan receives credit for the above gentleman, whom she placed in charge of her exhibits. Always courteous and energetic, with an excellent knowledge of pomology, he is one of the most promising of the younger race of Horticulturists, and we made his acquaintance with pleasure.

**COL. WILDER.**—As most of our readers know the good President of the Am. Pomological Society, was unable to be present with the body at the great Centennial reunion. But, he was represented by Marchant's celebrated portrait of him, and by 100 varieties of pears in Horticul-

tural, and 300 in the Centennial Exhibition. They will be gratified to learn that he is regaining his health, and will heartily wish that he may long enjoy it.

**AMERICAN TUBEROSES.**—We were astonished to read in a Boston paper recently an article on the tuberose from the pen of one of Boston's leading horticulturists, that "the bulbs are imported from Italy and France, as our seasons are not long enough to ripen them." Perhaps the season of Boston is the "our season" referred to, but Boston is not the United States by any means, and because they do not ripen there, is no reason for sending to Italy or France for them. If not known to this gentleman it is pretty well known to others that American tuberose are preferred in England to the best Italian. We hope Mr. Rand and his "two distinguished members of the Massachusetts Horticultural Society" will not think we are "as bitter as gall on everything in Boston," because we endeavor to correct a serious error on the part of one of its good citizens.

**SIR JOSEPH BANKS.**—The *London Journal of Horticulture* has a portrait and history of this distinguished Botanist and Horticulturist of the last age. He was born in Lincolnshire, in 1743. He was on the voyage of Captain Cook, and is well-known to gardeners by name through the grand new Holland genus, *Banksia*.

**WORCESTER CO., (MASS.) HORTICULTURAL SOCIETY FOR 1875.**—In the annual report by E. W. Lincoln, Secretary, the society mentions some difficulties to be overcome, but on the whole we understand that this very useful local society is prosperous.

**THE NEW SOUTH.**—By Col. M. B. Hillyard, McComb City, Miss. This is a compilation of what has been written by Northern men who have visited Mississippi and other parts of the South, and gives a great amount of information as to the astonishing natural resources and industrial prospects of this beautiful part of the country.

**OHIO STATE HORT. SOCIETY.**—Ninth annual report from M. B. Bateham, Secretary, Painesville, Ohio. There are some admirable essays in this volume, especially "pictures on grass," by Frank J. Scott. On the whole an improvement every way on former volumes.

**TWELFTH ANNUAL CATALOGUE, MICHIGAN STATE AGRICULTURAL COLLEGE.**—This is one of the few

successful agricultural colleges; and it is a pleasure to read what it has to say of itself. Dr. Abbot is President, and R. G. Baird, Secretary, Prof.

Kedzie, of Chemistry, Beal, of Botany, and Cook of Zoology and Entomology, are well known to our readers.

## HORTICULTURAL SOCIETIES.

### EDITORIAL NOTES.

**THE CENTENNIAL.**—By the time this reaches most of our readers, the great Exhibition will have closed; and we shall soon be in a position to see what gain, if any, has accrued to Agriculture and Horticulture—the last of which it is our especial business to deal with.

So far as the fruit and vegetable department is concerned, our readers have been tolerably well informed through copies of the reports of the Judges made from week to week, and which have been kindly placed at the disposal of the Press by the Centennial Commission. We have not been able to give all these reports on account of the length of some of them, and the reference occasionally to matters from distant parts of the earth, that, however interesting to the people of those districts, could hardly be of service to the majority of our readers. The awards which will be made on the strength of these reports may perhaps tell more in time than these reports do now.

We cannot but think that it was a mistake not to do for Horticulture proper what the Agricultural Department did for fruits and vegetables. A continuous floral exhibition, would have been a great charm. This week pansies, and other things in season—next week geraniums, then rhododendrons, then roses, then leaf plants for bedding, then gladiolus, and so on down to chrysanthemums; and not limiting the exhibition to anything named, but allowing any thing to be brought that was beautiful, and rewarding it according to its merits by an honorable mention in a report, as well as by a special medal and diploma at the close, in those cases where special merit was exemplified in the article exhibited.

Horticulture has gained a little by the Centennial Exhibition. It has exhibited good lessons in landscape gardening, in arranging bedding plants, and in arboriculture—in any other respect the great world, which in numbers ranging from near fifty thousand to two hundred and fifty thousand

a day visited the Exposition, knows little more than if the Exposition had never been held.\*

To Messrs. Such, Dick, and Williams of England, who at a great expense in personal attendance, kept collections of rare plants in the building all the season, Horticulture in America owes a debt of gratitude, and the special exhibit of Rhododendrons is entitled to no less praise. The points we have named are the chief redeeming features in one huge blank. Where the blame for this huge failure rests we have no disposition to investigate, and it would serve no good purpose now. We only know that a Centennial Horticultural Society was organized, and hoped to do something. The Centennial Commission hoped to do something. The Chief of the Bureau hoped, and we know, tried to bring these good things about. The Penna. Horticultural Society was no less earnest in its efforts to have Horticulture well sustained. We have heard many reasons given why they all failed, and to a certain extent there seems good ground in every case to account for the failure. All we have to do is with "the facts of history," and these unvarnished facts tell simply that while in Pomology we have been able to get a fair idea from the Centennial as to what fruit-growers are doing, in Horticulture we have not.

PHILADELPHIA, Sept. 28th, 1876.

HON. A. T. GOSHORN, Director General U. S. Centennial Commission.

Sir:—During the past week we have examined a collection of the native fruits of the Philippine Islands, exhibited by the "Inspector of Woods and Forests" in the Spanish pavilion. This is a particularly valuable contribution to the exhibition, making us for the first time acquainted with the indigenous pomological products of these Islands. There are 97 kinds in all, some of them, of course, of little more value than the wild berries of other countries, but many are regarded as of superior excellence. The following appear to be among the most striking, the botanical names being given as being more intellig-

able to the civilized world than the obscure native names.

*Averrhoë Camberala*. This is related to our Sour Grass (*Oxalis*), but is a tree, having fruit of the same form, but as large as a small cucumber. It is employed to make acidulated drink.

*Anona squarrosa*. This is closely allied to our North American Papaw, and so highly esteemed as to be already under extensive culture in the West Indies.

*Dillenia speciosa*. A tree not far removed from our Magnolia, and producing a fruit for acidulated drink.

*Artocarpus Rima* and *A. Carwansie* of the same genus as the celebrated "Bread" fruit and "Jack" fruit belong—these are much smaller fruit than they. *Sandoricum indicum*; this belongs to the same family as our "China" tree of the South (*Melia Azederach*), but the apple-like fruit is as large as a good-sized garden plum. So far as we can learn, its beauty is superior to its eatable character.

*Diospyros Sapota*. This is a persimmon double the size of ours.

There are several species of the orange family (*Citrus nobilis*, *C. Mitris*), mostly smaller than our popular kinds—Mangoes, Custard Apples, Tamarinds—and a curiously flattened form of the common cocoanut, yielding a superior quality of oil. As we believe this is the first specific exhibit of the fruits of the Philippines ever made, and as such especially instructive. We regard it as highly meritorious.

The New Jersey State Agricultural Society in Agricultural Hall exhibit watermelons and 90 plates of apples. The specimens were fully up to the average of the best specimens of the same kinds as grown any where in size and beauty—the Kings, Porters and Maiden's Blush rather above the average. The Washington strawberry apple, a kind seldom seen in collection, but reported to be of superior quality, was conspicuous for its size and beauty. As showing the fitness of the district represented by this society for producing superior apples, we regard the collection as meritorious.

Samuel Streeper, Broadaxe, Pa., apples. There were only 13 kinds in the exhibit, but all of them of remarkable good character, valuable varieties, and equal to the highest average in size. A very meritorious exhibit.

S. W. Noble, Jenkintown, Pa., Pennsylvania has given birth to a very large number of excellent apples. This collection of 53 kinds is made up

chiefly of these, and on the score of the instruction such an exhibit affords we commend them. The Cornell's Fancy in the collection is particularly meritorious.

Adam Hoover, two kinds of apples.

James Wardrop, Pittsburg, Pa., Seckel pears of great size, beauty, and general quality. They measured 8½ inches round each way.

Amos Murray, Frankford, Pa., exhibits peaches.

E. N. Wright, School Lane, Germantown, Phila., Alex. Cox, gardener, Black Hamburg grapes from glass culture. The berries were not of extra size, nor of the darkest color, but the bunches were above an average size (ten inches from the shoulder), of perfect form and superior flavor, two bunches being borne on each branchlet. On the whole, highly meritorious.

The State of Michigan, an additional exhibit grown by Samuel Hoppin, Bangor, Mich. This embraces 10 varieties of peaches, including Early Ann, about 6 in. round, Early York, 7½, Morris White, 10 in., Hill's Chili and Jacques Rare Ripe, and Barnard (said to be a popular, abundant bearer in the State). Apples, 75 varieties. These were, on the whole, rather superior to the same kinds as usually grown; especially superior were Baldwin (11 inches round), Northern Spy, Rhode Island Greening, Gilly Flower, Red Russet, Blenheim Pippin, Black Detroit (12½ in.) Chenango, Strawberry, Maiden's Blush, and Red Detroit. The last is considered a more profitable variety than Black Detroit. In the collection is an improved Siberian crab—more beautiful than the Hyslop, and a very valuable crab. The whole collection is a very meritorious one.

E. Bradfield, Adrian, Mich., per State of Mich., nine kinds of grapes. One of these, Bradfield's Prolific, is a large bunch, and the berries 3½ in. in circumference. This is a remarkable, good-looking, black variety, but scarcely ripe enough to warrant us in awarding to it special merit, which, perhaps, when mature, it may deserve.

E. Engle, Papaw, Mich., per State of Mich., nine kinds of grapes, good: Marthas Diana, good; Salem, small bunches but extra large berries; Barry, good; Concord, very fine; Ives', extra fine. On the whole, worthy of commendation for superior culture.

A. O. Winchester, Salem, Mich., per State, 25 plates, mostly Concord, Clinton, and Delaware—good fruit. Salem and Diana, extra fine.

John Whitelesley, St. Josephs, Mich., 8 kinds

of grapes. Rebecca, very good. Concords, very good—from a trellis the vine covered 48 feet.

George Prinkerhoff, Monroe, Mich., very good grapes. State of Michigan deserves credit for this whole exhibit, manifesting how well this part of the State is adapted to grape culture.

H. E. Bidwell, South Haven, Mich., Crawford's late peach, 9 inches in circumference, clear and beautiful.

J. S. Linderman, per South Haven Pomological Society, grapes, 30 plates, 4 kinds very good.

Peninsula Farmers' Club, Grand Traverse, Mich., peaches, apples, and pears. Of the two last we have to speak in terms of the highest praise. The Bartlett pears were not as large as often grown, but were of a clear brown color, of a brilliant scarlet on the sunny side, and with a delicious aroma. The Flemish Beauty pears were very highly colored, and measured 10 $\frac{3}{4}$  in. one way by 11 $\frac{1}{2}$  the other. Among the apples, Porter measured 10 $\frac{3}{4}$  by 11 inches round; Spice, sweet, 12 in.; Duchess of Oldenburg, 11 $\frac{1}{2}$ , Red Astrachan 10 $\frac{3}{4}$ , and very beautiful. Taking the whole collection, it is highly meritorious.

James Courteney, West Philadelphia, celery and red peppers.

Urbana Wire Co., Hammondsport, N. Y., grapes, 113 boxes unnamed, but confined to the following kinds: Catawba, Diana, Salem, Concord Iowa, and Delaware, all well-grown, average fruit demonstrating the fitness of the locality for good grape culture.

Signed,  
International Jury  
on Pomology.

W. L. SCHAFFER,  
A. W. HARRISON,  
EDWIN SATTERTHWAITE,  
THOMAS MEEHAN,  
JOSIAH HOOPES.

PHILADELPHIA, Sept 21st, 1876.

HON. A. T. GOSHORN, Director General U. S. Centennial Commission.

Sir:—During the week ending with this date the following additional exhibits have been placed on the table:

State of Michigan, twenty-five plates of grapes in 5 varieties, South Haven, Mich. These are not quite equal to the highest average attained by the same varieties in other places, but we regard them as superior when the high northern latitude is considered.

J. B. Seelye, Canandaigua, N. Y., grapes—the Iowa, Delaware, Concord, Diana, Salem. These were very good specimens; the "Concord" remarkable for the size of the berries, some of which were three inches in circumference.

Fruit-Growers' Society of Ontario. This Canadian Society have added during the week to their already extensive exhibits 120 plates of apples, 7 of plums, 5 of peaches, 16 of pears, 3 of tomatoes, and 2 of nuts. This exhibit equal in many respects in value to some they have already made, is superior in some respects, the apple being remarkably fine. The St. Lawrence apple is especially well grown, being highly colored, and some measured 11 inches in circumference. The Baldwin measured the same;

these were grown by Hugh Scott, Delaware, Ont. The peaches were of medium size, but we consider remarkable for Canada.

E. Anderson, Felton, Delaware; pears—Duchess d'Angoulême—of remarkable size. One measured 12 $\frac{1}{2}$  inches one way by 14 $\frac{1}{2}$  the other, and weighed 20 oz.; others weighed 17 $\frac{1}{2}$  oz., 19 oz., and 16 $\frac{1}{2}$  oz., respectively. G. M. Younglove, Hammondsport, N. Y., Diana, Concord, and Delaware grapes, the last particularly good.

The Berks County Agricultural Society of Pennsylvania, 150 varieties of fruits, chiefly apples and pears, made up by different growers of that region, and filling 349 plates. This exhibit is a particularly valuable one, as exhibiting a large number of Pennsylvania varieties of fruit of great merit, but which are little known outside of this region. Here were specimens of the Krauser, Yacht, Yost apples and the Reading pear. Other and well-known kinds were in superior condition—the "Fallowater," 13 inches round, and the Summer Rambo, 11 $\frac{1}{2}$  inches, in the same exhibit. The old White Doyenne, or Butter pear, grown by Washington Brookman, a variety now seldom seen, was of particularly superior excellence.

A. L. Felton, of Philadelphia, 215 kinds of fruits and vegetables. Among these were black Spanish watermelons, remarkable for solidity. One measured but 36 by 49 inches, but weighed 45 lbs. On the whole, the exhibit was very attractive to the visitors who crowded round the tables, and regard it as particularly instructive.

Chas. C. Hess, Germantown, Pa., Germantown quinces.

Henry Avery, Burlington, Iowa, apples and pears. The apples were superior specimens, indicating excellent cultivation; they were of the varieties Mother and Grimes' Golden, the latter 10 inches in circumference—large for this variety.

J. H. Lambert, Milwaukee, Oregon, one the egg plum, 6 inches in circumference.

Morgan Brown, Fontagany, Ohio, 70 varieties of vegetables—17 of these, potatoes, and one large pumpkin weighing 250 lbs. Having but a single specimen or so of a kind, the exhibit made no great display. The quality, on the whole, is not equal to that of the districts around our large cities, but as illustrating the capacity of a comparatively unknown region in Ohio for good vegetable growing it is regarded as meritorious.

Signed,  
International  
Judges  
on Pomology.

W. L. SCHAFFER,  
A. W. HARRISON,  
WM. PARRY,  
EDWIN SATTERTHWAITE,  
JOSIAH HOOPES,  
THOS. MEEHAN,  
T. T. LYON (of special exhibit).

HON. A. T. GOSHORN, Director General U. S. Centennial Commission.

Sir:—Since our last report, and during the week ending with this date, additional exhibits have been made and examined by us as follows:

State of Wisconsin. 11 varieties of grapes. Taking the whole collection, these are rather above the average of the same varieties in color and flavor. A bunch of the Lindley was 7 inches in length from the uppermost berry to the lower, and weighed 11½ oz.; Agawam, 7½ inches, and 12¾ oz., Wilder, 7 oz. This is not only a meritorious exhibit for Wisconsin but would do credit to any State.

W. P. Ottley, Phelps, Ontario Co., N. Y., 10 kinds of apples and pears, under-sized fruit, but well colored and attractive.

Truman Mabbett, Vineland, N. J., sweet potatoes, a full collection of the best varieties—White Bermuda, Southern Queen, and Mansemond. These were unusually large, if that is any merit in a sweet potato, and possessed much interest in the fact that half of them had been kept since 1875, showing an excellent knowledge in preserving them.

A. Tripp, Albion, N. Y., 5 kinds of apples.

H. M. Engle, Marietta, Pa., 38 kinds of apples and 2 of peaches. These had been evidently selected with great care, and on the whole is a highly meritorious exhibit of good fruit.

D. G. Gyger, Radnor, Delaware Co., Pa., 64 plates of apples in 25 kinds, although none of these apples exhibited higher characters than are seen occasionally in the best specimens of their kinds, yet they were all very good. Seldom, indeed, that we find so many kinds brought together all doing so well, and on this ground we regard it as of special merit. The Cornell Fancy weighed 8 oz., and measured 10½ inches round.

A. M. Smith, Grimsby, Ont., 20 kinds of apples; and White Doyenne, and Louise Bonne de Jersey pears. Taking into consideration the high northern latitude, the apples are of superior excellence. The Calvert, a beautiful specimen, weighed 7 oz.; Rhode Island Greening, 11½ oz.; Fall Pippin, 12 oz., and others about in proportion to their general growth.

Robert Snyder, per Fruit Growers' Society, of Ontario, apples—Thorndale, Alexander, St. Lawrence Chenango Strawberry, Pomme-gris, and a large, reddish, tart seedling. These were beautiful specimens of their kinds, fully equal to the best averages.

State of Iowa, a collection of vegetables made up from all parts of the State. There were 64 plates, and about 60 varieties of potatoes, and about 50 other kinds of vegetables. The potatoes, beets, and Mangel Wurtzels, were of remarkably fine appearance, and showed how well

the State is adapted to their growth. As illustrating the vegetable-growing capacity of the State, we regard the collection as very instructive and meritorious.

Signed,  
International Jury  
on Pomology.

W. L. SHAFFER,  
JOSIAH HOOPES,  
A. W. HARRISON,  
WM. PARRY,  
EDWIN SATTERTHWAITTE,  
THOS. MEEHAN.

### QUERIES.

OHIO FRUIT AT THE CENTENNIAL.—M. B. Bateham writes: "In your comments on the Centennial Pomological Exhibition, (Oct. p. 319,) you say 'Ohio had a very fine collection of fruit, but we understood that the State would pay no one to properly exhibit them, and so no one knew names of fruit or of parties who sent them, which was unfortunate.'

"Though unintentional, of course, your remark casts an unjust reflection upon the representatives of Ohio at the exhibition. The Ohio State Horticultural Society undertook the labor and expense of collecting and exhibiting the fruit from this State; and three of the officers of the Society were in attendance at the hall, most of the time, during each day of the pomological exhibition. The fruit was displayed on a range of tables assigned to it, the farthest side of the hall—although our application for space was among the earliest. It filled over 1100 plates, and the name of the variety was on each plate. The name of the Society was painted on two banner signs, each ten feet in length, stretched between the pillars, over the tables, and the names of the twenty or more counties and local societies from which the fruit came, was on placards upon the tables. Then a full list of the varieties in the entire collection was made out by the secretary, and handed to Capt. Landreth, as desired. If anything more was wanting for the 'proper exhibition' of the fruit, it was owing to a failure on our part to comprehend the duties of the august occasion."

[We should be sorry to cast reflections on Mr. Bateham, or any one, and had no intention of doing so. It seemed a duty to tell our readers why we gave credit to individuals in other States and none to Ohio. For this reason we have to repeat that if there were exhibitors' names on the productions any time between Monday, September 11th, and Friday, September 15th, we did not see them.—Ed. G. M.]

THE  
GARDENER'S MONTHLY  
AND  
HORTICULTURIST.

DEVOTED TO HORTICULTURE, ARBORICULTURE AND RURAL AFFAIRS.

Edited by THOMAS MEEHAN.

VOLUME XVIII.

DECEMBER, 1876.

NUMBER 216.

FLOWER GARDEN AND PLEASURE GROUND.

SEASONABLE HINTS.

There is not much to do in this department at this season, but much to remember. It is the season of thought, if not of work.

How often do we hear people say they cannot wait a life-time for trees to grow. Well then, manure, and see how they grow. To-day we measured a chestnut on a friend's lawn that was a two-year old tree when transplanted eight years ago. *Four feet* in circumference. He top-dresses his lawn every year. Nothing pays like manuring ornamental trees where growth is desired. For evergreens the manure must be well decayed.

If our advice has been followed in the past, trees are planted very thickly at first. Cheap ones are put in among valuable ones. As they grow, thin out the worse trees. Winter is the time to do it.

Our readers will do well to remember that it is not so much severe frost that hurts vegetation in winter, as it is severe thawings following the freezings. Everything, therefore, no matter how hardy they may be, will be benefited by having something thrown over them, to prevent *early thawing*. Small things, such as hardy herbaceous plants, can be protected by a little earth, and there is nothing better. Seed-beds are also improved by this covering, but if earth is used for them, it should be very sandy, because it cannot

well be removed, and seeds cannot come through stiff soil.

It would be well, at this season of leisure, to examine and decide on the course of improvements for the ensuing year.

Very few understand that an occasional change of soil is very beneficial to flowers in beds, though all know how important it is to flowers in pots. There is nothing better than surface soil from an old pasture, taken off about two inches deep, and thrown into a heap with about one-sixth part old hot-bed dung to partially decay. In addition to this "staple" item, smaller quantity of different matters should be gathered together for peculiar cases, or particular plants. Peat, for instance, will be found very useful for many kinds of plants. This is not, as is often supposed, mere black sand; but a spongy, fibrous substance from the surface of bogs and boggy wastes. Sand should be collected sharp and clean; the washings from turn-pike ditches are as good as anything. Leaf mould is best got already well decayed from the woods. That, one makes for himself from rotten leaves is seldom good for anything; it is always sour and seems "indigestible" to vegetation. A load or so of well-decayed cow-manure is a good thing for the gardener to have by him, as all those plants that dislike our hot summers, and want a cool soil to grow in, prefer it to any other manure. A small pile of hot-bed manure is almost indispensable to the garden.

## COMMUNICATIONS.

## HARDY HERBACEOUS PLANTS FOR OCTOBER.

BY MR. W. FALCONER.

Now, October 4th, beyond *Compositæ* we cannot boast of a great variety of seasonable hardy perennials. *Anemone japonica* is perhaps the best, growing, as it does, two to three feet high, with branched stems of large, purplish-red flowers; the variety known as *A. Honorine Jobert* is pure white, free, equally hardy, and very beautiful. Next comes *Sedum spectabile*, an excellent Japanese plant 12 to 15 inches high, with dense, rose-colored flower-heads, often six inches across. Amongst composites *Asters* yield us our chief supply, and just now they are decidedly fine, but again their commonness greatly detracts from their appreciation, as they are mostly natives, and abundant everywhere—different species in different places. The best of them, however, make fine garden plants, requiring but little care beyond cleanliness, occasional transplanting, once in two or three years, and timely staking. Prettiest amongst them at present are *A. cordifolius*, two to three feet, with numerous small whitish blooms crowded into racemes on the spreading branches; *Novæ-Anglæ roseus*, a reddish-colored variety of the common New England Aster, showy, and a distinct color amongst asters; and *lævis*, four to six feet, with showy mauve flowers. Besides these we have in best condition *ascendans*, *incisus*, *preanthoides*, *oblongifolius*, *patens*, *spectabilis*, *macrophyllus*, *corymbosus*, *Tradescanti*, *turbinnellus*, *anomalus*, *Drummondii*, *cameus*, *sericeus*, *tardiflorus*, and *multiflorus*. Nearly allied to and very like the *Asters* too, are in bloom the *Boltonias*, of which *B. glastifolia*, five to seven feet, with loosely paniced heads of pretty whitish flowers, and *B. latisquama*, four to five feet, with showy pinkish blooms, are the best. The *Galatellas* are also Aster-like plants with bluish flowers, and now in season. Of the *Vernonias* or Iron-weeds that decorate every swamp and moist pasture in the Middle States, we have two good representatives in *fasciculata*, now nearly past, and *Arkansana*, five to seven feet high, with rosy purple flowers, approaching its best. Golden Rods are about over, but many species of *Sunflowers* still maintain their standing. *Pyrethrum uliginosum*, four to five feet, with arge, white, ox-eye, daisy-like flowers, is one of our most noble perennials for Fall blooming,

and requiring an open exposure and free, moist soil. *Lobelia cardinalis* is still in bloom, and *Delphiniums*, *Campanulas*, *Lychinses*, *Tradescantias Virginica*, *pilosa* and *erecta*, *Centranthus ruber*, *Antirrhinums*, and a few others yield us some straggling flowers. *Tricyrtis hirta* is a very hardy plant, but here it blooms so late that its stems are often frost-killed before the flowers expand; hence we lift and pot several and let them bloom indoors. *Aconitum uncinatum*, native of the Middle and Southern States, three to five feet high, and with loose panicles of blue flowers, is in bloom, and quite handsome; and with us, amongst hardy shrubs, or rather shrubby plants, full flowers, *Hydrangea paniculata* is alone, still not so as a decorative plant, as many shrubs like *Snowberries*, *Berberries*, *Cratægus*, *Euonymus* are very showy in Fall, when laden with fruits.

## THE SIBERIAN PEA TREE.

BY GEN. W. H. NOBLE.

This tribe of hardy yellow blossoming plants deserves a place in every shrubbery. They are as hardy as oaks. In early spring they are covered with a shower of golden yellow pea blossoms.

I have two varieties, the *Arborescens* and the *Chamlaga*. I much prefer the latter, both for its miniature tree form and its richer and profuser bloom. As a dwarf tree, either in leaf or flower, I know of no plant which so exactly takes on this tiny form, of not above four to five feet high. Our public grounds should not fail to present these shrubs to the study of our people.

The *Chamlaga* grafted on the *Arborescens* is said to make a very pretty weeper. I have never seen it; but I doubt not, like many plants, it would gain by the stature and force of the more vigorous relative. This saves time, and the torment of having every plant bobbed to the flat-topped style, in which the average gardener delights.

## AILANTHUS GLANDULOSA.

BY MR. A. VEITCH, NEW HAVEN, CONN.

The *Ailanthus*, instead of being assigned its proper place in the shrubbery or on the lawn, is rarely to be met with but under circumstances which show it to be one of the most neglected of trees. This may arise in some measure from the fact that its flowers exhale a disagreeable odor, and one which, as some think, is hurtful to the health of those who may reside in its neighbor-



hood. This may be true, or it may not, but as the treatment we recommend prevents it from ever flowering at all, no danger need be apprehended from this cause.

What we do recommend is to plant in masses or clumps proportioned in size to the surroundings, and of such a form as may best harmonize with the general plan of the place. No particular form of beds need be specified, seeing that these may differ greatly, and yet be in perfect accord with true taste. Patterns appropriate enough, and most natural withal, can often be seen outlined by the sweeping curves and jagged edges of passing clouds, and by imitating these the ground plans of as appropriate beds may be formed as ever graced a lawn.

It is of the utmost importance to have the beds thoroughly enriched before planting, the object being to grow the leaves to as large a size as possible, and which, under proper management, might be all of three or four feet in length.

The after management is simple enough, and consists chiefly in regular attention to pruning, which operation can be best performed before the leaves come out in the spring. This is done by cutting to the ground, or in heading down to any desired height, the most advanced shoots, and in the case of small beds, never allowing any of them to remain to be over three or four years old. By this treatment the contour of a group will necessarily undergo important changes, but its main features may all the while be kept up to an equally high standard, and so look both pleasing and attractive. Of course, to do this well, fine opportunities will occur for the display of taste and judgment, and just as these are exercised will the effect be satisfactory or otherwise. It does not seem desirable in any case to prune so as to obtain uniformity of height, and small round clumps look best graded from the centre to the circumference; whilst it is better with those that are large and irregular in outline to imitate so far as practicable such inequalities as are most imposing in mountain scenery, where bold prominences rise and overlook deep gorges and undulating ridges. In masses so formed the matchless foliage of the *Ailanthus* can be more strikingly displayed than when grown in any other way, and will also present a more picturesque and imposing appearance than could well be produced by any other deciduous tree or shrub fitted to the climate.

## EDITORIAL NOTES.

SCIADOPITYS VERTICILLATA. — The *Gardener's Chronicle* says: "According to a statement in the *Revue Horticole*, two plants of *Sciadopitys verticillata*, each about three feet in height, in the nurseries of Messrs. Thibaut & Keteleer, at Sceaux, have produced cones. We have not heard of the production of cones in this country." [We should be glad to know where is the largest specimen of this very hardy and beautiful evergreen in this country, and how high it is.—Ed. G. M.]

CUT-LEAVED SUMACH.—Nearly 30 years ago one of Philadelphia's most excellent botanical florists, Robert Kilvington, found wild in a Chester County wood, the cut-leaved Sumach. Our people did not seem to take much to the novelty, and we doubt whether Mr. Kilvington, ever made a dollar on it. Perhaps after reading the following from the London *Gardener's Magazine*, our planters will esteem it more nearly as it well deserves:

"We know of no cut-leaved shrub or tree, that in departing from its normal condition, so effectually disguises itself as does the cut-leaved Sumach. This is a form of the common smooth Sumach, (*Rhus glabra*), as delicate and refined in its aspect as the other is coarse and common; indeed, we have rarely met with a person, even if very familiar with plants, who could identify this by the leaf. Fern-leaved Sumach would be a most appropriate name for it. Our object in noticing it at the present time is to call attention to its value in summer floral decorations, as in all large work of this kind, its leaves produce all the effect of fern fronds, and at the same time hold up much better than most of them do, retaining their form and freshness for several days; besides—an item of no little importance—they can be produced almost inexpensively. Indeed we are not sure but it would pay florists who do much decorative work to force the plant. As a lawn plant it should always be grown with a single stem, cutting it back each Fall, to get a start as near the ground as practicable; if allowed to branch it loses much of its beauty; if grown for the sake of a supply of its leaves, it would even then be better to treat it in this way, as they are much more luxuriant when the whole vigor of the roots is thrown into a single stem. In early summer a leaf-folding caterpillar sometimes at-

tacks the very tips of the leaves, which should be disposed of before the leaf is disfigured."

**HARDINESS OF THE SILVER THORN.**—There is a hedge of this on Meehan avenue in Germantown, formerly a part of Meehan's nurseries, that has been fifteen years entirely uninjured. Mr. Carew Sanders says, that wherever the Weigela and similar shrubs get killed back in winter, the Silver Thorn does also. In other respects Mr. Sanders thinks it a good hedge plant, "stiff, stocky and hedgy."

**THE GLADIOLUS DISEASE.**—When this was first brought to the attention of the *Gardener's Monthly*, now many years ago, we expressed the opinion that it was of fungoid origin. Of course we had to make the guess from analogy, as it requires great knowledge and skill in microscopical studies to be able to work these matters up positively. Mr. Worthington G. Smith has recently done this, and finds it is a fungus—a new one—and he names it *Urocystis Gladioli*.

### NEW PLANTS.

**TULIPA GREIGI** is the subject of a colored plate in the October number of the *London Florist and Pomologist*. It is a dwarf grower with flowers about four inches over, reflexed scarlet petals, and a yellow base with four oblong black spots. The leaves are rather large, thickly covered with black spots. It has been recently discovered in Turkistan and will be hardy in America.

**PENTSTEMON HETEROPHYLLUS.**—Forms neat, close tufts a foot or more in diameter, from which arise numerous slender stems eighteen inches high, bearing a profusion of flowers of a beautiful sky-blue. It is a native of California, and perfectly hardy.—*C. M. Hovey*.

**PENTSTEMON PALMERI.**—A remarkably distinct and handsome species. Grows from three to five feet in height, with panicles of peach-colored flowers. It is perfectly hardy, and succeeds in any well-drained soil.—*C. M. Hovey*.

**ALONSOA LINIFOLIA.**—This new and handsome species grows from a foot to a foot and a half in height, with dark green, flax-like foliage. The centre branches, as well as the surrounding ones, are so disposed as to form a symmetrical and graceful specimen, covered from almost the base to the summit, with innumerable glowing light-

scarlet blossoms. It is easily grown, and susceptible of both pot and open-ground culture.—*C. M. Hovey*.

**ALONSOA MYRTIFOLIA.**—This is another new species; grows from two to two and a half feet; is of very robust growth, and exceedingly floriferous. The individual flowers are larger by far than in any other species of this genus, and of a fine scarlet. It makes a very good pot-plant, but, by reason of its strong growth, is principally adapted for the open ground.—*C. M. Hovey*.

### QUERIES.

**THE CENTENNIAL ROCK-WORK.**—S. O. K., Jackson, Mich., writes:—"Since noticing your remarks on the display of "Rock-work" on the horticultural grounds at the Centennial, the query with me has been why an untutored eye like mine should have been so much attracted by the striking effect produced. May it not be that the perfect harmony and fitness of the plants used in ornamenting the same, made it somehow befitting in placing it in such strong contrast with its surroundings? The Yuccas, Agaves, Aloes and various plants of this class all seemed in such harmony with the design that I queried whether it all had not a right to be there in that prominent and beautiful spot. I noticed also in some greenhouses in Philadelphia, slate placed upon the benches before the covering of sand. I suppose to protect from decay, &c. I think I have discovered a better plan. I put a liberal sprinkling of broken rosin on the benches, then apply a hot flat-iron, forming a perfect coating, which is quickly done, and it is all right for all time to come, so far as I know."

[Yes, the choice of plants for the Rock-work was admirable. The whole work meritorious. Slate is used not only because of its endurance—but it is a better conductor and plants on it are warmer than on boards. Ed. G. M.]

**PYRACANTHA HEDGES.**—C. C., Decherd, Tenn., writes:—"Can you, through the Monthly, give me any information about the *Pyracantha* hedge plant? Is it the same as the Virginia White Thorn? Is there any difference as to hardiness between the white and red varieties? How far north can it be grown as a hedge? What is its true botanical name; and how should the seed be managed to sprout it?"

[We do not know what is Virginia White Thorn—probably some “common” name not worth while vexing oneself about. The Botanical name is *Crataegus Pyracantha*. There are two varieties, the common *Pyracantha* with red berries, and the White Berried *Pyracantha*, with (so far as generally seen) no berries at all. The former is hardy in Pennsylvania, sometimes only—the last is always hardy there. It is rather slow in growth—the white berried one—but makes an admirable hedge in time. We imagine there can be no more perfect hedge than an eight or ten year old white berry *Pyracantha* hedge. The red berried variety differs from the other in this, that it does not grow close and need pruning, and is not absolutely hardy here. The white berried variety was first brought to notice by Messrs. Parsons & Co., and whatever credit may be attached to the idea, is theirs. We suggested, however, in these pages at the time of its first introduction that the name of “White Berried *Pyracantha*” should be changed—but the suggestion, we regret to say, was not acted on, and it is too late now. Through a large extent of country the red *Pyracantha* is of no use as a hedge plant, while the other is invaluable, but no one would know this by its name.

The *Pyracantha* of both kinds is raised by nurserymen from cuttings—it is rarely attempted from seed. All the *Crataegus* family take a year to sprout. It is too slow a business whenever cuttings can be had. As for the white berried one, it seems very shy of seeding at all. In twenty years we have not seen a dozen berries, and these

were hardly white. It is hardly necessary to say that critically the fruit of these plants are not “berries”—but we are speaking in the common gardening language, and not for botanical students.—Ed. G. M.]

*PICEA PARSONSIANA*.—B. J., Cincinnati, Ohio, writes:—“In making out a list of rare trees lately, and which I sent to a leading firm, I had *Picea grandis* and *P. Parsonsiانا*. When the plants came I had two *grandis*’ sent me, with the remark that the two names belonged to one thing. As I think the nurseryman must be wrong, I ask you to decide.”

[Yes, the nurseryman is wrong. The form known as *Picea Parsonsiانا* is a very beautiful one—superior to the ordinary form of *P. grandis* as you buy them in nurseries. The whole of this trouble comes from the unfortunate English habit of giving Latin names to mere varieties. If this had been called the Parsons’ variety of *Picea grandis*, or even the Parsons’ Fir “for short,” there would have been no difficulty. As *Picea* “*Parsonsiانا*” it was thought to have claims to distinction as a distinct species—a claim the botanists do not recognize—yet, though it may not be specifically distinct, it is distinct as a variety—and any nurseryman who sends out ordinary nursery forms of *grandis* for *Parsonsiانا* makes a grievous mistake.—Ed. G. M.]

NAMES OF PLANTS.—C. W. H., Nashua, N. H. No. 1, *Chionanthus Virginicus*; 2, *Gymnocladus canadensis*; 3, *Gleditschia triacanthos*; 4, *Crataegus oxyacantha*.

## GREEN HOUSE AND HOUSE GARDENING.

### SEASONABLE HINTS.

Insects are apt to be troublesome in growing houses,—particularly Red-spider, Green-fly and Mealy-bug. A free use of the syringe is a good preventive. Tobacco-smoke, in two or three light doses, is still the best thing for the Green-fly. The Red-spider, fortunately, shows his depredations more villianously than most insects,—light yellow lines or spots marking almost at once the scenes of its depredations. If one has good eyes,

the finger and thumb will keep him down, as a slight and rapid passing of the finger over the leaves easily crushes his little body. When he becomes an “army with banners,” more scientific approaches must be made to give any show of success.

*Pelargoniums* become “drawn,” spindly, and worthless, if they are not allowed to occupy the lightest and most airy part of the house. If fine specimens are desired, the shoots should now be tied down to the surface of the pots and pinched off so as to induce them to shoot freely; but a

too frequent use of "finger and thumb" is bad,—nothing renders a *Pelargonium* weaker; rather encourage them to *grow* bushy, by the free use of light, air, and manure-water.

A good supply of young *Fuchsias* should be coming on now. Re-pot as their roots fill each pot; let them not want for moisture or light; do not pinch off their tops, but let them grow rapidly. The temperature in which they are grown should not exceed 55°. A turfy loam, moderately enriched with well-decayed manure, and well drained with charcoal, suits them admirably.

The *Mimulus* is receiving more attention than it has been. Where they are grown, they are much improved by having pans of water kept under their pots.

*Epiphyllums*, as they continue to flower, will require the warmest part of the house, and a fair supply of moisture.

The most interesting tribe of plants at this season of the year is, undoubtedly, the *Camellia*. The buds frequently drop off before flowering; this may spring from three causes—from the plants being kept too dry, or from the drainage being bad, whereby the soil becomes sodden, or from the house being kept too warm by insufficient ventilation. As the leaf-buds burst, the plants are benefited by occasional syringings; and, indeed, an increased supply of water altogether, in order to accommodate the demands of the young growth.

*Cinerarias* will soon be the chief attraction. The least frost kills them, yet they will not do well if kept in a high temperature. They love moisture, yet are very impatient of damp. No plant is more improved by the use of charcoal in potting than this.

The *Calceolaria* will require the same condition as the *Cineraria*.

*Hyacinths* that have been out of doors, or in any reserve place for protection, may be brought in a few weeks before wanted; they should not have much heat, light or moisture for a few days, and then only gradually.

*Carnations* and *Pinks* are much admired when grown in pots and flowered there early. They do not flower well if too much warmth be given but the usual temperature of the greenhouse will bring them forward a month before they can be had out of doors. Whenever the roots make their appearance through the bottoms of the pots, they should be shifted into a size larger. They require very little water, and love the light, and whatever manures are used to enrich the

soil should be thoroughly rotten. The *Pansy*, on the other hand, delights in half-rotten, strawy manure and turfy loam. If a quantity of seedlings have been raised in the Fall, they will require potting this month. They do not flower well here when the weather becomes warm; but when grown in pots, and forwarded slightly by the aid of a cool frame, they do very well.

*Cacti* and *succulent* plants generally, will scarcely require water at all, unless in very dry situations, and then receive but a slight sprinkling with a syringe. The rule "When you water a plant at all, let it soak right through," does not, by any means, hold good with these plants, if there be not some other good exception.

*Oranges* and *Lemons* will require the coolest part of the house, and to receive no more water than will just keep them fresh.

---

## COMMUNICATIONS.

---

### POT DRAINAGE.

BY F. WELLINGTON BEACH, BLOOMINGTON, ILLS.

Is it necessary to drain my flower-pots? I am asked this question many times during the year, and not only from personal visitors to our establishment does the question come, but from many of our friends and patrons from all parts of the globe. I have come to the conclusion that an answer to this question through the columns of your paper might not only be beneficial to those who have already made inquiry, but to many others who have not taken the trouble to inquire into the matter.

To make a short and decisive answer I would say that pot-drainage is not only useless but injurious. I expect to be contradicted in my assertion, and perhaps by those who are much older than I am, but I am perfectly confident that I can show points where drainage is not only useless but hurtful to flowering-plants, and I am confident that I will be upheld in my statements by some of our leading florists, and those of many years' experience. My objections are, first, a waste of time, for where the operator spends time to pick out the drainage from the bottom of the ball of earth, and again replace them in the new pot, before replacing the plant, he spends at least one-half of his time in the operation of replacing the drainage, and this would never do for a greenhouse operative. And in the second place, where drainage is placed in the

bottom of the pot, the roots grow down to the bottom of and through the drainage, and when the plant is shifted to a larger pot, you destroy many of the young fibers, or working-roots, so-called, for it is impossible to extract the drainage

rectly over the hole in the bottom of the pot; but this even is useless, if you are cautious not to give too much water, and this should always be avoided. If a farmer should remove the top soil and place a layer of stones under the soil, in

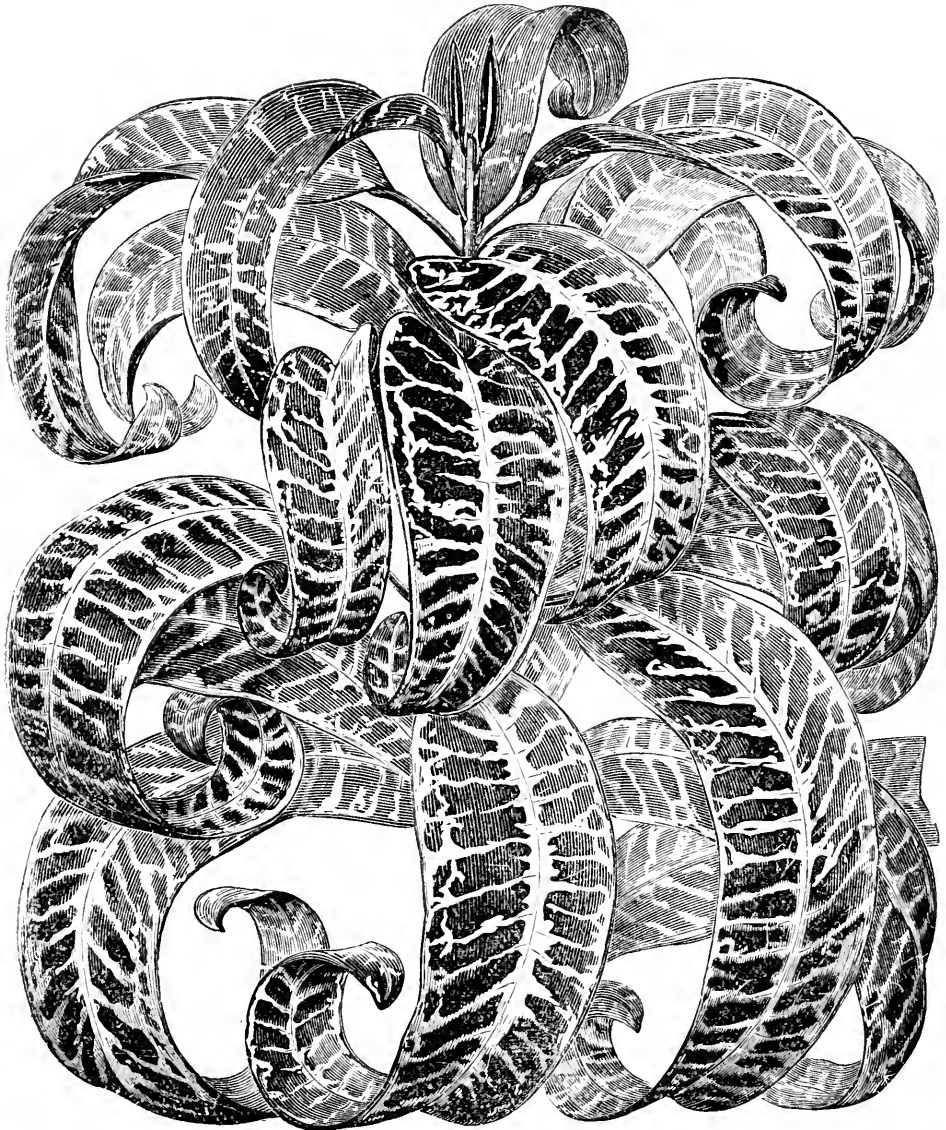

CROTON VOLUTUM.

from the old ball without breaking and otherwise injuring many of these tender roots, and this causes the plant to stop making top growth till it has formed a new set of roots. Some say use only one piece of drainage, and place that di-

rectly over the hole in the bottom of the pot; but this even is useless, if you are cautious not to give too much water, and this should always be avoided. If a farmer should remove the top soil and place a layer of stones under the soil, in

know that drainage is not necessary; I answer, by experience. I do not mean to say that a plant will not do well if it is drained, but I do mean to say that it will do just as well if it is not drained. I have tested it thoroughly, and I find that plants do just as well, if not better, without drainage. Again, I hear some one say that perhaps plants can be grown in the sandy soil of the East without the use of drainage, but drainage must be used for our loamy soil of the prairie; but I answer not so, for I have tried them both, and I find that by a sufficient use of sand in the potting soil which should consist of rotted sod from the pasture or road-side, and rotted refuse hops from the brewery, about two-thirds of the former and one-third of the latter, with a sufficient quantity of sand to make the soil porous, that no drainage is necessary. If my friends will try my plan of growing plants without the use of those old fogy crocks, and be careful not to use too much water, I am perfectly confident that they will have as good, if not better success with their Flora's Pets. Please give it a fair trial at least.

### CROTON CULTURE.

BY MANSFIELD MILTON, CLEVELAND, OHIO.

This genus of plants comprises some of the finest ornamental leaved plants in cultivation. Of late years from the South Sea Islands have been introduced some of the best species, some of which are not only attractive in the coloring of their leaves, but in the peculiar shape of them. In the collections of Messrs. Veitch and Mr. Bull, London, England, I saw, this last spring, some exquisite species of but very recent introduction, some of them surpassing anything hitherto introduced, as being decidedly distinct in general appearance, and especially in the shapes of the leaves.

Crotons are easily managed if sufficient moisture and heat be given them during their season of growth. If grown in too dry an atmosphere, they soon get covered with red spider, which soon discolors the leaves and destroys the vitality of the plant. A soil composed of turfy loam and peat with a good mixture of sand is the most suitable. As they require a good supply of water during their growing season, perfect drainage is indispensable to insure the water passing freely through the soil, nothing being more injurious for the welfare of the plant than stagnant water around the roots.

The species being so numerous I shall mention only such as are well worth growing even in a small collection. Not but most all kinds are worth growing, but some are more distinct and more easily managed than others.

*C. angustifolium*.—A narrow-leaved species from the East Indies; the leaves are long, drooping, of a bright yellow color and very attractive.

*C. aucubæfolium*.—The leaves of this one are short and broad, of a bright green mottled with yellow, having a pinkish tinge on the mid-rib and veins. Its compact habit gives it a distinct appearance from most of the others.

*C. grande*.—This beautiful species is from the South Sea Islands; the leaves are about 8 inches long and 3 inches wide, of a deep green color, spotted with yellow, the mid-rib being also yellow.

*C. Hillianum*.—An exquisite species of compact habit; the leaves being dark green the veins bright crimson on the upper side; on the under side they are of a dark red color. It is well adapted for decorative purposes, where such compact plants are required.

*C. interruptum*.—A species assuming often on the same plant very different leaves in shape, sometimes a spiral form is seen and in others nothing but the mid-rib exists for a space in the centre of the leaf. On a plant here about 6 feet high scarcely two leaves are alike in shape, some of them assuming the strangest shapes imaginable. The color of the leaf on the upper side is a dark red, the mid-rib very bright, the under side a dark purple.

*C. maximum*.—This, when well grown, is a fine looking plant; the leaves are about 10 inches long and 4 inches broad, of a bright yellow, with a dark green stripe on each side of the mid-rib.

*C. pictum*.—An old species in cultivation, but has few superiors in general appearance; when well grown the leaves are about 8 inches long, and from two to three in breadth, of a bright crimson color, spotted with green and black. It is one of the finest-growing species we have, but like all Crotons, requires plenty of light to bring out the true colors. The reason so many poor colored plants are seen is from keeping them too much shaded when growing. No plants we have endure a higher temperature with plenty of sun than Crotons, so long as plenty of moisture is kept in the house.

*C. spirale*.—In Mr. Bull's establishment I saw a fine specimen of this species; every leaf characteristic of the name. The leaves are about 10

inches long and one inch broad, twisted like a cork-screw; they are green, with a yellow mid-rib, changing with age to a bright crimson. Although interruptum sometimes shows this spiral form of leaf, I never saw it so perfectly done as

of which is dark green, blotched with yellow when young, changing to crimson with age. It is of free growth and excellent habit: native of South Sea Islands.

*C. volutum*.—This species I also saw in Mr.

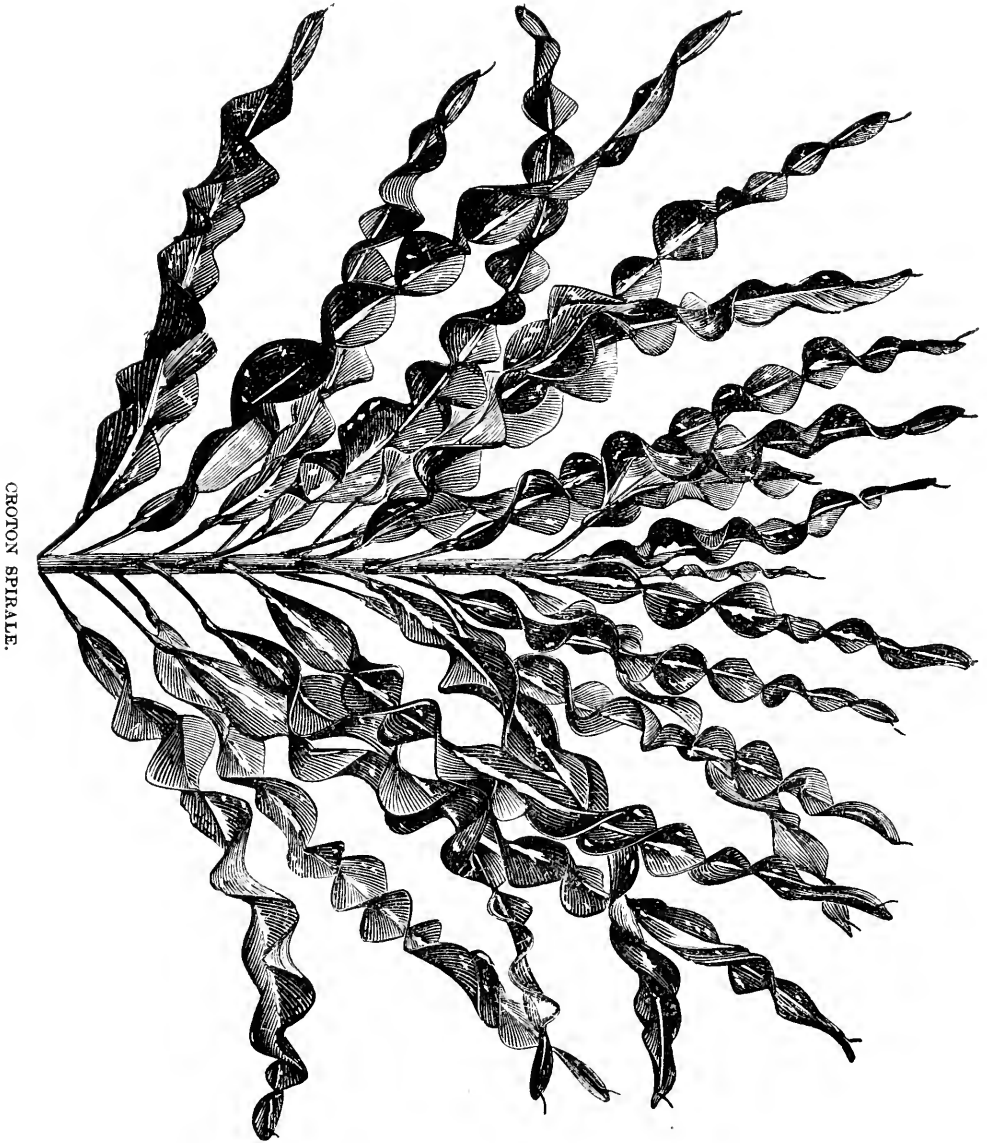

seen in this species. It is one of the most distinct and beautiful in cultivation.

*C. undulatum*.—Of the many Crotons now in cultivation, I think this the most beautiful; the beautifully undulated edges of the leaves give it a very attractive appearance, the ground color

Bull's collection and derives its name from the peculiar manner in which the leaves are rolled, about 6 inches long and beautifully colored, the ground color being bright green, the mid-rib, veins and edge of the leaf a bright yellow.

*C. variegatum*.—This species is an old inhabit-

ant of the hot-houses, having been introduced about the beginning of this century from the East Indies. The ground color of the leaves is green, the mid-rib and primary veins a bright yellow.

*C. Weismannii*.—This is a very handsome Croton, and one of very free growth: the habit is very graceful, the leaves grow about a foot long, the ground color being a shining green, the mid-rib and margin a bright yellow, also large yellow blotches scattered over the surfaces. For culture in a small collection this one is to be highly recommended.

### GLADIOLI FOR WINTER.

BY MR. BENJ. GREY, GARDENER TO E. S. RAND, JR.,  
BOSTON, MASS.

It is to be regretted that these highly ornamental bulbs are not generally cultivated for winter blooming. They are as easily grown as hyacinths and bulbs of a like nature, and their cheerful appearance for house decoration during our dull winter weather, will amply repay the little labor they give.

To insure success, select in spring, bulbs which have not pushed their buds. These should be kept dry until about September 1st, when they may be potted in rich sandy loam, single bulbs in five-inch pots, or a larger number of various colors in larger-sized pots. I sometimes put as many as twenty-five bulbs into about fourteen-inch pans, and if the bulbs are chosen of equal strength and forwardness they will come into bloom together, and give a splendid mass of flowers for parlor or other decoration. As soon as potted they may be placed in the greenhouse until they have made considerable growth, after which they may be moved to a warmer position, and watered occasionally with liquid manure.

Those who have no greenhouse, may plant the bulbs about the middle of July in the open air in a rich border. When they have made a growth of a foot or fifteen inches, they may be dug up and potted; and before there is any danger from frost, should be removed to a sunny window in the house, and kept well supplied with water. The best time to dig is after a continued spell of dry weather, when the soil is rather dry; and if they are potted and well-watered as soon as lifted, they receive no apparent check whatever, but will give as good spikes of bloom as those ordinarily flowered in

the open air. I have a bed in an intermediate house of about three hundred bulbs which I have lifted in this way, and they are all giving indications of bloom.

Bulbs grown this season in the open ground, and well matured, may be potted for spring flowering; they do not require to be covered to induce them to make a root growth, which is the case with hyacinths and some other winter-flowering bulbs; but I think it best to avoid giving much heat in the beginning, as this would be apt to cause them to make too weak a growth for bloom when forced in this way.

### AGAVE XALAPENSIS.

BY J. F. M. FARQUHAR, FOREST HILLS CEMETERY,  
BOSTON.

Last spring this variety of Agave flowered here. It threw up a central stem to the height of four feet, on the top of which the flowers were produced, extending downwards about fifteen inches. They were bell-shaped, about one inch across, and of a pale pea green color. Those lowest down expanded first, and the others followed in slow succession for nearly a month. The effort of flowering seemed to have exhausted the plant, and its faded appearance afterwards certainly justified the frequently expressed opinion of callers, that its days were numbered. As the plant was a fine specimen, I would have regretted its loss. I therefore endeavored to save it, and kept it perfectly dry until it had sent up a new crown, which it did about the first of September. From that time it was regularly watered as it needed, and now, October 2nd, the leaves have regained their fresh appearance, and the plant seems as healthy as though it never had flowered.

### VIOLETS.

BY RAMBLER.

A great gardening author has stated that if three flower-pots were kept in a window, one of the three should be devoted to the culture of violets. Well did he know how dear that little flower was to the human heart; and the more I think of that, the more I wonder that it is not more generally cultivated. For I don't know of any plant easier of cultivation, or that rewards more liberally the attention bestowed on it, whether grown in pots or in a frame. And I



am sure there are few of our lady friends to whom a small bouquet of sweet-scented violets would not be desirable in the cold days of winter and the earlier, stormier period of spring.

Not only for its usefulness and fragrance should we cherish, but also for its poetic associations. How, when in a musing mood, the sight of this simple flower conjures up associations, that enables us as "of old" to gambol amidst "the sweet scenes of our youth" in feats of skill and wanton merriment; yea, years have rolled on, and life with its stern duties has somewhat shaded the little romance within us; yet the time when the first-plucked violets were stealthily and bashfully presented to a favorite fair one, are as present to our memory as when "youth was young."

The Heart's Ease, from the harmonious combination and contrast of its colors, is often strikingly beautiful, and is frequently odoriferous, but it holds not the same place in our sympathies as the modest but sweet violet, that has little to attract the eye, but, like other objects, human as well as floral, would pass unnoticed in the crowd were it not for the beneficence they shed, the fragrance that they yield; and I only hope that the time is drawing nigh when this plant will be more universally cultivated. Any given rules for successfully growing the same are unnecessary; but I have found, myself, whether grown in pots or frames, they delight in nice drainage, a little charcoal, light loam, and plenty of air.

### FORCING TENDER ROSES.

BY W. J.

The writer wishes it understood that he makes a distinction between growing plants under glass and forcing them. We grow, for instance, grapes in cold graperies; no gardener would call that forcing grapes. We grow a variety of plants under glass for winter-flowering, such as Roses, Carnations, Violets, Heliotropes, Bouvardias, &c., but in general we do not call that forcing. By forcing, the writer understands the using of extra artificial means to produce flowers out of their season, as Roses, Lily of Valley Hyacinths, &c., about Christmas. Undoubtedly, Mr. Grey's method, as given in a former number, is a good one for *growing* roses; as to the forcing of them, the writer differs with him in some points. If we want to force roses, we have first to understand

why it is there is such an abundance of fine roses in March, and so few about Christmas. It is on account of the sun being more powerful in February and March. Mr. Grey speaks highly of a span-roofed house, facing east and west. At what angle the roof ought to be built, he does not mention, and that is a matter of the most importance. Flat-roofed houses are not good for growing flowers in winter. Commercial men know the value of sunlight, as witness their troubled faces if a week of cloudy weather precedes Christmas.

If we consider all this, we come to the conclusion that it is light and sunrays that help us so much in bringing out the flowers, and we should build our houses with a steep roof—say at an angle of 55°, or more. This may seem too much to some gardeners, but let them consider how low the sun is when most needed. Houses with such roofs would be either very high or very narrow, and a hip-roof becomes necessary. The northerly roof ought by no means be steep, for the less glass on the north side the better; a warm, hollow wall would be preferable. Best quality glass should be used, and of 10x12 size, with all the wood-work as light as possible.

That light is very essential to plant-life is nothing new, and that fine colors are produced by it is also well known. Very little airing is required, for sunheat in those days is more beneficial than injurious.

A forcing-house for roses should always face South. It will bring on flowers at Christmas that would not be seen much before Easter in a span-roof facing east and west.

As to the bed manure, &c., the writer agrees with Mr. Grey, but not with his method of renewing old bushes by tying them down to the ground.

The Roses recommended by Mr. Grey can easily be kept in shape by skilful pruning, provided they are not planted too thick, a fault which is rather too often committed, the result of which is that the plants are forced to grow up too straight. The exclusion of light from the side buds causes them to break feebly and produce small buds as a consequence. As to the Marshal Niel, that is nowhere so much at home as when it can run on a trellis near the glass.

Now, as we know that roses near the glass are generally the best in size and color, let us not lay the bushes to the ground. Should it become necessary to make roses break near the ground, they might be cut in the early part of summer,

when their flowers can be spared. They will then have time to make young wood before the following winter.

Thanks to Mr. Grey for bringing up this subject, and giving his method of culture.

---

### EDITORIAL NOTES.

---

**PRITCHARDIA FILIFERA**, (*see Frontispiece.*)—We give as an illustration with the title page for the annual volume a representation of this beautiful Palm, the recent discovery of which in the lower Colorado districts of the United States has caused so much interest, both in this country and in Europe. It is, we believe, about five years ago that we received a leaf for name from Mr. John Rock, of California, but for want of flowers or fruit, there was no way to identify it. The history of its name has already been given by Mr. Sereno Watson in our pages. As it extends up the Colorado River region almost to Utah, it will probably prove hardier than any other Palm we have; and as it will not be difficult to procure seed as it is with so many other palms, it will probably become more popular than any of the many beautiful things that form the Palm tribe.

**CIRCULATION OF HOT WATER.**—In scientific circles there is some interest taken in the fact that the soundings of the *Challenger* expedition shows that down in the deep water of the Pacific and Atlantic Ocean there are many places where the water is but little above the freezing point. Gardeners accustomed to the circulation in hot water boilers can easily understand this, as well as why the Gulf Stream flows towards the poles and other similar phenomena. As the water on the surface at the tropics is warmed and lightened, the colder from the poles flows down and re-replaces it, and the warm lightened water, of course, flows over the surface to take its place.

**THE NEW PALM.**—At the October meeting of the "Germantown Horticultural Society," the first premium for new and rare plants was awarded to Edwin Lonsdale, florist of that place, for a plant of the beautiful palm, *Pritchardia filifera*. We think this is the first time it has been exhibited in Philadelphia.

**HYDRANGEA THOMAS HOGG.**—This is a pure white variety of the common form, and will be

very popular. We have before had the pink, often a blue, and now a white, giving great variety to this beautiful plant.

**RHYNOSPERMUM JASMINOIDES.**—This popular greenhouse plant, which in spite of its long name, has managed to become well-known, will in future have to struggle along under *Trachelospermum jasminoides*.

**REMEDY FOR ANTS.**—The papers tell us that "a new industry has been introduced in France—the breeding of ants for their eggs. These eggs are sold to the breeder of pheasants. As yet the business is in the hands of its originator, a woman, and she already appears to be on the high-road to fortune." Perhaps they who are pestered with ants in greenhouses may here see a way out of their little trouble.

---

### QUERIES.

---

**LIME FOR CELLAR FLOORS.**—M. S. B., Portland, Oregon, writes: "I should be glad to be informed through the *Gardener's Monthly*, or otherwise, how to construct 'Lime floors' for cellar bottoms, and how long after making before the floor can be used.

"Is sand to be mixed with lime after the slacking; and is lime considered as good a *cement* for cellar bottoms where there is much dampness?"

[Lime for cellar floors should be "drawn" through water as plaster is—not slacked as it is when masons use it for brick or stone work. After being taken out of the water, it may have from one-half to three-fourths of its bulk of sand, gravel, or any hard material mixed with it. It will not "set" or crystalize as mortar does. Its solidity will depend on the pressure it receives. It will take two or three weeks to dry, the time varying according to the dryness of the cellar. In a very damp cellar it may never get hard—we have had no experience—for the hardening is due to drying, and this to evaporation.—Ed. G. M.]

**HEATING A CUCUMBER HOUSE.**—P. W., Winters, Yolo Co., California, writes: "I wish to inquire the best way to heat a greenhouse, three hundred and twenty feet long and thirteen feet wide. The house is used for the purpose of raising early cucumbers. I have been in the habit heretofore of using stable manure for bottom heat, but find I am so much troubled with the green fly, (or, lice, as we call them,) on the vines, that it is im-

possible to grow them with success. I think the lice originate from the manure. Would it not be better to heat with hot water? How would it do to have the boiler in the centre of the house, and have the water flow each way and return? I have plenty of one-inch pipe—would that be large enough? The thermometer never indicates lower than 26°."

[It is hardly probable that the lice are especially favored by the stable manure. Hundreds raise cucumbers by stable manure without this experience. If we had an abundance of stable manure, we should be loth to change it. No heat is so grateful to the cucumber, as that from this source. If, however, you will change, hot water will be best for so long a range, and the boiler be best in the position you suggest. The objections to one-inch pipe are that it is very liable to be obstructed—and water circulates with more difficulty on account of the greater comparative friction, and cools quicker. It takes more fire to keep up a regular temperature in a house with small pipe, than one with pipe of three or four inches diameter.—Ed. G. M.]

SUNRAY FUCHSIA.—W. C. L. D., El Dorado, Cal., says: "In July number one of the *Monthly's* correspondents desires to know who originated the Sunray Fuchsia. It originated with a Mr. Rudd. I think it a very desirable Fuchsia. The *Monthly* I consider at the head of all papers or magazines of its class, and its great popularity I believe entirely due to its untiring and devoted Editor."

[The Editor does take a pride in his work—but never forgets how much he owes to his extensive circle of correspondents. These make a good paper as much as a good Editor.—Ed. G. M.]

TAR IN GREENHOUSES AGAIN.—A correspondent at Ogdensburg, New York, is in trouble with the greenhouse. The leaves of the plants fall off, &c., &c., &c., &c. The pipes are painted by "some black material," and this tells the whole story. The predecessor of the present gardener could hardly have been a reader of the *Gardener's Monthly* or he would not have tarred the pipes—or indeed put anything on the pipes. If he left his situation for his bad success with his plants, he fully deserves his fate.

## FRUIT AND VEGETABLE GARDENING.

### SEASONABLE HINTS.

Very little can be done now in this department, except by way of preparation for another year.

Manure can be placed on the ground wherever required, and Asparagus beds, if not already done, should have a slight covering of it. Bean poles, pea-brush, and stakes of all kinds should be got now, the tool-house gone over and put in order, and everything kept in good order and studiously in its place. When the season of operations commences, there will then be nothing to hold back the attention.

Where there can be heat of 60° commanded, Bush Beans can be usually grown in pots, and can be gathered in two months from time of sowing.

If there is abundance of leaves or manure at command, and small frames, beds may be put up for early spring salads, at the end of the month.

Radishes and Lettuces are, however, very impatient of too much heat; they will come on well if the temperature be kept at 45°. When it goes above that, the sashes should be lifted entirely off.

The same remarks apply to the Potato and the Early Horn-Carrot.

Cauliflowers in frames require all the air possible. Never allow to become dry; this is the cause of many failures by way of "buttoning off."

In the fruit garden, there is not much to be done besides thinning of branches where too thick, cutting out weak or exhausted ones, so as to give place to younger or stronger ones—and, where there are scale insects on the bark, washing to get rid of them. When a tree is badly infested, the twiggy portions should be wholly cut away so as to more perfectly clean the balance.

The best wash is that recommended in our magazine of last spring—Linseed oil.

## COMMUNICATIONS.

## GRAPES AT BOSTON.

BY W. H. W. READING, MASS.

The display of grapes at the Massachusetts Horticultural Exhibition in September last was unusually fine. Some pronounced it the best that had ever been made. The season was remarkably favorable, on account of its exceptional heat, to early and thorough ripening, and as a consequence, almost every variety grown in Eastern Massachusetts was shown in its perfection.

Mr. Campbell's "Lady," of which we had such complimentary reports, did not make her appearance. There were many inquiries for her, and some had strong hopes of at least getting a glimpse of her face, if not of becoming personally acquainted with her. But probably no vines of this variety have yet fruited in our region, and we shall have to wait another year at least. My own plants have made a very feeble growth, though carefully nursed, and I hear the same complaint from one of my correspondents. But it is just so with Croton, and yet after it becomes well established it acquires all necessary vigor.

The "Brighton" was visible only in a single bunch. As this grew upon a young and feeble plant, it was probably no fair representative of the real size and character of the grape when grown upon a vine that has attained age and vigor. The bunch shown looked much like a small Diana, being shorter than the average Delaware, with the berries about the same size as these when well grown. If I may judge from a single grape, the quality is not by any means equal to Delaware or Iona, though much superior to such varieties as Hartford or Concord. But perhaps it is unfair to make any criticism at all upon fruit taken from so young and feeble a vine. My brief experience with the Brighton leads me to think it a healthy and vigorous grower, much more so at least than Lady, and I look forward to its revelations, when firmly established, with a good deal of hope that it will prove very desirable.

But the very cream of the display. (so far as new varieties are concerned) was Mr. Ricketts' exhibition of his new hybrids. He had a table entirely to himself, and it was covered with more than sixty varieties, which of course attracted a great deal of attention, making, as it doubtless

did, one of the very finest displays of out-door grapes ever seen in New England. Some of the clusters were magnificent, two bunches of Secretary being each nearly twelve inches in length; and the quality of several of them was superb. One small white one I thought had the most exquisite flavor of any grape that ever passed my lips. There were many and earnest inquiries for the vines, and many disappointed countenances when the reply was given that no single plants are for sale.

If the vines from which such grapes as these can be grown shall prove to be healthy and hardy, so that they will give us a reliable crop, then it would seem as if we have already reached the goal in out-door grape culture, beyond which no reasonable man need wish to go. But these splendid varieties have been tested only in Mr. Ricketts' garden on the Hudson. He is afraid to part with them for the purpose of having them tested elsewhere, lest they should be dishonorably propagated, and so the ownership of them be lost to him. It surely does seem as if the government ought in some way to protect his rights to these new and valuable fruits, which he has originated with so much skill and care, as thoroughly at least as it protects the rights of the man who invents a new mouse-trap or manufactures a new patent medicine.

[It is dangerous to build much on weak vines. The Lady grape is not generally a weak grower, and the reference to the Brighton is so foreign to its usual character as to excite a doubt as to whether W. H. W. has the real thing. In regard to Mr. Ricketts' grapes, the great commercial difficulty is that he has so many good ones. They compete one with another, and then there are many good kinds held by other parties—all are in competition. For all this, we believe that any one who has a good run of grape trade, would do well to buy the whole stock of one of Mr. Ricketts' good grapes and push it, even though he had to pay several thousand dollars for the right.

Still, here is the point for W. H. W. and others to consider:—Suppose the government were to give Mr. Ricketts' a "patent" for one of his new grapes, who would guarantee that another kind just as good or better would not be out before the owner of a "patent grape" could get his stock well into market? We repeat what we have said before, that there is not a nurseryman in the country but would give just as much for the whole stock of a good thing without a pat-

ent right as with it; perhaps more, for with a fruit right he would surely buy law suits. If it be asked why this is not the case with ordinary patents to the extent to be anticipated in this, we answer because the elements of novelty can be more clearly defined in a machine than in a fruit. Suppose W. H. W. tries his hand at it in illustration. Give us, for instance, the points of novelty claimed for the "Secretary" grape in such language that a patent office clerk could tell at once whether any other grapist was infringing on the "rights" of the Secretary. Let us see how the thing works and save so much theoretic talk.—Ed. G. M.]

### MRS. PINCE'S MUSCAT GRAPE.

BY JASPER STANDSTILL, BROOKLINE, MASS.

By referring to the June number, 1874, page 166, you will find notes about "Mrs. Pince's Muscat Grape." I now send by express a bunch of the same, an average one of twenty-two. I do this because I then said, "As to its keeping qualities it will fulfil the most extravagant wish; as to its flavor, it is not that of the Muscat of Alexandra." At that time it was a "cold graperly;" now a part embracing the Mrs. P. is heated, and as a consequence its substance and flavor is vastly improved. For its unapproachable keeping qualities it ought to find a place in every establishment where late grapes are desired.

[1 lb. 4 oz. A beautiful bunch, and of admirable flavor.—Ed G. M.]

### THE WINTER PROTECTION OF GRAPE VINES.

BY J. M. H., DOVER, N. H.

There seems to be no other way given where by the fruit culturist of the Northern States can combat the cold and frosty weather of these northern regions successfully, and produce in perfection the choicest varieties of grapes, except by giving them a good winter protection of some sort. My experience has been that any grape which has any foreign blood in its composition will almost invariably winter-kill, unless protected in some way. And although so much has been written upon this subject, still a large majority of cultivators in this vicinity still neglect this most essential element in grape culture. A neighbor being unable to cover his vines as usual last autumn, found when spring opened

that his Iona, Allen and Rogers Hybrids, Delawares and Eumelans were killed to the ground; while his Concord, Hartfords, and Northern Muscadines lived, but were late in starting. This plainly shows that those vines which are hybrids or contain in some manner foreign blood are more tender than those of native origin. Another neighbor interested enough in grape culture to plant several varieties, but believing that vines are capable of taking care of themselves, declares he will not protect his vines in the winter; result of this resolution—neighbor A. never eats the choicest varieties of grapes unless he purchases them or has them given him by some more careful neighbor. I know that fine grapes can be raised north of the 43d parallel of latitude; that you have only to use the materials within the reach of all to make it quite successful. In my own graperly I have succeeded by giving my vines an annual pruning, not always following the directions of the "books," but sometimes pruning close and at other times on the renewal system, adapting the pruning to the condition of the vine, manuring moderately with wood ashes or well rotted manure, and by giving the vines in autumn a covering of leaves, potato tops or what is just as good, the soil around the vines. In this manner grapes can be raised at the North where Indian corn can be ripened.

### THE SICILIAN NUT TREE.

BY ED. S. MASON, DETROIT, MICHIGAN.

Four or five years ago, seeing the Sicilian Nut Tree extensively advertised as a valuable nut-bearing shrub or tree, I ordered two plants from the proprietor, received them by express, and planted them in my garden in Detroit. They grew well and stood two winters without any apparent damage. The third winter, one of them was killed by the rigors of the season, the other still survives and puts out a large growth of strong shoots every year, but as yet has not borne fruit. It appears to be identical with the filbert, the improved and cultivated Corylus or Hazel. The seller, who is a nurseryman in Massachusetts, may not have intended fraud or imposition, as it is probable the nuts from which the trees were raised were imported from Sicily, as filberts are extensively grown in, and largely exported from that Island.

**MUSKINGUM PEAR.**

BY R. J. B.

This fruit which seems to do well in the north-east, is not considered valuable in the vicinity of the city of Zanesville, Ohio, on the Muskingum river. Since the finer varieties have become known it has been passed by. The opinion of the writer, formed from what he could learn 20 years ago, was that it was one of the *old time* fruits, like *Orange Bergamot*, &c. Recently he has conversed with a gentleman who was secretary of the Muskingum Valley Horticultural Society, a year or two ago, (and whose father is now president of the same); and he stated that after full discussion the society discarded it; its chief faults being insipidity and mealiness.

**THE PLUM CURCULIO.**

BY P. H. FOSTER, BABYLON, L. I.

I wish to write to the public through your progressive *Monthly*, how we cheated the little Turk out of some Purple Favorite Plums, this year, by casting air-slaked lime over the tree nearly every morning for six weeks; the consequence is, we have quite a quantity from two trees, which we never had before. Another idea may prove of benefit; no rotten plums, as heretofore.

[The plums were well earned. The easiest plan we know to get plums is to put a fence round the Plum orchard, and keep fowls therein. Throw grain or other very small feed under the trees, and let them scratch away for dear life and the chance is there will be cheap plums.—Ed. G. M.]

**JUNE-BUDDING PEACH TREES IN TEXAS.**

BY B.

My June-developed peach buds, where I cut the tops entirely off, are many of them dying; but where the young tree was small enough to bend over, or, where large, was first cut partly in two (as in plashing osage hedges) and then lopped over, the buds and stocks are all doing well. For years past I have adopted this plan in treating summer-budded roses; and one season I budded some fine quinces with pears, layered the quince limbs early, making the top of the curve just above the bud, and both pear buds and quince layers grew well. But the top

of peach stock is not worth saving, and an upward cut, half way through, will allow the top to lop over without further care, and keep up a healthy flow of sap. Where cut off, disease or death in our hot, dry climate, is inevitable.

**EDITORIAL NOTES.**

**WESTERN GRAPES.**—New seedling grapes come in once in a while from the West, only to excite astonishment East that any one appreciates them. When examining these, we think people have scarcely an idea how the grape has been improved. Some of these would have been popular fifty years ago, but are hardly endurable now.

**THE TOMATO DISEASE.**—The *Gardener's Chronicle* says that the identity of the Tomato fungus with that of the Potato fungus—the *Perenospora infestans*—is now undoubted.

**DISEASE IN CALIFORNIA CHERRIES.**—The *California Agriculturist* says:

"Several cherry orchards about San Jose have, within the last two or three years, showed the presence of some disease which has alarmed and puzzled the orchardists not a little. The trees, one by one, in portions of the orchard, would commence dying at the top. The topmost limbs would die first, and so down till, in some cases, the entire tree would die. In others, after a few of the main limbs died, the trees would take a new growth from the bottom limbs and show signs of recovery. We have visited several orchards and undertaken to ascertain the cause. No orchardist could account for the trouble."

[We find the roots of many trees that are sick injured by gophers, but much doubt whether such injuries, however harmful, would result in the appearance as described.—Ed. G. M.]

**LIME AND THE POTATO BEETLE.**—The *Gardener's Magazine* tells its readers that when the Potato Beetle makes its appearance in England, not to use the favorite thing on the other side—an arsenical preparation known as Paris Green—because it injures the soil, while dustings of hot lime benefit the ground, and are equally effectual and less dangerous. All this so positively rendered, reads funny to an American.

# NATURAL HISTORY AND SCIENCE.

## EDITORIAL NOTES.

**RAINFALL AND FORESTS.**—Our European friends are finding some curious “facts” in regard to rainfall and forests. In France, a Mr. Fautral found that there was much more rain fell in a forest than on a sandy plain not a great way from it. It so happened, however, that another forester kept an account in a forest about the same distance from the sandy plain, and the figures from the two forests do not agree. Most persons would have suspected an error in ascribing much influence to the forests, but these two fell to discussing the nature of the forests themselves; and now it is asked of us to believe, that while ten per cent. more rain will fall on a pine forest than on a sandy plain, only five per cent. more falls on an oak one! The only wonder is that 95 per cent. should fall on the treeless plain.

**ON THE DIURNAL OPENING OF FLOWERS.**—At a recent meeting of the Academy of Natural Sciences of Philadelphia, Mr. Thomas Meehan referred to observations he had made this season on the nocturnal and diurnal expansion of flowers, and said that, contrary to the popular impression, it was not probable that light or its absence alone determined the opening of the blossoms. There were some plants, as for instance (*Enothera biennis*, the Evening Primrose; *Anagallis arvensis*, the “Pimpernel,” and others which remained open or otherwise longer when the weather was humid or clear, and were looked on in consequence as kinds of floral barometers; but from other facts it was clear that it was not the weather merely, but some other incident accompanying the weather that governed the case.

For instance, though *Enothera biennis*, and other *Enotheras* opened at evening,—and if the atmosphere be moist, would continue open the greater part of next day.—many species opened only in the day time, and this they did regularly quite regardless of meteorological conditions. *E. serrata*, of Colorado, was one of these. It was regular in opening about noon, and the blossoms were all closed long before sun-down.

In other allied families, we saw similar divergencies. In the Cactus family, *Opuntia* and *Mammillaria* opened only about mid-day; while most of the *Cereus* opened at night. The night-blooming Cactus was a familiar example. But the chief interest was in the fact that many had their special hours of day or night for the expansion. The *Portulacca oleracea*, common Purslane, opened about eight A. M., and by nine had performed all its functions; while a closely-allied plant, the *Talinum teretifolium*, from the serpentine rocks of Chester County, opened at one P. M., and was closed by three. The conditions of the weather did not seem to influence them.

There was the same attention to daily periods in the growth of the parts of plants, as well as in the expansion of the petals. In composite plants, the floral growth was generally in the morning, and was usually all over by nine or ten o'clock A. M. The elongation and expansion of the corolla was usually completed in an hour after sunrise; but the stamens grew for an hour more, and the pistil continued for still another. There was little if any growth in the floral parts after nine o'clock in a very large portion of this order of plants. In grasses, *Cyperaceæ*, and some rushes, the floral parts were very exact in their time of opening. In the Plantains (*Plantago*) the pistils appeared a day or more in advance of the stamens, and these last appeared at about a regular time in each day. In *Luzula campestris*, the wood form, he had by a series of observations timed it exactly. Before nine the anthers were perfect, but by ten the pollen has been all committed to the winds, and only dried membraneous matter remained. So far as he could ascertain, meteorological conditions did not influence the time in the least in this case.

The popular impression of light and moisture, as agents in this behaviour, had seemed to receive a tacit scientific assent. It was clear he thought there was a more powerful agency underlying these, and it was perhaps a gain to science to be able to see this, though in so dim a light.

METALLIC SUBSTANCES IN PLANTS.—The number of metals absolutely indispensable to all plants, and consequently to fruit trees, is six; namely, potassium, calcium, sulphur, phosphorus, manganese, and iron. There is no doubt, however, that certain plants require, in addition to these, this or that other metal to complete their nourishment. We may even assume that silica, chlorine and sodium, and perhaps also magnesium, play a part in the functions of certain plants. If we reckon the four gaseous elements which furnish plants with their first and princi-

pal food, we have a total of ten, or sometimes thirteen or fourteen elements, which have proved essential to the perfect development of plants. According to Prof. Adolph Mayer's excellent text-book of agricultural chemistry, these elements are taken up in the following forms:—1, as free oxygen; 2, as water; 3, in the form of acids, namely, *a*, as carbonic acid; *b*, as nitric acid; *c*, as sulphuric acid, and *d*, as phosphoric acid. 4, in the form of bases, namely, *a*, as potassium; *b*, as calcium; *c*, as manganese, and *d*, as oxide of iron.—*Journal of Chemistry.*

## LITERATURE, TRAVELS & PERSONAL NOTES.

### COMMUNICATIONS.

#### VIEWS OF DISTANT LANDS.

BY W. T. HARDING, COLUMBUS, OHIO.

New Zealand, from the insular position it occupies, although much nearer the equator than Great Britain, is said to much resemble it, in the mildness and moisture of its climate. Probably it does, but in no other respect will it bear comparison. Its topography, when compared with the wonderful continent of Australia, differs much in general appearances. The atmosphere is also much lower in temperature; while the paucity of its Flora is as remarkable as the meagreness of its Fauna. Perhaps no country having the same extent of area, 51,584,000 acres, contains a less variety of either plants or animals.

True, there is a vast interior as yet unexplored; and from the hostility of the natives, is likely to remain so for some time to come. The learned Bacon says; "Man is an animal as well as a brute, but he is something more." But, in the case of the ferocious New Zealander, man is nothing less. So devilishly full of evil are they as to be a terror to *well* doers. Many a harrowing tale could be told of their diabolical doings, to honest and brave men, fair and faithful women, innocent babes and children. As long as the "red handed" wretches continue to oppose the approach of the white man, with the war-club and spear, but little can be known of the hidden treasures which remain for the venturesome traveler to gather at some future time. The axe,

the plough and the railroad, the three great civilizationers, are gradually bringing about the inevitable change which will people the wilderness, and make the desert rejoice and blossom as the rose.

But why dwell upon blood-curdling themes, the gentle readers may inquire, when there are happier subjects to dilate upon? Surely there are pretty flowers, beautiful trees, and pleasure scenes to describe, without introducing us to nasty, naked, blood-thirsty cannibals. With all due courtesy, let me inform them that my intentions are not to cause any needless pain. Be it known then, that I harbor no "bloody thoughts" or unkind feelings; God forbid. Yet, however painful it may be, the writer feels compelled to divulge the fact, that he has willingly associated, when in Europe, with bloody wall-flowers, *Cheiranthus Cheiri sanguineus*, by name, and without a blush; and confess to having many times seen *Love lies-bleeding* on the ground without shedding a tear. And, although he well knew the unhappy East Indian's name, *Amaranthus caudatus*, he sorrowed not. Without remorse, or qualms of conscience, he has dug and delved among blood flowers, at the Cape of Good Hope. This bulbous rooted subject, *Hiemanthus sanguineus*, with such a terribly bloody name, is, anomalous as it may seem, one of the most singular and beautiful occupants of the greenhouse, and *should be* in all collections. He has even taken pleasure in the handling of *Bloodwort*, the *Sanguinaria canadensis* (not meaning bloody Canadian), of the woods in this hemisphere. One of his chief delights has been to indulge in blood oranges, and feast on *Bloodgood*



pears, blood-elixir stone peaches and Bleeding-heart cherries.

Even the dark, bloody cinquefoil of Nepal, *Potentilla astrosanguinea*, and *Rubus sanguinolentus*, of the Isle of France, well-named, the bloody bramble; an old acquaintance. However terribly portentous such technical appellations may seem, by no means are they intended to convey the idea that they are the names of herbaceous vampires or ligneous leeches. Believe me, there are no raw-head and bloody-bone posies in the greenhouse, or frightful ghouls in the flower-garden.

After confessing to such a gory experience, startle not, ye timorous ones, when the kindly editor of this magazine offers to supply his patrons with blood-beech, blood-birch, and blood-peach trees to plant; or should he recommend blood-beets, or onions, or any of the sanguinary vegetables, be not alarmed; they are meant for your good.

My apology for writing such a biography, which seems at first sight like reading a gory chapter or page of blood, is simply a preface to what follows, an introduction to the bloody ferns of New Zealand.

*Hymenophyllum sanguinolentum* is a beautiful filmy fern, known as the Bloody Fern. It seems a dreadful name for a pretty fern, but it is more in the name than in the nature of the thing, which is anything but repulsive. *H. nitens*, with its more euphonious name, is a shining gem, which with its sanguinary companion, literally covered the rocky ravine, through which I picked my way.

No doubt among the numerous readers of the *Monthly* there are many whose hearts are as fondly attached to the lovely Filices as was the fair and gentle creature who so feelingly and emphatically declared, "Ferns are my devotion!" Such an appreciative soul, having a tender regard for whatever is good or beautiful, will ever manifest its purity of purpose in every state or condition of life.

Probably no species of fern find more admirers or devoted friends than the filmy ones, under notice. Whoever has been so fortunate as to see, or own *H. Tunbridgensis* will admit that it is a most lovable kind. Unfortunately the chary little beauty is constituted with so retiring and delicate a nature as to modestly hide from view. Their habitats are generally in some sequestered nook in the forest, or sylvan shades in some romantic glen. They cannot exist in the sunshine

as sunny flowers do; and whoever attempts to cultivate them must never allow a sun-ray to reach them, or they "will shrink like parchment in consuming fire." A well-drained Wardian case, or bell-glass, is necessary to secure the proper close, moist atmosphere they delight in. Two other lovely kinds, *H. dilatatum* and *H. flexuosum*, were profusely distributed in favorable spots. Of recent introductions from New Zealand are *Todea superba* and *T. pellucida*, two most superb filmy ferns.

*Dendrobium Cunninghamii*, a pretty white-flowering species, and the rare *Earina suaveolens*, the peculiarly formed white flowers of which are exquisitely fragrant, were the only two orchids I met with.

*Edwardia grandiflora* is certainly one of the grand flowers of the country. It is a splendid yellow-flowering leguminous plant, and is often seen in balloon-like masses some ten feet high, and sixty feet in circumference. They are uncommonly ornamental when bedded out in the summer months in this country. Mr. M. Hagerly, of Cleveland, produced some admirable examples of what they are capable of. Three other smaller, yet very interesting kinds, *E. minima*, *E. chrysophylla* and *E. microphylla*, are well worthy of a place in the greenhouse.

A little in advance stood a group of palms, *Entelia* (? Ed.) *arborescens*, some 40 feet high. This handsome palm is an excellent lofty conservatory plant, and would prove to be hardy in the Southern States.

Fringing a cluster of *Myoporum viscosum* some three feet high, and backed with *Aralia trifoliata* and *Metrosideros robusta*, was a ferny border, which *Asplenium bulbiferum*, and *Platy-loma rotundifolia*, rounded nicely.

*Tetragonia expansa*, with which most gardeners are familiar as New Zealand spinach, assumed arboreal proportions, from ten to twenty feet high. The remarkable broad-leaved conifer, *Dammara Australis*, is a lofty and bushy tree, but is rarely seen except on the Northern Island.

Of climbing plants, the most conspicuous is the Supple Jack, or *Ripogonum parvifolium* and *Freyinetia Banksii*. The natives are said to be fond of the sweet bractæ of the blossoms, which they eat with savage gusto. *Cordylines* and *Dracænas* are as common as the tree ferns.

*Cyathea medullaris* and *C. dealbata* are not only stately but are magnificent and beautiful. I well remember the time and circumstances which first brought us together, and whenever

I see them now, think of them then and there. *Dicksonia antarctica* and *D. squamosa*, were well represented; but having previously described them in the October number of the *Monthly* of 1870, I will pass them by.

*Phormium tenax*, is a common plant. The well-known *P. tenax variegata*, so universal a favorite, both in this country and Europe, was an exceedingly scarce plant at the time of which I write, and was but rarely seen. The New Zealand flax is one of the most useful plants in the country, especially so to the natives, who use it for thread, cordage, mats, baskets, bags and various things.

Along the margins of rivers, and the rich, loamy bottoms of the valleys, *Caladium esculentum* flourishes amazingly. As an esculent the natives of Australasia not only eat it, but the roots of *Cordylines*, as I have frequently seen. To judge them, according to my civilized palate, they are the most abominably insipid trash I ever tasted, *Marselia macropus*, or *Nardoo*, excepted.

Having erred and gone astray from the way I ought to have followed, I felt much perplexed and bewildered in trying to find my way out of the maze. (The famous maze at Hampton Court was not a circumstance to it.) The surface over which I stumbled was exceedingly rugged. With considerable difficulty I scrambled and floundered among the matted masses of *Clematis hexasepala*, a green flowering kind of no particular merit. *Clianthus carnea* and *C. puniceus*, two kinds of Glory Peas, having woven their stems wierdly together with the Clematises, seemed to conjointly aid in preventing a passage through. Sitting down to rest, I thought how pretty and interesting they used to appear on the greenhouse stages in England. But oh, that Glory Pea! How sad the change! Little did I then dream the time would come when I should be a prisoner in the woods, lassoed round the neck with Clematises, and my legs fettered with Glory Peas! Escaping from the durance of the ligneous forest warders, I made the best of my way out of *Tangle-foot Gully* to a more open ground.

Still among the ferns; in fact it would be difficult to find a yard of surface without more or less of them. They literally cover the face of the country. They flourish on the surface of extinct volcanoes, rocky ledges, deep ravines, alluvial plains, sandy and stony flats, swamps and morasses, the elevated table-lands, plateaus of

volcanic scoria, up to the limits of the eternal snow which cap the mountain summits of the Middle Island.

*Marattia elegans* is decidedly an elegant and imposing tree fern. Fine specimens will often reach from twenty to thirty feet above *Lomaria Frazeri* and *Hypolepis rugulosa*, which spread thickly beneath. Tall and graceful as it is, it is not unusual to see *Cyathea dealbata*, wave its handsome fronds sixteen feet above. When the writer visited Norfolk Island, years ago, it was then as common as the noted *Araucaria excelsa*, unquestionably the most beautiful of all coniferous trees. It is also found on the Auckland, Chatham and Macquarie's Island.

The inviting appearance of a settler's wigwam was in view, and which I found was occupied by a warm-hearted Scotchman and his family from "Bonny Dundee." Canny Sandy Macduff, his guid wife, braw laddies and bonnie lassies, made me feel as happy as any mortal could. No hospitable hearts or willing hands could possibly have done more to make me a welcome guest. The honest farmer had left "the land o' eakes" to grow wool and follow the plough in Australasia.

The moist climate, so favorable to cryptogamic growth, produces immense quantities of ferns, to the detriment of Sandy's broad acres. Pulling up a fern he said "it reminded him of Burns' John Barleycorn, which when put down would come up again." So tenacious are they of life as to survive and grow again after any treatment less than fire. On leaving the cosy sheeling where I spent the night, I in my heart implored benignant Providence to "lay on Macduff" and his kind-hearted wife and family every earthly blessing, and bid them adieu. But I was not to go alone; young Robby volunteered to pilot me through the bush, and see me safe at Mr. Trotter's, an old friend I was in quest of. Our way led through clumps and clusters of *Fuchsia excorticata*, *Pimelia prostrata*, and *Pittosporum cornifolium*, interspersed with the omnipresent ferns. Especially numerous were *Polystichum hispidulum*, *Platylooma rotundifolia* and *Goniopteris pennigera*, the gem of feathered ferns. Emerging from a copse of *Dacrydiums*, *Phyllocladus* and *Podocarpuses*, we reached the open road in front of Trotter's Nursery. Parting with good Robby at the gate, I was soon inside the rustic cottage and made welcome by the kind and generous people within. But a few years previous Mr. Trotter was the accomplished and excellent gardener at Flitwick House, Bed-

fordshire, England. I am happy to say he was flourishing in his new home. As an evidence of the interest taken in horticulture, the Wellington Horticultural and Botanical Society had been established at Port Nelson before it had been settled two years. Very pleasant, short and sweet, I may say, were the few days I spent with the good folks. They assured me bounteous heaven had blessed their endeavors, as I bid them farewell on deck of the good ship "Speedwell." In a few hours after leaving Cook's Strait the cloudy curtains of night gradually fell over land and sea, and veiled forever the writer's view of New Zealand in "its primal dress of sheeny, cooling green."

### VISIT TO CARROLLTON.

BY J. C., WASHINGTON, D. C.

As the season of beautiful flowers—in the flower-garden at least—is drawing to a close, it is perhaps a good time to communicate anything new or interesting to the *Gardener's Monthly*, so that each may have the experience of many. In a visit recently paid to Carrollton—of Charles Carroll fame—the country-seat of Jno. Lee Carroll, present Governor of Maryland, the writer was very favorably impressed with the style of ornamentation in use at this place. A liberal use is made of flowering-shrubs, pæonia, &c., which commencing to flower in Spring carry the bloom till the bedding plants proper are in full vigor. I would here remark, however, that a freer use of choice evergreen shrubs would greatly add to the beauty of the place—a matter, doubtless, which the present gardener, Mr. Flitton, a man of great experience and superior knowledge in the profession, will attend to. But to the heading proper. The first pair of oval beds, looking from the porch, are *Abutilon Thompsonii*, kept in the centre at about eighteen inches, graduating to edge, edged with *Achyranthus Gilsonii*. Continuing on beyond some intervening beds, we come to two long, irregular beds, edged in front with *Alternanthera paronychoides*, clumped with *Coleus* of the finest varieties—grand in luxuriance and coloring—backed with fine plants of *Plumbago capensis*, with its profusion of light blue flowers, showing splendidly above the *Coleus*. Again, beyond these, at the extreme limits of the flower-garden, are two circular beds filled with *Plumbago* and *Achyranthus*, and edged with a

double row of oak-leaved and scarlet *Geraniums*; looked at from the porch, they have the appearance of the most perfect bouquets; the graceful outline and perfect blending of colors is something remarkable. This may not be a new idea to some, but it is novel to the writer; and I think the effect of *Plumbago capensis*, with its profusion of light blue delicate bloom amongst and above so much rich coloring must be seen to be appreciated. One other little matter of attraction consisted of two beds of scarlet *Salvia*, the plants about not over 18 inches in height, liberally covered with long spikes of intense scarlet flowers, so distinct in habit, and so superior to other beds of *Salvia splendens*, in the same garden, that I am induced to ask, is it an improvement? Perhaps Mr. F. will inform the readers of the *Monthly*, he not being at home on my visit.

### FOREST HILL CEMETERY, UTICA, N. Y.

BY W. H. ARNOTT.

In paying a flying visit to this famed city of Central New York, I have been induced to see its beautiful cemetery, especially its conservatory, which is at present so interesting to all for its novel use. Upon reaching the cemetery I found, to my surprise, one of your own correspondents, and late gardener to that famed establishment of Mrs. Packer, Brooklyn, Rod. Campbell, who has the entire charge of all here. Not to dwell upon personalities, I will try and describe to the readers of the *Monthly*, through your kindness, something about this conservatory chapel. This building is built in the shape of a triple arch, the centre one reserved for funerals and the two smaller ones for plants planted out in prepared borders, and in these beds are planted some ten huge *Camellias*, about the best of whites I have seen in this country as to size and shape. One of these trees was at one time the property of Thorburn, of N. Y., and lately the property of James Parks, the celebrated Brooklyn florist. All these trees have been removed from Brooklyn to Utica, no mean undertaking for so large plants, or rather trees, and were planted in this conservatory chapel, and are looking remarkably well considering it takes so long a time for such large trees to recover and take hold of their new abode, which is well-known to practical men; and in a few years these *Camellias* will be objects worth looking at, if they only receive proper care,

which they will receive in the hands of Mr. Campbell; but what ruins more establishments of all kinds is the continued change of gardeners, and more so in corporations of this kind, where peculiar influence often reigns. But such is not to be hoped from this cemetery, which has set a noble example to all others. The city of Utica may feel proud of its cemetery, and the good judgment shown by its trustees in studying the welfare of its lot-owners. In returning to the conservatory I have found some nice plants of Azaleas, and a miscellaneous collection of plants, all a little too small for such a large house, but on the fair way to make good specimens. At one end of the building are two stories 16x20, one devoted to ferns, of which there is a small collection, but in good health; in the other are some Palms, Dracenas, Rex Begonias, and a lot of other nice things, which will in time make a nice display. On the roof of the conservatory are trained some fine Passifloras and roses, such as Lamarque and Glorie de Dijon, the roses to take the place of the Passifloras in after-time, the whole forming a beautiful festoon of graceful vines. Over the vestibule is a gallery, from which a grand view is obtained of the auditorium; and all around at the north end of the building, suspended from the roof and almost right over where the casket is placed, is a white stuffed dove carrying a bunch of artificial flowers; a beautiful thought, representing that symbol on our earth, of peace as represented by our faith of old. This idea originated with a Mr. Hopper, one of the trustees of the association, and the originator,—or might I use the term inventor—of a glass conservatory chapel; a gentleman of fine ideas and culture. Off from the conservatory are some other houses devoted to plant-culture; and in one of these is a small collection, but healthy, nice plants of orchids, and some Crotons, Clerodendrons, Screw Pines, Dieffenbachias, Eucharis amazonica, in flower; *Medinella magnifica*, *Alocasias*, *Marantas* of sorts; *Anthurium Scherzerianus*, fine plants of *Peperomia maculosa*, and a host of other good subjects too numerous to mention; but from what the writer saw in the city and vicinity the last-named plants are as yet a little too far in advance of what the people are educated to, in our inland cities; but it is to be hoped the example set at Philadelphia and at the last exhibition of the New York Horticultural Society will improve the taste of our better class of people up to that evinced abroad. Around the

conservatory is a flower-garden laid out in harmony with the buildings surrounding it, which is a very important feature in ornamental flower-gardening, and of which Mr. Campbell has shown himself to be a master while in Mrs. Packer's employ. As yet the flower-garden at Forest Hill is not complete; but for all there are some fine beds, especially one made in the form of a pillow and in the centre is laid out a beautiful cross, quite in keeping with the cemetery ground, and its uses: for the cross is a symbol of all. I am afraid that in a few years from the present, if Mr. Campbell is left in the management of Forest Hill, its namesake near Boston will have to look out for its laurels; as Forest Hill of Utica is in a fair way at the present to wrest from its brow, its past glory. From the flower-garden I will take the reader to the grounds. The site of the cemetery is simply grand. The visitor can see in every direction as far as the eye can reach, and feast on beautiful landscape. Among the finest monuments here may be mentioned those of Messrs. Lawrence, Crouse, Farwell, Comstock, Veeder and others, not omitting that of Mr. Barnard, which is to the writer the finest thing within the whole cemetery. It represents a beautiful canopy of the finest Italian marble, and in the centre of the canopy or arch is a bust of Faith, by the late H. Powers, and the last work of that great sculptor, whose works Americans and Europeans alike admire. Mr. Barnard ought to have the thanks of his community for placing so valuable a work of art in their beautiful cemetery. I must now conclude this letter, as I am encroaching on your valuable space, but I could say a great deal more. One objection to this cemetery is the poor way of getting there. Visitors have at least to walk over a mile to get to the entrance. Not far distant from Utica is the famed Trenton Falls, well worthy of a visit. The writer has a few notes on the Falls, and surrounding country and vegetation, and would be glad to communicate the same to the pages of the *Gardener's Monthly*, as he is at all times ready to aid its readers.

---

### EDITORIAL NOTES.

---

TYPOGRAPHICAL ERRORS.—We never object to any one's pointing out errors in the *Gardener's Monthly*. We prefer to have them do so. It is our ambition to make the magazine perfect

in every respect, and are glad of all the help we can get to make it so. We seldom refer to the errors we see elsewhere, as we do not know that the perfection we aim at in our work, or at least the freedom with which we ask for criticism, would be as well-relished in other quarters. We do not ask pardon for errors, but if we did should certainly get the *American Naturalist* to endorse it, as it no doubt would do, when even so particular a magazine uses "venation" for venation three times in one paragraph. See pp. 634, 635.

We could fill the whole of the *Gardener's Monthly* with such references to errors of our contemporaries if it were in our line of work. Just before us, in a leading scientific magazine, and in a quarter too which erst has amused itself at the errors of its contemporaries, is a paper on the "ostrich," in which occurs the following:

"He then takes his bow and arrows, and starts off in pursuit of the ostriches, using all possible precaution to approach them in such a direction that the wind may blow from them to him. Were he to neglect this, the watchful eyes would soon detect him by the scent, and dash away where he could not possibly follow them."

Watchful eyes detecting scents, is a new revelation in optics.

**THE VALENTINE BEAN.**—There is a rule in some part of England that the earliest beans should be sown on Valentine's day—14th of February. Can our "Early Valentine" bean have any relation to this custom?

**BAY TREE.**—The ancient Bay tree—Bay of the old writers—is *Laurus nobilis*. Many things have now the common name of Bay tree. The *Gardener's Chronicle* says *Laurus* (from which our common word Laurel is derived) means simply "berry" tree, and from this the word *Bay* tree is also derived.

**THE PLUM.**—Our garden plums appear, from the investigations of our Indian botanists, to be varieties produced by long cultivation of the *Prunus insititia*, a species common in the mountains of Asia, from the Caucasus to the Eastern Himalaya, but which we have no authentic evidence being a native of Europe. In all the more accurate European floras, the *P. domestica* and *insititia* are either omitted, or inserted as doubtful natives or escaped from cultivation; or, if in some instances positive native stations are given for the *P. insititia*, it is generally some variety of the *P. spinosa* that has been mistaken for it. Several varieties of the garden plum were intro-

duced by the ancient Romans from the East, as we are informed by Pliny, since the days of Cato, who was born 232 years before the Christian era.—*Gardener's Chronicle*.

**MR. C. M. HOVEY.**—We see it announced that Mr. Hovey will take charge of a horticultural department in the *American Cultivator*. We are much pleased at these evidences of a disposition to make eminent attainments practically useful. Science and high taste in art have gone on faster than the people have moved. We think the great want of the day is, that intelligence in every branch of culture should come down to the people. The writer of this, in so far as he is able, has never hesitated to employ voice or pen in any circle where either could be useful. It is peculiarly fitting that horticulture should assist agriculture, and we are pleased that Mr. Hovey has agreed to take this position, and congratulate the *Cultivator* on having obtained his services.

**THE CONFEDERATE STATES.**—Mr. Andrew Murray, as quoted in the *Gardener's Chronicle*, says the *Doryphora juncta*, a cousin, if not a brother of our old enemy the potato bug, inhabits the Confederate States. So far as we know, the only Confederate States are Mexico and Switzerland; and it may be worth while for our good neighbor of the *Chronicle* to get Mr. Murray to decide to which of these two countries he refers the beetle. Perhaps he means the United States, which, however, is not a confederacy,—a singular, not a plural term. This surely an educated gentleman like Mr. Murray understands.

**GEOLOGICAL SURVEY OF INDIANA.**—7th annual report, by E. T. Cox, State Geologist. This is one of the most valuable surveys at present in progress, and is especially of service to agriculturists and horticulturists, as well as to the mineralogist and man of science. This volume has the Flora of the Wabash Valley, by Dr. J. Schneck, connected with the survey.

**LOUISIANA AS IT IS.**—By Daniel Dennett, New Orleans. This is a paper-covered book of some three hundred pages, giving a complete account of the farm-products, grasses, vegetables, forests; indeed the whole natural and introduced resources of the State. Those who have the good fortune to know Col. Dennett as the writer has, will know that he is incapable of putting things forward in any other way than just as they are; and we can add, from our own personal expe-

rience of many matters referred to, that they are just as stated here. There is no doubt that Louisiana has the material for building up one of the greatest States in this Union. The efforts making by Col. Dennett to get people to see and to work up these advantages are better it strikes us, than millions of political speeches, and we wish them every success. The book is sent free by mail by Col. Dennett, New Orleans, for 60 cents.

## HORTICULTURAL SOCIETIES.

### COMMUNICATIONS.

#### POTOMAC FRUIT GROWERS.

BY G. F. NEEDHAM.

Prof. Brainard, Chairman of the Scientific Committee, read a paper on Pear Blight.

After an elaborate discussion of plant growth, he said: "The green and tender portions of the tree are made up of cells, whose membranous walls are very thin and delicate; consequently, when the sap, with which these walls are always filled, is subject to sudden expansion, from either high or low temperature, the cell walls are ruptured and the sap runs out. A putrefaction condition soon follows, giving rise to fungoid growth, if other conditions are favorable.

"There are two causes that produce the rupture of these newly formed cells, and their action is very sudden and certain. These are extremes of heat and cold.

"In the spring of 1875, in Ohio and along the lake shore fruit region, after the trees had put forth their leaves, a sudden fall of temperature from summer heat to from 12° to 15° below freezing killed outright nearly every pear tree in that extensive fruit district. I examined many of these trees soon after, and found the external appearance exactly similar to what is called *fire-blight*.

"In order to test the influence of heat in producing the blight, I have subjected a vigorous and healthy branch of a pear tree to an artificial heat of 108° Far., for 20 minutes. The effect upon the leaves and soft wood was vastly like the natural blight.

"The normal heat for the fruit-producing season ranges from 65° to 85°, the mean of which is 70°. A temperature of 95° is dangerous, and 100° and higher is disastrous.

"From careful observation and inquiry, I have found the trees upon a southern exposure much

more liable to blight than those on a northern or north-eastern exposure."

The Prof. then gave several examples to sustain his position. "A gentleman has a pear orchard near the city, which has a northern exposure. This orchard has not been affected by the blight, while trees in the vicinity with a southern exposure have been completely destroyed. Another had pear trees on a southern exposure which were troubled with the blight. These he removed to a northern exposure, and they soon became healthy and fruitful, and no blight has since affected them. &c. &c.

"Keep your trees low-headed, and plant with a northern exposure, and you will take the most important measures to prevent the pear blight."

[We always give our correspondents free scope, and of course are not responsible for their opinions. The effort of Prof. Brainard to ascertain the cause of pear blight by experiment, will attract attention at once, as the majority of those who profess to understand the disease will write for a year in preference to *observing* for an hour. In regard to the experiment itself, the fire-blight does not commence in the "leaves and soft wood," so that the analogy goes for nothing. Fire-blight commences in spots on the bark, often extending round the whole stem and girdling it—and not unless it does extend round and girdle the branch is there any injurious effect on "leaves and soft wood." The line between the healthy and unhealthy part is often so distinct as to be drawn by a hair line, and it is inconceivable that say one inch of bark should be injured by 108°, and an inch adjoining, separated but by a line, should be under the same temperature, and yet absolutely uninjured. The whole course of the Professor's argument, as well as of many other recent writers on fire-blight on the apple and pear, shows that he is thinking of some other disease than fire-blight, or else has given the appearances in the real disease, but a very cursory examination.—Ed. G. M.]

# INDEX.--VOL. XVIII.

**A**

*Alies alcoquiana*, 71  
 " *Egduumii*, 101  
 " *macrocarpa* a new coniferous tree 21  
 " *menziesii*, 178  
*Acacia*, Rose, Grated, 322  
*Aceraceae*, 195  
*Acer striatum*, 36  
*Achillea umbellata*, 33  
 Acknowledgments, 79  
*Adansonia digitata*, 27  
 Adaptation to Environment, 313  
 Admission to the Centennial, 128  
 Adornments of Cities, Public 262  
 Advertisements, 91  
 " Binding the, 25  
 Advice, Bad, and worse consequences, 124  
 Aesthetics in Conservatories, 8  
*Aesculapæ*, 195  
*Agave virginica*, 27  
*Agave xalapensis*, 362  
 Age of Mammoth Trees, 310  
 " Seeds Capable of Growth 343  
 Agricultural College, Plant House at, 136  
*Ailanthus glandulosa*, 354  
*Akebia quinata*, 324  
 Alexander Peach, 145, 272  
*Aloesia odorata*, 77  
*Alonsoa hirtifolia*, 356  
 " *myrtifolia*, 356  
 Alton, Ills., Horticultural Society, 96  
 American Agriculturist, 29  
 " Apples, 82  
 " Arboretum, 337  
 " Foliage in Europe, 291  
 " Forestry Assn., 178, 305  
 American Grapes in Europe, 291  
 " Lawn The, 156  
 " Naturalist, 29, 61  
 " Nurserymen, Meeting of, 127  
 " Pomological Society 32, 136, 213  
 " Potatoes in England, 85  
 " Potatoes, Seedling, 111  
 " Tuberoses, 343  
 Amherst College, Plant selling at, 136  
*Ampelopsis ineca*, 301  
 Amsden Peach, 272  
 Amsterdam International Hort. Exhibition, 316  
*Anacardiaceae*, 196  
 Analysis of the Onion, 333  
*Androneda arborea*, 290  
*Anemone nemorosa*, 199  
 Annual Register, 29  
 " Rootlets, 186  
 Annuals for Bouquets, 107  
*Anthurium crystallinum*, 268  
 Ants, Remedy for, 361  
*Apogon distachyon*, 24  
 Apple Borer, 173  
 " Blush Pippin, 52  
 " Classification of the, 143

Apple Crop in Massachusetts, 304  
 " Hays's, 273  
 " Lady, 111  
 " Northampton, 16  
 " or Pear, which, 245  
 " Peasgood's Nonsuch, 391  
 " *Pyrus malus*, 53  
 " Red-fleshed, 13  
 " Sour and Sweet, 378  
 " Summer Hagloe, 395  
 " Tree, W. H. H. 145  
 " Wabbinck & Edgar red-streak, 89  
 " Wealthy, 295  
 Apples, American 82  
 " " in England, 176  
 " Dwarf, 16  
 " for South-Eastern New Jersey, 18  
 " in New Jersey, A few that do well, 172  
 " Late, 81  
 " New, 112  
 " Variation in, 52  
 Aquatic Bouquet, 203  
*Aquifoliaceae*, 195  
*Aracaceae* excelsa, Seeding of, 297  
*Aralia papyrifera*, Hardy, 70, 161  
*Arboretum Americanum*, 194, 275  
 " Meehan's at the Centennial, 333  
*Arboretums American*, 337  
*Arbutus Trailing*, Seeding the, 279  
 Argument for Tree-planting, 148  
*Arnebia echioides*, 326  
 Art of making Wine, 208  
*Arundo conspica*, 5  
*Asparagus Culture*, 174  
 " New Culture for, 111  
*Asperula odorata*, 295  
*Astilbe*, 300  
 Attractions at Horticultural Societies, 160  
*Aucubas*, Seed from male plants of, 214  
 August, Hardy Herbaceous Plants for, 291  
*Auricula*, 296  
*Australian Grape Fungus*, 56  
 " Gun Wood, Value of, 85  
 " or Parlor Ivy, 168  
 " Tree Ferns, 347  
 Automatic Gate, 5  
 Avenue of Oranges, 70  
 Azalea Show, Mr. Sargent's, 233

**B**

Bad Advice and worse Consequences, 124  
 Bailey, W. H., Plattsburg, N. Y. 92  
*Balsamaceae*, 193  
 Baltimore, Cut-flower Trade of, 92  
 " Private gardens about, 92  
*Bambusa argentea striata*, 325  
 Banks, Sir Joseph, 343  
 Baobab Tree, 27

Barhardt Cherry, 242  
 Bay Tree, 375  
 Bean, Valentine, 375  
 Beacroft's Wheel II ve. 4  
 Bee-keeping, Profitable 15  
 Bess and Flowers, 134  
 Bedding, 5 *Chrysanths* for, 297  
*Begonia*, 95  
 " Holly, 31  
 " Propagating, 77  
 Belgium Hort. Horticulturists, 272  
 Bent Grass, Rhode Island 67  
 " " " Post-script on 98  
*Bernarda Grass*, 279  
*Bettulaeae*, 197  
 Billou's Comet Peach, 14, 27, 119  
 Binding The Advertisement, 28  
 Bird, the Peach 219  
 Black Spruce 85  
 " Walnut 13  
 Black's Early Peach, 83  
 Blight, Pear, 219  
 Blue Rosss, Strawberries on Trees, &c. 92  
 Blush Pippin Apple, 52  
 Bonne d'Ézée Pear, 82  
 Borders, Grape, 52  
*Borecole*, 89  
 Borer, Apple, 173  
 Boston Cultivator, 157  
 " Grapes at, 366  
 " Parks in, 199  
 Botanical Bulletin, 29  
 " Names, Orthography of, 341  
 Botanical Names, Pronunciation of, 152  
 Botanical Party, 315  
 Botanic Garden of Harvard University, 88  
 Botanic Gardens, 90  
 Botanico-Horticultural Congress, 95  
 Botanists, Our Early, 154  
 Botany of California, 252  
 Boulder, Colorado, Strawberry Grower at, 273  
 Bouquet, Aquatic, 203  
 Bouquets, Annuals for, 107  
 " of the Philadelphia Bells, 265  
 " Royal, 136  
*Bouvardias*, 293  
 " *Humboldtii corymbifora*, 40  
*Bouvardias* and Carnations, Winter-flowering, 293  
 Box in Washington's Garden, 155  
 Boynton's Dr., Pear Orchard, 304  
 Briggs' Red May Peach, 145, 241  
 Brighton Grape, 336  
 Brockworth Park Pear, 82  
*Brodiaea California*, 102  
 " *Coccinea*, 340  
 " *Volubilis* (Baker) 71  
*Browallia elata*, 301  
*Bryophyllum calycinum*, 171  
 Bedding, Gun Larrel 199  
 Buist's, R., Catalogue, 199  
 " Sale of Nurseries, 217  
 Bureau of Horticulture, Centennial Advisory Committee, 216

Latten-hub Ros., 9  

**C**

Cabbage, Colorado, 11  
 " Plants, 195 a - in 233  
 " Early, 81  
 Calhoun, Hon. J. C., Letter from the late, 134  
 California and Colorado Plants, New, 75  
 California, Botany of, 272  
 " Flora of, 218  
 " Onion Seed, 337  
 " " and Seed Growing in, 239  
 California Plants, New, 183  
 " Southern Palms of 245  
 California Chestnut, 55  
 Calla *Ethiopicæ*, 9  
 Callas, A few Facts about, 73  
*Calliopsis involucreta*, 214, 300  
 Camellias, Double Grating, 171  
 " in Florida, Failure, in, 133  
 " Summer Treatment of, 171  
 " Unhealthy, 75  
 Campanula, Fertilization of, 56  
 Carnation Pluks, 98  
 Carnations and Pouvardias, Winter-flowering, 293  
 Carolina Poplars, 86  
 Carrollton, Vi-it to, 373  
 Carter's Round-leaved Batavian Endive, 354  
 Catalpa Timber, 36, 339  
 Cause and Effect, 151  
*Cedrela sinensis*, 295  
*Celastus scandens*, 35  
 Celery Fly, Remedy for, 15  
 " Wild, 17  
 Cellar Floors, Lime for, 364  
 Cemeteries, Flowers in, 60  
 Centennial, Admission to the, 123  
 " Advisory Committee, Bureau Horticulture, 216  
 " England and the, 123  
 " Exhibition, 30, 63, 96, 190, 318  
 " Exhibition, Let us Profit by the, 312  
 " Flora at the, 219  
 " Fruits at the, 123  
 " " and Lodgings at the, 159  
 " Historical Calendar, 61  
 " Horticultural Department, 123  
 " Horticultural Judges at, 251  
 " Horticulture at, 251  
 " Hotel Rates at the, 123  
 " International Exhibition, 160, 221  
 " International Jury on Fruits 224  
 " Magnolia Tree, Our, 332  
 " Meehan's Arboretum at 338  
 " Ohio Fruit at, 352  
 " Rhododendrons, 258  
 " Roots Bulbs and Tubers at, 320

Centennial Rock Work, 356  
 " Stated Displays, 159  
 " Strawberries at, 160  
 " The Great, 159, 349  
 Cephalanthus occidentalis, 247  
 Charcoal, Dogwood, 147  
 Charter Oak, 25, 71, 91  
 Cherry, Barnhardt, 242  
 " Cornelian, 243  
 " and Plum Knot, 210  
 " Large Montmorency, 82  
 Cherries, California, Disease in, 358  
 Chestnut, Californian, 85  
 Chicago, Ellis Park, 94  
 Chickory Salads, 209  
 Chielanthus fragrans, 205  
 Chimonanthus fragrans, 70, 166  
 Chioceca racemosa, 38  
 Christmas Rose, 75  
 Chrysanthemums after Flowering, 265  
 Circulation of Hot Water, 361  
 Cities, Public Adornments of, 262  
 " Trees in, 35  
 Clapp's Favorite Pear, 82  
 Classification of Fruits, 271, 304  
 " Minute Fungi, 311  
 " the Apple, 143  
 Clematises, Raising, 72  
 Clematis ligusticifolia, 77  
 " New Double White, 200  
 Clover, Fertilization of, 153  
 Coal Tar, 105  
 Cocos nucifera, Coconut Palm, 311  
 Codling Moth, Fighting the, 208  
 Coffee, Hardiness of the, 44  
 Colens, Chamaleon, 11  
 Colorado Cabbage, 241  
 " Potato Beetle, Mite Parasites of, 279  
 Colored Plates, 284  
 Combretum, Culture of, 168  
 " grandiflorum, 108  
 Comet Peach, Billieu's, 14, 27  
 Coniferae, 198  
 Coulfers, Hardhood of, 34  
 " Variability of, 56  
 Conservatories, Aesthetics in, 8  
 Cope Alfred, Death of, 28  
 Corelopsis spicata, 6  
 Cork Oak in West Va., 146  
 " Tree, 118  
 " in the U.S., growth of, 115  
 Cornaceae, 196  
 Cornelian Cherry, 243  
 Correspondence, 2 to 26, 34 to 62, 66 to 95, 98 to 126, 130 to 158, 162 to 180, 193 to 213, 226 to 247, 258 to 284, 290 to 317, 322 to 341, 354 to 355, 358 to 364, 366 to 363, 370 to 374, 376  
 Corylaceae, 197  
 Corynolysis hybanthus albifolia, 245  
 Course of the Sap, 342  
 Covent Garden Market, Visit to, 109  
 Crab, Paul's Improved, 83  
 Crataegus pyracantha Hedges, 102  
 Criticism, 346  
 Cross Fertilization of Fruits, 58  
 " " " " 58  
 " Immediate Effects of, 23  
 Croton Culture, 369  
 " spiralis, 361  
 " undulatus, 268  
 " Weismanni, 301  
 Cucumber House, Heating a, 364  
 Cultivation of Ericas, 11  
 Culture, Asparagus, 174  
 " New, 111  
 " Combretum, of, 68

Culture, Croton, 369  
 " Fruit, 83  
 " Grape, 175  
 " Mushroom, 83  
 " Orchid, 188, 292  
 " Pitcher Plants, 322  
 " Plum, 52  
 " Poinsettia, 262  
 " Prunella sinensis, 264  
 " Small Fruits, Manual of, 189  
 " Trietelia laxa, 279  
 " Vanilla, 210  
 Cumberland Triumph Strawberry, 241  
 Cupheas, Standard, 269  
 Cureulio, Plum, 368  
 Currants, Standard, 269  
 Currant, Versailles, 209  
 Curves, 227, 284  
 Cut Flowers, 265  
 " Love of, 75  
 " Preserving, 36  
 Cut-leaved Sumach, 355  
 Cypress, White, 119  
 Dahlia gracilis, 37  
 " Maximiliana, 74, 164  
 Damages, reclaiming, 124  
 Daphniphyllum Roxburghii, 34  
 Darwin, Chas., 93, 153  
 " Age of, 188  
 De Candolle, Pronunciation of, 55  
 Decorative Plant, Ivy as a, 169  
 Decorators, Table, Hint to, 138  
 Delaware, Forest Trees of, 176  
 " Timber of, 147  
 Delphinium nudicaule, 102  
 Depth of Roots, 24  
 Destruction of Greenhouse Plants by Gas, 296  
 Destruction of the Rose Slug, 226  
 Deutzia crenata candidissima plena, 6  
 " gracilis, Forced, 137  
 " New Double, 134  
 Death of Alfred Cope, 28  
 " Dr. Hull, 28  
 " M. Louis Van Houtte, 248  
 Dietygonima japonica, 77  
 Diervilla, 121  
 Diseased Branches of Oaks and Maples, 210  
 " Geranium Leaves, 45  
 Disease, California Cherries, 368  
 " Gladiolus, 356  
 " Tomato, 368  
 " in Cabbage Plants, 243  
 " Evergreens, 38  
 " Larch, 22  
 " Palus, 11  
 " Violet Roots, 130  
 " Violets, 77  
 " Pear, 210  
 " Potato, 53  
 " Tomato, 90  
 Distant Lands, Views of, 370  
 Diurnal Opening of Flowers, 369  
 Dogwood Charcoal, 147  
 Don't use the Hatchet or Saw, 47  
 Double Clematis, White, 200  
 " Deutzia crenata, White, 201  
 " Lobelia, 11, 235  
 " Polyanthus, 296  
 Downing's Fruits, 2nd Appendix, 188  
 Dracenas, New Strain of, 6  
 Drainage Pot, 353  
 Drier's Lima Bean, 15  
 Drosera Roots and Water, 53  
 Drying White Flowers, 328  
 Duchess of Edinburg Rose, 193, 230, 330  
 Durand's Great American Strawberry, 242  
 Dwarf Apples, 16

Dye Mosses, Grasses and Flowers, How to, 169  
 E  
 Earliest Peaches, The Three, 50  
 " Peach, The, 336  
 Early Cabbages and Tomatoes, 81  
 " Peaches, 241, 242  
 Earth Blanching, 395  
 Echeverias for Bedding, 297  
 " Wintering, 5  
 Editorial, 19  
 " Notes, 4, 9, 15, 21, 27, 30, 35, 44, 50, 55, 59, 63, 70, 75, 80, 85, 88, 91, 100, 106, 111, 118, 120, 121, 127, 132, 136, 142, 147, 151, 154, 159, 166, 168, 178, 183, 186, 190, 199, 204, 208, 214, 215, 219, 240, 255, 210, 246, 248, 254, 232, 265, 272, 279, 283, 285, 293, 297, 303, 305, 310, 311, 313, 324, 328, 333, 338, 341, 345, 349, 353, 364, 368, 369, 374  
 Edgar Red Struck Apple, 80  
 Edgings, Garden, 101  
 " Festuca viridis for, 166  
 Effect, Cause and, 151  
 Egg Form, 156  
 Ekeagnae, 196  
 Eldred Cling Peach, 15  
 Ellis, John, 61  
 Elm, Insect Injury to, 133  
 " Slug, 230, 246  
 Elvira Grape, 346  
 Emblematic Description of the Passion Flower, 25  
 Endive, Carter's round-leaved Batavian, 334  
 England, American Apples in, 176  
 " at the Centennial, 128  
 " Foreign Fruits in, 111  
 " Paulownia in, 294  
 " Tulp Tree in, 5  
 English Maple, 148  
 " Nursery, First, 156  
 " Oak Timber, 85  
 " Peas, Large, 112  
 " Peas, The best, 82  
 " Sparrow, 69, 208  
 Environment, Adaptation to, 313  
 Ericas, Cultivation of, 11  
 Error, How propagated, 341  
 Errors, Typographical, 120, 374  
 Eskbank Bunch of Grapes, 334  
 Eucalyptus, Sub-hardy, 147  
 " Virtues of the, 86  
 Eucharis Amazonica, 75  
 Euonimus Americanus, 324  
 " flavescens, 325  
 Eupatorium ligustrinum, 136  
 Euphorbia jacquinetiflora, 10, 299  
 Europe, American Follage in, 294  
 " Grapes in, 333  
 Evergreens, 131  
 " Disease in, 38  
 " Rare in Maryland, 38  
 Evergreen, The, 125  
 Exchanges of Seeds and Plants, 284  
 Exhibition, Centennial, 30, 63, 96, 180, 318  
 Exhibition, Let us Profit by the, 312  
 Explorations in Japan, 155  
 F  
 Facts about Callas, A few 73  
 Failure of Camellias in Florida, 133  
 Failure of Paeonias, 133  
 Farmer's Home Journal, 157  
 Fern, New Variegated, 77

Ferns, Hybrid, 268  
 " Names of, 45  
 " Australian Tree, 347  
 Fertility, Re-isting Frost, 81  
 Fertilization of Campanula, 56  
 " Clover, 153  
 " Lilies, 184, 215  
 " Self of Plants, 344  
 Fertilizer, Human Hair as a, 113  
 " Strawberry, 15  
 Festivals, Ancient, Roses in, 315  
 Festuca viridis for Edgings, 166  
 Fighting the Codling Moth, 208  
 Figs, Preserving, 80  
 Filbert Nuts, Profit of, 81  
 Fire Blight in the Pear, 210, 335  
 Floral Decorations at Tunbridge Wells, 106  
 Flora at the Centennial, 219  
 " California, 218  
 " of Hokkaido, 180, 211, 244, 275  
 " Tropical at the Poles, 342  
 Florida, Camellias in, Failure of, 133  
 " Southern Trees of, 149  
 Florist and Pomologist, 284  
 Flower-beds, Gymothrix latifolia, a good centre plant for, 37  
 Flower Garden and Pleasure Ground—1, 33, 65, 97, 129, 161, 193, 225, 257, 289, 321, 353  
 Flower Pots, 137  
 " Machines for, 103  
 " Thieves, 283  
 Flowering, Chrysanthemums after, 265  
 " of Combretum grandiflorum, 108  
 " of Hoya carnosus, 236  
 " Paulownia in England, 294  
 Flowers, Bees and, 183  
 " Chas. Reade on, 313  
 " Cut, 265  
 " Diurnal Opening of, 369  
 " in Cemeteries, 60  
 " New York, 92  
 " Naming, for Persons, 324  
 " Prairie, 274, 309  
 " Vase of simple, 300  
 " White, Drying, 328  
 Font Grove Greenhouses, 314  
 Forced Deutzia gracilis, 137  
 " Fruit and Vegetables, 112  
 " Peaches, Profits of, 82  
 Foreign Rubarb, 304  
 " Roses, 244  
 " Tender Roses, 363  
 Forest Culture in Minnesota, 156  
 " Hill Cemetery, Utica, N. Y., 66, 373  
 " Trees of Delaware, 176  
 " Planting in Massachusetts, 35  
 Forestry—62, 84, 115, 146, 176, 305, 337  
 " Ass'n, American, 178, 305  
 " in Iowa, 85  
 " Work on, 87  
 Forests, German, 339  
 " Importance of, 200  
 " of Michigan, 84  
 " Rain-fall and, 369  
 " Sunken, 120  
 Forsyth, W., 348  
 France, Central Hort. Society of, 96  
 Fraxinus longispis, 37  
 Free and Cling-stone Peaches, 13  
 Freezing of Sap of Plants, 280  
 Fritularia ondica, 200



Fritillaria recurva, 200  
 Frost, Fertility Resisting, 81  
 Frozen Sap Blight—Pear Trees, 174  
 Fruit and Vegetable Gardening—12, 45, 78, 108, 139, 172, 205, 238, 268, 301, 331, 365  
 Fruit Buds, European Sparrow and, 50  
 " Culture, 83  
 " Growers Ass'n, Ontario, 253  
 " " Society, Penna., 32, 60, 94  
 " " Potomac, 126, 317, 376  
 " in Michigan, 332  
 " Ohio at Centennial, 352  
 " Prospects in Kentucky, 146  
 " Trees, Bark of, Management of the, 47  
 " Trees in Japan, Pruning, 335  
 " Variations, 309  
 Fruiting of Hickory Trees, 50  
 " " Pyrus japonica, 336  
 Fruits and Vegetables, Forced, 112  
 " at the Centennial, 128  
 " Classification of, 271, 304  
 " Cross-fertilization of, 58  
 " " Immediate effects, 23  
 " Foreign in England, 111  
 " Miscellaneous International Jury on, 224  
 " New, 16, 51, 82, 113, 145, 241, 275, 294  
 " Not s on, 331  
 " Patents for, 293, 314  
 Fuchsia, Lilac-flowered, 171  
 " Sun-ray, 205, 238, 365  
 Fuchsias, 137  
 " Winter-blooming, 75  
 Fungi, 58  
 " Classification of, Minute, 311  
 Fungus cracking the Pear, 23  
 " Rings-forming, 277  
 Furnaces, Greenhouse, 171, 232

G

Galveston, Gardeners at, 26  
 Garden Edgings, 101  
 " Kills and Cures in the, 291  
 " The, 125  
 " Varieties, Latin names for, 59  
 Gardeners at Galveston, 26  
 " Landscape, 290  
 " Monthly and Horticulturist, 19, 345  
 " Pleasing the, 132  
 Gardener, Test of a Good, 217  
 Gardening for Pleasure, 29  
 " Glories of, 162  
 Gardens. Botanic, 91  
 " of Germany, Note on, 198  
 " Private, about Baltimore, 92  
 " Wild, 36  
 Gas, Destruction of Greenhouse Plants by, 296  
 " Lime, 113  
 Gate, Automatic, 5  
 Gates, Self-opening, 79  
 Geranium, Happy Thought, 45  
 " Leaves, Diseased, 215  
 " Pyramid, 329  
 Geraniums and Orange and Lemon Trees, 103  
 " Bronze Bedding, Comparative value of, 330  
 " Hedge of, 70

German Forests, 339  
 Germantown Hort. Society, 95  
 Germany, Gardens of, 198  
 Genesee, Ill., Grass from, 215  
 Gilliflowers, Wallflowers and, 235  
 Glacietia tomentosa, 326  
 Gladioli for Winter, 362  
 Gladiolus Breuchleyensis, 330  
 " Cruentus, 37  
 " Disease, 356  
 " Pronunciation of, 29, 62  
 Glass, Rhododendrons under, 327  
 " Toughened, 23  
 Glories of Gardening, 162  
 Gloxinias, New Hybrid, 170  
 Golden Queen Grape, 80  
 " Yew, Original, 167  
 Good Old Strawberries, 50  
 Gooseberries, Standard, 269  
 " Trained, 50  
 " Training, 148  
 Gooseberry, Roe's Seedling, 240  
 Gould Nursery Co., Beaver Dam, Wis., 125  
 Grafted Rose Acacia, 322  
 Graft Hybrids, 306  
 Grafting, Do Persimmons Change by, 113  
 " Druble Camellias, 171  
 " the Feathery Weeping Cherry, 173  
 " Winter, of the Plum, 18  
 Grape Borders, 52  
 " Brighton, 336  
 " Culture, 175  
 " Elvira, 336  
 " Fungus, Australian, 56  
 " Golden Queen, 80  
 " Growing at Galveston Texas, 15  
 " Lady, 80  
 Grape, Mrs. Pince's Muscat, 367  
 " New, 337  
 " Phylloxera, 217  
 " " on the roots of, 17  
 " Vine Mildew, Notes on, 307  
 " Vine, Two Sets of Roots to, 111  
 " Vines, Water at the Roots of, 83  
 " Vines, Winter Production of, 367  
 Grapery, Moth in a, 336  
 Grapes, American, in Europe, 333  
 " at Boston, 363  
 " Eskbank, Bunch of, 334  
 " for a Cold Grapery, 17  
 " New, 332  
 " Preserving for Winter Use, 50  
 " Training and Mildew, 49  
 " Western, 368  
 Grass, Bermuda, 279  
 " from Genesee, Ill., 215  
 " New Agricultural, 151  
 " Orchards in, 303  
 " Rhode Island Bent, 67, 90  
 Grasses in Indiana, 132  
 Greenhouse and House Gardening—7, 39, 72, 103, 134, 168, 201, 232, 263, 295, 326  
 " Culture, Work on, 138  
 " Furnaces, 171, 232  
 " Plants, Soft-wooded, 266  
 " Destruction by Gas, 296  
 Greenhouses, Font Grove, 314  
 " Heating Small, 135  
 " Tar in, 42, 365  
 Growing, Peach, 142  
 " Plum, 18

Growing Poinsettia, 49  
 Growth of the Oak Tree in U. S., 115  
 " of Plants as affected by Latitude, 151  
 " of Timber Trees in Mass., Rapid, 149  
 " Rapidity of in Timber Trees, 23, 84  
 " Rate of, in the Oak, 119  
 " Slow Tree, 87  
 " Wood, Eccentricity of, 279  
 Grub, Strawberry, 333  
 Gum Trees, 86  
 " Wood, Australian, Value of, 86  
 Gun-barrel Budding, 196  
 Gymnothrix latifolia, a good Centre Plant, Flower-beds, 57

H

Hairs, Root, 213  
 Halesiaceae, 196  
 James Apple, 273  
 Hauner Peach, 241  
 Hand Book of Fruit Growers, 188  
 Hardihood of Conifers, 34  
 Hardiness of Aralia papyrifera, 70, 164  
 Hardiness of the Coffee, 44  
 " Silver Thorn, 356  
 Harding, W. T., 219  
 Hard Names, 118  
 Hardy Begonias, 36  
 " Herbaceous Plants for July and August, 261, 291  
 " Herbaceous Plants for October, 354  
 " Market Raspberry, 113  
 " Rhododendrons, 261  
 " Trees, New, 6  
 Harvard University, Botanic Garden of, 88  
 Hatchet or Saw, Don't Use, 47  
 Heat, Artificial, in Horticulture, 156  
 Heating, Hot Water, 44, 106  
 " Small Greenhouses, 135  
 " a Cucumber House, 364  
 Hedge of Geraniums, 70  
 Hedges, Crataegus pyracantha, 102  
 " Pyracantha, 356  
 " Silver Thorn and Pyracantha, 293  
 Hemlock in Limestone Soils, 230  
 Hickories, Planting, 50  
 Hickory Trees, Planting, 50  
 Highland Hardy Raspberry, 17, 83  
 Hints, Seasonable, 17, 12, 33, 39, 45, 65, 72, 78, 97, 103, 108, 129, 134, 139, 161, 193, 201, 205, 225, 232, 238, 259, 263, 268, 289, 295, 301, 321, 326, 331, 354, 357, 365  
 Hint to Table Decorators, 138  
 History, A Piece of, 19  
 " of the Catalpa, 339  
 " " Double Lobelia, 235  
 Hokkaido, Flora of, 180, 211, 244, 275  
 Hollyhock, 70  
 Home, A Happy, 226  
 Hoopes' Book of Evergreens, 217  
 Hoopes, Bro. & Thomas, 125  
 Horticultural Department of Centennial, 128  
 " Judges at the Centennial, 251  
 " Societies, 30, 62, 94, 126, 157, 190, 219, 254, 284, 316, 349  
 " Societies, Attractions at, 160

Horticultural Societies, State, Winter Meetings, 32  
 " Society, Alton, Ill., 96  
 " " Central, of France, 96  
 " " Germantown Phila., 95  
 " " Indiana, 187  
 " " Kansas State, 62, 95  
 " " Maryland, 160  
 " " Massachusetts, 96, 124, 127, 284  
 " " Minnesota, 127, 252  
 " " New Jersey, 252  
 " " N. York, 32, 127, 287  
 " " Northern Iowa, 158  
 " " Ohio, 348  
 " " Pennsylvania, 319  
 " " Royal, 160  
 " " S. E. Kansas, 157  
 " " Western N. Y., 96, 123  
 " " Wisconsin, 315  
 " " Worcester, Mass., 348  
 Horticulture, Artificial Heat in, 156  
 " at Centennial, 254, 285  
 " in New Orleans, 121  
 " Postal Laws as Affecting, 283  
 Horticulturists, Belgium honors, 252  
 Horticulturist, The, 92  
 Hotel Rates at the Centennial, 128  
 Hot-Water Heating, 44, 106  
 " Circulation of, 364  
 Hovey & Co.'s Arboretum  
 " Americanum, 194, 258  
 Hovey, C. M., Mr., 375  
 How Error is Propagated, 341  
 Hoya carnosia, Flowering of, 236  
 Huckleberries, 174  
 Hull, Dr., Death of, 28  
 Human Hair as a Fertilizer, 113  
 Hunnewells, Mr., Rhododendron Show, 233  
 Hyacinth, Proliferous, 167  
 Hyacinths Making Short Stems To Prevent, 236  
 Hybrid Ferns, 268  
 " Penstemons, 295  
 Hybrids, About, 216  
 " Graft, 306  
 " Peach and Apricot, 214  
 Hydrangea, Thos. Hogg, 295<sup>7</sup>  
 364

I

Iceing Watermelon, The, 47  
 Igenfritz, I. E., 348  
 Imperfect Reports, 208  
 Importance of Fruits, 200  
 Improved Petunias, 71  
 Indiana, Grasses for 132  
 " Geological Survey of, 375  
 " Horticultural Society, 187  
 Insect Injury to the Elm, 133  
 Insects, both Night and Day-flyers, 215  
 " Manure and Strawberry, 273  
 International Hort. Exhibition Amsterdam, 316

Iowa, Forestry in, 85  
 " Tree Growth in, Ratio of, 189  
 " Wedding in, 59  
 Ivy as a Decorative Plant, 168  
 " Australian or Parlor, 168

## J

Japan, Explorations in, 155  
 " Fruit Trees in, Pruning, 335  
 " Persimmon, 335  
 Jasminum nudiflorum, 190  
 Judas Tree, 314  
 Juglandaceae, 197  
 July, Hardy Herbaceous Plants for, 231  
 June Budding Peach Trees in Texas, 868  
 " Peach Budding, 79, 111

## K

Kalmias for Winter-blooming, 204  
 Kansas Agricultural Rep., 93, 315  
 " State Hort. Society, 62, 95  
 Kentucky, Fruit Prospects in, 136  
 Kew Gardens, visitors to, 234  
 Killing the Mealy Bug, 236  
 Kills and Cures in the Garden, 291

## L

Laburnum, Poisoning by, 310  
 Lady Apple, 111  
 " Grape, 80  
 Lakes, Rainfall and the, 310, 341  
 Landreth, Burnet, 183  
 Landreth's Rural Register, 61  
 Landscape Gardening, 226, 284  
 " Gardeners, 299  
 Language of Flowers, 156  
 Lantana, New Variegated, 107  
 " Variegated, 198  
 Lantanas, Large Keeping, 301  
 Larch, Disease in, 22  
 " Timber, 119  
 Large Lemons, 324  
 Lauraceae, 193  
 Law of Purchasing Plants, 27  
 Laws for Nurserymen, 215, 247, 312  
 " Postal, 345  
 " in Horticulture, 283  
 Leche's Nuts, 213  
 Leguminaceae, 195  
 Lemon and Orange Trees and Geraniums, 103  
 " Verbena, 2-3  
 Lemnons, Large, 324  
 Lettuce Mould, 80  
 Liatris pycnostachya, 263, 294, 321  
 Life Histories of Birds, 253  
 Ligustrum coriacaum, 133  
 Light-colored Fuchsia, 171  
 Lilies, 227, 230  
 " Fertilization of, 134, 215  
 " of the valley, 45  
 Lilium auratum, 230  
 " " Double-flowered, 325  
 " Parkumani, 132  
 Lima Bean, Dreer's, 15  
 Lime and the Potato Beetle, 368  
 " Floors, 167  
 " Gas, 113  
 " Oyster Shell, 83  
 Limestone Soils, Hemlock in, 230  
 Linnaea borealis, 216  
 Linseed Oil for Pear Blight, 240  
 Literature, Travels and Personal Notes, 26, 59, 91, 121, 154, 186, 215, 247, 280, 345, 370  
 Lobelia, Double, 11, 235  
 Locust Tree Slug, 339

Lond in Garden, 61  
 Louisiana as it is, 375  
 Lucy Grieve Pear, 16

## M

Maackia amurensis, 6  
 Machines for Flower Pots, 193  
 Madleya Yedoensis, 107  
 Magnolia Campbelli, 37  
 " Tree, Our Centennial, 322  
 Magnoliaceae, 195  
 Mammoth Rose Tree, 37  
 Management of the Bark of Fruit Trees, 47  
 Mandarin Orange, 82  
 Manor Born, 155  
 Manual of Small Fruits, 156  
 Maure and Strawberry Insects, 273  
 " Tobacco as, 11, 54  
 Maple, English, 118  
 " Purple-leaved, 133  
 " Weir's Cut leaved, Silver, 321  
 Maples, Diseases of Branches in, 200  
 Marechal Niel Rose, How Grows, 199  
 " " " Pink, 266  
 Marshall Pear, 51  
 Maryland Early Peach, 273  
 " Horticultural Society, 160  
 " Rare Evergreens in, 38  
 Massachusetts, Apple Crop in, 301  
 " Forest Planting in, 35  
 " Hort. Society, 96, 124, 217, 284  
 " Rapid Growth of Timber Trees in, 149  
 " Tree Planting in, 117  
 Mealy Bug, Killing the, 236  
 Meehan's Arboretum at the Centennial, 338  
 Mexican Ever-bearing Strawberry, 112  
 Michigan Agricultural College  
 " Catalogue, 318  
 " Forests of, 84  
 " Fruit in, 332  
 Midwinter, Tuberoses in, 293  
 Mignonette, 391  
 " Victoria, 167  
 Mildew, Grape Vines, Notes on, 307  
 Miller and Sievers, 347  
 Mill Stone, The, 189  
 Minnesota Hort. Society, 127, 252  
 Miscellaneous Publications, 156  
 Mississippi, Peach Raising in, 142  
 Mistletoe, 70  
 Montmorency Cherry, Large, 82  
 Moore, D. D., T. 218  
 Motion of Tendrils, 151  
 Moth in a Grapery, 336  
 Muhlenberg, Dr., Letter of, 154  
 Mushroom Culture, 83  
 Mushrooms, 110  
 " Twin, 151  
 " Subscriber on, 123  
 Mustangum Pear, 368  
 Myrsiphyllum asparagoides, 74

## N

Name of Plant, 136  
 " Plants for, 90  
 Naming Flowers for Persons, 324  
 Names, Botanical, Orthography of, 341  
 " Hard, 118  
 " of Ferns, 45  
 " Plants, 58, 107, 357  
 " " Common, 153

Names of Varieties, 132  
 " Vernacular, 341  
 Natural History and Science—21, 52, 87, 119, 149, 189, 211, 244, 274, 306, 334, 339  
 " Peach Stones, 176  
 Nectarine Produced from a Peach, 272  
 Neunzehnter Jahres-Bericht des Gartenbau-Vereins für Bremen, 187  
 New Agricultural Grass, 151  
 " Ampelopsis, 309  
 " Apples, 142  
 " California Plants, 183  
 " Candidate, Not a, 92  
 " Coniferous Tree—Abies macrocarpa, 21  
 " Double Deutzia, 134  
 " Ivy-leaved Pelargonium, König Albert, 267  
 " Double White Clematis, 209  
 " Double Zonale pelargonium, Wonderful, 236  
 " Early Peaches, 18  
 " Enemy, Has the Pear an, 302  
 " Flower, Agave Virginica, 27  
 " New French Pears, Two, 83  
 " Fruits and Vegetables—16, 51, 82, 113, 145, 241, 273, 294  
 " Fruits, Notes on, 331  
 " Golden Poplar, 326  
 " Grapes, 332, 337  
 " Hardy Tree, Cedrela sinensis, 295  
 " Hardy Trees, 6  
 " Hybrid glorioxias, 170  
 " Jersey, A few Apples that do Well in, 172  
 " Hort. Society, 252  
 " " Southeastern, Apples for, 18  
 " Orleans, Horticulture in, 121  
 " Palm, The, 364  
 " Plants—5, 10, 37, 71, 102, 107, 132, 167, 170, 200, 265, 218, 230, 236, 266, 325, 356  
 " Plants and Fruits, Patents for, 293  
 " " Colorado and California, 55  
 " South, The, 318  
 " Strain of Dracaena, 6  
 " Tea Rose, Duchess of Edinburgh, 230  
 " Trees, 295  
 " Varied Fern, 77  
 " " Lantana, 107  
 " Violet, Prince Consort, 325  
 " York, Flowers in, 92  
 " Hort. Society, 32, 127, 287  
 Non-nodulose, 183  
 Norman Strawberry, 145  
 Norris, Jno. T., 138  
 Northampton Apple, 16  
 Northern Iowa Hort. Society, 158  
 Notes from Tennessee, 332  
 " on a Summer's Tour, 42  
 " " The Grounds of Smith & Powell, Syracuse, N. Y., 280  
 Nursery Business, Organization of the, 96  
 " First English, 156  
 " Stock, American, low price of, 59  
 Nurserymen, American, Meeting of, 127  
 " and Tree Planters, 178  
 " and Tree Growers Ass'n., 287  
 " Laws for, 215, 247, 312  
 Nuts, Leche, 243

Nut Tree, Sicilian, 367  
 Nymphaea caerulea, 235

## O

Oak, Charter, 25, 71, 91  
 " Cork, in West Va., 146  
 " Live, 100  
 " Rate of Growth in the, 119  
 Oaks, Diseased Branches on, 209  
 Obituary, 23, 248  
 Observations in Northern Texas, 232  
 October, Hardy Herbaceous Plants for, 354  
 Odontoglossum cirrhosum, 203  
 Ohio Fruit at the Centennial, 352  
 " Horticultural Society, 348  
 " Plum Culture in, 209  
 Oleaceae, 196  
 Oleanders, Seal on, 139  
 Olea fragrans, 45  
 Olive Radish, Early, 112  
 Onion, Analysis of, 333  
 " and Seed Growing in California, 239  
 " Seed, California, 337  
 Ontario, Fruit Growers' Association, 253  
 Orange and Lemon Trees and Geraniums, 103  
 " Growing, Profits of, 112  
 " Mandarin, 82  
 Oranges, Avenue of, 70  
 " Treatment of, 9  
 Orchard of G. Zimmerman, 303  
 Orchards in Grass, 303  
 Orchid Culture, 188, 202  
 Orchid-, 315  
 " Money Value of, 204  
 " Rand's Book on, 213  
 Origin of Sericulture, 147  
 Ornamental Deciduous Trees, Hovey's, 194  
 " Grounds, Who shall lay Out, 164  
 Osage Orange Timber, 113  
 Osmundia cinnamomea, 151  
 Othelia japonica, 6  
 Othonia crassifolia, 107  
 Oyster shell Lime, 83  
 Ozone, 151

## P

Packing Paper, Waterproof, 4  
 Paeonias, Failure of, 133  
 Palm, Coconut, 311  
 " The New, 364  
 Palms, Disease in, 11  
 " of Southern California, 215  
 " on Palm Sunday, 251  
 Paneratum rotatum, 133  
 Pansies, White Bedding, 325  
 Parks in Boston, 199  
 " Public, 293  
 Parry, Dr. C. C., 27  
 Passion Flower, Emblematic Description of, 25  
 Patents for New Plants and Fruits, 293, 314  
 Paul's Improved Crab Apple, 83  
 Paulownia in England, Flowering of, 294  
 Peach, Alexander, 145, 272  
 " Amsted, 272  
 " and Apricot Hybrids, 214  
 " Billieu's Comet, 14, 27, 140  
 " Bird, 240  
 " Black's Early, 83  
 " Briggs' Red May, 145, 241  
 " Budding, June, 79, 111  
 " Earliest, 336  
 " Eldred Cling, 15  
 " Growing, 142  
 " Hammer, 241  
 " Maryland Early, 273  
 " Nectarine Produced from, 272

- Peach Raising in Mississippi, 142  
 " Seedlings, 114  
 " Stones, Natural, 175  
 " Trees in Texas, June Budding, 368  
 " Wilder, 82  
 " Yellow, 211  
 Peaches, Blodgett's Seedling, 331  
 " Early, 241, 242  
 " Free and Clingstone, 13  
 " New Early, The, 18  
 " Profits of Forcing, 82  
 " Three Earliest, 50  
 Pea, Dr. McLean, 83  
 " Tree, Siberian, 354  
 Peas, Best English, 82  
 Pear, a New Enemy, Has the 302  
 " Blight, Linsced Oil for, 24  
 " Clapp's Favorite, 82  
 " Disease, 210  
 " Fire Blight in the, 210, 335  
 " Fungus Cracking the, 23  
 " Lucy Grieve, 16  
 " Marshall, 51  
 " Muskingum, 368  
 " or Apple, Which? 245  
 " Orchard, Dr. Boynton's, 304  
 " Pitmaston Duchess, 115  
 " Pyrus communis, 56  
 " Slug, 146  
 " How to Destroy, 206  
 " Souvenir du Congres, 83  
 " Trees and Underdrain- ing 210  
 " " Frozen Sap Blight, 174  
 " Wilder, 50  
 Pears, Brockworth Park and Bonne d'Ezee, 82  
 " French, Two New, 83  
 " Influence of Stock on, 334  
 " Large English, 112  
 Peasgood's Nonsuch Apple, 301  
 Peccan, The, 118  
 Peerless Rose, 136  
 Pelargonium Konig Albert, New Double Ivy leaved 267  
 " Wonderful, New Double Zonale, 236  
 Pellæ ornithopus, 325  
 Penna. Fruit Growers' Society, 32, 60, 94  
 " Hortical Society, 319  
 Pentstemon heterophyllus, 356  
 " humilis, 6  
 " Palmieri, 71, 356  
 Pentstemons Hybrid, 295  
 Peraphyllum ramosissimum, 167  
 Persimmon, Japan, 336  
 " Seedless, 19  
 " Change by Graft- ing, Do, 113  
 Personal, 27  
 Petition, 16  
 Petunias, Improved, 71  
 Philadelphia Belles, Bouquets of the, 265  
 Phonetic Magazine, 156  
 Phormium Colensi variegatum 295  
 Phylloxera, 120  
 " Grape, 217  
 " on the Roots of Grape, 17  
 Physalis edulis, 283  
 Physanthus albanus, 5  
 Picea Parsoniana, 83, 357  
 Pince's Mrs, Muscat Grape, 367  
 Pine, Umbrella, 70  
 Pinks, Carnation, 98  
 " Remontant, 98  
 " Summer-flowering, 168  
 Pinus aristata, 55  
 " cembra, 36  
 Pitcher Plants, Culture of, 322  
 Pitmaston Duchesse Pear, 145  
 Pittosporum tobira, 264  
 Plant House at the Agricul- tural College, 136  
 " Name of, 136  
 " Selling at Amherst Col- lege, 136  
 Planting Hickories, 50  
 " Pyrus coronaria, Plea for, 2  
 Plants, Common Names of, 155  
 " for Name, 90  
 " Freezing of the Sap of, 280  
 " Growth of, as affected by Latitude, 151  
 " Hardy Herbaceous, for July, Aug., & Oct., 261, 291, 354  
 " Law of Purchasing, 27  
 " Names of, 58, 107, 357  
 " Need Water, Do, 22, 52  
 " New, 218  
 " " California, 183  
 " " and Colorado, 55  
 " Self-fertilization of, 344  
 " Silver-leaved, 10  
 " Soft wooded Green- house, 256  
 " Warfare of, on one an- other, 343  
 " Where, can be Pur- chased, 59  
 Pleasing the Gardeners, 132  
 Plinian Names, 57  
 Plum, 375  
 " and Cherry Knot, 210  
 " Culture, 52  
 " " in Ohio, 219  
 " " Progress of, 207  
 " Curculios, 368  
 " Growing, 18  
 " Richland, 242, 305  
 " Trees, 1 000 acres in 3 years, 207  
 " Wild Goose, 81, 175, 239, 303, 304  
 " Winter Grafting of the, 18  
 Plums, Species of American, 57  
 Poinsettia, 138  
 " Culture, 202  
 " " Growing the, 40  
 Poisoning by Laburnum, 310  
 " Rhus, 26  
 Poison Vine, 152  
 Poles, Tropical Flora at the, 342  
 Pollen, Mixing Potatoes by, 90  
 Polyanthus, Double, 296  
 Polygonum amphibium for Tanners, 211  
 Pomegranate, 166  
 " and Vine, Early History of, 348  
 Pomological Report, Interna- tional Exhibition, 221  
 Pomological Society, Ameri- can, 32, 186, 218  
 Poplar, New Golden, 326  
 Poplars, Carolina, 86  
 Populus canadensis, 280  
 Postal Laws, 345  
 " as Affecting Horti- culture, 283  
 " on Seeds and Plants, 156  
 Potato Beetle, Lime and the, 368  
 " " Mite Parasites of, 279  
 " Disease, 53  
 " Fungus Resting Spores of, 84  
 " Rot, 87  
 Potatoes, American, in England 82  
 " " Seedling, 111  
 Potato Mixing by Pollen, 90  
 Pot Drainage, 358  
 Potomac Fruit Growers, 126, 317, 376  
 Pots, Flower, 137  
 Pottsville, Pa., 59  
 Practical Farmer, 61  
 Prairie Flowers, 274, 309  
 Preparing Timber, 35  
 Preserving Cut-flowers, 136  
 " Figs, 80  
 " Grapes for Winter Use, 50  
 Primula sinensis, Culture of, 264  
 Pritchardia filifera, 361  
 Prizes for Tree-planting, 178  
 Profitable Bee-keeping, 15  
 Profit of Filbert Nuts, 81  
 Profits of Forced Peaches, 82  
 " Orange-growing, 112  
 " Tree-planting, 179  
 Proliferous Hyacinth, 167  
 Pronunciation of Botanical Names, 152  
 " " De Candolle 55  
 " " Gladiolus, 29, 62  
 Propagating Begonias, 77  
 " Roses, 170  
 Protecting Trees from Rabbits and Mice, 82  
 Protection from Tree Thieves, 253  
 Prouty's Strawberry, 242  
 Pruning Fruit Trees in Japan, 335  
 Prune Shrubs, Time to, and other Hints, 100  
 Public Parks, 291  
 Purple-leaved Maple, 133  
 Pyracantha Hedges, 356  
 " " Silver Thorn and, 293  
 " " japonica, 6  
 Pyracanthas, Standard, 137  
 Pyrus communis, 56  
 " coronaria, A Plea for Planting, 2  
 " japonica, Fruiting of, 336  
 " malus, 56  
 Q  
 Quercus, 11, 16, 24, 29, 38, 45, 52, 58, 62, 71, 77, 83, 87, 90, 102, 107, 113, 119, 121, 133, 138, 145, 152, 167, 171, 176, 200, 205, 210, 215, 230, 236, 247, 253, 263, 268, 280, 284, 301, 304, 311, 315, 330, 335, 344, 352, 356, 364  
 Quercus Andersonii, 295  
 " fastigiata, 167  
 " virens, 100  
 R  
 Radish, Early Olive, 112  
 Rainfall, Forest and, 369  
 " Trees, Lakes and, 310, 341  
 Rain, Utilizing the, 35  
 Raising Clematites, 72  
 Rare Evergreens in Maryland, 33  
 Raspberries from Mr. Roe, 272  
 " Hardy Market, 113  
 " Highland Hardy, 17, 83  
 " Snyder, 208  
 " Southern Red, 80  
 " Thornless 242  
 " Thwack, 113, 303, 345  
 Rattan Trellis, 70  
 Reade, Chas., on Flowers, 313  
 Reclaiming Damages, 124  
 Red-fleshed Apple, 18  
 Remedy for Ants, 364  
 " Celery Fly, 15  
 Remontant Plunks, 93  
 Reports, Imperfect, 208  
 Re-printing the 1st Vol., 62  
 Responsibility of Seedsmen, 59  
 Resting Spores of Potato Fun- gus, 54  
 Retinospora leptoclada 295  
 Revue de l'Horticulture, Belge, 157  
 Rhamnaceæ, 196  
 Rhode Island Bent Grass, 67, 90, 93  
 Rhododendron and American Yew, 259  
 " Arborem 131  
 " Show, Mr. Hun- newell's 233  
 Rhododendrons, 259, 262, 290  
 " and Roses, 230  
 " Centennial, 258  
 " Hardy, 261  
 " Under Glass, 327  
 Rhubarb, Forcing, 304  
 Rhus paniciformis, 37  
 " Poisoning by, 26  
 " Rufa, 37  
 Rhynchospermum jasminoides, 364  
 Richardia alba maculata, 75  
 " (Calla) Æthiopia, 136  
 Richland Plum, 242, 305  
 Ring-forming Fungus, 277  
 Rocky Mountain Silver Spruce, 25, 72, 121, 152  
 Roe's Seedling Gooseberry, 240  
 Rofia fibers, 55  
 Romneya Coulteri, 102  
 Root Cap, Th., 119  
 Root Hairs, 213  
 Rootlets, Annual, 186  
 Roots, Bulbs, and Tubers at the Centennial, 320  
 " Depth of, 24  
 " Drosera, and Water, 58  
 " Two Sets to a Grape- vine, 111  
 Rosaceæ, 196  
 Rose, Acacia, Grafted, 3.2  
 " Christmas, 75  
 " Duchess of Edinburg, 193, 230, 330  
 " Marechal Niel, How Grows, 199  
 " Peerless 136, Pink, 266  
 " Pink 266  
 " Pot, A Fine, 75  
 " Slug, Disstructure of the, 226  
 " Tea, for Market Purposes, A Good 167  
 " " (Niphotos) for Cut- ting, 138  
 " Tree, Mammoth, 37  
 Roses and Rhododendrons, 230  
 " An Election for, 35  
 " Button-hole, 9  
 " Forcing, 234  
 " for Winter Buds, 44  
 " in Ancient Festivals, 315  
 " Propagating, 170  
 " Tea in Winter, Protec- tion of, 263  
 " Ten-Jer, Forcing, 363  
 Rot, P-tato, 87  
 Royal Bouquets, 136,  
 " Horticultural Society, 160  
 Rubus roseifolius, 77  
 Rudgea macrophylla, 266  
 Rural Journal, 61  
 " New Yorker, 190  
 Russian Timber, 118  
 Rust, Verbena, Remedy for, 153, 264, 327  
 S  
 Sage, Variegated, 75  
 Salads, Chickory, 269  
 Saliacæ, 197  
 Santalacæ, 195  
 Sap, Course of the, 342  
 " of Plants, Freezing, 290  
 Sapidacæ, 195

- Saracenia Drummondii, 323  
 Sargent's Mr., Azalea Show, 233  
 Sargent, Prof. C. S., on Tree Planting, 123  
 Satterthwait, Edwin, 93  
 Saxifraga Huetii, 11  
 Scale, Linseed Oil for, 271  
 " on Oleanders, 139  
 Schizostylus coccinea, 101  
 Sciadopitys verticillata, 70, 355  
 Scientific Monthly, 29  
 Seed and Onion Growing in California, 239  
 " Lawn from, 230  
 " Thorn, Raising, 38  
 " Verbenas from, 10  
 " Vitality of, 342  
 Seeding of Aracarea excelsa, 297  
 " the Trailing Arbutus, 279  
 Seedless Persimmon, 19  
 Seedling Peaches, Blodgett's, 331  
 " Strawberry, 242  
 Seedlings, Peach, 114  
 Seeds and Plants, Postal Laws on, 156  
 " Exchanges of, 284  
 " from Male Plants of Aucubas, 211  
 " 2000 Years Old, Growing, 344  
 Seedsmen, Responsibility of, 59  
 Self-fertilization of Plants, 344  
 Self-opening Gate, 79  
 Sericulture, Origin of, 147  
 Seubertia laxa, 329  
 Shepherd's Manual, 156  
 Shrubs of Southern Utah, Beautiful, 164  
 " Time to Prune and other Hints, 100  
 Siberian Pea Tree, 354  
 Sicilian Nut Tree, 367  
 Silver leaved Plants, 10  
 " Thorn, Hardiness of the, 356  
 " " and Pyracantha, Hedges, 293  
 Slug, Elm, 230, 246  
 " Locust Tree, 339  
 " Pear, 146  
 " " How to Destroy, 206  
 " Rose, 226  
 Smith & Powell, Notes on Grounds of, 280  
 Smith's Pres. Lincoln Strawberry, 242  
 Snyder Raspberry, 208  
 Sour red Sweet Apple, 308  
 South-eastern Kansas Hort. Society, 157  
 Southern Red Raspberry, 80  
 " Thornless Raspberry, 242  
 " State's Agricultural and Industrial Exhibition, 63  
 " Utah, Beautiful Shrubs of, 164  
 Souvenir du Congres Pear, 83  
 Sparrow, English, 69, 208  
 " European, and the Fruit Buds, 50  
 Species of American Plums, 57  
 Spiraea palmata, 102  
 " sorbifolia, 36  
 Spontaneous Combustion, 88  
 Spruce, Black, 86  
 " Rocky Mountain Silver, 25, 72, 121, 152  
 " Weeping Hemlock, 132  
 Standard curcups, 328  
 " Currants and Gooseberries, 269  
 " Pyracantha, 137  
 State Horticultural Societies, Winter Meeting of, 32  
 States, Confederate, 375  
 Stems, Short, To Prevent Hyacinths Making, 236  
 Sterling Strawberries, 113, 145  
 Stock, Influence of the, on Pears, 334  
 Strawberries at the Centennial, 160  
 " Good old, 50  
 Strawberry, Cumberland Triumph, 241  
 " Durand's Great American, 242  
 " Fertilizer, 15  
 " Grower at Boulder, Colorado, 273  
 " Grub, 333  
 " Insects, Manure and, 273  
 " Mexican Ever-bearing, 142  
 " Norman, 145  
 " Prouty's, 242  
 " Seedling, 242  
 " Smith's Pres. Lincoln, 242  
 " Sterling, 113, 145  
 " White Alpine, 242  
 Stropholirion Californicum, 71  
 Strax japonica, 6  
 Sub-hardy Eucalyptus, 147  
 Substitutes for Wood, 178  
 Sumach, Cut-leaved, 355  
 Summer-Flowering Pinks, 168  
 " Hagloe Apple, 303  
 " Treatment of Camellias, 171  
 Summer's Tour, Notes on a, 42  
 Sunken Forests, 120  
 Sun-ray Fuchsia, 205, 268, 365
- T**
- Tacsonia insignis, 44  
 Tamarix plumosa, 37  
 Tannin Plant, Western, 280  
 Tanners, Polygonum amphibium for, 211  
 Tar, Coal, 105  
 " in Greenhouses, 42, 365  
 Taxacea, 198  
 Tea Rose, Niphetos, for Cutting, 139  
 Tendrils, Effect of Weight on, 184  
 " Motion of, 151  
 Tennessee, Notes from, 332  
 Texas, Geological Survey of, 217  
 " Grape Growing at Galveston, 13  
 " June Budding Peach Trees in, 368  
 " Northern, Observations in, 282  
 Text Book of Scientific Agriculture, 61  
 Thanks, 28  
 That Little Turk, 48  
 Thieves, Flower, 283  
 Thomas Hogg, Hydrangea, 295  
 Thorn Seed, Raising, 38  
 Thwack Raspberry, 113, 303, 345  
 Tilia, 195  
 Timber, Catalpa, 86, 339,  
 " English Oak, 15  
 " of Delaware, 146  
 " Larch, 119  
 " Osage Orange, 118  
 " Preparing, 35  
 " Russian, 119  
 " Trees in Mass., Rapid Growth of, 149  
 " " Rapidity of Growth in, 23, 84  
 Tobacco as Manure, 11, 54  
 Tomato, 346  
 " Disease, 90, 368  
 Tomatoes, Early, 81  
 Toughened Glass, 23  
 Trained Gooseberries, 50  
 Training and Mildew, Grapes, 49  
 " Gooseberries, 141  
 Treatment of Oranges, 9  
 Tree, Bay, 375  
 Tree, Cork, 115, 118  
 " Growth in Iowa, Ratio of, 180  
 " " Slow, 87  
 " Growers' Ass'n, Nurserymen and, 287  
 " Judas, 314  
 " New Hardy, Cedrela sinensis, 293  
 " Planters, Nurserymen and, 178  
 " Planting, 339  
 " " A few Suggestions on, 123  
 " " Argument for, 148  
 " " in Mass., 147  
 " " Prizes for, 178  
 " " Profits of, 179  
 " Thieves, Protection from, 253  
 Trees, Age of Mammoth, 310  
 " for Nothing, 92  
 " Gum, 86  
 " in Cities, 35  
 " New, 295  
 " " Hardy, 6  
 " of Southern Florida, 149  
 " Protecting, from Rabbits and Mice, 82  
 " Rainfall and the Lakes, 310  
 Trellis, Rattan, 70  
 Trietelia laxa, 278, 339  
 Tropical Flora at the Poles, 342  
 Tuberoses, American, 348  
 " in Midwinter, 298  
 Tulipa Greigi, 356  
 " Tree in England, 5  
 Typographical Errors, 120, 371  
 Twin Mushroom, 151
- U**
- Ulmaceae, 196  
 Umbrella Pine, 70  
 Underdraining and Pear Trees, 210  
 Unhealthy Camellias, 75  
 Utica, N. Y., Forest Hill Cemetery, 66, 373  
 Utilizing the Rain, 55
- V**
- Valentine Bean, 375  
 Value of Australian Gum Wood, 86  
 " Bronze Bedding Geraniums, 330  
 " Orchids, 204  
 Van Houtte, Death of, 248  
 " " Habits of, 315  
 " " Monument to, 315  
 Vanilla Culture, 210  
 Variability of Conifers, 55  
 Variation in Apples, 52  
 Variations, Fruit, 309  
 Variegated Lantana, 108  
 " Sage, 75  
 Varieties, Names of, 132  
 Vase of Simple Flowers, 300  
 Vegetables, Fruits and, Forced, 112  
 Verbena, Lemon, 283  
 " Rust, Remedy for, 153, 264, 327  
 Verbenas from Seed, 10  
 Vernacular Names, 341  
 Versailles Currant, 269  
 Viburnum Awafuki, 37  
 " plicatum, 295  
 Vick's Flower and Vegetable Garden, 61  
 Victoria Mignonette, 167  
 Views of Distant Lands, 330  
 Vine and Pomegranate, Early History of, 348  
 Violet, Prince Consort, Mr. Lee's New 325  
 " roots, Disease in, 130  
 " Victoria Regina, 45, 76  
 " Yellow, 134  
 Violets, 362  
 " Disease in, 77  
 " for Winter Blooming, 265
- Virtues of the Eucalyptus, 86  
 Visit to Carrollton, 373  
 Visitors to Kew Gardens, 284  
 Vitality of Seed, 342
- W**
- Waban Greenhouses of E. A. Wood & Co., 93  
 Walbridge Apple, 80  
 Wallflowers and Gilliflowers, 235  
 Walnut, Black, 13  
 Warder, Dr., at Centennial, 159  
 Warfare of Plants on one another, 343  
 Washington's Garden, Box in, 155  
 Water at the Roots of Grape Vines, 85  
 " Do Plants Need, 22, 52  
 " Melon, The Icing, 47  
 " Proof Packing-paper, 4  
 Wealthy Apple Tree, 145  
 Webster, David, 61  
 Weeping Cherry, Grafting, 173  
 " Hemlock Spruce, 192  
 " Willow, Female, 25  
 Weigela amabilis, Loomansi aurea, 324  
 " Lavallei, 6  
 Weight on Tendrils, Effect of, 184  
 Western Grapes, 368  
 " N. Y. Hort. Society, 96, 123  
 " Tannin Plant, 280  
 West Va., Cork Oak in, 146  
 Wheel Hoe, Becroft's, 4  
 White Alpine Strawberry, 242  
 " Cypress, 119  
 " Bedding Pansies, 325  
 Who shall lay out our Ornamental Grounds, 164  
 Wier's Cut-leaved Silver Maple, 324  
 Wild Celery, 17  
 " Gardens, 36  
 " Goose Plum, 31, 172, 175, 239, 303, 304  
 Wilder, Col. 187, 348  
 " Peach, 82  
 " Pear, 50  
 Williams' Pacific Tourist and Guide, 253  
 Willow, Female Weeping, 25  
 Wine, Art of Making, 208  
 Winter-blooming Fuchsias, 75  
 " Kalmias for, 204  
 " Violets for, 265  
 Winter Buds, Roses for, 44  
 Winter-flowering Carnations and Bouvardias, 298  
 Winter, Gladioli for, 362  
 " Protection of Grape Vines, 367  
 " Tea Roses in, Protection of, 263  
 Wintering Echeverias, 5  
 Wisconsin Hort. Society, 315  
 Wistaria macrobotrys, 37  
 Wood Growth, Eccentricity of, 279  
 " Substitute for, 178  
 Worcester Co., Mass., Hort. Society, 348
- X**
- Xanthoceras sorbifolia, 71
- Y**
- Yanthoxyaceae, 195  
 Yellows Peach, 211  
 Yellow Violet, 134  
 Yew, American and Rhododendron, 259  
 " Original Golden, 167
- Z**
- Zimmerman, G., Orchard of, 303  
 Zinnia Darwini, 133  
 Zonale pelargonium, Distinction, 77  
 Zoology, First Book in, 156



THE  
GARDENERS  
And MONTHLY  
HORTICULTURIST

EDITED BY THOMAS MEEHAN.

Vol. XVIII. No. 205.  
(Combined Magazines, Thirty-fifth Year.)

**JANUARY, 1876.**

PUBLISHED BY CHARLES H. MAROT,  
814 Chestnut Street, Philadelphia.

**TERMS—\$2.10 PER YEAR—POSTAGE PAID.**



*Wm. H. Wood*

*J. R. Stockton Sc.*

# THE GARDENER'S MONTHLY AND HORTICULTURIST.

EDITED BY THOMAS MEEHAN,

Assisted by an able Corps of AMERICAN and FOREIGN CORRESPONDENTS.

It is published on the first of every month, at the office, No. 814 CHESTNUT STREET, PHILADELPHIA, where all BUSINESS communications should be addressed.

Communications for the Editor should be addressed: THOMAS MEEHAN, GERMANTOWN, Philada.

SUBSCRIPTION PRICE, Postage paid, \$2.10.

## TERMS OF ADVERTISING.

	1/4 col.	1/2 col.	3/4 col.	1 col.	1 1/2 col.	1 col.	1 page.
One Time, . . . . .	\$3.00	\$4.70	\$5.40	\$8.00	\$12.00	\$24.00	\$18.00
Two to Three Times, each, . . . . .	2.70	3.60	5.40	7.20	10.80	21.60	43.20
Four to Six Times, . . . . .	2.25	3.00	4.25	6.00	9.00	18.00	36.00
Seven to Nine Times, " . . . . .	2.00	2.70	4.00	5.35	8.00	16.00	32.00
Ten to Twelve " . . . . .	1.80	2.40	3.60	4.80	7.20	14.40	18.80

Twelve lines nonpareil is 1/4 col. A less space than 1/4 col., will be furnished at rates in exact proportion, line for line.

For THIRD and LAST COVER PAGES; FIRST PAGE advertisements facing matter; "FLY-LEAF PAGE" (from 1st number) before reading matter and facing first cover—special figures will be given on application.

Changes of copy within space ordered may be made as often as suits advertiser's convenience or interest. COPY and orders for NEW advertisements should be in hand by the 23d of each month; and CHANGES of COPY in running contracts by the 16th of each month, to insure them in following issue. Address

CHAS. H. MAROT, Publisher, 814 Chestnut Street, Philadelphia.

## CONTENTS OF THE JANUARY NUMBER.

### SEASONABLE HINTS:

Flower Garden and Pleasure Ground.....	1
Green-House and House Gardening.....	7
Fruit and Vegetable Gardening.....	12

### CORRESPONDENCE:

Plea for Planting Pyrus Coronaria.....	2
Esthetics in Conservatories, No. 2.....	8
Free and Cling-Stone Peaches.....	13
Black Walnut.....	13
Grape Growing at Galveston.....	13
Comet Peach.....	14
Eldred Cling-Peach.....	15
Abies Macrocarpa, New Coniferous Tree.....	21
Do Plants Need Water.....	22
Poisoning by Rhus.....	26
Gardeners at Galveston.....	26

### EDITORIAL:

Waterproof Packing Paper—Becheroff's Wheel Hoe—Automatic Gate—Tulip Tree in England—Wintering Echeverias—Arundo Conspicua..... 4-5

Calla Ethiopica—Button-hole Roses—Treatment of Oranges—Verbenas from Seed—Euphorbia jaquiniiflora..... 9-10

Strawberry Fertilizer—Profitable Bee-Keeping—Dreer's Lima Bean—Remedy for Celery-fly—Dwarf Apples..... 15-16

Disease in the Lurch—Immediate effects of Cross Fertilization of Fruits—Fungus Cracking the Pear—Toughened Glass—Rapidity of Growth of Timber Trees..... 22-24

Law of Purchasing Plants—The Baobab Tree—Personal—Billieu's Comet Peach—Agave Virginica—Binding the Advertisements—Thanks—Alfred Copc—Death of Dr. Hull—R. Buist's Catalogue—Botanical Bulletin

—American Agriculturist—Scientific Monthly—Annual Register—Gardening for Pleasure..... 27-29

Centennial Exhibition—Philadelphia Academy Natural Sciences—New York Horticultural Society—Winter Meetings of State Horticultural Societies—American Pomological Society—Pennsylvania Fruit Growers' Society..... 30-32

### NEW PLANTS:

Physanthus albus—Penstemon humilis—New Hardy Trees—New Strain of Draconas—Pyracantha Japonica—Styrax Japonica—Deutzia crenata Candidissima plena—Weigela Lavellei..... 5-9

Silver-leaved Plants—Saxifraga Huettii..... 10-11

### NEW FRUITS:

The Northampton Apple—Lucy Grieve Pear..... 16

NATURAL HISTORY AND SCIENCE..... 21-26

LITERATURE, TRAVELS AND PERSONAL NOTES..... 26-30

HORTICULTURAL SOCIETIES..... 30-32

### QUERIES:

Disease in Palms—Tobacco as Manure—Double Lobelia—Cultivation of Ericas—Colous Chanelcon..... 11

Petition—Phylloxera on the Roots of Grape—Wild Celery—Grapes for a Cold Grapery—Highland Hardy Raspberry—New Early Peaches—Apples for South-Eastern New Jersey—Red Fleshed Apple—Winter Grafting of the Plum—Plum Growing—Seedless Persimmon..... 16-19

Depth of Roots—Aponogeton Distachyon—The Potato Disease—Female Weeping Willow—Emblematic Description of the Passion Flower—The Charter Oak—Rocky Mountain Silver Spruce..... 24-26

Gladiolus—Hidden Advertisements..... 29-30

AUGUST ROLKER & SONS

IMPORTERS

AND DEALERS IN

ALL KINDS OF  
FLORISTS'  
SUPPLIES.

CATALOGUE MAILED ON APPLICATION,

32 READE STREET,

NEW YORK CITY.

1876.

1876.

# CENTENNIAL ERA.

---

CONSOLIDATION

OF

# TWO MAGAZINES.

The "HORTICULTURIST" of New York City, having been purchased in the interest of the GARDENER'S MONTHLY, the former Magazine issued its last number with December, 1875, when it completed its Thirtieth year. Henry T. Williams, its late editor and proprietor, gives it up in order to confine his attention more effectively to the other branches of his expanding business.

THE GARDENER'S MONTHLY, with the present issue will be hereafter known as the "GARDENER'S MONTHLY AND HORTICULTURIST." It is, at this date, the *only Monthly Magazine* devoted to *Horticulture*, in the *United States, East of the Rocky Mountains*. It will continue under the able Editorship of THOMAS MEEHAN, and will as heretofore do its best to deserve the consideration and support of the increasing numbers, who, through cultivation, taste, interest, desire the companionship or aid of such a literature.

The subscribers of the GARDENER'S MONTHLY and those of the late HORTICULTURIST are kindly requested to give their encouragement to this consolidation, by an early renewal of their own subscriptions, and, if possible, the enclosure of, each, a new subscriber with their own orders.

The lovers of Horticulture generally are asked to give the Magazine a year's trial.

Single Subscription Price, \$2.10 per Year. Six Months for \$1.05; Four Months for 70 cents; Three Months for 53 cents. One Old with one New Subscriber, or Two New Subscribers, \$3.20 for the two.

Remit by Post Office Order, Draft, or Registered Letter, to avoid possible loss by miscarriage through the mails.

ADDRESS

CHAS. H. MAROT,

PUBLISHER,

814 CHESTNUT STREET, PHILA.

---

 SEE FIRST PAGE, FACING COVER.



MY  
CATALOGUE OF PLANTS

FOR THE  
SPRING OF 1876,

Will be ready about February 1st. It will contain an unusually fine assortment of Novelties in the way of

CANNAS, GERANIUMS, HELIOTROPES.

PELARGONIUMS, VERBENAS, &c.

Also, an admirable assortment of new and beautiful

FRENCH HYBRID GLADIOLUS,

Which are offered in large quantities at LOW RATES. Also,

TUBEROSE BULBS OF THE VERY BEST QUALITY.

Particular attention is called to my

STOCK PLANTS OF VERBENAS,

containing a fine selection of Varieties, all in vigorous health. Attention is also called to my list of

EXTRA CHOICE

FOREIGN GRAPES FOR GRAPERIES.

Catalogues may be had FREE OF CHARGE by addressing

GEORGE SUCH,

# John Saul's Catalogue of New, Rare and Beautiful Plants.

## FOR SPRING OF 1876,

Will be ready in FEBRUARY, with a Colored Plate. Many beautiful

### NEW PLANTS

are offered; all at VERY LOW RATES. Free to all my Customers; to others, 25 cents a copy. A plain copy to all applicants free. Jan 2

## PEACH STONES M. ZZARDS, CHERRY STONES.

A limited Stock of First-class Quality can still be supplied.

THOMAS MEEHAN,

Germantown, Phila.

Jan 1.



I have founded my business on the belief that the public are anxious to get their seed *directly from the grower*, and I therefore offer FREE to every man and woman in the United States who cultivates a farm, tills a vegetable garden, or plants a flower garden, my large, Illustrated Catalogue of Vegetable and Flower Seeds for 1876; it contains, in addition to the choicest kinds produced in Europe, one hundred and fifty varieties of vegetable seed grown on my four seed farms. Customers of last season need not write for it. As the original introducer of the Hubbard, Marblehead and Butman Squashes, Phinney's Melon, the Marblehead Cabbage, and a score of other new vegetables, I solicit your patronage. All seeds sold under three warrants. A 100,000 catalogues will be issued and sent out the 1st of January.

JAMES J. H. GREGORY,

Marblehead, Mass.

dec 5

## TWO GREENHOUSES FOR SALE

### AT A GREAT BARGAIN.

200 GREENHOUSE SASH, 6 x 3.
20 " " " 12 x 3.
16 " " " 16 x 3.

At less than half the cost.

Also a splendid Heating Apparatus in perfect condition, at the same rate, manufactured by Messrs. Hitchings & Co.

The Sash are made of best pine lumber and double French crown glass. We also offer a large number of assorted pots below manufacturers' prices. Also Three acres of "Nursery" consisting of all leading varieties of APPLES, PLUMS, CHERRIES, &c., which must be cleared in the spring, and which we offer very low. Correspondence solicited.

S. E. BROWNELL & CO.,

Brocton, N. Y.

Jan 1

## HEDGE PLANTS! HEDGE PLANTS!

Making Hedge plants a specialty, we have particularly to offer this spring Osage Orange, Norway Spruce, Hemlock Spruce, Arbor Vitae, in immense quantities, and of any size to suit.

THOMAS MEEHAN,

Jan 1

Germantown, Phila.

## New and Improved Fumigator.

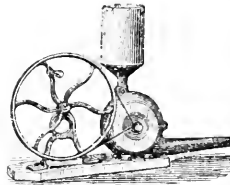

The undersigned having secured Letters Patent, March 23, 1875, for his new and Improved Fumigator for Hot-houses, Conservatories, &c. now offers it to Horticulturists, Gardeners and others, fully assured that it will do more in 10 minutes than could be done in one hour by the old system. It is operated outside of the greenhouse, thus avoiding the stifling fumes which is a great objection to the old mode. They are made of cast iron, and, with fair usage, will last a life time. Double Fan Fumigator, \$15. Single Fan Fumigator, \$12. I have also a small machine adapted for lady and gentlemen amateurs, for smoking one to a dozen plants; it is also adapted to Bee-keepers for smoking their hives. Price \$3. The desirability for these machines must be apparent to all. One trial will convince. For Circular, with directions, send to THOMAS SHAW, P. O. Box 612, Danville, Pa. oct 6

10,000 Camellias of all sizes, with and without buds.

2,000 Magnolia grandiflora grown in pots.

100,000 Roses, standards, half-standards and dwarfs.

Crab Apples, Crab Pears and Quince Stocks, per 100,000. For Catalogue and Prices apply to

Messrs. F. E. ROTEREAU & CO., Nurserymen, Angers, France. june 12

## THE NATIONAL AGRICULTURIST

AND

WORKING FARMER.

ESTABLISHED, 1847. UNITED, 1875.

A large, double quarto, 16 pages, Illustrated Family paper (*National Agriculturist* and *Working Farmer* consolidated). It treats of Stock Raising, Sheep Husbandry, Dairy Business, Swine, Poultry, Gardening and Fruit Growing, besides the elaborate departments of Bee Culture, Ladies or Home and Fireside, and Youth's Departments. A first-class Family paper, interesting, instructive, making young eyes sparkle and old hearts glad.

Great Illustrated Premium, Grange Price and Clubbing List with Sample Copy. Large Cash Commission to Agents, or valuable Premiums given.

Try it six months for 55 cents, or \$1.10 a year, post-paid.

Send to

WM. L. ALLISON,

128 Nassau Street, N. Y.

## GRAPE VINES.

Grown especially for the Trade and Planters in Quantity. CONCORD, MARTHA, Delaware, Harford, Prolific, Ives, Salem, Wilder, Iona, and many other varieties, one and two years old, in quantity.

A. HANCE & SON,

Nov 1 Nurserymen and Florists, Red Bank, N. J.

## New and Distinct Variegated Geranium, "HAPPY THOUGHT."

The most novel and welcome addition yet added to this most popular class of plants. See our Catalogue, containing colored plate. Ready February 1st, 1876.

SKED, PADDOCK & CO.,

Cleveland, Ohio.

Jan 1

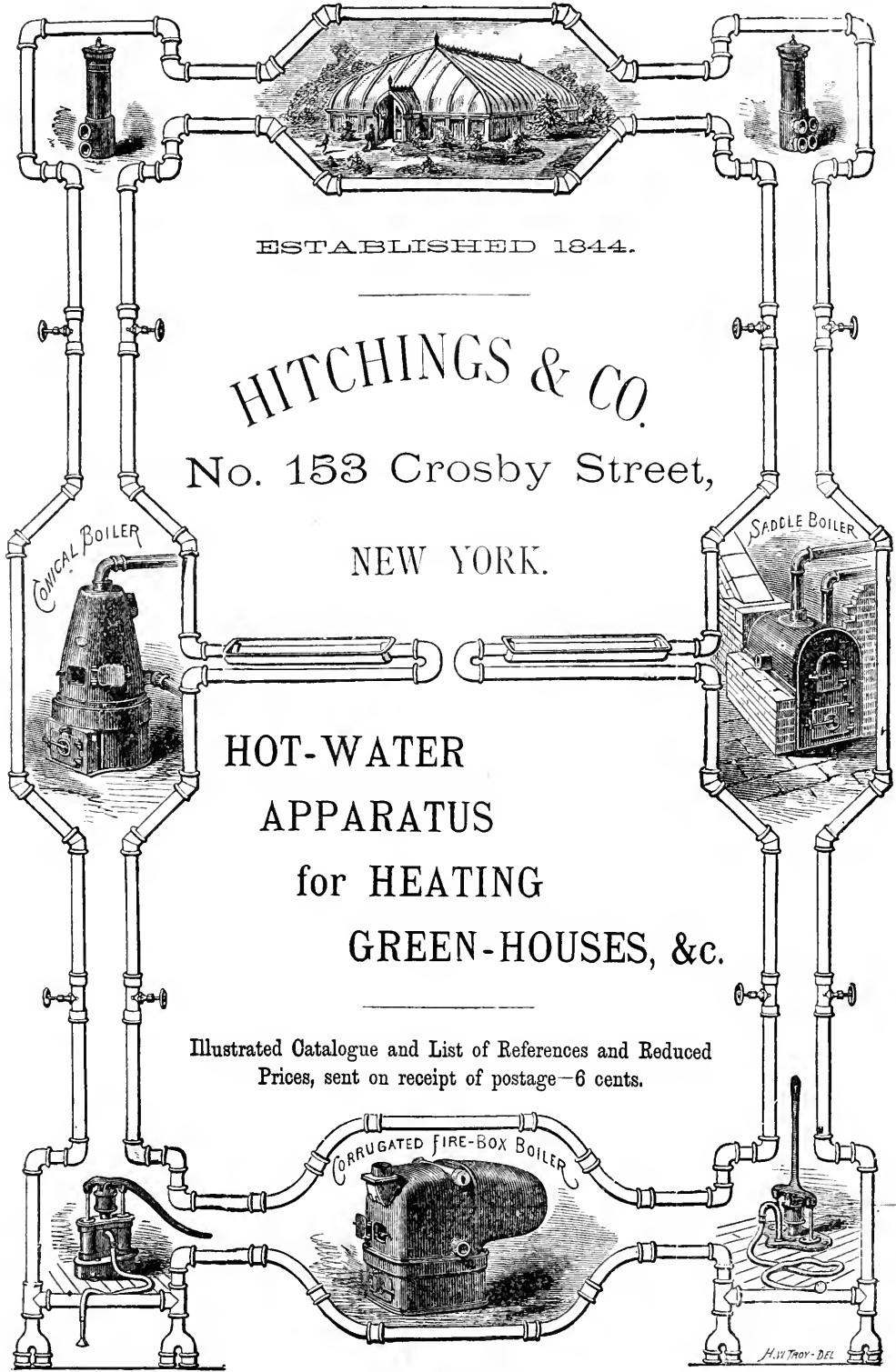

ESTABLISHED 1844.

HITCHINGS & CO.

No. 153 Crosby Street,  
NEW YORK.

HOT-WATER  
APPARATUS  
for HEATING  
GREEN-HOUSES, &c.

Illustrated Catalogue and List of References and Reduced  
Prices, sent on receipt of postage—6 cents.

H. W. TROY - DEL.

# HYBRID PERPETUAL ROSE, "EDMUND WOOD."

We are gratified to find that our friend M. VERDIER, the most celebrated Rose grower of France, has considered our establishment of sufficient importance to name one of his finest New Seedlings after our MR. EDMUND M. WOOD. In a special circular containing the names of his choicest New Varieties, he thus describes it: *Edmund Wood*; tree vigorous, with short reddish-green branches and numerous dark brown spines, leaves consisting of 3 to 5 leaflets oval, dark green: Flowers, large, full and perfect in form, growing in corymbs of 6; color lively, bright cherry red, reverse of petals, carmine—admirable. This variety is comprised in the series to which the silver gilt medal was awarded by the Paris Horticultural Society in May and June 1875. Depending upon the correctness of this description and the well-known veracity of Mons. Verdier, we have arranged for the importation in quantity of this variety with all the others raised last year in Europe, and shall offer it to the public of the United States on and after May 1st, at \$2 each. Orders will be executed in strict priority as they are received.

OUR NEW DESCRIPTIVE CATALOGUE, containing names and characters of all the best Roses, new and old, at present in cultivation, will be ready in a few days, and may be had on application.

EDMUND M. WOOD & CO.,

OFFICE OF

WABAN CONSERVATORIES,

tjan12

56 BROAD STREET, BOSTON, MASS.

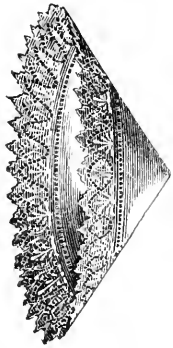

S. THANHAUSER,  
BOUQUET PAPERS,  
IN ALL VARIETIES.  
BRIDAL BOUQUETS,

White and Colors, trimmed with Satin, Lace, Tulle, &c.  
Large Assortment of Immortelles, Grasses, Moss, &c.

No. 19

PHILADA.,

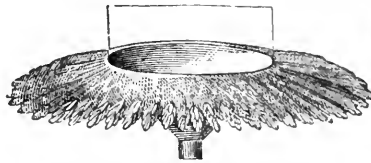

N.4thSt.,

PENN.

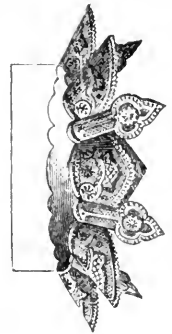

## MAHALEB STOCKS.

A fine lot of No. 1 in cellar ready for shipment at any time. \$1.25 per 100, \$10 per 1000. After April first, No. 2 at \$1 per 100, \$8 per 1000. For larger quantities, prices on application.

Our assortment of SEEDLINGS and YOUNG STOCK for NURSERYMEN is very extensive.

HOOPEs, BRO. & THOMAS,

Cherry Hill Nurseries, West Chester, Pa.

New Trade List, 20 pages, will be issued February 1st.

tjan3

## SEEDS OF FRUITS AND ORNAMENTAL TREES.

Knowing by experience the difficulty of getting Tree Seeds that would grow, we made TREE SEEDS A SPECIALTY in our business, now 17 years ago,—and sell to our customers the same seeds we sow ourselves.

The immense catalogue of seedlings we offer every year, attest their good quality. Catalogue always on hand.

THOMAS MEHMAN,

Germantown Nurseries, Philadelphia.

# WHEELER'S COMPOUND LIQUID HOSE DISTRIBUTOR

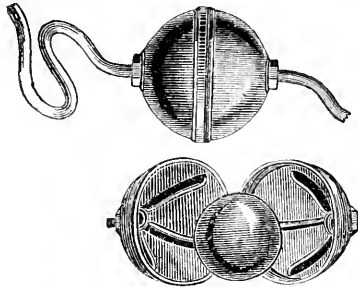

## AND WATERING POT.



Patented July 20, 1875.

These articles are of special interest to Agriculturists, Horticulturists, Florists, and others, as by their use compounds containing any special ingredient made for destroying *insects* or *mildew* on Plants, Shrubs, Trees, (under glass or in the open air) or for *fertilizing*, can be reduced to liquid form and distributed by the action of water flowing through hose-pipe or spout, without interrupting the original pressure of the water.

The advantage and economy of this method of applying these compounds, at the same time the ordinary daily watering is done, with no other labor or expense of time, must be evident to all who have had experience in making and applying in the usual way the disagreeable compounds for fertilizing, or for destroying insects such as Green Aphis, Thrips, Mealy Bugs, Red Spider, Scale, Currant Worm, Rose Slug, Caterpillar, Canker Worm, &c.

The method of using these articles is simply to place within the globe of the Hose Distributor and the several chambers of the Watering-pot the desired compounds, which by the action of the flowing water are dissolved or disintegrated, and are distributed with the water on the desired object.

The practical results of these machines in the saving of time, labor, material and annoyance, together with the increased health and vigor of the plants, commend them to all, and the hearty approval of prominent Horticulturists and Florists throughout the country, endorse the general opinion of their value.

The hollow globe of the Hose Distributor is made to fit couplings for 3-4 inch hose, Boston thread. It can be made to order to fit coupling of any size or thread.

Price of Distributor \$10.00; Watering-Pot \$6.00, C. O. D.

The Manufacture of the Compounds used with these machines is fully protected by Letters Patent, and is carried on solely by the Patentee and Proprietor.

The price of nearly all these special Compounds, put up in balls, ready for immediate use, is 20 cents per pound; in 5 lb. and 10 lb. boxes, 15 cents per pound, delivered at any Express in Boston, C. O. D. A liberal discount to the trade. Full directions for using the Compounds are sent with each machine. Agents wanted to introduce these machines throughout the United States.

Address **WM. F. WHEELER, Columbia St., 24th Ward, Boston, Mass.**

## TESTIMONIALS:

MR. WHEELER.—

MY DEAR SIR:—I am much pleased with your "Automatic Distributor." The facility with which it distributes compounds for the destruction of insects is remarkable, and I believe it will prove satisfactory to all who may purchase it. I would not be without it. Yours, &c., MARSHALL P. WILDER.  
Boston, April 19, 1875.

MR. WHEELER,—

DEAR SIR:—We have given your "Automatic Distributor" a trial in a rather hasty manner, for want of more time, but from its action, we have no doubt it will prove all you claim for it, as a ready means of ridding our plant houses of destructive insects, the bane of all good cultivation. It appears to be just what plant lovers require, and will add a new delight to all who wish to see fresh looking, healthy and perfect plants. Respectfully yours,  
Boston, April 19th, 1875. C. M. HOVEY.

That Wheeler's Automatic Compound Liquid Distributor will supply a much needed means of exterminating the numerous insects by which all vegetation has of late years been attacked we are fully convinced. The practical results of its use have so fully established its merits that we do not hesitate to recommend with perfect confidence its adoption by all engaged in the cultivation of flowers, shrubs and vegetables, either under glass or in the open air. Boston, July 15th, 1875. AMES PLOW CO.

BOSTON, July 13th, 1875.

W. F. WHEELER, Esq.—

DEAR SIR:—I have had in use in my greenhouses for the past three months your Patent Insect Annihilator and Compound Liquid Distributor, and in its praise I fail to find words sufficiently strong in recommendation of its effectiveness in destroying every species of insect that infest plants and troubles the brain and muscle of the gardener. Trusting you may receive the reward your genius merits I remain, your obedient servant,  
WILLIAM DOOGUE,  
849 Washington St., Boston.

QUINCY HALL, BOSTON, July 15th, 1875.

W. F. WHEELER, Esq.—

DEAR SIR:—It gives me great pleasure to inform you that after a thorough and careful examination of the use of your Automatic Compound Liquid Distributor by one of the largest Florists in this city, I am fully satisfied of the efficient work it performs. In hot-houses it will be appreciated, for while it can be relied on for the extermination of insects, it effects a great saving of time, labor, material and annoyance. I heartily congratulate you on your successful invention.

GEO. P. FOGG, SEEDSMAN.

# NEW AND RARE PLANTS,

FOR 1876.

HENRY A. DREER, Seedsman and Florist, 714 Chestnut Street, Philadelphia, takes pleasure in offering the following to the trade, a portion as Novelties for 1876. The balance of New things will be offered later, as stock will admit.

**Bouvardia Humboldtii Corymbiflora.** The finest, largest flowered, and most showy pure white Bouvardia. Strong plants, for propagating, \$5.00 per dozen.

**Bouvardia Candidissima.** Purest white, low compact growth, very free flowering, strong plants, \$5.00 per dozen.

**New Double Pink-Flowered Ivy-Leaved Geranium,** "Koenig Albert." The chief Novelty for 1876; of splendid drooping habit, perfect double flowers, \$9.00 per dozen, or \$1.00 each.

**Senecio Macroglossum.** A New German Ivy with dark thick, leathery leaves, very glossy, nearly like an Ivy, \$5.00 per dozen.

**Double White Oleander, "Madoni Grandiflora,"** \$4.00 per dozen.

**Fuchsia, Sun-ray.** Tricolor foliage, stock plants, \$3.00 per dozen.

**Our New Set of Double Petunias,** in advance of any yet introduced, in 12 varieties, \$2.50 per dozen.

**New Set of Single Petunias.** The finest show varieties, in 12 sorts, \$2.50 per dozen.

**New Double Show Pelargoniums, Single Zonale Geraniums, New Roses, &c.,** a description of which, please see Dreer's Garden Calendar, now ready, and mailed to all applicants.

HENRY A. DREER,

714 Chestnut Street,

Jan 6

PHILADELPHIA.

## DREER'S GARDEN CALENDAR,

FOR 1876.

Now ready and mailed free to all applicants; it contains well selected list of Vegetable and Flower Seeds, Plants, Small Fruits, and every Garden requisite, representing a large, well-grown, pure and fresh stock. We are growers of a large assortment of

## NEW VEGETABLE SEEDS,

Hanson Lettuce, Dreer's Improved Lima Bean, Giant Wax Bean, Tomato, Bastian Beet Seeds, and sorts requiring great care to insure the planter against loss. Of the

## FLOWER SEEDS

raised on our own grounds, we may mention Apple Geranium, Improved strain of blotched and marbled Single Petunia, the finest strain Double Petunia Seed of more than 15 years careful selection, unsurpassed by Continental-grown stock. Fresh Fern seeds of Pteris Argyrea, Tricolor, Adiantums, &c. Verbena Seed selected from a patch covering over an acre. In fact, the stock offered is the best that can be procured or produced.

HENRY A. DREER,

Seedsman and Florist,

Jan 6

714 Chestnut Street, Phila.

## J. M. THORBURN & CO.,

15 JOHN STREET,

NEW YORK,

mail to applicants their new annual priced

## CATALOGUE OF VEGETABLE SEEDS

For 1876. The largest collection of seeds in the world. Also, a New List of Magnificent HYBRID GLADIOLUS and other SPRING BULBS. Jan 3

MY  
Wholesale and Retail Catalogue of  
**Greenhouse and Bedding Plants,**  
**EVERGREENS, ETC.,**  
MAILED TO ALL APPLICANTS.  
**Wm. C. Wilson**  
Astoria, L. I. C.,  
June 12 New York City Office - 43 West 14th St.



## "DOMESTIC" SEWING MACHINES.

Liberal terms of Exchange  
for Second-hand Machines  
of every description.

"DOMESTIC" PAPER FASHIONS.  
The Best Patterns made. Send 5 cts. for Catalogue.

Address DOMESTIC SEWING MACHINE CO.,  
AGENTS WANTED. NEW YORK.

**Norwalk Nurseries.** LARGE stock of Stan-  
dard Apple all sizes. Nor-  
way, Black and White  
Spruce. Australian, Scotch, and White Pine. Arborvitæ,  
Balsam Fir and Irish Juniper. Also a general stock of other  
Fruit and Ornamentals.  
PRICE LIST FREE. G. & S. BOALT,  
Norwalk, O.  
sep 6

## BRANDYWINE,

The Most Profitable Raspberry;

In large quantities, guaranteed TRUE.

Descriptive Circular sent on Application.

A. HANCE & SON, Nurserymen and Florists,  
RED BANK, N. J.  
ncvtf.

# WABAN CONSERVATORIES

OFFICE :  
56 BROAD ST., BOSTON.  
Address all Letters to  
BOSTON OFFICE.

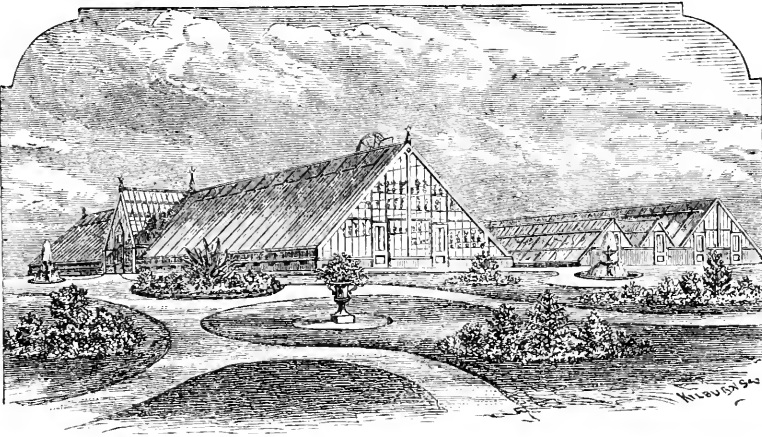

Send all Telegrams by  
Atlantic & Pacific Line. Address,  
*Waban Conservatories,*  
LAKE CROSSING, MASS.

## THESE CONSERVATORIES

Have in stock at all times, and offer at Wholesale,

## CUT FLOWERS IN QUANTITY, CONSISTING OF

Bon Silene, Saffrano and Isabella Sprunt Roses, Marechal Niel and General Jacquiminot, in great quantity, Souvenir de Malmaison, Yellow Tea, Persian Yellow, Devonensis, Gl'ire de Dijon in limited amounts. *The New Roses*—Le Nankin, La Jonquill, Madam Capucine, Belle Lyonnaise, Perle de Lyon, we shall be able to furnish in good quality. La France Rose in large quantity.

Also White and Red Bouvardia, White and Red Carnations, Violets, Stephanotis, Tuberoses, Jessamine and a general assortment of **Cut Flowers** used by the best Florists.

Lilium Longiflorum and Candidum in quantity at Easter.

Smilax & Fern Fronds in very large quantities for Decoration.

NEW ROSES, }  
NEW PLANTS, } AT LOWEST RATES.

We are pleased to inform the Florist Trade that we are able to furnish the coming season, a limited number of **CUT FLOWERS** of the following **LATEST NEW ROSES** :

**TEAS**—Aline Sisley, Comte de Sembuy, Jean Ducher, Marie Guillot, Marie Opoix, Perle des Jardine, Shirley Hibberd.

**NOISETTE**—Reine des Massis.

**BOURBON**—Mme. de Sevigne.

**MOSS**—Souppert et Notting.

**HYBRID PERPETUALS**—Adanson, Antoine Mouton, Bernerd Verlot, Cassimir Perrier, Comtesse de Serenye, Gaspard Monge, General Eerwangne, Henry Ward Beecher, Hypolite Jamain, Ingenieur Madele, La Rosiere, La Souveraine, Madame Rose Charmeux, May Eurner, Philippe Bardet, Princess Antoinette Strozio, Soeur Athunase, Souvenir de Mere Fontaine, Madame Lefebure de St Ouez, Claire Mathiew Melle, Tlona de Adorjas, Souvenir de Ducher.

Our importations for the present season are on a much larger scale than heretofore, and will embrace all the New Roses and other plants of merit raised in Europe during the past year.

We have the pleasure to state that our stock never was in so fine condition. Our new houses are in running order and we shall be able to supply all plants and Cut Flowers as stated in former advertisements, in large quantities—now having the largest establishment in the United States devoted to the sale of Cut Flowers. Our new descriptive Catalogue, revised and greatly improved, will be ready in February.

**N. B.**—Particular attention given to Plan, Arrangement, Construction and Heating of Greenhouses for the growth of **CUT FLOWER PLANTS** at a Profit for Market. Advice as to the most profitable Flowers and Plants to grow, and method of culture. Nine-tenths of the Failures can be traced to want of Knowledge in the Construction, Arrangement and Heating of Houses, and the Kinds of Plants and Flowers to put in them. *New Beginners*, we believe, will find our knowledge and large experience valuable to them.





# GERMANTOWN NURSERIES, PHILADELPHIA.

GORGAS LANE STATION, CHESTNUT HILL RAILROAD. Less than One Hour from the Centre of Philadelphia.

Those who desire to purchase largely, either for their own planting or to sell again, are invited to examine the extensive stock of

## FRUIT, SHADE AND ORNAMENTAL TREES AND SHRUBS,

Grown at the Germantown Nurseries. And those who need but A FEW ARTICLES, will find all ages and sizes to select from. A special feature of the business, is the raising of

Nursery Stock and Seedling Forest Trees

FOR DISTANT SHIPMENT. Many of these can be supplied by the millions at very low rates. Address, for CATALOGUES or information,

**THOMAS MEEHAN, Germantown Nurseries, Phila.**

# 2,000,000 FLOWER POTS,

AND AN EXTENSIVE STOCK OF

## FANCY EARTHENWARE.

*Do not Purchase your SPRING STOCK OF POTS until you have examined our Catalogue, now ready*

# A. H. HEWS & CO.,

NORTH CAMBRIDGE, MASS.

Jan 3

ESTABLISHED 1828.

ARE POPULAR  
BECAUSE  
RELIABLE.



1500 ACRES  
ANNUALLY GROWN  
IN SEEDS.

**THEY ARE THE LEADING SEEDS OF THIS COUNTRY.**

**BUIST'S** Garden Manual and Almanac containing 144 pages of useful information on Gardening, giving prices of Seeds by the Ounce, Pound and Bushel, mailed on receipt of a 10 cent stamp.

**Wholesale Price Current for Dealers** mailed to Merchants free ADDRESS **ROBERT BUIST, Jr., Seed Grower, Philadelphia.**  
Jan. 1. Lock Box 62, P. O.

Rowland Whitman.

Harry Lang.

# WHITMAN & LANG,

IMPORTERS OF

## BOUQUET PAPERS, FANCY GRASSES,

DRIED FLOWERS, IMMORTELLES, TIN FOIL, &c.,

No. 126 NORTH FOURTH STREET,

PHILADELPHIA.

THOMAS J. MYERS, JR.,  
 MANUFACTURER OF THE  
**PATENT ANGLE BOILER,**

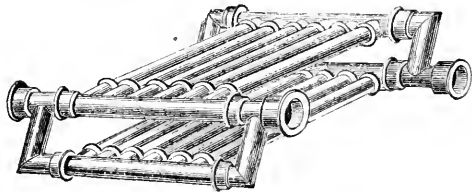

Tubes Patented May 4, 1870.

feb 12

Address, THOMAS J. MYERS, Jr., 1167 S. Ninth Street, Phila.

For Heating by Hot Water

GREEN-HOUSES HOT-HOUSES,  
 CONSERVATORIES, &c.

This Boiler is Guaranteed the

Best and Most Economical Boiler in the Country.

Also on hand all MATERIAL for Heating by Hot Water.

Send for a Circular of References, and Price List.

P. & E. TRANSON,  
**NURSERIES,**  
 ORLEANS, FRANCE,

Beg to inform their friends and customers generally that their

NEW LIST FOR 1875 AND 1876,

Is now ready, and may be had on application to

MESSRS. KNAUTH, NACHOD & KUHNE,  
 113 BROADWAY, NEW YORK.

This Catalogue contains Prices of all the FRUIT TREE STOCKS; an extensive list of FRUIT TREES, New and Hardy ORNAMENTAL PLANTS, CLIMBERS, the Hardest and Best CONIFERS, ROSES on their own roots. Also, SMALL CONIFERS, DECIDUOUS and EVERGREEN ORNAMENTAL TREES, one or two years' Seedlings, most useful for Nurserymen.

N. B.—The greatest attention given to packing.

M. M. BAYERSDORFER & CO.,

Importers of

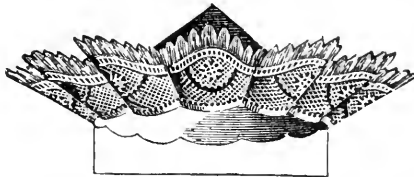

Every description of

**BOUQUET PAPERS.**

Plain White Satin for Bridal Bouquets. Fancy Lace for Weddings, Receptions, Parties. Italiens, Pasted Cartons, Immortelles in great varieties; Green Moss, French Dried Grasses and Flowers. Tin Foil. Prize Medal of Cincinnati Industrial Exposition of 1873 awarded to us for the best display of Bouquet Papers. Illustrated Catalogue furnished on application.

feb

56 N. Fourth St, Philadelphia, Pa.

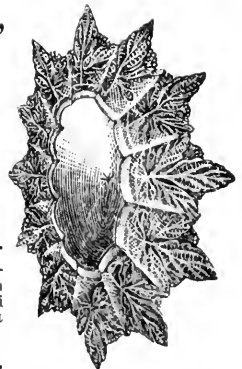

# JOHN A. SCOLLAY, IMPROVED HOT WATER APPARATUS,

Patented September 17, 1872.

*For Warming and Ventilating Dwellings, Greenhouses, Graperies, Forcing Pits, Drying Rooms, Heating Water for Public Baths, &c.*

This Boiler is perfectly self-cleaning, simple, economical and powerful, having more effective surface into less space than any Boiler in the market. Scollay's Patent Plant Sprinkler, for Window Gardening, &c., to be obtained of all Seedsmen, Florists, &c. Send for Circular and References. july 12

351 Adams Street, Brooklyn, New York.

# GRAPE VINES.

Also Grape Wood and Cuttings. Largest Stock in America.

All leading varieties in large supply. Extra Quality. True to name. Special rates to Agents, Dealers and Nurserymen. Our list of customers now embraces nearly all the leading nurserymen in the country, to whom we would refer those not acquainted with our stock. Send 6c. for DESCRIPTIVE CATALOGUE. Price List Free.

T. S. HUBBARD,

FREDONIA, N. Y.

aug9

THOS. J. MYERS, SR.

ESTABLISHED, 1851.

FELIX J. MYERS, JR.

## THOMAS J. MYERS & SON'S PATENT BOILER

# IMPROVED HOT & WATER APPARATUS,

For Warming and Ventilating

Greenhouses,  
Graperies,  
Conservatories, &c.

Also, for Public and Private Buildings.

### THE ADVANTAGES ARE :

The large amount of heating surface, they having twice the amount of any Boiler now in use; the facilities for cleaning, economy in fuel and space, and requiring very little attention. Also, their durability—they have no complicated flues to impede the draught, and are equally well adapted to work with or without a flue.

Our smallest Boiler has 10 feet of heating surface exposed to the direct action of the fire, with only 1 foot grate surface. They are also the cheapest Boiler in the market.

Circulars, with full description and Price List, furnished on application.

Also, estimates given.

THOMAS J. MYERS & SON,

1162 Passyunk Avenue, Philadelphia.

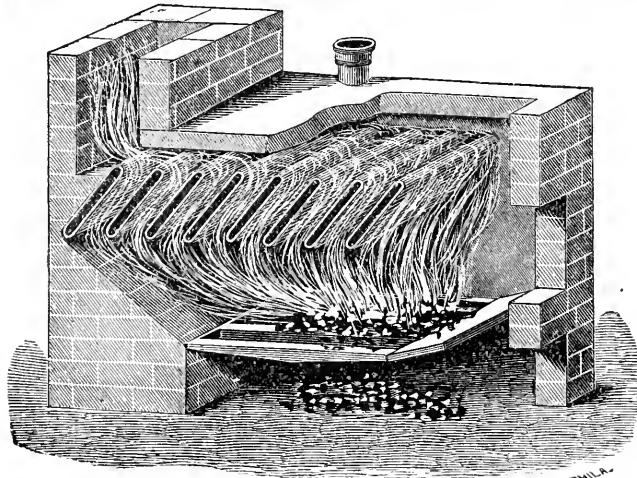

2, 4, 6, 8 Home Street, Cincinnati, Ohio.

LARGEST STOCK IN AMERICA OF

## EUROPEAN LARCH AND EVERGREEN TREES,

Both Seedling and Transplanted, all grown from seeds on our own grounds, and better and cheaper than imported stock.

## EUROPEAN LARCH AND EVERGREEN TREE SEEDS,

oct7

By the ounce, pound or hundred pounds. Send for Catalogue.

ROBERT DOUGLAS & SONS, Waukegan, Illinois.



are the best the world produces. They are planted by a million people in America, and the result is beautiful Flowers and splendid Vegetables. A Priced Catalogue sent free to all who inclose the postage—a 2 cent stamp



is the most beautiful work of the kind in the world. It contains nearly 150 pages, hundreds of fine illustrations, and four Chromo Plates of Flowers beautifully drawn and colored from nature. Price, 35 cents in paper covers; 65 cents, bound in elegant cloth.



This is a beautiful Quarterly Journal, finely illustrated, and containing an elegant colored Frontispiece with the first number. Price, only 25 cents for the year. The first number for 1876, just issued. Address

Dec2 JAMES VICK, Rochester, N. Y.

## The Nurseryman's Directory.

WE ISSUE AN  
APPENDIX

to THE NURSERYMAN'S DIRECTORY FOR THE U. S. on 1st of February, 1876, and request that any nurseryman, florist or seedsman who has not already sent us a postal card with his name, post office address and business plainly written thereon, do so at once, that we may give it in the work. Also note any new beginners, or those going out. Address

D. W. SCOTT & CO.,  
GALENA, ILLINOIS.

## CURRANT BUSHES.

VERY FINE AND VERY CHEAP.

LA VERSAILLES, CHERRY, RED DUTCH, White Grape, Black Naples, one and two years old. A superior stock.

A. HANCE & SON,  
Nurserymen & Florists, Red Bank, N. J.

## DOUBLE TUBEROSE BULBS.

Our Stock of BULBS this year is of very superior quality.

	Doz.	100	1000
1st quality large Flowering Bulbs.	\$ 75	\$4 00	\$30 00
2d quality	50	3 00	20 00
A few hundred extra large Bulbs	.....1 00	5 00	

nov6 MILLER & HAYES, 5774 Germantown Ave., Phila.

## THE SCIENTIFIC FARMER

AIMS TO UNITE SCIENCE WITH PRACTICE.

"We look upon such a publication as one much to be desired, and indeed, long and impatiently waited for by not a few. To cultivated readers it cannot fail of being intensely interesting and of great practical value."—*Termonth Watchman & State Journal.*

\$1.00 per year. On trial, three months, 25 cts.

CLARK W. BRYAN & CO.,  
SPRINGFIELD, MASS.

## FRENCH STOCKS,

L. PAILLET,

NURSERYMAN,

AT CHATENAY, NEAR PARIS,

FRANCE.

[Established.....1827.]

Begs to inform his customers that he offers for this season an IMMENSE LOT OF FINE

## FRUIT TREE STOCKS

of every description and choice, such as Pears, Quince, Mahaleb, Plums, Common CHERRIES; Doct'n, Paradise APPLE STOCKS; also, large quantities of

Ornamental Trees, Shrubs and Evergreen Stocks;

all at very low prices, and an immense and splendid lot of ROSES of every size, such as Standards, Half Standards, Dwarfs, and on their own roots; also New Roses of this season. GLADIOLUS by large quantities.

Magnolia oxoniensis, double varieties Lagalissonniere and others, Magnolia yerriani, Soulangeana, Spectosa cordata, macrophylla and others. Magnolia Lemoine—a large quantity of this fine Magnolia are disposable, the true variety from graft Tree and Sinensis Peonies—the best selection in Europe. Clematis, —50 varieties, also Clematis from seed at cheap prices.

Bolula alba foliis purpureis—this new fine tree is disposable by hundreds of the following size: young plants, about 4 to 5 in., 25 plants \$60, per 100 \$225; strong plants, in pot, from 15 to 18 in., 12 plants \$60, 25 plants \$100; strong plants, about 28 to 30 inch., 10 to 15 fcs.

N. B.—Persons wishing to have their orders filled up are invited to send them very early.

Catalogues and Lists sent on application. Orders may be sent to L. PAILLET direct, or to his Agents, DINGELSTEDT & CO., 27 William Street, New York. Deposits of money must be made with my Bankers, JOHN MUNROE & CO., No. 8 Wall Street, New York. nov3

**—FREE!—**

Send your name and address on Postal Card for sample copy of "PRACTICAL FARMER," the best Agricultural Weekly published. Splendid PREMIUM LIST and NEW CLUBBING TERMS. Address "Practical Farmer."

tnov3

Philadelphia, Pa.

## PEACH TREES.

LARGE AND CHOICE STOCK.

Crawford's Early and Crawford's Late, in large quantities. A full stock of new varieties, including Early Beatrice, Early Louise, Early Rivers, Alexander's Early, Steady, Amsden's June, Foster, &c., A. HANCE & SON,

novtf

Nurserymen and Florists, Red Bank, N. J.

**ALEX. NIMMO,**

(Late of the Firm of Nimmo & Scollay.)

**NEWLY IMPROVED HOT WATER BOILER,**

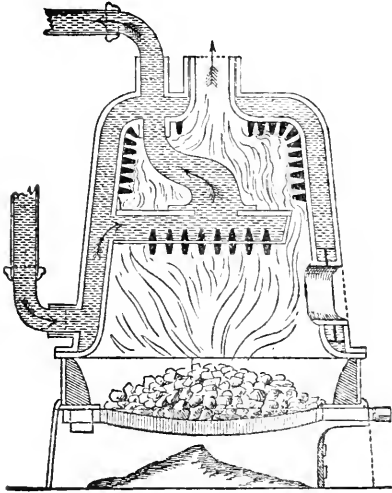

FOR HEATING

Green-Houses, Graperies, Conservatories,  
Forcing Pits, Water for Baths, Drying  
Rooms, Public and Private  
Buildings, &c.

*Proper steps have been taken to secure United States  
Letters Patent on this Invention.*

All the necessary Fittings for Hot Water Heating Apparatus,  
VENTILATION APPARATUS OF ALL KINDS.

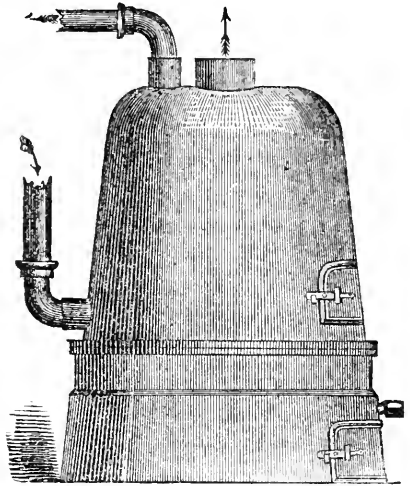

Wells Drove, Pumps of all kinds, Hydraulic Rams, &c., Garden Sun-Dials.

Agent for Joseph Kelly's Never Dry Vapor Pans, for all kinds of Hot Air Furnaces, Baltimore Heaters, &c.

**CHEAPEST AND BEST BOILER, &c., IN THE MARKET.**

Please send for Circular for explanation, etc., before you make up your mind to purchase elsewhere.

sep 12

P. S.—Be sure you get the right number.

335 Adams Street, Brooklyn, N. Y

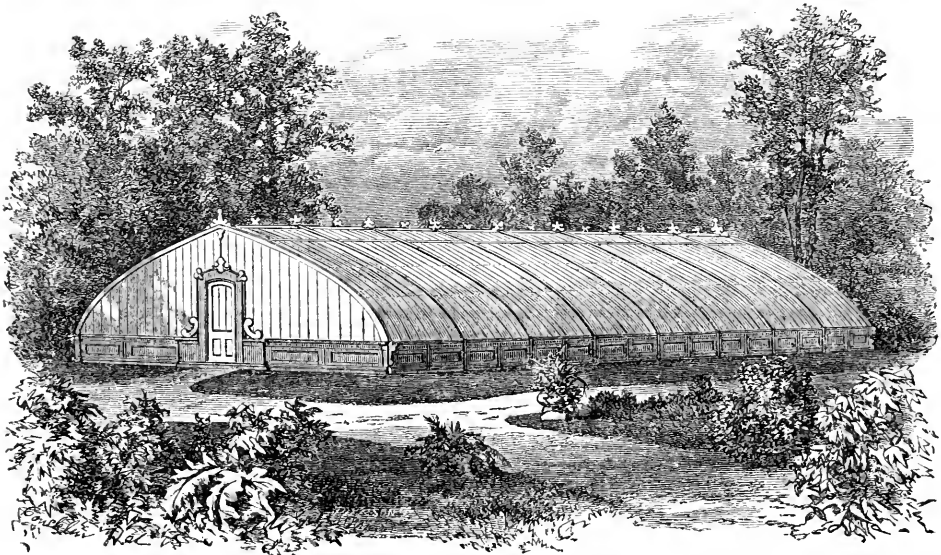

**GREENHOUSES, GRAPERIES, ETC.**

Their Construction a Specialty. Experience of 20 Years.

SHIPPED TO ALL PARTS OF THE COUNTRY. Send for Catalogue. Address,

LORD'S HORTICULTURAL WORKS,

Irvington-on-Hudson, New York.

TO RENT.—THE FIRST-CLASS COMMERCIAL GREENHOUSE PROPERTY,  
LOCATED IN BOSTON, MASS.

Formerly known as the "WALES CONSERVATORY," has been thoroughly reconstructed within the last two years at great expense, with all the conveniences and appurtenances to make it the BEST PROPERTY of its KIND in NEW ENGLAND. This property will be leased to responsible parties for a term of from three to eight years, at the option of the Lessee; The proprietor on account of ill health, being unable to give his personal attention to the business. Rent \$4,000 and Taxes, or less the Taxes if the Dwelling-house of the proprietor is reserved. Guaranteed rent required. Possession given immediately. For further particulars address  
WM. F. WHEELER, Columbia St., 24th Ward, Boston, Mass.  
REFERENCES:—Wm. C. Wilson, Astoria, L. I., C. L. Allen, Queens, N. Y., Wm. Dorgne, Boston, Mass. tjan1

THE  
NEW BLOOD BIRCH  
AND  
YELLOW WEEPING ELM.

The New Weeping Elm—*Ulmus Fulva Pendula*,

Is one of the most striking additions to our Ornamental Trees that we have introduced for some time. The branches are extremely vigorous; some from a height of ten feet arching over and touching the ground in a single season. It will be immensely popular, and nurserymen will do well to secure a plant for a specimen on their grounds and for propagation.

THE NEW BLOOD BIRCH promises to be even more popular than the celebrated Blood Beech. We have grown it the past year and find it all that has been claimed for it in Europe. A Limited Stock of each of the above is now offered at \$5.00 each.

sep

THOMAS MEEHAN, Germantown, Phila.

HAVE YOU A DOLLAR?

FOR ONE DOLLAR

WE WILL SEND, POSTAGE-PAID,

THE WEEKLY WORLD,  
ONE YEAR.

1. It contains **ALL THE NEWS** of the past seven days, collected by the agents and correspondents of the New York *World*, and in fulness, accuracy and enterprise in this respect is unequalled.
2. Its **AGRICULTURAL DEPARTMENT** contains the latest news of farm experiments at home and abroad, contributions by home and foreign writers, full reports of the Farmers' Club of the American Institute, and quotations of valuable and interesting articles appearing in the agricultural weeklies and magazines.
3. Its **GRANGE NEWS**, to which attention is specially called, is a feature which can be found in no other paper. All the resources at the command of a great metropolitan daily newspaper are employed in its collection, and the result is a page each week where the members may find a complete record of the work of the order in every State in the Union for the past seven days. In addition to this weekly record, *The World* gives the cream of all the local grange papers in every State. This department is and will continue to be under the charge of one of the active members of the order.
4. For the **FIRESIDE DEPARTMENT**, in addition to its other attractions, such as poetry, miscellany, humorous extracts, &c., during the coming year, there will be not less than one hundred short tales by the best writers of fiction in England and America.
5. The **MARKET REPORTS**, brought down to the hour of publication, are the best that can be made. Each market is reported by one whose special knowledge and training make him the best authority upon that subject in the United States. For accuracy and completeness the market reports of *The World* are unrivalled.

"*The World* is not only the best but the cheapest newspaper ever offered the farmer."

**SEMI-WEEKLY (104 Nos.) \$2 a year. DAILY (313 Nos.) \$10 a year.**

Specimen copies sent upon application. Address

Jan. 1.

"**THE WORLD**," 35 Park Row, New York.

FLOWER POTS BY THE MILLION.

The Best, Cheapest and Most Durable Pot in the Market. For Price List and Terms, Address  
THE NEW BRIGHTON FLOWER POT AND TERRA COTTA WORKS.

ELVERSON & SHERWOOD, Proprietors,

Please state where you saw the advertisement, also what business, whether Florist or Dealer.  
deci

NEW BRIGHTON, PA.

# ELLIS' BASE BURNING BOILER.

Estimates and Circulars furnished.

FOR WARMING Dwellings, Greenhouses, Graperies, Forcing Pits, Drying Rooms Heating Water for Public Baths, Baptisteries, &c., by Hot Water or by Steam.

182 CENTRE STREET, NEW YORK.

Our Combined WHOLESALE List of  
**EVERYTHING**  
 FOR THE  
**GARDEN!**  
 (Seeds, Plants, Florists' Requisites, etc.)  
**For the TRADE ONLY, mailed free on application.**  
*Peter Henderson & Co.*  
 35 Cortlandt Street  
 NEW YORK.

## THE THOMPSON WEEPING DOGWOOD.

To save further correspondence in regard to the WEEPING DOGWOOD, advertised heretofore, I would say that the tree has been purchased by Mr. Thomas Meehan, for his Germantown Nurseries.  
 t Jan. HORACE C. THOMPSON.

### FOR SALE OR TO LEASE,

TEN THOUSAND FEET OF GLASS AND FOUR ACRES OF LAND.

To any person wishing to enter the business this is a rare opportunity, and is one that will bear a thorough and searching investigation. The houses are in thorough repair, some of them but recently built, and none of them have been built over four years; are thoroughly heated with hot water apparatus and are admirably adapted for growing either plants or flowers, or both. Power for pumping is supplied by a four horse-power engine, which draws water from a never-failing well. Distributing pipes are laid in all the houses. The whole forming the most complete and thoroughly furnished plant establishment to be found. Entrance from the shed into all houses but one.

The buildings comprise the following:

- One house, 128x16 ft., running north and south.
- One house, 128x21 ft. 6 in., running north and south.
- One house, 92x11 ft. 6 in., running north and south.
- One house, 67x16 ft., running east and west.
- One house, 80x23 ft., running east and west.
- One house, 86x7 ft., running east and west, facing the north, and is adapted and has been used for a propagating house.

Six frames, each 67x6 ft.

Packing and potting shed, 80x14. Cellars under the whole length, 6 ft. deep. Sufficient stowage for the entire winter's supply of coal. For terms, &c., apply to

jan 1 GEORGE WILKINSON, Gorham Mfg. Co., Providence, R. I.

**ZELL'S**  
**ENCYCLOPEDIA**  
 NEW & REVISED  
 EDITION  
 AGENTS WANTED

The experience of five years has proved that this Compact and Reliable Work of General Information is better adapted to the wants of all classes of the community than any other work of the kind ever published. It has been proven by its

### IMMENSE SALES,

BY THE

NUMEROUS COMMENDATORY NOTICES RECEIVED

AND BY ITS UNIFORM

SUCCESS WITH AGENTS.

*The Edition of 1876 has been Thoroughly Revised to Date.*

It contains 150,000 articles, 3,000 wood engravings and eighteen handsomely engraved and colored maps. The work is issued in parts, and a specimen copy, with maps, will be sent to any address free of postage, for twenty cents.

**BAKER, DAVIS & CO., Publishers,**

(Successors to T. ELWOOD ZELL)

Nos. 17 and 19 South Sixth Street, Philadelphia, Pa.

# To TREE PLANTERS, Nurserymen, Dealers, etc.

The following CATALOGUES are now ready, and will be sent to all applicants as follows:

- No. 1—Fruits, just published, 56 pages, and Colored Plate, 15c.
- No. 2—Ornamental Trees, Shrubs, Roses, etc. 124 pages, 50 illustrations, and a fine Colored Plate of Roses, 25c.
- No. 3—Green & Hot-House & Bedding Plants, with supplemental List of Novelties, Free
- No. 4—Wholesale, Free.
- No. 5—List of New Roses for 1876. FREE.

In paper covers, mailed post free at annexed prices.  
Nos. 1 & 2—Neatly bound together, forming an interesting and valuable book for reference, 50c. by mail, post-paid Address,

**ELLWANGER & BARRY,** Rochester, N. Y.  
Jan 1

### SPECIAL OFFER TO THE TRADE! ROSES.

*Hybrid Perpetuals on Rosa canina*—STANDARDS. Per 100, 1st quality, \$20; 2d, \$16. Per 1000, 1st quality, \$16; 2d, \$12.  
Half Standards.—Per 100, 1st quality, \$12; 2d, \$10. Per 1000, 1st quality, \$10; 2d, \$8.

*Dwarf Roses on Rosa Multiflora de la Griffonade*.—Per 100, 1st quality, \$8; 2d, \$6. Per 1000 1st quality, \$7; 2d, \$5.

*Tea, Noisette and Bourbon Roses on Rosa Canina*.—Standards 3 to 7 feet, per 100, 1st quality, \$24 to \$36; 2d, \$20 to \$30. Half Standards; per 100, 1st quality, \$20; 2d, \$16

69.—A list of the names of the roses will be sent free on application. A remittance must accompany each order

A. M. C. JONGKINDT CONINCK.

"TOTTENHAM NURSERIES," at Delemsswaart, Near Zwolle, NETHERLANDS.

Aug 12

# PENN WIRE WORKS,

REAR, 428 WALNUT ST.

**RICHARD LYNEX,**

Manufacturer of

SIEVES, SCREENS, WIRE CLOTH,  
PLAIN & FANCY WIRE WORK

For FLORIST'S WREATHS,

CROSSES, STARS, CROWNS, HEARTS,  
ANCHORS, BIRDS, LAMBS, &c.  
GIPSY & OTHER BASKETS.

SEND FOR PRICE LIST. t aug 6.

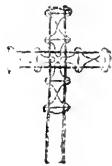

## BOWDITCH'S FLOWERS

My Illustrated Floral Catalogue for 1874 is now ready. Price 10 Cents, less than half the cost. WILLIAM E. BOWDITCH, 645 Warren St., Boston, Mass.

# SEEDLING PALMS, &c.

HEALTHY WELL-ROOTED PLANTS.

Corypha australis	\$8 00	per dozen.
Cocos Flexuosa	8 00	"
Chamaerops excelsa	\$6 to 8 00	"
Latania borbonica	5 00	"
Ptychosperma Alexandrae	12 00	"
Sabal Adansonii	4 00	"
Dracæno Draco	\$4 to 6 00	"
Cyclamen persicum	\$3 to 4 00	"
Gloxinias Seedling varieties	\$2 to 3 00	"

Address **DAVID I. SAUNDERS,** Florist,

noy3 1600 Third Street, N. W., Washington, D. C.

# GREENHOUSE & BEDDING PLANTS.

Large stock; plants well grown; finest New and Old varieties. Sent by Mail or Express. Illust. priced Catalogue free, address **ELLWANGER & BARRY,** Rochester, N. Y.

Jan 1

LARGEST STOCK IN AMERICA.

# LARCHES, EVERGREENS.

- 15 Million Evergreen Seedlings,
- 12 Million European Larch Seedlings,
- 4 Million Transplanted Evergreens,
- 2 Million Transplanted European Larch,
- 200,000 Mountain Ash Seedlings, &c. &c.

The above are all grown from seed on our own grounds, and are better and cheaper than imported stock. Send for Catalogue.

**ROBERT DOUGLASS & SONS,**

Waukegan, Ill.



# FRUIT AND ORNAMENTAL TREES!

LARGE STOCK. LOW RATES.

STANDARD PEAR TREES A SPECIALTY.

AGENTS WANTED. Address

**E. MOODY & SONS,** Lockport, N. Y.

Jan 1 Niagara Nurseries. Established 1839.

# BACK NUMBERS WANTED

IN GOOD CONDITION,

AS FOLLOWS:

April 1860. January, March, July, October and December, 1870. January 1873. January August and December, 1874. January and February 1875.

Receivable in exchange on subscription account, number for number, postage to be pre-paid to our address. Send numbers and advise by letter. Or will exchange other back numbers for above.

ADDRESS,

**CHAS. H. MAROT,**

814 Chestnut st., Phila.



# WEATHERED & CHEREVOY'S PATENT BOILERS,

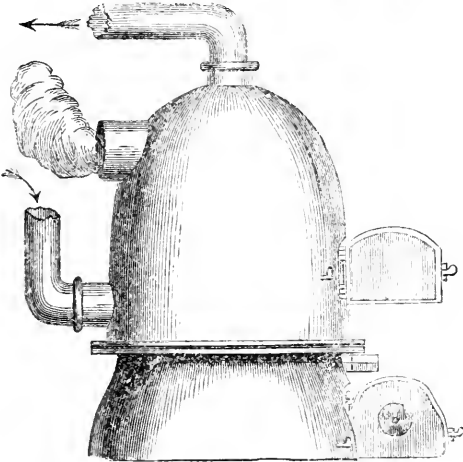

Fig. 1.

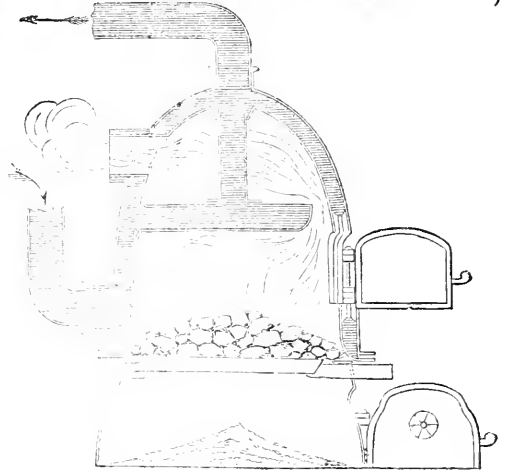

Fig. 2.

## AND IMPROVED HOT WATER APPARATUS,

No. 46 Marion Street, between Spring and Prince, New York.  
(TWO BLOCKS EAST OF BROADWAY.)

For Warming and Ventilating Public Buildings, Private Dwellings, Greenhouses, Graperies, Forcing Pits, Drying Rooms, and Heating Water for Public Baths.

Fig. 1 is an outside view. Fig. 2 is a vertical section through the centre.

*The following are a few names of Gentlemen who have our Boiler in use:*

Thos. Drake, Esq., Germantown, Pa.  
Simon Cameron, Esq., Harrisburg, Pa.  
J. D. Cameron, Esq., Harrisburg, Pa.  
Thos. Carter, Esq., Raleigh, N. C.  
J. H. Dunham, Esq., Chicago, Ill.  
Jas. B. Waller, Esq., "  
W. J. Gordon, Esq., Cleveland, Ohio.  
Geo. Stanley, Esq., "  
Harris Jaynes, Esq., "  
Geo. W. Cuyler, Esq., Palmyra, N. Y.  
D. M. Osborn, Esq., Auburn, N. Y.  
John B. Dutcher, Esq., Pawling, N. Y.  
A. M. Allerton, Esq., Bronxville, N. Y.  
Robert Hoe, Esq., Tarrytown, N. Y.  
Peter Hoe, Esq., "  
George Lewis, Esq., "  
Wm. H. Drew, Croton Falls, "  
Hon. James Y. Smith, Providence, R. I.  
Philip Caswell, Esq., Newport, R. I.  
Alfred Smith, Esq., "  
Wm. Findlay, Esq., "  
E. Learned, Esq., Pittsfield, Mass.  
D. O. Mills, Esq., San Francisco, Cal.  
W. L. Ferris, Esq., Westchester, N. Y.  
D. H. Haight, Esq., Goshen, N. Y.  
F. Newbold, Esq., Newark, N. J.  
James T. Closson, Esq., Plainfield N. J.  
Daniel W. Coit, Esq., Norwich, Conn.  
J. F. Slater, Esq., "  
H. W. Collender, Esq., Darien, "  
Chas. P. Palmer, Esq., Stouington, "

Wm. D. Black, Esq., New Milford, Conn.  
Rev. Stephen H. Tyng, Irvington, N. Y.  
H. F. Spaulding, Esq., Riverdale, "  
S. D. Babcock, Esq., "  
Percy R. Pyne, "  
Elisha Brooks, Esq., Inwood, "  
Camille Marie, Esq., "  
A. F. Smith, Esq., Fort Washington, "  
R. M. Olyphant, Esq., Dobb's Ferry, "  
Clarkson N. Potter, Esq., New Rochelle, "  
Chas. D. Dickey, Esq., West Farms, "  
Wm. Matthews, Esq., Harrison, "  
William Chorlton, Esq., New Brighton, S. I.  
F. H. Wolcott, Esq., Astoria, L. I.  
Bailey Leach, Esq., "  
Hon. W. B. Ogden, High Bridge, N. Y.  
Peter Moller, Esq., 295 Fifth Ave., New York City.  
Wm. Moller, Esq., 6 West 20th St., "  
John Moller, Esq., 127 East 54th St., "  
John Moller, Esq., 8 East 37th St., "  
Ch. Moller, Esq., 423 Washington St., "  
Henry B. Laidlaw, Esq., 33 Pine St., "  
George W. Lane, Esq., 93 Front St., "  
J. P. Robinson, Esq., 14 Coenties Slip, "  
J. B. Colgate, Esq., 47 Wall St., "  
John B. Trevor, Esq., 47 Wall St., "  
Charles Butler Esq., 12 "  
Richard Arnold, Esq., 309 Canal St., New York City.  
Jas. M. Constable, 309 Canal St., "  
W. T. Garner, Esq., "

Please send for Circular with list of References and Reduced Prices to

THOMAS W. WEATHERED, 46 Marion Street, N. Y.

**RURAL AND PRACTICAL BOOKS,** (and any others in the market not on this list) will be sent by mail, post paid, on receipt of price. Address CHAS. H. MAROT, 814 Chestnut St., Philada.

Allen's, R. L., Diseases of Domestic Animals.....	\$1 00	How to Manage a Building Association.....	\$2 00
Allen's, L. F., Rural Architecture.....	1 00	How to Pa'n'l.....	1 00
Allen's, L. F., American Cattle.....	2 50	Hunter and Trapper.....	1 00
Allen's, R. L. & L. F., New American Farm Book.....	2 50	Hussman's Grapes and Wines.....	1 50
American Architect.....	7 00	Jacques' Manual of the House.....	1 50
American Bird Fancier, (Brown's).....	30	Jacques' Manual of the Garden.....	1 75
American Farmer's Encyclopedia.....	6 00	Jennings' Cattle Doctor.....	1 75
American Horticultural Annual, paper 50 Cts., cloth.....	75	Jennings on the Horse and his Diseases.....	1 75
American Weeds and Useful Plants.....	1 75	Jennings' Sheep, Swine and Poultry.....	1 75
Apple Culturist, S. E. Todd.....	1 50	Johnson's Gardener's Dictionary.....	3 50
Art of Saw Filing.....	75	Johnson's How Crops Feed.....	2 00
Architecture, Modern American, Cummings & Miller.....	10 00	Johnson's How Crops Grow.....	2 00
" Principles and Practice of, By Loring & Jenning.....	12 00	Johnson's Peat and its uses.....	1 25
Baker's Fruit Culture.....	4 00	Johnson's Elements of Ag. Chemistry and Geology.....	1 50
Bassett on Cranberry Culture.....	30	Johnston's, J. S. W., Agricultural Chemistry.....	1 75
Barry's Fruit Garden.....	2 50	Kemp's Landscape Gardening.....	2 50
Bell's Carpentry made easy.....	5 00	Kilj part's Farm Drainage.....	1 75
Bement's Poulterer's Companion.....	2 00	Langstroth, Rev. L. L., on the Hive and Honey Bee.....	2 00
Bement's Rabbit Fancier.....	30	Leuchars' How to Build Hot-houses.....	1 50
Beet Root Sugar.....	1 50	Leibig's, Justus, Familiar Lectures on Chemistry.....	75
Bicknell's Village Builder, 77 plates.....	12 00	Louden's Encyclopedia of Plants.....	20 00
Bommer's Method of Making Manures.....	25	Lyman's Cotton-culture.....	1 50
Boussingault's, J. B., Rural Economy.....	1 00	McMahon's American Gardener.....	2 25
Brown's Trees of America.....	6 00	Mayhew's Practical Book-keeping for Farmers.....	90
Breck's New Book of Flowers.....	1 75	Mechanics Companion (Nicholson).....	3 00
Bridgeman's American Gardener's Assistant.....	2 50	Mechan's Ornamental Trees.....	1 00
Bridgeman's Fruit Cultivator's Manual.....	1 00	Miles on the Horse's Foot.....	75
Bridgeman's Kitchen Gardener's Instructor.....	1 00	Miner's, T. B., Bee-keeper's Manual.....	1 25
Buist's, Robert, Am. Flower Garden Directory.....	1 50	Mohr on the Grape-vine.....	1 00
Buist's, Robert, Family Kitchen Gardener.....	1 00	Money in the Garden.....	1 50
Burr's Field and Garden Vegetables of America.....	5 00	My Vineyard at Lakeview.....	1 25
Carpenter and Joiner (R. Riddell).....	7 00	My Farm of Edg-wood.....	1 75
Carpenter and Joiner's Hand Book, (Holly).....	75	My Ten-rod Farm.....	50
Chorlton's Grape Grower's Guide.....	75	North American Sylva, 5 vols., 156 col. plates, in 30 parts,	
Chemistry of the Farm, (Nichols).....	1 25	" " unbound.....	60 00
Cleveland's Villas and Cottages.....	4 00	" " Half Turkey Antique, gilt.....	70 00
Cobbett's American Gardener.....	75	" " full.....	75 00
Cole's, S. W., American Fruit Book.....	75	Nichol's Chemistry of the Farm and Sea.....	1 25
Cole's American Veterinarian.....	75	Norton's, John P., Elements of Scientific Agriculture.....	75
Cooper's Rural Hours.....	2 00	Norris' Fish-culture.....	1 75
Copeland's Country Life.....	5 00	Onion-culture.....	20
Dadd's, Geo. H., American Cattle Doctor.....	1 50	Our Farm of Four Acres.....	1 25
Dadd's Modern Horse Doctor.....	1 50	Packard's Guide to the Study of Insects.....cloth	6 00
Dana's, Samuel H., Muck Manual.....	1 25	Paul's Book of Roses.....	50
Darwin's Variations of Animals and Plants, (2 vols.).....	6 00	Paul's Rose Garden.....	3 00
Darwin's Insectivorous Plants.....	7 00	Paxton's Gardener's Dictionary.....	15 00
DeVoe's Market Assistant.....	2 50	Pardee on Strawberry-culture.....	75
Downing's, A. J., Landscape Gardening.....	6 50	Parkman's Book of Roses.....	3 00
Downing's Cottage Residences.....	3 00	Parsons, Samuel B., on the Rose.....	1 50
Downing's Fruits and Fruit Trees of America, new edition.....	5 00	Peat and its Uses.....	1 25
Downing's Rural Essays.....	3 50	Peat-culture, Fields.....	1 25
Downing's Ladies' Companion to the Garden.....	2 00	Pedder's, James, Farmer's Land-measurer.....	60
Du Breuil's Vineyard Culture, (Dr. Warden).....	2 00	Percheron Horse.....	1 00
Eastwood on Cultivation of the Cranberry.....	75	Peterson's Preservitzg, Pickling and Canning Fruit.....	50
Elliott's Western Fruit Grower's Guide.....	1 50	Phin on Wine-making.....	1 50
Elliott's Lawn and Shade Trees.....	1 50	Quinn's Pear-culture for Profit.....	1 00
Every Woman her own Flower Gardener.....	50	Quinby's Mysteries of Bee-keeping Explained.....	1 50
Farm Talk, (Brackett).....	1 00	Randall's Sheep Husbandry.....	1 50
Farming for Boys, Pear Culture.....	1 00	Randall's Fine Wool Sheep Husbandry.....	1 00
Fields, Thomas W., Pear Culture.....	1 25	Rand's Bulbs.....	3 00
Five Acres too Much, (illustrat'd).....	1 50	Rand's Flowers for Parlor and Garden.....	3 00
Flagg's European Villages.....	1 50	Rand's Seventy-five Flowers.....	1 50
Flax Culture.....	50	Rand's Flower Garden.....	3 00
Flint, Chas. L., on Grasses.....	2 50	Renaudin's, Charles, Vine-dressers' Manual.....	75
Flint's Milch Cows.....	2 50	Riddell's Architect.....	15 00
Fowler's Homes for All.....	1 50	Ropp's Commercial Calculator, cloth \$1, Morocco Tuck.....	2 00
Frank Forester's Fish and Fishing, 8 vo., 100 engravings.....	3 50	Rose Culturist.....	30
Frank Forester's Manual for Young Sportsmen, 8 vo.....	3 00	Robbins', E., Produce and Ready Reckoner.....	75
French's Farm Drainage.....	1 50	Saunders' Domestic Poultry, paper 40.....	75
Fuller's Grape Culturist.....	1 50	Saxton's Hand Books, in four series, each.....	1 50
Fuller's Small Fruit Culture.....	1 50	Scheneck's Gardener's Text-book.....	75
Fuller's Strawberry Culturist.....	25	Scribner's Ready Reckoner and Log Book.....	35
Fuller's Forest Tree Culturist.....	1 50	Song's Cultivation of the Grape.....	3 00
Fulton on Peach Culture.....	1 50	Ten Acres Enough.....	1 50
Geyelin's Poultry Breeding.....	1 25	Thomas, J. J., Farm Implements.....	1 50
Gray's How Plants Grow.....	1 25	Thomas, J. J., Fruit-culturist; new edition.....	3 00
Gray's Manual of Botany.....	2 25	Ville's Chemical Manures.....	1 25
Gray's Manual, Botany and Lessons, in one vol.....	4 00	Warder's American Pomology.....	3 00
Gray's School and Field Book of Botany.....	2 50	" Hedges and Evergreens.....	1 50
Green on Trout Culture.....	1 00	Waring's Drainage for Profit and Health.....	1 50
Gregory on Squashes, paper.....	30	" Elements of Agriculture.....	1 00
Guernon on Milch Cows.....	75	" Earth Closets.....	50
Guide to Fortune.....	1 00	Webster's Dictionary, Unabridged.....	12 00
Harzitz's Grape Culture and Wine Making.....	5 00	Well's Every Man his own Lawyer.....	2 00
Harris' Insects Injurious to Vegetation, clo. \$4; col. eng's.....	6 50	Williams, B. S., on Store & Greenhouse Plants, 2 vols., ill'd.....	5 00
Harris on the Pig.....	1 50	Williams, B. S., on Select Ferns and Lycopods.....	2 00
Hatfield's American House Carpenter.....	3 50	Williams, B. S., Orchid Grower's Manual.....	2 00
Henderson's Practical Floriculture.....	1 50	Window Gardening.....	1 50
Henderson's Gardening for Pleasure.....	1 50	White's Gardening for the South.....	2 00
Henderson's Gardening for Profit.....	1 50	" Cranberry Culture.....	1 25
Herbert's Hints to Horsekeepers.....	1 75	Wood's Class Book of Botany.....	3 50
Hoopes on Evergreens.....	3 00	Workingman's Way to Wealth.....	75
Hooper's Dog and Gun, paper 30 cents, cloth.....	60	Wright's Practical Poultry Keeper.....	2 00
Hop-culture.....	40	Youatt on the Horse.....	1 75
How to Buy a Farm, and Where to Find One.....	1 75	Youman's Household Science.....	2 00

# CLUB PAPERS AT NET PRICES,

## ALPHABETICALLY ARRANGED.

**TO REMIT IN CLUBBING** any of the following list with the **Gardener's Monthly** select such as you wish, foot up the prices annexed and add **TWO DOLLARS** for the **MONTHLY** to the total.

American Agriculturist.....	\$1 20	Maine Farmer.....	\$2 10
" Farmer.....	1 35	Manufacturer and Builder.....	1 85
" Artisan.....	1 60	Maryland Farmer.....	1 35
" Builder.....	2 60	Massachusetts Ploughman.....	2 60
" Naturalist.....	2 85	Metropolitan.....	1 85
" Odd Fellow.....	1 60	Milling Journal.....	1 85
Appleton's Journal.....	3 60	Moore's Rural New Yorker.....	2 35
Arthur's Home Magazine.....	2 35	Nation.....	4 60
Atlantic Monthly.....	3 60	National Baptist.....	2 35
Boston Cultivator.....	2 60	New England Farmer.....	2 85
Building Association Journal.....	75	" " Homestead.....	2 10
" Societies Gazette, London, England.....	1 35	New York Evangelist.....	2 60
Bucks County Intelligencer, old Subscribers \$2 60, new.....	2 10	New York Methodist.....	2 20
California Horticulturist.....	3 10	" " Post, Weekly, \$1.50; Semi-Weekly.....	2 60
Central Union Agriculturist and Chromo.....	1 70	" " Times, Weekly, \$1.50; Semi-Weekly.....	2 60
Children's Friend.....	1 35	" " Tribune, Weekly, \$1.50; Semi-Weekly.....	2 60
" Hour.....	1 10	" " World, Weekly; \$1-50; Semi-Weekly.....	2 60
Colman's Rural World.....	1 85	North-Western Farmer.....	1 10
Country Gentleman.....	2 35	Nursery.....	1 20
Demorest's Magazine.....	2 60	Ohio Farmer.....	1 85
Eclectic Magazine.....	4 60	Old and New.....	3 60
Every Saturday.....	4 60	Our Home Journal.....	2 25
Farmer's Home Journal.....	2 60	Park's Floral Gazette.....	70
Frank Leslie's Ladies' Magazine.....	3 10	Penn Monthly.....	2 10
" Illustrated Newspaper.....	3 60	Peter's Musical Monthly.....	2 60
Friends' Intelligencer.....	2 70	Peterson's Magazine.....	1 70
" Review.....	2 10	Philadelphia Weekly Press.....	1 60
Galaxy.....	3 60	Phrenological Journal.....	2 35
Germantown Telegraph, old subscribers \$2 50, new.....	2 20	Poultry World.....	1 10
Godey's Lady's Book.....	2 75	Popular Science Monthly.....	4 60
Hall's Journal of Health.....	1 10	Practical Farmer, (Weekly).....	2 60
Harper's Bazar.....	3 60	Prairie Farmer.....	1 70
" Magazine.....	3 60	Purdy's Small Fruit Recorder.....	85
" Weekly.....	3 60	Saint Nicholas.....	2 60
Hearth and Home.....	2 00	Saturday Evening Post.....	2 10
Herald of Health.....	1 60	Scientific American.....	2 75
Household.....	85	Scientific Farmer.....	85
Iowa Homestead.....	1 60	Scribner's Monthly.....	3 60
Journal of Chemistry.....	1 10	Southern Cultivator.....	1 85
" of the Farm.....	85	Southern Planter and Farmer.....	1 85
Journal of Materia Medica.....	1 10	Waverly Magazine.....	4 60
Kansas Farmer.....	1 35	Western Agriculturist.....	85
Lady's Floral Cabinet, with Chromo.....	1 10	Western Farmer.....	1 85
Ladies' Repository.....	3 35	" Rural.....	1 85
Leslie's Lady's Journal.....	3 60	Wood's Household Magazine.....	85
Lippincott's Magazine.....	3 25	" " with Chromo.....	1 00
Littell's Living Age.....	7 60	Working Farmer.....	1 10
London Garden.....	5 50	Youth's Companion, new subscribers \$1.35; old subscribers.....	1 50
London Gardener's Chronicle.....	7 50		

The above includes postage under the new U. S. Law requiring prepayment of postage before mailing.

After subscription to a club paper through this agency, report non-receipt of your numbers and other causes of dissatisfaction, irregularities of mails or changes of residences, *only to said paper direct* (not to this office).

Remit by P. O. Order, Draft or Registered Letter. Currency is at risk of mails.

If you wish a receipt or reply, enclose postage stamp for that purpose, otherwise the club papers will be considered a sufficient receipt.

Address **CHAS. H. MAROT, 814 Chestnut Street, Philadelphia.**

# To Exchange for NURSERY STOCK,

Three sections, 640 acres each, of land in North-western, Texas. Finely located and rich land. Price, \$1.25 per acre. Address  
C. C. HEMMING, Proprietor Fairview Nursery,  
BRENHAM, TEXAS.

dec2

## THE CHRISTIAN AT WORK.

T. De Witt Talmage, Editor.

Without Premiums, \$3; with Premiums, \$3.25. To Clergymen 75 cents less. *Best* A Choice of two premiums.

### OPINIONS OF THE PRESS.

"The Christian at Work is the liveliest religious paper published in these parts. Its columns are spicy and sparkling and to religious people who like things lively it is a readable paper. The Devil is more certain to be frightened with a radiant face than a solemn and forbidding one."—*N. Y. Commercial Advertiser.*

"The Christian at Work has donned a new dress and looks as pretty as a picture. The type of all sizes is admirably clear and a handsomer weekly there is not in these United States."—*N. Y. Evening Mail.*

"The Christian at Work is safe and reliable in all its utterances and ought to displace the — in every Presbyterian family. Its editor is a host in himself, and nothing will stagnate that he has anything to do with."—*London Correspondent Chicago Interior.*

"The Christian at Work is an admirably conducted sheet, filled with live matter."—*N. Y. Star.*

"The Christian at Work is one of the most readable religious papers published anywhere. The Doctor and his associates have discovered the art of making a publication orthodox without being flippant."—*Brooklyn Eagle.*

"In The Christian at Work everything is lively and life-like. This Christian smiles, laughs, sometimes actually whistles, while at his work, and that without letting down the dignities and proprieties that belong to the discussion of the themes it discusses."—*Brooklyn Union.*

"The Christian at Work is one of the best of the religious weeklies, and deserves the success it has attained."—*Brooklyn Argus.*

"The Christian at Work is one of the most sprightly, most gladly welcomed in every family of all religious weeklies. It flits from the pulpit to the pew, from the rod of authority to the kiss of love, from the paternal command to the child's obedience, and scatters flowers upon all, breathing content and happiness upon all its readers."—*American Garden.*

### Five Sabbath School Papers,

under the same editorial supervision, are published by us monthly, and are suitable for School or Home. The best and cheapest published. Beautiful premiums with these also.

### Good Words, My Paper, Good Cheer, Old and Young, Der Sonntagsgast. (German.)

We number our papers, but do not date them, making them good at any time.

Two papers with names nearly like our own have lately been issued in New York City. They are not in any way under the supervision of DR. TALMAGE or the control of THE CHRISTIAN AT WORK PUBLISHING COMPANY. Be careful to send your orders direct to the publisher of this paper.

Full particulars and sample copies of all papers furnished on application.

### HORATIO C. KING, Publisher,

July 14 No. 102 Chambers Street, New York.

"The Whispers of Peace."—A beautiful collection of religious gems; sent FREE Give address by postal card. Send now to S. HARRISON & CO., Brooklyn, New York, or H. A. KING, 37 Park Row, New York. aug12

**A**MSDEN PEACH—Earliest and best very early Peach in the world. Buds and trees furnished at Carthage, Mo., or Dayton, Ohio. Buds \$1 per 100, \$8 per 1000, \$70 per 10,000. Good trees \$1 each, \$9 per dozen, \$40 per 100. Full history on application. Address JOHN WAMPLER, Carthage, Mo. [aug12

### LONDON GARDENER'S CHRONICLE

Will be furnished post-paid, direct to subscribers in the U. S. for \$7.50 per year. Specimen Nos. 15 cents. Apply to nov17 CHAS. H. MAROT, Agent, 814 Chestnut St., Phila.

### The Fruit Recorder and Cottage Gardener.



will be sent FREE for 3 months to all applicants. We do not ask any one to subscribe for our paper until they know what they are going to get. It speaks for itself. Price only \$1 per year. Most liberal terms to Club agents of any paper in this country. Purdy's Small Fruit Instructor is a work of 64 pages that tells in simple language just how to grow fruits in abundance for home use or market. Price 25 cents, post-paid.

dec2

A. M. PURDY, Rochester, N. Y.



Contains over 1,200 varieties Vegetable and Flower Seeds. COLORED PLATES. Elegant wood-cuts of vegetables and flowers. Handsomest Guide Published! Send for it. DETROIT SEED CO., Detroit, Mich.

### Harper's Magazine.

ILLUSTRATED.

"Unquestionably the best sustained work of the kind in the World."

Postage free to all Subscribers in the United States.

### TERMS:

HARPER'S MAGAZINE, one year, \$4.00 \$4.00 includes prepayment of U. S. postage by the publishers.

Subscriptions to Harper's Magazine, Weekly and Bazar, to one address for one year, \$10.00; or, two of Harper's Periodicals, to one address for one year, \$7.00; postage free.

An Extra Copy of either the Magazine, Weekly or Bazar will be supplied gratis for every Club of Five Subscribers at \$4.00 each, in one remittance; or Six Copies for \$20.00, without extra copy; postage free.

Back Numbers can be supplied at any time. A Complete Set of Harper's Magazine, now comprising 51 Volumes, in neat cloth binding, will be sent by express, freight at expense of purchaser, for \$2.25 per volume. Single volumes, by mail, post-paid, \$3.00. Cloth cases, for binding, 58 cents, by mail, post-paid.

A Complete Analytical Index to the first Fifty Volumes of Harper's Magazine has just been published, rendering available for reference the vast and varied wealth of information which constitutes this periodical a perfect illustrated literary cyclopaedia. 8vo, Cloth, \$3.00; Half Calf, \$5.25. Sent postage pre-paid.

A series of papers under the title of "The First Century of the Republic," contributed by the most eminent American publicists, is now being published in Harper's Magazine. This series of over twenty papers gives a comprehensive review of Progress during the century now closing, in every department of our national life.

Newspapers are not to copy this advertisement without the express order of HARPER & BROTHERS. Address HARPER & BROTHERS, New York. Jan 1

### WALTER ELDER,

Landscape and Jobbing Gardener,

1231 Rodman Street, Philadelphia,

Attends to all branches of his business on reasonable terms.

**GARDENERS' DICTIONARY.**

By GEO. W. JOHNSON, Editor of "Cottage Gardener."

Describing the Plants, Fruits and Vegetables desirable for the Garden, and explaining the terms and operations employed in their cultivation. New Edition, with a supplement, including the new plants and varieties. 910 pages, 12mo, cloth, fine print. Price, \$3.50. Sent by mail post-paid on receipt of price.

Address, CHAS. H. MAROT,  
814 Chestnut Street, Philadelphia.

**PRACTICAL FLORICULTURE.**

By PETER HENDERSON.

A Guide to the successful cultivation of  
**FLORISTS' PLANTS,**  
for the *Amateur* and *Professional Florist*. Illustrated. 288 pages, 12mo, cloth, Price, \$1.50. Sent by mail post-paid on receipt of price.

Address, CHAS. H. MAROT,  
814 Chestnut Street, Philadelphia.

**GARDENING FOR PLEASURE.**

By PETER HENDERSON.

A guide to the Amateur in the  
**FRUIT, VEGETABLE and FLOWER GARDEN.**  
With full directions for the  
**Greenhouse, Conservatory and Window-Garden.**  
Illustrated. 250 Pages, 12mo, cloth. Price \$1.50. Sent by mail post-paid on receipt of price.

Address CHAS. H. MAROT, 814 Chestnut St., Phila.

**SMALL FRUIT CULTURIST.**

By ANDREW S. FULLER.

Giving Description, History, Cultivation, Propagation, Diseases, &c.

Beautifully Illustrated.

276 pages, 12mo, cloth. Price \$1.50. Sent by mail, post-paid on receipt of price.

Address, CHAS. H. MAROT, 814 Chestnut St., Phila.

**HOW PLANTS GROW.**

By Asa Gray, M. D.

A simple Introduction to Structural Botany, with a Popular Flora, or an arrangement and description of Common Plants, both wild and cultivated. Illustrated with 500 wood engravings. 233 pages, large 16mo, half-arabesque, paper sides. Price \$1 25. Sent by mail post-paid on receipt of price.

Address CHAS. H. MAROT,  
814 Chestnut St., Phila.

**AMERICAN FLOWER GARDEN DIRECTORY.**

By Robert Buist.

With practical directions for the Culture of Plants in Flower-Garden, Hot-House, Green-House, Rooms, or Parlor Windows, for every month of the year. Instructions for erecting Hot-house, Green-house, and laying out a Flower garden. Instruction for cultivating, propagating, pruning and training the Grape vine and description of best sorts for the open air. 342 pages, 12mo, cloth. Price \$1.50. Sent by mail post paid on receipt of price.

Address CHAS. H. MAROT,  
814 Chestnut St. Phila.

**BOOK OF ROSES.**

By Francis Parkman.

Description, Cultivation and Propagation. Beautifully illustrated. 225 pages, 12mo, cloth. Price \$1.50. Sent by mail post-paid on receipt of price.

Address CHAS. H. MAROT,  
814 Chestnut St., Phila.

**ROSE GARDEN.**

By Wm. Paul, F. R. H. S.

Embracing History of the Rose; formation of Rosarium; detailed account of practice for successful cultivation; arrangement in natural groups of most esteemed varieties, English and Foreign, in the most eminent Gardens; with full description and remarks on origin and mode of culture. Numerous illustrations. 256 pages, Royal 8vo, cloth. Price \$3.00. Sent by mail post-paid on receipt of price.

Address CHAS. H. MAROT,  
814 Chestnut St., Phila.

**AMERICAN GARDENER'S ASSISTANT.**

By Thomas Bridgeman.

Containing complete practical directions for the cultivation of Vegetables, Flowers, Fruit Trees and Grapevines. Illustrated. 529 pages, 12mo, cloth. Price \$2.50. Sent by mail post-paid on receipt of price.

Address CHAS. H. MAROT,  
814 Chestnut St., Phila.

**GRAPE CULTURALIST.**

By Andrew S. Fuller.

A treatise on the Cultivation of the Native Grape. Illustrated. 286 pages, 12mo, cloth. Price \$1.50. Sent by mail post-paid on receipt of price.

Address CHAS. H. MAROT,  
814 Chestnut St., Phila.

**WINDOW GARDENING.**

By Henry T. Williams.

Devoted specially to the Culture of Flowers and Ornamental Plants for *In-door use* and *Parlor Decoration*. Splendidly illustrated. 300 pages, med. 8vo, cloth. Price \$1.50. Sent by mail post-paid on receipt of price.

Address CHAS. H. MAROT,  
814 Chestnut St., Phila.

**GARDENING FOR PROFIT.**

By PETER HENDERSON.

A Guide to the successful cultivation of the

**MARKET AND FAMILY GARDEN.**

New and enlarged edition. Illustrated. 276 Pages, 12mo, cloth. Price, \$1.50. Sent by mail post-paid on receipt of price.

Address CHAS. H. MAROT, 814 Chestnut St., Phila.

**CHOICE STOVE AND GREENHOUSE PLANTS,**

By Benj. S. Williams, F. R. H. S.

With descriptions of upwards of eleven hundred species and varieties. Instructions for their cultivation and mode of management. Illustrated with colored frontispiece and numerous splendid illustrations. 686 pages, 2 vols., 12mo, cloth. Price \$5.00. Sent by mail post-paid on receipt of price.

Address CHAS. H. MAROT,  
814 Chestnut St., Phila.

**BOOK OF EVERGREENS.**

By Josiah Hoopes.

A practical treatise on the Coniferae or Cone-bearing plants. Handsomely illustrated. 435 pages, 12mo, cloth. Price \$3.00. Sent by mail post-paid on receipt of price.

Address CHAS. H. MAROT,  
814 Chestnut St., Phila.

Index to Advertisements.

Advertisers are requested to have orders in hand as EARLY AS POSSIBLE. Copy received after the 23rd of each month cannot be INSURED insertion in the next issue.

Alberts G. J., Boskoop, Netherlands..... 8  
 Allen S. L., Philadelphia..... 8  
 Allison W. L., New York city..... 2  
 Baker, Davis & Co., Philadelphia..... 15  
 Bayersdofer M. M. & Co., Philadelphia..... 10  
 Bliss B. K. & Sons, New York city..... cover  
 Boalt G. & S., Norwalk, Ohio..... 6  
 Bowditch W. E., Boston, Massachusetts..... 16  
 Briggs & Bro., Rochester, New York..... 8  
 Brownell S. E., Brocton, N.Y..... 2  
 Bryan Clark W. & Co..... 12  
 Buist R., Jr. Philadelphia..... 9  
 Christian at Work, New York city..... 18  
 Conring A. M. C. J., Dedemsvaart, Netherlands..... 16  
 Detroit Seed Co., Detroit, Michigan..... 18  
 Domestic Sewing Machine Company, New York city..... 6  
 Douglas Robert & Sons, Waukegan, Illinois..... 11  
 Dreer Henry A., Philadelphia..... 6  
 Dunham J. H., Chicago, Illinois..... 20  
 Elder Walter, Philadelphia..... 20  
 Ellis Chas. R., New York city..... 15  
 Ellwanger & Barry, Rochester, New York..... 16  
 Elverson & Sherwood, New Brighton, Pennsylvania..... 14  
 Ferry D. M., Detroit, Michigan..... 14  
 Goodspeed H. S. & Co., New York city..... 20  
 Gregory James J. S., Marblehead, Massachusetts..... 2  
 Hance A. & Son, Red Bank, New Jersey..... 2, 6, 12  
 Harding W. T., Columbus, Ohio..... 20  
 Harper & Brothers, New York city..... 18  
 Harrison S. & Co., Brooklyn, New York..... 18  
 Hews A. H. & Co., North Cambridge, Massachusetts..... 9  
 Henderson Peter & Co., New York city..... 15, cover  
 Hemming C. C., Brenham, Texas..... 18  
 Hitchings & Co., New York city..... 3  
 Hoopes Bros. & Thomas, West Chester, Pennsylvania..... 4  
 Hubbard T. S., Fredonia, New York..... 11  
 James Edward A..... 20  
 Jilz Angus Co., St. Louis, Missouri..... 8  
 King H. A., New York city..... 8  
 Knauth, Natchod & Kuhne, New York city..... 10  
 Lord's Horticultural Works, Irvington, New York..... 13  
 Lynex Richard, Philadelphia..... 16  
 Marot Chas. H., Philadelphia..... 17, 18, 19, Fly-leaf  
 McCurdy & Co., Philadelphia..... 20  
 Meehan Thomas, Germantown, Philadelphia..... 2, 4, 9, 14  
 Moody E. & Sons..... 16  
 Myers Thos. J. & Sons, Philadelphia..... 11  
 Myers Thos. J. Jr., Philadelphia..... 10  
 Miller & Haves..... 11  
 New York World, New York city..... 12  
 Nimmo Alexander, Brooklyn, New York..... 12  
 Paillet L., Paris, France..... 13  
 Parsons S. B. & Sons, Flushing, New York..... cover  
 Practical Farmer, Philadelphia..... 12  
 Purdy A. M., Rochester, New York..... 18  
 Raoux C., New York city..... 8  
 Rolker A. & Sons, New York city..... Fly-leaf  
 Rotereau F. E. & Co., Angers, France..... 2  
 Saul John, Washington, D. C..... 2  
 Saunders D. I., Washington, D. C..... 16  
 Scientific Farmer, Springfield, Massachusetts..... 12  
 Scollay John A., Brooklyn, New York..... 11  
 Scott D. W. & Co., Galena, Illinois..... 12  
 Shaw Thomas, Danville, Pennsylvania..... 2  
 Sked, Paddock & Co., Cleveland, Ohio..... 2  
 Steffens N., New York city..... 8  
 Straiton & Storm, New York city..... 8  
 Such George, South Amboy, New Jersey..... 1  
 Thanhauser S., Philadelphia..... 4  
 Thompson H. C., Warren, Maryland..... 15  
 Thorburn J. M. & Co., New York city..... 6  
 Transon, P. & E., Orleans, France..... 10  
 Tuttle A. G., Baraboo, Wisconsin..... 8  
 Vick James, Rochester, New York..... 12  
 Wampler John, Carthage, Missouri..... 18  
 Wheeler W. F., Boston, Massachusetts..... 5, 14  
 Whitman & Lang, Philadelphia..... 9  
 Wilkinson George, Providence, Rhode Island..... 15  
 Wilson William C., New York city..... 6  
 Wood Edmund M., Boston, Massachusetts..... 4, 7

**FOR SALE—Rare Chance.** A Greenhouse, nearly new, well stocked, good local business established, 12 miles from Boston 7 minutes walk from depot; also, 2 acres of excellent land. Apply to EDWARD A. JAMES, Weymouth, Mass.

[Jan 1

**FOR RENT—**For a term of years, Glass-houses, 200 feet long, with hot water, furnaces and pipes. Dwelling house (8 rooms) with 30 acres of cultivated garden, one mile south of the city of Chicago. Rare chance for a FLORIST. J. H. Dunham, 10 State st., Chicago.

**WANTED.**

ON account of the Legislature having failed to make the appropriation required for the Agricultural College, Columbus, Ohio, the Trustees are obliged to dispense with my services as Gardener to that Institution. In consequence, the advertiser is at liberty to engage with any one requiring a good, practical man in that capacity. Has been thoroughly trained to the profession, and has had every facility in various parts of the world to acquire a thorough knowledge of horticulture in all its branches. Eighteen years experience in this country. Good testimonials. Address, W. T. HARDING, nov1 John street, Columbus, Ohio.

**FOREMAN WANTED,**

A reliable man, in a Western Commercial Garden, where some ten or twelve hands are employed.

Must have a knowledge of flowers and vegetables, and be able to command the work in a practical manner, both in the Garden and Greenhouse.

This is a situation where Great Trust is required, and no second-class man need apply. Best references required from previous places.

Address in applicant's own hand, and inform of expected salary.

N. M., Room 13,  
College Building,

Jan 1 Cincinnati, Ohio.

**1000 Agents Wanted** at once for a new Religious Work, popular with all denominations, and sure to sell in every family. Positively the very best chance of the year for first-class agents. For circulars, address nov3 H. S. Goodspeed & Co., 14 Barclay St., N. Y.

**PARTNER WANTED**

IN the Nursery Business. \$2,050 will secure a half interest in the stock of a small Nursery. References given and required. Address "BUSINESS," Torresdale P. O.,

Jan 1 23d Ward, Philadelphia.

**SITUATIONS WANTED.**

A Gardener and Florist's situation wanted by a man of over sixteen years experience in some of the best Horticultural establishments in England and this country, where he has had every facility to acquire a thorough knowledge of the profession in all its branches; is capable of managing any Horticultural establishment, either commercial or private. First-class testimonials. Address T. J. Gardener, Lock Box 4, Morristown, N. Jersey.

BY a first-class Gardener who understands the business in all its branches. Would engage as Foreman in a commercial establishment, or gardener to a private gentleman. Has had 20 years' experience in first-class places and can give the very best of reference. For particulars apply to or address C. E. Sutherland, Landscape Gardener, 21st street, below Green street, Philadelphia.

BY a young man as Foreman and propagator in a commercial establishment. Understands the business thoroughly and can come well recommended. Address, H., Florist, care of H. Rainey, 1713 Chestnut street, Philadelphia.

TO take charge of a first-class private or florist establishment, as Foreman and propagator, where the service of a good man is required. Has had many years' experience in the business. Can give satisfactory reference as to ability, sobriety, &c. Address in the care of J. Dick, florist, 528 Woodland avenue, Philadelphia.

**100 Farmers wanted during the Winter, to engage with us in business paying 100 DOLLARS per month.** For full particulars, address

J. C. McCurdy & Co., Philadelphia, Pa.

tdcc3

# MUST BE SOLD TO MAKE ROOM!

We offer for the Month of JANUARY fine healthy stock of the following named

## PLANTS,

Guaranteeing safe delivery of same, if sent by Express.

	Per 100.		Per 100.
<b>Achyranthes</b> , 4 distinct sorts.	\$4.00	<b>Lemon Verbenas</b> , strong plants,	6.00
<b>Alternantheras</b> , 4 distinct sorts,	4.00	<b>Lobelia</b> , new double blue,	4.00
<b>Basket Plants</b> , 25 different sorts.	4.00	“ six distinct and beautiful sorts,	4.00
<b>Carnations</b> , large stock plants, 6 finest		<b>Lygodium Scandens</b> , (Japanese Climbing Fern),	8.00
Winter flowering sorts,	20.00	<b>Mesembryanthemum cordifolium</b>	
<b>Carnations</b> , 25 sorts, 3 inch pots,	6.00	var. (var'd Ice plant),	6.00
<b>Caladiums, Fancy</b> , 25 distinct sorts,	12.00	<b>Mosses</b> , (Lycopodiums and Selaginellas)	
<b>Calceolaria Aurea and Brown</b>		6 sorts,	4.00
Prince,	6.00	<b>Peperomia maculosa</b> , 3 inch pots,	6.00
<b>Centaurea Candida</b> , white leaved,	10.00	<b>Petunia</b> , double, 6 sorts,	6.00
“ <b>Gymnocarpa</b> , white leaved,	6.00	<b>Pentstemons</b> , 6 distinct sorts,	4.00
<b>Coleus</b> , Golden and Velvet, 25 best sorts,	4.00	<b>Roses</b> , Monthly, Tea, Bourbon and Bengal, 50 best sorts. Hybrid Perpetual and Hardy Climbing, 40 best sorts.	
<b>Cineraria Asplenæfolia</b> , white leaved,	4.00	Winter flowering, 6 leading sorts.	
<b>Dianthus Querteri</b> (German Pink),	4.00	Prices of the above Roses:	
<b>Dahlias</b> , dry roots, 100 sorts, bouquet and large flowering,	10.00	Our selection of sorts, 3 inch pots,	8.00
<b>Echeveria</b> , 4 distinct sorts,	6.00	Buyers' “ “ 3 “ “	10.00
<b>Eulalia Japonica</b> , variegated grass,	18.00	Our “ “ 4 “ “	12.00
<b>Fittonia</b> , (Gymnostachyum) 4 sorts,	4.00	Buyers' “ “ 4 “ “	15.00
<b>Fuchsias</b> , 25 sorts, 3 inch pots,	6.00	<b>Smilax</b> , (Myrsiphyllum asparagoides),	
<b>Geraniums</b> , Double, in 12 sorts,	6.00	2½ inch pots,	4.00
“ <b>Zonale</b> , 30 leading sorts,	6.00	<b>Verbenas</b> , named in 60 varieties, \$3 per set,	5.00
“ <b>Ivy leaved</b> , 12 sorts,	6.00	“ to special name or special color,	5.00
“ <b>Silver and Bronze</b> , 12 distinct sorts,	8.00	“ in twelve best market sorts,	4.00
<b>Hibiscus</b> , 3 sorts,	6.00	“ mixed, without name or color,	3.00
<b>Ivies, English</b> , three feet long,	12.00	<b>Violet</b> , double blue Neapolitan, 2½ inch pots,	4.00
<b>Latania Borbonica</b> , (Fan-leaved Palm), 3 inch pots,	8.00	“ <i>Marie Louise</i> , dark blue, 2½ “	4.00

We also offer a full assortment of

## FLORISTS' REQUISITES,

Consisting of all Styles of WIRE DESIGNS for CUT FLOWERS, FRENCH IMMORTELLS and GRASS BOUQUETS, BOUQUET PAPERS, GARDEN TRELLISES, PLANT STANDS, RUSTIC WORK, and many other articles, all of which are priced *very low* in our *Monthly Wholesale List*, mailed free to those who apply.

**PETER HENDERSON & CO.,**

35 Cortlandt St., New York,

# S. B. PARSONS & SONS,

## Kissena Nurseries,

### Near KISSENA STATION, FLUSHING, N. Y.,

OFFER a very large assortment of **TREES** and **PLANTS** of all the best families. Nearly all of them have been two years transplanted, and their roots are thus in the very best possible condition for a second transplanting.

Their assortment of **RARE EVERGREENS** has long been known to be the most complete. They now have in cultivation a very large variety of hardy

## Deciduous Trees and Shrubs,

numbering over **800** sorts, of which **300** sorts, one year grafted, are entirely new and have not yet been in their catalogue.

Their **JAPANESE DEPARTMENT** now includes more than **150** varieties in addition to the above, and is being constantly enriched by **Thomas Hogg**, now in Japan. Many of these varieties are unknown in Europe. The celebrated **JAPANESE MAPLES** and **AZALEA MOLLIS** are alone worthy of a visit.

**CAMELLIA JAPONICA** and **AZALEA INDICA** can be advantageously shipped during September, October and November; September being preferred. These plants are carefully formed and trimmed, and their symmetry is recognized by all who see them.

**Rhododendrons** and other hardy **Evergreens** can be safely transplanted in September.

*Estimates will be furnished for Planting Grounds under the care of an experienced Landscape Gardener, and much trouble thus saved to the owner.*

Catalogues will be furnished to applicants by mail, and those who wish to visit the Nurseries will always find either one of the proprietors, or **J. R. Trumpy**, the well-known propagator of the old establishment. They can take the ferries at **34th Street** or **James' Slip**, which connect with the railroad, leaving the first a quarter of an hour, and the last half an hour before the departure of trains, which make the transit in half an hour. The Nursery is adjoining the **Kissena Station** and one and a half miles from the other station. sep

RARE AND BEAUTIFUL FLOWERS AND CHOICE VEGETABLES  
CAN ALWAYS BE OBTAINED BY SOWING



**B. K. BLISS & SONS,**  
Importers, Growers and Dealers in

**GARDEN, FIELD & FLOWER SEEDS, SMALL FRUITS,**  
Agricultural and Horticultural Implements,

**FERTILIZERS, AND OTHER REQUISITES FOR THE FARM AND GARDEN.**

THE **TWENTIETH ANNUAL EDITION** of our celebrated **SEED CATALOGUE** and **AMATEUR'S GUIDE** to the **FLOWER** and **KITCHEN GARDEN**, containing upwards of **200** pages, including several hundred finely executed engravings of favorite flowers and vegetables, and a **BEAUTIFULLY COLORED CHROMO**, with a **SUPPLEMENT** for 1876, is now in press, and will be mailed to all applicants upon receipt of **35 cents**. An edition elegantly bound in cloth, **\$1.00**.

**Bliss's Gardeners' Almanac for 1876**, and **Abridged Catalogue**, Illustrated, containing upwards of **120** pages, and embracing a monthly calendar of operations and a price list of all the leading **Garden, Field and Flower Seeds**, with brief directions for their culture. A copy will be mailed to all applicants inclosing **10 cents**.

**Bliss's Illustrated Potato Catalogue**, with explicit directions for culture, mailed to applicants inclosing **3c.** stamp.

ADDRESS

**B. K. BLISS & SONS,**

P. O. BOX 5712.

[dec]

**34 Barclay Street, New York.**





THE  
GARDENERS'  
And MONTHLY  
HORTICULTURIST

EDITED BY THOMAS MEEHAN.

Vol. XVIII.

No. 206.

(Combined Magazines, Thirty-first Year.)

**FEBRUARY, 1876.**

PUBLISHED BY CHARLES H. MAROT,  
814 Chestnut Street, Philadelphia.

TERMS—\$2.10 PER YEAR—POSTAGE PAID.



Wm. Zierler & Co.

J. H. Stockton, Sr.

# THE GARDENER'S MONTHLY AND HORTICULTURIST.

EDITED BY THOMAS MEEHAN,

Assisted by an able Corps of AMERICAN and FOREIGN CORRESPONDENTS.

It is published on the first of every month, at the office, No. 814 CHESTNUT STREET, PHILADELPHIA, where all BUSINESS communications should be addressed.

Communications for the Editor should be addressed: THOMAS MEEHAN, GERMANTOWN, Philada.

SUBSCRIPTION PRICE, Postage paid, \$2.10.

## TERMS OF ADVERTISING.

	1/2 col.	1/3 col.	1/4 col.	1/5 col.	1/6 col.	1 col.	1 page.
One Time, . . . . .	\$3.00	\$4.00	\$6.00	\$8.00	\$12.00	\$24.00	\$48.00
Two to Three Times, each,	2.70	3.60	5.40	7.20	10.80	21.60	43.20
Four to Six Times, " "	2.25	3.00	4.25	6.00	9.00	18.00	36.00
Seven to Nine Times, " "	2.00	2.70	4.00	5.35	8.00	16.00	32.00
Ten to Twelve " " "	1.80	2.40	3.60	4.80	7.20	14.40	18.80

Twelve lines nonpareil is 1/2 col. A less space than 1/2 col. will be furnished at rates in exact proportion, line for line. For THIRD and LAST COVER PAGES; FIRST PAGE advertisements facing reading matter; "FLY-LEAF PAGE" (front of number) before reading matter and facing first cover.—special figures will be given on application. Changes of copy within space ordered may be made as often as suits advertiser's convenience or interest. COPY and orders for NEW advertisements should be in hand by the 23d of each month; and CHANGES of COPY in running contracts by the 16th of each month, to insure them in following issue. Address

CHAS. H. MAROT, Publisher, 814 Chestnut Street, Philadelphia.

## CONTENTS OF THE FEBRUARY NUMBER.

<b>SEASONABLE HINTS:</b>		
Flower Garden and Pleasure Ground.....	33-34	
Green-House and House Gardening.....	39-40	
Fruit and Vegetable Gardening.....	45-47	
<b>CORRESPONDENCE:</b>		
Touching the Hardihood of Conifers.....	34	
Celastrus Scandens.....	35	
Trees in Cities.....	35	
Growing the Poinsetta.....	40	
Bouvardia Humboldtii Corymbiflora.....	40	
Tar in Greenhouses.....	42	
Notes on a Summer's Tour.....	42	
Hot Water Heating.....	44	
The Icing Water-Melon.....	47	
Management of the Bark of Fruit Trees.....	47	
Don't Use the Hatchet or Saw.....	47	
That Little Turk.....	58	
Grapes—Training and Mildew.....	49	
Do Plants Need Water.....	52	
The Potato Disease.....	53	
Tobacco as Manure.....	54	
Resting Spores of the Potato Fungus.....	54	
Kansas State Horticultural Society.....	62	
<b>EDITORIAL NOTES:</b>		
Preparing Timber—Forest Planting in Massachusetts— Spiraea Sorbifolia—Hardy Begonias—Pinus Cembra— Wild Gardens—An Election for Roses—Acer striatum— Achillea umbellata for White Edgings—Mammoth Rose Tree.....	35-37	
Roses for Winter Buds—Tacsonia insignis—Hardi- ness of the Coffee—Lilies of the Valley—Bouvardia jasminiflora—Names of Ferns—Violet Victoria Regina—Geranium, Happy Thought—Olea Fragrans.	44-45	
Fruiting of Hickory Trees—Preserving Grapes for Winter Use—Planting Hickories—Good Old Strawber- ries—The Wilder Pear—Trained Gooseberries—The European Sparrow and the Fruit Buds—The Three Earliest Peaches.....	50-51	
Pinus Aristata—Utilizing the Rain—Rofia Fibers— Pronunciation of De Candolle—New Colorado and California Plants—Fertilization of Campanula—Vari- ability of Conifers—Australian Grape Fungus—The Pear (Pyrus Communis), and Apple (Pyrus Malus.— Species of American Plums.....	55-58	
Acknowledgments—A Wedding in Iowa—Where Plants can be Purchased—Latin Names for Garden Varieties—Pottsville, Pa—Low Price of American Nursery Stock—Responsibility of Seedsmen—Flowers in Cemeteries—Ann. Report Penna. Fruit Grower's Society, 1875—Sixth Biennial Report Board Trustees, Iowa State Agricultural College, 1874 and 1875—David Webster—John Ellis—Text Book of Scientific Agricul- ture—Landreth's Rural Register—Vick's Flower and Vegetable Garden—Centennial Historical Calendar— American Naturalist—Rural Journal—The Garden— Practical Farmer.....	59-61	
Southern States Agricultural and Industrial Expositi- on—The Centennial Exhibition.....	63	
<b>NEW PLANTS:</b>		
Dahlia gracilis—Gladolus cruentus—Rhus panacifor- mis—Rhus Rufa—Fraxinus longicupsis—Wistaria macrobotrys—Magnolia Campbelli—Gymnothrix latifolia—Viburnum Awafuki—Tamarix plu rosea— Daphniphyllum Roxburghii.....	37-38	
<b>NEW FRUITS:</b>		
Marshall Pear.....	51-53	
<b>NATURAL HISTORY AND SCIENCE.....</b>		51-53
<b>LITERATURE, TRAVELS AND PERSONAL NOTES.....</b>		59-62
<b>HORTICULTURAL SOCIETIES.....</b>		62-64
<b>QUERIES:</b>		
Rare Evergreens in Maryland—Disease in Evergreens —Chiccoca racenosa—Raising Thorn Seed.....	38-39	
Diseased Geranium Leaves.....	45	
Plum Culture—Variation in Apples—Grape Borders— Blush Pippin Apple.....	52	
Dracera Roots and Water—Cross Fertilization of Fruits—Plants' Names—Fungi.....	58	
Pronunciation of Gladolus—Forestry—Re-printing the first Volume.....	62	

# AUGUST RÖLKER & SONS,

32 Reade St., New York.

## OUR CATALOGUE OF FLORISTS' SUPPLIES

NOW READY.

Containing a full list of all the wants of Florists in Imported and Domestic Goods.  
Will be mailed free of charge, on application.

BOUQUET HOLDERS AND HANDLES, STRAW AND WILLOW BASKETS,  
WIRE DESIGNS

FOR CUT FLOWERS, POT COVERS, FANCY POTS.

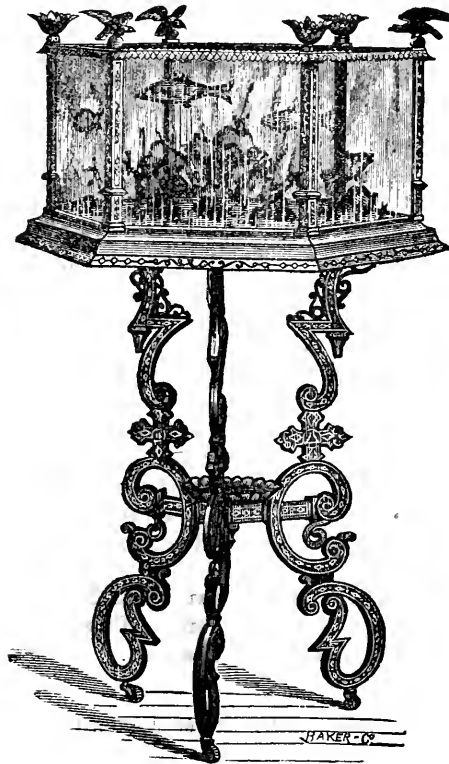

FERNERIES, FERNERY BASES, AQUARIA, AQUARIA WARE, TOOTHPICKS, TINFOIL, DRIED GRASSES.

WHITE AND COLORED IMMORTELLS, FRENCH MOSS, FALL LEAVES, FERNS,

IMMORTELLE WREATHS, INSCRIPTIONS and all NOVELTIES of the SEASON.

We can offer yet, of fresh importation, a few choice Bulbs in

HYACINTHS, TULIPS, CROCUS, &c.

Jan 12.

We request your orders, which shall receive our prompt attention, addressed to P. O. Box 899.

1876.

1876.

# CENTENNIAL ERA.

---

## CONSOLIDATION

OF

# TWO MAGAZINES.

The "HORTICULTURIST" of New York City, having been purchased in the interest of the GARDENER'S MONTHLY, the former Magazine issued its last number with December, 1875, when it completed its Thirtieth year. Henry T. Williams, its late editor and proprietor, gives it up in order to confine his attention more effectively to the other branches of his expanding business.

THE GARDENER'S MONTHLY, with the present issue will be hereafter known as the "GARDENER'S MONTHLY AND HORTICULTURIST." It is, at this date, the *only Monthly Magazine* devoted to *Horticulture*, in the *United States, East of the Rocky Mountains*. It will continue under the able Editorship of THOMAS MEEHAN, and will as heretofore do its best to deserve the consideration and support of the increasing numbers, who, through cultivation, taste, interest, desire the companionship or aid of such a literature.

The subscribers of the GARDENER'S MONTHLY and those of the late HORTICULTURIST are kindly requested to give their encouragement to this consolidation, by an early renewal of their own subscriptions, and, if possible, the enclosure of, each, a new subscriber with their own orders.

The lovers of Horticulture generally are asked to give the Magazine a year's trial.

Single Subscription Price, \$2.10 per Year. Six Months for \$1.05; Four Months for 70 cents; Three Months for 53 cents. One Old with one New Subscriber, or Two New Subscribers, \$3.20 for the two.

Remit by Post Office Order, Draft, or Registered Letter, to avoid possible loss by miscarriage through the mails.

ADDRESS

## CHAS. H. MAROT,

PUBLISHER,

814 CHESTNUT STREET, PHILA.



SEE FIRST PAGE, FACING COVER.

MY  
CATALOGUE OF PLANTS

FOR THE  
SPRING OF 1876,

Will be ready about February 1st. It will contain an unusually fine assortment of Novelties in the way of

CANNAS, GERANIUMS, HELIOTROPES.

PELARGONIUMS, VERBENAS, &c.

Also, an admirable assortment of new and beautiful

FRENCH HYBRID GLADIOLUS,

Which are offered in large quantities at LOW RATES. Also,

TUBEROSE BULBS OF THE VERY BEST QUALITY.

Particular attention is called to my

STOCK PLANTS OF VERBENAS,

containing a fine selection of Varieties, all in vigorous health. Attention is also called to my list of

EXTRA CHOICE

FOREIGN GRAPES FOR GRAPERIES.

Catalogues may be had FREE OF CHARGE by addressing

GEORGE SUCH,

# FRUIT AND ORNAMENTAL TREES FOR SPRING, 1876.

**ELLWANGER & BARRY**, Proprietors of the well known Mount Hope Nurseries at Rochester, N. Y., founded 40 years ago, and now covering 600 acres of land, invite the attention of **PLANTERS, NURSERYMEN and DEALERS**, to the extensive, varied and well grown stock, which they now offer for the Spring trade, embracing **STANDARD and DWARF FRUIT TREES**, the largest and most complete collection in the U. S., including all **New and Rare Fruits**—Sour du Congres and other New Pears—Rivers' and New American Peaches—**Grape Vines** for Vineyard and Gardes—**Foreign Grapes** for culture under glass—**Currants, Raspberries, Strawberries**, and all the Small Fruits—as well as **Figs, Nuts, etc.**

**ORNAMENTAL TREES, EVERGREENS, SHRUBS**, including **New and Rare Deciduous Trees**, Upright and Drooping, Cut-leaved, Variegated-leaved and Purple-leaved—**Evergreens**, for specimen trees and for hedges—**Shrubs, Flowering, Climbing, etc.**—**Roses** a specialty—**Paeonies, Clematis Jackmanni—Hardy Border Plants—Green-House, Hot-House and Bedding Plants** in great variety.

Descriptive and Illustrated priced Catalogues sent prepaid on receipt of stamps, as follows: No. 1. Fruits (new ed., with colored plate), 15 cts.; without, 10 cts. No. 2. Ornamental Trees, with col'd plate of Roses, 25 cts. No. 3. Greenhouse, Free. No. 4. Wholesale, Free. No. 5. List of New Roses for 1876, Free. Nos. 1 & 2—Neatly bound together, forming an interesting and valuable book for reference, 50 cts. by mail postpaid. Small parcels forwarded by mail when desired. Prompt attention given to all orders and inquiries.

Address—**ELLWANGER & BARRY, Rochester, N. Y.**

## R. B. PARSONS & CO., BOWNE AVENUE, FLUSHING, NEW YORK,

OFFER A GENERAL ASSORTMENT OF THE BEST

### TREES AND SHRUBS.

Our Office and Greenhouses being at the location once occupied by the old house of Parsons & Co. (now dissolved), of which R. B. Parsons was a member, visitors will find it quite accessible from either the Bridge or Main Street Railroad Stations.

We cultivate in great quantity and offer to

**LARGE BUYERS,**

a fine stock of **RARE TREES and SHRUBS**, embracing

**Rhododendrons of the certainly Hardy Sorts,**

**AZALEAS—CHINESE and GHEENT—CAMELLIAS, MAGNOLIAS, PURPLE BEECH, CLEMATIS; ROSES of Best Sorts and Quality.**

The attention of **DEALERS** is invited to our stock. For Catalogues, address,

feb3

Box 99, FLUSHING, NEW YORK.



I have founded my business on the belief that the public are anxious to get their seed *directly from the grower*, and I therefore offer **FREE** to every man and woman in the United States who cultivates a farm, tills a vegetable garden, or plants a flower garden, my large, Illustrated Catalogue of Vegetable and Flower Seeds for 1876; it contains, in addition to the choicest kinds produced in Europe, *one hundred and fifty varieties of vegetable seed grown on my four seed farms*. Customers of last season need not write for it. As the original introducer of the Hubbard, Marblehead and Butman Squashes, Phinney's Melon, the Marblehead Cabbage, and a score of other new vegetables, I solicit your patronage. All seeds sold under three warrants. A 100,000 catalogues will be issued and sent out the 1st of January.

JAMES J. H. GREGORY,  
Marblehead, Mass.

dec5

## GRAPE VINES

Grown especially for the Trade and Planters in Quantity. **CONCORD, MARTHA, Delaware, Hartford, Prolific, Ives, Salem, Wilder, Iona**, and many other varieties, one and two years old, in quantity.

A. HANCE & SON,

novtf

Nurserymen and Florists, Red Bank, N. J.

## TO THE TRADE.

A choice collection of **POPULAR PLANTS** for the Spring Sale of 1876. Send for price list. **L. B. CASE,**  
Richmond, Ind.

## SCHMITZ'S NEW DAHLIAS, FOR 1876.

Acis, Lilac, shaded.  
Adah Purple, golden tip.  
Ajax, Pure white, full centre, (Liliput).  
Amazon, Primrose, full centre.  
Beatrice, Plush, full centre.  
Beppo, Primrose, tipped with scarlet.  
Estella, Creamy white, perfect form.  
HIAWATHA, Blush white, full centre.  
Jewel, Bright scarlet.  
Mabel, Creamy white, full centre.  
Mira, Yellow and purple.  
Rosina, Bright rose, full centre.  
Siguet, Lilac, striped with crimson.  
Siren, Bronze, full centre.  
Soleil, Yellow, tipped with scarlet.  
Trojan, Yellow, tipped with rose, full centre.

Price \$2.00 per ground Root. \$20.00 per dozen.  
Discount to the Trade.

The above list comprises a selection of the very best Dahlias from the large collection of seedlings raised annually, by the celebrated Dahlia Grower, MR. GERHARD SCHMITZ. Introduced and sent out by

HENRY A. DREER, Seedsman and Florist,

feb1

714 Chestnut Street, Philadelphia.

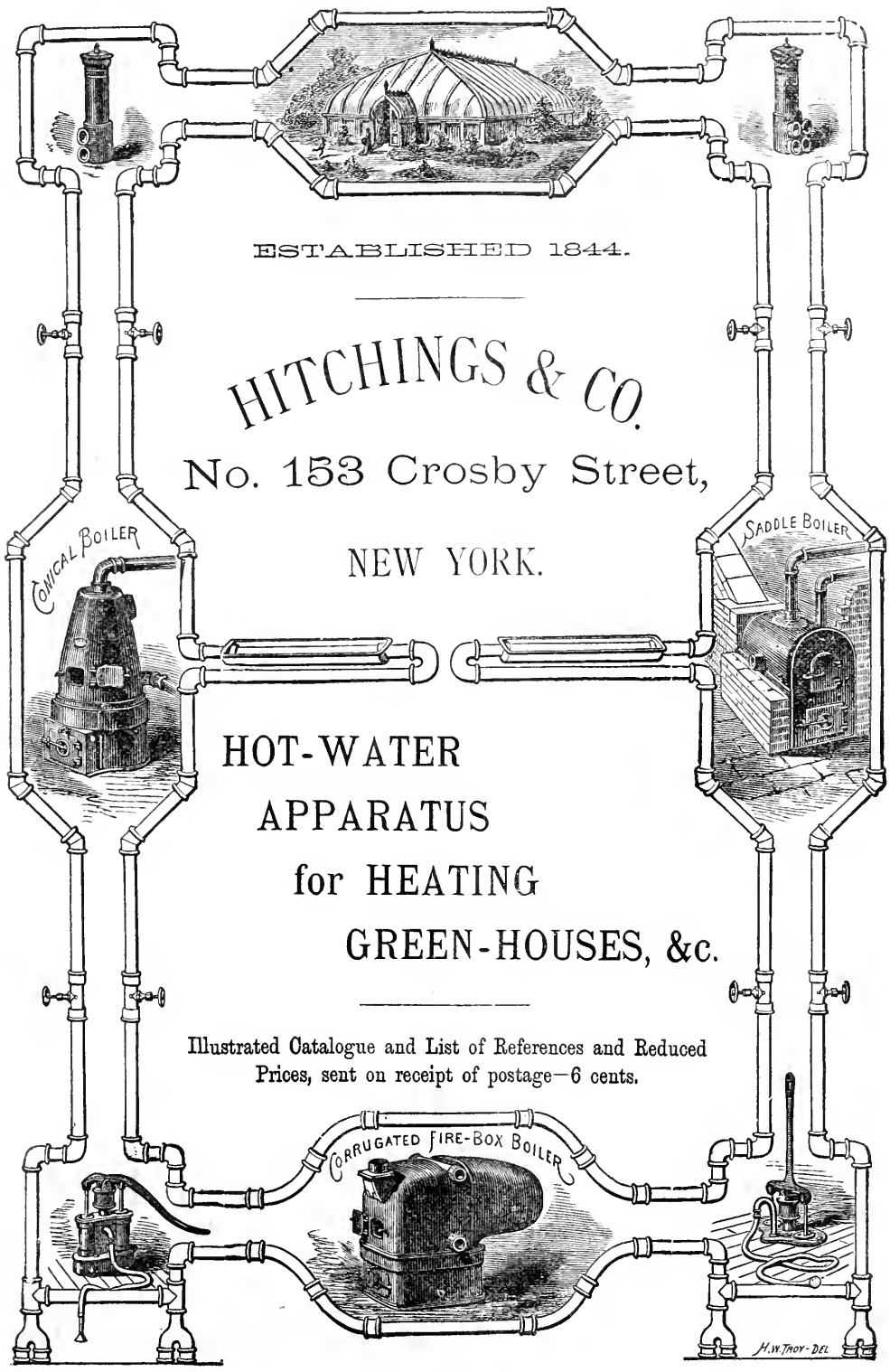

ESTABLISHED 1844.

HITCHINGS & CO.  
No. 153 Crosby Street,  
NEW YORK.

HOT-WATER  
APPARATUS  
for HEATING  
GREEN-HOUSES, &c.

Illustrated Catalogue and List of References and Reduced  
Prices, sent on receipt of postage—6 cents.

H. W. TROY - DEL.

# HYBRID PERPETUAL ROSE,

## "EDMUND WOOD."

We are gratified to find that our friend M. VERDIER, the most celebrated Rose grower of France, has considered our establishment of sufficient importance to name one of his finest New Seedlings after our Mr. EDMUND M. WOOD. In a special circular containing the names of his choicest New Varieties, he thus describes it: *Edmund Wood*: tree vigorous, with short reddish-green branches and numerous dark brown spines, leaves consisting of 3 to 5 leaflets oval, dark green; Flowers, large, full and perfect in form, growing in corymbs of 6; color lively, bright cherry red, reverse of petals, carmine—admirable. This variety is comprised in the series to which the silver gilt medal was awarded by the Paris Horticultural Society in May and June, 1875. Depending upon the correctness of this description and the well-known veracity of Mons. Verdier, we have arranged for the importation in quantity of this variety with all the others raised last year in Europe, and shall offer it to the public of the United States on and after May 1st, at \$2 each. Orders will be executed in strict priority as they are received.

OUR NEW DESCRIPTIVE CATALOGUE, containing names and characters of all the best Roses, new and old, at present in cultivation, will be ready in a few days, and may be had on application.

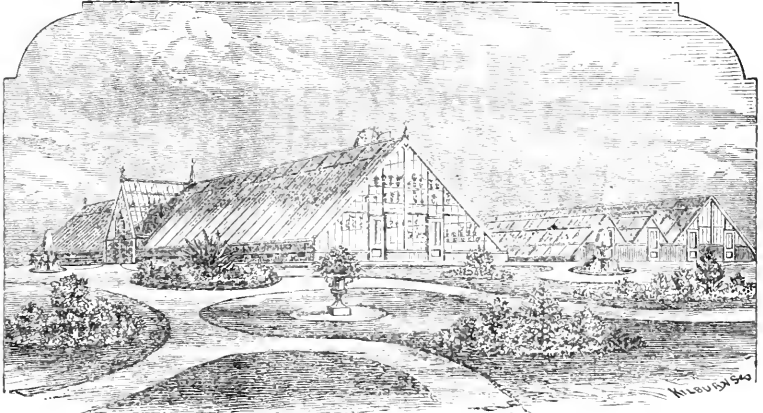

EDMUND M. WOOD & CO.,

OFFICE OF

WABAN CONSERVATORIES,

56 BROAD STREET, BOSTON, MASS.

tjan12

M. M. BAYERSDORFER & CO.,

Importers of Every description of

BOUQUET PAPERS.

Plain White Satin for Bridal Bouquets. Fancy Lace for Weddings, Receptions, Parties. Italiens, Pasted Cartons, Immortelles in great varieties; Green Moss, French Dried Grasses and Flowers. Tin Foil. Prize Medal of Cincinnati Industrial Exposition of 1873 awarded to us for the best display of Bouquet Papers. Illustrated Catalogue furnished on application.

feb 56 N. Fourth St., Philadelphia, Pa.

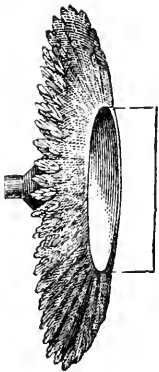

# THE NEW BLOOD BIRCH AND YELLOW WEEPING ELM.

The New Weeping Elm—*Ulmus Fulva Pendula*,

Is one of the most striking additions to our Ornamental Trees that we have introduced for some time. The branches are extremely vigorous; some from a height of ten feet arching over and touching the ground in a single season. It will be immensely popular, and nurserymen will do well to secure a plant for a specimen on their grounds and for propagation.

THE NEW BLOOD BIRCH promises to be even more popular than the celebrated Blood Beech. We have grown it the past year and find it all that has been claimed for it in Europe. A Limited Stock of each of the above is now offered at \$5.00 each.

THOMAS MEEHAN, Germantown, Phila.



*John Saul's  
Catalogue  
of New, Rare  
and Beautiful  
Plants.*

FOR SPRING OF 1876,

Will be ready in FEBRUARY, with a Colored Plate. Many beautiful

NEW PLANTS

are offered; all at VERY LOW RATES. Free to all my Customers; to others, 25 cents a copy. A plain copy to all applicants free.

- New Pelargoniums.**—A magnificent set of beautiful flowers.
- New Perpetual Pelargoniums.** Very distinct—beautiful.
- New Bergonias, tuberosus rooted.** A beautiful set.
- New Cannas.** Beautiful and distinct in foliage.
- New Zonale and Double Geraniums.** Raised by Mr. Laxton, Dr. Denny and others.
- New Victoria Daisies, new sets of Fuchsias, Roses, Phloxes Heliotropes, Dahlias, Chrysanthemums, Ageratum, Hibiscus, Caladiums, Clematis, &c.,** with other New and Rare Plants.

ROSES.

An immense stock of all the standard varieties grown in pots. CHEAP.

NEW FRUITS.

NEW PEARS, PEACHES, STRAWBERRIES, &c.

**NEW SHRUBS and ORNAMENTAL TREES,** with a large general Nursery Stock—Fruit Trees, Evergreens, &c., Norway Spruce, Austrian Pine, Silver Fir, and other Small Evergreens, Fruit Tree Stocks, &c., suitable for Nurserymen. CATALOGUES mailed to applicants.

JOHN SAUL,

feb3

Washington City, D. C.

FLOWER SEEDS.

Our **DESCRIPTIVE CATALOGUE** of Flower Seeds, with all the

NOVELTIES FOR 1876,

is now ready for mailing to applicants, also,

CATALOGUE OF SPRING BULBS,

also, Catalogue of

Vegetable and Agricultural Seeds.

J. M. THORBURN & CO.,

jan3

15 JOHN STREET, NEW YORK.

**ROSES, VERBENAS**  
BEDDING AND EXHIBITION PLANTS  
Sweepstakes Medal at Exposition  
Fine Stock at Low Figures. Catalogue FREE.  
Address B. P. CRITCHELL, Cincinnati, Ohio.

Park's Floral Gazette.

A BEAUTIFUL FLORAL MONTHLY.

Entirely Floral. Twenty pages—neat print—fine tinted paper—elegant illustrations—magnificent colored plates—tells all about Flowers, Ferneries, Conservatories, &c. Everybody who loves flowers should take it. Only 10 cts. per copy, or \$1.00 a year, post paid.

"The GAZETTE is splendid; every number is better than its predecessor. I would not be without it."—W. C. L. Drew, Eldorado, Cal.

"I consider PARK'S FLORAL GAZETTE one of the best and cheapest papers for the price that is published. Every lady, if she only wants to grow one plant, ought to take it."—James A. Nelson, Indian Run, Mercer Co., Pa.

"The FLORAL GAZETTE came and thoroughly charmed me with its neat appearance externally; and it's full to the brim internally. I felt that it was just what I wanted, and herewith send you my subscription."—Miss Jennie P. Owrn, Berlin Heights, Ohio.

GEO. W. PARK, Ed., Pub,

feb3

MOUNT VERNON, OHIO.

PEACH TREES.

The Largest Stock in the Country. Our stock of other leading articles is complete in assortment, and fine in quality. We excel in packing and in early and prompt shipments.

HEIKES NURSERIES CO.,

feb2

Dayton, Ohio.

TO THE TRADE.

USEFUL NEW PLANT—SEDUM AZOIDEUM VARIEGATA.

We find this the most useful ornamental plant of recent introduction, being equally adapted for centres of Hanging Baskets, Vases, Pot-culture or Bedding. Quite hardy, of free growth, but dwarf, compact habit; leaves of a deep green color, beautifully margined and blotched with creamy white, producing a very unique and pleasing effect. Price \$2.50 per dozen.

Address J. GREIVES, Sec'y Greenbrook and Paterson City Nurseries, Box 837, Paterson, N. J. feb3

The Cheapest Magazine published in the Civilized World is

THE FANCIERS' HERALD

AND

LIVE STOCK ADVERTISER.

A large illustrated 20 page Monthly, devoted to Poultry, Fish Culture, Bees, and Live Stock. Subscription price but 50 cents per year, postage paid. Circulation immense, and advertising rates but one cent per word, every advertiser receiving the copy containing his advertisement free. Endorsed by all the prominent breeders in the country, and contributed to by some of the most eminent writers. Sample copies, 10 cents.

Address

HERALD PUBLISHING HOUSE,

Mattituck, Suffolk Co.,

feb3

New York.

GOOD SEEDS

Grown with care and painstaking from selected stocks always pay. Try mine. See advertisement "All About Gardening." feb4  
J. B. ROOT, Seed Grower, Rockford, Illinois.

# MAHALEB STOCKS.

A fine lot of No. 1 in cellar ready for shipment at any time. \$1.25 per 100, \$10 per 1000. After April first, No. 2 at \$1 per 100, \$8 per 1000. For larger quantities, prices on application.

Our assortment of SEEDLINGS and YOUNG STOCK for NURSERYMEN is very extensive.

## HOOPEs, BRO. & THOMAS,

Cherry Hill Nurseries, West Chester, Pa.

New Trade List, 20 pages, will be issued February 1st.

tjan3

## S. THANHAUSER, BOUQUET PAPERS, IN ALL VARIETIES. BRIDAL BOUQUETS,

White and Colors, trimmed with Satin, Lace, Tarleton, &c.  
Large Assortment of Immortelles, Grasses, Moss, &c.

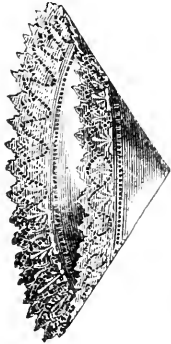

No. 19

PHILADA.,



N.4thSt.,

PENN.

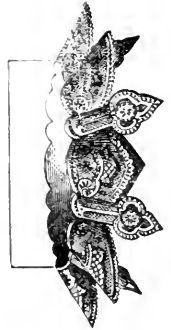

# SEEDS OF FRUITS AND ORNAMENTAL TREES.

Knowing by experience the difficulty of getting Tree Seeds that would grow, we made **TREE SEEDS A SPECIALTY** in our business, now 17 years ago,—and sell to our customers the same seeds we sow ourselves. The immense catalogue of seedlings we offer every year, attest their good quality. Catalogues always on hand.

## THOMAS MEEHAN,

Germantown Nurseries, Philadelphia.

sep.tf

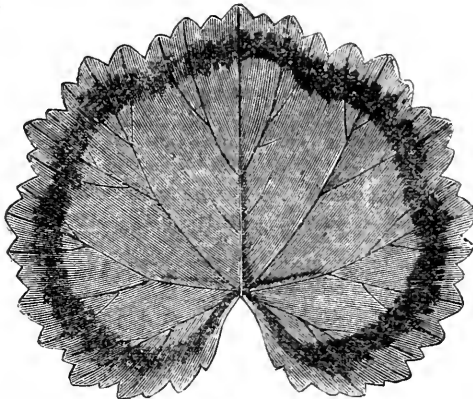

PELARGONIUM, DISTINCTION,  
50 cts. each. \$4.50 per doz.

We now offer the above exquisite Novelties with a large collection of choice Pelargoniums, of which a Special List for the Spring Trade is now ready.

Copies of Either of these Cuts,  
\$3.00 Each.

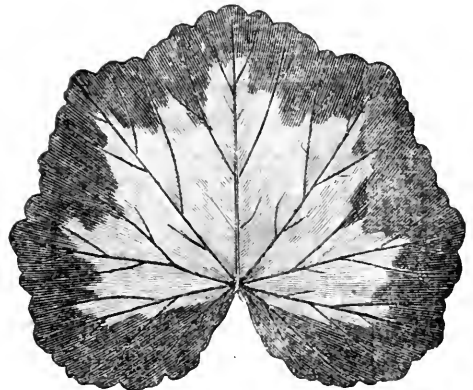

PELARGONIUM, HAPPY THOUGHT,  
\$1 each.

## THE BELLEVUE NURSERY CO.,

PATERSON, NEW JERSEY.

febt.f.

H. E. CHITTY, Sup't

**SEED CATALOGUES FREE.** All about growing FLOWERS and VEGETABLES. BEST SEEDS in the world; sure to grow; large packets; low prices. Books, Papers and Chromos as premiums. Address, **COLE & BROTHER,** Seedsmen, Pella, Iowa.

## VINEGAR.

HOW MADE IN TEN HOURS, from Cider, Wine, Molasses, or Sorghum, without using drugs.

Address, **F. I. SAGE,** Vinegar Maker, Springfield, Mass.

# WABAN CONSERVATORIES

OFFICE :  
56 BROAD ST., BOSTON.  
Address all Letters to  
BOSTON OFFICE.

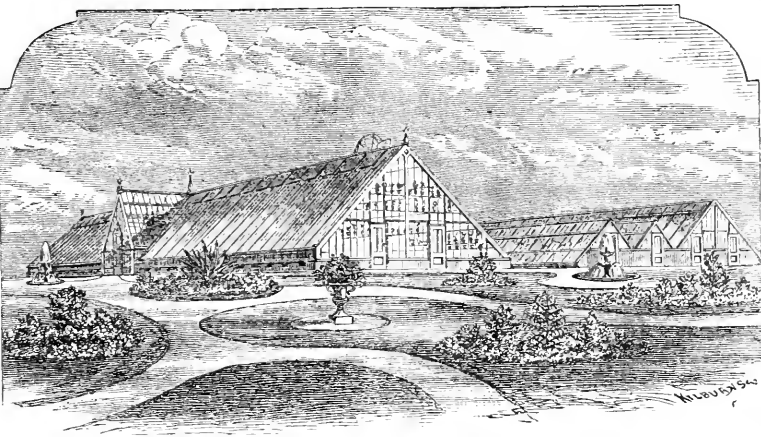

Send all Telegrams by  
Atlantic & Pacific Line. Address,  
*Waban Conservatories,*  
LAKE CROSSING, MASS.

THESE CONSERVATORIES  
Have in stock at all times, and offer at Wholesale,  
**CUT FLOWERS IN QUANTITY,**  
CONSISTING OF

Bon Silene, Saffrano and Isabella Sprunt Roses, Marechal Niel and General Jacquiminot, in great quantity, Souvenir de Malmaison, Yellow Tea, Persian Yellow, Devonensis, Gloire de Dijon in limited amounts. *The New Roses*—Le Nankin, La Jonquil, Madam Capucine, Belle Lyonnaise, Perle de Lyon, we shall be able to furnish in good quality.  
La France Rose in large quantity.

Also White and Red Bouvardia, White and Red Carnations, Violets, Stephanotis, Tuberoses, Jessamine and a general assortment of Cut Flowers used by the best Florists.

Lilium Longiflorum and Candidum in quantity at Easter.  
Smilax & Fern Fronds in very large quantities for Decoration.

NEW ROSES, }  
NEW PLANTS, } AT LOWEST RATES.

We are now packing and shipping Flowers with perfect success to Chicago, New York, Philadelphia, Baltimore, Washington, Montreal, and all important intervening places; and we are pleased to add that our shipments are giving universal satisfaction; in Telegraphic communications enabling us to fill orders to the most distant places quicker than Florists can obtain them by any other means.

**TEAS**—Aline Sisley, Comte de Sembuy, Jean Ducher, Marie Guillot, Marie Opoix, Perle des Jardine, Shirley Hibberd.  
**NOISETTE**—Reine des Massis. **BOURBON**—Mme. de Sevigne. **MOSS**—Souppert et Notting.

**HYBRID PERPETUALS**—Adanson, Antoine Mouton, Bernerd Verlot, Cassimir Perrier, Comtesse de Serenye, Gaspard Monge, General Eerwangne, Henry Ward Beecher, Hypolite Jamain, Ingenieur Madele, La Rosiere, La Souveraine, Madame Rose Charmeux, May Eurner, Philippe Bardet, Princess Antoinette Strozio, Soeur Athunase, Souvenir de Mere Fontaine, Madame Lefebure de St Ouez, Claire Mathiew Melle, Tlona de Adorjas, Souvenir de Ducher.

Our importations for the present season are on a much larger scale than heretofore, and will embrace all the New Roses and other plants of merit raised in Europe during the past year.

We have the pleasure to state that our stock never was in so fine condition. Our new houses are in running order and we shall be able to supply all plants and Cut Flowers as stated in former advertisements, in large quantities—now having the largest establishment in the United States devoted to the sale of Cut Flowers. Our new descriptive Catalogue, revised and greatly improved, will be ready in February.

**N. B.**—Particular attention given to Plan, Arrangement, Construction and Heating of Greenhouses for the growth of *CUT FLOWER PLANTS* at a Profit for Market. Advice as to the most profitable Flowers and Plants to grow, and method of culture. Nine-tenths of the Failures can be traced to want of Knowledge in the Construction, Arrangement and Heating of Houses, and the Kinds of Plants and Flowers to put in them. *New Beginners*, we believe, will find our knowledge and large experience valuable to them.

**N. STEFFEN'S WIRE WORKS,**  
335 E. 21st St. New York.

Manufacturer of all designs for FLORISTS. Wreaths, Crosses, Crowns, Hearts, Anchors, Pillars, Columns, Monuments, Bells, Composure, Faith, Hope and Charity, Harps and Lyres, &c. Leaning and Upright.  
Send for Price List. Jan 12.

**\$25 A DAY**

We warrant a man \$25 a day using our **WELL AUGER AND DRILLS** in good territory. Descriptive book sent free. Add. Jilz Auger Co., St. Louis, Mo.

**UNION IN CHRIST.**

**THREE MONTHS FREE.** A finely illustrated undenominational, union, religious monthly, will be sent free for three months, to all the readers of THE GARDENER'S MONTHLY who will send us a 3 cent postage stamp to pre-pay the postage on the paper. (as the law now requires pre-payment of postage.) Single copy 60 Cents per year; 25 Cents to Ministers of the Gospel and any person who will solicit subscriptions for us.

Two Papers for the Price of One.—UNION IN CHRIST will be sent a year free with any of the papers or books on our *Clipping List*, at publisher's prices, embracing the leading religious and agricultural papers, Lee Journal, and valuable books; perhaps just what you want. All explained in sample copy.

Agents wanted everywhere. Outfit of Chromes, Maps, and Books, at half price. Terms and sample copy sent free. Address, **H. A. KING,** 37 Park Row, N. Y.

P. O. Box 2289. sep6

**TO FLORISTS.**

**TOBACCO STEMS,** For Fumigating purposes, put up in bales of 250 lbs. each, at \$5.00 per bale, free on boat or cars. All orders from unknown parties must be accompanied by remittance. For sale by

**STRAITON & STORM,**  
No. 180 Pearl Street, New York.

aug12

**Allen's Planet Jr. SILVER MEDAL**



Hand Seed Drills and Wheel Hoes, perfected for '76. Four sizes. They "sow like a charm," no packing of seed in the hopper, no crushing it, no pausing or waste at the ends, no irregularity in depth, no springs or gearing to wear out, no "skips," no noise, no equal! This DOUBLE WHEEL HOE works easier, better, and from six to twelve times faster than the hand hoe; often saving the gardener \$100 in a season. Finishes two rows at once, when 8, 9, or 10 inches apart. Four pairs of hoes; blades tempered steel. We make an admirable COMBINED MACHINE possessing nearly all the excellencies of the separate ones. No vegetable garden, however small, should be without one. Our New HORSE HOE, perfected after ten years of experiment, saves most of the hoeing and makes the remainder easy; leaves the ground level or ridged as desired, opens furrows hills, and cultivates shallow or deep, and is a thorough weed killer; should be owned by every farmer. Full Descriptive Circulars and Testimonials free. Mention this paper. S. L. ALLEN & CO., Sole Manufacturers No. 119 S. 4th St., Philadelphia. We must have a list. Agents in Every Town.

**SCIONS.**

**TREES AND ROOT GRAFTS**

Of the following leading Iron-clad Apples for sale cheap—Pewaukee, Walbridge, Utter's Red, Plumb's Cider, Fameuse, Haas, or Gros Pomeire, Tetofski and the Briers' Sweet Crab. Send for catalogues and price lists to

dec3 **A. G. TUTTLE,** Baraboo, Wis.

**A NEW ERA IN**

**TRICOLOR GERANIUMS.**

**THE NEW TRICOLOR,**  
**MRS. GEORGE FOUST.**

As a test of the great merit of this new Geranium, I may state that all the Philadelphia Florists, on seeing it, purchased all the stock I could spare. Among them, Messrs. Buist, Dick, Dreer, and Harris. Mr. Harris, the great Geranium grower, says, "The best thing I have ever seen."

It perfectly withstands the hottest sun, holding its color and growing vigorous. I may also state, that grown in the greenhouse there is no other variety to equal it in growth and rich color. So much so that customers, on seeing it, will have nothing to do with the other kinds. Was awarded Special Premium by Pennsylvania Horticultural Society, in September, 1874.  
**PRICE, \$1.50.**

Messrs. John Saul, of Washington, D. C., and John Dick, 53rd & Darby Road, Philadelphia, have received consignments, and have it for sale; also the undersigned,

**GEO. FOUST,**  
feb3 2825 FRANKFORD Avenue, Philada.

**CLOSING OUT.**

**R. BUIST, FLORIST, PHILADELPHIA,**  
Will Mail 12 Gloxinea Bulbs, . . . \$1.50  
" 12 Achimenes " . . . 1.00  
" 12 Caladimus, . . . 2.50  
All of our own choice selection. feb1

**STRAWBERRY PLANTS**

By the 100, 1,000, 10,000 or 100,000.

**MONARCH OF THE WEST, COL. CHENEY, WILSONS' ALBANY, Seth Boyden, Chas. Downing, Downer, Triomphe de Gand, Kentucky. Also, STAR OF THE WEST, Champion, Dr. Warder, Late Prolific, Black Defiance, Agriculturist, Lenning's White, and others.**

**A. HANCE & SON,**  
nov.1f Nurserymen and Florists, Red Bank, N. J.

**VEITCH'S**

SET OF

**6 NEW GLOXINIAS.**

These Gloxinias were originated at the Royal Nursery, Chelsea, London, and are described as superior to any in cultivation. Some of the flowers are twice the size of the old varieties, and most of them have received first-class certificates.

**Price, \$5.00 for the Set of 6.**  
Grown and for sale by

**GEORGE FOUST,**  
feb3 2825 Frankford Ave., Philada.

**ALL ABOUT GARDENING**

For HOME use and for MARKET in ROOT'S GARDEN MANUAL—practical, pointed and thorough,—containing one-half as much matter as \$1.50 books on the subject. Gardeners throughout the country commend its practical labor-saving methods as invaluable to them. Sent for 10 cents, which will be allowed on the first order for seeds. **J. B. ROOT,** Seed Grower, Rockford, Illinois. feb4

**\$125 IN CASH PREMIUMS.**

For particulars see my Illustrated Catalogue for 1876, containing all the NEW and BEST Varieties of pure, fresh and reliable **VEGETABLE SEEDS,** carefully grown from selected stock, and the largest and BEST collection of **SEED POTATOES,** ever offered to the public. Sent Free to all applicants.  
feb1 **J. R. V. HAWKINS,** Goshen, N. Y.

# GERMANTOWN NURSERIES, PHILADELPHIA.

GORGAS LANE STATION, CHESTNUT HILL RAILROAD. Less than One Hour from the Centre of Philadelphia.

Those who desire to purchase largely, either for their own planting or to sell again, are invited to examine the extensive stock of

## FRUIT, SHADE AND ORNAMENTAL TREES AND SHRUBS,

Grown at the Germantown Nurseries. And those who need but A FEW ARTICLES, will find all ages and sizes to select from. A special feature of the business, is the raising of

### Nursery Stock and Seedling Forest Trees

FOR DISTANT SHIPMENT. Many of these can be supplied by the millions at very low rates. Address, for CATALOGUES or information,

**THOMAS MEEHAN, Germantown Nurseries, Phila.**

Estab. 1765.

2,000,000

IN STOCK

ILLUSTRATED CATALOGUES  
*Sent free on application.*

*Low freights from Boston allow us to compete with any Pottery in the United States.*

**A. H. HEWS & CO., - - No. Cambridge, Mass.**

Bowland Whitman.

Harry Lang.

## WHITMAN & LANG,

IMPORTERS OF

## BOUQUET PAPERS, FANCY GRASSES,

DRIED FLOWERS, IMMORTELLES, TIN FOIL, &c.,

No. 126 NORTH FOURTH STREET,

aug16

PHILADELPHIA.

## SOUTHERN GROWN PLANTS.

My stock of Southern grown Fruit, Shade and Ornamental Trees, has been grown with especial good care, and comprises, the most prominent of the

### HARDY EVERGREENS and FRAGRANT FLOWERING SHRUBBERY

Well known for the remarkable grace and beauty with which they adorn the lower Mississippi Valley.

### Of SEMI-TROPICAL or PLANTS of the WARM TEMPERATE ZONE

My collection consists of many, and most Attractive Specimens—Well fitted ornaments for Conservatories in Winter; or out-door decorations during the Summer season, in a more NORTHERN or WESTERN CLIMATE.

Price List on application sent postpaid. Address

**R. MAITRE, Seedsman and Florist,**

602 Magazine Street, New Orleans, La.

feb3

JOHN DICK, CATALOGUES FREE, 53d & Darby Road,  
 FLORIST, 30 GREENHOUSES, Philadelphia.  
 100,000 FEET OF GLASS.

ESTABLISHED—1836.

I invite attention to my stock of Plants, New and Rare

FOR THE GREENHOUSE AND CONSERVATORY,

Abutilon, Azalea, Begonia, Cactus, Caladium, Croton, Dracena, Echeveria, Gloxinia, Ferns, Hoya, Maranta, Orchid, Palms, Selaginellas, &c., &c.,

FOR OUT-DOOR DECORATION,

Coleus, Fuchsias, Geranium, Heliotrope, Lantana, Petunias, Roses, Salvias, Verbenas, &c.

VARIEGATED AND FANCY FOLIAGE PLANTS.

Plants for Baskets, Ferneries, Ribbon Beds and Borders.

New Conservatories and Greenhouses Stocked at Low Prices. Catalogues Free. A Wholesale Price List for the Trade. tfeb8

P. & E. TRANSON,  
 NURSERIES,  
 ORLEANS, FRANCE,

Beg to inform their friends and customers generally that their

NEW LIST FOR 1875 AND 1876,

Is now ready, and may be had on application to

MESSRS. KNAUTH, NACHOD & KUHNE,

113 BROADWAY, NEW YORK.

This Catalogue contains Prices of all the FRUIT TREE STOCKS; an extensive list of FRUIT TREES, New and Hardy ORNAMENTAL PLANTS, CLIMBERS, the Hardest and Best CONIFERS, ROSES on their own roots. Also, SMALL CONIFERS, DECIDUOUS and EVERGREEN ORNAMENTAL TREES, one or two years' Seedlings, most useful for Nurserymen.

N. B.—The greatest attention given to packing.

oct.5

**ZELL'S**  
**ENCYCLOPEDIA**  
**NEW & REVISED**  
**EDITION**  
**AGENTS WANTED**

The experience of five years has proved that this Compact and Reliable Work of General Information is better adapted to the wants of all classes of the community than any other work of the kind ever published. It has been proven by its

IMMENSE SALES,

BY THE

NUMEROUS COMMENDATORY NOTICES RECEIVED

AND BY ITS UNIFORM

SUCCESS WITH AGENTS.

*The Edition of 1876 has been Thoroughly Revised to Date.*

It contains 150,000 articles, 3,000 wood engravings and eighteen handsomely engraved and colored maps. The work is issued in parts, and a specimen copy, with maps, will be sent to any address free of postage, for twenty cents.

**BAKER, DAVIS & CO., Publishers,**

(Successors to T. ELWOOD ZELL)

Nos. 17 and 19 South Sixth Street, Philadelphia, Pa.

# Roses! Roses! Roses!

We offer a large stock of  
**FINE STRONG GROWING YOUNG ROSES,**  
 grown in 2 and 3 inch pots, and include the finest and leading varieties.

HYBRID PERPETUALS, TEAS, BOURBONS AND CHINAS.  
 Also MOSSES and CLIMBERS.  
 at very lowest prices. Orders solicited.

**JAMES ALDOUS & CO., Florists,**  
 tfeb7 **Iowa City, Iowa.**

NEW YORK, FEBRUARY 1st, 1876.

## A FEW THOUSAND PLANTS

in excellent condition, just

IMPORTED FROM FRANCE,

To be sold for CASH ONLY and delivered at once.

Mahaleb Stocks, middling size,	-	per 1000,	\$6.00
Pear Stocks, 1 year, 1st class,	-	"	16.00
Quince Stocks, Angers, 1st class,	-	"	20.00
Roses, Standard, 1st class, in choice varieties,	per 100,		50.00
Roses, Half Standard, 1st class, in choice varieties,	"		25.00

### PACKING, EXTRA.

Lilies, in collection of 30 fine varieties,	per 250 bulbs,	35.00
Pear Seed, fresh,	per pound,	1.50

### LIST OF ROSES AND LILIES

Will be sent to applicants.

**C. RAOUX,**

jantf **35 Maiden Lane.**

### THE 100 DAYS TOMATO

Actually ripens in one hundred days. **Earliest Good Tomato ever offered.** Free from rot; ship well; remarkably prolific. **\$119.50 Sold from One-fourth Acre.**

Positive proof of these claims in Free Circular. 25 cents per packet; 5 for \$1.00; post-paid. Address  
**J. A. FOOTE, Seedsman,**  
 512 Main St., Terre Haute, Ind.

### STRAWBERRY—RASPBERRY PLANTS,

Other Small Fruits, choicest kinds, for sale by

**E. P. ROE,**

Author of "Play and Profit in my Garden," "Opening a Chestnut Burr," &c. **SEND FOR CIRCULAR.** Also, a concise manual on the Culture of STRAWBERRIES, RASPBERRIES, and other Small Fruits, just how to grow and market them. **Price, 35 Cents.** Address

feb3 **E. P. ROE,**  
**Cornwall on the Hudson, Orange Co., N. Y.**

## FERNS, PALMS, &c.,

A large collection—many of which were imported from Germany the past spring.

Send for NEW TRADE LIST.

**HOOPEs, BROTHER & THOMAS,**  
**CHERRY HILL NURSERIES,**

tfeb3 **West Chester, Pa**

**A**MSDEN, Amsden, Amsden. Earliest and best early Peach in the world. Trees, root grafts and scions at Carthage, Missouri, and Dayton, Ohio. Price of the trees reduced for spring 1876. For full history of this Peach, and price of the trees, root grafts and scions, address  
 aug12 **JOHN WAMPLER, Carthage, Missouri.**

**P**EACH TREES, of best varieties; Norway Spruce and American Arbor Vitae, several sizes; Mammoth Cluster and Brandywine Raspberry; Cherry Currants; 2 yr. Concord Grape Vines; Strawberry Plants; and a general Nursery stock at greatly reduced rates. Satisfaction guaranteed. For prices, address  
 feb2 **DAVID BAIRD, Manalapan, N. J.**

A Hygroscope for 50 cents.

### THE CHEMICAL HYGROSCOPE.

This indicator of atmospheric moisture is as accurate as the costly ones. Rooms heated by furnaces or stoves are almost invariably so dry as to be damaging not only to health but to furniture. Some people take the consequences others keep water on the heater. The Hygroscope shows at a glance whether the air is too dry or not.

Sent by mail for 50 cents. Address,  
 febtf **CHAS. H. MAROT, 814 Chestnut St., Philadelphia.**

**Sussex Nurseries, near Georgetown, Del.** Orders for Peach Trees received for Spring delivery at the following low rates:

	Per 100,	Per 1,000
<b>Beatrice, 1 yr., 3 to 5 ft., stocky,</b>	\$7.00	\$60.00
" " 3 to 4 ft., light,	6.00	50.00
" " 2 to 3 ft., nice,	5.00	40.00
Assortments of varieties } 1 yr., 3 ft. & over, stocky	5.00	40.00
including Beatrice, Fos- } " 3 to 4 ft., light,	4.00	30.00
ter, and Wilson's Early } " 2 to 3 ft., nice,	3.00	20.00
Blackberry Plants,	2.50	15.00

All orders for \$10 worth or more packed to go to any part of the country without extra charge. Prices of other Nursery stock given on application. Can ship South at any time in winter when weather is mild.  
**R. S. JOHNSTON,**  
 feb2 **Georgetown, Del.**

### Roses, Lilies, Violets, Carnations, Geraniums, &c.

The Greenbrook and Paterson City Nurseries furnish them "Cheap as the Cheapest, Good as the Best."

Their Dollar Collections (mailed everywhere) contain Ten Different Varieties of Choice Plants and Roses with three fine Album Chromos or a beautiful Liliun. Buyer's choice.

Address  
**J. GREIVES, Sec'y,**  
**Box 837, Paterson, N. J.**  
 feb3

Catalogues FREE.

### GREAT BARGAINS

IN

**CAMELLIAS, AZALIAS**  
**PALMS, CROTONS,**  
**FERNS, GERANIUMS, &c.**

feb1 **R. BUIST, Darby Road, Phila.**

### HEDGE PLANTS! HEDGE PLANTS!

Making Hedge plants a specialty, we have particularly to offer this spring Osage Orange, Norway Spruce, Hemlock Spruce, Arbor Vitae, in immense quantities, and of any size to suit.

**THOMAS MEEHAN,**

jantf **Germantown, Phila.**

# ELLIS' BASE BURNING FOR WARMING DWELLINGS, GREENHOUSES, GRAPERIES, FORCING PITS, DRYING ROOMS BOILER. Heating Water for Public Baths, Baptisteries, &c., by Hot Water or by Steam.

Estimates and Circulars furnished. t. sep. 12. 182 CENTRE STREET, NEW YORK.

## FOR SALE OR TO LEASE,

TEN THOUSAND FEET OF GLASS AND FOUR ACRES OF LAND.

To any person wishing to enter the business this is a rare opportunity, and is one that will bear a thorough and searching investigation. The houses are in thorough repair, some of them but recently built, and none of them have been built over four years; are thoroughly heated with hot water apparatus and are admirably adapted for growing either plants or flowers, or both. Power for pumping is supplied by a four horse-power engine, which draws water from a never-failing well. Distributing pipes are laid in all the houses. The whole forming the most complete and thoroughly furnished plant establishment to be found. Entrance from the shed into all houses but one.

The buildings comprise the following:

One house, 128x16 ft., running north and south.

One house, 128x21 ft. 6 in., running north and south.

One house, 92x11 ft. 6 in., running north and south.

One house, 67x16 ft., running east and west.

One house, 80x23 ft., running east and west.

One house, 86x7 ft., running east and west, facing the north, and is adapted and has been used for a propagating house.

Six frames, each 67x6 ft.

Packing and potting shed, 80x14. Cellars under the whole length, 6 ft. deep. Sufficient stowage for the entire winter's supply of coal. For terms, &c., apply to

feb 1 GEORGE WILKINSON, Gorham Mfg. Co., Providence, R. I.

## JOHN A. SCOLLAY, IMPROVED HOT WATER APPARATUS,

Patented September 17, 1872.

*For Warming and Ventilating Dwellings, Greenhouses, Graperies, Forcing Pits, Drying Rooms, Heating Water for Public Baths, &c.*

This Boiler is perfectly self-cleaning, simple, economical and powerful, having more effective surface into less space than any Boiler in the market. Scollay's Patent Plant Sprinkler, for Window Gardening, &c., to be obtained of all Seedsmen, Florists, &c. Send for Circular and References. July 12

351 Adams Street, Brooklyn, New York.

# GRAPE VINES.

Also Grape Wood and Cuttings. Largest Stock in America.

All leading varieties in large supply. Extra Quality. True to name. Special rates to Agents, Dealers and Nurserymen. Our list of customers now embraces nearly all the leading nurserymen in the country, to whom we would refer those not acquainted with our stock. Send 6c. for DESCRIPTIVE CATALOGUE. Price List Free.

T. S. HUBBARD,  
FREDONIA, N. Y.

aug 9

## LARGEST STOCK IN AMERICA OF EUROPEAN LARCH AND EVERGREEN TREES,

Both Seedling and Transplanted, all grown from seeds on our own grounds, and better and cheaper than imported stock.

## EUROPEAN LARCH AND EVERGREEN TREE SEEDS,

oct 7

By the ounce, pound or hundred pounds. Send for Catalogue.

ROBERT DOUGLAS & SONS, Waukegan, Illinois.



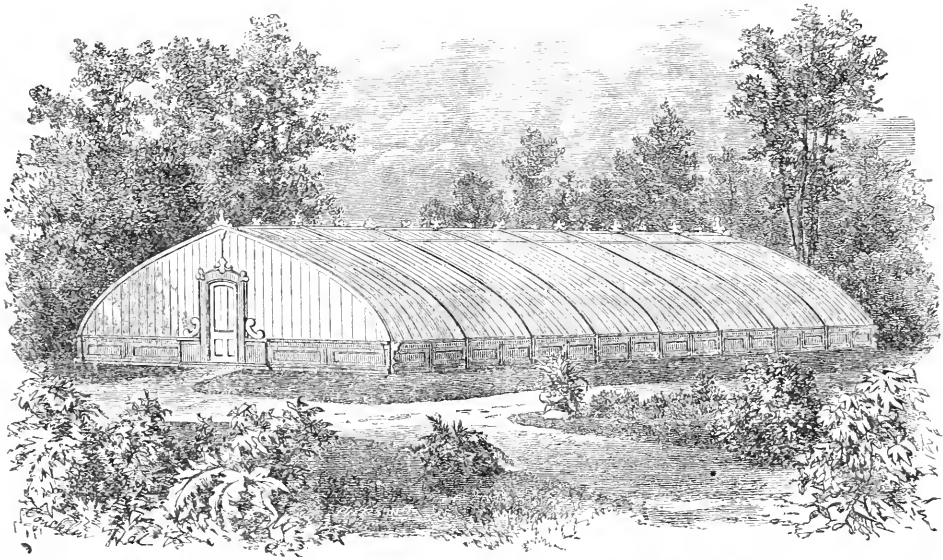

# GREENHOUSES, GRAPERIES, ETC.

Their Construction a Specialty. Experience of 20 Years.

SHIPPED TO ALL PARTS OF THE COUNTRY.  Send for Catalogue. Address,  
LORD'S HORTICULTURAL WORKS,

Irvington-on-Hudson, New York.

June 12

## ALEX. NIMMO,

(Late of the Firm of Nimmo & Scollay.)

# NEWLY IMPROVED HOT WATER BOILER,

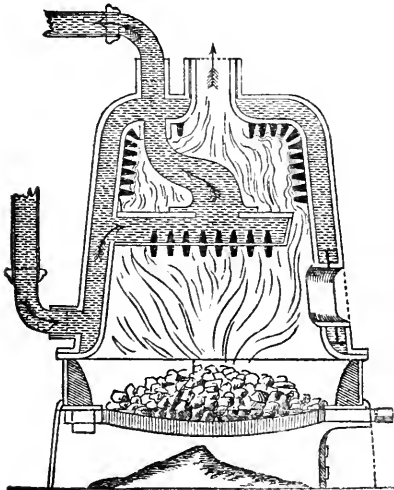

FOR HEATING

Green-Houses, Graperies, Conservatories,  
Forcing Pits, Water for Baths, Drying  
Rooms, Public and Private  
Buildings, &c.

*Proper steps have been taken to secure United States  
Letters Patent on this Invention.*

All the necessary Fittings for Hot Water Heating Apparatus.

VENTILATION APPARATUS OF ALL KINDS.

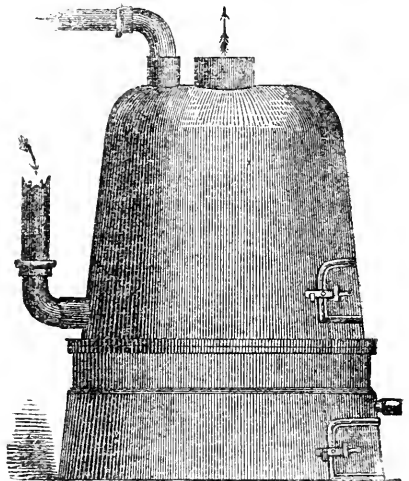

Wells Drove, Pumps of all kinds, Hydraulic Rams, &c., Garden Sun-Dials.

Agent for Joseph Kelly's Never Dry Vapor Pans, for all kinds of Hot Air Furnaces, Baltimore Heaters, &c.

CHEAPEST AND BEST BOILER, &c., IN THE MARKET.

 Please send for Circular for explanation, etc., before you make up your mind to purchase elsewhere.

sep 12

P. S.—Be sure you get the right number.

335 Adams Street, Brooklyn, N. Y.

# THE THOMPSON WEEPING DOGWOOD.

To save further correspondence in regard to the WEEPING DOGWOOD, advertised heretofore, I would say that the tree has been purchased by Mr. Thomas Meehan, for his Germantown Nurseries.  
t Jan. **HORACE C. THOMPSON.**

Our Combined **WHOLESALE** List of  
**EVERYTHING**  
FOR THE  
**GARDEN!**  
(Seeds, Plants, Florists' Requisites, etc.)  
For the **TRADE ONLY**, mailed  
free on application.  
*Peter Henderson & Co.*  
35 Cortlandt Street  
**NEW YORK.**

## PEACH STONES MAZZARDS, CHERRY STONES.

A limited Stock of First-class Quality can still be supplied.

**THOMAS MEEHAN,**  
Germantown, Phila.

jantf.

## New and Improved Fumigator.

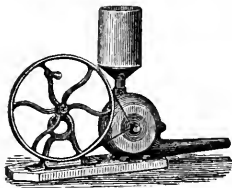

The undersigned having secured Letters Patent, March 23, 1875, for his new and Improved Fumigator for Hot-houses, Conservatories, &c. now offers it to Horticulturists, Gardeners and others, fully assured that it will do more in 10 minutes than could be done in one hour by the old system. It is operated outside of the greenhouse, thus avoiding the stifling fumes which is a great objection to the old mode. They are made of cast iron, and, with fair usage, will last a life time. Double Fan Fumigator, \$15. Single Fan Fumigator, \$12. I have also a small machine adapted for lady and gentlemen amateurs, for smoking one to a dozen plants; it is also adapted to Bee-keepers for smoking their hives. Price \$3. The desirability for these machines must be apparent to all. One trial will convince. For Circular, with directions, send to **THOMAS SHAW, P. O. Box 612, Danville, Pa.** oct6

**10,000** Camellias of all sizes, with and without BUDS.

**2,000** Magnolia grandiflora grown in pots.

**100,000** Roses, standards, half-standards and dwarfs.

Crab Apples, Crab Pears and Quince Stocks, per 100,000. For Catalogue and Prices apply to

**Messrs. F. E. ROTEREAU & CO., Nurserymen,**  
Angers, France.  
junc12

## THE NATIONAL AGRICULTURIST AND WORKING FARMER.

ESTABLISHED, 1847. UNITED, 1875.

A large, double quarto, 16 pages, Illustrated Family paper (*National Agriculturist* and *Working Farmer* consolidated). It treats of Stock Raising, Sheep Husbandry, Dairy Business, Swine, Poultry, Gardening and Fruit Growing, besides the elaborate departments of Bee Culture, Ladies or Home and Fireside, and Youth's Departments. A first-class Family paper, interesting, instructive, making young eyes sparkle and old hearts glad. Great Illustrated Premium, Grange Price and Clubbing List with Sample Copy. Large Cash Commission to Agents, or valuable Premiums given.

Try it six months for 55 cents, or \$1.10 a year, post-paid.  
Send to **WM. L. ALLISON,**  
123 Nassau Street, N. Y.

MY  
*Wholesale and Retail Catalogue of*  
**Greenhouse and Bedding Plants,**  
**EVERGREENS, ETC.,**  
MAILED TO ALL APPLICANTS.  
**Wm. C. Wilson**  
Astoria, L. I. C.,  
junc12 New York City Office—43 West 14th St.

**Norwalk Nurseries.** LARGE stock of Standard Apple all sizes. Norway, Black and White Spruce. Australian, Scotch, and White Pine. Arborvitae, Balsam Fir and Irish Juniper. Also a general stock of other Fruit and Ornamentals.

PRICE LIST FREE. **G. & S. BOALT,**  
sep6 Norwalk, O.

## BRANDYWINE,

The Most Profitable Raspberry;

In large quantities, guaranteed TRUE.

Descriptive Circular sent on Application.

**A. HANCE & SON, Nurserymen and Florists,**  
nctvf. **RED BANK, N. J.**

## DOUBLE TUBEROSE BULBS.

Our Stock of BULBS this year is of very superior quality.

	Doz.	100	1000
1st quality large Flowering Bulbs..	\$ 75	\$4 00	\$30 00
2d quality " "	50	3 00	20 00
A few hundred extra large Bulbs .....	1 00	5 00	

nov6 **MILLER & HAYES, 5774 Germantown Ave., Phila.**

## NEW ADIANTIUMS.

Seemanni and Gracillimum, described in

**GEO. FOUST'S CATALOGUE.**

Send free on receipt of 2 stamps.

feb.3

**2825 Frankford Ave., Philadelphia.**

# Peach Trees.

LARGE AND CHOICE STOCK.

Crawford's Early and Crawford's Late, in large quantities. A full stock of new varieties, including Early Beatrice, Early Louise, Early Rivers, Alexander's Early, Steadly, Amsden's June, Foster, &c., A. HANCE & SON, nurseriesmen and florists, Red Bank, N. J.

## NEW ROSES, AND ROSES IN QUANTITY. LOW PRICES

AT  
R. BUIST'S NURSERY,

67th & Darby Road, Philadelphia.

CALL AND SEE.

feb1

## New and Distinct Variegated Geranium, "HAPPY THOUGHT."

The most novel and welcome addition yet added to this most popular class of plants. See colored plate.

New Double Geraniums offered for the First time.

Dr. Torrey, a beautiful silvery rose colored variety, resembling G. Asa Gray.

Virginal. The finest shaped and largest Double White variety. SIX other new varieties.

See Catalogue, now ready.

SKED, PADDOCK & CO.,

Cleveland, Ohio.

feb4

## FRANCONIA RASPBERRY PLANTS.

From the celebrated Shuler Plantation. Plants warranted true to name.

Price,	\$20.00 per thousand.
"	3.00 " hundred.
"	1.00 " dozen.

Address

MRS. J. D. SHULER,

Lockport, Niagara Co., N. Y.

feb3

## RICHARD LYNEX,

Rear of 428 Walnut Street, Philada.

Manufacturer of Plain and Fancy Wire-work, for Florists; Wreaths, Crosses, Stars, Crowns, Hearts, Anchors, Birds, Lambs, Gipsy Baskets, Hanging Baskets, Flower Stands, &c.

SEND FOR PRICE LIST.

feb6

## EISELE BROS. CATALOGUE

of New and Best Greenhouse and Bedding Plants and Garden Requisites for 1876, will be ready in March, and mailed free to all applicants.

EISELE BROS.,

Tioga, Philadelphia, Pa.

feb4

**H**YDRANGEA OTAKSA "True." Flowers 20 inches in diameter, stock guaranteed true. Florists will find it particularly desirable for Spring Sales, as it requires no talking to push it. 2 nice plants, free by mail, for \$1.00.

For sale by GEO. FOUST,

2825 Frankford Avenue, Philadelphia.

feb3

## BEECROFT'S PATENT WHEEL HOE

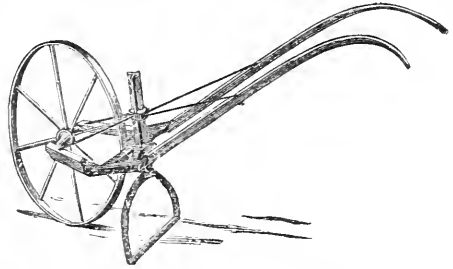

One of the greatest inventions of the age. One man can do more work than ten with a common hand hoe, and not one-quarter of the labor. Agents wanted in every town, to whom great inducements will be offered. Send Postal Card for full descriptive Price List. Address, THOMAS JACKSON, feb1 Proprietor and Sole Manufacturer, Portland, Maine.

## 1876 GERANIUM 1876

This is to Certify, that I have appointed GEO. FOUST, Sole Agent to distribute my NEW SEEDLING GERANIUM, which has been named "1876."

I do also certify that I have flowered the above Geranium, a full, perfect truss, "without flaws, all open at once," 11 inches in diameter. Signed

WM. K. HARRIS.

MR. HARRIS also states—"to prevent misapprehension"—that the largest truss he had was 11 inches by 13 inches, full and perfect. And he is also prepared at all times to flower it 11 inches clear.

Color: a bright Carmine-lake, in the style of Gen'l Lee.

Price, \$1.50 each.

I will commence to distribute this great Novelty after the 1st of March.

Orders received now and filled in strict rotation.

CATALOGUES sent on receipt of 2 ct. stamp. Address

GEO. FOUST,

Franklin Nursery,

2825 Frankford Avenue, Phila.

feb3

## SURPLUS STOCK.

WILSON'S ALBANY STRAWBERRY,  
DOOLITTLE RASPBERRY,  
NORWOOD PROLIFIC RASPBERRY,  
DORCHESTER BLACKBERRY.

I have a surplus of the above varieties of plants, and offer them at wholesale and retail at lowest prices. Other plants at reasonable rates.

WM. F. BASSETT,

Hammonton, N. J.

feb3

## NEW BEDDING PLANTS.

Double Flowering Ivy Leaf Geranium.  
Fuchsia, Mrs. H. Cannell.  
Fuchsia Procumbens, the Creeping Fuchsia. One of the best novelties ever introduced.

VERBENA LITTE GIANT.

Catalogue ready about 1st of March, and sent on receipt of 2 cent stamp, to prepay postage. Address,

GEO. FOUST,

2825 Frankford Ave., Phila.

feb3

# WEATHERED & CHEREVOY'S PATENT BOILERS,

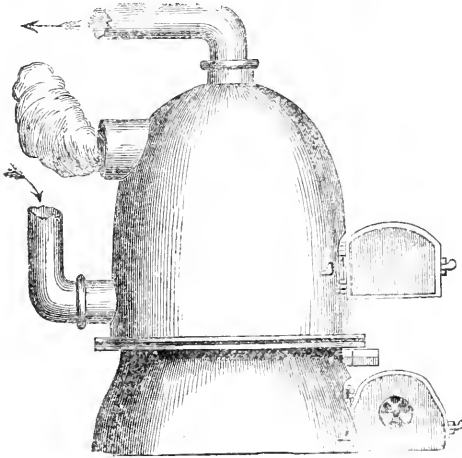

Fig. 1.

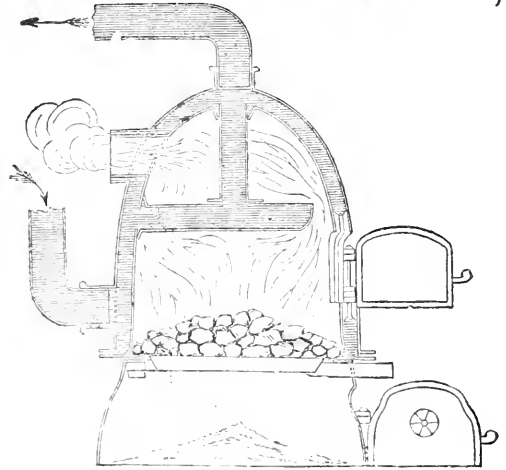

Fig. 2.

## AND IMPROVED HOT WATER APPARATUS,

No. 46 Marion Street, between Spring and Prince, New York.  
(TWO BLOCKS EAST OF BROADWAY.)

For Warming and Ventilating Public Buildings, Private Dwellings, Greenhouses, Graperies, Forcing Pits, Drying Rooms, and Heating Water for Public Baths.

Fig. 1 is an outside view. Fig. 2 is a vertical section through the centre.

*The following are a few names of Gentlemen who have our Boiler in use:*

Thos. Drake, Esq., Germantown, Pa.  
Simon Cameron, Esq., Harrisburg, Pa.  
J. D. Cameron, Esq., Harrisburg, Pa.  
Thos. Carter, Esq., Raleigh, N. C.  
J. H. Dunham, Esq., Chicago, Ill.  
Jas. B. Waller, Esq., " "  
W. J. Gordon, Esq., Cleveland, Ohio.  
Geo. Stanley, Esq., " "  
Harris Jaynes, Esq., " "  
Geo. W. Cuyler, Esq., Palmyra, N. Y.  
D. M. Osborn, Esq., Auburn, N. Y.  
John B. Dutcher, Esq., Pawling, N. Y.  
A. M. Allerton, Esq., Bronxville, N. Y.  
Robert Hoe, Esq., Tarrytown, N. Y.  
Peter Hoe, Esq., " "  
George Lewis, Esq., " "  
Wm. H. Drew, Croton Falls, " "  
Hon. James Y. Smith, Providence, R. I.  
Philip Caswell, Esq., Newport, R. I.  
Alfred Smith, Esq., " "  
Wm. Findlay, Esq., " "  
E. Learned, Esq., Pittsfield, Mass.  
D. O. Mills, Esq., San Francisco, Cal.  
W. L. Ferris, Esq., Westchester, N. Y.  
D. H. Haight, Esq., Goshen, N. Y.  
F. Newbold, Esq., Newark, N. J.  
James T. Closson, Esq., Plainfield N. J.  
Daniel W. Coit, Esq., Norwich, Conn.  
J. F. Slater, Esq., " "  
H. W. Collender, Esq., Darien, " "  
Chas. P. Palmer, Esq., Stonington, "

Wm. D. Black, Esq., New Milford, Conn.  
Rev. Stephen H. Tyng, Irvington, N. Y.  
H. F. Spaulding, Esq., Riverdale, "  
S. D. Babcock, Esq., " "  
Percy R. Pyne, " "  
Elisha Brooks, Esq., Inwood, "  
Camille Marie, Esq., " "  
A. F. Smith, Esq., Fort Washington, "  
R. M. Olyphant, Esq., Dobb's Ferry, "  
Clarkson N. Potter, Esq., New Rochelle, "  
Chas. D. Dickey, Esq., West Farms, "  
Wm. Matthews, Esq., Harrison, "  
William Chorlton, Esq., New Brighton, S. I.  
F. H. Wolcott, Esq., Astoria, L. I.  
Bailey Leach, Esq., " "  
Hon. W. B. Ogden, High Bridge, N. Y.  
Peter Moller, Esq., 295 Fifth Ave., New York City.  
Wm. Moller, Esq., 6 West 20th St., " "  
John Moller, Esq., 127 East 54th St., " "  
John Moller, Esq., 8 East 37th St., " "  
Ch. Moller, Esq., 426 Washington St., " "  
Henry B. Laidlaw, Esq., 33 Pine St., " "  
George W. Lane, Esq., 93 Front St., " "  
J. P. Robinson, Esq., 14 Coenties Slip, " "  
J. B. Colgate, Esq., 47 Wall St., " "  
John B. Trevor, Esq., 47 Wall St., " "  
Charles Butler, Esq., 12 " "  
Richard Arnold, Esq., 309 Canal St., New York City.  
Jas. M. Constable, 309 Canal St., " "  
W. T. Garner, Esq., 61 North St., N. Y. City.

Please send for Circular with list of References and Reduced Prices to

THOMAS W. WEATHERED, 46 Marion Street, N. Y.

# ROSES, ROSES, ROSES.

	Per 100.	Per 1000
Hybrid Perpetual Roses—Fine 1 year Dormant Plants, . . . . .	\$12	\$100
Mosses—including fair proportion white—Fine 1 year Dormant Plants, . . . . .	15	
Climbers—including P. Queen, B. Belle &c. “ “ “ . . . . .	10	90
Monthlies—A good assortment “ “ “ . . . . .	8	70

## ROSES IN 3-INCH POTS.

Hybrid Perpetuals, Monthlies and Climbers. Strong, well established Plants, . . . . .	8	70
Moss Roses—3-inch Pots . . . . .	12	

We ship safely by Express—at any time desired—and Guarantee safe arrival.

NO CHARGE FOR BOXES OR PACKING. PRICE LISTS free on application.

Address,

## THE DINGEE & CONARD CO., ROSE GROWERS,

feb3

WEST GROVE, CHESTER CO., PA.

## YOUNG ROSES FOR FLORISTS.

All the Leading Sorts! Fine Healthy Plants!

*Gloire de Dijon, Mad. Charles Wood, Bon Silene, Giant of Battles, Hermosa, Cheshunt Hybrid, Coquette de Lyon* (which may be called, *Yellow Hermosa*), and others in EXTRA LARGE QUANTITIES. PRICES LOW, as the space must be cleared. N. B.—No other firm in America offers such a choice assortment of Roses, at such low prices as we do. NEW GERANIUMS. Magnificent new DOUBLE GERANIUMS of 1875, surpassing in size and brilliancy of coloring any hitherto introduced. The leading characteristics of the finest Zonale and Nosegay classes are reproduced in these beautiful varieties, which are the productions of Sisley, Lemoine, Alegatiere, Laxton, &c. NEW SINGLE GERANIUMS of 1875, raised by the same eminent hybridisers as the New Doubles, and of equal merit. PRICE of both Double and Single varieties, 50 cts. each; \$5.00 per dozen. Of the older sorts of Double and Single and other classes of Geraniums, we have the finest collections in the West. ARISTOLOCHIA (*Dutchman's Pipe Vine*); a splendid lot, by the 100 or 1000. DESCRIPTIVE CATALOGUES FREE on application. Wholesale Lists to the Trade. Address,

feb3

E. Y. TEAS & CO., Rose Growers, Richmond, Ind.

## WATER AND AIR PROOF PAPER,

Made from first quality of paper, of great strength, for packing plants, vines, etc., by mail, or for any purpose where dampness and air should be excluded. GRAFTING WAX in small packages for retailing. In large packages for Nurserymen and Grafters, by mail at 50 cents per pound.

SEND FOR WHOLESALE PRICE LISTS.

feb 1

F. TROWBRIDGE, Milford, Conn.

## FLOWER POTS BY THE MILLION.

The Best, Cheapest and Most Durable Pot in the Market. For Price List and Terms, Address

THE NEW BRIGHTON FLOWER POT AND TERRA COTTA WORKS.

ELVERSON & SHERWOOD, Proprietors,

Please state where you saw the advertisement, also what business, whether Florist or Dealer.

NEW BRIGHTON, PA.

dec 4

OUR  
**Illustrated Catalogue**  
 OF  
**PLANTS FOR 1876.**

Contains descriptions of all the finest

**BEDDING**

AND

**GREENHOUSE PLANTS,**

including novelties and select varieties.

Also the best **Foreign Grape Vines for Graperies.**

Send free to our customers, and to all applicants on the receipt of one 3 cent stamp.

**HOVEY & CO.,**  
 53 N. Market St.,  
 BOSTON, MASS.

**Fruit and Ornamental Trees.**

Large stock of 2 year Peach Trees, also 1 year Peach Trees of leading varieties.

**APPLE TREES, PEAR TREES,  
 GRAPE VINES, CURRANTS,  
 ETC., ETC.**

—A LARGE STOCK OF—

**American Arborvitæ, Siberian Arborvitæ, Irish Juniper, Norway Fir, Balm of Gilead, &c., &c.**

**Silver Maple**—6 to 8, 8 to 10 and 10 to 12 feet.  
**Sugar Maple**—3 to 5 ft., and 8 to 10 ft.  
**Norway Maple**—7 to 9 feet.

The Nursery is within 2 minutes of the Depot at Christiana, on the P. R. R., 2½ hours from the city. Prices sent on application. Also, Greenhouse and Bedding Plants. Address

**W. P. BRINTON,**

feb3 Christiana, Lancaster Co., Pa.

**SMALL FRUITS**

A

**SPECIALTY.**

**300 Acres in Fruits. No. 1 Plants** of all best sorts at very lowest rates. Send for prices to

**JOHN S. COLLINS,**

feb1 MOORESTOWN, N. J.

**SPECIALTIES FOR SPRING 1875.**

**Peach Trees**, first and second sizes, including 2,000 Ea. Beatrice.  
**American Arborvitæ**, 6 to 10 in. and 1, 2, 3 and 4 ft., bushy.  
**Siberian Arborvitæ**, 2½, 3 and 4 ft., compact.  
**Irish Juniper**, 2, 3 and 4 ft.  
**Hemlock Spruce**, 12 to 15 in., twice trans.  
**Sugar Maple**, 3 yrs., trans., 2½ to 3 ft.  
 2 " " " 10 in.

**Concord Vines**, 2 and 3 yrs., strong.

Price Lists sent to all applicants. Nursery at Malvern, P. R. R. one hour's ride from Philadelphia. Address,  
 feba J. A. ROBERTS, PAOLI, PA.

**NEW PEACHES.**

**Alexander, Amsden's June, Early Beatrice, Early Louise, Early Rivers'** and 40 other varieties, in large quantities; very fine.

Send for New Trade List.

HOOPES, BRO. & THOMAS,

CHERRY HILL NURSERIES,

West Chester, Pa.

**APRICOTS AND NECTARINES.**

One year, 4 to 6 feet and 2½ to 4 feet, in large quantities, cheap. Send for New Trade List.

HOOPES, BRO. & THOMAS,

CHERRY HILL NURSERIES,

West Chester, Pa.

**EVERGREENS.**

An immense stock of all sizes, suitable for planting in Nursery rows, or for immediate effect. A fine collection of **New and Rare Conifers.**

Send for New Trade List.

HOOPES, BRO. & THOMAS,

CHERRY HILL NURSERIES,

West Chester, Pa.

**WEEPING TREES.**

Mountain Ash, Linden, Cherry, English Ash, Peach, and 4 varieties of Poplar.

HOOPES, BRO. & THOMAS,

CHERRY HILL NURSERIES,

West Chester, Pa.

**FOREIGN GRAPES.**

For Vineries, 1 year, in 5-inch pots; 2 year, in 10-inch pots, bearing size.

HOOPES, BRO. & THOMAS,

CHERRY HILL NURSERIES,

West Chester, Pa.

**ROSES.**

Strong dormant plants of everblooming and climbing, by the 100 or 1000.

HOOPES, BRO. & THOMAS,

CHERRY HILL NURSERIES,

West Chester, Pa.

**IVIES.**

A magnificent collection, embracing all the most unique forms and variegations of this very popular climber.

HOOPES, BRO. & THOMAS,

CHERRY HILL NURSERIES,

West Chester, Pa.

**HARDY PLANTS.**

Our splendid **New Illustrated and Descriptive Catalogue of Alpine and Hardy Perennial Plants, No. 3,** is now ready for mailing, price 10 cents.

The following Catalogues will be mailed on application, viz.:

No. 1. Descriptive Catalogue of Fruits, pp. 28, two 3 ct. stamps.  
 No. 2. Illustrated and descriptive Catalogue of Ornamental Trees, &c., pp. 51, 10 cents.

No. 4. Illustrated and Descriptive Catalogue of Greenhouse and Bedding Plants, **Free.**

No. 5. Wholesale Trade List, **Free.**

**HOOPES, BRO. & THOMAS,**

Cherry Hill Nurseries,

West Chester, Pa.

## Carnation Pink Plants.

I make the growing of **Carnation Pinks** a specialty, and can therefore offer the finest and most extensive Stock in the country at the lowest price.

Best White and Colored **Winter Blooming Varieties** \$5 per 100; \$40 per 1,000. *La Belle, Astoria, Peerless and Little Beauty*, \$10 per 100.

Newest Fancy Varieties, \$12 per 100.

DESCRIPTIVE CATALOGUE free to all applicants.

### CUT FLOWERS OF CARNATIONS,

to the trade, by the 100 or 1000; by mail or express.

**CHAS. T. STARR,**

febl

Avondale, Chester Co., Pa.

NEW

## VARIEGATED LANTANA HARKETT'S PERFECTION.

Best Variegated Bedding Plants to stand the Sun. Ready March 1st. \$1.00 each. \$10.00 per doz. Illustrated Descriptive Catalogue of Greenhouse and Bedding Plants. Sent to all applicants.

**W. A. HARKETT,**  
DUBUQUE, IOWA.

febl

## TREES

AND

## HEDGE PLANTS.

We offer for the Spring Trade over 300,000 Very Fine **Apple, Pear, Cherry, Plum, Peach**, and other Trees; 5,000,000 No. 1 **Osage Hedge Plants**, 200,000 **Large Evergreens**, and a large Stock of **Ornamental Trees, Shrubs, Roses, Bulbs, &c.** Great inducements to the wholesale trade. Spring Trade List now ready.

**HARGIS & SOMMER,**  
STAR NURSERIES,

febl

QUINCY, ILL.

## EVERGREENS.

## GREAT REDUCTION

### IN PRICES.

We now have the largest and best stock of **Evergreens** we have ever offered, especially **NORWAY SPRUCE** of small transplanted sizes, just the thing for planting in windbreaks or hedges, or for planting in Nursery rows. Quality very fine, and price low enough to suit anybody.

### NOTICE.

We will sell 1000 Norway Spruce 10 to 15 in. trans., fine, for \$15.00, or 5000 for \$60.00. Other sizes and varieties in proportion. SEND FOR CIRCULAR.

**JOHN V. WHITNEY & SON,**  
Montville, Geauga Co., Ohio.

## LONDON GARDENER'S CHRONICLE

Will be furnished, post-paid, direct to subscribers in the U. S. for \$7 50 per year. Specimen Nos. 3 cent stamp. Apply to  
novf **CHAS. H. MAROT, Agent, 814 Chestnut St., Phila.**

TO

## NURSERYMEN, DEALERS

AND

## PLANTERS.

We invite attention to our present stock of the following named articles which will be sold low, for CASH.

**Apricot**, 1 year from bud, very fine.

**Apple Trees.**

**Peach Trees**, (Ea. Beatrice, Ea. Louise and Ea. Rivers.)

**Cherry Trees**, (Ea. Richmond and May Duke.)

**Irish Juniper, Norway and Hemlock Spruce.**

**Arboretum, American, Siberian, Booth's and Hoopes Dwarf.**

Correspondence solicited

Address,

**RAKESTRAW & PYLE,**

feb2

Willow Dale, Chester Co., Pa.

## NEW ADIANTUM OF EXTRA MERIT.

**A. Martinicense.** One of the most gorgeous Adiantums ever introduced. Beautiful habit and good grower. On the style of, but very much superior to, *A. Sanctæ Catherineæ*.

Price, \$1.00 each.

Orders received now and filled in rotation from May 1st.

Grown and for sale by

**GEO FOUST,**

feb 3

2825 Frankford Ave., Phila.

## SURPLUS STOCK.

- 5000 **Apple Trees**, 5 to 7 and 6 to 8 ft.
- 1000 **Crab Apple**—Hyslop, Transcend, &c., very fine.
- 10000 **Peach**, 1st class, 4½ to 6 ft.
- 4000 **Peach**, 2nd class, 3 to 4½ ft.
- 500 **Cherry**, 1st and 2nd class.
- 1000 **Silver Maple**, all sizes, 8 to 12 ft., very fine.
- 2000 **Irish Juniper**, 1 to 2 ft., twice trans., very fine.
- 1000 **Osage Orange**, 1 year.
- 5000 **Honey Locust**, 1 and 2 years.
- 500 **Tamarix**, 2 years.
- 1000 **Currant**, 1 and 2 years, **Cherry, W. Grape and Victoria.**
- 500 **Concord Vines**, 1 year.
- 500 **Gooseberry**, 2 years, **Houghton and Cluster.**
- 100 **Angers Quince**, for stools or cuttings.

The above will be sold cheap.

**H. M. ENGLE & SON,**

feb3

Marietta, Lancaster Co., Pa.

## NEW ORNAMENTAL FOLIAGE PLANTS

- ANTHURIUM CRYSTALLINUM,**
- APHELANDRA FASCINATOR,**
- ARALIA GUILFOYLEI,**
- ARALIA VEITCHII,**
- CURMERIA PICTURATA,**
- CROTON SPIRALE,**
- CROTON VOLUTUM,**
- CYANAPHYLLUM SPECTANDUM,**
- DRACAENA MAGNIFICA,**
- DIEFFENBACHIA IMPERIALIS,**
- PHYLLOTAENIUM LINDENII.**

For full description see new Catalogue, ready about 1st of March. Sent on receipt of 2 cent stamp.

Address,

**GEO. FOUST,**

feb3

2825 Frankford Ave., Phila.

NEW MARANTAS.

Maranta Bellula, Hieroglyphica, Luciana, Majestica Makoyana, Mazelli, Nigrocostata, Pacifica, Undulata. Grown and for sale by

GEO. FOUST,

2825 Frankford Ave., Phila.

feb3

Catalogues ready about 1st of March, and sent on receipt of two stamps for postage.



Alfred Bridgeman,

876 Broadway, New York,

Grower, Importer and Dealer in  
**VEGETABLE, FIELD,  
AND  
FLOWER SEEDS.**

Garden Tools and Horticultural Books.

My annual priced catalogues are now ready, and mailed free to all applicants. They contain all the leading and most popular sorts of **Vegetable, Field and Flower seeds**, including all the most desirable novelties of the past season.



1876 DREER'S GARDEN CALENDAR, 1876

Contains descriptive and price list of Vegetable, Flower and Grass Seeds, Plants, Bulbs, Novelties, and every GARDEN REQUISITE. Beautifully illustrated. Send two 3 ct. stamps for postage.

HENRY A. DREER,

jan6

714 Chestnut Street, Phila.



My Illustrated Floral Catalogue for 1876 is now ready. Price 10 Cents, less than half the cost. WILLIAM E. BOWDITCH, 645 Warren St., Boston, Mass.

"The Whispers of Peace." - A beautiful collection of religious gems; sent FREE. Give address by postal card. Send now to S. HARRISON & CO., Brooklyn, New York, or H. A. KING, 37 Park Row, New York. aug12

NEW AND RARE  
**PLANTS,**

FOR 1876.

HENRY A. DREER, Seedsman and Florist, 714 Chestnut Street, Philadelphia, takes pleasure in offering the following to the trade, a portion as Novelties for 1876. The balance of New things will be offered later, as stock will admit.

**Bouvardia Humboldtii Corymbiflora.** The finest, largest flowered, and most showy pure white Bouvardia. Strong plants, for propagating, \$5.00 per dozen.

**Bouvardia Candidissima.** Purest white, low compact growth, very free flowering, strong plants, \$5.00 per dozen.

**Caladium Tubers.** Strong undivided tubers of the following choice list, at \$15 per 100; \$2.50 per dozen: Argyrites, D'Andolle, Ducharteri, Cannarti, Hercules, Houllletti, Lamart 1er, Miribai, Rubra Venosa. Also the following at \$12 per 100; \$2 per dozen: Auber, Baron Rothschild, Belleym 1er, Bicolor Splendens, Beethoven, Brongniarti, Chantini, Duc de Moray, Duc de Rutbow, Endlicherianum, Eudel, Maxime Duval, Meyerbeer, Milton, Napoleon III, Newman, Rene Victoria, Rossini, Rubra Maculata, Triomphe de Exposition, Bicolor picturata and Wrighti

**New Double Pink-Flowered Ivy-Leaved Geranium, "Koenig Albert."** The chief Novelty for 1876; of splendid drooping habit, perfect double flowers, \$9.00 per dozen, or \$1.00 each.

**Senecio Macroglossum.** A New German Ivy with dark thick, leathery leaves, very glossy, nearly like an Ivy, \$4.00 per dozen.

**Double White Oleander, "Madoni Grandiflora,"** \$1.00 per dozen.

**Fuchsia Sun-ray.** Tricolor foliage, stock plants, \$3.00 per dozen. Fine young plants at \$2.00 per dozen.

**Our New Set of Double Petunias,** in advance of any yet introduced, in 12 varieties, \$2.50 per dozen.

**New Set of Single Petunias.** The finest show varieties, in 12 sorts, \$2.50 per dozen.

**Camellia Stocks,** for spring grafting, strong, \$15.00 per 100.

**New Double Show Pelargoniums, Single Zonale Geraniums, New Roses, &c.,** a description of which, please see Dreer's Garden Calendar, now ready, and mailed to all applicants.

HENRY A. DREER,

714 Chestnut Street,

jan6

PHILADELPHIA

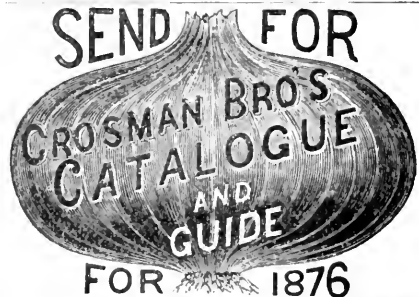

To the Flower and Vegetable Garden. Beautifully Illustrated and containing a Magnificent COLORED PLATE. Will be mailed to any address FREE. Address, [Established 1840.] CROSMAN BROS, Rochester, N. Y.



# SUFFIELD FRUIT & FLOWER GARDENS.

50,000 CARNATIONS FROM CUTTING BEDS.

*Strong well rooted Plants, true to name.*

PRES. DEGRAW, \$10 per 1000.

LA PURITE, 15 "

Plants ready from February 15th to May 1st.

## H. C. SMITH.

SUFFIELD, CONN.

### SPECIAL OFFER TO THE TRADE! ROSES.

*Hybrid Perpetuals on Rosa canina*—STANDARDS. Per 100, 1st quality, \$20; 2d, \$16. Per 1000, 1st quality, \$16; 2d, \$120.

Half Standards.—Per 100, 1st quality, \$12; 2d, \$10. Per 1000, 1st quality, \$100; 2d, \$80.

*Dwarf Roses on Rosa Multiflora de la Griffierale*.—Per 100, 1st quality, \$8; 2d, \$6. Per 1000 1st quality, \$70; 2d, \$50.

*Tea, Noisette and Bourbon Roses on Rosa Canina*.—Standards. 3 to 7 feet, per 100, 1st quality, \$24 to \$36; 2d, \$20 to \$30. Half Standards; per 100, 1st quality, \$20; 2d, \$16.

A list of the names of the roses will be sent free on application. A remittance must accompany each order.

A. M. C. JONGKINDT CONINCK,

"TOTTENHAM NURSERIES," at Dedemsvaart,

Aug 12 Near Zwolle, NETHERLANDS.



Contains over 1,200 varieties **Vegetable and Flower Seeds. COLORED PLATES.** Elegant wood-cuts of vegetables and flowers. **Handsome Guide Published!** Send for it.

DETROIT SEED CO., Detroit, Mich.

## Harper's Magazine.

ILLUSTRATED.

"Unquestionably the best sustained work of the kind in the World."

Postage free to all Subscribers in the United States.

### TERMS:

HARPER'S MAGAZINE, one year.....\$4.00

\$4.00 includes prepayment of U. S. postage by the publishers.

Subscriptions to *Harper's Magazine, Weekly and Bazar*, to one address for one year, \$10.00; or, two of Harper's Periodicals, to one address for one year, \$7.00; postage free.

An Extra Copy of either the *Magazine, Weekly* or *Bazar* will be supplied gratis for every Club of *Five Subscribers* at \$4.00 each, in one remittance; or Six Copies for \$20.00, without extra copy; postage free.

Back Numbers can be supplied at any time.

A Complete Set of *Harper's Magazine*, now comprising 51 Volumes, in neat cloth binding, will be sent by express, freight at expense of purchaser, for \$2.25 per volume. *Single volumes*, by mail, *post-paid*, \$3.00. Cloth cases, for binding, 58 cents, by mail, *post-paid*.

A Complete Analytical Index to the first Fifty Volumes of *Harper's Magazine* has just been published, rendering available for reference the vast and varied wealth of information which constitutes this periodical a perfect illustrated literary cyclopedia. 8vo, Cloth, \$3.00; Half Calf, \$5.25. Sent postage pre-paid.

A series of papers under the title of "The First Century of the Republic," contributed by the most eminent American publicists, is now being published in *Harper's Magazine*. This series of over twenty papers gives a comprehensive review of Progress during the century now closing, in every department of our national life.

*Newspapers are not to copy this advertisement without the express order of HARPER & BROTHERS.* "Address"

HARPER & BROTHERS, New York.

WANTED.—Good Greenhouse hands.  
Address,

The Dingee & Conard Co.,  
West Grove, Chester Co., Pa.

feb3

## THE CHRISTIAN AT WORK.

T. De Witt Talmage, Editor.

Without Premiums, \$3; with Premiums, \$3.25. To Clergymen 75 cents less. ~~48~~A Choice of two premiums.

### OPINIONS OF THE PRESS.

"*The Christian at Work* is the liveliest religious paper published in these parts. Its columns are spicy and sparkling and to religious people who like things lively it is a readable paper. The Devil is more certain to be frightened with a radiant face than a solemn and forbidding one."—*N. Y. Commercial Advertiser*.

"*The Christian at Work* has donned a new dress and looks as pretty as a picture. The type of all sizes is admirably clear and a handsomer weekly there is not in these United States."—*N. Y. Evening Mail*.

"*The Christian at Work* is safe and reliable in all its utterances and ought to displace the — in every Presbyterian family. Its editor is a host in himself, and nothing will stagnate that he has anything to do with."—*London Correspondent Chicago Interior*.

"*The Christian at Work* is an admirably conducted sheet, filled with live matter."—*N. Y. Star*.

"*The Christian at Work* is one of the most readable religious papers published anywhere. The Doctor and his associates have discovered the art of making a publication orthodox without being flippant."—*Brooklyn Eagle*.

"In *The Christian at Work* everything is lively and life-like. This Christian smiles, laughs, sometimes actually whistles, while at his work, and that without letting down the dignities and proprieties that belong to the discussion of the themes it discusses."—*Brooklyn Union*.

"*The Christian at Work* is one of the best of the religious weeklies, and deserves the success it has attained."—*Brooklyn Argus*.

"*The Christian at Work* is one of the most sprightly, most gladly welcomed in every family of all religious weeklies. It fits from the pulpit to the pew, from the rod of authority to the kiss of love, from the paternal command to the child's obedience, and scatters flowers upon all, breathing content and happiness upon all its readers."—*American Garden*.

### Five Sabbath School Papers,

under the same editorial supervision, are published by us monthly, and are suitable for School or Home. The best and cheapest published. Beautiful premiums with these also.

### Good Words, My Paper, Good Cheer, Old and Young, Der Sonntagsgast. (German.)

We number our papers, but do not date them, making them good at any time.

Two papers with names nearly like our own have lately been issued in New York City. They are not in any way under the supervision of DR. TALMAGE or the control of THE CHRISTIAN AT WORK PUBLISHING COMPANY. Be careful to send your orders direct to the publisher of this paper.

Full particulars and sample copies of all papers furnished on application.

### HORATIO C. KING, Publisher,

July 14 No. 102 Chambers Street, New York.

WALTER ELDER,  
Landscape and Jobbing Gardener,

1231 Rodman Street, Philadelphia,  
Attends to all branches of his business on reasonable terms.

**100 Farmers wanted during the Winter, to engage with us in business paying 100 DOLLARS per month.** For full particulars, address  
 J. C. McCurdy & Co., Philadelphia, Pa.  
 tdec3

## WANTED.

ASSISTANT PROPAGATOR and Gardener at the Bushberg Grape Nurseries, near St. Louis, Mo. A single man, who has some experience in the propagation of *Grape Vines*, and the culture of orchards, preferred. References to former employer required.

Apply to

**BUSH & SON & MEISSNER,**

febr

Bushberg, Mo.

## GUIDE TO THE STUDY OF INSECTS.

By A. S. PACKARD, JR., M.D.

Also a Treatise on those INJURIOUS and BENEFICIAL to ops. For the use of Colleges, Farms, Schools and Agriculturists. Illustrated with 11 plates, and 650 wood-cuts. 702 pages, 8vo, cloth. Price, \$6.00. Sent by mail post-paid on receipt of price.  
 Address, CHAS. H. MAROT,  
 814 Chestnut Street, Philadelphia.

## ORCHID GROWER'S MANUAL.

By BENJAMIN S. WILLIAMS, F.R.H.S.

Containing brief descriptions of over 800 species and varieties, with notices of times of flowering, approved modes of treatment and practical instructions on general culture. Remarks on heat, moisture, soil, seasons of growth and rest suited to the several species. Enlarged edition with illustrations. 300 pages, 12mo, cloth. Price, \$2.00. Sent by mail post-paid on receipt of price.  
 Address, CHAS. H. MAROT,  
 814 Chestnut Street, Philadelphia.

## FLORA OF THE SOUTHERN STATES.

By A. W. CHAPMAN, M.D.

Containing abridged descriptions of the FLOWERING PLANTS and FERNS of Tennessee, North and South Carolina, Georgia, Alabama, Mississippi and Florida, arranged according to the Natural system. 621 pages, 8vo, cloth. Price, \$3.60. Sent by mail post-paid on receipt of price.  
 Address, CHAS. H. MAROT,  
 814 Chestnut Street, Philadelphia.

## INSECTIVOROUS PLANTS.

By Chas. Darwin.

With copious descriptive contents and index. Illustrated. 462 pages, 12mo, cloth. Price \$7.00.  
 Sent by mail post-paid on receipt of price.

Address CHAS. H. MAROT,

814 Chestnut St., Phila.

## ORNAMENTAL TREES.

By Thomas Meehan.

An American Hand-Book, containing the personal observations of the author. 257 pages, 24mo, cloth. Price \$1.00. Sent by mail post-paid on receipt of price.  
 Address CHAS. H. MAROT,  
 814 Chestnut St., Phila.

## HOW TO MANAGE BUILDING ASSOCIATIONS.

By EDMUND WRIGLEY.

Being a Director's Guide and Secretary's Assistant, with forms for Keeping Books and Accounts, also rules, examples and explanations illustrating the various plans of working. 211 pages, 12mo, cloth. Price, \$2.00. Sent by mail post-paid on receipt of price.  
 Address, CHAS. H. MAROT,  
 814 Chestnut Street, Philadelphia.

## WORKING MAN'S WAY TO WEALTH.

By EDMUND WRIGLEY.

A practical treatise on *Building Associations, what they are, and how to use them.* 108 pages, 16mo, cloth. Price, 75 cents. Sent by mail post-paid on receipt of price.  
 Address, CHAS. H. MAROT,  
 814 Chestnut Street, Philadelphia.

## R. B. PARSONS & CO.

Bowne Avenue, Flushing, N. Y.,

OFFER THEIR

## RARE TREES & SHRUBS

And invite the Special Attention of

## LARGE BUYERS

To their Stock of Rhododendrons, Azaleas—Chinese and Ghent—Camellias, Clematis, Hydrangeas, Rare Conifers, Magnolias; Roses by the 1,000, &c. For Catalogues

Address,

febr12

Box 99, Flushing, N. Y.

WANTED—A Gardener, single, sober, honest, and of good habits and temper; must be fully competent in growing, flowering and foliage, greenhouse plants, a good propagator, well up in florists' business. Address Box 1270,

febr1

Saratoga Springs, N. Y.

FOR RENT—For a term of years, Glass-houses, 200 feet long, with hot water, furnaces and pipes. Dwelling house (8 rooms) with 3 acres of cultivated garden, one mile south of the city of Chicago. Rare chance for a FLORIST. J. H. Dunham, 10 State st., Chicago.

## SITUATIONS WANTED.

By a first-class Gardener, single, who understands the care and management of greenhouses, graperies and vegetables; has had seventeen years' experience; can bring first-class reference. Address, J. L., 1302 Washington Ave., Philadelphia.

A practical Gardener (single American), skilled in the various branches, wants a situation, in charge of a private, rural estate. Good references. Address, JOHN, care of Walter Elder, Landscape gardener, 1231 Rodman street, Philada., Pa.

BY a thoroughly practical Gardener (married, age 35), competent in fruits, flowers and vegetables under glass and out-doors, who has had 12 years experience in this country and 8 years in first-class establishments in Germany; desires to engage by the 6th of March as foreman in a commercial establishment or as Gardener to a private gentleman. Satisfactory reference. Address Gardener, care of Gerold Altorfier, Florist, West Chester, Pa.

BY a practical Gardener, with some private gentleman. Married, has no family. Disengaged March 7th. Address Gardener, Wilhington, Del., Du Pont's Box.

A S Gardener, by a married man without family; has a thorough knowledge of fruits, flowers and vegetables. First-class references. Address, care of James Dunlop, 731 Market St., Philadelphia.

BY a capable and practical German Gardener without family; is a versed and practical worker in Vineyards, Orchards, and understands grafting and training of roses and flowers in general; also hot-house plants. In fact, is an artist in gardens, flowers or vegetables. Address, August Konnu, Gardener, Dorr, Allegan Co., Mich.

TO FLORISTS AND NURSERYMEN.—A situation as propagator or foreman; understands the propagation and cultivation of all kinds of stove and greenhouse plants; thoroughly posted in the general routine of a first-class florist's establishment. Excellent references given. Address, J. A., care of J. Dick, 53rd and Woodland ave., Phila

A S Gardener by a man who has been many years in charge of some of the best public and private places near Boston, in all respects a thorough gardener; and well recommended. A first-class propagator; has grown plants and flowers for Boston market for years; is a thorough grounds man; growing fruits and vegetables inside and out; understands landscaping; will take charge of a small farm in connection with other duties; no objection to go anywhere with the right party. Address Gardener, care of Washburn & Co., Seedsmen, Tremont st., Boston, Mass.

BY a young man as Foreman and propagator in a commercial establishment. Understands the business thoroughly and can come well recommended. Address, H., Florist, care of H. Rainey, 1713 Chestnut street, Philadelphia.

# MUST BE SOLD TO MAKE ROOM!

We offer for the Month of **FEBRUARY** fine healthy stock of the following named

## PLANTS,

Guaranteeing safe delivery of same, if sent by Express.

	Per 100.		Per 100.
<b>Achyranthes</b> , 4 distinct sorts, . . . . .	\$4.00	<b>Lemon Verbenas</b> , strong plants, . . . . .	6.00
<b>Alternantheras</b> , 4 distinct sorts, . . . . .	4.00	<b>Lobelia</b> , new double blue, . . . . .	4.00
<b>Basket Plants</b> , 25 different sorts. . . . .	4.00	"    six distinct and beautiful sorts, . . . . .	4.00
<b>Carnations</b> , large stock plants, 6 finest		<b>Lygodium Scandens</b> , (Japanese Climbing Fern), . . . . .	8.00
Winter flowering sorts, . . . . .	20.00	<b>Mesembryanthemum cordifolium</b>	
<b>Carnations</b> , 25 sorts, 3 inch pots, . . . . .	6.00	var. (var'd Ice plant), . . . . .	6.00
<b>Caladiums, Fancy</b> , 25 distinct sorts, . . . . .	12.00	<b>Mosses</b> , (Lycopodiums and Selaginellas)	
<b>Calceolaria Aurea and Brown Prince</b> , . . . . .	6.00	6 sorts, . . . . .	4.00
<b>Centaurea Candida</b> , white leaved, . . . . .	10.00	<b>Peperomia maculosa</b> , 3 inch pots, . . . . .	6.00
" <b>Gymnocarpa</b> , white leaved, . . . . .	6.00	<b>Petunia</b> , double, 6 sorts, . . . . .	6.00
<b>Coleus</b> , Golden and Velvet, 25 best sorts, . . . . .	4.00	<b>Pentstemons</b> , 6 distinct sorts, . . . . .	4.00
<b>Cineraria Asplenæfolia</b> , white leaved, . . . . .	4.00	<b>Roses</b> , Monthly, Tea, Bourbon and Bengal, 50 best sorts. Hybrid Perpetual and Hardy Climbing, 40 best sorts. Winter flowering, 6 leading sorts.	
<b>Dianthus Querteri</b> (German Pink), . . . . .	4.00	Prices of the above Roses:	
<b>Dahlias</b> , dry roots, 100 sorts, bouquet and large flowering, . . . . .	10.00	Our selection of sorts, 3 inch pots, . . . . .	8.00
<b>Echeveria</b> , 4 distinct sorts, . . . . .	6.00	Buyers' "    "    3    "    "    . . . . .	10.00
<b>Eulalia Japonica</b> , variegated grass, . . . . .	18.00	Our "    "    4    "    "    . . . . .	12.00
<b>Fittonia</b> , (Gymnostachyum) 4 sorts, . . . . .	4.00	Buyers' "    "    4    "    "    . . . . .	15.00
<b>Fuchsias</b> , 25 sorts, 3 inch pots, . . . . .	6.00	<b>Smilax</b> , (Myrsiphyllum asparagoides),	
<b>Geraniums, Double</b> , in 12 sorts, . . . . .	6.00	2½ inch pots, . . . . .	4.00
" <b>Zonale</b> , 30 leading sorts, . . . . .	6.00	<b>Verbenas</b> , named in 60 varieties, \$3 per set, . . . . .	5.00
" <b>Ivy leaved</b> , 12 sorts, . . . . .	6.00	"    to special name or special color, . . . . .	5.00
" <b>Silver and Bronze</b> , 12 distinct		"    in twelve best market sorts, . . . . .	4.00
sorts, . . . . .	8.00	"    mixed, without name or color, . . . . .	3.00
<b>Hibiscus</b> , 3 sorts, . . . . .	6.00	<b>Violet</b> , double blue Neapolitan, 2½ inch pots, . . . . .	4.00
<b>Ivies, English</b> , three feet long, . . . . .	12.00	" <b>Marie Louise</b> , dark blue, 2½ "    . . . . .	4.00
<b>Latania Borbonica</b> , (Fan-leaved Palm),			
3 inch pots, . . . . .	8.00		

We also offer a full assortment of

## FLORISTS' REQUISITES,

Consisting of all Styles of **WIRE DESIGNS** for **CUT FLOWERS**, **FRENCH IMMORTELLS** and **GRASS BOUQUETS**, **BOUQUET PAPERS**, **GARDEN TRELLISES**, **PLANT STANDS**, **RUSTIC WORK**, and many other articles, all of which are priced *very low* in our *Monthly Wholesale List*, mailed free to those who apply.

**PETER HENDERSON & CO.,**

35 Cortlandt St., New York.

# S. B. PARSONS & SONS,

Kissena Nurseries,

Near KISSENA STATION, FLUSHING, N. Y.,

OFFER a very large assortment of **TREES** and **PLANTS** of all the best families. Nearly all of them have been two years transplanted, and their roots are thus in the very best possible condition for a second transplanting.

Their assortment of **RARE EVERGREENS** has long been known to be the most complete. They now have in cultivation a very large variety of hardy

## Deciduous Trees and Shrubs,

numbering over 800 sorts, of which 300 sorts, one year grafted, are entirely new and have not yet been in their catalogue.

Their **JAPANESE DEPARTMENT** now includes more than 150 varieties in addition to the above, and is being constantly enriched by Thomas Hogg, now in Japan. Many of these varieties are unknown in Europe. The celebrated **JAPANESE MAPLES** and **AZALEA MOLLIS** are alone worthy of a visit.

**CAMELLIA JAPONICA** and **AZALEA INDICA** can be advantageously shipped during September, October and November; September being preferred. These plants are carefully formed and trimmed, and their symmetry is recognized by all who see them.

**Rhododendrons** and other hardy **Evergreens** can be safely transplanted in September.

*Estimates will be furnished for Planting Grounds under the care of an experienced Landscape Gardener, and much trouble thus saved to the owner.*

Catalogues will be furnished to applicants by mail, and those who wish to visit the Nurseries will always find either one of the proprietors, or J. R. Trumpy, the well-known propagator of the old establishment. They can take the ferries at 34th Street or James' Slip, which connect with the railroad, leaving the first a quarter of an hour, and the last half an hour before the departure of trains, which make the transit in half an hour. The Nursery is adjoining the Kissena Station and one and a half miles from the other stations. sep

RARE AND BEAUTIFUL FLOWERS AND CHOICE VEGETABLES

CAN ALWAYS BE OBTAINED BY SOWING



B. K. BLISS & SONS,

Importers, Growers and Dealers in

GARDEN, FIELD & FLOWER SEEDS, SMALL FRUITS,

Agricultural and Horticultural Implements,

FERTILIZERS, AND OTHER REQUISITES FOR THE FARM AND GARDEN.

THE TWENTIETH ANNUAL EDITION of our celebrated SEED CATALOGUE and AMATEUR'S GUIDE to the FLOWER and KITCHEN GARDEN, containing upwards of 200 pages, including several hundred finely executed engravings of favorite flowers and vegetables, and a BEAUTIFULLY COLORED CHROMO, with a SUPPLEMENT for 1876, is now in press, and will be mailed to all applicants upon receipt of 35 cents. An edition elegantly bound in cloth, \$1.00.

Bliss's Gardeners' Almanac for 1876, and Abridged Catalogue, Illustrated,

containing upwards of 100 pages, and embraces a monthly calendar of operations and a price list of all the leading Garden, Field and Flower Seeds, with brief directions for their culture. A copy will be mailed to all applicants inclosing 10 cents.

Bliss's Illustrated Potato Catalogue, with explicit directions for culture, mailed to applicants inclosing 3c. stamp.

ADDRESS

B. K. BLISS & SONS,

P. O. BOX 5712.

[dec]

34 Barclay Street, New York.



THE  
GARDENERS  
And MONTHLY  
HORTICULTURIST

EDITED BY THOMAS MEEHAN.

Vol. XVIII.

No. 207.

(Combined Magazines, Thirty-first Year.)

**MARCH, 1876.**

PUBLISHED BY CHARLES H. MAROT,  
814 Chestnut Street, Philadelphia.

TERMS—\$2.10 PER YEAR—POSTAGE PAID.



MacKenzie & Co.

J. R. Stockton, Jr.

# THE GARDENER'S MONTHLY AND HORTICULTURIST.

EDITED BY THOMAS MEEHAN,

Assisted by an able Corps of AMERICAN and FOREIGN CORRESPONDENTS.

It is published on the first of every month, at the office, No. 814 CHESTNUT STREET, PHILADELPHIA, where all BUSINESS communications should be addressed.

Communications for the Editor should be addressed: THOMAS MEEHAN, GERMANTOWN, Philada.

SUBSCRIPTION PRICE, Postage paid, \$2.10.

## TERMS OF ADVERTISING.

	1/8 col.	1/4 col.	1/2 col.	3/4 col.	1 col.	1 page.
One Time,	\$3.00	\$4.00	\$6.00	\$8.00	\$12.00	\$24.00
Two to Three Times, each,	4.70	3.60	5.40	7.20	10.80	21.60
Four to Six Times,	2.25	3.00	4.50	6.00	9.00	18.00
Seven to Nine Times,	2.00	2.70	4.00	5.35	8.00	16.00
Ten to Twelve "	1.80	2.40	3.60	4.80	7.20	14.40

Twelve lines nonpareil is 1/2 col. A less space than 1/2 col., will be furnished at rates in exact proportion, line for line.

For THIRD and LAST COVER PAGES; FIRST PAGE advertisements facing reading matter; "FLY-LEAF PAGE" (front of number) before reading matter and facing first cover—special figures will be given on application.

Changes of copy within space ordered may be made as often as suits advertiser's convenience or interest. COPY and orders for NEW advertisements should be in hand by the 23d of each month; and CHANGES of COPY in running contracts by the 16th of each month, to insure them in following issue. Address

CHAS. H. MAROT, Publisher, 814 Chestnut Street, Philadelphia\*

## CONTENTS OF THE FEBRUARY NUMBER.

### SEASONABLE HINTS:

Flower Garden and Pleasure Ground.....	65-72
Green-House and House Gardening.....	72-78
Fruit and Vegetable Gardening.....	78-83

### CORRESPONDENCE:

Forest Hill Cemetery.....	66
Rhode Island Bent Grass.....	67
The English Sparrow.....	69
A Few Facts About Callas.....	73
Myrsiphyllum Asparagoides.....	74
Richardia Alba Maculata.....	75
June Peach Budding.....	79
Self Opening Gates.....	79
Rapidity of Growth of Timber Trees.....	84
The Forests of Michigan.....	84
Potato Rot.....	87
The Charter Oak.....	91
Pennsylvania Fruit Growers' Society.....	94
Germantown Horticultural Society.....	95
Kansas Horticultural Society.....	95

### EDITORIAL NOTES:

Rattan trellis—The Hollyhock—Aralia papyrifera, hardy—An avenue of Oranges—A Hedge of Geraniums—The Mistletoe—Chimonanthus fragrans—The Umbrella Pine (Sciadopitys verticillata).....	70
The Christmas Rose—Variegated Sage—Unhealthy Camellias—Winter-blooming Fuchsias—The Love of Cut Flowers—A Fine Pot Rose—Eucharis amazonica.....	75
The Lady Grape—The Southern Red Raspberry—Borecole—Grape, Golden Queen—Preserving Figs—The Walbridge and Edgar Red Streak Apple—The Lettuce Mould—The Wild Goose Plum—The Profit of Filbert Nuts—Fertility resisting Frost—Early Cabbages and Tomatoes—Late Apples—The Mandarin Orange—Brockworth Park and Bonne d'Ezee Pears—Clapp's Favorite Pear—American Potatoes in England—American Apples—The Best English Peas—Protecting Trees from Rabbits and Mice—Profits of Forced Peaches—The Wilder Peach.....	80-82
Forestry in Iowa—California Chestnut—English Oak Timber—Gum Trees—The Black Spruce—Carolina Poplars—Virtues of the Eucalyptus—Value of Australian Gum Wood—Catalpa Timber—The Range of	

American Forests—Slow Tree Growth.....	85-87
Spontaneous Combustion—Picea Parsonsiana—Botanic Garden of Harvard University—Rhode Island Bent Grass—Botanic Gardens.....	88-90
Advertisements—W. H. Bailey—The Horticulturist—The Cut Flower Trade of Baltimore—Private Gardens about Baltimore—Flowers in New York—Not a New Candidate—Blue Roses, Strawberries on Trees, &c.—Trees for Nothing—Kansas Agricultural Report, 1875—The Waban Greenhouses of E. A Wood & Co.—Mr. Darwin—Edwin Satterthwait.....	91-93
The Centennial Exhibition—Organization of the Nursery Business—A Botanic-Horticultural Congress—The Central Horticultural Society of France—Alton Horticultural Society—Western New York Horticultural Society—Massachusetts Horticultural Society.....	96

### NEW PLANTS:

Abies alcoquilana—Improved Petunias—Xanthoceras sorbifolia—Pentstemon Palmeri, Gray—Brodiaea Volubilis, Baker (Stropholirion Californicum, Torrey).....	71
Violet Victoria Regina—New Variegated Fern—Dahlia Maximilliana—Zonale Pelargonium, Distinction—Clematis ligusticifolia—Alocasia odorata.....	76-77

### NEW FRUITS AND VEGETABLES:

Large Montmorency Cherry—Paul's Improved Crab—Souvenir du Congress Pear—Two New French Pears—Dr. McLean Pea.....	82-83
--	-------

FORESTRY.....	84-87
NATURAL HISTORY AND SCIENCE.....	87-91
LITERATURE, TRAVELS AND PERSONAL NOTES.....	91-94
HORTICULTURAL SOCIETIES.....	94-96

### QUERIES:

The Charter Oak—Rocky Mountain Silver Spruce—Raising Clematises—Tar Walks.....	71-72
Rubus roseifolius—Diseases in Violets—Propagating Begonias.....	77
Mushroom Culture—Black's Early Peach—Water at the Roots of Grape Vines—Fruit Culture—Highland Hardy Raspberry—Oyster Shell Lime.....	83
Work on Forestry.....	87
Plants for Name—Mixing of Potatoes by Pollen—The Tomato Disease.....	90

# AUGUST RÖLKER & SONS,

32 Reade St., New York.

Importers and Dealers in

## FLORIST'S SUPPLIES,

A well-assorted stock on hand of

BOUQUET HOLDERS AND HANDLES, GRASS, STRAW AND WILLOW BASKETS  
WIRE DESIGNS

FOR CUT FLOWERS, POT COVERS, FANCY POTS, PARLOR TRELISES.

Grass and Dried Flower Bouquets, Wreaths and Crosses,  
From 75 cents, upwards.

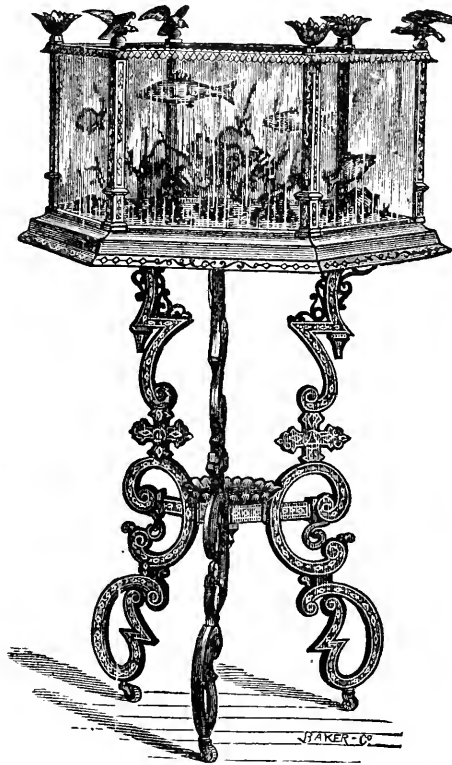

Weeping and Artificial Ivy, Smilax, Buttonhole Bouquets  
of Artificial Flowers, sold at reasonable terms.

FERNERIES, FERNERY BASES, AQUARIA, AQUARIA WARE, TOOTHPICKS, TINFOIL, DRIED GRASSES.

WHITE AND COLORED IMMORTELLS, FRENCH MOSS, FALL LEAVES, FERNS,

IMMORTELLE WREATHS, INSCRIPTIONS and all NOVELTIES of the SEASON.

We solicit timely orders for importation of

HYACINTHS, TULIPS, CROCUS, LILIES, &c.

Which one of our firm will place personally in the hands of growers when in Europe this Spring.  
Limit prices, and we will report at the time whether the order can be filled or not.

1876.

1876

# CENTENNIAL ERA.

---

CONSOLIDATION

OF

# TWO MAGAZINES.

The "HORTICULTURIST" of New York City, having been purchased in the interest of the GARDENER'S MONTHLY, the former Magazine issued its last number with December, 1875, when it completed its Thirtieth year. Henry T. Williams, its late editor and proprietor, gives it up in order to confine his attention more effectively to the other branches of his expanding business.

THE GARDENER'S MONTHLY, with the present issue will be hereafter known as the "GARDENER'S MONTHLY AND HORTICULTURIST." It is, at this date, the *only Monthly Magazine* devoted to *Horticulture*, in the *United States, East of the Rocky Mountains*. It will continue under the able Editorship of THOMAS MEEHAN, and will as heretofore do its best to deserve the consideration and support of the increasing numbers, who, through cultivation, taste, interest, desire the companionship or aid of such a literature.

The subscribers of the GARDENER'S MONTHLY and those of the late HORTICULTURIST are kindly requested to give their encouragement to this consolidation, by an early renewal of their own subscriptions, and, if possible, the enclosure of, each, a new subscriber with their own orders.

The lovers of Horticulture generally are asked to give the Magazine a year's trial.

Single Subscription Price, \$2.10 per Year. Six Months for \$1.05; Four Months for 70 cents; Three Months for 53 cents. One Old with one New Subscriber, or Two New Subscribers, \$3.20 for the two.

Remit by Post Office Order, Draft, or Registered Letter, to avoid possible loss by miscarriage through the mails.

ADDRESS

## CHAS. H. MAROT,

PUBLISHER,

814 CHESTNUT STREET, PHILA.

---

 SEE FIRST PAGE, FACING COVER.



MY  
CATALOGUE OF PLANTS

FOR THE  
SPRING OF 1876,

Will be ready about February 1st. It will contain an unusually fine assortment of Novelties in the way of

CANNAS, GERANIUMS, HELIOTROPES,  
PELARGONIUMS, VERBENAS, &c.

Also, an admirable assortment of new and beautiful

FRENCH HYBRID GLADIOLUS,

Which are offered in large quantities at LOW RATES. Also,

TUBEROSE BULBS OF THE VERY BEST QUALITY.

Particular attention is called to my

STOCK PLANTS OF VERBENAS,

containing a fine selection of Varieties, all in vigorous health. Attention is also called to my list of

EXTRA CHOICE

FOREIGN GRAPES FOR GRAPERIES.

Catalogues may be had FREE OF CHARGE by addressing

GEORGE SUCH,

# FRUIT AND ORNAMENTAL TREES, SHRUBS, ROSES, AND PLANTS.

ELLWANGER & BARRY, Proprietors of the Mount Hope Nurseries Rochester, N. Y.,  
invite attention of  
PLANTERS, NURSERYMEN, and DEALERS

to the extensive and varied stock in every department which they offer for the Spring Trade. Full particulars given in the following Catalogues, which will be sent to all our old customers free, and to others who enclose stamps as below.

No. 1. **FRUITS** (just published). 60 pages, with **Colored plate**, 15 cents, without, 10 cents.  
No. 2. — **ORNAMENTAL TREES, Shrubs, Evergreens, Roses, etc.**, 124 pages, 50 illustrations, and a **Fine Colored Plate of Roses** 25 cents.

No. 3. — **GREEN and HOT-HOUSE and BEDDING PLANTS**, with Supplemental List of Novelties **FREE**.

No. 4. — **WHOLESALE**, free.

No. 5. — **LIST of NEW ROSES**, for 1876, **FREE**.

feb3

Address — ELLWANGER & BARRY, Rochester, N. Y.

# R. B. PARSONS & CO.,

BOWNE AVENUE, FLUSHING N. Y.

Offer a General Assortment of the Best

## TREES AND SHRUBS.

Our Office and Greenhouses being at the location once occupied by the old house of Parsons & Co. (now dissolved), of which R. B. Parsons was a member, visitors will find it quite accessible from either the Bridge or Main Street Railroad Stations.

We cultivate in great quantity and offer to **LARGE BUYERS**, a very choice stock of **HARDY RHODODENDRONS, AZALEAS**, Chinese and Ghent, **CAMELLIAS, CLEMATIS, MAGNOLIA, CAMPBELLII, CHINESE MAGNOLIAS, PURPLE BEECH**, and other valuable Trees and Plants. We grow well rooted Evergreens in large numbers, and our

## RARE EVERGREENS

are widely known as being in great variety and well grown. We offer

## ROSES

in large quantity of our selection, at \$8 per 100 : \$70 per 1,000. **Deutzia Crenata**, double flowering, white—an entirely new variety, 75c. The attention of **Dealers** is invited to our stock, which being near the Flushing Depot, can easily be reached. The aid of an experienced Landscape Gardener can be offered to those wishing to plant. Catalogues furnished on application to

feb3

Box 99, FLUSHING, NEW YORK.



I have founded my business on the belief that the public are anxious to get their seed *directly from the grower*, and I therefore offer **FREE** to every man and woman in the United States who cultivates a farm, tills a vegetable garden, or plants a flower garden, my large, illustrated Catalogue of Vegetable and Flower Seeds for 1878; it contains, in addition to the choicest kinds produced in Europe, *one hundred and fifty varieties of vegetable seed grown on my four seed farms*. Customers of last season need not write for it. As the original introducer of the Hubbard, Marblehead and Butman Squashes, Phinney's Melon, the Marblehead Cabbage, and a score of other new vegetables, I solicit your patronage. All seeds sold under three warrants. A 100,000 catalogues will be issued and sent out the 1st of January.

JAMES J. H. GREGORY,

Marblehead, Mass.

dec5

## GRAPE VINES

Grown especially for the Trade and Planters in Quantity. **CONCORD, MARTHA, Delaware, Hartford, Prolific, Ives, Salem, Wilder, Iona**, and many other varieties, one and two years old, in quantity.

A. HANCE & SON,

Nurserymen and Florists, Red Bank, N. J.

nov1f

## C. F. A. HINRICHS,

29, 31 and 33 Park Place, New York City,

HYACINTH AND BULB GLASSES.

DECORATED

FLOWER POTS,

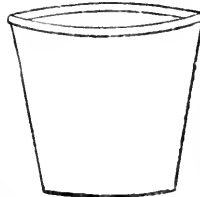

LAVA, MAJOLICA, &c, &c. Vases. Iron Sections for Flower Beds. Lawn, Fish and Flower Stands. Floating Animals for Aquaria. Button-hole Bouquet Holders. Only and Original GERMAN STUDENT LAMP for Conservatories.

Send for Prices to above address.

mch6

## PEACH TREES,

Handsomest stock of best new and old sorts, with general assortment of hardy Fruit and Ornamental Trees, Flowering Shrubs, Vines, small Fruits, &c.

New Price List Free.

EDWIN ALLEN,

mch1 New Brunswick Nurseries, N. J.

FORCE PUMP and PLANT SYRINGE \$4.50.

PAGES' IMPROVED—best in market for applying liquids to destroy insects on plants, vines or fruit trees; throws jet of water so fast: will change to coarse spray or fine mist instantly.

N. PAGE, Jr.,

Danvers, Mass.

mch2

# EVERGREENS, EVERGREENS,

NORWAY SPRUCE, from 1 to 6 feet IRISH JUNIPERS, from 6 inches to 6 feet. AMERICAN ARBORVITÆ, 1 foot to 6 feet. AUSTRIAN, SCOTCH and WHITE PINES, 1 to 6 feet. DWARF AKBORVITÆ, in great variety, all sizes.

# RETINOSPORAS AND OTHER NEW AND RARE EVERGREENS. DECIDUOUS TREES.

SILVER, SUGAR and NORWAY MAPLES, AMERICAN LINDEN and other Trees, for Street Planting. Also of small sizes for replanting.

## FLOWERING SHRUBS,

A general assortment of large and small sizes.

## SMALL FRUITS.

Herstine Raspberries, in large stock. Currants and Gooseberries, fine 2 year old's

## GRAPE VINES IN VARIETY.

Our stock is very fine, and will be offered at the **Lowest Prices**. Send list of stock needed in our line and see how low we can sell it; also for New Wholesale Catalogue.

**WILLIAM H. MOON,**

MORRISVILLE, PENNA.

# BEDDING PLANTS.

VERBENAS, very fine and thrifty. \$4 per 100.

## GERANIUMS! FUCHSIAS! COLEUS!

and other Standard Bedding Plants in great variety. We have a large stock of GREENHOUSE PLANTS, which we offer at very low prices.

## IRIS KEMPFERII---NEW JAPAN IRIS.

By far the finest Iris in cultivation. Perfectly hardy. Blooms in mid-summer. Flowers large, of various shades of color. It is now attracting considerable attention among the leading European Florists. \$10 per 100.

Send for Wholesale Price List to

tmch MAHLON MCON & SON, Morrisville, Bucks Co., Pa.

# COLUMBUS NURSERY.

ESTABLISHED 1855.

## Nurserymen and Dealers

Needing stock, and parties intending to plant, can find at this old and reliable establishment, a large and complete assortment of **Fruit Trees, Grape Vines, Small Fruits, Deciduous Trees, Evergreens, Roses, Shrubs, etc.**, of the best quality, at reasonable prices.

For the Spring of 1876 our stock is large, embracing STANDARD APPLES in large quantity, DWARF APPLES, STANDARD and DWARF PEARS, CHERRIES, PLUMS, PEACHES, APRICOTS, NECTARINES, QUINCKES, SPANISH CHESTNUTS, ENGLISH WALNUTS, BLACKBERRIES, GOOSEBERRIES, RASPBERRIES, STRAWBERRIES, CURRANTS, and GRAPES—old and new varieties.

EVERGREENS in great variety, good size trees for planting and shipping. DECIDUOUS trees of many kinds, large and small. **Kilmarnock, New American and Rosemary Willows, Weeping Ash, Elm and Poplar, Shrubs and Climbers. ROSES**, a fine collection on own roots, embracing many of the new and desirable varieties.

With railroads leading in all directions, and an Agent at Cincinnati to re-ship promptly to all parts of the South-west, purchasers may depend upon receiving what they order, without delay. We pack our Trees, &c., so they will reach any part of the country in good condition. Parties interested, are invited to call and examine our stock.

Correspondence solicited, and prices sent on application.

mch2 **R. G. HANFORD & SON, Columbus, O.**

## 5000 NORWAY SPRUCE

and BALSAM FIR,

Mostly 3 feet and 4 feet sizes. **Very Cheap.**

**ENGLE & BRO.,**

mch2

MARIETTA, PA.

## EVERGREENS.

I am prepared this spring, as heretofore, to furnish large quantities of Native Evergreens to Nurserymen and others for cash, or in exchange for first-class Nursery Stock.

75,000 Transplanted Norway Spruce; 20,000 Scotch Pine. 50,000 Hemlock will be so d low. Samples furnished with prices by request. All about 1 foot high—nice, compact plants.

mch1 **L. B. CHAPMAN, Portland, Me.**

# HYBRID PERPETUAL ROSE,

## "EDMUND WOOD."

We are gratified to find that our friend M. VERDIER, the most celebrated Rose grower of France, has considered our establishment of sufficient importance to name one of his finest New Seedlings after our Mr. EDMUND M. WOOD. In a special circular containing the names of his choicest New Varieties, he thus describes it: *Edmund Wood*: tree vigorous, with short reddish-green branches and numerous dark brown spines, leaves consisting of 3 to 5 leaflets oval, dark green; Flowers, large, full and perfect in form, growing in corymbs of 6; color lively, bright cherry red, reverse of petals, carmine—admirable. This variety is comprised in the series to which the silver gilt medal was awarded by the Paris Horticultural Society in May and June, 1875. Depending upon the correctness of this description and the well-known veracity of Mons. Verdier, we have arranged for the importation in quantity of this variety with all the others raised last year in Europe and shall offer it to the public of the United States on and after May 1st, at \$2 each. Orders will be executed in strict priority as they are received.

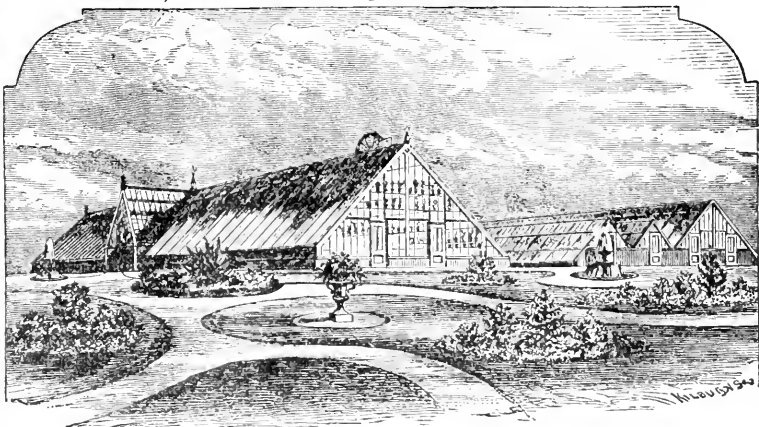

OUR NEW DESCRIPTIVE CATALOGUE, containing names and characters of all the best Roses, new and old, at present in cultivation, will be ready in a few days, and may be had on application.

EDMUND M. WOOD & CO.,

OFFICE OF

# WABAN CONSERVATORIES,

56 BROAD STREET, BOSTON, MASS.

tjan12

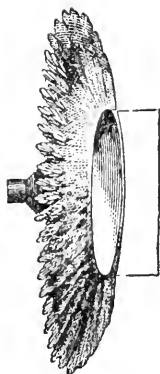

M. M. BAYERSDORFER & CO.,

Importers of Every description of

## BOUQUET PAPERS.

Plain White Satin for Bridal Bouquets. Fancy Lace for Weddings, Receptions, Parties. Jattens, Pasted Cartons, Immortelles in great varieties; Green Moss, French Dried Grasses and Flowers, Tin Foil. Prize Medal of Cincinnati Industrial Exposition of 1873 awarded to us for the best display of Bouquet Papers. Illustrated Catalogue furnished on application.

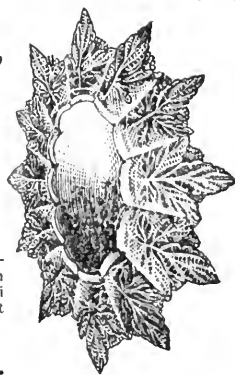

feb

56 N. Fourth St., Philadelphia, Pa.

# THOMPSON'S WEEPING DOGWOOD.

Having purchased the original of this magnificent WEEPING TREE, and believing it to be one of the most attractive things in this line

EVER INTRODUCED.

It will be placed at once under propagation, and when ready for sale it will be duly announced.

## BLOOD-LEAVED BIRCH.

This is of just as beautiful a color as the well known Blood leaved Beech. A few plants for sale this Spring at \$5 each.

# WEEPING YELLOW ELM.

A few Plants of this, regarded by all as **The Best of All Weeping Elms**, on six feet stems, at \$5; Small Plants, \$3.

THOMAS MEEHAN, Germantown Nurseries, Phila.

mch2

*John Saul's  
Catalogue of New, Rare  
and Beautiful  
Plants!*

FOR SPRING OF 1876,

Will be ready in FEBRUARY, with a Colored Plate. Man-  
beautiful

NEW PLANTS

are offered; all at VERY LOW RATES. Free to all my  
Customers; to others, 25 cents a copy. A plain copy to all  
applicants free.

- New Pelargoniums.**—A magnificent set of beautiful flowers.
- New Perpetual Pelargoniums.** Very distinct—beautiful.
- New Bergonias, tuberosus rooted.** A beautiful set.
- New Cannas.** Beautiful and distinct in foliage.
- New Zonale and Double Geraniums.** Raised by Mr. Lax-  
ton, Dr. Penny and others.
- New Victoria Daisies,** new sets of Fuchsias, Roses, Phloxes  
**Heliotropes, Dahlias, Chrysanthemums, Ager-  
atum, Hibiscus, Caladiums, Clematis,  
&c.,** with other New and Rare Plants.

ROSES.

An immense stock of all the standard varieties grown in pots.  
CHEAP.

NEW FRUITS.

NEW PEARS, PEACHES, STRAWBERRIES, &c.

**NEW SHRUBS and ORNAMENTAL TREES,** with a  
large general Nursery Stock—Fruit Trees, Evergreens, &c., Nor-  
way Spruce, Austrian Pine, Silver Fir and other Small Ever-  
greens, Fruit Tree Stocks, &c., suitable for Nurserymen.  
CATALOGUES mailed to applicants.

JOHN SAUL,

Washington City, D. C.

THE

TWO NEW POTATOES,

The Best Early and the Best Late.

Thorburn's Early Paragon,  
Thorburn's Late White Rose.

Priced Catalogues of

Vegetable and Agricultural Seeds, Flower Seeds,  
Tree Seeds, and Spring Bulbs,  
For 1876, on application to

J. M. THORBURN & CO.,

15 JOHN STREET, NEW YORK.

**ROSES, VERBENAS**  
BEDDING AND EXHIBITION PLANT  
Sweetstakes Medal at Exposition  
Fine stock at Low Figures. See Catalogue & K.E.  
Address B. P. CRITCHELL, Cincinnati, Ohio.

Park's Floral Gazette.

A BEAUTIFUL FLORAL MONTHLY.

Entirely Floral. Twenty pages—neat print—  
fine tinted paper—elegant illustrations—magnifi-  
cent colored plates—tells all about Flowers, Fern-  
eries, Conservatories, &c. Everybody who loves  
flowers should take it. Only 10 cts. per copy, or  
\$1.00 a year, post paid.

"The GAZETTE is splendid; every number is better than its  
predecessor. I would not be without it."—W. C. L. Drew,  
Eldorado, Cal.

"I consider PARK'S FLORAL GAZETTE one of the best and  
cheapest papers for the price that is published. Every lady, if  
she only wants to grow one plant, ought to take it."—James A.  
Nelson, Indian Run, Mercer Co., Pa.

"The FLORAL GAZETTE came and thoroughly charmed me  
with its neat appearance externally; and it's full to the brim in-  
ternally. I felt that it was just what I wanted, and herewith  
send you my subscription."—Miss Jennie P. Orran, Berlin  
Heights, Ohio.

GEO. W. PARK, Ed., Pub.,

MOUNT VERNON, OHIO.

feb3

PEACH TREES.

The Largest Stock in the Country. Our stock of **other**  
leading articles is complete in assortment, and fine in quality.  
We excel in packing and in early and prompt shipments.

HEIKES NURSERIES CO.,

Dayton, Ohio.

feb2

TO THE TRADE.

USEFUL NEW PLANT—**SEDUM AZOIDEUM VARIEGATA.**

We find this the most useful ornamental plant of recent intro-  
duction, being equally adapted for centres of Hanging Baskets,  
Vases, Pot-culture or Bedding. Quite hardy, of free growth,  
but dwarf, compact habit; leaves of a deep green color, beauti-  
fully margined and blotched with creamy white, producing a  
very unique and pleasing effect. Price \$2.50 per dozen.

Address J. GREIVES, Sec'y Greenbrook and Paterson  
City Nurseries, Box 837, Paterson, N. J.

feb3

The Cheapest Magazine published in the  
Civilized World is

THE FANCIERS' HERALD

AND

LIVE STOCK ADVERTISER.

A large illustrated 20 page Monthly, devoted to Poultry, Fish  
Culture, Bees, and Live Stock. Subscription price but 50 cents  
per year, postage paid. Circulation immense, and advertising  
rates but one cent per word, every advertiser receiving the  
copy containing his advertisement free. Endorsed by all the  
prominent Breeders in the country, and contributed to by some  
of the most eminent writers. Sample copies, 10 cents.

Address

HERALD PUBLISHING HOUSE,

Mattituck, Suffolk Co.,  
New York.

feb3

GOOD SEEDS

Grown with care and painstaking from selected stocks always  
dry. Try mine. See advertisement "All About Gardening."  
J. B. ROOT, Seed Grower, Rockford, Illinois.

feb4

# MAHALEB STOCKS.

A fine lot of No. 1 in cellar ready for shipment at any time. \$1.25 per 100, \$10 per 1000. After April 1st, No. 2 at \$1 per 100, \$8 per 1000. For larger quantities, prices on application.

Our assortment of SEEDLINGS and YOUNG STOCK for NURSERYMEN is very extensive.

**HOOPE, BRO. & THOMAS,**

Cherry Hill Nurseries, West Chester, Pa.

New Trade List, 20 pages, will be issued February 1st.

Jan 3

## S. THANHAUSER, BOUQUET PAPERS,

IN ALL VARIETIES.

BRIDAL BOUQUETS,

White and Colors, trimmed with Satin, Lace, Tulle, &c.  
Large Assortment of Immortelles, Grasses, Moss, &c.

No. 19

PHILADA.,



N. 4th St.,

PENN.

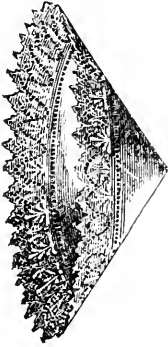

**AT BOTTOM PRICES,** 200,000 Evergreens and Larches Ornamental Trees, and Seedlings. Fruit Trees and (rosa canina) one year, etc., etc. Price list free.

mch2

E. Von OVEN, Naperville, Ill.

**CHAMPION GRAPE,**

Send for free circular to

The earliest good market Grape cultivated. Large bearer; no mildew; very hardy.

J. S. STONE,

Charlotte, Monroe Co., N. Y.

mch2

## Superb Lawn Trees.

NEW WEEPING BLOOD LEAVED BEECH.  
NEW WEEPING HAWTHORN-LEAVED BEECH, Varieg'd.  
Acacia Bugoti pendula. Purple Birch Standards 6 feet high.  
Specimen Rare Coniferous and other choice Evergreen Plants.

JOHN BUTTERTON,

The London Nursery, Hammonon N. J.

mch1

## PEACH TREES.

Nurserymen and Dealers desiring to purchase First-class Stock at Low Prices should correspond for SPECIAL QUOTATIONS. Samples forwarded by Express. Address,

W. M. FOULK,

COATESVILLE, Pa.

mch1

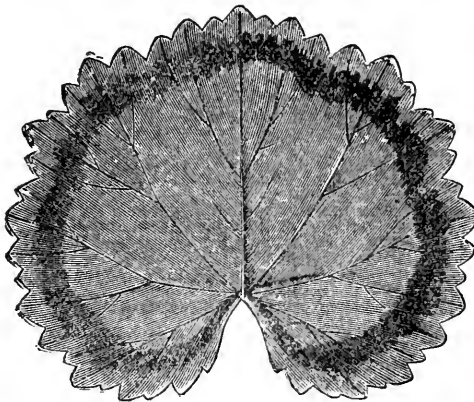

PELARGONIUM, DISTINCTION,  
50 cts. each. \$4.50 per doz.

We now offer the above exquisite Novelties with a large collection of choice Pelargoniums, of which a Special List for the Spring Trade is now ready.

Address

THE BELLEVUE NURSERY CO.,

PATERSON, NEW JERSEY.

febt.

H. E. CHITTY, Sup't

Copies of Either of these Cuts,  
\$3.00 Each.

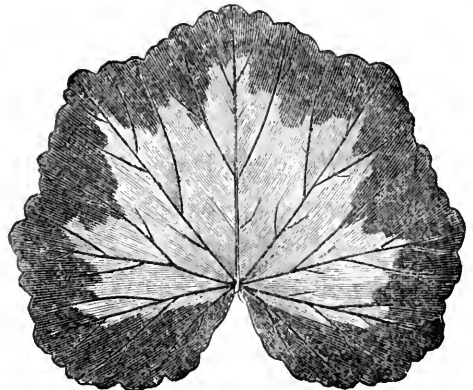

PELARGONIUM, HAPPY THOUGHT,  
\$1 each.

# WABAN CONSERVATORIES

OFFICE:  
56 BROAD ST., BOSTON.  
Address all Letters to  
BOSTON OFFICE.

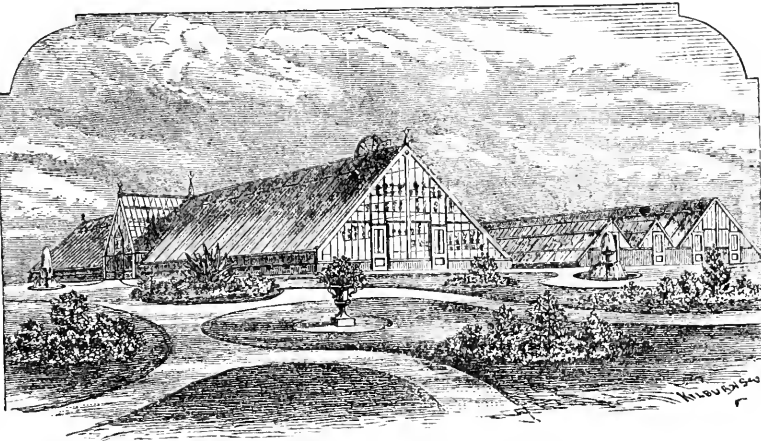

Send all Telegrams by  
Atlantic & Pacific Line. Address,  
*Waban Conservatories,*  
LAKE CROSSING, MASS.

## THESE CONSERVATORIES

Have in stock at all times, and offer at Wholesale,

## CUT FLOWERS IN QUANTITY, CONSISTING OF

**BON** Silene, Saffrano and Isabella Sprunt Roses, Marechal Niel and General Jacquiminot, in great quantity, Souvenir de Malmaison, Yellow Tea, Persian Yellow, Devonensis, Gloire de Dijon in limited amounts. *The New Roses*—Le Nankin, La Jonquil, Madam Capucine, Belle Lyonnaise, Perle de Lyon, we shall be able to furnish in good quality. La France Rose in large quantity.

Also White and Red Bouvardia, White and Red Carnations, Violets, Stephanotis, Tuberoses, Jessamine and a general assortment of Cut Flowers used by the best Florists.

Lilium Longiflorum and Candidum in quantity at Easter.

Smilax & Fern Fronds in very large quantities for Decoration.

NEW ROSES, }  
NEW PLANTS, } AT LOWEST RATES.

We are now packing and shipping Flowers with perfect success to Chicago, New York, Philadelphia, Baltimore, Washington, Montreal, and all important intervening places; and we are pleased to add that our shipments are giving universal satisfaction; our Telegraphic communications enabling us to fill orders to the most distant places quicker than Florists can obtain them by any other means.

**TEAS**—Aline Sisley, Comte de Sembuy, Jean Ducher, Marie Guillot, Marie Opoix, Perle des Jardine, Shirley Hibberd.  
**NOISETTE**—Reine des Massis. **BOURBON**—Mme. de Sevigne. **MOSS**—Souppert et Notting.

**HYBRID PERPETUALS**—Adanson, Antoine Mouton, Bernard Verlot, Cassimir Perrier, Comtesse de Serenye, Gaspard Monge, General Eerwagne, Henry Ward Beecher, Hypolite Jamain, Ingenieur Madele, La Rosiere, La Souveraine, Madame Rose Charmeux, May Eurner, Philippe Bardet, Princess Antoinette Strozio, Soeur Athunase, Souvenir de Mere Fontaine, Madame Lefebure de St Ouez, Claire Mathiew Melle, Tlona de Adorjas, Souvenir de Ducher.

Our importations for the present season are on a much larger scale than heretofore, and will embrace all the New Roses and other plants of merit raised in Europe during the past year.

We have the pleasure to state that our stock never was in so fine condition. Our new houses are in running order and we shall be able to supply all plants and Cut Flowers as stated in former advertisements, in large quantities—now having the largest establishment in the United States devoted to the sale of Cut Flowers. Our new descriptive Catalogue, revised and greatly improved, will be ready in February.

**N. B.**—Particular attention given to Plan, Arrangement, Construction and Heating of Greenhouses for the growth of **CUT FLOWER PLANTS** at a Profit for Market. Advice as to the most profitable Flowers and Plants to grow, and method of culture. Nine-tenths of the Failures can be traced to want of Knowledge in the Construction, Arrangement and Heating of Houses, and the Kinds of Plants and Flowers to put in them. *New Beginners*, we believe, will find our knowledge and large experience valuable to them.

EDMUND M. WOOD & CO.

**N. STEFFEN'S WIRE WORKS,**  
335 E. 21st St. New York.

manufacturer of all designs for FLORISTS. Wreaths, Crosses, Crowns, Hearts, Anchors, Pillars, Columns, Monuments, Bells Composure, Faith, Hope and Charity, Harps and Lyres, &c. Leaning and Upright.  
Send for Price List. jan 12.

**TO FLORISTS.**

**TOBACCO STEMS,** For Fumigating purposes, put up in Tales of 250 lbs. each, at \$5.00 per bale, free on boat or cars. All orders from unknown parties must be accompanied by remittance. For sale by

**STRAITON & STORM,**  
No. 180 Pearl Street, New York.

aug12

**Allen's Planet Jr.**  
**SILVER**  
**MEDAL**



Hand Seed Drills and Wheel Hoes, perfected for 75. Four sized They "sow like a charm!" no packing of seed in the hopper, no crushing it, no pausing or waste at the ends, no irregularity in depth, no springs or gearing to wear out, no "skips," no noise, no equal! Turn Double Wheel Hoes works easier, better, and from six to twelve times faster than the hand hoe; often saving the customer \$100 in a season; finishes two rows at once, when 6, 9 or 10 inches apart. Four pairs of hoes; blades tempered steel. We make an admirable COMBINATION MACHINE possessing nearly all the excellencies of the separate ones. No vegetable garden, however small, should be without one. Our New Horse Hoe, perfected after ten years of experiment, saves most of the hoeing and makes the remainder easy; leaves the ground level or ridged as desired, opens furrows, Aids, and cultivates shallow or deep, and is a thorough weed killer; should be owned by every farmer. Full Descriptive Circulars and Testimonials free. Mention this paper. S. L. ALLEN & CO., Sole Man'rs. No. 119 S. 4th St., Philada. Pa. We must have a Live Agent in Every Town.

**DELAWARE.**

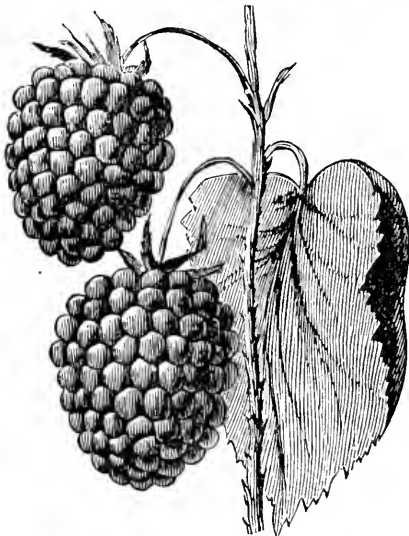

The Largest and Best Hardy Red Raspberry.  
Send for circulars.

**WM. PARRY,**  
Cinnaminson, N. J.

mch2

**A NEW ERA IN**  
**TRICOLOR GERANIUMS.**  
**THE NEW TRICOLOR,**  
**MRS. GEORGE FOUST.**

As a test of the great merit of this new Geranium, I may state that all the Philadelphia Florists, on seeing it, purchased all the stock I could spare. Among them, Messrs. Bust, Dick, Dreer, and Harris. Mr. Harris, the great Geranium grower, says, "The best thing I have ever seen"  
It perfectly withstands the hottest sun, holding its color and growing vigorous. I may also state, that grown in the greenhouse there is no other variety to equal it in growth and rich color. So much so that customers, on seeing it, will have nothing to do with the other kinds. Was awarded Special Premium by Pennsylvania Horticultural Society, in September, 1874.  
**PRICE, \$1.50.**

Messrs. John Saul, of Washington, D. C., and John Dick, 53rd & Darby Road, Philadelphia, have received consignments, and have it for sale; also the undersigned,

**GEO. FOUST,**  
2325 FRANKFORD Avenue, Philada.

feb3

**NEW AND CHOICE**  
**TREES AND SHRUBS.**

A Descriptive Price-List, free to applicants.  
**W. C. STRONG,**  
Nonantum Hill, Brighton, Mass.

mch2

**STRAWBERRY PLANTS**

By the 100, 1,000, 10,000 or 100,000.  
**MONARCH OF THE WEST, COL. CHENEY, WILSON'S ALBANY, Seth Boyden, Chas. Downing, Downer, Triomphe de Gand, Kentucky. Also, STAR OF THE WEST, Champion, Dr. Warden, Late Prolific, Black Deiance, Agriculturist, Lenning's White, and others.**  
**A. HANCE & SON,**  
Nurserymen and Florists, Red Bank, N. J.

nov.1f

**VEITCH'S**  
SET OF  
**6 NEW GLOXINIAS.**

These Gloxinias were originated at the Royal Nursery, Chelsea, London, and are described as superior to any in cultivation. Some of the flowers are twice the size of the old varieties, and most of them have received first-class certificates.  
**Price, \$5.00 for the Set of 6.**  
Grown and for sale by  
**GEORGE FOUST,**  
2825 Frankford Ave., Philada.

feb3

**ALL ABOUT GARDENING**

For HOME use and for MARKET in **ROOT'S GARDEN MANUAL**—practical, pointed and thorough,—containing one-half as much matter as \$1.50 books on the subject. Gardeners throughout the country commend its practical labor-saving methods as invaluable to them. Sent for 10 cents, which will be allowed on the first order for seeds. **J. B. ROOT, Seed Grower, Rockford, Illinois.** feb4

**FOR SALE.**

A Small Nursery and Florist's Business with about **Four Acres** of land, **Three Greenhouses**, house and out-houses, and a fine collection of **Plants, Shrubs and Evergreens, &c.** This is a chance rarely to be met with. For particulars apply to  
**S. BRYAN,**  
City Gardener, Petersburg, Va.

mch1



# SOUTHERN GROWN PLANTS.

My stock of Southern grown Fruit, Shade and Ornamental Trees, has been grown with especial good care, and comprises, the most prominent of the

**HARDY EVERGREENS and FRAGRANT FLOWERING SHRUBBERY**  
Well known for the remarkable grace and beauty with which they adorn the lower Mississippi Valley.

Of **SEMI-TROPICAL or PLANTS** of the **WARM TEMPERATE ZONE**

My collection consists of many, and most Attractive Specimens—Well fitted ornaments for Conservatories in Winter; or out-door decorations during the Summer season, in a more **NORTHERN or WESTERN CLIMATE.**

Price List on application sent postpaid. Address

**R. MAITRE, Seedsman and Florist,**  
602 Magazine Street, New Orleans, La.

tfeb3

Rowland Whitman.

Harry Lang.

## WHITMAN & LANG,

IMPORTERS OF

### BOUQUET PAPERS, FANCY GRASSES,

DRIED FLOWERS, IMMORTELLS, TIN FOIL, &c.,

No. 126 NORTH FOURTH STREET,

PHILADELPHIA.

aug1

## GERMANTOWN NURSERIES, PHILADELPHIA.

GORGAS LANE STATION, CHESTNUT HILL RAILROAD. Less than One Hour from the Centre of Philadelphia.

Those who desire to purchase largely, either for their own planting or to sell again, are invited to examine the **extensive stock** of

### FRUIT, SHADE AND ORNAMENTAL TREES AND SHRUBS,

Grown at the Germantown Nurseries. And those who need but A FEW ARTICLES, will find all ages and sizes to select from. A special feature of the business, is the raising of

**Nursery Stock and Seedling Forest Trees**

FOR DISTANT SHIPMENT. Many of these can be supplied by the millions at very low rates. Address, for CATALOGUES or information,

**THOMAS MEEHAN, Germantown Nurseries, Phila.**

Estab. 2,000,000 1765. IN STOCK

ILLUSTRATED CATALOGUES  
Sent free on application.

Low freights from Boston  
allow us to compete with any  
Pottery in the United States.

**A. H. HEWS & CO., - - No. Cambridge, Mass.**

**JOHN DICK,** CATALOGUES FREE, 53d & Darby Road,  
 FLORIST, 30 GREENHOUSES, Philadelphia.  
 100,000 FEET OF GLASS.  
**ESTABLISHED—1836.**

I invite attention to my stock of Plants, New and Rare

FOR THE GREENHOUSE AND CONSERVATORY,

Abutilon, Azalea, Begonia, Cactus, Caladium, Croton, Dracena, Echeveria, Gloxinia, Ferns, Hoya, Maranta, Orchid, Palms, Selaginellas, &c., &c.,

FOR OUT-DOOR DECORATION,

Coleus, Fuchsias, Geranium, Heliotrope, Lantana, Petunias, Roses, Salvias, Verbenas, &c.

VARIEGATED AND FANCY FOLIAGE PLANTS.

Plants for Baskets, Ferneries, Ribbon Beds and Borders.

New Conservatories and Greenhouses Stocked at Low Prices. Catalogues Free. A Wholesale Price List for the Trade. tfb3

## READING NURSERY.

(ESTABLISHED BY US IN 1854.)

200,000 EVERGREEN TREES of 50 VARIETIES.

1 to 3 times transplanted on a loam soil 6 inches to six feet high. Many of the **HEMLOCK** and **ARBOR VITÆ** are pruned into CONICAL and PYRAMIDAL form. Can be shipped with ball of earth set in tubs very sure to live thus treated.

10,000 MAPLE TREES,

8 to 15 feet, 1 to 2 transplantings, largely Rock Maple. Also **STRIPED-BARK MAPLES**, 4 to 8 feet.

ROSES, SHRUBS, RARE TREES.

1000 RHODODENDRONS, 1 to 3 Feet High.

3000 White and Blue SPRUCE, 2 to 6 Feet.

50,000 NORWAY SPRUCE, 1 to 4 Feet.

Also **BLACK** and **RED** SPRUCE.

2000 YUCCA FILLAMENTOSA.



Adam's Needle.

(See our remarks on Forest Planting on pages 36, 37 and 38 of Descriptive Catalogue.)

We do not offer you a CHROMO to buy our goods, but DR. GARDNER'S Patriotic ORATION of the Hundredth Anniversary of Bunker Hill, with a MAP of the BATTLE GROUND will be sent to all, who apply for our 40 page Catalogue, having 25 cuts of Fruits, Flowers and Trees, also a Wholesale List.

J. W. MANNING,

READING, MASS.



Pyramidal Arbor Vitæ.

mch1

**JOHN A. SCOLLAY,**  
**IMPROVED HOT WATER APPARATUS,**

Patented September 17, 1872.

*For Warming and Ventilating Dwellings, Greenhouses, Graperies, Forcing Pits, Drying Rooms, Heating Water for Public Baths, &c.*

This Boiler is perfectly self-cleaning, simple, economical and powerful, having more effective surface into less space than any Boiler in the market. Scollay's Patent Plant Sprinkler, for Window Gardening, &c., to be obtained of all Seedsmen, Florists, &c. Send for Circular and References. july12

351 Adams Street, Brooklyn, New York.

# Roses! Roses! Roses!

We offer a large stock of  
**FINE STRONG GROWING YOUNG ROSES,**  
 grown in 2 and 3 inch pots, and include the finest and leading varieties.

HYBRID PERPETUALS, TEAS, BOURBONS AND CHINAS.

Also **MOSSSES** and **CLIMBERS.**

at very lowest prices. Orders solicited.

**JAMES ALDOUS & CO., Florists,**  
 tfeb7 Iowa City, Iowa.

NEW YORK, FEBRUARY 1st, 1876.

A FEW

# THOUSAND PLANTS

In excellent condition, just

IMPORTED FROM FRANCE,

To be sold for CASH ONLY and delivered at once.

<b>Mahaleb Stocks</b> , middling size, - - -	per 1000,	\$6.00
<b>Pear Stocks</b> , 1 year, 1st class, - - -	" "	16.00
<b>Quince Stocks</b> , Angers, 1st class, - - -	" "	20.00
<b>Roses</b> , Standard, 1st class, in choice varieties, per 100,		50.00
<b>Roses</b> , Half Standard, 1st class, in choice varieties, "		25.00

PACKING, EXTRA.

<b>Lilies</b> , in collection of 30 fine varieties, - - -	per 250 bulbs,	35.00
<b>Pear Seed</b> , fresh, - - -	per pound,	1.50

## LIST OF ROSES AND LILIES

Will be sent to applicants.

**C. RAOUX,**

Jantf 35 Maiden Lane.

## THE 100 DAYS TOMATO

Actually ripens in one hundred days. Earliest Good Tomato ever offered. Free from rot; ship well; remarkably prolific. \$419.50 Sold from One-fourth Acre.

Positive proof of these claims in Free Circular. 25 cents per packet; 5 for \$1.00; post-paid. Address

J. A. FOOTE, Seedsman,  
 f:bj 512 Main St., Terre Haute, Ind.

## E. P. ROE,

In preparing his Manual on the Culture of Small Fruits has been led to more than DOUBLE its size, making it very full and complete as a practical guide, both for garden and field cultivation. It is also being published in handsome form. This makes it necessary to increase the price a little, and it will now be mailed on the receipt of price, 50 cents.

Send for CIRCULAR and PRICE LIST of STRAWBERRY and other plants, address **E. P. ROE,**  
 feb3 Cornwall on the Hudson, Orange Co., N. Y.

# Ferns, Palms, &c

A large collection—many of which were imported from Germany the past spring.

Send for NEW TRADE LIST.

**HOOPEs, BROTHER & THOMAS,**  
 CHERRY HILL NURSERIES,

tfeb3 West Chester, Pa

**AMSDEN, Amsden, Amsden.** Earliest and best early Peach in the world. Trees, root grafts and scions at Carthage, Missouri, and Dayton, Ohio. Price of the trees reduced for spring 1876. For full history of this Peach, and price of the trees, root grafts and scions, address  
 aug12 **JOHN WAMPLER, Carthage, Missouri.**

**PEACH TREES**, of best varieties; Norway Spruce and American Arbor Vites, several sizes; Mammoth Cluster and Brandywine Raspberry; Cherry Currants; 2 yr. Concord Grape Vines; Strawberry Plants; and a general Nursery stock at greatly reduced rates. Satisfaction guaranteed. For prices address  
 feb2 **DAVID BAIRD, Manalapan, N. J.**

A Hygroscope for 50 cents.

## THE CHEMICAL HYGROSCOPE.

This indicator of atmospheric moisture is as accurate as the costly ones. Rooms heated by furnaces or stoves are almost invariably so dry as to be damaging not only to health but to furniture. Some people take the consequences others keep water on the heater. The Hygroscope shows at a glance whether the air is too dry or not.

Sent by mail for 50 cents. Address,  
 febt6 **CHAS. H. MAROT, 814 Chestnut St., Philadelphia.**

**Sussex Nurseries, near Georgetown, Del.** Orders for Peach Trees received for Spring delivery at the following low rates:

	Per 100.	Per 1,000
<b>Beatrice</b> , 1 yr., 3 to 5 ft., stocky, . . .	\$7.00	\$60.00
" " 3 to 4 ft., light, . . .	6.00	50.00
" " 2 to 3 ft., nice, . . .	5.00	40.00
Assortments of varieties } 1 yr., 3 ft. & over, stocky	5.00	40.00
including Beatrice, Fos- } " 3 to 4 ft., light, . . .	4.00	30.00
ter. " " 2 to 3 ft., nice, . . .	3.00	20.00
Wilson's Early Blackberry Plants, . . .	2.50	15.00

All orders for \$10 worth or more packed to go to any part of the country without extra charge. Prices of other Nursery stock given on application. Can ship South at any time in winter when weather is mild.  
**R. S. JOHNSTON,**  
 febz Stockley, Del.

## Roses, Lilies, Violets, Carnations, Geraniums, &c.

The Greenbrook and Paterson City Nurseries furnish them "cheap as the Cheapest, Good as the Best."

Their Dollar Collections (mailed every where) contain Ten Different Varieties of Choice Plants and Roses with three fine Album Chromos or a beautiful Lilium. Buyer's choice.

Address  
**J. GREIVES, Sec'y,**  
 Box 837, Paterson, N. J.  
 Catalogues FREE. febz

## CHENOA NURSERIES.

APPLE and other FRUIT TREES, GRAPEVINES, HEDGE PLANTS, ORNAMENTAL PLANTS, GREENHOUSE and BEDDING PLANTS for sale. Stock SOUND and HEALTHY. Prices low. Great inducements to Granges, Clubs, and Dealers for CASH. Spring Price-list now ready. Free to all applicants. Address  
 mchz **SCOTT & MAXWELL, Chenoa, Ill.**

## HEDGE PLANTS! HEDGE PLANTS!

Making Hedge plants a specialty, we have particularly to offer this spring Osage Orange, Norway Spruce, Hemlock Spruce, Arbor Vite, in immense quantities, and of any size to suit.

**THOMAS MEEHAN,**  
 Jantf Germantown, Phila.

# ELLIS' BASE BURNING BOILER.

FOR WARMING Dwellings, Greenhouses, Graperies, Forcing Pits, Drying Rooms  
Heating Water for Public Baths, Baptisteries, &c., by Hot Water or by Steam.

Estimates and Circulars furnished. t.sep.12. 182 CENTRE STREET, NEW YORK.

# GRAPE VINES.

Also Grape Wood and Cuttings. Largest Stock in America.

All leading varieties in large supply. Extra Quality. True to name. Special rates to Agents, Dealers and Nurserymen. Our list of customers now embraces nearly all the leading nurserymen in the country, to whom we would refer those not acquainted with our stock. Send 6c. for DESCRIPTIVE CATALOGUE. Price List Free.

T. S. HUBBARD,  
FREDONIA, N. Y.

aug9

LARGEST STOCK IN AMERICA OF

## EUROPEAN LARCH AND EVERGREEN TREES,

Both Seedling and Transplanted, all grown from seeds on our own grounds, and better and cheaper than imported stock.

## EUROPEAN LARCH AND EVERGREEN TREE SEEDS,

oct7 By the ounce, pound or hundred pounds. Send for Catalogue.

ROBERT DOUGLAS & SONS, Waukegan, Illinois.

## \$125 IN CASH PREMIUMS.

Will be divided among the five successful competitors, who shall produce the largest quantity from one pound of the Mahopac Seedling Potato, subject to conditions named in my Catalogue.

### MAHOPAC SEEDLING.

The most productive of 150 varieties tested, yielding at the rate of 650 bushels per acre, healthy and hardy, quality fine, free from rot. Per pound \$1, 3 pounds to one address, \$2, by mail prepaid. By freight or express 1 Peck \$4, Bushel \$15, bbl. \$30.

Also Ruby, Alpha, Snowflake, Fureka, and the largest and Best collection of New and choice Seed Potatoes ever offered. Prices low. Strictly fine GARDEN SEEDS.

All the New and Best varieties carefully grown from selected stock. Try them. My Illustrated Catalogue for 1876, giving full description and Price List of the above, sent free to all applicants. DO NOT FAIL TO SEE IT.

J. R. V. HAWKINS,

mchl Goshen, N. Y.

## TUBE ROSES.

15,000 Tube Rose Bulbs, first class, \$25 per 1000; second-class, fine well grown Bulbs, in perfect order, \$18 per 1000; third-class, \$12 per 1000.

S. E. BYERS,

mch2 Houston, Texas.

## BEAUTIFUL FLOWERS

Delivered free of cost per mail at your door. Splendid assortment of Roses six for \$1, thirteen for \$2. Send for New Descriptive Catalogue of Plants gratis.

HOOPES, BRO. & THOMAS,  
Cherry Hill Nurseries, West Chester, Pa.

mch3

## TREES FOR FRUIT AND ORNAMENT.

500 Acres of Trees at Wholesale and Retail.

Pears, Apples, Cherries, Quinces,

Peaches, Plums, and Small Fruits.

New and Rare Ornamental Trees and Shrubs.

Evergreens, large quantities, large variety, cheap. Cut-Leaved Birch, Purple Beech, Weeping Trees.

CLEMATIS, JACKMANNI—Hardy and Perpetual, blooms profusely until frozen up.

PERPETUAL WHITE CLEMATIS, 15 Sorts. We have over 70 varieties of Clematis, in many shades of color, from dark rich purple to pure white—strong plants, safely sent by mail.

ROSES—Moss, Tea, Climbing and Perpetual.

Small Packages sent safely by Mail and Express.

Catalogues free. Address

mch2 T. C. MAXWELL & BROS., Geneva, N. Y.

## 200 BUSHELS TUBEROSES.

ALL DOUBLE FLOWERING BULBS.

First Quality, per 1000

\$25.

Second " "

10.

E. SATERTHWAIT,

Abbington Nurseries, Jenkintown, Montgom'y Co., Pa.

mch2.

and 300 Twelfth st. Market, Phila.

## NEW FRUITS AND SEEDLINGS.

A few thousand 1 year Norway Maples, fine American Seed and Grown, at \$8 per 1000. A few thousand Siberian Arbor Vitae, the very best stock in the country, 2 to 2½ feet, \$160 per 1000; 3 feet, \$25 per 100. Austrian, Scotch and Corsican Pine, about 2 feet, twice transplanted, \$15 per 100. Platanus Orientalis, two years transplanted, \$5 per 100. Large handsome shrubby \$10 per 100.

26 Varieties of New Russian Apples.

P. H. FOSTER,

Babylon, Nursery, N. Y.

mch

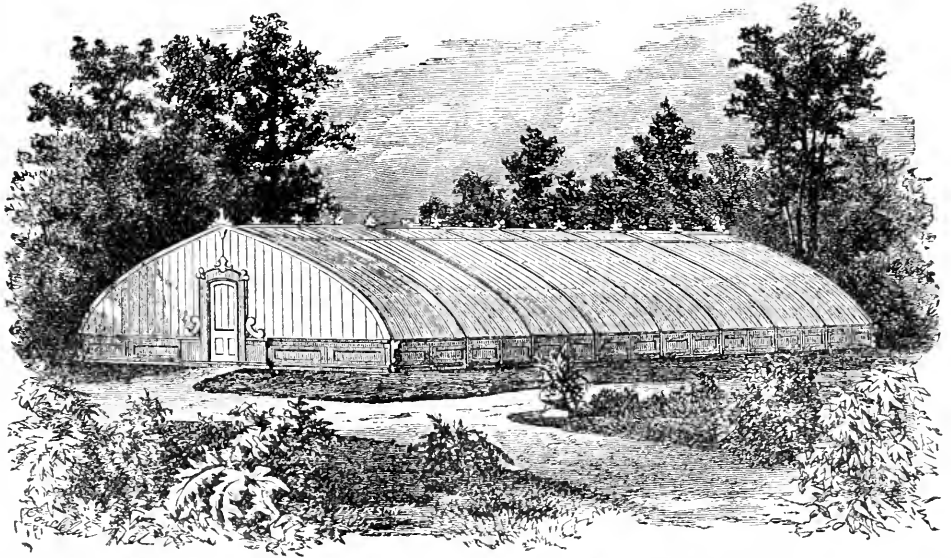

# GREENHOUSES, GRAPERIES, ETC.

Their Construction a Specialty. Experience of 20 Years.  
 SHIPPED TO ALL PARTS OF THE COUNTRY.  Send for Catalogue. Address,  
 LORD'S HORTICULTURAL WORKS,

June 12

Irington-on-Hudson, New York.

## ALEX. NIMMO,

(Late of the Firm of Nimmo & Scollay.)

# NEWLY IMPROVED HOT WATER BOILER,

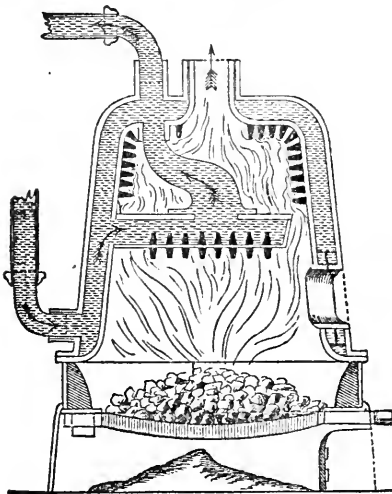

FOR HEATING

Green-Houses, Graperies, Conservatories,  
 Forcing Pits, Water for Baths, Drying  
 Rooms, Public and Private  
 Buildings, &c.

*Proper steps have been taken to secure United States  
 Letters Patent on this Invention.*

All the necessary Fittings for Hot Water Heating Apparatus.

VENTILATION APPARATUS OF ALL KINDS.

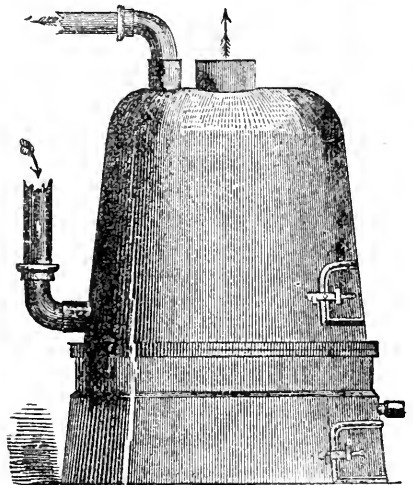

Wells Drove, Pumps of all kinds, Hydraulic Rams, &c., Garden Sun-Dials.

Agent for Joseph Kelly's Never Dry Vapor Pans, for all kinds of Hot Air Furnaces, Baltimore Heaters, &c.

CHEAPEST AND BEST BOILER, &c., IN THE MARKET.

 Please send for Circular for explanation, etc., before you make up your mind to purchase elsewhere.

sep 12

P. S.—Be sure you get the right number.

335 Adams Street, Brooklyn, N. Y.

NORWAY SPRUCE,  
3 to 4 feet, first-class, per 10 \$3, per 100 \$25.  
4 to 5 feet, " " \$3.50 per 100 \$30.

WHITE SPRUCE,  
2½ to 3 feet, first-class, per 10 \$3.50, per 100 \$30.

BALSAM FIR,  
2 to 2½ feet, first-class, per 10, \$3, per 100 \$25.

EUROPEAN LARCH,  
4 to 5 feet, first class, per 10, \$2, per 100 \$15.

tmchj J. S. BOYNTON, Stryker, Williams Co., O.

If you wish to grow Vegetables for sale, read } **GARDENING FOR PROFIT.**  
If you wish to become a Commercial Florist, read } **PRACTICAL FLORICULTURE.**  
If you wish to Garden for Amusement or for Home Use only, read } **GARDENING FOR PLEASURE.**

All by **PETER HENDERSON.**  
Price \$1.50 each, post-paid, by mail.  
Our combined Catalogue for 1876, of

**EVERYTHING FOR THE GARDEN**

Sent free to all Applicants.

Our large Illustrated Catalogues of *Seeds and Plants*, numbering 175 pages, and containing 2 colored plates, sent without charge to purchasers of any of the above three books. Sent to all others on receipt of 50 cents.

*Peter Henderson & Co.*  
35 Cortlandt Street, New York.

**PEACH STONES MAZZARDS, CHERRY STONES.**

A limited Stock of First-class Quality can still be supplied.

THOMAS MEEHAN,  
Germantown, Phila.

Jantf.

**New and Improved Fumigator.**

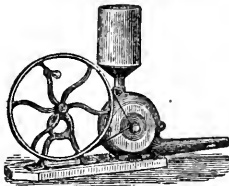

The undersigned having secured Letters Patent, March 23, 1875, for his new and Improved Fumigator for Hot-houses, Conservatories, &c. now offers it to Horticulturists, Gardeners and others, fully assured that it will do more in 10 minutes than could be done in one hour by the old system. It is operated outside of the greenhouse, thus avoiding the stifling fumes which is a great objection to the old mode. They are made of cast iron, and, with fair usage, will last a life time. Double Fan Fumigator, \$15. Single Fan Fumigator, \$12. I have also a small machine adapted for lady and gentlemen amateurs, for smoking one to a dozen plants; it is also adapted to Bee-keepers for smoking their hives. Price \$3. The desirability for these machines must be apparent to all. One trial will convince. For Circular, with directions, send to THOMAS SHAW, P. O. Box 612, Danville, Pa. oct6

10,000 Camellias of all sizes, with and without BUDS.

2,000 Magnolia grandiflora grown in pots.

100,000 Roses, standards, half-standards and dwarfs.

Crab Apples, Crab Pears and Quince Stocks, per 100,000. For Catalogue and Prices apply to

Messrs. F. E. ROTEREAU & CO., Nurserymen, Angers, France. June12

MY **Illustrated Catalogue**

OF **PLANTS FOR 1876,**

Contains descriptions of all the finest

**BEDDING AND GREENHOUSE PLANTS**

including novelties and select varieties.

Also a large Stock of Evergreens, Shade Trees, Shrubs, etc. Sent free to our customers and to all applicants on the receipt of one 3 cent stamp.

Wholesale Price List free.

Established 1851.

Small plants sent by mail, post-paid, at all seasons of the year.

**PAUL BUIZ,**

Croton Floral Gardens,

NEW CASTLE, PA.

tmch3

MY *Wholesale and Retail Catalogue of*

**Greenhouse and Bedding Plants**

**EVERGREENS, ETC.,**

MAILED TO ALL APPLICANTS.

**Wm. C. Wilson**

Astoria, L. I. C.,  
New York City Office—43 West 14th St.

June12

**STAMPED ZINC LABELS.**  
FOR TREES VINES & C SO CHEAP THAT NO ONE PLANTING TREES OR VINES CAN AFFORD TO BE WITHOUT THEM PRICE LIST & SAMPLES FREE JE. WOODHEAD, AGT FOR THE LAMB KNITTER CHICAGO, ILL.

**BRANDYWINE,**

The Most Profitable Raspberry;

In large quantities, guaranteed TRUE.

Descriptive Circular sent on Application.

A. HANCE & SON, Nurserymen and Florists, RED BANK, N. J. novtf.

**DOUBLE TUBEROSE BULBS.**

Our Stock of BULBS this year is of very superior quality.

	Doz.	100	1000
1st quality large Flowering Bulbs..	\$ 75	\$4 00	\$30 00
2d quality " " "	50	3 00	20 00
A few hundred extra large Bulbs .....	1 00	5 00	

nov6 MILLER & HAYES, 5774 Germantown Ave., Phila.

**NEW ADIANTIUMS.**

Scemanni and Gracillimum, described in

**GEO. FOUST'S CATALOGUE.**

Sent free on receipt of 2ct. stamp.

feb.3

2825 Frankford Ave., Philadelphia.

# Peach Trees.

LARGE AND CHOICE STOCK.

Crawford's Early and Crawford's Late, in large quantities. A full stock of new varieties, including Early Beatrice, Early Louise, Early Rivers, Alexander's Early, Steadly, Amsden's June, Foster, &c., A. HANCE & SON, N. J. Nurserymen and Florists, Red Bank, N. J.

## GRAVES, SELOVER & WILLARD, NURSERYMEN.

Dwarf and Standard Fruit Trees, Grapevines and Small Fruits, Ornamental Trees, Evergreens, Shrubs, and Roses.

Washington Street Nurseries, GENEVA N. Y.

Correspondence solicited.

mch

## New and Distinct Variegated Geranium, "HAPPY THOUGHT."

The most novel and welcome addition yet added to this most popular class of plants. See colored plate.

New Double Geraniums offered for the First time.

Dr. Torrey, a beautiful silvery rose colored variety, resembling G. Asa Gray.

Vinifol. The finest shaped and largest Double White variety SIX other new varieties.

See Catalogue, now ready.

SKED, PADDOCK & CO.,

Cleveland, Ohio.

feb4

## FRANCONIA RASPBERRY PLANTS.

From the celebrated Shuler Plantation. Plants warranted true to name.

Price,	\$20.00 per thousand.
"	3.00 " hundred.
"	1.00 " dozen.

Address

MRS. J. D. SHULER,

Lockport, Niagara Co., N. Y.

feb3

## RICHARD LYNEX,

Rear of 428 Walnut Street, Philada.

Manufacturer of Plain and Fancy Wire-work, for Florists; Wreaths, Crosses, Stars, Crowns, Hearts, Anchors, Birds, Lambs, Gipsy Baskets, Hanging Baskets, Flower Stands, &c.

SEND FOR PRICE LIST.

feb6

## EISELE BROS. CATALOGUE

of New and Best Greenhouse and Bedding Plants and Garden Requisites for 1876, will be ready March 1st., and mailed free to all applicants.

### EISELE BROS.

Tioga, Philadelphia, Pa.

feb4

**H**YDRANGEA OTAKSA "True." Flowers 20 inches in diameter, stock guaranteed true. Florists will find it particularly desirable for Spring Sales, as it requires no talking to push it. 2 nice plants, free by mail, for \$1.00.

For sale by

GEO. FOUST,

2825 Frankford Avenue, Philadelphia.

feb3

## BEECROFT'S PATENT WHEEL HOE

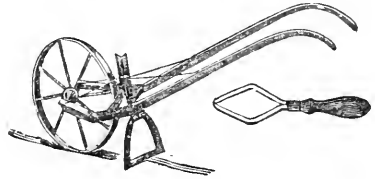

One of the greatest labor-saving machines invented, runs easy, cuts the weeds clean, sets up the soil well, and is very durable. Every Farmer, Nurseryman, Florist, Gardener, Small Fruit and Seed Grower should have one. It will pay for itself in a very short time.

### BEECROFT'S HAND WEEDER.

This is a very useful implement for Florist, Vegetable and Small Fruit Grower, Ladies can also use it to great advantage in their Flower Gardens. Agents wanted in every Town to whom great inducements will be offered. Also an immense stock of Evergreens and Deciduous Trees of all kinds and sizes, Fruit Trees, Grapevines, Small Fruits, Shrubs, &c. For sale at very low prices. Full Descriptive Price List sent Free. Address,

THOMAS JACKSON, Nurseryman, Portland, Maine.

mch

## 1876 GERANIUM 1876

This is to Certify, that I have appointed GEO. FOUST, Sole Agent to distribute my NEW SEEDLING GERANIUM, which has been named "1876."

I do also certify that I have flowered the above Geranium, a full, perfect truss, "without flaws, all open at once," 11 inches in diameter. Signed

WM. K. HARRIS.

Mr. HARRIS also states—"to prevent misapprehension"—that the largest truss he had was 11 inches by 13 inches, full and perfect. And he is also prepared at all times to flower it 11 inches clear.

Color; a bright Carmine-lake, in the style of Gen'l Lee.

Price, \$1.50 each.

I will commence to distribute this great Novelty after the 1st of March.

Orders received now and filled in strict rotation.

CATALOGUES sent on receipt of 2 ct. stamp. Address

## GEO. FOUST,

Franklin Nursery,

2825 Frankford Avenue, Phila.

feb3

## SURPLUS STOCK.

WILSON'S ALBANY STRAWBERRY,  
DOOLITTLE RASPBERRY,  
NORWOOD PROLIFIC RASPBERRY,  
DORCHESTER BLACKBERRY.

I have a surplus of the above varieties of plants, and offer them at wholesale and retail at lowest prices. Other plants at reasonable rates.

WM. F. BASSETT,

Hammonton, N. J.

feb3

## NEW BEDDING PLANTS.

Double Flowering Ivy Leaf Geranium.

Fuchsia, Mrs. H. Cannell.

Fuchsia Procumbens, the Creeping Fuchsia. One of the best novelties ever introduced.

### VERBENA LITTE GIANT.

Catalogue ready about 1st of March, and sent on receipt of 2 cent stamp, to prepay postage. Address,

GEO. FOUST,

2825 Frankford Ave., Phila.

feb3

# WEATHERED & CHEREVOY'S PATENT BOILERS,

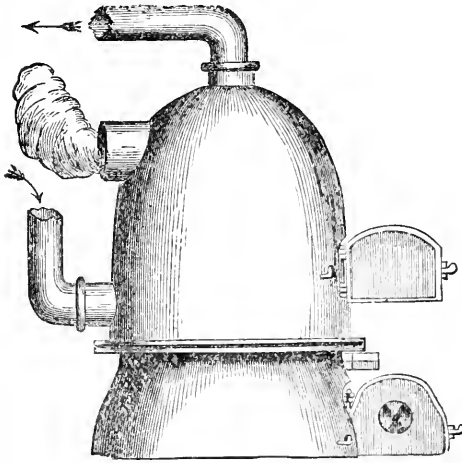

Fig. 1.

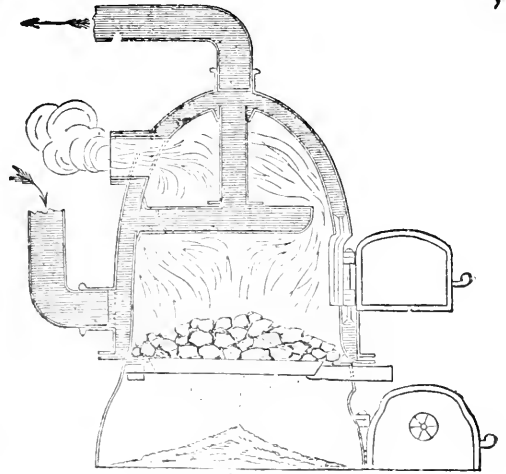

Fig. 2.

AND IMPROVED

## HOT WATER APPARATUS,

No. 46 Marion Street, between Spring and Prince, New York.

(TWO BLOCKS EAST OF BROADWAY.)

For Warming and Ventilating Public Buildings, Private Dwellings, Greenhouses, Graperies, Forcing Pits, Drying Rooms, and Heating Water for Public Baths.,

Fig. 1 is an outside view. Fig. 2 is a vertical section through the centre.

*The following are a few names of Gentlemen who have our Boiler in use:*

Thos. Drake, Esq., Germantown, Pa.  
Simon Cameron, Esq., Harrisburg, Pa.  
J. D. Cameron, Esq., Harrisburg, Pa.  
Thos. Carter, Esq., Raleigh, N. C.  
J. H. Dunham, Esq., Chicago, Ill.  
Jas. B. Waller, Esq., "  
W. J. Gordon, Esq., Cleveland, Ohio.  
Geo. Stanley, Esq., "  
Harris Jaynes, Esq., "  
Geo. W. Cuyler, Esq., Palmyra, N. Y.  
D. M. Osborn, Esq., Auburn, N. Y.  
John B. Dutcher, Esq., Pawling, N. Y.  
A. M. Allerton, Esq., Bronxville, N. Y.  
Robert Hoe, Esq., Tarrytown, N. Y.  
Peter Hoe, Esq., "  
George Lewis, Esq., "  
Wm. H. Drew, Croton Falls, "  
Hon. James Y. Smith, Providence, R. I.  
Philip Caswell, Esq., Newport, R. I.  
Alfred Smith, Esq., "  
Wm. Findlay, Esq., "  
E. Learned, Esq., Pittsfield, Mass.  
D. O. Mills, Esq., San Francisco, Cal.  
W. L. Ferris, Esq., Westchester, N. Y.  
D. H. Haicht, Esq., Goshen, N. Y.  
F. Newbold, Esq., Newark, N. J.  
James T. Fosson, Esq., Plainfield, N. J.  
Daniel W. Coit, Esq., Norwich, Conn.  
J. F. Slater, Esq., "  
H. W. Collender, Esq., Darien, "  
Chas. P. Palmer, Esq., Stonington, "

Wm. D. Black, Esq., New Milford, Conn.  
Rev. Stephen H. Tyng, Irvington, N. Y.  
H. F. Spaulding, Esq., Riverdale, "  
S. D. Balcock, Esq., "  
Percy R. Pyne, "  
Elisha Brooks, Esq., Inwood, "  
Camille Marie, Esq., "  
A. F. Smith, Esq., Fort Washington, "  
R. M. Olyrhant, Esq., Dobb's Ferry, "  
Clarkson N. Potter, Esq., New Rochelle, "  
Chas. D. Dickey, Esq., West Farms, "  
Wm. Matthews, Esq., Harrison, "  
William Chorlton, Esq., New Brighton, S. I.  
F. H. Wolcott, Esq., Astoria, L. I.  
Bailey Leach, Esq., "  
Hon. W. B. Ogden, High Bridge, N. Y.  
Peter Moller, Esq., 295 Fifth Ave., New York City.  
Wm. Moller, Esq., 6 West 20th St., "  
John Moller, Esq., 127 East 54th St., "  
John Moller, Esq., 8 East 37th St., "  
Ch. Moller, Esq., 424 Washington St., "  
Henry B. Laidlaw, Esq., 33 Pine St., "  
George W. Lane, Esq., 93 Front St., "  
J. P. Robinson, Esq., 14 Coenties Slip, "  
J. R. Colgate, Esq., 47 Wall St., "  
John B. Trevor, Esq., 47 Wall St., "  
Charles Butler, Esq., 12 "  
Richard Arnold, Esq., 309 Canal St., New York City.  
Jas. M. Constable, Esq., 309 Canal St., "  
W. T. Garner, Esq., 61 Worth St., N. Y. City.

Please send for Circular with list of References and Reduced Prices to

THOMAS W. WEATHERED, 46 Marion Street, N. Y.



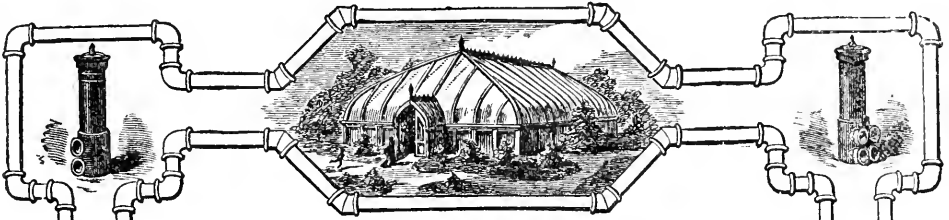

ESTABLISHED 1844.

HITCHINGS & CO.

No. 153 Crosby Street,

NEW YORK.

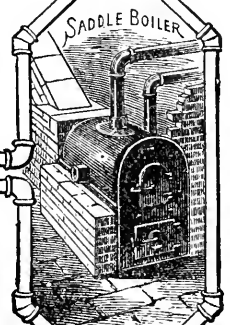
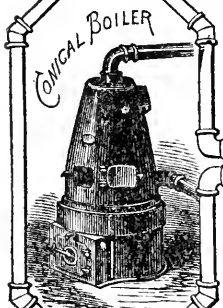

HOT-WATER  
 APPARATUS  
 for HEATING  
 GREEN-HOUSES, &c.

Illustrated Catalogue and List of References and Reduced  
 Prices, sent on receipt of postage—6 cents.

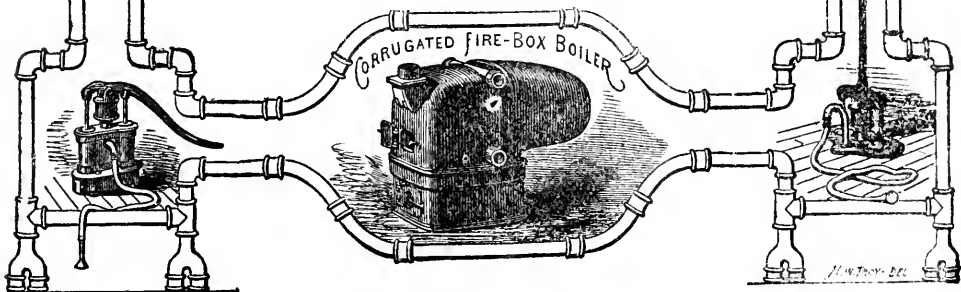

H. W. TOWN, DEL.

# THE LADY GRAPE.

The finest **Early White Grape** in cultivation. A pure Concord Seedling, perfectly hardy, healthy, productive, and reliable. Eight years tested. Ripens middle of August. Recommended by the best horticulturists in the Union. Single vines, 1 year strong, post-paid, for \$1.50, & 15 per doz.; 2 years, \$2 single, \$20 per doz. Also, large stock of Concord's, Delawares, and all valuable grapes. Illustrated Catalogue for 3-ct. stamp; with splendid colored plate of Lady Grape, 10c. Address

tmcb2

GEO. W. CAMPBELL, Delaware, Ohio

# ROSES, ROSES, ROSES.

Per 100. Per 1000

Hybrid Perpetual Roses—Fine 1 year Dormant Plants,	\$12	\$100
Mosses—including fair proportion white—Fine 1 year Dormant Plants,	15	
Climbers—including P. Queen, B. Belle &c. " " "	10	90
Monthlies—A good assortment " " "	8	70

## ROSES IN 3-INCH POTS.

Hybrid Perpetuals, Monthlies and Climbers. Strong, well established Plants,	8	70
Moss Roses—3-inch Pots	12	

We ship safely by Express—at any time desired—and Guarantee safe arrival.

NO CHARGE FOR BOXES OR PACKING. PRICE LISTS free on application.

Address,

## THE DINGEE & CONARD CO.,

### ROSE GROWERS,

WEST GROVE, CHESTER CO., PA.

feb3

# YOUNG ROSES FOR FLORISTS.

All the Leading Sorts! Fine Healthy Plants!

*Gloire de Dijon, Mad. Charles Wood, Bon Silene, Giant of Battles, Hermosa, Cheshnut Hybrid, Coquette de Lyon* (which may be called, *Yellow Hermosa*), and others in EXTRA LARGE QUANTITIES. PRICES LOW, as the space must be cleared. N. B.—No other firm in America offers such a *choice assortment* of Roses, at such low prices as we do. **NEW GERANIUMS.** Magnificent new **DOUBLE GERANIUMS** of 1875, surpassing in size and brilliancy of coloring any hitherto introduced. The leading characteristics of the finest Zonale and Nosegay classes are reproduced in these beautiful varieties, which are the productions of Sisley, Lemoine, Alegatiere, Laxton, &c. **NEW SINGLE GERANIUMS** of 1875, raised by the same eminent hybridisers as the New Doubles, and of equal merit. PRICE of both Double and Single varieties, 50 cts. each; \$5.00 per dozen. Of the older sorts of Double and Single and other classes of Geraniums, we have the finest collections in the West. **ARISTOLOCHIA** (*Dutchman's Pipe Vine*): a splendid lot, by the 100 or 1000, **DESCRIPTIVE CATALOGUES FREE** on application. Wholesale Lists to the Trade. Address

feb3

E. Y. TEAS & CO., Rose Growers, Richmond, Ind.

# FLOWER POTS BY THE MILLION.

The Best, Cheapest and Most Durable Pot in the Market. For Price List and Terms, Address

THE NEW BRIGHTON FLOWER POT AND TERRA COTTA WORKS.

ELVERSON & SHERWOOD, Proprietors,

Please state where you saw the advertisement, also what business, whether Florist or Dealer.

NEW BRIGHTON, PA.

det 4

OUR  
**Illustrated Catalogue**  
OF  
**PLANTS FOR 1876.**

Contains descriptions of all the finest  
**BEDDING**

AND  
**GREENHOUSE PLANTS,**  
including novelties and select varieties.  
Also the best **Foreign Grape Vines for Graperies.**  
Sent free to our customers, and to all applicants on the receipt  
of one 3 cent stamp.

**HOVEY & CO.,**  
53 N. Market St.,  
BOSTON, MASS.

**Fruit and Ornamental Trees.**

Large stock of 2 year Peach Trees, also 1 year Peach Trees  
of leading varieties.

**APPLE TREES, PEAR TREES,**  
**GRAPE VINES, CURRANTS,**  
ETC., ETC.

- A LARGE STOCK OF -

**American Arborvitæ, Siberian Arbor-**  
**vitæ, Irish Juniper, Norway Fir,**  
**Balm of Gilead, &c., &c.**  
**Silver Maple**-6 to 8, 8 to 10 and 10 to 12 feet.  
**Sugar Maple**-3 to 5 ft., and 8 to 10 ft.  
**Norway Maple**-7 to 9 feet.

The Nursery is within 2 minutes of the Depot at  
Christiana, on the P. R. R., 2½ hours from the city.  
Prices sent on application. Also, Greenhouse  
and Bedding Plants. Address

**W. P. BRINTON,**  
feb3 Christiana, Lancaster Co., Pa.

**SMALL FRUITS**  
A  
**SPECIALTY.**

300 Acres in Fruits. No. 1 Plants of all best sorts at  
very lowest rates. Send for prices, or order direct.

**JOHN S. COLLINS,**  
mch1 **MOORESTOWN, N. J.**

**SPECIALTIES FOR SPRING 1876.**

**Peach Trees,** first and second sizes, including 2,000 Ea. Beatrice  
**Apricots,** 1 and 2 years strong growth—low price.  
**Siberian Arborvitæ,** 2½, 3 and 4 ft., compact.  
**American Arborvitæ,** 6 to 10 in. and 1, 2, 3 and 4 ft., bushy.  
**Irish Juniper,** 2, 3 and 4 ft.  
**Sugar Maple,** 3 yrs., trans, 2½ to 3 ft.  
2 yrs., 10 in.  
**Concord Vines,** 2 and 3 yrs., strong.  
Price Lists sent to all applicants. Nursery at Malvern, P. R. R.  
one hour's ride from Philadelphia. Address,  
feb2 J. A. ROBERTS, PAOLI, PA.

**CENTENNIAL,** Commission House of HULL & SCOTNEY, 346  
N. Water St., Phila., dealers in Vegetables,  
Fruit, Produce, Furs, &c. Marking plates, Tags, Price lists, etc.,  
on application.

**New Peaches.**

Alexander, Amsden's June, Early Beatrice, Early  
Louise, Early Rivers' and 40 other varieties, in large quanti-  
ties; very fine.

Send for New Trade List.

**HOOPES, BRO. & THOMAS,**  
CHERRY HILL NURSERIES, West Chester, Pa.

**Market Gardeners**

AND

**FLORISTS**

WILL BE SENT OUR  
WHOLESALE LIST OF

**FLOWER & VEGETABLE PLANTS**

And SEEDS,

ON APPLICATION.

*Peter Henderson & Co.*

35 Cortlandt Street,  
NEW YORK.

I offer a large stock of

**TREES!!**

**APPLE TREES, APRICOTS,**

**IRISH JUNIPERS, GOOSEBERRIES,**

and a general assortment of

**FRUIT TREES and EVERGREENS**

Letters will be answered in English, German or French. Address

**GEORGE ACHELIS,**  
mch2 West Chester, Pa.

**Hardy Plants.**

Our splendid New Illustrated and Descriptive Cata-  
logue of Alpine and Hardy Perennial Plants, No. 3,  
is now ready for mailing, price 10 cents.

The following Catalogues will be mailed on application, viz.:

No. 1. Descriptive Catalogue of Fruits, pp. 28, two 3 ct. stamps.

No. 2. Illustrated and descriptive Catalogue of Ornamental Trees,  
&c., pp. 51, 10 cents.

No. 4. Illustrated and Descriptive Catalogue of Greenhouse and  
Bedding Plants, Free.

No. 5. Wholesale Trade List, Free.

**HOOPES, BRO. & THOMAS,**

Cherry Hill Nurseries,

West Chester, Pa.

**NEW**

## VARIEGATED LANTANA HARKETT'S PERFECTION.

Best Variegated Bedding Plants to stand the Sun.  
Ready March 1st. \$1.00 each. \$10.00 per doz.  
Illustrated Descriptive Catalogue of Greenhouse and  
Bedding Plants. Sent to all applicants.

**W. A. HARKETT,**  
feb10 DUBUQUE, IOWA.

## EVERGREENS. GREAT REDUCTION IN PRICES.

We now have the largest and best stock of Evergreens we have ever offered, especially NORWAY SPRUCE of small transplanted sizes, just the thing for planting in windbreaks or hedges, or for planting in Nursery rows. Quality very fine, and price low enough to suit anybody.

### NOTICE.

We will sell 1000 Norway Spruce 10 to 15 in. trans., fine, for \$15.00, or 5000 for \$60.00. Other sizes and varieties in proportion. SEND FOR CIRCULAR.

**JOHN V. WHITNEY & SON,**  
Montville, Geauga Co., Ohio.

## Brighton Grapevines.

Strong, healthy, vigorous plants, one year old, (grown out o doors) sent by mail for

\$2 Each.

## DEALERS, CLUBS,

And other buyers of large quantities, allowed a liberal discount.

**H. E. HOOKER & BRO.,**

Rochester, N. Y.

Feb 1st, 1876.

mch2

## ROSES, ROSES,

We have in our cellars, ready to be supplied when called for, at Low Prices,

### 20,000 DORMANT ROSES,

All very strong, one and two year old plants, grown from cuttings by ourselves, viz.:

**HYBRID PERPETUAL ROSES,**

**MOSS ROSES,**

**CLIMBING ROSES,**

**MONTHLY ROSES.**

**H. E. HOOKER & BRO.,**

Hooker Nurseries, Rochester, N. Y.

Feb. 1st, 1876.

mch1

## TO NURSERYMEN, DEALERS AND PLANTERS.

We invite attention to our present stock of the following named articles which will be sold low, for CASH.

Apricot, 1 year from bud, very fine.

Apple Trees.

Peach Trees, (Ea. Beatrice, Ea. Louise and Ea. Rivers.)

Cherry Trees, (Ea. Richmond and May Duke.)

Irish Juniper, Norway and Hemlock Spruce.

Arborvitæ, American, Siberian, Booth's and Hoopes Dwarf.

Correspondence solicited

Address,

## RAKESTRAW & PYLE,

feb2 Willow Dale, Chester Co., Pa.

## NEW ADIANTUM OF EXTRA MERIT.

A. Martinicense. One of the most gorgeous Adiantums ever introduced. Beautiful habit and good grower. On the style of, but very much superior to, A. Sanctæ Catherinæ.

Price, \$1.00 each.

Orders received now and filled in rotation from May 1st. Grown and for sale by

GEO FOUST,

feb 3

2825 Frankford Ave., Phila.

## SURPLUS STOCK.

5000 Apple Trees, 5 to 7 and 6 to 8 ft.  
1000 Crab Apple—Hyslop, Transcend, &c., very fine.  
10000 Peach, 1st class, 4½ to 6 ft.  
4000 Peach, 2nd class, 3 to 4½ ft.  
500 Cherry, 1st and 2nd class.  
1000 Silver Maple, all sizes, 8 to 12 ft., very fine.  
2000 Irish Juniper, 1 to 2 ft., twice trans., very fine.  
15,000 Osage Orange, 1 year.  
5000 Honey Locust, 1 and 2 years.  
500 Tamarix, 2 years.  
1000 Currant, 1 and 2 years, Cherry, W. Grape and Victoria.  
500 Concord Vines, 1 year.  
500 Gooseberry, 2 years, Houghton and Cluster.  
100 Angers Quince, for stools or cuttings.

The above will be sold cheap.

**H. M. ENGLE & SON,**

Marietta, Lancaster Co., Pa.

feb3

## NEW ORNAMENTAL FOLIAGE PLANTS

ANTHURIUM CRYSTALLINUM,  
APHELANDRA FASCINATOR,  
ARALIA GUILFOYLEI,  
ARALIA VEITCHII,  
CURMERIA PICTURATA,  
CROTON SPIRALE,  
CROTON VOLUTUM,  
CYANAPHYLLUM SPECTANDUM,  
DRACAENA MAGNIFICA,  
DIEFFENBACHIA IMPERIALIS,  
PHYLLOTAENIUM LINDENIL

For full description see new Catalogue, ready about 1st of March. Sent on receipt of 2 cent stamp

Address,

GEO. FOUST,

feb3

2825 Frankford Ave., Phila.

NEW MARANTAS.

**Maranta Bellula, Hieroglyphica, Luciana, Majestica Makoyana, Mazelli, Nigrocostata, Pacifica, Undulata.**  
Grown and for sale by

GEO. FOUST,

feb3 2825 Frankford Ave., Phila.

Catalogues ready about 1st of March, and sent on receipt of two stamps for postage.

**SEEDS.**

My New Priced Lists are ready, and mailed free. They contain the most desirable kinds of

**VEGETABLE, FIELD**

AND

**FLOWER SEEDS,**

including all the important novelties of 1875.

**ALFRED BRIDGEMAN,**

876 Broadway, New York.



1876 DREER'S GARDEN CALENDAR, 1876

Contains descriptive and price list of Vegetable, Flower and Grass Seeds, Plants, Bulbs, Novelties, and every GARDEN REQUISITE. Beautifully illustrated. Send two 3 ct. stamps for postage.

HENRY A. DREER,

an6

714 Chestnut Street, Phila.



My Illustrated Floral Catalogue for 1876 is now ready. Price 10 Cents, less than half the cost. WILLIAM E. BOWDITCH, 645 Warren St., Boston, Mass.

Jenkins' Nurseries.—Sugar Maple, Linden, Transp. Evergreen, very low. Magnolia, \$15 p. M.; Concord, \$10, \$15 and \$20 p. M. Apple Seed, Pyrus Japonica, &c. Send for Catalogue. J. Jenkins, Winona, Columbiana Co., O.

NEW AND RARE  
**PLANTS,**

FOR 1876.

HENRY A. DREER, Seedsman and Florist, 714 Chestnut Street, Philadelphia, takes pleasure in offering the following to the trade, a portion as Novelties for 1876. Prices Net. The balance of New things will be offered later, as stock will admit.

**Alocasia Gibsoni.** Large leaves marbled green and black; constant, \$3.00 per dozen.

**Bouvardia Humboldtii Corymbiflora.** The finest, largest flowered, and most showy pure white Bouvardia. Stock plants, \$5.00 per dozen. Fall-struck plants, \$2.50 per dozen.

**Bouvardia Candidissima.** Purest white, low compact growth, very free flowering, strong, \$3.00 per dozen.

**Caladium Tubers.** Strong undivided tubers of the following choice list, at \$15 per 100; \$2.50 per dozen: Argyrites, DeCandolle, Ducharteri, Cannaerti, Hercules, Houlettii, Lamartine, Miribile, Rubra Venosa. Also the following at \$12 per 100; \$2 per dozen: Auber, Baron Rothschild, Bellemel, Bicolor Splendens, Beethoven, Brongniarti, Chantini, Duc de Morny, Duc de Ratibon, Endlicherianum, Enckel, Maxime Duval, Meyerbeer, Milton, Napoleon III, Newman, Reine Victoria, Rossini, Rubra Maculata, Triomphe de Exposition, Bicolor picturata and Wright.

**Canna Brenningsi.** Broad green foliage ornamented with broad bands of yellow; constant, \$3.00 per dozen.

**Camellia Stocks,** for spring grafting, strong, \$15.00 per 100.

**Fuchsia, Sun-ray.** Tricolor foliage, fine plants, \$2.00 per dozen.

**Geranium, Apple-scented,** \$8.00 per 100.

**Oleander, Double White,** "Mandoni Grandiflora," \$4.00 per dozen.

**Oleander, Double, Purple,** Purpurea Plena, \$6.00 per dozen. Yellow, Flavum Duplex, \$6.00 per dozen.

**Pelargonium, Double Show (Regal),** "Queen Victoria," \$9.00 per dozen.

**Petunia.** Our new set of Double varieties in advance of any yet introduced, \$2.00 per dozen. New Set of Single varieties. The finest show varieties in 12 sorts, \$2 per dozen.

**Senecio Macroglossum.** A New German Ivy with dark thick, leathery leaves, very glossy, nearly like an Ivy, \$4.00 per dozen.

**New Double Show Pelargoniums, Single Zonale Geraniums, New Roses, &c.,** a description of which, please see Dreer's Garden Calendar, now ready, and mailed to all applicants.

HENRY A. DREER,

714 Chestnut Street,

an6

PHILADELPHIA

INSECTIVOROUS PLANTS.

By Chas. Darwin.

With copious descriptive contents and index. Illustrated. 462 pages, 12mo, cloth. Price \$7.00.

Sent by mail post-paid on receipt of price.

Address CHAS. H. MAROT,

814 Chestnut St., Phila.

AMERICAN FRUIT CULTURIST.

BY JOHN J. THOMAS.

Practical directions for the Cultivation of Fruit Trees in the NURSERY, ORCHARD AND GARDEN.

Descriptions of the principal American and Foreign varieties. Plain Edition, 480 engravings, 511 pages, 12 mo. Price, \$3.00. Mailed post-paid on receipt of price.

Extra Edition, 576 pages, heavy paper, fine cloth, 508 illustrations and chromo frontispiece; mailed, for \$3.75. Address CHAS. H. MAROT, 814 Chestnut St., Phila.

## SUFFIELD FRUIT AND FLOWER GARDENS.

50,000 CARNATIONS from propagating beds. Strong well-rooted plants.

PRES. "DEGRAU,	-	-	-	\$10.00	per 1000
"	per mail,	-	-	1.25	" 100
LA PURITE,	-	-	-	15.00	" 1000
"	per mail,	-	-	1.75	" 100
"	250 at 1000 rate.	-	-	-	-
VERBENAS.	Strong well-rooted plants,	-	-	12.00	" 1000
"	250 at 1000 rate.	-	-	-	-
"	per mail,	-	-	1.30	" 100

Plants ready from March 1st to June 1st.

**H. C. SMITH,**

mch1

SUFFIELD, Conn.

## Foreign Grapes.

For Vineries, 1 year, in 5-inch pots; 2 year, in 10-inch pots, bearing size.

HOOPES, BRO. & THOMAS,

CHERRY HILL NURSERIES,

West Chester, Pa.

### SPECIAL OFFER TO THE TRADE! ROSES.

*Hybrid Perpetuals on Rosa canina*—STANDARDS. Per 100, 1st quality, \$20; 2d, \$16. Per 1000, 1st quality, \$16; 2d, \$120.  
Half Standards.—Per 100, 1st quality, \$12; 2d, \$10. Per 1000, 1st quality, \$10; 2d, \$80.  
*Dwarf Roses on Rosa Multiflora de la Griffierale*—Per 100, 1st quality, \$8; 2d, \$6. Per 1000, 1st quality, \$70; 2d, \$50.  
*Tea, Noisette and Bourbon Roses on Rosa Canina*—Standards. 7 to 7 feet, per 100, 1st quality, \$24 to \$36; 2d, \$20 to \$30. Half Standards; per 100, 1st quality, \$20; 2d, \$16.

A list of the names of the roses will be sent free on application. A remittance must accompany each order.

A. M. C. JONGKINDT CONINCK,  
"TOTTENHAM NURSERIES," at Dedemsvaart,

Aug12

Near Zwolle, NETHERLANDS.

## Golden Trophy TOMATO.

A sport of the well-known Trophy, and like it in size and productiveness; but of a rich golden yellow color, and exquisite flavor.

### HEADQUARTER SEED,

Selected with the greatest care from extra fine specimens.

Price 25 cents per packet, post-paid.

Address,

**A. M. HALSTED,**

mch1

Rye, N. Y.

## IVIES.

A magnificent collection, embracing all the most unique forms and variegations of this very popular climber.

HOOPES, BRO. & THOMAS,

CHERRY HILL NURSERIES,

West Chester, Pa.

10,000 ORDERS WANTED FOR SMALL FRUIT PLANTS.

See page,  
mch

JNO. S. COLLINS,  
Moorestown, N. J.

WANTED.—Good Greenhouse hands.  
Address,

feb3

The Dinqee & Conard Co.,

West Grove, Chester Co., Pa.

## THE CHRISTIAN AT WORK.

T. De Witt Talmage, Editor.

Without Premiums, \$3; with Premiums, \$3.25. To Clergymen 75 cents less. ~~40~~ A Choice of two premiums.

### OPINIONS OF THE PRESS.

"The Christian at Work is the liveliest religious paper published in these parts. Its columns are spicy and sparkling and to religious people who like things lively it is a readable paper. The Devil is more certain to be frightened with a radiant face than a solemn and forbidding one."—*N. Y. Commercial Advertiser*.

"The Christian at Work has donned a new dress and looks as pretty as a picture. The type of all sizes is admirably clear and a handsomer weekly there is not in these United States."—*N. Y. Evening Mail*.

"The Christian at Work is safe and reliable in all its utterances and ought to displace the \_\_\_\_\_ in every Presbyterian family. Its editor is a host in himself, and nothing will stagnate that he has anything to do with."—*London Correspondent Chicago Interior*.

"The Christian at Work is an admirably conducted sheet, filled with live matter."—*N. Y. Star*.

"The Christian at Work is one of the most readable religious papers published anywhere. The Doctor and his associates have discovered the art of making a publication orthodox without being flippant."—*Brooklyn Eagle*.

"In The Christian at Work everything is lively and life-like. This Christian smiles, laughs, sometimes actually whistles, while at his work, and that without letting down the dignities and proprieties that belong to the discussion of the themes it discusses."—*Brooklyn Union*.

"The Christian at Work is one of the best of the religious weeklies, and deserves the success it has attained."—*Brooklyn Argus*.

"The Christian at Work is one of the most sprightly, most gladly welcomed in every family of all religious weeklies. It flits from the pulpit to the pew, from the rod of authority to the kiss of love, from the paternal command to the child's obedience, and scatters flowers upon all, breathing content and happiness upon all its readers."—*American Garden*.

### Five Sabbath School Papers,

under the same editorial supervision, are published by us monthly, and are suitable for School or Home. The best and cheapest published. Beautiful premiums with these also.

Good Words, My Paper, Good Cheer, Old and Young, Der Sonntagsgast. (German.)

We number our papers, but do not date them, making them good at any time.

Two papers with names nearly like our own have lately been issued in New York City. They are not in any way under the supervision of DR. TALMAGE or the control of THE CHRISTIAN AT WORK PUBLISHING COMPANY. Be careful to send your orders direct to the publisher of this paper.

Full particulars and sample copies of all papers furnished on application.

**HORATIO C. KING, Publisher,**

July 14

No. 102 Chambers Street, New York.

WALTER ELDER,  
Landscape and Jobbing Gardener,

1231 Rodman Street, Philadelphia,  
Attends to all branches of his business on reasonable terms.

# ROSES! ROSES! ROSES!

NOW READY FOR DELIVERY.

We offer to the trade a very large and fine stock of Young Roses, from 2 to 2½ inch pots, mostly struck in autumn; thrifty, well rooted plants. They are well assorted, leading varieties of Hybrid Perpetual, Climbing, Bourbon, Noisette China and Tea, (the latter largely of Bon Silene, Isabella Sprunt and Comtesse de la Bath.) Price \$7 per hundred, \$60 per thousand. We expect selection of varieties to be left to us, but will follow wishes of purchasers as far as possible.

**Young Moss Roses**—Well assorted, a large proportion of Perpetual White. Price \$10 per hundred, \$80 per thousand. Ready for delivery in April.

**Verbenas**—Fine healthy Plants. A splendid Assortment. Price \$4 per hundred.

**Bedding Plants**—A general assortment at low rates.

R. G. HANFORD & SON,

Columbus Nursery, Columbus, Ohio.

tmch2



The experience of five years has proved that this Compact and Reliable Work of General Information is better adapted to the wants of all classes of the community than any other work of the kind ever published. It has been proven by its

IMMENSE SALES,  
BY THE

NUMEROUS COMMENDATORY NOTICES RECEIVED

AND BY ITS UNIFORM

SUCCESS WITH AGENTS.

*The Edition of 1876 has been Thoroughly Revised to Date.*

It contains 150,000 articles, 3,000 wood engravings and eighteen handsomely engraved and colored maps.

The work is issued in parts, and a specimen copy, with maps, will be sent to any address free of postage, for twenty cents.

BAKER, DAVIS & CO., Publishers,

(Successors to T. ELWOOD ZELL)

Nos. 17 and 19 South Sixth Street, Philadelphia, Pa.

BENJ. A. ELLIOTT & CO.'S

SPRING CATALOGUE

OF

PLANTS AND SEEDS

IS NOW READY.

PLANT DEPARTMENT.

New Geraniums, New Phloxes, New Cannas, New Fuchsias, with a complete collection of the most popular bedding plants, Roses, &c., Cheap.

FRUIT AND ORNAMENTAL TREES.

An immense stock of Apple, Pear, Cherry, Peach and Plum Trees. Over 100,000 Apple, Cheap.

VEGETABLE SEEDS.

Fresh and Genuine.

FLOWER SEEDS.

Imported and home grown of the finest quality.

The following CATALOGUES are now ready and will be mailed FREE to all who apply.

No. 1. Descriptive Catalogue of Seeds and Plants.

No. 2. Descriptive Catalogue of Trees.

No. 3. Wholesale List for Dealers and Nurserymen.

BENJ. A. ELLIOTT & CO.,

mch2 114 Market St., Pittsburgh, Pa.

TREES, SEEDS, PLANTS.

FRUIT TREES,

ORNAMENTAL TREES,

RELIABLE VEGETABLE SEEDS,

CHOICE FLOWER SEEDS,

FINEST LAWN GRASS SEED,

ROSES, SPRING BULBS,

BEDDING PLANTS, &c., &c.

Wholesale and Retail.

Catalogues on application.

J. R. & A. MURDOCK,

112 Smithfield Street,

mch2

Pittsburgh, Pa.

EVERGREENS.

An immense stock of all sizes, suitable for planting in Nursery rows, or for immediate effect. A fine collection of New and Rare Conifers.

Send for New Trade List.

HOOPES, BRO. & THOMAS,

CHERRY HILL NURSERIES,

West Chester, Pa.

LONDON GARDENER'S CHRONICLE

Will be furnished, post-paid, direct to subscribers in the U. S. for \$7 50 per year. Specimen Nos. 3 cent stamp. Apply to CHAS. H. MAROT, Agent, 814 Chestnut St., Phila.

novtf

# LAUREL HILL NURSERIES.

FOREIGN GRAPEVINES a Specialty.

My Vines are now in excellent condition, and the stock comprises all the LEADING SORTS.

Strong 2 Year Old Canes, \$24 per Dozen.  
1 Year Old, \$9 per Dozen.

Usual discount to the Trade. List of Sorts on application.

Also Camellias, Azaleas, Acacias, and a general variety of Bedding Plants.

Also Ornamental Evergreens, Shrubs and Nursery Stock in variety.

DAVID FERGUSSON,

LAUREL HILL NURSERIES,

Ridge Avenue, Philada.

tmch3

## TREES, FLOWERS, PLANTS.

The following list of plants are all in good health and vigor, and will be packed free at prices named—

Begonias, Flowering, 6 best sorts,	per 100.	\$5.00
Carnations, nice young plants,		6.00
Centaurea Gymnocarpa, strong,		8.00
Cineraria Maritima, strong,		6.00
Fittonia,		6.00
Fuchsias, beautiful healthy plants,		7.00
Geraniums Zonale, including Master Christine, General Grant, &c., strong,		6.00
Geraniums, Double, including Asa Gray and Alice Sisley, strong,		6.00
Heliotropes,		6.00
Roses, H. P., strong, 1st class,		12.00
“ Giant des B., Gen. 1 Washington, and La France, 1 year dormant,		15.00
Roses, Monthly, 1st class,		12.00
“ “ Bellao Bon Silene and Safrans, 2-inch pot,		10.00
“ “ Marshall Neil, 2nd size, \$8.00 per 100,		
1st class,		12.00
Smilax, strong, 3-inch pot,		6.00
Tritoma, strong,		6.00
Tuberoses,		3.00
Verbenas, very healthy, \$30 per 1000.		4.00

Send for new Spring Catalogue of Nursery Stock; also of new and rare plants. Full set, 4 Catalogues, 25c. Address,

F. K. PHENIX,

Bloomington Nursery,

Bloomington, Ills.

mch2

## PRAIRIE LANDS.

Send your address on POSTAL CARD to LAND COMMISSIONER, B. & M. R. R., BURLINGTON, IOWA, and receive free copy of Iowa and Nebraska Farmer with Chart of Lands.  
mch3

## WARBASSE'S

# Patent Wheeled Hoe,

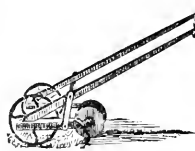

The most simple and effective HAND CULTIVATOR in use. Adapted for all kinds of market garden cultivation, especially onions and other root crops, and small nursery stock, &c., &c., and thoroughly protecting the plants from being covered with the earth. It will do the work of from 6 to 12 men with ordinary hoes.  
Send for Descriptive Circular.

WM. L. BOYER & BRO.

Agricultural and Implement Manufactory

2101 Germantown Avenue,

PHILADELPHIA, PA.

mch2

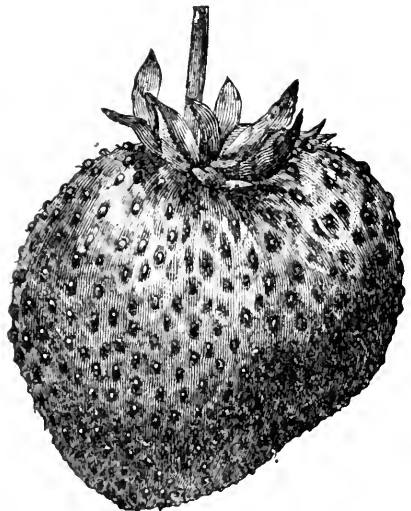

## New Seedling Strawberry, "STERLING."

WILL be OFFERED FOR SALE After APRIL 1,

My new seedling, the "Sterling." It has all the qualities of a Superior market fruit; large size, handsome form, firm texture and bright red color, with fine flavor, rich and sprightly, much sweeter than Wilson; stem long and fruit easily picked and prepared for table. Having grown strawberries more than twenty years for the Cleveland market testing all the approved varieties, and having grown the Sterling on both sandy and clay soils. I am convinced that it is the best market berry as yet known. Send for Circular giving history of berry and testimony of F. R. Elliot, M. B. Eatham and other horticulturists and persons who are well acquainted with the berry. Cut is exact size of one of the largest Sterling berries.

Plants will be sent and orders filled in their turn as received. Price, for 6, \$2; 12, \$3; 25, \$5; 100, \$20. Payment to accompany orders.

Remit by Draft, Money Order, or Registered Letter.

GEO. H. LODGE,

Cuyahoga Falls, Summit Co., Ohio.

mch1

FOR RENT—For a term of years, Glass-houses, 200 feet long, with hot water, furnaces and pipes. Dwelling house (8 rooms) with 3 acres of cultivated garden, one mile south of the city of Chicago. Rare chance for a FLORIST. J. H. Dunham, 10 State St., Chicago.



THE WHOLE COLLECTION  
OF  
**Hot-House and Greenhouse  
PLANTS**  
OF  
**R. BUIST,**  
NURSERYMAN, PHILADELPHIA.

Will be sold during the 3rd week in June. No orders will be executed after the first of that month.

**FLORISTS**

Send your orders at once to Buist's Nursery, Philadelphia. Plants at very low rates by the dozen or 100.  
mch2 R. BUIST, 67th St. and Darby Road.

**Weeping Trees,**

Mountain Ash, Linden, Cherry, English Ash, Peach, and 4 varieties of Poplar.

HOOPES, BRO. & THOMAS,

CHERRY HILL NURSERIES, West Chester, Pa.

**GOOD PLANTS, PURE, PACKED FREE.**

100 or less Strawberries, dozen other plan	doz.	100	1000
Monarch of West, 10000, \$50.	50c.	\$1.00	\$ 6.00
Wilson Albany, 10000, \$22.	40c.	75	2.50
Chas. Downing, 10000, \$20.	40c.	75	2.50
Kentucky, 10000, \$20.	40c.	75	2.50
Jucunda, Col. Cheeny,	40c.	1.00	6.00
Boyden, No. 30, Agriculturist,	40c.	80	4.00
Triumph deGand,	40c.	80	5.00
Green Prolific, 10000, \$25.	40c.	75	3.00
Pres. Wilder, Hudson Early, Early Surprise, Kessina Champion Cow- ing Seedling,	40c.	75	4.00
Star of West, Springdale, Cumber- laud Triumph,	1.25	7.00	
Duncan Strawberry,	1.00	5.00	20.00
Excelsior,	5.00	30.00	
Doolittle B. Cap Ras.,	50	1.00	8.00
Brandywine,	1.00	2.00	15.00
Herstine and Saunders,	1.00	3.00	25.00
Wilson Early Blackberry,	50	3.00	20.00
Kittaning, Lawton,	50	1.00	8.00
Col. Asp, seed 50c. per lb., roots,	20	1.00	3.00
Early Beatrice, Rivers Louise, and 15 other later sorts,		8.00	60.00

For any of the above or prices of Currants, Grapes, &c., please address  
mch1 **JOHN S. COLLINS,**  
Moorestown, N. J.

**STANDARD PEAR TREES.**

We offer for Spring (from unbroken rows) a very superior article of Standard Pear. Can furnish Extra Size—No 1 and No. 2. Good supply **Flemish Beauty.**

**RATES LOW.**

We also offer to any responsible party Eight Hundred (800) Acres of Land Unsurpassed in Fertility—situated in the finest portion of the South-west, only three miles from County Seat, R. R. Station and River—at a rent merely nominal.

**T. T. SOUTHWICK & CO.,**

mch1 Dansville, N. Y.

**HIGHLAND.**

The most profitable market Raspberry grown. Produced last season \$1000 worth of fruit to the acre. Has withstood 30° below zero. It bears enormous crops and is the earliest of all. "I regard the Highland Hardy as one of the most promising Raspberries grown. It is the earliest that I have seen, and is perfectly hardy."—Rev. E. P. ROE, author of "Play and Profit in my Garden," etc.

Price by Mail, post-paid, 75c. per doz., \$3.50 per 100. By Express, \$3 per 100, \$15 per 1000.

**FRUIT TREES! SHRUBS! VINES!**

**ROSES! GREENHOUSE STOCK!**

20,000 surplus and very fine American Arbor Vitæ, 3 to 6 feet, twice transplanted, very cheap. Downing Gooseberry, best American Gooseberry; per doz., \$2.50, post-paid. Also all kinds of Seeds, wholesale and retail.

Send for Catalogue. Established 1863.

**W. L. FERRIS Jr., & CO.,**

Duchess Nurseries, Poughkeepsie, N. Y.

**HARDY.**

mch2 Please state paper with this notice.

**APRICOTS AND NECTARINES.**

One year, 4 to 6 feet and 2½ to 4 feet, in large quantities, cheap. Send for New Trade List.

HOOPES, BRO. & THOMAS,

CHERRY HILL NURSERIES, West Chester, Pa.

**MAPLE GROVE AND WATERLOO NURSERIES.**

Read carefully, **Special Inducements to Large Buyers.** A general assortment of Nursery Stock, Standard Apples, Standard Pears and Hedge Evergreens, in LARGE QUANTITIES. A few medium size Standard Pears very low to clear ground. Send for Price-list to

mch1 **E. C. PEIRSON, Waterloo, N. Y.**

The undersigned take great pleasure in offering the new

**TEA ROSE,**  
"Duchess of Edinburgh."

This **NEW ROSE** is certainly the greatest acquisition in the line of

**TEA ROSE**

introduced of late years. In color it is very much like H. P. Rose Gen'l Jaqueminot, a good free grower, not subject to mildew.

Price, \$12 per dozen in 5 inch pots.

Extra fine stock plants \$3 each.

**KELLER & DEAN,**  
FLORISTS,

56th Street and 3rd Avenue,

mch2 BROOKLYN, N. Y.

**BEST SEEDS AND LOWEST PRICES.**

**VEGETABLE SEEDS.**

I am supplying farmers and gardeners this season with the choicest varieties of **VEGETABLE** and **FLOWER SEEDS** at lowest rates. Premiums in books, plants, etc. Illustrated catalogues sent free for two 3 cent stamps.

mch1 **Wm. H. SPJONER, Boston, Mass.**

# MARIETTA NURSERIES,

## MARIETTA, PA.

ESTABLISHED IN 1856.

### THE STOCK FOR SPRING

IS PARTICULARLY LARGE AND FINE.

PRICES LOW.

Send for Descriptive Catalogue and Trade List.

We invite early correspondence from the Nurserymen and Dealers.

mch2

ENGLE & BRO.

## MAIDEN HAIR FERN.

BEST SORT FOR THE

### CUT FLOWER TRADE.

•\$10 per Hundred Thrifty Plants.

HENRY A. DREER,

mch1

Philadelphia.

### GREENHOUSE AND BEDDING PLANTS.

Large stock; fine assortment; packed to go safely any distance. Satisfaction guaranteed. Send 3-cent stamp for splendid Illustrated Catalogue. Address

R. G. HANFORD & SON,  
Columbus, Ohio.

mch3

## WHITE WATER LILY.

(Nymphida Olorata).

I have on hand a good supply of first class roots of this beautiful and fragrant Lily fresh from the ponds, which I will send out by mail postage paid for 25 cents each, 5 for \$1, or \$2 per dozen. Printed instructions for growing them in ponds, tubs or aquariums, sent with each package.

Address,

J. E. S. CRANDALL,

ROCKVILLE, Washington Co., R. I.

Please state where you saw this advertisement.

mch2

BLOOMINGTON NURSERY, F. K. PHENIX, Bloomington, Ill. Price lists free. 4 Catalogues, 25c.

## THE BEST SCARLET VERBENA

"MRS. WOODRUFF,"

always scarce and particularly desirable for Florists, we offer from March 1st to April 1st for \$3.50 per 100; healthy plants, without rust.

CENTAUREA CANDIDISSIMA ready April 1st, \$10. per 100.

C. CLEMENTII, \$15 per 100.

C. GYMNOCARPA, \$8 per 100.

Grown and for sale by

EISELE BROS., Florists,

Tioga, Philadelphia.

mch1

## THE 100 DAYS' TOMATO

Is the earliest ever offered. Sown any time upto last of March, you can have ripe Tomatoes for your

CENTENNIAL FOURTH OF JULY DINNER.

Free Circular, with proof. 35c. a packet; 5 for \$1.00

J. A. FOOTE, Seedsman, Terre Haute, Ind.

## ROCHESTER COMMERCIAL NURSERIES.

Estab'd 1830.]

SPRING PRICE LIST, per dozen, 100 and 1000, of Trees and Plants, with select list of Specialties and Novelties, FREE to all Beautiful ornamental Catalogue, 10cts.; Fruit Catalogue, 6 cts. Free to customers. Address  
mch2 W. S. LITTLE, Rochester, N. Y.

THE

SELLS HIGHER, CARRIES

BETTER, KEEPS LONGER

DUNCAN

than any other, and we believe will attain a high rank as a Market and family Berry.

For prices &c., address

STRAWBERRY.

E. & J. C. WILLIAMS,

Montclair, N. J.

mch3

## Harper's Magazine.

ILLUSTRATED.

"Unquestionably the best sustained work of the kind in the World."

Postage free to all Subscribers in the United States.

TERMS:

HARPER'S MAGAZINE, one year.....\$4.00  
\$4.00 includes prepayment of U. S. postage by the publishers.

Subscriptions to Harper's Magazine, Weekly and Bazar, to one address for one year, \$10.00; or, two of Harper's Periodicals, to one address for one year, \$7.00; postage free.

An Extra Copy of either the Magazine, Weekly or Bazar will be supplied gratis for every Club of Five Subscribers at \$4.00 each, in one remittance; or Six Copies for \$20.00, without extra copy; postage free.

Back Numbers can be supplied at any time.

A Complete Set of Harper's Magazine, now comprising 51 Volumes, in neat cloth binding, will be sent by express, freight at expense of purchaser, for \$2.25 per volume. Single volumes, by mail, post-paid, \$3.00. Cloth cases, for binding, 58 cents, by mail, post-paid.

A Complete Analytical Index to the first Fifty Volumes of Harper's Magazine has just been published, rendering available for reference the vast and varied wealth of information which constitutes this periodical a perfect illustrated literary cyclopaedia. 8vo, Cloth, \$3.00; Half Cal., \$3.25. Sent postage pre-paid.

A series of papers under the title of "The First Century of the Republic," contributed by the most eminent American publicists, is now being published in Harper's Magazine. This series of over twenty papers gives a comprehensive review of Progress during the century now closing, in every department of our national life.

News-papers are not to copy this advertisement without the express order of HARPER & BROTHERS. Address

Jan 1

HARPER & BROTHERS, New York.

CATALOGUE GRATIS—PRICES REDUCED—Of all leading items of NURSELY STOCK; especially in my unsurpassed list of new and popular Peaches, among which may be found the only desirable kind to grow for market value, such as Early Beatrice, Early Louise, Early Rivers, Early Alexander, Amsden's June, Briggs' May, Chickitana, Braudwynne, Nantcoke, Bilyen's Late October, Truckahoe, Newtoning Free, and all the new and approved orchard list.

Send for Catalogue, which will be a great help to all who plant orchards, as I give the exact rotation of ripening, so that all can plant intelligently—so they can have one variety succeeding another the whole season. Also, at correspondingly low prices, Apple Trees, Cherry, Plum, Pears, standard and dwarf; Small Fruits, Ornamental Trees and Shrubbery, and Green-house Plants; in fact, all stock usually found in any first-class establishment. Peach Pits in sand all winter \$1.50 per bushel.

RANDOLPH PETERS,

Great Northern and Southern Nurseries,

mch2

Wilmington, Delaware.

## GARDENING BY MYSELF.

By Anna Warner.

Containing Hints and Experiences under heading of each month in the year. Illustrated. 16mo, 223 pages, cloth. Price \$1.25. Sent by mail post-paid on receipt of price.

Address

CHAS. H. MAROT,

814 Chestnut St., Phila.

# CLUB PAPERS AT NET PRICES,

## ALPHABETICALLY ARRANGED.

**TO REMIT IN CLUBBING** any of the following list with the  
 as you wish, foot up the prices annexed and add **TWO DOLLARS** Gardener's Monthly select such  
 for the **MONTHLY** to the total.

<p><b>American</b> Agriculturist.....\$1 20                  " Farmer.....1 35                  " Artisan.....1 60                  " Builder.....2 60                  " Naturalist.....3 25                  " Odd Fellow.....1 60  <b>Appleton's Journal</b>.....3 60  <b>Arthur's Home Magazine</b>.....2 35  <b>Atlantic Monthly</b>.....3 60  <b>Boston Cultivator</b>.....2 60  <b>Building Association Journal</b>.....75                  " Societies Gazette, London, England.....1 35  <b>Bucks County Intelligencer, old Subscribers \$2 60, new</b>.....2 10  <b>California Horticulturist</b>.....2 75  <b>Central Union Agriculturist and Chromo</b>.....1 70  <b>Children's Friend</b>.....1 35                  " Hour.....1 10  <b>Colman's Rural World</b>.....1 85  <b>Country Gentleman</b>.....2 35  <b>Demorest's Magazine</b>.....2 60  <b>Eclectic Magazine</b>.....4 60  <b>Every Saturday</b>.....4 60  <b>Farmer's Home Journal</b>.....2 60  <b>Frank Leslie's Ladies' Magazine</b>.....3 10                  " Review.....2 10  <b>Galaxy</b>.....3 60  <b>Germantown Telegraph, old subscribers \$2 50, new</b>.....2 20  <b>Godey's Lady's Book</b>.....2 75  <b>Hall's Journal of Health</b>.....1 10  <b>Harper's Bazar</b>.....3 60                  " Magazine.....3 60                  " Weekly.....3 60  <b>Hearth and Home</b>.....2 00  <b>Herald of Health</b>.....1 60  <b>Household</b>.....85  <b>Iowa Homestead</b>.....1 60  <b>Journal of Chemistry</b>.....1 10                  " of the Farm.....85  <b>Journal of Mater'a Medica</b>.....1 10  <b>Kansas Farmer</b>.....1 35  <b>Lady's Floral Cabinet, with Chromo</b>.....1 10  <b>Ladies' Repository</b>.....3 35  <b>Leslie's Lady's Journal</b>.....3 60  <b>Lippincott's Magazine</b>.....3 25  <b>Littell's Living Age</b>.....7 60  <b>London Garden</b>.....8 75  <b>London Gardener's Chronicle</b>.....7 50</p>	<p><b>Maine Farmer</b>.....\$2 10  <b>Manufacturer and Builder</b>.....1 85  <b>Maryland Farmer</b>.....1 35  <b>Massachusetts Ploughman</b>.....2 60  <b>Metropolitan</b>.....1 85  <b>Milling Journal</b>.....1 85  <b>Moore's Rural New Yorker</b>.....2 35  <b>Nation</b>.....4 60  <b>National Baptist</b>.....2 35  <b>New England Farmer</b>.....2 35                  " " Homestead.....2 10  <b>New York Evangelist</b>.....2 60  <b>New York Methodist</b>.....2 20                  " " Post, Weekly, \$1.50; Semi-Weekly.....2 60                  " " Times, Weekly, \$1.50; Semi-Weekly.....2 60                  " " Tribune, Weekly, \$1.50; Semi-Weekly.....2 60                  " " World, Weekly, \$1.50; Semi-Weekly.....2 60  <b>North-Western Farmer</b>.....1 10  <b>Nursery</b>.....1 20  <b>Ohio Farmer</b>.....1 85  <b>Old and New</b>.....3 60  <b>Our Home Journal</b>.....2 25  <b>Park's Floral Gazette</b>.....2 70  <b>Penn Monthly</b>.....2 10  <b>Peter's Musical Monthly</b>.....2 60  <b>Peterson's Magazine</b>.....1 70  <b>Philadelphia Weekly Press</b>.....1 60  <b>Phrenological Journal</b>.....2 35  <b>Poultry World</b>.....1 10  <b>Popular Science Monthly</b>.....4 60  <b>Practical Farmer, (Weekly)</b>.....2 00  <b>Prairie Farmer</b>.....1 70  <b>Purdv's Small Fruit Recorder</b>.....2 60  <b>Saint Nicholas</b>.....2 60  <b>Saturday Evening Post</b>.....2 10  <b>Scientific American</b>.....2 75  <b>Scientific Farmer</b>.....85  <b>Scribner's Monthly</b>.....3 60  <b>Southern Cultivator</b>.....1 85  <b>Southern Planter and Farmer</b>.....1 85  <b>Waverly Magazine</b>.....4 60  <b>Western Agriculturist</b>.....85  <b>Western Farmer</b>.....1 85                  " Rural.....1 85  <b>Wood's Household Magazine</b>.....85                  " " with Chromo.....1 00  <b>Working Farmer</b>.....1 10  <b>Youth's Companion, new subscribers \$1.40; old subscribers</b>.....1 75</p>
--	---

The above includes postage under the new U. S. Law requiring prepayment of postage before mailing.

After subscription to a club paper through this agency, report non-receipt of your numbers and other causes of dissatisfaction, irregularities of mails or changes of residences, *only to said paper direct* (not to this office).

Remit by P. O. Order, Draft or Registered Letter. Currency is at risk of mails.

If you wish a receipt or reply, enclose postage stamp for that purpose, otherwise the club papers will be considered a sufficient receipt.

Address **CHAS. H. MAROT, 814 Chestnut Street, Philadelphia.**

**RURAL AND PRACTICAL BOOKS,** (and any others in the market not on this list) will be sent by mail, post paid, on receipt of price. Address CHAS. H. MAROT, 814 Chestnut St., Philada.

Allen's R. L., Diseases of Domestic Animals.....	\$1 60	How to Manage a Building Association.....	\$2 00
Allen's, L. F., Rural Architecture.....	1 60	How to Paint.....	1 00
Allen's, L. F., American Cattle.....	2 50	Hunter and Trapper.....	1 00
Allen's, R. L. & L. F., New American Farm Book.....	2 50	Husman's Grapes and Wines.....	1 50
American Architect.....	7 00	Jacques' Manual of the House.....	1 50
American Bird Fancier, (Brown's).....	30	Jacques' Manual of the Garden.....	1 75
American Farmer's Encyclopedia.....	6 00	Jennings' Cattle Doctor.....	1 75
American Horticultural Annual, paper 50 Cts., cloth.....	75	Jennings on the Horse and his Diseases.....	1 75
American Weeds and Useful Plants.....	1 75	Jennings' Sheep, Swine and Poultry.....	1 75
Apple Culturist, S. E. Todd.....	1 50	Johnson's Gardener's Dictionary.....	3 50
Art of Saw Filing.....	75	Johnson's How Crops Feed.....	2 00
Architecture, Modern American, Cummings & Miller.....	10 00	Johnson's How Poultry Grow.....	2 00
"    Principles and Practice of, By Loring & Jenning.....	12 00	Johnson's Peat and its uses.....	1 25
Baker's Fruit Culture.....	4 00	Johnson's Elements of Ag. Chemistry and Geology.....	1 50
Bassett on Cranberry Culture.....	30	Johnston's, J. S. W., Agricultural Chemistry.....	1 75
Barry's Fruit Garden.....	2 50	Kemp's Landscape Gardening.....	2 50
Bell's Carpentry made easy.....	5 00	Klippart's Farm Drainage.....	1 75
Bement's Poulterer's Companion.....	2 00	Langstroth, Rev. L. L., on the Hive and Honey Bee.....	2 00
Bement's Rabbit Fancier.....	30	Leuchars' How to Build Hot-houses.....	1 50
Beet Root Sugar.....	1 50	Leibig's, Justus, Familiar Lectures on Chemistry.....	75
Bicknell's Village Builder, 77 plates.....	12 00	Louden's Encyclopaedia of Plants.....	20 00
Bommer's Method of Making Manures.....	25	Lyman's Cotton-culture.....	1 50
Boussingault's, J. B., Rural Economy.....	1 60	McMahon's American Gardener.....	2 25
Browne's Trees of America.....	6 00	Mayhew's Practical Book-keeping for Farmers.....	90
Breck's New Book of Flowers.....	1 75	Mechanics' Companion (Nicholson).....	3 00
Bridgeman's American Gardener's Assistant.....	2 50	Mechan's Ornamental Trees.....	75
Bridgeman's Fruit Cultivator's Manual.....	1 00	Miles on the Horse's Foot.....	75
Bridgeman's Kitchen Gardener's Instructor.....	1 00	Miner's, T. B., Bee-keeper's Manual.....	1 25
Buisi's, Robert, Am. Flower Garden Directory.....	1 50	Mobro on the Grape-vine.....	1 00
Buisi's, Robert, Family Kitchen Gardener.....	1 00	Money in the Garden.....	1 50
Burr's Field and Garden Vegetables of America.....	5 00	My Vineyard at Lakewood.....	1 25
Carpenter and Joiner (R. Riddell).....	7 00	My Farm of Edgewood.....	1 75
Carpenter and Joiner's Hand Book, (Holly).....	75	My Ten-rod Farm.....	50
Chorlton's Grape Grower's Guide.....	75	North American Sylva, 5 vols., 156 col. plates, in 30 parts,	
Chemistry of the Farm, (Nichols).....	1 25	"    "    "    unbound.....	60 00
Cleveland's Villas and Cottages.....	4 00	"    "    "    Half Turkey Antique, gilt.....	70 00
Cobbett's American Gardener.....	75	"    "    "    full.....	75 00
Cole's, S. W., American Fruit Book.....	75	Nichol's Chemistry of the Farm and Sea.....	1 25
Cole's American Veterinarian.....	75	Norton's, John P., Elements of Scientific Agriculture.....	75
Cooper's Rural Hours.....	2 00	Norris' Fish-culture.....	1 75
Copeland's Country Life.....	5 00	Onion-culture.....	20
Dadd's, Geo. H., American Cattle Doctor.....	1 50	Our Farm of Four Acres.....	1 25
Dadd's Modern Horse Doctor.....	1 50	Packard's Guide to the Study of Insects..... cloth	6 00
Dana's, Samuel H., Muck Manual.....	1 25	Paul's Book of Roses.....	50
Darwin's Variations of Animals and Plants, (2 vols.).....	6 00	Paul's Rose Garden.....	3 00
Darwin's Insectivorous Plants.....	7 00	Paxton's Gardener's Dictionary.....	15 00
DeVoe's Market Assistant.....	2 50	Pardee on strawberry-culture.....	75
Downing's, A. J., Landscape Gardening.....	6 50	Parkman's Book of Roses.....	3 00
Downing's Cottage Residences.....	3 00	Parsons, Samuel B., on the Rose.....	1 50
Downing's Fruits and Fruit Trees of America.....	5 00	Peat and its Uses.....	1 25
Downing's Rural Essays.....	3 50	Peat-culture, Field.....	1 25
Downing's Ladies' Companion to the Garden.....	2 00	Pedder's, James, Farmer's Land-measurer.....	60
Du Breuil's Vineyard Culture, (Dr. Warden).....	2 00	Percheron Horse.....	1 00
Eastwood on Cultivation of the Cranberry.....	75	Peterson's Preserving, Pickling and Canning Fruit.....	1 50
Elliott's Western Fruit Grower's Guide.....	1 50	Phin on Wine-making.....	1 50
Elliott's Lawn and Shade Trees.....	1 50	Quincy's Pear-culture for Profit.....	1 00
Every Woman her own Flower Gardener.....	1 50	Quincy's Mysteries of Bee-keeping Explained.....	1 50
Farm Talk, (Brackett).....	1 60	Randall's Sheep Husbandry.....	1 50
Farming for Boys.....	1 50	Randall's Fine Wool Sheep Husbandry.....	1 00
Field's, Thomas W., Pear Culture.....	1 25	Rand's Bulbs.....	3 00
Five Acres too Much, (illustrated).....	1 50	Rand's Flowers for Parlor and Garden.....	3 00
Flagg's European Vineyards.....	1 50	Rand's S. twenty-five Flowers.....	1 50
Flax Culture.....	50	Rand's Flower Garden.....	3 00
Flint, Chas. L., on Grasses.....	2 50	Reemelin's, Charles, Vinedressers Manual.....	75
Flint's Milch Cows.....	2 50	Riddell's Architect.....	15 00
Fowler's Homers for All.....	1 50	Rupp's Commercial Calculator, cloth \$1, Morocco Tuck.....	2 00
Frank Forester's Fish and Fishing, 8 vo. 100 engravings.....	3 50	Rose Culturist..... paper	30
Frank Forester's Manual for Young Sportsmen, 8 vo.....	3 00	Robbins', R., Produce and Ready Reckoner.....	75
French's Farm Drainage.....	1 50	Saunders' Domestic Poultry, paper 40..... cloth	75
Fuller's Grape Culturist.....	1 50	Saxton's Hand Books, in four series, each.....	1 50
Fuller's Small Fruit Culture.....	1 50	Schenck's Gardener's Text-book.....	75
Fuller's Strawberry Culturist.....	25	Scribner's Ready Reckoner and Log-book.....	30
Fuller's Forest Tree Culturist.....	1 50	Strong's Cultivation of the Grape.....	3 00
Fulton on Peach Culture.....	1 50	Ten Acres Enough.....	1 50
Geyelin's Poultry Breeding.....	1 25	Thomas, J. J., Farm Implements.....	1 50
Gray's How Plants Grow.....	1 25	Thomas, J. J., Fruit-culturist; old ed., \$3 00; new edition.....	3 75
Gray's Manual of Botany.....	2 25	Ville's Chemical Manures.....	1 25
Gray's Manual, Botany and Lessons, in one vol.....	4 00	Warder's American Pomology.....	3 00
Gray's School and Field Book of Botany.....	2 50	"    Hedges and Evergreens.....	1 50
Green on Trout Culture.....	1 00	Waring's Drainage for Profit and Health.....	1 50
Gregory on Squashes, paper.....	30	"    Elements of Agriculture.....	1 00
Guernon on Milch Cows.....	75	"    Earth Closets.....	50
Guide to Fortune.....	1 00	Webster's Dictionary, Unabridged.....	12 00
Harazthy's Grape Culture and Wine Making.....	5 00	Well's Every Man his own Lawn Lawyer.....	2 00
Harris' Insects Injurious to Vegetation, clo. \$4; col. eng's.....	6 50	Williams, B. S., on Stone & Greenhouse Plants, 2 vols., ill'd.....	5 00
Harris on the Pig.....	1 50	Williams, B. S., on Select Ferns and Lycopods.....	2 00
Hatfield's American House Carpenter.....	3 50	Williams, B. S., Orchard Grower's Manual.....	2 00
Henderson's Practical Floriculture.....	1 50	Window Gardening.....	1 50
Henderson's Gardening for Pleasure.....	1 50	White's Gardening for the South.....	2 00
Henderson's Gardening for Profit.....	1 50	"    Cranberry Culture.....	1 25
Herbert's Hints to Horsekeepers.....	1 75	Wood's Class Book of Botany.....	3 50
Hoopes on Evergreens.....	3 00	Workingman's Way to Wealth.....	75
Hooper's Dog and Gun, paper 30 cents, cloth.....	60	Wright's Practical Poultry Keeper.....	2 00
Hop-culture.....	40	Youatt on the Horse.....	1 75
How to Buy a Farm, and Where to Find One.....	1 75	Youman's Household Science.....	2 00

# NEW CALIFORNIA PEACH.

## "BRIGG'S RED MAY."

This is undoubtedly the Earliest Peach known, the only Peach ever sold in market during May. It was raised from Hale's Early, which it much resembles. Fruit fully as large; tree strong and healthy, and free from curl, and fully two weeks earlier than Hale's Early—Dormant buds by mail, \$1 each.

tmch2

JOHN ROCK, San Jose, California.

### SITUATIONS WANTED.

BY a thoroughly practical Gardener (married, age 35), competent in fruits, flowers and vegetables under glass and out-doors, who has had 12 years experience in this country and 8 years in first-class establishments in Germany; desires to engage by the 6th of March as foreman in a commercial establishment or as Gardener to a private gentleman. Satisfactory reference. Address Gardener, care of Gerold Altorfer, Florist, West Chester, Pa.

BY a thoroughly practical manager of many years' experience a position over a Fruit, Vegetable or Seed Farm, or would be a salesman at the Centennial, best references. Address, A. J. Crawford, 923 DeKalb Avenue, Brooklyn, N. Y.

AS Gardener by a married man without family; has a thorough knowledge of his business in all its branches; 25 years' experience in England and America; first-class references can be given. R. L. W., 67th & Darby Road, Phila

SITUATIONS wanted by two first-class men who can give the best of reference, either as private Gardeners or foremen in commercial establishments. Call, or address Gardener, care of C. E. Sutherland, Horticulturist, 21st st. below Green, Phila.

A situation as under Gardener by a young man who has worked for a florist, and on private place. Address G. B. McClellan, 72 Lexington st., Baltimore, Md.

BY a young man, a place under a first-class Gardener, where he will have a chance to learn the business thoroughly; has had four years' experience in the business and understands propagating, potting and the general care of plants. Address Thomas Edwards, West Roxbury Station, Boston, Mass.

BY a practical Gardener, Scotchman, with small family, thoroughly understands the cultivation of Fruits, Flowers and Vegetables, greenhouses, hot and cold Graperies, Fruit-houses, &c. Twenty years' experience in this country, having lived with one family 11 years. Undoubted reference. Address R. F., care Odds & Trumbull, No. 50 Pittsburg st., New Castle, Pa

SITUATION as Under-gardener in a first-class place, by a young man who has had long experience in private and commercial establishments. Address Edward Farrington, New Rochelle, N. Y.

BY a middle aged married Swiss Gardener, no children, acquainted with all kinds of in and out-door culture for pleasure or profit; forcing plants and fruits. Reference as first-class man, of easy temper, strictly sober, honest and industrious. Address L. M., Landscape Gardener, 402 5th ave., Pittsburgh, Pa.

### PARSONS ON THE ROSE.

By Samuel B. Parsons.

A treatise on the Propagation, Culture and History of the Rose. Illustrated. 215 pages 12mo, cloth. Price \$1.50. Sent by mail post-paid on receipt of price.

Address CHAS. H. MAROT,  
814 Chestnut St., Phila.

### ROSES AND ROSE CULTURE.

By Wm. PAUL, F.R.H.S.

The rationale of Rose cultivation in a nut-shell. Intended to place within a small compass all that is necessary for the successful cultivation of the "Queen of Flowers." 83 pages, 12mo, paperboards. Price, 50 cents. Sent by mail post-paid on receipt of price.

Address,  
CHAS. H. MAROT,  
814 Chestnut Street, Philadelphia.

### TO THE TRADE.

A choice collection of POPULAR PLANTS for the Spring Sale of 1876. Send for price list. L. B. CASE,  
6b3 Richmond, Ind.

### GARDENING FOR PLEASURE.

BY PETER HENDERSON.

A guide to the Amateur in the  
FRUIT, VEGETABLE and FLOWER GARDEN.

With full directions for the  
Greenhouse, Conservatory and Window-Garden.  
Illustrated. 250 Pages, 12mo, cloth. Price \$1.50. Sent by mail post-paid on receipt of price.

Address CHAS. H. MAROT, 814 Chestnut St., Phila.

### SELECT FERNS AND LYCOPODS.

BY BENJAMIN S. WILLIAMS, F.R.H.S.

Comprising descriptions of 950 choice species and varieties, British and Exotic, with directions for their management in the Tropical, Temperate and Hardy Fernery, with numerous beautiful full-page illustrations. 353 pages, 12mo, cloth. Price, \$2.00. Sent by mail post-paid on receipt of price.

Address, CHAS. H. MAROT,  
814 Chestnut Street, Philadelphia.

### Manual of Botany of the Northern United States.

By ASA GRAY.

Including the district east of the Mississippi and north of Carolina and Tennessee. Arranged according to the Natural System. Illustrated with 20 plates of Sedges, Grasses, Ferns, &c. 703 pages, 8vo, half-arabesque cloth sides. Price, \$2.25. Sent by mail post-paid on receipt of price.

Address, CHAS. H. MAROT,  
814 Chestnut Street, Philadelphia.

### CARPENTRY MADE EASY,

OR, THE SCIENCE AND ART OF BUILDING.

By W. E. BELL, Architect.

A new and improved system. Specific instructions for Balloon Frames, Barn Frames, Mill Frames, Warehouses, Church Spires, &c. Also, System of Bridge Building, Bills, Estimates of Cost and valuable tables. Illustrated by 38 plates and nearly 200 figures. 134 pages, 8vo, cloth. Price, \$5.00. Sent by mail post-paid on receipt of price.

Address, CHAS. H. MAROT,  
814 Chestnut Street, Philadelphia.

### ORCHID GROWER'S MANUAL.

BY BENJAMIN S. WILLIAMS, F.R.H.S.

Containing brief descriptions of over 800 species and varieties, with notices of times of flowering, approved modes of treatment and practical instructions on general culture. Remarks on heat, moisture, soil, seasons of growth and rest suited to the several species. Enlarged edition with illustrations. 300 pages, 12mo, cloth. Price, \$2.00. Sent by mail post-paid on receipt of price.

Address, CHAS. H. MAROT,  
814 Chestnut Street, Philadelphia.

### FLORA OF THE SOUTHERN STATES.

By A. W. CHAPMAN, M.D.

Containing abridged descriptions of the FLOWERING PLANTS and FERNS of Tennessee, North and South Carolina, Georgia, Alabama, Mississippi and Florida, arranged according to the Natural system. 621 pages, 8vo, cloth. Price, \$3.60. Sent by mail post-paid on receipt of price.

Address, CHAS. H. MAROT,  
814 Chestnut Street, Philadelphia.

Index to Advertisements.

Advertisers are requested to have orders in hand as EARLY AS POSSIBLE. Copy received after the 23rd of each month cannot be INSURED insertion in the next issue.

Achelis, George, West Chester, Pa. 19  
 Aldous James, Iowa City, Iowa 11  
 Allen Edwin, New Brunswick, N. J. 2  
 Allen S. L., Philadelphia 8  
 Baird David, Manalapan, N. J. 11  
 Baker, Davis & Co., Philadelphia 23  
 Bass I. Wm. F., Hammonton, N. J. 15  
 Bausendorfer M. M. & Co., Philadelphia 4  
 Bellevue Nursery Co., Paterson, N. J. 6  
 Bliss B. K. & Sons, New York city cover  
 Brinton W. P., Christiana, Pa. 19  
 Bridgeman A., New York 21  
 Bowditch W. E., Boston, Massachusetts 21  
 Boyer, W. L. & Bro., Phila. 24  
 Boynton J. S., Stryker, Ohio 14  
 Bryan S., Petersburg, Va. 8  
 Bryant, J. M., Phila. 24  
 Buist R., Philadelphia 25  
 Buttinton John, Hammonton, N. J. 6  
 Butz Paul, New Castle, Pa. 14  
 Byers S. E., Houston, Texas 12  
 Campbell, Geo. W., Delaware, Ohio 18  
 Case L. B., Richmond, Ind. 29  
 Chapman L. B., Portland, Me. 3  
 Christian at Work, New York city 18  
 Collins Jno. S., Moorestown, N. J. 19, 22, 25  
 Coninck A. M. C. J., D. demsvaart, Netherlands 22  
 Crandall, J. E. S., Rockville, R. I. 26  
 Critchell B. P., Cincinnati, Ohio 5  
 Dick John, Philada. 10  
 Dingee & Conrad Co., West Grove, Pa. 18, 22  
 Douglass Robert & Sons, Waukegan, Illinois 12  
 Dreer Henry A., Philadelphia 21, 26  
 Dunham J. H., Chicago, Illinois 24  
 Eisele Br. s., Tioga, Philada. 15, 26  
 Elder Walter, Philadelphia 22  
 Ellis Chas. R., New York city 12  
 Elliott, B. A. & Co., Pittsburgh, Pa. 23  
 Ellwang-r & Barry, Rochester, New York 2  
 Elverson & Sherwood, New Brighton, Pennsylvania 18  
 Engle H. M. & Son, Marietta, Pa. 24  
 Engle & Bro., Marietta, Pa. 3, 26  
 Faucier's Herald, Mattituck, N. Y. 5  
 Ferguson, David, Phila. 24  
 Ferris W. L. Jr. & Co., Poughkeepsie, N. Y. 25  
 Ferry D. M. & Co., Detroit Michigan 21  
 Foote J. A., Terre Haute, Ind. 11, 16  
 Foster P. H., Babylon, N. Y. 12  
 Foulk W. M., Coatesville, Pa. 6  
 Foust Geo., Philada. 8, 14, 15, 20, 21  
 Graves, Glover & Willard, Geneva, N. Y. 15  
 Gregory James J. S., Marblehead, Massachusetts 2  
 Grieves J. Paterson, N. J. 5, 11  
 Halsted, A. M., Rye, N. Y. 22  
 Hancock & Son, Red Bank, New Jersey 2, 8, 14, 15  
 Hanford R. G. & Son, Columbus, O. 3, 23, 26  
 Harding W. T., Columbus, Ohio 31  
 Harkett Wm. A., Duquesne, Iowa 26  
 Harpet & Brothers, New York city 26  
 Hawkins Jas., R. V., Goshen, N. Y. 12  
 Heikes Nurseries Co., Dayton, Ohio 5  
 Henderson Peter & Co., New York city 14, 19, cover  
 Hews A. H. & Co., North Cambridge, Massachusetts 9  
 Hinrichs C. F. A., New York city 2  
 Hitchings & Co., New York city 17  
 Hooker H. E. & Bro., Rochester, N. Y. 19  
 Hoop Bros. & Thomas, West Chester, Pa. 6, 11, 12, 19, 22, 23, 25  
 Hovey & Co., Boston, Mass. 19  
 Hubbard T. S., Fredonia, New York 12  
 Hull & Scotney, Phila. 19  
 Jackson Thomas, Portland, Me. 15  
 Jenkins, J. Wenona, Ohio 21  
 Johnston R. H., Stockley Del. 11  
 Keller D. an, Brooklyn, N. Y. 25  
 King, H. C., N. Y. City 22  
 Lattie, W. S., Rochester, N. Y. 25  
 Lodge, G. o. H., Cuyahoga Falls, O. 24  
 Lord's Horticultural Works, Irvington, New York 13  
 Lynex Richard Philadelphia 15  
 Maire Reinhardt, New Orleans, La. 9  
 Manning J. W., Reading, Mass. 10  
 Marot Uvas H., Philadelphia 11, 21, 23, 26, 27, 28, Fly-leaf  
 Maxwell T. C. & B. es, Geneva, N. Y. 12  
 Meehan Thomas, Germantown, Philadelphia 4, 9, 11, 14  
 Miller & Hayes, Philadelphia 11  
 Moon Mahlon, & Son, Morrisville, Pa. 3

Moon W. H., Morrisville, Pa. 3  
 Murdoch, J. R. & A., Pittsburgh, Pa. 23  
 Nimmo Alexander, Brooklyn, New York 13  
 Page N., Jr., Danvers, Mass. 2  
 Park Geo. W., Mt. Vernon, Ohio 5  
 Parry Wm., Cincinnati, N. J. 3  
 Parsons, R. B. & Co., Flushing, N. Y. 2, 30  
 Parsons S. B. & Sons, Flushing, New York cover  
 Pierson E. C., Waterloo, N. Y. 25  
 Peters Randolph, Wilmington, Del. 29  
 Phoenix, F. K., Bloomington, Ill. 24, 26  
 Rakestraw & Pyle, Willow Dale, Pa. 20  
 Raoux C., New York city 11  
 Rock, John, San Jose, Cal. 29  
 Roberts J. A., Paoli, Pa. 19  
 Roe E. P., Cornwall-on-Hudson, N. Y. 11  
 Rolker A. & Sons, New York city Fly-leaf  
 Root J. B., Rockford, Ill. 5, 8  
 Rotureau F. E. & Co., Angers, France 14  
 Sattenwaite E., Jenkintown, Pa. 12  
 Saul John A., Washington, D. C. 5  
 Scellay John A., Brooklyn, New York 10  
 Scott & Maxwell, Chenoa, Ill. 11  
 Shaw Thomas, Danville, Pennsylvania 14  
 Shuler Mrs. J. D., Lockport, N. Y. 15  
 Sked, Paddock & Co., Cleveland, Ohio 15  
 Smith H. C., Suffield, Conn. 22  
 Southwick T. T. & Co., Danville, N. Y. 25  
 Spooner, Wm. H., Boston, Mass. 25  
 Steffens N., New York city 8  
 Stone J. S., Charlotte, N. Y. 6  
 Stra ton & Storm, New York 8  
 Strong W. C., Brighton, Mass. 8  
 Such George, South Amboy, New Jersey 1  
 T as E. Y. & Co., Richmond, Ind. 18  
 Thauhauser S., Philadelphia 6  
 Thorburn J. M. & Co., New York city 5  
 Von Oven E., Naps-rsvil e, Ill. 6  
 Wamler John, Carthage, Missouri 11  
 Weathered & Cherevoy, N. Y. City 16  
 Whitman & Lang, Philadelphia 9  
 Whitney J. V. & Son, Montville, Ohio 20  
 Williams E. & J. C., Mont Clair, N. J. 26  
 Wilson William C., New York city 14  
 Wood Edmund M., Boston, Massachusetts 4, 7  
 Woodhead J. E., Chicago, Ill. 14

R. B. PARSONS & CO.,

Bowne Avenue, Flushing, N. Y.,

OFFER THEIR

RARE TREES & SHRUBS

as well as the well known sorts, and invite the special attention of

LARGE BUYERS

To their Stock of Rhododendrons, Azaleas— Chinese and Ghent Camellias, Clematis, Hydrangeas, Magnollas Roses by the 1,000.

RARE EVERGREENS,

are well known to be cultivated in large variety by them.

For Catalogues address

Box 99, Flushing, N. Y.

See Advertisement on page 2.

WANTED.

ON account of the Legislature having failed to make the appropriation required for the Agricultural College, Columbus, Ohio, the trustees are obliged to dispense with my services as Gardener to that Institution. In consequence, the advertiser is at liberty to engage with any one requiring a good practical man in that capacity. Has been thoroughly trained to the profession, and has had ever facility in vari ous parts of the world to acquire a thorough knowledge of horticulture in all its branches. Eighteen years experience in this country. Good testimonials. Address, nov1 W. T. HARDING, John street, Columbus, Ohio.

# FLORISTS' STOCK, TWO MILLION PLANTS!

AT WHOLESALE.

Examine and COMPARE PRICES. Safe Delivery GUARANTEED if sent by Express. No Charge for Boxes or Packing.

	Per 100.		Per 100.
Astilbe Japonica,	\$10.00	Lantanas, 25 named sorts,	8.00
Achyranthes, 4 distinct sorts,	4.00	"    unnamed,	5.00
Alternantheras, 4 distinct sorts,	6.00	Lemon Verbenas, strong plants, 6.00 to 10.00	
Basket Plants, 25 different sorts,	4.00	Lobelia, new double blue,	4.00
Begonias, 6 best flowering sorts,	6.00	"    six distinct and beautiful sorts,	4.00
Argyroneura Veitchii, 3		Lygodium Scandens, (Japanese Climbing Fern),	8.00
inch pots,	8.00	Mesembryanthemum cordifolium	
Carnations, White Perfection and Degraw, large stock plants,	20.00	var. (var'd Ice plant),	6.00
Carnations, 25 sorts, fine young plants,	6.00	Mosses, (Lycopodiums and Selaginellas)	
Caladiums, Fancy, 25 distinct sorts,	12.00	6 sorts,	6.00
"    Esculentum, large bulbs,	\$8 to 16.00	Pampas Grass, strong roots, 4 inch pots,	25.00
Canna Indica, 6 sorts,	6.00	Pansies, very fine mixed English,	4.00
Chrysanthemums, 50 leading sorts,	6.00	"    12 separate colors, pot grown,	6.00
Calceolaria Aurea and Brown Prince,	8.00	Phloxes, 25 named sorts,	6.00
Centaurea Gymnocarpa, white leaved,	6.00	Pinks, Florists', 12 sorts,	6.00
Coleus, Golden and Velvet, 25 best sorts,	4.00	Pinks, Alba Fimbriata, (white fringed),	6.00
Cineraria, 2 sorts, white leaved,	6.00	Petunias, single, finest striped and blotched	4.00
Dianthus Quarteri, (German Pink),	6.00	Petunia, double, 6 sorts,	8.00
Dahlias, dry roots, 100 sorts, bouquet and large flowering,	10.00	Pentstemons, 6 distinct sorts,	4.00
Dahlias, Green Cuttings, 100 sorts,	6.00	Roses, Monthly, Tea, Bourbon and Bengal, 50 best sorts. Hybrid Perpetual and Hardy Climbing, 40 best sorts. Winter flowering, 6 leading sorts.	
Daisy, English, (Bellis perennis),	6.00	Prices of the above Roses:	
Daisy, (New) Queen Victoria	10.00	Our selection of sorts, 3 inch pots,	8.00
Echeveria, 4 distinct sorts,	6.00	Buyers' " " 3 " " . . . . .	10.00
Eulalia Japonica, new variegated grass,	18.00	Our " " 4 " " . . . . .	12.00
Fittonia, (Gymnostachyum) 4 sorts,	4.00	Buyers' " " 4 " " . . . . .	15.00
Fuchsias, 25 sorts, very fine plants,	\$5 to 8.00	Smilax, (Myrsiphyllum Asparagoides),	
Ferns, 12 sorts,	16.00	2½ inch pots,	4.00
Golden Feather,	4.00	Tritoma (Red-hot-poker plant)	\$6 to 12.00
Geraniums, Double, in 12 sorts,	6.00	Tuberose, Pearl, Southern grown,	8 to 12.00
"    Zonale, 30 leading sorts,	6.00	"    common, double,	\$3, \$4 and 6.00
"    Ivy leaved, 12 sorts,	6.00	Verbenas, named in 60 varieties, \$3 per set,	5.00
"    Silver, 6 distinct sorts,	8.00	"    to special name or special color,	5.00
Hibiscus, 3 sorts,	6.00	"    in twelve best market sorts,	4.00
Heliotropes, 8 sorts,	6.00	"    mixed, without name or color,	3.00
Honeysuckle, Golden Japan, 2½ inch pots,	5.00	Besides nearly every other plant in cultivation by Florists, for which see our Monthly Price Current of Plants, Seeds, &c.	
Ivies, English, three feet long,	12.00	Every Plant is labelled.	
Latania Borbonica, (Fan-leaved Palm), 3 inch pots,	12.00		

## VEGETABLE PLANTS.

	Per 1000.		Per 1000.
Cabbage, Early Jersey Wakefield, (cold frame plants),	10.00	Lettuce, Boston Market and Curled Simpson,	10.00
Spring sown plants of the above ready in May, at half the above rates. TOMATO, PEPPER, CELERY and EGG PLANTS contracted for at low rates. Also,			

## FLORISTS REQUISITES.

Consisting of all Styles of WIRE DESIGNS for CUT FLOWERS, FRENCH IMMORTELLS and GRASS BOUQUETS, BOUQUET PAPERS, GARDEN TRELLISES, PLANT STANDS, RUSTIC WORK, and many other articles, all of which are priced very low in our Monthly Wholesale List, mailed free to those who apply.

**PETER HENDERSON & CO.,**  
35 Cortlandt St., New York.

# S. B. PARSONS & SONS,

## Kissena Nurseries,

### Near KISSENA STATION, FLUSHING, N. Y.,

OFFER a very large assortment of TREES and PLANTS of all the best families. Nearly all of them have been two years transplanted, and their roots are thus in the very best possible condition for a second transplanting.

Their assortment of **RARE EVERGREENS** has long been known to be the most complete. They now have in cultivation a very large variety of hardy

## Deciduous Trees and Shrubs,

numbering over 800 sorts, of which 300 sorts, one year grafted, are entirely new and have not yet been in their catalogue.

Their JAPANESE DEPARTMENT now includes more than 150 varieties in addition to the above, and is being constantly enriched by Thomas Hogg, now in Japan. Many of these varieties are unknown in Europe. The celebrated JAPANESE MAPLES and AZALEA MOLLIS are alone worthy of a visit.

CAMELLIA JAPONICA and AZALEA INDICA can be advantageously shipped during September, October and November; September being preferred. These plants are carefully formed and trimmed, and their symmetry is recognized by all who see them.

Rhododendrons and other hardy Evergreens can be safely transplanted in September.

*Estimates will be furnished for Planting Grounds under the care of an experienced Landscape Gardener, and much trouble thus saved to the owner.*

Catalogues will be furnished to applicants by mail, and those who wish to visit the Nurseries will always find either one of the proprietors, or J. R. Trumpy, the well-known propagator of the old establishment. They can take the ferries at 34th Street or James' Slip, which connect with the railroad, leaving the first a quarter of an hour, and the last half an hour before the departure of trains, which make the transit in half an hour. The Nursery is adjoining the Kissena Station and one and a half miles from the other stations. sep

## TWO NEW POTATOES—\$700 IN PREMIUMS.

### RUBY. (Pringle.)

A new red kidney shaped potato of excellent promise, from the Early Rose hybridized with the White Peachblow. The shape is oblong, slightly flattened, resembling that of the Early Rose. In its coloring the red of the latter variety is deepened by the carmine which shows in the blotches of the White Peachblow. The eyes, which are but slightly sunken, are carmine like those of this variety. The flesh white, fine-grained, firm, and of excellent flavor. Tubers of medium size; and are clustered close about the foot of the stalks. The time of maturity is the same as that of the Early Rose, and it is equally productive.

To those who prefer a red-skin potato we can confidently recommend this excellent variety.

*Per lb., \$1.00; 3 lbs. to one address, \$2.50, by mail, prepaid. By express or freight, charges paid by the purchaser, ½ peck, \$3.00; 1 peck, \$5.00.*

### ALPHA. (Pringle.) The Earliest Variety Known.

A very early variety for farm and garden culture, also for forcing under glass; fit for the table ten or fifteen days before the Early Rose. Of medium size, clear white, with the slightest tinge of red about the eyes; flesh very white, fine-grained, dry, and of excellent flavor; quality, of the highest excellence. A first-class certificate was awarded by the Royal Horticultural Society, of London, in 1874. A silver medal was also awarded by the Massachusetts Horticultural Society. We can recommend this with the greatest confidence as the very best early variety in cultivation.

*Per pound, \$1.00; 3 pounds to one address, \$2.50, by mail, prepaid. By express or freight, charges paid by the purchaser, ½ peck, \$2.00; 1 peck, \$3.00; ½ bushel, \$5.00; 1 bushel, \$9.00; 1 barrel, \$20.00.*

### SNOWFLAKE.

Beautiful in appearance, superior in quality, early ripening a few days later than the Early Rose, very productive.

*Price per pound, 60 cts; 2 pounds to one address, \$1.00, by mail, prepaid. By express or freight, 1 peck, \$1.50; ½ bushel, \$2.50; 1 bushel, \$4.00; 1 barrel, \$8 00*

### PRINGLE'S HYBRIDIZED POTATO SEED.

The extraordinary success which has attended Mr. Pringle in his attempts to improve this valuable esculent—which has resulted in the production of the Snowflake and Alpha, and last, though not least, the Ruby—has encouraged him to still greater efforts in his favorite pursuit of hybridization, and we have now the pleasure of offering a very choice strain of seed saved by him, which is the product of numerous hybridizations, variously operated, with every care during the past season, between the above named and many of the best new and old varieties in cultivation, both English and American, and includes every strain, which Mr. Pringle will himself sow the coming spring. Packets of 25 seeds, 70 cents; 5 packets, \$4.00.

**\$500** to be divided among the six most successful growers who shall produce the largest quantity from 1 pound of Ruby and Alpha potatoes.

### CENTENNIAL PREMIUMS.

**\$150** to be awarded for the best collection, one peck each of potatoes introduced by us since 1867.

**\$50** for the best and most promising seedlings raised this year from Pringle's Hybridized Potato Seed. The collection for which the last two premiums of \$500 are offered will be exhibited at the Centennial Exhibition, in Philadelphia, in October, and premiums will be awarded by their committee. For conditions and full particulars send for circular, mailed free to all.

### The Best Early Tomato—THE CONQUEROR.

Ten days earlier than any other Tomato. Prof. Thurber, the well-known editor of the *American Agriculturist*, thus describes it: "I have over a dozen varieties, including this, among which were several novelties, as well as those accepted as standard varieties. I think it a moderate statement to say the Conqueror was ten days earlier than any other in the garden. I would also add that in color, shape, and quality, this variety was highly satisfactory." Price, 25 cts. per packet; 6 packets, \$1.00.

Bliss's Illustrated Seed Catalogue and Amateur's Guide to the Flower and Kitchen Garden. 200 pages, 35 cents.  
Bliss's Gardener's Almanac and Abridged Catalogue of Garden, Field and Flower Seeds. 116 pages, beautifully illustrated, mailed to all applicants enclosing 10 cents.

Bliss's Illustrated Potato Catalogue contains a descriptive list of all the new varieties recently introduced, with many other desirable sorts, also much useful information upon their cultivation. 32 pages, 10 cents.

B. K. BLISS & SONS,

P. O. BOX No. 5712.

32 Barclay Street, New York.





THE  
GARDENERS  
And MONTHLY  
HORTICULTURIST

EDITED BY THOMAS MEEHAN.

Vol. XVIII.

No. 208.

(Combined Magazines, Thirty-first Year.)

**APRIL, 1876.**

PUBLISHED BY CHARLES H. MAROT,

814 Chestnut Street, Philadelphia.

**TERMS—\$2.10 PER YEAR—POSTAGE PAID.**



Howison & Co. Del.

J. R. Stockton, Sc.

# THE GARDENER'S MONTHLY AND HORTICULTURIST.

EDITED BY THOMAS MEEHAN,

Assisted by an able Corps of AMERICAN and FOREIGN CORRESPONDENTS.

It is published on the first of every month, at the office, No. 814 CHESTNUT STREET, PHILADELPHIA, where all BUSINESS communications should be addressed.

Communications for the Editor should be addressed: THOMAS MEEHAN, GERMANTOWN, Philada.

SUBSCRIPTION PRICE, Postage paid, \$2.10.

## TERMS OF ADVERTISING.

	1/4 col.	1/2 col.	2/3 col.	3/4 col.	1 col.	1 page.
One Time,	\$3. 0	\$4. 0	\$6. 00	\$8. 00	\$12. 00	\$18. 00
Two or Three Times, each,	2. 75	3. 60	5. 40	7. 20	10. 80	16. 20
Four to Six Times, "	2. 25	3. 10	4. 50	6. 00	9. 00	13. 00
Seven to Nine Times, "	2. 00	2. 75	4. 00	5. 35	8. 00	12. 00
Ten to Twelve "	1. 80	2. 40	3. 60	4. 80	7. 20	10. 80

Twelve lines nonpareil is 1/4 col. A less space than 1/4 col. will be furnished at rates in exact proportion, line for line.

For THIRD and LAST COVER PAGES: FIRST PAGE advertisements *free* of reading matter; "FLY-LEAF PAGE" (front of number) *before* reading matter and *1/4 col.* first cover page advertisements will be given on application. 1 COPY and orders for NEW advertisements should be in hand by the 23d of each month; and CHANGES of COPY in running contracts by the 16th of each month, to insure them in following issue. Address

CHAS. H. MAROT, Publisher, 814 Chestnut Street, Philadelphia.

## CONTENTS OF THE APRIL NUMBER.

### SEASONABLE HINTS:

Flower Garden and Pleasure Ground.....	97-102
Green House and House Gardening.....	103-108
Fruit and Vegetable Gardening.....	108-114

### CORRESPONDENCE:

Postscript to Article on R. I. Bent Grass.....	98
Remouant Pinks (Carnation).....	98
Time to Prune Shrubs, and other Hints.....	100
Orange and Lemon Trees and Geraniums.....	103
Coal Tar.....	105
Heating with Hot Water.....	106
A Visit to Covent Garden.....	109
A New Culture for Asparagus.....	111
The Growth of the Cork Tree in the United States...	115
The Root-Cap.....	119
Potomac Fruit Growers—February Meeting—Gala Day.....	126

### EDITORIAL NOTES:

Jasminum nudiflorum—The Live Oak (Quercus virens)—Garden Edgings—Abies Engelmannii—Schizostylis eocinea.....	100-102
Floral Decorations at Tunbridge Wells—Annuals for Bouquets.....	106-107
June Budding Peach Trees—The Lady Apple—Foreign Fruits in England—American Seedling Potatoes—Two Sets of Roots to a Grape Vine—Fored Fruits and Vegetables—The Early Olive Radish—The Profits of Orange Growing—The Big Rambo Apple—Large English Pears.....	111-113
The Cork Tree—The Pecan—Osage Orange Timber—Hard Names—The English Maple—Russian Timber.....	118-119
Typographical—The Phylloxera—Sunken Forests... Horticulture in New Orleans—A Few Suggestions on Tree Planting—"Subscriber" on Mushrooms—Proceedings of the Western New York Horticultural	120

Society—Transactions of the Massachusetts Horticultural Society for 1875—Bad Advice and Worse Consequences—Reclaiming Damages—The Garden—Mr. Robert Demcker—Hoopes Bros. & Thomas, West Chester, Pa.—Gould Nursery Co. Beaver Dam, Wisconsin, Annual Catalogue of Greenhouse Plants—The Eye green.....	121-125
New York Horticultural Association—Minnesota State Horticultural Society—Meeting of American Nurserymen—Horticultural Department of the Centennial—Admission to the Centennial—Hotel Rates at the Centennial—England and the Centennial—Fruits at the Centennial.....	127-128

### NEW PLANTS:

Rouneya Coultieri—Delphinium nudicaule—Brodiaea Californica—Spiraea palmata.....	102
Macleaya Yedoensis—New Variegated Lantana—Othonna crassifolia—Begonia Frobeldii.....	107

### NEW FRUITS AND VEGETABLES:

Thwack Raspberry—The Sterling Strawberry.....	113
---	-----

### FORESTRY.....

### NATURAL HISTORY AND SCIENCE.....

### LITERATURE, TRAVELS AND PERSONAL NOTES.....

### HORTICULTURAL SOCIETIES.....

### QUERIES:

Crataegus Pyracantha Hedges.....	102
Names of Plants—Machius for Flower Pots—Flowering of Combretum grandiflorum—Variegated Lantana.....	107-108
Human Hair as a Fertilizer—Gas Lime—Hardy Market Raspberry—Do Persimmons Change by Grafting?—Teach seedlings.....	113-114
Larch Timber—White Cypress—Rate of Growth in the Oak.....	119
Diervilla—Rocky Mountain Silver Spruce.....	121

# AUGUST RÖLKER & SONS,

32 Reade St., New York.

Importers and Dealers in

## FLORIST'S SUPPLIES,

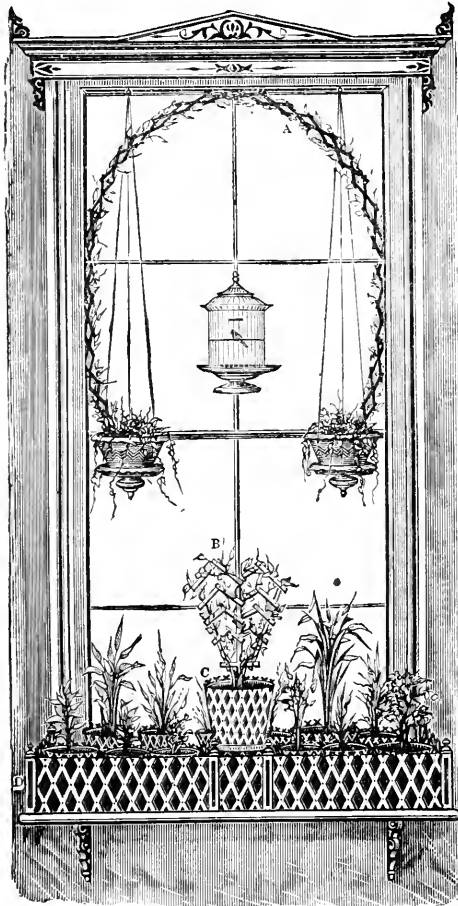

### A. EXTENSION IVY TRELLIS,

6 inches wide, expanding 7 feet.	\$0.60
6 " " 14 " "	1.20
8 " " 10 " "	.80
8 " " 20 " "	1.60

### B. ADJUSTABLE FLOWER TRELLIS.

18 inch Pot Trellis 30c.	4 feet Garden Trellis, 65c.
24 " " 40c.	5 " " " 75c.
30 " " 50c.	6 " " " 90c.
36 " " 60c.	7 " " " \$1.10

### C. ADJUSTABLE FLOWER-POT FENCE OR COVER.

5 inches,	35c.
6 " "	40c.
7 " "	45c.
8 " "	50c.
9 " "	55c.

### D. WINDOW GARDEN FENCE.

6 inches high,	\$1.75.
8 inches high,	\$2.25.

These goods are all made of Black Walnut, handsomely finished, fastened with fancy nails; they open and close freely, and may be adjusted to fit different windows, pots, shelves, or flower-stands. To the trade 25 per cent. discount, and 5 per cent. extra for C. O. D.

The latest novelties on hand in DOMESTIC and IMPORTED

## FLOWER BASKETS AND WIRE DESIGNS

AT MANUFACTURERS PRICES.

HYACINTHS, LILIES, TULIPS, CONVALLARIA, &C.

Bulbs imported to order, will be selected by one of the firm personally when in Europe this summer.

1876.

1876

# CENTENNIAL ERA.

---

CONSOLIDATION

OF

# TWO MAGAZINES.

The "HORTICULTURIST" of New York City, having been purchased in the interest of the GARDENER'S MONTHLY, the former Magazine issued its last number with December, 1875, when it completed its Thirtieth year. Henry T. Williams, its late editor and proprietor, gives it up in order to confine his attention more effectively to the other branches of his expanding business.

THE GARDENER'S MONTHLY, with the present issue will be hereafter known as the "GARDENER'S MONTHLY AND HORTICULTURIST." It is, at this date, the *only Monthly Magazine devoted to Horticulture, in the United States, East of the Rocky Mountains.* It will continue under the able Editorship of THOMAS MEEHAN, and will as heretofore do its best to deserve the consideration and support of the increasing numbers, who, through cultivation, taste, interest, desire the companionship or aid of such a literature.

The subscribers of the GARDENER'S MONTHLY and those of the late HORTICULTURIST are kindly requested to give their encouragement to this consolidation, by an early renewal of their own subscriptions, and, if possible, the enclosure of, each, a new subscriber with their own orders.

The lovers of Horticulture generally are asked to give the Magazine a year's trial.

Single Subscription Price, \$2.10 per Year. Six Months for \$1.05; Four Months for 70 cents; Three Months for 53 cents. One Old with one New Subscriber, or Two New Subscribers, \$3.20 for the two.

Remit by Post Office Order, Draft, or Registered Letter, to avoid possible loss by miscarriage through the mails.

ADDRESS

CHAS. H. MAROT,

PUBLISHER,

814 CHESTNUT STREET, PHILA.



SEE FIRST PAGE, FACING COVER.

MY  
CATALOGUE OF PLANTS

FOR THE  
SPRING OF 1876,

Will be ready about February 1st. It will contain an unusually fine assortment of Novelties in the way of

CANNAS, GERANIUMS, HELIOTROPES.

PELARGONIUMS, VERBENAS, &c.

Also, an admirable assortment of new and beautiful

FRENCH HYBRID GLADIOLUS,

Which are offered in large quantities at LOW RATES. Also,

TUBEROSE BULBS OF THE VERY BEST QUALITY.

Particular attention is called to my

STOCK PLANTS OF VERBENAS,

containing a fine selection of Varieties, all in vigorous health. Attention is also called to my list of

EXTRA CHOICE

FOREIGN GRAPES FOR GRAPERIES.

Catalogues may be had FREE OF CHARGE by addressing

GEORGE SUCH,

# FRUIT AND ORNAMENTAL TREES, SHRUBS, ROSES, AND PLANTS.

ELLWANGER & BARRY, Proprietors of the Mount Hope Nurseries Rochester, N. Y.,  
invite attention of  
PLANTERS, NURSERYMEN, and DEALERS

to the extensive and varied stock in every department which they offer for the Spring Trade. Full particulars given in the following Catalogues, which will be sent to all our old customers free, and to others who enclose stamps as below.

- No. 1.—FRUITS (just published). 60 pages, with Colored plate, 15 cents, without, 10 cents.  
No. 2.—ORNAMENTAL TREES, Shrubs, Evergreens, Roses, etc., 124 pages, 50 Illustrations, and a Fine Colored Plate of Roses, 25 cents.  
No. 3.—GREEN and HOT-HOUSE and BEDDING PLANTS, with Supplemental List of Novelties FREE.  
No. 4.—WHOLESALE, free.  
No. 5.—LIST of NEW ROSES, for 1876, FREE.

feb3 Address—ELLWANGER & BARRY, Rochester, N. Y.

# R. B. PARSONS & CO.,

BOWNE AVENUE, FLUSHING N. Y.

Offer a General Assortment of the Best

## TREES AND SHRUBS.

Our Office and Greenhouses being at the location once occupied by the old house of Parsons & Co. (now dissolved), of which R. B. Parsons was a member, visitors will find it quite accessible from either the Bridge or Main Street Railroad Stations.

We cultivate in great quantity and offer to LARGE BUYERS, a very choice stock of HARDY RHODODENDRONS, AZALEAS, Chinese and Ghent, CAMELLIAS, CLEMATIS, MAGNOLIA CAMPBELLII, CHINESE MAGNOLIAS, PURPLE BEECH, and other valuable Trees and Plants. We grow well rooted Evergreens in large numbers, and our

## RARE EVERGREENS

are widely known as being in great variety and well grown. We offer

## ROSES

in large quantity of our selection, at \$8 per 100; \$70 per 1000. *Dentzia Crenata*, double flowering, white—an entirely new variety, 75c. The attention of Dealers is invited to our stock, which being near the Flushing Depot, can easily be reached. The aid of an experienced Landscape Gardener can be offered to those wishing to plant. Catalogues furnished on application to

feb3

Box 99, FLUSHING, NEW YORK.



I have founded my business on the belief that the public are anxious to get their seed directly from the grower, and I therefore offer FREE to every man and woman in the United States who cultivates a farm, fills a vegetable garden, or plants a flower garden, my large, illustrated Catalogue of Vegetable and Flower Seeds for 1876; it contains, in addition to the choicest kinds produced in Europe, one hundred and fifty varieties of vegetable seed grown on my four seed farms. Customers of last season need not write for it. As the original introducer of the Hubbard, Marblehead and Butman Squashes, Phinney's Melon, the Marblehead Cabbage, and a score of other new vegetables, I solicit your patronage. All seeds sold under three warrants. A 100,000 catalogues will be issued and sent out the 1st of January.

JAMES J. H. GREGORY,

dec5

Marblehead, Mass.

## GRAPE VINES

Grown especially for the Trade and Planters in Quantity. CONCORD, MARTHA, Delaware, Hartford, Prolific, Ives, Salem, Wilder, Iona, and many other varieties, one and two years old, in quantity.

A. HANCE & SON,

nov1f Nurserymen and Florists, Red Bank, N. J.

## C. F. A. HINRICHS,

29, 31 and 33 Park Place, New York City,

## HYACINTH AND BULB GLASSES.

DECORATED

## FLOWER POTS,

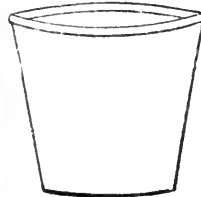

LAVA, MAJOLICA, &c., &c. Vases. Iron Sections for Flower Beds. Lawn, Fish and Flower Stands. Floating Animals for Aquaria. Button-hole Bouquet Holders. Only and Original GERMAN STUDENT LAMP for Conservatories.

Send for Prices to above address.

mch6

## SUBSCRIBE TO THE NEW JERSEY AGRICULTURIST.

A Monthly devoted to the interests of the Farm, Garden and Household. Only Agricultural Paper in New Jersey. Subscription 50 cents per year. Sample numbers free. Liberal terms to Agents. Address,

apl1

CHARLES WESTALL,  
20 Hiram Street, New Brunswick, N. J.

## FORCE PUMP and PLANT SYRINGE \$4.50.

PAGE'S IMPROVED—best in market for applying liquids to destroy insects on plants, vines or fruit trees; throws jet of water 50 feet; will change to coarse spray or fine mist instantly.

mch2

N. PAGE, JR.,  
Danvers, Mass.

# EVERGREENS, EVERGREENS,

NORWAY SPRUCE, from 1 to 6 feet. IRISH JUNIPERS, from 6 inches to 6 feet. AMERICAN ARBORVITÆ, 1 foot to 6 feet. AUSTRIAN. SCOTCH and WHITE PINES, 1 to 6 feet. DWARF ARBORVITÆ, in great variety, all sizes.

## RETINOSPORAS AND OTHER NEW AND RARE EVERGREENS. DECIDUOUS TREES.

SILVER, SUGAR and NORWAY MAPLES, AMERICAN LINDEN and other Trees, for Street Planting. Also of small sizes for replanting.

### FLOWERING SHRUBS,

A general assortment of large and small sizes.

### SMALL FRUITS.

Herstine Raspberries, in large stock. Currants and Gooseberries, fine 2 year old's

### GRAPE VINES IN VARIETY.

Our stock is very fine, and will be offered at the **Lowest Prices**. Send list of stock needed in our line and see how low we can sell it; also for **New Wholesale Catalogue**.

**WILLIAM H. MOON,**

MORRISVILLE, PENNA.

## BEDDING PLANTS.

VERBENAS, very fine and thrifty, \$4 per 100.

### GERANIUMS! FUCHSIAS! COLEUS!

and other Standard Bedding Plants in great variety. We have a large stock of GREENHOUSE PLANTS, which we offer at very low prices.

### IRIS KÖEMPFERII---NEW JAPAN IRIS.

By far the finest Iris in cultivation Perfectly hardy. Blooms in mid-summer. Flowers large, of various shades of color. It is now attracting considerable attention among the leading European Florists. \$10 per 100.

Send for Wholesale Price List to

tmch

MAHLON MOON & SON, Morrisville, Bucks Co., Pa.

# COLUMBUS NURSERY.

ESTABLISHED 1855.

## Nurserymen and Dealers

Needing stock, and parties intending to plant, can find at this old and reliable establishment, a large and complete assortment of **Fruit Trees, Grape Vines, Small Fruits, Deciduous Trees, Evergreens, Roses, Shrubs**, etc., of the best quality, at reasonable prices;

For the Spring of 1876 our stock is large, embracing STANDARD APPLES in large quantity, DWARF APPLES, STANDARD and DWARF PEARS, CHERRIES, PLUMS, PEACHES, APRICOTS, NECTARINES, QUINCES, SPANISH CHESTNUTS, ENGLISH WALNUTS, BLACKBERRIES, GOOSEBERRIES, RASPBERRIES, STRAWBERRIES, CURRANTS, and GRAPES—old and new varieties.

EVERGREENS in great variety, good size trees for planting and shipping. DECIDUOUS trees of many kinds, large and small. **Kilmarnock, New American and Rosemary Willows, Weeping Ash, Elm and Poplar, Shrubs and Climbers. ROSES**, a fine collection on own roots, embracing many of the new and desirable varieties.

With railroads leading in all directions, and an Agent at Cincinnati to re-ship promptly to all parts of the South-west, purchasers may depend upon receiving what they order, without delay. We pack our Trees, &c., so they will reach any part of the country in good condition. Parties interested, are invited to call and examine our stock.

Correspondence solicited, and prices sent on application.

mch2

**R. G. HANFORD & SON, Columbus, O.**

5000 NORWAY SPRUCE  
and BALSAM FIR,

Mostly 3 feet and 4 feet sizes. Very Cheap.

**ENGLE & BRO.,**

mch2

MARIETTA, PA.

**R. H. HAINES** will send free to all applicants his new descriptive price list of **Hudson River Fruit Gardens**. Many novelties. **Star and Monarch of the West, Kerr's Prolific**, and 20 other promising Strawberries. **Highland Hardy, Ganargua, Norwood, &c.** Raspberries, **Currants, Fruit Trees, New Grapes, Brighton, Walter, &c.** Also **BERRY BASKETS and CRATES**, largest assortment in America. Address,

**R. H. HAINES,**

Malden-on-Hudson, N. Y.

apl

# HYBRID PERPETUAL ROSE,

"EDMUND WOOD."

We are gratified to find that our friend M. VERDIER, the most celebrated Rose grower of France, has considered our establishment of sufficient importance to name one of his finest New Seedlings after our Mr. EDMUND M. WOOD.

In a special circular containing the names of his choicest New Varieties, he thus describes it: *Edmund Wood*: tree vigorous, with short reddish-green branches and numerous dark brown spines, leaves consisting of 3 to 5 leaflets oval, dark green; Flowers, large, full and perfect in form, growing in corymbs of 6; color lively, bright cherry red, reverse of petals, carmine—admirable. This variety is comprised in the series to which the silver gilt medal was awarded by the Paris Horticultural Society in May and June, 1875. Depending upon the correctness of this description and the well-known veracity of Mons. Verdier, we have arranged for the importation in quantity of this variety with all the others raised last year in Europe, and shall offer it to the public of the United States on and after May 1st, at \$2 each. Orders will be executed in strict priority as they are received.

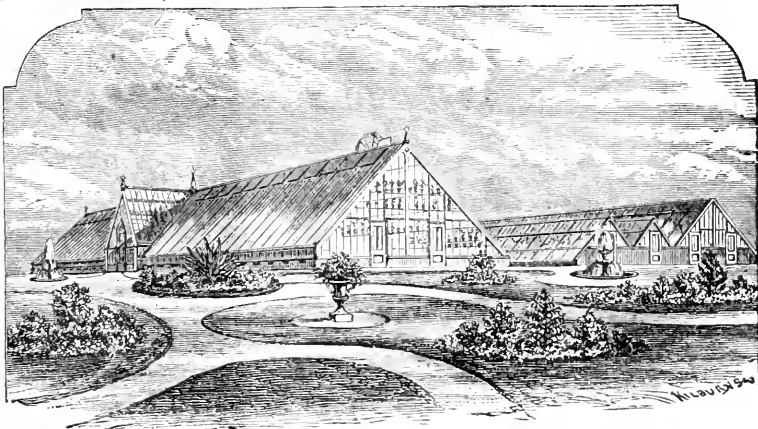

OUR NEW DESCRIPTIVE CATALOGUE, containing names and characters of all the best Roses, new and old, at present in cultivation, will be ready in a few days, and may be had on application.

EDMUND M. WOOD & CO.,

OFFICE OF

## WABAN CONSERVATORIES,

56 BROAD STREET, BOSTON, MASS.

Jan 12

M. M. BAYERSDORFER & CO.,

Importers of Every description of

## BOUQUET PAPERS.

Plain White Satin for Bridal Bouquets. Fancy Lace for Weddings, Receptions, Parties. Italiens, Pasted Cartons, Immortelles in great varieties; Green Moss, French Dried Grasses and Flowers. Tin Foil. Prize Medal of Cincinnati Industrial Exposition of 1873 awarded to us for the best display of Bouquet Papers. Illustrated Catalogue furnished on application.

feb 56 N. Fourth St., Philadelphia, Pa.

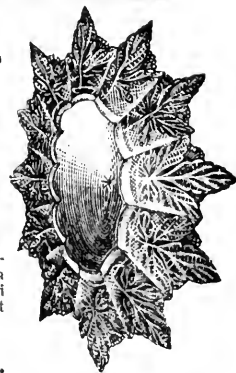
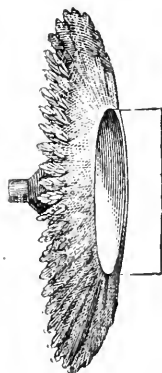

# THOMPSON'S WEEPING DOGWOOD.

Having purchased the original of this magnificent WEEPING TREE, and believing it to be one of the most attractive things in this line

EVER INTRODUCED.

It will be placed at once under propagation, and when ready for sale it will be duly announced.

## BLOOD-LEAVED BIRCH.

This is of just as beautiful a color as the well known Blood leaved Beech. A few plants for sale this Spring at \$5 each.

## WEEPING YELLOW ELM.

A few Plants of this, regarded by all as The Best of All Weeping Elms, on six feet stems, at \$5; Small Plants, \$3.

THOMAS MEEHAN, Germantown Nurseries, Phila.



*John Saul's  
Catalogue  
of New, Rare  
and Beautiful  
Plants.*

FOR SPRING OF 1876,

Will be ready in FEBRUARY, with a Colored Plate. Man-  
beautiful

NEW PLANTS

are offered; all at VERY LOW RATES. Free to all my  
Customers; to others, 25 cents a copy. A plain copy to all  
applicants free.

- New Pelargoniums.**—A magnificent set of beautiful flowers.
- New Perpetual Pelargoniums.** Very distinct—beautiful.
- New Bergonias, tuberosus rooted.** A beautiful set.
- New Cannas.** Beautiful and distinct in foliage.
- New Zonale and Double Geraniums.** Raised by Mr. Lax-  
ton, Dr. Denny and others.
- New Victoria Daisies, new sets of Fuchsias, Roses, Phloxes  
Heliotropes, Dahlias, Chrysanthemums, Ager-  
atums, Hibiscus, Caladiums, Clematis,  
&c., with other New and Rare Plants.**

ROSES.

An immense stock of all the standard varieties grown in pots.  
CHEAP.

NEW FRUITS.

NEW PEARS, PEACHES, STRAWBERRIES, &c.

**NEW SHRUBS and ORNAMENTAL TREES,** with a  
large general Nursery Stock—Fruit Trees, Evergreens, &c., Nor-  
way Spruce, Austrian Pine, Silver Fir, and other Small Ever-  
greens, Fruit Tree Stocks, &c., suitable for Nurserymen.  
CATALOGUES mailed to applicants.

JOHN SAUL,

feb3 Washington City, D. C.

*The Cheapest Magazine published in the  
Civilized World is*

THE FANCIERS' HERALD

AND

LIVE STOCK ADVERTISER.

A large illustrated 20 page Monthly, devoted to Poultry, Fish  
Culture, Bees, and Live Stock. Subscription price but 50 cents  
per year, postage paid. Circulation immense, and advertising  
rates but one cent per word, every advertiser receiving the  
copy containing his advertisement free. Endorsed by all the  
prominent Breeders in the country, and contributed to by some  
of the most eminent writers. Sample copies, 10 cents.

Address

HERALD PUBLISHING HOUSE,  
Mattituck, Suffolk Co.,  
New York.

feb3

**ROSES, VERBENAS**  
BEDDING AND EXHIBITION PLANTS  
Sweepstakes Medal at Exposition  
Fine Stock at Low Figures. Catalogue FREE.  
Address B. P. CRITCHELL, Cincinnati, Ohio.

GREENHOUSE AND BEDDING PLANTS.

Large stock; plants well grown; finest New and Old varieties.  
Sent by Mail or Express. Illustrated Priced Catalogue free.  
tapl Address, ELLWANGER & BARRY, Rochester, N. Y.

Park's Floral Gazette.

A BEAUTIFUL FLORAL MONTHLY.

Entirely Floral. Twenty pages—neat print—  
fine tinted paper—elegant illustrations—magnifi-  
cent colored plates—tells all about Flowers, Fern-  
eries, Conservatories, &c. Everybody who loves  
flowers should take it. Only 10 cts. per copy, or  
\$1.00 a year, post paid.

"The GAZETTE is splendid; every number is better than its  
predecessor. I would not be without it"—W. C. L. Drew,  
Eldorado, Cal.

"I consider PARK'S FLORAL GAZETTE one of the best and  
cheapest papers for the price that is published. Every lady, if  
she only wants to grow one plant, ought to take it."—James A.  
Nelson, Indian Run, Mercer Co., Pa.

"The FLORAL GAZETTE came and thoroughly charmed me  
with its neat appearance externally; and it's full to the brim inter-  
nally. I felt that it was just what I wanted, and herewith  
send you my subscription."—Miss Jennie P. Owan, Berlin  
Heights, Ohio.

GEO. W. PARK, Ed., Pub.,

feb3

MOUNT VERNON, OHIO.

TO THE TRADE.

USEFUL NEW PLANT—SEDUM AZOIDEUM VARIEGATA.

We find this the most useful ornamental plant of recent intro-  
duction, being equally adapted for centres of Hanging Baskets,  
Vases, Pot-culture or Bedding. Quite hardy, of free growth,  
but dwarf, compact habit; leaves of a deep green color, beau-  
tifully margined and blotched with creamy white, producing a  
very unique and pleasing effect. Price \$2.50 per dozen.

Address J. GREIVES, Sec'y Greenbrook and Paterson  
City Nurseries, Box 837, Paterson, N. J. feb3

SURPLUS STOCK.

WILSON'S ALBANY STRAWBERRY,  
DOOLITTLE RASPBERRY,  
NORWOOD PROLIFIC RASPBERRY,  
DORCHESTER BLACKBERRY.

I have a surplus of the above varieties of plants, and offer  
them at wholesale and retail at lowest prices. Other plants at  
reasonable rates.

WM. F. BASSETT,

feb3

Hammonton, N. J.

NEW BEDDING PLANTS.

Double Flowering Ivy Leaf Geranium.  
Fuchsia, Mrs. H. Cannell.  
Fuchsia Procumbens, the Creeping Fuchsia. One of  
the best novelties ever introduced.

VERBENA LITTE GIANT.

Catalogue ready about 1st of March, and sent on receipt of 2  
cent stamp, to prepay postage. Address,

GEO. FOUST,

feb3

2825 Frankford Ave., Phila.

GOOD SEEDS

Grown with care and painstaking from selected stocks always  
pay. Try mine. See advertisement "All About Gardening."  
feb4 J. B. ROOT, Seed Grower, Rockford, Illinois.

**AT BOTTOM PRICES,** 200,000 Evergreens and Larches from 6 inches up. Fruit Trees and Ornamental Trees, and Seedlings. Wilson Strawberry, Dog rose (*rosa canina*) one year, etc. Price list free.

mch2 **E. Von OVEN, Naperville, Ill.**

**CAPE COD CRANBERRY PLANTS.**

35 cents per 100, \$2.25 per 1000, prepaid by mail. 10,000 by express \$15.00.

**WHITE POND-LILY ROOTS.**

cents each, \$1.50 per dozen, prepaid by mail. They bloom finely in tubs and artificial ponds.

Circulars, with directions for planting both, free.

pl1 **J. A. VAUGHAN, Carver, Plymouth Co., Mass.**

**I WILL SEND BY MAIL FREE,**

**Gladiolus,** scarlet, 4 varieties named, for \$6.50 per 100  
 " assorted colors, 9 varieties named, for 7.00 "  
 " extra fine light colors, 8 varieties named 10.00 "  
**Geraniums,** fine strong plants, 27 varieties named 10.00 "

Address,

**W. E. MEEHAN, Florist,**

tap1

**Germantown, Philadelphia.**

**CHAMPION GRAPE,**

The earliest good market Grape cultivated. Large bearer; no mildew; very hardy. Send for free circular to

**J. S. STONE,**

mch2

Charlotte, Monroe Co., N. Y.

**S. THANHAUSER,  
 BOUQUET PAPERS,  
 IN ALL VARIETIES.  
 BRIDAL BOUQUETS,**

White and Colors, trimmed with Satin, Lace, Tulle, &c.  
 Large Assortment of Immortelles, Grasses, Moss, &c.

**No. 19**

PHILADA.,

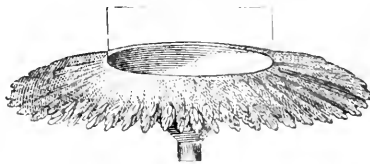

**N. 4th St.,**

PENN.

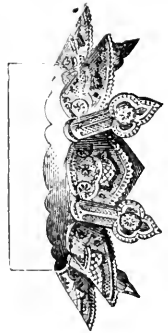
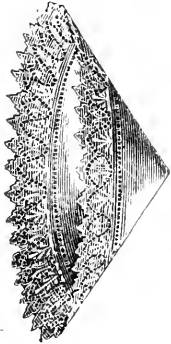

**MOUNT AIRY NURSERIES.**

**ROSES.**

NEW AND RARE

Our stock of Roses is large and superior before, including most of

**TEAS, in four and five inch pots,  
 HYBRID PERP. and NOISETTS,**



**ROSES.**

ROSES A SPECIALTY.

in growth to any we have ever offered the new varieties.

\$4.00 per doz., \$20 per 100.

\$4.50 per doz., 30 "

The above include the choicest varieties grown from recent importations. We have also grown in 4 and 5 inch pots, on their own roots, from our last Spring importations a fine stock of young new Roses which we can sell at prices less than they can be imported.

**PRICES ON APPLICATION.** Plain Catalogues sent on receipt of 3 cent postage stamp. Catalogue with Colored Plate, 10 cts.

**NEW AND RARE NURSERY STOCK.**

All the choicest varieties of Nursery Stock such as RHODODENDRONS, EVERGREEN and other SHRUBS in a variety, and DECIDUOUS TREES, RETINISPORAS, SPRUCES, CUPRESSUS, &c. *Hydrangea Paniculata grandiflora*, large plants, 75 cents to \$1 each, *Hydrangea Paniculata grandiflora*, smaller plants, 40 cents each, \$3.50 per dozen. *American Arbor vitæ* in quantity, and fine growth for Hedges, from \$20 to \$40 per hundred.

**ORNAMENTAL GREENHOUSE AND HOTHOUSE PLANTS.**

A large collection of well grown Palms, Agaves, Ferns, Lycopodiums, Dracaenas, etc., at very low rates.

**LATANIA BORBONICA**—Fine plants, 1 to 2 feet high, growing in 6 and 7 inch pots, 75 cents each, \$6 per dozen, \$40 per 100.

Catalogue sent on application and a receipt of 3 cent postage stamp.

apl2 **MILLER & HAYES, 5774 Germantown Ave., Philadelphia.**

# WABAN CONSERVATORIES

OFFICE :  
56 BROAD ST., BOSTON.  
Address all Letters to  
BOSTON OFFICE.

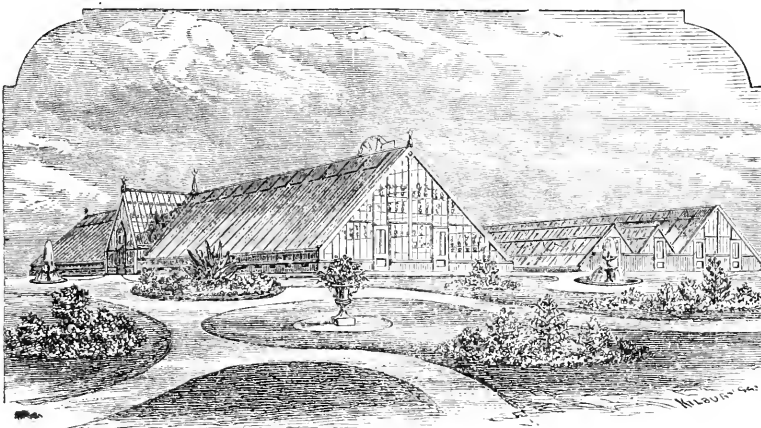

Send all Telegrams by  
Atlantic & Pacific Line. Address,  
*Waban Conservatories,*  
LAKE CROSSING, MASS.

THESE CONSERVATORIES  
Have in stock at all times, and offer at Wholesale,  
**CUT FLOWERS IN QUANTITY,**  
CONSISTING OF

Bon Silene, Saffrano and Isabella Sprunt Roses, Marechal Niel and General Jacqueminot, in great quantity, Souvenir de Malmaison, Yellow Tea, Persian Yellow, Devonensis, Gloire de Dijon in limited amounts. *The New Roses*—Le Nankin, La Jonquil, Madam Capucine, Belle Lyonnaise, Perle de Lyon, we shall be able to furnish in good quality. La France Rose in large quantity.

Also White and Red Bouvardia, White and Red Carnations, Violets, Stephanotis, Tuberoses, Jessamine and a general assortment of Cut Flowers used by the best Florists.

Lilium Longiflorum and Candidum in quantity at Easter.

Smilax & Fern Fronds in very large quantities for Decoration.

NEW ROSES, }  
NEW PLANTS, } AT LOWEST RATES.

We are now packing and shipping Flowers with perfect success to Chicago, New York, Philadelphia, Baltimore, Washington, Montreal, and all important intervening places; and we are pleased to add that our shipments are giving universal satisfaction; in our Telegraphic communications enabling us to fill orders to the most distant places quicker than Florists can obtain them by any other means.

**TEAS**—Aline Sisley, Comte de Sembuy, Jean Ducher, Marie Guillot, Marie Opoix, Perle des Jardine, Shirley Hibberd.  
**NOISETTE**—Reine des Massis. **BOURBON**—Mme. de Sevigne. **MOSS**—Souppert et Notting.

**HYBRID PERPETUALS**—Adanson, Antoine Mouton, Bernerd Verlot, Cassimir Perrier, Comtesse de Serenye, Gaspard Monge, General Eerwangne, Henry Ward Beecher, Hypolite Jamain, Ingenieur Madele, La Rosiere, La Souveraine, Madame Rose Charmeux, May Eurner. Philippe Bardet, Princess Antoinette Strozio, Soeur Athunase, Souvenir de Mere Fontaine, Madame Lefebvre de St Ouez, Claire Mathiew Melle, Tlona de Adorjas, Souvenir de Ducher.

Our importations for the present season are on a much larger scale than heretofore, and will embrace all the New Roses and other plants of merit raised in Europe during the past year.

We have the pleasure to state that our stock never was in so fine condition. Our new houses are in running order and we shall be able to supply all plants and Cut Flowers as stated in former advertisements, in large quantities—now having the largest establishment in the United States devoted to the sale of Cut Flowers. Our new descriptive Catalogue, revised and greatly improved, will be ready in February.

**N. B.**—Particular attention given to Plan, Arrangement, Construction and Heating of Greenhouses for the growth of **CUT FLOWER PLANTS** at a Profit for Market. Advice as to the most profitable Flowers and Plants to grow, and method of culture. Nine-tenths of the Failures can be traced to want of Knowledge in the Construction, Arrangement and Heating of Houses, and the **Kinds of Plants and Flowers to put in them.** *New Beginners*, we believe, will find our knowledge and large experience valuable to them.

## N. STEFFEN'S WIRE WORKS,

335 E. 21st St. New York.

manufacturer of all designs for FLORISTS. Wreaths, Crosses, Crowns, Hearts, Anchors, Pillars, Columns, Monuments, Bells, Composure, Faith, Hope and Charity, Harps and Lyres, &c. Leaning and Upright.

Send for Price List.

jan 12.

## TO FLORISTS.

**TOBACCO STEMS**, For Fumigating purposes, put up in bales of 250 lbs. each, at \$5.00 per bale, free on boat or cars. All orders from unknown parties must be accompanied by remittance. For sale by

STRAITON &amp; STORM,

No. 180 Pearl Street, New York.

aug 12

Allen's Planet Jr.  
SILVER  
MEDAL



Hand Seed Drills and Wheel Hoes, perfected for '76. Four sized They "sow like a charm;" no packing of seed in the hopper, no crushing it, no pausing or waste at the ends, no irregularity in depth, no springs or gearing to wear out, no "skips," no noise, no equal! The Double Wheel Hoe works easier, better, and from six to twelve times faster than the hand hoe; often saving the gardener \$100 in a season; finishes two rows at once, when 6, 9, or 10 inches apart. Four pairs of hoes; blades tempered steel. We make an admirable Corn and Machine possessing nearly all the excellencies of the separate ones. No vegetable garden, however small, should be without one. Our New Horse Hoe, perfected after ten years of experiment, saves most of the hoeing and makes the remainder easy; leaves the ground level or ridged as desired, opens furrows, hills, and cultivates shallow or deep, and is a thorough weed killer; should be owned by every farmer. Full Descriptive Circulars and Testimonials free. Mention this paper. S. L. ALLEN & CO., Sole Mfrs. No. 119 S. 4th St., Philadelphia. We must have a Live Agent in Every Town.

## DELAWARE.

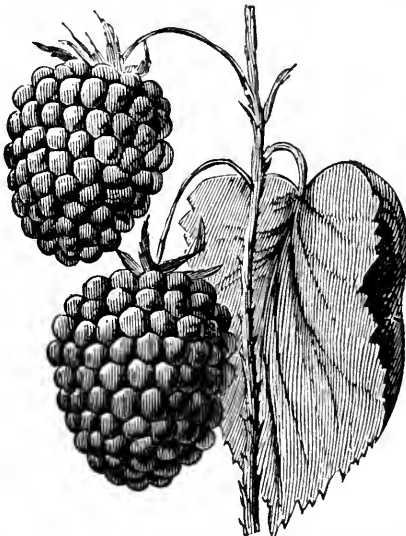

The Largest and Best Hardy Red Raspberry.  
Send for circulars.

WM. PARRY,

Cinnaminson, N. J.

mch 2

A NEW ERA IN

## TRICOLOR GERANIUMS.

THE NEW TRICOLOR,  
MRS. GEORGE FOUST.

As a test of the great merit of this new Geranium, I may state that all the Philadelphia Florists, on seeing it, purchased all the stock I could spare. Among them, Messrs. Buist, Dick, Dreer, and Harris. Mr. Harris, the great Geranium grower, says, "The best thing I have ever seen."

It perfectly withstands the hottest sun, holding its color and growing vigorous. I may also state, that grown in the greenhouse there is no other variety to equal it in growth and rich color. So much so that customers, on seeing it, will have nothing to do with the other kinds. Was awarded Special Premium by Pennsylvania Horticultural Society, in September, 1874.

PRICE, \$1.50.

Messrs. John Saul, of Washington, D. C. and John Dick, 521d & Darby Road, Philadelphia, have received consignments, and have it for sale; also the undersigned,

GEO. FOUST,

feb 3

2825 FRANKFORD Avenue, Philada.

NEW AND CHOICE

## TREES AND SHRUBS.

A Descriptive PRICE-LIST, free to applicants.

W. C. STRONG,

mch 2

Nonantum Hill, Brighton, Mass.

## STRAWBERRY PLANTS

By the 100, 1,000, 10,000 or 100,000.

MONARCH OF THE WEST, COL. CHENEY, WILSONS' ALBANY, Seth Boyden, Chas. Downing, Downer, Triomphe de Gand, Kentucky. Also, STAR OF THE WEST, Champion, Dr. Warder, Late Prolific, Black Defiance, Agriculturist, Lenning's White, and others.

A. HANCE &amp; SON,

nov. 12

Nurserymen and Florists, Red Bank, N. J.

VEITCH'S

SET OF

## 6 NEW GLOXINIAS.

These Gloxinias were originated at the Royal Nursery, Chelsea, London, and are described as superior to any in cultivation. Some of the flowers are twice the size of the old varieties, and most of them have received first-class certificates.

Price, \$5.00 for the Set of 6.

Grown and for sale by

GEORGE FOUST,

feb 3

2825 Frankford Ave., Philada.

## ALL ABOUT GARDENING

For HOME use and for MARKET in ROOT'S GARDEN MANUAL—practical, pointed and thorough,—containing one-half as much matter as \$1.50 books on the subject. Gardeners throughout the country commend its practical labor-saving methods as invaluable to them. Sent for 10 cents, which will be allowed on the first order for seeds. J. B. ROOT, Seed Grower, Rockford, Illinois. feb 4

10,000 Camellias of all sizes, with and without BUDS.

2,000 Magnolia grandiflora grown in pots.

100,000 Roses, standards, half-standards and dwarfs.

Crab Apples, Crab Pears and Quince Stocks, per 100,000. For Catalogue and Prices apply to

Messrs. F. E. ROTEREAU &amp; CO., Nurserymen, Angers, France.

june 12

# SOUTHERN GROWN PLANTS.

My stock of Southern grown Fruit, Shade and Ornamental Trees, has been grown with especial good care, and comprises, the most prominent of the

## HARDY EVERGREENS and FRAGRANT FLOWERING SHRUBBERY

Well known for the remarkable grace and beauty with which they adorn the lower Mississippi Valley.

Of SEMI-TROPICAL or PLANTS of the WARM TEMPERATE ZONE

My collection consists of many, and most Attractive Specimens—Well fitted ornaments for Conservatories in Winter; or out-door decorations during the Summer season, in a more NORTHERN or WESTERN CLIMATE.

Price List on application sent postpaid. Address

R. MAITRE, Seedsman and Florist,  
602 Magazine Street, New Orleans, La.

tfeb3

ROWLAND WHITMAN.

HARRY LANG.

## WHITMAN & LANG,

IMPORTERS OF

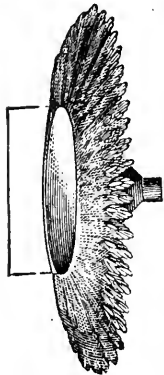

BOUQUET PAPERS.

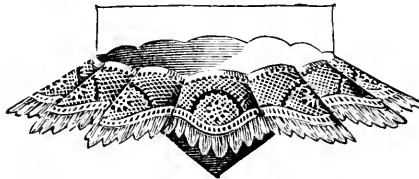

DRIED FLOWERS, IMMORTELES, TIN FOIL &c.

augtf.

No. 126 N. 4th St., Philadelphia.

FANCY GRASSES

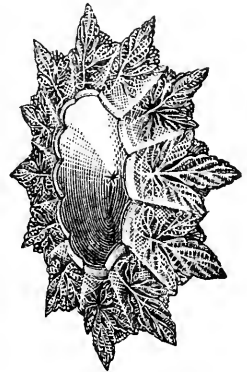

## GERMANTOWN NURSERIES, PHILADELPHIA.

GORGAS LANE STATION, CHESTNUT HILL RAILROAD. Less than One Hour from the Centre of Philadelphia.

Those who desire to purchase largely, either for their own planting or to sell again, are invited to examine the extensive stock of

### FRUIT, SHADE AND ORNAMENTAL TREES AND SHRUBS,

Grown at the Germantown Nurseries. And those who need but A FEW ARTICLES, will find all ages and sizes to select from.

A special feature of the business, is the raising of

Nursery Stock and Seedling Forest Trees

FOR DISTANT SHIPMENT. Many of these can be supplied by the millions at very low rates. Address, for CATALOGUES or information,

THOMAS MEEHAN, Germantown Nurseries, Phila.

## JOHN A. SCOLLAY, IMPROVED HOT WATER APPARATUS,

Patented September 17, 1872.

*For Warming and Ventilating Dwellings, Greenhouses, Graperies, Forcing Pits, Drying Rooms, Heating Water for Public Baths, &c.*

This Boiler is perfectly self-cleaning, simple, economical and powerful, having more effective surface into less space than any Boiler in the market. Scollay's Patent Plant Sprinkler, for Window Gardening, &c., to be obtained of all Seedsman, Florists, &c. Send for Circular and References.

july12

351 Adams Street, Brooklyn, New York.

**JOHN DICK,** CATALOGUES FREE, 53d & Darby Road,  
 FLORIST, 30 GREENHOUSES, Philadelphia.  
 100,000 FEET OF GLASS.  
**ESTABLISHED—1836.**

I invite attention to my stock of Plants, New and Rare  
 FOR THE GREENHOUSE AND CONSERVATORY,  
 Abutilon, Azalea, Begonia, Cactus, Caladium, Croton, Dracena, Echiveria, Gloxinia, Ferns, Hoya,  
 Maranta, Orchid, Palms, Selaginellas, &c., &c.,  
 FOR OUT-DOOR DECORATION,  
 Coleus, Fuchsias, Geranium, Heliotrope, Lantana, Petunias, Roses, Salvias, Verbenas, &c.  
 VARIEGATED AND FANCY FOLIAGE PLANTS.

Plants for Baskets, Ferneries, Ribbon Beds and Borders.  
 New Conservatories and Greenhouses Stocked at Low Prices. Catalogues Free. A Wholesale  
 Price List for the Trade. tfcb3

# NURSERY STOCK

SPRING, 1876.

## SYRACUSE NURSERIES.

With a very superior general Nursery Stock at Low Rates, we can offer special inducements in **ELMS, SILVER MAPLES, all varieties of EVERGREENS, SHRUBS & ROSES.**  
 aplz **SMITH & POWELL, Syracuse, N. Y.**

# Norway Spruce, &c.

All fine transplanted stock; 12 to 15 inches, \$30 per 1000; 15 to 18 inches, \$40; 20 to 27 inches, \$60; 2 to 3 feet, fine for hedges and transplanting, \$100. Trained trees, stocky and fine, 2 to 2½ feet, \$150; 3 feet, \$200; 4 feet, \$300. **Peach Trees,** 3½ to 5 feet, healthy and stocky, \$60; 3 to 3½ feet, \$40. A full supply of Fruit and Ornamental Trees, Shrubs, Vines, Greenhouse and Bedding Plants, &c. 23 years, 400 acres, 13 greenhouses. Price list free to all who apply.

**STORRS, HARRISON & CO.,**

aplz Painesville, Lake Co., Ohio.

# SELECT HARDY PLANTS

Phloxes, Primulas, Iris, Anthericums, Aquilegias, Campanulas, Delphiniums, Day Lilies, etc.

## CHOICE SHRUBS AND CLIMBERS.

TEA AND PERPETUAL ROSES.

**CHARLES SANDER,**

Agent of F. Parkman, Jamaica Plain, Mass.

List on application. aplz

# RUE'S HAND CULTIVATOR

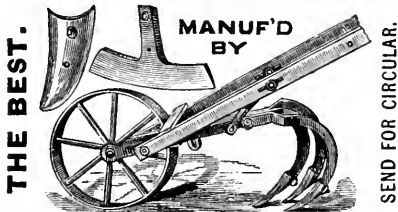

**GEO. W. RUE, Hamilton, O.**

New and Distinct Variegated Geranium,  
**"HAPPY THOUGHT."**

The most novel and welcome addition yet added to this most popular class of plants. See colored plate.

**New Double Geraniums** offered for the **First time.**

**Dr. Torrey,** a beautiful silvery rose colored variety, resembling G. Asa Gray.

**Virginal** The finest shaped and largest Double White variety SIX other new varieties.

See Catalogue, now ready.

**SKED, PADDOCK & CO.,**

feb4

Cleveland, Ohio.

# FRANCONIA RASPBERRY PLANTS.

From the celebrated Shuler Plantation. Plants warranted true to name.

Price,	\$20.00 per thousand.
"	3.00 " hundred.
"	1.00 " dozen.

Address

**MRS. J. D. SHULER,**

feb3

Lockport, Niagara Co., N. Y.

# RICHARD LYNEX,

Rear of 428 Walnut Street, Philada.

Manufacturer of Plain and Fancy Wire-work, for Florists; Wreaths, Crosses, Stars, Crowns, Hearts, Anchors, Birds, Lambs, Gipsy Baskets, Hanging Baskets, Flower Stands, &c.

SEND FOR PRICE LIST.

feb6

# EISELE BROS. CATALOGUE

of New and Best Greenhouse and Bedding Plants and Garden Requisites for 1876, will be ready March 1st., and mailed free to all applicants.

**EISELE BROS.,**

Tioga, Philadelphia, Pa.

feb4

**HYDRANGEA OTAKSA "True."** Flowers 20 inches in diameter, stock guaranteed true. Florists will find it particularly desirable for Spring Sales, as it requires no talking to push it. 2 nice plants, free by mail, for \$1.00.

For sale by

**GEO. FOUST,**

feb3

2825 Frankford Avenue, Philadelphia.

# Roses! Roses! Roses!

We offer a large stock of  
**FINE STRONG GROWING YOUNG ROSES,**  
 grown in 2 and 3 inch pots, and include the finest and leading varieties.

HYBRID PERPETUALS, TEAS, BOUQUONS AND CHINAS.

Also **MOSESSES** and **CLIMBERS.**

at very lowest prices. Orders solicited.

**JAMES ALDOUS & CO., Florists,**  
 tfeb7 Iowa City, Iowa.

**A**MSDEN, Amsden, Amsden. Earliest and best early Peach in the world. Trees, root grafts and scions at Carthage, Missouri, and Dayton, Ohio. Price of the trees reduced for spring 1876. For full history of this Peach, and price of the trees, root grafts and scions, address  
 aug12 **JOHN WAMPLER, Carthage, Missouri.**

## Roses, Lilies, Violets, Carnations, Geraniums, &c.

The Greenbrook and Paterson City Nurseries furnish them "Cheap as the Cheapest, Good as the Best."

Their **Dollar Collections** (mailed everywhere) contain **Ten Different Varieties of Choice Plants and Roses with three fine Album Chromos** or a beautiful **Lilium**. Buyer's choice.

Address

**J. GREIVES, Sec'y,**  
 Box 837, Paterson, N. J.

Catalogues FREE.

## NEW VARIEGATED LANTANA HARKETT'S PERFECTION.

**Best Variegated Bedding Plants to stand the Sun.**  
 Ready March 1st. \$1.00 each. \$10.00 per doz.  
**Illustrated Descriptive Catalogue of Greenhouse and Bedding Plants.** Sent to all applicants.

**W. A. HARKETT,**  
 febro DUBUQUE, IOWA.

# NOTICE.

In justice to Mr. GEORGE FOUST, I beg leave to inform his customers and the public in general, that owing to an accident to the heating apparatus, the stock of Geraniums "1876" was frozen on the night of February 24th. I was under contract to furnish Mr. Foust with 1000 plants, but all I was able to furnish was 16.

WM. K. HARRIS.

## 1876 GERANIUM 1876

Ready for Distribution  
**OCTOBER 1st NEXT.**

Orders filed now, and when ready filled in rotation  
 For full description send 2 cent stamp for Catalogue.  
 Address,

**GEO. FOUST,**

feb3 2825 Frankford Avenue, Phila.

## Ferns, Palms, &c

A large collection—many of which were imported from Germany the past spring.

Send for NEW TRADE LIST.

**HOOPES, BROTHER & THOMAS,**  
**CHERRY HILL NURSERIES,**

tfeb3

West Chester, Pa

NEW YORK, APRIL 1st, 1876.

A FEW

## THOUSAND PLANTS

Now on the way from

## EUROPE,

viz.:

Mahaleb Stocks, middling size,

Pear Stocks, 1 year, 1st class.

Angers Quinces, 1st class,

Standard and Half Standard Roses, 1st class, choice varieties,

Norway Spruce, transplanted, 6 to 12 inches.

Black American Spruce, transplanted, 6 to 12 inches.

For Sale by

**C. RAOUX,**

Jan1f

76 Park Place.

PRICE LIST will be sent to applicants.

## SMALL FRUITS.

Plants of choicest kinds for sale. Also

**A Large Handsome Manual of 82 Pages,** directing how to raise and market them, mailed on receipt of 50c.

Send for Circular. Address,

feb3 **E. P. ROE,**  
 Cornwall on the Hudson, Orange Co., N. Y.

## DOUBLE TUBEROSE BULBS.

Our Stock of BULBS this year is of very superior quality.

	Doz.	100	1000
1st quality large Flowering Bulbs..	\$ 75	\$4 00	\$30 00
2d quality	50	3 00	20 00
A few hundred extra large Bulbs .....	1 00	5 00	

nov6 **MILLER & HAYES, 5774 Germantown Ave., Phila.**

## NEW ADIANTIUMS.

Seemanni and Gracillimum, described in

**GEO. FOUST'S CATALOGUE.**

Sent free on receipt of 2ct. stamp.

feb.3

2825 Frankford Ave., Philadelphia.

# ELLIS' BASE BURNING BOILER.

FOR WARMING Dwellings, Greenhouses, Graperies, Forcing Pits, Drying Rooms Heating Water for Public Baths, Baptistries, &c., by Hot Water or by Steam.

Estimates and Circulars furnished. t.sep.12. 182 CENTRE STREET, NEW YORK.

# GRAPE VINES.

Also Grape Wood and Cuttings. Largest Stock in America.

All leading varieties in large supply. Extra Quality. True to name. Special rates to Agents, Dealers and Nurserymen. Our list of customers now embraces nearly all the leading nurserymen in the country, to whom we would refer those not acquainted with our stock. Send 6c. for DESCRIPTIVE CATALOGUE. Price List Free.

T. S. HUBBARD,  
FREDONIA, N. Y.

aug9

LARGEST STOCK IN AMERICA OF

## EUROPEAN LARCH AND EVERGREEN TREES,

Both Seedling and Transplanted, all grown from seeds on our own grounds, and better and cheaper than imported stock.

## EUROPEAN LARCH AND EVERGREEN TREE SEEDS,

oct7

By the ounce, pound or hundred pounds. \$2- Send for Catalogue.

ROBERT DOUGLAS & SONS, Waukegan, Illinois.

## TUBE ROSES.

15,000 Tube Rose Bulbs, first class, \$25 per 1000; second-class, fine well grown Bulbs, in perfect order, \$18 per 1000; third-class, \$12 per 1000.

S. E. BYERS,

mch2

Houston, Texas.

## BEAUTIFUL FLOWERS

Delivered free of cost per mail at your door. Splendid assortment of Roses, six for \$1, thirteen for \$2. Send for New Descriptive Catalogue of Plants gratis.

HOOPES, BRO. & THOMAS,  
Cherry Hill Nurseries, West Chester, Pa.

mch3

## CHENOA NURSERIES.

APPLE and other FRUIT TREES, GRAPEVINES, HEDGE PLANTS, ORNAMENTAL PLANTS, GREENHOUSE and BEDDING PLANTS for sale. Stock SOUND and HEALTHY. Prices low. Great inducements to Granges, Clubs, and Dealers for CASH. Spring Price-list now ready. Free to all applicants. Address

mch2

SCOTT & MAXWELL, Chenoa, Ill.

## HEDGE PLANTS! HEDGE PLANTS!

Making Hedge plants a specialty. we have particularly to offer this spring Osage Orange, Norway Spruce, Hemlock Spruce, Arbor Vitae, in immense quantities, and of any size to suit.

jantf

THOMAS MEEHAN,  
Germantown, Phila.

GREEN MOUNT NURSERIES.—Large stock of Greenhouse Plants, Seeds, Fruit and Ornamental Trees etc. Great inducements. Satisfaction guaranteed. Send for Catalogues. Address TIPTON & LEE, Barnesville, O.

apl

## TREES FOR FRUIT AND ORNAMENT.

500 Acres of Trees at Wholesale and Retail.

Pears, Apples, Cherries, Quinces,

Peaches, Plums, and Small Fruits.

New and Rare Ornamental Trees and Shrubs.

Evergreens, large quantities, large variety, cheap. Cut-Leaved Birch, Purple Beech, Weeping Trees.

CLEMATIS, JACKMANNI—Hardy and Perpetual, blooms profusely until frozen.

PERPETUAL WHITE CLEMATIS, 15 Sorts. We have over 70 varieties of Clematis, in many shades of color, from dark rich purple to pure white—strong plants, safely sent by mail.

ROSES—Moss, Tea, Climbing and Perpetual.

Small Packages sent safely by Mail and Express.

\$2-Catalogues free. Address

mch2

T. C. MAXWELL & BROS., Geneva, N. Y.

## 200 BUSHELS TUBEROSES.

ALL DOUBLE FLOWERING BULBS.

First Quality, per 1000

\$25.

Second " " "

10.

E. SATTERTHWAIT,

Abbington Nurseries, Jenkintown, Montgom'y Co., Pa.

mch2.

and 300 Twelfth st. Market, Phila.

## NEW FRUITS AND SEEDLINGS.

A few thousand 1 year Norway Maples, fine American Seed and Grown, at \$8 per 1000. A few thousand Siberian Arbor Vitae, the very best stock in the country, 2 to 2½ feet, \$160 per 1000; 3 feet, \$25 per 100. Austrian, Scotch and Corsican Pine, about 2 feet, twice transplanted, \$15 per 100. Platanus Orientalis, two years transplanted, \$5 per 100. Large handsome shrubbery \$10 per 100.

26 Varieties of New Russian Apples.

mch

P. H. FOSTER,  
Babylon, Nursery, N. Y.



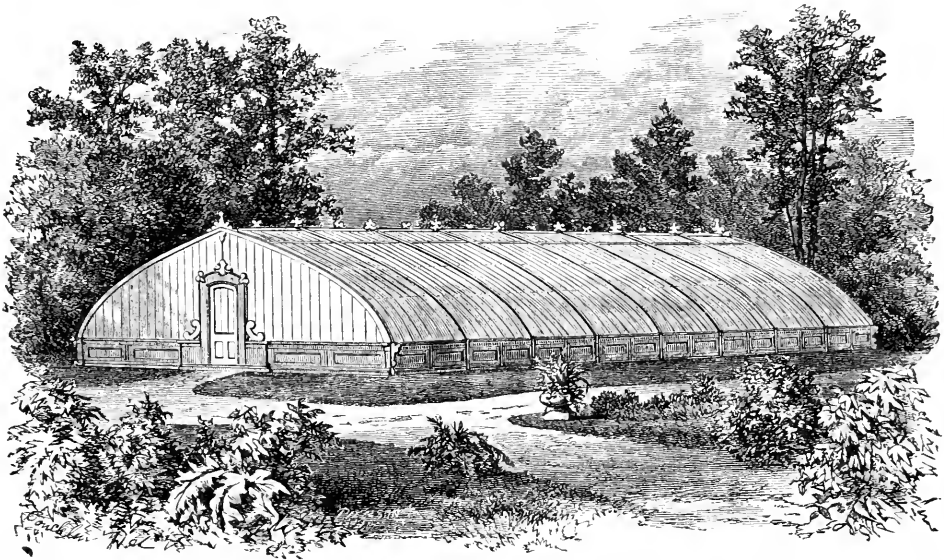

# GREENHOUSES, GRAPERIES, ETC.

Their Construction a Specialty. Experience of 20 Years.  
 SHIPPED TO ALL PARTS OF THE COUNTRY.  Send for Catalogue. Address,  
 LORD'S HORTICULTURAL WORKS,

June 12

Irvington-on-Hudson, New York.

## ALEX. NIMMO,

(Late of the Firm of Nimmo & Scollay.)

# NEWLY IMPROVED HOT WATER BOILER,

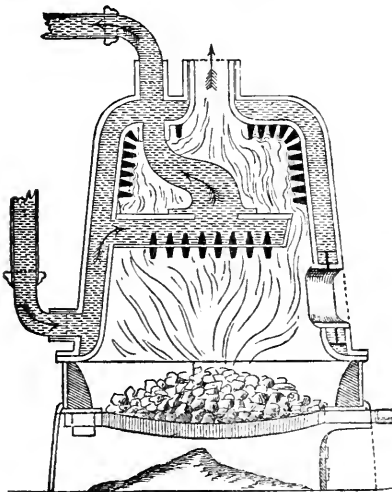

FOR HEATING  
 Green-Houses, Graperies, Conservatories,  
 Forcing Pits, Water for Baths, Drying  
 Rooms, Public and Private  
 Buildings, &c.

*Proper steps have been taken to secure United States  
 Letters Patent on this Invention.*

All the necessary Fittings for Hot Water Heating Apparatus.  
 VENTILATION APPARATUS OF ALL KINDS.

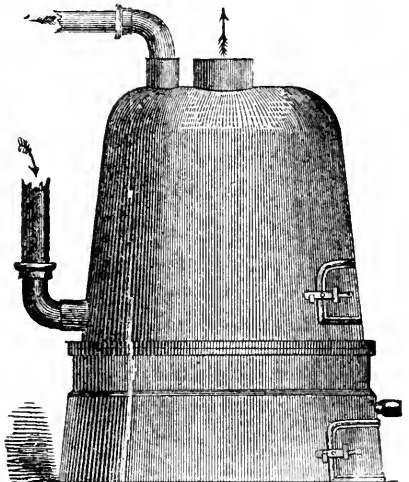

Wells Drove, Pumps of all kinds, Hydraulic Rams, &c., Garden Sun-Dials.

Agent for Joseph Kelly's Never Dry Vapor Pans, for all kinds of Hot Air Furnaces, Baltimore Heaters, &c.  
**CHEAPEST AND BEST BOILER, &c., IN THE MARKET.**

 Please send for Circular for explanation, etc., before you make up your mind to purchase elsewhere.

sep 12

P. S.—Be sure you get the right number.

335 Adams Street, Brooklyn, N. Y.

If you wish to grow }  
Vegetables for sale, read } **GARDENING**  
If you wish to become a } **FOR PROFIT.**  
Commercial Florist, read } **PRACTICAL**  
If you wish to Garden for } **GARDENING**  
Amusement or for Home } **FOR PLEASURE.**  
Use only, read } **FLORICULTURE.**

All by **PETER HENDERSON.**

Price \$1.50 each, post-paid, by mail.

Our combined Catalogue for 1876, of

**EVERYTHING**

FOR THE

**GARDEN**

Sent free to all Applicants.

Our large Illustrated Catalogues of *Seeds and Plants*, numbering 175 pages, and containing 2 colored plates, sent without charge to purchasers of any of the above three books. Sent to all others on receipt of 50 cents.

*Peter Henderson & Co.*

35 Cortlandt Street, New York.

**PEACH STONES** MAZZARDS,  
**CHERRY STONES.**

A limited Stock of First-class Quality can still be supplied.

THOMAS MEEHAN,  
Germantown, Phila.

Jan1f.

**NEW ORNAMENTAL FOLIAGE PLANTS**

ANTHURIUM CRYSTALLINUM,  
APHELANDRA FASCINATOR,  
ARALIA GUILFOYLEI,  
ARALIA VEITCHII

CURMERIA PICTURATA,  
CROTON SPIRALE,  
CROTON VOLUTUM,  
CYANAPHYLLUM SPECTANDUM.  
DRACAENA MAGNIFICA,  
DIEFFENBACHIA IMPERIALIS,  
PHYLLOTAENIUM LINDENII

For full description see new Catalogue, ready about 1st of March. Sent on receipt of 2 cent stamp

Address,

**GEO. FOUST,**

feb3

2825 Frankford Ave., Phila.

**SURPLUS STOCK.**

5000 Apple Trees, 5 to 7 and 6 to 8 ft.  
1000 Crab Apple—Hyslop, Trauscendt, &c., very fine.  
10000 Peach, 1st class, 4½ to 6 ft.  
4000 Peach, 2nd class, 3 to 4½ ft.  
500 Cherry, 1st and 2nd class.  
1000 Silver Maple, all sizes, 8 to 12 ft., very fine.  
2000 Irish Juniper, 1 to 2 ft., twice trans., very fine.  
15,000 Osage Orange, 1 year.  
5000 Honey Locust, 1 and 2 years.  
500 Tamarix, 2 years.  
1000 Currant, 1 and 2 years, Cherry, W. Grape and Victoria  
500 Concord Vines, 1 year.  
500 Gooseberry, 2 years, Houghton and Cluster.  
100 Angers Quince, for stools or cuttings.

The above will be sold cheap.

**H. M. ENGLE & SON,**

feb3

Marietta, Lancaster Co., Pa.

MY

**Illustrated Catalogue**  
OF  
**PLANTS FOR 1876,**

Contains descriptions of all the finest

**BEDDING AND GREENHOUSE PLANTS**  
including novelties and select varieties.

Also a large Stock of **Evergreens, Shade Trees, Shrubs,** etc. Sent free to our customers and to all applicants on the receipt of one 3 cent stamp.

Wholesale Price List free.

Established 1851.

Small plants sent by mail, post-paid, at all seasons of the year.

**PAUL BUTZ,**

Croton Floral Gardens,

tmch3

NEW CASTLE, PA.

MY

*Wholesale and Descriptive Catalogues of*

**Greenhouse and Bedding Plants**

**SHRUBS, EVERGREENS, ETC.,**

MAILED TO ALL APPLICANTS.

**Wm. C. Wilson**

Astoria, L. I. C.,

june12

New York City Office—45 West 14th St.

**BRANDYWINE,**

The Most Profitable Raspberry;

In large quantities, guaranteed TRUE.

Descriptive Circular sent on Application.

**A. HANCE & SON,** Nurserymen and Florists,  
nevtf. **RED BANK, N. J.**

**ROSES, ROSES,**

We have in our cellars, ready to be supplied when called for, at **Low Prices,**

**20,000 DORMANT ROSES,**

All very strong, one and two year old plants, grown from cuttings by ourselves, viz.:

**HYBRID PERPETUAL ROSES,**

**MOSS ROSES,**

**CLIMBING ROSES,**

**MONTHLY ROSES.**

**H. E. HOOKER & BRO.,**

Hooker Nurseries, Rochester, N. Y.

Feb. 1st, 1876.

mch1



ESTABLISHED 1844.

HITCHINGS & CO.

No. 153 Crosby Street,

NEW YORK.

HOT-WATER  
APPARATUS  
for HEATING  
GREEN-HOUSES, &c.

Illustrated Catalogue and List of References and Reduced  
Prices, sent on receipt of postage—6 cents.

H. W. TROY - DEL.

# WEATHERED & CHEREVOY'S PATENT BOILERS

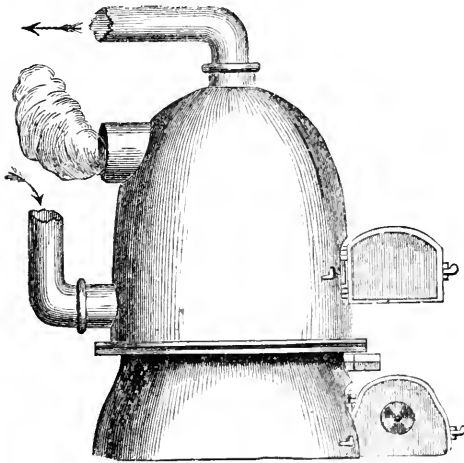

Fig. 1.

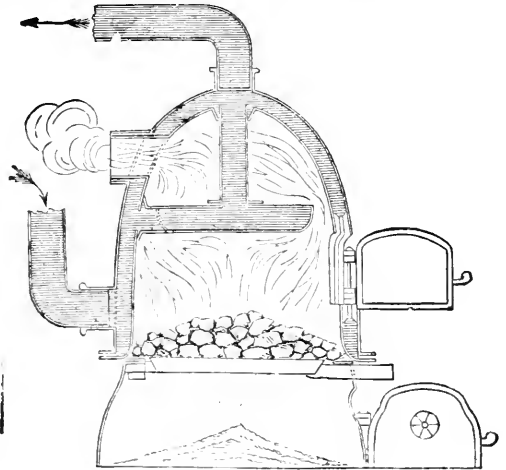

Fig. 2.

## AND IMPROVED HOT WATER APPARATUS,

No. 46 Marion Street, between Spring and Prince, New York.

(TWO BLOCKS EAST OF BROADWAY.)

For Warming and Ventilating Public Buildings, Private Dwellings, Greenhouses,  
Graperies, Forcing Pits, Drying Rooms, and Heating Water for Public Baths.

Fig. 1 is an outside view. Fig. 2 is a vertical section through the centre.

*The following are a few names of Gentlemen who have our Boiler in use:*

Thos. Drake, Esq., Germantown, Pa.  
Simon Cameron, Esq., Harrisburg, Pa.  
J. D. Cameron, Esq., Harrisburg, Pa.  
Thos. Carter, Esq., Raleigh, N. C.  
J. H. Dinham, Esq., Chicago, Ill.  
Jas. B. Waller, Esq., "  
W. J. Gordon, Esq., Cleveland, Ohio.  
Geo. Stanley, Esq., "  
Harris Jaynes, Esq., "  
Geo. W. Cuyler, Esq., Palmyra, N. Y.  
D. M. Osborn, Esq., Auburn, N. Y.  
John B. Dutcher, Esq., Pawling, N. Y.  
A. M. Allerton, Esq., Bronxville, N. Y.  
Robert Hoe, Esq., Tarrytown, N. Y.  
Peter Hoe, Esq., "  
George Lewis, Esq., "  
Wm. H. Drew, Croton Falls, "  
Hon. James Y. Smith, Providence, R. I.  
Philip Caswell, Esq., Newport, R. I.  
Alfred Smith, Esq., "  
Wm. Findlay, Esq., "  
E. Learned, Esq., Pittsfield, Mass.  
D. O. Mills, Esq., San Francisco, Cal.  
W. L. Ferris, Esq., Westchester, N. Y.  
D. H. Haight, Esq., Goshen, N. Y.  
F. Newbold, Esq., Newark, N. J.  
James T. Closson, Esq., Plainfield, N. J.  
Daniel W. Coit, Esq., Norwich, Conn.  
J. F. Slater, Esq., "  
H. W. Collender, Esq., Darien, "  
Chas. P. Palmer, Esq., Stonington, "

Wm. D. Black, Esq., New Milford, Conn.  
Rev. Stephen H. Tyng, Irvington, N. Y.  
H. F. Spaulding, Esq., Riverdale, "  
S. D. Babcock, Esq., "  
Percy R. Pyne, "  
Elisha Brooks, Esq., Inwood, "  
Camille Marie, Esq., "  
A. F. Smith, Esq., Fort Washington, "  
R. M. Olyphant, Esq., Dobb's Ferry, "  
Clarkson N. Potter, Esq., New Rochelle, "  
Chas. D. Dickey, Esq., West Farms, "  
Wm. Matthews, Esq., Harrison, "  
William Chorlton, Esq., New Brighton, S. I.  
F. H. Wolcott, Esq., Astoria, L. I.  
Bailey Leach, Esq., "  
Hon. W. B. Ogdén, High Bridge, N. Y.  
Peter Moller, Esq., 295 Fifth Ave., New York City.  
Wm. Moller, Esq., 6 West 20th St., "  
John Moller, Esq., 127 East 54th St., "  
John Moller, Esq., 8 East 37th St., "  
Ch. Moller, Esq., 426 Washington St., "  
Henry B. Laidlaw, Esq., 33 Pine St., "  
George W. Lane, Esq., 93 Front St., "  
J. P. Robinson, Esq., 14 Counties Slip, "  
J. B. Colgate, Esq., 47 Wall St., "  
John B. Trevor, Esq., 47 Wall St., "  
Charles Butler, Esq., 12 "  
Richard Arnold, Esq., 309 Canal St., New York City.  
Jas. M. Constable, Esq., 309 Canal St., "  
W. T. Garner, Esq., 61 Worth St., N. Y. City.

Please send for Circular with list of References and Reduced Prices to

THOMAS W. WEATHERED, 46 Marion Street, N. Y.

**PLANTS BY MAIL! GREAT OFFERS!**

More liberal offers were never made than the following. We will send by mail, post paid, safe carriage guaranteed, any of the following collections on receipt of \$1.00:

No. 1.	8 beautiful Monthly Roses	for	\$1.00
No. 2.	25 choice Verbenas, assorted	"	1.00
No. 3.	10 very fine Zonale Geraniums	"	1.00
No. 4.	10 best Double	"	1.00
No. 5.	12 beautiful Colons, assorted colors	"	1.00
No. 6.	10 choice Fuchsias, double and single	"	1.00
No. 7.	12 fine Monthly Carnations	"	1.00
No. 8.	12 best Chrysanthemum, assorted	"	1.00
No. 9.	10 Bouvardias, assorted colors	"	1.00
No. 10.	12 Double Tuberoses, 1st size	"	1.00
No. 11.	18 choice Bedding Plants, assorted	"	1.00
No. 12.	20 beautiful Basket Plants	"	1.00

Not less than one collection will be mailed. Any six of these collections will be mailed to one address for \$5.00, with directions for treatment.

Our handsome illustrated Catalogue of Plants, 1876, sent free to customers, and all others on receipt of one cent stamp.

Wholesale Price List FREE. Est'd 1851. **PAUL BUTZ,**  
 taplz Croton Flower Gardens, New Castle, Pa.

**Brighton Grapevines.**

Strong, healthy, vigorous plants, one year old, (grown out o doors) sent by mail f r

\$2 Each.

**DEALERS, CLUBS,**

And other buyers of large quantities, allowed a liberal discount.

**H. E. HOOKER & BRO.,**

**Rochester, N. Y.**

Feb 1st, 1876.

mch2

**SEEDS.**

My New Priced Lists are ready, and mailed free. They contain the most desirable kinds of

**VEGETABLE, FIELD**

AND

**FLOWER SEEDS,**

including all the important novelties of 1875.

**ALFRED BRIDGEMAN,**

876 Broadway, New York.

**STAMPED ZINC LABELS.**  
 FOR TREES VINES & C. SO CHEAP THAT  
 NO ONE PLANTING TREES OR VINES CAN AFFORD  
 TO BE WITHOUT THEM PRICE LIST & SAMPLES FREE  
 J.E. WOODHEAD, AGT FOR THE LAMB KNITTER  
 CHICAGO, ILL.

**NEW ADIANTUM OF EXTRA MERIT.**

**A. Martinicense.** One of the most gorgeous Adiantums ever introduced. Beautiful habit and good grower. On the style of, but very much superior to, A. Sanctæ Catherinæ.

Price, \$1.00 each.

Orders received now and filled in rotation from May 1st. Grown and for sale by

**GEO FOUST,**

2825 Frankford Ave., Phila,

feb 3

apl

**NEW AND RARE**

**PLANTS,**

FOR 1876.

**HENRY A. DREER,** Seedsman and Florist, 714 Chestnut Street, Philadelphia, takes pleasure in offering the following to the trade, a portion as Novelties for 1876. Prices Net. The balance of New things will be offered later, as stock will admit.

**Alocasia Gibsoni.** Large leaves marbled green and black; constant, \$3.00 per dozen.

**Caladium Tubers.** Strong undivided tubers of choice varieties \$12.00 per hundred.

**Canna Brenningsi.** Broad green foliage ornamented with broad bands of yellow; constant, \$3.00 per dozen.

**Camellia Stocks,** for spring grafting, strong, \$15.00 per 100.

**Fuchsia, Sun-ray.** Tricolor foliage, fine plants, \$2.00 per dozen.

**Geranium, Apple-scented,** \$5.00 per 100.

**Oleander, Double White,** "Mandoni Grandiflora," \$4.00 per dozen.

**Oleander, Double, Purple,** Purpurea Plena, \$6.00 per dozen.

" Yellow, Flavum Duplex, \$6.00 per dozen.

**Pelargonium, Double Show (Regal),** "Queen Victoria," \$9.00 per dozen.

**Petunia.** Our new set of Double varieties in advance of any yet introduced, \$2.00 per dozen. New Set of Single varieties. The finest show varieties in 12 sorts, \$2 per dozen.

**Senecio Macroglossum.** A New German Ivy with dark thick, leathery leaves, very glossy, nearly like an Ivy, \$4.00 per dozen.

**New Double Show Pelargoniums, Single Zonale Geraniums, New Roses, &c.,** a description of which, please see Dreer's Garden Calendar, now ready, and mailed to all applicants.

**HENRY A. DREER,**

714 Chestnut Street,

and

PHILADELPHIA.

**THE NEW SCENTED PELARGONIUM  
 TRANSIT.**

Was raised in 1874, and is chiefly distinguished for the strong citron odor of its leaves. The plant is a vigorous grower; leaves large and finely formed, and footstalks much longer than those of the well-known Rose-scented variety, thus rendering it more valuable to florists.

It was exhibited at the New York Horticultural Society's Meeting, January last, and noticed as "a Seedling of Great Promise."

Price, 75 cts. each.

**A. VEITCH,**

**NEW HAVEN,**

Conn.

# THE LADY GRAPE.

The finest **Early White Grape** in cultivation. A pure Concord Seedling, perfectly hardy, healthy, productive, and reliable. Eight years tested. Ripens middle of August. Recommended by the best horticulturists in the Union. Single vines, 1 year strong, post-paid, for \$1.50, & 15 per doz.; 2 years, \$2 single, \$20 per doz. Also, large stock of Concord's, Delawares, and all valuable grapes. Illustrated Catalogue for 3-ct. stamp; with splendid colored plate of Lady Grape, 10c. Address

tmch2

GEO. W. CAMPBELL, Delaware, Ohio

# ROSES, ROSES, ROSES.

	Per 100.	Per 1000
Hybrid Perpetual Roses—Fine 1 year Dormant Plants,	\$12	\$100
Mosses—including fair proportion white—Fine 1 year Dormant Plants,	15	
Climbers—including P. Queen, B. Belle &c. " " " "	10	90
Monthlies—A good assortment " " " "	8	70

## ROSES IN 3-INCH POTS.

Hybrid Perpetuals, Monthlies and Climbers. Strong, well established Plants,	8	70
Moss Roses—3-inch Pots	12	

We ship safely by Express—at any time desired—and Guarantee safe arrival.

No CHARGE FOR BOXES OR PACKING. PRICE LISTS free on application.

Address,

## THE DINGEE & CONARD CO., ROSE GROWERS,

feb3

WEST GROVE, CHESTER CO., PA.

# YOUNG ROSES FOR FLORISTS.

All the Leading Sorts! Fine Healthy Plants!

*Gloire de Dijon, Mad. Charles Wood, Bon Silence, Giant of Buttes, Hermosa, Cheshunt Hybrid, Coquette de Lyon* (which may be called, *Yellow Hermosa*), and others in EXTRA LARGE QUANTITIES. PRICES LOW, as the space must be cleared. N. B.—No other firm in America offers such a *choice assortment* of Roses, at such low prices as we do. **NEW GERANIUMS.** Magnificent new **DOUBLE GERANIUMS** of 1875, surpassing in size and brilliancy of coloring any hitherto introduced. The leading characteristics of the finest Zonale and Nosegay classes are reproduced in these beautiful varieties, which are the productions of Sisley, Lemoine, Alegatiere, Laxton, &c. **NEW SINGLE GERANIUMS** of 1875, raised by the same eminent hybridisers as the New Doubles, and of equal merit. PRICE of both Double and Single varieties, 50 cts. each; \$5.00 per dozen. Of the older sorts of Double and Single and other classes of Geraniums, we have the finest collections in the West. **ARISTOLOCHIA** (*Dutchman's Pipe Vine*); a splendid lot, by the 100 or 1000, **DESCRIPTIVE CATALOGUES FREE** on application. Wholesale Lists to the Trade. Address

feb3

E. Y. TEAS & CO., Rose Growers, Richmond, Ind.

## GARDENERS' DICTIONARY.

By GEO. W. JOHNSON, Editor of "Cottage Gardener"

Describing the Plants, Fruits and Vegetables desirable for the Garden, and explaining the terms and operations employed in their cultivation. New Edition, with a supplement, including the new plants and varieties. 910 pages, 12mo, cloth, fine print. Price, \$3 50. Sent by mail post-paid on receipt of price.

Address, CHAS. H. MAROT,  
814 Chestnut Street, Philadelphia.

## AMERICAN FRUIT CULTURIST.

BY JOHN J. THOMAS.

Practical directions for the Cultivation of Fruit Trees in the NURSERY, ORCHARD AND GARDEN.

Descriptions of the principal American and Foreign varieties. Plain Edition, 480 engravings, 611 pages, 12 mo. Price, \$3.00. Mailed post-paid on receipt of price.

Extra Edition, 576 pages, heavy paper, fine cloth, 508 illustrations and chromo frontispiece; mailed, for \$3.75. Address CHAS. H. MAROT, 814 Chestnut St., Phila.

# ROSES! ROSES! ROSES!

NOW READY FOR DELIVERY.

We offer to the trade a very large and fine stock of Young Roses, from 2 to 2½ inch pots, mostly struck in autumn; thrifty, well rooted plants. They are well assorted, leading varieties of Hybrid Perpetual, Climbing, Bourbon, Noisette China and Tea, (the latter largely of Bon Silene, Isabella Sprunt and Comtesse de la Bath.) Price \$7 per hundred, \$60 per thousand. We expect selection of varieties to be left to us, but will follow wishes of purchasers as far as possible.

**Young Moss Roses**—Well assorted, a large proportion of Perpetual White. Price \$10 per hundred, \$80 per thousand. Ready for delivery in April.

**Verbenas**—Fine healthy Plants. A splendid Assortment. Price \$4 per hundred.

**Bedding Plants**—A general assortment at low rates.

R. G. HANFORD & SON,

Columbus Nursery, Columbus, Ohio.

tmch2

Estab. 1765.

2000000 IN STOCK

ILLUSTRATED CATALOGUES  
Sent free on application.

Low freights from Boston  
allow us to compete with any  
Pottery in the United States.

**A. H. HEWS & CO., - - No. Cambridge, Mass.**

BENJ. A. ELLIOTT & CO.'S  
SPRING CATALOGUE  
OF  
**PLANTS AND SEEDS**  
IS NOW READY.

**PLANT DEPARTMENT.**

New Geraniums, New Phloxes, New Cannas, New Fuchsias, with a complete collection of the most popular bedding plants, Roses, &c., Cheap.

**FRUIT AND ORNAMENTAL TREES.**

An immense stock of Apple, Pear, Cherry, Peach and Plum Trees. Over 100,000 Apple, Cheap.

**VEGETABLE SEEDS.**

Fresh and Genuine.

**FLOWER SEEDS.**

Imported and home grown of the finest quality.

The following CATALOGUES are now ready and will be mailed FREE to all who apply.

No. 1. Descriptive Catalogue of Seeds and Plants.

No. 2. Descriptive Catalogue of Trees.

No. 3. Wholesale List for Dealers and Nurserymen.

BENJ. A. ELLIOTT & CO.,

mch2 114 Market St., Pittsburgh, Pa.

**TREES, SEEDS, PLANTS.**

FRUIT TREES,

ORNAMENTAL TREES,

RELIABLE VEGETABLE SEEDS,

CHOICE FLOWER SEEDS,

FINEST LAWN GRASS SEED,

ROSES, SPRING BULBS,

BEDDING PLANTS, &c., &c.

Wholesale and Retail.

Catalogues on application.

J. R. & A. MURDOCK,

112 Smithfield Street,

mch2

Pittsburgh, Pa.

**EVERGREENS.**

An immense stock of all sizes, suitable for planting in Nursery rows, or for immediate effect. A fine collection of New and Rare Conifers.

Send for New Trade List.

HOOPES, BRO. & THOMAS,

CHERRY HILL NURSERIES,

West Chester, Pa.

**LONDON GARDENER'S CHRONICLE**

Will be furnished, post-paid, direct to subscribers in the U. S. for \$7 50 per year. Specimen Nos. 3 cent stamp. Apply to CHAS. H. MAKOT, Agent, 874 Chestnut St., Phila.

# LAUREL HILL NURSERIES.

FOREIGN GRAPEVINES a Specialty.

My Vines are now in excellent condition, and the stock comprises all the **LEADING SORTS.**

Strong 2 Year Old Canes, \$24 per Dozen.  
1 Year Old, \$9 per Dozen.

Usual discount to the Trade. List of Sorts on application.

Also Camellias, Azaleas, Acacias, and a general variety of Bedding Plants.

Also Ornamental Evergreens, Shrubs and Nursery Stock in variety.

DAVID FERGUSON,

LAUREL HILL NURSERIES,

Ridge Avenue, Philada.

tmch3

# WARBASSE'S Patent Wheeled Hoe,

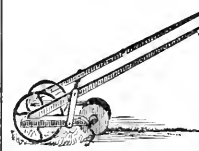

The most simple and effective **HAND CULTIVATOR** in use. Adapted for all kinds of market garden cultivation, especially onions and other root crops, and small nursery stock, &c., &c., and thoroughly protecting the plants from being covered with the earth. It will do the work of from 6 to 12 men with ordinary hoes.  
*Send for Descriptive Circular.*

WM. L. BOYER & BRO.,

Agricultural and Implement Manufactory

2101 Germantown Avenue,

PHILADELPHIA, PA.

mch2

## TREES, FLOWERS, PLANTS.

The following list of plants are all in good health and vigor, and will be packed free at prices named—

	per 100.
Begonias, Flowering, 6 best sorts,	\$6.00
Carnations, nice young plants,	6.00
Centaurea Gymnocarpa, strong,	8.00
Cineraria Maritima, strong,	6.00
Fittonia,	6.00
Fuchsias, beautiful healthy plants,	7.00
Geraniums Zonale, including Master Christine, General Grant, &c., strong,	6.00
Geraniums, Double, including Asa Gray and Alice Sisley, strong,	6.00
Heliotropes,	6.00
Roses, H. P., strong, 1st class,	12.00
" Giant des B., Gen'l Washington, and La France,	
1 year dormant,	15.00
Roses, Monthly, 1st class,	12.00
" Bellao Bon Silene and Safrans, 2-inch pot,	10.00
" Marshall Neil, 2nd size, \$8.00 per 100,	
1st class,	12.00
Smilax, strong, 3-inch pot,	6.00
Tritoma, strong,	6.00
Tuberose,	3.00
Verbenas, very healthy, \$30 per 1000.	4.00

Send for new Spring Catalogue of Nursery Stock; also of new and rare plants. Full set, 4 Catalogues, 25c. Address,

F. K. PHENIX,

Bloomington Nursery,

Bloomington, Ills.

mch2

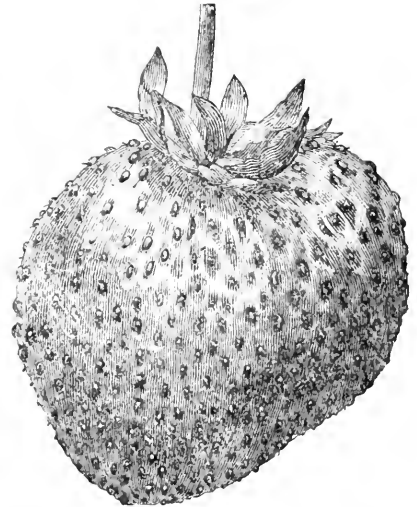

## New Seedling Strawberry, "STERLING."

WILL be OFFERED FOR SALE After APRIL 1,

My new seedling, the "Sterling." It has all the qualities of a Superior market fruit; large size, handsome form, firm texture and bright red color, with fine flavor, rich and sprightly, much sweeter than Wilson; stem long and fruit easily picked and prepared for table. Having grown strawberries more than twenty years for the Cleveland market testing all the approved varieties, and having grown the Sterling on both sandy and clay soils, I am convinced that it is the best market berry as yet known. Send for Circular giving history of berry and testimony of F. R. Elliot, M. B. Bateham and other horticulturists and persons who are well acquainted with the berry. Cut is exact size of one of the largest Sterling berries.

Plants will be sent and orders filled in their turn as received. Price, for 6, \$2; 12, \$3; 25, \$5; 100, \$20. Payment to accompany orders.

Remit by Draft, Money Order, or Registered Letter.

GEO. H. LODGE,

Cuyahoga Falls, Summit Co., Ohio.

mch2

## PRAIRIE LANDS.

Send your address on POSTAL CARD to LAND COMMISSIONER, B. & M. R. R., EURLINGTON, IOWA, and receive free copy of Iowa and Nebraska Farmer with Chart of Lands.

mch3



THE WHOLE COLLECTION  
OF  
**Hot-House and Greenhouse  
PLANTS**  
OF  
**R. BUIST,**  
NURSERYMAN, PHILADELPHIA.

Will be sold during the 3rd week in June. No orders will be executed after the first of that month.

**FLORISTS**

Send your orders at once to Buist's Nursery, Philadelphia. Plants at very low rates by the dozen or 100.  
R. BUIST, 67th St. and Darby Road.

**Weeping Trees,**

Mountain Ash, Linden, Cherry, English Ash, Peach, and 4 varieties of Poplar.

HOOPES, BRO. & THOMAS,

CHERRY HILL NURSERIES, West Chester, Pa

**GOOD PLANTS, PURE, PACKED FREE.**

100 or less Strawberries, dozen other plants by mail :

Monarch of West, 10000, \$50.	doz.	100	1000
Wilson Albany, 10000, \$22.	50c.	\$1.00	\$ 6.00
Chas. Downing, 10000, \$20.	40c.	75	2.50
Kentucky, 10000, \$20.	40c.	75	2.50
Jucunda, Col. Cheeny,	40c.	1.00	6.00
Boyd, No. 30, Agriculturist,	40c.	80	4.00
Triumph de Gand,	40c.	80	5.00
Green Prolific, 10000, \$25.	40c.	75	3.00
Pres. Wilder, Hudson Early, Early Surprise, Kessina Champion Cowing Seedling,	40c.	75	4.00
Star of West, Springdale, Cumberland Triumph,	1.25	7.00	
Durcan Strawberry,	1.00	5.00	20.00
Excelsior,	5.00	30.00	
Doolittle B. Cap Ras.,	50	1.00	8.00
Brandywine,	1.00	2.00	15.00
Herstine and Saunders,	1.00	3.00	25.00
Wilson Early Blackberry,	50	3.00	20.00
Kittaning, (L.V. 1)	50	1.00	8.00
Col. Asp, seed. 50c. per lb., roots,	20	1.00	3.00
Early Beatrice, Rivers Louise, and 15 other later sorts,		8.00	60.00

For any of the above or prices of Currants, Grapes, &c., please address  
**JOHN S. COLLINS,**  
mchl Moorestown, N. J.

**HIGHLAND.**

The most profitable market Raspberry grown. Produced last season \$1000 worth of fruit to the acre. Has withstood 30° below zero. It bears enormous crops and is the earliest of all. "I regard the Highland Hardy as one of the most promising Raspberries grown. It is the earliest that I have seen, and is perfectly hardy."—Rev. E. P. ROE, author of "Play and Profit in my Garden," etc.

Price by Mail, post-paid, 75c. per doz., \$3.50 per 100. By Express, \$3 per 100, \$15 per 1000.

**FRUIT TREES! SHRUBS! VINES!  
ROSES! GREENHOUSE STOCK!**

20,000 surplus and very fine American Arbor Vitæ, 3 to 6 feet, twice transplanted, very cheap. Downing Gooseberry, best American Gooseberry; per doz., \$2.50, post-paid. Also all kinds of Seeds, wholesale and retail.

Send for Catalogue. Established 1863.

**W. L. FERRIS Jr., & CO.,**

Duchess Nurseries, Poughkeepsie, N. Y.

**HARDY.**

mchz Please state paper with this notice.

The undersigned take great pleasure in offering the new

**TEA ROSE,**  
"Duchess of Edinburgh."

This NEW ROSE is certainly the greatest acquisition in the line of

**TEA ROSE**

introduced of late years. In color it is very much like H. P. Rose Gen'l Jaqueminot, a good free grower, not subject to mildew.

Price, \$12 per dozen in 5 inch pots.  
Extra fine stock plants £3 each.

**KELLER & DEAN,**  
FLORISTS,

56th Street and 3rd Avenue,

mchz

BROOKLYN, N. Y

**APRICOTS AND NECTARINES.**

One year, 4 to 6 feet and 2½ to 4 feet, in large quantities, cheap.  
Send for New Trade List.

HOOPES, BRO. & THOMAS,

CHERRY HILL NURSERIES, West Chester, Pa.



**1876 DREER'S GARDEN CALENDAR, 1876**

Contains descriptive and price list of Vegetable, Flower and Grass Seeds, Plants, Bulbs, Novelties, and every GARDEN REQUISITE. Beautifully illustrated. Send two 3 ct. stamps for postage.

**HENRY A. DREER,**

an6 714 Chestnut Street, Phila

**NEW MARANTAS.**

**Maranta Bellula, Hieroglyphica, Luciana, Majestica, Makoyana, Mazelli, Nigrocostata, Pacifica, Undulata.**  
Grown and for sale by

**GEO. FOUST,**

feb3 2825 Frankford Ave., Phila.

Catalogues ready about 1st of March, and sent on receipt of two stamps for postage.

**SPECIAL OFFER TO THE TRADE!**

ROSES.

*Hybrid Perpetuals on Rosa canina*—STANDARDS. Per 100, 1st quality, \$2c; 2d, \$16. Per 1000, 1st quality, \$16; 2d, \$120.  
Half Standards.—Per 100, 1st quality, \$12; 2d, \$10. Per 1000, 1st quality, \$100; 2d, \$80.

*Dwarf Roses on Rosa Multiflora de la Grifferale*.—Per 100, 1st quality, \$8; 2d, \$6. Per 1000, 1st quality, \$70; 2d, \$50.

*Tea, Noisette and Bourbon Roses on Rosa Canina*.—Standards. 3 to 7 feet, per 100, 1st quality, \$24 to \$36; 2d, \$20 to \$30. Half Standards; per 100, 1st quality, \$20; 2d, \$16.

A list of the names of the roses will be sent free on application. A remittance must accompany each order.

A. M. C. JONGKINDT CONINCK,

"TOTTENHAM NURSERIES," at Dedemsvaart, Near Zwolle, NETHERLANDS.

Aug 12

# NEW CALIFORNIA PEACH.

## “BRIGG’S RED MAY.”

This is undoubtedly the Earliest Peach known, the only Peach ever sold in market during May. It was raised from Hale’s Early, which it much resembles. Fruit fully as large; tree strong and healthy, and free from curl, and fully two weeks earlier than Hale’s Early—Dormant buds by mail, \$1 each.

tmch2

JOHN ROCK, San Jose, California.

**A Premium Worth \$30 in Gold.**

## Important Notice to Subscribers.

### Grand Premium Gift

Of the Finest and Largest Engraving ever offered, given to each and every Subscriber to this Magazine. A grand opportunity! Read!

The National Art Co., of Cin’ti, O., have made arrangements which secure to the patrons of this magazine the grandest ART PREMIUM ever offered in this country. It consists of one of the largest and finest steel engravings ever produced, being in size 26x37 inches—more than 3 feet high and 2 feet 2 inches wide—and is entitled

## The Three Graces.

It portrays three of the most grandly beautiful women, representing the three Christian Graces—Faith, Hope and Charity. Each figure is more than one-third life size and all are wonderfully beautiful. Its value may be determined by the following card, issued by the National Art Co.:

OFFICE OF NAT’L ART CO., Cincinnati, O.—DEAR SIR: Assure all subscribers that the retail price of the foreign impressions of “The Graces” is Thirty Dollars Gold, and that we will pay \$5 for each and every copy equal to our Premium edition, outside of our issue. NATIONAL ART CO.

This grand Premium is given to each reader of this magazine who cuts out the Premium Certificate found below, and sends it to the Nat’l Art Co., together with (25c.) twenty-five cents. It is sent by MAIL, securely packed, and warranted to reach its destination uninjured.

*Cut out this Certificate and send it to the National Art Co. It is worth \$5.*

**Premium Certificate**

On receipt of this Certificate, together with 25 cents to pay postage and mailing tube, we will mail to the sender one copy of the Engraving, size 26x37 inches, entitled

### The Three Graces.

This Certificate is good until July 15, 1876, after which 10 cents additional will be charged. No copy will be sent without this Certificate except on receipt of \$7, the retail price for our and the only American edition. All certificates must be sent directly to

THE NATIONAL ART CO., 230 Walnut Street, Cincinnati, Ohio.

**Note these Instructions.** All Certificates should be sent in by July 15, 1876. All sent in thereafter require 10 cents additional, as a new edition will then become necessary. The Certificate must in all cases be sent, otherwise persons who are not subscribers might reap the benefits intended solely for the patrons of this paper. Each copy of “The Graces” will be inclosed in a strong tube, 28 inches long, and postage will be prepaid thereon out of the 25 cents sent in. But ONE copy can be obtained for each copy of the magazine, AND THE CERTIFICATE WILL NOT BE AGAIN PRINTED IN THIS MAGAZINE, hence the importance of cutting out the Certificate at once and sending it in for redemption. Address all Certificates to the National Art Co., 230 Walnut Street, Cincinnati, Ohio, and you will receive by return mail the largest and handsomest Premium Engraving you ever saw.

## TO NURSERYMEN AND FLORISTS.

### Roses, Roses, Roses!

A very fine collection in 3 and 4 inch pots. Handsome plants to retail this spring. By the 100 or 1000 at lowest prices.

WILLIAM H. MOON,  
Morrisville, Pa.

apl1

## TRUE RHODE ISLAND BENT SEED, Not Red Top,

Can be had of us at \$2.50 to \$3.00 per measured bushel.  
Cash with order.

W. E. BARRETT & CO.  
44 Canal St., Providence, R. I.

apl3

# WORKS ON GARDENING

AND THE  
CARE OF HOUSE PLANTS,  
By EDWARD S. RAND, Jr.

Will be Published immediately,

## ORCHIDS,

In one volume, crown 8vo, cloth.

This work will be a manual of the culture of Orchidaceous Plants, giving full directions for Potting, Propagation, Care of Orchid House, and a full descriptive list of the best species and varieties, especially those most desirable for culture by amateurs, from their brilliancy or fragrance of flower, or peculiarity of structure. Chapters will also be given on Cool Culture, Growth for Market Purposes and Exhibition, and on the Construction of Orchid Houses.

New editions of the following are now ready.

**FLOWERS FOR THE PARLOR AND GARDEN.** Twenty-fifth thousand. In one volume, 8vo, 450 pages, beautifully illustrated. Cloth, \$2.50.

**GARDEN FLOWERS;** How to cultivate them. New edition, thoroughly revised, with additions to January, 1876. In one volume, 8vo, containing more than 400 pages, illustrated. Cloth \$2.50.

**BULBS.** Sixth thousand. New edition. In one volume, 8vo, 375 pages, beautifully illustrated, with two appendices. Cloth \$2.50.

**RHODODENDRONS.** Third thousand, newly revised. In one volume, 8vo, 211 pages. Cloth, \$1.50.

**POPULAR FLOWERS, AND HOW TO CULTIVATE THEM.** Tenth thousand with appendix; thoroughly revised and enlarged. In one volume, square 8vo, 250 pages, illustrated. Cloth, \$2.00.

**THE WINDOW GARDENER.** Fifth edition, greatly enlarged. In one volume, square 8vo, 150 pages. Cloth, \$1.25.

\*.\* For sale by Booksellers and Horticulturists. Sent by mail, post-paid, on receipt of price by the Publishers.

**HURD & HOUGHTON, New York.**

The Riverside Press, Cambridge.

apl1



## DOUBLE HARPOON HORSE HAY-FORK.

BEST IN THE WORLD.  
MAY BE SEEN AT CENTENNIAL.

Descriptive Catalogue sent free.  
Pennock Manufacturing Company,  
Kennett Square, Chester Co., Pa.

## Fruit and Ornamental Trees.

Large stock of 2 year Peach Trees, also 1 year Peach Trees of leading varieties.

**APPLE TREES, PEAR TREES,  
GRAPE VINES, CURRANTS,  
ETC., ETC.**

—A LARGE STOCK OF—

**American Arborvitæ, Siberian Arborvitæ, Irish Juniper, Norway Fir, Balm of Gilead, &c., &c.**

**Silver Maple—6 to 8, 8 to 10 and 10 to 12 feet.  
Sugar Maple—3 to 5 ft., and 8 to 10 ft.  
Norway Maple—7 to 9 feet.**

The Nursery is within 2 minutes of the Depot at Christiana, on the P. R. R., 2½ hours from the city. Prices sent on application. Also, Greenhouse and Bedding Plants. Address

**W. P. BRINTON,**

Christiana, Lancaster Co., Pa.

feb3

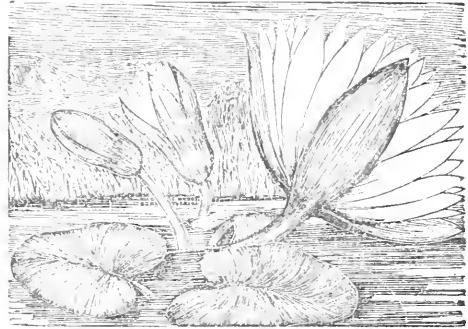

**WHITE WATER LILY—Nympha odorata.**

Reader, are you a lover of flowers, and do you want something this Spring that your neighbor has not got? Something that can't be found in any Floral catalogue in the country? If so, procure some of the roots of this beautiful and fragrant Lily. Plant them in tubs filled with water, and set them around your dwellings, and when in bloom they will be admired by all who see them. I have a good supply of first-class roots, fresh from the ponds, which I will send out by mail, postage paid, for 25 cents each, 5 for \$1, and \$2 per doz. Painted instructions for growing them in ponds, tubs or aquariums, sent with each package. From four to six of these roots planted in a half-barrel make a splendid tub of flowers. Address,

J. E. S. CRANDALL, Rockville, Washington Co., R. I.

Please state where you saw this

apla

# BEGONIA

## FROEBELI.

New Tuberous-rooted Begonia.

Bright Scarlet Flowers.

Found in the Peruvian mountains by the celebrated collector B. Roezl, and pronounced by him to be the finest of all Begonias. Plants in bloom with me now prove that it is the

## QUEEN OF BEGONIAS.

Flowers measure two inches across, are borne in large clusters and of the most brilliant scarlet imaginable. Splendid for bedding out, as it is a most profuse bloomer. Send for descriptive circular and sample flower. Large original bulbs started in pots, price \$2.50 each.

Address,

# J. ROEHRS,

270 SECOND STREET,

tap13

Jersey City, N. J.

## AGENTS, CLUBS, CANVASSERS!!

To enable us to increase the circulation of the **NEW JERSEY AGRICULTURIST** as rapidly as possible, we pay liberal **Cash Premiums** to parties obtaining subscribers. Our paper is a first-class monthly, full of interesting reading matter (Hints for the month worth more than the subscription price, 50 cents per year). Subscription price so low that canvassers will find most everyone, interested in Rural affairs, ready to subscribe. Write for specimen copy.

**CHARLES WESTALL, Publisher,**

New Brunswick, N. J.

apl1

THE  
CHRISTIAN AT WORK.

T. De Witt Talmage, Editor.

Without Premiums, \$3; with Premiums, \$3.25. To Clergymen 75 cents less. ~~45~~A Choice of two premiums.

OPINIONS OF THE PRESS.

"The Christian at Work is the liveliest religious paper published in these parts. Its columns are spicy and sparkling and to religious people who like things lively it is a readable paper. The Devil is more certain to be frightened with a radiant face than a solemn and forbidding one."—*N. Y. Commercial Advertiser*.

"The Christian at Work has donned a new dress and looks as pretty as a picture. The type of all sizes is admirably clear and a handsomer weekly there is not in these United States."—*N. Y. Evening Mail*.

"The Christian at Work is safe and reliable in all its utterances and ought to displace the ——— in every Presbyterian family. Its editor is a host in himself, and nothing will stagnate that he has anything to do with."—*London Correspondent Chicago Interior*.

"The Christian at Work is an admirably conducted sheet, filled with live matter."—*N. Y. Star*.

"The Christian at Work is one of the most readable religious papers published anywhere. The Doctor and his associates have discovered the art of making a publication orthodox without being flippant."—*Brooklyn Eagle*.

"In The Christian at Work everything is lively and life-like. This Christian smiles, laughs, sometimes actually whistles, while at his work, and that without letting down the dignities and proprieties that belong to the discussion of the themes it discusses."—*Brooklyn Union*.

"The Christian at Work is one of the best of the religious weeklies, and deserves the success it has attained."—*Brooklyn Argus*.

"The Christian at Work is one of the most sprightly, most gladly welcomed in every family of all religious weeklies. It flits from the pulpit to the pew, from the rod of authority to the kiss of love, from the paternal command to the child's obedience, and scatters flowers upon all, breathing content and happiness upon all its readers."—*American Garden*.

Five Sabbath School Papers,

under the same editorial supervision, are published by us monthly, and are suitable for School or Home. The best and cheapest published. Beautiful premiums with these also.

Good Words, My Paper, Good Cheer, Old and Young, Der Sonntagsgast. (German.)

We number our papers, but do not date them, making them good at any time.

Two papers with names nearly like our own have lately been issued in New York City. They are not in any way under the supervision of DR. TALMAGE or the control of THE CHRISTIAN AT WORK PUBLISHING COMPANY. Be careful to send your orders direct to the publisher of this paper.

Full particulars and sample copies of all papers furnished on application.

HORATIO C. KING, Publisher,

July 14 No. 102 Chambers Street, New York.

New Peaches.

Alexander, Amsden's June, Early Beatrice, Early Louise, Early Rivers' and 40 other varieties, in large quantities; very fine.

Send for New Trade List.

HOOPES, BRO. & THOMAS,

CHERRY HILL NURSERIES, West Chester, Pa.

THE  
EARLIEST GRAPE KNOWN,  
THE CHAMPION.

From 10 to 15 days earlier than the Hartford Prolific; bunches large and compact; Berries black, large and covered with a rich bloom. It is a strong, healthy grower, no mildew, immense bearer. Fruit brought from 15 to 20 cents per pound at wholesale in Rochester market, last season. Endorsed by leading horticulturists in the United States. 75c. each, \$6 per doz, sent free by mail.

Send for Descriptive Circular.

R. J. DONNELLY,

Rochester & Lake Avenue Nurseries,  
apl1 Rochester, N. Y.

Foreign Grapes.

For Vineries, 1 year, in 5-inch pots; 2 year, in 10-inch pots, bearing size.

HOOPES, BRO. & THOMAS,

CHERRY HILL NURSERIES,

West Chester, Pa.

I offer a large stock of

TREES!!

APPLE TREES, APRICOTS,

IRISH JUNIPERS, GOOSEBERRIES,

and a general assortment of

FRUIT TREES and EVERGREENS

Letters will be answered in English, German or French. Address

GEORGE ACHELIS,

mch2

West Chester, Pa.

Hardy Plants.

Our splendid New Illustrated and Descriptive Catalogue of Alpine and Hardy Perennial Plants, No. 3., is now ready for mailing, price 10 cents.

The following Catalogues will be mailed on application, viz.:

No. 1. Descriptive Catalogue of Fruits, pp. 28, two 3 ct. stamps.

No. 2. Illustrated and descriptive Catalogue of Ornamental Trees, &c., pp. 51, 10 cents.

No. 4. Illustrated and Descriptive Catalogue of Greenhouse and Bedding Plants, Free.

No. 5. Wholesale Trade List, Free.

HOOPES, BRO. & THOMAS,

Cherry Hill Nurseries,

West Chester, Pa.

WALTER ELDER,

Landscape and Jobbing Gardener,

1231 Rodman Street, Philadelphia,

Attends to all branches of his business on reasonable terms.

# MARIETTA NURSERIES, MARIETTA, PA.

ESTABLISHED IN 1856.

## THE STOCK FOR SPRING

IS PARTICULARLY LARGE AND FINE.

PRICES LOW.

Send for Descriptive Catalogue and Trade List.

We invite early correspondence from the Nurserymen and Dealers.

ENGLE & BRO.

mch2

### GREEN HOUSE AND BEDDING PLANTS.

Large stock; fine assortment; packed to go safely any distance. Satisfaction guaranteed. Send 3-cent stamp for splendid Illustrated Catalogue. Address

R. G. HANFORD & SON,  
Columbus, Ohio,

mch3

### THE 100 DAYS' TOMATO

Is the earliest ever offered. Sown any time upto last of March, you can have ripe Tomatoes for your

CENTENNIAL FOURTH OF JULY DINNER.

Free Circular, with proof. 25c. a packet; 5 for \$1.00

J. A. FOOTE, Seedsman, Terre Haute, Ind.

### ROCHESTER COMMERCIAL NURSERIES.

[Estab'd 1830.]

SPRING PRICE LIST, per dozen, 100 and 1000, of Trees and Plants, with select list of Specialties and Novelties, FREE to all. Beautiful ornamental Catalogue, 10cts.; Fruit Catalogue, 6 cts. Free to customers. Address

W. S. LITTLE, Rochester, N. Y.

mch2

### THE DUNCAN STRAWBERRY.

SELLS HIGHER, CARRIES BETTER, KEEPS LONGER than any other, and we believe will attain a high rank as a Market and family Berry.

For prices &c., address

E. & J. C. WILLIAMS,  
Montclair, N. J.

mch3

CATALOGUE GRATIS—PRICES REDUCED—Of all leading items of NURSERY STOCK; especially in my unsurpassed list of new and popular Peaches, among which may be found the only desirable kind to grow for market value, such as Early Beatrice, Early Louise, Early Rivers, Early Alexander, Amsden's June, Briggs' May, Christiana, Brandywine, Nanticoke, Bilyen's Late October, Tuckahoe, Newington Free, and all the new and approved orchard list.

Send for Catalogue, which will be a great help to all who plant orchards, as I give the exact rotation of ripening, so that all can plant intelligently—so they can have one variety succeeding another the whole season. Also, at correspondingly low prices, Apple Trees, Cherry, Plum, Pears, standard and dwarf; Small Fruits, Ornamental Trees and Shrubbery, and Green-house Plants; in fact, all stock usually found in any first-class establishment. Peach Pits in sand all winter \$1.50 per bushel.

RANDOLPH PETERS,

Great Northern and Southern Nurseries,  
Wilmington, Delaware.

mch2

## TO THE TRADE.

A choice collection of POPULAR PLANTS for the Spring Sale of 1876. Send for price list. L. B. CASE, eb3 Richmond, Ind.

A Hygroscope for 50 cents.

### THE CHEMICAL HYGROSCOPE.

This indicator of atmospheric moisture is as accurate as the costly ones. Rooms heated by furnaces or stoves are almost invariably so dry as to be damaging not only to health but to furniture. Some people take the consequences others keep water on the heater. The Hygroscope shows at a glance whether the air is too dry or not.

Sent by mail for 50 cents. Address,

febtf CHAS. H. MAROT, 814 Chestnut St., Philadelphia.

### EVERGREENS.

I am prepared this spring, as heretofore, to furnish large quantities of Native Evergreens to Nurserymen and others for cash, or in exchange for first-class Nursery Stock.

75,000 Transplanted Norway Spruce; 20,000 Scotch Pine. 50,000 Hemlock will be so'd low. Samples furnished with prices by request. All about 1 foot high—nice, compact plants

apl1 L. B. CHAPMAN, Portland, Me.

### WANTED.

ON account of the Legislature having failed to make the appropriation required for the Agricultural College, Columbus, Ohio, the trustees are obliged to dispense with my services as Gardener to that Institution. In consequence, the advertiser is at liberty to engage with any one requiring a good practical man in that capacity. Has been thoroughly trained to the profession, and has had every facility in various parts of the world to acquire a thorough knowledge of horticulture in all its branches. Eighteen years experience in this country. Good testimonials. Address,

nov1 W. T. HARDING, John street, Columbus, Ohio.

### LAWN AND SHADE TREES.

By F. R. ELLIOTT.

Deciduous and Evergreen Trees and Shrubs, for planting in Parks, Gardens, Cemeteries, &c., &c. Illustrated. 125 pages, 12mo, cloth. Price, \$1.50. Sent by mail, post-paid, on receipt of price.

Address, CHAS. H. MAROT,  
814 Chestnut Street, Philadelphia.

### CARPENTRY MADE EASY,

OR, THE SCIENCE AND ART OF BUILDING.

By W. E. BELL, Architect.

A new and improved system. Specific instructions for Balloon Frames, Barn Frames, Mill Frames, Warehouses, Church Spires, &c. Also, System of Bridge Building, Bills, Estimates of Cost and valuable tables. Illustrated by 38 plates and nearly 200 figures. 134 pages, 8vo, cloth. Price, \$5.00. Sent by mail post-paid on receipt of price.

Address, CHAS. H. MAROT,  
814 Chestnut Street, Philadelphia.

### WORKING MAN'S WAY TO WEALTH.

By EDMUND WRIGLEY.

A practical treatise on Building Associations, what they are, and how to use them. 108 pages, 16mo, cloth. Price, 75 cents. Sent by mail post-paid on receipt of price.

Address, CHAS. H. MAROT,  
814 Chestnut Street, Philadelphia.

### HOW TO MANAGE BUILDING ASSOCIATIONS.

By EDMUND WRIGLEY.

Being a Director's Guide and Secretary's Assistant, with forms for Keeping Books and Accounts, also rules, examples and explanations illustrating the various plans of working. 211 pages, 12mo, cloth. Price, \$2.00. Sent by mail post-paid on receipt of price.

Address, CHAS. H. MAROT,  
814 Chestnut Street, Philadelphia.

## HOW PLANTS GROW.

By Asa Gray, M. D.

A simple Introduction to Structural Botany, with a Popular Flora, or an arrangement and description of Common Plants, both wild and cultivated. Illustrated with 599 wood engravings. 233 pages, large 16mo, half-arabesque, paper sides. Price \$1.25. Sent by mail post-paid on receipt of price.

Address CHAS. H. MAROT,  
814 Chestnut St., Phila.

## GUIDE TO THE STUDY OF INSECTS.

By A. S. PACKARD, JR., M.D.

Also a Treatise on those INJURIOUS and BENEFICIAL to us. For the use of Colleges, Farms, Schools and Agriculturists. Illustrated with 11 plates, and 650 wood-cuts. 722 pages, 8vo, cloth. Price, \$6.00. Sent by mail post-paid on receipt of price.

Address, CHAS. H. MAROT,  
814 Chestnut Street, Philadelphia.

## INSECTIVOROUS PLANTS.

By Chas. Darwin.

With copious descriptive contents and index. Illustrated. 462 pages, 12mo, cloth. Price \$7.50.

Sent by mail post-paid on receipt of price.

Address CHAS. H. MAROT,  
814 Chestnut St., Phila.

## Manual of Botany of the Northern United States.

By ASA GRAY.

Including the district east of the Mississippi and north of Carolina and Tennessee. Arranged according to the Natural System. Illustrated with 20 plates of Sedges, Grasses, Ferns, &c. 723 pages, 8vo, half-arabesque cloth sides. Price, \$2.25. Sent by mail post-paid on receipt of price.

Address, CHAS. H. MAROT,  
814 Chestnut Street, Philadelphia.

## FLORA OF THE SOUTHERN STATES.

By A. W. CHAPMAN, M.D.

Containing abridged descriptions of the FLOWERING PLANTS and FERNS of Tennessee, North and South Carolina, Georgia, Alabama, Mississippi and Florida, arranged according to the Natural system. 621 pages, 8vo, cloth. Price, \$3.60. Sent by mail post-paid on receipt of price.

Address, CHAS. H. MAROT,  
814 Chestnut Street, Philadelphia.

## SELECT FERNS AND LYCOPODS.

By BENJAMIN S. WILLIAMS, F.R.H.S.

Comprising descriptions of 950 choice species and varieties, British and Exotic, with directions for their management in the Tropical, Temperate and Hardy Fernery, with numerous beautiful full-page illustrations. 353 pages, 12mo, cloth. Price, \$2.00. Sent by mail post-paid on receipt of price.

Address, CHAS. H. MAROT,  
814 Chestnut Street, Philadelphia.

## SMALL FRUIT CULTURIST.

By ANDREW S. FULLER.

Giving Description, History, Cultivation, Propagation, Diseases, &c.

Beautifully Illustrated.

276 pages, 12mo, cloth. Price \$1.50. Sent by mail, post-paid on receipt of price.

Address, CHAS. H. MAROT, 814 Chestnut St., Phila.

## GRAPE CULTURALIST.

By Andrew S. Fuller.

A treatise on the Cultivation of the Native Grape. Illustrated. 286 pages, 12mo, cloth. Price \$1.50. Sent by mail post-paid on receipt of price.

Address CHAS. H. MAROT,  
814 Chestnut St., Phila.

## CLASS BOOK OF BOTANY.

By ALPHONSO WOOD, A. M.

Being outlines of the Structure, Physiology and Classification of Plants; with a Flora of the United States and Canada. 832 pages, 8vo, half-arabesque cloth sides. Price, \$3.50. Sent by mail post-paid on receipt of price.

Address, CHAS. H. MAROT,  
814 Chestnut Street, Philadelphia.

## BOOK OF EVERGREENS.

By Josiah Hoopes.

A practical treatise on the Conifere or Cone-bearing plants. Handsomely illustrated. 455 pages, 12mo, cloth. Price \$3.00. Sent by mail post-paid on receipt of price.

Address CHAS. H. MAROT,  
814 Chestnut St., Phila.

## ORNAMENTAL TREES.

By Thomas Mehan.

An American Hand-Book, containing the personal observations of the author. 257 pages, 24mo, cloth. Price \$1.00. Sent by mail post-paid on receipt of price.

Address CHAS. H. MAROT,  
814 Chestnut St., Phila.

# How To Paint

A New Work by a Practical Painter, designed for the use of Tradesmen, Mechanics, Merchants, Farmers, and as a Guide to Professional Painters. Containing a Plain Common-Sense Statement of the Methods employed by Painters to produce satisfactory results in Plain and Fancy Painting of every description, including Formulas for Mixing Paint in Oil or Water, Tools required, etc. This is just the Book needed by any person having anything to paint, and makes

**"Every Man His Own Painter."**

Full Directions for Using White Lead—Lamp-Black—Green—Yellow—Brown—Whiting—Glue—Pumice Stone—Spirits of Turpentine—Oils—Varnishes—Furniture Varnish—Milk Paint—Preparing Kalsomine, etc.

## Paint for Outbuildings

--Whitewash—Paste for Paper-Hanging—Hanging Paper—Graining in Oak, Maple, Rosewood, Black Walnut—Staining—Decalomania—Making Rustic Pictures—Painting Flower-Stands—Rosewood Polish—Varnishing Furniture—Waxing Furniture—Cleaning Paint—

## Paint for Farming Tools

--for Machinery—Household Fixtures, etc.

## To Paint a Farm Wagon

--to Re-Varnish a Carriage—to make Plaster Casts. The work is neatly printed, with illustrations wherever they can serve to make the subject plainer, and it will save many times its cost yearly. Every family should possess a copy. Price by mail, post-paid, \$1.

CHARLES H. MAROT,

814 Chestnut St., Philadelphia, Pa

**GARDENING BY MYSELF.**

By Anna Warner.

Containing Hints and Experiences under heading of each month in the year. Illustrated. 16mo, 223 pages, cloth. Price \$1.25. Sent by mail post-paid on receipt of price.

Address CHAS. H. MAROT,  
814 Chestnut St., Phila.

**GARDENING FOR PLEASURE.**

BY PETER HENDERSON.

A guide to the Amateur in the

**FRUIT, VEGETABLE and FLOWER GARDEN.**

With full directions for the

**Greenhouse, Conservatory and Window-Garden.**

Illustrated. 250 Pages, 12mo, cloth. Price \$1.50. Sent by mail post-paid on receipt of price.

Address CHAS. H. MAROT, 814 Chestnut St., Phila.

**GARDENING FOR PROFIT.**

BY PETER HENDERSON.

A Guide to the successful cultivation of the

**MARKET AND FAMILY GARDEN.**

New and enlarged edition. Illustrated. 276 Pages, 12mo, cloth. Price, \$1.50. Sent by mail post-paid on receipt of price.

Address CHAS. H. MAROT, 814 Chestnut St., Phila.

**WINDOW GARDENING.**

By Henry T. Williams.

Devoted specially to the Culture of Flowers and Ornamental Plants for *In-door use and Parlor Decoration.* Splendidly illustrated. 300 pages, med. 8vo, cloth. Price \$1.50. Sent by mail post-paid on receipt of price.

Address CHAS. H. MAROT,  
814 Chestnut St., Phila.

**AMERICAN GARDENER'S ASSISTANT.**

By Thomas Bridgeman.

Containing complete practical directions for the cultivation of Vegetables, Flowers, Fruit Trees and Grapevines. Illustrated. 520 pages, 12mo, cloth. Price \$2.50. Sent by mail post-paid on receipt of price.

Address CHAS. H. MAROT,  
814 Chestnut St., Phila.

**ROSE GARDEN.**

By Wm. Paul, F. R. H. S.

Embracing History of the Rose; formation of Rosarium; detailed account of practice for successful cultivation; arrangement in natural groups of most esteemed varieties, English and Foreign, in the most eminent Gardens; with full description and remarks on origin and mode of culture. Numerous illustrations. 276 pages, Royal 8vo, cloth. Price \$3.00. Sent by mail post-paid on receipt of price.

Address CHAS. H. MAROT,  
814 Chestnut St., Phila.

**PRACTICAL FLORICULTURE.**

BY PETER HENDERSON.

A Guide to the successful cultivation of

**FLORISTS' PLANTS,**

for the *Amateur and Professional Florist.* Illustrated. 288 pages, 12mo, cloth, Price, \$1.50. Sent by mail post-paid on receipt of price.

Address, CHAS. H. MAROT,  
814 Chestnut Street, Philadelphia.

**HOW TO LAY OUT A GARDEN.**

By Edward Kemp.

A general guide in Choosing, Forming and Improving an Estate (from a quarter-acre to a hundred acres in extent) with reference to both design and execution. Illustrated with numerous plans, sections and sketches. 403 pages, 12mo, cloth. Price \$2.50. Sent by mail post-paid on receipt of price.

Address CHAS. H. MAROT,  
814 Chestnut St., Phila.

**PARSONS ON THE ROSE.**

By Samuel B. Parsons.

A treatise on the Propagation, Culture and History of the Rose. Illustrated. 215 pages 12mo, cloth. Price \$1.50. Sent by mail post-paid on receipt of price.

Address CHAS. H. MAROT,  
814 Chestnut St., Phila.

**ROSES AND ROSE CULTURE.**

By Wm. Paul, F. R. H. S.

The rationale of Rose cultivation in a nut-shell. Intended to place within a small compass all that is necessary for the successful cultivation of the "Queen of Flowers." 83 pages, 12mo, paper-bound. Price, 50 cents. Sent by mail post-paid on receipt of price.

Address, CHAS. H. MAROT,  
814 Chestnut Street, Philadelphia.

**BOOK OF ROSES.**

By Francis Parkman.

Description, Cultivation and Propagation. Beautifully illustrated. 225 pages, 12mo, cloth. Price \$1.50. Sent by mail post-paid on receipt of price.

Address CHAS. H. MAROT,  
814 Chestnut St., Phila.

**ORCHID GROWER'S MANUAL.**

By BENJAMIN S. WILLIAMS, F. R. H. S.

Containing brief descriptions of over 800 species and varieties, with notices of times of flowering, approved modes of treatment and practical instructions on general culture. Remarks on heat, moisture, soil, seasons of growth and rest suited to the several species. Enlarged edition with illustrations. 300 pages, 12mo, cloth. Price, \$2.50. Sent by mail post-paid on receipt of price.

Address, CHAS. H. MAROT,  
814 Chestnut Street, Philadelphia.

**CHOICE STOVE AND GREENHOUSE PLANTS,**

By Benj. S. Williams, F. R. H. S.

With descriptions of upwards of eleven hundred species and varieties. Instructions for their cultivation and mode of management. Illustrated with colored frontispiece and numerous splendid illustrations. 686 pages, 2 vols., 12mo, cloth. Price \$5.00. Sent by mail post-paid on receipt of price.

Address CHAS. H. MAROT,  
814 Chestnut St., Phila.

**AMERICAN FLOWER GARDEN DIRECTORY.**

By Robert Buist.

With practical directions for the Culture of Plants in Flower-Garden, Hot-House, Green-House, Rooms, or Parlor Windows, for every month of the year. Instructions for erecting Hot-house, Green-house, and laying out a Flower garden. Instruction for cultivating, propagating, pruning and training the Grape vine and description of best sorts for the open air. 342 pages, 12mo, cloth. Price \$1.50. Sent by mail post paid on receipt of price.

Address, CHAS. H. MAROT,  
814 Chestnut St. Phila.

**BULBS.**

By EDWARD SPRAGUE RAND, JR.

A treatise on Hardy and Tender Bulbs and Tubers. 357 pages, 12mo, cloth. Price, \$1.50. Sent by mail post-paid on receipt of price.

Address, CHAS. H. MAROT,  
814 Chestnut Street, Philadelphia.

# CLUB PAPERS AT NET PRICES,

## ALPHABETICALLY ARRANGED.

**TO REMIT IN CLUBBING** any of the following list with the  
 as you wish, foot up the prices annexed and add **TWO DOLLARS** select such  
 for the **MONTHLY** to the total. **Gardener's Monthly**

American Agriculturist.....	\$1 20	Maine Farmer.....	\$2 10
" Farmer.....	1 35	Manufacturer and Builder.....	1 85
" Artisan.....	1 60	Maryland Farmer.....	1 35
" Builder.....	2 60	Massachusetts Ploughman.....	2 60
" Naturalist.....	3 25	Metropolitan.....	1 85
" Odd Fellow.....	1 60	Milling Journal.....	1 85
Appleton's Journal.....	3 60	Moore's Rural New Yorker.....	2 35
Arthur's Home Magazine.....	2 35	Nation.....	4 75
Atlantic Monthly.....	3 60	National Baptist.....	2 35
Boston Cultivator.....	2 60	New England Farmer.....	2 35
Building Association Journal.....	75	" " Homestead.....	2 10
" Societies Gazette, London, England.....	1 35	New York Evangelist.....	2 60
Bucks County Intelligencer, old subscribers \$2 60, new.....	2 10	New York Methodist.....	2 20
California Horticulturist.....	2 75	" " Post, Weekly, \$1.50; Semi-Weekly.....	2 60
Central Union Agriculturist and Chromo.....	1 70	" " Times, Weekly, \$1.50; Semi-Weekly.....	2 60
Children's Friend.....	1 35	" " Tribune, Weekly, \$1.50; Semi-Weekly.....	2 60
" Hour.....	1 10	" " World, Weekly; \$1.50; Semi-Weekly.....	2 60
Colman's Rural World.....	1 85	North-Western Farmer.....	1 10
Country Gentleman.....	2 35	Nursery.....	1 20
Demorest's Magazine.....	2 60	Ohio Farmer.....	1 85
Eclectic Magazine.....	4 60	Old and New.....	3 60
Every Saturday.....	4 60	Our Home Journal.....	2 25
Farmer's Home Journal.....	2 60	Park's Floral Gazette.....	70
Frank Leslie's Ladies' Magazine.....	3 10	Penn Monthly.....	2 10
" Review.....	2 10	Peter's Musical Monthly.....	2 60
Galaxy.....	3 60	Peterson's Magazine.....	1 70
Germantown Telegraph, old subscribers \$2 50, new.....	2 20	Philadelphia Weekly Press.....	1 60
Godey's Lady's Book.....	2 75	Phrenological Journal.....	2 35
Hall's Journal of Health.....	1 10	Poultry World.....	1 10
Harper's Bazar.....	3 60	Popular Science Monthly.....	4 60
" Magazine.....	3 60	Practical Farmer, (Weekly).....	2 60
" Weekly.....	3 60	Prairie Farmer.....	1 70
Hearth and Home.....	2 00	Purd's Small Fruit Recorder.....	85
Herald of Health.....	1 60	Saint Nicholas.....	2 60
Household.....	85	Saturday Evening Post.....	2 10
Iowa Homestead.....	1 60	Scientific American.....	2 75
Journal of Chemistry.....	1 10	Scientific Farmer.....	85
" of the Farm.....	85	Scribner's Monthly.....	3 60
Journal of Materia Medica.....	1 10	Southern Cultivator.....	1 85
Kansas Farmer.....	1 35	Southern Planter and Farmer.....	1 85
Lady's Floral Cabinet, with Chromo.....	1 10	Waverly Magazine.....	4 60
Ladies' Repository.....	3 35	Western Agriculturist.....	85
Leslie's Lady's Journal.....	3 60	Western Farmer.....	1 85
Lippincott's Magazine.....	3 25	" Rural.....	1 85
Littell's Living Age.....	7 60	Wood's Household Magazine.....	85
London Garden.....	8 75	" " with Chromo.....	1 00
London Gardener's Chronicle.....	7 50	Working Farmer.....	1 10
		Youth's Companion, new subscribers \$1.40; old subscribers..	1 75

The above includes postage under the new U. S. Law requiring prepayment of postage before mailing.

After subscription to a club paper through this agency, report non-receipt of your numbers and other causes of dissatisfaction, irregularities of mails or changes of residences, *only to said paper direct* (not to this office).

Remit by P. O. Order, Draft or Registered Letter. Currency is at risk of mails.

If you wish a receipt or reply, enclose postage stamp for that purpose, otherwise the club papers will be considered a ~~suffi-~~ receipt.

Address **CHAS. H. MAROT, 814 Chestnut Street, Philadelphia.**



**RURAL AND PRACTICAL BOOKS,** (and any others in the market not on this list) will be sent by mail, post paid, on receipt of price. Address CHAS. H. MAROT, 814 Chestnut St., Philada.

Allen's, R. L., Diseases of Domestic Animals.....	\$1 00	How to Manage a Building Association.....	\$2 80
Allen's, L. F., Rural Architecture.....	1 60	How to Paint.....	1 00
Allen's, L. F., American Cattle.....	2 50	Hunter and Trapper.....	1 00
Allen's, R. L. & L. F., New American Farm Book.....	2 50	Hussman's Grapes and Wines.....	1 50
American Architect.....	7 00	Jacques' Manual of the House.....	1 50
American Bird Fancier, (Brown's).....	30	Jacques' Manual of the Garden.....	1 75
American Farmer's Encyclopedia.....	6 00	Jennings' Cattle Doctor.....	1 75
American Horticultural Annual, paper 50 Cts., cloth.....	75	Jennings on the Horse and his Diseases.....	1 75
American Weeds and Useful Plants.....	1 75	Jennings' Sheep, Swine and Poultry.....	1 75
Apple Culturist, S. E. Todd.....	1 50	Johnson's Gardener's Dictionary.....	3 50
Art of Saw Filing.....	75	Johnson's How Crops Feed.....	2 00
Architecture, Modern American, Cummings & Miller.....	10 00	Johnson's How Crops Grow.....	2 00
Principles and Practice of, By Loring & Jenning	12 00	Johnson's Peat and its uses.....	1 25
Baker's Fruit Culture.....	4 00	Johnston's Elements of Ag. Chemistry and Geology.....	1 50
Basset on Cranberry Culture.....	30	Johnston's, J. S. W., Agricultural Chemistry.....	1 75
Barry's Fruit Garden.....	2 50	Kemp's Landscape Gardening.....	2 50
Bell's Carpentry made easy.....	5 00	Klippart's Farm Drainage.....	1 75
Bement's Poultryer's Companion.....	2 00	Langstroth, Rev. L. L., on the Hive and Honey Bee.....	2 00
Bement's Rabbit Fancier.....	30	Leuchars' How to Build Hot-houses.....	1 50
Beet Root Sugar.....	1 50	Leibig's, Justus, Familiar Lectures on Chemistry.....	75
Bicknell's Village Builder, 77 plates.....	12 00	Louden's Encyclopedia of Plants.....	20 00
Bommer's Method of Making Manures.....	25	Lyman's Cotton-culture.....	1 50
Boussingault's, J. B., Rural Economy.....	1 60	McMahon's American Gardener.....	2 25
Brown's Trees of America.....	6 00	Mayhew's Practical Book-keeping for Farmers.....	90
Breck's New Book of Flowers.....	1 75	Mechanics' Companion (Nicholson).....	3 00
Bridgeman's American Gardener's Assistant.....	2 50	Meehan's Ornamental Trees.....	75
Bridgeman's Fruit Cultivator's Manual.....	1 00	Miles on the Horse's Foot.....	75
Bridgeman's Kitchen Gardener's Instructor.....	1 00	Miner's, T. B., Bee-keeper's Manual.....	1 25
Buist's, Robert, Am. Flower Garden Directory.....	1 50	Mohr on the Grape-vine.....	1 00
Buist's, Robert, Family Kitchen Gardener.....	1 00	Money in the Garden.....	1 50
Burr's Field and Garden Vegetables of America.....	5 00	My Vineyard at Lak-view.....	1 25
Carpenter and Joiner (R. Riddell).....	7 00	My Farm of Edgewood.....	1 75
Carpenter and Joiner's Hand Book, (Holly).....	75	My Ten-rod Farm.....	50
Chorlton's Grape Grower's Guide.....	75	North American Sylva, 5 vols., 156 col. plates, in 30 parts, 2	
Chemistry of the Farm, (Nichols).....	1 25	"    "    unbound.....	60 00
Cleveland's Villas and Cottages.....	4 00	"    "    Half Turkey Antique, gilt.....	70 00
Cobbett's American Gardener.....	75	"    "    full.....	75 00
Cole's, S. W., American Fruit Book.....	75	Nichol's Chemistry of the Farm and Sea.....	1 25
Cole's American Veterinarian.....	75	Norton's, John P., Elements of Scientific Agriculture.....	75
Cooper's Rural Hours.....	2 00	Norris' Fish-culture.....	1 75
Copeland's Country Life.....	5 00	Onion-culture.....	1 20
Dadd's, Geo. H., American Cattle Doctor.....	1 50	Our Farm of Four Acres.....	1 25
Dadd's Modern Horse Doctor.....	1 50	Packard's Guide to the Study of Insects.....	cloth 6 00
Dana's, Samuel H., Muck Manual.....	1 25	Paul's Book of Roses.....	50
Darwin's Variations of Animals and Plants, (2 vols.).....	6 00	Paul's Rose Garden.....	3 00
Darwin's Insectivorous Plants.....	7 00	Paxton's Gardener's Dictionary.....	15 00
DeVoe's Market Assistant.....	2 50	Pardee on Strawberry-culture.....	75
Downing's, A. J., Landscape Gardening.....	6 50	Parkman's Book of Roses.....	1 50
Downing's Cottage Residences.....	3 00	Parsons, Samuel B., on the Rose.....	1 50
Downing's Fruits and Fruit Trees of America.....	5 00	Peat and its Uses.....	1 25
Downing's Rural Essays.....	3 50	Pear-culture, Fields.....	1 25
Downing's Ladies' Companion to the Garden.....	2 00	Pedder's, James, Farmer's Land-measurer.....	60
Du Breuil's Vineyard Culture, (Dr. Warden).....	2 00	Percheron Horse.....	1 00
Eastwood on Cultivation of the Cranberry.....	75	Peterson's Preserving, Pickling and Canning Fruit.....	50
Elliott's Western Fruit Grower's Guide.....	1 50	Phin on Wine-making.....	1 50
Elliott's Lawn and Shade Trees.....	1 50	Quinn's Pear-culture for Profit.....	1 00
Every Woman her own Flower Gardener.....	50	Quinby's Mysteries of Bee-keeping Explained.....	1 50
Farm Talk, (Brackett).....	1 00	Randall's Sheep Husbandry.....	1 50
Farming for Boys.....	1 50	Randall's Fine Wool Sheep Husbandry.....	1 00
Fields, Thomas W., Pear Culture.....	1 25	Rand's Bulbs.....	3 00
Five Acres too Much, (illustrated).....	1 50	Rand's Flowers for Parlor and Garden.....	3 00
Flagg's European Vineyards.....	1 50	Rand's Seventy-five Flowers.....	1 50
Flax Culture.....	50	Rand's Flower Garden.....	3 00
Flint, Chas. L., on Grasses.....	2 50	Reemelin's, Charles, Vinedressers' Manual.....	75
Flint's Milch Cows.....	2 50	Riddell's Architect.....	15 00
Fowler's Homes for All.....	1 50	Ropp's Commercial Calculator, cloth \$1, Morocco Tuck.....	2 00
Frank Forester's Fish and Fishing, 8 vo. 100 engravings.....	3 50	Rose Culturist.....	paper 30
Frank Forester's Manual for Young Sportsmen, 8 vo.....	3 00	Robbins', R., Produce and Ready Reckoner.....	75
French's Farm Drainage.....	1 50	Saunders' Domestic Poultry, paper 40.....	75
Fuller's Grape Culturist.....	1 50	Saxton's Hand Books, in four series, each.....	cloth 1 50
Fuller's Small Fruit Culture.....	1 50	Schenck's Gardener's Text-book.....	30
Fuller's Strawberry Culturist.....	25	Scribner's Ready Reckoner and Log-book.....	30
Fuller's Forest Tree Culturist.....	1 50	Strong's Cultivation of the Grape.....	3 00
Fulton on Peach Culture.....	1 50	Ten Acres Enough.....	1 50
Geyelin's Poultry Breeding.....	1 25	Thomas, J. J., Farm Implements.....	1 50
Gray's How Plants Grow.....	1 25	Thomas, J. J., Fruit-culturist; old ed., \$3 00; new edition.....	3 75
Gray's Manual of Botany.....	2 25	Ville's Chemical Manures.....	1 25
Gray's Manual, Botany and Lessons, in one vol.....	4 00	Warder's American Pomology.....	3 00
Gray's School and Field Book of Botany.....	2 50	"    Hedges and Evergreens.....	1 50
Green on Trout Culture.....	1 00	Waring's Drainage for Profit and Health.....	1 50
Gregory on Squashes, paper.....	30	"    Elements of Agriculture.....	1 00
Guernon on Milch Cows.....	75	"    Earth Closets.....	50
Guide to Fortune.....	1 00	Webster's Dictionary, Unabridged.....	12 00
Harazthy's Grape Culture and Wine Making.....	5 00	Well's Every Man his own Lawyer.....	2 00
Harris' Insects Injurious to Vegetation, clo. \$4; col. eng's.....	6 50	Williams, B. S., on Stove & Greenhouse Plants, 2 vols., ill'd.....	5 00
Harris on the Fig.....	1 50	Williams, B. S., on Select Ferns and Lycopods.....	2 00
Hatfield's American House Carpenter.....	3 50	Williams, B. S., Orchid Grower's Manual.....	2 00
Henderson's Practical Floriculture.....	1 50	Window Gardening.....	1 50
Henderson's Gardening for Pleasure.....	1 50	White's Gardening for the South.....	2 00
Henderson's Gardening for Profit.....	1 50	"    Cranberry Culture.....	1 25
Herber's Hints to Horsekeepers.....	1 75	Wood's Class Book of Botany.....	3 50
Hoopes on Evergreens.....	3 00	Workingman's Way to Wealth.....	75
Hooper's Dog and Gun, paper 30 cents, cloth.....	60	Wright's Practical Poultry Keeper.....	2 00
Hop-culture.....	40	Yonatt on the Horse.....	1 75
How to Buy a Farm, and Where to Find One.....	1 75	Youman's Household Science.....	2 00

Index to Advertisements.

Advertisers are requested to have orders in hand as EARLY AS POSSIBLE. Copy received after the 23rd of each month cannot be INSURED insertion in the next issue.

Achelis, George, West Chester, Pa. .... 24  
 Aldous James, Iowa City, Iowa. .... 11  
 Allen S. L., Philadelphia. .... 8  
 Barrett W. E. & Co., Providence, E. I. .... 22  
 Bass-it Wm. F., Hammon-ton, N. J. .... 5  
 Baerens-dorfer M. M. & Co., Philad-elphia. .... 4  
 Bliss B. K. & Sons, New York city. .... cover  
 Brinton W. P., Christiana, Pa. .... 23  
 Bridg-man A., New York. .... 17  
 Boyer, W. L. & Bro., Phila. .... 20  
 Bryant, J. M., Phila. .... 20  
 Buist R., Philadelphia. .... 21  
 Butz Paul, New Castle, Pa. .... 11, 17  
 Byers S. E., Houston, Texas. .... 12  
 Campbell, Geo. W., Delaware, Ohio. .... 18  
 Case L. B., Richmond, Ind. .... 25  
 Christian at Work, New York city. .... 24  
 Collins Jno. S., Moorestown, N. J. .... 21  
 Conink A. M. C. J., De-mens-vaart, Netherlands. .... 21  
 Crandall, J. E. S., Rockville, R. I. .... 23  
 Critch-ll B. P., Cincinnati, Ohio. .... 5  
 Dick John, Philada. .... 10  
 Dinee & Conard Co., West Grove, Pa. .... 18  
 Donnelly R. J., Roche-ter, N. Y. .... 24  
 Dougla-, Robert & Sons, Waukegan, Illinois. .... 12  
 Dreer Henry A., Philadelphia. .... 17, 21  
 Eisele Br s., Tioga, Philada. .... 10  
 Elder Walter, Philadelphia. .... 24  
 Ellis Chas. R., New York city. .... 12  
 Elliott, B. A. & Co., Pittsburgh, Pa. .... 19  
 Ellwang-er & Barry, Rochester, New York. .... 2, 5  
 Engle H. M. & Son, Marietta, Pa. .... 14  
 Engle & Bro., Marietta, Pa. .... 3, 25  
 Fancier's H-rald, Mattituck, N. Y. .... 5  
 Fergusson, David, Phila. .... 20  
 Ferris W. L. Jr. & Co., Pough-keepsie, N. Y. .... 21  
 Fote J. A., Terre Haute, Ind. .... 25  
 Foster P. H., Babylon, N. Y. .... 12  
 Foust Geo., Philada. .... 5, 8, 10, 11, 14, 17, 21  
 Gregory James J. S., Marblehead, Massachusetts. .... 2  
 Grieves J. Pat-erson, N. J. .... 5, 11  
 Haines R. H., Malden, N. Y. .... 3  
 Hance A. & Son, Red Bank, New Jersey. .... 2, 8, 14  
 Hanford R. G. & Son, Columbus, O. .... 3, 19  
 Harding, W. T., Columbus, Ohio. .... 25  
 Harkett Wm. A., Dubuque, Iowa. .... 11  
 Henderson Peter & Co., New York city. .... 14, cover  
 Hews A. H. & Co., North Cambridge, Massachusetts. .... 19  
 Hurrichs C. F. A., New York city. .... 2  
 Hitchings & Co., New York city. .... 15  
 Hooker, H. E. & Bro., Rochester, N. Y. .... 14, 17  
 Hoopes Bros. & Thomas, West Chester, Pa. .... 11, 12, 19, 21, 24  
 Houghton H. O. & Co., New York City. .... 23  
 Hubbard T. S., Fredonia, New York. .... 12  
 Keller & Dean, Brooklyn, N. Y. .... 21  
 King, H. C., N. Y. City. .... 24  
 Little, W. S., Rochester, N. Y. .... 25  
 Lodge, Geo. H., Cuyahoga Falls, O. .... 20  
 Lord's Horticultural Works, Irvington, New York. .... 13  
 Lynex Richard, Philadelphia. .... 10  
 Maivre Bernhard, New Orleans, La. .... 9  
 Marot, Chas H., Philadelphia. .... 11, 18, 19, 26, 27, 28, 29, Fly-leaf  
 Maxwell T. C. & Bros., Geneva, N. Y. .... 12  
 Meehan Thomas, Germantown, Philadelphia. .... 4, 9, 12, 14  
 Meehan W. E., Germantown, Phila. .... 6  
 Miller & Hayes, Mount Airy, Philadelphia. .... 6, 11  
 Moon Mahlon & Son, Morrisville, Pa. .... 3  
 Moon W. H., Morrisville, Pa. .... 3, 22  
 Mardoeh, J. R. & A., Pittsburgh, Pa. .... 19  
 National Art Co., Cincinnati, O. .... 22  
 Nimmo Alexander, Brooklyn, New York. .... 13  
 Page N., Jr., Danvers, Mass. .... 2  
 Park Goe. W., Mt. Vernon, Ohio. .... 2  
 Parry Wm., Cinnaminson, N. J. .... 8  
 Parsons, R. B. & Co., Flushing, N. Y. .... 2, 8  
 Parsons S. B. & Sons, Flushing, New York. .... cover  
 Pennock Manufacturing Co., Kennett Square, Pa. .... 23  
 Peters, Randolph, Wilmington, Del. .... 25  
 Phenix, F. K., Bloomington Ill. .... 20  
 Raoux C., New York city. .... 11  
 R chrs J., Jersey City, N. J. .... 23  
 Rock, John, San Jose, Cal. .... 22  
 Roe E. P., Corn-wall on-Hudson, N. Y. .... 11  
 Rolker A. & Sons, New York city. .... Fly-leaf

Root J. B., Rockford, Ill. .... 5, 8  
 Rotureau F. E. & Co., Angeis, France. .... 8  
 Rue Geo. W., Hamilton, Ohio. .... 10  
 Sander Chas., Jamaica Plain, Mass. .... 10  
 Satterwaite E., Jenkintown, Pa. .... 12  
 Saul John, Washington, D. C. .... 5  
 Secllay Joha A., Brooklyn, New York. .... 9  
 Scott & Maxwell, Chenoa, Ill. .... 12  
 Shuler Mrs. J. D., Lockport, N. Y. .... 10  
 Sked, Faddock & Co., Cleveland, Ohio. .... 10  
 Smith & Powell, Syracuse, N. Y. .... 10  
 Steffens N., New York city. .... 8  
 Stone J. S., Charlotte, N. Y. .... 6  
 Storrs, Harrison & Co., Painesville, Ohio. .... 10, 20  
 Stratton & Storm, New York. .... 8  
 Strong W. C., Brighton, Mass. .... 8  
 Such George, South Amboy, New Jersey. .... 1  
 Teas E. Y. & Co., Richmond, Ind. .... 18  
 Thanhauser S., Philadelphia. .... 6  
 Tiptan & Lee, Barnesville, Ohio. .... 12  
 Vaughan J. A., Carver, Mass. .... 6  
 Veitch A., New Haven, Conn. .... 17  
 Von Oven E., Napiersville, Ill. .... 6  
 Wampler John, Carthage, Missouri. .... 11  
 Weathered & Cherevoy, N. Y. City. .... 16  
 Westall Chas., New Brunswick, N. J. .... 2, 23  
 Whitman & Lang, Philadelphia. .... 9  
 Williams E. & J. C., Mount Clair, N. J. .... 25  
 Wilson William C., New York city. .... 14  
 Wood Edmund M., Boston, Massachusetts. .... 4, 7  
 Woodhead J. E., Chicago, Ill. .... 17

R. B. PARSONS & CO.,

Bowne Avenue, Flushing, N. Y.,

OFFER THEIR

RARE TREES & SHRUBS

as well as the well known sorts, and invite the special attention of

LARGE BUYERS

To their Stock of Rhododendrons, Azaleas—Chinese—Ghent Camellias, Clematis, Hydrangeas, Magnolias Roses by the 1,000.

RARE EVERGREENS,

are well known to be cultivated in large variety by them.

For Catalogues address

Box 99, Flushing, N. Y.

See Advertisement on page 2.

SITUATIONS WANTED.

By a thoroughly practical manager of many years' experience a position over a Fruit, Vegetable or Seed Farm, or would be a salesman at the Centennial; best references. Address, A. J. Crawford, 928 D. Kalb Avenue, Brooklyn, N. Y.

SITUATION as Under-gardener in a first-class place, by a young man who has had long experience in commercial establishments. Address W. L. care of Gerald Altortier, West Chester, Pa.

TO take charge of a first-class private place as Florist, or small fruit establishment; has many years' experience in the business. Best references can be given. Address, Henry Bal-dinger, 31st Ward, Pittsburgh, Pa.

SITUATION wanted as Superintendent of a first-class green-house, where a general shipping trade is carried on; am 21 years of age, have had six years' experience in one of the largest establishments in Massachusetts; can furnish the best of reference as to my character, &c., from last place employed, where I spent some four years. Salary not so much of an object as steady employment. Address, W. F. Beach, Pittsfield, Mass. Box 47.

AS Head gardener or Nursery Foreman, by an Englishman; three years American experience with G. Such, South Amboy; well recommended by present and previous employers. Address, A. J. Higgs, care of G. Such, Esq., South Amboy, N. J.

# FLORISTS' STOCK, TWO MILLION PLANTS!

AT WHOLESALE.

Examine and COMPARE PRICES. Safe delivery GUARANTEED if sent by Express. No Charge for Boxes or Packing.

	Per 100.		Per 100.
Astilbe Japonica,	\$10.00	Lantanas, 25 named sorts,	8.00
Achyranthes, 4 distinct sorts,	4.00	"    unnamed,	5.00
Alternantheras, 4 distinct sorts,	6.00	Lemon Verbenas, strong plants,	6.00 to 10.00
Basket Plants, 25 different sorts,	4.00	Lobelia, new double blue,	4.00
Begonias, 6 best flowering sorts,	6.00	"    six distinct and beautiful sorts,	4.00
Argyoneura Veitchii, 3 inch pots.	8.00	Lygodium Scandens, (Japanese Climbing Fern),	8.00
Carnations, White Perfection and Degraw, large stock plants,	20.00	Mesembryanthemum cordifolium var. (var'd Ice plant),	6.00
Carnations, 25 sorts, fine young plants,	6.00	Mosses, (Lycopodiums and Selaginellas) 6 sorts,	6.00
Caladiums, Fancy, 25 distinct sorts,	12.00	Pampas Grass, strong roots, 4 inch pots,	25.00
Esculentum, large bulbs,	\$8 to 16.00	Pansies, very fine mixed English,	4.00
Canna Indica, 6 sorts,	6.00	12 separate colors, pot grown,	6.00
Chrysanthemums, 50 leading sorts,	6.00	Phloxes, 25 named sorts,	6.00
Calceolaria Aurea and Brown Prince,	8.00	Pinks, Florists', 12 sorts,	6.00
Centaurea Gymnocarpa, white leaved,	6.00	Pinks, Alba Fimbriata, (white fringed),	6.00
Coleus, Golden and Velvet, 25 best sorts,	4.00	Petunias, single, finest striped and blotched	4.00
Cineraria, 2 sorts, white leaved,	6.00	Petunia, double, 6 sorts,	8.00
Dianthus Querteri, (German Pink),	6.00	Pentstemons, 6 distinct sorts,	4.00
Dahlia, dry roots, 100 sorts, bouquet and large flowering,	10.00	Roses, Monthly, Tea, Bourbon and Ben- gal, 50 best sorts. Hybrid Perpetual and Hardy Climbing, 40 best sorts. Winter flowering, 6 leading sorts.	
Dahlia, Green Cuttings, 100 sorts,	6.00	Prices of the above Roses:	
Daisy, English, (Bellis perennis),	6.00	Our selection of sorts, 3 inch pots,	8.00
Daisy, (New) Queen Victoria	10.00	Buyers' " " 3 " " . . . . .	10.00
Delphinium, 4 distinct sorts,	6.00	Our " " 4 " " . . . . .	12.00
Eulalia Japonica, new variegated grass,	18.00	Buyers' " " 4 " " . . . . .	15.00
Fittonia, (Gymnostachyum) 4 sorts,	4.00	Smilax, (Myrsiphyllum Asparagoides), 2½ inch pots,	4.00
Fuchsias, 25 sorts, very fine plants,	\$5 to 8.00	Tritoma (Red-hot-poker plant)	\$6 to 12.00
Ferns, 12 sorts,	16.00	Tuberose, Pearl, Southern grown,	8 to 12.00
Golden Feather,	4.00	common, double,	\$3, \$4 and 6.00
Geraniums, Double, in 12 sorts,	6.00	Verbenas, named in 60 varieties, \$3 per set,	5.00
Zonale, 30 leading sorts,	6.00	"    to special name or special color,	5.00
Ivy leaved, 12 sorts,	6.00	"    in twelve best market sorts,	4.00
Silver, 6 distinct sorts,	8.00	"    mixed, without name or color,	3.00
Hibiscus, 3 sorts,	6.00	Besides nearly every other plant in cultivation by Florists, for which see our Monthly Price Cur- rent of Plants, Seeds, &c.	
Heliotropes, 8 sorts,	6.00	Every Plant is labelled.	
Honeysuckle, Golden Japan, 2½ inch pots,	5.00		
Ivies, English, three feet long,	12.00		
Latania Borbonica, (Fan-leaved Palm), 3 inch pots,	12.00		

## VEGETABLE PLANTS.

	Per 1000.		Per 1000.
Cabbage, Early Jersey Wakefield, (cold frame plants),	10.00	Lettuce, Boston Market and Curled Simp- son,	10.00
Spring sown plants of the above ready in May, at half the above rates. TOMATO, PEPPER, CELERY and EGG PLANTS contracted for at low rates. Also,			

## FLORISTS' REQUISITES.

Consisting of all Styles of WIRE DESIGNS for CUT FLOWERS, FRENCH IMMORTELLS and GRASS BOUQUETS, BOUQUET PAPERS, GARDEN TRELLISES, PLANT STANDS, RUSTIC WORK, and many other articles, all of which are priced very low in our Monthly Wholesale List, mailed free to those who apply.

**PETER HENDERSON & CO.,**

35 Cortlandt St., New York.

# S. B. PARSONS & SONS,

Kissena Nurseries,

Near KISSENA STATION, FLUSHING, N. Y.,

OFFER a very large assortment of TREES and PLANTS of all the best families. Nearly all of them have been two years transplanted, and their roots are thus in the very best possible condition for a second transplanting.

Their assortment of **RARE EVERGREENS** has long been known to be the most complete. They now have in cultivation a very large variety of hardy

## Deciduous Trees and Shrubs,

numbering over 800 sorts, of which 300 sorts, one year grafted, are entirely new and have not yet been in their catalogue.

Their JAPANESE DEPARTMENT now includes more than 150 varieties in addition to the above, and is being constantly enriched by Thomas Hogg, now in Japan. Many of these varieties are unknown in Europe. The celebrated JAPANESE MAPLES and AZALEA MOLLIS are alone worthy of a visit.

CAMELLIA JAPONICA and AZALEA INDICA can be advantageously shipped during September, October and November; September being preferred. These plants are carefully formed and trimmed, and their symmetry is recognized by all who see them.

Rhododendrons and other hardy Evergreens can be safely transplanted in September.

*Estimates will be furnished for Planting Grounds under the care of an experienced Landscape Gardener, and much trouble thus saved to the owner.*

Catalogues will be furnished to applicants by mail, and those who wish to visit the Nurseries will always find either one of the proprietors, or J. R. Trumpy, the well-known propagator of the old establishment. They can take the ferries at 34th Street or James' Slip, which connect with the railroad, leaving the first a quarter of an hour, and the last half an hour before the departure of trains, which make the transit in half an hour. The Nursery is adjoining the Kissena Station and one and a half miles from the other stations. sep

## TWO NEW POTATOES—\$700 IN PREMIUMS.

### RUBY. (Pringle.)

A new red kidney shaped potato of excellent promise, from the Early Rose hybridized with the White Peachblow. The shape is oblong, slightly flattened, resembling that of the Early Rose. In its coloring the red of the latter variety is deepened by the carmine which shows in the blotches of the White Peachblow. The eyes, which are but slightly sunken, are carmine like those of this variety. The flesh white, fine-grained, firm, and of excellent flavor. Tubers of medium size; and are clustered close about the foot of the stalks. The time of maturity is the same as that of the Early Rose, and it is equally productive.

To those who prefer a red-skin potato we can confidently recommend this excellent variety.  
Per lb., \$1.00; 3 lbs. to one address, \$2.50, by mail, prepaid. By express or freight, charges paid by the purchaser, ½ peck, \$3.00; 1 peck, \$5.00.

### ALPHA. (Pringle.) The Earliest Variety Known.

A very early variety for farm and garden culture, also for forcing under glass; fit for the table ten or fifteen days before the Early Rose. Of medium size, clear white, with the slightest tinge of red about the eyes; flesh very white, fine-grained, dry, and of excellent flavor; quality of the highest excellence. A first-class certificate was awarded by the Royal Horticultural Society, of London, in 1874. A silver medal was also awarded by the Massachusetts Horticultural Society. We can recommend this with the greatest confidence as the very best early variety in cultivation.

Per pound, \$1.00; 3 pounds to one address, \$2.50, by mail, prepaid. By express or freight, charges paid by the purchaser, ½ peck, \$2.00; 1 peck, \$3.00; ½ bushel, \$5.00; 1 bushel, \$9.00; 1 barrel, \$20.00.

### SNOWFLAKE.

Beautiful in appearance, superior in quality, early ripening a low days later than the Early Rose, very productive.

Price per pound, 60 cts.; 2 pounds to one address, \$1.00, by mail, prepaid. By express or freight, 1 peck, \$1.50; ½ bushel, \$2.50; 1 bushel, \$4.00; 1 barrel, \$8 00

### PRINGLE'S HYBRIDIZED POTATO SEED.

The extraordinary success which has attended Mr. Pringle in his attempts to improve this valuable esculent—which has resulted in the production of the Snowflake and Alpha, and last, though not least, the Ruby—has encouraged him to still greater efforts in his favorite pursuit of hybridization, and we have now the pleasure of offering a very choice strain of seed saved by him, which is the product of numerous hybridizations, variously operated, with every care during the past season, between the above named and many of the best new and old varieties in cultivation, both English and American, and includes every strain which Mr. Pringle will himself sow the coming spring. Packets of 25 seeds, 50 cents; 5 packets, \$2.00.

\$500 to be divided among the six most successful growers who shall produce the largest quantity from 1 pound of Ruby and Alpha potatoes.

### CENTENNIAL PREMIUMS.

\$150 to be awarded for the best collection, one peck each, of potatoes introduced by us since 1867.

\$50 for the best and most promising seedlings raised this year from Pringle's Hybridized Potato Seed. The collection for which the last two premiums of \$500 are offered will be exhibited at the Centennial Exhibition, in Philadelphia, in October, and premiums will be awarded by their committee. For conditions and full particulars send for circular, mailed free to all.

### The Best Early Tomato—THE CONQUEROR.

Ten days earlier than any other Tomato. Prof. Thurber, the well-known editor of the American Agriculturist, thus describes it: "I have over a dozen varieties, including this, among which were several novelties, as well as those accepted as standard varieties. I think it a moderate statement to say the Conqueror was ten days earlier than any other in the Garden. I would also add that in color, shape, and quality, this variety was highly satisfactory." Price, 25 cts. per packet; 6 packets, \$1.00.

Bliss's Illustrated Seed Catalogue and Amateur's Guide to the Flower and Kitchen Garden. 200 pages, 35 cents.

Bliss's Gardener's Almanac and Abridged Catalogue of Garden, Field and Flower Seeds. 116 pages, beautifully illustrated, mailed to all applicants enclosing 10 cents.

Bliss's Illustrated Potato Catalogue contains a descriptive list of all the new varieties recently introduced, with many other desirable sorts, also much useful information upon their cultivation. 32 pages, 10 cents.

B. K. BLISS & SONS,  
32 Barclay Street, New York.

P. O. BOX No. 5712.



THE  
GARDENERS  
And MONTHLY  
HORTICULTURIST

EDITED BY THOMAS MEEHAN.

Vol. XVIII.

No. 209.

(Combined Magazines, Thirty-first Year.)

**MAY, 1876.**

PUBLISHED BY CHARLES H. MAROT,  
814 Chestnut Street, Philadelphia.

TERMS—\$2.10 PER YEAR—POSTAGE PAID.



*Wm. H. Bennett Del.*

*J. R. Stockton Co.*

# THE GARDENER'S MONTHLY AND HORTICULTURIST.

EDITED BY THOMAS MEEHAN,

Assisted by an able Corps of AMERICAN and FOREIGN CORRESPONDENTS.

It is published on the first of every month, at the office, No. 814 CHESTNUT STREET, PHILADELPHIA, where all BUSINESS communications should be addressed.

Communications for the Editor should be addressed: THOMAS MEEHAN, GERMANTOWN, Philada.

SUBSCRIPTION PRICE, Postage paid, \$2.10.

## TERMS OF ADVERTISING.

	1/2 col.	1/3 col.	1/4 col.	1/5 col.	1/6 col.	1 col.	1 page.
One Time, . . . . .	\$3.00	\$4.00	\$6.00	\$8.00	\$12.00	\$24.00	\$48.00
Two to Three Times, each, . . . . .	4.70	3.60	5.40	7.20	10.80	21.60	43.20
Four to Six Times, . . . . .	2.25	3.00	4.50	6.00	9.00	18.00	36.00
Seven to Nine Times, . . . . .	2.00	2.70	4.00	5.35	8.00	16.00	32.00
Ten to Twelve . . . . .	1.80	2.40	3.60	4.80	7.20	14.40	18.80

Twelve lines nonpareil is 1/2 col. A less space than 1/2 col. will be furnished at rates in exact proportion, line for line.

For THIRD and LAST COVER PAGES; FIRST PAGE advertisements facing reading matter; "FLY-LEAF PAGE" (front of number) before reading matter and facing first cover,—special figures will be given on application. COPY and orders for NEW advertisements should be in hand by the 23d of each month; and CHANGES of COPY in running contracts by the 16th of each month, to insure them in following issue. Address

CHAS. H. MAROT, Publisher, 814 Chestnut Street, Philadelphia.

## CONTENTS OF THE MAY NUMBER.

### SEASONABLE HINTS:

Flower Garden and Pleasure Ground.....	129-134
Green House and House Gardening.....	134-139
Fruit and Vegetable Gardening.....	139-146

### CORRESPONDENCE:

Disease in Violet Roots.....	130
Evergreens—Rhododendron Arboreum.....	131
Heating Small Greenhouses.....	135
Peerless Rose.....	136
Mushrooms—Bilyeu's Comet Peach.....	140
Training Gooseberries.....	141
The Cork Oak in West Virginia.....	146
Trees of Southern Florida.....	149
South-Eastern Kansas Horticultural Society.....	157
Northern Iowa Horticultural Society.....	158

### EDITORIAL NOTES:

Pleasing the Gardeners—Grasses for Indiana—Names of Varieties—Weeping Hemlock Spruce.....	132
Eupatorium ligustrinum—The Richardia (Calla) Æthiopica—Preserving Cut Flowers—Name of Plant Plant-selling at Amherst College—The Plant House at the Agricultural College—Royal Bouquets—Flower Pots—Forced Deutzia gracilis—Fuchsias—Standard Pyracanthas—A Hint to Table Decorators—Poinsettia	136-138
Peach Growing—Mexican Ever-bearing Strawberry Peach Raising in Mississippi—New Apples—Classification of the Apple.....	142-145
Timber of Delaware—Tree-planting in Massachusetts—Sub-hardy Eucalyptus—Dogwood Charcoal—Origin of Sericulture—An Argument for Tree-planting Rapid Growth of Timber Trees in Massachusetts.....	147-149
Twin Mushrooms—A New Agricultural Grass—Osmundia Cinnamomea—Motion of Tendrils—Ozone—Growth of Plants as affected by Latitude—Cause and Effect—Pronunciation of Botanical Names.....	151-152
Letter from the Late Hon. J. C. Calhoun of South Carolina—Our early Botanists—"Rincaton," Indiana—Common Names of Plants—To the "Manor Born"—	

Box in Washington's Garden—Exploration in Japan—Postal Laws on Seeds and Plants—Artificial Heat in Horticulture—The First English Nursery—Mr. Charles Darwin—Miscellaneous Publications—The Language of Flowers—First Book of Zoology—The Shepherd's Manual—The American Lawn—Forest Culture in Minnesota—An Egg Farm—Manual of Small Fruits—Phonetic Magazine—The Boston Cultivator—Farmer's Home Journal—Reveu de L'Horticulture Belge.....	154-157
The Great Centennial—Stated Displays—Dr. Warder—Fruits and Lodging at the Centennial—International Exhibition—Strawberries at the Centennial—Maryland Horticultural Society—Attractions at Horticultural Societies—Royal Horticultural Society of London.....	159-160

### NEW PLANTS:

Lilium Parkmani—Ligustrum coriaceum—Zinnia Darwini—The Purple-leaved Maple—Panicum rotatum.....	132-133
---	---------

### NEW FRUITS AND VEGETABLES:

Pitmaston Duchess Pear—Alexander Peach—Briggs' Red May Peach—The Wealthy Apple Tree—The Norman Strawberry.....	145
--	-----

FORESTRY.....	146-149
NATURAL HISTORY AND SCIENCE.....	149-154
LITERATURE, TRAVELS AND PERSONAL NOTES.....	154-157
HORTICULTURAL SOCIETIES.....	157-160

### QUERIES:

Insect Injury to the Elm—Failure of Camellias in Florida—Failure of Peonias—New Double Deutzia—Yellow Violet.....	133-134
Work on Greenhouse Culture—Scale on Oleanders—Niphotos Tea Rose for Cutting.....	138-139
Sterling Strawberry—The Pear Slug—Fruit Prospects in Kentucky.....	145-146
Poison-vine—Rocky Mountain Silver Spruce—Verbena Rust—Fertilization of Clover.....	162-164

# AUGUST RÖLKER & SONS,

32 Reade St., New York.

Importers and Dealers in

## FLORIST'S SUPPLIES,

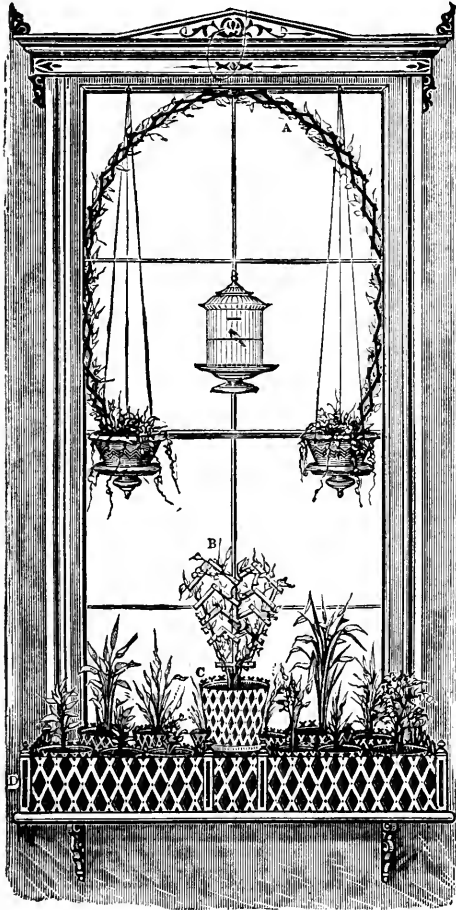

### A, EXTENSION IVY TRELLIS,

6 inches wide, expanding 7 feet.	\$0.60
6 " " " 14 " "	1.20
8 " " " 10 " "	.80
8 " " " 20 " "	1.60

### B, ADJUSTABLE FLOWER TRELLIS.

18 inch Pot Trellis 30c.	4 feet Garden Trellis, 65c.
24 " " " 40c.	5 " " " 75c.
30 " " " 50c.	6 " " " 90c.
36 " " " 60c.	7 " " " \$1.10

### C, ADJUSTABLE FLOWER-POT FENCE OR COVER.

5 inches,	35c.
6 " "	40c.
7 " "	45c.
8 " "	50c.
9 " "	55c.

### D, WINDOW GARDEN FENCE.

6 inches high,	\$1.75.
8 inches high,	\$2.25.

These goods are all made of Black Walnut, handsomely finished, fastened with fancy nails; they open and close freely, and may be adjusted to fit different windows, pots, shelves, or flower-stands. To the trade 25 per cent. discount, and 5 per cent. extra for C. O. D.

The latest novelties on hand in DOMESTIC and IMPORTED

## FLOWER BASKETS AND WIRE DESIGNS

AT MANUFACTURERS PRICES.

HYACINTHS, LILIES, TULIPS, CONVALLARIA, &C.

Bulbs imported to order, will be selected by one of the firm personally when in Europe this summer.

**RURAL AND PRACTICAL BOOKS,** (and any others in the market not on this list) will be sent by mail, post paid, on receipt of price. Address CHAS. H. MAROT, 814 Chestnut St., Philada.

Allen's, R. L., Diseases of Domestic Animals.....	\$1 00	How to Manage a Building Association.....	\$2 00
Allen's, L. F.'s Rural Architecture.....	1 00	How to Paint.....	1 00
Allen's, L. F.'s American Cattle.....	2 50	Hunter and Trapper.....	1 00
Allen's, R. L. & L. F. New American Farm Book.....	2 50	Hussman's Grapes and Wines.....	1 50
American Architect.....	7 00	Jaques' Manual of the House.....	1 50
American Bird Fancier (Brown's).....	30	Jaques' Manual of the Garden.....	1 75
American Farmer's Encyclopedia.....	6 00	Jennings' Cattle Doctor.....	1 75
American Horticultural Annual, paper 50 Cts., cloth.....	1 75	Jennings on the Horse and his Diseases.....	1 75
American Weeds and Useful Plants.....	1 75	Jennings' Sheep, Swine and Poultry.....	1 75
Apple Culturist, S. E. Todd.....	1 50	Johnson's Gardener's Dictionary.....	3 50
Art of Saw Filing.....	75	Johnson's How Crops Feed.....	2 00
Architecture, Modern American, Cummings & Miller.....	10 00	Johnson's How Crops Grow.....	2 00
" Principles and Practice of, By Loring & Juning.....	12 00	Johnson's Peat and its uses.....	1 25
Baker's Fruit Culture.....	4 00	Johnston's Elements of Ag. Chemistry and Geology.....	1 50
Bassett on Cranberry Culture.....	30	Johnston's, J. S. W., Agricultural Chemistry.....	1 75
Barry's Fruit Garden.....	2 50	Kemp's Landscape Gardening.....	2 50
Bell's Carpentry made easy.....	5 00	Klippart's Farm Drainage.....	1 75
Bement's Poultryer's Companion.....	2 00	Langstroth, Rev. L. L., on the Hive and Honey Bee.....	2 00
Bement's Rabbit Fancier.....	30	Leuchars' How to Build Hot-houses.....	1 50
Beet Root Sugar.....	1 50	Leibig's, Justus, Familiar Lectures on Chemistry.....	75
Bicknell's Village Builder, 77 plans.....	12 00	Louden's Encyclopedia of Plants.....	20 00
Bommer's Method of Making Manures.....	25	Lymman's Cotton-culture.....	1 50
Boussingault's, J. B., Rural Economy.....	1 60	McMahon's American Gardener.....	2 25
Brown's Trees of America.....	6 00	Mayhew's Practical Book-keeping for Farmers.....	90
Breck's New Book of Flowers.....	1 75	Mechanics' Companion (Nicholson).....	3 00
Bridgeman's American Gardener's Assistant.....	2 50	Meehan's Ornamental Trees.....	75
Bridgeman's Fruit Cultivator's Manual.....	1 00	Miles on the Horse's Foot.....	75
Bridgeman's Kitchen Gardener's Instructor.....	1 60	Miner's, T. B., Bee-keeper's Manual.....	1 25
Buist's, Robert, Am. Flower Garden Directory.....	1 50	Mohr on the Grape-vine.....	1 00
Buist's, Robert, Family Kitchen Gardener.....	1 00	Money in the Garden.....	1 50
Burr's Field and Garden Vegetables of America.....	5 00	My Vineyard at Lak view.....	1 25
Carpenter and Joiner (R. Riddell).....	7 00	My Farm of Edgewood.....	1 75
Carpenter and Joiner's Hand Book, (Holly).....	75	My Ten-rood Farm.....	50
Chorlton's Grape Grower's Guide.....	75	North American Sylva, 5 vols., 156 col. plates, in 30 parts, unbound.....	60 00
Chemistry of the Farm, (Nichols).....	1 25	" " Half Turkey Antique, gilt.....	70 00
Cleveland's Villas and Cottages.....	4 00	" " full.....	75 00
Cobbett's American Gardener.....	75	Nichol's Chemistry of the Farm and Sea.....	1 25
Cole's, S. W., American Fruit Book.....	75	Norton's, John P., Elements of Scientific Agriculture.....	75
Cole's American Veterinarian.....	75	Norris' Fish-culture.....	1 75
Cooper's Rural Hours.....	2 00	Onion-culture.....	20
Copeland's Country Life.....	5 00	Our Farm of Four Acres.....	1 25
Dadd's, Geo. H., American Cattle Doctor.....	1 50	Paekard's Guide to the Study of Insects..... cloth	6 00
Dadd's Modern Horse Doctor.....	1 50	Paul's Book of Roses.....	50
Dana's, Samuel H., Muck Manual.....	1 25	Paul's Rose Garden.....	3 00
Darwin's Variations of Animals and Plants, (2 vols).....	6 00	Paxton's Gardener's Dictionary.....	15 00
Darwin's Insectivorous Plants.....	7 00	Pardee on Strawberry-culture.....	75
DeVoe's Market Assistant.....	2 50	Parkman's Book of Roses.....	1 50
Downing, A. J., Landscape Gardening.....	6 50	Parsons, Samuel B., on the Rose.....	1 50
Downing's Cottage Residences.....	3 00	Peat and its Uses.....	1 25
Downing's Fruits and Fruit Trees of America.....	5 00	Pear-culture, Field.....	1 25
Downing's Rural Essays.....	3 50	Pedder's, James, Farmer's Land-measurer.....	60
Downing's Ladies' Companion to the Garden.....	2 00	Percheron Horse.....	1 00
Du Breuil's Vineyard Culture, (Dr. Warden).....	2 00	Peterson's Preserving, Pickling and Canning Fruit.....	1 50
Eastwood on Cultivation of the Cranberry.....	75	Phin on Wine-making.....	1 50
Elliott's Western Fruit Grower's Guide.....	1 50	Quinn's Pear-culture for Profit.....	1 00
Elliott's Lawn and Shade Trees.....	1 50	Quinby's Mysteries of Bee-keeping Explained.....	1 50
Every Woman her own Flower Gardener.....	50	Randall's Sheep Husbandry.....	1 50
Farm Talk, (Brackett).....	1 00	Randall's Fine Wool Sheep Husbandry.....	1 00
Farming for Boys.....	1 50	Rand's Bulbs.....	3 00
Field's, Thomas W., Pear Culture.....	1 25	Rand's Flowers for Parlor and Garden.....	3 00
Five Acres too Much, (illustrated).....	1 50	Rand's Seventy-five Flowers.....	1 50
Flagg's European Vineyards.....	1 50	Rand's Flower Garden.....	3 00
Flax Culture.....	50	Reemelin's, Charles, Vinedressers' Manual.....	75
Flint, Chas. L., on Grasses.....	2 50	Riddell's Architect.....	15 00
Flint's Milch Cows.....	2 50	Ropp's Commercial Calculator, cloth \$1, Morocco Tuck.....	2 00
Fowler's Homs' for All.....	1 50	Rose Culturist..... paper	30
Frank Forester's Fish and Fishing, 8 vo. 100 engravings.....	3 50	Robbins', R., Produce and Ready Reckoner.....	75
Frank Forester's Manual for Young Sportsmen, 8 vo.....	3 00	Saunders' Domestic Poultry, paper 40..... cloth	75
French's Farm Drainage.....	1 50	Saxton's Hand Books, in four series, each.....	1 50
Fuller's Grape Culturist.....	1 50	Schenck's Gardener's Text-book.....	75
Fuller's Small Fruit Culture.....	1 50	Scribner's Ready Reckoner and Log-book.....	30
Fuller's Strawberry Culturist.....	25	Song's Cultivation of the Grape.....	3 00
Fuller's Forest Tree Culturist.....	1 50	Ten Acres Enough.....	1 50
Fulton on Peach Culture.....	1 50	Thomas, J. J., Farm Implements.....	1 50
Fulton on Poultry Breeding.....	1 25	Thomas, J. J., Fruit-culturist; old ed. \$3 00; new edition.....	3 75
Geyelin's Poultry Breeding.....	1 25	Ville's Chemical Manures.....	1 25
Gray's How Plants Grow.....	2 25	Warder's American Pomology.....	3 00
Gray's Manual of Botany.....	4 00	" Hedges and Evergreens.....	1 50
Gray's Manual, Botany and Lessons, in one vol.....	2 50	Waring's Drainage for Profit and Health.....	1 50
Gray's School and Field Book of Botany.....	2 50	" Elements of Agriculture.....	1 00
Green on Trout Culture.....	1 00	" Earth Closets.....	50
Gregory on Squashes, paper.....	75	Webster's Dictionary, Unabridged.....	12 00
Gueron on Milch Cows.....	75	Well's Every Man his own Lawyer.....	2 00
Guide to Fortune.....	1 00	Williams, B. S., on Stove & Greenhouse Plants, 2 vols., ill'd.....	5 00
Harzthy's Grape Culture and Wine Making.....	5 00	Williams, B. S., on Select Ferns and Lycopods.....	2 00
Harris' Insects Injurious to Vegetation, clo. \$4; col. eng's.....	6 50	Williams, B. S., Orchid Grower's Manual.....	2 00
Harris on the Pig.....	1 50	Willow Gardening.....	1 50
Hatfield's American Horse Carpenter.....	3 50	White's Gardening for the South.....	2 00
Henderson's Practical Floriculture.....	1 50	" Cranberry Culture.....	1 25
Henderson's Gardening for Pleasure.....	1 50	Wood's Class Book of Botany.....	3 50
Henderson's Gardening for Profit.....	1 50	Workingman's Way to Wealth.....	75
Herbert's Hints to Horsekeepers.....	1 75	Wright's Practical Poultry Keeper.....	2 00
Hoopes on Evergreens.....	3 00	Youatt on the Horse.....	1 75
Hooper's Dog and Gun, paper 30 cents, cloth.....	60	Youman's Household Science.....	2 00
Hop-culture.....	40		
How to Buy a Farm, and Where to Find One.....	1 75		



# JORDAN'S PATENT WATER AND STEAM BOILER.

Constructed of Horizontal Pipes of the same inside diameter as those that form flow and return pipes, thereby producing a very rapid circulation of the water.

LENGTH, SEVEN FEET.

## DESCRIPTION.

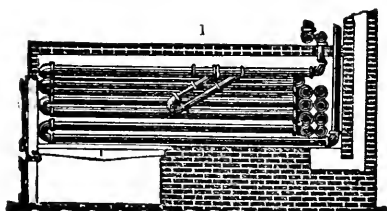

No. 1 Shows a side view of one-half section, with U steam propeller. Also shows section of chimney, ash-pit and brick arch around the boiler, with downward draft to chimney.

No. 2 Shows end view, with rear end closed with pipes; ash-pit below and brick arch above.

No. 3 Shows boiler before it is set in the brick, with a few pipes broken away, to show the steam generator.

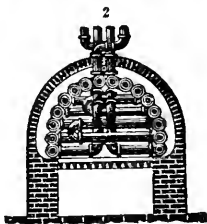

The improvements claimed are: a larger heating surface, as compared to the amount of water in the boiler; a more rapid circulation of water by the use of steam generator to move the water; a larger fire-hole, so that soft coal can be used and not obstruct the draft; and cheapness.

The boiler is adapted to the heating of any building, and can be set up on a level with the room heated. Also, can be used for steam heating when required.

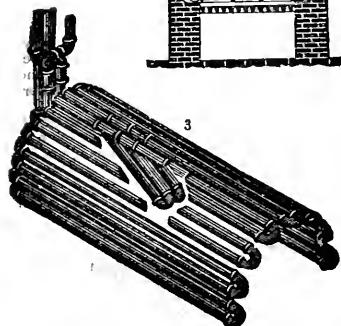

## PRICES OF BOILERS, INCLUDING IRON FRONTS.

No. 1, to heat 500 feet of 4-inch pipe.....	\$ 75.
No. 2, to heat 750 feet of 4-inch pipe.....	100.
No. 3, to heat 1000 feet of 4-inch pipe.....	125.
No. 4, to heat 1500 feet of 4-inch pipe.....	175.
No. 5, to heat 2000 feet of 4-inch pipe.....	225.
No. 6, to heat 3000 feet of 4-inch pipe.....	300.

Water-pipe and fittings furnished at factory prices. The work of putting up the boiler and pipes, furnished at low rates.

**J. M. JORDAN & BRO.,**  
612 Olive Street. St. Louis, Mo.

## REFERENCES.

T. R. PULLIS, of Mississippi Iron Works, St. Louis, Mo.

EX-MAYOR COLE, President Merchants' Exchange, St. Louis.

W. F. COZZEN, O. P. SAYLOR, GEO. LYNCH, St. Louis; or any prominent Florist in the County of St. Louis.

J. T. McCONNEL & CO. and GEO. MATHEWS, Jacksonville, Ill.

CHICAGO FLORAL COMPANY, Chicago, Ill.

ROBERT EXCELL, WM. FANCOURT, JOHN GOOD, WM. DESMOND, AUGUST DRESSER, SELL and JOHN WESTON, of Chicago, Ill.

## Visitors Guide to the Centennial and Philadelphia.

Only authorized Guide Book on Centennial Grounds. Map of Centennial Grounds, Map of Philadelphia, 48 pages, 12mo, mailed for 30 cents. Address,  
t CHAS. H. MAROT, 814 Chestnut St., Phila.

## GRAPE VINES

Grown especially for the Trade and Planters in Quantity. CONCORD, MARTHA, Delaware, Hartford, Prolific, Ives, Salem, Wilder, Iona, and many other varieties, one and two years old, in quantity.

nov7f A. HANCE & SON,  
Nurserymen and Florists, Red Bank, N. J.

### C. F. A. HINRICHS,

29, 31 and 33 Park Place, New York City,

### HYACINTH AND BULB GLASSES.

DECORATED

### FLOWER POTS,

LAVA, MAJOLICA, &c., &c. Vases. Iron Sections for Flower Beds. Lawn, Fish and Flower Stands. Floating Animals for Aquaria. Button-hole Bouquet Holders. Only and Original GERMAN STUDENT LAMP for Conservatories.

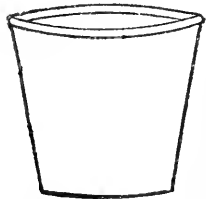

Send for Prices to above address.

mch6

## 19 Years in the Trade.

I have this Spring abandoned the growing and management of out-door nursery stock, and intend in the future giving my whole attention to the growing of hot-house, green-house and bedding stock, connected with Seeds, Small Fruits and Vegetable Plants.

Having many years personal experience, and taking the full charge of the management myself (having no foreman), I am enabled to supply the trade and the public with almost anything in my line at reasonable rates and with NUMBER ONE stock.

### DANIEL HARKINS.

WILKESBARRE,

may1

Penna.

## KANSAS PACIFIC HOMESTEAD.

This paper is full of reliable information about Kansas, her climate, soil, products and progress. Contains a nice map of the United States, and a fine view of a prosperous Colony from Pennsylvania.

It is a faithful guide to the best and cheapest body or lands in the West. 5,000,000 acres for sale. For a copy, send your address to may3 S. J. GILMORE,  
Land Commissioner Kansas Pacific Railway, Lawrence, Kansas.

## CRANBERRY PLANTS BY MAIL

100 to 1000 Plants can be forwarded direct to persons ordering them by mail. Circulars relating to culture, soil, price, etc., free.

### F. TROWBRIDGE,

Dealer in Trees, Plants, Vines,

may1

Spring of 1876.

Milford, Conn.

## WILL BE SOLD CHEAP.

15,000 Fine Verbenas, as are in this country, in 50 varieties; and a general collection of Bedding and Basket Plants, Sweet Potato Plants. Send for Price List.

HENRY WEBER,

may2

Cumberland, Mo.

### New and Distinct Variegated Geranium,

### "HAPPY THOUGHT."

The centre of the leaves of this novelty is nearly pure white extending two-thirds over the entire surface, and being of as free growth as a Zonale Geranium, will undoubtedly become a popular market variety. We now offer extra strong plants in 3-inch pots, per dozen \$5.00.

Carnations, in 12 varieties, 3-inch pots, per 100	\$4.00
Pansies, choice strain,	3.00
Verbenas, best scarlet, white, purple and pink, fine healthy plants, per 100	2.50
Roses, 2-inch pots, per 100	6.00

Send for Catalogue

SKED, PADDOCK & CO.,

feb4

Cleveland, Ohio.

BEECROFT'S  
PATENT

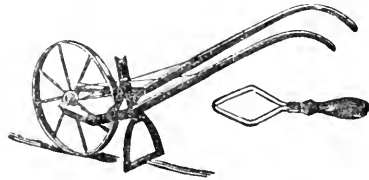

WHEEL  
HOE.

One of the greatest labor-saving machines invented, runs easy, cuts the weeds clean, stirs up the soil well, and is very durable. Every Farmer, Nurseryman, Florist, Gardener, Small Fruit and Seed Grower should have one: it will pay for itself in a very short time.

### BEECROFT'S HAND WEEDER.

This is a very useful implement for Florist, Vegetable and Small Fruit Grower, Ladies can also use it to great advantage in their Flower Gardens. Agents wanted in every Town to whom great inducements will be offered. Also an immense stock of Evergreens and Deciduous Trees of all kinds and sizes, Fruit Trees, Grapevines, Small Fruits, Shrubs, &c. For sale at very low prices. Full Descriptive Price List sent Free.

### REMOVAL.

The subscriber will have his head-quarters at Portland, Me., for the Spring of 1876, instead of 50 & 52 Vesey St, New York, as heretofore, where he will be pleased to fill all orders for Nursery Stock from old customers as well as new ones at very low prices.

Wholesale Price List sent Free. Address,

THOMAS JACKSON, Nurseryman,

may1

Portland, Maine.

## TREES, SHRUBS, &c., HANDSOME EVERGREENS,

of large size, in quantity. Hemlock Spruce, Norway Spruce and American Arbor vita 3 to 15 feet

Evergreens for hedging.

Send for Catalogue.

WILLIAM H. MOON,

may1

Morrisville, Pa.

## FOR SALE,---THREE PAIR OF PEA FOWLS.

Very handsome, three years old, at \$10 per pair.

Apply to

ALEX. BURNETT, Florist, &c.

may1

READING, PA.

**NEW EXCELSIOR LAWN MOWER.**



PRICES REDUCED FOR 1876.

IT HAS THE LARGEST SALE OF ANY LAWN MOWER IN THE WORLD.

It has been adapted, and can be seen in practical operation on **Central Park** and all the other **City Parks, New York; Government Grounds and City Parks, Washington; Boston Common, Boston; Prospect Park, Brooklyn;** and on almost every prominent Park throughout the **United States and Canada.**

**THE GREAT TRIAL** of Lawn Mowers was held in **New York City** June 25th, 1874. There the **Excelsior** came into competition with all the best Lawn Mowers in the world, and was awarded the **HIGHEST PREMIUM.**

Four sizes for hand-power; four sizes for horse-power.  
Prices from **\$14** to **\$200.**

Every Machine Warranted.

Address

**CHADBORN & COLDWELL M'FG CO.,**  
**NEWBURGH, N. Y.**

Send for Circular.

**N. B.**—We call special attention to our new **HORSE MOWER** for 1876. Gears entirely covered and weight reduced 200 lbs. It is the **LIGHTEST** and **BEST HORSE MOWER EVER MADE.**

Estab.

**2,000,000**

ILLUSTRATED CATALOGUES

*Sent free on application.*

1765.

**IN STOCK**

*Low freights from Boston allow us to compete with any Pottery in the United States.*

**A. H. HEWS & CO., - - No. Cambridge, Mass.**

**ROSES!**

**ROSES!**

Young Roses for Nurserymen and Florists. Fine, Healthy Pot-grown Plants. Prices very low by the 100, 1000, or 10,000. Handsome Plants in 3 1/2 and 4 inch pots, splendid for retailing. Send for Special rates.

**WILLIAM H. MOON,**  
may1 Morrisville, Pa.

**SELECT HARDY PLANTS**

Phloxes, Primulas, Iris, Anthericums, Aquilegias, Campanulas, Delphiniums, Day Lilies, etc.

**CHOICE SHRUBS AND CLIMBERS.**

**TEA AND PERPETUAL ROSES.**

**CHARLES SANDER,**

Agent of F. Parkman, Jamaica Plain, Mass.

List on application. ap2

**Garden, Field & Flower Seeds.**



may3

**AGRICULTURAL  
IMPLEMENTS,  
HORTICULTURAL  
TOOLS, &c.**

Catalogues Free.

**D. LANDRETH & SONS,**  
21 & 23 S. Sixth St.,

Between Market & Chestnut St.,

PHILADELPHIA.

**GOOD SEEDS**

Grown with care and painstaking from selected stocks always pay. Try mine. See advertisement "All About Gardening" feb4  
J. B. ROOT, Seed Grower, Rockford, Illinois.

# AN ARBORETUM AT THE CENTENNIAL.

Visitors to the CENTENNIAL EXHIBITION are invited to examine the ARBORETUM planted on the Horticultural Grounds by

**THOMAS MEEHAN, Nurseryman,  
GERMANTOWN, PHILA.**

The collection embraces nearly **EIGHT HUNDRED** Species or well marked varieties, all named for the information of Visitors, and is believed to be one of the most complete collections of hardy, vigorous plants ever got together in this latitude. **mays**

## HYBRID PERPETUAL ROSE, "EDMUND WOOD."

We are gratified to find that our friend M. VERDIER, the most celebrated Rose grower of France, has considered our establishment of sufficient importance to name one of his finest New Seedlings after our Mr. EDMUND M. WOOD. In a special circular containing the names of his choicest New Varieties, he thus describes it: *Edmund Wood*; tree vigorous, with short reddish-green branches and numerous dark brown spines, leaves consisting of 3 to 5 leaflets oval, dark green; Flowers, large, full and perfect in form, growing in choicely of 6; color lively, bright cherry red, reverse of petals, carmine—admirable. This variety is comprised in the series to which the silver gilt medal was awarded by the Paris Horticultural Society in May and June, 1875. We can now supply nice young plants in 3 inch pots of this variety, together with all the new "Hybrid Perpetuals" issued by Mr. Verdier in 1876, at greatly reduced prices.

We have flowered Edmund Wood and some others of the set, and find them justly up to the descriptions.

Catalogues with full descriptions of Roses, Greenhouse Plants, &c., &c., mailed free to all applicants.

Orders will be executed in strict priority as they are received.

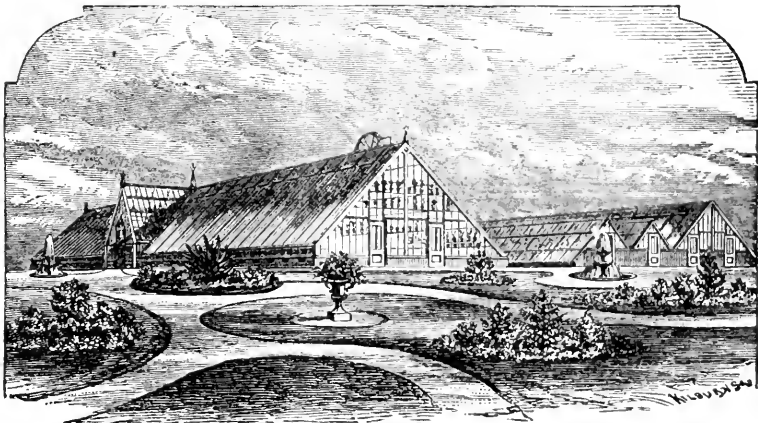

**EDMUND M. WOOD & CO.,**  
OFFICE OF

**WABAN CONSERVATORIES,**  
56 BROAD STREET, BOSTON, MASS. Janza

**M. M. BAYERSDORFER & CO.,**

Importers of Every description of

**BOUQUET PAPERS.**

Plain White Satin for Bridal Bouquets. Fancy Lace for Weddings. Receptions. Parties. Italians, Pasted Cartons, Immortelles in great varieties; Green Moss, French Dried Grasses and Flowers. Tin Foil. Prize Medal of Cincinnati Industrial Exposition of 1873 awarded to us for the best display of Bouquet Papers. Illustrated Catalogue furnished on application.

feb

56 N. Fourth St., Philadelphia, Pa.

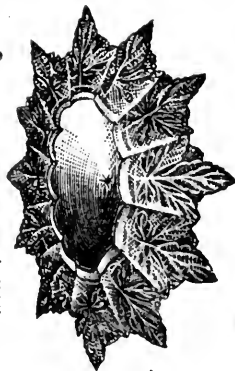
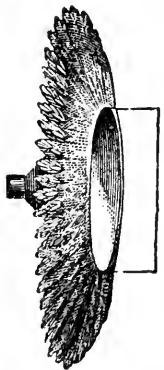

**N. STEFFEN'S WIRE WORKS,**  
335 E. 21st St. New York.

manufacturer of all designs for FLORISTS. Wreaths, Crosses, Crowns, Hearts, Anchors, Pillars, Columns, Monuments, Bells, Composure, Faith, Hope and Charity, Harps and Lyres, &c. Leaning and Upright  
Send for Price List. jan 12.

**TO FLORISTS.**

**TOBACCO STEMS,** For Fumigating purposes, put up in bales of 250 lbs. each, at \$5.00 per bale, free on boat or cars. All orders from unknown parties must be accompanied by remittance. For sale by

**STRAITON & STORM,**  
No. 180 Pearl Street, New York.

aug12

**Allen's Planet Jr.**  
**SILVER**  
**MEDAL**



Seed Drills and Wheel Hoes, perfected for '76. FOUR SIZES. They "sow like a charm," and hoe better, easier and six to twelve times faster than the hand hoe; often saving \$100 in a season!  
OUR **NEW HORSE HOE** with Polished Steel blades, perfected after ten years of experiment, saves most of the hoeing and makes the remainder easy; leaves the ground level or ridged as desired; opens furrows, ridges, and cultivates shallow or deep, and is a thorough weed killer; should be owned by every farmer. ESPECIALLY USEFUL to Market Gardeners. Break Corn, Tobacco, Cotton, Rice and Root Growers, and to all lovers of thorough work.  
THE **POTATO BUGS** the PLANET Jr. DESTROYER! It is light, simple and effective. Paris-Green (strictly pure) supplied. Complete directions for use sent with each machine.  
Our full Descriptive Price-List and Testimonials free. Mention this paper. S. L. ALLEN & CO., 119 So. Fourth St., Phila., Pa.  
WE MUST HAVE A LIVE AGENT IN EVERY TOWN.

**STRAWBERRY PLANTS**

By the 100, 1,000, 10,000 or 100,000.

**MONARCH OF THE WEST, COL. CHENEY, WILSONS' ALBANY, Seth Boyden, Chas. Downing, Downer, Triomphe de Gand, Kentucky.** Also, **STAR OF THE WEST, Champion, Dr. Waider, Late Prolific, Black Defiance, Agriculturist, Lennings' White, and others.**

**A. HANCE & SON,**

nov.11 Nurserymen and Florists, Red Bank, N. J.

**ALL ABOUT GARDENING**

For HOME use and for MARKET in **ROOT'S GARDEN MANUAL**—practical, pointed and thorough,—containing one-half as much matter as \$1.50 books on the subject. Gardeners throughout the country commend its practical labor-saving methods as invaluable to them. Sent for 10 cents, which will be allowed on the first order for seeds. **J. B. ROOT, Seed Grower, Rockford, Illinois.** feb4

**10,000** Camellias of all sizes, with and without buds.

**2,000** Magnolia grandiflora grown in pots.

**100,000** Roses, standards, half-standards and dwarfs.

**Crab Apples, Crab Pears and Quince Stocks,** per 100,000. For Catalogue and Prices apply to

Messrs. **F. E. ROTEREAU & CO.,** Nurserymen, Angers, France. june12

**50,000**

**IRISH JUNIPERS, DWARF ARBOR VITES, NORWAY SPRUCE,**

from 2 to 5 feet. PRICES REDUCED. Send for estimate.

**WILLIAM H. MOON,** Morrisville, Pa. may1

**NURSERY STOCK**

SPRING, 1876.

**SYRACUSE NURSERIES.**

With a very superior general Nursery Stock at Low Rates, we can offer special inducements in **ELMS, SILVER MAPLES,** and varieties of **EVERGREENS, SIBIRUS & ROSES.** apl2  
**SMITH & POWELL, Syracuse, N. Y.**

**RICHARD LYNEX,**

Rear of 428 Walnut Street, Philada.

Manufacturer of Plain and Fancy Wire-work, for Florists; Wreaths, Crosses, Stars, Crowns, Hearts, Anchors, Birds, Lambs, Gipsy Baskets, Hanging Baskets, Flower Stands, &c.

SEND FOR PRICE LIST.

feb6

**EISELE BROS. CATALOGUE**

of New and Best Greenhouse and Bedding Plants and Garden Requisites for 1876, will be ready March 1st., and mailed free to all applicants.

**EISELE BROS.,**

Tioga, Philadelphia, Pa.

feb4

**RUE'S HAND CULTIVATOR**

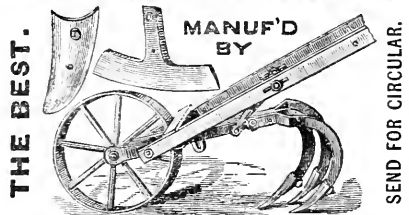

**GEO. W. RUE, Hamilton, O.**

**NEW**

**VARIEGATED LANTANA HARKETT'S PERFECTION.**

Best Variegated Bedding Plants to stand the Sun. Ready March 1st. \$1.00 each. \$10.00 per doz. Illustrated Descriptive Catalogue of Greenhouse and Bedding Plants. Sent to all applicants.

**W. A. HARKETT,** DUBUQUE, IOWA.

feb10

**SALE OF**

**RARE STOVE AND GREENHOUSE PLANTS.**

AT THE

**BELVIDERE GREENHOUSE, LEXINGTON, MASS.**

This celebrated stock of Rare Plants of recent importation, will be immediately disposed of at reduced prices, in lots to suit. For particulars and circular, address, or apply to

**JAMES COMLY, Lexington, Mass.,** Or **M. H. Merriam, 31 High St., Boston.**

# CARNATIONS.

Transplanted young plants for bedding out. Price Low.

WILLIAM H. MOON,

may1 Morrisville, Pa.

## DUTCH FLOWER-ROOTS AND BULBS,

Cultivated and sold by

M. C. ALKEMADE & SON,

at

Noordwijk-Binnen, near Haarlem, Holland.

Catalogue for 1876 will be forwarded post-free on application.

may4

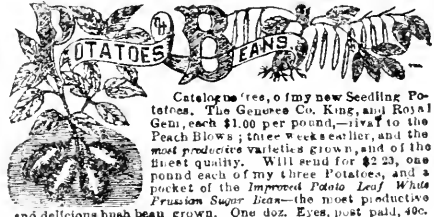

Catalogue free, of my new Seedling Potatoes. The Genesee Co. King, and Royal Gem, each \$1.00 per pound,—rival to the Peach Blow; three week earlier, and the most productive varieties grown, and of the finest quality. Will send for \$2.25, one pound each of my three Potatoes, and a packet of the Improved *Faldo Leaf White Frazier Sugar Beans*—the most productive and delicious bush bean grown. One doz. Eyes, post paid, 40c.  
Address, A. N. JONES, LeRoy, N. Y.

## ROSES, VERBENAS

BEDDING AND EXHIBITION PLANTS  
Successes at the Exposition  
Fine Stock at Low Figures. Free Catalogue FREE.  
Address B. P. CRITCHELL, Cincinnati, Ohio.

# THE CENTENNIAL TREE AND SHRUB SEEDS.

Visitors to the CENTENNIAL are invited to examine the collection of Tree Seeds, comprising over

THREE HUNDRED KINDS

of species, hardy in the greater part of the United States, and on exhibition in the AGRICULTURAL HALL, by

THOMAS MEEHAN,

COLLECTOR AND DEALER IN TREE SEEDS,

may5

GERMANTOWN, PHILA.

## MOUNT AIRY NURSERIES.

# ROSES.

NEW AND RARE

Our stock of Roses is large and superior before, including most of

TEAS, in four and five inch pots,

HYBRID PERP. and NOISSETTS,



# ROSES.

ROSES A SPECIALTY.

in growth to any we have ever offered the new varieties.

\$4.00 per doz., \$20 per 100.

\$4.50 per doz., 30 "

The above include the choicest varieties grown from recent importations. We have also grown in 4 and 5 inch pots, on their own roots, from our last Spring importations a fine stock of young new Roses which we can sell at prices less than they can be imported.

PRICES ON APPLICATION. Plain Catalogues sent on receipt of 3 cent postage stamp. Catalogue with Colored Plate, 10 cts.

## NEW AND RARE NURSERY STOCK.

All the choicest varieties of Nursery Stock such as RHODODENDRONS, EVERGREEN and other SHRUBS in a variety, and DECIDUOUS TREES, RETINISPORAS, SPRUCES, CUPRESSUS, &c. *Hydrangea Paniculata grandiflora*, large plants, 75 cents to \$1 each, *Hydrangea Paniculata grandiflora*, smaller plants, 40 cents each, \$3.50 per dozen. *American Arbor vita* in quantity, and fine growth for Hedges, from \$20 to \$40 per hundred.

## ORNAMENTAL GREENHOUSE AND HOTHOUSE PLANTS.

A large collection of well grown Palms, Agaves, Ferns, Lycopodiums, Dracenas, etc., at very low rates.

LATANIA BORBONICA—Fine plants, 1 to 2 feet high, growing in 6 and 7 inch pots, 75 cents each, \$6 per dozen, \$40 per 100.

Catalogue sent on application and a receipt of 3 cent postage stamp.

apl2

MILLER & HAYES, 5774 Germantown Ave., Philadelphia.

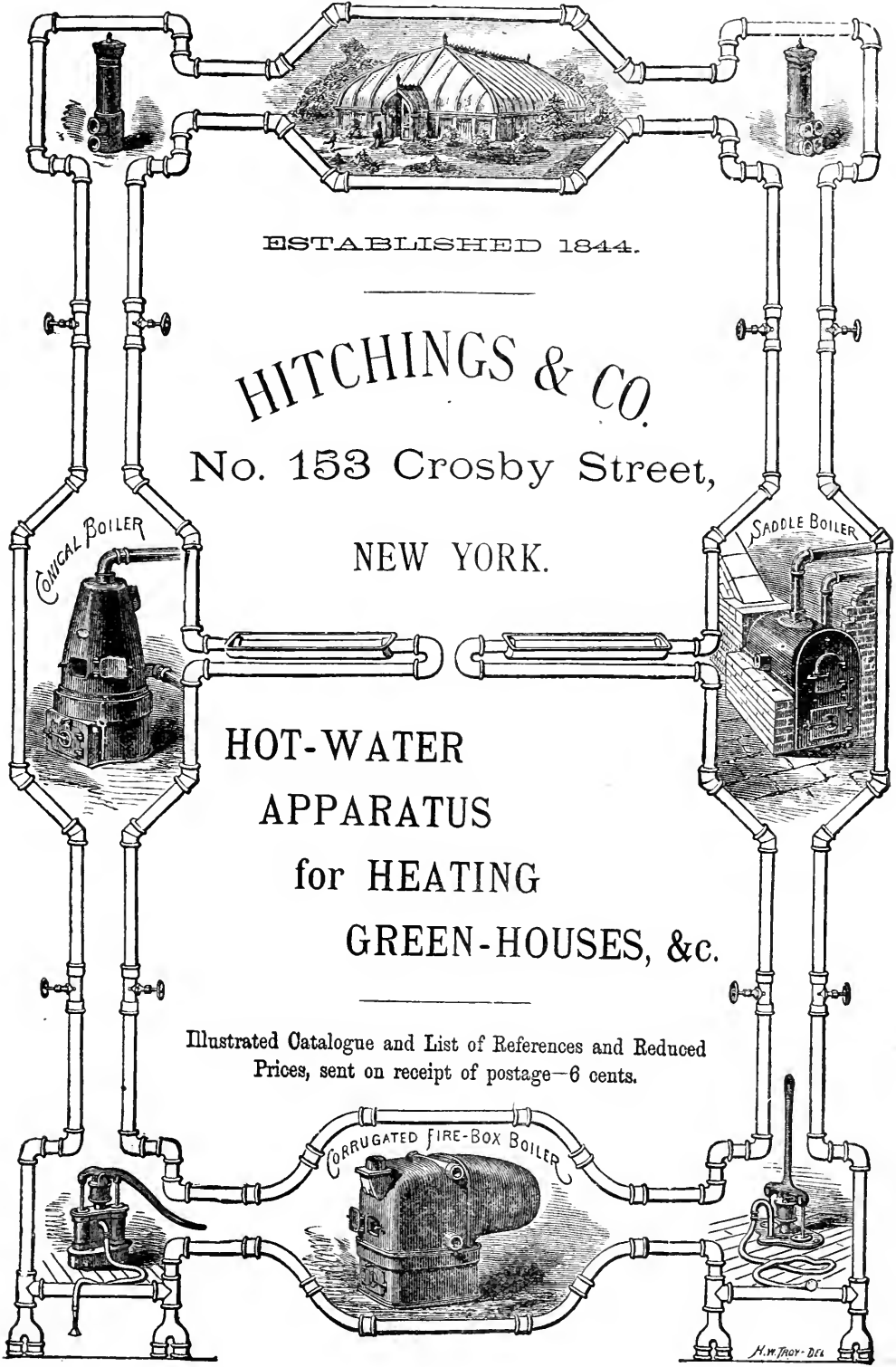

ESTABLISHED 1844.

HITCHINGS & CO.

No. 153 Crosby Street,  
NEW YORK.

HOT-WATER  
APPARATUS  
for HEATING  
GREEN-HOUSES, &c.

Illustrated Catalogue and List of References and Reduced  
Prices, sent on receipt of postage—6 cents.

H. M. THORP - DEL.

# Roses! Roses! Roses!

We offer a large stock of  
**FINE STRONG GROWING YOUNG ROSES,**  
grown in 2 and 3 inch pots, and include the finest and leading varieties.

HYBRID PERPETUALS, TEAS, BOURBONS AND CHINAS.

Also **MOSESSES** and **CLIMBERS.**

at very lowest prices. Orders solicited.

**JAMES ALDOUS & CO., Florists,**  
tfeb7 Iowa City, Iowa.

NEW YORK, APRIL 1st, 1876.

A FEW

## THOUSAND PLANTS

Now on the way from

## EUROPE,

viz:

**Mahaleb Stocks,** middling size,

**Pear Stocks,** 1 year, 1st class.

**Angers Quinces,** 1st class.

**Standard and Half Standard Roses,** 1st class, choice varieties,

**Norway Spruce,** transplanted, 6 to 12 inches.

**Black American Spruce,** transplanted, 6 to 12 inches.

For Sale by

**C. RAOUX,**

Jantf 76 Park Place.

PRICE LIST will be sent to applicants.

## DOUBLE TUBEROSE BULBS.

Our Stock of BULBS this year is of very superior quality.

	Doz.	100	1000
1st quality large Flowering Bulbs..	\$ 75	\$4 00	\$30 00
2d quality " " "	50	3 00	20 00
A few hundred extra large Bulbs .....	1 00	5 00	

may1 **MILLER & HAYES, 5774 Germantown Ave., Phila.**

## HEDGE PLANTS! HEDGE PLANTS!

Making Hedge plants a specialty, we have particularly to offer this spring Osage Orange, Norway Spruce, Hemlock Spruce, Arbor Vite, in immense quantities, and of any size to suit.

**THOMAS MEEHAN,**

Jantf Germantown, Phila.

## LAUREL HILL NURSERIES.

**FOREIGN GRAPEVINES a Specialty.**

My Vines are now in excellent condition, and the stock compares all the **LEADING SORTS.**

**Strong 2 Year Old Canes, \$24 per Dozen.**  
**1 Year Old, \$9 per Dozen.**

Usual discount to the Trade. List of Sorts on application.

Also Camellias, Azaleas, Acacias, and a general variety of Bedding Plants.

Also Ornamental Evergreens, Shrubs and Nursery Stock in variety.

**DAVID FERGUSSON,**

**LAUREL HILL NURSERIES,**

Ridge Avenue, Philada.

tmch3

## BEAUTIFUL FLOWERS

Delivered free of cost per mail at your door. Splendid assortment of **Roses, six for \$1, thirteen for \$2.** Send for **New Descriptive Catalogue of Plants gratis.**

**HOOPES, BRO. & THOMAS,**

Cherry Hill Nurseries, West Chester, Pa.

mch3

## NEW FRUITS AND SEEDLINGS.

A few thousand 1 year Norway Maples, fine American Seed and Grown, at \$8 per 1000. A few thousand Siberian Arbor Vite, the very best stock in the country, 2 to 2½ feet, \$160 per 1000; 3 feet, \$25 per 100. Austrian, Scotch and Corsican Pine, about 2 feet, twice transplanted, \$15 per 100. Platanus Orientalis, two years transplanted, \$5 per 100. Large handsome shrubbery \$10 per 100. Prouty's Seedling Strawberry, 10 for \$1; \$5 per 100

**P. H. FOSTER,**

Babylon, Nursery, N. Y.

mch3

MY

*Wholesale and Descriptive Catalogues of*

## Greenhouse and Bedding Plants

SHRUBS, EVERGREENS, ETC.,

MAILED TO ALL APPLICANTS

## Wm. C. Wilson

Astoria, L. I. C.,

New York City Office—45 West 14th St.

June12

## BRANDYWINE,

**The Most Profitable Raspberry;**

In large quantities, guaranteed TRUE.

Descriptive Circular sent on Application.

**A. HANCE & SON, Nurserymen and Florists,**

ncvtf.

**RED BANK, N. J.**

## PRAIRIE LANDS.

Send your address on **POSTAL CARD** to **LAND COMMISSIONER, B. & M. R. R., BURLINGTON, IOWA,** and receive free copy of *Iowa and Nebraska Farmer* with **Chart of Lands.**

uch3



# ELLIS' BASE BURNING BOILER.

FOR WARMING Dwellings, Greenhouses, Graperies, Forcing Pits, Drying Rooms, Heating Water for Public Baths, Baptisteries, &c., by Hot Water or by Steam.

Estimates and Circulars furnished. Sept. 12. 182 CENTRE STREET, NEW YORK.

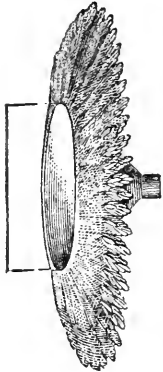

ROWLAND WHITMAN.

HARRY LANG.

## WHITMAN & LANG,

IMPORTERS OF

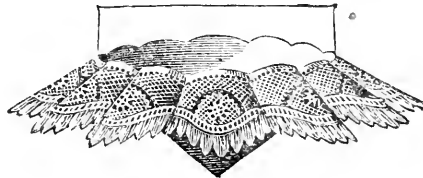

DRIED FLOWERS, IMMORTELES, TIN FOIL &c.

augtf.

No. 126 N. 4th St., Philadelphia.

FANCY GRASSES

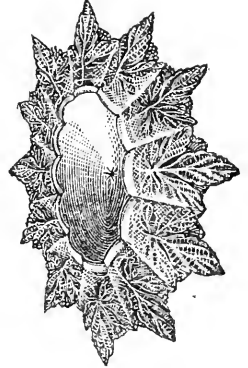

## GERMANTOWN NURSERIES, PHILADELPHIA.

GORGAS LANE STATION, CHESTNUT HILL RAILROAD. Less than One Hour from the Centre of Philadelphia.

Those who desire to purchase largely, either for their own planting or to sell again, are invited to examine the extensive stock of

### FRUIT, SHADE AND ORNAMENTAL TREES AND SHRUBS,

Grown at the Germantown Nurseries. And those who need but A FEW ARTICLES, will find all ages and sizes to select from.

A special feature of the business, is the raising of

Nursery Stock and Seedling Forest Trees

FOR DISTANT SHIPMENT. Many of these can be supplied by the millions at very low rates. Address, for CATALOGUES or Information,

THOMAS MEEHAN, Germantown Nurseries, Phila.

## JOHN A. SCOLLAY, IMPROVED HOT WATER APPARATUS,

Patented September 17, 1872.

*For Warming and Ventilating Dwellings, Greenhouses, Graperies, Forcing Pits, Drying Rooms, Heating Water for Public Baths, &c.*

This Boiler is perfectly self-cleaning, simple, economical and powerful, having more effective surface into less space than any Boiler in the market. Scollay's Patent Plant Sprinkler, for Window Gardening, &c., to be obtained of all Seedsmen, Florists, &c. Send for Circular and References.

July 12

351 Adams Street, Brooklyn, New York.



### DOUBLE HARPOON HORSE HAY-FORK.

BEST IN THE WORLD.

MAY BE SEEN AT CENTENNIAL.

Descriptive Catalogue sent free.

Pennock Manufacturing Company,  
Kennett Square, Chester Co., Pa.

### TRUE RHODE ISLAND BENT SEED, Not Red Top,

Can be had of us at \$2.50 to \$3.00 per measured bushel.  
Cash with order.

W. E. BARRETT & CO.

44 Canal St., Providence, R. I.

ap13

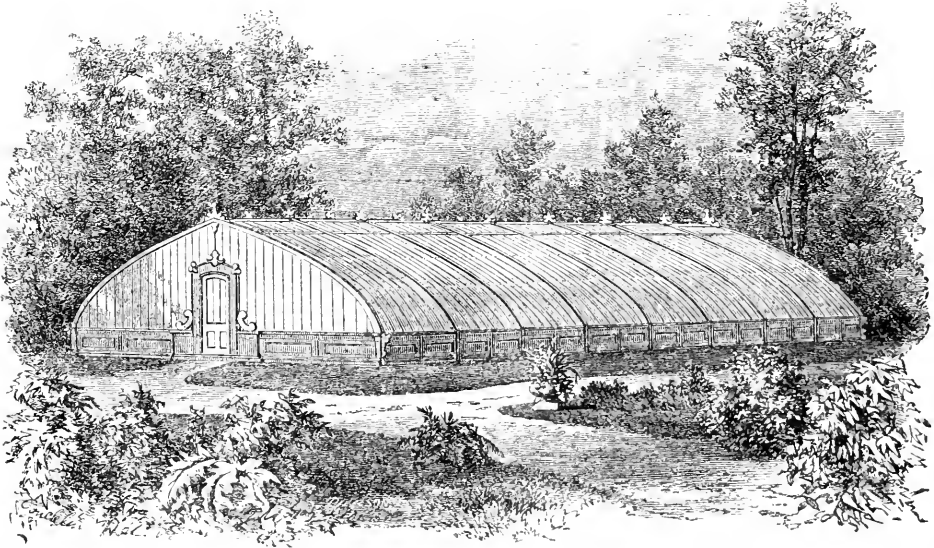

# GREENHOUSES, GRAPERIES, ETC.

Their Construction a Specialty. Experience of 20 Years.  
 SHIPPED TO ALL PARTS OF THE COUNTRY.  Send for Catalogue. Address,  
 LORD'S HORTICULTURAL WORKS,

June 12

Irvington-on-Hudson, New York.

## ALEX. NIMMO,

(Late of the Firm of Nimmo & Scollay.)

# NEWLY IMPROVED HOT WATER BOILER,

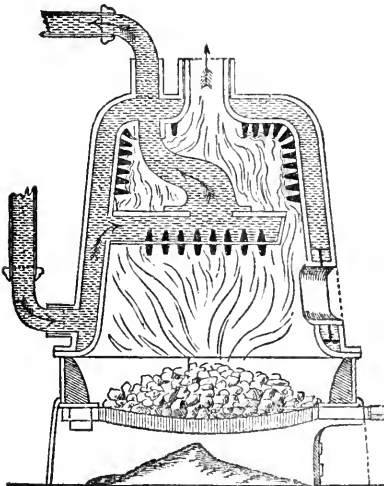

FOR HEATING  
 Green-Houses, Graperies, Conservatories,  
 Forcing Pits, Water for Baths, Drying  
 Rooms, Public and Private  
 Buildings, &c.

*Proper steps have been taken to secure United States  
 Letters Patent on this Invention.*

All the necessary Fittings for Hot Water Heating Apparatus.  
 VENTILATION APPARATUS OF ALL KINDS.

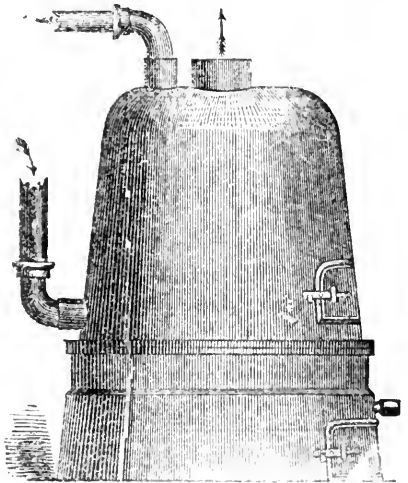

Wells Drove, Pumps of all kinds, Hydraulic Rams, &c., Garden Sun-Dials.

Agent for Joseph Kelly's Never Dry Vapor Pans, for all kinds of Hot Air Furnaces, Baltimore Heaters, &c.  
**CHEAPEST AND BEST BOILER, &c., IN THE MARKET.**

 Please send for Circular for explanation, etc., before you make up your mind to purchase elsewhere.

sep 12

P. S.—Be sure you get the right number.

335 Adams Street, Brooklyn, N. Y.

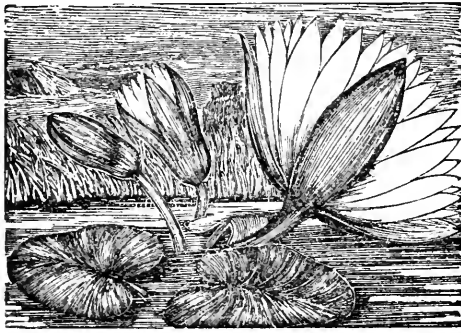

WHITE WATER LILY—*Nymphaea odorata*.

Reader, are you a lover of flowers, and do you want something this Spring that your neighbor has not got? Something that can't be found in any Floral catalogue in the country? If so, procure some of the roots of this beautiful and fragrant Lily. Plant them in tubs filled with water, and set them around your dwellings, and when in bloom they will be admired by all who see them. I have a good supply of first-class roots, fresh from the ponds, which I will send out by mail, postage paid, for 25 cents each, 5 for \$1, and \$2 per doz. Printed instructions for growing them in ponds, tubs or aquariums, sent with each package. From four to six of these roots planted in a half-barrel make a splendid tub of flowers. Address,

J. E. S. CRANDALL, Rockville, Washington Co., R. I.  
Please state where you saw this. aplz

# BEGONIA FROEBELI.

New Tuberos-rooted Begonia.  
Bright Scarlet Flowers.

Found in the Peruvian mountains by the celebrated collector B. Roelz, and pronounced by him to be the finest of all Begonias. Plants in bloom with me now prove that it is the

# QUEEN OF BEGONIAS.

Flowers measure two inches across, are borne in large clusters and of the most brilliant scarlet imaginable.

Splendid for bedding out, as it is a most profuse bloomer.

Send for descriptive circular and sample flower.

Large original bulbs started in pots, price \$2.50 each.

Address,

## J. ROEHR'S,

270 SECOND STREET,

tapl3

Jersey City, N. J.

**THE DUNCAN STRAWBERRY.**  
SELLS HIGHER, CARRIES BETTER, KEEPS LONGER than any other, and we believe will attain a high rank as a Market and family Berry.  
For prices &c., address  
E. & J. C. WILLIAMS,  
Montclair, N. J.

mch8

# THE CHRISTIAN AT WORK.

T. De Witt Talmage, Editor.

Without Premiums, \$3; with Premiums, \$3.25. To Clergy-  
men 75 cents less. ~~65¢~~ A Choice of two premiums.

### OPINIONS OF THE PRESS.

"The Christian at Work is the liveliest religious paper published in these parts. Its columns are spicy and sparkling and to religious people who like things lively it is a readable paper. The Devil is more certain to be frightened with a radiant face than a solemn and forbidding one."—*N. Y. Commercial Advertiser*.

"The Christian at Work has donned a new dress and looks as pretty as a picture. The type of all sizes is admirably clear and a handsomer weekly there is not in these United States."—*N. Y. Evening Mail*.

"The Christian at Work is safe and reliable in all its utterances and ought to displace the ——— in every Presbyterian family. Its editor is a host in himself, and nothing will stagnate that he has anything to do with."—*London Correspondent Chicago Interior*.

"The Christian at Work is an admirably conducted sheet, filled with live matter."—*N. Y. Star*.

"The Christian at Work is one of the most readable religious papers published anywhere. The Doctor and his associates have discovered the art of making a publication orthodox without being flippant."—*Brooklyn Eagle*.

"In The Christian at Work everything is lively and life-like. This Christian smiles, laughs, sometimes actually whistles, while at his work, and that without letting down the dignities and proprieties that belong to the discussion of the themes it discusses."—*Brooklyn Union*.

"The Christian at Work is one of the best of the religious weeklies, and deserves the success it has attained."—*Brooklyn Argus*.

"The Christian at Work is one of the most sprightly, most gladly welcomed in every family of all religious weeklies. It fits from the pulpit to the pew, from the rod of authority to the kiss of love, from the paternal command to the child's obedience, and scatters flowers upon all, breathing content and happiness upon all its readers."—*American Garden*.

### Five Sabbath School Papers,

under the same editorial supervision, are published by us monthly, and are suitable for School or Home. The best and cheapest published. Beautiful premiums with these also.

### Good Words, My Paper, Good Cheer, Old and Young, Der Sonntagsgast. (German.)

We number our papers, but do not date them, making them good at any time.

Two papers with names nearly like our own have lately been issued in New York City. They are not in any way under the supervision of DR. TALMAGE or the control of THE CHRISTIAN AT WORK PUBLISHING COMPANY. Be careful to send your orders direct to the publisher of this paper.

Full particulars and sample copies of all papers furnished on application.

HORATIO C. KING, Publisher,

July 14

No. 102 Chambers Street, New York.

**AMSDEN, Amsden, Amsden.** Earliest and best early Peach in the world. Trees, root grafts and scions at Carthage, Missouri, and Dayton, Ohio. Price of the trees reduced for spring 1876. For full history of this Peach, and price of the trees, root grafts and scions, address  
aug12 JOHN WAMPLER, Carthage, Missouri.

### LONDON GARDENER'S CHRONICLE

Will be furnished, post-paid, direct to subscribers in the U. S. for \$7 50 per year. Specimen Nos. 3 cent stamp. Apply to  
novtf CHAS. H. MAROT, Agent, 814 Chestnut St., Phila.

**PLANTS BY MAIL! GREAT OFFERS!**

More liberal offers were never made than the following. We will send by mail, post paid, safe carriage guaranteed, any of the following collections on receipt of \$1.00:

No. 1.	8 beautiful Monthly Roses	for	\$1.00
No. 2.	25 choice Verbenas, assorted	"	1.00
No. 3.	10 very fine Zonale Geraniums	"	1.00
No. 4.	10 best Double "	"	1.00
No. 5.	12 beautiful Coleus, assorted colors	"	1.00
No. 6.	10 choice Fuchsias, double and single	"	1.00
No. 7.	12 fine Monthly Carnations	"	1.00
No. 8.	12 best Chrysanthemum, assorted	"	1.00
No. 9.	10 Bouvardias, assorted colors	"	1.00
No. 10.	12 Double Tuberoses, 1st size	"	1.00
No. 11.	18 choice Bedding Plants, assorted	"	1.00
No. 12.	20 beautiful Basket Plants	"	1.00

Not less than one collection will be mailed. Any six of these collections will be mailed to one address for \$5.00, with directions for treatment.

Our handsome illustrated Catalogue of Plants, 1876, sent free to customers, and all others on receipt of one cent stamp.  
Wholesale Price List Form. Est'd 1851. **PAUL BUTZ,**  
Caplz Croton Flower Gardens, New Castle, Pa.

# SEEDS.

My New Priced Lists are ready, and mailed free. They contain the most desirable kinds of

## VEGETABLE, FIELD

## FLOWER SEEDS,

including all the important novelties of 1875.

## ALFRED BRIDGEMAN,

876 Broadway, New York.

### GOOD PLANTS, PURE, PACKED FREE.

100 or less Strawberries, dozen other plants by mail

	doz.	100	1000
Monarch of West, 10000,	50c.	\$1.00	\$ 6.00
Wilson Albany, 10000,	40c.	75	2.50
Chas. Downing, 10000,	40c.	75	2.50
Kentucky, 10000,	40c.	75	2.50
Juennada, Col. Cheeny,	40c.	1.00	6.00
Boyd, No. 30, Agriculturist,	40c.	80	4.00
Triumph de Gand,	40c.	80	5.00
Green Prolific, 10000,	40c.	75	3.00
Pres. Wilder, Hudson Early, Early Surprise, Kessina Champion Cowing Seedling,	40c.	75	4.00
Star of West, Springdale, Cumberland Triumph,	1.25	7.00	
Dutcan Strawberry,	1.00	5.00	20.00
Excelsior,	5.00	30.00	
Doolittle B. Cap Ras.,	50	1.00	8.00
Brandywine,	1.00	2.00	15.00
Herstine and Saunders,	1.00	3.00	25.00
Wilson Early Blackberry,	50	3.00	29.00
Kittaning, L. W. W.,	50	1.00	8.00
Col. Asp. seed 50c. per lb., roots,	20	1.00	3.00
Early Beatrice, Rivers Louise, and 15 other later sorts,			8.00 60.00

For any of the above or prices of Currants, Grapes, &c., please address **JOHN S. COLLINS,** mchl Moorestown, N. J.

## PEACH STONES MAZZARDS, CHERRY STONES.

A limited Stock of First-class Quality can still be supplied.

THOMAS MEEHAN,  
Germantown, Phila.

Jan 2.

## NEW AND RARE

# PLANTS,

FOR 1876.

**HENRY A. DREER,** Seedsman and Florist, 714 Chestnut Street, Philadelphia, takes pleasure in offering the following to the trade, a portion as Novelties for 1876. Prices Net. The balance of New things will be offered later, as stock will admit.

**Alocasia Gibsoni.** Large leaves marbled green and black; constant, \$3.00 per dozen.

**Caladium Tubers.** Strong undivided tubers of choice varieties \$12.00 per hundred.

**Canna Bremingsi.** Broad green foliage ornamented with broad bands of yellow; constant, \$3.00 per dozen.

**Camellia Stocks,** for spring grafting, strong, \$15.00 per 100.

**Fuchsia, Sun-ray.** Tricolor foliage, fine plants, \$2.00 per dozen.

**Geranium, Apple-scented,** \$5.00 per 100.

**Oleander, Double White,** "Mandoni Grandiflora," \$4.00 per dozen.

**Oleander, Double, Purple,** Purpurea Plena, \$6.00 per dozen.

" **Yellow, Flavum Duplex,** \$6.00 per dozen.

**Pelargonium, Double Show (Regal), "Queen Victoria,"** \$9.00 per dozen.

**Petunia.** Our new set of Double varieties in advance of any yet introduced, \$2.00 per dozen. New Set of Single varieties. The finest show varieties in 12 sorts, \$2 per dozen.

**Senecio Macroglossum.** A New German Ivy with dark thick, leathery leaves, very glossy, nearly like an Ivy, \$4.00 per dozen.

**New Double Show Pelargoniums, Single Zonale Geraniums, New Roses, &c.,** a description of which, please see Dreer's Garden Calendar, now ready, and mailed to all applicants.

## HENRY A. DREER,

714 Chestnut Street,

and

PHILADELPHIA.

## THE NEW SCENTED PELARGONIUM TRANSIT.

Was raised in 1874, and is chiefly distinguished for the strong citron odor of its leaves. The plant is a vigorous grower; leaves large and finely formed, and footstalks much longer than those of the well-known Rose-scented variety, thus rendering it more valuable to florists.

It was exhibited at the New York Horticultural Society's Meeting, January last, and noticed as "a Seedling of Great Promise."

Price, 75 cts. each.

## A. VEITCH,

NEW HAVEN,

Conn.

Jan 2

# WABAN CONSERVATORIES

OFFICE :  
56 BROAD ST., BOSTON.  
Address all Letters to  
BOSTON OFFICE.

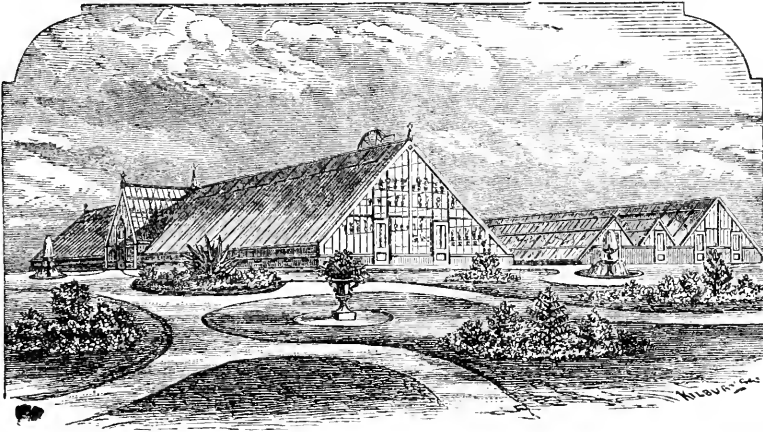

Send all Telegrams by  
Atlantic & Pacific Line. Address,  
*Waban Conservatories,*  
LAKE CROSSING, MASS.

## THESE CONSERVATORIES

Have in stock at all times, and offer at Wholesale,

## CUT FLOWERS IN QUANTITY, CONSISTING OF

**Bon Silene, Saffrano and Isabella Sprunt Roses, Marechal Niel and General Jacquiminot, in great quantity, Souvenir de Malmaison, Yellow Tea, Persian Yellow, Devonensis, Gloire de Dijon in limited amounts. Belle Lyonnaise, Perle de Lyon, La France Rose in large quantity.**

**White and Red Bouvardia, White and Red Carnations, Violets, Stephanotis, Tuberoses, Jessamine and a general assortment of Cut Flowers used by the best Florists.**

**Smilax & Fern Fronds in very large quantities for Decoration.**

NEW ROSES, }  
NEW PLANTS, } AT LOWEST RATES.

We are now packing and shipping Flowers with perfect success to Chicago, New York, Philadelphia, Baltimore, Washington, Montreal, and all important intervening places; and we are pleased to add that our shipments are giving universal satisfaction; our Telegraphic communications enabling us to fill orders to the most distant places quicker than Florists can obtain them by any other means.

We offer for the next sixty days SURPLUS STOCK of young ROSES, in 3-inch pots, of the leading varieties; Bon Silene, Safrano, Isabella Sprunt, Marshall Neil, Gen'l Jacqueminot, &c., &c., at unusually low rates by the 100 or 1000. New HYBRID PERPETUALS of 1876, at a great Reduction.

### GERANIUM "EARL ROSLYN,"

WARRANTED the best Bronze Zonale in cultivation, improving in color in the hottest sunlight.

BEDDING PLANTS of all descriptions at special rates for large quantities. For varieties see Catalogue, which will be mailed Free to all applicants.

**N. B.**—Particular attention given to Plan, Arrangement, Construction and Heating of Greenhouses for the growth of CUT FLOWER PLANTS at a Profit for Market. Advice as to the most profitable Flowers and Plants to grow, and method of culture. Nine-tenths of the Failures can be traced to want of Knowledge in the Construction, Arrangement and Heating of Houses, and the kinds of Plants and Flowers to put in them. New Beginners, we believe, will find our knowledge and large experience valuable to them.

EDMUND M. WOOD & CO.

# WEATHERED & CHEREVOY'S PATENT BOILERS

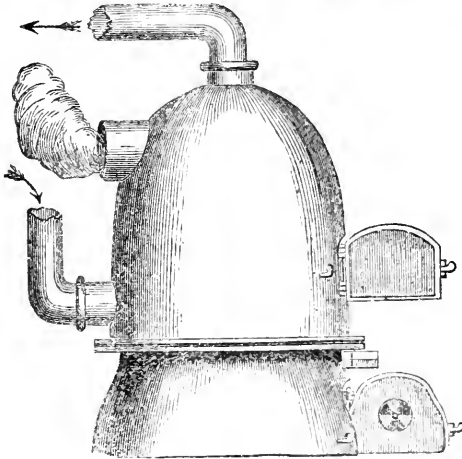

Fig. 1.

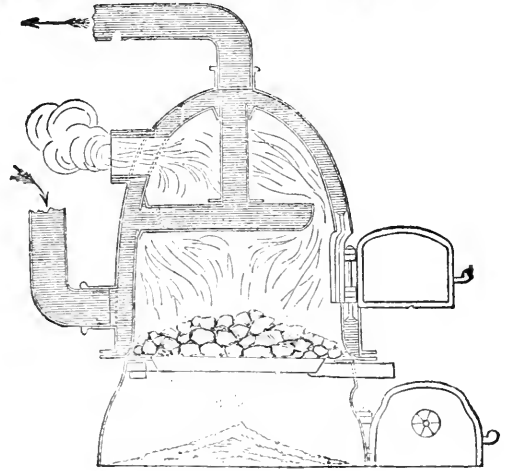

Fig. 2.

## AND IMPROVED HOT WATER APPARATUS,

No. 46 Marion Street, between Spring and Prince, New York.  
(TWO BLOCKS EAST OF BROADWAY.)

For Warming and Ventilating Public Buildings, Private Dwellings, Greenhouses, Graperies, Forcing Pits, Drying Rooms, and Heating Water for Public Baths.

Fig. 1 is an outside view. Fig. 2 is a vertical section through the centre.

*The following are a few names of Gentlemen who have our Boiler in use:*

Thos. Drake, Esq., Germantown, Pa.  
Simon Cameron, Esq., Harrisburg, Pa.  
J. D. Cameron, Esq., Harrisburg, Pa.  
Thos. Carter, Esq., Raleigh, N. C.  
J. H. Dunham, Esq., Chicago, Ill.  
Jas. B. Waller, Esq., " "  
W. J. Gordon, Esq., Cleveland, Ohio.  
Geo. Stanley, Esq., " "  
Harris Jaynes, Esq., " "  
Geo. W. Cuyler, Esq., Palmyra, N. Y.  
D. M. Osborn, Esq., Auburn, N. Y.  
John B. Dutcher, Esq., Pawling, N. Y.  
A. M. Allerton, Esq., Bronxville, N. Y.  
Robert Hoe, Esq., Tarrytown, N. Y.  
Peter Hoe, Esq., " "  
George Lewis, Esq., " "  
Wm. H. Drew, Croton Falls, " "  
Hon. James Y. Smith, Providence, R. I.  
Philip Caswell, Esq., Newport, R. I.  
Alfred Smith, Esq., " "  
Wm. Findlay, Esq., " "  
E. Learned, Esq., Pittsfield, Mass.  
D. O. Mills, Esq., San Francisco, Cal.  
W. L. Ferris, Esq., Westchester, N. Y.  
D. H. Haight, Esq., Goshen, N. Y.  
F. Newbold, Esq., Newark, N. J.  
James T. Closson, Esq., Plainfield, N. J.  
Daniel W. Coit, Esq., Norwich, Conn.  
J. F. Slater, Esq., " "  
H. W. Collender, Esq., Dorlen, " "  
Chas. P. Palmer, Esq., Stonington, "

Wm. D. Black, Esq., New Milford, Conn.  
Rev. Stephen H. Tyng, Irvington, N. Y.  
H. F. Spaulding, Esq., Riverdale, " "  
S. D. Balcock, Esq., " "  
Percy R. Pyne, " "  
Elisha Brooks, Esq., Inwood, " "  
Camille Marie, Esq., " "  
A. F. Smith, Esq., Fort Washington, " "  
B. M. Olyphant, Esq., Dobb's Ferry, " "  
Clarkson N. Potter, Esq., New Rochelle, " "  
Chas. D. Dickey, Esq., West Farms, " "  
Wm. Matthews, Esq., Harrison, " "  
William Chorlton, Esq., New Brighton, S. I.  
F. H. Wolcott, Esq., Astoria, L. I.  
Bailey Leach, Esq., " "  
Hon. W. B. Ogden, High Bridge, N. Y.  
Peter Moller, Esq., 295 Fifth Ave., New York City.  
Wm. Moller, Esq., 6 West 20th St., " "  
John Moller, Esq., 127 East 54th St., " "  
John Moller, Esq., 8 East 37th St., " "  
Ch. Moller, Esq., 426 Washington St., " "  
Henry B. Laidlaw, Esq., 33 Pine St., " "  
George W. Lane, Esq., 93 Front St., " "  
J. P. Robinson, Esq., 14 Centies Slip, " "  
J. B. Colgate, Esq., 47 Wall St., " "  
John B. Trevor, Esq., 47 Wall St., " "  
Charles Butler, Esq., 12 " "  
Richard Arnold, Esq., 309 Canal St., New York City.  
Jas. M. Constable, Esq., 309 Canal St., " "  
W. T. Garner, Esq., 61 Worth St., N. Y. City.

Please send for Circular with list of References and Reduced Prices to

THOMAS W. WEATHERED, 46 Marion Street, N. Y.



1876 DREER'S GARDEN CALENDAR, 1876

Contains descriptive and price list of Vegetable, Flower and Grass Seeds, Plants, Bulbs, Novelties, and every GARDEN REQUISITE. Beautifully illustrated. Send two 3 ct. stamps for postage.

HENRY A. DREER,

an6 714 Chestnut Street, Phila

GREEN HOUSE AND BEDDING PLANTS.

Large stock; fine assortment; packed to go safely any distance. Satisfaction guaranteed. Send 3-cent stamp for splendid Illustrated Catalogue. Address

R. G. HANFORD & SON, Columbus, Ohio,

mch3

The Gardener's Monthly.

THE FOLLOWING

BACK NUMBERS

WANTED, IN

GOOD CONDITION.

April, 1860.	October, 1870.	August, 1874.
January, 1870.	December, "	December, "
March, "	January, 1873.	January, 1875.
July, "	January, 1874.	December, "
		January, 1876.

Receivable in exchange on Subscription account, or exchangeable for other numbers not in above list. Send numbers and advise the publisher by letter. Address,

CHAS. H. MAROT,  
814 Chestnut, St., Phila.

GARDENING FOR THE SOUTH, or HOW TO GROW VEGETABLES AND FRUITS.

By WM. N. WHITE.

Containing instructions and hints in formation and management of Gardens, Soils and improvement, manures and their sources, rotation, hot-beds, cold frames, pits, propagation, budding and grafting, pruning and training, transplanting, mulching, shading and watering, protection, garden implements, insects and vermin, Vegetables, Fruits, description, varieties and culture. Illustrated, 444 pages, 12mo, Cloth. Price \$2.00. Sent by mail, post-paid, on receipt of price. Address, CHAS. H. MAROT, 814 Chestnut St., Phila.

PRESERVING, PICKLING AND CANNING FRUIT.

By MRS. M. E. PETERSON.

Containing a choice collection of receipts of Preserving, Pickling, and Canning Fruits, many of them being original from house wives of experience. 72 pages, 16mo, Cloth. Price 50 cents. Sent by mail, post-paid, on receipt of price.

Address, CHAS. H. MAROT,  
814 Chestnut St., Phila.

THE OFFICIAL GUIDE BOOK TO

PHILADELPHIA AND CENTENNIAL EXHIBITION.

By THOMPSON WESTCOTT.

Author of the History of Philadelphia. The only full and complete Guide Book. Illustrated with two maps and 93 engravings. 425 pages, 16mo, Cloth, \$1.50; Morocco, \$2.00. Mailed, post-paid, on receipt of price. Address,

CHAS. H. MAROT,  
814 Chestnut St., Phila.

The Nurseryman's Directory.

A reference book of the Nurserymen, Florists, Seedsmen, Tree Dealers, &c., for the United States. Alphabetically arranged by States and Post Offices. 242 pages, 8vo. Price \$5. Mailed, post-paid, on receipt of price.

Address, CHAS. H. MAROT,  
814 Chestnut St., Phila.

Orchid Culture.

By EDWARD SPRAGUE RAND, JR.

Including culture, propagation, collection and hybridization of Orchids; the construction and management of Orchid-houses; a glossary of Botanical terms and significance of their names; the whole forming a COMPLETE MANUAL of ORCHID CULTURE. Cloth 12 mo, 476 pages. Price \$3.50. Mailed, post-paid, on receipt of price.

Address, CHAS. H. MAROT,  
814 Chestnut St., Phila.

ORCHID GROWER'S MANUAL.

By BENJAMIN S. WILLIAMS, F.R.H.S.

Containing brief descriptions of over 800 species and varieties, with notices of times of flowering, approved modes of treatment and practical instructions on general culture. Remarks on heat, moisture, soil, seasons of growth and rest suited to the several species. Enlarged edition with illustrations. 300 pages, 12mo, cloth. Price, \$2.00. Sent by mail post-paid on receipt of price.

Address, CHAS. H. MAROT,  
814 Chestnut Street, Philadelphia.

A Hygroscope for 50 cents.

THE CHEMICAL HYGROSCOPE.

This indicator of atmospheric moisture is as accurate as the costly ones. Rooms heated by furnaces or stoves are almost invariably so dry as to be damaging not only to health but to furniture. Some people take the consequences others keep water on the heater. The Hygroscope shows at a glance whether the air is too dry or not.

Sent by mail for 50 cents. Address, febtff CHAS. H. MAROT, 814 Chestnut St., Philadelphia.

WALTER ELDER,

Landscape and Jobbing Gardener,

1231 Rodman Street, Philadelphia,

Attends to all branches of his business on reasonable terms.

FLORA OF THE SOUTHERN STATES.

By A. W. CHAPMAN, M.D.

Containing abridged descriptions of the FLOWERING PLANTS and FERNS of Tennessee, North and South Carolina, Georgia, Alabama, Mississippi and Florida, arranged according to the Natural system. 621 pages, 8vo, cloth. Price, \$3.60. Sent by mail post-paid on receipt of price.

Address, CHAS. H. MAROT,  
814 Chestnut Street, Philadelphia.

AMERICAN FRUIT CULTURIST.

By JOHN J. THOMAS.

Practical directions for the Cultivation of Fruit Trees in the NURSERY, ORCHARD AND GARDEN. Descriptions of the principal American and Foreign varieties. Plain Edition, 430 engravings, 511 pages, 12 mo. Price, \$3.00. Mailed post-paid on receipt of price.

Extra Edition, 576 pages, heavy paper, fine cloth, 508 illustrations and chromo frontispiece; mailed, for \$3.75. Address CHAS. H. MAROT, 814 Chestnut St., Phila.

GRAPE CULTURALIST.

By Andrew S. Fuller.

A treatise on the Cultivation of the Native Grape. Illustrated. 286 pages, 12mo, cloth. Price \$1.50. Sent by mail post-paid on receipt of price.

Address CHAS. H. MAROT,  
814 Chestnut St., Phila.

Index to Advertisements.

Advertisers are requested to have orders in hand as EARLY AS POSSIBLE. Copy received after the 23rd of each month cannot be INSURED insertion in the next issue.

Aldous James, Iowa City, Iowa.....	8
Alkemade, M. C. & Co., Haarlem, Holland.....	6
Allen S. L., Philadelphia.....	5
Barrett W. E. & Co., Providence, R. I.....	9
Baversdorfer M. M. & Co., Philadelphia.....	4
Bliss B. K. & Sons, New York city.....	cover
Bridgeman A., New York City.....	12
Butz Paul, New Castle, Pa.....	12
Burnett, Alex., Reading, Pa.....	2
Chadborn & Coldwell, Newburgh, N. Y.....	3
Christian at Work, New York city.....	11
Collins Jno. S., Moorestown, N. J.....	12
Comly, James, Lexington, Mass.....	5
Crandall, J. E. S., Rockville, R. I.....	11
Critchell B. P., Cincinnati, Ohio.....	6
Dreer Henry A., Philadelphia.....	12, 13
Eisele Bros., Tioga, Philada.....	5
Elder Walter, Philadelphia.....	15
Ellis Chas. R., New York city.....	9
Fergusson, David, Phila.....	8
Foster P. H., Babylon, N. Y.....	8
Gilmore, S. J., Lawrence, Kan.....	2
Hance A. & Son, Red Bank, New Jersey.....	5, 8
Hanford R. G., & Son, Columbus, O.....	15
Harkett Wm. A., Dubuque, Iowa.....	5
Harkins, Daniel, Wilkesharre, Pa.....	2
Henderson Peter & Co., New York city.....	cover
Hews A. H. & Co., North Cambridge, Massachusetts.....	3
Hinrichs C. F. A., New York city.....	7
Hitchings & Co., New York city.....	7
Hoopes Bros. & Thomas, West Chester, Pa.....	2
Jackson, Thomas, Portland, Me.....	6
Jones, A. L., Le Roy, N. Y.....	6
Jordan, J. M. & Bro., St. Louis, Mo.....	1
Landreth, D. & Son, Phila.....	3
Lord's Horticultural Works, Irvington, New York.....	10
Lynch Richard, Philadelphia.....	5
Marot, Chas. H., Philadelphia.....	11, 15, 16, Fly-leaf
Meehan Thomas, Germantown, Philadelphia.....	4, 6, 8, 9, 12
Miller & Hayes, Mount Airy, Philadelphia.....	6, 8
Moon W. H., Morrisville, Pa.....	2, 3, 5, 6
Ninmo Alexander, Brooklyn, New York.....	10
Parsons R. B. & Co., Flushing, N. Y.....	16
Parsons S. B. & Sons, Flushing, New York.....	cover
Pennock Manufacturing Co., Kennett Square, Pa.....	9
Raoux C., New York city.....	8
Roehrs J., Jersey City, N. J.....	11
Rolker A. & Sons, New York city.....	Fly-leaf
Root J. B., Rockford, Ill.....	3, 5
Rotureau F. E. & Co., Angers, France.....	5
Rue Geo. W., Hamilton, Ohio.....	5
Sander Chas., Jamaica Plain, Mass.....	3
Scollay John A., Brooklyn, New York.....	9
Sked, Paddock & Co., Cleveland, Ohio.....	2
Smith & Powell, Syracuse, N. Y.....	5
Steffens N., New York city.....	5
Straiton & Storm, New York city.....	5
Trowbridge, F., Milford, Conn.....	2
Veitch A., New Haven, Conn.....	12
Wampler John, Carthage, N. Y.....	11
Weathered & Cherevoy, N. Y. City.....	14
Weber, Henry, Cumberland, Md.....	2
Whitman & Lang, Philadelphia.....	9
Williams E. & J. C., Mont Clair, N. J.....	11
Wilson William C., New York city.....	8
Wood Edmund M., Boston, Massachusetts.....	4, 13

SITUATIONS WANTED.

A S Propagator in some good establishment, has had 30 years' experience, both in this country and England, or would accept of a good private place. Unquestionable reference given. A. C. Andrews, care F. Schmoltd, Jr., cor Superior and Delaware sts., Cleveland, Ohio.

BY a married French Gardener (age 35), small family, desires to engage as foreman in a commercial establishment, or as gardener in a first-class private place. Best references can be given. Address, A. S., care G. Schellhamer, 11 Minnesota St., Cleveland, Ohio.

R. B. PARSONS & CO.,  
Bowne Avenue, Flushing, N. Y.,  
OFFER THEIR  
RARE TREES & SHRUBS

as well as the well known sorts, and invite the special attention of

LARGE BUYERS

To their Stock of Rhododendrons, Azaleas—Chinese and Ghent—Camellias, Clematis, Hydrangeas, Magnolias Roses by the 1,000.

RARE EVERGREENS,

are well known to be cultivated in large variety by them. For Catalogues address

Box 99, Flushing, N. Y.

feb.12

PARSONS ON THE ROSE.

By Samuel B. Parsons.

A treatise on the Propagation, Culture and History of the Rose. Illustrated. 215 pages 12mo, cloth. Price \$1.50. Sent by mail post-paid on receipt of price.

Address CHAS. H. MAROT,  
814 Chestnut St., Phila.

ROSES AND ROSE CULTURE.

By WM. PAUL, F.R.H.S.

The rationale of Rose cultivation in a nut-shell. Intended to place, within a small compass all that is necessary for the successful cultivation of the "Queen of Flowers." 83 pages, 12mo, paper-boards. Price, 50 cents. Sent by mail post-paid on receipt of price.

Address, CHAS. H. MAROT,  
814 Chestnut Street, Philadelphia.

BOOK OF ROSES.

By Francis Parkman.

Description, Cultivation and Propagation. Beautifully Illustrated. 225 pages, 12mo, cloth. Price \$1.50. Sent by mail post-paid on receipt of price.

Address CHAS. H. MAROT,  
814 Chestnut St., Phila.

ROSE GARDEN.

By Wm. Paul, F. R. H. S.

Embracing History of the Rose; formation of Rosarium; detailed account of practice for successful cultivation; arrangement in natural groups of most esteemed varieties, English and Foreign, in the most eminent Gardens; with full description and remarks on origin and mode of culture. Numerous illustrations. 256 pages, Royal 8vo, cloth. Price \$3.00. Sent by mail post-paid on receipt of price.

Address CHAS. H. MAROT,  
814 Chestnut St., Phila.

PRACTICAL FLORICULTURE.

By PETER HENDERSON.

A Guide to the successful cultivation of FLORISTS' PLANTS, for the Amateur and Professional Florist. Illustrated. 88 pages, 12mo, cloth, Price, \$1.50. Sent by mail post-paid on receipt of price.

Address, CHAS. H. MAROT,  
814 Chestnut Street, Philadelphia.

GARDENING BY MYSELF.

By Anna Warner.

Containing Hints and Experiences under heading of each month in the year. Illustrated. 16mo, 223 pages, cloth. Price \$1.25. Sent by mail post-paid on receipt of price.

Address CHAS. H. MAROT,  
814 Chestnut St., Phila.



# FLORISTS' STOCK, TWO MILLION PLANTS!

AT WHOLESALE.

Examine and COMPARE PRICES. Safe delivery GUARANTEED if sent by Express. No Charge for Boxes or Packing. Five plants will be sold at the hundred rate, provided 100 plants are taken in one order.

	Per 100.		Per 100.
Asilbe Japonica, large,	\$25.00	Lemon Verbenas, strong plants,	6.00 to 10.00
Achyranthes, 4 distinct sorts,	6.00	Lobelia, new double blue,	4.00
Alternantheras, 4 distinct sorts,	6.00	“ six distinct and beautiful sorts,	4.00
Basket Plants, 25 different sorts,	4.00	Lygodium Scandens, (Japanese Climbing Fern),	8.00
Begonias, 6 best flowering sorts,	6.00	Mesembryanthemum cordifolium	
“ Argyroneura Veitchii, 3		var. (var'd Ice plant),	6.00
inch pots,	8.00	Mosses, (Lycopodiums and Selaginellas)	
Carnations, 25 sorts, fine young plants,	6.00	6 sorts,	6.00
Caladiums, Fancy, 25 distinct sorts,	12.00	Pampas Grass, strong roots, 4 inch pots,	25.00
Canna Indica, 6 sorts,	6.00	Pansies, very fine mixed English,	4.00
Chrysanthemums, 50 leading sorts,	6.00	“ 12 separate colors, pot grown,	6.00
Calceolaria Aurea and Brown Prince,	8.00	Phloxes, 25 named sorts,	6.00
Calceolaria Herbaceous, very fine,	6.00	Pinks, Florists', 12 sorts,	6.00
Calla Ethiopica, fine plants,	\$6.00 to 25.00	Pinks, Alba Fimbriata, (white fringed),	6.00
Centaurea Gymnocarpa, white leaved,	10.00	Petunias, single, finest striped and blotched	4.00
Coleus, Golden and Velvet, 25 best sorts,	6.00	Petunias, double, 6 sorts,	8.00
Cobea Scandens, var., good plants,	25.00	Pentstemons, 6 distinct sorts,	6.00
Cineraria, 2 sorts, white leaved,	6.00	Roses, Monthly, Tea, Bourbon and Bengal,	
Cineraria Hybrida, (flowering sorts),	6.00	50 best sorts. Hybrid Perpetual	
Dianthus Querteri, (German Pink),	8.00	and Hardy Climbing, 40 best sorts.	
Dahlias, Green Cuttings, 100 sorts,	8.00	Winter flowering, 6 leading sorts.	
Daisy, English, (Bellis perennis),	6.00	Prices of the above Roses:	
Daisy, (New) Queen Victoria	10.00	Our selection of sorts, 3 inch pots,	8.00
Echeveria, 4 distinct sorts,	6.00	Our “ “ “ 4 “ “	12.00
Eulalia Japonica, new variegated grass,	16.00	Our “ “ “ 5 and 6 inch pots	
Fittonia, (Gymnostachyum) 4 sorts,	6.00	ready for sale now, just coming in-	
Fuchsias, 25 sorts, very fine plants,	\$5 to 8.00	to flower,	20.00
Ferns, 12 sorts, fine young plants,	8.00	Smilax, (Myrsiphyllum Asparagoides),	
Golden Feather,	8.00	2½ inch pots,	4.00
Geraniums, Double, in 12 sorts,	6.00	Salvias, scarlet, white, etc.,	6.00
“ Zonale, 30 leading sorts,	6.00	Tritoma (Red-hot-poker plant)	6.00
“ Ivy leaved, 12 sorts,	6.00	Tuberose, Pearl, Southern grown,	8 to 12.00
“ Silver, 6 distinct sorts,	8.00	“ common, double,	\$3, \$4 and 6.00
Gladiolus, fine mixed,	4.00	Verbenas, named in 60 varieties,	\$3 per set, 5.00
“ 25 named sorts,	8.00	“ to special name or special color,	5.00
Hibiscus, 3 sorts,	6.00	“ in twelve best market sorts,	4.00
Heliotropes, 8 sorts,	4.00 to 8.00	“ mixed, without name or color,	3.00
Honeysuckle, Golden Japan, 2½		Besides nearly every other plant in cultivation	
inch pots,	5.00	by Florists, for which see our Monthly Price Cur-	
Ivies, English, three feet long,	12.00	rent of Plants, Seeds, &c.	
Latania Borbonica, (Fan-leaved Palm),		Every Plant is labelled.	
3 inch pots,	12.00		
Lantanas, 25 named sorts,	8.00		
“ unnamed,	5.00		

## VEGETABLE PLANTS.

	Per 1000.		Per 1000.
Cabbage, Early Jersey Wakefield, (cold		Lettuce, Boston Market and Curled Simp-	
frame plants),	10.00	son,	10.00
Spring sown plants of the above ready in May, at half the above rates. TOMATO, PEPPER, CELERY		and EGG PLANTS contracted for at low rates. Also,	

## FLORISTS' REQUISITES.

Consisting of all Styles of WIRE DESIGNS for CUT FLOWERS, FRENCH IMMORTELLS and GRASS BOUQUETS, BOUQUET PAPERS, GARDEN TRELLISES, PLANT STANDS, RUSTIC WORK, and many other articles, all of which are priced very low in our *Monthly Wholesale List*, mailed free to those who apply.

**PETER HENDERSON & CO.,**

Dec. 6.

35 Cortlandt St., New York.

# S. B. PARSONS & SONS,

## Kissena Nurseries,

### Near KISSENA STATION, FLUSHING, N. Y.,

OFFER a very large assortment of TREES and PLANTS of all the best families. Nearly all of them have been two years transplanted, and their roots are thus in the very best possible condition for a second transplanting.

Their assortment of **RARE EVERGREENS** has long been known to be the most complete. They now have in cultivation a very large variety of hardy

## Deciduous Trees and Shrubs,

numbering over 800 sorts, of which 300 sorts, one year grafted, are entirely new and have not yet been in their catalogue.

Their JAPANESE DEPARTMENT now includes more than 150 varieties in addition to the above, and is being constantly enriched by Thomas Hogg, now in Japan. Many of these varieties are unknown in Europe. The celebrated JAPANESE MAPLES and AZALEA MOLLIS are alone worthy of a visit.

CAMELLIA JAPONICA and AZALEA INDICA can be advantageously shipped during September, October and November; September being preferred. These plants are carefully formed and trimmed, and their symmetry is recognized by all who see them.

Rhododendrons and other hardy Evergreens can be safely transplanted in September.

Estimates will be furnished for Planting Grounds under the care of an experienced Landscape Gardener, and much trouble thus saved to the owner.

Catalogues will be furnished to applicants by mail, and those who wish to visit the Nurseries will always find either one of the proprietors, or J. R. Trumpy, the well-known propagator of the old establishment. They can take the ferries at 34th Street or James' Slip, which connect with the railroad, leaving the first a quarter of an hour, and the last half an hour before the departure of trains, which make the transit in half an hour. The Nursery is adjoining the Kissena Station and one and a half miles from the other stations. sep

## NEW AND BEAUTIFUL JAPAN LILIES.

Now offered for the first time in this Country by B. K. BLISS & SONS, NEW YORK.

### LILIUM KRAMERI.

Since the introduction of the beautiful *Lilium Auratum*, first brought out by us in 1867, nothing has been offered that will compare with this lovely variety. We take much pleasure in being the first to offer it in this country, having received a consignment of this and the following variety (*Lilium Hansonii*) direct from Mr. Thomas Hogg, to whom we are already indebted for many of our most popular Japanese plants, who thus describes it: "Its general character is that of *L. longiflorum*, of which it may prove a variety, only its flowers, instead of being white, are of various shades of pink color. Coming from the southern part of Japan, it may not prove hardy at the North, but for a greenhouse or frame culture it will be an acquisition of no little merit, owing to its beautiful shades of color." It was exhibited in England last season, and received a first-class certificate from the Royal Horticultural Society, where it attracted considerable attention suggesting the idea of a natural hybrid, between *longiflorum* and *Auratum*. It bears a considerable resemblance to the latter Lily, both in shape and size, but has neither spot or centre band. The petals are suffused with a bright delicate pink blush. Mr. Kramer writes: "Among them are some new and sterling varieties of all colors, from a pure white to a rich rose or mauve tint. When well cultivated at home it will make a charming Lily."

Flowering Bulbs, \$2.00 and \$3.00; extra size Flowering Bulbs, grown in this country one year, \$5.

### LILIUM HANSONI.

This new and beautiful Japan Lily was named by Max Leichtlin, of Carlsruhe, Baden, in honor of Mr. P. Hanson, of Brooklyn, N. Y., and to whom we are indebted for the accompanying description. We believe that the plant in Mr. Hanson's garden is the first one of the kind that has bloomed in this country. This Lily is of a gigantic structure, often attaining a height of from four to six feet, and has proved to be quite hardy. The leaves are produced in whorls, and are seven to eight inches long and two broad. The flowers are borne in clusters, and the buds being nearly globular they look very much like potato balls. The full expanded flowers are about two and a half inches in diameter, and the petals are very thick, looking more like wax than natural flowers. Their color is also very peculiar, one side of the petals being yellow with a streak of white running through the centre; the other side is a brilliant yellow spotted with purple. It is not quite as showy a Lily as the *Auratum*, or some of the varieties of *speciosum*; still it is one of the most interesting and valuable varieties introduced in some time. This variety was never before offered in this country, and is to be found only in a very few collections in Europe. Flowering Bulbs, \$5.00 each.

### LILIUM AURATUM.

"This golden-rayed *Queen of Lilies* is the most beautiful of the Lily family. It is perfectly hardy, and for the adornment of the flower garden, the conservatory, and the sitting-room it is unrivaled."

	Each.	Doz.
Lilium Auratum Flowering Bulbs,.....	\$0 30	\$3 00
— — — large size,.....	50	4 50
— — — extra size,.....	1 00	10 00
— Lancifolium Album, pure white,.....	50	5 00
— — rubrum, white, spotted with crimson,.....	25	2 50
— — roseum, white, spotted with rose,.....	25	2 50
— Punctatum, white, spotted with delicate Salmon,.....	75	7 50

Bliss's Illustrated Seed Catalogue and Amateur's Guide to the Flower and Kitchen Garden, contains a descriptive list of 2500 varieties of Garden, Field and Flower Seeds, with explicit directions for culture, 200 pages, several hundred engravings, and a beautifully colored lithograph. Sent post-paid, for 35 cents.

Bliss's Gardener's Almanac and Abridged Catalogue of Garden, Field and Flower Seeds. 116 pages, beautifully illustrated, mailed to all applicants inclosing 10 cents.

Bliss's Illustrated Potato Catalogue contains a descriptive list of all the new varieties recently introduced, with many other desirable sorts, also much useful information upon their cultivation. 32 pages, 10 cents.

**B. K. BLISS & SONS,**  
34 Barclay Street, New York.

P. O. BOX No. 5712.



THE  
GARDENERS  
And MONTHLY  
HORTICULTURIST

EDITED BY THOMAS MEEHAN.

Vol. XVIII.

No. 210.

(Combined Magazines, Thirty-first Year.)

**JUNE, 1876.**

PUBLISHED BY CHARLES H. MAROT

814 Chestnut Street, Philadelphia.

TERMS—\$2.10 PER YEAR—POSTAGE PAID.

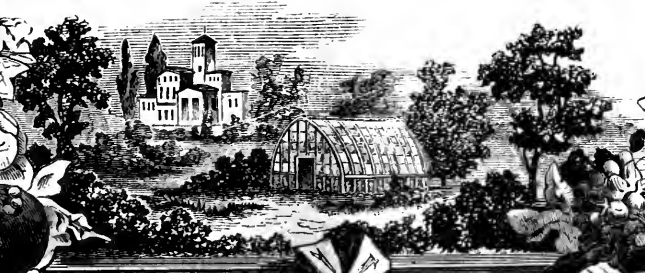

For Annuals &c.

J. S. Stockton, Jr.

# THE GARDENER'S MONTHLY AND HORTICULTURIST.

EDITED BY THOMAS MEEHAN,

Assisted by an able Corps of AMERICAN and FOREIGN CORRESPONDENTS.

It is published on the first of every month, at the office, No. 814 CHESTNUT STREET, PHILADELPHIA, where all BUSINESS communications should be addressed.  
Communications for the Editor should be addressed: THOMAS MEEHAN, GERMANTOWN, Philada.

SUBSCRIPTION PRICE, Postage paid, \$2.10.

## TERMS OF ADVERTISING.

	1/8 col.	1/4 col.	1/2 col.	3/4 col.	1 col.	1 page.
One Time,	\$3.00	\$4.00	\$6.00	\$8.00	\$12.00	\$18.00
Two to Three Times, each,	4.70	3.60	5.40	7.20	10.80	43.20
Four to Six Times, " "	2.25	3.00	4.50	6.00	9.00	36.00
Seven to Nine Times, " "	2.00	2.70	4.00	5.35	8.00	32.00
Ten to Twelve " "	1.80	2.40	3.60	4.80	7.20	18.80

Twelve lines nonpareil is 1/4 col. A less space than 1/4 col., will be furnished at rates in exact proportion, line for line.  
For THIRD and LAST COVER PAGES; FIRST PAGE advertisements facing reading matter; "FLY-LEAF PAGE" (front of number) before reading matter and facing first cover,—special figures will be given on application.  
COPY and orders for NEW advertisements should be in hand by the 23d of each month; and CHANGES of COPY in running contracts by the 16th of each month, to insure them in following issue. Address

CHAS. H. MAROT, Publisher, 814 Chestnut Street, Philadelphia.

## CONTENTS OF THE JUNE NUMBER.

### REASONABLE HINTS:

Flower Garden and Pleasure Ground.....	161-162
Green House and House Gardening.....	168
Fruit and Vegetable Gardening.....	172

### CORRESPONDENCE:

The Glories of Gardening; or, "The Goodliness of Trees".....	162
Dahlia Maximilliana.....	164
Beautiful Shrubs of S. Utah.....	164
Hardiness of Aralia Papyrifera.....	164
Who shall lay Out our Ornamental Grounds?.....	164
Culture of Combretum.....	168
Wild Goose Plum.....	172
A Few Apples that do Well in New Jersey.....	172
Grafting the Feathery Weeping Cherry.....	173
The Apple Borer.....	173
Huckleberries.....	174
Asparagus Culture.....	174
Pear Trees—Frozen-Sap-Blight.....	174
Grape Culture—The Wild Goose Plum.....	175
The Forest Trees of Delaware.....	176
General Observations on the Flora of Hokkaido.....	180

### EDITORIAL NOTES:

The Pomegranate—Chimonanthus fragrans—Festuca viridis for Edgings—The Original Golden Yew—A good Tea Rose for Market Purposes—Quercus fastigiata.....	166-167
The Australian or Parlor Ivy—Pinks for Summer Flowering—Carbolic Acid for House Plants—Ivy as a Decorative Plant—How to Dye Mosses, Grasses, Flowers, &c.—Propagating Roses.....	168-170

Nurserymen and Tree Planters—Abies Menziesii—Prizes for Tree Planting—Substitutes for Wood—The American Forestry Association—The Profits of Tree Planting—Ratio of Tree Growth in Iowa.....	178-180
New California Plants—Nomenclature—Bees and Flowers—Freezing of the Sap of Plants—Fertilization of Lilies—Effect of Weight on Tendrils—Annual Rootlets.....	183-18
American Pomological Society—Indiana Horticultural Society—Neunzehnter Jahres-Bericht des Gartenbau-Vereins für Bremen—Col. Wilder—John T. Norris—Burnett Landreth—Age of Mr. Charles Darwin—Hand-Book for Fruit Growers—Second Appendix to Downing's Fruits—Orchid Culture—Manual on the Culture of Small Fruits—The Mill Stone—The Rural New Yorker.....	186-190
Opening of the Centennial Exhibition.....	190-192

### NEW PLANTS:

Peraphyllum ramosissimum—Victoria Mignonette.....	167
New Hybrid Gloxinias—The Lilac-flowered Fuchsia.....	170-171

FORESTRY.....	176-180
---------------	---------

NATURAL HISTORY AND SCIENCE.....	180-186
----------------------------------	---------

LITERATURE, TRAVELS AND PERSONAL NOTES.....	186-190
---	---------

HORTICULTURAL SOCIETIES.....	190-192
------------------------------	---------

### QUERIES:

Proliferous Hyacinth—Lime Floors.....	167
Bryophyllum calycinum—Grafting Double Camellias—Summer Treatment of Camellias—Greenhouse Furnaces.....	171
Natural Peach Stones—American Apples in England—Small Fruits.....	176

# AUGUST RÖLKER & SONS,

32 READE STREET,

**NEW YORK,**

P. O. Box 899.

IMPORTERS AND DEALERS IN ALL KINDS OF

# F LORIST'S S SUPPLIES

## *BASKETS,*

*Wire Designs, Wire Tinfoil, Toothpicks, Bouquet  
Papers,*

ORNAMENTAL GRASSES,

IMMORTElLES, MOSS,

STUFFED PIGEONS, &c., &c.

We call the attention of Centennial Visitors to our Exhibition in Horticultural Building, S. W. Room.

**RURAL AND PRACTICAL BOOKS,** (and any others in the market not on this list) will be sent by mail, post paid, on receipt of price. Address CHAS. H. MAROT, 814 Chestnut St., Philada.

Allen, R. L., Diseases of Domestic Animals.....	\$1 00	How to Manage a Building Association.....	\$2 00
Allen, L. F., Rural Architecture.....	1 60	How to Paint.....	1 00
Allen, L. F., American Cattle.....	2 50	Hunter and Trapper.....	1 00
Allen, R. L. & L. E., New American Farm Book.....	2 50	Hussman's Grapes and Wines.....	1 50
American Architect.....	7 00	Jacques' Manual of the House.....	1 50
American Bird Fancier (Brown's).....	30	Jacques' Manual of the Garden.....	1 75
American Farmer's Encyclopedia.....	6 00	Jennings' Cattle Doctor.....	1 75
American Horticultural Annual, paper 50 Cts., cloth.....	75	Jennings on the Horse and his Diseases.....	1 75
American Weeds and Useful Plants.....	1 75	Jennings' Sheep, Swine and Poultry.....	1 75
Apple Culturist, S. E. Todd.....	1 50	Johnson's Gardener's Dictionary.....	3 50
Art of Saw Filing.....	75	Johnson's How Crops Grow.....	2 00
Architecture, Modern American, Cummings & Miller.....	10 00	Johnson's How Crops Grow.....	2 00
Principles and Practice of, By Loring & Jenning	12 00	Johnson's Peat and its uses.....	1 25
Baker's Fruit Culture.....	4 00	Johnston's Elements of Ag. Chemistry and Geology.....	1 50
Bassett on Cranberry Culture.....	30	Johnston's, J. S. W., Agricultural Chemistry.....	1 75
Barry's Fruit Garden.....	2 50	Kemp's Land-cape Gardening.....	2 50
Bell's Carpentry made easy.....	5 00	Kilpart's Farm Drainage.....	1 75
Bement's Poultryer's Companion.....	2 00	Langstroth, Rev. L. L., on the Hive and Honey Bee.....	2 00
Bement's Rabbit Fancier.....	30	Leuchars' How to Build Hot-houses.....	1 50
Beet Root Sugar.....	1 50	Leibig's, Justus, Familiar Lectures on Chemistry.....	75
Bicknell's Village Builder, 77 plates.....	12 00	Louden's Encyclopedia of Plants.....	20 00
Bommer's Method of Making Manures.....	25	Lyman's Cotton-culture.....	1 50
Boussingault's, J. B., Rural Economy.....	1 60	McMahon's American Gardener.....	2 25
Browne's Trees of America.....	6 00	Mayhew's Practical Book-keeping for Farmers.....	90
Breck's New Book of Flowers.....	1 75	Mechanics' Companion (Nicholson).....	3 00
Bridgeman's American Gardener's Assistant.....	2 50	Meehan's Ornamental Trees.....	75
Bridgeman's Fruit Cultivator's Manual.....	1 00	Miles on the Horse's Foot.....	75
Bridgeman's Kitchen Gardener's Instructor.....	1 00	Mincer, T. B., Bee-keeper's Manual.....	1 25
Buist's, Robert, Am. Flower Garden Directory.....	1 50	Mohr on the Grape-vine.....	1 50
Buist's, Robert, Family Kitchen Gardener.....	1 00	Money in the Garden.....	1 50
Burr's Field and Garden Vegetables of America.....	5 00	My Vineyard at Lak-view.....	1 25
Carpenter and Joiner (R. Riddell).....	7 60	My Farm of Edgewood.....	1 75
Carpenter and Joiner's Hand Book, (Holly).....	75	My Ten-rod Farm.....	50
Chorlton's Grape Grower's Guide.....	75	North American Sylva, 5 vols., 156 col. plates, in 30 parts,	
Chemistry of the Farm, (Nichols).....	1 25	"    "    unbound.....	60 00
Cleveland's Villas and Cottages.....	4 00	"    "    Half Turkey Antique, gilt.....	70 00
Cobbett's American Gardener.....	75	"    "    full.....	75 00
Cole, S. W., American Fruit Book.....	75	Nichol's Chemistry of the Farm and Sea.....	1 25
Cole's American Veterinarian.....	75	Norton's, John P., Elements of Scientific Agriculture.....	1 75
Cooper's Rural Hours.....	2 00	Norris' Fish-culture.....	1 75
Copeland's Country Life.....	5 00	Onion-culture.....	1 25
Dadd's, Geo. H., American Cattle Doctor.....	1 50	Our Farm of Four Acres.....	1 25
Dadd's Modern Horse Doctor.....	1 50	Packard's Guide to the Study of Insects.....	cloth 6 00
Dana's, Samuel H., Muck Manual.....	1 25	Paul's Book of Roses.....	20
Darwin's Variations of Animals and Plants, (2 vols.).....	6 00	Paul's Rose Garden.....	3 00
Darwin's Insectivorous Plants.....	7 00	Faxton's Botanical Dictionary.....	15 00
DeVoe's Market Assistant.....	2 50	Fardee on Strawberry-culture.....	1 50
Downing, A. J., Landscape Gardening.....	6 50	Farkman's Book of Roses.....	1 50
Downing's Cottage Residences.....	3 40	Parsons, Samuel B., on the Rose.....	1 25
Downing's Fruits and Fruit Trees of America.....	5 40	Peat and its Uses.....	1 25
Downing's Rural Essays.....	3 50	Pear-culture, Fields.....	1 25
Downing's Ladies' Companion to the Garden.....	2 00	Pedder's, James, Farmer's Land-measurer.....	60
Du Breuil's Vineyard Culture, (Dr. Warden).....	75	Peterson on Horse-culture.....	1 50
Eastwood on Cultivation of the Cranberry.....	1 50	Peterson's Preserving, Pickling and Canning Fruit.....	1 00
Elliott's Western Fruit Grower's Guide.....	1 50	Phin on Wine-making.....	1 50
Elliott's Lawns and Shade Trees.....	1 00	Quinn's Pear-culture for Profit.....	1 00
Elliott's Fruit Growers' Hand Book, paper, 50 cents, cloth	1 00	Quinby's Mysteries of Bee-keeping Explained.....	1 50
Farm Talk, (Brackett).....	1 00	Randall's Sheep Husbandry.....	1 50
Farming for Boys.....	1 50	Randall's Fine Wool Sheep Husbandry.....	3 00
Field's, Thomas W., Pear Culture.....	1 25	Rand's Bulbs.....	1 00
Five Acres too Much, (illustratd).....	1 50	Rand's Flowers for Parlor and Garden.....	3 00
Flagg's European Vineyards.....	1 50	Rand's Seventy-five Flowers.....	1 50
Flax Culture.....	50	Rand's Flower Garden.....	3 00
Flint, Chas. L., on Grasses.....	2 50	Rand's Orchid Culture.....	3 50
Flint's Milch Cows.....	2 50	Riddell's Architect.....	15 00
Fowler's Homes for All.....	1 50	Ropp's Commercial Calculator, cloth \$1, Morocco Tuck.....	2 00
Frank Forester's Fish and Fishing, 8 vo. 100 engravings.....	3 50	Rose Culturist.....	paper 30
Frank Forester's Manual for Young Sportsmen, 8 vo.....	3 00	Robbins, R., Produce and Ready Reckoner.....	75
French's Farm Drainage.....	1 50	Saunders' Domestic Poultry, paper 40.....	cloth 1 50
Fuller's Grape Culturist.....	1 50	Saxton's Hand Books, in four series, each.....	1 50
Fuller's Small Fruit Culture.....	1 50	Schenck's Gardener's Text-book.....	75
Fuller's Strawberry Culturist.....	25	Scribner's Ready Reckoner and Log-book.....	30
Fuller's Forest Tree Culturist.....	1 50	Strong's Cultivation of the Grape.....	3 00
Fulton on Peach Culture.....	1 50	Ten Acres Enough.....	1 50
Geyelin's Poultry Breeding.....	1 25	Thomas, J. J., Farm Implements.....	1 50
Gray's How Plants Grow.....	1 25	Thomas, J. J., Fruit-culturist; old ed., \$3 00; new edition,	3 75
Gray's Manual of Botany.....	2 25	Ville's Chemical Manures.....	1 25
Gray's Manual, Botany and Lessons, in one vol.....	4 00	Warder's American Pomology.....	3 00
Gray's School and Field Book of Botany.....	2 50	Hedges and Evergreens.....	1 50
Green on Trout Culture.....	1 00	Waring's Drainage for Profit and Health.....	1 50
Gregory on Squashes, paper.....	30	Elements of Agriculture.....	1 00
Guernon on Milch Cows.....	75	Earth Closets.....	50
Guide to Fortune.....	1 00	Webster's Dictionary, Unabridged.....	12 00
Harazthy's Grape Culture and Wine Making.....	5 00	Well's Every Man his own Lawyer.....	2 00
Harris' Insects Injurious to Vegetation, clo. \$4; col. eng's.....	6 50	Williams, B. S., on Stove & Greenhouse Plants, 2 vols., Ill'd.....	5 00
Harris on the Pig.....	1 50	Williams, B. S., on Select Ferns and Lycopods.....	2 50
Hatfield's American House Carpenter.....	3 50	Williams, B. S., Orchid Grower's Manual.....	2 50
Henderson's Practical Floriculture.....	1 50	Window Gardening.....	1 50
Henderson's Gardening for Pleasure.....	1 50	White's Gardening for the South.....	2 00
Henderson's Gardening for Profit.....	1 50	Cranberry Culture.....	1 25
Herbert's Hints to Horsekeepers.....	1 75	Wood's Class Book of Botany.....	3 50
Hoopes on Evergreens.....	3 00	Workingman's Way to Wealth.....	75
Hooper's Dog and Gun, paper 30 cents, cloth.....	60	Wright's Practical Poultry Keeper.....	2 00
Hop-culture.....	40	Youatt on the Horse.....	1 75
How to Buy a Farm, and Where to Find One.....	1 75	Youman's Household Science.....	2 00



SEE FIRST PAGE, FACING COVER.

**PUBLIC SALE**  
**OF OVER 100,000**  
**VALUABLE PLANTS,**

*At ROBERT BUIST, Sr.'s Rosedale Nurseries,*

DARBY ROAD & SIXTY-SEVENTH ST., 27th WARD, PHILA.

Commencing Tuesday, June 20th, 1876, on the Premises,

And continuing 21st, 22d and 23d, at 10 o'clock each day, at the ROSEDALE NURSERIES, Darby Road and 67th St., 27th Ward,

Comprising the whole of ROBERT BUIST, SR.'s Valuable Collection of Hot House and Green House Plants. Together with the Green Houses and Hot Water Erections.

The Stock is in First-class Condition and Consists of

20,000 Azaleas, all sizes, in perfection.

20,000 Camellias, in perfect health.

3,000 Crotons, including all the new sorts.

1,000 Dracenas, all true.

5,000 Ferns, including 3,000 Tree Ferns.

5,000 Geraniums, all the new sorts.

5,000 Palms, and about

40,000 Miscellaneous Green House and Hot House Plants, &c.

☞ This is the largest Public Sale of Valuable Plants ever made in the United States, and the Entire Collection will be sold without reserve or limitation.

☞ Visitors reach the Nursery by the red cars on Walnut street every half hour, or by the steam cars, from Broad and Prime streets, at 7, 10.30, 12.30, 2.50 and 3.40.

tjune.1

M. THOMAS & SONS, Auctioneers.

# The Centennial.

ADVERTISERS Are requested to note that CURRENT NUMBERS of THE GARDENER'S MONTHLY, from MAY to NOVEMBER inclusive,

will lie upon the tables of the Reading Room at Horticultural Hall, Centennial Grounds, for the inspection of the thousands directly interested in the stock you have for sale. Those who take advantage of this fact will have practically an extra circulation, during the months named. Two files of the MONTHLY, from May to November, will constantly remain for the inspection of visitors. Be in time with your orders. Take notice changes of copy in current advertisements must be in hand by the 16th of each month, and new orders by the 23d to insure insertion in following issue. Address C. H. MAROT,

t

814 Chestnut St., Philadelphia.

JOHN A. SCOLLAY,

## IMPROVED HOT WATER APPARATUS,

Patented September 17, 1872.

*For Warming and Ventilating Dwellings, Greenhouses, Graperies, Forcing Pits, Drying Rooms, Heating Water for Public Baths, &c.*

This Boiler is perfectly self-cleaning, simple, economical and powerful, having more effective surface into less space than any Boiler in the market. Scollay's Patent Plant Sprinkler, for Window Gardening, &c., to be obtained of all Seedsmen, Florists, &c. Send for Circular and Reference.

july12

351 Adams Street, Brooklyn, New York.

Visitors Guide to the  
**Centennial and Philadelphia.**

Only authorized Guide Book on Centennial Grounds. Map of Centennial Grounds, Map of Philadelphia, 48 pages, 12mo, mailed for 30 cents. Address,

CHAS. H. MAROT, 814 Chestnut St., Phila.

**C. F. A. HINRICHS,**

29, 31 and 33 Park Place, New York City,  
**HYACINTH AND BULB GLASSES.**

**DECORATED**

**FLOWER POTS,**

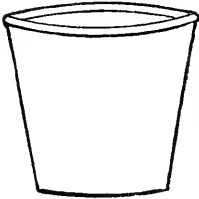

LAVA, MAJOLICA, &c., &c. Vases. Iron Sections for Flower Beds. Lawn, Fish and Flower Stands. Floating Animals for Aquaria. Button-hole Bouquet Holders. Only and Original GERMAN STUDENT LAMP for Conservatories.

Send for Prices to above address.

mch6

**KANSAS PACIFIC  
HOMESTEAD.**

This paper is full of reliable information about Kansas, her climate, soil, products and progress. Contains a nice map of the United States, and a fine view of a prosperous Colony from Pennsylvania.

It is a faithful guide to the best and cheapest land or lands in the West. 5,000,000 acres for sale. For a copy, send your address to  
S. J. GILMORE,  
Land Commissioner Kansas Pacific Railway, Lawrence, Kansas.

**WILL BE SOLD CHEAP.**

15,000 Fine Verbenas, as are in this country, in 50 varieties; and a general collection of Bedding and Basket Plants, Sweet Potato Plants. Send for Price List.

**HENRY WEBER,**

Cumberland, Md.

may2

New and Distinct Variegated Geranium,

**"HAPPY THOUGHT."**

The centre of the leaves of this novelty is nearly pure white extending two-thirds over the entire surface, and being of as free growth as a Zonale Geranium, will undoubtedly become a popular market variety. We now offer extra strong plants in 3-inch pots, per dozen \$5.00.

**Carnations**, in 12 varieties, 3-inch pots, per 100 \$4.00  
**Pansies**, choice strain, " " 3.00  
**Verbenas**, best scarlet, white, purple and pink, fine healthy plants, per 100 2.50  
**Roses**, 2-inch pots, per 100 6.00

Send for Catalogue.

**SKED, PADDOCK & CO.,**

Cleveland, Ohio.

feb4



**Pest Poison** is not only a Safe, Sure and Cheap **DESTROYER** of the Colorado Beetle or **Potato Bug**, but of all insects, which prey on Vegetation, Cut and Army Worm, Green Fly, &c. Unlike Paris Green and other Poisons, it can be entirely dissolved in water and applied by sprinkling. **Not injurious to plants—Not dangerous to use—Never fails to kill—Costs about 25 cents an acre.** Put up in half lb. boxes, enough for two acres. **Price, 50 cents.** Send for circular. Made only by the **KEARNEY Chemical Works, 66 Cortlandt St., N. Y. P. O. box 3139.**

SEASON 1876.

**DUTCH BULBS**

AND

**FLOWER ROOTS,**

GROWN BY

**E. H. KRELAGE & SON,**

HAARLEM, HOLLAND,

For Catalogues, which will be forwarded as soon as they are issued, apply to Messrs. E. H. KRELAGE & SON, Haarlem, Holland, or to their Agent for America,

**C. RAOUX,**

76 Park Place,

NEW YORK CITY.

jan1

**SURPLUS STOCK.**

**BOUVARDIA** fine young plants.  
**DAVISONI** (white) and **HOGARTH** (Carmine.)

Price very low by the 100 or 1,000.

Address **EDWIN LONSDALE, Florist,**  
June1 Germantown, Phila.

Following Horticultural Advertising Papers will be forwarded gratis and post-free on application:

To Amateurs, "Die Allgemeine Baum-Offerte."

To Nurserymen, "Die Allgemeine Samen-s Pflanzen-Offerte."

**BERNHARD SHALACKER,**  
June7 Gohlis, near Leipzig.

**Fruit Growers' Hand-Book.**

By **F. R. Elliott**, author of "Western Fruit Growers' Guide," (one of the best posted men on the subject in the United States). Contains the practice on all subjects connected with fruit growing. The book is made for those who grow fruit for their own use. Also an Appendix, containing matter relating to the selection and culture of Ornamental Trees, Roses, Plants, &c. Illustrated with 45 wood-cuts, 130 pages, 16mo cloth, \$1; paper, 60 cts. Sent by mail post-paid on receipt of price.  
Address **C. H. MAROT, 814 Chestnut St., Phila.**

**N. STEFFEN'S WIRE WORKS,**

335 E. 21st St. New York.

Manufacturer of all designs for **FLORISTS.** Wreaths, Crosses, Crowns, Hearts, Anchors, Pillars, Columns, Monuments, Bells, Composure, Faith, Hope and Charity, Harps and Lyres, &c. Leaning and Upright.

Send for Price List.

Jan 12.



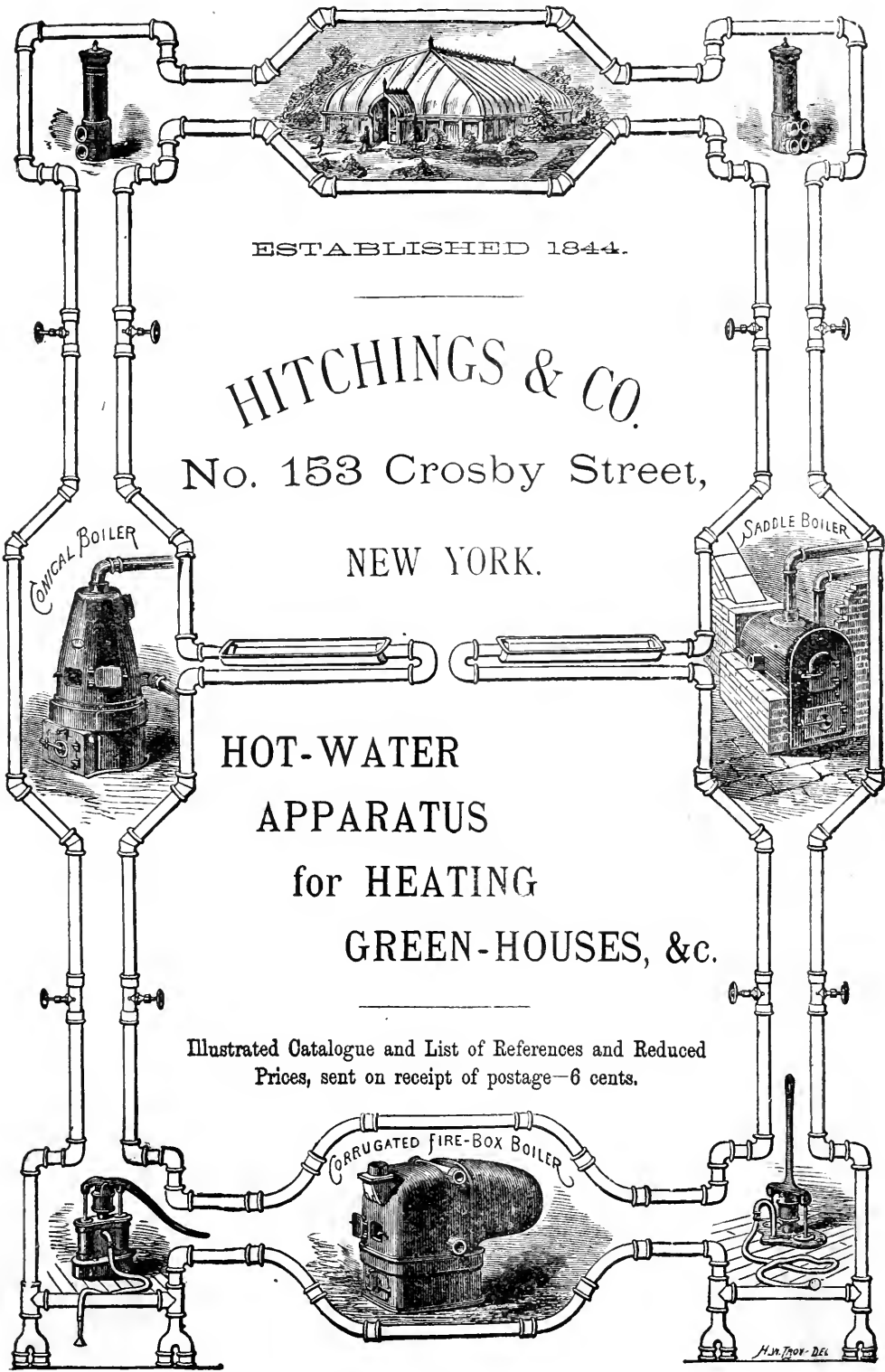

ESTABLISHED 1844.

HITCHINGS & CO.

No. 153 Crosby Street,  
NEW YORK.

HOT-WATER  
APPARATUS  
for HEATING  
GREEN-HOUSES, &c.

Illustrated Catalogue and List of References and Reduced  
Prices, sent on receipt of postage—6 cents.

CORRUGATED FIRE-BOX BOILER

H. J. THOR. DEL.

# AN ARBORETUM AT THE CENTENNIAL.

Visitors to the CENTENNIAL EXHIBITION are invited to examine the ARBORETUM planted on the Horticultural Grounds by

**THOMAS MEEHAN, Nurseryman,  
GERMANTOWN, PHILA.**

The collection embraces nearly **EIGHT HUNDRED** Species or well marked varieties, all named for the information of Visitors, and is believed to be one of the most complete collections of hardy vigorous plants ever got together in this latitude.

## HYBRID PERPETUAL ROSE, "EDMUND WOOD."

We are gratified to find that our friend M. VERDIER, the most celebrated Rose grower of France, has considered our establishment of sufficient importance to name one of his finest New Seedlings after our MR. EDMUND M. WOOD. In a special circular containing the names of his choicest New Varieties, he thus describes it: *Edmund Wood*; tree vigorous, with short reddish-green branches and numerous dark brown spines, leaves consisting of 3 to 5 leaflets oval, dark green; Flowers, large, full and perfect in form, growing in corymbs of 6; color lively, bright cherry red, reverse of petals, carmine—admirable. This variety is comprised in the series to which the silver gilt medal was awarded by the Paris Horticultural Society in May and June, 1875. We can now supply nice young plants in 3-inch pots of this variety, together with all the new "Hybrid Perpetuals" issued by Mr. Verdier in 1876, at greatly reduced prices.

We have flowered Edmund Wood and some others of the set, and find them justly up to the descriptions.

Catalogues with full descriptions of Roses, Greenhouse Plants, &c., &c., mailed free to all applicants.

Orders will be executed in strict priority as they are received.

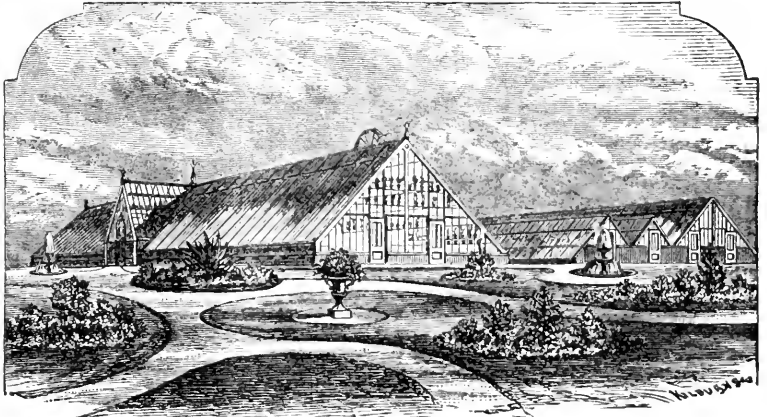

**EDMUND M. WOOD & CO.,**  
OFFICE OF

**WABAN CONSERVATORIES,**  
56 BROAD STREET, BOSTON, MASS.

tjan12

**M. M. BAYERSDORFER & CO.,**

Importers of Every description of

## BOUQUET PAPERS.

Plain White Satin for Bridal Bouquets. Fancy Lace for Weddings, Receptions, Parties. Italiens, Pasted Cartons, Immortelles in great varieties; Green Moss, French Dried Grasses and Flowers. Tin Foil. Prize Medal of Cincinnati Industrial Exposition of 1873 awarded to us for the best display of Bouquet Papers. Illustrated Catalogue furnished on application.

feb

56 N. Fourth St., Philadelphia, Pa.

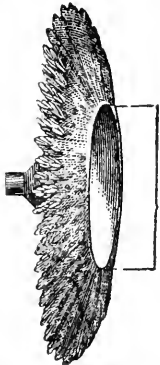

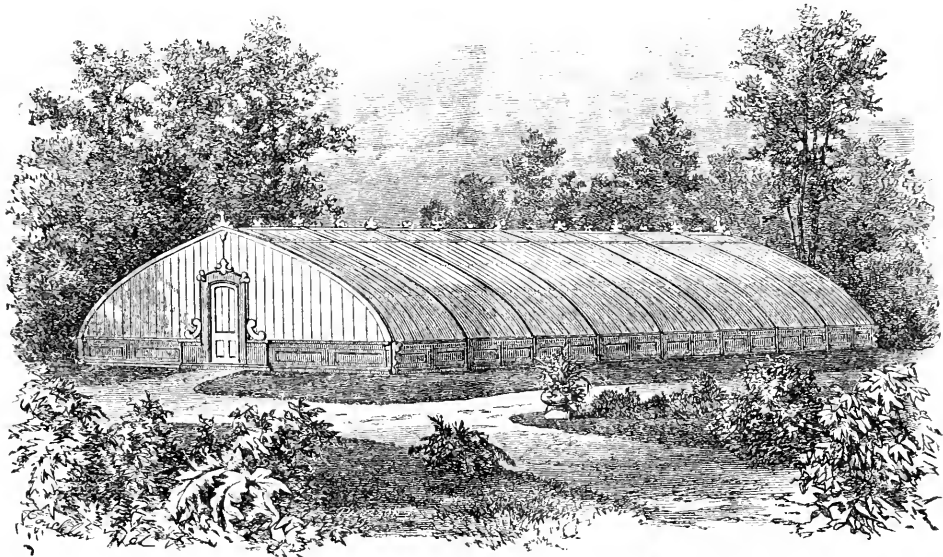

# GREENHOUSES, GRAPERIES, ETC.

Their Construction a Specialty. Experience of 20 Years.

SHIPPED TO ALL PARTS OF THE COUNTRY.  Send for Catalogue. Address,  
LORD'S HORTICULTURAL WORKS,

Irvington-on-Hudson, New York.

June 12

## ALEX. NIMMO,

(Late of the Firm of Nimmo & Scollay.)

# NEWLY IMPROVED HOT WATER BOILER,

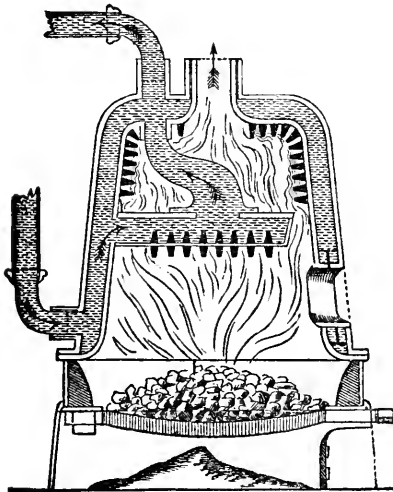

FOR HEATING

Green-Houses, Graperies, Conservatories,  
Forcing Pits, Water for Baths, Drying  
Rooms, Public and Private  
Buildings, &c.

*Proper steps have been taken to secure United States  
Letters Patent on this invention.*

All the necessary Fittings for Hot Water Heating Apparatus.

VENTILATION APPARATUS OF ALL KINDS.

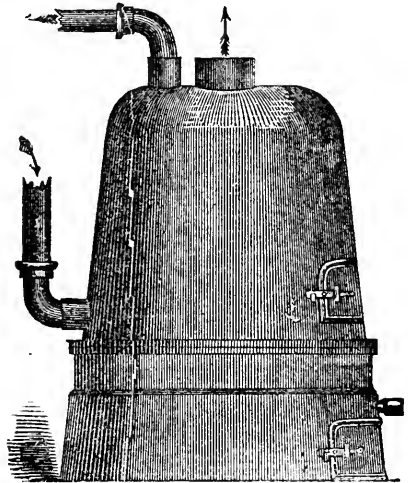

Wells Drove, Pumps of all kinds, Hydraulic Rams, &c., Garden Sun-Dials.

Agent for Joseph Kelly's Never Dry Vapor Pans, for all kinds of Hot Air Furnaces, Baltimore Heaters, &c.

CHEAPEST AND BEST BOILER, &c., IN THE MARKET.

 Please send for Circular for explanation, etc., before you make up your mind to purchase elsewhere.

sep 12

P. S.—Be sure you get the right number.

335 Adams Street, Brooklyn, N. Y.

# JORDAN'S PATENT WATER AND STEAM BOILER.

Constructed of Horizontal Pipes of the same inside diameter as those that form flow and return pipes, thereby producing a very rapid circulation of the water.

LENGTH, SEVEN FEET.

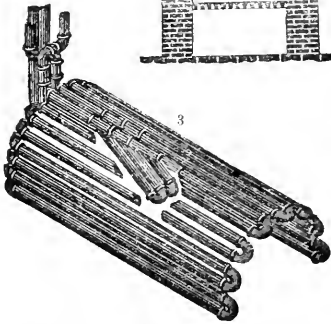
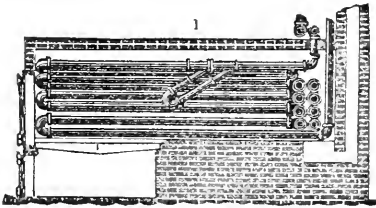

## DESCRIPTION.

No. 1 Shows a side view of one-half section, with U steam propeller. Also shows section of chimney, ash-pit and brick arch around the boiler, with downward draft to chimney.

No. 2 Shows end view, with rear end closed with pipes; ash-pit below and brick arch above.

No. 3 Shows boiler before it is set in the brick, with a few pipes broken away, to show the steam generator.

The improvements claimed are: a larger heating surface, as compared to the amount of water in the boiler; a more rapid circulation of water by the use of steam generator to move the water; a larger fire-hole, so that soft coal can be used and not obstruct the draft; and cheapness.

The boiler is adapted to the heating of any building, and can be set up on a level with the room heated. Also, can be used for steam heating when required.

## PRICES OF BOILERS, INCLUDING IRON FRONTS.

No. 1, to heat 500 feet of 4-inch pipe.....	\$ 75.
No. 2, to heat 750 feet of 4-inch pipe.....	100.
No. 3, to heat 1000 feet of 4-inch pipe.....	125.
No. 4, to heat 1500 feet of 4-inch pipe.....	175.
No. 5, to heat 2000 feet of 4-inch pipe.....	225.
No. 6, to heat 3000 feet of 4-inch pipe.....	300.

Water-pipe and fittings furnished at factory prices. The work of putting up the boiler and pipes, furnished at low rates.

**J. M. JORDAN & BRO.,**  
612 Olive Street. St. Louis, Mo.

## REFERENCES.

T. R. PULLIS, of Mississippi Iron Works, St. Louis, Mo.

EX-MAYOR COLE, President Merchants' Exchange, St. Louis.

W. F. COZZEN, O. P. SAYLOR, GEO. LYNCH, St. Louis; or any prominent Florist in the County of St. Louis.

J. T. McCONNEL & CO. and GEO. MATHEWS, Jacksonville, Ill.

CHICAGO FLORAL COMPANY, Chicago, Ill.

ROBERT EXCELL, WM. FANCOURT, JOHN GOOD, WM. DESMOND, AUGUST DRESS-SELL and JOHN WESTON, of Chicago, Ill.

# WEATHERED & CHEREVOY'S PATENT BOILERS

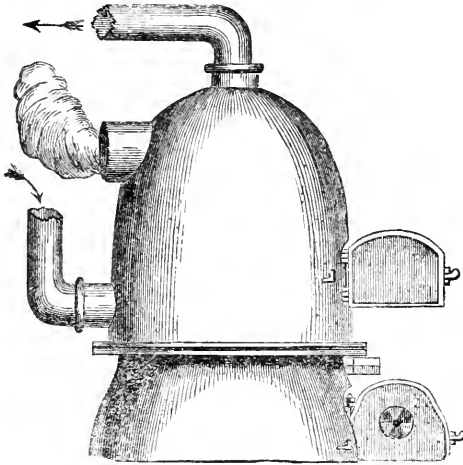

Fig. 1.

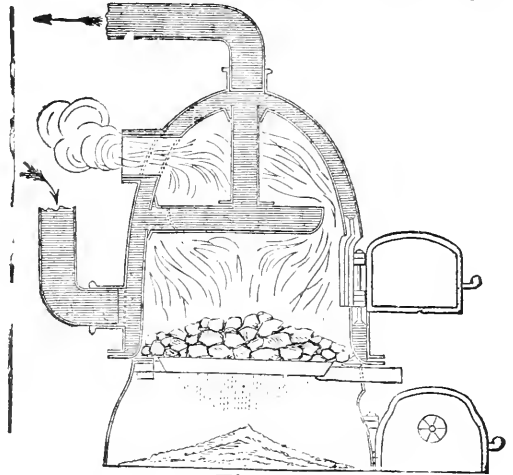

Fig. 2.

## AND IMPROVED HOT WATER APPARATUS,

No. 46 Marion Street, between Spring and Prince, New York.  
(TWO BLOCKS EAST OF BROADWAY.)

For Warming and Ventilating Public Buildings, Private Dwellings, Greenhouses, Graperies, Forcing Pits, Drying Rooms, and Heating Water for Public Baths.

Fig. 1 is an outside view. Fig. 2 is a vertical section through the centre.

*The following are a few names of Gentlemen who have our Boiler in use:*

Thos. Drake, Esq., Germantown, Pa.  
Simon Cameron, Esq., Harrisburg, Pa.  
J. D. Cameron, Esq., Harrisburg, Pa.  
Thos. Carter, Esq., Raleigh, N. C.  
J. H. Dunham, Esq., Chicago, Ill.  
Jas. B. Waller, Esq., " "  
W. J. Gordon, Esq., Cleveland, Ohio.  
Geo. Stanley, Esq., " "  
Harris Jaynes, Esq., " "  
Geo. W. Cuyler, Esq., Palmyra, N. Y.  
D. M. Osborn, Esq., Auburn, N. Y.  
John B. Dutcher, Esq., Pawling, N. Y.  
A. M. Allerton, Esq., Bronxville, N. Y.  
Robert Hoe, Esq., Tarrytown, N. Y.  
Peter Hoe, Esq., " "  
George Lewis, Esq., " "  
Wm. H. Drew, Croton Falls, " "  
Hon. James Y. Smith, Providence, R. I.  
Philip Caswell, Esq., Newport, R. I.  
Alfred Smith, Esq., " "  
Wm. Findlay, Esq., " "  
E. Learned, Esq., Pittsfield, Mass.  
D. O. Mills, Esq., San Francisco, Cal.  
W. L. Ferris, Esq., Westchester, N. Y.  
D. H. Haight, Esq., Goshen, N. Y.  
F. Newbold, Esq., Newark, N. J.  
James T. Closson, Esq., Plainfield N. J.  
Daniel W. Coit, Esq., Norwich, Conn.  
J. F. Slater, Esq., " "  
H. W. Collender, Esq., Darlen, " "  
Chas. P. Palmer, Esq., Stonington, "

Wm. D. Black, Esq., New Milford, Conn.  
Rev. Stephen H. Tyng, Irvington, N. Y.  
H. F. Spaulding, Esq., Riverdale, " "  
S. D. Babcock, Esq., " "  
Percy R. Pyne, " "  
Elisha Brooks, Esq., Inwood, " "  
Camille Marie, Esq., " "  
A. F. Smith, Esq., Fort Washington, " "  
R. M. Olyphant, Esq., Dobb's Ferry, " "  
Clarkson N. Potter, Esq., New Rochelle, " "  
Chas. D. Dickey, Esq., West Farms, " "  
Wm. Matthews, Esq., Harrison, " "  
William Chortlon, Esq., New Brighton, S. I.  
F. H. Wolcott, Esq., Astoria, L. I.  
Bailey Leach, Esq., " "  
Hon. W. B. Ogden, High Bridge, N. Y.  
Peter Moller, Esq., 295 Fifth Ave., New York City.  
Wm. Moller, Esq., 6 West 20th St., " "  
John Moller, Esq., 127 East 54th St., " "  
John Moller, Esq., 8 East 37th St., " "  
Ch. Moller, Esq., 425 Washington St., " "  
Henry B. Laidlaw, Esq., 33 Pine St., " "  
George W. Lane, Esq., 93 Front St., " "  
J. P. Robinson, Esq., 14 Coenties Slip, " "  
J. B. Colgate, Esq., 47 Wall St., " "  
John B. Trevor, Esq., 47 Wall St., " "  
Charles Butler, Esq., 12 " "  
Richard Arnold, Esq., 309 Canal St., New York City.  
Jas. M. Constable, Esq., 309 Canal St., " "  
W. T. Garner, Esq., 61 Worth St., N. Y. City.

Please send for Circular with list of References and Reduced Prices to

**THOMAS W. WEATHERED, 46 Marion Street, N. Y.**

THOMAS J. MYERS.  
 PATENT BOILERS  
 AND  
 HOT WATER APPARATUS

FOR HEATING  
 GREENHOUSES, HOT-HOUSES, CONSERVATORIES, &c.

THOMAS J. MYERS & SON,  
 No. 1162 PASSYUNK AVE., PHILADELPHIA.

2, 4, 6, and 8 Home St., Cincinnati, O.

Please send for Descriptive Circular and Price List.

tjunetf

AMERICAN FLOWER GARDEN DIRECTORY. AMERICAN GARDENER'S ASSISTANT.

By Robert Buist.

With practical directions for the Culture of Plants in Flower-Garden, Hot-House, Green-House, Rooms, or Parlor Windows, for every month of the year. Instructions for erecting Hot-house, Green-house, and laying out a Flower garden. Instruction for cultivating, propagating, pruning and training the Grape vine and description of best sorts for the open air. 342 pages, 12mo, cloth. Price \$1.50. Sent by mail post-paid on receipt of price.

CHAS. H. MAROT,  
 814 Chestnut St. Phila.

By Thomas Bridgeman.

Containing complete practical directions for the cultivation of Vegetables, Flowers, Fruit Trees and Grapevines. Illustrated. 529 pages, 12mo, cloth. Price \$2.50. Sent by mail post-paid on receipt of price.

Address CHAS. H. MAROT,  
 814 Chestnut St., Phila.

CLASS BOOK OF BOTANY.

By ALPHONSO WOOD, A. M.

Being outlines of the Structure, Physiology and Classification of Plants; with a Flora of the United States and Canada. 832 pages, 8vo, half arabesque cloth sides. Price, \$3.50. Sent by mail post-paid on receipt of price.

Address, CHAS. H. MAROT,  
 814 Chestnut Street, Philadelphia.

WINDOW GARDENING.

By Henry T. Williams.

Devoted specially to the Culture of Flowers and Ornamental Plants for *In-door use and Parlor Decoration*. Splendidly illustrated. 300 pages, med. 8vo, cloth. Price \$1.50. Sent by mail post-paid on receipt of price.

Address CHAS. H. MAROT,  
 814 Chestnut St., Phila.

NEW EXCELSIOR LAWN MOWER.



PRICES REDUCED FOR 1876.

IT HAS THE LARGEST SALE OF ANY  
 LAWN MOWER IN THE WORLD.

It has been adopted, and can be seen in practical operation on **Central Park** and all the other **City Parks, New York; Government Grounds and City Parks, Washington; Boston Common, Boston; Prospect Park, Brooklyn;** and on almost every prominent Park throughout the **United States and Canada.**

**THE GREAT TRIAL** of Lawn Mowers was held in **New York City** June 25th, 1874. There the **Excelsior** came into competition with all the best Lawn Mowers in the world, and was awarded the **HIGHEST PREMIUM.**

Four sizes for hand-power; four sizes for horse-power.  
 Prices from \$14 to \$200.

Every Machine Warranted.

Address

CHADBORN & COLDWELL M'F'G CO.,

NEWBURGH, N. Y.

Send for Circular.

**N. B.**—We call special attention to our new **HORSE MOWER** for 1876. Gears entirely covered and weight reduced 200 lbs. It is the **LIGHTEST** and **BEST HORSE MOWER EVER MADE.**

**ELLIS' BASE BURNING BOILER.** FOR WARMING Dwellings, Greenhouses, Graperies, Forcing Pits, Drying Rooms Heating Water for Public Baths, Baptisteries, &c., by Hot Water or by Steam.

Estimates and Circulars furnished. t.sep.12. **182 CENTRE STREET, NEW YORK.**

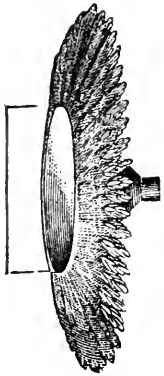

ROWLAND WHITMAN.

**WHITMAN & LANG,**

IMPORTERS OF

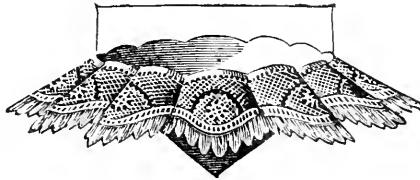

DRIED FLOWERS, IMMORTELES, TIN FOIL &c.

augtf. No. 126 N. 4th St., Philadelphia.

HARRY LANG.

FANCY GRASSES

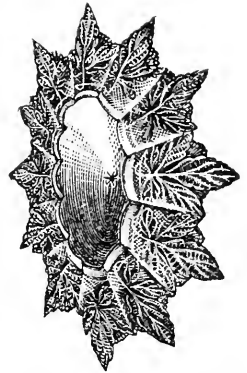

**GERMANTOWN NURSERIES, PHILADELPHIA.**

GORGAS LANE STATION, CHESTNUT HILL RAILROAD. Less than One Hour from the Centre of Philadelphia.

Those who desire to purchase largely, either for their own planting or to sell again, are invited to examine the extensive stock of

**FRUIT, SHADE AND ORNAMENTAL TREES AND SHRUBS,**

Grown at the Germantown Nurseries. And those who need but A FEW ARTICLES, will find all ages and sizes to select from. A special feature of the business, is the raising of

Nursery Stock and Seedling Forest Trees

FOR DISTANT SHIPMENT. Many of these can be supplied by the millions at very low rates. Address, for CATALOGUES or information,

**THOMAS MEEHAN, Germantown Nurseries, Phila.**

**THE CENTENNIAL. TREE AND SHRUB SEEDS.**

Visitors to the CENTENNIAL are invited to examine the collection of Tree Seeds, comprising over

**THREE HUNDRED KINDS**

of species, hardy in the greater part of the United States, and on exhibition in the AGRICULTURAL HALL, (At G 16) by

**THOMAS MEEHAN,**

COLLECTOR AND DEALER IN TREE SEEDS,

may5

**GERMANTOWN, PHILA.**



**DOUBLE HARPOON HORSE HAY-FORK.**

BEST IN THE WORLD.

MAY BE SEEN AT CENTENNIAL.

Descriptive Catalogue sent free.

**Pennock Manufacturing Company,**  
Kennett Square, Chester Co., Pa.

**TRUE RHODE ISLAND BENT SEED,**

Not Red Top,

Can be had of us at \$2.50 to \$3.00 per measured bushel. Cash with order.

**W. E. BARRETT & CO.**  
44 Canal St., Providence, R. I.

apl3

# Roses! Roses! Roses!

We offer a large stock of  
FINE STRONG GROWING YOUNG ROSES,  
grown in 2 and 3 inch pots, and include the finest and leading varieties.

HYBRID PERPETUALS, TEAS, BOURBONS AND CHINAS.

Also MOSSES and CLIMBERS.

at very lowest prices. Orders solicited.

JAMES ALDOUS & CO., Florists,  
Feb 7 Iowa City, Iowa.

## Garden, Field & Flower Seeds.

AGRICULTURAL  
IMPLEMENTS,  
HORTICULTURAL  
TOOLS, &c.



Catalogues Free.

D. LANDRETH & SONS,  
21 & 23 S. Sixth St.,

Between Market & Chestnut St.,

PHILADELPHIA.

May 3

## TO FLORISTS.

**TOBACCO STEMS,** For fumigating purposes, put up in bales of 250 lbs. each, at \$5.00 per bale, free on boat or cars. All orders from unknown parties must be accompanied by remittance. For sale by

STRAITON & STORM,

No. 180 Pearl Street, New York.

Aug 12

Allen's Planet Jr.

SILVER  
MEDAL



Seed Drills and Wheel Hoes, perfected for '76. Four Sizes. They "sow like a charm," and hoe better, easier and six to twelve times faster than the hand hoe; often saving \$100 in a season!

OUR NEW HORSE HOE, with *Patented* Steel blades, perfected after ten years of experiment, saves most of the hoeing and makes the remainder easy; leaves the ground level or ridged as desired; opens furrows, hills, and cultivates shallow or deep, and is a thorough weed killer; should be owned by every farmer. ESPECIALLY USEFUL to Market Gardeners, Broom Corn, Tobacco, Cotton, Rice and Root Growers, and to all lovers of thorough work.

THE POTATO BUGS are coming! Fight them with the PLANET Jr. DESTROYER! It is light, simple and effective. Early Green (strictly pure) supplied. Complete directions for use sent with each machine.

Our full Descriptive Price-List and Testimonials free. Mention this paper. S. L. ALLEN & CO., 119 So. FORTH ST., Phila., Pa. WE MUST HAVE A LIVE AGENT IN EVERY TOWN.

## RICHARD LYNEX,

Rear of 428 Walnut Street, Philada.

Manufacturer of Plain and Fancy Wire-work, for Florists; Wreaths, Crosses, Stars, Crowns, Hearts, Anchors, Birds, Lambs, Gipsy Baskets, Hanging Baskets, Flower Stands, &c.

SEND FOR PRICE LIST.

Feb 6

**Landscape Gardening and Home Improvements.**  
Mr. James MacPherson, late of the Royal Gardens, Kew, Gold Medalist of the Agri-Horticultural Society, Madras, &c., furnishes advice upon and superintends the laying out of Ornamental Grounds, Country Places, Parks, Cemeteries, City and Village Gardens, Ornamental Walks and Drives, Commons, Farms, &c. He also furnishes lists of trees, shrubs and exotic plants, for any particular purpose, North or South; his residence in both climates having made him familiar with the most desirable effects of either section.

Address, JAMES MACPHERSON,  
June 12 Care Gardener's Monthly Office, 814 Chestnut St., Phila.

MY

Wholesale and Descriptive Catalogues of

## Greenhouse and Bedding Plants

SHRUBS, EVERGREENS, ETC.,

MAILED TO ALL APPLICANTS.

# Wm. C. Wilson

Astoria, L. I. C.,

June 12 New York City Office—45 West 14th St.

## DOUBLE TUBEROSE BULBS.

Our Stock of BULBS this year is of very superior quality.

	Doz.	100	1000
1st quality large Flowering Bulbs..	\$ 75	\$4 00	\$30 00
2d quality "	50	3 00	20 00
A Large hundred extra large Bulbs .....	1 00	5 00	

May 1 MILLER & HAYES, 5774 Germantown Ave., Phila.

NEW

## VARIEGATED LANTANA HARKETT'S PERFECTION.

Best Variegated Bedding Plants to stand the Sun.  
Ready March 1st. \$1.00 each. \$10.00 per doz  
Illustrated Descriptive Catalogue of Greenhouse and Bedding Plants. Sent to all applicants.

W. A. HARKETT,

DUBUQUE, IOWA.

Feb 10

## DUTCH FLOWER-ROOTS AND BULBS,

Cultivated and sold by

M. C. ALKEMEDE & SON,

at

Noordwijk-Binnen, near Haarlem, Holland.

Catalogue for 1876 will be forwarded post-free on application.

May 4

## GARDENING FOR THE SOUTH, or HOW TO GROW VEGETABLES AND FRUITS.

By WM. N. WHITE.

Containing instructions and hints in formation and management of Gardens, Soils and improvement, manures and their sources, rotation, hot-beds, cold frames, pits, propagation, budding and grafting, pruning and training, transplanting, mulching, shading and watering, protection, garden implements, insects and vermin. Vegetables, Fruits, description, varieties and culture. Illustrated, 444 pages, 12mo, Cloth. Price \$2.00. Sent by mail, post-paid, on receipt of price. Address, CHAS. H. MAROT, 814 Chestnut St., Phila.



THE  
CHRISTIAN AT WORK.

T. De Witt Talmage, Editor.

Without Premiums, \$3; with Premiums, \$3.25. To Clergy-  
men 75 cents less. ~~\$3~~—A Choice of two premiums.

OPINIONS OF THE PRESS.

"The Christian at Work is the liveliest religious paper published in these parts. Its columns are spicy and sparkling and to religious people who like things lively it is a readable paper. The Devil is more certain to be frightened with a radiant face than a solemn and forbidding one."—*N. Y. Commercial Advertiser.*

"The Christian at Work has donned a new dress and looks as pretty as a picture. The type of all sizes is admirably clear and a handsomer weekly there is not in these United States."—*N. Y. Evening Mail.*

"The Christian at Work is safe and reliable in all its utterances and ought to displace the ——— in every Presbyterian family. Its editor is a host in himself, and nothing will stagnate that he has anything to do with."—*London Correspondent Chicago Interior.*

"The Christian at Work is an admirably conducted sheet, filled with live matter."—*N. Y. Star.*

"The Christian at Work is one of the most readable religious papers published anywhere. The Doctor and his associates have discovered the art of making a publication orthodox without being flippant."—*Brooklyn Eagle.*

"In The Christian at Work everything is lively and life-like. This Christian smiles, laughs, sometimes actually whistles, while at his work, and that without letting down the dignities and proprieties that belong to the discussion of the themes it discusses."—*Brooklyn Union.*

"The Christian at Work is one of the best of the religious weeklies, and deserves the success it has attained."—*Brooklyn Argus.*

"The Christian at Work is one of the most sprightly, most gladly welcomed in every family of all religious weeklies. It flits from the pulpit to the pew, from the rod of authority to the kiss of love, from the paternal command to the child's obedience, and scatters flowers upon all, breathing content and happiness upon all its readers."—*American Garden.*

Five Sabbath School Papers,

under the same editorial supervision, are published by us monthly, and are suitable for School or Home. The best and cheapest published. Beautiful premiums with these also.

Good Words, My Paper, Good Cheer, Old and Young, Der Sonntagsgast. (German.)

We number our papers, but do NOT date them, making them good at any time.

Two papers with names nearly like our own have lately been issued in New York City. They are not in any way under the supervision of DR. TALMAGE or the control of THE CHRISTIAN AT WORK PUBLISHING COMPANY. Be careful to send your orders direct to the publisher of this paper.

Full particulars and sample copies of all papers furnished on application.

HORATIO C. KING, Publisher,

July 14 No. 102 Chambers Street, New York.

**A**MSDEN, Amsden, Amsden. Earliest and best early Peach in the world. Trees, root grafts and scions at Carthage, Missouri, and Dayton, Ohio. Price of the trees reduced for spring 1876. For full history of this Peach, and price of the trees, root grafts and scions, address  
J. H. WAMPLER, Carthage, Missouri.

LONDON GARDENER'S CHRONICLE

Will be furnished, post-paid, direct to subscribers in the U. S. for **\$7 50** per year. Specimen Nos. 3 cent stamp. Apply to  
CHAS. H. MAROT, Agent, 814 Chestnut St., Phila.

BEGONIA  
FROEBELI.

New Tuberos-rooted Begonia.

Bright Scarlet Flowers.

Found in the Peruvian mountains by the celebrated collector B. Roezl, and pronounced by him to be the finest of all Begonias. Plants in bloom with me now prove that it is the

QUEEN OF BEGONIAS.

Flowers measure two inches across, are borne in large clusters and of the most brilliant scarlet imaginable.

Splendid for bedding out, as it is a most profuse bloomer.

Send for descriptive circular and sample flower.

Large original bulbs started in pots, price \$2.50 each.

Address,

J. ROEHR'S,

270 SECOND STREET,

tapl3

Jersey City, N. J.

The Gardener's Monthly.

THE FOLLOWING

BACK NUMBERS

WANTED, IN

GOOD CONDITION.

April, 1860.	October, 1870.	August, 1874.
January, 1870.	December, "	December, "
March, "	January, 1873.	January, 1875.
July, "	January, 1874.	December, "
		January, 1876.

Receivable in exchange on Subscription account, or exchangeable for other numbers not in above list. Send numbers and advise the publisher by letter. Address,

CHAS. H. MAROT,

814 Chestnut, St., Phila.

PRESERVING, PICKLING AND CANNING FRUIT.

By MRS. M. E. PETERSON.

Containing a choice collection of receipts of Preserving, Pickling, and Canning Fruits, many of them being original from house wives of experience. 72 pages, 16mo, Cloth. Price 50 cents. Sent by mail, post-paid, on receipt of price.

Address,

CHAS. H. MAROT,

814 Chestnut St., Phila.

THE OFFICIAL GUIDE BOOK TO  
PHILADELPHIA AND CENTENNIAL EXHIBITION.

By THOMPSON WESTCOTT.

Author of the History of Philadelphia. The only full and complete Guide Book. Illustrated with two maps and 93 engravings. 425 pages, 16mo, Cloth, \$1.50; Morocco, \$2.00. Mailed, post-paid, on receipt of price.

Address,

CHAS. H. MAROT,

814 Chestnut St., Phila.

## ORNAMENTAL TREES.

By Thomas Meehan.

An American Hand-Book, containing the personal observations of the author. 257 pages, 24mo, cloth. Price 75 cts. Sent by mail post-paid on receipt of price.

Address CHAS. H. MAROT,  
814 Chestnut St., Phila.

## BOOK OF EVERGREENS.

By Josiah Hoopes.

A practical treatise on the Coniferæ or Cone-bearing plants. Handsomely illustrated. 435 pages, 12mo, cloth. Price \$3.75. Sent by mail post-paid on receipt of price.

Address CHAS. H. MAROT,  
814 Chestnut St., Phila.

## LAWN AND SHADE TREES.

By F. R. ELLIOTT.

Deciduous and Evergreen Trees and Shrubs, for planting in Parks, Gardens, Cemeteries, &c., &c. Illustrated. 125 pages, 12mo, cloth. Price, \$1.50. Sent by mail, post-paid, on receipt of price.

Address, CHAS. H. MAROT,  
814 Chestnut Street, Philadelphia.

## THE ABBOTT

# POCKET MICROSCOPE.

Is an Instrument of great practical usefulness to Teachers, Farmers, Merchants, Mechanics, Physicians, Botanists, Miners, and many others. It is the best Instrument ever invented for examining Flowers, Seeds, Plants, Minerals, Engravings, Bank Notes, Fabrics, Etc. By means of a

case, accompanying each Instrument, one can examine all kinds of Insects or Worms alive. The

## EYE OF A FLY,

or other Insect of like size, can be readily seen. It is simple in construction and easy to operate. One of these interesting Instruments ought to be in every family. We have made arrangements to furnish the POCKET MICROSCOPE at the manufacturer's price, \$1.50. It will be sent, post-paid, to any reader of this Paper desiring it, on receipt of price, or may be had at this office.

Address,

CHAS. H. MAROT,  
814 Chestnut St., Phila.

## GUIDE TO THE STUDY OF INSECTS.

By A. S. PACKARD, JR., M.D.

Also a Treatise on those INJURIOUS and BENEFICIAL to us. For the use of Colleges, Farms, Schools and Agriculturists. Illustrated with 11 plates, and 650 wood-cuts. 702 pages, 8vo, cloth. Price, \$6.00. Sent by mail post-paid on receipt of price.

Address, CHAS. H. MAROT,  
814 Chestnut Street, Philadelphia.

## INSECTIVOROUS PLANTS.

By Chas. Darwin.

With copious descriptive contents and index. Illustrated. 462 pages, 12mo, cloth. Price \$7.00. Sent by mail post-paid on receipt of price.

Address CHAS. H. MAROT,  
814 Chestnut St., Phila.

## HOW PLANTS GROW.

By Asa Gray, M. D.

A simple Introduction to Structural Botany, with a Popular Flora, or an arrangement and description of Common Plants, both wild and cultivated. Illustrated with 500 wood engravings. 233 pages, large 16mo, half-arabesque, paper sides. Price \$1 25. Sent by mail post-paid on receipt of price.

Address CHAS. H. MAROT,  
814 Chestnut St., Phila.

## CHOICE STOVE AND GREENHOUSE PLANTS,

By Benj. S. Williams, F. R. H. S.

With descriptions of upwards of eleven hundred species and varieties. Instructions for their cultivation and mode of management. Illustrated with colored frontispiece and numerous splendid illustrations. 686 pages, 2 vols., 12mo, cloth. Price \$5.00. Sent by mail post-paid on receipt of price.

Address CHAS. H. MAROT,  
814 Chestnut St., Phila.

## SMALL FRUIT CULTURIST.

BY ANDREW S. FULLER.

Giving Description, History, Cultivation, Propagation, Diseases, &c.

Beautifully Illustrated.

276 pages, 12mo, cloth. Price \$1.50. Sent by mail, post-paid on receipt of price.

Address, CHAS. H. MAROT, 814 Chestnut St., Phila.

## GARDENERS' DICTIONARY.

By GEO. W. JOHNSON, Editor of "Cottage Gardener."

Describing the Plants, Fruits and Vegetables desirable for the Garden, and explaining the terms and operations employed in their cultivation. New Edition, with a supplement, including the new plants and varieties. 910 pages, 12mo, cloth, fine print. Price, \$3.50. Sent by mail post-paid on receipt of price.

Address, CHAS. H. MAROT,  
814 Chestnut Street, Philadelphia.

## GARDENING FOR PLEASURE.

BY PETER HENDERSON.

A guide to the Amateur in the

## FRUIT, VEGETABLE and FLOWER GARDEN.

With full directions for the Greenhouse, Conservatory and Window-Garden. Illustrated. 250 Pages, 12mo, cloth. Price \$1.50. Sent by mail post-paid on receipt of price.

Address CHAS. H. MAROT, 814 Chestnut St., Phila.

## GARDENING FOR PROFIT.

BY PETER HENDERSON.

A Guide to the successful cultivation of the

## MARKET AND FAMILY GARDEN.

New and enlarged edition. Illustrated. 276 Pages, 12mo, cloth. Price, \$1.50. Sent by mail post-paid on receipt of price.

Address CHAS. H. MAROT, 814 Chestnut St., Phila.

## HOW TO MANAGE BUILDING ASSOCIATIONS.

By EDMUND WRIGLEY.

Being a Director's Guide and Secretary's Assistant, with forms for Keeping Books and Accounts, also rules, examples and explanations illustrating the various plans of working. 211 pages, 12mo, cloth. Price, \$2.00. Sent by mail post-paid on receipt of price.

Address, CHAS. H. MAROT,  
814 Chestnut Street, Philadelphia.

## WORKING MAN'S WAY TO WEALTH.

By EDMUND WRIGLEY.

A practical treatise on Building Associations, what they are, and how to use them. 108 pages, 16mo, cloth. Price, 75 cents. Sent by mail post-paid on receipt of price.

Address, CHAS. H. MAROT,  
814 Chestnut Street, Philadelphia.

**GARDENING BY MYSELF.**

By Anna Warner.

Containing Hints and Experiences under heading of each month in the year. Illustrated. 16mo, 223 pages, cloth. Price \$1.25. Sent by mail post-paid on receipt of price.

Address CHAS. H. MAROT,  
814 Chestnut St., Phila.

**FLORA OF THE SOUTHERN STATES.**

By A. W. CHAPMAN, M.D.

Containing abridged descriptions of the FLOWERING PLANTS and FERNS of Tennessee, North and South Carolina, Georgia, Alabama, Mississippi and Florida, arranged according to the Natural system. 621 pages, 8vo, cloth. Price, \$3.60. Sent by mail post-paid on receipt of price.

Address, CHAS. H. MAROT,  
814 Chestnut Street, Philadelphia.

**GRAPE CULTURALIST.**

By Andrew S. Fuller.

A treatise on the Cultivation of the Native Grape. Illustrated. 286 pages, 12mo, cloth. Price \$1.50. Sent by mail post-paid on receipt of price.

Address CHAS. H. MAROT,  
814 Chestnut St., Phila.

**PARSONS ON THE ROSE.**

By Samuel B. Parsons.

A treatise on the Propagation, Culture and History of the Rose. Illustrated. 215 pages 12mo, cloth. Price \$1.50. Sent by mail post-paid on receipt of price.

Address CHAS. H. MAROT,  
814 Chestnut St., Phila.

**BOOK OF ROSES.**

By Francis Parkman.

Description, Cultivation and Propagation. Beautifully illustrated. 225 pages, 12mo, cloth. Price \$1.50. Sent by mail post-paid on receipt of price.

Address CHAS. H. MAROT,  
814 Chestnut St., Phila.

**ROSE GARDEN.**

By Wm. Paul, F. R. H. S.

Embracing History of the Rose; formation of Rosarium; detailed account of practice for successful cultivation; arrangement in natural groups of most esteemed varieties, English and Foreign, in the most eminent Gardens; with full description and remarks on origin and mode of culture. Numerous illustrations. 256 pages, Royal 8vo, cloth. Price \$3.00. Sent by mail post-paid on receipt of price.

Address CHAS. H. MAROT,  
814 Chestnut St., Phila.

**ROSES AND ROSE CULTURE.**

By Wm. Paul, F. R. H. S.

The rationale of Rose cultivation in a nut-shell. Intended to place within a small compass all that is necessary for the successful cultivation of the "Queen of Flowers." 83 pages, 12mo, paper-boards. Price, 60 cents. Sent by mail post-paid on receipt of price.

Address, CHAS. H. MAROT,  
814 Chestnut Street, Philadelphia.

**PRACTICAL FLORICULTURE.**

By PETER HENDERSON.

A Guide to the successful cultivation of

**FLORISTS' PLANTS,**

for the *Amateur and Professional Florist*. Illustrated. 288 pages, 12mo, cloth, Price, \$1.50. Sent by mail post-paid on receipt of price.

Address, CHAS. H. MAROT,  
814 Chestnut Street, Philadelphia.

**How To Paint**

A New Work by a **Practical Painter**, designed for the use of **Tradesmen, Mechanics, Merchants, Farmers**, and as a Guide to **Professional Painters**. Containing a Plain Common-Sense Statement of the Methods employed by Painters to produce satisfactory results in **Plain and Fancy Painting** of every description, including **Formulas for Mixing Paint in Oil or Water**, Tools required, etc. This is just the Book needed by any person having anything to paint, and makes

**"Every Man His Own Painter."**

Full Directions for **Using White Lead—Lamp-Black—Greer—Yellow—Brown—Whiting—Glue—Pumice Stone—Spirits of Turpentine—Oils—Varnishes—Furniture Varnish—Milk Paint—Preparing Kalsomine**, etc.

**Paint for Outbuildings**

—**Whitewash—Paste for Paper-Hanging—Hanging Paper—Graining in Oak, Maple, Rosewood, Black Walnut—Staining—Decalcomania—Making Rustic Pictures—Painting Flower-Stands—Rosewood Polish—Varnishing Furniture—Waxing Furniture—Cleaning Paint—**

**Paint for Farming Tools**—for **Machinery—Household Fixtures**, etc.**To Paint a Farm Wagon**

—to **Re-Varnish a Carriage**—to make **Plaster Casts**. The work is neatly printed, with illustrations wherever they can serve to make the subject plainer, and it will save **many times** its cost yearly. Every family should possess a copy. Price by mail, post-paid, \$1.

CHARLES H. MAROT,

814 Chestnut St., Philadelphia, Pa

**ORCHID GROWER'S MANUAL.**

By BENJAMIN S. WILLIAMS, F. R. H. S.

Containing brief descriptions of over 800 species and varieties, with notices of times of flowering, approved modes of treatment and practical instructions on general culture. Remarks on heat, moisture, soil, seasons of growth and rest suited to the several species. Enlarged edition with illustrations. 300 pages, 12mo, cloth. Price, \$2.50. Sent by mail post-paid on receipt of price.

Address, CHAS. H. MAROT,  
814 Chestnut Street, Philadelphia.

**Manual of Botany of the Northern United States.**

By ASA GRAY.

Including the district east of the Mississippi and north of Carolina and Tennessee. Arranged according to the Natural System. Illustrated with 20 plates of Sedges, Grasses, Ferns, &c. 703 pages, 8vo, half-arabesque cloth sides. Price, \$2.25. Sent by mail post-paid on receipt of price.

Address, CHAS. H. MAROT,  
814 Chestnut Street, Philadelphia.

Index to Advertisements.

Advertisers are requested to have orders in hand as EARLY AS POSSIBLE. Copy received after the 23rd of each month cannot be INSURED insertion in the next issue.

Aldous James, Iowa City, Iowa.....	10
Alkemede, M. C. & Co., Haarlem, Holland.....	10
Allen S. L., Philadelphia.....	10
Barrett W. E. & Co., Providence, R. I.....	9
Bayersdorfer M. M. & Co., Philadelphia.....	4
Bliss B. K. & Sons, New York city.....	cover
Buist R., Philadelphia.....	1
Burnett, Alex., Reading, Pa.....	2
Chadborn & Coldwell, Newburgh, N. Y.....	8
Christian at Work, New York city.....	11
Elder Walter, Philadelphia.....	14
Ellis Chas. R., New York city.....	9
Gilmore, S. J., Lawrence, Kan.....	2
Harkett Wm. A., Dubuque, Iowa.....	10
Hews A. H. & Co., North Cambridge, Massachusetts.....	8
Hinrichs C. F. A., New York city.....	2
Hitchings & Co., New York city.....	3
Jordan, J. M. & Bro., St. Louis, Mo.....	6
Kearney Chemical Works, New York.....	2
Landreth, D. A Son, Phila.....	10
Lonsdale Edward, Germantown, Pa.....	2
Lord's Horticultural Works, Irvington, New York.....	5
Lynx Richard, Philadelphia.....	10
Marot, Chas. H., Philadelphia.....	1, 2, 10, 11, 12, 13, 14, Fly-leaf
Meehan Thomas, Germantown, Philadelphia.....	4, 9
Miller & Hayes, Mount Airy, Philadelphia.....	6, 8
Milton M., Andover, Mass.....	14
Myers Thomas J., Philadelphia.....	8
Nimmo Alexander, Brooklyn, New York.....	5
Parsons, R. B. & Co., Flushing, N. Y.....	14
Parsons S. B. & Sons, Flushing, New York.....	cover
Pennock Manufacturing Co., Kennett Square, Pa.....	9
Raoux C., New York city.....	2
Roehrs J., Jersey City, N. J.....	11
Rolker A. & Sons, New York city.....	Fly-leaf
Scollay John A., Brooklyn, New York.....	9
Shalacker Bernhard, Gohlis, Leipzig.....	2
Sked, Paddock & Co., Cleveland, Ohio.....	2
Steffens N., New York city.....	2
Stratton & Storn, New York city.....	10
Wampler John, Carthage, Missouri.....	11
Weathered & Cherevoy, N. Y. City.....	7
Weber, Henry, Cumberland, Md.....	2
Whitman & Lang, Philadelphia.....	9
Wilson William C., New York city.....	10
Wood Edmund M., Boston, Massachusetts.....	4, cover

SITUATIONS WANTED.

**T**O GENTLEMEN & FLORISTS.—As Propagator, Plant Grower, Manager, or Salesman, a first-class man of great experience, from England, (been out here upwards of 2 years,) rapid grower of hard and soft wooded plants, orchids, &c. Would not object to a good private place. Well up in carpet bedding, having been foreman at the Crystal Palace and for-man at Hyde Park. Three years in a large London Nursery, and took a Diploma in this country. First-rate references. An abstainer. Address J. C. G. Bridgeport, Conn. P. O. box 1147.

**W**ANTED a situation as head Gardener to go south of Philadelphia; twenty years experience in greenhouse and thoroughly competent in all kinds of floral work; married; English by birth, been in this country 7 years. Address, A. W. Elliott, Medford, Mass.

**B**Y a Gardener, single, Scotch; has a practical knowledge of the management of a private place, or the laying out and taking care of Public Grounds. Only a situation of responsibility is wanted. Distance no object. Address, G. C., care of Chas. H. Marot, 814 Chestnut St., Philadelphia.

**W**ANTED by an Englishman, single, aged 28, a situation in a private or commercial establishment. Well up in all branches of the profession. Active, sober, honest and obliging, and can give first-class references. Please address B. C., Office of the Gardner's Monthly.

**WALTER ELDER,**  
Landscape and Jobbing Gardener,  
1231 Rodman Street, Philadelphia,  
Attends to all branches of his business on reasonable terms.

**R. B. PARSONS & CO.,**  
Bowne Avenue, Flushing, N. Y.,  
OFFER THEIR  
**RARE TREES & SHRUBS**

as well as the well known sorts, and invite the special attention of

**LARGE BUYERS**

To their Stock of **Rhododendrons, Azaleas—Chinese and Ghent—Camellias, Clematis, Hydrangeas, Magnolias** Roses by the 1,000.

**RARE EVERGREENS,**

are well known to be cultivated in large variety by them.  
For Catalogues address

**Box 99, Flushing, N. Y.**

feb.12

**SITUATION WANTED.**

As Gardener or Nursery foreman by Mansfield Milton, who for the last five years had charge of one of the largest private horticultural establishments in Massachusetts. Thoroughly understands the culture of Orchids, Stove and Greenhouse plants, propagation and forcing of Roses and florists plants of all kinds; treatment of Orchids, in-door and out door grapevines, the management of lawns, Vegetable crops, and everything relating to all practical branches of horticulture. Very best of references, jun  
M. MILTON, Box 189, Andover, Mass.

A Hygroscope for 50 cents.

**THE CHEMICAL HYGROSCOPE.**

This indicator of atmospheric moisture is as accurate as the costly ones. Rooms heated by furnaces or stoves are almost invariably so dry as to be damaging not only to health but to furniture. Some people take the consequences others keep water on the heater. The Hygroscope shows at a glance whether the air is too dry or not.

Sent by mail for 50 cents. Address,  
febtf CHAS. H. MAROT, 814 Chestnut St., Philadelphia.

**The Nurseryman's Directory.**

A reference book of the Nurserymen, Florists, Seedsmen, Tree Dealers, &c., for the United States. Alphabetically arranged by States and Post Offices. 242 pages, 8vo. Price \$5. Mailed, post-paid, on receipt of price.

Address, CHAS. H. MAROT,  
814 Chestnut St., Phila.

**Orchid Culture.**

By EDWARD SPRAGUE RAND, JR.

Including culture, propagation, collection and hybridization of Orchids; the construction and management of Orchid-houses; a glossary of Botanical terms and significance of their names; the whole forming a COMPLETE MANUAL of ORCHID CULTURE. Cloth 12 mo, 476 pages. Price \$3.50. Mailed, post-paid, on receipt of Price.

Address, CHAS. H. MAROT,  
814 Chestnut St., Phila.

**AMERICAN FRUIT CULTURIST.**

By JOHN J. THOMAS.

Practical directions for the Cultivation of Fruit Trees in the NURSERY, ORCHARD AND GARDEN. Descriptions of the principal American and Foreign varieties. Plain Edition, 480 engravings, 511 pages, 12 mo. Price, \$3.00. Mailed post-paid on receipt of price.

Extra Edition, 576 pages, heavy paper, fine cloth, 508 illustrations and chromo frontispiece; mailed, for \$3.75. Address CHAS. H. MAROT, 814 Chestnut St., Phila.

# WABAN CONSERVATORIES

OFFICE :  
56 BROAD ST., BOSTON.  
Address all Letters to  
BOSTON OFFICE.

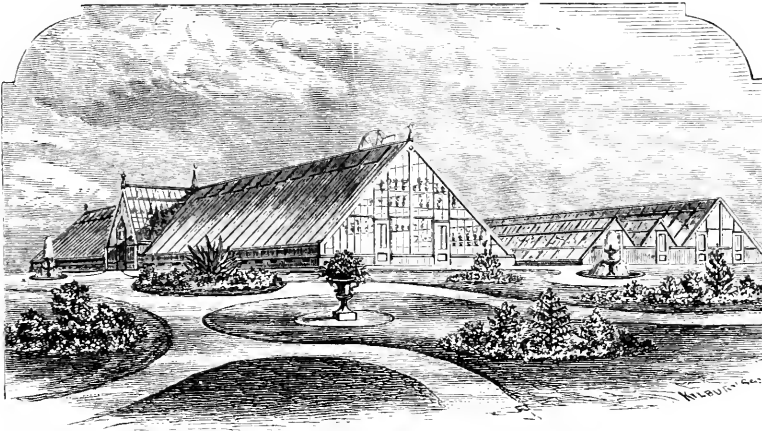

Send all Telegrams by  
Atlantic & Pacific Line. Address,  
*Waban Conservatories,*  
LAKE CROSSING, MASS.

## THESE CONSERVATORIES

Have in stock at all times, and offer at Wholesale,

## CUT FLOWERS IN QUANTITY, CONSISTING OF

Bon Silene, Saffrano and Isabella Sprunt Roses, Marechal Niel and General Jacqueminot, in great quantity, Souvenir de Malmaison, Yellow Tea, Persian Yellow, Devonensis, Gloire de Dijon in limited amounts. Belle Lyonnaise, Perle de Lyon, La France Rose in large quantity.

White and Red Bouvardia, White and Red Carnations, Violets, Stephanotis, Tuberoses, Jessamine and a general assortment of Cut Flowers used by the best Florists.

Smilax & Fern Fronds in very large quantities for Decoration.

NEW ROSES, }  
NEW PLANTS, } AT LOWEST RATES.

We are now packing and shipping Flowers with perfect success to Chicago, New York, Philadelphia, Baltimore, Washington, Montreal, and all important intervening places; and we are pleased to add that our shipments are giving universal satisfaction; our Telegraphic communications enabling us to fill orders to the most distant places quicker than Florists can obtain them by any other means.

We offer for the next sixty days SURPLUS STOCK of young ROSES, in 3-inch pots, of the leading varieties: Bon Silene, Safrano, Isabella Sprunt, Marshall Neil, Gen'l Jacqueminot, &c., &c., at unusually low rates by the 100 or 1000. New HYBRID PERPETUALS of 1876, at a great Reduction.

### GERANIUM "EARL ROSLYN,"

WARRANTED the best Bronze Zonale in cultivation, improving in color in the hottest sunlight.

BEDDING PLANTS of all descriptions at special rates for large quantities. For varieties see Catalogue, which will be mailed Free to all applicants.

**N. B.**—Particular attention given to Plan, Arrangement, Construction and Heating of Greenhouses for the growth of CUT FLOWER PLANTS at a Profit for Market. Advice as to the most profitable Flowers and Plants to grow, and method of culture. Nine-tenths of the Failures can be traced to want of Knowledge in the Construction, Arrangement and Heating of Houses, and the Kinds of Plants and Flowers to put in them. New Beginners, we believe, will find our knowledge and large experience valuable to them.

EDMUND M. WOOD & CO.

# S. B. PARSONS & SONS,

## Kissena Nurseries,

### Near KISSENA STATION, FLUSHING, N. Y.,

OFFER a very large assortment of TREES and PLANTS of all the best families. Nearly all of them have been two years transplanted, and their roots are thus in the very best possible condition for a second transplanting.

Their assortment of **RARE EVERGREENS** has long been known to be the most complete. They now have in cultivation a very large variety of hardy

## Deciduous Trees and Shrubs,

numbering over 800 sorts, of which 300 sorts, one year grafted, are entirely new and have not yet been in their catalogue.

Their JAPANESE DEPARTMENT now includes more than 150 varieties in addition to the above, and is being constantly enriched by Thomas Hogg, now in Japan. Many of these varieties are unknown in Europe. The celebrated JAPANESE MAPLES and AZALEA MOLLIS are alone worthy of a visit.

CAMELLIA JAPONICA and AZALEA INDICA can be advantageously shipped during September, October and November; September being preferred. These plants are carefully formed and trimmed, and their symmetry is recognized by all who see them.

Rhododendrons and other hardy Evergreens can be safely transplanted in September.

Estimates will be furnished for Planting Grounds under the care of an experienced Landscape Gardener, and much trouble thus saved to the owner.

Catalogues will be furnished to applicants by mail, and those who wish to visit the Nurseries will always find either one of the proprietors, or J. R. Trumpy, the well-known propagator of the old establishment. They can take the ferries at 34th Street or James' Slip, which connect with the railroad, leaving the first a quarter of an hour, and the last half an hour before the departure of trains, which make the transit in half an hour. The Nursery is adjoining the Kissena Station and one and a half miles from the other stations. aep

## NEW AND BEAUTIFUL JAPAN LILIES.

Now offered for the first time in this Country by B. K. BLISS & SONS, NEW YORK.

### LILIUM KRAMERI.

Since the introduction of the beautiful *Lilium Auratum*, first brought out by us in 1867, nothing has been offered that will compare with this lovely variety. We take much pleasure in being the first to offer it in this country, having received a consignment of this and the following variety (*Lilium Hansonii*) direct from Mr. Thomas Hogg, to whom we are already indebted for many of our most popular Japanese plants, who thus describes it: "Its general character is that of *L. longiflorum*, of which it may prove a variety, only its flowers, instead of being white, are of various shades of pink color. Coming from the southern part of Japan, it may not prove hardy at the North, but for a greenhouse or frame culture it will be an acquisition of no little merit, owing to its beautiful shades of color." It was exhibited in England last season, and received a first class certificate from the Royal Horticultural Society, where it attracted considerable attention suggesting the idea of a natural hybrid between *longiflorum* and *Auratum*. It bears a considerable resemblance to the latter Lily, both in shape and size, but has neither spot or centre band. The petals are suffused with a bright delicate pink blush. Mr. Kramer writes: "Among them are some new and sterling varieties of all colors, from a pure white to a rich rose or mauve tint. When well cultivated at home it will make a charming Lily."

Flowering Bulbs, \$2.00 and \$3.00; extra size Flowering Bulbs, grown in this country one year, \$5.

### LILIUM HANSONII.

This new and beautiful Japan Lily was named by Max Leichlin, of Carlsruhe, Baden, in honor of Mr. P. Hanson, of Brooklyn, N. Y., and to whom we are indebted for the accompanying description. We believe that the plant in Mr. Hanson's garden is the first one of the kind that has bloomed in this country. This Lily is of a gigantic structure, often attaining a height of from four to six feet, and has proved to be quite hardy. The leaves are produced in whorls, and are seven to eight inches long and two broad. The flowers are borne in clusters, and the buds being nearly globular they look very much like potato balls. The full expanded flowers are about two and a half inches in diameter, and the petals are very thick, looking more like wax than natural flowers. Their color is also very peculiar, one side of the petals being yellow with a streak of white running through the centre; the other side is a brilliant yellow spotted with purple. It is not quite as showy a Lily as the *Auratum*, or some of the varieties of *speciosum*: still it is one of the most interesting and valuable varieties introduced in some time. This variety was never before offered in this country, and is to be found only in a very few collections in Europe. Flowering Bulbs, \$5.00 each.

### LILIUM AURATUM.

"This golden-rayed Queen of Lilies is the most beautiful of the Lily family. It is perfectly hardy, and for the adornment of the flower garden, the conservatory, and the sitting-room it is unrivaled."

	Each.	Doz.
<i>Lilium Auratum</i> Flowering Bulbs, .....	\$0 30	\$3 00
— — — large size, .....	50	4 50
— — — extra size, .....	1 00	10 00
— <i>Lanceifolium Album</i> , pure white, .....	50	5 00
— <i>rubrum</i> , white, spotted with crimson, .....	25	2 50
— <i>roseum</i> , white, spotted with rose, .....	25	2 50
— <i>Punctatum</i> , white, spotted with delicate Salmon, .....	75	7 50

Bliss's Illustrated Seed Catalogue and Amateur's Guide to the Flower and Kitchen Garden, contains a descriptive list of 2500 varieties of Garden, Field and Flower Seeds, with explicit directions for culture, 200 pages, several hundred engravings, and a beautifully colored lithograph. Sent post-paid, for 35 cents.

Bliss's Gardener's Almanac and Abridged Catalogue of Garden, Field and Flower Seeds. 116 pages, beautifully illustrated, mailed to all applicants inclosing 10 cents.

Bliss's Illustrated Potato Catalogue contains a descriptive list of all the new varieties recently introduced, with many other desirable sorts, also much useful information upon their cultivation. 32 pages, 10 cents.

## B. K. BLISS & SONS,

34 Barclay Street, New York.

P. O. BOX No. 5712.



THE  
GARDENERS  
And MONTHLY  
HORTICULTURIST

EDITED BY THOMAS MEEHAN.

Vol. XVIII.

No. 211.

(Combined Magazines, Thirty-first Year.)

**JULY, 1876.**

PUBLISHED BY CHARLES H. MAROT

814 Chestnut Street, Philadelphia.

TERMS—\$2.10 PER YEAR—POSTAGE PAID.



Wm. Assheton Del.

J. R. Stockton Co.

# THE GARDENER'S MONTHLY AND HORTICULTURIST.

EDITED BY THOMAS MEEHAN,

Assisted by an able Corps of AMERICAN and FOREIGN CORRESPONDENTS.

It is published on the first of every month, at the office, No. 814 CHESTNUT STREET, PHILADELPHIA, where all BUSINESS communications should be addressed.

Communications for the Editor should be addressed: THOMAS MEEHAN, GERMAINTOWN, Philada.

SUBSCRIPTION PRICE, Postage paid, \$2.10.

## TERMS OF ADVERTISING.

	1/8 col.	1/4 col.	1/2 col.	3/4 col.	1 col.	1 col.	1 page.
One Time,	\$3.00	\$4.00	\$6.00	\$8.00	\$12.00	\$24.00	\$48.00
Two to Three Times, each,	2.70	3.60	5.40	7.20	10.80	21.60	43.20
Four to Six Times, "	2.25	3.00	4.50	6.00	9.00	18.00	36.00
Seven to Nine Times, "	2.00	2.70	4.00	5.35	8.00	16.00	32.00
Ten to Twelve "	1.80	2.40	3.60	4.80	7.20	14.40	28.80

Twelve lines nonpareil is 1/4 col. A less space than 1/4 col., will be furnished at rates in exact proportion, line for line. For THIRD and LAST COVER PAGES; FIRST PAGE advertisements facing reading matter; "FLY-LEAF PAGE" (front of number) before reading matter and facing first cover,—special figures will be given on application. COPY and orders for NEW advertisements should be in hand by the 23d of each month; and CHANGES of COPY in running contracts by the 16th of each month, to insure them in following issue. Address

CHAS. H. MAROT, Publisher, 814 Chestnut Street, Philadelphia.

## CONTENTS OF THE JULY NUMBER.

### SEASONABLE HINTS:

Flower Garden and Pleasure Ground.....	193
Green House and House Gardening.....	201
Fruit and Vegetable Gardening.....	205-206

### CORRESPONDENCE:

Rose—Dutchess of Edinburgh.....	193
Arboretum Americanum.....	194
Note on the Gardens of Germany.....	198
Poinsettia Culture.....	202
Orchid Culture.....	202
The Aquatic Bouquet.....	203
How to Destroy the Pear Slug.....	205
Progress of Plum Culture—A Thousand Acres Planted Within Three Years.....	207
General Observations on the Flora of Hokkaido.....	211
Root Hairs.....	213

### EDITORIAL NOTES:

Parks in Boston—Anemone nemorosa—How Marchal Niel Rose Grows—Gun-barrel Budding—Importance of Forests—Andromeda arborea.....	199-200
Odontoglossum cirrhosum—Kalmias for Winter Blooming—Money Value of Orchids.....	204-205
Imperfect Reports—The English Sparrow—Fighting the Codling Moth—Snyder Raspberry—The Wealthy Apple—The Art of Making Wine—Versailles Currant—Plum Culture in Ohio—Chickory Salads—The Plum and Cherry Knot.....	208-210
Peach and Apricot Hybrids—'Nuts for the Scientific to Crack'—Callirhoe involucrata—Seeds from Male Plants of Aucubas.....	214
Laws for Nurserymen—Advisory Committee of the	

Bureau of Horticulture of the Centennial—Linnaea borealis—About Hybrids—Hoopes' Book of Evergreens—The Grape Phylloxera—Sale of the Rosedale Nurseries—Test of a Good Gardener—Geological Survey of Texas—Transactions of the Massachusetts Horticultural Society for 1876—Report of the American Pomological Society—Mr. Rand's Book on Orchids—Flora of California—Guide to the Pacific Coast—D. D. T. Moore—New Plants—Mr. W. T. Harding.....	215-219
Flora at the Centennial—International Exhibition—Pomological Reports—The International Jury upon Miscellaneous Fruits—Massachusetts Horticultural Society.....	219-224

### NEW PLANTS:

New Double White Clematis—Fritillaria pudica—Fritillaria recurva.....	200
Cheilanthes fragrans—Phormium Colensoi variegatum—Corynostylis hybanthus albiflora.....	205

### NATURAL HISTORY AND SCIENCE.....

### LITERATURE, TRAVELS AND PERSONAL NOTES.....

### HORTICULTURAL SOCIETIES.....

### QUERIES:

Diseased Branches on Oaks and Maples—Double White Deutzia crenata.....	200-201
Sun Ray Fuchsia—Nymphaea cerulea.....	205
Fire Blight in the Pear—Pear Disease—Pear Trees and Underdraining—Vanilla Culture—Peach Yellows—Polygonum amphibium for Tanners.....	210-211
Insects, both Night and Day Flyers—Fertilization of Lilies—Grass from Geneseo, Ill.....	215



ASK PRICES FOR

# SOLUBLE PACIFIC GUANO

FOR

## HORTICULTURE

OF

# AUGUST RÖLKER & SONS,

IMPORTERS AND DEALERS IN

## FLORISTS' SUPPLIES,

### 32 READE ST., NEW YORK.

---

This Guano contains *no ammonia to excess* in the condition of ready formed salts; but, containing it *only in its elements* and generating it gradually as the decomposition takes place after application, no injurious effect, only the *most beneficial results* are had on the tender fibres of plants, which advance in vigor by its use. It has *no equal fertilizer* for the cultivation of *Roses*.

Only when the roots are in working order and thoroughly established in the pot, commence watering with

*Soluble Pacific Guano for Horticulture*

as per directions on package of 2½ lb. and 25-lb. tin cans. By the ton it is shipped in barrels.

**RURAL AND PRACTICAL BOOKS,** (and any others in the market not on this list) will be sent by mail, post paid, on receipt of price. Address CHAS. H. MAROT, 814 Chestnut St., Philada.

Allen's, R. L., Diseases of Domestic Animals.....	\$1 00	How to Manage a Building Association.....	\$2 00
Allen's, L. F., Rural Architecture.....	1 60	How to Paint.....	1 00
Allen's, L. F., American Cattle.....	2 50	Hunter and Trapper.....	1 00
Allen's, R. L. & L. F., New American Farm Book.....	2 50	Hussman's Grapes and Wines.....	1 50
American Architect.....	7 00	Jacques' Manual of the House.....	1 50
American Bird Fancier, (Brown's).....	30	Jacques' Manual of the Garden.....	1 75
American Farmer's Encyclopedia.....	6 00	Jennings' Cattle Doctor.....	1 75
American Horticultural Annual, paper 50 Cts., cloth.....	75	Jennings on the Horse and his Diseases.....	1 75
American Weeds and Useful Plants.....	1 50	Jennings' Sheep, Swine and Poultry.....	1 75
Apple Culturist, S. E. Todd.....	75	Johnson's Gardener's Dictionary.....	3 50
Art of Saw Filing.....	10 00	Johnson's How Crops Feed.....	2 00
Architecture, Modern American, Cummings & Miller.....	12 00	Johnson's How Crops Grow.....	2 00
Principles and Practice of, By Loring & Jenning	12 00	Johnson's Feat and its Uses.....	1 25
Baker's Fruit Culture.....	4 00	Johnson's Elements of Ag. Chemistry and Geology.....	1 50
Bassett on Cranberry Culture.....	30	Johnston's, J. S. W., Agricultural Chemistry.....	1 75
Barry's Fruit Garden.....	2 50	Kemp's Landscape Gardening.....	2 50
Bell's Carpentry made easy.....	5 00	Klippart's Farm Drainage.....	1 75
Bement's Poulterer's Companion.....	2 00	Langstroth, Rev. L. L., on the Hive and Honey Bee.....	2 00
Bement's Rabbit Fancier.....	30	Leuchars' How to Build Hot-houses.....	1 50
Beet Root Sugar.....	1 50	Leibig's, Justus, Familiar Lectures on Chemistry.....	75
Bicknell's Village Builder, 77 plates.....	12 00	Leid-n's Encyclopedia of Plants.....	20 00
Bommer's Method of Making Manures.....	25	Lyman's Cotton-culture.....	1 50
Boussingault's, J. B., Rural Economy.....	1 60	McMahon's American Gardener.....	2 25
Brown's Treatise of America.....	6 00	Mayhew's Practical Book-keeping for Farmers.....	90
Breck's New Book of Flowers.....	1 75	Mechanics' Companion (Nicholson).....	3 00
Bridgeman's American Gardener's Assistant.....	2 50	McMahon's Ornamental Trees.....	75
Bridgeman's Fruit Cultivator's Manual.....	1 00	Miles on the Horse's Foot.....	75
Bridgeman's Kitchen Gardener's Instructor.....	1 00	Miner's, T. B., Bee-keeper's Manual.....	1 25
Buist's, Robert, Am. Flower Garden Directory.....	1 50	Mohr on the Grape-vine.....	1 00
Buist's, Robert, Family Kitchen Gardener.....	1 00	Money in the Garden.....	1 50
Burr's Field and Garden Vegetables of America.....	5 00	My Vineyard at Lak view.....	1 25
Carpenter and Joiner (R. Riddell).....	7 00	My Farm of Edgewood.....	1 75
Carpenter and Joiner's Hand Book, (Holly).....	75	My Ten-rod Farm.....	50
Chorlton's Grape Grower's Guide.....	75	North American Sylva, 5 vols., 156 col. plates, in 30 parts,	
Chemistry of the Farm, (Nichols).....	1 25	"    "    unbound.....	60 00
Cleveland's Villas and Cottages.....	4 00	"    "    Half Turkey Antique, gilt.....	70 00
Cobbett's American Gardener.....	75	"    "    full.....	75 00
Cole's, S. W., American Fruit Book.....	75	Nichol's Chemistry of the Farm and Sea.....	1 25
Cole's American Veterinarian.....	75	Norton's, John P., Elements of Scientific Agriculture.....	75
Cooper's Rural Hours.....	2 00	Norris' Fish-culture.....	1 75
Copland's Country Life.....	5 00	Onion-culture.....	20
Dadd's, Geo. H., American Cattle Doctor.....	1 50	Our Farm of Four Acres.....	1 25
Dadd's Modern Horse Doctor.....	1 50	Packard's Guide to the Study of Insects.....	cloth 6 00
Dana's, Samuel H., Muck Manual.....	1 25	Paul's Book of Roses.....	60
Darwin's Variations of Animals and Plants, (2 vols.).....	6 00	Paul's Rose Garden.....	3 00
Darwin's Insectivorous Plants.....	7 00	Paxton's Botanical Dictionary.....	15 00
DeVoe's Market Assistant.....	2 50	Parlee on Strawberry-culture.....	75
Downing's, A. J., Landscape Gardening.....	6 50	Parkman's Book of Roses.....	1 50
Downing's Cottage Residences.....	3 00	Parsons, Samuel B., on the Rose.....	1 50
Downing's Fruits and Fruit Trees of America.....	5 00	Peat and its Uses.....	1 25
Downing's Rural Essays.....	3 50	Pear-culture, Fields.....	1 25
Downing's Ladies' Companion to the Garden.....	2 00	Pedder's, James, Farmer's Land-measurer.....	60
Du Breuil's Vineyard Culture, (Dr. Warden).....	2 00	Percheron Horse.....	1 00
Eastwood on Cultivation of the Cranberry.....	75	Peterson's Preserving, Pickling and Canning Fruit.....	50
Elliott's Western Fruit Grower's Guide.....	1 50	Phin on Wine-making.....	1 50
Elliott's Lawn and Shade Trees.....	1 50	Quinn's Pear-culture for Profit.....	1 00
Elliott's Fruit Growers' Hand Book, paper, 60 cents, cloth	1 00	Quinby's Mysteries of Bee-keeping Explained.....	1 50
Farm Talk, (Brackett).....	1 00	Randall's Sheep Husbandry.....	1 50
Farming for Boys.....	1 50	Randall's Fine Wool Sheep Husbandry.....	1 00
Fields, Thomas W., Pear Culture.....	1 25	Rand's Bulbs.....	3 00
Five Acres too Much, (illustrated).....	1 50	Rand's Flowers for Parlor and Garden.....	3 00
Flagg's European Vineyards.....	1 50	Rand's Seventy-five Flowers.....	1 50
Flax Culture.....	50	Rand's Flower Garden.....	3 00
Flint, Chas. L., on Grasses.....	2 50	Rand's Orchid Culture.....	3 50
Flint's Milch Cows.....	2 50	Riddell's Architect.....	15 00
Fowler's Homes for All.....	1 50	Ropp's Commercial Calculator, cloth \$1, Morocco Tuck.....	2 00
Frank Forester's Fish and Fishing, 8 vo. 100 engravings.....	3 50	Rose Culturist.....	paper 30
Frank Forester's Manual for Young Sportsmen, 8 vo.....	3 00	Robbins', R., Produce and Ready Reckoner.....	75
French's Farm Drainage.....	1 50	Saunders' Domestic Poultry, paper 40.....	cloth 75
Fuller's Grape Culturist.....	1 50	Saxton's Hand Books, in four series, each.....	1 50
Fuller's Small Fruit Culture.....	1 50	Schenck's Gardener's Text-book.....	75
Fuller's Strawberry Culturist.....	25	Scribner's Ready Reckoner and Log-book.....	50
Fuller's Forest Tree Culturist.....	1 50	Strong's Cultivation of the Grape.....	3 00
Fulton on Peach Culture.....	1 50	Ten Acres Enough.....	1 50
Geyelin's Poultry Breeding.....	1 25	Thomas, J. J., Farm Implements.....	1 50
Gray's How Plants Grow.....	1 25	Thomas, J. J., Fruit-culturist; old ed. \$3 00; new edition.....	3 75
Gray's Manual of Botany.....	2 25	Wille's Chemical Manures.....	1 25
Gray's Manual, Botany and Lessons, in one vol.....	4 00	Warder's American Pomology.....	3 00
Gray's School and Field Book of Botany.....	2 50	"    "    Hedges and Evergreens.....	1 50
Green on Trout Culture.....	1 00	Waring's Drainage for Profit and Health.....	1 50
Gregory on Squashes, paper.....	30	"    "    Elements of Agriculture.....	1 50
Guernon on Milch Cows.....	75	"    "    Earth closets.....	50
Guide to Fortune.....	1 00	Webster's Dictionary, Unabridged.....	12 00
Harazthy's Grape Culture and Wine Making.....	5 00	W. L.'s Every Man his own Lawyer.....	2 00
Harris' Insects Injurious to Vegetation, clo. \$1; col. engs.....	6 50	Williams, B. S., on Stove & Greenhouse Plants, 2 vols., ill'd.....	5 00
Harris on the Pig.....	1 50	Williams, B. S., on Select Ferns and Lycopods.....	2 50
Hatfield's American House Carpenter.....	3 50	Williams, B. S., Orchid Grower's Manual.....	2 50
Henderson's Practical Floriculture.....	1 50	Window Gardening.....	1 50
Henderson's Gardening for Pleasure.....	1 50	White's Gardening for the South.....	2 00
Henderson's Gardening for Profit.....	1 50	"    "    Cranberry Culture.....	1 25
Herbert's Hints to Horsekeepers.....	1 75	Wood's Class Book of Botany.....	3 50
Hoopes on Evergreens.....	3 00	Workingman's Way to Wealth.....	75
Hooper's Dog and Gun, paper 30 cents, cloth.....	60	Wright's Practical Poultry Keeper.....	2 00
Hop-culture.....	40	Youatt on the Horse.....	1 75
How to Buy a Farm, and Where to Find One.....	1 75	Youman's Household Science.....	2 00



SEE FIRST PAGE, FACING COVER.

# WEATHERED & CHEREVOY'S PATENT BOILERS

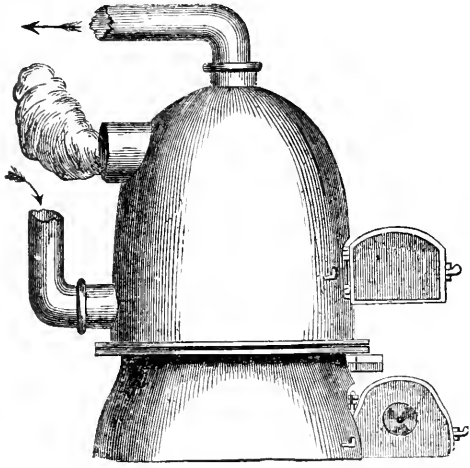

Fig. 1.

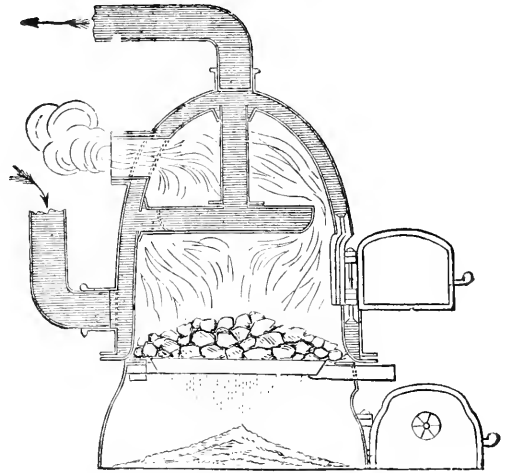

Fig. 2.

AND IMPROVED

## HOT WATER APPARATUS,

No. 46 Marion Street, between Spring and Prince, New York.  
(TWO BLOCKS EAST OF BROADWAY.)

For Warming and Ventilating Public Buildings, Private Dwellings, Greenhouses, Graperies, Forcing Pits, Drying Rooms, and Heating Water for Public Baths.

Fig. 1 is an outside view. Fig. 2 is a vertical section through the centre.

*The following are a few names of Gentlemen who have our Boiler in use:*

Thos. Drake, Esq., Germantown, Pa.  
Simon Cameron, Esq., Harrisburg, Pa.  
J. D. Cameron, Esq., Harrisburg, Pa.  
Thos. Carter, Esq., Raleigh, N. C.  
J. H. Dunham, Esq., Chicago, Ill.  
Jas. B. Waller, Esq., "  
W. J. Gordon, Esq., Cleveland, Ohio.  
Geo. Stanley, Esq., "  
Harris Jaynes, Esq., "  
Geo. W. Cuyler, Esq., Palmyra, N. Y.  
D. M. Osborn, Esq., Auburn, N. Y.  
John B. Dutcher, Esq., Pawling, N. Y.  
A. M. Allerton, Esq., Bronxville, N. Y.  
Robert Hoe, Esq., Tarrytown, N. Y.  
Peter Hoe, Esq., "  
George Lewis, Esq., "  
Wm. H. Drew, Croton Falls, "  
Hon. James Y. Smith, Providence, R. I.  
Philip Caswell, Esq., Newport, R. I.  
Alfred Smith, Esq., "  
Wm. Findlay, Esq., "  
E. Learned, Esq., Pittsfield, Mass.  
B. O. Mills, Esq., San Francisco, Cal.  
W. L. Ferris, Esq., Westchester, N. Y.  
D. H. Haight, Esq., Goshen, N. Y.  
F. Newbold, Esq., Newark, N. J.  
James T. Glosson, Esq., Plainfield, N. J.  
Daniel W. Coit, Esq., Norwich, Conn.  
J. F. Slater, Esq., "  
H. W. Collender, Esq., Darien, "  
Chas. P. Palmer, Esq., Stonington, "

Wm. D. Black, Esq., New Milford, Conn.  
Rev. Stephen H. Tyng, Irvington, N. Y.  
H. F. Spaulding, Esq., Riverdale, "  
S. D. Babcock, Esq., "  
Percy R. Pyne, "  
Elisha Brooks, Esq., Inwood, "  
Camille Marie, Esq., "  
A. F. Smith, Esq., Fort Washington, "  
R. M. Olyphant, Esq., Dobb's Ferry, "  
Clarkson N. Potter, Esq., New Rochelle, "  
Chas. D. Dickey, Esq., West Farms, "  
Wm. Matthews, Esq., Harrison, "  
William Chorlton, Esq., New Brighton, S. I.  
F. H. Wolcott, Esq., Astoria, L. I.  
Bailey Leach, Esq., "  
Hon. W. B. Ogden, High Bridge, N. Y.  
Peter Moller, Esq., 295 Fifth Ave., New York City.  
Wm. Moller, Esq., 6 West 20th St., "  
John Moller, Esq., 127 East 54th St., "  
John Moller, Esq., 8 East 37th St., "  
Ch. Moller, Esq., 426 Washington St., "  
Henry B. Laidlaw, Esq., 33 Pine St., "  
George W. Lane, Esq., 93 Front St., "  
J. P. Robinson, Esq., 14 Coenties Slip, "  
J. B. Colgate, Esq., 47 Wall St., "  
John B. Trevor, Esq., 47 Wall St., "  
Charles Butler, Esq., 12 "  
Richard Arnold, Esq., 309 Canal St., New York City.  
Jas M. Constable, Esq., 309 Canal St., "  
W. T. Garner, Esq., 61 Worth St., N. Y. City.

Please send for Circular with list of References and Reduced Prices to

THOMAS W. WEATHERED, 46 Marion Street, N. Y.

## LANDS SUITABLE FOR MARKET GARDENING. 600 ACRES OF LAND.

Valuable tract of land on Broad River, Beaufort Co., S. C., within ten miles by water of the new City of Port Royal, from whence there are weekly steamers running direct to New York. 300 acres of the foregoing are prime river bottom land of a black loam, and eminently well suited for vegetable gardening and fruit culture. The other 300 acres are in wood. No buildings. The New York steamers will stop and take in produce at the place. This section has been well named "The garden spot of the South." The land is very productive, and is unsurpassed for raising early vegetables for the Northern markets, a business which will surely prove very profitable. Price \$200,000 for the whole tract, terms of payment to suit purchaser. The foregoing will be sold in smaller tracts if desired. Taxes in this State the coming year about 12 mills on the dollar. For further particulars address.

N. CHRISTENSEN, Beaufort, S. C.

## SEEDS

or

### RUTA BAGA and other TURNIPS

Of our own Raising. Our Motto is

Low Prices with High Quality.

Farmers can obtain supplies by Mail direct, post-paid, at small charge. Send Postal Card for List of Prices.

DAVID LANDRETH & SONS,  
PHILADELPHIA, PA.

july1

## NEW DOUBLE POINSETTIA,

(Poinsettia Pulcherrima Plenissima)

We take pleasure in offering to the Trade a limited number of this magnificent novelty, which have just been received in good order from the Introducers, Messrs. Veitch & Son, London. Strong Plants (perfectly ripe wood) each \$10 00.

HENRY A. DREER,  
Seedsman and Florist,

No. 714 Chestnut Street,

july1

PHILADELPHIA.

## STANDARD PEARS.

We offer for fall the finest lot of 2 and 3 years STANDARD PEARS in the country. A large assortment of new and standard varieties, among them are

50,000 BARTLETTS,  
40,000 CLAPP'S FAVORITE,  
30,000 FLEMISH BEAUTY,  
20,000 BEU. D'ANJOU,  
15,000 SHELDON.

Also APPLES, CHERRIES, PLUMS, DWARF PEARS, PEACHES, ORANGES, QUINCES, and other Nursery Stock.

RICHARDSON & NICHOLAS,

july4

GENEVA, N. Y.

## LILIES.

5000 Superbum, \$7.00 per hundred.  
5000 Canadence, \$6.00 per hundred,  
Samples sent after July 20th, post-paid, for 15c. each.

Address,

tjuly1

J. COBB, Peekskill, N. Y.

## NEW PLANTS--TO THE TRADE.

NEW DOUBLE WHITE DAISY.

The largest and finest white daisy yet offered, flowers perfectly double. 50c. each.

NEW VARIEGATED LANTANA.

Best variegated bedding plant to stand the sun. Very free blooming. 60c. ea. b, \$5 00 per doz., free by mail.

W. A. HARKETT,  
DUBUQUE, IOWA.

feb10

SEASON 1876.

## DUTCH BULBS

AND

## FLOWER ROOTS,

GROWN BY

## E. H. KRELAGE & SON,

HAARLEM, HOLLAND,

For Catalogues, which will be forwarded as soon as they are issued, apply to Messrs. E. H. KRELAGE & SON, Haarlem, Holland, or to their Agent for America,

C. RAOUX,

jan1f

76 Park Place,

NEW YORK CITY.

## ORCHIDS, ORCHIDS!

Wishing to give up Orchid-growing, I offer a choice collection for sale entire. It consists of Cattleyas, Laelias, Dendrobiums, Aerides, &c.

List and price on application.

Also in addition to the above, fine plants of Phalaenopsis amabilis, Grandiflora and Schilleriana, much cheaper than usually offered. Plants of the lovely

TODEA SUPERBA,

with very large crowns and splendid fronds, at a very low price. Adiantum Farleyense from \$1 upwards. Musa ensata, young plants, \$2. I also offer this Musa to the trade.

EDMUND D. STURTEVANT,

Bordentown, N. J.



ESTABLISHED 1844.

HITCHINGS & CO.

No. 153 Crosby Street,  
NEW YORK.

HOT-WATER  
APPARATUS  
for HEATING  
GREEN-HOUSES, &c.

Illustrated Catalogue and List of References and Reduced  
Prices, sent on receipt of postage—6 cents.

H.W. THOM. D.C.

# Roses! Roses! Roses!

We offer a large stock of  
FINE STRONG GROWING YOUNG ROSES,  
grown in 2 and 3 inch pots, and include the finest and leading varieties.

HYBRID PERPETUALS, TEAS, BOURBONS AND CHINAS.

Also MOSSES and CLIMBERS.

at very lowest prices. Orders solicited.

JAMES ALDOUS & CO., Florists,  
tfeb7 Iowa City, Iowa.

## FARMERS! \$16 FORGES,

FOR YOUR FARMS!

ALSO, A COMPLETE "KIT OF TOOLS."

Just what is wanted. Send three-cent stamp for circular to  
EMPIRE PORTABLE FORGE CO., Troy, N. Y.

## FOR SALE,

IN BALTIMORE COUNTY, MD.,

One of the BEST FRUIT FARMS in the country. The farm contains about 40 ACRES. The fruit will pay a profit of from 25 to 50 per cent. Also, a good store stand attached. Will be sold very low. Address,

July 1. A. JOHNSON, Long Green, Baltimore Co., Md.

## WHOLESALE TRADE LIST

OF

## DUTCH FLOWER ROOTS

Franco and gratis on application.

A. M. C. J. CONINCK,

July 2 Dedemsvaart, Netherlands.

## C. F. A. HINRICHS,

29, 31 and 33 Park Place, New York City,

HYACINTH AND BULB GLASSES.

DECORATED

FLOWER POTS,

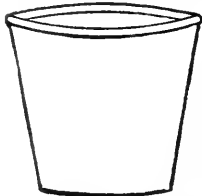

LAVA, MAJOLICA, &c., &c. Vases.  
Iron Sections for Flower Beds. Lawn,  
Fish and Flower Stands Floating Animals  
for Aquaria. Button-hole Bouquet  
Holders. Only and Original GERMAN  
STUDENT LAMP for Conservatories.

Send for Prices to above address.

mch6

THE POTATO BUGS are here. Save your crops with the Planet Exterminator: a cheap apparatus for blowing a cloud of Paris Green among the plants in the most rapid, effectual, and economical manner possible. Price, \$3.00. Paris Green (strictly pure) supplied. Directions for use with each machine. Send for circular. Mention this paper. S. L. ALLEN & CO., 119 S. 4th St., Phila.

We must have a live agent in every town.

## WILL BE SOLD CHEAP.

15,000 Fine Verbenas, as are in this country, in 50 varieties; and a general collection of Bedding and Basket Plants, Sweet Potato, Cabbage and Celery Plants. Send for Price List.

HENRY WEBER,

may 3

Cumberland, Md.

## Florists' Flower Seeds.

Primula, Calceolaria, Cineraria, Smilax and Apple-Geranium Seeds, new crop of the finest strains. Send for price list of seasonable seeds.

HENRY A. DREER,

Seedsman and Florist,

July 2

No. 714 Chestnut St., Phila.

## KANSAS PACIFIC

# HOMESTEAD.

This paper is full of reliable information about Kansas, her climate, soil, products and progress. Contains a nice map of the United States, and a fine view of a prosperous Colony from Pennsylvania.

It is a faithful guide to the best and cheapest body of lands in the West. 5,000,000 acres for sale. For a copy, send your address to  
may 3 S. J. GILMORE,

Land Commissioner Kansas Pacific Railway, Lawrence, Kansas.

## N. STEFFEN'S WIRE WORKS,

338 E. 21st St. New York.

manufacturer of all designs for FLORISTS. Wreaths, Crosses, Crowns, Hearts, Anchors, Pillars, Columns, Monuments, Bells, Composure, Faith, Hope and Charity, Harps and Lyres, &c. Leaning and Upright

Send for Price List.

Jan 12.

Following Horticultural Advertising Papers will be forwarded gratis and post-free on application:

To Amateurs, "Die Allgemeine Baum-Offerte."

To Nurserymen, "Die Allgemeine Samen-s Pflanzen-Offerte."

BERNHARD THALACKER,  
July 7 Gohlis, near Leipzig.

## GARDEN, FIELD

AND

# FLOWER SEEDS,

AGRICULTURAL IMPLEMENTS,

HORTICULTURAL TOOLS, &c.

Catalogues Free.

D. LANDRETH & SONS,

Nos. 21 & 23 SOUTH SIXTH STREET,

Between Market & Chestnut St.,

may 3

PHILADELPHIA.

TO FLORISTS.

TOBACCO STEMS, For Fumigating purposes, put up in bales of 250 lbs. each, at \$5.00 per bale, free on boat or cars. All orders from unknown parties must be accompanied by remittance. For sale by

STRAITON & STORM,

aug 12

No. 180 Pearl Street, New York.

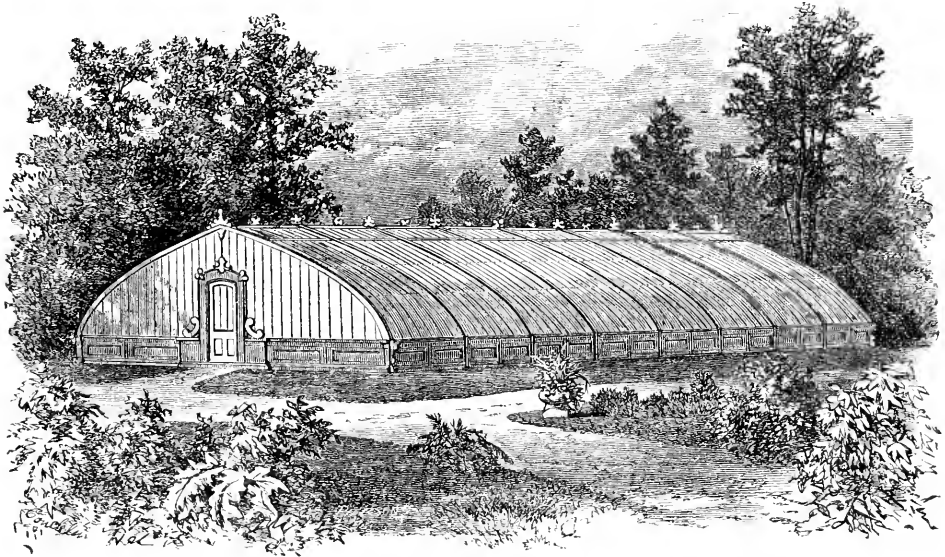

# GREENHOUSES, GRAPERIES, ETC.

Their Construction a Specialty. Experience of 20 Years.

SHIPPED TO ALL PARTS OF THE COUNTRY.  Send for Catalogue. Address, LORD'S HORTICULTURAL WORKS.

June 12

Irvington-on-Hudson, New York.

## ALEX. NIMMO,

(Late of the Firm of Nimmo & Scollay.)

# NEWLY IMPROVED HOT WATER BOILER,

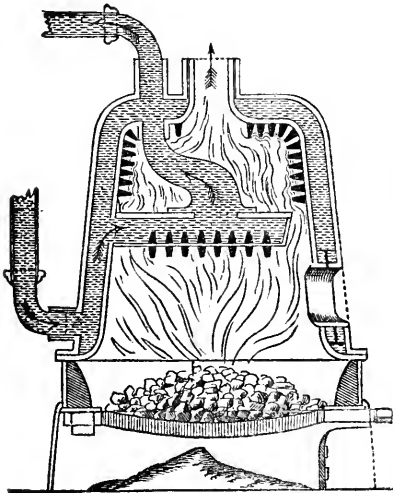

FOR HEATING  
Green-Houses, Graperies, Conservatories,  
Forcing Pits, Water for Baths, Drying  
Rooms, Public and Private  
Buildings, &c.

*Proper steps have been taken to secure United States  
Letters Patent on this Invention.*

All the necessary Fittings for Hot Water Heating Apparatus.

VENTILATION APPARATUS OF ALL KINDS.

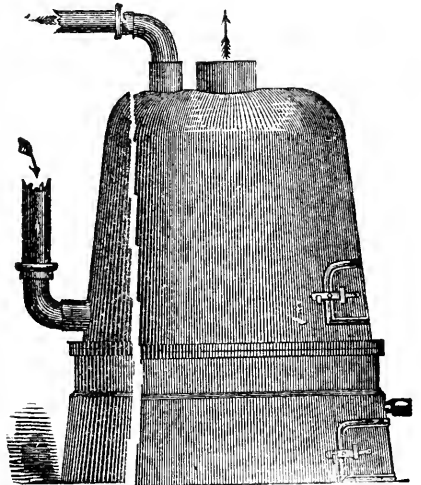

Wells Drove, Pumps of all kinds, Hydraulic Rams, &c., Garden Sun-Dials.

Agent for Joseph Kelly's Never Dry Vapor Pans, for all kinds of Hot Air Furnaces, Baltimore Heaters, &c.

CHEAPEST AND BEST BOILER, &c., IN THE MARKET.

 Please send for Circular for explanation, etc., before you make up your mind to purchase elsewhere.

sep 12

P. S.—Be sure you get the right number.

335 Adams Street, Brooklyn, N. Y.

# THE CHRISTIAN AT WORK.

T. De Witt Talmage, Editor.

Without Premiums, \$3; with Premiums, \$3.25. To Clergy-  
men 75 cents less. 每册 A Choice of two premiums.

## OPINIONS OF THE PRESS.

"The Christian at Work is the liveliest religious paper published in these parts. Its columns are spicy and sparkling and to religious people who like things lively it is a readable paper. The Devil is more certain to be frightened with a radiant face than a solemn and forbidding one."—*N. Y. Commercial Advertiser.*

"The Christian at Work has donned a new dress and looks as pretty as a picture. The type of all sizes is admirably clear and a handsomer weekly there is not in these United States."—*N. Y. Evening Mail.*

"The Christian at Work is safe and reliable in all its utterances and ought to displace the ——— in every Presbyterian family. Its editor is a host in himself, and nothing will stagnate that he has anything to do with."—*London Correspondent Chicago Interior.*

"The Christian at Work is an admirably conducted sheet, filled with live matter"—*N. Y. Star.*

"The Christian at Work is one of the most readable religious papers published anywhere. The Doctor and his associates have discovered the art of making a publication orthodox without being flippant."—*Brooklyn Eagle.*

"In The Christian at Work everything is lively and life-like. This Christian smiles, laughs, sometimes actually whistles, while at his work, and that without letting down the dignities and proprieties that belong to the discussion of the themes it discusses."—*Brooklyn Union.*

"The Christian at Work is one of the best of the religious weeklies, and deserves the success it has attained."—*Brooklyn Argus.*

"The Christian at Work is one of the most sprightly, most gladly welcomed in every family of all religious weeklies. It flits from the pulpit to the pew, from the rod of authority to the kiss of love, from the paternal command to the child's obedience, and scatters flowers upon all, breathing content and happiness upon all its readers."—*American Garden.*

## Five Sabbath School Papers,

under the same editorial supervision, are published by us monthly and are suitable for School or Home. The best and cheapest published. Beautiful premiums with these also.

## Good Words, My Paper, Good Cheer, Old and Young, Der Sonntagsgast. (German.)

We number our papers, but do not date them, making them good at any time.

Two papers with names nearly like our own have lately been issued in New York City. They are not in any way under the supervision of DR. TALMAGE or the control of THE CHRISTIAN AT WORK PUBLISHING COMPANY. Be careful to send your orders direct to the publisher of this paper.

Full particulars and sample copies of all papers furnished on application.

## HORATIO C. KING, Publisher,

July 14 No. 102 Chambers Street, New York.

**A**MSDEN, Amsden, Amsden. Earliest and best early Peach in the world. Trees, root grafts and scions at Carthage, Missouri, and Dayton, Ohio. Price of the trees reduced for spring 1876. For full history of this Peach, and price of the trees, root grafts and scions, address  
aug 12 JOHN WAMPLER, Carthage, Missouri.

## LONDON GARDENER'S CHRONICLE

Will be furnished, post-paid, direct to subscribers in the U. S. for  
nov 7 \$7 50 per year. Specimen Nos. 3 cent stamp. Apply to  
CHAS. H. MAROT, Agent, 814 Chestnut St., Phila.

## RICHARD LYNEX.

Rear of 428 Walnut Street, Philada.

Manufacturer of Plain and Fancy Wire-work, for Florists; Wreaths, Crosses, Stars, Crowns, Hearts, Anchors, Birds, Lambs, Gipsy Baskets, Hanging Baskets, Flower Stands, &c.

SEND FOR PRICE LIST.

feb 6

MY  
Wholesale and Descriptive Catalogues of  
**Greenhouse and Bedding Plants**  
SHRUBS, EVERGREENS, ETC.,  
MAILED TO ALL APPLICANTS.  
**Wm. C. Wilson**  
Astoria, L. I. C.,  
June 12 New York City Office 45 West 14th St.

## DUTCH FLOWER-ROOTS AND BULBS,

Cultivated and sold by

M. C. ALKEMEDE & SON,

at

Noordwijk-Binnen, near Haarlem, Holland.

Catalogue for 1876 will be forwarded post free on application.  
may 4

## DECLARATION OF INDEPENDENCE

FACSIMILE LITHOGRAPHED in the handwriting of THOMAS JEFFERSON, with the inter-lined corrections and erasures as made by JOHN ADAMS and Dr. FRANKLIN, in 1776. Pamphlet form, 11 pages, on extra heavy, highly colored, and tinted paper, with a beautiful cover, in four colors, embellished with the National Emblems,

OLD INDEPENDENCE HALL,

As it appeared in 1776.

THE "OLD LIBERTY BELL"

which rang out "the LIBERTY we now enjoy to all the people, etc., etc." To which is added the names of the signers in their own handwriting, making one of the most ornate, unique, and interesting centennial memorials of the "time that tried men's souls" that could possibly be imagined. Should be placed on the centre table of every American citizen.

Price 50 cents each, postage paid. Address.

CHAS. H. MAROT,

814 Chestnut St., Phila.

## The Gardener's Monthly.

THE FOLLOWING

**BACK NUMBERS**

WANTED, IN

**GOOD CONDITION.**

April, 1860.	October, 1870.	August, 1874.
January, 1870.	December, "	December, "
March, "	January, 1873.	January, 1875.
July, "	January, 1874.	December, "
		January, 1876.

Receivable in exchange on Subscription account, or exchangeable for other numbers not in above list. Send numbers and advise the publisher by letter. Address,

CHAS. H. MAROT,  
814 Chestnut St., Phila.



# JORDAN'S PATENT WATER AND STEAM BOILER.

Constructed of Horizontal Pipes of the same inside diameter as those that form flow and return pipes, thereby producing a very rapid circulation of the water.

LENGTH, SEVEN FEET.

## DESCRIPTION.

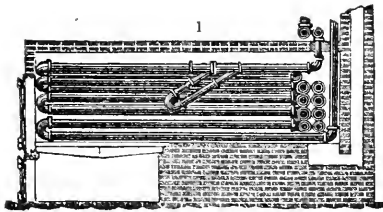

No. 1 Shows a side view of one-half section, with U steam propeller. Also shows section of chimney, ash-pit and brick arch around the boiler, with downward draft to chimney.

No. 2 Shows end view, with rear end closed with pipes; ash-pit below and brick arch above.

No. 3 Shows boiler before it is set in the brick, with a few pipes broken away, to show the steam generator.



The improvements claimed are: a larger heating surface, as compared to the amount of water in the boiler; a more rapid circulation of water by the use of steam generator to move the water; a larger fire-hole, so that soft coal can be used and not obstruct the draft; and cheapness.

The boiler is adapted to the heating of any building, and can be set up on a level with the room heated. Also, can be used for steam heating when required.

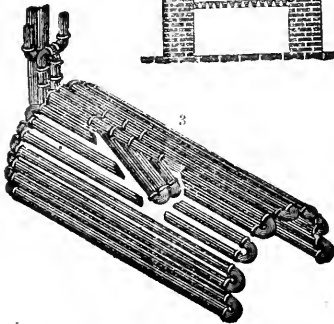

## PRICES OF BOILERS, INCLUDING IRON FRONTS.

No. 1, to heat 500 feet of 4-inch pipe.....	\$ 75.
No. 2, to heat 750 feet of 4-inch pipe.....	100.
No. 3, to heat 1000 feet of 4-inch pipe.....	125.
No. 4, to heat 1500 feet of 4-inch pipe.....	175.
No. 5, to heat 2000 feet of 4-inch pipe.....	225.
No. 6, to heat 3000 feet of 4-inch pipe.....	300.

Water-pipe and fittings furnished at factory prices. The work of putting up the boiler and pipes, furnished at low rates.

**J. M. JORDAN & BRO.,**  
612 Olive Street. St. Louis, Mo.

## REFERENCES.

- T. R. PULLIS, of Mississippi Iron Works, St. Louis, Mo.  
 EX-MAYOR COLE, President Merchants' Exchange, St. Louis.  
 W. F. COZZEN, O. P. SAYLOR, GEO. LYNCH, St. Louis; or any prominent Florist in the County of St. Louis.  
 J. T. McCONNEL & CO. and GEO. MATHEWS, Jacksonville, Ill.  
 CHICAGO FLORAL COMPANY, Chicago, Ill.  
 ROBERT EXCELL, WM. FAN COURT, JOHN GOOD, WM. DESMOND, AUGUST DRESS-SELL and JOHN WESTON, of Chicago, Ill.

# AN ARBORETUM AT THE CENTENNIAL.

Visitors to the CENTENNIAL EXHIBITION are invited to examine the **ARBORETUM** planted on the Horticultural grounds by

**THOMAS MEEHAN, Nurseryman,**  
GERMANTOWN, PHILA.

The collection embraces nearly **EIGHT HUNDRED** Species or well marked varieties, all named for the information of Visitors, and is believed to be one of the most complete collections of hardy, vigorous plants ever got together in this latitude. Visitors may

## HYBRID PERPETUAL ROSE, "EDMUND WOOD."

We are gratified to find that our friend M. VERDIER, the most celebrated Rose grower of France, has considered our establishment of sufficient importance to name one of his finest New Seedlings after our Mr. EDMUND M. WOOD.

In a special circular containing the names of his choicest New Varieties, he thus describes it: *Edmund Wood*: tree vigorous, with short reddish-green branches and numerous dark brown spines, leaves consisting of 3 to 5 leaflets oval, dark green; Flowers, large, full and perfect in form, growing in cymes of 6, color lively, bright cherry red, reverse of petals, carmine—admirable. This variety is comprised in the series to which the silver gilt medal was awarded by the Paris Horticultural Society in May and June, 1875. We can now supply nice young plants in 3 inch pots of this variety, together with all the new "Hybrid Perpetuals" issued by Mr. Verdier in 1876, at greatly reduced prices.

We have flowered Edmund Wood and some others of the set, and find them justly up to the descriptions.

Catalogues with full descriptions of Roses, Greenhouse Plants, &c., &c., mailed free to all applicants.

Orders will be executed in strict priority as they are received.

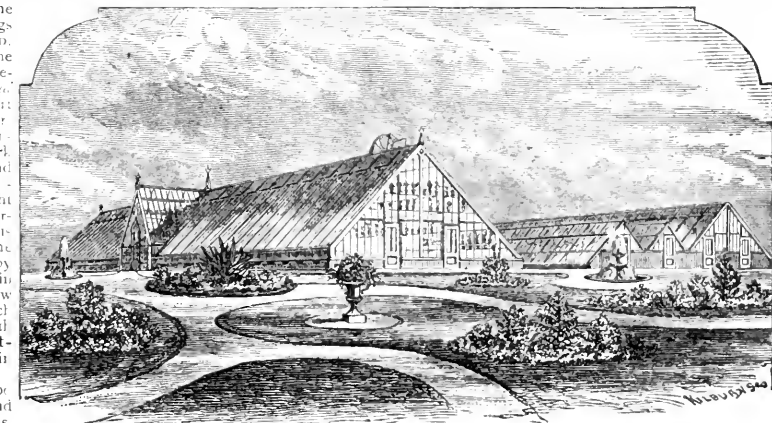

EDMUND M. WOOD & CO.,

OFFICE OF

**WABAN CONSERVATORIES,**  
56 BROAD STREET, BOSTON, MASS.

1jan12

M. M. BAYERSDORFER & CO.,

Importers of Every description of

**BOUQUET PAPERS.**

Plain White Satin for Bridal Bouquets. Fancy Lace for Weddings Receptions, Parties. Italiens, Pasted Cartons, Immortelles in great varieties; Green Moss, French Dried Grasses and Flowers. Tin Foil. Prize Medal of Cincinnati Industrial Exposition of 1873 awarded to us for the best display of Bouquet Papers. Illustrated Catalogue furnished on application.

feb

56 N. Fourth St., Philadelphia, Pa.

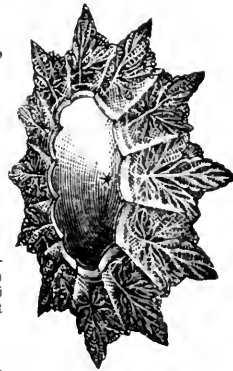
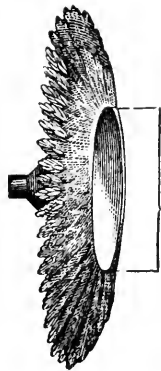

# ELLIS' BASE BURNING BOILER.

FOR WARMING Dwellings, Greenhouses, Graperies, Forcing Pits, Drying Rooms Heating Water for Public Baths, Baptisteries, &c., by Hot Water or by Steam.

Estimates and Circulars furnished. t.<sub>sep.12.</sub> 182 CENTRE STREET, NEW YORK.

ROWLAND WHITMAN.

HARRY LANG.

## WHITMAN & LANG,

IMPORTERS OF

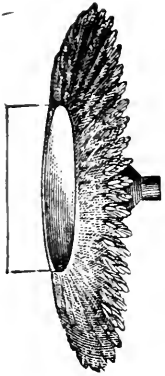

BOUQUET PAPERS.

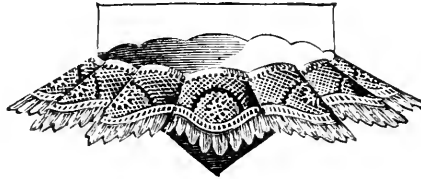

DRIED FLOWERS, IMMORTELLES, TIN FOIL &c.

augf.

No. 126 N. 4th St., Philadelphia.

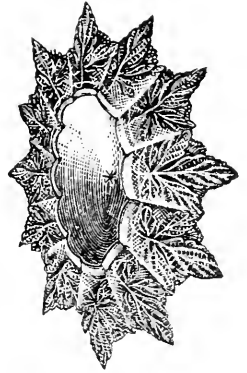

FANCY GRASSES

## GERMANTOWN NURSERIES, PHILADELPHIA.

GORGAS LANE STATION, CHESTNUT HILL RAILROAD. Less than One Hour from the Centre of Philadelphia.

Those who desire to purchase largely, either for their own planting or to sell again, are invited to examine the extensive stock of

### FRUIT, SHADE AND ORNAMENTAL TREES AND SHRUBS,

Grown at the Germantown Nurseries. And those who need but A FEW ARTICLES, will find all ages and sizes to select from. A special feature of the business, is the raising of

Nursery Stock and Seedling Forest Trees

FOR DISTANT SHIPMENT. Many of these can be supplied by the millions at very low rates. Address, for CATALOGUES or information,

THOMAS MEEHAN, Germantown Nurseries, Phila.

## THE CENTENNIAL. TREE AND SHRUB SEEDS.

Visitors to the CENTENNIAL are invited to examine the collection of Tree Seeds, comprising over

THREE HUNDRED KINDS

of species, hardy in the greater part of the United States, and on exhibition in the AGRICULTURAL HALL, (At G 16) by

THOMAS MEEHAN,

COLLECTOR AND DEALER IN TREE SEEDS,

may5

GERMANTOWN, PHILA.

### THE OFFICIAL GUIDE BOOK TO PHILADELPHIA AND CENTENNIAL EXHIBITION.

By THOMPSON WESTCOTT.

Author of the History of Philadelphia. The only full and complete Guide Book. Illustrated with two maps and 93 engravings. 426 pages, 16mo, Cloth, \$1.50; Morocco, \$2.00. Mailed, post-paid, on receipt of price.

Address,

CHAS. H. MAROT, 814 Chestnut St., Phila.

Visitors Guide to the

### Centennial and Philadelphia.

Only authorized Guide Book on Centennial Grounds. Map of Centennial Grounds, Map of Philadelphia, 48 pages, 12mo, mailed for 30 cents. Address,

CHAS. H. MAROT, 814 Chestnut St., Phila.

# WHEELER'S INSECT ANNIHILATOR, LIQUID DISTRIBUTOR

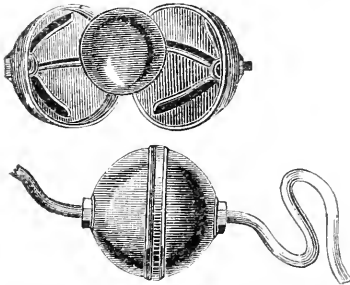

Compound Liquid Hose Distributor.  
Price \$5.00.

AND

INSECTICIDES.

Patented July 20, 1875.

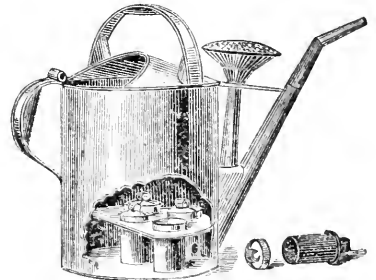

Compound Liquid Watering Pot.  
Average size, \$6.00.

These devices attached to hose pipe of aqueduct or force pump, and operated by water under pressure, and the Watering Pot constructed under the same patent, are the best ever yet used for destroying insects (Potato Bug and Currant Worm not excepted) on plants under glass or in open air, or for fertilizing the same. Fumigation unnecessary. Compound of Tobacco, Sulphur, Guano, in 5 lb. Boxes, 15c. per lb.; of Paris Green and Hellebore, 30c. per lb.

## INSECT ANNIHILATOR & FERTILIZER DISTRIBUTOR

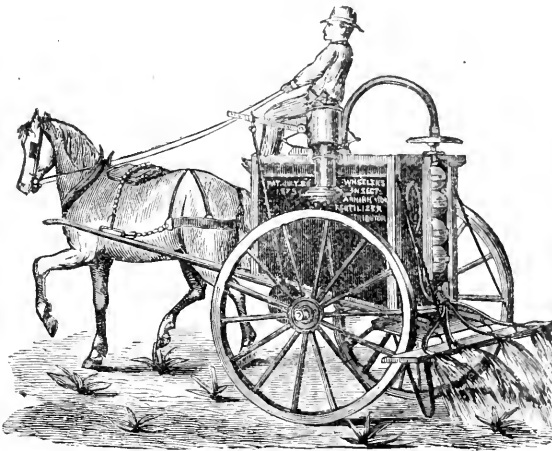

is operated by horse for field use, distributing any desired liquid compound in rows broadcast, or on trees. It is also a powerful Fire Engine, throwing an inch stream from 50 to 75 feet.

PRICE \$200.

## Liquid Fertilizer Distributor



To reduce solid manures, coarse or fine to liquid form, and distribute the same under pressure through hose pipe.

PRICE \$50.

These Machines and Insecticides are on exhibit at the Centennial Exposition, and can be seen in practical operation on the grounds. Above goods delivered C. O. D. Highest testimonials with descriptive circular sent on application.

July 1st.

W. F. WHEELER, 24th Ward, Boston, Mass.

THOMAS J. MYERS.  
 PATENT BOILERS  
 AND  
 HOT WATER APPARATUS

FOR HEATING  
 GREENHOUSES, HOT-HOUSES, CONSERVATORIES, &c.

THOMAS J. MYERS & SON,  
 No. 1162 PASSYUNK AVE., PHILADELPHIA.

2, 4, 6, and 8 Home St., Cincinnati, O.  
 Please send for Descriptive Circular and Price List.

tjunetf

AMERICAN FLOWER GARDEN DIRECTORY. AMERICAN GARDENER'S ASSISTANT.  
 By Robert Buist. By Thomas Bridgeman.

With practical directions for the Culture of Plants in Flower-Garden, Hot-House, Green-House, Rooms, or Parlor Windows, for every month of the year. Instructions for erecting Hot-house, Green-house, and laying out a Flower garden. Instruction for cultivating, propagating, pruning and training the Grape vine and description of best sorts for the open air. 342 pages, 12mo, cloth. Price \$1.50. Sent by mail post paid on receipt of price.  
 CHAS. H. MAROT,  
 814 Chestnut St. Phila.

Containing complete practical directions for the cultivation of Vegetables, Flowers, Fruit Trees and Grapevines. Illustrated. 529 pages, 12mo, cloth. Price \$2.50. Sent by mail post-paid on receipt of price.  
 Address CHAS. H. MAROT,  
 814 Chestnut St., Phila.

CLASS BOOK OF BOTANY.  
 By ALPHONSO WOOD, A. M.

Being outlines of the Structure, Physiology and Classification of Plants; with a Flora of the United States and Canada. 832 pages, 8vo, half arabesque cloth sides. Price, \$3.50. Sent by mail post-paid on receipt of price.  
 Address, CHAS. H. MAROT,  
 814 Chestnut Street, Philadelphia.

WINDOW GARDENING.  
 By Henry T. Williams.

Devoted specially to the Culture of Flowers and Ornamental Plants for *Indoor use and Parlor Decoration*. Splendidly illustrated. 300 pages, med. 8vo, cloth. Price \$1.50. Sent by mail post-paid on receipt of price.  
 Address CHAS. H. MAROT,  
 814 Chestnut St., Phila.

# The Centennial.

ADVERTISERS Are requested to note that CURRENT NUMBERS of THE GARDENER'S MONTHLY, from MAY to NOVEMBER inclusive, will lie upon the tables of the Reading Room at Horticultural Hall, Centennial Grounds, for the inspection of the thousands directly interested in the stock you have for sale. Those who take advantage of this fact will have practically an **extra circulation**, during the months named. Two files of the MONTHLY, from May to November, will constantly remain for the inspection of visitors. Be in time with your orders. Take notice **changes of copy** in current advertisements must be in hand by the **16th of each month**, and new orders by the **23d** to insure insertion in following issue. Address C. H. MAROT,  
 814 Chestnut St., Philadelphia.

GARDENING FOR THE SOUTH, or HOW TO GROW VEGETABLES AND FRUITS.

By WM. N. WHITE.  
 Containing instructions and hints in formation and management of Gardens, Soils and improvement, manures and their sources, rotation, hot-beds, cold frames, pits, propagation, budding and grafting, pruning and training, transplanting, mulching, shading and watering, protection, garden implements, insects and vermin, Vegetables, Fruits, description, varieties and culture. Illustrated, 444 pages, 12mo, Cloth. Price \$2.00. Sent by mail, post-paid, on receipt of price. Address, CHAS. H. MAROT,  
 814 Chestnut St., Phila.

Fruit Growers' Hand-Book.

By F. R. ELLIOTT, author of "Western Fruit Growers' Guide," (one of the best posted men on the subject in the United States), contains the practice on all subjects connected with fruit growing. The book is made for those who grow fruit for their own use. Also an Appendix, containing matter relating to the selection and culture of Ornamental Trees, Roses, Plants, &c. Illustrated with 45 wood-cuts, 130 pages, 16mo cloth, \$1; paper, 60 cts. Sent by mail post-paid on receipt of price.  
 Address C. H. MAROT, 814 Chestnut St., Phila.

## ORNAMENTAL TREES.

By Thomas Meehan.

An American Hand-Book, containing the personal observations of the author. 257 pages, 24mo, cloth. Price 75 cts. Sent by mail post-paid on receipt of price.

Address CHAS. H. MAROT,  
814 Chestnut St., Phila.

## BOOK OF EVERGREENS.

By Josiah Hoopes.

A practical treatise on the Coniferae or Cone-bearing plants. Handsomely illustrated. 435 pages, 12mo, cloth. Price \$3.00 Sent by mail post-paid on receipt of price.

Address CHAS. H. MAROT,  
814 Chestnut St., Phila.

## LAWN AND SHADE TREES.

By F. R. ELLIOTT.

Deciduous and Evergreen Trees and Shrubs, for planting in Parks, Gardens, Cemeteries, &c., &c. Illustrated. 125 pages, 12mo, cloth. Price, \$1.50. Sent by mail, post-paid, on receipt of price.

Address, CHAS. H. MAROT,  
814 Chestnut Street, Philadelphia.

## THE ABBOTT

### Pocket Microscope

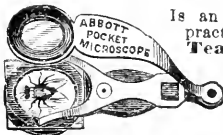

Is an instrument of great practical usefulness to Teachers, Farmers, Merchants, Mechanics, Physicians, Botanists, Miners, and many others. It is the best

Instrument ever invented for examining Flowers, Seeds, Plants, Minerals, Engravings, Bank Notes, Fabrics, Etc. By means of a cage, accompanying each Instrument, one can examine all kinds of Insects or Worms alive. The

### EYE OF A FLY,

or other insect of like size, can be readily seen. It is simple in construction and easy to operate. One of these interesting Instruments ought to be in every family. We have made arrangements to furnish the **Pocket Microscope** at the manufacturer's price, \$1.50. It will be sent, post-paid, to any reader of this Paper desiring it, on receipt of price, or may be had at this office.

Address,  
CHAS. H. MAROT,  
814 Chestnut St., Phila.

## GUIDE TO THE STUDY OF INSECTS.

By A. S. PACKARD, JR., M.D.

Also a Treatise on those INJURIOUS and BENEFICIAL to ops. For the use of Colleges, Farms, Schools and Agriculturists. Illustrated with 11 plates, and 650 wood-cuts. 702 pages, 8vo, cloth. Price, \$6.00. Sent by mail post-paid on receipt of price.

Address, CHAS. H. MAROT,  
814 Chestnut Street, Philadelphia.

## INSECTIVOROUS PLANTS.

By Chas. Darwin.

With copious descriptive contents and index. Illustrated. 462 pages, 12mo, cloth. Price \$7.00. Sent by mail post-paid on receipt of price.

Address CHAS. H. MAROT,  
814 Chestnut St., Phila.

## AMERICAN FRUIT CULTURIST.

BY JOHN J. THOMAS.

Practical directions for the Cultivation of Fruit Trees in the NURSERY, ORCHARD AND GARDEN. Descriptions of the principal American and Foreign varieties. Plain Edition, 480 engravings, 511 pages, 12 mo. Price, \$3.00. Mailed post-paid on receipt of price.

**Extra Edition, 576 pages, heavy paper, fine cloth, 508 illustrations and chromo frontispiece; mailed, for \$3.75.**  
Address CHAS. H. MAROT, 814 Chestnut St., Phila.

## PRESERVING, PICKLING AND CANNING FRUIT.

By MRS. M. E. PETERSON.

Containing a choice collection of receipts of Preserving, Pickling, and Canning Fruits, many of them being original from house wives of experience. 72 pages, 16mo, Cloth. Price 50 cents Sent by mail, post-paid, on receipt of price.

Address, CHAS. H. MAROT,  
814 Chestnut St., Phila.

## SMALL FRUIT CULTURIST.

BY ANDREW S. FULLER.

Giving Description, History, Cultivation, Propagation, Diseases, &c.

Beautifully Illustrated.

276 pages, 12mo, cloth. Price \$1.50. Sent by mail, post-paid on receipt of price.

Address, CHAS. H. MAROT, 814 Chestnut St., Phila.

## GARDENERS' DICTIONARY.

By GEO. W. JOHNSON, Editor of "Cottage Gardener."

Describing the Plants, Fruits and Vegetables desirable for the Garden, and explaining the terms and operations employed in their cultivation. New Edition, with a supplement, including the new plants and varieties. 910 pages, 12mo, cloth, fine print. Price, \$3.50. Sent by mail post-paid on receipt of price.

Address, CHAS. H. MAROT,  
814 Chestnut Street, Philadelphia.

## GARDENING FOR PLEASURE.

BY PETER HENDERSON.

A guide to the Amateur in the

FRUIT, VEGETABLE and FLOWER GARDEN.

With full directions for the Greenhouse, Conservatory and Window-Garden. Illustrated. 250 Pages, 12mo, cloth. Price \$1.50. Sent by mail post-paid on receipt of price.

Address CHAS. H. MAROT, 814 Chestnut St., Phila.

## GARDENING FOR PROFIT.

BY PETER HENDERSON.

A Guide to the successful cultivation of the

MARKET AND FAMILY GARDEN.

New and enlarged edition. Illustrated. 276 Pages, 12mo, cloth. Price, \$1.50. Sent by mail post-paid on receipt of price.

Address CHAS. H. MAROT, 814 Chestnut St., Phila.

## HOW TO MANAGE BUILDING ASSOCIATIONS.

By EDMUND WRIGLEY.

Being a Director's Guide and Secretary's Assistant, with forms for Keeping Books and Accounts, also rules, examples and explanations illustrating the various plans of working. 211 pages, 12mo, cloth. Price, \$2.00. Sent by mail post-paid on receipt of price.

Address, CHAS. H. MAROT,  
814 Chestnut Street, Philadelphia.

## WORKING MAN'S WAY TO WEALTH.

By EDMUND WRIGLEY.

A practical treatise on Building Associations, what they are, and how to use them. 108 pages, 16mo, cloth. Price, 75 cents. Sent by mail post-paid on receipt of price.

Address, CHAS. H. MAROT,  
814 Chestnut Street, Philadelphia.

## GARDENING BY MYSELF.

By Anna Warner.

Containing Hints and Experiences under heading of each month in the year. Illustrated. 16mo, 223 pages, cloth. Price \$1.25. Sent by mail post-paid on receipt of price.

Address CHAS. H. MAROT,  
814 Chestnut St., Phila.

## FLORA OF THE SOUTHERN STATES.

By A. W. CHAPMAN, M.D.

Containing abridged descriptions of the FLOWERING PLANTS and FERNS of Tennessee, North and South Carolina, Georgia, Alabama, Mississippi and Florida, arranged according to the Natural system. 621 pages, 8vo, cloth. Price, \$3.60. Sent by mail post-paid on receipt of price.

Address, CHAS. H. MAROT,  
814 Chestnut Street, Philadelphia.

## GRAPE CULTURALIST.

By Andrew S. Fuller.

A treatise on the Cultivation of the Native Grape. Illustrated. 286 pages, 12mo, cloth. Price \$1.50. Sent by mail postpaid on receipt of price.

Address CHAS. H. MAROT,  
814 Chestnut St., Phila.

## PARSONS ON THE ROSE.

By Samuel B. Parsons.

A treatise on the Propagation, Culture and History of the Rose. Illustrated. 215 pages 12mo, cloth. Price \$1.50. Sent by mail post-paid on receipt of price.

Address CHAS. H. MAROT,  
814 Chestnut St., Phila.

## BOOK OF ROSES.

By Francis Parkman.

Description, Cultivation and Propagation. Beautifully illustrated. 225 pages, 12mo, cloth. Price \$1.50. Sent by mail post-paid on receipt of price.

Address CHAS. H. MAROT,  
814 Chestnut St., Phila.

## ROSE GARDEN.

By Wm. Paul, F. R. H. S.

Embracing History of the Rose; formation of Rosarium; detailed account of practice for successful cultivation; arrangement in natural groups of most esteemed varieties, English and Foreign, in the most eminent Gardens; with full description and remarks on origin and mode of culture. Numerous illustrations. 276 pages, Royal 8vo, cloth. Price \$3.00. Sent by mail post-paid on receipt of price.

Address CHAS. H. MAROT,  
814 Chestnut St., Phila.

## ROSES AND ROSE CULTURE.

By Wm. Paul, F.R.H.S.

The rationale of Rose cultivation in a nut-shell. Intended to place within a small compass all that is necessary for the successful cultivation of the "Queen of Flowers." 83 pages, 12mo, paperboards. Price, 60 cents. Sent by mail post-paid on receipt of price.

Address CHAS. H. MAROT,  
814 Chestnut Street, Philadelphia.

## PRACTICAL FLORICULTURE.

By PETER HENDERSON.

A Guide to the successful cultivation of

### FLORISTS' PLANTS,

for the *Amateur* and *Professional Florist*. Illustrated. 288 pages, 12mo, cloth, Price, \$1.50. Sent by mail post-paid on receipt of price.

Address, CHAS. H. MAROT,  
814 Chestnut Street, Philadelphia.

# How To Paint

A New Work by a Practical Painter, designed for the use of Tradesmen, Mechanics, Merchants, Farmers, and as a Guide to Professional Painters. Containing a Plain Common-Sense Statement of the Methods employed by Painters to produce satisfactory results in Plain and Fancy Painting of every description, including Formulas for Mixing Paint in Oil or Water, Tools required, etc. This is just the Book needed by any person having anything to paint, and makes

"Every Man his Own Painter."

Full Directions for Jasing White Lead—Lamp-Black—Greer—Yellow—Brown—Whiting—Glue—Pumice Stone—Spirits of Turpentine—Oils—Varnishes—Furniture Varnish—Milk Paint—Preparing Kalsomine, etc.

## Paint for Outbuildings

—Whitewash—Paste for Paper-Hanging—Hanging Paper—Graining in Oak, Maple, Rosewood, Black Walnut—Staining—Decalcomania—Making Rustic Pictures—Painting Flower-Stands—Rosewood Polish—Varnishing Furniture—Waxing Furniture—Cleaning Paint—

## Paint for Farming Tools

—for Machinery—Household Fixtures, etc.

## To Paint a Farm Wagon

—to Re-Varnish a Carriage—to make Plaster Casts. The work is neatly printed, with illustrations wherever they can serve to make the subject plainer, and it will save many times its cost yearly. Every family should possess a copy. Price **only mail, post-paid, \$1.**

CHARLES H. MAROT,

814 Chestnut St., Philadelphia, Pa

## ORCHID GROWER'S MANUAL.

By BENJAMIN S. WILLIAMS, F.R.H.S.

Containing brief descriptions of over 800 species and varieties, with notices of times of flowering, approved modes of treatment and practical instructions on general culture. Remarks on heat, moisture, soil, seasons of growth and rest suited to the several species. Enlarged edition with illustrations. 300 pages, 12mo, cloth. Price, \$2.50. Sent by mail post-paid on receipt of price.

Address, CHAS. H. MAROT,  
814 Chestnut Street, Philadelphia.

## Manual of Botany of the Northern United States.

By ASA GRAY.

Including the district east of the Mississippi and north of Carolina and Tennessee. Arranged according to the Natural System. Illustrated with 20 plates of Sedges, Grasses, Ferns, &c. 703 pages, 8vo, half-arabesque cloth sides. Price, \$2.25. Sent by mail post-paid on receipt of price.

Address, CHAS. H. MAROT,  
814 Chestnut Street, Philadelphia.

Index to Advertisements.

Advertisers are requested to have orders in hand as EARLY AS POSSIBLE. Copy received after the 23rd of each month cannot be insured insertion in the next issue.

Aldous James, Iowa City, Iowa.....	4
Alkemede, M. C. & Co., Haarlem, Holland.....	6
Allen S. L. & Co., Phila., Pa.....	4
Baversdorfer M. M. & Co., Philadelphia.....	8
Bliss B. K. & Sons New York city.....	cover
Burnett, Alex., Reading, Pa.....	2
Christian at Work, New York city.....	2
Christensen, N., Beaufort, S. C.....	2
Cobb J., Peckskill, N. Y.....	2
Coninck, A. M. C. J., Dedem-vaat, Netherlands.....	4
Dreer Henry A., Philadelphia.....	2, 4
Elder Walter, Philadelphia.....	14
Ellis Chas. R., New York city.....	9
Empire Portable Forge Co., Troy, N. Y.....	4
Gilmore, S. J., Lawrence, Kan.....	4
Harkett Wm. A., Dubuque, Iowa.....	2
Hews A. H. & Co., North Cambridge, Massachusetts.....	8
Henderson Peter, New York.....	14
Hinrichs C. F. A., New York city.....	4
Hitchings & Co., New York city.....	3
Johnson A., Long Green, Baltimore Co., Md.....	4
Jordan, J. M. & Bro., St. Louis, Mo.....	7
Landreth, D. A. Son, Phila.....	2
Lord's Horticultural Works, Irvington, New York.....	5
Lord's Richard, Philadelphia.....	6
Lynex H. H., Philadelphia.....	5, 9, 11, 12, 13, 14, Fly-leaf
MacPherson James, Philadelphia.....	14
Meehan Thomas, Germantown, Philadelphia.....	8, 9
Myers Alexander, Brooklyn, New York.....	11
Parsons, R. B. & Co., Flushing, N. Y.....	15
Parsons S. B. & Sons, Flushing, New York.....	cover
Raoux C., New York city.....	2
Richardson & Nicholas, Geneva, N. Y.....	2
Rolker A. & Sons, New York city.....	Fly-leaf
Thalacker Bernhard, Gohlis, Leipzig.....	4
Steffens N., New York city.....	4
Straight & Storm, New York city.....	4
Sturtevant Edmund D., Bordentown, N. J.....	3
Wampler John, Carthage, Missouri.....	6
Weathered & Cherevoy, N. Y. City.....	1
Weber, Henry, Cumberland, Md.....	4
Wheeler W. F., Boston, Mass.....	10
Whitman & Lang, Philadelphia.....	9
Wilson William C., New York city.....	6
Wood Edmund M., Boston, Massachusetts.....	8, cover

SITUATIONS WANTED.

By a young man 23 years of age, who has been with a florist for the past six years. A position as under-gardener would be acceptable. Address, W. SHEEHAN, 16 Wilcox St., Baltimore, Md.

SITUATION wanted by a first class Gardener, has a general knowledge of the management of Greenhouses, Hothouses, Graperies, propagating and cut flower business. First class reference. Address, C. L. S., Florist, care of Box 119, Maysville, Mason Co., Ky.

A single man wants a situation as Gardener, with a private family, understands the care of Greenhouses, Graperies, Vegetables and Lawns; having seventeen years experience. Can bring first-class references. Address, J. L., 1302 Washington Ave., Philadelphia.

By a Prussian, to take charge of a Cemetery or a private place. Has experience in Flowers and Landscape Gardening for the last 18 years. Also owns considerable glass that would build several greenhouses if wanted. Learned his trade in Rhein, Prussia. Can give the best references. Address G. Doerr, No. 9 and 11 Mittle St., Allegheny City, Pa.

By a single man in a private or commercial place, practical in many of the departments of Horticulture, Orchids, Stove Plants, etc.; Bouquets and Floral designs set on most approved principles. Reference if required; is a reliable propagator of Roses, Verbenas, etc. Address J. M. B., Mt. Kisco, New York.

WANTED by an Englishman, single, aged 28, a situation in a private or commercial establishment. Well up in all branches of the profession. Active, sober, honest and obliging, and can give first-class references. Please address, Gardener, Mount Moriah Lane, 65th & Darby Road, Phila.

WALTER ELDER,

Landscape and Jobbing Gardener,  
1231 Rodman Street, Philadelphia,  
Attends to all branches of his business on reasonable terms.

SITUATION WANTED,

By a Scotchman, married, as Foreman and Propagator in a commercial establishment, where a general shipping trade is carried on; has had charge of one of the largest establishments in this country for the past 3 years; thoroughly understands the growing and management of stove and greenhouse plants, propagation and forcing of Roots and Florist's Plants of all kinds. A place of Responsibility is wanted. Best of reference given.  
Address, D. L., care of PETER HENDERSON,  
july1 35 Cortlandt St., New York.

R. B. PARSONS & CO.,  
Bowne Avenue, Flushing, N. Y.,  
OFFER THEIR  
RARE TREES & SHRUBS

as well as the well known sorts, and invite the special attention of  
LARGE BUYERS

To their Stock of Rhododendrons, Azaleas—Chinese and Ghent Camellias, Clematis, Hydrangeas, Magnolias, Roses by the 1,000.

RARE EVERGREENS,

are well known to be cultivated in large variety by them.  
For Catalogues address

Box 99, Flushing, N. Y.

t-b-12

Landscape Gardening and Home Improvements.

Mr James MacPherson, late of the Royal Gardens, Kew, Gold Medalist of the Agri Horticultural Society, Madras, &c., furnishes advice upon and superintends the laying out of Ornamental Grounds, Country Places, Parks, Cemeteries, City and Village Gardens, Ornamental Walks and Drives, Commons, Farms, &c. He also furnishes lists of trees, shrubs and exotic plants, for any particular purpose, North or South; his residence in both climates having made him familiar with the most desirable effects of either section.

Address, JAMES MACPHERSON,  
tjun12 Care Gardener's Monthly Office, 814 Chestnut St., Phila.

A Hygroscope for 50 cents.

THE CHEMICAL HYGROSCOPE.

This indicator of atmospheric moisture is as accurate as the costly ones. Rooms heated by furnaces or stoves are almost invariably so dry as to be damaging not only to health but to furniture. Some people take the consequences, others keep water on the heater. The Hygroscope shows at a glance whether the air is too dry or not.

Sent by mail for 50 cents. Address,  
febtf CHAS. H. MAROT, 814 Chestnut St., Philadelphia.

The Nurseryman's Directory.

A reference book of the Nurserymen, Florists, Seedsmen, Tree Dealers, &c., for the United States. Alphabetically arranged by States and Post Offices. 242 pages, 8vo. Price \$5. Mailed, post-paid, on receipt of price.

Address, CHAS. H. MAROT,  
814 Chestnut St., Phila.

Orchid Culture.

By EDWARD SPRAGUE RAND, JR.

Including culture, propagation, collection and hybridization of Orchids; the construction and management of Orchid-houses; a glossary of Botanical terms and significance of their names; the whole forming a COMPLETE MANUAL OF ORCHID CULTURE. Cloth 12 mo, 476 pages. Price \$3.50. Mailed, post-paid, on receipt of Price.

Address, CHAS. H. MAROT,  
814 Chestnut St., Phila.



# WABAN CONSERVATORIES

OFFICE :  
56 BROAD ST., BOSTON.  
Address all Letters to  
BOSTON OFFICE.

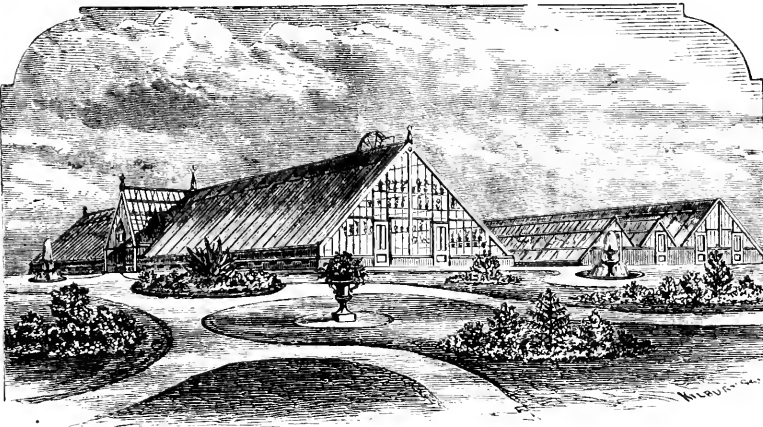

Send all Telegrams by  
Atlantic & Pacific Line. Address,  
*Waban Conservatories,*  
LAKE CROSSING, MASS.

## FALL TRADE 1876.

The following choice **SELECTED NOVELTIES** will be ready for delivery during the coming **FALL**, and to which attention is specially directed.

### ROSE "EDMUND WOOD." (Verdier).

This superb hybrid perpetual we have bloomed and find it fully equal, if not superior, to the description. Its color is richer and slightly darker than Gen'l Jacqueminot, far more double and equally prolific in growth, blooming as freely as that favorite variety. Good plants, on own roots, \$2 each.

### CARNATION "WELLESLEY BEAUTY."

Color soft fine cinnamon, beautifully striped and spotted with carmine rose; habit, free compact and vigorous. A valuable acquisition. 75c. each.

### BRONZE ZONALE GERANIUM "EARL ROSLYN."

Unquestionably the best bronze and gold bedding Geranium yet produced, superior to the acknowledged favorites, Marshall MacMahon and Black Douglass. 50c. each.

### DOUBLE ZONALE GERANIUM.

**P. BUCK.**—Violet and salmon, new and effective color, and a very valuable variety.

**J. C. RODBARD.**—Double salmon red not very double, but beautifully joined and much superior to Asa Grey.

**MADAME THIBAND.**—Rose petals, marked with white at their base, semi-double, but producing a novel and pleasing effect. Also many other new Zonale and other Geraniums, for description of which see Catalogue.

### PELARGONIUM REGAL "QUEEN VICTORIA."

This is one of the most marvellously beautiful novelties ever offered. Color rich vermilion, margined with fine white, and upper petals blotched with deep purple maroon. The flower has thick, crispy petals, which give it the appearance of being double. It is a remarkable and striking improvement in Pelargoniums. \$1.50 each.

### PELARGONIUM REGAL, "BEAUTY OF AXTON."

Similar in form to the above, but quite distinct in color, which is; upper petals rich maroon; centre rose; all the petals being margined with pure white; flowers large and full, having the appearance of being semi-double, and a most beautiful and extraordinary novelty. \$3 each.

**New Hybrid and Tuberoso Rooted Begonias,** many introduced for the first time.

We are making the culture of these really beautiful plants a specialty, and shall be glad to forward price list on application. Also of many other novelties which are in course of propagation.

## FOR FLORISTS' WINTER STOCK.

We shall be able to offer at lowest rates.

**ROSES.**—Bon Silene, Safrano, Isabella Spratt, Marshall Neil, La France, Gen'l Jacqueminot, in 2 and 4 inch pots in large quantities. **CARNATIONS.**—fine plants from open Ground. **IVIES.**—Irish and others. **VINCA ELEGANTISSIMA.** **VIOLETS.**—Neapolitan and Marie Louise. **BEGONIA REX** in variety. **BEGONIA FLOWERING** in variety. **FUCHSIAS,** new. **ADIANTUM CUNIATUM.** **FERNS** in variety by the 100. **RICHARDIA ALBA MACCULATA.** **CALLAS,** &c.

Orders promptly executed. Send for Circular.

EDMUND M. WOOD & CO.

# S. B. PARSONS & SONS,

Kissena Nurseries,

Near KISSENA STATION, FLUSHING, N. Y.,

OFFER a very large assortment of TREES and PLANTS of all the best families. Nearly all of them have been two years transplanted, and their roots are thus in the very best possible condition for a second transplanting.

Their assortment of **RARE EVERGREENS** has long been known to be the most complete. They now have in cultivation a very large variety of hardy

## Deciduous Trees and Shrubs,

numbering over 800 sorts, of which 300 sorts, one year grafted, are entirely new and have not yet been in their catalogue.

Their JAPANESE DEPARTMENT now includes more than 150 varieties in addition to the above, and is being constantly enriched by Thomas Hogg, now in Japan. Many of these varieties are unknown in Europe. The celebrated JAPANESE MAPLES and AZALEA MOLLIS are alone worthy of a visit.

CAMELLIA JAPONICA and AZALEA INDICA can be advantageously shipped during September, October and November; September being preferred. These plants are carefully formed and trimmed, and their symmetry is recognized by all who see them.

Rhododendrons and other hardy Evergreens can be safely transplanted in September.

*Estimates will be furnished for Planting Grounds under the care of an experienced Landscape Gardener, and much trouble thus saved to the owner.*

Catalogues will be furnished to applicants by mail, and those who wish to visit the Nurseries will always find either one of the proprietors, or J. R. Trumpy, the well-known propagator of the old establishment. They can take the ferries at 34th Street or James' Slip, which connect with the railroad, leaving the first a quarter of an hour, and the last half an hour before the departure of trains, which make the transit in half an hour. The Nursery is adjoining the Kissena Station and one and a half miles from the other stations. sep

## Seeds of Florists' Flowers.

For the Conservatory & the Flower Garden, for Sowing in August & September.

Particular attention is invited to the following list of Seeds of Florist's Flowers, which have been carefully selected from the stocks of several of the most successful cultivators and exhibitors in Europe, and can be confidently recommended

	PER PKT.
<b>Balsam, Double White Camellia-Flowered</b> —For pot culture during winter, much used by florists for bouquets.....	\$0 25
<b>Calceolarias</b> —extra select, from flowers which took the 1st prize at the late London and Continental Exhibition.....	50
<b>Calceolaria rugosa</b> —From the finest Shrubby varieties.....	50
<b>Cineraria</b> —Extra choice, from all the new varieties.....	50
<b>Cineraria new double-flowering</b> —This is unquestionably the finest novelty in the way of Florist Flowers for the greenhouse that has been sent out for many years; they represent all the modifications of color usually found among Cinerarias, namely, crimson and magenta in various shades; purples, both light and dark, as well as flowers tipped with different tints of scarlet and magenta, and perfectly double; habit very good; will prove a most desirable acquisition. Pac. ets contains 20 seeds.....	1 50
<b>Cyclamen Persicum</b> —From the finest hybridized varieties.....	50
<b>Gloxinias</b> —The finest erect and drooping varieties.....	50
<b>Hollyhocks</b> —Very double saved from an unrivaled collection of 75 English varieties; if sown now, will flower freely next year, (100 seeds).....	25
<b>Pansy, English</b> —Extra select, saved from the finest prize flowers.....	50
— Finest mixed German varieties, very attractive, from one of the finest continental collections.....	25
— <b>New Fancy</b> —very beautiful.....	50
<b>Primula sinensis vimbricata</b> —Chinese Primrose (trig'd) various colors mixed, extra.....	50
— (New fern-leaved varieties) very beautiful mixed varieties.....	50
— New double varieties, rose and white, each.....	1 00
<b>Pink, Tree or Perpetual Carnation</b> —Continues in flower a long time, extra quality, (20 seeds).....	50
<b>Pink, Carnation and Picotee</b> —Celebrated German collection. (20 seeds).....	50
<b>Polyanthus</b> —Finest mixed varieties from the collection of an English Amateur.....	25
<b>Stock</b> —Scarlet and white intermediate London, extra, each.....	25
— <b>East Lothian</b> —Superior for pot culture, scarlet, white and purple, each.....	25
— <b>New German Ten Weeks</b> —extra fine, many colors mixed.....	25
— <b>New White Wallflower-leaved</b> —A superb variety for pot culture, pure white with large double flowers.....	25
<b>Sweet William, Hunt's New Auricula-flowered</b> —Far surpassing anything hitherto offered.....	25
<b>Tropaeolum</b> —Finest mixed varieties, for Winter-flowering in greenhouse.....	25
<b>Wallflower</b> —Extra fine double German.....	25

☞ The entire Collection for \$9.

Collections of twenty varieties of HARDY ANNUALS, BIENNIALS and PERENNIALS, for Autumn sowing. \$1. If sown during the months of August and September, and protected during Winter by a covering of evergreen boughs, will bloom next year.

Catalogue of *Bulbous Roots for Autumn planting*, 44 pages, beautifully illustrated, mailed to applicants enclosing 10 cents. Address

B. K. BLISS & SONS,

P. O. BOX No. 5712.

34 Barclay Street, New York.



THE  
GARDENERS  
And MONTHLY  
HORTICULTURIST

EDITED BY THOMAS MEEHAN.

Vol. XVIII. No. 212.  
(Combined Magazines, Thirty-first Year.)

**AUGUST, 1876.**

PUBLISHED BY CHARLES H. MAROT  
814 Chestnut Street, Philadelphia.  
TERMS—\$2.10 PER YEAR—POSTAGE PAID.

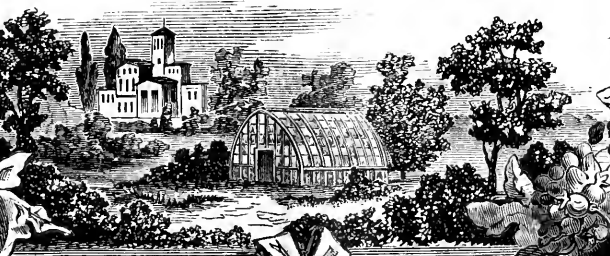

Wm. Rosenthal Del.

J. A. Stockton Sc.

# THE GARDENER'S MONTHLY AND HORTICULTURIST.

EDITED BY THOMAS MEEHAN,

Assisted by an able Corps of AMERICAN and FOREIGN CORRESPONDENTS.

It is published on the first of every month, at the office, No. 814 CHESTNUT STREET, PHILADELPHIA, where all BUSINESS communications should be addressed.  
Communications for the Editor should be addressed: THOMAS MEEHAN, GERMANTOWN, Philada.

SUBSCRIPTION PRICE, Postage paid, \$2.10.

## TERMS OF ADVERTISING.

	1/4 col.	1/2 col.	1/3 col.	1/3 col.	1/2 col.	1 col.	1 page.
One Time,	\$3.00	\$4.00	\$3.00	\$8.00	\$12.00	\$24.00	\$48.00
Two to Three Times, each,	4.75	3.60	5.40	7.20	10.80	21.60	43.20
Four to Six Times,	2.25	3.00	4.50	6.00	9.00	18.00	36.00
Seven to Nine Times,	2.00	2.70	4.00	5.35	8.00	16.00	32.00
Ten to Twelve	1.80	2.40	3.60	4.80	7.20	14.40	18.80

Twelve lines nonpareil is 1/4 col. A less space than 1/4 col. will be furnished at rates in exact proportion, line for line.  
For THIRD and LAST COVER PAGES; FIRST PAGE advertisements facing reading matter; "FLY-LEAF PAGE" (front of number) before reading matter and facing first cover—special figures will be given on application.  
COPY and orders for NEW advertisements should be in hand by the 23d of each month; and CHANGES of COPY in running contracts by the 16th of each month, to insure them in following issue. Address

CHAS. H. MAROT, Publisher, 814 Chestnut Street, Philadelphia.

## CONTENTS OF THE AUGUST NUMBER.

### SEASONABLE HINTS:

Flower Garden and Pleasure Ground.....	225-231
Green House and House Gardening.....	232-237
Fruit and Vegetable Gardening.....	238-243

### CORRESPONDENCE:

Landscape Gardening.....	226
Destruction of the Rose Slug.....	226
A Happy Home.....	226
Lilies.....	227
Curves.....	227
Greenhouse Furnaces.....	232
Mr. Sargent's Azalea Show.....	233
Forcing Roses.....	234
History of the Double Lobelia.....	235
Onion and Seed Growing in California.....	239
The Wild Goose Plum.....	239
General Observations on the Flora of Hokkaido....	244
Pear or Apple: which?.....	245
Palms of Southern California.....	245
"Laws for Nurserymen".....	247

### EDITORIAL NOTES:

Lilies—Rhododendrons and Rose—The Elm Slug—Lawn from Seed—Hemlock in Limestone Soil.....	230
Wall-flowers and Gilliflowers—Royal Patronage of Cut Flowers—To Prevent Hyacinths having Short Stems.....	235-236
Roe's Seedling Gooseberry—Lined Oil for Pear Blight—The Peach Bird—The Early Peaches—Colorado Cabbage.....	240-241
The Elm Slug.....	246-247
M. Louis Van Houtte—Horticultural Judges at the Centennial—"Palms" on Palm Sunday—Belgium	

Honors Horticulturists—Forsythia splendens—Proceedings of the New Jersey Horticultural Society, 1876—Minnesota State Horticultural Society—Botany of California—Fruit Growers' Association of Ontario—Insects of the State of Missouri—Williams' Pacific Tourist and Guide Across the Continent—Life Histories of Birds.....	248-253
Horticulture at the Centennial.....	254-256

### NEW PLANTS:

New Tea Rose, Dutchess of Edinburgh.....	230
New Double Zonale Pelargonium Wonderful.....	236

### NEW FRUITS AND VEGETABLES:

Briggs' Red May Peach—The Hammer Peach—Cumberland Triumph Strawberry—Durand's Great American Strawberry—Smith's President Lincoln Strawberry—Prouty's Strawberry—Southern Red Thornless Raspberry—The Barnhardt Cherry.....	241-242
---	---------

### NATURAL HISTORY AND SCIENCE.....

### LITERATURE, TRAVELS AND PERSONAL NOTES..

### HORTICULTURAL SOCIETIES.....

### QUERIES:

Lilium Auratum.....	230
Flowering of the Hoya Carnosa—Killing the Mealy Bug.....	236
Seedling Strawberry—Richland Plum—The Early Peaches—Cornelian Cherry—White Alpine Strawberry—Larch Nuts—Disease in Cabbage Plants....	242-248
Cephalanthus Occidentalis.....	247
Protection from Tree Thieves.....	253

ASK PRICES FOR

# SOLUBLE PACIFIC GUANO

FOR

## HORTICULTURE

OF

# AUGUST RÖLKER & SONS,

IMPORTERS AND DEALERS IN

## FLORISTS' SUPPLIES,

## 32 READE ST., NEW YORK.

---

This Guano contains *no ammonia to excess* in the condition of ready formed salts; but, containing it *only in its elements* and generating it gradually as the decomposition takes place after application, no injurious effect, only the *most beneficial results* are had on the tender fibres of plants, which advance in vigor by its use. It has *no equal fertilizer* for the cultivation of *Roses*.

Only when the roots are in working order and thoroughly established in the pot, commence watering with

*Soluble Pacific Guano for Horticulture*

as per directions on package of 2½ lb. and 25-lb. tin cans. By the ton it is shipped in barrels.

Our Fall Catalogue of Florists' Supplies is ready and will be mailed free to every applicant, sending his business card.

**RURAL AND PRACTICAL BOOKS,** (and any others in the market not on this list) will be sent by mail, post paid, on receipt of price. Address CHAS. H. MAROT, 814 Chestnut St., Philada.

Allen's, R. L., Diseases of Domestic Animals.....	\$1 00	How to Manage a Building Association.....	\$2 00
Allen's, L. F., Rural Architecture.....	1 60	How to Paint.....	1 00
Allen's, L. F., American Cattle.....	2 50	Hunter and Trapper.....	1 00
Allen's, R. L. & L. F., New American Farm Book.....	2 50	Hussman's Grapes and Wines.....	1 50
American Architect.....	7 00	Jacques' Manual of the House.....	1 50
American Bird Fancier, (Brown's).....	3 00	Jacques' Manual of the Garden.....	1 75
American Farmer's Encyclopedia.....	6 00	Jacquets' Cattle Doctor.....	1 75
American Horticultural Annual, paper 50 Cts., cloth.....	1 75	Jennings on the Horse and his Diseases.....	1 75
American Weeds and Useful Plants.....	1 75	Jennings' Sheep, Swine and Poultry.....	1 75
Apple Culturist, S. E. Todd.....	1 50	Jennings' Gardener's Dictionary.....	3 50
Art of Saw Filing.....	1 75	Johnson's How Crops Feed.....	2 00
Architecture, Modern American, Cummings & Miller.....	10 00	Johnson's How Crops Grow.....	2 00
Principles and Practice of, By Loring & Jenning.....	12 00	Johnson's Peat and its uses.....	1 25
Baker's Fruit Culture.....	4 00	Johnston's Elements of Ag. Chemistry and Geology.....	1 50
Bassett on Cranberry Culture.....	3 00	Johnston's, J. S. W., Agricultural Chemistry.....	1 75
Barry's Fruit Garden.....	2 50	Kemp's Landscape Gardening.....	2 50
Bell's Carpentry made easy.....	5 00	Klippart's Farm Drainage.....	1 75
Bement's Poulterer's Companion.....	2 00	Langstroth, Rev. L. L., on the Hive and Honey Bee.....	3 00
Bement's Rabbit Fancier.....	3 00	Lezchars' How to Build Hot-houses.....	1 50
Beet Root Sugar.....	1 50	Leibig's, Justus, Familiar Lectures on Chemistry.....	75
Bicknell's Village Builder, 77 plates.....	12 00	Louden's Encyclopedia of Plants.....	20 00
Bommer's Method of Making Manures.....	1 60	Lyman's Cotton-culture.....	1 50
Boussingault's, J. B., Rural Economy.....	6 00	McMahon's American Gardener.....	2 25
Brown's Trees of America.....	1 75	Mayhew's Practical Book-keeping for Farmers.....	90
Breck's New Book of Flowers.....	1 75	Mechanics' Companion (Nicholson).....	8 00
Bridgeman's American Gardener's Assistant.....	2 50	Mechan's Ornamental Trees.....	75
Bridgeman's Fruit Cultivator's Manual.....	1 00	Miles on the Horse's Foot.....	75
Bridgeman's Kitchen Gardener's Instructor.....	1 00	Ninck's T. B., Bee-keeper's Manual.....	1 25
Buis's, Robert, Am. Flower Garden Directory.....	1 50	Mohr on the Grape-vine.....	1 00
Buis's, Robert, Family Kitchen Gardener.....	1 00	Money in the Garden.....	1 50
Burr's Field and Garden Vegetables of America.....	5 00	My Vineyard at Lak view.....	1 25
Carpenter and Joiner (R. Riddell).....	7 00	My Farm of Edgewood.....	1 75
Carpenter and Joiner's Hand Book, (Holly).....	75	My Ten-rod Farm.....	50
Chorlton's Grape Grower's Guide.....	75	North American Sylva, 5 vols., 156 col. plates, in 30 parts, "                    unbound.....	60 00
Chemistry of the Farm, (Nichols).....	1 25	"                    Half Turkey Antique, gilt.....	70 00
Cleveland's Villas and Cottages.....	4 00	"                    "          full.....	75 00
Cobbett's American Gardener.....	75	Nichol's Chemistry of the Farm and Sea.....	1 25
Cole's, S. W., American Fruit Book.....	75	Norton's, John P., Elements of Scientific Agriculture.....	1 75
Cole's American Veterinarian.....	75	Norris' Fish-culture.....	1 75
Cooper's Rural Hours.....	2 00	Onion-culture.....	20
Copland's Country Life.....	5 00	Our Farm of Four Acres.....	1 25
Dadd's, Geo. H., American Cattle Doctor.....	1 50	Packard's Guide to the Study of Insects..... cloth	6 00
Dadd's Modern Horse Doctor.....	1 50	Paul's Book of Roses.....	60
Dana's, Samuel H., Muck Manual.....	1 25	Paul's Rose Garden.....	3 00
Darwin's Variations of Animals and Plants, (2 vols.).....	6 00	Paxton's Botanical Dictionary.....	15 00
Darwin's Insectivorous Plants.....	7 00	Pardee on Strawberry-culture.....	75
DeVoe's Market Assistant.....	2 50	Parkman's Book of Roses.....	1 50
Downing's, A. J., Landscape Gardening.....	6 50	Parsons, Samuel B., on the Rose.....	1 50
Downing's Cottage Residences.....	3 00	Peat and its Uses.....	1 25
Downing's Fruits and Fruit Trees of America.....	5 00	Pear-culture, Field.....	1 25
Downing's Rural Essays.....	3 50	Pedder's, James, Farmer's Land-measurer.....	60
Downing's Ladies' Companion to the Garden.....	2 00	Percheron Horse.....	1 00
Du Breuil's Vineyard Culture, (Dr. Warden).....	2 00	Peterson's Preserving, Pickling and Canning Fruit.....	50
Eastwood on Cultivation of the Cranberry.....	75	Phin on Wine-making.....	1 50
Elliott's Western Fruit Grower's Guide.....	1 50	Quinn's Pear-culture for Profit.....	1 00
Elliott's Lawn and Shade Trees.....	1 50	Quinby's Mysteries of Bee-keeping Explained.....	1 50
Elliott's Fruit Grower's Hand Book, paper, 60 cents, cloth	1 00	Randall's Sheep Husbandry.....	1 50
Farm Talk, (Brackett).....	1 00	Randall's Fine Wool Sheep Husbandry.....	1 00
Farming for Boys.....	1 50	Rand's Bulbs.....	3 00
Field's, Thomas W., Pear Culture.....	1 25	Rand's Flowers for Parlor and Garden.....	3 00
Five Acres too Much, (illustrated).....	1 50	Rand's Seventy-five Flowers.....	1 50
Flagg's European Vineyards.....	1 50	Rand's Flower Garden.....	3 00
Flax Culture.....	50	Rand's Orchard Culture.....	3 50
Flint, Chas. L., on Grasses.....	2 50	Riddell's Architect.....	15 00
Flint's Milch Cows.....	2 50	Ropp's Commercial Calculator, cloth \$1, Morocco Tuck.....	2 00
Flint's Horns for All.....	1 50	Rose Culturist..... paper	75
Frank Forester's Fish and Fishing, 8 vo. 100 engravings.....	3 00	Robbins, R., Produce and Ready Reckoner.....	c 75
Frank Forester's Manual for Young Sportsmen, 8 vo.....	3 00	Saunders' Domestic Poultry, paper 40..... cloth	75
French's Farm Drainage.....	1 50	Saxton's Hand Books, in four series, each.....	1 50
Fuller's Grape Culturist.....	1 50	Schenck's Gardener's Text-book.....	75
Fuller's Small Fruit Culture.....	1 50	Scribner's Ready Reckoner and Log-book.....	80
Fuller's Strawberry Culturist.....	25	Srong's Cultivation of the Grape.....	8 00
Fuller's Forest Tree Culturist.....	1 50	Ten Acres Enough.....	1 50
Fulton on Peach Culture.....	1 50	Thomas, J. J., Farm Implements.....	1 50
Geyelin's Poultry Breeding.....	1 25	Thomas, J. J., Fruit-culturist; old ed \$3 00; new edition.....	3 75
Gray's How Plants Grow.....	1 25	Ville's Chemical Manures.....	1 25
Gray's Manual of Botany.....	2 25	Warder's American Pomology.....	3 00
Gray's Manual, Botany and Lessons, In one vol.....	4 00	"          Hedges and Evergreens.....	1 50
Gray's School and Field Book of Botany.....	2 50	"          Elements of Agriculture.....	1 00
Green on Trout Culture.....	1 00	"          Earth Closets.....	75
Gregory on Squashes, paper.....	30	Webster's Dictionary, Unabridged.....	12 00
Guernon on Milch Cows.....	75	Wells' Every Man his own Lawyer.....	2 00
Guide to Fortune.....	1 00	Williams, B. S., on Stove and Greenhouse Plants, 2 vols., Ill'd.....	5 00
Harnozthy's Grape Culture and Wine Making.....	5 00	Williams, B. S., on Select Ferns and Lycopods.....	2 50
Harris' Insects Injurious to Vegetation, clo \$4; col. eng's.....	6 50	Williams, B. S., Orchard Grower's Manual.....	2 50
Harris on the Pig.....	1 50	Window Gardening.....	1 50
Hatfield's American House Carpenter.....	3 50	White's Gardening for the South.....	2 00
Henderson's Practical Friculture.....	1 50	"          Cranberry Culture.....	1 25
Henderson's Gardening for Pleasure.....	1 50	Wood's Class Book of Botany.....	3 50
Henderson's Gardening for Profit.....	1 50	Workingman's Way to Wealth.....	75
Herbert's Hints to Horsekeepers.....	1 75	Wright's Practical Poultry Keeper.....	2 00
Hoopes on Evergreens.....	3 00	Yount on the Horse.....	1 75
Hooper's Dog and Gun, paper 30 cents, cloth.....	60	Youman's Household Science.....	2 00
Hop-culture.....	40		
How to Buy a Farm, and Where to Find One.....	1 75		

# WEATHERED & CHEREVOY'S PATENT BOILERS

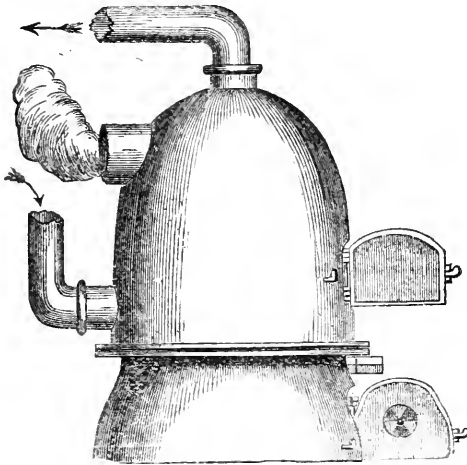

Fig. 1.

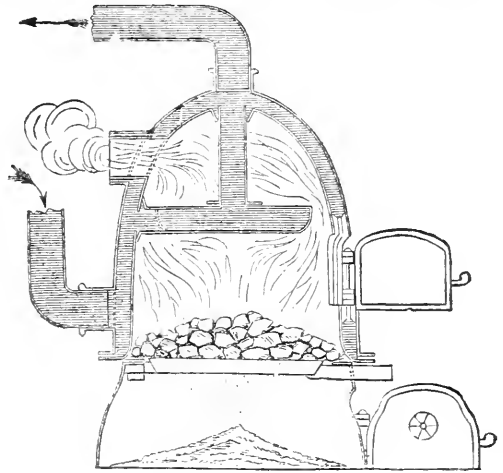

Fig. 2.

## AND IMPROVED HOT WATER APPARATUS,

No. 46 Marion Street, between Spring and Prince, New York.  
(TWO BLOCKS EAST OF BROADWAY.)

For Warming and Ventilating Public Buildings, Private Dwellings, Greenhouses, Graperies, Forcing Pits, Drying Rooms, and Heating Water for Public Baths.

Fig. 1 is an outside view. Fig. 2 is a vertical section through the centre.

*The following are a few names of Gentlemen who have our Boiler in use:*

Thos. Drake, Esq., Germantown, Pa.  
Simon Cameron, Esq., Harrisburg, Pa.  
J. D. Cameron, Esq., Harrisburg, Pa.  
Thos. Carter, Esq., Raleigh, N. C.  
J. H. Dunham, Esq., Chicago, Ill.  
Jas. B. Waller, Esq., "  
W. J. Gordon, Esq., Cleveland, Ohio.  
Geo. Stanley, Esq., "  
Harris Jaynes, Esq., "  
Geo. W. Cuyler, Esq., Palmyra, N. Y.  
D. M. Osborn, Esq., Auburn, N. Y.  
John B. Dutcher, Esq., Pawling, N. Y.  
A. M. Allerton, Esq., Bronxville, N. Y.  
Robert Hoe, Esq., Tarrytown, N. Y.  
Peter Hoe, Esq., "  
George Lewis, Esq., "  
Wm. H. Drew, Croton Falls, "  
Hon. James Y. Smith, Providence, R. I.  
Philip Caswell, Esq., Newport, R. I.  
Alfred Smith, Esq., "  
Wm. Findlay, Esq., "  
E. Learned, Esq., Pittsfield, Mass.  
D. O. Mills, Esq., San Francisco, Cal.  
W. L. Ferris, Esq., Westchester, N. Y.  
D. H. Haight, Esq., Goshen, N. Y.  
F. Newbold, Esq., Newark, N. J.  
James T. Closson, Esq., Plainfield N. J.  
Daniel W. Coit, Esq., Norwich, Conn.  
J. F. Slater, Esq., "  
H. W. Collender, Esq., Darien, "  
Chas. P. Palmer, Esq., Stonington, "

Wm. D. Black, Esq., New Milford, Conn.  
Rev. Stephen H. Tyng, Irvington, N. Y.  
H. F. Spaulding, Esq., Riverdale, "  
S. D. Babcock, Esq., "  
Percy R. Pyne, "  
Elisha Brooks, Esq., Inwood, "  
Camille Marie, Esq., "  
A. F. Smith, Esq., Fort Washington, "  
R. M. Olyphant, Esq., Dobb's Ferry, "  
Clarkson N. Potter, Esq., New Rochelle, "  
Chas. D. Dickey, Esq., West Farms, "  
Wm. Matthews, Esq., Harrison, "  
William Chorlton, Esq., New Brighton, S. I.  
F. H. Wolcott, Esq., Astoria, L. I.  
Bailey Leach, Esq., "  
Hon. W. B. Ogden, High Bridge, N. Y.  
Peter Moller, Esq., 295 Fifth Ave., New York City.  
Wm. Moller, Esq., 6 West 20th St., "  
John Moller, Esq., 127 East 54th St., "  
John Moller, Esq., 8 East 37th St., "  
Ch. Moller, Esq., 425 Washington St., "  
Henry B. Laidlaw, Esq., 33 Pine St., "  
George W. Lane, Esq., 93 Front St., "  
J. P. Robinson, Esq., 14 Coenties Slip, "  
J. B. Colgate, Esq., 47 Wall St., "  
John B. Trevor, Esq., 47 Wall St., "  
Charles Butler, Esq., 12 "  
Richard Arnold, Esq., 309 Canal St., New York City.  
Jas. M. Constable, Esq., 309 Canal St., "  
W. T. Garner, Esq., 61 Worth St., N. Y. City.

Please send for Circular with list of References and Reduced Prices to

THOMAS W. WEATHERED, 46 Marion Street, N. Y.

# 50,000 IRISH JUNIPERS,

FROM 1 TO 5 FEET.

We can sell them cheaper than any establishment in the United States.  
Send for Price List.

TRUETT'S SONS & MORGAN,  
ROSEBANK NURSERIES,  
taug5 Nashville, Tenn.

## STRAWBERRY PLANTS,

and other SMALL FRUITS, for sale by

E. P. ROE,

Author of "Culture of Small Fruits," "Play and Profit in my Garden," &c.

Send for Circular. Address,

E. P. ROE,

aug3 Cornwall-on-Hudson, Orange Co., N. Y.

HENRY A. DREER,  
Seedsman and Florist,  
No. 714 Chestnut Street,  
PHILADELPHIA,

Begs to offer to the trade the following

## NEW AND RARE PLANTS.

### NEW DOUBLE POINSETTIA, (Poinsettia Pulcherrima Plenissima)

We take pleasure in offering to the Trade a limited number of this magnificent novelty, which have just been received in good order from the Introducers, Messrs. Veitch & Son, London.  
Strong Plants (perfectly ripe wood) each \$10 00.

Ferns of the following sorts at \$10 per 100 in fine thrifty condition.

Adiantum assimile, A. diaphanum, Gymnogramma chryso-phylla, G. sulphurea, G. tartarea, Hastraea, Pteris argyrea, P. hastata, P. nemoralis, P. palmata, P. serrulata, P. serrulata cristata, &c., &c.

Pteris tricolor, good plants. Doz. \$2 50. [aug1  
Pteris rubra venia (very rare). Doz \$2 50.

Tuberose Bulbs dry bulbs). Double extra roots in best condition for autumn and winter flowering. Per 100, \$4.00.

## STANDARD PEARS.

We offer for fall the finest lot of 2 and 3 years STANDARD PEARS in the country. A large assortment of new and standard varieties, among them are

50,000 BARTLETTS,  
40,000 CLAPP'S FAVORITE,  
30,000 FLEMISH BEAUTY,  
20,000 BEU. D'ANJOU,  
15,000 SHELDON.

Also APPLES, CHERRIES, PLUMS, DWARF PEARS, PEACHES, ORANGE QUINCES, and other Nursery Stock.

RICHARDSON & NICHOLAS,

GENEVA, N. Y.

july4

## BRIDGEMAN'S

878 BROADWAY, N. Y.

LYNCH & KELLY.

CELERY PLANTS { \$5.00 per 1000.  
75c. per 100.

CAULIFLOWER PLANTS { \$8 per 1000.  
\$1 per 100.

CABBAGE PLANTS, of the best { \$3 per 1000  
varieties { 40c. per 100

Cash, or good city reference with each order, required.  
Address,

LYNCH & KELLY,

878 Broadway, N. Y., or Astoria, Long Island City.  
aug1

## NEW PLANTS--TO THE TRADE.

NEW DOUBLE WHITE DAISY.

The largest and finest white daisy yet offered, flowers perfectly double. 50c. each.

NEW VARIEGATED LANTANA.

Best variegated bedding plant to stand the sun. Very free blooming. 60c. each, \$5 00 per doz., free by mail.

W. A. HARKETT,

feb10

DUBUQUE, IOWA.

SEASON 1876.

## DUTCH BULBS

AND

## FLOWER ROOTS,

GROWN BY

## E. H. KRELAGE & SON,

HAARLEM, HOLLAND,

For Catalogues, which will be forwarded as soon as they are issued, apply to Messrs. E. H. KRELAGE & SON, Haarlem, Holland, or to their Agent for America,

C. RAOUX,

jantf

76 Park Place,

NEW YORK CITY.

NEVADA MAMMOTH RYE.

The greatest wonder at the Centennial Exposition, producing 75 bushels to the acre, making bread equal to the best wheat; now for the first time offered for sale. 1 lb. 50c., 2 1/2 lbs. \$1.00, 10 lbs. \$3.00, 100 lbs. \$25.00. Address C. B. ROGERS, 133 Market Street, Phila.



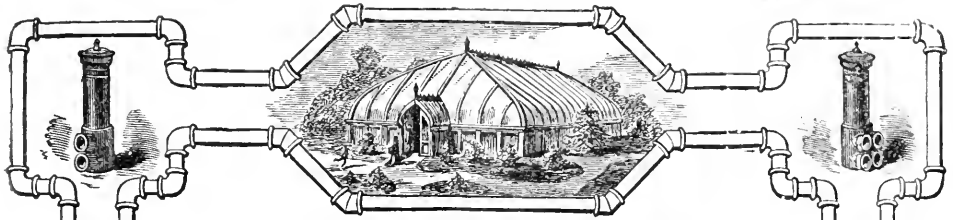

ESTABLISHED 1844.

HITCHINGS & CO.

No. 153 Crosby Street,  
NEW YORK.

CONICAL BOILER

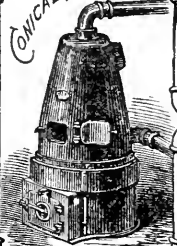

SADDLE BOILER

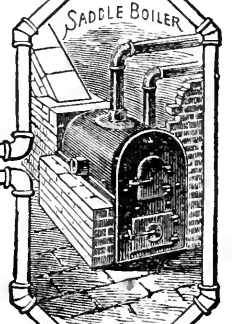

HOT-WATER  
APPARATUS  
for HEATING  
GREEN-HOUSES, &c.

Illustrated Catalogue and List of References and Reduced  
Prices, sent on receipt of postage—6 cents.

CORRUGATED FIRE-BOX BOILER

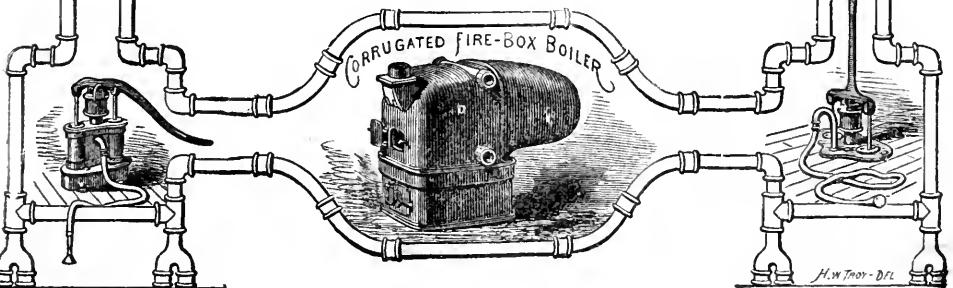

H. W. TROTTER - DEL.

# Roses! Roses! Roses!

We offer a large stock of  
**FINE STRONG GROWING YOUNG ROSES,**  
 grown in 2 and 3 inch pots, and include the finest and leading varieties.  
**HYBRID PERPETUALS, TEAS, BOURBONS AND CHINAS.**  
 Also **MOSESSES** and **CLIMBERS.**  
 at very lowest prices. Orders solicited.

**JAMES ALDOUS & CO., Florists,**  
 Feb 7 Iowa City, Iowa.

## FARMERS! \$16 FORGES,

**FOR YOUR FARMS!**

ALSO, A COMPLETE "KIT OF TOOLS."

Just what is wanted. Send three-cent stamp for circular to  
**EMPIRE PORTABLE FORGE CO., Troy, N. Y.**

**N. STEFFEN'S WIRE WORKS,**  
 333 E. 21st St. New York.

Manufacturer of all designs for **FLORISTS.** Wreaths, Crosses, Crowns, Hearts, Anchors, Pillars, Columns, Monuments, Bells, Composure, Faith, Hope and Charity, Harps and Lyres, &c. Leaning and Upright  
 Send for Price List. Jan 12.

Following Horticultural Advertising Papers will be forwarded gratis and post-free on application:

To Amateurs, "Die Allgemeine Baum-Offerte."

To Nurserymen, "Die Allgemeine Samen-s Pflanzen-Offerte."

**BERNHARD THALACKER,**  
 Gohlis, near Leipzig.  
 June 7

**WHOLESALE TRADE LIST**

OF

## DUTCH FLOWER ROOTS

France and gratis on application.

**A. M. C. J. CONINCK,**  
 July 2 Dedemsvaart, Netherlands.

**C. F. A. HINRICHS,**

29, 31 and 33 Park Place, New York City,

**HYACINTH AND BULB GLASSES.**

DECORATED

**FLOWER POTS,**

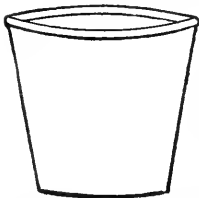

LAVA, MAJOLICA, &c., &c. Vases.  
 Iron Sections for Flower Beds. Lawn, Fish and Flower Stands. Floating Animals for Aquaria. Button-hole Bouquet Holders. Only and Original **GERMAN STUDENT LAMP** for Conservatories.

Send for Prices to above address.

mh6

## Prouty's Seedling STRAWBERRY.

Now is the time to secure plants of this wonderfully prolific and fine fruit for home use or market purposes.  
 Orders sent to

**LEWIS ELLSWORTH,**

of the

Du Page Co. Nurseries, Naperville, Ill.,

or

**KNEELAND PROUTY,**

of

Hinsdale, Du Page Co., Ill.,

will be promptly filled. Circulars and Lithograph sent on application  
 aug 1

## Florists' Flower Seeds.

Primula, Calceolaria, Cineraria, Smilax, Apple-Geranium Seed, &c., &c., new crop of the finest strains. The latter should be sown at once to germinate freely.

Send for price list of seasonable seeds.

**HENRY A. DREER,**

Seedsman and Florist,

No. 714 Chestnut St., Phila.  
 July 2

## BUDS.

We offer the following buds of **PEACH TREES, &c.,** by mail postage free, at prices affixed:

**BILVEU'S LATE OCTOBER** (Bilveu's Comet),  
**BRANDYWINE** (Peters' Seedling No. 1),  
**LEATHERBURY'S LATE, TUCKAHOE LATE,**  
 \$1.50 per 100; \$10.00 per 1000.

**AMSDEN'S JUNE, ALEXANDER'S EARLY,**  
**STEADLY, NANTICOKE,**

**PETERS' SEEDLING NO. 2.,**

**SHIPLEY'S LATE RED,**

**WILKINS' (Kingold Mammoth Cling),**

**NEWINGTON FREE,**

**GEARY'S HOLD ON, OAKLAND,**

and fifteen other new varieties, \$1 per 100; \$5 per 1000.  
 Standard varieties, including forty kinds, 75c per 100; \$3 per 1000. **APRICOTS** and **NECTARINES** 75c per 100; \$5 per 1000

**A. HANCE & SON,**

aug 2 Nurserymen and Florists, Red Bank, N. J.

## NURSERY STOCK

**FOR FALL 1876.**

**Apple Trees,** 5 to 8 feet.  
**Crab Apple,** largely Hyslop, 6 to 7 and 7 to 8 feet, very fine.  
**Cherry,** 3 years, on Mazzard stock, very fine.  
**Cherry,** 2 years, on Mahaleb stock, very fine.  
**Peach,** 1st and 2d class.  
**Silver Maple,** extra fine, all sizes to 12 feet.  
**Sugar and Norway Maple,** 8 to 10 feet, fine.  
**Horse Chestnut,** 4 to 5 feet.  
**Norway Spruce and Balsam Fir,** 2 to 4 feet, fine and stocky,  
**Scotch and Austrian Pine,** 4 to 6 feet, fine.  
**Irish Juniper,** very fine, all sizes 1½ to 6 feet.  
**Swedish Juniper,** very fine, 2 feet.  
**American Arborvitae,** 3 to 6 feet, fine.  
**Siberian and Globe Arborvitae,** very fine specimens.  
**Honey Locust,** 2 years; **Osage Orange,** 1 year.  
**Currant and Gooseberry,** 2 years, transplanted.  
**Tamarix, Deutzia, Forsythia and Weigela.**  
 Some of the above must be moved and will be sold low.

**H. M. ENGLE & SON,**

aug 2

Marietta, Pa.

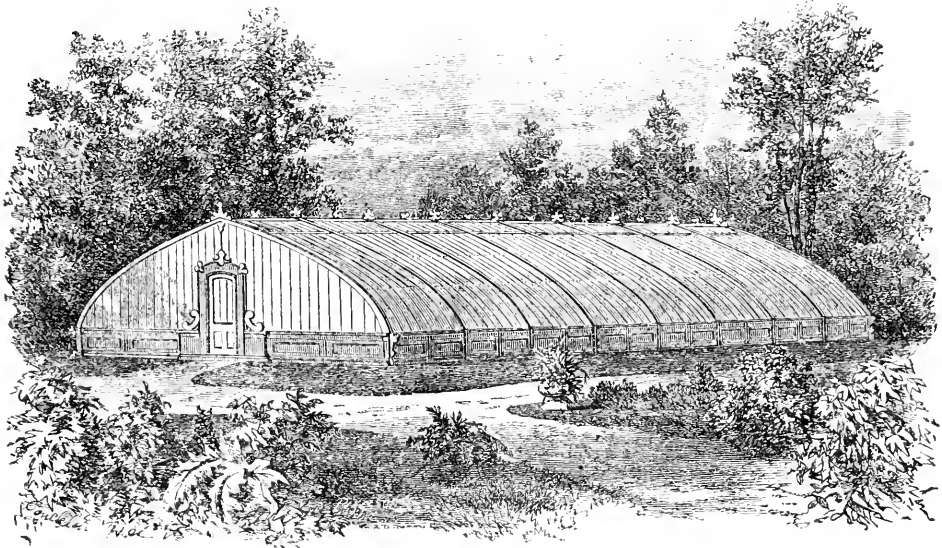

# GREENHOUSES, GRAPERIES, ETC.

Their Construction a Specialty. Experience of 20 Years.

SHIPPED TO ALL PARTS OF THE COUNTRY.  Send for Catalogue. Address,  
LORD'S HORTICULTURAL WORKS,

June 12

Irvington-on-Hudson, New York.

## ALEX. NIMMO,

(Late of the Firm of Nimmo & Scollay.)

# NEWLY IMPROVED HOT WATER BOILER,

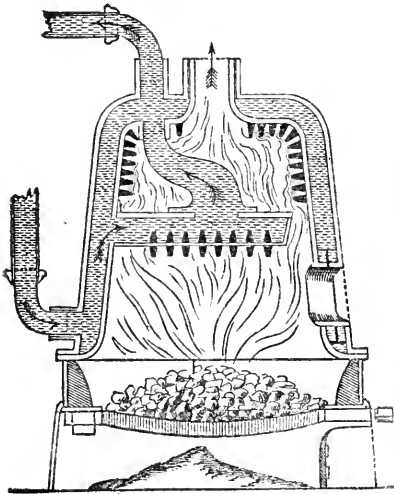

FOR HEATING  
Green-Houses, Graperies, Conservatories,  
Forcing Pits, Water for Baths, Drying  
Rooms, Public and Private  
Buildings, &c.

*Proper steps have been taken to secure United States  
Letters Patent on this Invention.*

All the necessary Fittings for Hot Water Heating Apparatus.

VENTILATION APPARATUS OF ALL KINDS.

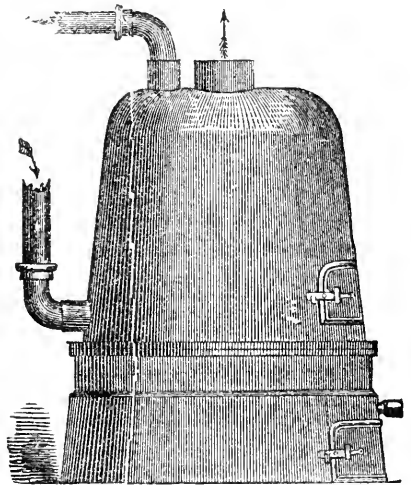

Wells Drove, Pumps of all kinds, Hydraulic Rams, &c., Garden Sun-Dials.

Agent for Joseph Kelly's Never Dry Vapor Pans, for all kinds of Hot Air Furnaces, Baltimore Heaters, &c.

CHEAPEST AND BEST BOILER, &c., IN THE MARKET.

Please send for Circular for explanation, etc., before you make up your mind to purchase elsewhere.

sep 12

P. S.—Be sure you get the right number.

335 Adams Street, Brooklyn, N. Y

THE  
CHRISTIAN AT WORK.

T. De Witt Talmage, Editor.

Without Premiums, \$3; with Premiums, \$3.25. To Clergymen 75 cents less. ~~2~~A Choice of two premiums.

OPINIONS OF THE PRESS.

"The Christian at Work is the liveliest religious paper published in these parts. Its columns are spicy and sparkling and to religious people who like things lively it is a readable paper. The Devil is more certain to be frightened with a radiant face than a solemn and forbidding one."—*N. Y. Commercial Advertiser.*

"The Christian at Work has donned a new dress and looks as pretty as a picture. The type of all sizes is admirably clear and a handsomer weekly there is not in these United States."—*N. Y. Evening Mail.*

"The Christian at Work is safe and reliable in all its utterances and ought to displace the ——— in every Presbyterian family. Its editor is a host in himself, and nothing will stagnate that he has anything to do with."—*London Correspondent Chicago Interior.*

"The Christian at Work is an admirably conducted sheet, filled with live matter."—*N. Y. Star.*

"The Christian at Work is one of the most readable religious papers published anywhere. The Doctor and his associates have discovered the art of making a publication orthodox without being fippant."—*Brooklyn Eagle.*

"In The Christian at Work everything is lively and life-like. This Christian smiles, laughs, sometimes actually whistles, while at his work, and that without letting down the dignities and proprieties that belong to the discussion of the themes it discusses."—*Brooklyn Union.*

"The Christian at Work is one of the best of the religious weeklies, and deserves the success it has attained."—*Brooklyn Argus.*

"The Christian at Work is one of the most sprightly, most gladly welcomed in every family of all religious weeklies. It fits from the pulpit to the pew, from the rod of authority to the kiss of love, from the paternal command to the child's obedience, and scatters flowers upon all, breathing content and happiness upon all its readers."—*American Garden.*

Five Sabbath School Papers,

under the same editorial supervision, are published by us monthly, and are suitable for School or Home. The best and cheapest published. Beautiful premiums with these also.

Good Words, My Paper, Good Cheer, Old and Young, Der Sonntagsgast. (German.)

We number our papers, but do not date them, making them good at any time.

Two papers with names nearly like our own have lately been issued in New York City. They are not in any way under the supervision of DR. TALMAGE or the control of THE CHRISTIAN AT WORK PUBLISHING COMPANY. Be careful to send your orders direct to the publisher of this paper.

Full particulars and sample copies of all papers furnished on application.

HORATIO C. KING, Publisher,

July 14 No. 102 Chambers Street, New York.

CARTHAGE PEACH NURSERY.

Amsden Peach a specialty. The Amsden is the earliest, and best early peach in the world, being 8 to 10 days earlier than Beatrice, nearly twice as large, and of better quality. For full history and price of buds and trees, address, JOHN WAMPLER,

Carthage, Mo., or Totowood, Ohio.

LONDON GARDENER'S CHRONICLE

Will be furnished, post-paid, direct to subscribers in the U. S. for \$7 50 per year. Specimen Nos. 3 cent stamp. Apply to CHAS. H. MAROT, Agent, 314 Chestnut St., Phila.

R. LYNEX,

Rear of 428 Walnut Street, Philada.

Manufacturer of Plain and Fancy Wire-work, for Florists; Wreaths, Crosses, Stars, Crowns, Hearts, Anchors, Birds, Lambs, Gipsy Baskets, Hanging Baskets, Flower Stands, &c.

SEND FOR PRICE LIST.

aug6

MY

Wholesale and Descriptive Catalogues of

Greenhouse and Bedding Plants

SHRUBS, EVERGREENS, ETC.,

MAILED TO ALL APPLICANTS.

Wm. C. Wilson

Astoria, L. I. C.,

June 12

New York City Office—45 West 14th St.

DUTCH FLOWER-ROOTS AND BULBS,

Cultivated and sold by

M. C. ALKEMEDE & SON,

at

Noordwijk-Binnen, near Haarlem, Holland.

Catalogue for 1876 will be forwarded post-free on application. may4

TREES, TREES,  
TREES!

Standard Pears and Standard Apples in large quantities; also Plum, Cherry, Peach, Dwarf Trees, Orange, Quince, Grape Vines, Small Fruits, and Ornamental Trees and Shrubs

Stock for the coming season extra nice and thrifty. For TRADE LIST, which will be out by the middle of August, or special inquiry, address,

PEIRSON & DEY,

(Successors to E. C. Peirson)

Maple Grove Nurseries,

aug2

WATERLOO, N. Y.

HONEYWELL,

THE EARLIEST OF PEACHES.

A. HANCE & SON,

aug11 Nurserymen and Florists, Red Bank, N. J.

PEACH BUDS.

Sixty varieties, including our famous Alexander, which has been fruited again this year with most satisfactory results, and is undoubtedly the Best Early Peach in cultivation. Also "Amsden" and "Briggs' Red May," and many other new and rare sorts. Sent by mail or express, carefully packed in moss, at low rates. Safe arrival guaranteed. For list of varieties, and prices of buds and trees, address

aug1 J. CAPPS & SON, Mt. Pulaski, Ill.

# JORDAN'S PATENT WATER AND STEAM SADDLE BOILER.

Constructed of Horizontal Pipes of the same inside diameter as those that form flow and return pipes, thereby producing a very rapid circulation of the water.

### DESCRIPTION.

Cut shows a side view of one-half section, with U steam propeller. Also shows section of chimney, ash-pit and brick arch around the boiler, with downward draft to chimney.

LENGTH, SEVEN FEET.

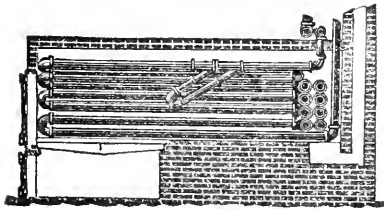

### PRICES OF BOILERS, WITH IRON FRONT.

- No. 1, to heat 500 to 750 feet of 4-inch pipe.....\$ 75.
- No. 2, to heat 750 to 1000 feet of 4-inch pipe..... 100.
- No. 3, to heat 1000 to 1500 feet of 4-inch pipe..... 125.
- No. 4, to heat 1500 to 2000 feet of 4-inch pipe..... 175.
- No. 5, to heat 2000 to 3000 feet of 4-inch pipe..... 225.
- No. 6, to heat 3000 to 5000 feet of 4-inch pipe..... 300.

SMALL BOILERS TO ORDER, \$30 TO \$50.

## SURPLUS STOCK FOR AUGUST, 1876.

FROM

# JORDAN HORTICULTURAL CO'S, ST. LOUIS, MO.

	PER DOZ.	PER 100.		PER DOZ.	PER 100.
Alocasias, assorted varieties, \$1.00 to 10.00.			Ferns 3-in. pots, in varieties .....	\$1.50	\$10.00
" 4-in. pot .....	\$3 00		" 4 " .....	2.00	15.00
" 6 " .....	5.00		" Large plants in varieties, \$2.00 to		
" 10 " .....	20.00		\$25.00 each .....		
" Large plants, \$5.00 to \$10.00 each ..			Palms, 50 cts. to \$50.00 each .....		
Begonias, Rex varieties, 4 in. pot.....	3.00	\$20.00	Primroses M. white, 3-in. pots.....	3.00	
" Flowering varieties, 3-in. pot.....	1.50	12.00	" " " 4 " .....	4.00	
Caladiums, choice variegated varieties, our			" " " 5 " .....	5.00	
selection.....			" fine Seedly 2-in. pot.....	75	
Caladiums 3-inch pot.....	2.00	15.00	" " 4 " .....	1.50	
" 5 " " Show plants.....	6.00		Hydrangeas, 4 to 6-in. pots.....	4.00	
Callas, 3 inch pots.....	1.50		Ivies, English and others, 2-in. pots.....	75	6.00
" 5 " .....	3.00		" " " 3 " .....	1.00	8.00
" 6 and 7-inch pots.....	4.00		" " " 4 " .....	1.25	10.00
Dracena Terminalis, 10 inches high.....	2.00		" " Large plant.....	3.00	
" 15 " .....	4.00		Roses, 25,000 fine everblooming.....		
" 20 " .....	5.00		" 3-in. pots, fine everblooming.....	1.50	10.00
" 24 " .....	6.00		" 4 " .....	2.00	15.00
Ferns 10,000 fine plants.....			" 5 to 6-in. pots, fine heads.....	3.00	20.00
" 2-in. pots, in varieties.....	75	6.00	Smilax, one year plant, fine.....		6.00

**J. M. JORDAN & BRO.,**  
612 Olive Street. St. Louis, Mo.

THOMAS J. MYERS.  
 PATENT BOILERS  
 AND  
 HOT WATER APPARATUS

FOR HEATING  
 GREENHOUSES, HOT-HOUSES, CONSERVATORIES, &c.

THOMAS J. MYERS & SON,  
 No. 1162 PASSYUNK AVE., PHILADELPHIA.

2, 4, 6, and 8 Home St., Cincinnati, O.

Please send for Descriptive Circular and Price List.

tjunetf

# GRAPE VINES.

Also GRAPE WOOD and CUTTINGS. LARGEST STOCK IN AMERICA.

All leading varieties in large supply. Extra Quality. True to name. Special rates to Agents, Dealers and Nurserymen. Our list of customers now embraces nearly all the leading nurserymen in the country, to whom we would refer those not acquainted with our stock. Descriptive Catalogue and Price List Free. T. S. HUBBARD, Fredonia, N. Y. aug10

## AN ARBORETUM AT THE CENTENNIAL.

Visitors to the CENTENNIAL EXHIBITION are invited to examine the ARBORETUM planted on the Horticultural Grounds by

THOMAS MEEHAN, Nurseryman,  
 GERMANTOWN, PHILA.

The collection embraces nearly EIGHT HUNDRED Species or well marked varieties, all named for the information of Visitors, and is believed to be one of the most complete collections of hardy, vigorous plants ever got together in this latitude. may5

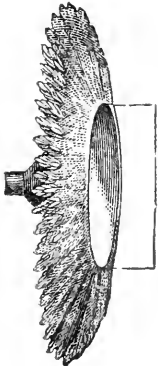

M. M. BAYERSDORFER & CO.,

Importers of Every description of

### BOUQUET PAPERS.

Plain White Satin for Bridal Bouquets. Fancy Lace for Weddings, Receptions, Parties. Italiens, Pasted Cartons, Immortelles in great varieties; Green Moss, French Dried Grasses and Flowers. Tin Foil. Prize Medal of Cincinnati Industrial Exposition of 1873 awarded to us for the best display of Bouquet Papers. Illustrated Catalogue furnished on application.



feb

56 N. Fourth St., Philadelphia, Pa.

# ELLIS' BASE BURNING BOILER.

FOR WARMING Dwellings, Greenhouses, Graperies, Forcing Pits, Drying Rooms Heating Water for Public Baths, Baptisteries, &c., by Hot Water or by Steam.

Estimates and Circulars furnished. t.sep.12. 182 CENTRE STREET, NEW YORK.

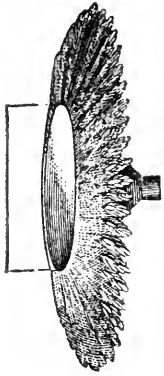

ROWLAND WHITMAN.

## WHITMAN & LANG,

IMPORTERS OF

HARRY LANG.

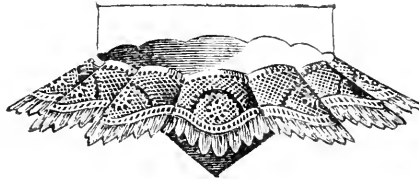

BOUQUET PAPERS.

FANCY GRASSES

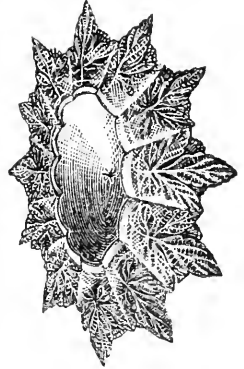

DRIED FLOWERS, IMMORTELES, TIN FOIL &c.

augtf. No. 126 N. 4th St., Philadelphia.

## GERMANTOWN NURSERIES, PHILADELPHIA.

GORTAS LANE STATION, CHESTNUT HILL RAILROAD. Less than One Hour from the Centre of Philadelphia.

Those who desire to purchase largely, either for their own planting or to sell again, are invited to examine the extensive stock of

### FRUIT, SHADE AND ORNAMENTAL TREES AND SHRUBS,

Grown at the Germantown Nurseries. And those who need but A FEW ARTICLES, will find all ages and sizes to select from. A special feature of the business, is the raising of

Nursery Stock and Seedling Forest Trees

FOR DISTANT SHIPMENT. Many of these can be supplied by the millions at very low rates. Address, for CATALOGUES or information,

THOMAS MEEHAN, Germantown Nurseries, Phila.

## THE CENTENNIAL TREE AND SHRUB SEEDS.

Visitors to the CENTENNIAL are invited to examine the collection of Tree Seeds, comprising over

THREE HUNDRED KINDS

of species, hardy in the greater part of the United States, and on exhibition in the AGRICULTURAL HALL, (At G 16) by

THOMAS MEEHAN,

COLLECTOR AND DEALER IN TREE SEEDS,

may 5

GERMANTOWN, PHILA.

### THE OFFICIAL GUIDE BOOK TO PHILADELPHIA AND CENTENNIAL EXHIBITION.

By THOMPSON WESTCOTT.

Author of the History of Philadelphia. The only full and complete Guide Book. Illustrated with two maps and 93 engravings. 425 pages, 16mo, Cloth, \$1.50; Morocco, \$2.00. Mailed, post-paid, on receipt of price. Address,

CHAS. H. MAROT, 814 Chestnut St., Phila.

Visitors Guide to the

### Centennial and Philadelphia.

Only authorized Guide Book on Centennial Grounds. Map of Centennial Grounds, Map of Philadelphia, 48 pages, 12mo, mailed for 30 cents. Address,

CHAS. H. MAROT, 814 Chestnut St., Phila.

# WHEELER'S INSECT ANNIHILATOR, LIQUID DISTRIBUTOR

AND

INSECTICIDES.

Patented July 20, 1875.

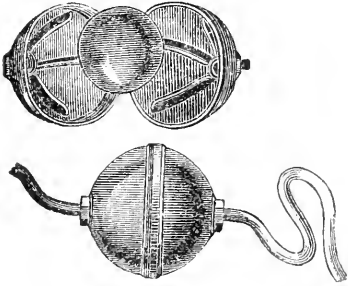

Compound Liquid Hose Distributor,  
Price \$5.00.

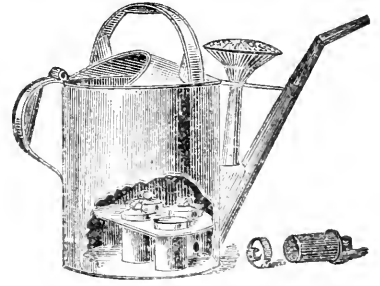

Compound Liquid Watering Pot,  
Average size, \$6.00.

These devices attached to hose pipe of aqueduct or force pump, and operated by water under pressure, and the Watering Pot constructed under the same patent, are the best ever yet used for destroying insects (Potato Bug and Currant Worm not excepted) on plants under glass or in open air, or for fertilizing the same. Fumigation unnecessary. Compound of Tobacco, Sulphur, Guano, in 5 lb. Boxes, 15c. per lb.; of Paris Green and Hellebore, 30c. per lb.

## INSECT ANNIHILATOR & FERTILIZER DISTRIBUTOR

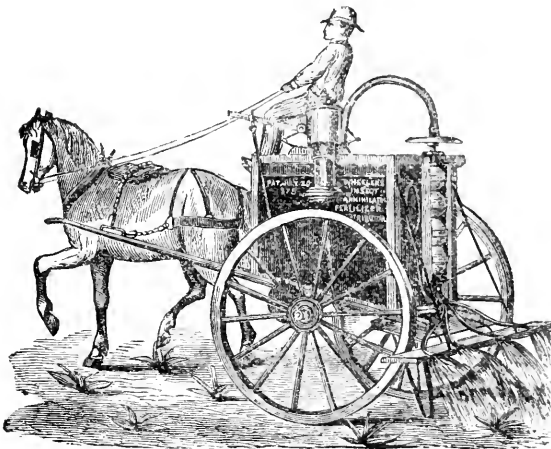

is operated by horse for field use, distributing any desired liquid compound in rows broadcast, or on trees. It is also a powerful Fire Engine, throwing an inch stream from 50 to 75 feet.

PRICE \$200.

## Liquid Fertilizer Distributor

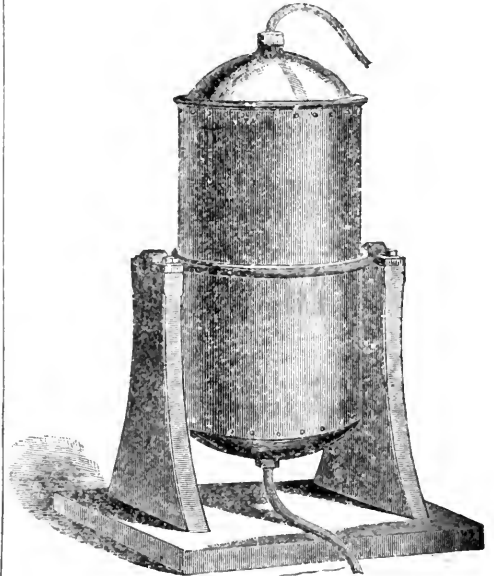

To reduce solid manures, coarse or fine to liquid form, and distribute the same under pressure through hose pipe.

PRICE \$50.

These Machines and Insecticides are on exhibit at the Centennial Exposition, and can be seen in practical operation on the grounds. Above goods delivered C. O. D. Highest testimonials with descriptive circular sent on application.

julytf.

W. F. WHEELER, 24th Ward, Boston, Mass.



# SPECIAL NOTICE.

In order to reduce my immense stock, I shall offer for the Fall and Spring trade, in addition to my usually full assortment of older nursery stock, the following

- ONE YEAR OLD TREES,
- 100,000 STANDARD PEAR,
- 25,000 PLUM, ON PLUM STOCKS,
- 25,000 DWARF PEAR,
- 25,000 CHERRY,

which in size and quality are unsurpassed by any in the State. This is a rare opportunity for Southern and Western Planters or Dealers to buy a class of stock not often to be found in the market.

A full description of this stock, with list of varieties, prices, terms, &c., will be given on application.

Address,  
**E. H. PRATT,**  
 Dansville, Liv. Co., N. Y.  
 aug3

## Cascade Nursery and Greenhouses.

RICHMOND, IND., July 13, 1876.

The copartnership heretofore existing under the firm name of E. Y. TEAS & CO., as Nurserymen and Florists, is this day dissolved by mutual consent; E. Y. TEAS and J. H. STUART retiring. A. K. WILLIAMS will continue the business at the old place, and with him all accounts in favor of or against the firm must be settled.

E. Y. TEAS,  
 A. K. WILLIAMS.  
 J. H. STUART.

### A CARD.

In retiring from the firm of E. Y. TEAS & CO., we would thank our friends and customers for the liberal patronage bestowed upon the late firm, and would recommend Mr. A. K. WILLIAMS (who continues the business at the old place) to you and to the general public, confident that he will use every effort to render satisfaction to all.

E. Y. TEAS,  
 J. H. STUART.

In assuming control of the above business I beg to assure the trade and the public that no efforts will be spared to maintain and advance the character of the collection of

**ROSES AND GREENHOUSE PLANTS,**  
**HARDY SHRUBS AND HERBACEOUS PLANTS,**  
 &c., &c. Parties contemplating the purchase of stock for fall and spring use are respectfully invited to correspond with me.

Address,  
**A. K. WILLIAMS,**  
 (Successor to E. Y. Teas & Co.)  
 Richmond, Ind.  
 aug1

## STRAWBERRY PLANTS.

All the best varieties, Great American, Cumberland, Triumph, Sterling, &c. Lowest rates. Prices free.

Address,  
**JOHN S. COLLINS,**  
 Moorestown, N. J.  
 aug7

## WILD GOOSE PLUM.

Buds of the true sort.

Address,  
**D. B. WEIR,**  
 Lacon, Marshall Co., Ill.  
 aug1

## TO FLORISTS

To Rent on very reasonable terms to a good tenant, a lot 62 by 160 feet, with nice brick cottage, two large and one small greenhouses, all new, in perfect order, with a good stock of plants.

For particulars address,  
**W. S. JOHNSTON,**  
 Poughkeepsie, N. Y.  
 aug7

## TO NURSERYMEN, DEALERS, PLANTERS, &c.

Our Wholesale Catalogue will be issued about 1st of August. The stock in every department will be unusually fine.

**ELLWANGER & BARRY,**  
 MOUNT HOPE NURSERIES,  
 taug1 Rochester, N. Y.

## FRUIT AND ORNAMENTAL TREES!

LARGE STOCK. LOW RATES.  
 STANDARD PEACH TREES A SPECIALTY.

AGENTS WANTED Address,  
**E. MOODY & SONS, Lockport, N. Y.**  
 NIAGARA NURSERIES. Established 1839. ang3

## PEACH BUDS BY MAIL.

Amsden June 50 cts. per 100, \$4 per 1000; Alexander and Thurber 75 cts. per 100, \$5 per 1000; 50 other varieties 50 cts. per 100, \$3 per 1000; also Apple, Pear, Cherry and Plum at 50 cts. per 100, \$3 per 1000. 70,000 Peach Trees including Amsden, Alexander, and all the best varieties. 30,000 1 and 2-year-old Concord grapes. 25,000 Wilson's Early Blackberry, and a full assortment of all Small Fruit, Plants, Fruit and Ornamental Trees, &c., at low prices. Satisfaction guaranteed. Address,  
**CHAS. BLACK & BRO.,**  
 Village Nurseries, Hightstown, N. J.  
 aug1

## TOBACCO STEMS,

For Fumigating purposes, for sale in bales of about 250 lbs., free on boat or cars at \$5 per bale, or three bales for \$12 on one order.

**STRAITON & STORM,**  
 178 & 180 Pearl Street,  
 New York City.  
 aug12

## A WELL IMPROVED FARM IN NEBRASKA FOR SALE.

Thirty miles north of the Kansas and Nebraska State line, within one mile of the Missouri River, the same distance from the county seat of one of the best counties in the State, the present terminus of an operating railroad. Society and religious advantages excellent. Educational advantages unsurpassed. Two hundred and twenty acres, all under fence and cultivation. Principal surrounding and sub-division, fences, live hedge. Forty acres in bearing orchard—Apples, Pears, Peaches, Plums, Cherries, Apricots and Grape Vines; 200 bearing Chestnut trees; Ornamental trees, Evergreens, Flowering Shrubs, Vines and Bulbs, in endless number and variety. Large three-story Brick House, with 13 rooms; farm tenant house, with 5 rooms; large frame barn, with stone basement; two wells, two cisterns, and ever-living running stock water. A rare chance for one who wishes to go west and enjoy all the advantageous surroundings of the old States. Terms easy. Address,

**ROBT. W. FURNAS,**  
 Brownville, Nemaha County, Nebraska.  
 aug1

THIS PAPER IS KEPT ON FILE  
 AT THE OFFICE OF,

**N. W. ADVERTISING  
 AGENTS,**

733 Sansom St., PHILADELPHIA,

Who are our authorized agents, and will  
 receive Advertisements at our  
 LOWEST CASH RATES.

## DOUBLE ZONALE PELARGONIUM WONDERFUL, Geo. Smith.

Magnificent Orange Scarlet, a sport from Vesuvius; Flowers semi-double, trusses large, produced abundantly on small plants; a splendid bedding or market plant. See illustration in this number of the *Gardener's Monthly*.

Plants ready for sale first of October. Price: Small Plants, \$1 each; extra ditto, \$2.50 each; and very strong Imported Plants, \$5 each, with many other varieties.  
Copies of Cut for Sale \$5 each. Address,

THE BELLEVUE NURSERY CO.,

PATERSON, N. J.

aug.

H. E. CHITTY, Sup't.

Entered according to Act of Congress, in the year 1876, by the National Art Co., in the Office of the Librarian of Congress, at Washington.

# "God's Promise."

The Finest WORK OF ART ever issued in this Country,

## GIVEN AWAY

To every Subscriber to this Paper.

Reproduced in 17 Chromatic Water Colors, under the artist's personal supervision, and acknowledged by connoisseurs to be the best Water Color Chromatic Printing ever produced in America. This unsurpassed work of art, through the splendid liberality of the National Art Co., of Cincinnati, Ohio, can be secured by every subscriber of this paper, as a

## Grand Premium Gift,

It being delivered Free of Purchase Charge to every patron of this paper. It consists of

## Four Complete Chromatic Paintings,

Embodying the fullest and richest conception of God's glorious promise: "While the earth remaineth, seed-time and harvest, and cold and heat, and summer and winter, and day and night shall not cease." America's most favored landscape painter, Mr. F. D. Grafion, has grouped together, on a large plate, four splendid Landscape and Figure Paintings, and clothed them in the richest and warmest colors. To show in what light this splendid work of art is regarded, one thousand copies have been sold in Cincinnati and New York, at \$10 per copy, and \$5,000 in cash was offered the National Art Co. for its exclusive use as a Premium, by one of the most prominent newspapers in the country.

So large has been the demand on the National Art Co. for former Premium Engravings, and so universal the request that their works should not be confined to any one paper, that the Company have determined to make "GOD'S PROMISE" the crowning triumph of their art publications, and have steadily refused all offers for its exclusive control by any one paper. In order that the better class of newspapers generally may be benefited in being able to advertise it as the last and best Premium Gift of the National Art Co. Hence the announcement is made that arrangements have been made which secure to every reader of this paper a perfect copy of this latest, largest, and best American art publication.

The only requirement exacted is, that each reader shall cut out the following Premium Certificate, showing that it is sent to by a bona fide patron of this paper, together with 25 cents, the actual cost of postage, wrapping and mailing charges, and forward the same to the National Art Co. for redemption. In return you will receive a perfect copy of this grand work of art, mailed in a strong tube, postage fully prepaid, and every copy is warranted to reach its destination uninjured. Any copy that should be broken in transmission through the mail, will be duplicated free of any charge, upon your notifying the National Art Co. of the facts in the case. Postage stamps may be sent at their face value, as the amount is heavily all used in paying return postage on the Picture.

Cut out this Certificate and forward to the NATIONAL ART CO. for redemption.  
It is worth \$10.

**PREMIUM CERTIFICATE.** On receipt of this Premium Certificate, together with 25 cents to pay cost of tube, postage, and packing, we hereby agree to return to the sender, postage prepaid, safely wrapped and packed, a perfect copy of Grafion's four celebrated paintings, entitled

## "GOD'S PROMISE."

This Certificate is good until October 15, 1876, after which 10 cents additional will be charged. No copy will be sent without this Certificate accompanying the order, to show us that you are a bona fide patron of this paper. [Signed] NATIONAL ART CO., 230 Walnut Street, Cincinnati, Ohio.

[TRADE MARK.]

**NOTE THESE INSTRUCTIONS.** All Certificates should be sent in by Oct. 15, 1876. Those sent in thereafter require 10c. additional, as a new edition will then become necessary. A Certificate for each Painting must in all cases be sent, otherwise persons who are not subscribers might reap the benefits intended solely for the patrons of this paper. Each copy will be enclosed in a strong tube, and postage will be paid thereon out of the 25c. sent in. THE CERTIFICATE WILL NOT BE AGAIN PRINTED IN THIS PAPER, hence the importance of cutting it out at once and sending it in for redemption. Address all Certificates to the National Art Co., 230 Walnut Street, Cincinnati, Ohio, and you will receive by return mail the largest and handsomest Premium Painting you ever saw.

## 100 BARRELS RED OAK ACORNS.

Also Seeds of White Pine, Pitch Pine, Sugar Maple, Scarlet Maple, White Birch, Poplar-Leaved Birch, Yellow Birch, Hemlock Spruce, White Ash, Brown Ash, Juniperus Prostrata, &c., will be offered for sale this fall by

JAMES D. MAHONEY,

Fisherville, N. H., or Saco, Me.

Orders, to ensure fulfillment must be sent in before time for collections. aug2

## CAMELLIAS.

A fine stock of the above, different sizes, mostly Double White, well set with buds.

R. SCOTT,

755 South 19th St.,

aug:

PHILA.

# The Centennial.

**ADVERTISERS** Are requested to note that **CURRENT NUMBERS** of **THE GARDENER'S MONTHLY**, from **MAY** to **NOVEMBER** inclusive, will lie upon the tables of the Reading Room at Horticultural Hall, Centennial Grounds, for the inspection of the thousands directly interested in the stock you have for sale. Those who take advantage of this fact will have practically an **extra circulation**, during the months named. Two files of the **MONTHLY**, from May to November, will constantly remain for the inspection of visitors. Be in time with your orders. Take notice **changes of copy** in current advertisements must be in hand by the **16th** of each month, and new orders by the **23d** to insure insertion in following issue. Address **C. H. MAROT,**  
814 Chestnut St., Philadelphia.

## ARITHMETIC MADE EASY

BY

### Ropp's Commercial Calculator

No farmer, mechanic, business man or laborer should be without it.

Contains more **useful** and **practical** tables, and **original** and **rapid** methods of calculation than all the other Reckoners and Calculators combined.

Shows at a glance the value of all kinds of grain, stock, hay, coal, lumber and merchandise, for any quantity and any price; the interest on any sum for any time at 6, 7, 8 and 10 per cent; measurement of lumber, saw logs, cisterns, tanks, granaries, corn-cribs, wagon-beds, etc.; also a time, wages, and many other valuable tables.

It is simple and easily comprehended. **Any one**—the least conversant with figures—can instantaneously become his own accountant.

Enables anyone to compute numbers with lightning rapidity, by mastering a simple arithmetical principle which has never been used before.

Is an Arithmetic, Ready Reckoner, Lightning Calculator, Silicate Slate, Memorandum and Pocket-book combined.

Price: Bound in Russia leather with gilt edges, \$2 00; Morocco, \$1.50; Fine Cloth, \$1.00; without slate, memorandum, etc., 60 cts. Sent post-paid on receipt of price.

Address

**CHAS. H. MAROT,**

814 Chestnut St., Phila.

## DECLARATION OF INDEPENDENCE

**FACSIMILE LITHOGRAPHED** in the handwriting of **THOMAS JEFFERSON**, with the interlined corrections and erasures as made by **JOHN ADAMS** and **Dr. FRANKLIN**, in 1776. Pamphlet form, (7 pages,) on extra heavy, highly calendered, and tinted paper, with a beautiful cover, in four colors, embellished with the National Emblems,

### OLD INDEPENDENCE HALL,

(As it appeared in 1776.)

### THE "OLD LIBERTY BELL"

which rang out the **LIBERTY** we now enjoy to all the people, etc., etc. To which is added the *names of the signers in their own handwriting*, making one of the most ornate, unique, and interesting centennial memorials of the "time that tried men's souls," that could possibly be imagined. Should be placed on the centre table of every American citizen.

Price 50 cents each, postage paid. Address.

**CHAS. H. MAROT,**

814 Chestnut St., Phila.

## AMERICAN FRUIT CULTURIST.

BY JOHN J. THOMAS.

Practical directions for the Cultivation of Fruit Trees in the **NURSERY, ORCHARD AND GARDEN.**

Descriptions of the principal American and Foreign varieties. Plain Edition, 480 engravings, 511 pages, 12 mo. Price, \$3.00. Mailed post-paid on receipt of price.

**Extra Edition**, 576 pages, heavy paper, fine cloth, 608 illustrations and chromo frontispiece; mailed, for \$3.75. Address **CHAS. H. MAROT,** 814 Chestnut St., Phila.

## The Gardener's Monthly.

THE FOLLOWING

### BACK NUMBERS

WANTED, IN

### GOOD CONDITION.

April, 1860.	October, 1870.	August, 1874.
January, 1870.	December, "	December, "
March, "	January, 1873.	January, 1875.
July, "	January, 1874.	December, "
		January, 1876.

Receivable in exchange on Subscription account, or exchangeable for other numbers not in above list. Send numbers and advise the publisher by letter. Address,

**CHAS. H. MAROT,**

814 Chestnut St., Phila.

## THE ABBOTT

### Pocket Microscope

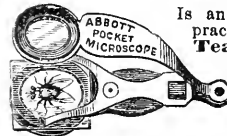

Is an instrument of great practical usefulness to **Teachers, Farmers, Merchants, Mechanics, Physicists, Botanists, Miners,** and many others. It is the best

instrument ever invented for examining **Flowers, Seeds, Plants, Minerals, Engravings, Bank Notes, Fabrics,** Etc. By means of a cage, accompanying each instrument, one can examine all kinds of **Insects or Worms** alive. The

### EYE OF A FLY,

or other insect of like size, can be readily seen. It is simple in construction and easy to operate. One of these interesting instruments ought to be in every family. We have made arrangements to furnish the **Pocket Microscope** at the manufacturer's price, \$1.50. It will be sent, post-paid, to any reader of this Paper desiring it, on receipt of price, or may be had at this office.

Address,

**CHAS. H. MAROT,**

814 Chestnut St., Phila.

## PRESERVING, PICKLING AND CANNING FRUIT.

BY MRS. M. E. PETERSON.

Containing a choice collection of receipts of Preserving, Pickling, and Canning Fruits, many of them being original from house wives of experience. 72 pages, 16mo, Cloth. Price 50 cents. Sent by mail, post-paid, on receipt of price.

Address,

**CHAS. H. MAROT,**

814 Chestnut St., Phila.

Index to Advertisements.

Advertisers are requested to have orders in hand as EARLY AS POSSIBLE. Copy received after the 23rd of each month cannot be insured insertion in the next issue.

Aldous James, Iowa City, Iowa.....	4
Alkemade, M. C. & Co., Haarlem, Holland.....	6
Ayer N. W. & Son, Phila.....	11
Baversdorfer M. M. & Co., Philadelphia.....	8
Bellevue Nursery Co., Paterson, N. J.....	12
Black, Chas. & Bro., Hightstown, N. J.....	11
Blies B. K. & Sons New York city.....	cover
Burnett, Alex., Reading, Pa.....	2
Capps J. & Son, Mt. Pulaski, Ill.....	6
Christian at Work, New York city.....	6
Collins, John S. Moorestown, N. J.....	11
Coninck, A. M. C. J., Dedem-vaart, Netherlands.....	4
Dreer Henry A., Philadelphia.....	2, 4
Elder Walter, Philadelphia.....	14
Ellis Chas. R., New York city.....	9
Ellwanger & Barry, Rochester, N. Y.....	11
Empire Portable Forge Co., Troy, N. Y.....	4
Engle H. M. & Son, Marietta, Pa.....	4
Foster, P. H., Babylon, New York.....	14
Furnas Robt. W., Brownville, Nebraska.....	11
Harkett Wm. A., Dubuque, Iowa.....	2
Hance A. & Son, Red Bank, N. J.....	4, 6
Hinrichs C. F. A., New York city.....	3
Hitchings & Co., New York city.....	3
Hubbard T. S., Fredonia, N. Y.....	7
Jordan, J. M. & Bro., St. Louis, Mo.....	7
Johnston, W. S., Poughkeepsie, N. Y.....	11
Lord's Horticultural Works, Irvington, New York.....	5
Lynch & Kelly, New York.....	2
Lynex Richard, Philadelphia.....	12, 13, 14, Fly-leaf
Marot, Chas. H., Philadelphia.....	14
MacPherson James, Philadelphia.....	12
Mahoney Jas. D., Fishersville, N. H.....	12
Meehan Thomas, Germantown, Philadelphia.....	8, 9
Moody E. & Sons, Lockport, N. Y.....	11
Myers Thomas J., Philadelphia.....	8
National Art Co., Cincinnati, Ohio.....	12
Nimmo Alexander, Brooklyn, New York.....	5
Parsons, R. B. & Co., Flushing, N. Y.....	14
Parsons R. B. & Sons, Flushing, New York.....	cover
Pierson & Day, Waterloo, N. Y.....	6
Pratt E. H., Danville, N. Y.....	11
Prouty Kneeland, Hinsdale, Ill.....	4
Raoux C., New York city.....	2
Richardson & Nicholas, Geneva, N. Y.....	2
Roe E. P., Cornwall-on-Hudson, N. Y.....	2
Rogers C. B., Phila.....	2
Rolker A. & Sons, New York city.....	Fly-leaf
Scott R., Phila.....	12
Steffens N., New York city.....	4
Straiton & Sturm, New York city.....	11
Thalacker Bernhard, Gohlis, Leipzig.....	4
Truett's Sons & Morgan, Nashville Tenn.....	2
Wampler John, Carthage, Missouri.....	6
Weathered & Cherevoy, N. Y. City.....	1
Weir, D. B., Lacon, Ill.....	11
Wheeler W. F., Boston, Mass.....	10
Whitman & Lang, Philadelphia.....	9
Wilson William C., New York city.....	6
Williams A. K., Richmond, Ind.....	11
Wood Edmund M., Boston, Massachusetts.....	cover

SITUATIONS WANTED.

By a young man in a private or commercial establishment, has had three years experience in a public green-house near Boston, Mass. Understands the arrangement of cut flowers, bouquets and designs. Would take a position in private green-house or Florist's establishment. Address FLORIST, 460 North Third street, Philadelphia.

A Gardener by a married man, no children. Private or commercial situation. Has had sixteen years practice in the culture of hot and green-house plants. Also understands the growing of all kinds of vegetables. Is now in place and can be well recommended by both present and last employers. Those wishing a capable gardener, address JOHN WHITE, Florist, &c., Jersey City, N. J.

By a thorough practical man; the best of reasons for leaving the present employers, and the best of reference from past employer. Address WILLIAM Gardner, Upland, Del. Co., Pa. By a first-class Gardener, understands the management of green-houses, hot houses, graperies, propagating, cut flower business, and care of grounds. First-class references. Address, C. L. S., Florist, Box 119, Maysville, Mason Co., Ky.

WALTER ELDER,

Landscape and Jobbing Gardener,

1231 Rodman Street, Philadelphia,

Attends to all branches of his business on reasonable terms.

WANTED,

A practical Gardener of skill and intelligence, who has traveled extensively and acquired great practice, desires the management of some establishment in the vicinity of New York, Philadelphia, Baltimore, Boston or Washington. He would prefer a place where winter flowers would be made a specialty, and would not object to an arrangement being made under which duplicate plants, &c., would be sold or exchanged. He has been for some years gardener to the Hon. J. D. Cameron, Secretary of War, from whom he holds un-exceptionable recommendations. Address, JAMES MACPHERSON, tjun3 Care Gardener's Monthly Office, 814 Chestnut St., Phila.

R. B. PARSONS & CO.,  
Bowne Avenue, Flushing, N. Y.,

OFFER THEIR

RARE TREES & SHRUBS

as well as the well known sorts, and invite the special attention of

LARGE BUYERS

To their Stock of Rhododendrons, Azaleas—Chinese and Ghent—Camellias, Clematis, Hydrangeas, Magnolias, Roses by the 1,000.

RARE EVERGREENS,

are well known to be cultivated in large variety by them. For Catalogues address

Box 99, Flushing, N. Y.

feb. 12

WANTED, A SITUATION as Gardener in a private, or Foreman in a commercial establishment, by an Englishman, aged 25 years, single; has served nine years in three good places in England; for the last three years has had good practice in the U. S.; is thoroughly well versed in the propagation and cultivation of Stove and Greenhouse Plants, Roses, Orchids, &c., &c., the management of Hot and Cold Graperies; the growing of winter flowers, making of bouquets, and arrangement of cut flowers; also the growing of Vegetables. Character will bear strict investigation. Those in want of a steady, sober and reliable man, can have testimonials and references, by addressing GARDENER, care John B. Neebes, Esq., Mount Auburn, Cincinnati, Ohio. aug1

WANTED at the Babylon Nursery, immediately, a man to act as Foreman in Nursery and greenhouse who fully understands the business; such will receive good wages.

Address,

P. H. FOSTER,

Babylon, N. Y.

A Subscription to Harper's Weekly

For 1876 from January 1st, will be furnished, on receipt of \$3 if applied for at once at this office.

Address

CHAS. H. MAROT,

814 Chestnut St., Phila.

A Hygroscope for 50 cents.

THE CHEMICAL HYGROSCOPE.

This indicator of atmospheric moisture is as accurate as the costly ones. Rooms heated by furnaces or stoves are almost invariably so dry as to be damaging not only to health but to furniture. Some people take the consequences others keep water on the heater. The Hygroscope shows at a glance whether the air is too dry or not.

Sent by mail for 50 cents. Address, febt6 CHAS. H. MAROT, 814 Chestnut St., Philadelphia.

The Nurseryman's Directory.

A reference book of the Nurserymen, Florists, Seedsmen, Tree Dealers, &c., for the United States. Alphabetically arranged by States and Post Offices. 242 pages, 8vo. Price \$5. Mailed, post-paid, on receipt of price.

Address,

CHAS. H. MAROT,

814 Chestnut St., Phila.

# WABAN CONSERVATORIES

OFFICE :  
56 BROAD ST., BOSTON.  
Address all Letters to  
BOSTON OFFICE.

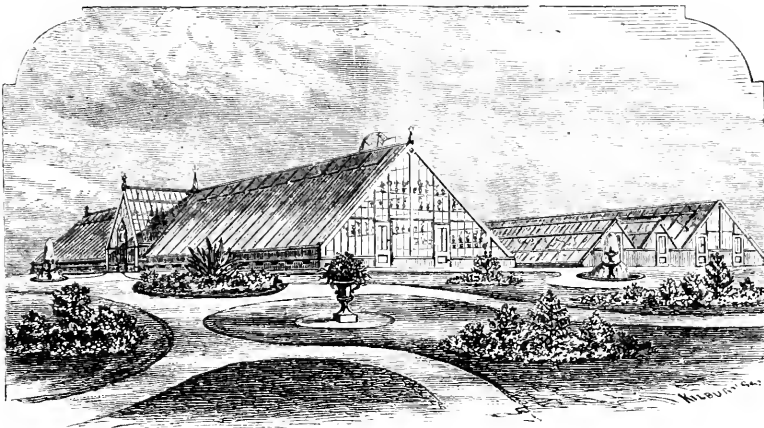

Send all Telegrams by  
Atlantic & Pacific Line. Address,  
*Waban Conservatories,*  
LAKE CROSSING, MASS.

## FALL TRADE 1876.

The following choice **SELECTED NOVELTIES** will be ready for delivery during the coming **FALL**, and to which attention is specially directed.

### ROSE "EDMUND WOOD." (Verdier).

This superb hybrid perpetual we have bloomed and find it fully equal, if not superior, to the description. Its color is richer and slightly darker than Gen'l Jacqueminot, far more double and equally prolific in growth, blooming as freely as that favorite variety. Good plants, on own roots, \$2 each.

### CARNATION "WELLESLEY BEAUTY."

Color soft fine cinnamon, beautifully striped and spotted with carmine rose; habit, free compact and vigorous. A valuable acquisition. 75c, each.

### BRONZE ZONALE GERANIUM "EARL ROSLYN."

Unquestionably the best bronze and gold bedding Geranium yet produced, superior to the acknowledged favorites, Marshall MacMahon and Black Douglass. 50c. each.

### DOUBLE ZONALE GERANIUM.

**P. BUCK.**—Violet and salmon, new and effective color, and a very valuable variety.

**J. C. ROBBARD.**—Double salmon red not very double, but beautifully joined and much superior to Asa Grey.

**MADAME THIBAND.**—Rose petals, marked with white at their base, semi-double, but producing a novel and pleasing effect. Also many other new Zonale and other Geraniums, for description of which see Catalogue.

### PELARGONIUM REGAL "QUEEN VICTORIA."

This is one of the most marvellously beautiful novelties ever offered. Color rich vermilion, margined with fine white, and upper petals blotched with deep purple maroon. The flower has thick crispy petals, which give it the appearance of being double. It is a remarkable and striking improvement in Pelargoniums. \$1.50 each.

### PELARGONIUM REGAL, "BEAUTY OF AXTON."

Similar in form to the above, but quite distinct in color, which is; upper petals rich maroon; centre rose; all the petals being margined with pure white; flowers large and full, having the appearance of being semi-double, and a most beautiful and extraordinary novelty. \$3 each.

**New Hybrid and Tuberose Rooted Begonias,** many introduced for the first time.

We are making the culture of these really beautiful plants a speciality, and shall be glad to forward price list on application. Also of many other novelties which are in course of propagation.

## FOR FLORISTS' WINTER STOCK.

We shall be able to offer at lowest rates.

**ROSES.**—Bon Silene, Safrano, Isabella Sprant, Marshall Neil, La France, Gen'l Jacqueminot, in 2 and 4 inch pots in large quantities. **CARNATIONS.**—fine plants from open Ground. **IVIES.**—Irish and others. **VINCA ELGANTISSIMA.** **VIOLETS.**—Neapolitan and Marie Louise. **BEGONIA REX** in variety. **BEGONIA FLOWERING** in variety. **FUCHSIAS,** new. **ADIANTUM CUNIATUM.** **FERNS** in variety by the 100. **RICHARDIA ALBA MACULATA.** **CALLAS;** &c.

Orders promptly executed. Send for Circular.

EDMUND M. WOOD & CO.

# S. B. PARSONS & SONS,

## Kissena Nurseries,

### Near KISSENA STATION, FLUSHING, N. Y.,

OFFER a very large assortment of TREES and PLANTS of all the best families. Nearly all of them have been two years transplanted, and their roots are thus in the very best possible condition for a second transplanting.

Some of their best specimens can now be seen at the CENTENNIAL GROUNDS, and they are able to furnish good plants of all the sorts there exhibited.

Their Catalogue of

## New and Rare Hardy Trees and Shrubs

is now READY, and will be sent on application. It contains some 65 varieties of NEW

### JAPANESE PLANTS,

including the remarkable JAPANESE MAPLES, and also a large number of new Hardy Plants from Europe. They think themselves safe in asserting that so rich a collection has not before been in this country.

CAMELLIA JAPONICA and AZALEA INDICA can be advantageously shipped during August, September, October and November. These plants are carefully formed and trimmed, and their symmetry is recognized by all who see them.

Rhododendrons and other hardy Evergreens can be safely transplanted in August and September.

*Estimates will be furnished for Planting Grounds under the care of an experienced Landscape Gardener, and much trouble thus saved to the owner.*

Catalogues will be furnished to applicants by mail, and those who wish to visit the Nurseries will always find either one of the proprietors, or J. R. Trumpy, the well-known propagator of the old establishment. They can take the ferries at 34th Street or James' Slip, which connect with the railroad, leaving the first a quarter of an hour, and the last half an hour before the departure of trains, which make the transit in half an hour. The Nursery is adjoining the Kissena Station and one and a half miles from the other stations, from which carriages are free sep

## Seeds of Florists' Flowers.

For the Conservatory & the Flower Garden, for Sowing in August & September.

Particular attention is invited to the following list of Seeds of Florists' Flowers, which have been carefully selected from the stocks of several of the most successful cultivators and exhibitors in Europe, and can be confidently recommended

	PER PKT.
<b>Balsam, Double White Camellia-Flowered</b> —For pot culture during winter, much used by florists for bouquets.....	\$0 25
<b>Calceolarias</b> —Extra select, from flowers which took the 1st prize at the late London and Continental Exhibition.....	50
<b>Calceolaria rugosa</b> —From the finest Shrubby varieties.....	50
<b>Cineraria</b> —Extra choice, from all the new varieties.....	50
<b>Cineraria new double-flowering</b> —This is unquestionably the finest novelty in the way of Florist Flowers for the greenhouse that has been sent out for many years; they represent all the modifications of color usually found among Cinerarias, namely, crimsons and magentas in various shades; purples, both light and dark, as well as flowers tipped with different tints of scarlet and magenta, and perfectly double; habit very good; will prove a most desirable acquisition. Pac-ets contains 20 seeds.....	1 50
<b>Cyclamen Persicum</b> —From the finest hybridized varieties.....	50
<b>Gloxinias</b> —The finest erect and drooping varieties.....	50
<b>Hollyhocks</b> —Very double saved from an unrivaled collection of 75 English varieties; if sown now, will flower freely next year, (100 seeds).....	25
<b>Pansy, English</b> —Extra select, saved from the finest prize flowers.....	50
— Finest mixed German varieties, very attractive, from one of the finest continental collections.....	25
— <b>New Fancy</b> —very beautiful.....	50
<b>Primula sinensis fimbriata</b> —(Chinese Primrose fringed) various colors mixed, extra.....	50
— (New fern-leaved varieties) very beautiful mixed varieties.....	50
— New double varieties, rose and white, each.....	1 00
<b>Pink, Tree or Perpetual Carnation</b> —Continues in flower a long time, extra quality, (20 seeds).....	50
<b>Pink, Carnation and Picotee</b> —Celebrated German collection, (20 seeds).....	50
<b>Polyanthus</b> —Finest mixed varieties from the collection of an English Amateur.....	25
<b>Stock</b> —Scarlet and white intermediate London, extra, each.....	25
— <b>East Lothian</b> —Superior for pot culture, scarlet, white and purple, each.....	25
— <b>New German Ten Weeks</b> —Extra fine, many colors mixed.....	25
— <b>New White Wallflower-leaved</b> —A superb variety for pot culture, pure white with large double flowers.....	25
<b>Sweet William, Hunt's New Auricula-flowered</b> —Far surpassing anything hitherto offered.....	25
<b>Tropæolum</b> —Finest mixed varieties, for Winter-flowering in greenhouse.....	25
<b>Wallflower</b> —Extra fine double German.....	25

☛ The entire Collection for \$9.

Collections of twenty varieties of HARDY ANNUALS, BIENNIALS and PERENNIALS, for Autumn sowing, \$1. If sown during the months of August and September, and protected during Winter by a covering of evergreen boughs, will bloom next year.

Catalogue of *Bulbous Roots for Autumn planting*, 44 pages, beautifully illustrated, mailed to applicants enclosing 10 cents. Address

## B. K. BLISS & SONS,

P. O. BOX No. 5712.

34 Barclay Street, New York.

OF THE  
**THE GARDENERS**  
And **MONTHLY**  
**HORTICULTURIST**

EDITED BY THOMAS MEEHAN.

Vol. XVIII. No. 213.  
(Combined Magazines, Thirty-first Year.)

**SEPTEMBER, 1876.**

PUBLISHED BY CHARLES H. MAROT  
814 Chestnut Street, Philadelphia.

TERMS—\$2.10 PER YEAR—POSTAGE PAID.

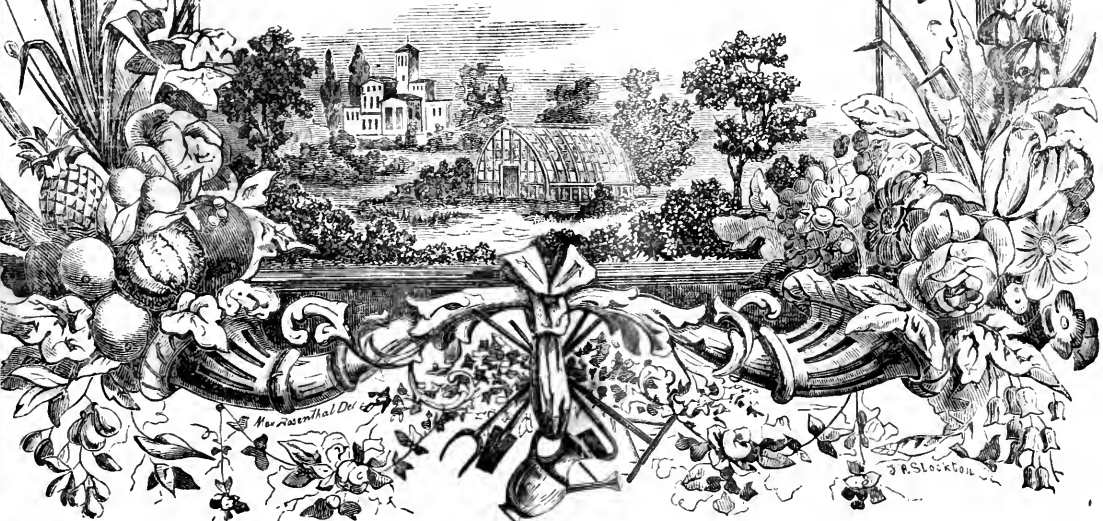

*Wm. H. Wood*

*J. R. Stockton*

# THE GARDENER'S MONTHLY AND HORTICULTURIST.

EDITED BY THOMAS MEEHAN,

Assisted by an able Corps of AMERICAN and FOREIGN CORRESPONDENTS.

It is published on the first of every month, at the office, No. 814 CHESTNUT STREET, PHILADELPHIA, where all BUSINESS communications should be addressed.  
Communications for the Editor should be addressed: THOMAS MEEHAN, GERMANTOWN, Philada.

SUBSCRIPTION PRICE, Postage paid, \$2.10.

## TERMS OF ADVERTISING.

	1/2 col.	1/4 col.	1/4 col.	1/2 col.	1/2 col.	1 col.	1 page.
One Time,	\$3.00	\$4.00	\$6.00	\$8.00	\$12.00	\$24.00	\$48.00
Two to Three Times, each,	2.70	3.60	5.40	7.20	10.80	21.60	43.20
Four to Six Times, "	2.25	3.00	4.50	6.00	9.00	18.00	36.00
Seven to Nine Times, "	2.00	2.70	4.00	5.35	8.00	16.00	32.00
Ten to Twelve "	1.80	2.40	3.60	4.80	7.20	14.40	18.80

Twelve lines nonpareil is 1/2 col. A less space than 1/4 col. will be furnished at rates in exact proportion, line for line.  
For THIRD and LAST COVER PAGES; FIRST PAGE advertisements facing reading matter; "FLY-LEAF PAGE" (front of number) before reading matter and facing first cover,—special figures will be given on application.  
COPY and orders for NEW advertisements should be in hand by the 25th of each month; and CHANGES of COPY in running contracts by the 16th of each month, to insure them in following issue. Address

CHAS. H. MAROT, Publisher, 814 Chestnut Street, Philadelphia.

## CONTENTS OF THE SEPTEMBER NUMBER.

### SEASONABLE HINTS:

Flower Garden and Pleasure Ground.....	257-263
Green House and House Gardening.....	263-268
Fruit and Vegetable Gardening.....	268-274

### CORRESPONDENCE:

Centennial Rhododendrons.....	258
Mr. Hovey's Arboretum Americanum.....	258
The Rhododendron and American Yew.....	259
Rhododendrons.....	279
Hardy Rhododendrons.....	261
Hardy Herbaceous Plants for July.....	261
Remedy for Verbena Rust.....	264
Pittosporum Tobira.....	264
Culture of Primula Sinensis.....	264
The Standard Currants and Gooseberries.....	269
Linseed Oil for Scale.....	271
Classification of Fruits.....	271
Prairie Flowers.....	274
General Observations on the Flora of Hokkaido....	275
Ring Forming Fungus.....	277
Trietelia Laxa.....	278
Eccentricity in Wood Growth.....	279
Notes upon the Grounds of Smith & Powell, Syracuse, N. Y.....	280
Observations in Northern Texas.....	282
Massachusetts Horticultural Society.....	284

after Flowering—Soft-wooded Greenhouse Plants....	265-266
Nectarine Produced from a Peach—Raspberry from Mr. Roe—The Amsden Peach—The Alexander Peach—Manure and Strawberry Insects—A Strawberry Grower at Boulder, Colorado.....	272-273
Seeding of the Trailing Arbutus—Mite Parasites of the Colorado Potato Beetle—The Bermuda Grass....	279-280
The Postal Laws as affecting Horticulture—Flower Thieves—Physalis edulis—The Lemon Verbena—Visitors to Kew Gardens—Landscape Gardening—Exchanges of Seeds and Plants—Colored Plates—The Florist and Pomologist.....	283-284
Horticulture at the Centennial—New York Horticultural Association—The Nurserymen and Tree Growers—Pomology at the Centennial.....	285-288

### NEW PLANTS:

Rudcea macrophylla—Pink Marechal Niel Rose—The New Double Flowering Ivy-leaved Pelargonium—Croton undulatus—Anthurium crystallinum.....	266-268
---	---------

### NEW FRUITS AND VEGETABLES:

Hame's Apple—Maryland Early Peach.....	273-274
--	---------

### NATURAL HISTORY AND SCIENCE.....

### LITERATURE, TRAVELS AND PERSONAL NOTES..

### HORTICULTURAL SOCIETIES.....

### QUERIES:

Protection of Tea Roses in Winter.....	268
Hybrid Ferns—Sun-ray Fuchsia.....	268
Freezing of the Sap of Plants—Populus Canescens, Ait—Western Tannin Plant.....	280
Corrections in the article on Curves.....	284

### EDITORIAL NOTES:

Public Adornments of Cities—The Rhododendron—Liatris pycnostachya.....	262-263
Bouquets of the Philadelphia Belles—Violets for Winter Blooming—Cut Flowers—Chrysanthemums	



ASK PRICES FOR

# SOLUBLE PACIFIC GUANO

FOR

## HORTICULTURE

OF

# AUGUST RÖLKER & SONS,

IMPORTERS AND DEALERS IN

## FLORISTS' SUPPLIES,

## 32 READE ST., NEW YORK.

This Guano contains *no ammonia to excess* in the condition of ready formed salts; but, containing it *only in its elements* and generating it gradually as the decomposition takes place after application, no injurious effect, only the *most beneficial results* are had on the tender fibres of plants, which advance in vigor by its use. It has *no equal fertilizer* for the cultivation of *Roses*.

Only when the roots are in working order and thoroughly established in the pot, commence watering with

*Soluble Pacific Guano for Horticulture*

as per directions on package of 2½ lb. and 25-lb. tin cans. By the ton it is shipped in barrels.

Our Fall Catalogue of Florists' Supplies is ready and will be mailed free to every applicant, sending his business card.

**RURAL AND PRACTICAL BOOKS,** (and any others in the market not on this list) will be sent by mail, post paid, on receipt of price. Address CHAS. H. MAROT, 814 Chestnut St., Philada.

Allen's, R. L., Diseases of Domestic Animals.....	\$1 00	How to Manage a Building Association.....	\$2 00
Allen's, L. F., Rural Architecture.....	1 60	How to Paint.....	1 00
Allen's, L. F., American Cattle.....	2 50	Hunter and Trapper.....	1 00
Allen's, R. L. & L. F., New American Farm Book.....	2 50	Hussman's Grapes and Wines.....	1 50
American Architect.....	7 00	Jacques' Manual of the House.....	1 50
American Bird Fancier, (Brown's).....	30	Jacques' Manual of the Garden.....	1 75
American Farmer's Encyclopedia.....	6 00	Jennings' Cattle Doctor.....	1 75
American Horticultural Annual, paper 50 Cts., cloth.....	75	Jennings on the Horse and his Diseases.....	1 75
American Weeds and Useful Plants.....	1 75	Jennings' Sheep, Swine and Poultry.....	1 75
Apple Culturist, S. E. Todd.....	1 50	Johnson's Gardener's Dictionary.....	3 50
Art of Saw Filing.....	75	Johnson's How Crops Feed.....	2 00
Architecture, Modern American, Cummings & Miller.....	10 00	Johnson's Hov Crops Grow.....	2 00
Principles and Practice of, By Loring & Jenning.....	12 00	Johnson's Peat and its uses.....	1 25
Baker's Fruit Culture.....	4 00	Johnston's Elements of Ag. Chemistry and Geology.....	1 50
Bassett on Cranberry Culture.....	30	Johnston's, J. S. W., Agricultural Chemistry.....	2 50
Berry's Fruit Garden.....	2 50	Kemp's Landscape Gardening.....	1 75
Bell's Carpentry made easy.....	5 00	Klippart's Farm Drainage.....	1 75
Bement's Poultryer's Companion.....	2 00	Langstroth, Rev. L. L., on the Hive and Honey Bee.....	2 00
Bement's Rabbit Fancier.....	30	Leichars' How to Build Hot-houses.....	1 50
Beet Root Sugar.....	1 50	Leibig's, Justus, Familiar Lectures on Chemistry.....	75
Bicknell's Village Builder, 77 plates.....	12 00	Louden's Encyclopedia of Plants.....	20 00
Bommer's Method of Making Manures.....	25	Lyman's Cotton-culture.....	1 50
Boussingault's, J. B., Rural Economy.....	1 60	McMahon's American Gardener.....	2 25
Browne's Trees of America.....	6 00	Mayhew's Practical Book-keeping for Farmers.....	80
Breck's New Book of Flowers.....	1 75	Mechanics' Companion (Nicholson).....	3 00
Bridgeman's American Gardener's Assistant.....	2 50	Mechan's Ornamental Trees.....	75
Bridgeman's Fruit Cultivator's Manual.....	1 00	Miles on the Horse's Foot.....	75
Bridgeman's Kitchen Gardener's Instructor.....	1 00	Miner's, T. B., Bee-keeper's Manual.....	1 25
Buisi's, Robert, Am. Flower Garden Directory.....	1 50	Mohr on the Grape-vine.....	1 00
Buisi's, Robert, Family Kitchen Gardener.....	1 00	Money in the Garden.....	1 50
Burr's Field and Garden Vegetables of America.....	5 00	My Vineyard at Lakewood.....	1 25
Carpenter and Joiner (R. Riddell).....	7 00	My Farm of Edgewood.....	1 75
Carpenter and Joiner's Hand Book, (Holly).....	75	My Ten-rod Farm.....	50
Chorlton's Grape Grower's Guide.....	75	North American Sylva, 5 vols., 156 col. plates, in 30 parts,	
Chemistry of the Farm, (Nichols).....	1 25	"    "    unbound.....	60 00
Cleveland's Villas and Cottages.....	4 00	"    "    Half Turkey Antique, gilt.....	70 00
Cobbett's American Gardener.....	75	"    "    full.....	75 00
Cole's, S. W., American Fruit Book.....	75	Nichol's Chemistry of the Farm and Sea.....	1 25
Cole's American Veterinarian.....	75	Norton's, John P., Elements of Scientific Agriculture.....	1 75
Cooper's Rural Hours.....	2 00	Norris' Fish-culture.....	1 75
Cop-land's Country Life.....	5 00	Onion-culture.....	20
Dadd's, Geo. H., American Cattle Doctor.....	1 50	Our Farm of Four Acres.....	1 25
Dadd's Modern Horse Doctor.....	1 50	Packard's Guide to the Study of Insects.....	6 00
Dand's, Samuel H., Muck Manual.....	1 25	Paul's Book of Roses.....	60
Darwin's Variations of Animals and Plants, (2 vols).....	6 00	Paul's Rose Garden.....	3 00
Darwin's Insectivorous Plants.....	7 00	Paxton's Botanical Dictionary.....	15 00
DeVoe's Market Assistant.....	2 50	Parlee on Strawberry-culture.....	75
Downing, A. J., Landscape Gardening.....	6 50	Parkman's Book of Roses.....	1 50
Downing's Cottage Residences.....	3 00	Parsons, Samuel B., on the Rose.....	1 50
Downing's Fruits and Fruit Trees of America.....	5 00	Peat and its Uses.....	1 25
Downing's Rural Essays.....	3 50	Pear-culture, Fields.....	1 25
Downing's Ladies' Companion to the Garden.....	2 00	Pedder's, James, Farmer's Land-measurer.....	60
Du Breuil's Vineyard Culture, (Dr. Warden).....	2 00	Percheron Horse.....	1 00
Eastwood on Cultivation of the Cranberry.....	75	Peterson's Preserving, Pickling and Canning Fruit.....	50
Elliott's Western Fruit Grower's Guide.....	1 50	Phin on Wine-making.....	1 50
Elliott's Lawn and Shade Trees.....	1 50	Quinn's Pear-culture for Profit.....	1 00
Elliott's Fruit Growers' Hand Book, paper, 60 cents, cloth.....	1 00	Quinby's Mysteries of Bee-keeping Explained.....	1 50
Farm Talk, (Brackett).....	1 00	Randall's Sheep Husbandry.....	1 50
Farming for Boys.....	1 50	Randall's Fine Wool Sheep Husbandry.....	1 00
Field's, Thomas W., Pear Culture.....	1 25	Rand's Bulbs.....	3 00
Five Acres too Much, (illustrated).....	1 50	Rand's Flowers for Parlor and Garden.....	3 00
Flagg's European Vineyards.....	1 50	Rand's Seventy-five Flowers.....	1 50
Flax Culture.....	50	Rand's Flower Garden.....	3 00
Flint, Chas. L., on Grasses.....	2 50	Rand's Orchard Culture.....	3 50
Flint's Milch Cows.....	2 50	Riddell's Architect.....	15 00
Fowler's Homes for All.....	1 50	Ropp's Commercial Calculator, cloth \$1, Morocco Tuck.....	2 00
Frank Forester's Fish and Fishing, 8 vo., 100 engravings.....	3 50	Rose Culturist.....	30
Frank Forester's Manual for Young Sportsmen, 8 vo.....	3 00	Robbins, R., Produce and Ready Reckoner.....	75
French's Farm Drainage.....	1 50	Saunders' Domestic Poultry, paper 40.....	75
Fuller's Grape Culturist.....	1 50	Saxton's Hand Books, in four series, each.....	1 50
Fuller's Small Fruit Culture.....	1 50	Schenck's Gardener's Text-book.....	75
Fuller's Strawberry Culturist.....	25	Scribner's Ready Reckoner and Log-book.....	30
Fuller's Forest Tree Culturist.....	1 50	Strong's Cultivation of the Grape.....	3 00
Fulton on Peach Culture.....	1 50	Ten Acres Enough.....	1 50
Geyelin's Poultry Breeding.....	1 25	Thomas, J. J., Farm Implements.....	1 50
Gray's How Plants Grow.....	1 25	Thomas, J. J., Fruit-culturist; old ed., \$3 00; new edition.....	3 75
Gray's Manual of Botany.....	2 25	Ville's Chemical Manures.....	1 25
Gray's Manual, Botany and Lessons, in one vol.....	4 00	Warder's American Pomology.....	3 00
Gray's School and Field Book of Botany.....	2 50	"    Hedges and Evergreens.....	1 50
Green on Trout Culture.....	1 00	"    Drainage for Profit and Health.....	1 50
Gregory on Squashes, paper.....	30	"    Elements of Agriculture.....	1 00
Guernon on Milch Cows.....	75	"    Earth Closets.....	50
Guide to Fortune.....	1 00	Webster's Dictionary, Unabridged.....	12 00
Harnzthy's Grape Culture and Wine Making.....	5 00	Well's Every Man his own Lawyer.....	2 00
Harris' Insects Injurious to Vegetation, clo. \$4; col. eng's.....	6 50	Williams, B. S., on Stove & Greenhouse Plants, 2 vols., ill'd.....	5 00
Harris on the Pig.....	1 50	Williams, B. S., on Select Ferns and Lycopods.....	2 50
Hatfield's American House Carpenter.....	3 50	Williams, B. S., Orchard Grower's Manual.....	2 50
Henderson's Practical Floriculture.....	1 50	Window Gardening.....	1 50
Henderson's Gardening for Pleasure.....	1 50	White's Gardening for the South.....	2 00
Henderson's Gardening for Profit.....	1 50	"    Cranberry Culture.....	1 25
Herbert's Hints to Horsekeepers.....	1 75	Wood's Class Book of Botany.....	3 50
Hoopes on Evergreens.....	3 00	Workingman's Way to Wealth.....	75
Hooper's Dog and Gun, paper 30 cents, cloth.....	60	Wright's Practical Poultry Keeper.....	2 00
Hop-culture.....	40	Youatt on the Horse.....	1 75
How to Buy a Farm, and Where to Find One.....	1 75	Youman's Household Science.....	2 00



**SEE FIRST PAGE, FACING COVER.**

# SPECIAL OFFER

TO

# FLORISTS, DEALERS,

AND

# BUYERS IN QUANTITY.

## WINTER FLOWERING PLANTS.

Pot grown and specially prepared. All fine, healthy plants graded in price according to size.

	PER 100.		PER 100
<b>Abutilon, Boule de Neige, white,</b>	\$8, \$16 and \$30	<b>Lygodium Scandens (new Japanese climbing Fern),</b>	\$8 and 15
<b>Begonias, all the leading winter-flowering sorts,</b>	6 and 10	<b>Smilax,</b>	6 and 10
<b>Bouvardias, 6 best winter-flowering sorts.</b>	\$6, 8 and 12	<b>Primula, double white,</b>	35 to 75
<b>Carnations, white,</b>	8 and 15	“ single, red, white, purple and spotted,	8 to 18
<b>Chrysanthemums, white and other varieties,</b>	4 and 12	“ semi-double, white,	16 and 25
<b>Eupatorium and Stevia, in variety,</b>	\$8, 12 and 20	<b>Roses, leading winter flowering sorts,</b>	12 to 25

Five plants of any variety will be sold at hundred rates, but not less than one hundred plants in one order.  
Our Wholesale List from which above is an extract, embraces many hundred varieties besides those named above.

## MIXED HYACINTHS, for Forcing or Bedding.

Ranging according to color from \$7.50 to \$8.50 per 100, extra fine bulbs.

	PER 100		PER 100
<b>Lily of the Valley, in large clumps,</b>	\$40	<b>LILIIUM CANDIDUM, extra large bulbs,</b>	\$14
“ “ in single crowns,	3	“ Longiflorum, “ “ “	12

## FLOWER SEEDS, for present Sowing.

	PER PKT.		PER PKT.
<b>Verbena, saved from our own collection, \$5 per oz.,</b>	15c.	<b>Apple Geranium, scented, seed of 1876,</b>	30c.
<b>Petunia, finest striped and blotched, \$5 per oz.,</b>	15c.	<b>Double Cineraria,</b>	75c.
“ double,	30c.	<b>Primula sinensis fimbriata, double red and white,</b>	75c.
<b>Lygodium Scandens, (Japanese Climbing Fern)</b>	30c.	“ “ “ single “ “ “	30c.

## VEGETABLE SEEDS, for Fall Sowing.

<b>Cabbage, Jersey Wakefield, (true) 75c. per oz. \$2 per ¼ lb.</b>	<b>Cauliflower, Extra Early Dwarf Erfurt, \$2 per oz. \$7 per ¼ lb., \$24 per lb.</b>
\$6 per lb.	<b>Cauliflower, Early Paris, 75c. per oz., \$2.50 per ¼ lb., \$9 per lb.</b>
<b>Cabbage, Early York, 40c. per ¼ lb., \$1.25 per lb.</b>	<b>Lettuce, Curled Simpson, 60c. per ¼ lb., \$2 per lb.</b>
“ <b>Early Flat Dutch (true L. Island) 75c. per oz., \$2 per ¼ lb., \$6 per lb.</b>	“ <b>Curled Silesia, 30c. per ¼ lb., \$1 per lb.</b>
<b>Cabbage, Early Summer, (new), see special list of testimonials,—\$1.50 per oz., \$5 per ¼ lb., \$16 per lb.</b>	“ <b>Boston Market (for forcing) 60c. per ¼ lb., \$2 per lb.</b>
	<b>Spinach, Round and Prickly, 10c. per ¼ lb., 25c. per lb.</b>

## FLORISTS' REQUISITES.

Embracing **BOUQUET PAPERS, WILLOW and RUSTIC BASKETS, GRASS BOUQUETS and IMMORTELES, POT COVERS, WARDIAN CASES, WIRE DESIGNS for CUT FLOWERS** (embracing 30 different patterns), all of which will be sold at lowest wholesale rates.

Our **MONTHLY LIST**, descriptive of above, together with all other articles wanted by Florists and Gardeners, will be mailed **FREE** on application. To our regular customers it will be mailed monthly as usual.

*Peter Henderson & Co.*

**SEEDSMEN, MARKET GARDENERS AND FLORISTS,**

**35 CORTLANDT ST., NEW YORK.**

# 50,000 IRISH JUNIPERS, FROM 1 TO 5 FEET.

We can sell them cheaper than any establishment in the United States.  
Send for Price List.

**TRUETT'S SONS & MORGAN,**  
ROSEBANK NURSERIES,  
taug5 Nashville, Tenn.



## BULBOUS FLOWER ROOTS,

Superb Double and Single  
HYACINTHS,

Tulips, Crocus, Jonquils, Narcissus Lilies  
Crown Imperials, Snow Drops, Iris, Lily  
of the Valley, Ranunculus, Anemones,  
and other Flower Roots for planting in  
the autumn.

Extra Large and Sound Bulbs,

Received by direct importation, selected  
expressly for my sales. Also, Plants for Winter Blooming, for  
the Window, Garden and Conservatory. Prices moderate. Send  
for my New Illustrated Catalogue, which will be mailed to all  
applicants.

HENRY A. DREER,

714 Chestnut Street, Philadelphia.

## IMPORTED DUTCH BULBS

Our NEW DESCRIPTIVE PRICED  
CATALOGUE of the above  
is ready for mailing.

**J. M. THORBURN & CO.,**  
15 JOHN STREET, NEW YORK.

sep2

## STANDARD PEARS.

We offer for fall the finest lot of 2 and 3 years **STANDARD PEARS** in the country. A large assortment of new and standard varieties, among them are

50,000 BARTLETTS,  
40,000 CLAPP'S FAVORITE,  
30,000 FLEMISH BEAUTY,  
20,000 BEU. D'ANJOU,  
15,000 SHELDON.

Also APPLES, CHERRIES, PLUMS, DWARF PEARS,  
PEACHES, ORANGE QUINCES, and other Nursery  
Stock.

**RICHARDSON & NICHOLAS,**  
july4 GENEVA, N. Y.

## BRIDGEMAN'S

878 BROADWAY, N. Y.

## LYNCH & KELLY.

CELERY PLANTS { \$5.00 per 1000.  
75c. per 100.

CAULIFLOWER PLANTS { \$8 per 1000.  
\$1 per 100.

CABBAGE PLANTS, of the best { \$3 per 1000  
varieties { 40c. per 100

Cash, or good city reference with each order, required.

Address,

**LYNCH & KELLY,**

878 Broadway, N. Y., or Astoria, Long Island City.

aug2

## NEW PLANTS--TO THE TRADE.

NEW DOUBLE WHITE DAISY.

The largest and finest white daisy yet offered, flowers perfectly double. 50c. each.

NEW VARIEGATED LANTANA.

Best variegated bedding plant to stand the sun. Very free blooming 60c. each. \$5 00 per doz., free by mail.

**W. A. HARKETT,**

feb10

DUBUQUE, IOWA.

## HYACINTHS,

## Tulips, Crocuses

AND OTHER

## DUTCH BULBS,

Now ready for Delivery.

CONVALLARIAS, MAJALIS,

ROMAN HYACINTHS,

FRESH PEAR SEEDS,

STANDARD ROSES,

&c., &c., TO ARRIVE.

FOR SALE BY

**C. RAOUX,**

jantf

76 Park Place,

NEW YORK CITY.

Box 2956.

NEVADA MAMMOTH RYE.

The greatest wonder at the Centennial Exposition, producing 75 bushels to the acre, making bread equal to the best wheat; now for the first time offered for sale. 1 lb. 50c., 2½ lbs. \$1.00, 10 lbs. \$3.00, 100 lbs. \$25.00.

Address **C. B. ROGERS,**  
133 Market Street, Phila.

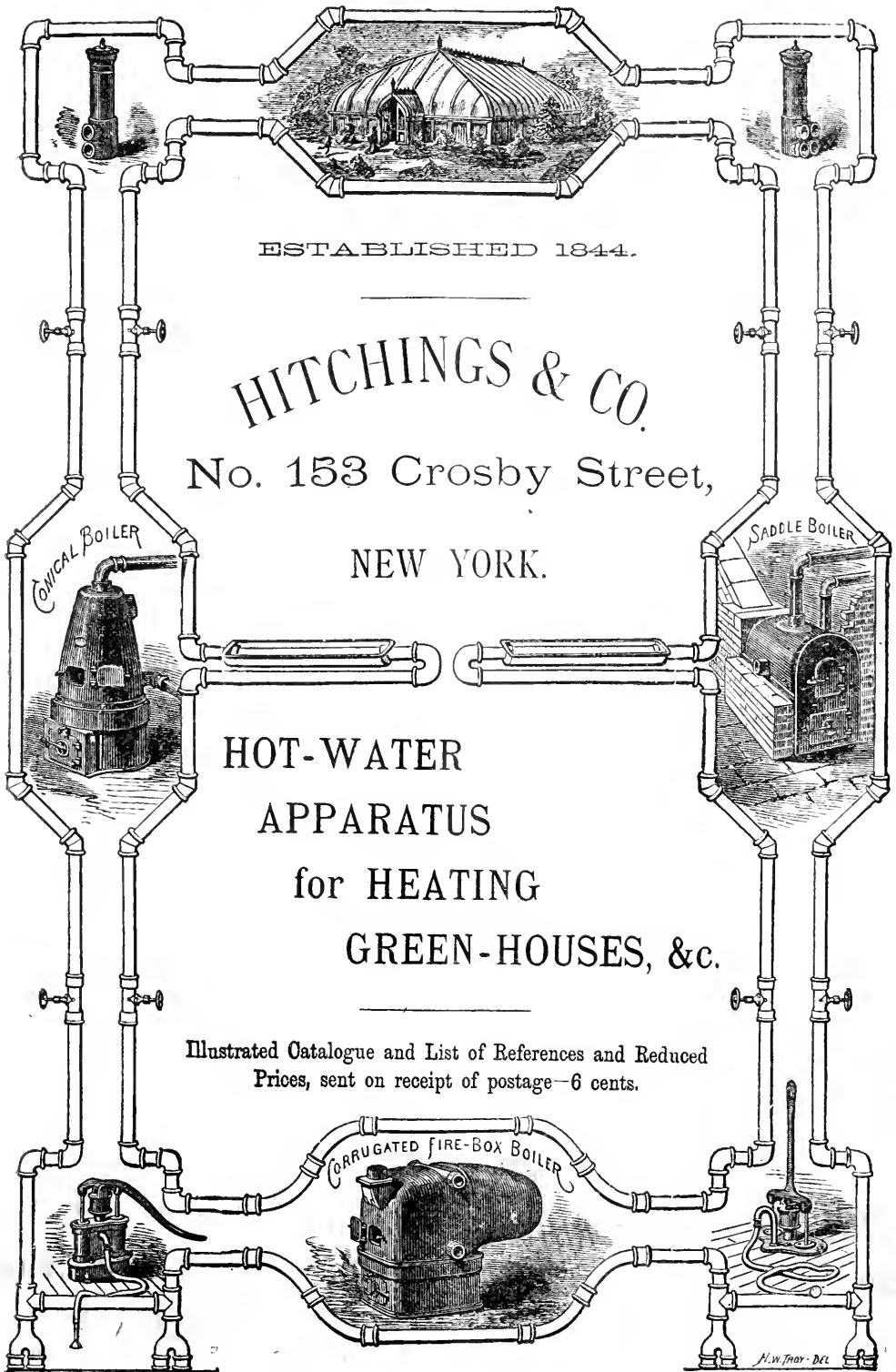

ESTABLISHED 1844.

HITCHINGS & CO.

No. 153 Crosby Street,  
NEW YORK.

HOT-WATER  
APPARATUS  
for HEATING  
GREEN-HOUSES, &c.

Illustrated Catalogue and List of References and Reduced  
Prices, sent on receipt of postage—6 cents.

H. W. TRAY - DEL.

# APPLE TREES

100,000 very fine, well grown, thrifty Apple Trees, comprising all the leading varieties: **Cheap.**  
Send for New Trade List.

**HOOPES, BRO. & THOMAS,**

Cherry Hill Nurseries. sep6 West Chester, Pa.

# Lily Longiflorum.

Being obliged to move a lot of the above this fall, I would like to dispose of a quantity at a low rate.

I will sell blooming size for \$8 per 100; next size, \$4 per 100. \$30 per 1,000. Smaller, but perfect bulbs, \$2 per 100, \$15 per 1,000.

Bulbs will be sent C. O. D., if it is desired, but there will be no deviation from the prices given, which includes Boxes, Packing, and delivery to the express office.

The Bulbs will be ripe enough to move by the 1st of October. I will send by mail, postage prepaid, samples of each size to any one who sends me 20 cents for that purpose.

**W. W. COOK,**

sept Worcester, Mass.

# TREES, TREES,

A full and fine stock of **STANDARD PEARS, DWARF PEARS, CHERRIES, APPLES, PEACHES, ORNAMENTAL TREES, SMALL FRUITS, &c.**, at low rates.

Address,

**RICHARDSON & KELSEY,**  
**GENEVA,**

sept New York.

# DUTCH FLOWER ROOTS

Our New Catalogue of the finest kinds of **HYACINTHS, TULIPS, LILIES, NARCISSUS, CROCUS,** and a great variety of other desirable Flowering Bulbs, for the house or garden, with practical directions for culture, sent free to all on application.

**HOVEY & CO.,**

sep3. 53 North Market St., Boston, Mass.

# DEGRAW CARNATIONS.

**FINE LARGE PLANTS** for Winter blooming, very cheap by the 100 or 1,000. Also fine lot of **LAWSON'S CYPRESS** and **HARDY ROSES** that *must* be sold

**H. W. HALES,**  
Spring Avenue Gardens,  
Ridgewood, N. J.

sept

# APRICOTS & NECTARINES

One year 3 to 5 feet and 2 to 3 feet, in large quantities. **Very Cheap.**

Send for new Trade List.

**HOOPES, BRO. & THOMAS,**

Cherry Hill Nurseries. sep2 West Chester, Pa.

# BUDS.

We offer the following buds of **PEACH TREES, &c.**, by mail postage free, at prices affixed:

**BILYEU'S LATE OCTOBER** (Bilyeu's Comet),  
**BRANDYWINE** (Peters' Seedling No. 1.),  
**LEATHERBURY'S LATE, TUCKAHOE LATE,**  
\$1.50 per 100; \$10.00 per 1000.

**AMSDEN'S JUNE, ALEXANDER'S EARLY,**  
**STEADLY, NANTICOKE,**

**PETERS' SEEDLING NO. 2.,**

**SHIPLEY'S LATE RED,**

**WILKINS' (Ringgold Mammoth Cling),**

**NEWINGTON FREE,**

**GEARY'S HOLD ON, OAKLAND,**

and fifteen other new varieties, \$1 per 100; \$5 per 1000. Standard varieties, including forty kinds, 75c per 100; \$3 per 1000. **APRICOTS** and **NECTARINES** 75c per 100; \$5 per 1000.

**A. HANCE & SON,**

aug2 Nurserymen and Florists, Red Bank, N. J.

# NURSERY STOCK

FOR FALL 1876.

Apple Trees, 5 to 8 feet.

Crab Apple, largely Hyslop, 6 to 7 and 7 to 8 feet, very fine.

Cherry, 1 year, on Mazzard stock, very fine.

Cherry, 2 years, on Mahaleb stock, very fine.

Peach, 1st and 2d class.

Silver Maple, extra fine, all sizes to 12 feet.

Sugar and Norway Maple, 8 to 10 feet, fine.

Horse Chestnut, 4 to 6 feet.

Norway Spruce and Balsam Fir, 2 to 4 feet, fine and stocky.

Scotch and Austrian Pine, 4 to 6 feet, fine.

Irish Juniper, very fine, all sizes 1½ to 6 feet.

Swedish Juniper, very fine, 2 feet.

American Arborvite, 3 to 6 feet, fine.

Siberian and Globe Arborvite, very fine specimens.

Honey Locust, 2 years; **Osage Orange**, 1 year.

Currant and Gooseberry, 2 years, transplanted.

Tamarix, Deutzia, Forsythia and Weigela.

Some of the above must be moved and will be sold low.

**H. M. ENGLE & SON,**

aug2 Marietta, Pa.

# FARMERS!

# \$16 FORGES,

FOR YOUR FARMS!

ALSO, A COMPLETE "KIT OF TOOLS."

Just what is wanted. Send three-cent stamp for circular to  
**EMPIRE PORTABLE FORGE CO., Troy, N. Y.**

**N. STEFFEN'S WIRE WORKS,**

335 E. 21st St. New York.

Manufacturer of all designs for **FLORISTS**. Wreaths, Crosses, Crowns, Hearts, Anchors, Pillars, Columns, Monuments, Bells, Composure, Faith, Hope and Charity, Harps and Lyres, &c. Leaning and Upright

Send for Price List.

jan 12.

WHOLESALE TRADE LISTS

OF

# Dutch Bulbs & Flower Roots

Franco and gratis on application.

**A. M. C. JONGKINDT CONINCK,**

sep.1

Tottenham Nurseries,

Dedemsvaart, near Zwolle, Netherlands.

# LARCHES, EVERGREENS!

LARGEST STOCK IN AMERICA.

BOTH SEEDLINGS AND TRANSPLANTED TREES.

All grown from seed on our own grounds, and better and cheaper than imported stock.

EUROPEAN LARCH AND EVERGREEN TREE SEEDS,

by the ounce, pound and ten pounds. Send for Catalogue.

ROBERT DOUGLAS & SONS,

Waukegan, Ill.

tsppg

# JOHN DICK'S PATENT BOILER

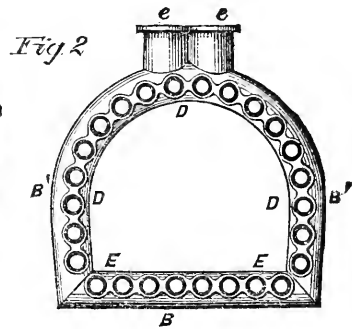
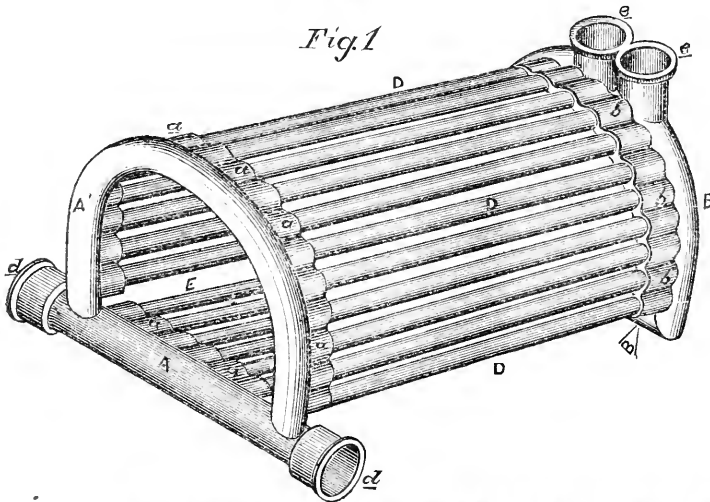

**Economy, Simplicity and Durability.**

SEND FOR CIRCULAR.

**J. DICK, Florist,**

*53d & Darby Road, Philadelphia, Penna.*

sep6

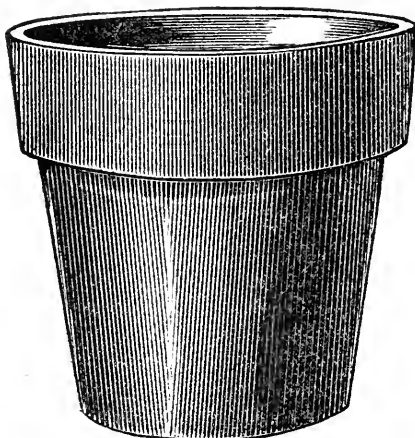

## FLOWER POTS BY THE MILLION!

The BEST, CHEAPEST and MOST DURABLE FLOWER POTS in the MARKET.

Also a full line of

Vases, Fancy Flower Pots, Hanging Baskets, &c.,

At the

NEW BRIGHTON

Flower Pot and Terra-Cotta

WORKS.

Illustrated Catalogue on application.

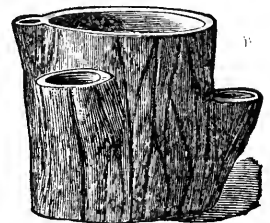

sep3

Address,

**ELVERSON & SHERWOOD, New Brighton, Pa.**

**SEASON OF 1876.**

WM. KILPATRICK,  
Landscape Gardener and Florist,  
COLLEGEVILLE, 23d WARD, PHILADA.

Begs to offer to  
**TO THE TRADE.**

the following list of  
**ORNAMENTAL PLANTS.**

Begonia Rex, B. Lewis Schwitter B Gem, B. nabilosa, B. Zebra, B. Sir Colin Campbell, B. Marshall.

**Flowering Begonias**—Glaucophylla scandens, Weltonensis, Hybrid multiflora, Fuchsoides, Sandersonii, Argyrostigma, picta, alba.

**Ferns of Good Habit**—Pteris argyrea, P. tricolor, P. tremula, Adiantum assimile, A. diaphanum.

Also a good assortment of **Lycopodiums and Selaginellas, Ornamental Grasses, &c.**

ts-pl

**NOTICE.**

Owing to the unprecedented dull times, I beg leave to make the following liberal offer: 50 Greenhouse plants for \$5 00, packing included, and containing numerous new plants of this season's introduction. Florists will find them very desirable for stock, and Amateurs will find them equally useful for greenhouse or room culture. If purchasers will send me the names of those they possess I shall send them entirely distinct sorts. Any plants not wanted I can send something of same value. One each of the following: Fuchsia procumbens, Nertera depressa, Verbena Little Giant, Abutilon Boule de Niece, Double White Achillea, Adiantum, Azalea, Calla, Chorizema varia, Large Fruit Lem on, New Coleus, Cypridium insigne, Cuphea hysopifolia, Dichroandra unguata, Croton, Dracaena, Echeveria, Eupatorium, Fittonia, Heliotrop: Juliette, Inja pulchella, Kleinia repens, Lantana, Double White Lychnis, Lycopodium, Maranta, Smilax, New Double White Oleander, Passion flower, Pteris Argylea, Retinaspora plumosa aurea, Fairy Rose, Yucca recurva, Cactus, Sanchezia, Iris Iberica, Rhynchospermum Jas. var. Barbara, Bouvardia, Double Ivy Leaf Geranium, 2 Hydrangea Otaksa, 4 distinct Geraniums, 2 Begonias, 3 Ferns assorted.

For 50 cents extra will be added a plant of Ficus Parvelli, new; the prettiest variegated plant introduced for years. Hydrangea Otaksa, trusses 2 1/2 inches in diameter. Good plants for propagation, \$2 per dozen. Prepaid by mail if desired. Pteris Argylea \$10 per 100.

Nertera depressa spreads over the surface like moss and covered with scarlet berries, resembling coral beads, \$1 50 per dozen.

Bronze Geranium, Earl Rosslyn, \$2 50 per doz. n. Sonerila Margaritacea, beautiful, 50 cents each. 3 distinct Marantas for \$1.

**WANTED.**

Plants of the following of any size in exchange for new and rare plants. "See Catalogue, mailed on application." Alocasia Sedenii, Metallica, Lowii, Zebra, Ananassa sativa var., Anthurium, Schezerianum; Maranta Veitchii; Aralia reticulata and Veitchii; Cephalotus follicularis; Lasiandra Macrautha floribunda; Nepenthes in sorts; Pavetta Borbonica, Terminia elegans, Adiantum Excisum multifidum, Hendersonii, Veitchii; Caladium, Princess of Teck, Yucca quadricolor and filamentosa var.

**GEORGE FOUST,**

2825 Frankford Ave., Phila.

sep2

**20,000 AGENTS WANTED!**

TO CANVASS FOR

**400 PAPERS** and MAGAZINES, which are furnished at Club Rates for single copies. Book and other agents can act without interfering with present business. Good pay, easy work.

sep4 **C. W. BENNETT, Gen'l Agent, Quincy, Mich.**

**Irish Junipers**

AND

**SIBERIAN ARBORVITÆ.**

All sizes at greatly reduced prices.

Send for New Trade List.

**HOOPES, BRO. & THOMAS,**

Cherry Hill Nurseries.

sep2

West Chester, Pa.

**R. LYNEX,**

Rear of 428 Walnut Street, Philada.

Manufacturer of Plain and Fancy Wire-work, for Florists; Wreaths, Crosses, Stars, Crowns, Hearts, Anchors, Birds, Lambs, Gipsy Baskets, Hanging Baskets, Flower Stands, &c.

SEND FOR PRICE LIST.

aug6

**DUTCH FLOWER-ROOTS AND BULBS,**

Cultivated and sold by

**M. C. ALKEMADE & SON,**

at

**Noordwijk-Binnen, near Haarlem, Holland.**

Catalogue for 1876 will be forwarded post-free on application.

sep1

**TREES, TREES, TREES!**

Standard Pears and Standard Apples in large quantities; also Plum, Cherry, Peach, Dwarf Trees, Orange Quince, Grape Vines, Small Fruits, and Ornamental Trees and Shrubs.

Stock for the coming season extra nice and thrifty.

For TRADE LIST, which will be out by the middle of August, or special inquiry, address,

**PEIRSON & DEY,**

(Successors to E. C. Peirson)

Maple Grove Nurseries,

aug2

**WATERLOO, N. Y.**

**HONEYWELL,**

THE EARLIEST OF PEACHES.

**A. HANCE & SON,**

aug1f Nurserymen and Florists, Red Bank, N. J.

**CAMELLIAS.**

A fine stock of the above, different sizes, mostly Double White, well set with buds.

**R. SCOTT,**

755 South 19th St.,

aug3

**PHILA.**

**100 BARRELS RED OAK ACORNS.**

Also Seeds of White Pine, Pitch Pine, Sugar Maple, Scarlet Maple, White Birch, Poplar-Leaved Birch, Yellow Birch, Hemlock Spruce, White Ash, Brown Ash, Juniperus Prostrata, &c., will be offered for sale this fall by

**JAMES D. MAHONEY,**

Fisherville, N. H., or Saco, Me.

Orders, to ensure fulfillment must be sent in before time for collections.

aug2

**CARTHAGE PEACH NURSERY.**

Amsden Peach a specialty. The Amsden is the earliest, and best early peach in the world, being 8 to 10 days earlier than Beatrice, nearly twice as large, and of better quality. For full history and price of buds and trees, address, **JOHN WAMPLER,**

aug2

Carthage, Mo., or Trotwood, Ohio.

**LONDON GARDENER'S CHRONICLE**

Will be furnished, post-paid, direct to subscribers in the U. S. for \$7 50 per year. Specimen Nos. 3 cent stamp. Apply to

nov1f

**CHAS. H. MAROT, Agent, 814 Chestnut St., Phila.**



# JORDAN'S PATENT WATER AND STEAM SADDLE BOILER.

Constructed of Horizontal Pipes of the same inside diameter as those that form flow and return pipes, thereby producing a very rapid circulation of the water.

### DESCRIPTION.

Cut shows a side view of one-half section, with U steam propeller. Also shows section of chimney, ash-pit and brick arch around the boiler, with downward draft to chimney.

LENGTH, SEVEN FEET.

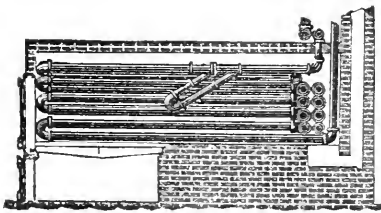

### PRICES OF BOILERS, WITH IRON FRONT.

No. 1, to heat 500 to 750 feet of 4-inch pipe.....	\$ 75.
No. 2, to heat 750 to 1000 feet of 4-inch pipe.....	100.
No. 3, to heat 1000 to 1500 feet of 4-inch pipe.....	125.
No. 4, to heat 1500 to 2000 feet of 4-inch pipe.....	175.
No. 5, to heat 2000 to 3000 feet of 4-inch pipe.....	225.
No. 6, to heat 3000 to 5000 feet of 4-inch pipe.....	300.

SMALL BOILERS TO ORDER, \$30 TO \$50.

J. M. JORDAN & BRO.,  
612 Olive Street. St. Louis, Mo.

SURPLUS STOCK FOR SEPTEMBER, 1876.

FROM

## JORDAN HORTICULTURAL CO'S, ST. LOUIS, MO.

		PER DOZ.	PER 100.			PER DOZ.	PER 100
Alocasias, assorted varieties, \$1.00 to 10 00.				Ferns 3-in. pots, in varieties .....		\$1.50	\$10.00
“ 4-in. pot .....	\$3.00			“ 4 “ “ “ .....		2.00	15.00
“ 6 “ .....	6.00			“ Large plants in varieties, \$2.00 to \$25.00 each.....			
“ 10 “ .....	20.00			Palms, 50 cts. to \$50.00 each.....			
“ Large plants, \$5.00 to \$10.00 each.....				Primroses M. white, 3-in. pots.....	3.00		
Begonias, Rex varieties, 4 in. pot.....	3.00	\$20.00		“ “ “ 4 “ .....	4.00		
“ Flowering varieties, 3-in. pot.....	1.50	12.00		“ “ “ 5 “ .....	5.00		
Caladiums, choice variegated varieties, our selection.....				“ “ “ fine Seedly 2-in. pot.....	75		
“ “ “ “ “ “ .....	2.00	15.00		“ “ “ “ 4 “ .....	1.50		
Caladiums 3-inch pot.....	6.00			Hydrangeas, 4 to 6-in. pots.....	4.00		
“ “ “ “ “ Show plants.....	1.50			Ivies, English and others, 2 in. pots.....	75	6.00	
Callas, 3 inch pots.....	3.00			“ “ “ “ 3 “ .....	1.00	8.00	
“ 5 “ “ “ .....	4.00			“ “ “ “ 4 “ .....	1.25	10.00	
“ 6 and 7-inch pots .....	2.00			“ “ “ “ Large plant.....	3.00		
Dracena Terminalis, 10 inches high.....	4.00			Roses, 25,000 fine everblooming.....	1.50	10.00	
“ “ 15 “ “ .....	4.00			“ 3-in. pots, fine everblooming.....	2.00	15.00	
“ “ 20 “ “ .....	5.00			“ 4 “ “ “ .....	3.00	20.00	
“ “ 24 “ “ .....	6.00			“ 5 to 6-in. pots, fine heads.....			6.00
Ferns 10,000 fine plants.....	75	6.00		Smilax, one year plant, fine.....			
“ 2-in. pots, in varieties.....							

J. M. JORDAN, President.

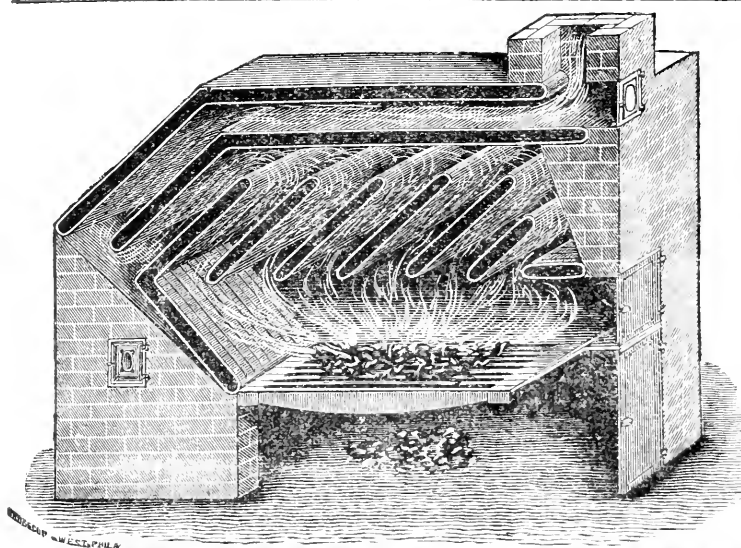

THOMAS J. MYERS,  
PATENT BOILERS

AND

Hot Water Apparatus

FOR HEATING

Greenhouses,  
Hot-Houses,  
Conservatories, &c.

THOMAS J. MYERS & SON,

1162 Passyunk Ave.,

PHILADELPHIA.

2, 4, 6 & 8 Home Street, Cin-  
cinnati, O.

Please send for Descriptive Cir-  
cular and Price List. [tjuneff

# GRAPE VINES.

Also GRAPE WOOD and CUTTINGS. LARGEST STOCK IN AMERICA.

All leading varieties in large supply. Extra Quality. True to name. Special rates to Agents, Dealers and Nurserymen. Our list of customers now embraces nearly all the leading nurserymen in the country, to whom we would refer those not acquainted with our stock. Descriptive Catalogue and Price List Free. T. S. HUBBARD, Fredonia, N. Y. aug10

## AN ARBORETUM AT THE CENTENNIAL.

Visitors to the CENTENNIAL EXHIBITION are invited to examine the ARBORETUM planted on the Horticultural Grounds by

THOMAS MEEHAN, Nurseryman,  
GERMANTOWN, PHILA.

The collection embraces nearly EIGHT HUNDRED Species or well marked varieties, all named for the information of Visi-  
tors, and is believed to be one of the most complete collections of hardy vigorous plants ever got together in this latitude. may5

M. M. BAYERSDORFER & CO.,

Importers of Every description of

BOUQUET PAPERS.

Plain White Satin for Bridal Bouquets. Fancy Lace for Weddings, Receptions, Parties. Italiens, Pasted Cartons, Immortelles in great varieties; Green Moss, French Dried Grasses and Flowers. Tin Foil. Prize Medal of Cincinnati Industrial Exposition of 1873 awarded to us for the best display of Bouquet Papers. Illustrated Catalogue furnished on application.

feb

56 N. Fourth St., Philadelphia, Pa.

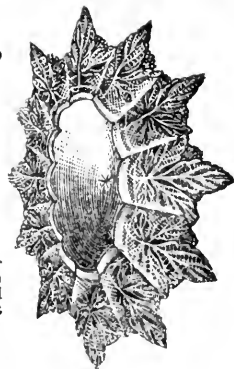
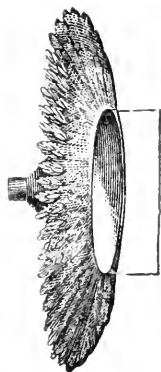

**ELLIS' BASE BURNING BOILER.** FOR WARMING Dwellings, Greenhouses, Graperies, Forcing Pits, Drying Rooms Heating Water for Public Baths, Baptisteries, &c., by Hot Water or by Steam.

Estimates and Circulars furnished. t.sep.12. 182 CENTRE STREET, NEW YORK.

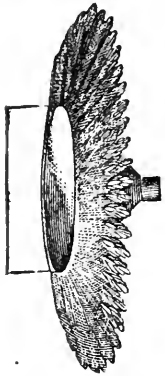

ROWLAND WHITMAN.

HARRY LANG.

**WHITMAN & LANG,**

IMPORTERS OF

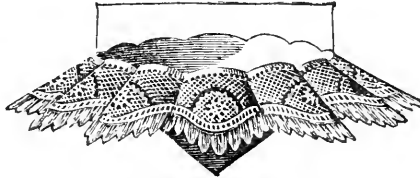

DRIED FLOWERS, IMMORTELES, TIN FOIL &c.

augf. No. 126 N. 4th St., Philadelphia.

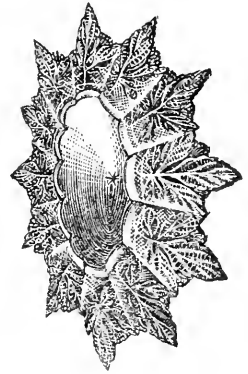

FANCY GRASSES

**GERMANTOWN NURSERIES, PHILADELPHIA.**

GORGAS LANE STATION, CHESTNUT HILL RAILROAD. Less than One Hour from the Centre of Philadelphia.

Those who desire to purchase largely, either for their own planting or to sell again, are invited to examine the extensive stock of

**FRUIT, SHADE AND ORNAMENTAL TREES AND SHRUBS,**

Grown at the Germantown Nurseries. And those who need but A FEW ARTICLES, will find all ages and sizes to select from.

A special feature of the business, is the raising of

Nursery Stock and Seedling Forest Trees

FOR DISTANT SHIPMENT. Many of these can be supplied by the millions at very low rates. Address, for CATALOGUES or information,

**THOMAS MEEHAN, Germantown Nurseries, Phila.**

**THE CENTENNIAL. TREE AND SHRUB SEEDS.**

Visitors to the CENTENNIAL are invited to examine the collection of Tree Seeds, comprising over

**THREE HUNDRED KINDS**

of species, hardy in the greater part of the United States, and on exhibition in the AGRICULTURAL HALL, (At G 16) by

**THOMAS MEEHAN,**

**COLLECTOR AND DEALER IN TREE SEEDS,**

may5

**GERMANTOWN, PHILA.**

**THE OFFICIAL GUIDE BOOK TO PHILADELPHIA AND CENTENNIAL EXHIBITION.**

By THOMPSON WESTCOTT.

Author of the History of Philadelphia. The only full and complete Guide Book. Illustrated with two maps and 93 engravings. 425 pages, 16mo, Cloth, \$1.50; Morocco, \$2.00. Mailed, post-paid, on receipt of price.

Address, CHAS. H. MAROT, 814 Chestnut St., Phila.

Visitors Guide to the

**Centennial and Philadelphia.**

Only authorized Guide Book on Centennial Grounds. Map of Centennial Grounds, Map of Philadelphia, 48 pages, 12mo, mailed for 30 cents. Address,

CHAS. H. MAROT, 814 Chestnut St., Phila.

# WHEELER'S INSECT ANNIHILATOR, LIQUID DISTRIBUTOR

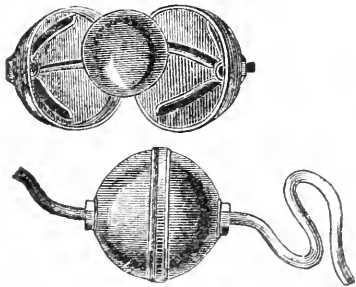

Compound Liquid Hose Distributor.  
Price \$5.00.

AND  
INSECTICIDES.

Patented July 20, 1875.

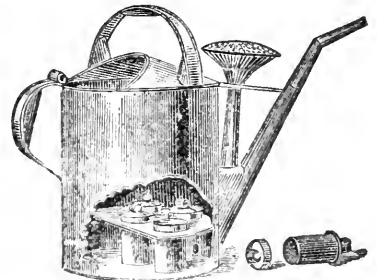

Compound Liquid Watering Pot,  
Average size, \$6.00.

These devices attached to hose pipe of aqueduct or force pump, and operated by water under pressure, and the Watering Pot constructed under the same patent, are the best ever yet used for destroying insects (Potato Bug and Currant Worm not excepted) on plants under glass or in open air, or for fertilizing the same. Fumigation unnecessary. Compound of Tobacco, Sulphur, Guano, in 5 lb. Boxes, 15c. per lb.; of Paris Green and Hellebore, 30c. per lb.

## INSECT ANNIHILATOR & FERTILIZER DISTRIBUTOR



is operated by horse for field use, distributing any desired liquid compound in rows broadcast, or on trees. It is also a powerful Fire Engine, throwing an inch stream from 50 to 75 feet.

PRICE \$200.

## Liquid Fertilizer Distributor

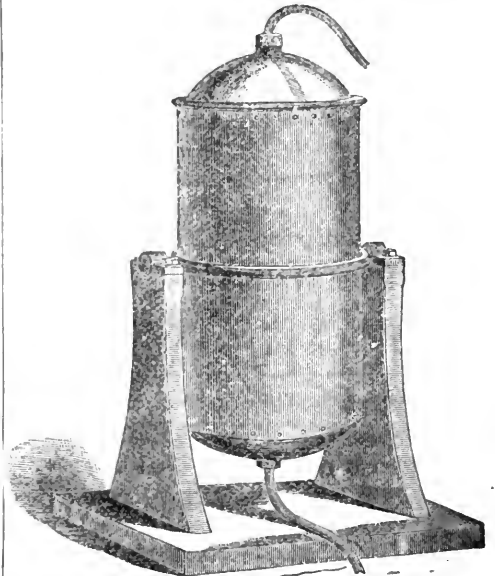

To reduce solid manures, coarse or fine to liquid form, and distribute the same under pressure through hose pipe.

PRICE \$50.

These Machines and Insecticides are on exhibit at the Centennial Exposition, and can be seen in practical operation on the grounds. Above goods delivered C. O. D. Highest testimonials with descriptive circular sent on application.

July 1st.

W. F. WHEELER, 24th Ward, Boston, Mass.

# CHERRIES.

Largely of Early Richmond, with a good assortment of Hearts and Bigarreaus.  
Send for new Trade List.

HOOPES, BRO. & THOMAS,

Cherry Hill Nurseries. sep2 West Chester, Pa.

13th Year---300 Acres---10 Greenhouses.

## FLORISTS AND NURSERYMEN,

Don't fail to see our trade list prior to purchasing. Prices DOWN, DOWN, DOWN!

The largest stock in the west of

CARNATIONS, ROSES, STEVIA EUPATORIUM,  
SMILAX. BOUVARDIAS,

and all other Winter Blooming Plants.

MILLIONS of Apple Seedlings, Honey Locust and  
Osage Orange.

An immense stock of FRUIT TREES,

SMALL FRUITS AND ORNAMENTALS.

SPECIAL INDUCEMENTS in the way of freight for Southern and extreme WESTERN TRADE. Correspondence in French and German.

Lists free. Address,

sep2 ENNIS & PATTON, Clinton, Iowa.

## SPECIAL NOTICE.

In order to reduce my immense stock, I shall offer for the Fall and Spring trade, in addition to my usually full assortment of older nursery stock, the following

ONE YEAR OLD TREES,

100,000 STANDARD PEAR,

25,000 PLUM, ON PLUM STOCKS,

25,000 DWARF PEAR,

25,000 CHERRY,

which in size and quality are unsurpassed by any in the State.

This is a rare opportunity for Southern and Western Planters or Dealers to buy a class of stock not often to be found in the market.

A full description of this stock, with list of varieties, prices, terms, &c., will be given on application.

Address,

E. H. PRATT,

aug3 Dansville, Liv. Co., N. Y.

## STRAWBERRY PLANTS.

All the best varieties, Great American, Cumberland, Triumph, Sterling, &c. Lowest rates. Prices free.

JOHN S. COLLINS,

aug2 Moorestown, N. J.

## WILD GOOSE PLUM.

Buds of the true sort.

D. B. WEIR,

aug1 Lacon, Marshall Co., Ill.

TO THE TRADE ONLY.

## Begonia Froebeli

First-class Certificate, Royal Hort. Society, London, Aug. 4, '75.  
Silver Medal, Lyons, September 11, 1875.  
Gold Medal, International Exhibition, Cologne, August, 1875,

As the best New Flowering Plant.

We offer this, the grandest novelty of late years, in extra large sound and heavy bulbs, at 10s. 6d. per 12, 20s. per 25, 36s. per 50, and 70s. per 100. For full description, see our catalogue of new Bulbous Plants, Lilies and other Bulbs. Should be in the hands of every seedsman and nurseryman, and will be posted on application to

F. SANDER & CO.,

tsep2

Seed Growers,

ST. ALBANS, ENGLAND.

30,000

## Good White Carnation Plants

for winter flowering, from open ground. Price, from \$6 to \$15 per 100. No charge for packing. Address

J. W. MORRIS,

sep2

Utica, N. Y.

## WHITE BOUVARDIAS.

Strong Plants for Winter Blooming.

Also Chinese Primroses, white and red, for sale by the dozen or hundred.

ROBERT J. SIDDALL,

Stenton Hill Nursery, Opposite Fisher's Station, Germantown.

sep1.

Post Office Address, Station G, Philadelphia.

## California Flowers.

Send stamp for our Special Autumn Catalogue, containing engravings, descriptions and directions for growing these rare and lovely flowers, now offered for the first time at wholesale or retail prices. Address at once,

GEORGE W. PARK,

sep1

Mt. Vernon, Ohio.

## WILLOW DALE NURSERIES.

To Nurserymen, Dealers and Planters, we offer a full assortment of thrifty well-grown stock, largely of Apple, Peach, Plum, Apricot, Cherry (including Luelling, the largest cherry known), Brandywine Raspberries and Ornamental trees. Special rates given for Baldwin and Fallawater Apple trees. In larger quantity, prices low.

Address,

RAKESTRAW & PYLE,

sep1

Willow Dale, Chester Co., Pa.

## FRUIT AND ORNAMENTAL TREES!

LARGE STOCK. LOW RATES.  
STANDARD PEAR TREES A SPECIALTY.

AGENTS WANTED Address

E. MOODY & SONS, Lockport, N. Y.

NIAGARA NURSERIES. Established 1839.

aug2

## TOBACCO STEMS,

For Fumigating purposes, for sale in bales of about 400 lbs., free on boat or cars at \$5 per bale, or three bales for \$12 on one order.

STRAITON & STORM,

178 & 180 Pearl Street,

aug12

New York City.

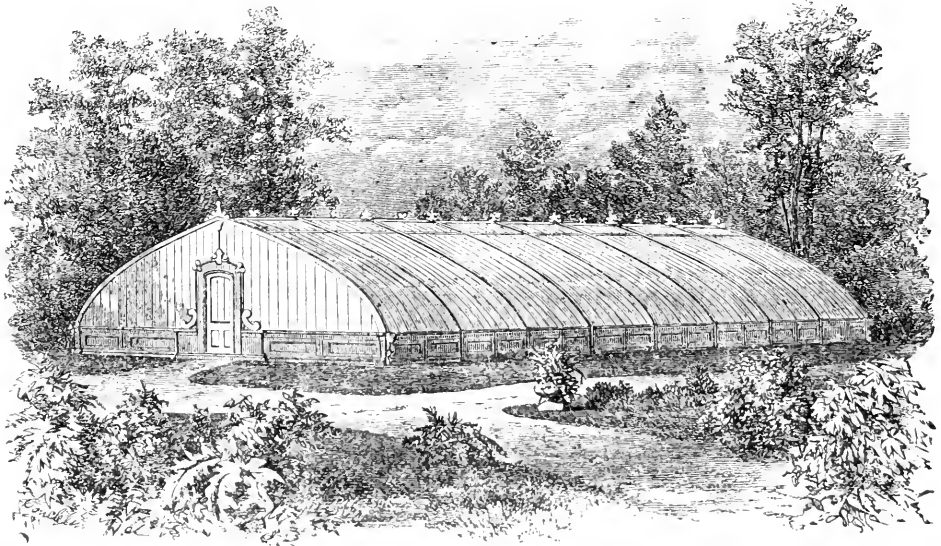

# GREENHOUSES, GRAPERIES, ETC.

Their Construction a Specialty. Experience of 20 Years.  
 SHIPPED TO ALL PARTS OF THE COUNTRY. Send for Catalogue. Address,  
 LORD'S HORTICULTURAL WORKS,

June 12

Irvington-on-Hudson, New York.

## ALEX. NIMMO,

(Late of the Firm of Nimmo & Scollay.)

# NEWLY IMPROVED HOT WATER BOILER,

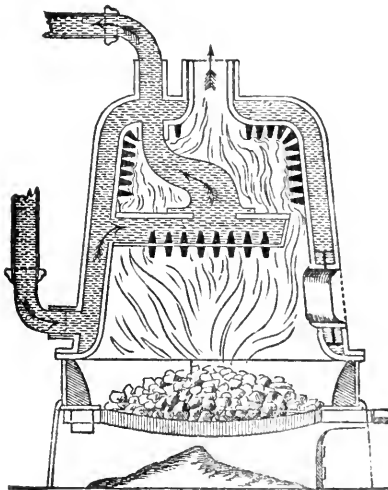

FOR HEATING

Green-Houses, Graperies, Conservatories,  
 Forcing Pits, Water for Baths, Drying  
 Rooms, Public and Private  
 Buildings, &c.

*Proper steps have been taken to secure United States  
 Letters Patent on this invention.*

All the necessary Fittings for Hot Water Heating Apparatus.

VENTILATION APPARATUS OF ALL KINDS.

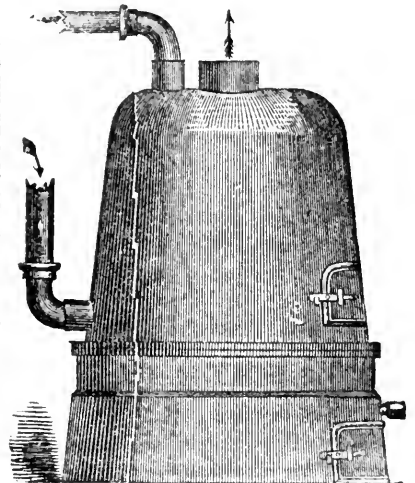

Wells Drove, Pumps of all kinds, Hydraulic Rams, &c., Garden Sun-Dials.

Agent for Joseph Kelly's Never Dry Vapor Pans, for all kinds of Hot Air Furnaces, Baltimore Heaters, &c.

CHEAPEST AND BEST BOILER, &c., IN THE MARKET.

Please send for Circular for explanation, etc., before you make up your mind to purchase elsewhere.

sep 12

P. S.—Be sure you get the right number.

335 Adams Street, Brooklyn, N. Y

# NEW AND RARE FRUIT AND ORNAMENTAL TREES, SHRUBS, &c. FOR FALL 1876.

We have the pleasure of offering the following:

## NEW AND VALUABLE FRUITS.

**PEARS**, the following and other valuable new sorts, **Souvenir du Congres**, **Brookworth Park**, **Petite Marguerite**, **Beurre de l'Assomption**, **Mount Vernon**.  
**CHERRY**: **Montmorency Ordinaire**, the largest and finest of all the hardy Early Richmond class.  
**PEACHES**: **Amsden's June**, **Alexander**, **Early Beatrice**, **Early Rivers**, **Early Louise** and other recent fine early sorts.

## New & Rare Ornamental Trees & Shrubs

**Birch**, the following elegant new varieties: **Young's New Weeping**, considered the finest of the class; **Purple-leaved**, very striking; **Pendula elegans**, a very graceful drooping tree; **Fastigiata**, erect and pointed, like a Lombardy Poplar.

We also invite attention to our general **NURSERY STOCK**. In the departments of **Hardy Fruit Trees**, **Ornamental Trees**, **Shrubs**, **Roses**, etc., the collections are the most extensive and complete in the United States.

Full particulars in the following Catalogues, which will be mailed prepaid on receipt of stamps as noted:  
No. 1. Fruits, with colored plate, 15 cts.; plain, 10 cts. No. 2. Ornamental Trees, etc., with plate, 25 cts. No. 3. Greenhouse; No. 4. Wholesale, and No. 5. List of New Roses, Free. Address,

ELLWANGER & BARRY, Rochester, N. Y.

aug 2 Mt. Hope Nurseries. tsep2

## DOUBLE ZONALE PELARGONIUM WONDERFUL, Geo. Smith.

Magnificent Orange Scarlet, a sport from Vesuvius; Flowers semi-double, trusses large, produced abundantly on small plants; a splendid bedding or market plant. See illustration in this number of the *Gardener's Monthly*.

Plants ready for sale first of October. Price: Small Plants, \$1 each; extra ditto, \$2.50 each; and very strong Imported Plants, \$5 each, with many other varieties.  
Copies of Cut for Sale \$5 each. Address,

THE BELLEVUE NURSERY CO.,

PATERSON, N. J.

aug 2 H. E. CHITTY, Sup't.

# GRAPE VINES.

The largest assortment of STANDARD as well as NEW varieties. Plants of EXCELLENT QUALITY are offered for Fall Trade at GREATLY REDUCED RATES. Price list free.

Our Illustrated and Descriptive Bushberg Catalogue (80 pages) by mail, post-paid, for 25 cents. Address,

BUSH, SON & MEISSNER,

Bushberg, Jefferson County, Mo.

sep2

## CLEMATIS.

50 Varieties, 2 and 3 years, grown in 5 inch pots. A large stock of JACKMANNI, fine plants.

Send for New Trade List.

HOOPES, BRO. & THOMAS,

Cherry Hill Nurseries. sep2 West Chester, Pa.

## Fruit Farm and Nursery For Sale.

250 acres, healthy location, good water, one mile from depot, on the railroad. Nursery stock in fine order, with an increasing trade. Also a good supply of berry crates and baskets. I will either sell or take a partner with \$3,000 or \$10,000 capital.

For full particulars address,

C. W. WESTBROOK,  
Wilson, Wilson Co., N. C.

sep1

## NURSERY STOCK.

FOR FALL, 1876.

We offer in large or small quantities a very complete assortment of both

FRUIT and ORNAMENTAL TREES,  
AND SHRUBS,

including STANDARD and DWARF APPLE and PEAR, PLUM, CHERRY, PEACH, and SMALL FRUITS.

OUR ORNAMENTAL STOCK IS A No. 1.  
in every particular.

A large part of our stock must be dug, and will therefore be sold very low.

Special rates given to large buyers. Price-list free.

SELOVER & WILLARD,

Washington St. Nurseries, Geneva, N. Y.

sep3

# NURSERY STOCK,

FALL OF 1876.

The LARGEST and FINEST  
STOCK OF

Dwarf Pears, Cherries, Apples  
and Crab Apples,

In the country, at prices that defy competition. Also, St. Pears, Plums, Currants, Gooseberries, English and Houghton's, Evergreens, Maples, Elms, and Roses in large quantities, and of the finest quality at low rates.

SMITH & POWELL,

Syracuse Nurseries, SYRACUSE, N. Y.

## HEIKES

# NURSERIES.

We offer to the trade for fall of 1876, a large stock, especially in the following:

Apples, including Tetofski and Marengo, Plums, Peaches, Cherries, Wild Goose Plums, Currants, Gooseberries, Raspberries, Strawberries, etc.

We are prepared to offer inducements, and solicit correspondence.

THE HEIKES NURSERIES CO.,

DAYTON, OHIO.

The undersigned offer for the Fall Trade

## New TEA Rose

DUCHESS OF EDINBURG.

Fine plants in 5-inch pots, \$9.00 per dozen

## New Palm

PRITCHARDIA FILIFOSA (Brahea Filamentosa).

Fine one year old plants \$25.00 per 100, \$4.00 per dozen.

DRACÆNA INDIVISA.

Extra fine, in 6-inch pots, \$50.00 per 100, \$7.00 per dozen.

MARANTA ZEBRINA.

Very strong, \$6.00 per dozen.

## FERNS.

In best varieties, very fine \$12.00 per 100.

Also a general assortment of

GREENHOUSE AND STOVE PLANTS.

KELLER & DEAN, Florists,

56th St. & 3rd Ave., Brooklyn, N. Y.

## Peach Trees.

We invite the attention of buyers to our large stock of Peach Trees, including Alexander, Amsden's June, and other new varieties.

Send for our new Trade List.

HOOPES, BRO. & THOMAS,

Cherry Hill Nurseries West Chester, Pa.

## TO FLORISTS.

A well stocked business to be disposed of on easy terms.

Apply to

GEORGE BURTON, Port Orm Road, Dover, N. J.

## ALEXANDER PEACH.

And other New kinds. Cherry, 2 years, strong growth. Red Dutch Currants, 1 and two years, Philadelphia, Herstine and Brandywine Raspberries. Norway Maple, 8 and 9 feet; Sugar Maple, 4 to 5 feet nursery grown in quantities. Hemlock Spruce, 2 to 2½ feet, bushy. American Arbor-vita, 8 inches to 8 feet, Siberian, 3 to 4 feet. Irish Juniper, 3 to 5 feet. Stock of best quality and offered low.

JOSIAH A. ROBERTS.

sep2f

Paoli, Pa.

## Decorative Plants.

Send for our New Trade List of Palms, Ferns, and other Greenhouse and Stove Plants. We offer a large assortment at low rates.

HOOPES, BRO. & THOMAS,

Cherry Hill Nurseries.

sep6

West Chester, Pa.

## HONEY LOCUST.

We offer a large and fine stock of this popular Hedge plant, 5 years old. Prices on application.

Address,

S. BOARDMAN & CO.,

sep1

Rochester, N. Y.

WILSON'S BLACKBERRY,

Plants \$12 per 1,000.

BRANDYWINE RASPBERRY,

Plants, \$10 per 100.

PEACH TREES, &c..

At low rates.

sep2

R. S. JOHNSON, Stockley, Del.

## TREES, ETC.

Fruit and Ornamental. A large and complete assortment. Trade list now ready, and will be sent to all who favor us with their address. Also descriptive list of fruits and hardy ornamentals, etc.

STORRS, HARRISON & CO.,

sep2

Painesville, Lake Co., O.

## Established 1836.

30 Greenhouses, 100 000 feet of Glass.

The largest collection of plants in the United States. For the Trade, for the Amateur. CAMELIAS and AZALEAS a specialty. Catalogues mailed free to all applicants.

JOHN DICK, Florist,

sep2

53rd & Darby Road, Phila., Pa.

## FOR SALE.

A GREENHOUSE and Stock of PLANTS

will be sold upon terms satisfactory. Trade already established and can be increased. GOOD REASONS FOR SELLING. Will be SOLD LOW. Apply to

W. B. KELLY,

sep2

Abingdon, Va.

## CHAMPION GRAPE.

The earliest good market Grape cultivated. Large bearer; no mildew; very hardy. Send for free descriptive circular to

sep2

J. S. STONE, Charlotte, Monroe Co., N. Y.

WALTER ELDER,

Landscape and Jobbing Gardener,

1231 Rodman Street, Philadelphia,

Attends to all branches of his business on reasonable terms.



# Peach Stones

AND OTHER

## FRUIT SEEDS.

Notwithstanding the general scarcity of Fruit Seeds this season we expect to furnish our customers with full supplies at our usual low prices; but solicit

EARLY ORDERS.

THOMAS MEEHAN,  
tsep GERMANTOWN, PHILA.

## WILD GOOSE PLUM.

One and two year on Peach, **Genuine** worked from our bearing trees. Also a good assortment of other varieties, stocky and well branched.

Send for new Trade List.

HOOPES, BRO. & THOMAS,

Cherry Hill Nurseries. sept2 West Chester, Pa.

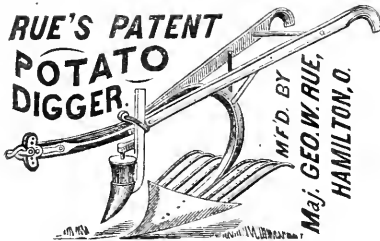

Digs Irish or sweet, and is free from choking.  
Send for circular.

sep1

## PLANTS, NEW AND RARE.

From the Victoria Nursery, London, England, now on exhibition at the Horticultural Hall, Centennial Grounds.  
For Descriptive Lists and Prices, apply to

JOHN DICK,

sep2 53rd and Darby Road, Phila., Pa.

### APRICOTS.

1 and 2 years, \$90.00 per 1,000.

### RED DUTCH CURRANTS.

2 years, fine, \$30.00 per 1000.

### IRISH JUNIPERS.

3-3½, bushy, \$15.00 per 100; price per 1000 on application.

GEORGE ACHELIS, Nurseryman,

sep2 West Chester, Pa.

## SPECIALTIES.

Apple Trees, Peach Trees, Cherry Trees, Gooseberries, Double flowering White Almonds, Prunus triloba (Double flowering Plum), Norway Maples of all sizes, Dwarf Arborvitæ, Siberian, American Arborvitæ, and Hemlocks for Hedging, Norway Spruce, Pyrus Japonica, Purple Mist.

GEORGE ACHELIS, Nurseryman,

sep2 WEST CHESTER, PA.

TREES, PLANTS Bulbs, Fall Price List and Bulb Catalogue GRATIS. Address, F. K. PHENIX, Bloomington Nursery, Ill.

# Saul's Nurseries,

## WASHINGTON, D. C.

The undersigned offers a fine stock of the following at low rates:

**New Pears**—Souvenir du Congress; Beure d'Assumption; Pitmaster; Duchess, and other new Pears.

**New Peaches**—American and European varieties.

**Fruit Trees**—An extensive stock of well-grown Trees. Pears, Standards and dwarf, of extra size—a heavy stock. Apple, Cherry, Plum, Apricot, &c.

**Grape Vines, Strawberries, Raspberries, &c.**

**Evergreens**—Ornamental Trees, Shrubs, &c. Small sizes, suitable for Nurserymen; as well as large Stock in great variety.

## Dutch Bulbs.

Large Importations direct from the leading growers in Holland.

First quality Bulbs: Hyacinths, Lilies, Tulips, &c

**New and Rare Greenhouse Plants** for winter blooming.

**New Roses**—Duchess of Edinburgh, Perle de Lyon, &c., at reduced rates.

**New and Scarce Roses**, an immense stock grown in pots—prices low.

**New Wisterias, New Clematis, New Pelargoniums, Geraniums, Primula Japonica, &c.**

Catalogues mailed to applicants.

# JOHN SAUL,

## WASHINGTON, D. C.

t,sep3

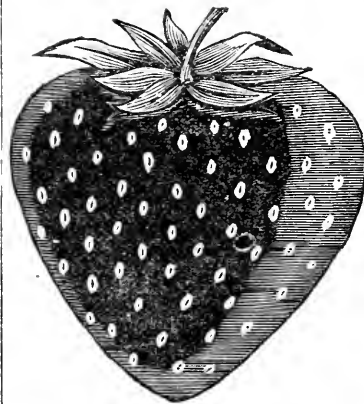

## CUMBERLAND TRIUMPH.

Unquestionably one of the finest berries under cultivation.

\$1 per dozen.

Circular free.

A. MILLER,

Box 318,

Carlisle, Pa. sep1



The Autumn No. of Vick's Floral Guide,

Containing descriptions of Hyacinths, Tulips, Lilies and all Bulbs and Seeds for Fall Planting in the Garden, and for Winter Flowers in the House—just published and sent free to all.

Address

JAMES VICK, Rochester, N. Y.

sep2

# WEATHERED & CHEREVOY'S PATENT BOILERS

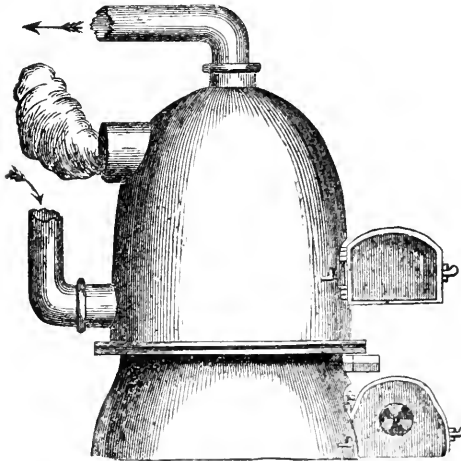

Fig. 1.

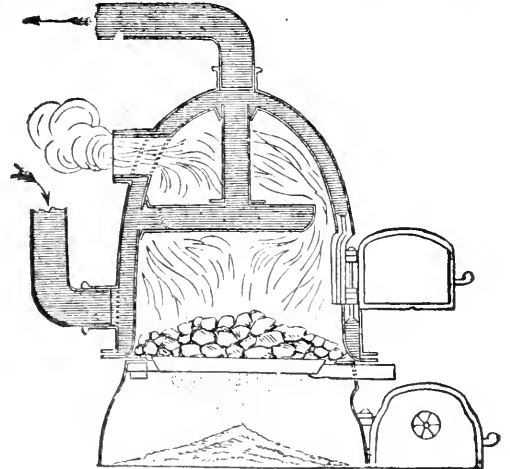

Fig. 2.

## AND IMPROVED HOT WATER APPARATUS,

No. 46 Marion Street, between Spring and Prince, New York.  
(TWO BLOCKS EAST OF BROADWAY.)

For Warming and Ventilating Public Buildings, Private Dwellings, Greenhouses, Graperies, Forcing Pits, Drying Rooms, and Heating Water for Public Baths.

Fig. 1 is an outside view. Fig. 2 is a vertical section through the centre.

*The following are a few names of Gentlemen who have our Boiler in use:*

Thos. Drake, Esq., Germantown, Pa.  
Simon Cameron, Esq., Harrisburg, Pa.  
J. D. Cameron, Esq., Harrisburg, Pa.  
Thos. Carter, Esq., Raleigh, N. C.  
J. H. Dunham, Esq., Chicago, Ill.  
Jas. B. Waller, Esq., " "  
W. J. Gordon, Esq., Cleveland, Ohio.  
Geo. Stanley, Esq., " "  
Harris Jaynes, Esq., " "  
Geo. W. Cuyler, Esq., Palmyra, N. Y.  
D. M. Osborn, Esq., Auburn, N. Y.  
John B. Dutcher, Esq., Pawling, N. Y.  
A. M. Allerton, Esq., Bronxville, N. Y.  
Robert Hoe, Esq., Tarrytown, N. Y.  
Peter Hoe, Esq., " "  
George Lewis, Esq., " "  
Wm. H. Drew, Croton Falls, " "  
Hon. James Y. Smith, Providence, R. I.  
Philip Caswell, Esq., Newport, R. I.  
Alfred Smith, Esq., " "  
Wm. Findlay, Esq., " "  
E. Learned, Esq., Pittsfield, Mass.  
D. O. Mills, Esq., San Francisco, Cal.  
W. L. Ferris, Esq., Westchester, N. Y.  
D. H. Haight, Esq., Goshen, N. Y.  
F. Newbold, Esq., Newark, N. J.  
James T. Closson, Esq., Plainfield N. J.  
Daniel W. Coit, Esq., Norwich, Conn.  
J. F. Slater, Esq., " "  
H. W. Collender, Esq., Darlen, " "  
Chas. P. Palmer, Esq., Stonington, "

Wm. D. Black, Esq., New Milford, Conn.  
Rev. Stephen H. Tyng, Irvington, N. Y.  
H. F. Spaulding, Esq., Riverdale, " "  
S. D. Babcock, Esq., " "  
Percy R. Pyne, " "  
Elisha Brooks, Esq., Inwood, " "  
Camille Marie, Esq., " "  
A. F. Smith, Esq., Fort Washington, " "  
R. M. Olyphant, Esq., Dobb's Ferry, " "  
Clarkson N. Potter, Esq., New Rochelle, " "  
Chas. D. Dickey, Esq., West Farms, " "  
Wm. Matthews, Esq., Harrison, " "  
William Chorlton, Esq., New Brighton, S. I.  
F. H. Wolcott, Esq., Astoria, L. I.  
Bailey Leach, Esq., " "  
Hon. W. B. Ogden, High Bridge, N. Y.  
Peter Moller, Esq., 295 Fifth Ave., New York City.  
Wm. Moller, Esq., 6 West 20th St., " "  
John Moller, Esq., 127 East 54th St., " "  
John Moller, Esq., 8 East 37th St., " "  
Ch. Moller, Esq., 425 Washington St., " "  
Henry B. Laidlaw, Esq., 33 Pine St., " "  
George W. Lane, Esq., 93 Front St., " "  
J. P. Robinson, Esq., 14 Coenties Slip, " "  
J. B. Colgate, Esq., 47 Wall St., " "  
John B. Trevor, Esq., 47 Wall St., " "  
Charles Butler, Esq., 12 " "  
Richard Arnold, Esq., 309 Canal St., New York City.  
Jas. M. Constable, Esq., 309 Canal St., " "  
W. T. Garner, Esq., 61 Worth St., N. Y. City.

Please send for Circular with list of References and Reduced Prices to

THOMAS W. WEATHERED, 46 Marion Street, N. Y.



WE OFFER  
FROM OUR

LARGE AND SELECT LIST OF ROSES

Fine plants of all the LATEST and CHOICEST VARIETIES, grown on their OWN ROOTS, and ready for delivery at any time

AFTER OCTOBER 1st.

We can also supply all the NEW and BEST VARIETIES of

HARDY ORNAMENTAL TREES AND SHRUBS,

**EVERGREEN AND DECIDUOUS,**

For planting in Lawns, Yards, &c.

ROSE and PLANT CATALOGUES sent on receipt of 3ct postage stamp.

sept1

MILLER & HAYES, Mt. Airy Nurseries, Philadelphia.

NURSERYMEN'S WATERPROOF SHIPPING CARDS

AND  
EYELETTED TAGS,

either plain or printed with shipper's address "PLANTS—PERISHABLE;" "SEEDS—KEEP DRY;" &c., &c. The best and cheapest in the market. For samples and prices address

H. E. CHITTY, Sup't.

sept1

THE BELLEVUE NURSERY CO., Paterson, N. J.

FOR SALE.

A farm of 60 acres, 35 miles from Philadelphia, on Camden & Atlantic R. R., 1/2 mile from Magnolia Station; well adapted to cultivation of Fruit Trees, Small Fruits and Vegetables. Large section of it Cedar Swamp and Natural Cranberry Ground. 4 acres in Cranberries under cultivation, 140 Fruit Trees, Apple, Pear, Peach, Plum, &c., just coming into bearing. House and barn. Water excellent and abundant. Location healthy. Will be sold at reasonable price and terms to close an estate; or will be exchanged for city property. Philadelphia or Reading preferred.

Address,

CHAS. H. MAROT,

septf. 814 Chestnut St., Philadelphia.

A Subscription to Harper's Weekly

For 1876 from January 1st, will be furnished on receipt of \$2.50 if applied for at once at this office.

Address

CHAS. H. MAROT,

814 Chestnut St., Phila.

SITUATIONS WANTED.

A Position as Foreman in a Florist establishment by an Englishman, aged 43, having had over 35 years experience in the propagation and culture of plants, both for market and exhibition, the last 7 years in America; good salesman, also first-class hand at cut flower work. Address with particulars as to quantity of glass, &c., J. L. GRIFFIN, care of Geo. Such, South Amboy, N. J. 2t

By a thorough practical Gardener, a married man; good reason for leaving present employer; has filled first-class places in Europe and also this country. Reference to ability and character will be given satisfactory. Address M, Gardener, Owego, Tioga Co., N. Y. sept2

By a Florist, married, without children; German Protestant; a situation as Foreman or to take charge of a gentleman's place; has 14 years experience in the business. Can give the best references. Address R. BARBECK, Florist, Harrowgate Lane, 25th Ward, Philadelphia.

By a first-class Gardener; married, but no children; one who is well versed in all branches of the business. First-class reference. Private situation preferred. Address GARDENER, 4767 Main St., Germantown, Philadelphia.

A S Gardener in a private family, by an Englishman, aged 40; understands the propagation and cultivation of stove and greenhouse plants, roses and orchids, also a good vegetable grower; has had great experience growing plants, grapes and peaches, all kinds of early forcing; a good knowledge of excavating; married, no family. B B., 121 Pine St., Philadelphia.

TWO first-class Gardeners wish situations, one as Nursery Foreman, the other as private Gardener. Apply to or Address C. E. SUTHERLAND, Horticulturist, 21st St., below Green, Philadelphia.

WANTED by an Englishman, single, aged 28, a situation in a private or commercial establishment. Well up in all branches of the profession. Active, sober, honest and obliging, and can give first-class references. Please address GARDENER, Mount Moriah Lane, 65th & Darby Road, Philadelphia.

By a well learned, practical German Gardener, family small, could come at once, with or without family. Please address M. Gardener, Rome, Floyd Co., Georgia.

By a young man, single, sober and energetic, 12 years practical experience in the cultivation of stove and greenhouse plants, florists' flowers, etc. Bouquets and other floral designs set on most approved principles. Will accept a situation in any department. Management of a commercial place preferred. Address Gardener's Monthly office, 814 Chestnut street, Philadelphia, for B. E. R.

A S Gardener, single, competent to manage a large place, with a practical knowledge of plants and all branches of forcing. Testimonials given. Distance no object. Address, D. B., care of P. Fergusson, Laurel Hill Nursery, Ridge Av., Philadelphia.

By a single man, a situation as Gardener in a private place, understands all branches of the business. Good references. Address, W. NICOLAUS, 2100 Callowhill St., Philadelphia.

By a married Swiss German Gardener, no children; is thoroughly competent in all branches, improvement of grounds, greenhouse and hothouse plants; graper, both inside and outside culture. Can produce the best of reference from present employer. Address H. M., 402 Fifth Avenue, Pittsburgh, Pa.

By a good practical Gardener, in a private place, and can take care of green and hot house plants, grapes, fruit trees and vegetables. Good reference. Address P. K., 1719 Market street, Phila., Pa.

By a good Florist (German); has worked several years for an American gentleman. Has good references and only a small family. For particulars apply to FRED. MEYER, Florist, Tidouite, Warren County, Pa.

# The Centennial.

ADVERTISERS Are requested to note that CURRENT NUMBERS of THE GARDENER'S MONTHLY, from MAY to NOVEMBER inclusive, will lie upon the tables of the Reading Room at Horticultural Hall, Centennial Grounds, for the inspection of the thousands directly interested in the stock you have for sale. Also at Rowell's Newspaper Exhibition, and Pettengill's Newspaper Agency. Those who take advantage of this fact will have practically an extra circulation, during the months named. Two files of the MONTHLY, from May to November, will constantly remain for the inspection of visitors. Be in time with your orders. Take notice changes of copy in current advertisements must be in hand by the 16th of each month, and new orders by the 23d to insure insertion in following issue. Address C. H. MAROT, 814 Chestnut St., Philadelphia.

## ARITHMETIC MADE EASY

BY

### Ropp's Commercial Calculator

No farmer, mechanic, business man or laborer should be without it.

Contains more useful and practical tables, and original and rapid methods of calculation than all the other Reckoners and Calculators combined.

Shows at a glance the value of all kinds of grain, stock, hay, coal, lumber and merchandise, for any quantity and any price; the interest on any sum for any time at 6, 7, 8 and 10 per cent; measurement of lumber, saw-logs, cisterns, tanks, granaries, corn-cribs, wagon-beds, etc.; also a time, wages, and many other valuable tables.

It is simple and easily comprehended. Any one—the least conversant with figures—can instantaneously become his own accountant.

Enables anyone to compute numbers with lightning rapidity, by mastering a simple arithmetical principle which has never been used before.

Is an Arithmetic, Ready Reckoner, Lightning Calculator, Silicate Slate, Memorandum and Pocket-book combined.

Price: Bound in Russia leather with gilt edges, \$2 00; Morocco, \$1.50; Fine Cloth, \$1.00; Cloth, without slate, memorandum, etc., 60 cts. Sent post-paid on receipt of price.

Address

CHAS. H. MAROT,

814 Chestnut St., Phila.

## DECLARATION OF INDEPENDENCE

FACSIMILE LITHOGRAPHED in the handwriting of THOMAS JEFFERSON, with the interlined corrections and erasures as made by JOHN ADAMS and Dr. FRANKLIN, in 1776. Pamphlet form, (7 pages,) on extra heavy, highly colored, and tinted paper, with a beautiful cover, in four colors, embellished with the National Emblems,

### OLD INDEPENDENCE HALL,

(As it appeared in 1776.)

### THE "OLD LIBERTY BELL"

which rang out the LIBERTY we now enjoy to all the people, etc., etc. To which is added the names of the signers in their own handwriting, making one of the most ornate, unique, and interesting centennial memorials of the "time that tried men's souls," that could possibly be imagined. Should be placed on the centre table of every American citizen.

Price 50 cents each, postage paid. Address,

CHAS. H. MAROT,

814 Chestnut St., Phila.

## AMERICAN FRUIT CULTURIST.

BY JOHN J. THOMAS.

Practical directions for the Cultivation of Fruit Trees in the NURSERY, ORCHARD AND GARDEN.

Descriptions of the principal American and Foreign varieties. Plain Edition, 480 engravings, 511 pages, 12 mo. Price, \$3.00. Mailed post-paid on receipt of price.

4 Extra Edition, 576 pages, heavy paper, fine cloth, 508 illustrations and chromo frontispiece; mailed, for \$3.75. Address CHAS. H. MAROT, 814 Chestnut St., Phila.

## The Gardener's Monthly.

THE FOLLOWING

### BACK NUMBERS

WANTED, IN

### GOOD CONDITION.

April, 1860.	October, 1870.	August, 1874.
January, 1870.	December, "	December, "
March, "	January, 1873.	January, 1875.
July, "	January, 1874.	December, "
		January, 1876.

Receivable in exchange on Subscription account, or exchangeable for other numbers not in above list. Send numbers and advise the publisher by letter. Address,

CHAS. H. MAROT,  
814 Chestnut St., Phila.

## THE ABBOTT

### Pocket Microscope

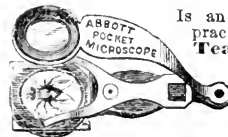

Is an instrument of great practical usefulness to Teachers, Farmers, Merchants, Mechanics, Physicians, Botanists, Miners, and many others. It is the best instrument ever invented for examining Flowers, Seeds, Plants, Minerals, Engravings, Bank Notes, Fabrics, Etc. By means of a cage, accompanying each instrument, one can examine all kinds of Insects or Worms alive. The

### EYE OF A FLY,

or other insect of like size, can be readily seen. It is simple in construction and easy to operate. One of these interesting instruments ought to be in every family. We have made arrangements to furnish the Pocket Microscope at the manufacturer's price, \$1.50. It will be sent, post-paid, to any reader of this Paper desiring it, on receipt of price, or may be had at this office.

Address,

CHAS. H. MAROT,

814 Chestnut St., Phila.

## PRESERVING, PICKLING AND CANNING FRUIT.

BY MRS. M. E. PETERSON.

Containing a choice collection of receipts of Preserving, Pickling, and Canning Fruits, many of them being original from house wives of experience. 72 pages, 16mo. Cloth. Price 50 cents. Sent by mail, post-paid, on receipt of price.

Address,

CHAS. H. MAROT,

814 Chestnut St., Phila.

# CLUB PAPERS AT NET PRICES,

## ALPHABETICALLY ARRANGED.

**TO REMIT IN CLUBBING** any of the following list with the  
 Gardener's Monthly select such  
 as you wish, foot up the prices annexed and add **TWO DOLLARS**  
 for the **MONTHLY** to the total.

<p>American Agriculturist.....\$1 20                  " Farmer.....1 35                  " Artisan.....1 60                  " Builder.....2 60                  " Naturalist.....3 25                  " Odd Fellow.....1 60                  Appleton's Journal.....3 60                  Arthur's Home Magazine.....2 35                  Atlantic Monthly.....3 60                  Boston Cultivator.....2 60                  Building Association Journal.....75                  " Societies Gazette, London, England.....1 35                  Bucks County Intelligencer, old subscribers \$2 60, new.....2 10                  California Horticulturist.....2 75                  Central Union Agriculturist and Chromo.....1 70                  Children's Friend.....1 35                  " Hour.....1 10                  Colman's Rural World.....1 85                  Country Gentleman.....2 35                  Demorest's Magazine.....2 60                  Eclectic Magazine.....4 60                  Every Saturday.....4 60                  Farmer's Home Journal.....2 60                  Frank Leslie's Ladies' Magazine.....3 10                  " Review.....2 10                  Galaxy.....3 60                  Germantown Telegraph, old subscribers \$2 50, new.....2 20                  Godey's Lady's Book.....2 75                  Hall's Journal of Health.....1 50                  Harper's Bazar.....3 60                  " Magazine.....3 60                  " Weekly.....3 60                  Hearth and Home.....2 00                  Herald of Health.....1 60                  Household.....85                  Iowa Homestead.....1 60                  Journal of Chemistry.....1 10                  " of the Farm.....85                  Journal of Materia Medica.....1 10                  Kansas Farmer.....1 35                  Lady's Floral Cabinet, with Chromo.....1 10                  Ladies' Repository.....3 35                  Leslie's Lady's Journal.....3 60                  Lippincott's Magazine.....3 25                  Littell's Living Age.....7 60                  London Garden.....8 75                  London Gardener's Chronicle.....7 50</p>	<p>Maine Farmer.....\$2 10                  Manufacturer and Builder.....1 85                  Maryland Farmer.....1 35                  Massachusetts Ploughman.....2 60                  Metropolitan.....1 85                  Milling Journal.....1 85                  Moore's Rural New Yorker.....2 35                  Nation.....4 75                  National Baptist.....2 35                  New England Farmer.....2 35                  " Homestead.....2 10                  New York Evangelist.....2 60                  New York Methodist.....2 20                  " Post, Weekly, \$1.50; Semi-Weekly.....2 60                  " Times, Weekly, \$1.50; Semi-Weekly.....2 60                  " Tribune, Weekly, \$1.50; Semi-Weekly.....2 60                  " World, Weekly; \$1.50; Semi-Weekly.....2 60                  North-Western Farmer.....1 10                  Nursery.....1 20                  Ohio Farmer.....1 85                  Old and New.....3 60                  Our Home Journal.....2 72                  Park's Floral Gazette.....05                  Penn. Monthly.....2 10                  Peter's Musical Monthly.....2 60                  Peterson's Magazine.....1 70                  Philadelphia Weekly Press.....1 60                  Phreunological Journal.....2 35                  Poultry World.....1 10                  Popular Science Monthly.....4 60                  Practical Farmer, (Weekly).....2 60                  Prairie Farmer.....1 70                  Purdy's Small Fruit Recorder.....85                  Saint Nicholas.....2 60                  Saturday Evening Post.....2 10                  Scientific American.....2 75                  Scientific Farmer.....85                  Scribner's Monthly.....3 60                  Southern Cultivator.....1 85                  Southern Planter and Farmer.....1 85                  Waverly Magazine.....4 60                  Western Agriculturist.....85                  Western Farmer.....1 85                  " Rural.....1 85                  Wood's Household Magazine.....85                  " " with Chromo.....1 00                  Working Farmer.....1 10                  Youth's Companion, new subscribers \$1.40; old subscribers..1 75</p>
--	---

The above includes postage under the new U. S. Law requiring prepayment of postage before mailing.

After subscription to a club paper through this agency, report non-receipt of your numbers and other causes of dissatisfaction, irregularities of mails or changes of residences, *only to said paper direct* (not to this office).

Remit by P. O. Order, Draft or Registered Letter. Currency is at risk of mails.

If you wish a receipt or reply, enclose postage stamp for that purpose, otherwise the club papers will be considered a sufficient receipt.

Address **CHAS. H. MAROT, 814 Chestnut Street, Philadelphia.**

**GARDENING BY MYSELF.**

By Anna Warner.

Containing Hints and Experiences under heading of each month in the year. Illustrated. 16mo, 223 pages, cloth. Price \$1.25. Sent by mail post-paid on receipt of price.

Address CHAS. H. MAROT,  
814 Chestnut St., Phila.

**ROSES AND ROSE CULTURE.**

By Wm. PAUL, F.R.H.S.

The rationale of Rose cultivation in a nut-shell. Intended to place within a small compass all that is necessary for the successful cultivation of the "Queen of Flowers." 83 pages, 12mo, paperboards. Price, 60 cents. Sent by mail post-paid on receipt of price.

Address,  
CHAS. H. MAROT,  
814 Chestnut Street, Philadelphia.

**PARSONS ON THE ROSE.**

By Samuel B. Parsons.

A treatise on the Propagation, Culture and History of the Rose. Illustrated. 215 pages 12mo, cloth. Price \$1.50. Sent by mail post-paid on receipt of price.

Address CHAS. H. MAROT,  
814 Chestnut St., Phila.

**ROSE GARDEN.**

By Wm. Paul, F. R. H. S.

Embracing History of the Rose; formation of Rosarium; detailed account of practice for successful cultivation; arrangement in natural groups of most esteemed varieties, English and Foreign, in the most eminent Gardens; with full description and remarks on origin and mode of culture. Numerous illustrations. 256 pages, Royal 8vo, cloth. Price \$3.00. Sent by mail post-paid on receipt of price.

Address CHAS. H. MAROT,  
811 Chestnut St., Phila.

**BOOK OF ROSES.**

By Francis Parkman.

Description, Cultivation and Propagation. Beautifully illustrated. 225 pages, 12mo, cloth. Price \$1.50. Sent by mail post-paid on receipt of price.

Address CHAS. H. MAROT,  
814 Chestnut St., Phila.

**GUIDE TO THE STUDY OF INSECTS.**

By A. S. PACKARD, JR., M.D.

Also a Treatise on those INJURIOUS and BENEFICIAL to us. For the use of Colleges, Farms, Schools and Agriculturists. Illustrated with 11 plates, and 650 wood-cuts. 702 pages, 8vo, cloth. Price, \$6.00. Sent by mail post-paid on receipt of price.

Address, CHAS. H. MAROT,  
814 Chestnut Street, Philadelphia.

**INSECTIVOROUS PLANTS.**

By Chas. Darwin.

With copious descriptive contents and index. Illustrated. 462 pages, 12mo, cloth. Price \$7.00. Sent by mail post-paid on receipt of price.

Address CHAS. H. MAROT,  
814 Chestnut St., Phila.

**WORKING MAN'S WAY TO WEALTH.**

By EDMUND WRIGLEY.

A practical treatise on *Building Associations, what they are, and how to use them.* 108 pages, 16mo, cloth. Price, 75 cents. Sent by mail post-paid on receipt of price.

Address, CHAS. H. MAROT,  
814 Chestnut Street, Philadelphia.

**HOW TO MANAGE BUILDING ASSOCIATIONS.**

By EDMUND WRIGLEY.

Being a Director's Guide and Secretary's Assistant, with forms for Keeping Books and Accounts, also rules, examples and explanations illustrating the various plans of working. 211 pages, 12mo, cloth. Price, \$2.00. Sent by mail post-paid on receipt of price.

Address, CHAS. H. MAROT,  
814 Chestnut Street, Philadelphia.

**HOW TO LAY OUT A GARDEN.**

By Edward Kemp.

A general guide in Choosing, Forming and Improving an Estate (from a quarter-acre to a hundred acres in extent), with reference to both design and execution. Illustrated with numerous plans, sections and sketches. 403 pages, 12mo, cloth. Price \$2.50. Sent by mail post-paid on receipt of price.

Address CHAS. H. MAROT,  
814 Chestnut St., Phila.

**AMERICAN FLOWER GARDEN DIRECTORY.**

By Robert Buist.

With practical directions for the Culture of Plants in Flower-Garden, Hot-House, Green-House, Rooms, or Parlor Windows, for every month of the year. Instructions for erecting Hot-house, Green-house, and laying out a Flower garden. Instruction for cultivating, propagating, pruning and training the Grape vine and description of best sorts for the open air. 342 pages, 12mo, cloth. Price \$1.50. Sent by mail post-paid on receipt of price.

CHAS. H. MAROT,  
814 Chestnut St. Phila.

**WINDOW GARDENING.**

By Henry T. Williams.

Devoted specially to the Culture of Flowers and Ornamental Plants for *In-door use and Parlor Decoration.* Splendidly illustrated. 300 pages, med. 8vo, cloth. Price \$1.50. Sent by mail post-paid on receipt of price.

Address CHAS. H. MAROT,  
814 Chestnut St., Phila.

**PRACTICAL FLORICULTURE.**

By PETER HENDERSON.

A Guide to the successful cultivation of  
**FLORISTS' PLANTS,**  
for the *Amateur and Professional Florist.* Illustrated. 288 pages, 12mo, cloth, Price, \$1.50. Sent by mail post-paid on receipt of price.

Address, CHAS. H. MAROT,  
814 Chestnut Street, Philadelphia.

**AMERICAN GARDENER'S ASSISTANT.**

By Thomas Bridgeman.

Containing complete practical directions for the cultivation of Vegetables, Flowers, Fruit Trees and Grapevines. Illustrated. 520 pages, 12mo, cloth. Price \$2.50. Sent by mail post-paid on receipt of price.

Address CHAS. H. MAROT,  
814 Chestnut St., Phila.

**GRAPE CULTURALIST.**

By Andrew S. Fuller.

A treatise on the Cultivation of the Native Grape. Illustrated. 286 pages, 12mo, cloth. Price \$1.50. Sent by mail post-paid on receipt of price.

Address CHAS. H. MAROT,  
814 Chestnut St., Phila.

**SMALL FRUIT CULTURIST.**

By ANDREW S. FULLER.

Giving Description, History, Cultivation, Propagation, Diseases, &c.

Beautifully Illustrated.

276 pages, 12mo, cloth. Price \$1.50. Sent by mail, post-paid on receipt of price.

Address,  
CHAS. H. MAROT, 814 Chestnut St., Phila.

**CARPENTRY MADE EASY,**

OR, THE SCIENCE AND ART OF BUILDING.

By W. E. BELL, Architect.

A new and improved system. Specific instructions for Balloon Frames, Barn Frames, Mill Frames, Warehouses, Church Spires, &c. Also, System of Bridge Building, Mills, Estimates of Cost and valuable tables. Illustrated by 38 plates and nearly 200 figures. 124 pages, 8vo, cloth. Price, \$5.00. Sent by mail post-paid on receipt of price.

Address,  
CHAS. H. MAROT,  
814 Chestnut Street, Philadelphia.

## HOW PLANTS GROW.

By Asa Gray, M. D.

A simple Introduction to Structural Botany, with a Popular Flora, or an arrangement and description of Common Plants, both wild and cultivated. Illustrated with 500 wood engravings. 233 pages, large 16mo, half-arabesque, paper sides. Price \$1 25. Sent by mail post-paid on receipt of price.

Address CHAS. H. MAROT,  
814 Chestnut St., Phila.

## CLASS BOOK OF BOTANY.

By ALPHONSO WOOD, A. M.

Being outlines of the Structure, Physiology and Classification of Plants; with a Flora of the United States and Canada. 832 pages, 8vo, half-arabesque cloth sides. Price, \$3.50. Sent by mail post-paid on receipt of price.

Address, CHAS. H. MAROT,  
814 Chestnut Street, Philadelphia.

## GARDENERS' DICTIONARY.

By GEO. W. JOHNSON, Editor of "Cottage Gardener."

Describing the Plants, Fruits and Vegetables desirable for the Garden, and explaining the terms and operations employed in their cultivation. New Edition, with a supplement, including the new plants and varieties. 910 pages, 12mo, cloth, fine print. Price, \$3.50. Sent by mail post-paid on receipt of price.

Address, CHAS. H. MAROT,  
814 Chestnut Street, Philadelphia.

## ORNAMENTAL TREES.

By Thomas Meehan.

An American Hand-Book, containing the personal observations of the author. 257 pages, 24mo, cloth. Price 75 cts. Sent by mail post-paid on receipt of price.

Address CHAS. H. MAROT,  
814 Chestnut St., Phila.

## BOOK OF EVERGREENS.

By Josiah Hoopes.

A practical treatise on the Coniferæ or Cone-bearing plants. Handsomely illustrated. 435 pages, 12mo, cloth. Price \$3.00. Sent by mail post-paid on receipt of price.

Address CHAS. H. MAROT,  
814 Chestnut St., Phila.

## LAWN AND SHADE TREES.

By F. R. ELLIOTT.

Deciduous and Evergreen Trees and Shrubs, for planting in Parks, Gardens, Cemeteries, &c., &c. Illustrated. 125 pages, 12mo, cloth. Price, \$1.50. Sent by mail, post-paid, on receipt of price.

Address, CHAS. H. MAROT,  
814 Chestnut Street, Philadelphia.

## GARDENING FOR PROFIT.

BY PETER HENDERSON.

A Guide to the successful cultivation of the

## MARKET AND FAMILY GARDEN.

New and enlarged edition. Illustrated. 276 Pages, 12mo, cloth. Price, \$1.50. Sent by mail post-paid on receipt of price.

Address CHAS. H. MAROT, 814 Chestnut St., Phila.

## GARDENING FOR PLEASURE.

BY PETER HENDERSON.

A guide to the Amateur in the

## FRUIT, VEGETABLE and FLOWER GARDEN.

With full directions for the Greenhouse, Conservatory and Window-Garden. Illustrated. 250 Pages, 12mo, cloth. Price \$1.50. Sent by mail post-paid on receipt of price.

Address CHAS. H. MAROT, 814 Chestnut St., Phila.

# How To Paint

A New Work by a Practical Painter, designed for the use of Tradesmen, Mechanics, Merchants, Farmers, and as a Guide to Professional Painters. Containing a Plain Common-Sense Statement of the Methods employed by Painters to produce satisfactory results in Plain and Fancy Painting of every description, including Formulas for Mixing Paint in Oil or Water, Tools required, etc. This is just the Book needed by any person having anything to paint, and makes

"Every Man His Own Painter."

Full Directions for Using White Lead—Lamp-Black—Green—Yellow—Brown—Whiting—Glue—Pumice Stone—Spirits of Turpentine—Oils—Varnishes—Furniture Varnish—Milk Paint—Preparing Kalsomine, etc.

## Paint for Outbuildings

—Whitewash—Paste for Paper-Hanging—Hanging Paper—Graining in Oak, Maple, Rosewood, Black Walnut—Staining—Decalcomania—Making Rustic Pictures—Painting Flower-Stands—Rosewood Polish—Varnishing Furniture—Waxing Furniture—Cleaning Paint—

## Paint for Farming Tools

—for Machinery—Household Fixtures, etc.

## To Paint a Farm Wagon

—to Re-Varnish a Carriage—to make Plaster Casts. The work is neatly printed, with illustrations wherever they can serve to make the subject plainer, and it will save many times its cost yearly. Every family should possess a copy. Price by mail, post-paid, \$1.

CHARLES H. MAROT,

814 Chestnut St., Philadelphia, Pa

## Manual of Botany of the Northern United States.

By ASA GRAY.

Including the district east of the Mississippi and north of Carolina and Tennessee. Arranged according to the Natural System. Illustrated with 20 plates of Sedges, Grasses, Ferns, &c. 703 pages, 3vo, half-arabesque cloth sides. Price, \$2.25. Sent by mail post-paid on receipt of price.

Address, CHAS. H. MAROT,  
814 Chestnut Street, Philadelphia.

## FLORA OF THE SOUTHERN STATES.

By A. W. CHAPMAN, M.D.

Containing abridged descriptions of the Flowering Plants and Ferns of Tennessee, North and South Carolina, Georgia, Alabama, Mississippi and Florida, arranged according to the Natural system. 621 pages, 8vo, cloth. Price, \$3.60. Sent by mail post-paid on receipt of price.

Address, CHAS. H. MAROT,  
814 Chestnut Street, Philadelphia.

Index to Advertisements.

Advertisers are requested to have orders in hand as EARLY AS POSSIBLE. Copy received after the 23rd of each month cannot be INSURED insertion in the next issue.

Achelis George, West Chester, Pa.....	15
Alkemade, M. C. & Co., Haarlem, Holland.....	6
Bayersdorfer M. M. & Co., Philadelphia.....	8
Bennett C. W., Quincy, Mich.....	6
Bliss B. K. & Sons, New York city.....	cover
Boardman S. & Co., Rochester, N. Y.....	14
Bellevue Nursery Co., Paterson, N. J.....	13, 17
Burton George, Dover, N. J.....	14
Bush, Son & Meissner, Bushberg, Jefferson Co., Mo.....	13
Collins, John S. Moorestown, N. J.....	11
Coninck, A. M. C. J., Dedemsvaart, Netherlands.....	4
Cook W. W., Worcester, Mass.....	4
Dick John, Phila., Pa.....	5, 14, 15
Dreer Henry A., Philadelphia.....	2
Douglas Robert & Sons, Waukegan, Ill.....	5
Elder Walter, Philadelphia.....	14
Ellis Chas. R., New York city.....	9
Ellwanger & Barry, Rochester, N. Y.....	13
Elverson & Sherwood, New Brighton, Pa.....	5
Empire Portable Forge Co., Troy, N. Y.....	4
Engle H. M. & Son, Marrietta, Pa.....	4
Ennis & Patton, Clinton, Iowa.....	11
Foust Geo., Phila., Pa.....	6
Furnas Robt. W., Brownville, Nebraska.....	11
Hales H. W., Ridgewood, N. J.....	4
Harkett Wm. A., Dubuque, Iowa.....	2
Hance A. & Son, Red Bank, N. J.....	4, 6
Heikes Nurseries Co., Dayton, O.....	14
Henderson Peter & Co., New York.....	1
Hitchings & Co., New York city.....	3
Hoopes Bro. & Thomas, West Chester, Pa.....	4, 6, 11, 13, 14, 15
Hovey & Co., Boston, Mass.....	4
Hubbard F. S., Fredonia, N. Y.....	8
Johnson R. S., Stockloy, Del.....	14
Jordan, J. M. & Bro., St. Louis, Mo.....	7
Keller & Dean, Brooklyn, N. Y.....	14
Kelly W. B., Abington, Va.....	14
Kilpatrick Wm., Collegeville, Pa.....	6
Lord's Horticultural Works, Irvington, New York.....	12
Lynch & Kelly, New York.....	6
Lynex Richard, Philadelphia.....	6
Marot, Chas. H., Philadelphia.....	9, 17, 18, Fly-leaf
Mahoney Jas. D., Fishersville, N. H.....	6
Meehan Thomas, Germantown, Philadelphia.....	8, 9, 15
Miller A., Carlisle, Pa.....	15
Miller & Hayes, Phila., Pa.....	17
Moody E. & Sons, Lockport, N. Y.....	11
Morris J. W., Utica, N. Y.....	11
Myers Thomas J., Philadelphia.....	8
Nimmo Alexander, Brooklyn, New York.....	12
Park G. W., Mt. Vernon, O.....	11
Parsons, R. B. & Co., Flushing, N. Y.....	22
Parsons S. B. & Sons, Flushing, New York.....	cover
Phenix, Bloomington, Ill.....	15
Pierson & Dey, Waterloo, N. Y.....	6
Pratt E. H., Dansville, N. Y.....	11
Rakestraw & Pyle, Willow Dale, Chester Co., Pa.....	11
Raoux C., New York city.....	2
Richardson & Kelsey, Geneva, N. Y.....	4
Richardson & Nicholas, Geneva, N. Y.....	4
Roberts Josiah A., Paoli, Pa.....	14
Roe E. P., Cornwall-on-Hudson, N. Y.....	22
Rogers C. B., Phila.....	22
Rolker A. & Sons, New York city.....	Fly-leaf
Rue Maj. Geo. W., Hamilton, O.....	15
Sander F. & Co., St. Albans, England.....	11
Saul John, Washington, D. C.....	15
Scott R., Phila.....	6
Selover & Willard, Geneva, N. Y.....	13
Siddall Robt. J., Phila., Pa.....	11
Smith & Powell, Syracuse, N. Y.....	14
Steffens N., New York city.....	4
Stone J. S., Charlotte, Monroe Co., N. Y.....	14
Storrs, Harrison & Co., Plainville, Lake Co., O.....	14
Straiton & Storm, New York city.....	11
Thornburn J. M. & Co., New York.....	2
Truett's Sons & Morgan, Nashville, Tenn.....	2
Vick James, Rochester, N. Y.....	15
Wampler John, Carthage, Missouri.....	6
Weathered & Cherevoy, N. Y. City.....	16
Weir, D. B., Lacon, Ill.....	11
Westbrook C. W., Wilson, Wilson Co., N. C.....	18
Wheeler W. F., Boston, Mass.....	10
Whitman & Lang, Philadelphia.....	9
Wood Edmund M., Boston, Massachusetts.....	cover

For Situations Wanted, see page 17.

**R. B. PARSONS & CO.,**  
Bowne Avenue, Flushing, N. Y.,

OFFER THEIR

**RARE TREES & SHRUBS**

as well as the well known sorts, and invite the special attention of

**LARGE BUYERS**

To their Stock of **Rhododendrons, Azaleas—Chinese and Ghent—Camellias, Clematis, Hydrangeas, Magnolias** Roses by the 1,000.

**RARE EVERGREENS,**

are well known to be cultivated in large variety by them.  
For Catalogues address

**Box 99, Flushing, N. Y.**

feb.12

**STRAWBERRY PLANTS,**

and other **SMALL FRUITS,** for sale by

**E. P. ROE,**

Author of "Culture of Small Fruits," "Play and Profit in my Garden," &c.

Send for Circular. Address,

**E. P. ROE,**

aug3

**Cornwall-on-Hudson, Orange Co., N. Y.**

**WANTED, A SITUATION** as Gardener in a private, or Foreman in a commercial establishment, by an Englishman, aged 25 years, single; has served nine years in three good places in England; for the last three years has had good practice in the U. S.; is thoroughly well versed in the propagation and cultivation of Stove and Greenhouse Plants, Roses, Orchids, &c., &c., the management of Hot and Cold Graperies; the growing of winter flowers, making of bouquets, and arrangement of cut flowers; also the growing of Vegetables. Character will bear strict investigation. Those in want of a steady, sober and reliable man, can have testimonials and references, by addressing GARDENER, care John B. Nech, Esq., Mount Auburn, Cincinnati, Ohio. aug2

**WANTED** a gentleman to assist me to start a nursery on shares in a good place. I understand the Nursery and Florist Business.

Any one favoring this project will please address

J. X. L., care Col. E. WILKINS,

sep1

Chestertown, Kent Co., Md.

**New Jersey Agriculturist,** 8 page Monthly. Specimen copy free to any address. Although subscription is low, we pay liberal CASH Commissions to reliable agents. Agents wanted in every town in Penna. N. J. Agriculturist, 20 Hiram st, New Brunswick, N. J.

**WANTED,** a position as Farmer and Gardener by a man of experience in both branches; erecting agricultural or horticultural buildings, breeding blood and grade stock, raising of cereal and root crops, agl. machinery, &c.; forcing grapes, peaches, strawberries, stove and greenhouse plants, flower and vegetable gardening; treatment of orchards and vineyards. Address, stating particulars, Post Office Box, No. 88, New Rochelle, N. Y.

**A Hygroscope for 50 cents.**

**THE CHEMICAL HYGROSCOPE.**

This indicator of atmospheric moisture is as accurate as the costliest ones. Rooms heated by furnaces or stoves are almost invariably so dry as to be damaging not only to health but to furniture. Some people take the consequences, others keep water on the heater. The Hygroscope shows at a glance whether the air is too dry or not.

Send by mail for 50 cents. Address,

febtf

**CHAS. H. MAROT, 814 Chestnut St., Philadelphia.**



# WABAN CONSERVATORIES

OFFICE:  
56 BROAD ST., BOSTON.  
Address all Letters to  
BOSTON OFFICE.

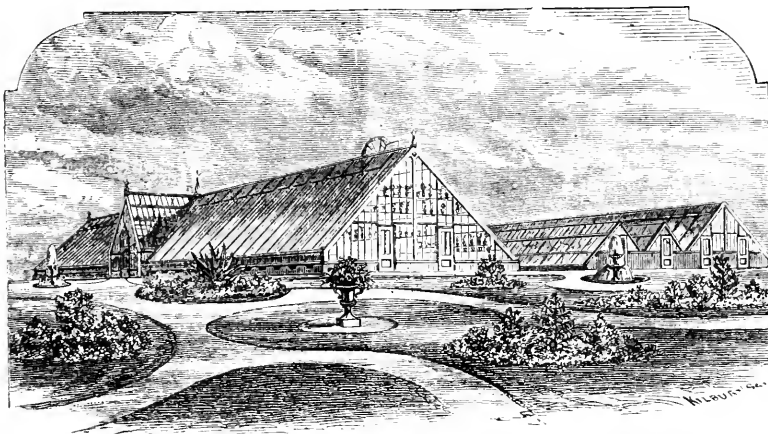

Send all Telegrams by  
Atlantic & Pacific Line. Address,  
*Waban Conservatories,*  
LAKE CROSSING, MASS.

## FALL TRADE 1876.

The following choice **SELECTED NOVELTIES** will be ready for delivery during the coming **FALL**, and to which attention is specially directed.

### ROSE "EDMUND WOOD." (Verdier).

This superb hybrid perpetual we have bloomed and find it fully equal, if not superior, to the description. Its color is richer and slightly darker than Gen'l Jacqueminot, far more double and equally prolific in growth, blooming as freely as that favorite variety. Good plants, on own roots, \$2 each.

### CARNATION "WELLESLEY BEAUTY."

Color soft fine cinnamon, beautifully striped and spotted with carmine rose; habit, free compact and vigorous. A valuable acquisition. 75c, each.

### BRONZE ZONALE GERANIUM "EARL ROSLYN."

Unquestionably the best bronze and gold bedding Geranium yet produced, superior to the acknowledged favorites, Marshall MacMahon and Black Douglass. 50c. each.

### DOUBLE ZONALE GERANIUM.

**P. BUCK.**—Violet and salmon, new and effective color, and a very valuable variety.

**J. C. RODBARD.**—Double salmon red not very double, but beautifully joined and much superior to Asa Grey.

**MADAME THIBAND.**—Rose petals, marked with white at their base, semi-double, but producing a novel and pleasing effect. Also many other new Zonale and other Geraniums, for description of which see Catalogue.

### PELARGONIUM REGAL "QUEEN VICTORIA."

This is one of the most marvellously beautiful novelties ever offered. Color rich vermilion, margined with fine white, and upper petals blotched with deep purple maroon. The flower has thick, crisp petals, which give it the appearance of being double. It is a remarkable and striking improvement in Pelargoniums. \$1.50 each.

### PELARGONIUM REGAL, "BEAUTY OF AXTON."

Similar in form to the above, but quite distinct in color, which is: upper petals rich maroon; centre rose; all the petals being margined with pure white; flowers large and full, having the appearance of being semi-double, and a most beautiful and extraordinary novelty. \$3 each.

**New Hybrid and Tuberosed Rooted Begonias**, many introduced for the first time.

We are making the culture of these really beautiful plants a specialty, and shall be glad to forward price list on application. Also of many other novelties which are in course of propagation.

## FOR FLORISTS' WINTER STOCK.

We shall be able to offer at lowest rates.

**ROSES.**—Bon Silene, Safrano, Isabella Sprant, Marshall Neil, La France, Gen'l Jacqueminot, in 2 and 4 inch pots in large quantities. **CARNATIONS.**—fine plants from open Ground. **IVIES.**—Irish and others. **VINCA ELEGANTISSIMA.** **VIOLETS.**—Neapolitan and Marie Louise. **BEGONIA REX** in variety. **BEGONIA FLOWERING** in variety. **FUCHSIAS**, new. **ADIANTUM CUNIATUM.** **FERNS** in variety by the 100. **RICHARDIA ALBA MACCULATA.** **CALLAS**, &c.

Orders promptly executed. Send for Circular.

# S. B. PARSONS & SONS,

Kissena Nurseries,

Near KISSENA STATION, FLUSHING, N. Y.,

OFFER a very large assortment of TREES and PLANTS of all the best families. Nearly all of them have been two years transplanted, and their roots are thus in the very best possible condition for a second transplanting.

Some of their best specimens can now be seen at the CENTENNIAL GROUNDS, and they are able to furnish good plants of all the sorts there exhibited.

Their Catalogue of

## New and Rare Hardy Trees and Shrubs

is now READY, and will be sent on application. It contains some 65 varieties of NEW

### JAPANESE PLANTS,

including the remarkable JAPANESE MAPLES, and also a large number of new Hardy Plants from Europe. They think themselves safe in asserting that so rich a collection has not before been in this country.

CAMELLIA JAPONICA and AZALEA INDICA can be advantageously shipped during August, September, October and November. These plants are carefully formed and trimmed, and their symmetry is recognized by all who see them.

Rhododendrons and other hardy Evergreens can be safely transplanted in August and September.

*Estimates will be furnished for Planting Grounds under the care of an experienced Landscape Gardener, and much trouble thus saved to the owner.*

Catalogues will be furnished to applicants by mail, and those who wish to visit the Nurseries will always find either one of the proprietors, or J. R. Trumpy, the well-known propagator of the old establishment. They can take the ferries at 34th Street or James' Slip, which connect with the railroad, leaving the first a quarter of an hour, and the last half an hour before the departure of trains, which make the transit in half an hour. The Nursery is adjoining the Kissena Station and one and a half miles from the other stations, from which carriages are free.

## Seeds of Florists' Flowers.

For the Conservatory & the Flower Garden, for Sowing in August & September.

Particular attention is invited to the following list of Seeds of Florist's Flowers, which have been carefully selected from the stocks of several of the most successful cultivators and exhibitors in Europe, and can be confidently recommended

	PER PKT.
<b>Balsam, Double White Camellia-Flowered</b> —For pot culture during winter, much used by florists for bouquets.....	\$0 25
<b>Calceolarias</b> —Extra select, from flowers which took the 1st prize at the late London and Continental Exhibition.....	50
<b>Calceolaria rugosa</b> —From the finest Shrubby varieties.....	50
<b>Cineraria</b> —Extra choice, from all the new varieties.....	50
<b>Cineraria new double-flowering</b> —This is unquestionably the finest novelty in the way of Florist Flowers for the greenhouse that has been sent out for many years; they represent all the modifications of color usually found among Cinerarias, namely, crimsons and magentas in various shades; purples, both light and dark, as well as flowers tipped with different tints of scarlet and magenta, and perfectly double; habit very good; will prove a most desirable acquisition. Packet contains 20 seeds.....	1 50
<b>Cyclamen Persicum</b> —From the finest hybridized varieties.....	50
<b>Gloxinias</b> —The finest erect and drooping varieties.....	50
<b>Hollyhocks</b> —Very double saved from an unrivaled collection of 75 English varieties; if sown now, will flower freely next year. (100 seeds).....	25
<b>Pansy, English</b> —Extra select, saved from the finest prize flowers.....	50
— Finest mixed German varieties, very attractive, from one of the finest continental collections.....	25
— New Fancy—very beautiful.....	50
<b>Primula sinensis fimbriata</b> —Chinese Primrose fringed various colors mixed, extra.....	50
— (New fern-leaved varieties) very beautiful mixed varieties.....	50
— New double varieties, rose and white, each.....	1 00
<b>Pink, Tree or Perpetual Carnation</b> —Continues in flower a long time, extra quality, (20 seeds).....	50
<b>Pink, Carnation and Picotee</b> —Celebrated German collection (20 seeds).....	50
<b>Polyanthus</b> —Finest mixed varieties from the collection of an English Amateur.....	25
<b>Stock</b> —Scarlet and white intermediate London, extra, each.....	25
— East Lothian—Superior for pot culture, scarlet, white and purple, each.....	25
— New German Ten Weeks—Extra fine, many colors mixed.....	25
— New White Wallflower-leaved—A superb variety for pot culture, pure white with large double flowers.....	25
<b>Sweet William, Hunt's New Auricula-flowered</b> —Far surpassing anything hitherto offered.....	25
<b>Tropeolum</b> —Finest mixed varieties, for Winter-flowering in greenhouse.....	25
<b>Wallflower</b> —Extra fine double German.....	25

‡ The entire Collection for \$9.

Collections of twenty varieties of HARDY ANNUALS, BIENNIALS and PERENNIALS, for Autumn sowing, \$1. If sown during the months of August and September, and protected during Winter by a covering of evergreen boughs, will bloom next year.

Catalogue of Bulbous Roots for Autumn planting, 44 pages, beautifully illustrated, mailed to applicants enclosing 10 cents. Address

B. K. BLISS & SONS,

34 Barclay Street, New York.

P. O. BOX No. 5712.



THE  
GARDENERS  
And MONTHLY  
HORTICULTURIST

EDITED BY THOMAS MEEHAN.

Vol. XVIII.

No. 214.

(Combined Magazines, Thirty-first Year.)

**OCTOBER, 1876.**

PUBLISHED BY CHARLES H. MAROT

814 Chestnut Street, Philadelphia.

TERMS—\$2.10 PER YEAR—POSTAGE PAID.

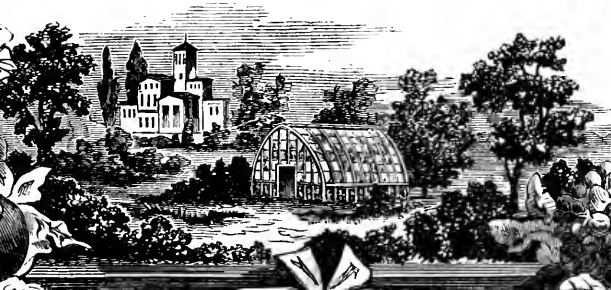

*For Annuals, See*

*J. R. Stockton*

# THE GARDENER'S MONTHLY AND HORTICULTURIST.

EDITED BY THOMAS MEEHAN,

Assisted by an able Corps of AMERICAN and FOREIGN CORRESPONDENTS.

It is published on the first of every month, at the office, No. 814 CHESTNUT STREET, PHILADELPHIA, where all BUSINESS communications should be addressed.  
Communications for the Editor should be addressed: THOMAS MEEHAN, GERMANTOWN, Philada.

SUBSCRIPTION PRICE, postage paid, \$2.10.

## TERMS OF ADVERTISING.

	1/8 col.	1/4 col.	1/2 col.	3/4 col.	1 col.	1 col.	1 page.
One Time,	\$3.00	\$4.00	\$6.00	\$8.00	\$12.00	\$24.00	\$48.00
Two to Three Times, each,	4.70	3.60	5.40	7.20	10.80	21.60	43.20
Four to Six Times, "	2.25	3.00	4.50	6.00	9.00	18.00	36.00
Seven to Nine Times, "	2.00	2.70	4.00	5.35	8.00	16.00	32.00
Ten to Twelve "	1.80	2.40	3.60	4.80	7.20	14.40	18.80

Twelve lines nonpareil is 1/8 col. A less space than 1/8 col., will be furnished at rates in exact proportion, line for line.  
For THIRD and LAST COVER PAGES; FIRST PAGE advertisements facing reading matter; "FLY-LEAF PAGE" (front of number) before reading matter and facing first cover,—special figures will be given on application.  
COPY and orders for NEW advertisements should be in hand by the 23d of each month; and CHANGES of COPY in running contracts by the 16th of each month, to insure them in following issue. Address

CHAS. H. MAROT, Publisher, 814 Chestnut Street, Philadelphia.

## CONTENTS OF THE OCTOBER NUMBER.

### SEASONABLE HINTS:

Flower Garden and Pleasure Ground.....	289-295
Green House and House Gardening.....	295-301
Fruit and Vegetable Gardening.....	301-305

### CORRESPONDENCE:

Landscape Gardeners.....	290
Rhododendrons.....	290
Kills and Cures in the Garden.....	291
Hardy Herbaceous Plants for August.....	291
Destruction of Greenhouse Plants by Gas.....	296
Echeverias for Bedding.....	297
Has the Pear a New Enemy.....	302
On Graft Hybrids.....	306
Notes on the American Grape Vine Mildew.....	307
The Sour and Sweet Apple.....	308
Fruit Variations.....	309
Prairie Flowers.....	309
Laws for Nurserymen.....	312
Let us Profit by the Exposition.....	312
Charles Read on Flowers.....	313
International Horticultural Exhibition, in 1877, at Amsterdam, in the Palace of Industry.....	316
Potomac Fruit Growers.....	317

### EDITORIAL NOTES:

Public Parks—Patents for New Plants and Fruits— Silver-thorn and Pyracantha Hedges—Flowering of the Paulownia in England—American Foliage in Europe.....	293-294
Seeding of Aracaurea excelsa—Winter-flowering Carnations and Bouvardias—Bouvardia—Tuberose in Midwinter—Euphorbia jacquinesflora—Astilbe— A Vase of Simple Flowers.....	297-301
The Thwack Raspberry—Orchards in Gra.—Or-	

chard of Godfrey Zimmerman—Wild Goose Plum— Peasgood's Nonsuch Apple—Dr. Boynton's Pear Orchard—The Apple Crop in Massachusetts—Another Wild Goose.....	303-304
The American Forestry Association.....	305-306
Poisoning by Laburnum—Trees, Rain-fall and the Lakes—Age of the Mammoth Trees—Cocoanut Palm	310-311
Patents for Plants and Fruits—The Judas Tree— The Font Grove Greenhouses—Roses in Ancient Festivals—Monument to M. Louis Van Houtte— Fourth Annual Report of the Kansas State Board of Agriculture—Transactions of the Wisconsin State Horticultural Society—Orchids—Botanical Party....	314-315
The Centennial Exposition—The Pennsylvania Hor- ticultural Society—Roots, Bulbs and Tubers at the Centennial.....	315-320

### NEW PLANTS:

Liatria pycnostachya—Hybrid Pentstemons—Re- tinoporolectoclada—Asperula odorata—Hydrangea, "Thomas Hogg."—Viburnum plicatum—New Trees —A New Hardy Tree, Cedrela sinensis—Quercus Andersoni.....	294-295
New Ampelopsis—Croton Weismanni.....	301

### FORESTRY.....

### NATURAL HISTORY AND SCIENCE.....

### LITERATURE, TRAVELS AND PERSONAL NOTES.....

### HORTICULTURAL SOCIETIES.....

### QUERIES:

Keeping Large Lantanas—Browallia elata—Mig- nonette.....	301
Classification of Fruits—Forcing Rhubarb—The Richland Plum—Summer Hagloe.....	301-305
Classification of the Minute Fungi.....	311-312
Habits of Van Houtte.....	315

# OUR FALL CATALOGUE

Contains a full list of all kinds of

# F L O R I S T S ' S S U P P L I E S

Such as: Bouquet Papers, Imported and Domestic Baskets of Willow, Straw, Grass or Wire; Tin Foil, Wire Designs, Immortelles, Dried Grasses, Preserved and Pressed Ferns, Autumn Leaves, Plantsticks, Pot-labels, &c.

---

## SPECIAL CASH OFFER FOR OCTOBER MONTH,

As long as Stock lasts of Dried Grasses and Immortelles.

Uncleaned Stipa, natural color white, per lb	- - - - -	\$ 1.25
“ “ “ “ per 10 lb	- - - - -	10.00
“ “ if dyed, per lb	- - - - -	2.00
Cleaned Stipa, in half oz. bunches, natural color, per lb	- - - - -	3.75
“ “ “ “ if dyed, assorted colors, per lb	- - - - -	5.75
Fine White Bleached Bromus, per lb	- - - - -	2.00
Assorted Grasses, natural color, per lb	- - - - -	1.00
“ “ dyed, assorted colors, per lb	- - - - -	2.00
Immortelles, <i>natural yellow</i> , \$4.00; <i>white</i> , \$4.75; <i>colored</i> , at \$5.25 per dozen.		

---

## WE HAVE A LIMITED STOCK LEFT OF

Roman Hyacinths, at \$7.50 per 100, fine stock; *Lilium Candidum*, fair size, at \$7.50 per 100; and expect shortly to arrive *Lilium Longiflorum*, *Lancifolium*, &c.; also later on, very fine strong German Lily of the Valley pips, guaranteed three years old, the best kind for early forcing, at \$25.00 per thousand.

We have made arrangements for the importation of French and Luxemburg Roses, and solicit orders for importation. Prices sent on application.

# *AUGUST RÖLKER & SONS,*

*32 READE ST., NEW YORK.*

**RURAL AND PRACTICAL BOOKS,** (and any others in the market not on this list) will be sent by mail, post paid, on receipt of price. Address CHAS. H. MAROT, 814 Chestnut St., Philada.

Allen's, R. L., Diseases of Domestic Animals.....	£1 60	How to Manage a Building Association.....	\$2 00
Allen's, L. F., Rural Architecture.....	1 60	How to Paint.....	1 00
Allen's, L. F., American Cattle.....	2 50	Hunter and Trapper.....	1 00
Allen's, R. L. & L. F., New American Farm Book.....	2 50	Husman's Grapes and Wines.....	1 50
American Architect.....	7 00	Jacqucs' Manual of the House.....	1 50
American Bird Fancier, (Brown's).....	30	Jacqucs' Manual of the Garden.....	1 75
American Farmer's Encyclopedia.....	6 00	Jennings' Cattle Doctor.....	1 75
American Horticultural Annual, paper 50 Cts., cloth.....	75	Jennings on the Horse and his Diseases.....	1 75
American Weeds and Useful Plants.....	1 75	Jennings' Sheep, Swine and Poultry.....	1 75
Apple Culturist, S. E. Todd.....	1 50	Johnson's Gardener's Dictionary.....	3 50
Art of Saw Filing.....	75	Johnson's How Crops Feed.....	2 00
Architecture, Modern American, Cummings & Miller.....	10 00	Johnson's How Crops Grow.....	2 00
Principles and Practice of, By Loring & Jennings.....	12 00	Johnson's Peat and its uses.....	1 25
Baker's Fruit Culture.....	4 00	Johnston's Elements of Ag. Chemistry and Geology.....	1 50
Bassett on Cranberry Culture.....	5 00	Johnston's, J. S. W., Agricultural Chemistry.....	1 75
Barry's Fruit Garden.....	2 50	Kemp's Landscape Gardening.....	2 50
Bell's Carpentry made easy.....	5 00	Kilpart's Farm Drainage.....	1 75
Bement's Poulterer's Companion.....	2 00	Langstroth, Rev. L., on the Hive and Honey Bee.....	2 00
Bement's Rabbit Fancier.....	50	Leach's How to Build Hot-houses.....	1 50
Best Root Sugar.....	1 50	Lechig's, Justus, Familiar Lectures on Chemistry.....	75
Bicknell's Village Builder, 77 plates.....	12 00	Loud's Encyclopedia of Plants.....	20 00
Bommer's Method of Making Measures.....	1 25	Lyman's Cotton-culture.....	1 50
Boussingault's, J. B., Rural Economy.....	1 60	McMahon's American Gardener.....	2 25
Brown's Trees of America.....	6 00	Mayhew's Practical Book-keeping for Farmers.....	90
Bridgman's Book of Flowers.....	1 75	Mechanics' Companion (Nicholson).....	3 00
Bridgman's American Gardener's Assistant.....	2 50	Mechan's Ornamental Trees.....	75
Bridgman's Fruit Cultivator's Manual.....	1 00	Miles on the Horse's Foot.....	75
Bridgman's Kitchen Gardener's Instructor.....	1 00	Miner, T. B., Bee-keeper's Manual.....	1 25
Buis's, Robert, Am. Flower Garden Directory.....	1 50	Mohr on the Grape-vine.....	1 00
Buis's, Robert, Family Kitchen Gardener.....	1 00	Monier on the Garden.....	1 50
Burr's Field and Garden Vegetables of America.....	5 00	My Vineyard at Lakewood.....	1 25
Carpenter and Joiner (R. Riddle).....	7 00	My Farm of Edgewood.....	1 75
Carpenter and Joiner's Hand Book, (Holly).....	75	My Ten-rod Farm.....	50
Chorlton's Grape Grower's Guide.....	75	North American Sylva, 5 vols., 166 col. plates, in 30 parts,	
Chymistry of the Farm, (Nichols).....	1 25	"    "    unbound.....	60 00
Cleveland's Villas and Cottages.....	4 00	"    "    Half Turkey Antique, gilt.....	70 00
Cobbett's American Gardener.....	75	"    "    full.....	75 00
Cole's, S. W., American Fruit Book.....	50	Nichol's Chemistry of the Farm and Sea.....	1 25
Cole's American Veterinarian.....	75	Norton's, J. in P., Elements of Scientific Agriculture.....	75
Copper's Rural Hours.....	2 60	Norris' Fish-culture.....	1 75
Copland's Country Life.....	5 00	Onion-culture.....	20
Dad's, Geo. H., American Cattle Doctor.....	1 50	Our Farm of Four Acres.....	1 25
Dadd's Modern Horse Doctor.....	1 50	Packard's Guide to the Study of Insects.....cloth	6 00
Dana's, Samuel H., Muck Manual.....	1 25	Paul's Book of Roses.....	60
Darwin's Variations of Animals and Plants, (2 vols.).....	6 00	Paul's Rose Garden.....	3 00
Darwin's Insectivorous Plants.....	7 00	Paxton's Botanical Dictionary.....	15 00
DeVoe's Market Assistant.....	2 50	Pardee on Strawberry-culture.....	75
Downing, A. J., Landscape Gardening.....	6 50	Parkman's Book of Roses.....	1 50
Downing's Cottage Residences.....	3 70	Parsons, Samuel B., on the Rose.....	1 60
Downing's Fruits and Fruit Trees of America.....	5 00	Peat and its Uses.....	1 25
Downing's Rural Essays.....	3 50	Pear-culture, Field.....	1 25
Downing's Ladies' Companion to the Garden.....	2 00	Pedder's, James, Farmer's Land-measurer.....	60
Du Breuil's Vineyard Culture, (Dr. Warden).....	2 00	Percheron Horse.....	1 00
Eastwood on Cultivation of the Cranberry.....	75	Peterson's Preserving, Pickling and Canning Fruit.....	50
Elliott's Western Fruit Grower's Guide.....	1 50	Phin on Wine-making.....	1 50
Elliott's Lawn and Shade Trees.....	1 50	Quinn's Pear-culture for Profit.....	1 00
Elliott's Fruit Growers' Hand Book, paper, 60 cents, cloth.....	1 00	Quinby's Mysteries of Bee-keeping Explained.....	1 50
Farm Talk, (Brackett).....	1 00	Randall's Sheep Husbandry.....	1 50
Farming for Boys.....	1 50	Randall's Fine Wool Sheep Husbandry.....	1 00
Field's, Thomas W., Pear Culture.....	1 25	Rand's Bulbs.....	3 00
Five Acres too Much, (illustrated).....	1 50	Rand's Flowers for Parlor and Garden.....	3 00
Flagg's European Vineyards.....	1 50	Rand's Seventy-five Flowers.....	1 60
Flax Culture.....	50	Rand's Flower Garden.....	3 00
Flint, Chas. L., on Grasses.....	2 50	Rand's Orchard Culture.....	3 50
Flint's Milk Cows.....	2 50	Riddell's Architect.....	15 00
Fowler's Hom's for All.....	1 50	Ropp's Commercial Calculator, cloth \$1, Morocco Tuck.....	2 00
Frank Forester's Fish and Fishing, 8 vo., 100 engravings.....	3 50	Rose Culturist.....paper	30
Frank Forester's Manual for Young Sportsmen, 8 vo.....	3 00	Robbins', R., Produce and Ready Reckoner.....	75
French's Farm Drainage.....	1 50	Saunders' Domestic Poultry, paper 40.....	75
Fuller's Grape Culturist.....	1 50	Saxton's Hand Books, in four series, each.....	1 50
Fuller's Small Fruit Culture.....	1 50	Scheneck's Gardener's Text-book.....	75
Fuller's Strawberry Culturist.....	25	Scribner's Ready Reckoner and Log book.....	30
Fuller's Forest Tree Culturist.....	1 50	Song's Cultivation of the Grape.....	3 00
Fulton on Peach Culture.....	1 50	Ten Acres Enough.....	1 50
Geyelin's Poultry Breeding.....	1 25	Thomas, J. J., Farm Implements.....	1 50
Gray's How Plants Grow.....	1 25	Thomas, J. J., Fruit-culturist; old ed. \$3 00; new edition,	3 75
Gray's Manual of Botany.....	2 25	Ville's Chemical Manures.....	1 25
Gray's Manual, Botany and Lessons, in one vol.....	4 00	Warder's American Pomology.....	3 00
Gray's School and Field Book of Botany.....	2 70	"    Hedges and Evergreens.....	1 50
Green on Trout Culture.....	1 00	Waring's Drainage for Profit and Health.....	1 50
Gregory on Squashes, paper.....	30	"    Elements of Agriculture.....	1 00
Guernon on Milch Cows.....	75	"    Earth Closets.....	50
Guide to Fortune.....	1 00	Webster's Dictionary, Unabridged.....	12 40
Harzith's Grape Culture and Wine Making.....	5 00	Wells' Every Man his own Lawyer.....	2 00
Harris' Insects Injurious to Vegetation, clo. \$1; col. engs.....	6 50	Williams, B. S., on Stove & Greenhouse Plants, 2 vols., Ill'd	5 00
Harris on the Pig.....	1 50	Williams, B. S., on Select Ferns and Lycopods.....	2 50
Hatfield's American House Carpenter.....	3 50	Williams, R. S., Orchard Grower's Manual.....	2 50
Henderson's Practical Friculture.....	1 50	Window Gardening.....	1 50
Henderson's Gardening for Pleasure.....	1 50	White's Gardening for the South.....	2 00
Henderson's Gardening for Profit.....	1 50	"    Cranberry Culture.....	1 25
Herbert's Hints to Horsekeepers.....	1 75	Wood's Class Book of Botany.....	3 50
Hoopers on Evergreens.....	3 00	Workingman's Way to Wealth.....	75
Hoopers' Dog and Gun, paper 30 cents, cloth.....	60	Wright's Practical Poultry Keeper.....	2 00
Hop-culture.....	40	Yount on the Horse.....	1 75
How to Buy a Farm, and Where to Find One.....	1 75	Yount's Household Science.....	2 00

# SPECIAL OFFER

TO

# FLORISTS, DEALERS,

AND

# BUYERS IN QUANTITY.

## WINTER FLOWERING PLANTS.

Pot grown and specially prepared. All fine, healthy plants graded in price according to size.

	PER 100.		PER 100
<b>Abutilon, Boule de Neige</b> , white, . . . . .	\$8, \$16 and \$30	<b>Lygodium Scandens</b> (new Japanese climbing Fern),	\$8 and 16
<b>Begonias</b> , all the leading winter-flowering sorts,	6 and 10	<b>Smilax</b> ,	6 and 10
<b>Bouvardias</b> , 6 best winter-flowering sorts.	\$6, 8 and 12	<b>Primula</b> , double white,	35 to 75
<b>Carnations</b> , white,	8 and 15	“ single, red, white, purple and spotted,	8 to 16
<b>Chrysanthemums</b> , white and other varieties,	4 and 12	“ semi-double, white,	16 and 25
<b>Eupatorium and Stevia</b> , in variety,	\$8, 12 and 20	<b>Roses</b> , leading winter flowering sorts,	12 to 25

Five plants of any variety will be sold at hundred rates, but not less than one hundred plants in one order.  
Our Wholesale List from which above is an extract, embraces many hundred varieties besides those named above.

## MIXED HYACINTHS, for Forcing or Bedding.

Ranging according to color from \$7.50 to \$8.50 per 100, extra fine bulbs.

	PER 100		PER 100
<b>Lily of the Valley</b> , in large clumps, . . . . .	\$40	<b>LILIUM CANDIDUM</b> , extra large bulbs,	\$14
“ “ in single crowns,	3	“ <b>Longiflorum</b> , “ “ “	12

## FLOWER SEEDS, for present Sowing.

	PER PKT.		PER PKT.
<b>Verbena</b> , saved from our own collection, \$5 per oz.,	15c.	<b>Apple Geranium</b> , scented, seed of 1876,	30c.
<b>Petunia</b> , finest striped and blotched, \$5 per oz.,	15c.	<b>Double Cineraria</b> ,	75c.
“ double,	30c.	<b>Primula sinensis fimbriata</b> , double red and white,	75c.
<b>Lygodium Scandens</b> , (Japanese Climbing Fern)	30c.	“ “ “ single “ “ “	30c.

## VEGETABLE SEEDS, for Fall Sowing.

<b>Cabbage, Jersey Wakefield</b> , (true) 75c. per oz. \$2 per ¼ lb. \$6 per lb.		<b>Cauliflower, Extra Early Dwarf Erfurt</b> , \$2 per oz. \$7 per ¼ lb., \$24 per lb.
<b>Cabbage, Early York</b> , 40c. per ¼ lb., \$1.25 per lb.		<b>Cauliflower, Early Paris</b> , 75c. per oz., \$2.50 per ¼ lb., \$9 per lb.
“ <b>Early Flat Dutch</b> (true L. Island) 75c. per oz., \$2 per ¼ lb., \$6 per lb.		<b>Lettuce, Curled Simpson</b> , 60c. per ¼ lb., \$2 per lb.
<b>Cabbage, Early Summer</b> , (new), see special list of testimonials,—\$1.50 per oz., \$5 per ¼ lb., \$16 per lb.		“ <b>Curled Silesia</b> , 30c. per ¼ lb., \$1 per lb.
		“ <b>Boston Market</b> (for forcing) 60c. per ¼ lb., \$2 per lb.
		<b>Spinach, Round and Prickly</b> , 10c. per ¼ lb., 25c. per lb.

## FLORISTS' REQUISITES.

Embracing **BOUQUET PAPERS, WILLOW and RUSTIC BASKETS, GRASS BOUQUETS and IMMORTELLS, POT COVERS, WARDIAN CASES, WIRE DESIGNS for CUT FLOWERS** (embracing 30 different patterns), all of which will be sold at lowest wholesale rates.

Our **MONTHLY LIST**, descriptive of above, together with all other articles wanted by Florists and Gardeners, will be mailed **FREE** on application. To our regular customers it will be mailed monthly as usual.

*Peter Henderson & Co.*

SEEDSMEN, MARKET GARDENERS AND FLORISTS,

35 CORTLANDT ST., NEW YORK.

# 50,000 IRISH JUNIPERS, FROM 1 TO 5 FEET.

We can sell them cheaper than any establishment in the United States.  
Send for Price List.

TRUETT'S SONS & MORGAN,  
ROSEBANK NURSERIES,  
Nashville, Tenn.



## BULBOUS FLOWER ROOTS, HYACINTHS,

Superb Double and Single  
Tulips, Crocus, Jonquils, Narcissus Lilies  
Crown Imperials, Snow Drops, Iris, Lily  
of the Valley, Ranunculus, Anemones,  
and other Flower Roots for planting in  
the autumn.

Extra Large and Sound Bulbs,

Received by direct importation, selected  
expressly for my sales. Also, Plants for Winter Blooming,  
for the Window, Garden and Conservatory. Prices moderate. Send  
for my New Illustrated Catalogue, which will be mailed to all  
applicants.

HENRY A. DREEL,  
714 Chestnut Street, Philadelphia.

## IMPORTED DUTCH BULBS

Our NEW DESCRIPTIVE PRICED  
CATALOGUE of the above  
is ready for mailing.

J. M. THORBURN & CO.,  
15 JOHN STREET, NEW YORK.

## STANDARD PEARS.

We offer for fall the finest lot of 2 and 3 years STANDARD  
PEARS in the country. A large assortment of new and stand-  
ard varieties, among them are

50,000 BARTLETTS,  
40,000 CLAPP'S FAVORITE,  
30,000 FLEMISH BEAUTY,  
20,000 BEU. D'ANJOU,  
15,000 SHELDON.

Also APPLES, CHERRIES, PLUMS, DWARF PEARS,  
PEACHES, ORANGE QUINCES, and other Nursery  
Stock.

RICHARDSON & NICHOLAS,  
GENEVA, N. Y.

July 4

A. HENRY & C. HUGO JACQUOT,  
FLORISTS AND NURSERYMEN,  
St. John's River Nurseries and Greenhouses,  
Jacksonville,

toctt

Florida.

## NEW PLANTS--TO THE TRADE.

NEW DOUBLE WHITE DAISY.

The largest and finest white daisy yet offered, flowers perfect-  
ly double. 50c. each.

NEW VARIEGATED LANTANA.

Best variegated bedding plant to stand the sun. Very free  
blooming. 60c. each, \$5 00 per doz., free by mail.

febto

W. A. HARKETT,  
DUBUQUE, IOWA.

## CATALOGUES

OF

E. H. KRELAGE & SON, Nurserymen, Seedsmen and Florists,  
Haarlem, Holland.

JOHN STEWART & SONS, Nurserymen, Seed-men and Flor-  
ists, Dundee, Scotland.

PETER S. ROBERTSON & CO., Nurserymen, Seedsmen and  
Florists, Edinburgh, Scotland.

LEVAVASSEUR & FILS, Nurserymen and Florists, Ussy,  
France.

ANDRE LEROY, Nurseryman, Seedsmen and Florist, Angers,  
France,

GRANGER, Rose Grower, Suisnes, France.

EU ENE VERDIER FILS AINE, Florist; New Gladioluses,  
Roses, Paeonias, etc., a specialty, Paris, France.

V. LEMOINE, Florist; new varieties of Plants a specialty,  
Nancy, France.

ALEGATIERE, Florist; new varieties of Plants a specialty,  
Lyon, France.

C. PLATZ & SON, Seedsmen, Erfurt, Prussia.

WILHELM BUCHNER, Seed Grower, Erfurt, Prussia.

And many other European Nurserymen, Seedsmen and Flor-  
ists. Sent to all applicants, free of expense, as soon as they are  
received for distribution by their Agent,

C. RAOUX,

jantf

Office 76 Park Place,

NEW YORK CITY.

P. O. Box 2956.

## DELAWARE,

New, large and very fine. Also

BRANDYWINE (True), HIGHLAND HARDY, GAM-  
ARGUA, and other

RASPBERRY PLANTS,

In large supply.

A. HANCE & SON., Nurserymen and Florists,

oct tf

RED BANK, N. J.



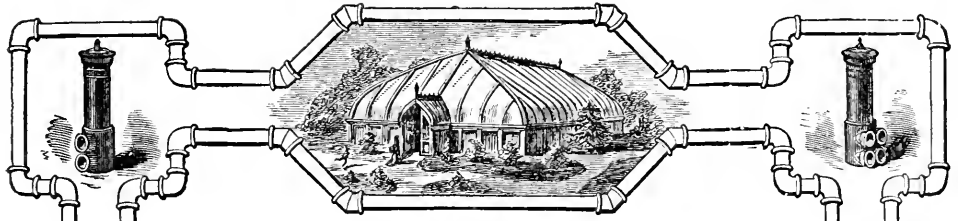

ESTABLISHED 1844.

HITCHINGS & CO.  
No. 153 Crosby Street,  
NEW YORK.

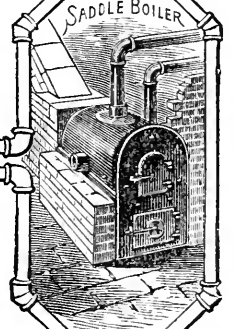
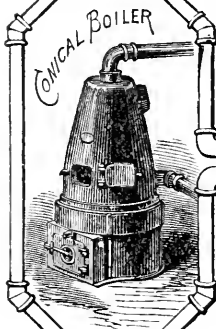

HOT-WATER  
APPARATUS  
for HEATING  
GREEN-HOUSES, &c.

Illustrated Catalogue and List of References and Reduced  
Prices, sent on receipt of postage—6 cents.

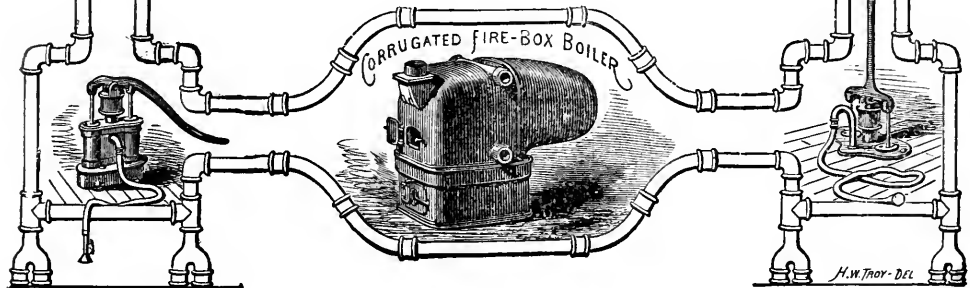

H. W. TROY - DEL.

# Apple Trees!

100,000 very fine, well grown, thrifty Apple Trees, comprising all the leading varieties; Cheap.  
Send for New Trade List.

**HOOPES, BRO. & THOMAS,**

Cherry Hill Nurseries. sep6 West Chester, Pa.

**A. M. C. JONGKINDT CONINCK,**

Tottenham Nurseries,

Dedemsvaart, near Zwolle, Netherlands.

Offers at the Lowest Prices:

**BULBS, FLOWER ROOTS, PERENNIALS, FRUIT TREES, ROSES, MOSS-ROSES, Etc.**

Catalogues gratis on application. oct3

## APPLE, PEACH, PEAR AND PLUM TREES,

and a general assortment of FRUIT and ORNAMENTAL TREES, VINES, SHRUBS, ROSES, &c., &c., SMALL FRUITS, APPLE SEEDLINGS and OSAGE HEDGE PLANTS. The **TEBO RASPBERRY** a specialty. The **Tebo** is a New Early Black Cap, earlier, fully as large and more productive than Doonille or Seneca, and of excellent flavor.

Address, **The Tebo Nurseries Co.,**

oct1 Clinton, Mo.

## POT ROSES.

We offer a large stock of Extra fine **ROSES FROM 3-IN. POTS**, suitable for florists' use. Can be sent safely with or without Balls as desired. Price, \$3 per 100; \$70 per 1000.  
See Lists, now ready. Address,

**THE DINGEE & CONARD CO.,**

oct3 West Grove, Chester Co., Pa.

**30,000**

## Good White Carnation Plants

for winter flowering, from open ground. Price, from \$6 to \$15 per 100. No charge for packing. Address

**J. W. MORRIS,**  
Utica, N. Y.

sep2

## GRAPE VINES.

Grown especially for the Trade and Planters, in Quantity. **Concord, Martha, Delaware, Ives, Hartford Prolific, Salem, Wilder, Agawam, etc., etc.** Also a large assortment of New varieties.

**A. HANCE & SON,**

oct1f NURSERYMEN AND FLORISTS, RED BANK, N. J.

## DUTCH FLOWER ROOTS

Our New Catalogue of the finest kinds of **HYACINTHS, TULIPS, LILIES, NARCISSUS, CROCUS**, and a great variety of other desirable Flowering Bulbs, for the house or garden, with practical directions for culture, sent free to all on application.

**HOVEY & CO.,**

sep3. 53 North Market St., Boston, Mass.

## APRICOTS & NECTARINES

One year 3 to 5 feet and 2 to 3 feet, in large quantities. **Very Cheap.**

Send for new Trade List.

**HOOPES, BRO. & THOMAS,**

Cherry Hill Nurseries. sep2 West Chester, Pa.

## DOUBLE TUBEROSE BULBS.

Very superior in quality.

	Doz.	100	1000
First Quality Large Flowering Bulbs,	\$ .75	\$4.00	\$30.00
Second Quality Flowering Bulbs,	.50	3.00	20.00
A few hundred EXTRA Large Bulbs,	1.00	5.00	
Dwarf Pearl, 1st quality Flowering Bulbs,	1.50	6.00	

If sent by Mail 25 cents per dozen EXTRA.

**MILLER & HAYES,**

toct6 5774 Germantown Avenue, Philadelphia,

**THAT**

## RASPBERRY,

**THE THWACK** leads all other sorts in prolificness, hardness, firmness, size, color and flavor. Endorsed as the best by J. C. Evans, President of the **Missouri State Horticultural Society** and hundreds of others who have fruited it.

The **Pike County Horticultural Society** at its July session, 1876, resolved as follows: "That the **Thwack Raspberry**, as grown at Foster's Hillside Nursery, Louisiana, Mo., possesses more fine qualities for market or table uses than any other Raspberry we know of. Its extreme hardness and prolificness as well as its superior shipping qualities, large size, brilliant color, and good flavor, make it a favorite wherever known." Unanimously adopted.

Address with stamp for circular.

oct2 **Foster's Hillside Nursery Co., Louisiana, Mo.**

## FARMERS!

## \$16 FORGES,

**FOR YOUR FARMS!**

**ALSO, A COMPLETE "KIT OF TOOLS."**

Just what is wanted. Send three-cent stamp for circular to **EMPIRE PORTABLE FORGE CO., Troy, N. Y.**

## N. STEFFEN'S WIRE WORKS,

335 E. 21st St. New York.

Manufacturer of all designs for **FLORISTS**. Wreaths, Crosses, Crowns, Hearts, Anchors, Pillars, Columns, Monuments, Bells, Composure, Faith, Hope and Charity, Harps and Lyres, &c. Leaning and Upright

Send for Price List.

Jan 12.

## B. T. BABBITT'S BABY SOAP

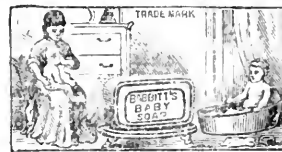

Only the purest vegetable oils used in its manufacture. No artificial and deceptive colors to cover common and deteriorated ingredients. UNRIVALLED for the TOILET and the BATH. Used in bathing children, will protect eruptions, keep the skin soft and smooth, contribute to health, and prevent disease. Does away with all powders, chalk or other emollients. A certain preventive of *choking*, *teething*, &c., in babies, the causes of half the crying and crossness of babyhood. Worth ten times its cost to every mother and family in Christendom; packed in boxes of 12 cakes of 6 ozs. each, and sent free to any address on receipt of \$2.50. Address, **B. T. Babbitt, N. Y.**

For Sale by all Druggists. **15, T. Babbitt, N. Y.**

## CARNATIONS AND BOUVARDIAS.

Best Winter-blooming varieties (**LARGE PLANTS**), \$3.00 per dozen. \$15.00 per 100.

**CARNATIONS.**

Perfection **WHITE**, La Purite **PINK**, Var. La Purite **PINK** and **WHITE**, Meteor **SCARLET**, and President DeGraw **WHITE**

**BOUVARDIAS.**

Davidsoni **WHITE**, Elegans **SCARLET**, Hogarth **CRIMSON**, Sciantha **SCARLET**

For sale by **MILLER & HAYES, Mount Airy Nurseries, Phila.**



**WE OFFER**  
FROM OUR  
**LARGE AND SELECT LIST OF ROSES**

Fine plants of all the LATEST and CHOICEST VARIETIES, grown on their OWN ROOTS, and ready for delivery at any time

AFTER OCTOBER 1st.

We can also supply all the NEW and BEST VARIETIES of

HARDY ORNAMENTAL TREES AND SHRUBS,

**EVERGREEN AND DECIDUOUS,**

For planting in Lawns, Yards, &c.

ROSE and PLANT CATALOGUES sent on receipt of 3ct postage stamp.

tsep2

MILLER & HAYES, Mt. Airy Nurseries, Philadelphia.

**LARCHES, EVERGREENS!**

LARGEST STOCK IN AMERICA.

BOTH SEEDLINGS AND TRANSPLANTED TREES.

All grown from seed on our own ground, and better and cheaper than imported stock.

EUROPEAN LARCH AND EVERGREEN TREE SEEDS,

by the ounce, pound and 100 pounds. Send for Catalogue.

ROBERT DOUGLAS & SONS,

Waukegan, Ill.

tsep3

**JOHN DICK'S PATENT BOILER**

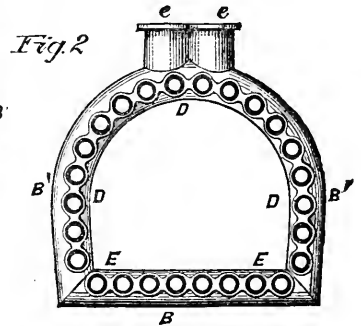
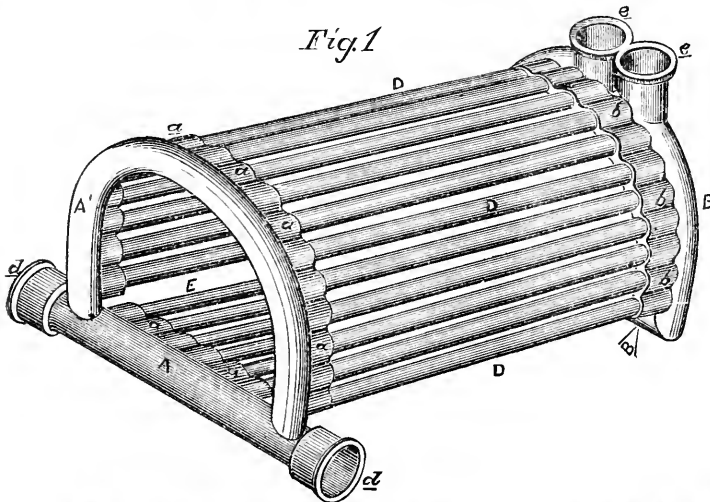

**Economy, Simplicity and Durability.**

SEND FOR CIRCULAR.

**J. DICK, Florist,**

53d & Darby Road, Philadelphia, Penna.

sep6

# R. LYNEK,

Rear of 428 Walnut Street, Philada.

Manufacturer of Plain and Fancy Wire-work, for Florists; Wreaths, Crosses, Stars, Crowns, Hearts, Birds, Lambs, Gipsy Baskets, Hanging Baskets, Flower Stands, &c.

SEND FOR PRICE LIST.

aug6

# CAMELLIAS.

A fine stock of the above, different sizes, mostly Double White, well set with buds.

R. SCOTT,  
755 South 19th St.,  
PHILA.

aug8

## NOTICE.

Owing to the unprecedented dull times, I beg leave to make the following liberal offer: 50 Greenhouse plants for \$5 00, packing included, and containing numerous new plants of this season's introduction. Florists will find them very desirable for stock, and Amateurs will find them equally useful for greenhouse or room culture. If purchasers will send me the names of those they possess I shall send them entirely distinct sorts. Any plants not wanted I can send something of same value. One each of the following: Fuchsia procumbens, Nertera depressa, Verbena Little Giant, Abutilon Boule de Nègè, Double White Achillea, Adiantum, Azalea, Calla, Chorizema varia, Large Fruit Lemon, New Coleus, Cyrtopodium insigne, Cuphea hyssopifolia, Dicharisandra undata, Croton, Dracaena, Echeveria, Eupatorium, Fittonia, Heliotrope Juliette, Inja pulchella, Kleinia repens, Lantana, Double White Lychnis, Lycopodium, Maranta, Smilax, New Double White Oleander, Passion flower, Pteris Argyrea, Retinaspora plumosa aurea, Fairy Rose, Yucca recurva, Cactus, Sanchezia, Iris iberica, Rhynchospermum Jas. var. Barbarea, Bouvardia, Double Ivy leaf Geranium, 2 Hydrangea Otaksa, 4 distinct Geraniums, 2 Begonias, 3 Ferns assorted.

For 50 cents extra will be added a plant of Ficus Parcellii, new; the prettiest variegated plant introduced for years. Hydrangea Otaksa, trusses 20 inches in diameter. Good plants for propagation, \$2 per dozen. Prepaid by mail if desired. Pteris Argyrea \$10 per 100.

Nertera depressa spreads over the surface like moss and covered with scarlet berries, resembling coral beads, \$1 50 per dozen. Bronze Geranium, Earl Rosslyn, \$2 50 per dozen. Sonerila Margaritacea, beautiful, 50 cents each. 3 distinct Marantas for \$1.

## WANTED.

Plants of the following of any size in exchange for new and rare plants. "See Catalogue, mailed on application." Alocasias Sedenii, Metallica, Lowii, Zebrina, Ananassa sativa var., Anthurium, Scherzerianum; Maranta Veitchii; Aralia reticulata and Veitchii; Cephalotus follicularis; Lasiandra Macrantha floribunda; Nepenthes in sorts; Pavetta Borbonica, Terminia elegans. Adiantum Excisum multifidum, Hendersonii, Veitchii; Caladium, Princess of Teck, Yucca quadricolor and filamentosa var.

GEORGE FOUST,

sep2 2825 Frankford Ave., Phila.

## 20,000 AGENTS WANTED!

TO CANVASS FOR

400 PAPERS and MAGAZINES, which are furnished at Club Rates for single copies. Book and other agents can act without interfering with present business. Good pay, easy work.

sep4 C. W. BENNETT, Gen'l Agent, Quincy, Mich.

## Irish Junipers

AND

## SIBERIAN ARBORVITÆ.

All sizes at greatly reduced prices. Send for New Trade List.

HOOPES, BRO. & THOMAS,

Cherry Hill Nurseries. sep2 West Chester, Pa.

# ROSES! ROSES!

We offer a large stock of

## Roses from open Ground.

All on own Roots.

	Per 100.	Per 1000.
Hybrid Perpetuals, 1st class, 2nd size	\$12	\$100
Climbers, Prairie, assd., first class	8	70
Misses, extra strong, 2 yr., fine	12	100
" " " " " " " "	20	
" " " " " " " "	15	

Lists on application. Address,

The Dingee & Conard Co.,  
tact3 West Grove, Chester Co., Pa.

## OSAGE ORANGE.

Quality prime, prices low. Special rates by the 10,000 and upwards.

A. HANCE & SON.,

octtf Nurserymen and Florists, Red Bank, N. J.

## PEACH TREES

1 year from Bud, 4 to 7 feet.

## APPLE TREES.

5 to 7 and 6 to 8 feet.

## CHERRY TREES.

4 to 7 feet, including Luelling the largest cherry known Also a general assortment of FRUIT and ORNAMENTAL TREES at prices to suit the times. Address,

RAKESTRAW & PYLE,

oct1 Willow Dale, Chester Co., Pa.

# Wood Labels

For Trees and Plants, superior quality, made of best white Pine.

## LARGE STOCK

Constantly on hand. Address,

## TREVOR & CO.,

LOCKPORT, N. Y.

oct3.

## GRAPE VINES.

Concord, 1 year, No. 1. \$20 per 1000  
Ives' Seedling, 1 year, No. 1. 25 " " "

oct1 JOHN GRAVETT, Lancaster, Fairfield Co., O.

CIRCULAR.

THE NEW

# Japanese White Flowering HYDRANGEA, "THOMAS HOGG."

We have great pleasure in announcing to the Horticultural world, that the distribution of this fine plant, the most superb novelty in plants ever introduced into this country, will commence on **October 1st, 1876**. It has received the unqualified admiration of all American and European Florists and Nurserymen who have seen it in flower.

Orders will be received at the following rates:

<b>One Plant \$5.</b>	<b>Where 12 Plants are taken,</b>	<b>2 additional sent.</b>
" 25 "	" " "	5 " "
" 50 "	" " "	12 " "
" 100 "	" " "	25 " "

This, the finest of all Hydrangeas, was sent to the United States by Mr. THOMAS HOGG, from Japan. It has been exhibited in flower at the Massachusetts Horticultural Society weekly meeting in Boston, where it took the Society's silver medal for new plants; and also, at the New York Horticultural Society's monthly meeting in May. In the report of that meeting to the "American Agriculturist," by Mr. Peter Henderson, he says:—"We think it safe to say, that no ornamental plant ever introduced exceeds this in value."

It belongs to the Hortensia section of the family, but is a far more free and abundant bloomer than any other, for the Florist, and for all decorative purposes it will be invaluable; the flowers are of the purest white, of very firm texture, and continues in flower for a great length of time. It will no doubt prove quite as hardy as the old Hortensias.

All ordering 12 plants, or more, will get a large plant (included in the number, at regular rates,) suitable for exhibition next spring.

All orders must be sent to **JOHN CADNESS, FLUSHING, L. I., N. Y.**

Cash must accompany the order, and all remittances by Draft or Post Office Order, or Bank Cheque, as we cannot be responsible for the safety of greenbacks by mail.

JOHN CADNESS.

Flushing, Sept. 1st, 1876.

toct12

## P. & E. TRANSON, NURSERIES, ORLEANS, FRANCE,

Beg to inform their friends and customers generally that their

### NEW LIST FOR 1876 AND 1877,

Is now ready, and may be had on application to

### MESSRS. KNAUTH, NACHOD & KUHNE, 113 BROADWAY, NEW YORK.

This Catalogue contains Prices of all the **FRUIT TREE STOCKS**; an extensive list of **FRUIT TREES**, New and Hardy **ORNAMENTAL PLANTS**, **CLIMBERS**, the Hardest and Best **CONIFERS**, **ROSES** on their own roots. Also, **SMALL CONIFERS**, **DECIDUOUS** and **EVERGREEN ORNAMENTAL TREES**, one or two years' Seedlings, most useful for Nurserymen.

 N. B.—The greatest attention given to packing.

oct5

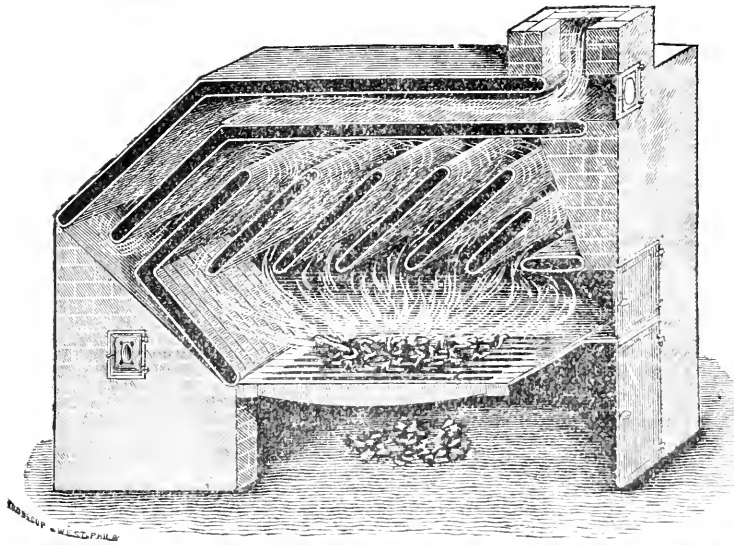

THOMAS J. MYERS,  
PATENT BOILERS  
AND  
**Hot Water Apparatus**

FOR HEATING

Greenhouses,  
Hot-Houses,  
Conservatories, &c.

THOMAS J. MYERS & SON,

1162 Passyunk Ave.,  
PHILADELPHIA.

2, 4, 6 & 8 Home Street, Cin-  
cinnati, O.

Please send for Descriptive Cir-  
cular and Price List. [tjuef]

# GRAPE VINES.

Also GRAPE WOOD and CUTTINGS. LARGEST STOCK IN AMERICA.

All leading varieties in large supply. Extra Quality. True to name. Special rates to Agents, Dealers and Nurserymen. Our list of customers now embraces nearly all the leading nurserymen in the country, to whom we would refer those not acquainted with our stock. Descriptive Catalogue and Price List Free. T. S. HUBBARD, Fredonia, N. Y. aug10

## AN ARBORETUM AT THE CENTENNIAL.

Visitors to the CENTENNIAL EXHIBITION are invited to examine the ARBORETUM planted on the Horticultural Grounds by

**THOMAS MEEHAN, Nurseryman,**  
GERMANTOWN, PHILA.

The collection embraces nearly EIGHT HUNDRED Species or well marked varieties, all named for the information of Visi-  
tors, and is believed to be one of the most complete collections of hardy vigorous plants ever got together in this latitude. may5

M. M. BAYERSDORFER & CO.,

Importers of Every description of

### BOUQUET PAPERS.

Plain White Satin for Bridal Bouquets. Fancy Lace for Weddings, Receptions, Parties. Italians, Pasted Cartons, Immortelles in great varieties; Green Moss, French Dried Grasses and Flowers. Tin Foil. Prize Medal of Cincinnati Industrial Exposition of 1873 awarded to us for the best display of Bouquet Papers. Illustrated Catalogue furnished on application.

feb

56 N. Fourth St., Philadelphia, Pa.

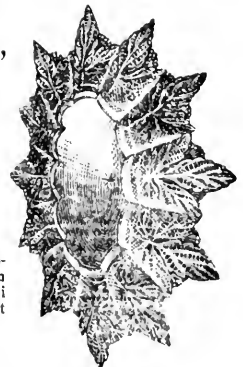
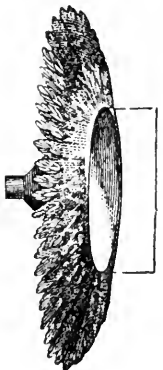

# ELLIS' BASE BURNING BOILER.

FOR WARMING Dwellings, Greenhouses, Graperies, Forcing Pits, Drying Rooms Heating Water for Public Baths, Baptisteries, &c., by Hot Water or by Steam.

Estimates and Circulars furnished. t. sep. 12. 182 CENTRE STREET, NEW YORK.

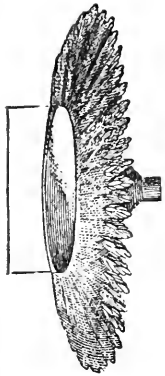

BOUQUET PAPERS.

ROWLAND WHITMAN.

## WHITMAN & LANG,

IMPORTERS OF

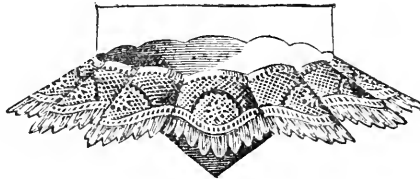

DRIED FLOWERS, IMMORTELLS, TIN FOIL &c.

augtf. No. 126 N. 4th St., Philadelphia.

HARRY LANG.

FANCY GRASSES

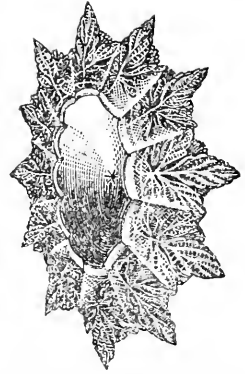

## GERMANTOWN NURSERIES, PHILADELPHIA.

GORGAS LANE STATION, CHESTNUT HILL RAILROAD. Less than One Hour from the Centre of Philadelphia.

Those who desire to purchase largely, either for their own planting or to sell again, are invited to examine the extensive stock of

### FRUIT, SHADE AND ORNAMENTAL TREES AND SHRUBS,

Grown at the Germantown Nurseries. And those who need but A FEW ARTICLES, will find all ages and sizes to select from. A special feature of the business, is the raising of

Nursery Stock and Seedling Forest Trees

FOR DISTANT SHIPMENT. Many of these can be supplied by the millions at very low rates. Address, for CATALOGUES or Information,

THOMAS MEEHAN, Germantown Nurseries, Phila.

## THE CENTENNIAL TREE AND SHRUB SEEDS.

Visitors to the CENTENNIAL are invited to examine the collection of Tree Seeds, comprising over

THREE HUNDRED KINDS

of species, hardy in the greater part of the United States, and on exhibition in the AGRICULTURAL HALL, (At G 16) by

THOMAS MEEHAN,

COLLECTOR AND DEALER IN TREE SEEDS,

may5

GERMANTOWN, PHILA.

### THE OFFICIAL GUIDE BOOK TO PHILADELPHIA AND CENTENNIAL EXHIBITION.

By THOMPSON WESTCOTT.

Author of the History of Philadelphia. The only full and complete Guide Book. Illustrated with two maps and 93 engravings. 425 pages, 16mo, Cloth, \$1.50; Morocco, \$2.00. Mailed, post-paid, on receipt of price.

Address

CHAS. H. MAROT,  
814 Chestnut St., Phila.

Visitors Guide to the

### Centennial and Philadelphia.

Only authorized Guide Book on 'Centennial Grounds. Map of Centennial Grounds, Map of Philadelphia, 48 pages, 12mo, mailed for 30 cents. Address,

CHAS. H. MAROT, 814 Chestnut St., Phila.

# WHEELER'S INSECT ANNIHILATOR, LIQUID DISTRIBUTOR

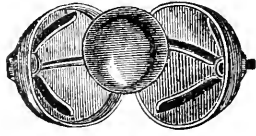

AND

INSECTICIDES.

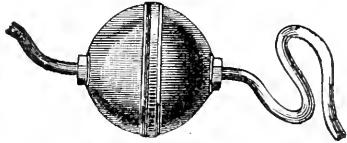

Compound Liquid Hose Distributor,  
Price \$5.00.

Patented July 20, 1875.

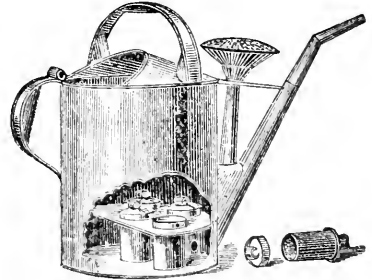

Compound Liquid Watering Pot,  
Average size, \$6.00.

These devices attached to hose pipe of aqueduct or force pump, and operated by water under pressure, and the Watering Pot constructed under the same patent, are the best ever yet used for destroying insects (Potato Bug and Currant Worm not excepted) on plants under glass or in open air, or for fertilizing the same. Fumigation unnecessary. Compound of Tobacco, Sulphur, Guano, in 5 lb. Boxes, 15c. per lb.; of Paris Green and Hellebore, 30c. per lb.

## INSECT ANNIHILATOR & FERTILIZER DISTRIBUTOR

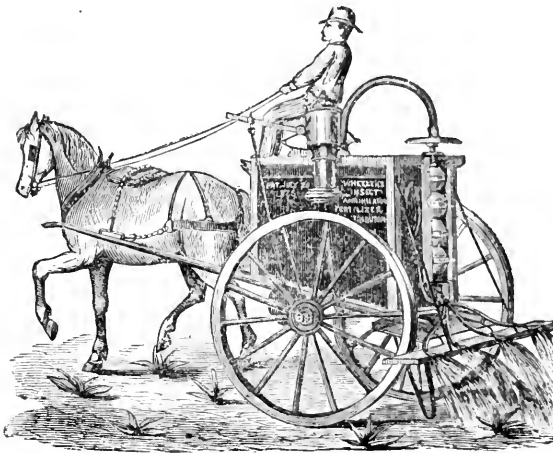

is operated by horse for field use, distributing any desired liquid compound in rows broadcast, or on trees. It is also a powerful Fire Engine, throwing an inch stream from 50 to 75 feet.

PRICE \$200.

## Liquid Fertilizer Distributor

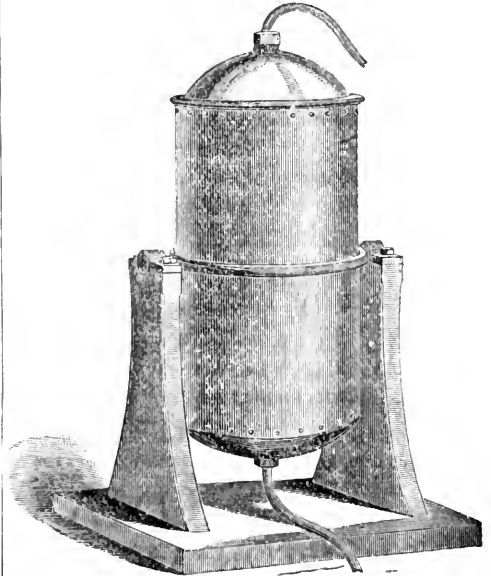

To reduce solid manures, coarse or fine to liquid form, and distribute the same under pressure through hose pipe.

PRICE \$50.

These Machines and Insecticides are on exhibit at the Centennial Exposition, and can be seen in practical operation on the grounds. Above goods delivered C. O. D. Highest testimonials with descriptive circular sent on application.

julytf.

W. F. WHEELER, 24th Ward, Boston, Mass.



EUROPEAN ADVERTISEMENT.

Rare Lilies and Plants,  
VERY CHEAP.

Descriptive Catalogue and Trade-list of Lilies, etc., will be forwarded, post free, to all applicants.

J. VANDER SWAELMEN,

The Lily Nursery,  
Gendbrugge-Ghent, Belgium.

P. S.—I beg Nurserymen to send me their catalogues. oct1

**CHERRIES.**

Largely of Early Richmond, with a good assortment of Hearts and Bigarrecaus.  
Send for new Trade List.

HOOPES, BRO. & THOMAS,

Cherry Hill Nurseries. sep2 West Chester, Pa.

13th Year---300 Acres---10 Greenhouses,

FLORISTS AND NURSERYMEN,

Don't fail to see our trade list prior to purchasing. Prices DOWN, DOWN!  
The largest stock in the west of

CARNATIONS, ROSES, STEVIA EUPATORIUM,  
SMILAX. BOUVARDIAS,

and all other Winter Blooming Plants.

MILLIONS of Apple Seedlings, Honey Locust and Osage Orange.

An immense stock of FRUIT TREES,

SMALL FRUITS AND ORNAMENTALS.

SPECIAL INDUCEMENTS in the way of freight for Southern and extreme WESTERN TRADE. Correspondence in French and German.

Lists free. Address,

sep2 ENNIS & PATTON, Clinton, Iowa.

SPECIAL NOTICE.

In order to reduce my immense stock, I shall offer for the Fall and Spring trade, in addition to my usually full assortment of older nursery stock, the following

ONE YEAR OLD TREES,

100,000 STANDARD PEAR,

25,000 PLUM, ON PLUM STOCKS,

25,000 DWARF PEAR,

25,000 CHERRY,

which in size and quality are unsurpassed by any in the State. This is a rare opportunity for Southern and Western Planters or Dealers to buy a class of stock not often to be found in the market.

A full description of this stock, with list of varieties, prices, terms, &c., will be given on application.

Address,

E. H. PRATT,

Dansville, Liv. Co., N. Y.

aug3

TO THE TRADE ONLY.

Begonia Froebeli

First-class Certificate, Royal Hort. Society, London, Aug. 4, 75. Silver Medal, Lyons, September 11, 1875. Gold Medal, International Exhibition, Cologne, August, 1875,

As the best New Flowering Plant.

We offer this, the grandest novelty of late years, in extra large sound and heavy bulbs, at 10s. 6d. per 12, 20s. per 25, 36s. per 50, and 70s. per 100. For full description, see our catalogue of new Bulbous Plants, Lilies and other Bulbs. Should be in the hands of every seedsman and nurseryman, and will be posted on application to

F. SANDER & CO.,  
Seed Growers,

ST. ALBANS, ENGLAND.

tsep2

APPLE STOCKS.

A fine lot 2 year Apple Roots. Price, packed and delivered to R. R., \$5 per 1000. Address,

THE DINGEE & CONARD CO.,

oct3

West Grove, Chester Co., Pa.

New PEACHES.

Alexander's Early, Amsden's June, Steady, Leather-bury's Late, Tuckahoe Late, Bilyew's Late October (Bilyew's Comet), Brandywine and twenty other varieties of merit.

A. HANCE & SON.,

oct1f NURSERYMEN AND FLORISTS, RED BANK, N. J.

THE GREAT HARD TIMES PAPER. The Best, the Cheapest, and the Most Popular. You cannot afford to be without the CRICKET ON THE HEARTH.

It is a mammoth 16-page illustrated paper (size of *Harpers' Weekly*), filled with the choicest reading for old and young. Serial and Short Stories, Sketches, Poems, Useful Knowledge, Wit and Humor, "Answers to Correspondents," Puzzles, Games, "Popular Songs," etc., etc. Lively, entertaining, amusing, and instructive. The largest, handsomest, best, and cheapest paper of its class published. Only \$1 per year, with choice of three premiums: the beautiful new chromo, "Yes or No?" size 15 x 19 inches; any one of the celebrated novels by Charles Dickens, or an elegant Box of Stationery. Paper without premium, only 75 cts. per year. Or we will send it Four Months on trial for only 25 Cents.

Specimen copy sent on receipt of stamp. Agents wanted. Address, F. M. LUPTON & CO., Publishers, 37 Park Row, New York. oct2

Gray, Dry Faded and Falling  
HAIR

Is now restored to its natural condition by the use of

WOOD'S IMPROVED HAIR RESTORATIVE.

The IMPROVED ARTICLE is now taking the lead over all others, leaving the hair clean, soft and glossy. C. A. COOK & CO., Chicago Sole Agents for the United States and Canada. Sold by all Druggists everywhere. Trade supplied by J. F. HENRY, CURRAN & CO., New York. oct5

TOBACCO STEMS,

For Fumigating purposes, for sale in bales of about 400 lbs., free on boat or cars at \$5 per bale, or three bales for \$12 on one order.

STRAITON & STORM,

178 & 180 Pearl Street,  
New York City.

aug12

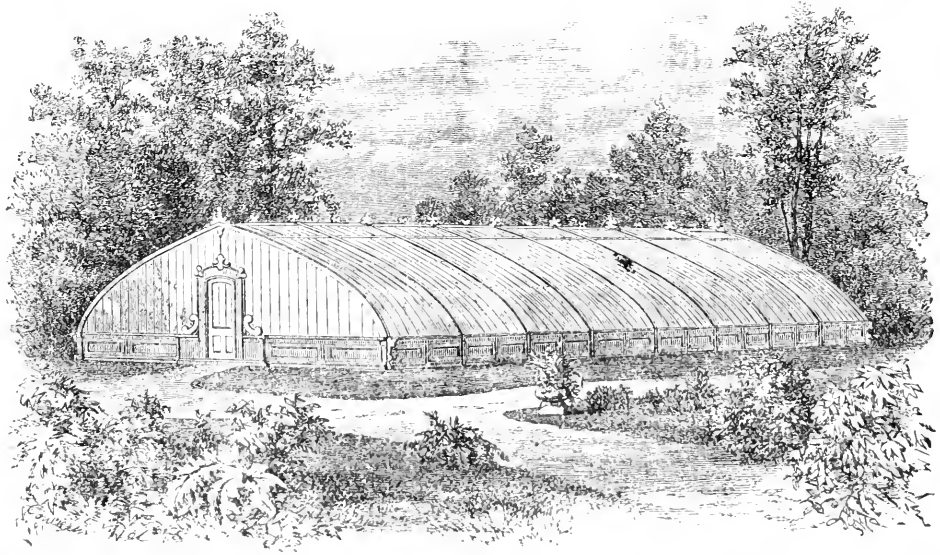

# GREENHOUSES, GRAPERIES, ETC.

Their Construction a Specialty. Experience of 20 Years.  
 SHIPPED TO ALL PARTS OF THE COUNTRY. Send for Catalogue. Address,  
 LORD'S HORTICULTURAL WORKS,

June 12

Irvington-on-Hudson, New York.

## ALEX. NIMMO,

(Late of the Firm of Nimmo & Scollay.)

# NEWLY IMPROVED HOT WATER BOILER,

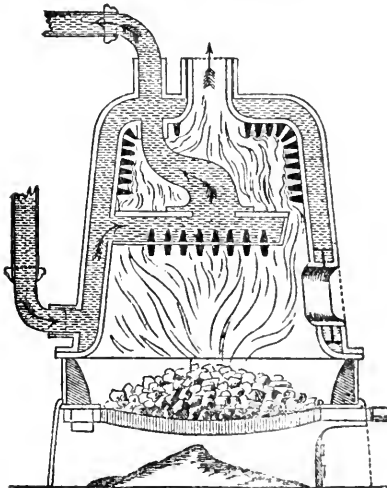

FOR HEATING  
 Green-Houses, Graperies, Conservatories,  
 Forcing Pits, Water for Baths, Drying  
 Rooms, Public and Private  
 Buildings, &c.  
*Proper steps have been taken to secure United States  
 Letters Patent on this Invention.*

All the necessary Fittings for Hot Water Heating Apparatus.  
 VENTILATION APPARATUS OF ALL KINDS.

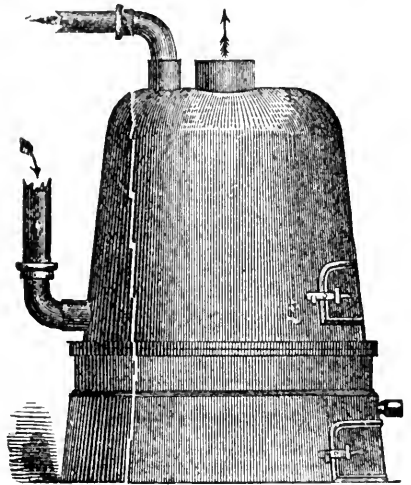

Wells Drove, Pumps of all kinds, Hydraulic Rams, &c., Garden Sun-Dials.

Agent for Joseph Kelly's Never Dry Vapor Pans, for all kinds of Hot Air Furnaces, Baltimore Heaters, &c.

CHEAPEST AND BEST BOILER, &c., IN THE MARKET.

Please send for Circular for explanation, etc., before you make up your mind to purchase elsewhere.

sep 12

P. S.—Be sure you get the right number.

335 Adams Street, Brooklyn, N. Y

# NEW AND RARE FRUIT AND ORNAMENTAL TREES, SHRUBS, &c. FOR FALL 1876.

We have the pleasure of offering the following :

## NEW AND VALUABLE FRUITS.

**PEARS**, the following and other valuable new sorts, **Souvenir du Congres**, **Brockworth Park**, **Petite Marguerite**, **Beurre de l'Assomption**, **Mount Vernon**, **CHERRY: Montmorency Ordinaire**, the largest and finest of all the hardy Early Richmond class.  
**PEACHES: Amsden's June**, **Alexander**, **Early Beatrice**, **Early Rivers**, **Early Louise** and other recent fine early sorts.

## New & Rare Ornamental Trees & Shrubs

**Birch**, the following elegant new varieties: **Young's New Weeping**, considered the finest of the class; **Purple-leaved**, very striking; **Pendula elegans**, a very graceful drooping tree; **Fastigiata**, erect and pointed, like a Lombardy Poplar.

We also invite attention to our general **NURSERY STOCK**. In the departments of **Hardy Fruit Trees**, **Ornamental Trees**, **Shrubs**, **Roses**, etc., the collections are the most extensive and complete in the United States.

Full particulars in the following Catalogues, which will be mailed prepaid on receipt of stamps as noted: No. 1. Fruits, with colored plate, 15 cts.; plain, 10 cts. No. 2. Ornamental Trees, etc., with plate, 25 cts. No. 3. Greenhouse; No. 4. Wholesale, and No. 5. List of New Roses, Free. Address,

Mt. Hope Nurseries.

tsep2

ELLWANGER & BARRY, Rochester, N. Y.

# GRAPE VINES.

The largest assortment of STANDARD as well as NEW varieties. Plants of EXCELLENT QUALITY are offered for Fall Trade at GREATLY REDUCED RATES. Price list free.

Our Illustrated and Descriptive Bushberg Catalogue (80 pages) by mail, post-paid, for 25 cents. Address,

BUSH, SON & MEISSNER,

Bushberg, Jefferson County, Mo.

sep2

## CLEMATIS.

50 Varieties, 2 and 3 years, grown in 5 inch pots. A large stock of **JACKMANNI**, fine plants. Send for New Trade List.

HOOPES, BRO. & THOMAS,

Cherry Hill Nurseries. sep2 West Chester, Pa.

## BACK VOLUMES

OF THE

## Gardener's Monthly

Can still be had in numbers, per year	\$2 10
Bound in neat cloth cases, including numbers,	3 00
" " Roan	3 15

Delivered postage free.

Or mail us your own numbers, and have them bound in cloth cases for 90 cents. Return them to you postage free. Address,

CHAS. H. MAROT,

814 Chestnut Street,

Philadelphia.

## NURSERY STOCK.

FOR FALL, 1876.

We offer in large or small quantities a very complete assortment of both

FRUIT and ORNAMENTAL TREES, AND SHRUBS,

including STANDARD and DWARF APPLE and PEAR, PLUM, CHERRY, PEACH, and SMALL FRUITS.

OUR ORNAMENTAL STOCK IS A No. 1. in every particular.

A large part of our stock must be dug, and will therefore be sold very low.

Special rates given to large buyers. Price-list free.

SELOVER & WILLARD,

sep3

Washington St. Nurseries, Geneva, N. Y.

## CARNATION PINKS.

Varieties President DeGraw and La Purite. Several thousand offered for sale by

EDWARD DELAHUNT,

oct1

CHESTER, PA.

## LONDON GARDENER'S CHRONICLE

Will be furnished, post-paid, direct to subscribers in the U. S. for \$7 50 per year. Specimen Nos. 3 cent stamp. Apply to  
CHAS. H. MAROT, Agent, 814 Chestnut St., Phila.

nov1

**NURSERY STOCK,**

FALL OF 1876.

The **LARGEST** and **FINEST**

STOCK OF

**Dwarf Pears, Cherries, Apples  
and Crab Apples,**

in the country, at prices that defy competition. Also, St. Pears, Plums, Currants, Gooseberries, English and Houghton's, Evergreens Maples, Elms, and Roses in large quantities, and of the finest quality at low rates.

**SMITH & POWELL,**

Syracuse Nurseries, SYRACUSE, N. Y.

sep2

**HEIKES****NURSERIES.**

We offer to the trade for fall of 1876, a large stock, especially in the following:

Apples, including Tetofski and Marengo, Plums, Peaches, Cherries, Wild Goose Plums, Currants, Gooseberries, Raspberries, Strawberries, etc.

We are prepared to offer inducements, and solicit correspondence.

**THE HEIKES NURSERIES CO.,**

sep2

DAYTON, OHIO.

The undersigned offer for the Fall Trade

**New TEA Rose**

DUCHESS OF EDINBURG.

Fine plants in 5-inch pots, \$9.00 per dozen.

**New Palm****PRITCHARDIA FILIFOSA (Brahea Filamentosa).**

Fine one year old plants \$25.00 per 100, \$4.00 per dozen.

**DRACÆNA INDIVISA.**

Extra fine, in 6-inch pots, \$50.00 per 100, \$7.00 per dozen.

**MARANTA ZEBRINA.**

Very strong, \$6.00 per dozen.

**FERNS.**

In best varieties, very fine \$12.00 per 100.

Also a general assortment of

**GREENHOUSE AND STOVE PLANTS.****KELLER & DEAN, Florists,**

sep2

56th St. &amp; 3rd Ave., Brooklyn, N. Y.

**Peach Trees.**

We invite the attention of buyers to our large stock of Peach Trees, including Alexander, Amsden's June, and other new varieties.

Send for our new Trade List.

**HOOPES, BRO. & THOMAS,**

Cherry Hill Nurseries. sep2 West Chester, Pa.

**KILMARNOCK WEEPING WILLOWS.**

A superb lot that will be sold below the market value. Also a splendid lot of *Magnolia Acuminata* Seedlings, Nursery grown, from six inches to four feet high, that we offer at a bargain. Price list free.

**STORRS, HARRISON & CO.,**

oct2

Painesville, Lake Co., O.

**ALEXANDER PEACH.**

And other New kinds. Cherry, 2 years, strong growth. Red Dutch Currants, 1 and two years. Philadelphia, Herstine and Brandywine Raspberries. Norway Maple, 8 and 9 feet; Sugar Maple, 4 to 5 feet nursery grown, in quantities. Hemlock Spruce, 2 to 2½ feet, bushy. American Arbor-vitæ, 8 inches to 8 feet. Siberian, 3 to 4 feet. Irish Juniper, 3 to 5 feet. Stock of best quality and offered low.

**JOSIAH A. ROBERTS.**

tseptf

Paoli, Pa.

**Decorative Plants.**

Send for our New Trade List of Palms, Ferns, and other Greenhouse and Stove Plants. We offer a large assortment at low rates.

**HOOPES, BRO. & THOMAS,**

Cherry Hill Nurseries.

sep6

West Chester, Pa.

**TREES.**

PEACH, Apricot and Nectarine in large supply, best assortment and rates low.

New Brunswick Nurseries, N. J.

OCT1

EDWIN ALLEN.

**WILSON'S BLACKBERRY,**

Plants \$12 per 1,000.

**BRANDYWINE RASPBERRY,**

Plants, \$10 per 1000.

**PEACH TREES, &c..**

At low rates.

sep2 R. S. JOHNSTON, Stockley, Del.

**TREES, ETC.**

Fruit and Ornamental. A large and complete assortment. Trade list now ready, and will be sent to all who favor us with their address. Also descriptive list of fruits and hardy ornamentals, etc.

**STORRS, HARRISON & CO,**

sep2

Painesville, Lake Co., O.

**Established 1836.****30 Greenhouses, 100 000 feet of Glass.**

The largest collection of plants in the United States. For the Trade, for the Amateur. CAMELIAS and AZALEAS a specialty. Catalogues mailed free to all applicants.

**JOHN DICK, Florist,**

sep2

53rd &amp; Darby Road, Phila., Pa.

**FOR SALE.****A GREENHOUSE and Stock of PLANTS**

will be sold upon terms satisfactory. Trade already established and can be increased. GOOD REASONS FOR SELLING. Will be SOLD LOW. Apply to

**W. B. KELLY,**

sep2

Abingdon, Va.

**CHAMPION GRAPE.**

The earliest good market Grape cultivated. Large bearer; no mildew; very hardy. Send for free descriptive circular to

sep2

**J. S. STONE, Charlotte, Monroe Co., N. Y.****WALTER ELDER,**

Landscape and Jobbing Gardener,

1231 Rodman Street, Philadelphia,

Attends to all branches of his business on reasonable terms.

# Peach Stones

AND OTHER

## FRUIT SEEDS.

Notwithstanding the general scarcity of Fruit Seeds this season we expect to furnish our customers with full supplies at our usual low prices; but solicit

EARLY ORDERS.

THOMAS MEEHAN,

sept GERMANTOWN, PHILA.

## WILD GOOSE PLUM.

One and two year on Peach, **Genuine** worked from our bearing trees. Also a good assortment of other varieties, stocky and well branched.

Send for new Trade List.

HOOPEES, BRO. & THOMAS,

Cherry Hill Nurseries. sept West Chester, Pa.

## Black Maples.

La Versailles, Cherry, White Grape, and RED DUTCH

## Currant Bushes,

Of fine quality and low in price.

A. HANCE & SON,

oct Nurserymen and Florists, Red Bank, N. J.

## PLANTS, NEW AND RARE.

From the Victoria Nursery, London, England, now on exhibition at the Horticultural Hall, Centennial Grounds.

For Descriptive Lists and Prices, apply to

JOHN DICK,

sept 53rd and Darby Road, Phila., Pa.

### APRICOTS.

1 and 2 years, \$90.00 per 1,000.

### RED DUTCH CURRANTS.

2 years, fine, \$30.00 per 1000.

### IRISH JUNIPERS.

3-3½, bushy, \$15.00 per 100; price per 1000 on application.

GEORGE ACHELIS, Nurseryman,

sept West Chester, Pa.

## SPECIALTIES.

Apple Trees, Peach Trees, Cherry Trees, Gooseberries, Double flowering White Almonds, Prunus triloba (Double flowering Plum), Norway Maples of all sizes, Dwarf Arborvitae, Siberian, American Arborvitae and Hemlocks for Hedging, Norway Spruce, Pyrus Japonica, Purple Mist.

GEORGE ACHELIS, Nurseryman,

sept WEST CHESTER, PA.

TREES, PLANTS Bulbs. Fall Price List and Bulb Catalogue GRATIS. Address, sept F. K. PHENIX, Bloomington Nursery, Ill.

# Saul's Nurseries,

## WASHINGTON, D. C.

The undersigned offers a fine stock of the following at low rates:

**New Pears.**—Souvenir du Congress; Beure d'Assumption; Pitmaston Duchess, and other new Pears.

**New Peaches.**—American and European varieties.

**Fruit Trees.**—An extensive stock of well-grown Trees. Pears, Standards and dwarf, of extra size—a heavy stock. Apple, Cherry, Plum, Apricot, &c.

**Grape Vines, Strawberries, Raspberries, &c.**

**Evergreens.**—Ornamental Trees, Shrubs, &c. Small sizes, suitable for Nurserymen; as well as large Stock in great variety.

## Dutch Bulbs.

Large Importations direct from the leading growers in Holland.

First quality Bulbs: Hyacinths, Lilies, Tulips, &c.

**New and Rare Greenhouse Plants** for winter blooming.

**New Roses.**—Duchess of Edinburgh, Perle de Lyon, &c., at reduced rates.

**New and Scarce Roses,** an immense stock grown in pots—prices low.

**New Wisterias,** New Clematis, New Pelargoniums, Geraniums, Primula Japonica, &c.

Catalogues mailed to applicants.

# JOHN SAUL,

## WASHINGTON, D. C.

t.sept3

## TUBEROSE BULBS

(For sale during October and November.)

50,000 first quality flowering bulbs, by Freight or Express, at \$3 per 100; \$20 per 1000.

### New Dwarf Pearl Tuberose.

First quality flowering bulbs, a choice lot at \$5 per 100; \$40 per 1000.

### CUT FLOWERS OF CARNATIONS,

always on hand. Send for Catalogue.

CHAS. T. STARR,

oct Avondale, Chester Co., Pa.



The Autumn No. of Vick's Floral Guide, containing descriptions of Hyacinths, Tulips, Lilies and all Bulbs and Seeds for Fall Planting in the Garden, and for Winter Flowers in the House—just published and sent free to all.

Address

sept2 JAMES VICK, Rochester, N. Y.

# WEATHERED & CHEREVOY'S PATENT BOILERS

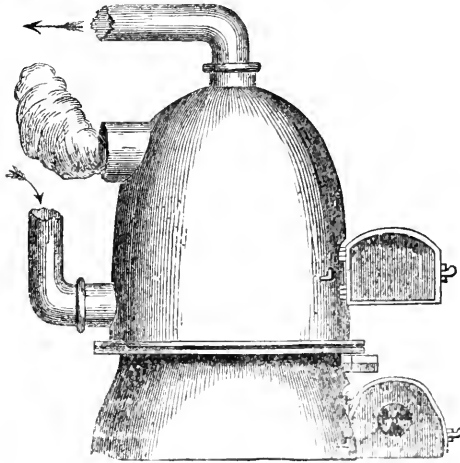

Fig. 1.

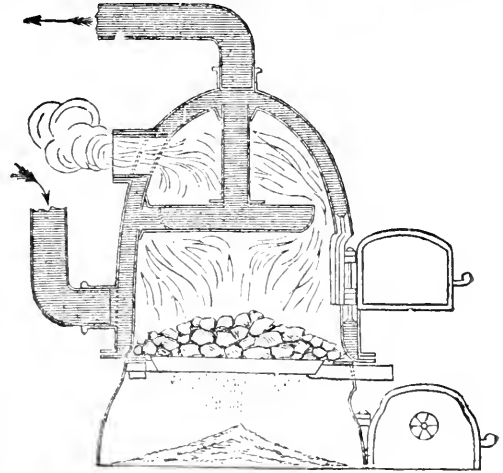

Fig. 2.

## AND IMPROVED HOT WATER APPARATUS,

No. 46 Marion Street, between Spring and Prince, New York.  
(TWO BLOCKS EAST OF BROADWAY.)

For Warming and Ventilating Public Buildings, Private Dwellings, Greenhouses, Graperies, Forcing Pits, Drying Rooms, and Heating Water for Public Baths.

(Fig. 1 is an outside view. Fig. 2 is a vertical section through the centre.)

*The following are a few names of Gentlemen who have our Boiler in use:*

Thos. Drake, Esq., Germantown, Pa.  
Simon Cameron, Esq., Harrisburg, Pa.  
J. D. Cameron, Esq., Harrisburg, Pa.  
Thos. Carter, Esq., Raleigh, N. C.  
J. H. Dunham, Esq., Chicago, Ill.  
Jas. B. Waller, Esq., "  
W. J. Gordon, Esq., Cleveland, Ohio.  
Geo. Stanley, Esq., "  
Harris Jaynes, Esq., "  
Geo. W. Cuyler, Esq., Palmyra, N. Y.  
D. M. Osborn, Esq., Auburn, N. Y.  
John B. Dutcher, Esq., Pawling, N. Y.  
A. M. Allerton, Esq., Bronxville, N. Y.  
Robert Hoe, Esq., Tarrytown, N. Y.  
Peter Hoe, Esq., "  
George Lewis, Esq., "  
Wm. H. Drew, Croton Falls, "  
Hon. James Y. Smith, Providence, R. I.  
Philip Caswell, Esq., Newport, R. I.  
Alfred Smith, Esq., "  
Wm. Findlay, Esq., "  
E. Learned, Esq., Pittsfield, Mass.  
D. O. Mills, Esq., San Francisco, Cal.  
W. L. Ferris, Esq., Westchester, N. Y.  
D. H. Haight, Esq., Goshen, N. Y.  
F. Newbold, Esq., Newark, N. J.  
James T. Blosson, Esq., Plainfield N. J.  
Daniel W. Coit, Esq., Norwich, Conn.  
J. F. Slater, Esq., "  
H. W. Collender, Esq., Darien, "  
Chas. P. Palmer, Esq., Stonington, "

Wm. D. Black, Esq., New Milford, Conn.  
Rev. Stephen H. Tyng, Irvington, N. Y.  
H. F. Spaulding, Esq., Riverdale, "  
S. D. Babcock, Esq., "  
Percy R. Pyne, "  
Elisha Brooks, Esq., Inwood, "  
Camille Marie, Esq., "  
A. F. Smith, Esq., Fort Washington, "  
R. M. Olyphant, Esq., Dobb's Ferry, "  
Clarkson N. Potter, Esq., New Rochelle, "  
Chas. D. Dickey, Esq., West Farms, "  
Wm. Matthews, Esq., Harrison, "  
William Chorlton, Esq., New Brighton, S. I.  
F. H. Wolcott, Esq., Astoria, L. I.  
Bailey Leach, Esq., "  
Hon. W. B. Ogden, High Bridge, N. Y.  
Peter Moller, Esq., 295 Fifth Ave., New York City.  
Wm. Moller, Esq., 6 West 20th St., "  
John Moller, Esq., 127 East 54th St., "  
John Moller, Esq., 8 East 57th St., "  
Ch. Moller, Esq., 42½ Washington St., "  
Henry B. Laidlaw, Esq., 33 Pine St., "  
George W. Lane, Esq., 93 Front St., "  
J. P. Robinson, Esq., 14 Coenties Slip, "  
J. B. Colgate, Esq., 47 Wall St., "  
John B. Trevor, Esq., 47 Wall St., "  
Charles Butler, Esq., 12 "  
Richard Arnold, Esq., 309 Canal St., New York City.  
Jas. M. Constable, Esq., 309 Canal St., "  
W. T. Garner, Esq., 61 Worth St., N. Y. City.

Please send for Circular with list of References and Reduced Prices to

THOMAS W. WEATHERED, 46 Marion Street, N. Y.

# WABAN CONSERVATORIES

OFFICE:  
56 BROAD ST., BOSTON.  
Address all Letters to  
BOSTON OFFICE.

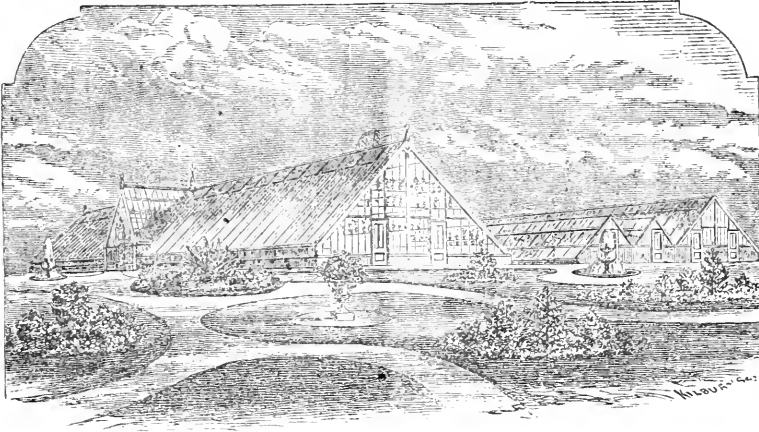

Send all Telegrams by  
Atlantic & Pacific Line. Address,  
*Waban Conservatories,*  
LAKE CROSSING, MASS.

## FALL TRADE 1876.

The following choice **SELECTED NOVELTIES** will be ready for delivery during the coming **FALL**, and to which attention is specially directed.

### ROSE "EDMUND WOOD." (Verdier).

This superb hybrid perpetual we have bloomed and find it fully equal, if not superior, to the description. Its color is richer and slightly darker than Gen'l Jacqueminot, far more double and equally prolific in growth, blooming as freely as that favorite variety. Good plants, on own roots, \$2 each.

### CARNATION "WELLESLEY BEAUTY."

Color soft fine cinnamon, beautifully striped and spotted with carmine rose; habit, free compact and vigorous. A valuable acquisition. 75c. each.

### BRONZE ZONALE GERANIUM "EARL ROSLYN."

Unquestionably the best bronze and gold bedding Geranium yet produced, superior to the acknowledged favorites, Marshall MacMahon and Black Douglass. 50c. each.

### DOUBLE ZONALE GERANIUM.

**P. BUCK.**—Violet and salmon, new and effective color, and a very valuable variety.

**J. C. ROBBARD.**—Double salmon red, not very double, but beautifully joined and much superior to Aea Grey.

**MADAME THIBAUD.**—Rose petals, marked with white at their base, semi-double, but producing a novel and pleasing effect. Also many other new Zonale and other Geraniums, for description of which see Catalogue.

### PELARGONIUM REGAL "QUEEN VICTORIA."

This is one of the most marvellously beautiful novelties ever offered. Color rich vermilion, margined with fine white, and upper petals blotched with deep purple maroon. The flower has thick, crispy petals, which give it the appearance of being double. It is a remarkable and striking improvement in Pelargoniums. \$1.50 each.

### PELARGONIUM REGAL, "BEAUTY OF AXTON."

Similar in form to the above, but quite distinct in color, which is; upper petals rich maroon; centre rose; all the petals being margined with pure white; flowers large and full, having the appearance of being semi-double, and a most beautiful and extraordinary novelty. \$3 each.

## FOR FLORISTS' WINTER STOCK.

Send for Abridged Trade Circular of new Tuberoses, Rooted Begonias, Double Zonale and other Pelargoniums; Roses, Carnations, Ivies, Vincas, &c.

We have a good stock of the new Double Ivy-leaved Geranium, described in the September number of the Gardener's Monthly, which we offer at \$1.00 each, or \$2.50 for three. Also new **ABUTILONS** of beautiful colors; Le Liliput, mauve; Le Nain, mauve, shaded orange, Perle d'or, canary; Simon de Leaux, chamoux shaded with purple and veined with rose. 75 cts. each. The set \$2.00.

We are making the importation of Rhododendrons and Clematis a specialty.

Orders promptly executed. Send for Circular.

EDMUND M. WOOD & CO.

# DOUBLE ZONALE PELARGONIUM WONDERFUL, Geo. Smith.

Magnificent Orange Scarlet, a sport from Vesuvius; Flowers semi-double, trusses large, produced abundantly on small plants; a splendid bedding or market plant. See illustration in this number of the *Gardener's Monthly*.  
 Plants ready for sale first of October. Price: Small Plants, \$1 each; extra ditto, \$2.50 each; and very strong Imported Plants, \$5 each, with many other varieties.  
 Copies of Cut for Sale \$5 each.

## NURSERYMEN'S WATERPROOF SHIPPING CARDS AND EYELETTED TAGS,

either plain or printed with shipper's address "PLANTS—PERISHABLE;" "SEEDS—KEEP DRY;" &c., &c. The best and cheapest in the market. Send for samples and prices.

*Carnations for Winter Flowering,  
 Zonale Pelargoniums, &c., &c.*

For wholesale price list,

H. E. CHITTY, Sup't.

**BELLEVUE NURSERY CO.,**

toct. 1

PATERSON, NEW JERSEY.

### PUBLISHERS' CARD.

THE

# NURSERYMAN'S DIRECTORY.

The undersigned have in preparation VOLUME II of the NURSERYMAN'S DIRECTORY, embracing a list of the NURSERIES, FLORISTS, SEEDSMEN and TREE DEALERS, of the United States. The work will be sold wholly by subscription, the price of which will be TEN DOLLARS per copy and will be issued January 1st, 1877.

A limited space will be given to Advertisements, at the following Low Rates:

Full Page,	\$35 00	One-Third Page,	\$15 00
Half Page,	20 00	One-Fourth Page,	10 00
	One-Sixth Page,		\$8 00

For further information, address

D. W. SCOTT & CO.,

Printers and Publishers, Galena, Illinois.

oct



## Cascade Rose Nursery AND GREENHOUSES.

ROSES in pots, all the best Winter-blooming sorts, extra; Price, \$1.50 per doz.; \$3 00 per 100.  
 New Double and Single GERANIUMS (most of 1876), superb sorts that all should have.  
 Price, in 2 1/2-inch pots, \$2 00 per doz.; \$14 00 per 100. In 6-inch pots, extra, \$3 00 per doz.  
 GERANIUMS, especially prepared for Winter blooming, extra fine stock. Price, in 3-inch pots, \$1 25 per doz.; \$8 00 per 100. In 4-inch pots, \$1 50 per doz.; \$10 00 per 100.  
 Cascade Set of New VERBENAS for 1877 25 superior sorts; the set \$2 50.  
 Trade List sent to all dealers, on application. Address,

oct 1

A. K. WILLIAMS, Richmond, Ind.

### CLEMATIS, NEW AND OLD SORTS.

Aquilegia cornuta, Astilbe japonica, Azalea Indica, Bouvardias, white and red, Carnations, Dianthus spectabilis, Dianthus fibulata alba, Ixias, Oranges, Lomaria gibba and other Ferns.  
 Prices low. Send for Trade List.

oct 2.

G. ALTORFER,  
 West Chester, Pa

### GRAPE VINES.

Concord, Hartford, Ives and Catawba, very low by the quantity; quality extra.  
 G. & S. BOALT,  
 Norwalk, Ohio.

oct 4

### SMALL FRUIT PLANTS,

Strawberries, Raspberries, Blackberries, Currants, Grapes, Asparagus Roots, &c. Prices low. Send for Circular.

JOHN S. COLLINS,

oct 11

MOORESTOWN, N. J.

## The Nurseryman's Directory.

A reference book of the Nurserymen, Florists, Seedsmen, Tree Dealers, &c., for the United States. Alphabetically arranged by States and Post Offices. 242 pages, 8vo. Price \$5. Mailed, postpaid, on receipt of price.

Address, CHAS. H. MAROT,  
 814 Chestnut St., Phila.



# To Nurserymen and Dealers.

Your attention is respectfully asked to my extensive stock of

## FRUIT TREES,

superior quality, offered for

### FALL TRADE,

at prices that **CHALLENGE COMPETITION** on same quality of stock. The past favorable season has produced an exceedingly fine growth of well-matured wood, making the stock desirable in every particular.

To parties who cannot conveniently see the stock, I would refer for information as to its extent and quality to several respectable Nurserymen and Dealers from different parts of the country who called lately and saw it. The advantage of selecting from an extensive stock and good assortment should not be overlooked by purchasers. The following figures will give some idea of the amount of stock I offer at present, viz: 200,000 Standard Apple, 30,000 Dwarf Apple, 80,000 Std. Pear, 35,000 Dwarf Pear, 45,000 Ch.rrv., 5,000 Plum, 2,000 Orange Quince, 2,000 Horse-chestnut. In addition to above I am solicited to furnish Peach Trees in large or small orders either from this State or Delaware, at the lowest possible rates. Also Seedlings and stocks for Nurserymen, both Foreign and Domestic. Digging and packing done in best possible manner. Charge for packing very moderate. Please call and examine stock, or address for particulars,

toctt JOHN MURPHY, Dansville, Liv. Co., N. Y.

# NEW PLANTS.

## AUTUMN, 1876.

**NEW DOUBLE POINSETTIA**, Strong Improved plants, from James Veitch & Son, \$10 each.  
Fine young plants, 5 "

**FERNS**, a choice and rare collection, 2½-inch pots, \$8 per 100  
" " " " " 3 " " 10 "  
" *Pteris tricolor*, \$2.50 per doz  
" *Rubra venia* (rare) 2.50 "

**DOUBLE WHITE OLEANDER** (Duplex), *Madca grandiflora*, splendid large white panicles, large stock plants, \$4 per doz.

**DOUBLE PELARGONIUM**, Queen Victoria, \$5 per doz.

**VERBENA S**, Stock plants now ready, including our unsurpassed set of new striped varieties, named, \$5 per 100

**CAMELLIA STOCKS** for grafting, strong, 15 "

Sent for Wholesale Price List and Descriptive Catalogue of Dulbs and Winter Blooming Plants.

# HENRY A. DREER, Seedsman and Florist,

714 Chestnut Street,

oct Philadelphia.

# CARNATIONS.

Edwardsii, La Purite, Pres. DeGraw, strong plants, per 100 \$8.  
**Geranium Happy Thought**, per dozen, \$2.50.  
Fall Price list now ready.

**SKED, PADDOCK & CO.,**

oct1 Cleveland, O.

# WINTER BLOOMING PLANTS, &C.

**ROSES**, in 4-inch pots: Bella, \$8 per 100; Isabel Sprunt, Saranno, David Pradel, Duch. de Brabant, Bon Silene, &c., \$10 per 100.

**DRACENA** Brazilensis, 15 hands high, \$2 50 per dozen.

**ARANTA**, Bic for \$1.50 per doz.

**BOUVARDIAS**, extra strong, \$25 per 100; do. good, \$18.

**CARNATIONS**, strong, \$20 per 100.

**CEBROGANS**, 2 to 4, trained, \$2 50 per dozen

**BEGONIAS**, ast., **HELIOTROPES**, 4½ in., \$10 per 100, &c.

**GEO. S. WOODRUFF**, Florist,

toctt Mt. Airy, Philadelphia.

# NURSERY

FOR RENT.

On Harrowgate Lane, comprising nearly 3 acres of ground, with Dwelling House, three Greenhouses, Hot-beds, Bums, &c. Rent \$400, or will be sold if desired. Inquire 1125 Chestnut Street or address P. O. Box 2476, Philadelphia. oct1

A Hygroscope for 50 cents.

## THE CHEMICAL HYGROSCOPE.

This indicator of atmospheric moisture is as accurate as the costly ones. Rooms heated by furnaces or stoves are almost invariably so dry as to be damaging not only to health but to furniture. Some people take the consequences others keep water on the heater. The Hygroscope shows at a glance whether the air is too dry or not.

Sent by mail for 60 cents. Address,

toctt CHAS. H. MAROT, 814 Chestnut St., Philadelphia

# Orchid Culture.

By EDWARD SPRAGUE RAND, JR.

Including culture, propagation, collection and hybridization of Orchids; the construction and management of Orchid-houses; a glossary of botanical terms and significance of their names; the whole forming a COMPLETE MANUAL OF ORCHID CULTURE. Cloth 12 mo., 476 pages. Price \$3.50. Mailed, postpaid, on receipt of Price.

Address, CHAS. H. MAROT, 814 Chestnut St., Phila.

## Fruit Growers' Hand-Book.

By F. R. Elliott, author of "Western Fruit Growers' Guide," (one of the best posted men on the subject in the United States), contains the practice on all subjects connected with fruit growing. The book is made for those who grow fruit for their own use. Also an Appendix, containing matter relating to the selection and culture of Ornamental Trees, Roses, Plants, &c.

Illustrated with 45 wood cuts, 130 pages, 16mo cloth, \$1; paper, 60 cts. Sent by mail postpaid on receipt of price.

Address CH. H. MAROT, 814 Chestnut St., Phila.

# FOR SALE.

A farm of 60 acres, 35 miles from Philadelphia, on Camden & Atlantic R. R., ¼ mile from Magnolia Station; well adapted to cultivation of **Fruit Trees, Small Fruits and Vegetables**. Large section of it Cedar Swamp and **Natural Cranberry Ground**. 4 acres in **Cranberries** under cultivation, 140 Fruit Trees, **Apple, Pear, Peach, Plum, &c.**, just coming into bearing. House and barn. Water excellent and abundant. Location healthy. Will be sold at reasonable price and terms to close an estate; or will be exchanged for city property. Philadelphia or Reading preferred.

Address,

CHAS. H. MAROT,

septf. 814 Chestnut St., Philadelphia.

# The Centennial.

ADVERTISERS Are requested to note that CURRENT NUMBERS OF THE GARDENER'S MONTHLY, from MAY to NOVEMBER inclusive, will lie upon the tables of the Reading Room at Horticultural Hall, Centennial Grounds, for the inspection of the thousands directly interested in the stock you have for sale. Also at Rowell's Newspaper Exhibition, and Pettengill's Newspaper Agency; and sold by news dealers on the grounds. Those who take advantage of this fact will have practically an extra circulation, during the months named. Two files of the MONTHLY, from May to November, will constantly remain for the inspection of visitors. Be in time with your orders. Take notice changes of copy in current advertisements must be in hand by the 16th of each month, and new orders by the 23d to insure insertion in following issue. Address C. H. MAROT, 814 Chestnut St., Philadelphia.

## ARITHMETIC MADE EASY

BY

### Ropp's Commercial Calculator

No farmer, mechanic, business man or laborer should be without it.

Contains more useful and practical tables, and original and rapid methods of calculation than all the other Reckoners and Calculators combined.

Shows at a glance the value of all kinds of grain, stock, hay, coal, lumber and merchandise, for any quantity and any price; the interest on any sum for any time at 6, 7, 8 and 10 per cent; measurement of lumber, saw logs, cisterns, tanks, granaries, corn-cribs, wagon-beds, etc.; also a time, wages, and many other valuable tables.

It is simple and easily comprehended. Any one—the least conversant with figures—can instantaneously become his own accountant.

Enables anyone to compute numbers with lightning rapidity, by mastering a simple arithmetical principle which has never been used before.

Is an Arithmetic, Ready Reckoner, Lightning Calculator, Silicate Slate, Memorandum and Pocket-book combined.

Price: Bound in Russia leather with gilt edges, \$2 00; Morocco, \$1.50; Fine Cloth, \$1 00; Cloth, without slate, memorandum, etc., 60 cts. Sent post-paid on receipt of price.

Address

CHAS. H. MAROT,  
814 Chestnut St., Phila.

## DECLARATION OF INDEPENDENCE

FACSIMILE LITHOGRAPHED in the handwriting of THOMAS JEFFERSON, with the interlin'd corrections and erasures as made by JOHN ADAMS and Dr. FRANKLIN, in 1776. Pamphlet form, (7 pages,) on extra heavy, highly colored, and tinted paper, with a beautiful cover, in four colors, embellished with the National Emblems.

### OLD INDEPENDENCE HALL,

(As it appeared in 1776.)

### THE "OLD LIBERTY BELL"

which rang out the LIBERTY we now enjoy to all the people, etc., etc. To which is added the names of the signers in their own handwriting, making one of the most ornate, unique, and interesting centennial memorials of the "time that tried men's souls," that could possibly be imagined. Should be placed on the centre table of every American citizen.

Price 50 cents each, postage paid. Address

CHAS. H. MAROT,  
814 Chestnut St., Phila.

## AMERICAN FRUIT CULTURIST.

BY JOHN J. THOMAS.

Practical directions for the Cultivation of Fruit Trees in the NURSERY, ORCHARD AND GARDEN.

Descriptions of the principal American and Foreign varieties. Plain Edition, 480 engravings, 611 pages, 12 mo. Price, \$3.00. Mailed post-paid on receipt of price.

Extra Edition, 576 pages, heavy paper, fine cloth, 508 illustrations and chromo frontispiece; mailed, for \$3.75. Address CHAS. H. MAROT, 814 Chestnut St., Phila.

## The Gardener's Monthly.

THE FOLLOWING  
**BACK NUMBERS**

WANTED, IN  
**GOOD CONDITION.**

April, 1860.	October, 1870.	August, 1874.
January, 1870.	December, "	December, "
March, "	January, 1873.	January, 1875.
July, "	January, 1874.	December, "
		January, 1876.

Receivable in exchange on Subscription account, or exchangeable for other numbers not in above list. Send numbers prepaid by mail and advise the publisher Address,

CHAS. H. MAROT,  
814 Chestnut St., Phila.

## THE ABBOTT

### Pocket Microscope

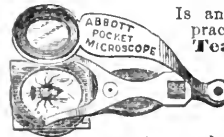

Is an instrument of great practical usefulness to Teachers, Farmers, Merchants, Mechanics, Physicians, Botanists, Miners, and many others. It is the best instrument ever invented for examining Flowers, Seeds, Plants, Minerals, Engravings, Bank Notes, Fabrics, Etc. By means of a case, accompanying each instrument, one can examine all kinds of Insects or Worms alive. The

### EYE OF A FLY,

or other insect of like size, can be readily seen. It is simple in construction and easy to operate. One of these interesting instruments ought to be in every family. We have made arrangements to furnish the **Pocket Microscope** at the manufacturer's price, \$1.50. It will be sent post-paid, to any reader of this Paper desiring it, on receipt of price, or may be had at this office.

Address,

CHAS. H. MAROT,  
814 Chestnut St., Phila.

## PRESERVING, PICKLING AND CANNING FRUIT.

BY MRS. M. E. PETERSON.

Containing a choice collection of receipts of Preserving, Pickling, and Canning Fruits, many of them being original from house wives of experience. 72 pages, 16mo, Cloth. Price 50 cents. Sent by mail, post-paid, on receipt of price.

Address,

CHAS. H. MAROT,  
814 Chestnut St., Phila.

# PATENT BOOK COVERS.

Adapted to preserve and Bind loose sheets quickly, conveniently and in their order

	Size	Cloth back and corners, marbled paper sides	Full cloth, embossed, with gilt side title.	Am. Russia back and corners, cloth sides.	Tex. Moro. back and corners, cloth sides.
Gardener's Monthly,	7x10½	\$.75	\$1.00		
Harpers' Magazine,	6½x10½	.67	.88	\$1.25	
"    Weekly,	11½x17½	1.25	1.50	2.00	\$2.25
New York Herald,	16x24	1.67	2.25	3.00	
Boston Post,	23½x31½	2.25	3.00		
Frank Leslie's Boys' and Girls' Weekly,	9½x14	1.00	1.25	1.67	
Peterson's Magazine,	6½x10½	.67	.88	1.25	
U. S. Official Gazette,	7½x11½	.75	1.00	1.38	1.50
New York Ledger,	14½x22½	1.50	2.00	2.50	
London Punch,	9½x12½	1.00	1.25	1.63	1.75
Ueber Land und Meer,	12½x16½	1.25	1.50	2.13	2.25
Fliegende Blaetter,	9½x11½	.88	1.13	1.50	1.67
Gartenlaube,	9½x13½	1.00	1.25	1.63	1.75
Invoices,	8½x15	1.00	1.25	1.50	
Letter,	8½x11	.88	1.00	1.50	
Note,	5x8½	.50	.75	1.00	
Music,	10½x14½	1.00	1.25	1.75	2.00

NOTE.—Sizes not stated above will be made to order and price furnished on application. Please either mail a copy of the Paper to be bound, or state the exact length and breadth of same. Covers mailed to order on receipt of price. Address,

CHAS. H. MAROT, 814 Chestnut Street, Philadelphia.

## SITUATIONS WANTED.

A Position as Foreman in a Florist establishment by an Englishman, aged 43, having had over 35 years experience in the propagation and culture of plants, both for market and exhibition, the last 7 years in America: good salesman, also first-class hand at cut flower work. Address with particulars as to quantity of glass, &c., J. L. GRIFFIN, care of Geo. Such, South Amboy, N. J. 2t

By a thorough practical Gardener, a married man: good reason for leaving present employer; has filled first-class places in Europe and also this country. Reference to ability and character will be given satisfactory. Address M. Gardener, Owego, Tioga Co., N. Y. sep2

TO NURSERYMEN & FLORISTS.—A first-class Propagator of hard or soft wooded plants wants a situation as foreman or Propagator; has thorough knowledge of the cultivation of stove and greenhouse plants; can grow for exhibition on the English system, or for market; also make bouquets and floral designs. Twenty years practice in the London and Provincial nurseries; five years practice in the United States. Cut flowers for market a specialty. Address JOHN HOLLAND, 1189 Second Ave., New York City.

A S Gardener, married, no children, comes well recommended as a first-class hand in all in and out door gardening, bears satisfactory reference as such, and as an industrious one; strictly sober; easy habits, and of good ability; is willing to agree to suit times, and might do on shares; prefers a hot climate. Address, B. ELLIOTT, 114 Market St., Pittsburg, Pa., L. Landscape Gardener.

A S Foreman and Propagator in a Nursery, a single man who well understands his profession in all its various departments; satisfactory reference given. Apply by letter to B. C. in care of Miller & Hayes, Mt. Airy Nurseries, Germantown, Philadelphia.

By a Gardener, single, with good reference; understands the business in all its branches; will take charge of a private or commercial establishment; speaks English and French; no objection to any part of the country. Address G. B., 245 N. 4th St., Philadelphia, Pa.

A Situation as Gardener, by a man who has had many years charge in some of the best public and private places in the vicinity of Boston; has cultivated plants and flowers for Boston Market for years; is a first-class propagator, a thorough Gardener, and well recommended as such; will take charge of a small farm in connection with other duties, if required. Address GARDENER, care Breck & Sons, North Market St., Boston, Mass.

By a Gardener, single, with good reference from this country and France, a situation as Propagator, or to take charge of a commercial establishment; speaks English, French and German; distance no object. Apply to S. H., 1527 Lawrence St., Philadelphia, Pa.

A S a Gardener, single, to take charge of a private or commercial establishment; well up in all branches of the profession; can give first class reference from Europe and this country; willing to go to any part of the country. Address N. S. K., 2011 Mervine St., Philadelphia, Pa.

By a French Gardener and Florist; small family; can give first-class references. Address GEORGE SCHOELLHAMMER Gardener, No. 11 Minnesota St., Cleveland, O.

## HOW TO LAY OUT A GARDEN.

By Edward Kemp.

A general guide in Choosing, Forming and Improving an Estate (from a quarter-acre to a hundred acres in extent), with reference to both design and execution. Illustrated with numerous plans, sections and sketches. 403 pages, 12mo, cloth. Price \$2.50. Sent by mail post-paid on receipt of price.

Address CHAS. H. MAROT, 814 Chestnut St., Phila.

## AMERICAN FLOWER GARDEN DIRECTORY.

By Robert Duist.

With practical directions for the Culture of Plants in Flower-garden, Hot-House, Green-House, Rooms, or Parlor Windows, for every month of the year. Instructions for erecting Hot-house, Green-house, and laying out a Flower garden. Instruction for cultivating, propagating, pruning and training the Grape vine and description of best sorts for the open air. 342 pages, 12mo, cloth. Price \$1.50. Sent by mail post paid on receipt of price.

CHAS. H. MAROT, 814 Chestnut St. Phila.

## WINDOW GARDENING.

By Henry T. Williams.

Devoted to the Culture of Flowers and Ornamental Plants for In-door use and Parlor Decoration. Splendidly illustrated. 300 pages, med. 8vo, cloth. Price \$1.50. Sent by mail post-paid on receipt of price.

Address CHAS. H. MAROT, 814 Chestnut St., Phila.

Index to Advertisements.

Advertisers are requested to have orders in hand as EARLY AS POSSIBLE. Copy received after the 23rd of each month cannot be insured insertion in the next issue.

Table listing advertisers and their locations, such as Achelis George, West Chester, Pa., and Allen Edwin, New Brunswick, N. J., with corresponding page numbers.

FELTEN'S RASPBERRIES,

"EARLY PROLIFIC" and "RELIANCE," highly commended by the Centennial Committee on Fruits for their fine, luxurious flavor and unsurpassed firmness in transportation. The severity of our northern winters have hitherto failed to effect the canes or retard their fruit development. The Prolific being ten days earlier than Reliance, makes it a valuable acquisition to the grower and market gardener. Price, per 100 \$25; per 1000 \$200. Send for a Circular, testimonials and

FELTEN & BROTHER 31st and Park Ave., Philadelphia

R. B. PARSONS & CO., Bowne Avenue, Flushing, N. Y., OFFER THEIR RARE TREES & SHRUBS

as well as the well known sorts, and invite the special attention of LARGE BUYERS

To their Stock of Rhododendrons, Azaleas—Chinese and Ghent Camellias, Clematis, Hydrangeas, Magnolias, Roses by the 1,000.

RARE EVERGREENS,

are well known to be cultivated in large variety by them. For Catalogues address

Box 99, Flushing, N. Y.

Feb. 12

WANTED an experienced Gardener, single, as propagator, raising of flowers making floral designs, bouquets, &c, of good habits, pleasant and agreeable especially to customers, honest and upright. Address GARDENER, Boston, Mass.

STRAWBERRY PLANTS,

and other SMALL FRUITS, for sale by

E. P. ROE,

Author of "Culture of Small Fruits," "Play and Profit in my garden," &c.

Send for Circular. Address,

E. P. ROE,

aug3

Cornwall-on-Hudson, Orange Co., N. Y.

WANTED a first class Gardener, single, well up in the cultivation of plants and flowers, making floral designs; of good habits, pleasant and agreeable, especially to customers, honest and obliging. Address GARDENER, Boston, Mass.

Yorkshire, Berks'ire, Essex, Poland China and Chester WHITE SWINE, of unsurpassed excellence. Alderney, Ayrshire and Shorthorn Cattle, Southdown and Cotswold SHEEP. Imported and Prize POULTRY, and PIGEONS bred on 3 FARMS. DOGS, &c. New descriptive circular free. Elegant new Catalogue with cuts from life of our stock, 20c. SEEDS, TREES, PLANTS, FERTILIZERS, IMPLEMENTS, &c. 6 PACKAGES seeds, free, as samples, for two 3c stamps. Benson & Burpee, successors to W. Atlee Burpee, Seed Warehouse, 223 Church Street, Philadelphia Pa. oct12

GARDENING FOR THE SOUTH or HOW TO GROW VEGETABLES AND FLOWERS.

BY Wm. N. WATTE.

Containing instructions and hints in formation and management of Gardens. Soil's and improvement, manures and their sources, rotation, hot-beds, cold frames, pits, propagation, ludding and grafting, pruning and training, transplanting, mulching, shading and watering, protection, garden implements, insects and vermin. Vegetables, Fruits, description, varieties and culture. Illustrated, 444 pages, 12mo, Cloth. Price \$2.00. Sent by mail, post-paid, on receipt of price. Address, CHAS. H. MAROT, 814 Chestnut St., Phila.

A Subscription to Harper's Weekly

For 1876 from January 1st, will be furnished on receipt of \$2.50 if applied for at once at this office.

Address, CHAS. H. MAROT,

814 Chestnut St., Phila.

For Situations Wanted, see page 21.

# Jordan's Patent Wrought Iron Water Heater.

## A NEW PRINCIPLE.

The boilers are constructed of horizontal pipes of the same inside diameter as those that form the heating pipes, thereby producing a very rapid circulation of the water.

LENGTH SEVEN FEET.

### DESCRIPTION.

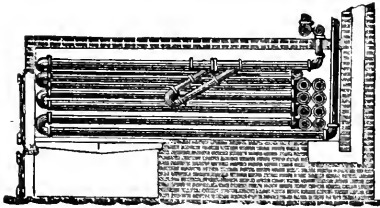

No. 1 shows a side view of one-half section, with U steam propeller. Also shows sections of chimney, ash-pit, and brick arch around the boiler, with downward draft to chimney.

No. 2 shows end view, with rear end closed with pipes; ash-pit below and brick arch above.

No. 3 shows boiler before it is set in the brick, with a few pipes broken away, to show the steam generator.

The improvements claimed are: a larger heating surface, as compared to the amount of water in the boiler; a more rapid circulation of water by the use of steam-generator to move the water; a larger fire-hole, so that soft coal can be used and not obstruct the draft; and cheapness.



Extracts from the Patent, No. 173,300, Dated February 8th, 1876.

By making the pipes throughout the whole length of the boiler and heater of the same interior diameter there is an even flow through the pipe at all parts, and no shoulders in the pipe to cause any check to the flow.

It is obvious that the boiler-pipes being exactly the same interior size as the radiator and connecting-pipes, a new and quite valuable result is obtained, as the simultaneous movement of the water is insured through the whole series of pipes at the same speed, thus preventing any eddy and dead water.

The U-formed steam water propeller, by descending into the furnace and entering the water-pipe at an inclination, causes a circulation in the water-pipes almost immediately the fire is lighted, and before the water has time to become

heated in the water-pipes. The end bends of the water-pipes, which close partially the back of the fire-space, receive the full blast of the products of consumption.

### TRUTHS TO BE CONSIDERED.

If water moves rapidly into and out of the furnace it must carry off the heat rapidly into the room to be heated, thereby saving the fuel. The front is of iron and can be easily removed to clean out dust, &c.

### SETTING THE BOILER.

Build foundation wall 12 inches wide, so the pipes will set about 1½ inches inside the walls, and 3 inches above the grate bars; let the boiler rest on one fire brick at front and one at rear. Let the rear bridge wall for the grate bars be heavy and raise above the grate bars about 10 inches to one foot, and of fire brick. The Chimney should be started from the bottom of the furnace, and be at least 25 feet high, and an opening at least one foot square.

### PRICE OF BOILERS (OF WROUGHT IRON, WITH IRON FRONT AND GRATE BARS.)

Small boilers without grate bars or iron front, ...	\$25 to \$50 each.	No. 4 to heat 1900 to 2000 feet of pipe.....	\$175.00 each
No. 1 to heat 500 to 750 feet of pipe.....	\$ 75 00 "	" 5 " " 2000 " 3000 " " " .....	225 00 "
" 2 " 750 " 1000 " " " .....	100.00 "	" 6 " " 3000 " 5000 " " " .....	300.00 "
" 3. " 1000 " 1500 " " " .....	125.00 "	Valves for 4 inch pipe.....	10.00 "

Large boilers made to order. Where no iron front or grate bars are wanted, 10 per cent. deducted.

Water-pipe and all kinds of fittings at present 30 per cent. off the card prices.

Men furnished to put up the furnace and contracts taken to heat any building, and can be placed where hot air furnace has been used.

We have had seventeen years experience in handling water heaters, and can guarantee our work.

**JORDAN & BRO.,**

612 Olive Street, St. Louis, Mo.

# S. B. PARSONS & SONS,

Kissena Nurseries,

Near KISSENA STATION, FLUSHING, N. Y.,

OFFER a very large assortment of TREES and PLANTS of all the best families. Nearly all of them have been two years transplanted, and their roots are thus in the very best possible condition for a second transplanting.

Some of their best specimens can now be seen at the CENTENNIAL GROUNDS. The whole or part of the large collection there is now for sale, to be delivered at the close of the Exposition. A list of the sorts will be furnished on application. Any one purchasing this entire collection will have an assortment of trees and shrubs rarely equaled.

Their Catalogue of

## New and Rare Hardy Trees and Shrubs

is now READY, and will be sent on application. It contains some 65 varieties of NEW

### JAPANESE PLANTS,

including the remarkable JAPANESE MAPLES, and also a large number of new Hardy Plants from Europe. They think themselves safe in asserting that so rich a collection has not before been in this country.

CAMELLIA JAPONICA and AZALEA INDICA can be advantageously shipped during October, November and December. These plants are carefully formed and trimmed, and their symmetry is recognized by all who see them.

*Estimates will be furnished for Planting Grounds under the care of an experienced Landscape Gardener, and much trouble thus saved to the owner.*

Catalogues will be furnished to applicants by mail, and those who wish to visit the Nurseries will always find either one of the proprietors, or J. R. Trumpy, the well-known propagator of the old establishment. They can take the ferries at 34th Street or James' Slip, which connect with the railroad, leaving the first a quarter of an hour, and the last half an hour before the departure of trains, which make the transit in half an hour. The Nursery is adjoining the Kissena Station and one and a half miles from the other stations, from which carriages are free.

sep

## DUTCH BULBS

AND

## SMALL FRUITS.

Our New Autumn Catalogue of

## Bulbs & Small Fruits,

### ORNAMENTAL IRON AND RUSTIC WORK

FOR WINDOW GARDENS AND HOUSE PLANTS.

Beautifully illustrated with many engravings, is now ready and will be mailed to all applicants enclosing 10 cents. Regular customers supplied gratis. Collections of Bulbs \$3, \$5, \$10, \$20, mailed post-paid, to any address upon receipt of price. Our list of

## SMALL FRUITS,

Comprises every desirable variety of

Strawberries, Raspberries, Grapes, &c.

Bulbs and Plants mailed to any address at Catalogue prices. Address,

## B. K. BLISS & SONS,

SEED, PLANT AND BULB WAREHOUSE,

P. O. BOX 5712.

34 Barclay Street, New York.





THE  
GARDENERS'  
And MONTHLY  
HORTICULTURIST

EDITED BY THOMAS MEEHAN.

Vol. XVIII. No. 215.  
(Combined Magazines, Thirty-first Year.)

**NOVEMBER, 1876.**

PUBLISHED BY CHARLES H. MAROT

814 Chestnut Street, Philadelphia.

TERMS—\$2.10 PER YEAR—POSTAGE PAID.



Nov. 21st 1876

J. A. Stockton

# THE GARDENER'S MONTHLY AND HORTICULTURIST.

EDITED BY THOMAS MEEHAN,

Assisted by an able Corps of AMERICAN and FOREIGN CORRESPONDENTS.

It is published on the first of every month, at the office, No. 814 CHESTNUT STREET, PHILADELPHIA, where all BUSINESS communications should be addressed.  
Communications for the Editor should be addressed: THOMAS MEEHAN, GERMANTOWN, Philada.

SUBSCRIPTION PRICE, Postage paid, \$2.10.

## TERMS OF ADVERTISING.

	¼ col.	½ col.	¾ col.	1 col.	1½ col.	2 col.	1 page.
One Time,	\$3.00	\$4.00	\$6.00	\$8.00	\$12.00	\$24.00	\$48.00
Two to Three Times, each,	2.70	3.60	5.40	7.20	10.80	21.60	43.20
Four to Six Times, “	2.25	3.00	4.50	6.00	9.00	18.00	36.00
Seven to Nine Times, “	2.00	2.70	4.00	5.35	8.00	16.00	32.00
Ten to Twelve “	1.80	2.40	3.60	4.80	7.20	14.40	18.80

Twelve lines nonpareil is ¼ col. A less space than ¼ col., will be furnished at rates in exact proportion, line for line.  
For THIRD and LAST COVER PAGES; FIRST PAGE advertisements facing reading matter; “FLY-LEAF PAGE” (front of number) before reading matter and facing first cover,—special figures will be given on application.  
COPY and orders for NEW advertisements should be in hand by the 23d of each month; and CHANGES of COPY in running contracts by the 16th of each month, to insure them in following issue. Address

CHAS. H. MAROT, Publisher, 814 Chestnut Street, Philadelphia.

## CONTENTS OF THE NOVEMBER NUMBER.

### SEASONABLE HINTS:

Flower Garden and Pleasure Ground.....	321-326
Green House and House Gardening.....	326-331
Fruit and Vegetable Gardening.....	331-337

### CORRESPONDENCE:

The Culture of Pitcher Plants.....	322
Grafted Rose Acacia.....	322
Our Centennial Magnolia Tree.....	322
Liatris Pycnostachya.....	324
Verbena Rusf.....	327
Rhododendrons under Glass.....	327
Notes on New Fruits.....	331
Blodgett's Seedling Peaches.....	331
Notes From Tennessee.....	332
Fruit in Michigan.....	332
New Grapes.....	332
The Strawberry Grub.....	333
American Arboretums.....	337
Triteleia Laxa;—or Seubertia Laxa;—Which?.....	339
Brodiaea Coccinea.....	340
Rain-fall and the Lakes.....	341

### EDITORIAL NOTES:

Akebia quinata—Wier's Cut-leaved Silver Maple— Euonymus Americanus—Weigela amabilis Loomansii aurea—On Naming Flowers for Persons— White Bedding Pansies.....	324-325
Drying White Flowers—Standard Cuppeas—A Geranium Pyramid.....	328-330
Analysis of the Onion—American Grapes in Europe —Influence of the Stock on Pears—Carter's Round- leaved Batavian endive. Earth-blanching—The Esk- bank Bunch of Grapes—Pruning Fruit Trees in Japan.....	333-335
Meehan's Arboretum at the Centennial Grounds— History of the Catalpa—The Catalpa Timber—The Locust Tree Slug—The German Forests—Tree-	

Planting..... 335-339

Vernacular Names—How Error is Propagated—Tropi-  
cal Flora at the Poles—Vitality of Seed—Course of  
the Sap—The Warfare of Plants on one Another—  
Adaptation to the Environment—The Self-Fertiliza-  
tion of Plants..... 341-344

The Thwack Raspberry—Postal Laws—The Gardener's  
Monthly—Criticism—The Tomato—Miller &  
Sievers—The Early History of the Vine and Pome-  
granate—W. Forsyth—J. E. Ilgenfritz—Col. Wikler  
—American Tuberoses—Sir Joseph Banks—Worcester  
Co., (Mass.) Horticultural Society—The New  
South—Ohio State Hort. Society—Twelfth Annual  
Catalogue, Michigan State Agricultural College..... 345-348

The Centennial..... 349-352

### NEW PLANTS:

Double-flowered Liliun auratum—Enonymus flavescens—  
Pellaea ornithopus—Mr. Lee's New Violet,  
Prince Consort—Bambusa argentea striata—Stangeria  
schizodon—Arnebia echinoides—Galactites tomentos-  
a—New Golden Poplar..... 325-326

FORESTRY..... 337-339

NATURAL HISTORY AND SCIENCE..... 339-345

LITERATURE, TRAVELS AND PERSONAL NOTES.. 345-349

HORTICULTURAL SOCIETIES..... 349-352

### QUERIES:

Rose, Tea Duchess of Edinburgh—Gladolus Brenchleyensis—Comparative value of Bronze Bedding Geraniums..... 330

Fire Blight in the Pear—Elvira Grape—Fruiting of Pyrus Japonica—Moth in a Grapery—The Earliest Peach—Brighton Grape—Japan Perstimmon—A New Grape—California Onion Seed..... 335-337

Seeds Two Thousand Years Old Growing—Orthography of Botanical Names..... 344

Ohio Fruit at the Centennial..... 352



# LILY OF THE VALLEY PIPS,

Guaranteed three years old ; best kind for early forcing, \$25 per M.

LILIUM LONGIFLORUM, \$60 per M.

SPIREA JAPONICA (Astilba) \$9 per hundred.

IRIS SUZIANA, \$35 per hundred:

LILIUM LANCIFOLIUM ALBUM, \$30 per hundred.

“ “ RUBRUM, 12 “ “

“ UMBELLATUM, \$7.50 per hundred.

CROCUS MONT BLANC (Early Whites). \$6.50 per thousand.

“ CLOTH OF GOLD (Yellow). \$6 per thousand.

ROMAN HYACINTHS, DUTCH HYACINTHS  
Named and Mixed, TULIPS, NARCISSUS, JONQUIL,  
DAFFODILS, CAMPERNELLES,  
SNOWDROPS, Ect.,

On hand and for sale.

## Ornamental Grasses, Immortelles, GRASS BOUQUETS,

On hand, fresh importation and in large variety. HARTFORD and NATIVE PAPER-PRESSED FERN ; also AUTUMN LEAVES at special figures-for quantities.

All kinds of Willow ; Wheat and Grass trimmed

### BASKETS,

And a full line of FLORISTS' SUPPLIES, furnished at lowest prices. Send for Catalogue.

# *AUGUST RÖLKER & SONS,*

*32 READE ST., NEW YORK.*

Or P. O. BOX 899.

**RURAL AND PRACTICAL BOOKS,** (and any others in the market not on this list) will be sent by mail, post paid, on receipt of price. Address CHAS. H. MAROT, 814 Chestnut St., Philada.

Allen's, R. L., Diseases of Domestic Animals.....	\$1 00	How to Manage a Building Association.....	\$2 80
Allen's, L. F., Rural Architecture.....	1 60	How to Paint.....	1 00
Allen's, L. F., American Cattle.....	2 50	Hunter and Trapper.....	1 00
Allen's, R. L. & L. F., New American Farm Book.....	2 50	Hussman's Grapes and Wines.....	1 50
American Architect.....	7 00	Jacques' Manual of the House.....	1 50
American Bird Fancier, (Brown's).....	30	Jacques' Mannel of the Garden.....	1 75
American Farmer's Encyclopedia.....	6 00	Jennings' Cattle Doctor.....	1 75
American Horticultural Annual, paper 50 Cts., cloth.....	75	Jennings on the Horse and his Diseases.....	1 75
American Weeds and Useful Plants.....	1 75	Jennings' Sheep, Swine and Poultry.....	1 75
Apple Culturist, S. E. Todd.....	1 50	Johnson's Gardener's Dictionary.....	3 50
Art of Saw Filing.....	75	Johnson's How Crops Feed.....	2 00
Architecture, Modern American, Cummings & Miller.....	10 00	Johnson's How Crops Grow.....	2 00
Principles and Practice of, By Loring & Jenning.....	12 00	Johnson's Peat and its uses.....	1 25
Baker's Fruit Culture.....	4 00	Johnston's Elements of Ag. Chemistry and Geology.....	1 50
Bassett on Cranberry Culture.....	30	Johnston's, J. S. W., Agricultural Chemistry.....	1 75
Barry's Fruit Garden.....	2 50	Kemp's Landscape Gardening.....	2 50
Bell's Carpentry made easy.....	5 00	Klippart's Farm Drainage.....	1 75
Bement's Poultryer's Companion.....	2 00	Langstroth, Rev. L. L., on the Hive and Honey Bee.....	2 00
Bement's Rabbit Fancier.....	30	Leuchars' How to Build Hot-houses.....	1 50
Beet Root Sugar.....	1 50	Leibig's, Justus, Familiar Lectures on Chemistry.....	75
Bicknell's Village Builder, 77 plates.....	12 00	Louden's Encyclopedia of Plants.....	20 00
Bommer's Method of Making Manures.....	25	Lyman's Cotton-culture.....	1 50
Boussingault's, J. B., Rural Economy.....	1 60	McMahon's American Gardener.....	2 25
Browne's Trees of America.....	6 00	Mayhew's Practical Book-keeping for Farmers.....	90
Breck's New Book of Flowers.....	1 75	Mechanics' Companion, Nicholson.....	3 00
Bridgeman's American Gardener's Assistant.....	2 50	Meehan's Ornamental Trees.....	75
Bridgeman's Fruit Cultivator's Manual.....	1 00	Miles on the Horse's Foot.....	75
Bridgeman's Kitchen Gardener's Instructor.....	1 00	Miner's, T. B., Bee-keeper's Manual.....	1 25
Buist's, Robert, Am. Flower Garden Directory.....	1 50	Mohr on the Grape-vine.....	1 00
Buist's, Robert, Family Kitchen Gardener.....	1 00	Money in the Garden.....	1 50
Burr's Field and Garden Vegetables of America.....	5 00	My Vineyard at Lakeview.....	1 25
Carpenter and Joiner (R. Riddell).....	7 00	My Farm of Edgewood.....	1 75
Carpenter and Joiner's Hand Book, (Holly).....	75	My Ten-rod Farm.....	50
Chorlton's Grape Grower's Guide.....	75	North American Sylva, 5 vols., 156 col. plates, in 30 parts,	
Chemistry of the Farm, (Nichols).....	1 25	"    "    unbound.....	60 00
Cleveland's Villas and Cottages.....	4 00	"    "    Half Turkey Antique, gilt.....	70 00
Cobbett's American Gardener.....	75	"    "    full.....	75 00
Cole's, S. W., American Fruit Book.....	75	Nichol's Chemistry of the Farm and Sea.....	1 25
Cole's American Veterinarian.....	75	Norton's, J. H. P., Elements of Scientific Agriculture.....	75
Cooper's Rural Hours.....	2 00	Norris' Fish-culture.....	1 75
Copland's Country Life.....	5 00	Onion-culture.....	20
Dadd's, Geo. H., American Cattle Doctor.....	1 50	Our Farm of Four Acres.....	1 25
Dadd's Modern Horse Doctor.....	1 50	Packard's Guide to the Study of Insects..... cloth	6 00
Dana's, Samuel H., Muck Manual.....	1 25	Paul's Book of Roses.....	60
Darwin's Variations of Animals and Plants, 12 vols.....	6 00	Paul's Rose Garden.....	3 00
Darwin's Insectivorous Plants.....	7 00	Paxton's Botanical Dictionary.....	15 00
DeVoe's Market Assistant.....	2 50	Pardee on Strawberry-culture.....	75
Downing, A. J., Landscape Gardening.....	6 50	Parkman's Book of Roses.....	1 50
Downing's Cottage Residences.....	3 00	Parsons, Samuel B., on the Rose.....	1 50
Downing's Fruits and Fruit Trees of America.....	5 00	Peat and its Uses.....	1 25
Downing's Rural Essays.....	3 50	Pear-culture, Fields.....	1 25
Downing's Ladies' Companion to the Garden.....	2 00	Pedder's, James, Farmer's Land-measurer.....	60
Du Breuil's Vineyard Culture, (Dr. Warden).....	2 00	Percheron Horse.....	1 00
Eastwood on Cultivation of the Cranberry.....	75	Peterson's Preserving, Pickling and Canning Fruit.....	50
Elliott's Western Fruit Grower's Guide.....	1 50	Phin's Open-air Grape Culture, and Wine Making.....	1 50
Elliott's Lawn and Shade Trees.....	1 50	Quinby's Pear-culture for Profit.....	1 00
Elliott's Fruit Growers' Hand Book, paper, 60 cents, cloth.....	1 00	Quinby's Mysteries of Bee-keeping Explained.....	1 50
Farm Talk, (Brackett).....	1 00	Randall's Sheep Husbandry.....	1 50
Farming for Boys.....	1 50	Randall's Fine Wool Sheep Husbandry.....	1 00
Field's, Thomas W., Pear Culture.....	1 25	Randall's Bulbs.....	3 00
Five Acres too Much, (illustrated).....	1 50	Rand's Flowers for Parlor and Garden.....	3 00
Flagg's European Vineyards.....	1 50	Rand's Seventy-five Flowers.....	1 50
Flax Culture.....	50	Rand's Flower Garden.....	3 00
Flint, Chas. L., on Grasses.....	2 50	Rand's Orchid Culture.....	3 50
Flint's Milch Cows.....	2 50	Riddell's Architect.....	15 00
Fowler's Homes for All.....	1 50	Ripp's Commercial Calculator, cloth \$1, Morocco Tuck.....	2 00
Frank Forester's Fish and Fishing, 8 vo., 100 engravings.....	3 50	Rose Culturist..... paper	30
Frank Forester's Manual for Young Sportsmen, 8 vo.....	3 00	Robbins', R., Produce and Ready Reckoner.....	75
French's Farm Drainage.....	1 50	Saunders' Domestic Poultry, paper 40..... cloth	75
Fuller's Grape Culturist.....	1 50	Saxton's Hand Books, in four series, each.....	1 50
Fuller's Small Fruit Culture.....	1 50	Scheneck's Gardener's Text-book.....	75
Fuller's Strawberry Culturist.....	1 50	Scheneck's Reader's Text-book.....	50
Fuller's Forest Tree Culturist.....	1 50	Scribner's Reckoner and Log-book.....	3 00
Fulton on Peach Culture.....	1 50	Strong's Cultivation of the Grape.....	3 00
Gentry's Life Histories of Birds, 1st vol.....	2 00	Ten Acres Enough.....	1 50
Gray's How Plants Grow.....	2 25	Thomas, J. J., Farm Implements.....	1 50
Gray's Manual of Botany.....	2 50	Thomas, J. J., Fruit-culturist; old ed., \$3 00; new edition.....	3 75
Gray's Manual, Botany and Lessons, in one vol.....	4 00	Ville's Chemical Manures.....	1 25
Gray's School and Field Book of Botany.....	2 50	Warner's American Pomology.....	3 00
Green on Trout Culture.....	1 00	"    Hedges and Evergreens.....	1 50
Gregory on Squashes, paper.....	20	Waring's Drainage for Profit and Health.....	1 50
Guernon on Milch Cows.....	75	"    Elements of Agriculture.....	1 00
Guide to Fortune.....	1 00	"    Earth Closets.....	50
Harazthy's Grape Culture and Wine Making.....	5 00	Webster's Dictionary, Unabridged.....	12 00
Harris' Insects Injurious to Vegetation, clo. \$4; col. eng's.....	6 50	Well's Every Man his own Lawyer.....	2 00
Harris on the Pig.....	1 50	Williams, B. S., on Stove & Greenhouse Plants, 2 vols., ill'd.....	5 00
Hatfield's American House Carpenter.....	3 50	Williams, B. S., on Select Ferns and Lycopods.....	2 50
Henderson's Practical Floriculture.....	1 50	Williams, B. S., Orchard Grower's Manual.....	2 50
Henderson's Gardening for Pleasure.....	1 50	Window Gardening.....	1 50
Henderson's Gardening for Profit.....	1 50	White's Gardening for the South.....	2 00
Herbert's Hints to Horsekeepers.....	1 75	"    Cranberry Culture.....	1 25
Hoopes on Evergreens.....	3 00	Wood's Class Book of Botany.....	3 50
Hooper's Dog and Gun, paper 30 cents, cloth.....	60	Workingman's Way to Wealth.....	75
Hop-culture.....	40	Wright's Practical Poultry Keeper.....	2 00
How to Buy a Farm, and Where to Find One.....	1 75	Youatt on the Horse.....	1 75
		Youman's Household Science.....	2 00

# SPECIAL OFFER

TO

# FLORISTS, DEALERS,

AND

# BUYERS IN QUANTITY.

## WINTER FLOWERING AND OTHER PLANTS.

Pot grown and specially prepared. All fine, healthy plants graded in price according to size.

	PER 100.		PER 100
Geranium, Apple, scented,	§ 8	Geranium, Happy Thought,	§16
Abutilon, Boule de Neige, white,	§8, §16 and §30	Lygodium Scandens (climbing Fern), 2 to 3 feet,	§8 and 16
Begonias, all the leading winter-flowering sorts,	6 and 10	Smilax, from 1 to 3 feet,	6 and 10
Bouvardias, 6 best winter-flowering sorts,	§6, 8 and 12	Primula, double white,	25 to 75
Carnations, white, strong from ground,	8 and 15	" single, red, white, purple and spotted,	8 to 12
Chrysanthemums, white and other varieties,	4 and 12	" semi-double, white,	12 and 16
Eupatorium and Stevia, in variety,	§8, 12 and 20	Roses, leading winter flowering sorts,	12 to 25
Verbenas, stock mixed,	3		
" 12 best market sorts,	4		

Five plants of any variety will be sold at hundred rates, but not less than one hundred plants in one order.

Our Wholesale List from which above is an extract, embraces many hundred varieties besides those named above.

## MIXED HYACINTHS, for Forcing or Bedding.

Ranging according to color from \$7.50 to \$8.50 per 100, extra fine bulbs.

	PER 100		PER 100
Lily of the Valley, in large clumps,	§35	LILIUM CANDIDUM, extra large bulbs,	§12
" " in single crowns,	3	" Longiflorum, " " "	12

## FLOWER SEEDS, for present Sowing.

	PER PKT.		PER PKT.
Verbena, saved from our own collection, §5 per oz..	15c.	Apple Geranium, scented, seed of 1876,	30c.
Petunia, finest striped and blotched, §5 per oz.,	15c.	Double Cineraria,	75c.
" double,	30c.	Primula sinensis fimbriata, double red and white,	75c.
Lygodium Scandens, (Japanese Climbing Fern)	30c.	" " " single " " "	30c.

## VEGETABLE SEEDS, for Fall Sowing.

Cabbage, Jersey Wakefield, (true) 75c. per oz. §2 per ¼ lb. \$6 per lb.	Cauliflower, Extra Early Dwarf Erfurt, §2 per oz. §7 per ¼ lb., §24 per lb.
Cabbage, Early York, 40c. per ¼ lb., §1.25 per lb.	Cauliflower, Early Paris, 75c. per oz., §2.50 per ¼ lb., §9 per lb.
" Early Flat Dutch (true L. Island) 75c. per oz., §2 per ¼ lb., §6 per lb.	Lettuce, Curled Simpson, 60c. per ¼ lb., §2 per lb.
Cabbage, Early Summer, (new), see special list of testimonials,—§1.50 per oz., §5 per ¼ lb., §16 per lb.	" Curled Silesia, 30c. per ¼ lb., §1 per lb.
	" Boston Market (for forcing) 60c. per ¼ lb., §2 per lb.
	Spinach, Round and Prickly, 10c. per ¼ lb., 25c. per lb.

## FLORIST'S REQUISITES.

Embracing BOUQUET PAPERS, WILLOW and RUSTIC BASKETS, BASKETS FOR SHIPPING PLANTS, GRASS BOUQUETS and IMMORTELES, POT COVERS, WARDIAN CASES, WIRE DESIGNS for CUT FLOWERS (embracing 30 different patterns), all of which will be sold at lowest wholesale rates.

Our MONTHLY LIST, descriptive of above, together with all other articles wanted by Florists and Gardeners, will be mailed FREE on application. To our regular customers it will be mailed monthly as usual

*Peter Henderson & Co*

SEEDSMEN, MARKET GARDENERS AND FLORISTS,

35 CORTLANDT ST., NEW YORK.

**50,000****IRISH JUNIPERS,****FROM 1 TO 5 FEET.**

We can sell them cheaper than any establishment in the United States.  
Send for Price List.

**TRUETT'S SONS & MORGAN,**  
ROSEBANK NURSERIES,  
taug5 Nashville, Tenn.

**DUTCH BULBS**

AND

**FLOWER ROOTS,****HYACINTHS,****Tulips, Crocus, &c.,**

ALSO

**ROMAN****HYACINTHS,**

of excellent quality, in prime condition

**FOR SALE CHEAP,**

to close a consignment.

For Price list, apply to the importer.

**C. RAOUX,**

Jan1f Office 76 Park Place,  
NEW YORK CITY.  
P. O. Box 2956.

**DELAWARE,**

New, large and very fine; also  
**BRANDYWINE True), HIGHLAND HARDY, GAN-  
ARGUA, THWACK**

**RASPBERRY PLANTS,**

In large supply.

**A. HANCE & SON., Nurserymen and Florists,**  
RED BANK, N. J.

Oct 1f

**New Peaches,**

AND NEW LONG-KEEPING

**Winter Apples,**

also full assortment of all the old popular market varieties. Grapes, and Small Fruits, Evergreens, Ornamental Trees and Shrubby; a large stock of all items usually found in a first-class Nursery, all of which will be sold for less than half the usual retail price. Fifty page Catalogue mailed gratis, showing how and what to plant.

**RANDOLPH PETERS,**

Great Northern & Southern Nurseries,  
WILMINGTON, DEL.

Nov1

**NEW PLANTS--TO THE TRADE.****New Double White Daisy, Belle of Dubuque.**

The largest and finest white daisy yet offered, flowers perfectly double. 50c. each. Daisy, Harkett's Perfection, 35cets., each; \$3 per doz.

**NEW VARIEGATED LANTANA.**

Best variegated bedding plant to stand the sun. Very free blooming. 50c. ea. h. \$4 00 per doz. Smaller plants, 30c. each; \$3 per doz. free by mail.

**W. A. HARKETT,**

Feb10

DUBUQUE, IOWA.

**TREMONT****Botanic Gardens,**

Tremont, New York City,  
NEW and RARE

**Stove & Greenhouse Plants,**

ORCHIDS, PALMS and FERNS.

CATALOGUES sent FREE of CHARGE.

**JOHN S. BUSH,****A GIFT WORTHY OF A ROTHSCHILD**

FOR

**ONE CENT,**

A copy of Brown's Illustrated Shakespearean Almanac for 1877, together with a copy of his Illustrated paper, the *Growing World*, which is devoted to Natural History, will be sent to any one free who will send us his address on a one cent postal card. Address

Nov1 **Dr. O. P. BROWN, 21 Grand St., Jersey City, N. J.****A. VAN GEERT,**

Nurseryman,

**Ghent, Belgium**

Begs to inform his numerous American patrons, that his

**NEW GENERAL CATALOGUE**

has just been issued. It will be mailed free to all intended purchasers. Orders for exportation, packed on the most approved principle, insuring perfect success.

Nov3

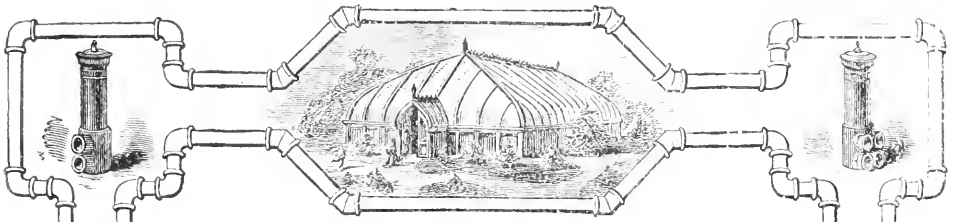

ESTABLISHED 1844.

HITCHINGS & CO.

No. 153 Crosby Street,

NEW YORK.

CONICAL BOILER

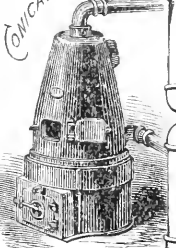

SADDLE BOILER

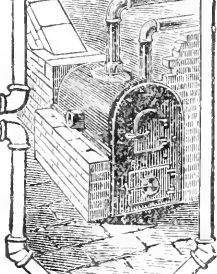

HOT-WATER  
 APPARATUS  
 for HEATING  
 GREEN-HOUSES, &c.

Illustrated Catalogue and List of References and Reduced Prices, sent on receipt of postage—6 cents.

CORRUGATED FIRE-BOX BOILER

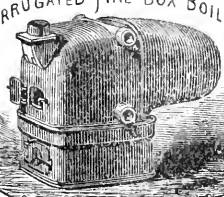

H. W. TROY DEL.

## 2 GRAND MEDALS AWARDED

One for our fine collection of

**ROSES,**

One for our superior collection of

**HARDY PLANTS.**

nov1 **R. BUIST, Rosedale Nurseries, Philadelphia.**

# Apple Trees!

100,000 very fine, well grown, thrifty Apple Trees, comprising all the leading varieties; **Cheap.**  
Send for New Trade List.

**HOOPES, BRO. & THOMAS,**

Cherry Hill Nurseries. sep6 **West Chester, Pa.**

**A. M. C. JONGKINDT CONINCK,**

Tottenham Nurseries,

Dedemsvaart, near Zwolle, Netherlands.

Offers at the Lowest Prices:

**BULBS, FLOWER ROOTS, PERENNIALS, FRUIT TREES, ROSES, MOSS-ROSES, Etc.**

Catalogues gratis on application.

oct3

## POT ROSES.

We offer a large stock of Extra fine **ROSES FROM 3-IN. POTS**, suitable for florists' use. Can be sent s. f. l. with or without Balls as desired. Price, \$6 per 100; \$70 per 1000.  
See Lists, now ready. Ad. dress,

**THE DINGEE & CONARD CO.,**

oct3 **West Grove, Chester Co., Pa.**

# Grape Vines.

Grown Especially for the Trade and Planters, in Quantity Concord, Martha, Delaware, Ives, Hartford Prolific, Salem, Wilder, Agawan, etc., etc. Also a large assortment of New varieties.

**A. HANCE & SON,**

oct1f **NURSERYMEN AND FLORISTS, RED BANK, N. J.**

## DUTCH FLOWER ROOTS

Our New Catalogue of the finest kinds of **HYACINTHS, TULIPS, LILIES, NARCISSUS, CROCUS**, and a great variety of other desirable Flowering Bulbs, for the house or garden, with practical directions for culture, sent free to all on application.

**HOVEY & CO.,**

sep3. **53 North Market St., Boston, Mass.**

# NURSERY STOCK.

**FOR FALL, 1876.**

We offer in large or small quantities a very complete assortment of both

**FRUIT and ORNAMENTAL TREES, AND SHRUBS,**

including **STANDARD and DWARF APPLE and PEAR PLUM, CHERRY, PEACH, and SMALL FRUITS.**

**OUR ORNAMENTAL STOCK IS A No. 1.**  
in every particular

A large part of our stock must be dug, and will therefore be sold very low.

Special rates given to large buyers. Price list free.

**SELOVER & WILLARD,**

sep3 **Washington St. Nurseries, Geneva, N. Y.**

## DOUBLE TUBEROSE BULBS.

Very superior in quality.

	Doz.	100	1000
First Quality Large Flowering Bulbs,	\$ 75	\$4.00	\$30.00
Second Quality Flowering Bulbs,	.50	3.00	20.00
A few hundred EXTRA Large Bulbs,	1.00	5.00	
Dwarf Pearl, 1st quality Flowering Bulbs,	1.50	6.00	

11 sent by Mail 25 cents per dozen EXTRA

**MILLER & HAYES,**

toct6 **5774 Germantown Avenue, Philadelphia,**

# THAT RASPBERRY,

**THE THWACK** leads all other sorts in prolificness, hardness, firmness, size, color and flavor. Endorsed as the best by J. C. Evans, President of the **Missouri State Horticultural Society** and hundreds of others who have tried it.

The **Pike County Horticultural Society** at its July session, 1876, resolved as follows: "That the Thwack Raspberry, as grown at Foster's Hillside Nursery, Louisiana, Mo., possesses more fine qualities for market or table uses than any other Raspberry we know of. Its extreme hardness and prolificness as well as its superior shipping qualities, large size, brilliant color, and good flavor, make it a favorite wherever known." Unanimously adopted. Address with stamp for circular.

oct2 **Foster's Hillside Nursery Co., Louisiana, Mo.**

## N. STEFJEN'S WIRE WORKS,

335 E. 21st St. New York.

Manufacturers of all designs for **FLORISTS**. Wreaths, Crosses, Crowns, Hearts, Anchors, Pillars, Columns, Monuments, Bells, Composure, Faith, Hope and Charity, Harps and Lyres, &c. Luminous and Upright

Send for Price List.

jan 12.

## B. T. BABBITT'S BABY SOAP



Only the purest vegetable oil used in its manufacture.

No artificial and deceptive colors to cover common and objectionable ingredients. UNRIVALLED for the tender and sensitive skin of the infant. It will prevent eruptions, keep the skin soft and smooth, counteract scalds, and prevent disease. Does away with all powders, ointments, and emollients. A perfect substitute for *Softening Soaps, Etc.* in bath-tubs, and superior to the ordinary and cross-grained baby-soap. We manufacture its cost in every mother and family in Christendom, packed in boxes of 12 cakes of 6 ozs. each, and sent free to any address on receipt of 25c. Address, **470 Broadway, New York.** For sale by all Druggists. **B. T. Babbitt, N. Y.**

# ROSES.

The finest out-door grown Roses, Hybrids, Mosses, Prairies, Teas, Chinas, Noisettes and Bourbons, at the very lowest prices.

Send for Catalogues

**WM H. MOON,**

nov1 **Morrisville, Pa.**

# ROSES FOR SALE

Strong plants out of the ground.

**2000 GEN'L JACQUIMENOT.**

**2000 SAFRANO,**

**1000 BON SILENE.**

Also other good market varieties.

**CRAIG & BRO.,**

nov1 **221 S. 11th St., or 49th and Market St., Philadelphia.**

## LONDON GARDENER'S CHRONICLE

Will be furnished, post-paid, direct to subscribers in the U. S. for \$7 50 per year. Specimen Nos. 3 cent stamp. Apply to

nov1 **CHAS. H. MAKOT, Agent, 814 Chestnut St., Phila**



**WE OFFER**

FROM OUR

**LARGE AND SELECT LIST OF ROSES**

Fine plants of all the LATEST and CHOICEST VARIETIES, grown on their OWN ROOTS, and now ready for delivery. HYBRID PERPETUALS, TEAS, NOISSETTES, 1 year, fine plants, grown in 4 and 5 inch pots, at \$3 per doz.; \$15 per hundred.

We can also supply all the NEW and BEST VARIETIES of

**HARDY ORNAMENTAL TREES AND SHRUBS,  
EVERGREEN AND DECIDUOUS,**

For planting in Lawns, Yards, &c.

ROSE and PLANT CATALOGUES sent on receipt of 3ct postage stamp.

tsep3

MILLER & HAYES Mt. Airy Nurseries, Philadelphia.

**LARCHES, EVERGREENS!**

LARGEST STOCK IN AMERICA.

**BOTH SEEDLINGS AND TRANSPLANTED TREES.**

All grown from seed on our own ground, and better and cheaper than imported stock.

EUROPEAN LARCH AND EVERGREEN TREE SEEDS,

by the ounce, pound and 100 pounds. Send for Catalogue

ROBERT DOUGLAS & SONS,

Waukegan, Ill.

tsep9

**JOHN DICK'S PATENT BOILER**

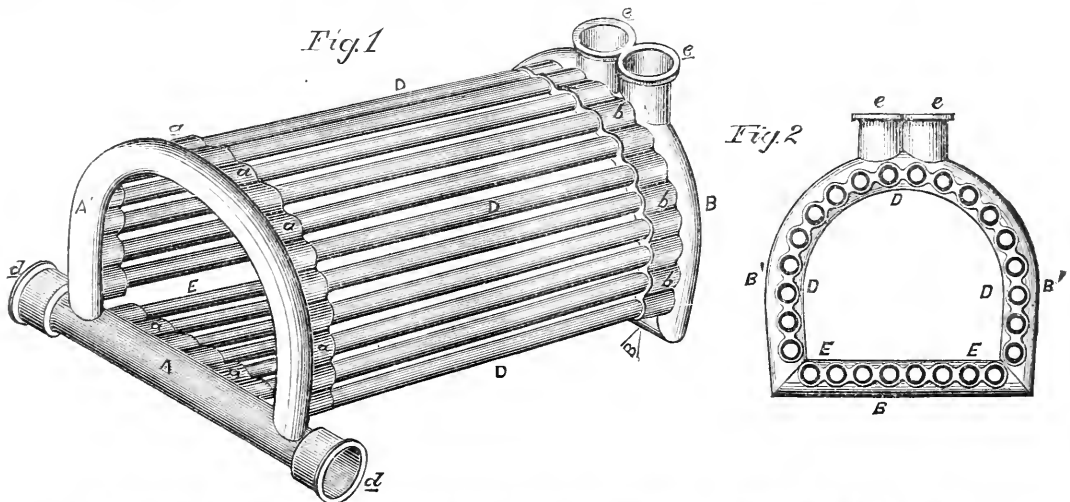

**Economy, Simplicity and Durability.**

SEND FOR CIRCULAR.

**J. DICK, Florist,**

53d & Darby Road, Philadelphia, Penna.

sep6

**R. BUIST,**

Offers the following

**NEW PLANTS,**

- HYDRANGEA HORTENSIA** "Thos. Hogg," with pure white flowers in very large heads, \$5 each.
- EUPHORBIA POINSETTIA PLENISSIMA**, the double POINSETTIA, brilliant crimson, remains a long time in bloom, \$4 each.
- VERONICA JAPONICA**, brilliant blue. The plant shown at the Centennial by me was 2 feet high and 2 feet wide, with 50 spikes of bloom. \$1 each, strong ground roots.
- PHLOX Madam Miller**, (Buist), the finest pure white Phlox in cultivation, remaining 4 months in bloom, ground roots \$1 each.

With many other new and rare plants.

Rosedale Nurseries, Philadelphia.

nov1 **R. BUIST.**

**WALLACE'S MONTHLY.**

THE only Illustrated Magazine devoted to Domestic Animals.

The recognized **AUTHORITY** on the **HORSE** and the Organ of American Breeders.

**Uncompromising Hostility to Gambling and Fraud of every Description.**

Thorough in the investigation and exposure of fraudulent pedigrees and all shams.

Able and fearless in discussion, and the contributions of the best writers in the land are to be found in its columns.

Not a "Sporting Paper," but COMPLETE in its reports and indexes of all performances.

*Every Farmer who loves a good horse and fair dealing should have it.*

The Cheapest of its Class in the World.

Three Dollars a year, in Advance.

**WALLACE'S MONTHLY,**

nov3 170 Fulton St., New York City.

**APPLE STOCKS.**

200,000 Extra No. 1 Apple Stocks.

CHEAP FOR CASH.

**L. KAUFFMAN,**

nov1 IOWA CITY, IOWA.

**BEGONIA FROEBELI.**

New Tuberous-rooted Begonia. Price per doz. \$6.

Address,

**J. ROEHR**, Florist,

nov2 Jersey City, N. J.

**MAPLES.**

**NORWAY, SUGAR AND SILVER,**

of all sizes at low prices, also **Poplars, Elms, Lindens** and other Shade Trees and Shrubs.

**Wm. H. MOON,**

nov1 Morrisville, Pa.

**ROSES! ROSES!**

We offer a large stock of

**Roses from open Ground.**

All on own Roots.

	Per 100.	Per 1000.
<b>Hybrid Perpetuals</b> , 1st class,	\$12	\$100
2nd size	8	70
<b>Climbers</b> , Prairie, asd., first class,	12	100
<b>Mosses</b> , extra strong, 2 yr.,	20	
" fine           1 yr.,	15	

Lists on application. Address,

The Dingee & Conard Co.,

oct3 West Grove, Chester Co., Pa.

**Osage Orange.**

Quality prime, prices low. Special rates by the 10,000 and upwards.

**A. HANCE & SON,**

octf Nurserymen and Florists, Red Bank, N. J.

**Wood Labels**

For Trees and Plants, superior quality, made of best white Pine.

**LARGE STOCK**

Constantly on hand. Address,

**TREVOR & CO.,**

LOCKPORT, N. Y.

oct3.



**R. LYNEX,**

Rear of 428 Walnut Street, Philada.

Manufacturer of **Plain and Fancy Wire-work**, for **Florists**; Wreaths, Crosses, Stars, Crowns, Hearts, Anchors, Birds, Lambs, Gipsy Baskets, Hanging Baskets, Flower Stands, &c.

SEND FOR PRICE LIST.

aug6

**20,000 AGENTS WANTED!**

TO CANVASS FOR

**400 PAPERS** and **MAGAZINES**, which are furnished at Club Rates for single copies. Book and other agents can act without interfering with present business. Good pay, easy work

sep4 **C. W. BENNETT**, Gen'l Agent, Quincy, Mich.



CIRCULAR.

THE NEW

# Japanese White Flowering HYDRANGEA, "THOMAS HOGG."

We have great pleasure in announcing to the Horticultural world, that the distribution of this fine plant, the most superb novelty in plants ever introduced into this country, will commence on **October 1st, 1876**. It has received the unqualified admiration of all American and European Florists and Nurserymen who have seen it in flower.

Orders will be received at the following rates:

One Plant \$5.	Where 12 Plants are taken,	2 additional sent.
" 25	" " " "	5 " "
" 50	" " " "	12 " "
" 100	" " " "	25 " "

This, the finest of all Hydrangeas, was sent to the United States by Mr. THOMAS HOGG, from Japan. It has been exhibited in flower at the Massachusetts Horticultural Society weekly meeting in Boston, where it took the Society's silver medal for new plants; and also, at the New York Horticultural Society's monthly meeting in May. In the report of that meeting to the "American Agriculturist," by Mr. Peter Henderson, he says:—"We think it safe to say, that no ornamental plant ever introduced exceeds this in value."

It belongs to the Hortensia section of the family, but is a far more free and abundant bloomer than any other, for the Florist, and for all decorative purposes it will be invaluable; the flowers are of the purest white, of very firm texture, and continues in flower for a great length of time. It will no doubt prove quite as hardy as the old Hortensias.

All ordering 12 plants, or more, will get a large plant included in the number, at regular rates, suitable for exhibition next spring.

All orders must be sent to **JOHN CADNESS, FLUSHING, L. I., N. Y.**

Cash must accompany the order, and all remittances by Draft or Post Office Order, or Bank Cheque, as we cannot be responsible for the safety of greenbacks by mail.

JOHN CADNESS.

Flushing, Long Island, N. Y., Sept. 1st, 1876.

toct12

## P. & E. TRANSON, NURSERIES, ORLEANS, FRANCE,

Beget to inform their friends and customers generally that their

### NEW LIST FOR 1876 AND 1877,

Is now ready, and may be had on application to

### MESSRS. KNAUTH, NACHOD & KUHNE, 113 BROADWAY, NEW YORK.

This Catalogue contains Prices of all the **FRUIT TREE STOCKS**; an extensive list of **FRUIT TREES**, New and Hardy **ORNAMENTAL PLANTS**, **CLIMBERS**, the Hardest and Best **CONIFERS**, **ROSES** on their own roots. Also, **SMALL CONIFERS**, **DECIDUOUS** and **EVERGREEN ORNAMENTAL TREES**, one or two years' Seedlings, most useful for Nurserymen.

N. B.—The greatest attention given to packing.

oct5

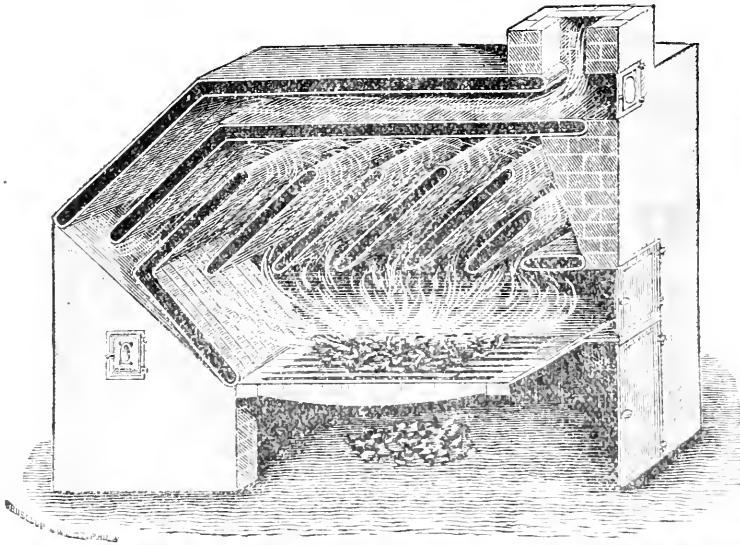

THOMAS J. MYERS,  
 PATENT BOILERS  
 AND  
**Hot Water Apparatus**

FOR HEATING

Greenhouses,  
 Hot-Houses,  
 Conservatories, &c.

THOMAS J. MYERS & SON,  
 1162 Passyunk Ave.,  
 PHILADELPHIA.

2, 4, 6 & 8 Home Street, Cincinnati, O.

Please send for Descriptive Circular and Price List. (1)net

# GRAPE VINES.

Also GRAPE WOOD and CUTTINGS. LARGEST STOCK IN AMERICA.

All leading varieties in large supply. Extra quality. True to name. Special rates to Agents, Dealers and Nurserymen. Our list of customers now embraces nearly all the leading nurserymen in the country to whom we would refer those not acquainted with our stock. Descriptive Catalogue and Price List Free. T. S. HUBBARD, Fredonia, N. Y. aug10

Estab. 1765.

**2,000,000**



**IN STOCK**

ILLUSTRATED CATALOGUES  
*Sent free on application.*

*Low freights from Boston allow us to compete with any Pottery in the United States.*

**A. H. HEWS & CO., - - No. Cambridge, Mass.**

M. M. BAYERSDORFER & CO.,

Importers of Every description of

## BOUQUET PAPERS.

Plain White Satin for Bridal Bouquets. Fancy Lace for Weddings, Receptions, Parties. Italiens, Fasted Cartons, Immortelles in great varieties; Green Moss, French Dried Grasses and Flowers, Tin Foil. Prize Medal of Cincinnati Industrial Exposition of 1873 awarded to us for the best display of Bouquet Papers. Illustrated Catalogue furnished on application.

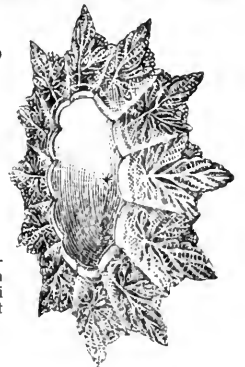
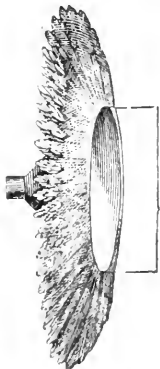

feb

56 N. Fourth St., Philadelphia, Pa.

**ELLIS' BASE BURNING BOILER.** FOR WARMING Dwellings, Greenhouses, Graperies, Forcing Pits, Drying Rooms Heating Water for Public Baths, Baptisteries, &c., by Hot Water or by Steam.

Estimates and Circulars furnished. t.sep.12. 182 CENTRE STREET, NEW YORK.

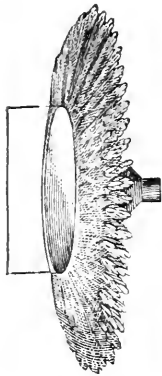

ROWLAND WHITMAN.

HARRY LANG.

**WHITMAN & LANG,**

IMPORTERS OF

BOUQUET PAPERS.

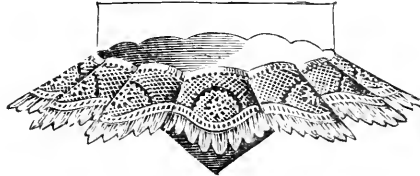

FANCY GRASSES

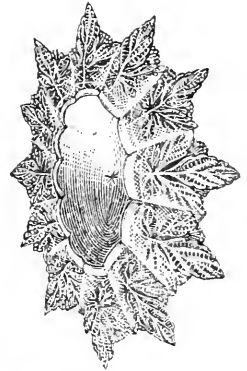

DRIED FLOWERS, IMMORTELES, TIN FOIL &c.

augf. No. 126 N. 4th St., Philadelphia.

**GERMANTOWN NURSERIES, PHILADELPHIA.**

GORGAS LANE STATION, CHESTNUT HILL RAILROAD. Less than One Hour from the Centre of Philadelphia.

Those who desire to purchase largely, either for their own planting or to sell again, are invited to examine the extensive stock of

**FRUIT, SHADE AND ORNAMENTAL TREES AND SHRUBS,**

Grown at the Germantown Nurseries. And those who need but A FEW ARTICLES, will find all ages and sizes to select from. A special feature of the business, is the raising of

Nursery Stock and Seedling Forest Trees

FOR DISTANT SHIPMENT. Many of these can be supplied by the millions at very low rates. Address, for CATALOGUES or information,

**THOMAS MEEHAN, Germantown Nurseries, Phila.**

**JOHN A. SCOLLAY,**

**IMPROVED HOT WATER APPARATUS,**

Patented September 17, 1872.

*For Warming and Ventilating Dwellings, Greenhouses, Graperies, Forcing Pits, Drying Rooms, Heating Water for Public Baths, &c.*

This Boiler is perfectly self-cleaning, simple, economical and powerful, having more effective surface into less space than any Boiler in the market. Scollay's Patent Plant Sprinkler, for Window Gardening, &c., to be obtained of all Seedsmen, Florists, &c. Send for Circular and References. nov.12

351 Adams Street, Brooklyn, New York.

**THE OFFICIAL GUIDE BOOK TO PHILADELPHIA AND CENTENNIAL EXHIBITION.**

By THOMPSON WESTCOTT.

Author of the History of Philadelphia. The only full and complete Guide Book. Illustrated with two maps and 93 engravings. 425 pages, 16mo, Cloth, \$1.50; Morocco, \$2.00. Mailed, post-paid, on receipt of price. Address,

CHAS. H. MAROT, 814 Chestnut St., Phila.

Visitors Guide to the

**Centennial and Philadelphia.**

Only authorized Guide Book on Centennial Grounds. Map of Centennial Grounds, Map of Philadelphia, 43 pages, 12mo, mailed for 30 cents. Address,

CHAS. H. MAROT, 814 Chestnut St., Phila.

# WHEELER'S INSECT ANNIHILATOR, LIQUID DISTRIBUTOR

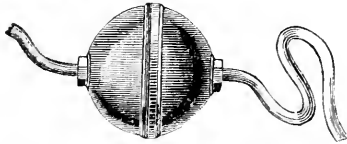
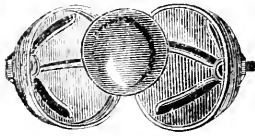

Compound Liquid Hose Distributor,  
Price \$5.00.

AND

INSECTICIDES.

Patented July 20, 1875.

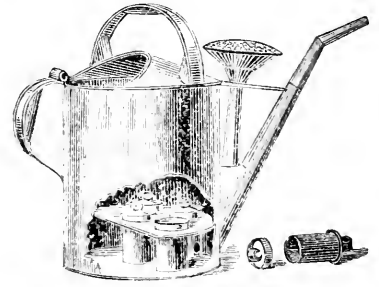

Compound Liquid Watering Pot,  
Average size, \$6.00.

These devices attached to hose pipe of aqueduct or force pump, and operated by water under pressure, and the Watering Pot constructed under the same patent, are the best ever yet used for destroying insects (Potato Bug and Currant Worm not excepted) on plants under glass or in open air, or for fertilizing the same. Fumigation unnecessary. Compound of Tobacco, Sulphur, Guano, in 5 lb. Boxes, 15c. per lb.; of Paris Green and Hellebore, 30c. per lb.

## INSECT ANNIHILATOR & FERTILIZER DISTRIBUTOR

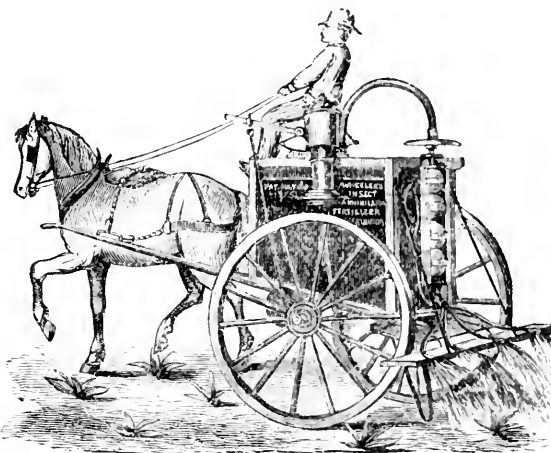

is operated by horse for field use, distributing any desired liquid compound in rows broadcast, or on trees. It is also a powerful Fire Engine, throwing an inch stream from 50 to 75 feet.

PRICE \$200.

## Liquid Fertilizer Distributor

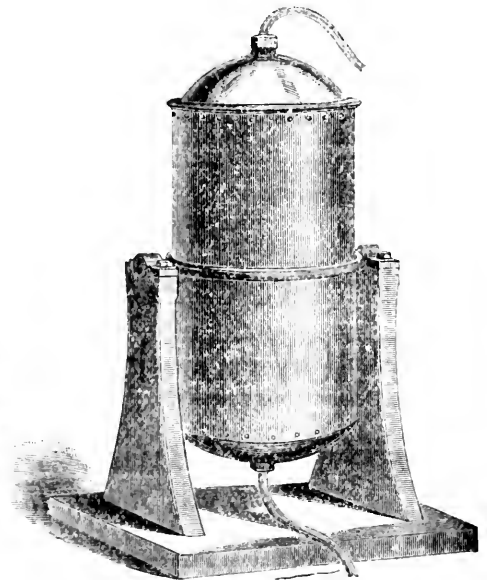

To reduce solid manures, coarse or fine to liquid form, and distribute the same under pressure through hose pipe.

PRICE \$50.

These Machines and Insecticides are on exhibit at the Centennial Exposition, and can be seen in practical operation on the grounds. Above goods delivered C. O. D. Highest testimonials with descriptive circular sent on application.

julytf.

W. F. WHEELER, 24th Ward, Boston, Mass.

**FOR SALE OR RENT.**

Three Greenhouses, and a two-story House, and Barn. Or would take a good respectable, sober partner, with the same amount of capital invested. To Florists or Market Gardeners this will be found a first-class opportunity, as both can be carried on with good success. The property is three quarters mile from business centre of town. The houses and dwelling is situated on the side of a beautiful river. For further particulars, Address,

WM. HALE or E. L. PRATT, Prop.,  
West Hudson St., Elmira, N. Y.

tnov6

**SIX GREENHOUSES  
ON 8 YEARS' LEASE.**

Owing to failing health, I will dispose of my good-will and interest in the above, situated on one of the leading avenues in the city. I have made the cut flower department a specialty. The Trade is sure and constant. To an active enterprising man this opportunity offers inducements seldom met with. For particulars apply to

T. FOWLER GERRARD,  
877 Euclid Ave., Cleveland, O.

tnov3

**Fruit Growers' Hand-Book.**

By F. R. Elliott, author of "Western Fruit Growers' Guide," (one of the best posted men on the subject in the United States). Contains the practice on all subjects connected with fruit growing. The book is made for those who grow fruit for their own use. Also an Appendix, containing matter relating to the selection and culture of Ornamental Trees, Roses, Plants, &c. Illustrated with 45 wood-cuts, 130 pages, 16mo cloth, \$1; paper, 60 cts. Sent by mail post-paid on receipt of price.

Address C. H. MAROT, 814 Chestnut St., Phila.

**ALEXANDER PEACH.**

And other New kinds. Cherry, 2 years, strong growth. Red Dutch Currants, 1 and two years, Apricots, 1 to 2 years, fine at \$9 per hundred. Norway Maple, 8 and 9 feet; Sugar Maple, 4 to 5 feet nursery grown, in quantities. Hemlock Spruce, 2 to 2½ feet, bushy. American Arborvite, 8 inches to 8 feet, Siberian, 3 to 4 feet. Irish Juniper, 3 to 5 feet. Stock of best quality and offered low.

JOSIAH A. ROBERTS.

Paoli, Pa.

tseptf

**Decorative Plants.**

Send for our New Trade List of Palms, Ferns, and other Greenhouse and Stove Plants. We offer a large assortment at low rates.

HOOPES, BRO. & THOMAS,

Cherry Hill Nurseries. West Chester, Pa.

sept6

A Hygroscope for 50 cents.

**THE CHEMICAL HYGROSCOPE.**

This indicator of atmospheric moisture is as accurate as the costly ones. Rooms heated by furnaces or stoves are almost invariably so dry as to be damaging not only to health but to furniture. Some people take the consequences others keep water on the heater. The Hygroscope shows at a glance whether the air is too dry or not.

Sent by mail for 50 cents. Address,  
CHAS. H. MAROT, 814 Chestnut St., Philadelphia.

febtf

**Orchid Culture.**

By EDWARD SPRAGUE RAND, JR.

Including culture, propagation, collection and hybridization of Orchids; the construction and management of Orchid-houses; a glossary of Botanical terms and significance of their names; the whole forming a COMPLETE MANUAL OF ORCHID CULTURE. Cloth 12 mo, 476 pages. Price \$3.50. Mailed, post-paid, on receipt of Price.

Address, CHAS. H. MAROT,  
814 Chestnut St., Phila.

WALTER ELDER,  
Landscape and Jobbing Gardener,  
1231 Rodman Street, Philadelphia

Attends to all branches of his business on reasonable terms.

**COMMUNICATIONS**

are invited from FIRST-CLASS GARDENERS to take charge of next Spring and work on shares a large

**VEGETABLE GARDEN,**

with FORCING HOUSES and GRAPERIES, gardener's house and stable, and to keep in order the CONSERVATORY and GROUNDS attached to a PRIVATE RESIDENCE, near Baltimore City.

Address "SUDBROOK,"

tnovt Pikesville P. O., Baltimore Co., Md.

**Gray, Dry Faded and Falling  
HAIR**

Is now restored to its natural condition by the use of

**WOOD'S IMPROVED HAIR RESTORATIVE.**

The IMPROVED ARTICLE is now taking the lead over all others, leaving the hair clean, soft and glossy. C. A. COOK & CO., Chicago Sole Agents for the United States and Canada. Sold by all Druggists everywhere. Trade supplied by J. F. HENKY, CURKAN & CO., New York. oct5

**To Nurserymen and Dealers.**

Your attention is respectfully asked to my extensive stock of

**FRUIT TREES,**

superior quality, offered for

**FALL TRADE,**

at prices that CHALLENGE COMPETITION on same quality of stock. The past favorable season has produced an exceedingly fine growth of well-matured wood, making the stock desirable in every particular.

To parties who cannot conveniently see the stock, I would refer for information as to its extent and quality to several respectable Nurserymen and Dealers from different parts of the country who called lately and saw it. The advantage of selecting from an extensive stock and good assortment should not be overlooked by purchasers. The following figures will give some idea of the amount of stock I offer at present, viz.: 200,000 Standard Apple, 30,000 Dwarf Apple, 80,000 Std. Pear, 35,000 Dwarf Pear, 45,000 Cherry, 5,000 Plum, 2,000 Orange Quince, 2,000 Horse-chestnut. In addition to above I am prepared to furnish Peach Trees in large or small orders either from this State or Delaware, at the lowest possible rates. Also Seedlings and stocks for Nurserymen, both Foreign and Domestic. Digging and packing done in the best possible manner. Charge for packing very moderate. Please call and examine stock, or address for particulars,

toctt JOHN MURPHY, Dansville, Liv. Co., N. Y.

**FOR SALE.**

A farm of 60 acres, 35 miles from Philadelphia, on Camden & Atlantic R. R., ½ mile from Magnolia Station; well adapted to cultivation of Fruit Trees, Small Fruits and Vegetables. Large section of it Cedar Swamp and Natural Cranberry Ground. 4 acres in Cranberries under cultivation, 140 Fruit Trees, Apple, Pear, Peach, Plum, &c., just coming into bearing. House and barn. Water excellent and abundant. Location healthy. Will be sold at reasonable price and terms to close an estate; or will be exchanged for city property. Philadelphia or Reading preferred.

Address,

CHAS. H. MAROT,

septf.

814 Chestnut St., Philadelphia.

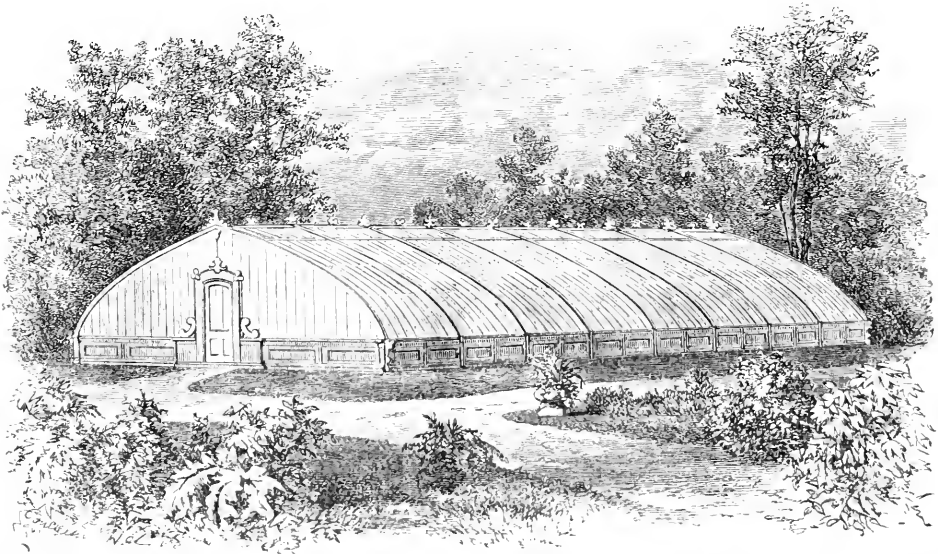

# GREENHOUSES, GRAPERIES, ETC.

Their Construction a Specialty. Experience of 20 Years.  
 SHIPPED TO ALL PARTS OF THE COUNTRY. Send for Catalogue. Address,  
 LORD'S HORTICULTURAL WORKS,

June 12

Irvington-on-Hudson, New York.

## ALEX. NIMMO,

Late of the Firm of Nimmo & Scollay.

# NEWLY IMPROVED HOT WATER BOILER,

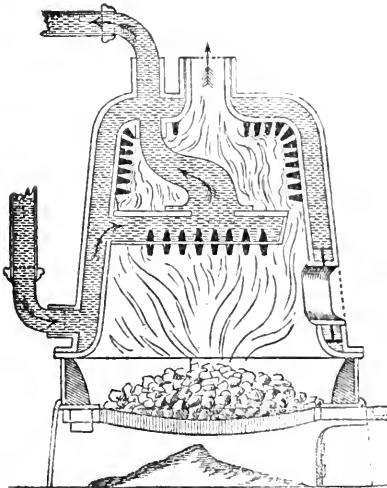

FOR HEATING

Green-Houses, Graperies, Conservatories,  
 Forcing Pits, Water for Baths, Drying  
 Rooms, Public and Private  
 Buildings, &c.

*Proper steps have been taken to secure United States  
 Letters Patent on this Invention.*

All the necessary Fittings for Hot Water Heating Apparatus.  
 VENTILATION APPARATUS OF ALL KINDS.

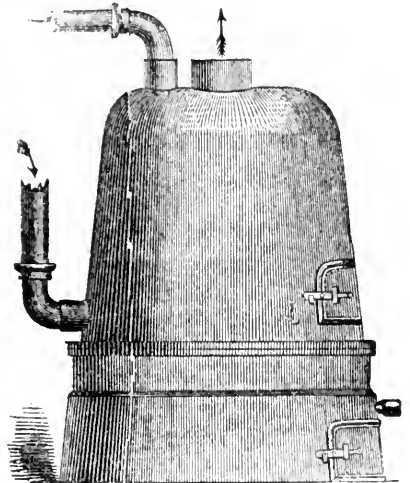

Wells Drove, Pumps of all kinds, Hydraulic Rams, &c., Garden Sun-Dials.

Agent for Joseph Kelly's Never Dry Vapor Pans, for all kinds of Hot Air Furnaces, Baltimore Heaters, &c.

CHEAPEST AND BEST BOILER, &c. IN THE MARKET.

Please send for Circular for explanation, etc., before you make up your mind to purchase elsewhere.

sep 12

P. S.—Be sure you get the right number.

335 Adams Street, Brooklyn, N. Y

# WABAN CONSERVATORIES

OFFICE:  
56 BROAD ST., BOSTON.  
Address all Letters to  
BOSTON OFFICE.

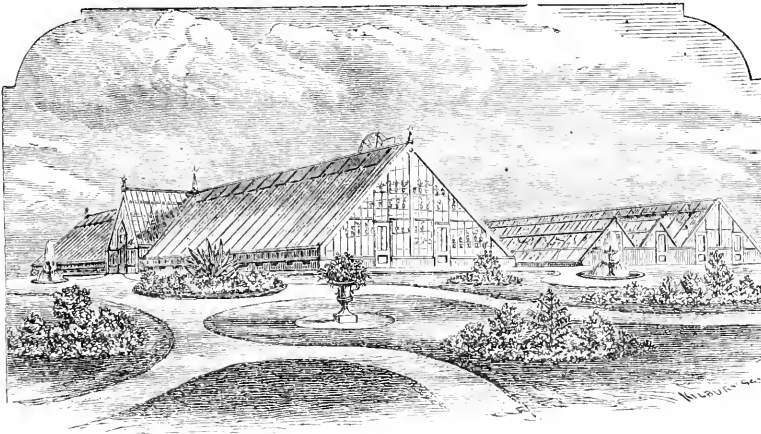

Send all Telegrams by  
Atlantic & Pacific Line. Address,  
*Waban Conservatories,*  
LAKE CROSSING, MASS.

## FALL TRADE 1876.

The following choice **SELECTED NOVELTIES** will be ready for delivery during the coming **FALL**, and to which attention is specially directed.

### ROSE "EDMUND WOOD." (Verdier).

This superb hybrid perpetual we have bloomed and find it fully equal, if not superior, to the description. Its color is richer and slightly darker than Gen'l Jacqueminot, far more double and equally prolific in growth, blooming as freely as that favorite variety. Good plants, on own roots, \$2 each.

### CARNATION "WELLESLEY BEAUTY."

Color soft fine cinnamon, beautifully striped and spotted with earmine rose; habit, free compact and vigorous. A valuable acquisition. 75c. each.

### BRONZE ZONALE GERANIUM "EARL ROSLYN."

Unquestionably the best bronze and gold bedding Geranium yet produced, superior to the acknowledged favorites, Marshall MacMahon and Black Douglass 50c. each.

### DOUBLE ZONALE GERANIUM.

**P. BUCK.**—Violet and salmon, new and effective color, and a very valuable variety.

**J. C. ROBBARD.**—Double salmon red not very double, but beautifully joined and much superior to Asa Grey.

**MADAME THIBAUD.**—Rose petals, marked with white at their base, semi-double, but producing a novel and pleasing effect. Also many other new Zonale and other Geraniums, for description of which see Catalogue.

### PELARGONIUM REGAL "QUEEN VICTORIA."

This is one of the most marvellously beautiful novelties ever offered. Color rich vermilion, margined with fine white, and upper petals blotched with deep purple maroon. The flower has thick, crispy petals, which give it the appearance of being double. It is a remarkable and striking improvement in Pelargoniums. \$1.50 each.

### PELARGONIUM REGAL, "BEAUTY OF AXTON."

Similar in form to the above, but quite distinct in color, which is; upper petals rich maroon; centre rose; all the petals being margined with pure white; flowers large and full, having the appearance of being semi-double, and a most beautiful and extraordinary novelty. \$3 each.

## FOR FLORISTS' WINTER STOCK.

Send for Abridged Trade Circular of new Tuberoses, Rooted Begonias, Double Zonale and other Pelargoniums; Roses, Carnations, Ivies, Vincas, &c.

We have a good stock of the new Double Ivy-leaved Geranium, described in the September number of the Gardener's Monthly, which we offer at \$1.00 each, or \$2.50 for three. Also new **ABUTILONS** of beautiful colors; *Le Liliput*, mauve; *Le Nain*, mauve, shaded orange, *Perle d'or*, canary; *Simon de Leaux*, chamoix shaded with purple and veined with rose. 75 cts. each. The set \$2.00.

We are making the importation of Rhododendrons and Clematis a specialty.

Orders promptly executed. Send for Circular.

EDMUND M. WOOD & CO.

**DOUBLE ZONALE PELARGONIUM WONDERFUL, Geo. Smith.**

Magnificent Orange Scarlet, a sport from Vesuvius; Flowers semi-double, trusses large, produced abundantly on small plants; a splendid bedding or market plant.  
 Plants ready for sale first of October. Price: Small Plants, \$1 each; extra ditto, \$2 50 each; and very strong Imported Plants, \$5 each, with many other varieties.  
 Copies of Cut for Sale \$5 each.

**NURSERYMEN'S WATERPROOF SHIPPING CARDS  
 AND  
 EYELETTERED TAGS,**

either plain or printed with shippers address "PLANTS—PERISHABLE;" "SEEDS—KEEP DRY;" &c., &c. The best and cheapest in the market. Send for samples and prices.

*Carnations for Winter Flowering,  
 Zonale Pelargoniums, &c., &c*

For wholesale price list, address

H. E. CHITTY, Sup't. **BELLEVUE NURSERY CO.,**  
 PATERSON, NEW JERSEY.

**PUBLISHERS' CARD.**

THE  
**NURSERYMAN'S DIRECTORY.**

The undersigned have in preparation VOLUME II of the NURSERYMAN'S DIRECTORY, embracing a list of the NURSEYMEN, FLORISTS, SEEDSMEN and TREE DEALERS, of the United States. The work will be sold wholly by subscription, the price of which will be TEN DOLLARS per copy and will be issued January 1st, 1877.

A limited space will be given to Advertisements, at the following Low Rates:

Full Page,	\$35 00	One-Third Page,	\$15 00
Half Page,	20 00	One-Fourth Page,	10 00
	One-Sixth Page,	\$8 00	

For further information, address

oct D. W. SCOTT & CO., Printers and Publishers, Galena, Illinois.

**VALUABLE PLANTS**

We offer **TO THE TRADE** and others in large or small quantities, Camellias (full flowering buds), Azaleas, Eucharis Amazonica, Bletias, Tankervilias and Stercoraria Cypripedium Indigo, Dracenas (varieties) Guzmania picta, Yucca quadricolor, Daphne Indica, Phormium Tenax (var.) Crinum amabile, Str-lizia Regina, Pine Apples, Quadricolor, and others, Imantophyllums, Marantas, &c. We have a large stock of valuable plants and can always send out FINE PLANTS at low rates. Send address for Catalogue.

tnov6 **JOHN SHERWOOD & SON, Bristol, Pa.**

**CLEMATIS,  
 NEW AND OLD SORTS.**

Aquilegia ceculea, Astilbejaponica, Azalea Indica, Bourvardias, white and red, Carnations, Dicentra spectabilis, Dianthus fibriata alba, Ives, Oranges, Lomaria gibba and other Ferns.  
 Prices low. Send for Trade List.

G. ALTORFER,  
 West Chester, Pa

oct2.

**GRAPE VINES.**

Concord, Hartford, Ives and Catawba, very low by the quantity; quality extra.  
 G. & S. BOALT,  
 Norwalk, Ohio

oct4

**SMALL FRUIT PLANTS.**

Strawberries, Raspberries, Blackberries, Currants, Grapes, Asparagus Roots, &c. Prices low. Send for Circular.

JOHN S. COLLINS,  
 MOORESTOWN, N. J

octtf

**The Nurseryman's Directory.**

A reference book of the Nurserymen, Florists, Seedsmen, Tree Dealers, &c., for the United States. Alphabetically arranged by States and Post Offices. 242 pages, 8vo. Price \$5. Mailed, post-paid, on receipt of price.

Address, **CHAS. H. MAROT,**  
 314 Chestnut St., Phila.



# Peach Stones

AND OTHER

## FRUIT SEEDS.

Notwithstanding the general scarcity of Fruit Seeds this season we expect to furnish our customers with full supplies at our usual low prices; but solicit

EARLY ORDERS.

THOMAS MEEHAN,  
tsep GERMANTOWN, PHILA

## Black Naples.

LA VERSAILLES, CHERRY, WHITE GRAPE,  
and RED DUTCH

## Currant Bushes,

Of fine quality and low in price.

A. HANCE & SON,

Octf Nurserymen and Florists, Red Bank, N. J.

## TOBACCO STEMS,

For Fumigating purposes for sale in bales of about 400 lbs., free on boat or cars at \$5 per bale, or three bales for \$12 on one order.

STRAITON & STORM,  
178 & 180 Pearl Street,  
New York City.

aug12

## APPLE STOCKS.

A fine lot 2 year Apple Roots. Price, packed and delivered to R. R., \$5 per 1000. Address,

THE DINGEE & CONARD CO,  
oct3 West Grove, Chester Co., Pa.

## New PEACHES.

Alexander's Early, Amsden's June, Steadly, Leatherbury's Late, Tuckahoe Late, Bilyeu's Late October (Bilyeu's Comet), Braudywine and twenty other new varieties of merit.

A. HANCE & SON.,

octf NURSERYMEN AND FLORISTS, RED BANK, N. J.

THE GREAT HARD TIMES PAPER. The Best, the Cheapest, and the Most Popular. You cannot afford to be without the

## CRICKET ON THE HEARTH.

It is a mammoth 16-page Illustrated paper (size of *Harpers' Weekly*), filled with the choicest reading for old and young. Serial and Short Stories, Sketches, Poems, Useful Knowledge, Wit and Humor, "Answers to Correspondents," Puzzles, Games, "Popular Songs," etc., etc. Lively, entertaining, amusing, and instructive. The largest, handsomest, best, and cheapest paper of its class published. Only \$1 per year, with choice of three premiums: the beautiful new chromo, "Yes or No?" size 15 x 19 inches; any one of the celebrated novels by Charles Dickens, or an elegant Box of Stationery. Paper without premium, only 75 cts. per year. Or we will send it Four Months on trial for only 25 Cents.

Specimen copy sent on receipt of stamp. Agents wanted. Address, F. M. LUPTON & CO., Publishers, 37 Park Row, New York. oct2

# Saul's Nurseries,

## WASHINGTON, D. C.

The undersigned offers a fine stock of the following at low rates:

New Pears—Souvernir du Congress; Beure d'Assumption; Pitmaston Duchess, and other new Pears.  
New Peaches—American and European varieties.  
Fruit Trees.—An extensive stock of well-grown Trees. Pears, Standards and dwarf, of extra size—a heavy stock. Apple, Cherry, Plum, Apricot, &c.  
Grape Vines, Strawberries, Raspberries &c.  
Evergreens.—Ornamental Trees, Shrubs, &c. Small sizes, suitable for Nurserymen; as well as large Stock in great variety.

## Dutch Bulbs.

Large Importations direct from the leading growers in Holland. First quality Bulbs: Hyacinths, Lilies, Tulips, &c.  
New and Rare Greenhouse Plants for winter blooming.  
New Roses—Duchess of Edinburgh, Perle de Lyon, &c., at reduced rates.  
New and Scarce Roses, an immense stock grown in pots—prices low.  
New Wisterias, New Clematis, New Polargoniums, Geraniums, Primula Japonica, &c.  
Catalogues mailed to applicants

# JOHN SAUL,

## WASHINGTON, D. C.

tsep3

## For Sale--5 Greenhouses

And a well-selected stock of

## PLANTS.

LOW RENT AND LEASE GIVEN.

Situated in Philadelphia; horse cars pass the door both ways; every convenience, Hydrants in all the houses, and stock fully up to the highest standard; both a local and Catalogue trade. Apply in the first instance to CHAS. H. MAROT, 814 Chestnut St., Phila.

## LIFE HISTORIES OF BIRDS

Of Eastern Pennsylvania. First vol. By THOMAS G. GENTRY. From observations of facts carried through a period of six years in the field, and elaborate examinations in the studio. With alphabetical indices of scientific and common names. 400 pages, 12mo, cloth. Price \$2. Sent by mail, post-paid, on receipt of price. Address,

CHAS. H. MAROT,  
814 Chestnut St., Phila.

## KILMARNOCK WEEPING WILLOWS.

A superb lot that will be sold below the market value. Also a splendid lot of *Magnolia Acuminata Seedlings*, a nursery grown, from six inches to four feet high, that we offer at a bargain. Price list free. STORRS, HARRISON & CO., oct2 Painesville, Lake Co., O.

## AMERICAN FRUIT CULTURIST.

BY JOHN J. THOMAS.

Practical directions for the Cultivation of Fruit Trees in the NURSERY, ORCHARD AND GARDEN. Descriptions of the principal American and Foreign varieties. Plain Edition, 430 engravings, 511 pages, 12 mo. Price, \$3.00. Mailed post-paid on receipt of price.

Extra Edition, 576 pages, heavy paper, fine cloth, 508 illustrations and chromo frontispiece; mailed, for \$3.75. Address CHAS. H. MAROT, 814 Chestnut St., Phila.

# WEATHERED & CHEREVOY'S PATENT BOILERS

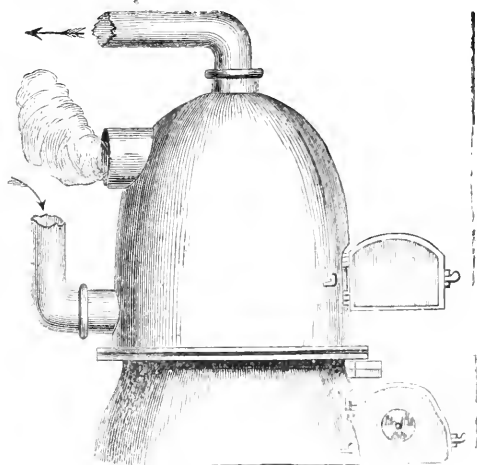

Fig. 1.

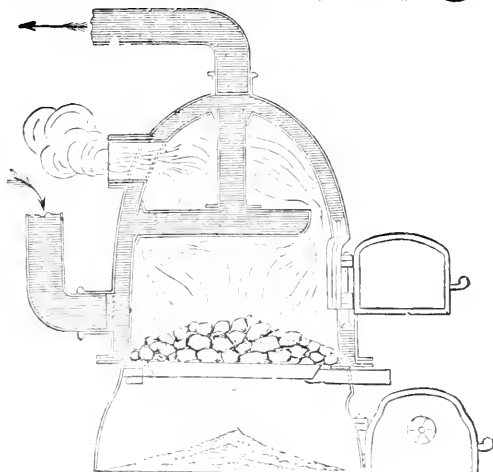

Fig. 2.

## AND IMPROVED HOT WATER APPARATUS,

No. 46 Marion Street, between Spring and Prince, New York.

(TWO BLOCKS EAST OF BROADWAY.)

For Warming and Ventilating Public Buildings, Private Dwellings, Greenhouses, Graperies, Forcing Pits, Drying Rooms, and Heating Water for Public Baths.

Fig. 1 is an outside view. Fig. 2 is a vertical section through the centre.

*The following are a few names of Gentlemen who have our Boiler in use:*

Thos. Drake, Esq., Germantown, Pa.  
Simon Cameron, Esq., Harrisburg, Pa.  
J. D. Cameron, Esq., Harrisburg, Pa.  
Thos. Carter, Esq., Raleigh, N. C.  
J. H. Dunham, Esq., Chicago, Ill.  
Jas. B. Waller, Esq., " "  
W. J. Gordon, Esq., Cleveland, Ohio.  
Geo. Stanley, Esq., " "  
Harris Jaynes, Esq., " "  
Geo. W. Cuyler, Esq., Palmyra, N. Y.  
D. M. Osborn, Esq., Auburn, N. Y.  
John B. Dutcher, Esq., Pawling, N. Y.  
A. M. Allerton, Esq., Bronxville, N. Y.  
Robert Hoe, Esq., Tarrytown, N. Y.  
Peter Hoe, Esq., " "  
George Lewis, Esq., " "  
Wm. H. Drew, Croton Falls, " "  
Hon. James Y. Smith, Providence, R. I.  
Phillip Caswell, Esq., Newport, R. I.  
Alfred Smith, Esq., " "  
Wm. Findlay, Esq., " "  
E. Learned, Esq., Pittsfield, Mass.  
D. O. Mills, Esq., San Francisco, Cal.  
W. L. Ferris, Esq., Westchester, N. Y.  
D. H. Haight, Esq., Goshen, N. Y.  
F. Newbold, Esq., Newark, N. J.  
James T. Closson, Esq., Plainfield N. J.  
Daniel W. Coit, Esq., Norwich, Conn.  
J. F. Slater, Esq., " "  
H. W. Colander, Esq., Darien, " "  
Chas. P. Palmer, Esq., Stonington, "

Wm. D. Black, Esq., New Milford, Conn.  
Rev. Stephen H. Tyng Irvington, N. Y.  
H. F. Spaulding, Esq., Riverdale, " "  
S. D. Babcock, Esq., " "  
Percy R. Pyne, " "  
Elisha Brooks, Esq., Inwood, " "  
Candice Marie, Esq., " "  
A. F. Smith, Esq., Fort Washington, " "  
R. M. Olyphant, Esq., Dobb's Ferry, " "  
Clarkson N. Potter, Esq., New Rochelle, " "  
Chas. D. Dickey, Esq., West Farms, " "  
Wm. Matthews, Esq., Harrison, " "  
William Chorlton, Esq., New Brighton, S. I.  
F. H. Wolcott, Esq., Astoria, L. I.  
Bailey Leach, Esq., " "  
Hon. W. B. Ozden, High Bridge, N. Y.  
Peter Moller, Esq., 255 Fifth Ave., New York City.  
Wm. Moller, Esq., 6 West 20th St., " "  
John Moller, Esq., 127 East 51th St., " "  
John Moller, Esq., 8 East 37th St., " "  
Ch. Moller, Esq., 426 Washington St., " "  
Henry B. Lashlaw, Esq., 33 Pine St., " "  
George W. Lane, Esq., 92 Front St., " "  
J. P. Robinson, Esq., 14 Coenties Slip, " "  
J. B. Colgate, Esq., 47 Wall St., " "  
John B. Trevor, Esq., 47 Wall St., " "  
Charles Butler, Esq., 12 " "  
Richard Arnold, Esq., 399 Canal St., New York City.  
Jas. M. Constable, Esq., 399 Canal St., " "  
W. T. Garner, Esq., 61 Worth St., N. Y. City.

Please send for Circular with list of References and Reduced Prices to

THOMAS W. WEATHERED, 46 Marion Street, N. Y.

# CLUB PAPERS AT NET PRICES, ALPHABETICALLY ARRANGED.

**TO REMIT IN CLUBBING** any of the following list with the  
Gardener's Monthly select such  
as you wish, foot up the prices annexed and add **TWO DOLLARS**  
for the **MONTHLY** to the total.

American Agriculturist.....	\$1 20	Maine Farmer.....	\$2 10
“ Farmer.....	1 35	Manufacturer and Builder.....	1 85
“ Artisan.....	1 60	Maryland Farmer.....	1 35
“ Builder.....	2 60	Massachusetts Ploughman.....	2 60
“ Naturalist.....	3 25	Metropolitan.....	1 85
“ Odd Fellow.....	1 60	Milling Journal.....	1 85
Appleton's Journal.....	3 60	Moore's Rural New Yorker.....	2 35
Arthur's Home Magazine.....	2 35	Nation.....	4 75
Atlantic Monthly.....	3 60	National Baptist.....	2 35
Boston Cultivator.....	2 60	New England Farmer.....	2 35
Building Association Journal.....	75	“ Homestead.....	2 10
“ Societies Gazette, London, England.....	1 35	New York Evangelist.....	2 60
Bucks County Intelligencer, old subscribers \$2 60, new.....	2 10	New York Methodist.....	2 20
California Horticulturist.....	2 75	“ Post, Weekly, \$1.50; Semi-Weekly.....	2 60
Central Union Agriculturist and Chromo.....	1 70	“ Times, Weekly, \$1.50; Semi-Weekly.....	2 60
Children's Friend.....	1 35	“ Tribune, Weekly, \$1.50; Semi-Weekly.....	2 60
“ Hour.....	1 10	“ World, Weekly, \$1.50; Semi-Weekly.....	2 60
Colman's Rural World.....	1 85	North-Western Farmer.....	1 10
Country Gentleman.....	2 35	Nursery.....	1 20
Demorest's Magazine.....	2 60	Ohio Farmer.....	1 85
Eclectic Magazine.....	4 60	Old and New.....	3 60
Every Saturday.....	4 60	Our Home Journal.....	2 72
Farmer's Home Journal.....	2 60	Park's Floral Gazette.....	.05
Frank Leslie's Ladies' Magazine.....	3 10	Penn Monthly.....	2 10
“ Review.....	2 10	Peter's Musical Monthly.....	2 60
Galaxy.....	3 60	Peterson's Magazine.....	1 70
Germantown Telegraph, old subscribers \$2 50, new.....	2 20	Philadelphia Weekly Press.....	1 60
Godey's Lady's Book.....	2 75	Phrenological Journal.....	2 35
Hall's Journal of Health.....	1 50	Poultry World.....	1 10
Harper's Bazar.....	3 60	Popular Science Monthly.....	4 60
“ Magazine.....	3 60	Practical Farmer, (Weekly).....	2 60
“ Weekly.....	3 60	Prairie Farmer.....	1 60
Hearth and Home.....	2 00	Purly's Small Fruit Recorder.....	.85
Herald of Health.....	1 60	Saint Nicholas.....	2 60
Household.....	85	Saturday Evening Post.....	2 10
Iowa Homestead.....	1 60	Scientific American.....	2 75
Journal of Chemistry.....	1 10	Scientific Farmer.....	85
“ of the Farm.....	85	Scribner's Monthly.....	3 60
Journal of Materia Medica.....	1 10	Southern Cultivator.....	1 85
Kansas Farmer.....	1 35	Southern Planter and Farmer.....	1 85
Lady's Floral Cabinet, with Chromo.....	1 10	Waverly Magazine.....	4 60
Ladies' Repository.....	3 35	Western Agriculturist.....	85
Leslie's Lady's Journal.....	3 60	Western Farmer.....	1 85
Lippincott's Magazine.....	3 25	“ Rural.....	1 85
Littell's Living Age.....	7 60	Wood's Household Magazine.....	85
London Garden.....	8 75	“ “ with Chromo.....	1 00
London Gardener's Chronicle.....	7 50	Working Farmer.....	1 10
		Youth's Companion, new subscribers \$1.40; old subscribers..	1 75

The above includes postage under the new U. S. Law requiring prepayment of postage before mailing

After subscription to a club paper through this agency, report non-receipt of your numbers, and other causes of dissatisfaction, irregularities of mails or changes of residences, *only to said paper direct (not to this office).*

Remit by P. O. Order, Draft or Registered Letter. Currency is at risk of mails.

If you wish a receipt or reply, enclose postage stamp for that purpose, otherwise the club papers will be considered a sufficient receipt.

Address **CHAS. H. MAROT, 814 Chestnut Street, Philadelphia.**

Index to Advertisements.

Advertisers are requested to have orders in hand as EARLY AS POSSIBLE. Copy received after the 23rd of each month cannot be INSURED insertion in the next issue.

Altorfer G., West Chester, Pa.....	14
Babbit B. T., New York.....	4
Baversdorfer M. M. & Co., Philadelphia.....	8
Bellevue Nursery Co., Paterson, N. J.....	14
Bennett C. W., Quincy, Mich.....	6
Benson & Burpee, Phila., Pa.....	18
Bliss B. K. & Sons New York city.....	cover
Boalt G. & S., Norwalk, O.....	14
Brown Dr. O. P., Jersey City, N. J.....	2
Buist R., Rosedale Nurseries, Phila.....	4, 6
Bush John S., New York City.....	2
Cadness John, Flushing, L. I., New York.....	7
Collins, John S. Moorestown, N. J.....	14
Coniuek A. M. C. J., Dedemsvaart, Netherlands.....	4
Craig & Bro., Phila.....	4
Dick John, Phila.....	5
Dingee & Conard Co., West Grove, Pa.....	4, 6, 15
Douglas Robert & Sons, Waukegan, Ill.....	5
Elder Walter, Philadelphia.....	11
Ellis Chas. R., New York city.....	9
Freshman E. N. & Bro., Cincinnati, O.....	6
Foster's Hillside Nursery Co., Louisiana, Mo.....	4
Furnas Robt W., Brownville, Nebraska.....	4
Gerrard T. Fowler, Cleveland, O.....	11
Gravett John, Lancaster, O.....	6
Harkett Wm. A., Dubuque, Iowa.....	2
Hance A. & Son, Red Bank, N. J.....	2, 4, 6, 15
Helkes Nurseries Co., Dayton, O.....	14
Henderson Peter & Co., New York.....	1
Henry J. F. Curran & Co., New York.....	11
Hews A. H. & Co., No. Cambridge, Mass.....	8
Hitchings & Co., New York city.....	3
Hoopes Bro. & Thomas, West Chester, Pa.....	4, 11
Hovey & Co., Boston, Mass.....	4
Hubbard T. S., Fredonia, N. Y.....	8
Johnston E. S., Stockley, Del.....	14
Jordan, J. M. & Bro., St. Louis, Mo.....	cover
Kauffman, Iowa City, Iowa.....	6
Knauth, Nachod & Kuhne, New York.....	7
Lalor, Wm., Rochester, N. Y.....	18
Lord's Horticultural Works, Irvington, New York.....	12
Lupton F. M. & Co., New York.....	15
Lynx Richard, Philadelphia.....	6
Marot Chas. H., Phila.....	4, 9, 11, 14, 15
Meehan Thomas, Germantown, Philadelphia.....	9, 15
Miller & Hayes, Phila., Pa.....	4, 5
Moon Wm. H., Morrisville, Pa.....	4, 6
Murphy John, Dansville, N. Y.....	11
Myers Thomas J., Philadelphia.....	8
Nimmo Alexander, Brooklyn, New York.....	12
Parsons, R. E. & Co., Flushing, N. Y.....	18
Parsons S. B. & Sons, Flushing, New York.....	cover
Peters Randolph, Wilmington, Del.....	2
Raoux C., New York city.....	2
Roberts Josiah A., Paoli, Pa.....	2
Roehrs, Florist, Jersey City, N. J.....	11
Rolker A. & Sons, New York city.....	6
Scollay John A., Brooklyn, N. Y.....	Fly-leaf
Saul John, Washington, D. C.....	14
Scott D. W. & Co., Galena, Ill.....	15
Selover & Willard, Geneva, N. Y.....	14
Sherwood John & Son, Bristol, N. Y.....	4
Sked, Paddock & Co., Cleveland, O.....	14
Steffens N., New York city.....	19
Storrs, Harrison & Co., Plainville, Pa.....	4
Stralton & Storm, New York city.....	15
Sudbrook, Pikesville, Md.....	15
Transon P. & E., Orleans, France.....	11
Trevor & Co., Lockport, N. Y.....	7
Truett's Sons & Moran, Nashville, Tenn.....	6, 2
VanGeert, Ghent, Belgium.....	2
Wallace's Monthly, New York City.....	6
Weathered & Cherevoy, N. Y. City.....	16
Weir, D. B., Lacon, Ill.....	11
Wheeler W. F., Boston, Mass.....	10
Whitman & Lang, Philadelphia.....	9
Wm. Hale or E. L. Pratt, Elmira, N. Y.....	11
Wood Edmund M., Boston, Massachusetts.....	13

SITUATIONS WANTED.

**A** Situation as clerk in a Seed Store; has had many years experience, and can produce first class testimonials. Address S. care of John Plender, 10 N. 12th St., Philadelphia.

**B**y a young man of good habits and strictly temperate, as superintendent or propagator, in a good greenhouse establishment, where a general shipping business is carried on; is twenty-two years of age; has had eight years experience in some of the largest establishments both East and West; is now employed in a large western house, but would like to make a change. Can give best of references from present and former employers. Address F. WELLINGTON BEACH, 1913 North McLean St., Bloomington, Ill. nov17

**B**y a French Gardener and Florist; small family; can give first-class references. Address GEORGE SCHOELLHAMMER, Gardener, No. 11 Minnesota St., Cleveland, O.

**A**s a Gardener, single, with good reference; will take charge of a private or commercial establishment; speaks English, French and German; no objection to any part of the country. Address J. K., 145 N. 4th.

**A**s Foreman and Propagator, single, with good reference; understands the business in all its branches; distance no object. Apply to S. H., 1527 Lawrence St., Philadelphia, Pa.

**R. B. PARSONS & CO.,**

Bowne Avenue, Flushing, N. Y.,

OFFER THEIR

**RARE TREES & SHRUBS**

as well as the well known sorts, and invite the special attention of

**LARGE BUYERS**

To their Stock of Rhododendrons, Azaleas—Chinese and Ghent—Camellias, Clematis, Hydrangeas, Magnolias, Roses by the 1,000.

**RARE EVERGREENS,**

are well known to be cultivated in large variety by them.

For Catalogues address

Box 99, Flushing, N. Y.

Feb. 12

**PARTNER IN A MARKET GARDEN WANTED.**

A good opportunity. Address, nov17 WM. LALOR, Rochester, N. Y.

**WANTED.**

**A SINGLE MAN AS GARDENER,**

must be thoroughly competent, and have undoubted testimonials: ENGLISH or SCOTCH and a PROTESTANT. Address, M. care of Robert Buist, Jr., Philadelphia. nov17

Yorkshire, Berkshire, Essex, Poland China, and Chester WHITE SWINE, of unsurpassed excellence. Alderney, Ayrshire and Shorthorn Cattle, Southdown and Cotswold SHEEP. Imported and Prize POULTRY, and PIGEONS bred on 3 FARMS. DOGS, &c. New descriptive circular free. Elegant new Catalogue with cuts from life of our stock, 20c. SEEDS, TREES, PLANTS, FERTILIZERS, IMPLEMENTS, &c. 6 PACKAGES seeds, free, as samples, for two 3c. stamps. Benson & Burpee, successors to W. Atlee Burpee, Seed Warehouse, 223 Church Street, Philadelphia, Pa. oct12

**GARDENING FOR THE SOUTH, or HOW TO GROW VEGETABLES AND FRUITS.**

By WM. N. WHITE.

Containing instructions and hints in formation and management of Gardens, Soils and improvement, manures and their sources, rotation, hot-beds, cold frames, pits, propagation, budding and grafting, pruning and training, transplanting, mulching, shading and watering, protection, garden implements, insects and vermin, Vegetables, Fruits, description, varieties and culture. Illustrated, 444 pages, 12mo, Cloth. Price \$2.00. Sent by mail, post-paid, on receipt of price. Address, CHAS. H. MAROT, 814 Chestnut St., Phila.

**OUR NEW CHROMO,**

For December, *Pritchardia filifera*, will be duplicated to customers, at following prices, if ordered before the 15th of November:

Per 1000, \$70; 500 and less than 1000, at \$8 per 100; and less than 500, at \$10 per 100.

CHAS. H. MAROT, 814 Chestnut St., Phila.

# Jordan's Patent Wrought Iron Water Heater.

## A NEW PRINCIPLE.

The boilers are constructed of horizontal pipes of the same inside diameter as those that form the heating pipes, thereby producing a very rapid circulation of the water.

LENGTH SEVEN FEET.

### DESCRIPTION.

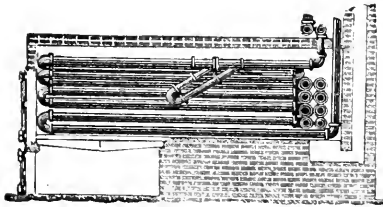

No. 1 shows a side view of one-half section, with U steam propeller. Also shows sections of chimney, ash-pit, and brick arch around the boiler, with downward draft to chimney.

No. 2 shows end view, with rear end closed with pipes; ash-pit below and brick arch above.

No. 3 shows boiler before it is set in the brick, with a few pipes broken away, to show the steam generator.

The improvements claimed are: a larger heating surface, as compared to the amount of water in the boiler; a more rapid circulation of water by the use of steam generator to move the water; a larger fire-hole, so that soft coal can be used and not obstruct the draft; and cheapness.

Extracts from the Patent, No. 173,300, Dated February 8th, 1876.

By making the pipes throughout the whole length of the boiler and heater of the same interior diameter there is an even flow through the pipe at all parts, and no shoulders in the pipe to cause any check to the flow.

It is obvious that the boiler-pipes being exactly the same interior size as the radiator and connecting-pipes, a new and quite valuable result is obtained, as the simultaneous movement of the water is insured through the whole series of pipes at the same speed, thus preventing any eddy and dead water.

The U-formed steam water propeller, by descending into the furnace and entering the water-pipe at an inclination, causes a circulation in the water-pipes almost immediately the fire is lighted, and before the water has time to become

heated in the water-pipes. The end bends of the water-pipes, which close partially the back of the fire-space, receive the full blast of the products of consumption.

### TRUTHS TO BE CONSIDERED.

If water moves rapidly into and out of the furnace it must carry off the heat rapidly into the room to be heated, thereby saving the fuel. The front is of iron and can be easily removed to clean out dust, &c.

### SETTING THE BOILER.

Build foundation wall 12 inches wide, so the pipes will set about 1½ inches inside the walls, and 3 inches above the grate bars; let the boiler rest on one fire brick at front and one at rear. Let the rear bridge wall for the grate bars be heavy and raise above the grate bars about 10 inches to one foot, and of fire brick. The Chimney should be started from the bottom of the furnace, and be at least 25 feet high, and an opening at least one foot square.

### PRICE OF BOILERS (OF WROUGHT IRON, WITH IRON FRONT AND GRATE BARS.)

Small boilers without grate bars or iron front...	\$25 to \$50 each.	No. 4 to heat 1900 to 2000 feet of pipe.....	\$175.00 each
No. 1 to heat 500 to 750 feet of pipe.....	\$ 75 00 "	" 5 " " 2000 " 3000 " " " .....	225.00 "
" 2 " 750 " 1000 " " " .....	100.00 "	" 6 " " 3000 " 5000 " " " .....	300.00 "
" 3 " 1000 " 1500 " " " .....	125.00 "	Valves for 4 inch pipe.....	10.00 "

Large boilers made to order. Where no iron front or grate bars are wanted, 10 per cent. deducted.

Water-pipe and all kinds of fittings at present 30 per cent. off the card prices.

Men furnished to put up the furnace and contracts taken to heat any building, and can be placed where hot air furnace has been used.

We have had seventeen years experience in handling water heaters, and can guarantee our work.

**JORDAN & BRO.,**

612 Olive Street, St. Louis, Mo.

# S. B. PARSONS & SONS,

## Kissena Nurseries,

### Near KISSENA STATION, FLUSHING, N. Y.,

OFFER a very large assortment of **TREES and PLANTS** of all the best families. Nearly all of them have been two years transplanted, and their roots are thus in the very best possible condition for a second transplanting.

Some of their best specimens can now be seen at the **CENTENNIAL GROUNDS**. The whole or part of the large collection there is now for sale, to be delivered at the close of the Exposition. A list of the sorts will be furnished on application. Any one purchasing this entire collection will have an assortment of trees and shrubs rarely equalled.

Their Catalogue of

## New and Rare Hardy Trees and Shrubs

is now **READY**, and will be sent on application. It contains some 65 varieties of **NEW**

### JAPANESE PLANTS,

including the remarkable **JAPANESE MAPLES**, and also a large number of new Hardy Plants from Europe. They think themselves safe in asserting that so rich a collection has not before been in this country.

**CAMELLIA JAPONICA** and **AZALEA INDICA** can be advantageously shipped during October, November and December. These plants are carefully formed and trimmed, and their symmetry is recognized by all who see them.

*Estimates will be furnished for Planting Grounds under the care of an experienced Landscape Gardener, and much trouble thus saved to the owner.*

Catalogues will be furnished to applicants by mail, and those who wish to visit the Nurseries will always find either one of the proprietors, or J. R. Trumpy, the well-known propagator of the old establishment. They can take the ferries at 34th Street or James' Slip, which connect with the railroad, leaving the first a quarter of an hour, and the last half an hour before the departure of trains, which make the transit in half an hour. The Nursery is adjoining the Kissena Station and one and a half miles from the other stations, from which carriages are free. sep



## DUTCH BULBS

AND

## SMALL FRUITS.

Our New Autumn Catalogue of

## Bulbs & Small Fruits, ORNAMENTAL IRON AND RUSTIC WORK FOR WINDOW GARDENS AND HOUSE PLANTS.

Beautifully illustrated with many engravings, is now ready and will be mailed to all applicants enclosing 10 cents. Regular customers supplied gratis. Collections of Bulbs \$3, \$5, \$10, \$20, mailed post-paid, to any address upon receipt of price. Our list of

## SMALL FRUITS,

Comprises every desirable variety of

Strawberries, Raspberries, Grapes, &c.

Bulbs and Plants mailed to any address at Catalogue prices. Address,

# B. K. BLISS & SONS,

## SEED, PLANT AND BULB WAREHOUSE,

P. O. BOX 5712.

34 Barclay Street, New York.



THE  
GARDENERS  
And MONTHLY  
HORTICULTURIST

EDITED BY THOMAS MEEHAN.

Vol. XVIII.

No. 216.

(Combined Magazines, Thirty-first Year.)

**DECEMBER, 1876.**

PUBLISHED BY CHARLES H. MAROT

814 Chestnut Street, Philadelphia.

TERMS—\$2.10 PER YEAR—POSTAGE PAID.

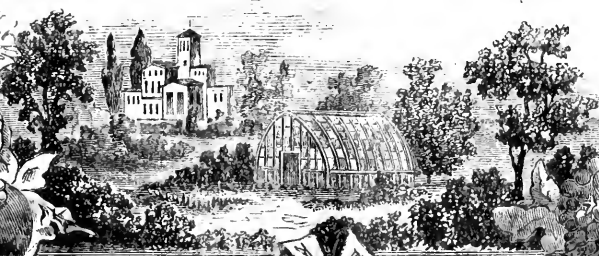

Wm. Rosenthal Del.

J.R. Stockton Sc.

# THE GARDENER'S MONTHLY AND HORTICULTURIST.

EDITED BY THOMAS MEEHAN,

Assisted by an able Corps of AMERICAN and FOREIGN CORRESPONDENTS.

It is published on the first of every month, at the office, No. 814 CHESTNUT STREET, PHILADELPHIA, where all BUSINESS communications should be addressed.

Communications for the Editor should be addressed: THOMAS MEEHAN, GERMANTOWN, Philada.

SUBSCRIPTION PRICE, Postage paid, \$2.10.

## TERMS OF ADVERTISING.

	1/8 col.	1/4 col.	1/2 col.	3/4 col.	1 col.	1 page.
One Time,	\$3.00	\$4.00	\$6.00	\$8.00	\$12.00	\$18.00
Two to Three Times, each,	4.70	3.80	5.40	7.20	10.80	16.20
Four to Six Times, "	2.25	3.00	4.50	6.00	9.00	13.50
Seven to Nine Times, "	2.00	2.70	4.00	5.35	8.00	12.00
Ten to Twelve "	1.80	2.40	3.60	4.80	7.20	10.80

Twelve lines nonpareil is 1/8 col. A less space than 1/8 col. will be furnished at rates in exact proportion, line for line. For THIRD and LAST COVER PAGES; FIRST PAGE advertisements facing reading matter; "FLY-LEAF PAGE" (front of number) before reading matter and facing first cover,—special figures will be given on application. COPY and orders for NEW advertisements should be in hand by the 23d of each month; and CHANGES of COPY in running contracts by the 16th of each month, to insure them in following issue. Address

CHAS. H. MAROT, Publisher, 814 Chestnut Street, Philadelphia.

## CONTENTS OF THE DECEMBER NUMBER.

### SEASONABLE HINTS:

Flower Garden and Pleasure Ground.....	353-357
Green House and House Gardening.....	357-365
Fruit and Vegetable Gardening.....	365-368

### CORRESPONDENCE:

Hardy Herbaceous Plants for October...	354
The Siberian Pea Tree.....	354
Ailanthus Glandulosa.....	354
Pot Drainage.....	358
Croton Culture.....	360
Gladioli for Winter.....	362
Agave Xalapensis.....	362
Violets.....	362
Forcing Tender Roses.....	363
Grapes at Boston.....	366
Mrs. Pince's Muscat Grape.....	367
The Winter Protection of Grape Vines...	367
The Sicilian Nut Tree.....	367
Muskingum Pear.....	368
The Plum Curculio.....	368
June-Budding Peach Trees in Texas.....	368
Views of Distant Lands.....	370
Visit to Carrollton.....	373
Forest Hill Cemetery, Utica, N. Y.....	373
Potomac Fruit Growers.....	376

### EDITORIAL NOTES:

Sciadopitys verticillata—Cut-leaved Sumach—Hardness of the Silver Thorn—The Gladiolus Disease.....	355-356
Pritchardia filifera—Circulation of Hot	

Water—The New Palm—Hydrangea Thomas Hogg—Rhynchospermum jasmynoides—Remedy for Ants.....	364
Western Grapes—The Tomato Disease—Disease in California Cherries—Lime and the Potato Beetle.....	368
Rainfall and Forests—On the Diurnal Opening of Flowers—Metallic Substances in Plants.....	369-370
Typographical Errors—The Valentine Bean—Bay Tree—The Plum—Mr. C. M. Hovey—The Confederate States—Geological Survey of Indiana—Louisiana as it is.	374-376

### NEW PLANTS:

Tulipa Greigi—Pentstemon heterophyllus—Pentstemon Palmeri—Alonsoa linifolia Alonsoa myrtifolia.....	356
---	-----

### NATURAL HISTORY AND SCIENCE.....

### LITERATURE, TRAVELS & PERSONAL NOTES..

### HORTICULTURAL SOCIETIES.....

### QUERIES:

The Centennial Rock-work—Pyracantha Hedges—Picea Parsonsiiana—Names of Plants.....	356-357
Lime for Cellar Floors—Heating a Cucumber House—Sunray Fuchsia—Tar in Greenhouses Again.....	364-365



# LILY OF THE VALLEY PIPS,

Guaranteed three years old ; best kind for early forcing, \$25 per M. ; \$3 per 100.

LILIUM LONGIFLORUM, \$60 per M.

SPIREA JAPONICA (Astilba) \$9 per hundred.

TUBEROSE, double, 1st size bulbs, \$3 per hundred:

LILIUM LANCIFOLIUM ALBUM, \$30 per hundred.

“ “ RUBRUM, 12 “ “

“ UMBELLATUM, \$7.50 per hundred.

## AUTUMN LEAVES,

Hartford and Native FERNS,

PAPER-PRESSED at Special Figures for Quantities.

## Ornamental Grasses, Immortelles, GRASS BOUQUETS,

Fresh importations on hand in large varieties.

All kinds of Willow ; Wheat and Grass, trimmed

## BASKETS,

And a full line of FLORISTS' SUPPLIES, furnished at lowest prices. Send your orders for the Holidays in time, and do not wait till the last moment. Catalogue mailed on application.

# *AUGUST RÖLKER & SONS,*

*32 READE ST., NEW YORK.*

Or P. O. BOX 899.

**RURAL AND PRACTICAL BOOKS,** (and any others in the market not on this list) will be sent by mail, post paid, on receipt of price. Address CHAS. H. MAROT, 814 Chestnut St., Philada.

Allen's, R. L., Diseases of Domestic Animals.....	\$1 69	How to Manage a Building Association.....	\$2 00
Allen's, L. F., Rural Architecture.....	1 69	How to Farm.....	1 00
Allen's, L. F., American Cattle.....	2 50	Hunter and Trap-poring.....	1 00
Allen's, R. L. & L. F., New American Farm Book.....	2 50	Husman's Grapes and Wines.....	1 50
American Architect.....	7 00	Jacques' Manual of the Lous.....	1 50
American Bird Fancier, (Brown's).....	30	Jacques' Manual of the Garden.....	1 75
American Farmer's Encyclopedia.....	6 90	Jennings' Cattle Doctor.....	1 75
American Horticultural Annual, paper 50 cts., cloth.....	75	Jennings on the Horse and his Diseases.....	1 75
American Weeds and Useful Plants.....	1 75	Jennings' Sheep, Swine and Poultry.....	1 75
Apple Culturist, S. E. Todd.....	1 50	Johnson's Gardener's Dictionary.....	3 50
Art of Saw Filing.....	75	Johnson's How Crops Fail.....	2 00
Architecture, Modern American, Cummings & Miller.....	19 99	Johnson's How Crops Grow.....	2 00
Principles and Practice of, By Loring & Jenning	12 00	Johnson's Peat and its uses.....	1 25
Baker's Fruit Culture.....	4 99	Johnston's Elements of Ag. Chemistry and Geology.....	1 50
Bassett on Cranberry Culture.....	39	Johnston's, J. S. W., Agricultural Chemistry.....	1 75
Barry's Fruit Garden.....	2 50	Keim's Landscape Gardening.....	2 50
Bell's Carpentry made easy.....	5 00	Klippart's Farm Drainage.....	1 75
Bement's Poulterer's Companion.....	2 00	Lanstrath, R. v. L. L., on the Hive and Honey Bee.....	2 00
Bement's Rabbit Fancier.....	30	Leuchars, How to Build Hot-houses.....	1 50
Beet Root Sugar.....	1 50	Leibich, Justus, Familiar Lectures on Chemistry.....	75
Bicknell's Village Builder, 77 plates.....	12 00	Leaden's Encyclopedia of Plants.....	20 00
Bonner's Method of Making Manures.....	25	Lyman's Cotton-culture.....	1 50
Boussingault's, J. B., Rural Economy.....	1 50	McMahon's American Land-measure.....	2 25
Browne's Trees of America.....	6 00	Mayhew's Practical Book-keeper for Farmers.....	99
Breck's New Book of Flowers.....	1 75	Mechanics' Companion, New Edition.....	3 00
Breedman's American Gardener's Assistant.....	2 50	Mechan's Ornamental Pottery.....	75
Breedman's Fruit Cultivator's Manual.....	1 00	Miles on the Horse's Food.....	75
Breedman's Kitchen Gardener's Instructor.....	1 00	Miner's, T. B., Bee-keeper's Manual.....	1 25
Buist's, Robert, Am. Flower Garden Directory.....	1 50	Mohr on the Grape-vine.....	1 00
Buist's, Robert, Family Kitchen Garden.....	1 00	Money in the Garden.....	1 50
Burr's Field and Garden Vegetables of America.....	90	My Vineyard at Lakewood.....	1 25
Carpenter and Joiner R. Tidwell.....	7 99	My Farm of Edgewood.....	1 75
Carpenter and Joiner's Hand Book, (Holly).....	75	My Ten-foot Farm.....	50
Chorlton's Grape Grower's Guide.....	75	North American sylvan, 5 vols., 156 col. plates, in 30 parts, any one.....	60 00
Chemistry of the Farm, (Nichols).....	1 25	North American sylvan, 5 vols., 156 col. plates, in 30 parts, any one.....	60 00
Cleveland's Villas and Cottages.....	1 00	North American sylvan, 5 vols., 156 col. plates, in 30 parts, any one.....	60 00
Cobbett's American Gardener.....	75	Nichols' Chemistry of the Farm and Soil.....	1 25
Cole's, S. W., American Fruit Book.....	75	Norris, J. M. P., Elements of Scientific Agriculture.....	1 75
Cole's American Veterinarian.....	75	Orbit-culture.....	20
Cooper's Rural Hours.....	2 00	Our Farm of Four Acres.....	1 25
Copeland's Country Life.....	5 00	Pachard's Guide to the Study of Insects.....	6 00
Dadt's, Geo. H., American Cattle Doctor.....	1 50	Paul's Book of Roses.....	60
Dadt's, Modern Horse Doctor.....	1 75	Paul's Rose Garden.....	3 00
Dana's, Samuel H., Muck Manual.....	1 25	Paxton's Botanical Dictionary.....	15 00
Darwin's Variations of Animals and Plants, 12 vols.....	6 66	Pardee on Strawberry-culture.....	75
Darwin's Insectivorous Plants.....	7 00	Parkman's Book of Roses.....	1 50
DeVoe's Market Assistant.....	2 50	Parsons, Samuel L., on the R.....	1 50
Downing's, A. J., Land-seer's Gardening.....	6 75	Peat and its Uses.....	1 25
Downing's Cottage Residence.....	3 00	Peat-culture, Fields.....	1 25
Downing's Fruits and Fruit Trees of America.....	5 00	Peader's, James, Farmer's Land-measurer.....	60
Downing's Rural Essays.....	3 50	Peterson's Horse.....	1 00
Downing's Ladies' Companion to the Garden.....	2 69	Peterson's Preserving, Pickling and Canning Fruit.....	50
DuRoi's Vineyard Culture, (Dr. Warder).....	2 00	Phin's Open-air Grape Culture and Wine Making.....	1 50
Eastwood on Cultivation of the Cranberry.....	75	Phin's Pear-culture for Profit.....	1 00
Elliott's Western Fruit Grower's Guide.....	1 50	Phin's Mysteries of Bee-keeping Explained.....	1 50
Elliott's Lawn and Shade Trees.....	1 50	Randell's Sheep Husbandry.....	1 50
Elliott's Fruit Growers' Hand Book, paper, 60 cents, cloth	1 00	Randall's Fine Wool Sheep Husbandry.....	1 00
Farm Talk, (Brackett).....	1 00	Rand's Bulls.....	3 00
Farming for Boys.....	1 50	Rand's Flowers for Parlor and Garden.....	3 00
Field's, Thomas W., Pear Culture.....	1 25	Rand's Seventy-five Flowers.....	1 50
Five Acres too Much, (Illustrated).....	1 50	Rand's Flower Garden.....	3 00
Flagg's European Vineyards.....	1 50	Randell's Architect.....	3 50
Flax Culture.....	75	Rapp's Commercial Calculator, cloth \$1, Morocco Buck.....	2 00
Flint, Chas. L., on Grasses.....	2 50	Rose Culturist.....	30
Flint's Milch Cows.....	2 50	Robbins', R., Produce and Ready Reckoner.....	75
Fowler's Homes for All.....	1 50	Saunders' Domestic Poultry, in four series, each.....	75
Frank Forester's Fish and Fishing, 8 vo. 100 engravings.....	3 50	Saxton's Hand Books, in four series, each.....	1 50
Frank Forester's Manual for Young Sportsmen, 8 vo.....	3 00	Schneek's Gardener's Text-book.....	75
French's Farm Drainage.....	1 50	Scribner's Ready Reckoner and Log-book.....	36
Fuller's Grape Culturist.....	1 50	Srong's Cultivation of the Grape.....	3 00
Fuller's Small Fruit Culture.....	1 50	Thomas, J. J., Farm Implements.....	1 50
Fuller's Strawberry Culturist.....	25	Thomas, J. J., Fruit-culturist; old ed. \$3 00; new edition.....	3 75
Fuller's Forest Tree Culturist.....	1 50	Ward's American Pomology.....	1 25
Fulton on Peach Culture.....	1 50	Hedges and Evergreens.....	3 00
Gentry's Life Histories of Birds, 1st vol.....	2 00	Waring's Drainage for Profit and Health.....	1 50
Gray's How Plants Grow.....	1 25	" Elements of Agriculture.....	1 00
Gray's Manual of Botany.....	2 25	" Earth Closets.....	50
Gray's Manual, Botany and Lessons, in one vol.....	4 00	Webster's Dictionary, Unabridged.....	12 00
Gray's School and Field Book of Botany.....	2 50	Well's Every Man his own Lawver.....	2 00
Green on Trout Culture.....	1 00	Williams, B. S., on Stove & Greenhouse Plants, 2 vols., Ill'd.....	5 00
Gregory on Squashes, paper.....	30	Williams, B. S., on Select Ferns and Lycopods.....	2 50
Guernon on Milch Cows.....	75	Williams, B. S., Orchard Grower's Manual.....	2 50
Guide to Fortune.....	1 00	Window Gardening.....	1 50
Haratzky's Grape Culture and Wine Making.....	5 00	White's Gardening for the South.....	2 00
Harris' Insects Injurious to Vegetation, clo. \$4; col. eng's.....	6 50	" Cranberry Culture.....	1 25
Harris on the Pig.....	1 50	Wood's Class Book of Botany.....	3 50
Hartfield's American House Carpenter.....	3 50	Workingman's Way to Wealth.....	75
Henderson's Practical Floriculture.....	1 50	Wright's Practical Poultry Keeper.....	2 00
Henderson's Gardening for Pleasure.....	1 50	Yount on the Horse.....	1 75
Henderson's Gardening for Profit.....	1 50	Youman's Household Science.....	2 00
Herbert's Hints to Horse-keepers.....	1 75		
Hoppe on Evergreens.....	3 00		
Hopper's Dog and Gun, paper 30 cents, cloth.....	60		
How to Buy a Farm, and Where to Find One.....	1 75		

# SPECIAL OFFER

TO

# FLORISTS, DEALERS,

AND

# BUYERS IN QUANTITY.

## WINTER FLOWERING AND OTHER PLANTS.

Pot grown and specially prepared. All fine, healthy plants graded in price according to size.

	PER 100.		PER 100
Geranium, Apple, scented,	\$ 8	Geranium, Happy Thought,	\$16
Abutilon, Boule de Neige, white,	\$8, \$16 and \$30	Lygodium Scandens (climbing Fern), 2 to 3 feet,	\$8 and 16
Begonias, all the leading winter-flowering sorts,	6 and 10	Smilax, from 1 to 3 feet,	6 and 10
Bouvardias, 6 best winter-flowering sorts.	\$6, 8 and 12	Primula, double white,	25 to 75
Carnations, white, strong from ground,	8 and 15	" single, red, white, purple and spotted,	8 to 12
Chrysanthemums, white and other varieties,	4 and 12	" semi-double, white,	12 and 16
Eupatorium and Stevia, in variety,	\$8, 12 and 20	Roses, leading winter flowering sorts,	12 to 25
Verbenas, stock mixed,	3		
" 12 best market sorts,	4		

Five plants of any variety will be sold at hundred rates, but not less than one hundred plants in one order.

Our Wholesale List from which above is an extract, embraces many hundred varieties besides those named above.

## MIXED HYACINTHS, for Forcing or Bedding.

Ranging according to color from \$7.50 to \$8.50 per 100, extra fine bulbs.

	PER 100		PER 100
Lily of the Valley, in large clumps,	\$35	LILIUM CANDIDUM, extra large bulbs,	\$12
" " in single crowns,	3	" Longiflorum, " " "	12

## FLOWER SEEDS, for present Sowing.

	PER PKT.		PER PKT.
Verbena, saved from our own collection, \$5 per oz.,	15c.	Apple Geranium, scented, seed of 1876,	30c.
Petunia, finest striped and blotched, \$5 per oz.,	15c.	Double Cineraria,	75c.
" double,	30c.	Primula sinensis fimbriata, double red and white,	75c.
Lygodium Scandens, (Japanese Climbing Fern)	30c.	" " " single " " "	30c.

## VEGETABLE SEEDS, for Fall Sowing.

Cabbage, Jersey Wakefield, (true) 75c. per oz. \$2 per ¼ lb. \$6 per lb.	Cauliflower, Extra Early Dwarf Erfurt, \$2 per oz. \$7 per ¼ lb., \$24 per lb.
Cabbage, Early York, 40c. per ¼ lb., \$1.25 per lb.	Cauliflower, Early Paris, 75c. per oz., \$2.50 per ¼ lb., \$9 per lb.
" Early Flat Dutch (true L. Island) 75c. per oz., \$2 per ¼ lb., \$6 per lb.	Lettuce, Curled Simpson, 60c. per ¼ lb., \$2 per lb.
Cabbage, Early Summer, (new), see special list of testimonials.—\$1.50 per oz., \$5 per ¼ lb., \$16 per lb.	" Curled Silesia, 30c. per ¼ lb., \$1 per lb.
	" Boston Market (for forcing) 60c. per ¼ lb., \$2 per lb.
	Spinach, Round and Frickly, 10c. per ¼ lb., 25c. per lb.

## FLORIST'S REQUISITES.

Embracing BOUQUET PAPERS, WILLOW and RUSTIC BASKETS, BASKETS FOR SHIPPING PLANTS, GRASS BOUQUETS and IMMORTELES, POT COVERS, WARDIAN CASES, WIRE DESIGNS for CUT FLOWERS (embracing 30 different patterns), all of which will be sold at lowest wholesale rates.

Our MONTHLY LIST, descriptive of above, together with all other articles wanted by Florists and Gardeners, will be mailed FREE on application. To our regular customers it will be mailed monthly as usual.

*Peter Henderson & Co*

SEEDSMEN, MARKET GARDENERS AND FLORISTS,

35 CORTLANDT ST., NEW YORK.

# 50,000 IRISH JUNIPERS, FROM 1 TO 5 FEET.

We can sell them cheaper than any establishment in the United States.  
Send for Price List.

**TRUETT'S SONS & MORGAN,**  
ROSEBANK NURSERIES,  
taug5 Nashville, Tenn.

## WALLACE'S MONTHLY.

THE only Illustrated Magazine devoted to Domestic Animals.

The recognized **AUTHORITY** on the **HORSE** and the Organ of American Breeders.

**Uncompromising Hostility to Gambling and Fraud of every Description.**

Thorough in the investigation and exposure of fraudulent pedigrees and all shams

Able and fearless in discussion, and the contributions of the best writers in the land are to be found in its columns.

Not a "Sporting Paper," but COMPLETE in its reports and indexes of all performances.

*Every Farmer who loves a good horse and fair dealing should have it.*

**The Cheapest of its Class in the World.**  
Three Dollars a year, in Advance.

WALLACE'S MONTHLY,  
nov3 170 Fulton St., New York City.

## BEGONIA FROEBELI.

New Tuberos-rooted Begonia. Price per doz. \$6.

Address,

**J. ROEHRS, Florist,**

nov2 Jersey City, N. J.

# DELAWARE,

New, large and very fine; also

3 **RANDYWINE (True), HIGHLAND HARDY, GAN-  
ARGUA, THWACK**

and other

**RASPBERRY PLANTS,**

In large supply.

**A. HANCE & SON, Nurserymen and Florists,**  
oct 4 RED BANK, N. J.

## NEW AND VALUABLE FLOWER SEEDS.

**DANIEL BARKER, Norfolk, Va.,**

(Late Sup't of OAK HILL CEMETERY, Georgetown, D. C.)

Has just received from one of the best Collections in Europe a small supply of the finest Strains of Show, Belgian and New Black Pansy Seed. 25 and 50 cents per Pkt.

**ZONALE GERANIUM,**

Carefully fertilized with the finest prize kinds in Cultivation, and is most confidently recommended. 50 cents per Pkt.

**CYCLAMEN PERSICUM,**

From Edwards' prize kinds. 50 cents per Pkt

### BEST HOLIDAY GIFT.

Of constant and permanent value, is WEBSTER'S NEW ILLUSTRATED DICTIONARY, for parent, child, teacher, pastor, friend. Sold everywhere, in common and fine bindings.

AN INDISPENSABLE REQUISITE FOR EVERY TEACHER,  
ADVANCED STUDENT, INTELLIGENT FAMILY.

THE BEST ENGLISH DICTIONARY.



## WEBSTER'S UNABRIDGED.

"The Best Practical English Dictionary extant."—*London Quarterly Review, Oct. 1873.*

FROM THE CHIEF JUSTICE OF THE UNITED STATES.

WASHINGTON, D. C., Oct. 25, 1875.—The book has become indispensable to every student of the English Language. A Law Library is not complete without it, and the Courts look to it as of the highest authority in all questions of definition.—MERRISON R. WAITE.

FOUR PAGES COLORED PLATES.

Published by G. & C. MERRIAM, Springfield, Mass.  
decr Sold by all Booksellers.

## NEW PLANTS--TO THE TRADE.

**New Double White Daisy, Belle of Dubuque.**

The largest and finest white daisy yet offered, flowers perfectly double. 50c. each. Daisy, Harkett's Perfection, 35cts., each; \$3 per doz.

**NEW VARIEGATED LANTANA.**

Best variegated bedding plant to stand the sun. Very free blooming. 50c. each, \$4 00 per doz. Smaller plants, 30c. each, \$3 per doz; free by mail.

**W. A. HARKETT,**  
feb10 DUBUQUE, IOWA.

## SMALL FRUIT PLANTS.

Strawberries, Raspberries, Blackberries, Currants, Grapes, Asparagus Roots, &c. Prices low. Send for Circular.

**JOHN S. COLLINS,**

oct1f MOORESTOWN, N. J.

**A. VAN GEERT,**  
Nurseryman,

## GHEENT, BELGIUM

Begs to inform his numerous American patrons, that his

**NEW GENERAL CATALOGUE**

has just been issued. It will be mailed free to all intended purchasers. Orders for exportation, packed on the most approved principle, insuring perfect success.  
nov3

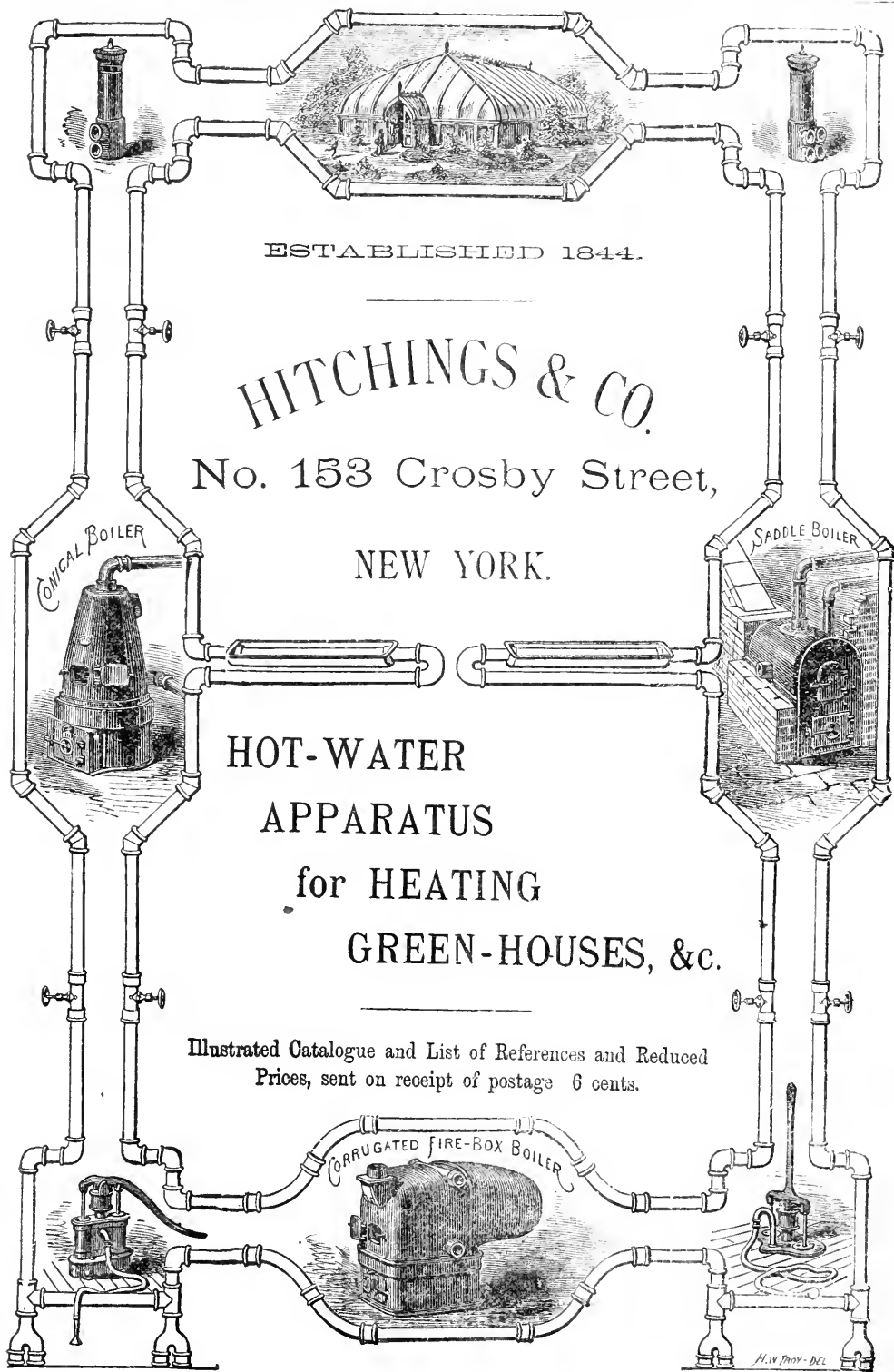

ESTABLISHED 1844.

HITCHINGS & CO.

No. 153 Crosby Street,

NEW YORK.

HOT-WATER  
APPARATUS  
for HEATING  
GREEN-HOUSES, &c.

Illustrated Catalogue and List of References and Reduced  
Prices, sent on receipt of postage 6 cents.

H.W. Snow - Del.

## NEW DOUBLE GERANIUM BISHOP WOOD,

The upper petals carmine scarlet, lower petals violet rose—a new color in double Geraniums; habit is dwarf and compact; small foliage; truss is large, borne in great profusion, well above the foliage. Now ready and for sale by the grower. Price, \$1 each; \$9 per doz.; \$5 per ½ dozen.

WM. K. HARRIS,

5501 Darby Road, Philadelphia, Pa.

dec5



My annual Catalogue of Vegetable and Flower Seed for 1877 will be ready by January, and sent free to all who apply. Customers of last season need not write for it. I offer one of the largest collections of vegetable seed ever sent out by any seed house in America, a large portion of which were grown on my six seed farms. Printed directions for cultivation on every package. All seed sold from my establishment warranted to be both fresh and true to name; so far, that should it prove otherwise I will refill the order gratis. As the original introducer of the Hubbard and Marblehead Squashes, the Marblehead Cabbages, and a score of other new vegetables, I invite the patronage of all who are anxious to have their seed fresh, true, and of the very best strain. New Vegetables a Specialty.

dec5 JAMES J. H. GREGORY, Marblehead, Mass.

## Apple Trees!

100,000 very fine, well grown, thrifty Apple Trees, comprising all the leading varieties; Cheap.  
Send for New Trade List.

HOOPES, BRO. & THOMAS,

Cherry Hill Nurseries. sep6 West Chester, Pa.

A. M. C. JONGKINDT CONINCK,  
Tottenham Nurseries,

Dedemsvaart, near Zwolle, Netherlands.

Offers at the Lowest Prices:

BULBS, FLOWER ROOTS, PEREN-  
NIALS, FRUIT TREES, ROSES,  
MOSS-ROSES, Etc.

Catalogues gratis on application.

oct3

## POT ROSES.

We offer a large stock of Extra fine ROSES FROM 3-IN. POTS, suitable for florists' use. Can be sent safely with or without Balls as desired. Price, \$8 per 100; \$70 per 1000.  
See Lists, now ready. Address,

THE DINGEE & CONARD CO.,

oct3 West Grove, Chester Co., Pa.

## Grape Vines.

Grown Especially for the Trade and Planters, in Quantity. Concord, Martha, Delaware, Ives, Hartford Prolific, Salem, Wilder, Agawam, etc., etc. Also a large assortment of New varieties.

A. HANCE & SON,

oct6f NURSERYMAN AND FLORISTS, RED BANK, N. J.

## DOUBLE TUBEROSE BULBS.

Very superior in quality.

	Doz.	100	1000
First Quality Large Flowering Bulbs,	\$ 75	\$4.00	\$30.00
Second Quality Flowering Bulbs,	.50	3.00	20.00
A few hundred EXTRA Large Bulbs,	1.00	5.00	
Dwarf Pearl, 1st quality Flowering Bulbs,	1.50	6.00	

If sent by Mail 25 cents per dozen EXTRA.

MILLER & HAYES,

oct6 5774 Germantown Avenue, Philadelphia,

## B. T. BABBITT'S BABY SOAP



Only the purest vegetable oils used in its manufacture. No artificial and deceptive odors as cover common and deleterious ingredients. UNSUITABLE for the TOILET and the BATH. Unwholesome bathing children, will prevent eruptions, keep the skin soft and smooth, contribute to health, and prevent disease. Does away with all powders, chalk or other emollients. A certain preventive of *choking*, *itching*, &c. In babies, the cause of half the crying and crossness of babyhood. Worth ten times its cost to every mother and family in Christendom; packed in boxes of 12 cakes of 6 ozs. each, and sent free to any address on receipt of \$2.50. Address, 27-1 for Sale by all Druggists, &c. B. T. Babbitt, N.Y.

## N. STEFFEN'S WIRE WORKS,

335 E. 21st St. New York.

Manufacturer of all designs for FLORISTS. Wreaths, Crosses, Crowns, Hearts, Anchors, Pillars, Columns, Monuments, Bells, Composure, Faith, Hope and Charity, Harps and Lyres, &c. Leaning and Upright

Send for Price List.

jan 12.

THE

## HAND-BOOK

OF

## PRACTICAL LANDSCAPE GARDENING.

BY

F. R. ELLIOTT.

PRICE \$1.50.

Designed for city and suburban residences, containing designs for Lots and Grounds from 30 x 100 feet to a 40 acre plot. Each plan is drawn to a scale with schedule to each, showing where each Tree, Shrub, &c., should be planted; complete instructions for Landscape Gardening; illustrated by over 20 wood cuts. Will be ready to mail early in December. Sent post-paid on receipt of price. Nurserymen and Tree Dealers will find this work valuable in the sale of Ornamental Stock.

Send for Dewey's Catalogue of our 2000 Colored Fruit Plates.

Bound \$1. paper 60c.

Send for Dewey's Catalogue of our 2000 Colored Fruit Plates.

The new Medium-size Cheap Fruit Plate Books now ready. N. B.—Colored Fruit Plate Books—always on hand, at prices from \$3 to \$25 each. Send for Catalogues.

Downing's Fruits of America. Illustrated ed., 2 vols., 100 colored illustrations; bound in ½ Turkey morocco, price \$35

Agents wanted to sell above books. Address,

D. M. DEWEY,

HORTICULTURAL BOOKSELLER,

dec3

Rochester, N. Y.

## LONDON GARDENER'S CHRONICLE

Will be furnished, post-paid, direct to subscribers in the U. S. for \$7.50 per year. Specimen Nos. 3 cent stamp. Apply to CHAS. H. MAROT, Agent, 814 Chestnut St., Phila

nov1



**WE OFFER**  
FROM OUR  
**LARGE AND SELECT LIST OF ROSES**

Fine plants of all the LATEST and CHOICEST VARIETIES, grown on their OWN ROOTS, and now ready for delivery. HYBRID PERPETUALS, TEAS, NOISETTETTES, 1 year, fine plants, grown in 4 and 5 inch pots, at \$3 per doz.; \$15 per hundred.

We can also supply all the NEW and BEST VARIETIES of

**HARDY ORNAMENTAL TREES AND SHRUBS,**  
**EVERGREEN AND DECIDUOUS,**

For planting in Lawns, Yards, &c.

ROSE and PLANT CATALOGUES sent on receipt of 3ct postage stamp.

tsep4

MILLER & HAYES, Mt. Airy Nurseries, Philadelphia.

**LARCHES, EVERGREENS!**

LARGEST STOCK IN AMERICA.

**BOTH SEEDLINGS AND TRANSPLANTED TREES.**

All grown from seed on our own grounds, and better and cheaper than imported stock.

**EUROPEAN LARCH AND EVERGREEN TREE SEEDS,**

by the ounce, pound and roo pounds. Send for Catalogue.

ROBERT DOUGLAS & SONS,

Waukegan, Ill.

tsep9

**JOHN DICK'S PATENT BOILER**

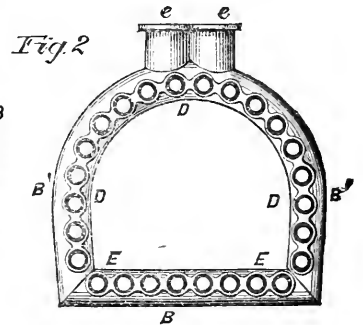
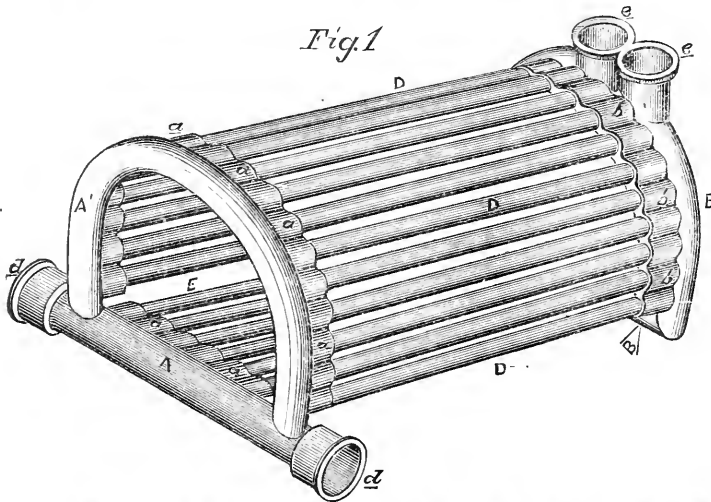

**Economy, Simplicity and Durability.**

SEND FOR CIRCULAR.

**J. DICK, Florist,**

53d & Darby Road, Philadelphia, Penna.

sep6

# C. RAOUX'S NURSERYMEN'S AGENCY,

ESTABLISHED IN 1857,

**76 PARK PLACE,**

P. O. Box 2956. New York City,

REPRESENTS IN THE UNITED STATES:

Messrs. E. H. KRELAGE & SON, Nurserymen, Seedsmen and Florists, Haarlem, Holland.  
 Messrs. JOHN STEWART & SONS, Nurserymen, Seedsmen and Florists, Dundee, Scotland.  
 Messrs. PETER S. ROBERTSON & CO., Nurserymen, Seedsmen and Florists, Edinburgh, Scotland.  
 Messrs. LEVAVASSEUR & FILS, Nurserymen and Florists, Ussy, France.  
 Mr. ANDRE LEROY, Nurseryman, Seedsman and Florist, Angers, France.  
 Mr. GRANGER, Rose Grower, Suisnes, France.  
 Mr. EUGENE VERDIER FILS AINE, Florist; New Gladioluses, Roses, Peonias, etc., a specialty, Paris, France.  
 Mr. V. LEMOINE, Florist; new varieties of Plants a specialty, Nancy, France.  
 Mr. ALEGATIERE, Florist; new varieties of Plants, a specialty, Lyon, France.  
 Messrs. C. PLATZ & SON, Seedsman, Erfurt, Prussia.  
 Mr. WILHELM BUCHNER, Seed Grower, Erfurt, Prussia.  
 And many other European Nurserymen, Seedsmen and Florists, whose Catalogues will be sent to all applicants, free of expense, as soon as they are received for distribution. idecl

# Andre Leroy's NURSERIES, AT Angers, France.

The largest in Europe and the richest in collections of Fruit and Ornamental Trees, Shrubs, Coniferæ, Camellias, Rhododendrons, Roses, Fruit Tree Stocks, &c., &c.

## SPECIAL CULTURE of SEEDS.

Catalogues can be had on application, from

**Mr. C. RAOUX,**  
**76 PARK PLACE,**

P. O. Box 2956. New York City.

# ROSES! ROSES!

We offer a large stock of

**Roses from open Ground.**

All on own Roots.

Hybrid Perpetuals, 1st class,	Per 100.	Per 1000.
" " 2nd size	\$12	\$100
Climbers, Prairie, asd., first class,	8	70
Mosses, extra strong, 2 yr.,	12	100
" " fine 1 yr.,	20	
" " " 1 yr.,	15	

Lists on application. Address,

The Dingee & Conard Co.,  
West Grove, Chester Co., Pa.

# Osage Orange.

Quality prime, prices low. Special rates by the 10,000 and upwards.

A. HANCE & SON,

Nurserymen and Florists, Red Bank, N. J.

# Wood Labels

For Trees and Plants, superior quality, made of best white Pine.

LARGE STOCK

Constantly on hand. Address,

**TREVOR & CO.,**  
LOCKPORT, N. Y.

oct3



# R. LYNEX,

Rear of 428 Walnut Street, Philada.

Manufacturer of Plain and Fancy Wire-work, for Florists; Wreaths, Crosses, Stars, Crowns, Hearts, Anchors, Birds, Lambs, Gipsy Baskets, Hanging Baskets, Flower Stands, &c.

SEND FOR PRICE LIST.

aug6

**20,000 AGENTS WANTED!**  
TO CANVASS FOR

**400 PAPERS** and MAGAZINES, which are furnished at Club Rates for single copies. Book and other agents can act without interfering with present business. Good pay, easy work.

sep4 C. W. BENNETT, Gen'l Agent, Quincy, Mich.



CIRCULAR.

THE NEW  
**Japanese White Flowering  
 HYDRANGEA,**  
 "THOMAS HOGG."

We have great pleasure in announcing to the Horticultural world, that the distribution of this fine plant, the most superb novelty in plants ever introduced into this country, will commence on **October 1st, 1876.** It has received the unqualified admiration of all American and European Florists and Nurserymen who have seen it in flower.

Orders will be received at the following rates:

One Plant \$5.	Where 12 Plants are taken,	2 additional sent.
	25 " " " "	5 " "
	50 " " " "	12 " "
	100 " " " "	25 " "

This, the finest of all Hydrangeas, was sent to the United States by Mr. THOMAS HOGG, from Japan. It has been exhibited in flower at the Massachusetts Horticultural Society weekly meeting in Boston, where it took the Society's silver medal for new plants; and also, at the New York Horticultural Society's monthly meeting in May. In the report of that meeting to the "American Agriculturist," by Mr. Peter Henderson, he says:—"We think it safe to say, that no ornamental plant ever introduced exceeds this in value."

It belongs to the Hortensia section of the family, but is a far more free and abundant bloomer than any other, for the Florist, and for all decorative purposes it will be invaluable; the flowers are of the purest white, of very firm texture, and continues in flower for a great length of time. It will no doubt prove quite as hardy as the old Hortensias.

All ordering 12 plants, or more, will get a large plant (included in the number, at regular rates,) suitable for exhibition next spring.

All orders must be sent to **JOHN CADNESS, FLUSHING, L. I., N. Y.**

Cash must accompany the order, and all remittances by Draft or Post Office Order, or Bank Cheque, as we cannot be responsible for the safety of greenbacks by mail.

JOHN CADNESS.

Flushing, Long Island, N. Y., Sept. 1st, 1876.

toct12

P. & E. TRANSON,  
**NURSERIES,**  
 ORLEANS, FRANCE.

Beg to inform their friends and customers generally that their

**NEW LIST FOR 1876 AND 1877,**

Is now ready, and may be had on application to

**MESSRS. KNAUTH, NACHOD & KUHNE,**  
 113 BROADWAY, NEW YORK.

This Catalogue contains Prices of all the **FRUIT TREE STOCKS**; an extensive list of **FRUIT TREES**, New and Hardy **ORNAMENTAL PLANTS**, **CLIMBERS**, the Hardest and Best **CONIFERS**, **ROSES** on their own roots. Also, **SMALL CONIFERS**, **DECIDUOUS** and **EVERGREEN ORNAMENTAL TREES**, one or two years' Seedlings, most useful for Nurserymen.

N. B.—The greatest attention given to packing.

oct5

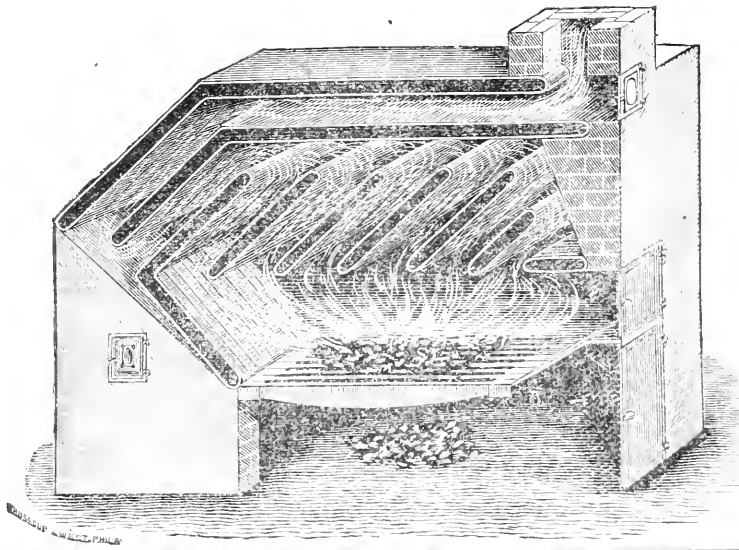

THOMAS J. MYERS,  
 PATENT BOILERS  
 AND  
**Hot Water Apparatus**

FOR HEATING  
 Greenhouses,  
 Hot-Houses,  
 Conservatories, &c.  
 THOMAS J. MYERS & SON,  
 1162 Passyunk Ave.,  
 PHILADELPHIA.  
 2, 4, 6 & 8 Home Street, Cin-  
 cinnati, O.  
 Please send for Descriptive Cir-  
 cular and Price List. [tjnet]

# GRAPE VINES.

Also GRAPE WOOD and CUTTINGS. LARGEST STOCK IN AMERICA.

All leading varieties in large supply. Extra Quality. True to name. Special rates to Agents, Dealers and Nurserymen. Our list of customers now embraces nearly all the leading nurserymen in the country, to whom we would refer those not acquainted with our stock. Descriptive Catalogue and Price List Free. T. S. HUBBARD, Fredonia, N. Y. aug10

Estab. 1765.

**2,000,000**

ILLUSTRATED CATALOGUES

*Sent free on application.*

1765.

**IN STOCK**

*Low freights from Boston allow us to compete with any Pottery in the United States.*

**A. H. HEWS & CO., - No. Cambridge, Mass.**

M. M. BAYERSDORFER & CO.,

Importers of Every description of

## BOUQUET PAPERS.

Plain White Satin for Bridal Bouquets. Fancy Lace for Weddings, Receptions, Parties. Italiens, Pasted Cartons, Immortelles in great varieties; Green Moss, French Dried Grasses and Flowers. Tin Foil. Prize Medal of Cincinnati Industrial Exposition of 1873 awarded to us for the best display of Bouquet Papers. Illustrated Catalogue furnished on application.

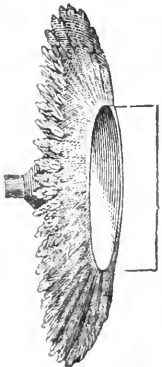

feb 56 N. Fourth St., Philadelphia, Pa.

**ELLIS' BASE BURNING BOILER.** FOR WARMING Dwellings, Greenhouses, Graperies, Forcing Pits, Drying Rooms  
 Heating Water for Public Baths, Baptisteries, &c., by Hot Water or by Steam.

Estimates and Circulars furnished. t.sep.12. 182 CENTRE STREET, NEW YORK.

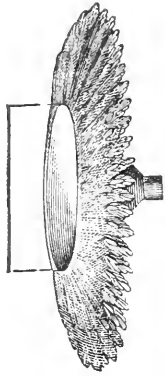

ROWLAND WHITMAN.

HARRY LANG.

**WHITMAN & LANG,**  
 IMPORTERS OF

BOUQUET PAPERS.

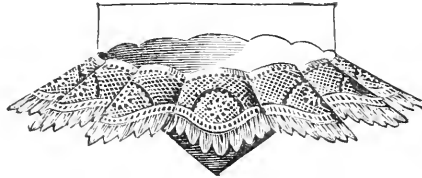

DRIED FLOWERS, IMMORTELES, TIN FOIL &c.

augtf. No. 126 N. 4th St., Philadelphia.

FANCY GRASSES

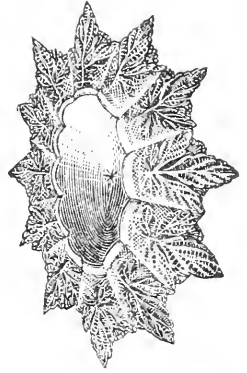

**GERMANTOWN NURSERIES,**  
**PHILADELPHIA.**

GORGAS LANE STATION, CHESTNUT HILL RAILROAD. Less than One Hour from the Centre of Philadelphia.

Those who desire to purchase largely, either for their own planting or to sell again, are invited to examine the extensive stock of

**FRUIT, SHADE AND ORNAMENTAL TREES AND SHRUBS,**

Grown at the Germantown Nurseries. And those who need but A FEW ARTICLES, will find all ages and sizes to select from. A special feature of the business, is the raising of

Nursery Stock and Seedling Forest Trees

FOR DISTANT SHIPMENT. Many of these can be supplied by the millions at very low rates. Address, for CATALOGUES or information,

**THOMAS MEEHAN, Germantown Nurseries, Phila.**

**JOHN A. SCOLLAY,**  
**IMPROVED HOT WATER APPARATUS,**

Patented September 17, 1872.

*For Warming and Ventilating Dwellings, Greenhouses, Graperies, Forcing Pits, Drying Rooms, Heating Water for Public Baths, &c.*

This Boiler is perfectly self-cleaning, simple, economical and powerful, having more effective surface into less space than any Boiler in the market. Scollay's Patent Plant Sprinkler, for Window Gardening, &c., to be obtained of all Seedsmen, Florists, &c. Send for Circular and References.

nov. 12

351 Adams Street, Brooklyn, New York.

**GELSEMINUM NITIDUM,**  
 (Carolina Jasmine)

Plants of this lovely sweet-scented shrub by mail at 30c. each.

**DANIEL BARKER,**

(Late Supt. Oak Hill Cemetery, Georgetown, D. C.)

dec2 150 GRANBY ST., Norfolk, Va.

**Chamærops, Latanias,**  
 and CYCAS REVOLUTA; Ferns, Agaves, Yuccas, Magnolias, Gardenias, Callas, and all kinds of

**SEMI-TROPICAL PLANTS,**  
 Greenhouse Plants, Roses, Tuberoses, and a great collection of Bedding Plants. Address,

**A. HENRY & C. HUGO JAQUOT,**  
 dec3 Jacksonville, Florida.

# THE AMERICAN NATURALIST;

*A Popular Illustrated Monthly Magazine of Natural  
History and Travel.*

## Announcement for 1877.

This journal of popular Natural Science will continue to be published by Messrs. H. O. HOUGHTON & Co., Riverside Press, Cambridge, Mass., under the editorial management of Dr. A. S. PACKARD, Jr., with the assistance of eminent men of science.

Since January, 1876, the amount of matter given in each number has been increased over former volumes. The typographical dress and illustrations which have heretofore given character to this magazine, have been improved, and it is of a thoroughly popular nature, so as to interest the general reader as well as the young naturalist. It will continue to be a journal of science-education and for the use of science-teachers.

## Its Features for 1877.

In 1876 the latter half of the magazine was entirely remodeled, and a department of **GEOGRAPHY AND TRAVEL** added. The Department of **BOTANY** will be edited as formerly by Prof. G. L. Goodale, of Harvard University. That of **MICROSCOPY** will be edited as heretofore by Dr. R. H. Ward, Troy, N. Y. Arrangements have been made to report the **PROCEEDINGS OF SCIENTIFIC SOCIETIES** with great promptness. A digest of the **CONTENTS OF FOREIGN SCIENTIFIC JOURNALS AND TRANSACTIONS** will also be given each month, together with the **LATEST HOME AND FOREIGN SCIENTIFIC NEWS**.

The attention of publishers and teachers is called to critical notices of scientific books, to which especial attention will be given.

## Articles for Vol. XI., 1877,

By Professors Asa Gray, J. D. Whitney, N. S. Shaler, W. G. Farlow, G. L. Goodale, of Harvard University; Professors O. C. Marsh, A. E. Verrill, of Yale College; Mr. A. Agassiz, Hon. Lewis H. Morgan, Col. Theodore Lyman, Mr. L. F. Pourtales, Mr. S. H. Scudder, Professors E. D. Cope, F. V. Hayden, A. Hyatt; Drs. Elliott Coues, W. H. Dall, C. C. Abbot, Rev. S. Lockwood, J. A. Allen, H. Gillman, C. C. Parry, R. E. C. Stearns, O. T. Mason, and other leading naturalists, are either in hand or promised. Notes from abroad will occasionally be contributed by Mr. Alfred W. Bennett, the distinguished English botanist.

*Note.*—The ten volumes which have been published form an elegantly printed and illustrated Library of American Natural History, invaluable for school, college, and public libraries. They contain standard articles by Agassiz, Dana, Wyman, Gray, Whitney, Leidy, Cope, Hunt, Dawson, Newberry, Marsh, Verrill, Morse, Gill, Coues, Scudder, Hagen, Dall, Shaler, Brewer, Ridgway, Parry, Caton, Abbott, Farlow, Lockwood, Grote, Ward, and many other scientists.

**Terms:**—35 cents a number; \$4.00 a year, postage free. Bound volumes, \$5.00; vols. I.-X., \$40 00; unbound \$30.00. Back numbers supplied.

Remittances by mail should be sent by a money-order, draft on New York or Boston, or registered letter, to H. O. HOUGHTON & Co., Riverside Press, Cambridge, Mass.

H. O. HOUGHTON & COMPANY, corner Beacon and Somerset Sts., Boston.

HURD & HOUGHTON, 13 Astor Place, New York.

European Advertisement.

**THE LILY NURSERY**

Can supply Lilies of all kinds; prices very low; wholesale and retail Special List and General Descriptive Catalogue of Plants, Bulbs, & Grats and post free on application, to any part of the World.

**Christmas Rose** (Helleborus niger), very fine white winter flower for bouquets. Large stock; at \$4.00 per 100. \$30.00 per 1000.

**Hepaticus, 6 fine varieties**, in large quantities, very cheap; prices on application. All orders solicited to be directed to

**J. VANDER SWAELMEN,**

t.deci The Lily Nursery, Genbrugge, Ghent, Belgium.

**SIX GREENHOUSES ON 8 YEARS' LEASE.**

Owing to failing health, I will dispose of my good will and interest in the above; situated on one of the leading avenues in the city. I have made the cut flower department a specialty. The Trade is sure and constant. To an active enterprising man this opportunity offers inducements seldom met with. For particulars apply to

**T. FOWLER GERRARD,**

tnov3 877 Euclid Ave., Cleveland, O.

**ALEXANDER PEACH.**

And other New kinds. **Cherry**, 2 years, strong growth. **Red Dutch Currants**, 1 and two years. **Apricots**, 1 to 2 years, fine at \$9 per hundred. **Norway Maple**, 8 and 19 feet; **Sugar Maple**, 4 to 5 feet nursery grown, in quantities. **Hemlock Spruce**, 2 to 2 1/2 feet, bushy. **American Arborvitae**, 8 inches to 8 feet. **Siberian**, 3 to 4 feet. **Irish Juniper**, 3 to 5 feet. Stock of best quality and offered low.

**JOSIAH A. ROBERTS.**

tseptf Paoli, Pa.

**Decorative Plants.**

Send for our New Trade List of Palms, Ferns, and other Greenhouse and Stove Plants. We offer a large assortment at low rates.

**HOOPES, BRO. & THOMAS,**

Cherry Hill Nurseries, s-p6 West Chester, Pa.

TO

**Gardeners and Orchardmen.**

The **LAYTONIA LAND COMPANY** will offer extraordinary inducements to Market Gardeners and Fruit raisers who will engage in the business at Laytonia. For particulars address

**WM. L. LAY, Pres.,**

Laytonia Land Co.,

decc **LAYTONIA, BRAZORIA CO., TEXAS.**

**CUT-FLOWERS**

OF

**CARNATIONS.**

For Bouquet makers, in large quantities. Price, \$1.50 per 100 in standing orders for the season, forwarded by Express; not less than 250 in one shipment.

Transient orders delivered by mail pre paid, and at the Holidays \$2 per 100. Orders by telegraph promptly attended to.

Young Plants of Carnations in 2 1/2 in. pots of Whites, Reds, Yellows, and variegated, \$1 per doz.; \$5 per 100.; \$45 per 1000. A few Large Stool Plants of the whites for Winter-flowering, or stock, @ \$8 per 100. Address,

**CHAS. T. STARR,**

deci Avondale, Chester Co., Pa.

**WALTER ELDER,**

Landscape and Jobbing Gardener,

1231 Rodman Street, Philadelphia

Attends to all branches of his business on reasonable terms.

**COMMUNICATIONS**

are invited from **FIRST-CLASS GARDENERS** to take charge of next Spring and work on shares a large

**VEGETABLE GARDEN,**

with **FORCING HOUSES** and **GRAPERY**, gardener's house and stable, and to keep in order the **CONSERVATORY** and **GROUNDS** attached to a **PRIVATE RESIDENCE**, near Baltimore City.

Address **"SUDBROOK,"**

tnovt Pikesville P. O., Baltimore Co., Md.

**Gray, Dry Faded & Falling HAIR**

Is now restored to its natural condition by the use of

**WOOD'S IMPROVED HAIR RESTORATIVE.**

The **IMPROVED ARTICLE** is now taking the lead over all others, leaving the hair clean, soft and glossy. **C. A. COOK & CO.,** Chicago Sole Agents for the United States and Canada. Sold by all Druggists everywhere. Trade supplied by **J. F. HENRY, CURRAN & CO.,** New York. oct5

**Plants for Winter-Flowering and Florists' Stock.**

	PER 10	PER 100
A'ntillon "Boule de neige," pure white, free blooming	2.50	
" "	1.50	
" "	1.00	
Begonias for Winter flowering, 4 varieties	2.00	
Cinerarias, choice strain	2.00	
" "	1.00	
Euphorbia Jacquiniiflora	2.50	
" "	1.50	
" "	1.00	
Fuchsia procumbens (trailing Fuchsia)	2.50	
Geranium "Gen'l Grant," beaut. scarlet for massing	75	6.00
Lage stromelia Indica (new crimson crape myrtle)	1.50	
Nertera depressa (scarlet berried plant, used during the past season in the London Parks as a carpet bedding plant)	1.50	
Primula sinensis, red and white	1.50	
Verbenas, strong plants, perfectly free from disease, 25 plants in 25 varieties for \$1.50		4.00
Address	<b>EDWIN LONSDALE, Florist,</b>	
decc9	Germantown Phila.	

**C. F. A. HINRICH'S,**

29, 31 and 33 Park Place, New York City,

**HYACINTH AND BULB GLASSES.**

DECORATED

**FLOWER POTS,**

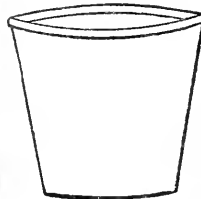

LAVA, MAJOLICA, &c., &c. Vases, Iron Sections for Flower Beds. Lawn, Fish and Flower Stands. Floating Animals for Aquaria. Bottom hole Bouquet Holders. Only and Original GERMAN STUDENT LAMP for Conservatories.

Send for Prices to above address.

decc6om

**The Greenbrook & Paterson City Nurseries**

Floral and Fashion Journal. Free for 1876! Address **GREIVES & CO.,** Box 2838, New York.

**200 BUSH. PEACH PITS,**

FRESH, and saved with special care for

**OUR OWN USE,**

Having more than we need we offer the above lot on reasonable terms.

decc2

**WM. CORSE & SON,**

Baltimore, Md.

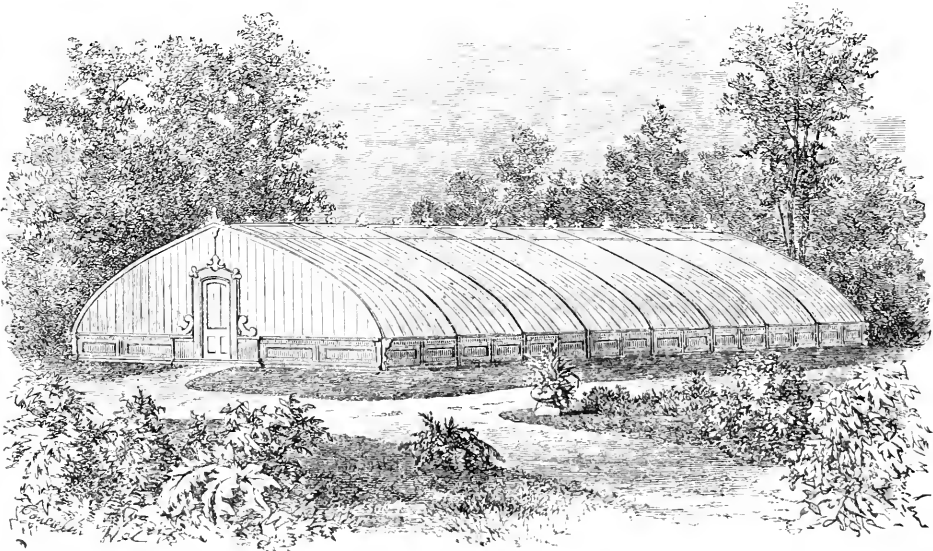

# GREENHOUSES, GRAPERIES, ETC.

Their Construction a Specialty. Experience of 20 Years.

SHIPPED TO ALL PARTS OF THE COUNTRY. Send for Catalogue. Address,  
LORD'S HORTICULTURAL WORKS,

Irvington-on-Hudson, New York.

June 12

## ALEX. NIMMO,

(Late of the Firm of Nimmo & Scollay.)

# NEWLY IMPROVED HOT WATER BOILER,

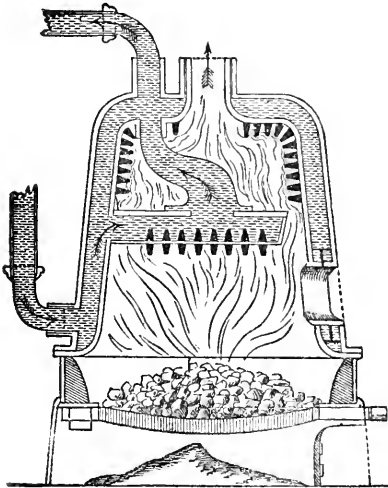

FOR HEATING

Green-Houses, Graperies, Conservatories,  
Forcing Pits, Water for Baths, Drying  
Rooms, Public and Private  
Buildings, &c.

*Proper steps have been taken to secure United States  
Letters Patent on this Invention.*

All the necessary Fittings for Hot Water Heating Apparatus.

VENTILATION APPARATUS OF ALL KINDS.

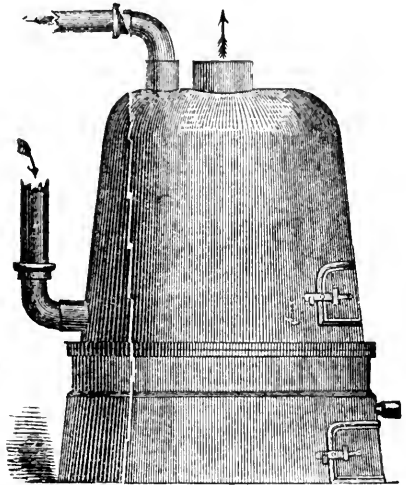

Wells Drove, Pumps of all kinds, Hydraulic Rams, &c., Garden Sun-Dials.

Agent for Joseph Kelly's Never Dry Vapor Pans, for all kinds of Hot Air Furnaces, Baltimore Heaters, &c.

CHEAPEST AND BEST BOILER, &c., IN THE MARKET.

Please send for Circular for explanation, etc., before you make up your mind to purchase elsewhere.

sep 12

P. S.—Be sure you get the right number.

335 Adams Street, Brooklyn, N. Y

# WABAN CONSERVATORIES

OFFICE :  
56 BROAD ST., BOSTON.  
Address all Letters to  
BOSTON OFFICE.

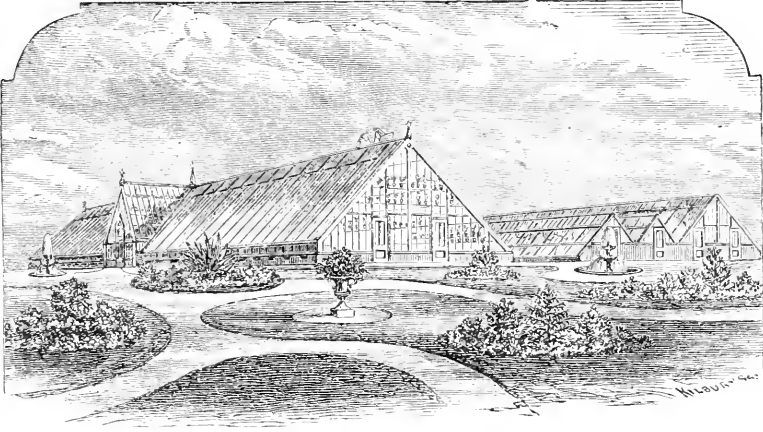

Send all Telegrams by  
Atlantic & Pacific Line. Address,  
*Waban Conservatories,*  
LAKE CROSSING, MASS.

## FALL TRADE 1876.

The following choice **SELECTED NOVELTIES** will be ready for delivery during the coming **FALL**, and to which attention is specially directed.

### ROSE "EDMUND WOOD." (Verdier).

This superb hybrid perpetual we have bloomed and find it fully equal, if not superior, to the description. Its color is richer and slightly darker than Gen'l Jacqueminot, far more double and equally prolific in growth, blooming as freely as that favorite variety. Good plants, on own roots, \$2 each.

### CARNATION "WELLESLEY BEAUTY."

Color soft fine cinnamon, beautifully striped and spotted with carmine rose; habit, free compact and vigorous. A valuable acquisition. 75c, each.

### BRONZE ZONALE GERANIUM "EARL ROSLYN."

Unquestionably the best bronze and gold bedding Geranium yet produced, superior to the acknowledged favorites, Marshall MacMahon and Black Douglass. 50c. each.

### DOUBLE ZONALE GERANIUM.

**P. BUCK.**—Violet and salmon, new and effective color, and a very valuable variety.

**J. C. ROBBARD.**—Double salmon red, not very double, but beautifully joined and much superior to Asa Grey.

**MADAME THIBAUD.**—Rose petals, marked with white at their base, semi-double, but producing a novel and pleasing effect. Also many other new Zonale and other Geraniums, for description of which see Catalogue.

### PELARGONIUM REGAL "QUEEN VICTORIA."

This is one of the most marvellously beautiful novelties ever offered. Color rich vermilion, margined with fine white, and upper petals blotched with deep purple maroon. The flower has thick, crispy petals, which give it the appearance of being double. It is a remarkable and striking improvement in Pelargoniums. \$1.50 each,

### PELARGONIUM REGAL, "BEAUTY OF AXTON."

Similar in form to the above, but quite distinct in color, which is; upper petals rich maroon; centre rose; all the petals being margined with pure white; flowers large and full, having the appearance of being semi-double, and a most beautiful and extraordinary novelty. \$3 each.

## FOR FLORISTS' WINTER STOCK.

Send for Abridged Trade Circular of new Tuberose, Rooted Begonias, Double Zonale and other Pelargoniums; Roses, Carnations, Ivies, Vincas, &c.

We have a good stock of the new Double Ivy-leaved Geranium, described in the September number of the Gardener's Monthly, which we offer at \$1.00 each, or \$2.50 for three. Also new **ABUTILONS** of beautiful colors; Le Liliput, mauve; Le Nain, mauve, shaded orange, Perle d'or, canary; Simon de Leaux, chamoix shaded with purple and veined with rose. 75 cts. each. The set \$2.00.

We are making the importation of Rhododendrons and Clematis a specialty.

Orders promptly executed. Send for Circular.

EDMUND M. WOOD & CO.

1875.  
THREE MEDALS,  
AND  
DIPLOMA,  
N. ENG. AGR. SOCIETY.

# WHEELER'S



1876.  
TWO MEDALS,  
AND  
DIPLOMA,  
CENTENNIAL EXHIBITION.

INSECTICIDES, LIQUID FERTILIZER DISTRIBUTORS, WATERING-POTS, and DISINFECTORS, for WATER CLOSETS, URINALS, and SINKS; also, COMPOUNDS to be used with the above machines, are now manufactured under Patent July 20, 1875.

Intelligent Culturists in the field, garden, greenhouse, and holders of public and private buildings, must use the above, if they wish to adopt the cheapest, most effective, and satisfactory method yet devised, either to destroy insects and mildew on plants, shrubs, trees, grown under glass or in open air, especially those cultivated for their fruit or seed, or to distribute solid fertilizers of any kind in a liquid form, or to disinfect foul places. They have stood the severest tests during the last two seasons, and at the Centennial Exhibition. Satisfaction guaranteed only when THE COMPOUNDS are used according to directions. All the above machines, except the Watering-Pot, can be used only where there is water under pressure in pipe attached to Hydrant or Force-Pump. References, prices, and other information given by addressing,

*W. F. WHEELER,*

24th Ward, Boston, Mass.

 The English, French, Belgian, and Canadian Patents for sale. 

## PUBLISHERS' CARD.

THE

# NURSERYMAN'S DIRECTORY.

The undersigned have in preparation VOLUME II of the NURSERYMAN'S DIRECTORY, embracing a list of the NURSEYMEN, FLORISTS, SEEDSMEN and TREE DEALERS, of the United States. The work will be sold wholly by subscription, the price of which will be TEN DOLLARS per copy and will be issued January 1st, 1877.

A limited space will be given to Advertisements, at the following Low Rates:

Full Page,	\$35 00	One-Third Page,	\$15 00
Half Page,	20 00	One-Fourth Page,	10 00
One-Sixth Page,	\$8 00		

For further information, address

oct D. W. SCOTT & CO., Printers and Publishers, Galena, Illinois.

 Subscriptions received for above work by CHAS. H. MAROT, office of Gardener's Monthly.

## TREMONT

# BOTANIC GARDENS,

Tremont, New York City.

NEW AND RARE

# STOVE AND GREENHOUSE PLANTS,

ORCHIDS, PALMS AND FERNS.

CATALOGUES sent FREE OF CHARGE.

## JOHN S. BUS H.



# Peach Stones

AND OTHER

## FRUIT SEEDS.

Notwithstanding the general scarcity of Fruit Seeds this season we expect to furnish our customers with full supplies at our usual low prices; but solicit

EARLY ORDERS.

THOMAS MEEHAN,  
tsep GERMANTOWN, PHILA.

## Black Naples.

LA VERSAILLES, CHERRY, WHITE GRAPE,  
and RED DUTCH

## Currant Bushes,

Of fine quality and low in price.

A. HANCE & SON,

Octf Nurserymen and Florists, Red Bank, N. J.

## TOBACCO STEMS,

For Fumigating purposes, for sale in bales of about 400 lbs., free on boat or cars at \$5 per bale, or three bales for \$12 on one order.

STRAITON & STORM,  
178 & 180 Pearl Street,  
aug12 New York City.

## APPLE STOCKS.

A fine lot 2 year Apple Roots. Price, packed and delivered to R. R., \$5 per 1000. Address,

THE DINGEE & CONARD CO,  
oct8 West Grove, Chester Co., Pa.

## New PEACHES.

Alexander's Early, Amsden's June, Steadly, Leatherbury's Late, Tuckahoe Late, Bilyeu's Late October (Bilyeu's Comet), Brandywine and twenty other new varieties of merit.

A. HANCE & SON,

octf NURSERYMEN AND FLORISTS, RED BANK, N. J.

## ENGLISH YORKSHIRE PIGS.

Bred by a careful and experienced breeder, from stock imported directly from Yorkshire, England. By a system of judicious crosses, a breed of swine have been produced that are perfect in all points, characteristic of a model Hog. For practical utility they are excelled by no other breed. They are medium size, white color, light-haired, very prolific, quiet, excellent nurses, mature early, and are ready fatteners. Shipped to destination at my risk, and warranted as represented. Prices reasonable. Illustrated Catalogue mailed free. Also Holstein and Short-Horn Cattle.

MARLBOROUGH STOCK FARM,  
dec1 P. O. Address, Box 352. NEWBURYPORT, MASS.

## GRAPE VINES.

Concord, Hartford, Ives and Catawba, very low by the quantity; quality extra.  
oct4 G. & S. BOALT,  
Norwalk, Ohio.



Fifty pages—300 Illustrations, with Descriptions of thousands of the best Flowers and Vegetables in the world, and the way to grow them—all for a Two CENT postage stamp. Printed in German and English.

Vick's Floral Guide, Quarterly, 25 cents a year.  
Vick's Flower and Vegetable Garden, 50 cents in paper, in elegant cloth cover, \$1.00  
Dec4 Address, JAMES VICK, Rochester, N. Y.

Adapted to all Sections of the Country.

### THE NEW JERSEY AGRICULTURIST.

A plain, practical 8 page monthly, adapted to Farming, Gardening, and Household interests; tells when and how to plant, hints for each month; Wind w and In-door Gardening, Greenhouse, Ladies' Department, &c. Is a Journal just suited for the times. Only 50 cents per year, sample copies free. Address,

NEW JERSEY AGRICULTURIST,  
20 Hiram St., New Brunswick, N. J.

Liberal Cash pay to Agents (as large as some other high-priced Journals) also a Cash Premium for the largest list of subscribers.  
dec1

## ROOT CUTTINGS

OF THE

## SNYDER BLACKBERRY.

with directions; SURE TO GROW.

50 cents per 100; \$4 per 1000.

dec1 SAMUEL KINSEY, Dayton, O.

## ANCIENT HORTICULTURAL ESTABLISHMENT,

VICTOR VERDIER, Sr.,  
CHAS. VERDIER, Jr., Successor,  
Rue Bandricourt, Paris, France.  
Roses, Pæonies, Gladioli

are grown in very large quantities. Catalogues gratis and franco on application.  
dec3

## The FRUIT RECORDER and COTTAGE GARDENER



will be sent FREE 3 months to all applicants. We do not ask anyone to subscribe for our paper until they know what they are to get. It speaks for itself. Price only \$1 per year. Most liberal terms to club agents of any paper in this country. Purdy's Small Fruit Instructor is a work of 64 pp. that tells in simple language just how to grow fruits in abundance for home use or market. Price 25 cents, post paid.

A. M. PURDY, Rochester, N. Y.

WILSON BLACKBERRY, IVES' SEEDLING and CONCORD GRAPE Vines, BRANDYWINE RASPBERRY Plants, and other NURSERY STOCK for SALE CHEAP by

JAMES O. RANSOM,

dec1 Hammonton, Atlantic Co., N. J.

## The Nurseryman's Directory of 1876.

A reference book of the Nurserymen, Florists, Seedsmen, Tree Dealers, &c., for the United States. Alphabetically arranged by States and Post Offices. 242 pages, 8vo. Price \$5. Mailed, post-paid, on receipt of price.  
Address,

CHAS. H. MAROT,  
314 Chestnut St., Phila.

# WEATHERED & CHEREVOY'S PATENT BOILERS

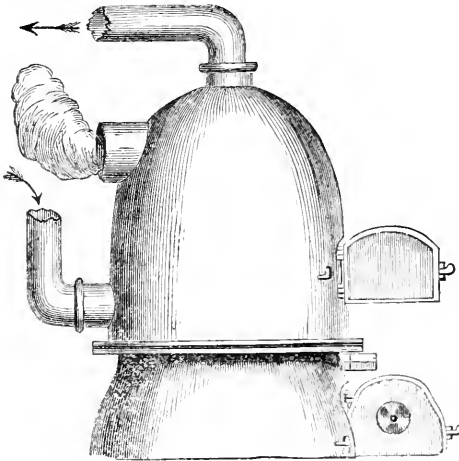

Fig. 1.

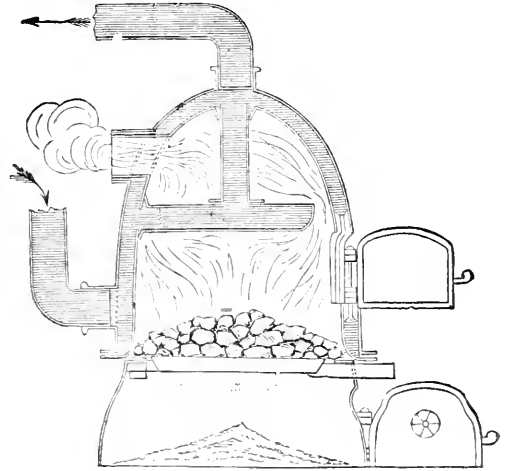

Fig. 2.

## AND IMPROVED HOT WATER APPARATUS,

No. 46 Marion Street, between Spring and Prince, New York.  
(TWO BLOCKS EAST OF BROADWAY.)

For Warming and Ventilating Public Buildings, Private Dwellings, Greenhouses, Graperies, Forcing Pits, Drying Rooms, and Heating Water for Public Baths.

Fig. 1 is an outside view. Fig. 2 is a vertical section through the centre.

*The following are a few names of Gentlemen who have our Boiler in use:*

Thos. Drake, Esq., Germantown, Pa.  
Simon Cameron, Esq., Harrisburg, Pa.  
J. D. Cameron, Esq., Harrisburg, Pa.  
Thos. Carter, Esq., Raleigh, N. C.  
J. H. Dunham, Esq., Chicago, Ill.  
Jas. B. Waller, Esq., " "  
W. J. Gordon, Esq., Cleveland, Ohio.  
Geo. Stanley, Esq., " "  
Harris Jaynes, Esq., " "  
Geo. W. Cuyler, Esq., Palmyra, N. Y.  
D. M. Osborn, Esq., Auburn, N. Y.  
John B. Dutcher, Esq., Pawling, N. Y.  
A. M. Allerton, Esq., Bronxville, N. Y.  
Robert Hoe, Esq., Tarrytown, N. Y.  
Peter Hoe, Esq., " "  
George Lewis, Esq., " "  
Wm. H. Drew, Croton Falls, " "  
Hon. James Y. Smith, Providence, R. I.  
Philip Caswell, Esq., Newport, R. I.  
Alfred Smith, Esq., " "  
Wm. Findlay, Esq., " "  
E. Learned, Esq., Pittsfield, Mass.  
D. O. Mills, Esq., San Francisco, Cal.  
W. L. Ferris, Esq., Westchester, N. Y.  
D. H. Haight, Esq., Goshen, N. Y.  
F. Newbold, Esq., Newark, N. J.  
James T. Closson, Esq., Plainfield N. J.  
Daniel W. Coit, Esq., Norwich, Conn.  
J. F. Slater, Esq., " "  
H. W. Collender, Esq., Darien, " "  
Chas. P. Palmer, Esq., Stonington, "

Wm. D. Black, Esq., New Milford, Conn.  
Rev. Stephen H. Tyng, Irvington, N. Y.  
H. F. Spaulding, Esq., Riverdale, " "  
S. D. Babcock, Esq., " "  
Percy R. Pyne, " "  
Elisha Brooks, Esq., Inwood, " "  
Camille Marie, Esq., " "  
A. F. Smith, Esq., Fort Washington, " "  
R. M. Olyphant, Esq., Dobb's Ferry, " "  
Clarkson N. Potter, Esq., New Rochelle, " "  
Chas. D. Diekey, Esq., West Farms, " "  
Wm. Matthews, Esq., Harrison, " "  
William Chorlton, Esq., New Brighton, S. I.  
F. H. Wolcott, Esq., Astoria, L. I.  
Bailey Leach, Esq., " "  
Hon. W. B. Ogden, High Bridge, N. Y.  
Peter Moller, Esq., 295 Fifth Ave., New York City.  
Wm. Moller, Esq., 6 West 20th St., " "  
John Moller, Esq., 127 East 54th St., " "  
John Moller, Esq., 8 East 37th St., " "  
Ch. Moller, Esq., 426 Washington St., " "  
Henry B. Laidlaw, Esq., 33 Pine St., " "  
George W. Lane, Esq., 93 Front St., " "  
J. P. Robinson, Esq., 14 Coenties Slip, " "  
J. B. Colgate, Esq., 47 Wall St., " "  
John B. Trevor, Esq., 47 Wall St., " "  
Charles Butler, Esq., 12 " "  
Richard Arnold, Esq., 309 Canal St., New York City.  
Jas. M. Constable, Esq., 309 Canal St., " "  
W. T. Garner, Esq., 61 Worth St., N. Y. City.

Please send for Circular with list of References and Reduced Prices to

THOMAS W. WEATHERED, 46 Marion Street, N. Y.

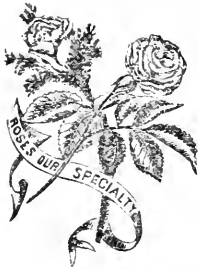

# Cascade Rose Nursery

NOW READY a fine lot of young **Tea, Bourbon, China and Noisette Roses** at \$6 per 100; \$50 per 1000. **H. P. ROSES** will be ready in large quantity early in 1877. **Prairie Queen**, 1 year, extra \$1.50 per doz.: \$10 per 100; \$90 per 1000.  
**New Double and Single GERANIUMS**, the Superb Novelties of 1876, \$2 per doz.: \$14 per 100.  
**Double and Single GERANIUMS**, Standard Sorts, 3 inch pots, \$1.25 per doz.: \$8 per 100, in **One Hundred** sorts if desired.  
**Cascade Set of New VERBENAS for 1877**, 25 truly Superior Sorts \$2.50 per set. **VERBENAS**, **General Collection**, a splendid lot in perfect health, \$4 per 100; \$30 per 1000.  
**Aristolochia, or Dutchman's Pipe-vine**, \$2 per doz.: \$12 per 100.  
**TUBEROSES**, Double Italian, blooming bulbs, \$3.50 per doz.; \$25 per 1000.

tdcc12

A. K. WILLIAMS, Richmond, Ind.

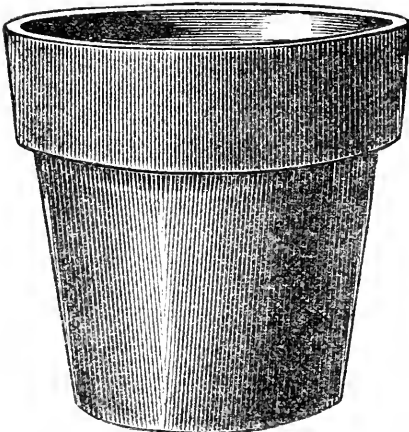

## FLOWER POTS BY THE MILLION!

The BEST, CHEAPEST and MOST DURABLE FLOWER POTS in the MARKET.

Also a full line of

Vases, Fancy Flower Pots, Hanging Baskets, &c.,

At the

NEW BRIGHTON

Flower Pot and Terra-Cotta

WORKS.

Illustrated Catalogue on application.

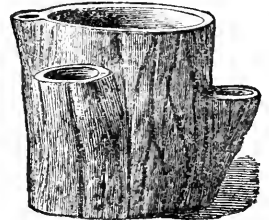

sep3 Address, ELVERSON & SHERWOOD, New Brighton, Pa.

# VALUABLE PLANTS.

We offer TO THE TRADE and others in large or small quantities, Camellias (full flowering buds), Azaleas, Eucharis Amazonica, Bletias, Tankervillias and Sherardias Cypridium, insignis, Draceas (varieties Guzmania picta, Yucca quadricolor, Daphne Indica, Phormium Tenax (var.) Crinum amabilis, Strelitzia Regina, Pine Apples, Quadricolor, and others, Imantophyllums, Marantas, &c. We have a large stock of valuable plants and can always send out FINE PLANTS at low rates. Send address for Catalogue.

tnov6

JOHN SHERWOOD & SON, Bristol, Pa.

## For Sale--5 Greenhouses

And a well-selected stock of

### PLANTS.

LOW RENT AND LEASE GIVEN.

Situated in Philadelphia horse cars pass the door both ways; every convenience, Hydrants in all the houses, and stock fully up to the highest standard; both a local and Catalogue trade. Apply in the first instance to CHAS. H. MAROT, 814 Chestnut St., Phila.

## Fruit Growers' Hand-Book.

By F. R. Elliott, author of "Western Fruit Growers' Guide," (one of the best posted men on the subject in the United States). Contains the practice on all subjects connected with fruit growing. The book is made for those who grow fruit for their own use. Also an Appendix, containing matter relating to the selection and culture of Ornamental Trees, Roses, Plants, &c. Illustrated with 45 wood-cuts, 130 pages, 16mo cloth, \$1; paper, 60 cts. Sent by mail post-paid on receipt of price.

Address C. H. MAROT, 814 Chestnut St., Phila.

## LIFE HISTORIES OF BIRDS

Of Eastern Pennsylvania. First vol. By THOMAS G. GENTRY. From observations of facts carried through a period of six years in the field, and elaborate examinations in the studio. With alphabetical indices of scientific and common names. 400 pages, 12mo, cloth. Price \$2. Sent by mail, post-paid, on receipt of price.

Address,

CHAS. H. MAROT,

814 Chestnut St., Phila.

A Hygroscope for 50 cents.

## THE CHEMICAL HYGROSCOPE.

This Indicator of atmospheric moisture is as accurate as the costly ones. Rooms heated by furnaces or stoves are almost invariably so dry as to be damaging not only to health but to furniture. Some people take the consequences others keep water on the heater. The Hygroscope shows at a glance whether the air is too dry or not.

Sent by mail for 50 cents. Address,

febtf CHAS. H. MAROT, 814 Chestnut St., Philadelphia.

## Harper's Bazar.

ILLUSTRATED.

"A Repository of Fashion, Pleasure, and Instruction."

### TERMS.

Postage free to all Subscribers in the United States.

HARPER'S BAZAR, one year \$4.00

\$4.00 includes prepayment of U. S. postage by the publishers.

Subscriptions to HARPER'S MAGAZINE, WEEKLY, and BAZAR, to one address, for one year, \$10 00; or, two of Harper's Periodicals, to one address for one year, \$7 00; postage free.

An Extra Copy of either the MAGAZINE, WEEKLY, or BAZAR will be supplied gratis for every Club of FIVE SUBSCRIBERS at \$4 00 each, in one remittance; or, Six Copies for \$20 00, without extra Copy: postage free.

Back Numbers can be supplied at any time.

The Volumes of the Bazar commence with the year. When no time is mentioned, it will be understood that the subscriber wishes to commence with the number next after the receipt of his order.

The Annual Volumes of HARPER'S BAZAR, in neat cloth binding, will be sent by express, free of expense, for \$7 00 each. A complete Set, comprising Nine Volumes, sent on receipt of cash at the rate of \$5 25 per vol., freight at expense of purchaser.

Cloth Cases for each volume, suitable for binding, will be sent by mail, post-paid, on receipt of \$1 00 each.

Indexes to each volume sent gratis on receipt of stamp.

Newspapers are not to copy this advertisement without the express order of HARPER & BROTHERS.

dec1 Address HARPER & BROTHERS, New York.

## Harper's Weekly.

ILLUSTRATED.

"A Complete Pictorial History of the Times."—"The best, cheapest, and most Successful Family Paper in the Union."

### TERMS.

Postage free to all Subscribers in the United States.

HARPER'S WEEKLY, one year \$4 00

\$4 00 includes prepayment of U. S. postage by the publishers.

Subscriptions to HARPER'S MAGAZINE, WEEKLY, and BAZAR, to one address for one year, \$10 00; or, two of Harper's Periodicals, to one address for one year, \$7 00; postage free.

An Extra Copy of either the MAGAZINE, WEEKLY, or BAZAR will be supplied gratis for every Club of FIVE SUBSCRIBERS at \$4 00 each, in one remittance; or, Six Copies for \$20 00, without extra copy: postage free.

Back Numbers can be supplied at any time.

The Volumes of the Weekly commence with the year. When no time is mentioned, it will be understood that the subscriber wishes to commence with the number next after the receipt of his order.

The Annual Volumes of HARPER'S WEEKLY, in neat cloth binding, will be sent by express, free of expense, for \$7 00 each. A complete Set, comprising Twenty Volumes, sent on receipt of cash at the rate of \$5 25 per vol., freight at expense of purchaser.

Cloth Cases for each volume, suitable for binding, will be sent by mail, postpaid, on receipt of \$1 00 each.

Indexes to each volume sent gratis on receipt of stamp.

Newspapers are not to copy this advertisement without the express order of HARPER & BROTHERS.

dec1 Address HARPER & BROTHERS, New York.

## Orchid Culture.

By EDWARD SPRAGUE RAND, JR.

Including culture, propagation, collection and hybridization of Orchids; the construction and management of Orchid-houses; a glossary of Botanical terms and significance of their names; the whole forming a COMPLETE MANUAL OF ORCHID CULTURE. Cloth 12 mo, 476 pages. Price \$3.50. Mailed, post-paid, on receipt of Price.

Address,

CHAS. H. MAROT,

314 Chestnut St., Phila.

## Harper's Magazine.

ILLUSTRATED.

"Unquestionably the best sustained work of the kind in the World."

### TERMS.

Postage free to all Subscribers in the United States.

HARPER'S MAGAZINE, one year \$4 00

\$4 00 includes prepayment of U. S. postage by the publishers.

Subscriptions to HARPER'S MAGAZINE, WEEKLY, and BAZAR, to one address for one year, \$10 00; or, two of Harper's Periodicals, to one address for one year, \$7 00; postage free.

An Extra Copy of either the MAGAZINE, WEEKLY, or BAZAR, will be supplied gratis for every Club of FIVE SUBSCRIBERS at \$4 00 each, in one remittance; or, Six Copies for \$20 00, without extra copy: postage free.

Back Numbers can be supplied at any time.

The Volumes of the Magazine commence with the Numbers for June and December of each year. Subscriptions may commence with any number. When no time is specified, it will be understood that the subscriber wishes to begin with the first number of the current volume, and back numbers will be sent accordingly.

A Complete Set of HARPER'S MAGAZINE, now comprising 53 Volumes, in neat cloth binding, will be sent by express, freight at expense of purchaser, for \$2 25 per volume. Single volumes, by mail, postpaid, \$3 00. Cloth cases, for binding, 53 cents, by mail, postpaid.

A Complete Analytical Index to the first Fifty Volumes of HARPER'S MAGAZINE has just been published, rendering available for reference the vast and varied wealth of information which constitutes this periodical, a perfect illustrated literary cyclopedia. 8vo, Cloth, \$3 00; Half Cliff, \$5 25. Sent postage prepaid.

Newspapers are not to copy this advertisement without the express orders of HARPER & BROTHERS.

dec1 Address HARPER & BROTHERS, New York.

## THE ABBOTT

### Pocket Microscope

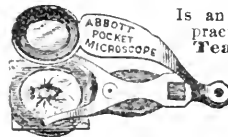

Is an instrument of great practical usefulness to Teachers, Farmers, Merchants, Mechanics, Physicists, Botanists, Miners, and many others. It is the best

Instrument ever invented for examining Flowers, Seeds, Plants, Minerals, Engravings, Bank Notes, Fabrics, Etc. By means of a cage, accompanying each Instrument, one can examine all kinds of Insects or Worms alive. The

### EYE OF A FLY,

or other insect of like size, can be readily seen. It is simple in construction and easy to operate. One of these interesting Instruments ought to be in every family. We have made arrangements to furnish the Pocket Microscope at the manufacturer's price, \$1.50. It will be sent, post-paid, to any reader of this Paper desiring it, on receipt of price, or may be had at this office.

Address,

CHAS. H. MAROT,

314 Chestnut St., Phila.

## GRAPE-WOOD.

I will send 5000 and upwards of CONCORD and IVES 2 eyed cuttings for \$1. per 1000, cut, bunched, and packed, to early orders. Also GRAPEVINES extremely low.

L. L. WOOD,

dec1

Vineland, N. J.

**A TOWN LOT ABSOLUTELY GIVEN AWAY!**  
**Worth \$100.**

**WE OFFER FOR THIRTY DAYS, A TOWN LOT IN MINERAL CITY, GRAYSON COUNTY**



**TEXAS, FREE EVERY LOT GIVEN AWAY UNCONDITIONALLY.**

**NO SETTLEMENT OR IMPROVEMENT REQUIRED.**

**YOUNG MEN, SECURE A HOME IN THE FINEST PORTION OF THE UNITED STATES, FOR NOTHING.**

**FACTS AND STATISTICS.**

Grayson county, Texas, is in the fucst portion of the State, and is traversed by THREE railroads, and enjoys the advantages of the Red River navigation. Has been settled for **THIRTY** years. **SUMMER THE YEAR ROUND.** From the United States statistics of 1876, Grayson county, Texas, produces a variety of production unrivaled in the country. **COTTON, TOBACCO, CORN, WHEAT, POTATOES,** and all the **FRUITS** of the **SUNNY SOUTH,** as well as the growths of harder climates, making this country truly a paradise.

**MINERAL CITY** is located on a beautiful plat of high, rolling prairie, interspersed with fine timber, in Grayson county, on Big Mineral creek, an unfailling stream of pure water, and on the Gainsville branch of the Missouri, Kansas & Texas Railroad, twelve miles west of the intersection of the M. K. & T. and Texas Central Railroads. The location is beautiful and healthy, and in all respects desirable, having natural parks, good drainage, an abundance of pure water at all seasons of the year.

**WHY WE GIVE LOTS AWAY.**

The Ohio, Kentucky and Texas Land Company have **LARGE TRACTS** of the best agricultural and mineral land in Northern Texas. And the time seems to be favorable to throw some of our lands on the market, at prices ranging from \$5 to \$10 per acre for unimproved, and \$20 to \$30 for improved lands. We have platted in the midst of our lands the town of **MINERAL CITY,** and to encourage emigration there, we give to any one sending their names to us, a **WARRANTY DEED** in fee simple for one or more lots in **MINERAL CITY,** the only charge being the sum of **ONE DOLLAR** to pay the Notary Public for acknowledging the deed, and actual expenses. **WE DO NOT GIVE EVERY LOT AWAY,** but every alternate one. We do not expect that every one who takes a lot in Mineral City will go there, but **WE DO THINK A GREAT MANY WILL,** and they will induce their friends to follow, and it will be but a short time until we have a **FLOURISHING CITY.** And as we own every other lot it is obvious to all how we are to make money. We make out the deeds **UNCONDITIONALLY,** not requiring you to settle or improve. Our limit to any one person taking advantage of our liberal offer is five lots.

**INSTRUCTIONS.**—We will send, by return mail, to any one who will send us, within thirty days from date of this paper, one dollar with their names written plainly in **FULL,** a clear **WARRANTY DEED** to a **25X100 FT.** town lot in **MINERAL CITY,** Grayson county, Texas. **CLEAR OF ALL TAXES TO JANUARY 1, 1878.** Your application for a town lot must in all cases be accompanied by **ONE DOLLAR,** to pay cost of drawing, and acknowledging deed, and registry fee, and mailing, and postage. You lot can then be sold or transferred at pleasure. **LET ALL IMPROVE THE CHANCE TO SECURE A HOME.** Deeds sent to any part of the **UNITED STATES AND CANADAS.** Address all communications to the

**OHIO, KENTUCKY, AND TEXAS LAND COMPANY, 206 Race St., Cincinnati, O.**

Remember this offer is good for **THIRTY DAYS ONLY.**

Parents, Secure a Few Lots for Your Children!

This advertisement will not appear again in the paper.

**FOR SALE.**

A farm of 60 acres, 35 miles from Philadelphia, on Camden & Atlantic R. R., 1/2 mile from Magnolia Station; well adapted to cultivation of **Fruit Trees, Small Fruits and Vegetables.** Large section of it Cedar Swamp and Natural Cranberry Ground. 4 acres in **Cranberries** under cultivation, 140 Fruit Trees, **Apple, Pear, Peach, Plum, &c.**, just coming into bearing. House and barn. Water excellent and abundant. Location healthy. Will be sold at reasonable price and terms to close an estate; or will be exchanged for city property. Philadelphia or Reading preferred.

Address,  
**CHAS. H. MAROT,**  
 septf. 814 Chestnut St., Philadelphia.

**AMERICAN FRUIT CULTURIST.**

BY JOHN J. THOMAS.

Practical directions for the Cultivation of Fruit Trees in the **NURSERY, ORCHARD AND GARDEN.**

Descriptions of the principal American and Foreign varieties. Plain Edition, 480 engravings, 511 pages, 12 mo. Price, \$3.00. Mailed post-paid on receipt of price.

Extra Edition, 576 pages, heavy paper, fine cloth, 508 illustrations and chromo frontispiece; mailed, for \$3.75. Address **CHAS. H. MAROT, 814 Chestnut St., Phila.**

**HOW TO LAY OUT A GARDEN.**

By Edward Kemp.

A general guide in Choosing, Forming and Improving an Estate (from a quarter-acre to a hundred acres in extent), with reference to both design and execution. Illustrated with numerous plans, sections and sketches. 403 pages, 12mo, cloth. Price \$2.50. Sent by mail post-paid on receipt of price.

Address **CHAS. H. MAROT,**  
 814 Chestnut St., Phila.

# PATENT BOOK COVERS.

Adapted to preserve and Bind loose sheets quickly and in their order

	Size	Cloth back and corners, marble paper sides	Full cloth, embossed, with gilt side title.	Am. Russia back and corners, cloth sides.	Tly. Moro. back and corners, cloth sides.
Gardener's Monthly,	7x10 $\frac{1}{2}$	\$.75	\$1.00		
Harpers' Magazine,	6 $\frac{1}{4}$ x10 $\frac{1}{4}$	.67	.88	\$1.25	
" Weekly,	11 $\frac{3}{4}$ x17 $\frac{1}{4}$	1.25	1.50	2.00	\$2.25
New York Herald,	16x24	1.67	2.25	3.00	
Boston Post,	23 $\frac{3}{4}$ x31 $\frac{1}{2}$	2.25	3.00		
Frank Leslie's Boys' and Girls' Weekly,	9 $\frac{1}{4}$ x14	1.00	1.25	1.67	
Peterson's Magazine,	6 $\frac{1}{4}$ x10 $\frac{1}{4}$	.67	.88	1.25	
U. S. Official Gazette,	7 $\frac{1}{2}$ x11 $\frac{1}{2}$	.75	1.00	1.38	1.50
New York Ledger,	14 $\frac{1}{2}$ x22 $\frac{1}{2}$	1.50	2.00	2.50	
London Punch,	9 $\frac{1}{4}$ x12 $\frac{1}{4}$	1.00	1.25	1.63	1.75
Ueber Land und Meer.	12 $\frac{3}{4}$ x16 $\frac{1}{2}$	1.25	1.50	2.13	2.25
Fliegende Blaetter,	9 $\frac{1}{4}$ x11 $\frac{1}{2}$	.88	1.13	1.50	1.67
Gartenlaube,	9 $\frac{1}{4}$ x13 $\frac{1}{4}$	1.00	1.25	1.63	1.75
Invoices,	8 $\frac{1}{2}$ x15	1.00	1.25	1.50	
Letter,	8 $\frac{1}{2}$ x11	.88	1.00	1.50	
Note,	5x8 $\frac{1}{4}$	.50	.75	1.00	
Music,	10 $\frac{1}{2}$ x14 $\frac{1}{2}$	1.00	1.25	1.75	2.00

NOTE.—Sizes not stated above will be made to order and price furnished on application. Please either mail one number of the Paper to be bound, or state the exact length and breadth of same.

Covers mailed to order on receipt of price. Address.

CHAS. H. MAROT, 814 Chestnut Street, Philadelphia.

## BACK VOLUMES

OF THE

## Gardener's Monthly

Can still be had in numbers, per year \$4 10  
Bound in neat cloth cases, including numbers. 3 00  
" " Roan " " " 3-15

Delivered postage free.

Or mail us your own numbers, and have them bound in cloth cases for 90 cents. Returned to you bound postage free. Address,

CHAS. H. MAROT,

814 Chestnut Street,  
Philadelphia.

## The Gardener's Monthly.

THE FOLLOWING

## BACK NUMBERS

WANTED, IN

### GOOD CONDITION.

April, 1860.	October, 1870.	August, 1874.
January, 1870.	December, "	December, "
March, "	January, 1873.	January, 1875.
July, "	January, 1874.	December, "
		January, 1876.

Receivable in exchange on Subscription account, or exchangeable for other numbers not in above list. Send numbers prepaid by mail and advise the publisher. Address.

CHAS. H. MAROT,  
814 Chestnut, St., Phila.

## DECLARATION OF INDEPENDENCE

FACSIMILE LITHOGRAPHED in the handwriting of THOMAS JEFFERSON, with the interlined corrections and erasures as made by JOHN ADAMS and Dr. FRANKLIN, in 1776. Pamphlet form, (7 pages,) on extra heavy, highly calendered, and tinted paper, with a beautiful cover, in four colors, embellished with the National Emblems,

OLD INDEPENDENCE HALL,

(As it appeared in 1776.)

THE "OLD LIBERTY BELL"

which rang out the LIBERTY we now enjoy to all the people, etc., etc. To which is added the names of the signers in their own handwriting, making one of the most ornate, unique, and interesting centennial memorials of the "time that tried men's souls," that could possibly be imagined. Should be placed on the centre table of every American citizen.

Price 50 cents each, postage paid. Address.

CHAS. H. MAROT,  
814 Chestnut St., Phila.

## ARITHMETIC MADE EASY

BY

## Ropp's Commercial Calculator

No farmer, mechanic, business man or laborer should be without it.

Contains more useful and practical tables, and original and rapid methods of calculation than all the other Reckoners and Calculators combined.

Shows at a glance the value of all kinds of grain, stock, hay, coal, lumber and merchandise, for any quantity and any price; the interest on any sum for any time at 6, 7, 8 and 10 per cent; measurement of lumber, saw-logs, cisterns, tanks, granaries, corn-cribs, wagon-beds, etc.; also a time, wages, and many other valuable tables.

It is simple and easily comprehended. Any one—the least conversant with figures—can instantaneously become his own accountant

Enables anyone to compute numbers with lightning rapidity, by mastering a simple arithmetical principle which has never been used before.

Is an Arithmetic, Ready Reckoner, Lightning Calculator, Silicate Slate, Memorandum and Pocket-book combined.

Price: Bound in Russia leather with gilt edges, \$2.00; Morocco, \$1.50; Fine Cloth, \$1.00; Cloth, without slate, memorandum, etc., 60 cts. Sent post-paid on receipt of price.

Address

CHAS. H. MAROT,  
814 Chestnut St., Phila.

# CLUB PAPERS AT NET PRICES,

## ALPHABETICALLY ARRANGED.

**TO REMIT IN CLUBBING** any of the following list with the  
 Gardener's Monthly select such  
 as you wish, foot up the prices annexed and add **TWO DOLLARS**  
 for the **MONTHLY** to the total.

American Agriculturist.....	\$1 20	Maine Farmer.....	\$2 10
" Farmer.....	1 35	Manufacturer and Builder.....	1 85
" Artisan.....	1 60	Maryland Farmer.....	1 35
" Builder.....	2 60	Massachusetts Ploughman.....	2 60
" Naturalist.....	3 25	Metropolitan.....	1 85
" Odd Fellow.....	1 60	Milling Journal.....	85
Appleton's Journal.....	3 60	Moore's Rural New Yorker.....	35
Arthur's Home Magazine.....	2 35	Nation.....	4 75
Atlantic Monthly.....	3 45	National Baptist.....	2 35
Boston Cultivator.....	2 60	New England Farmer.....	2 35
Building Association Journal.....	75	" Homestead.....	2 10
" Societies Gazette, London, England.....	1 35	New York Evangelist.....	2 60
Bucks County Intelligencer, old Subscribers \$2 60, new.....	2 10	New York Methodist.....	2 20
California Horticulturist.....	2 75	" Post, Weekly, \$1.50; Semi-Weekly.....	2 60
Central Union Agriculturist and Chrono.....	1 70	" Times, Weekly, \$1.50; Semi-Weekly.....	2 60
Children's Friend.....	1 35	" Tribune, Weekly, \$1.50; Semi-Weekly.....	2 60
" Hour.....	1 10	" World, Weekly; \$1.50; Semi-Weekly.....	2 60
Colman's Rural World.....	1 85	North-Western Farmer.....	1 10
Country Gentleman.....	2 25	Nursery.....	1 20
Demorest's Magazine.....	2 60	Ohio Farmer.....	1 85
Eclectic Magazine.....	4 60	Old and New.....	3 60
Every Saturday.....	4 60	Our Home Journal.....	2 72
Farmer's Home Journal.....	2 60	Park's Floral Gazette.....	65
Frank Leslie's Ladies' Magazine.....	3 10	Penn Monthly.....	2 10
" Review.....	2 10	Peter's Musical Monthly.....	2 60
Galaxy.....	3 45	Peterson's Magazine.....	1 70
Germanantown Telegraph, old subscribers \$2 50, new.....	2 20	Philadelphia Weekly Press.....	1 60
Godey's Lady's Book.....	2 75	Phreoneological Journal.....	2 35
Hall's Journal of Health.....	1 50	Poultry World.....	1 10
Harper's Bazar.....	3 45	Popular Science Monthly.....	4 60
" Magazine.....	3 45	Practical Farmer, (Weekly).....	2 60
" Weekly.....	3 45	Prairie Farmer.....	1 60
Hearth and Home.....	2 00	Purdy's Small Fruit Recorder.....	85
Herald of Health.....	1 60	Saint Nicholas.....	2 60
Household.....	85	Saturday Evening Post.....	2 10
Iowa Homestead.....	1 60	Scientific American.....	2 75
Journal of Chemistry.....	1 10	Scientific Farmer.....	85
" of the Farm.....	85	Scribner's Monthly.....	3 45
Journal of Materia Medica.....	1 10	Southern Cultivator.....	1 85
Kansas Farmer.....	1 35	Southern Planter and Farmer.....	1 85
Lady's Floral Cabinet, with Chromo.....	1 10	Waverly Magazine.....	4 60
Ladies' Repository.....	3 35	Western Agriculturist.....	85
Leslie's Lady's Journal.....	3 60	Western Farmer.....	1 85
Lippincott's Magazine.....	3 25	" Rural.....	1 85
Littell's Living Age.....	7 60	Wood's Household Magazine.....	85
London Garden.....	8 75	" " " " with Chromo.....	1 00
London Gardener's Chronicle.....	7 50	Working Farmer.....	1 10
		Youth's Companion, new subscribers \$1.40; old subscribers..	1 75

The above includes postage under the new U. S. Law requiring prepayment of postage before mailing.

After subscription to a club paper through this agency, report non-receipt of your numbers and other causes of dissatisfaction, irregularities of mails or changes of residences, *only to said paper direct* (not to this office).

Remit by P. O. Order, Draft or Registered Letter. Currency is at risk of mails.

If you wish a receipt or reply, enclose postage stamp for that purpose, otherwise the club papers will be considered a sufficient receipt.

Address **CHAS. H. MAROT, 814 Chestnut Street, Philadelphia.**

Index to Advertisements.

Advertisers are requested to have orders in hand as EARLY AS POSSIBLE. Copy received after the 23rd of each month cannot be INSURED insertion in the next issue.

Babbit B. T., New York..... 4  
 Barker Daniel, Norfolk, Va..... 2, 9  
 Bayersdorfer M. M. & Co., Philadelphia..... 8  
 Bennett C. W., Quincy, Mich..... 6  
 Beeson & Burpee, Phila., Pa..... 22  
 Bliss B. K. & Sons, New York city..... cover  
 Bolt G. & S., Norwalk, O..... 14  
 Bush John S., New York City..... 14  
 Cadness John, Flushing, L. I., New York..... 7  
 Collins, John S. Moorestown, N. J..... 2  
 Coninck, A. M. C. J., Dedemsvaart, Netherlands..... 4  
 Corsey Wm. & Son, Baltimore, Md..... 11  
 Dewey D. M., Rochester, N. Y..... 4  
 Dick John, Phila..... 5  
 Dince & Conard Co., West Grove, Pa..... 4, 6, 15  
 Douglas Robert & Sons, Waukegan, Ill..... 5  
 Elder Walter, Philadelphia..... 11  
 Ellis Chas. R., New York city..... 9  
 Elverson & Sherwood, New Brighton, Pa..... 17  
 Freshman E. N. & Bro., Cincinnati, O..... 6  
 Gerrard T. Fowler, Cleveland, O..... 11  
 Gregory James J. H., Marblehead, Mass..... 4  
 Greives & Co., New York..... 11  
 Harkett Wm. A., Dubuque, Iowa..... 2  
 Harris Wm. K., Philadelphia, Pa..... 4  
 Hance A. & Son, Red Bank, N. J..... 2, 4, 6, 15  
 Harper & Brothers, New York..... 18  
 Henderson Peter & Co., New York..... 11  
 Henry J. F. Curran & Co., New York..... 8  
 Hews A. H. & Co., No. Cambridge, Mass..... 8  
 Hinrichs, C. F., New York city..... 11  
 Hitchings & Co., New York city..... 3  
 Hoopes Bro. & Thomas, West Chester, Pa..... 4, 11  
 Houghton H. O. & Co., Boston, Mass..... 10  
 Hubbard P. S., Fredonia, N. Y..... 8  
 Jaquot A. Henry & C. Hugo, Jacksonville, Fla..... 9  
 Jordan, J. M. & Bro., St. Louis, Mo..... cover  
 Kinsay Samuel, Dayton, O..... 15  
 Knauth, Nachod & Kuhne, New York..... 7  
 Lalor, Wm., Rochester, N. Y..... 18  
 Lay Wm. L., Laytonia, Texas..... 11  
 Luike Adolph, Rochester, N. Y..... 22  
 Lonsdale Edwin, Germantown, Pa..... 11  
 Lord's Horticultural Works, Irvington, New York..... 12  
 Lynex Richard, Philadelphia..... 6  
 Marlborough Stock Farm, Newburyport, Mass..... 15  
 Marot Chas. H., Phila..... 17, 18, 19, 20  
 Meehan Thomas, Germantown, Philadelphia..... 9, 15  
 Merriam G. & C., Springfield, Mass..... 2  
 Miller & Hayes, Phila., Pa..... 4, 5  
 Myers Thomas J., Philadelphia..... 8  
 New Jersey Agriculturist, New Brunswick, N. J..... 15  
 Nimmo Alexander, Brooklyn, New York..... 12  
 Ohio, Kentucky and Texas Land Co., Cincinnati, Ohio..... 19  
 Parsons, R. B. & Co., Flushing, N. Y..... 22  
 Parsons S. B. & Sons, Flushing, New York..... cover  
 Purdy A. M., Rochester, N. Y..... 15  
 Ransom James O., Hammonnton N. J..... 15  
 Raoux C., New York city..... 6  
 Roberts Josiah A., Paoli, Pa..... 11  
 Roehrs, Florist, Jersey City, N. J..... 2  
 Rolker A. & Sons, New York city..... Fly-leaf  
 Scott John A., Brooklyn, N. Y..... 9  
 Scott D. W. & Co., Galena, Ill..... 14  
 Sherwood John & Son, Bristol, Pa..... 14  
 Starr Chas. T., Avondale, Pa..... 11  
 Steffens N., New York city..... 4  
 Straiton & Storm, New York city..... 15  
 Sudbrook, Pikesville, Md..... 11  
 Transon P. & E., Orleans, France..... 7  
 Trevor & Co., Lockport, N. Y..... 6  
 Truett's Sons & Morgan, Nashville, Tenn..... 2  
 Vander Swaelmen J., Ghent, Belgium..... 11  
 VanGeert, Ghent, Belgium..... 2  
 Verdier Chas. Jr., Rue Bandricourt, Paris, France..... 15  
 Vick James, Rochester, N. Y..... 15  
 Wallace's Monthly, New York City..... 2  
 Weathered & Cherevoy, N. Y. City..... 16  
 Wheeler W. F., Boston, Mass..... 14  
 Whitman & Lang, Philadelphia..... 9  
 Williams A. K., Richmond, Ind..... 17  
 Wood Edmund M., Boston, Massachusetts..... 13  
 Wood L. L., Vineland, N. J..... 18

Situation Wanted

By a FIRST-CLASS GARDENER, at either commercial or private establishment; has had a long experience at different places in this country and Germany. Would be willing to take charge of any establishment as Foreman and Propagator. Best references given.

ADOLPH LUIKE,

No. 4 Clarissa St., Rochester, N. Y.

SITUATIONS WANTED.

A Situation as clerk in a Seed Store; has had many years experience, and can produce first class testimonials. Address S. care of John Plender, 10 N. 12th St., Philadelphia.

By a young man of good habits and strictly temperate, as superintendent or propagator, in a good greenhouse establishment, where a general shipping business is carried on; is twenty-two years of age; has had eight years experience in some of the largest establishments both East and West; is now employed in a large western house, but would like to make a change. Can give best of references from present and former employers. Address F. WELLINGTON BEACH, 1013 North McLean St., Bloomington, Ill. nov17

By an experienced young Gardener, single man, 23 years of age, on a gentleman's place or as foreman in a commercial establishment. Has served in the largest establishments in this country and Germany, and understands gardening in all its branches. Address R. A. WITZLEBEN, Hooker's Nursery, Rochester, N. Y.

By a practical experienced Gardener to take charge of a greenhouse or private gentleman's place; well recommended. Address J. LINFOOT, Forrest Ave., Avondale, Cincinnati, Ohio.

By a practical Gardener, married, no children, 50 years of age; English by birth, 26 years in this country, competent to take charge of any first-class place, where there are hot and cold grapes, greenhouses, forcing and propagating pits and the general care of a gentleman's place; best of references given. Address J. J. No. 4 Alley St., Lynn, Mass. dec2

R. B. PARSONS & CO.,

Bowne Avenue, Flushing, N. Y.,

OFFER THEIR

RARE TREES & SHRUBS

as well as the well known sorts, and invite the special attention of

LARGE BUYERS

To their Stock of Rhododendrons, Azaleas—Chinese and Ghent—Camellias, Clematis, Hydrangeas, Magnolias, Roses by the 1,000.

RARE EVERGREENS,

are well known to be cultivated in large variety by them.

For Catalogues address

Box 99, Flushing, N. Y.

feb.12

Yorkshire, Berkshire, Essex, Poland China, and Chester WHITE SWINE, of unsurpassed excellence. Alderney, Ayrshire and Shorthorn Cattle, Southdown and Cotswold SHEEP, Imported and Prize POULTRY, and PIGEONS bred on 3 FARMS, DOGS, &c. New descriptive circular free. Elegant new Catalogue with cuts from life of our stock, 20c. SEEDS, TREES, PLANTS, FERTILIZERS, IMPLEMENTS, &c. 6 PACKAGES see is, free, as samples, for two 3c. stamps. Benson & Burpee, successors to W. Atlee Burpee, Seed Warehouse, 223 Church Street, Philadelphia, Pa. oct12

GARDENING FOR THE SOUTH, or HOW TO GROW VEGETABLES AND FRUITS.

By WM. N. WHITE.

Containing instructions and hints in formation and management of Gardens, Soils and improvement, manures and their sources, rotation, hot-beds, cold frames, pits, propagation, budding and grafting, pruning and training, transplanting, mulching, shading and watering, protection, garden implements, insects and vermin, Vegetables, Fruits, description, varieties and culture. Illustrated, 444 pages, 12mo, Cloth. Price \$2.00. Sent by mail, post-paid, on receipt of price. Address, CHAS. H. MAROT, 814 Chestnut St., Phila.



# Jordan's Patent Wrought Iron Water Heater.

## A NEW PRINCIPLE.

The boilers are constructed of horizontal pipes of the same inside diameter as those that form the heating pipes, thereby producing a very rapid circulation of the water.

LENGTH SEVEN FEET.

### DESCRIPTION.

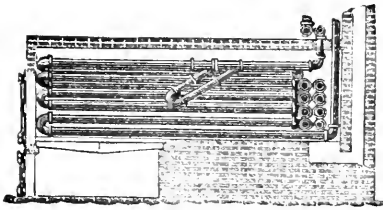

No. 1 shows a side view of one-half section, with U steam propeller. Also shows sections of chimney, ash-pit, and brick arch around the boiler, with downward draft to chimney.

No. 2 shows end view, with rear end closed with pipes; ash-pit below and brick arch above.

No. 3 shows boiler before it is set in the brick, with a few pipes broken away, to show the steam generator.

The improvements claimed are: a larger heating surface, as compared to the amount of water in the boiler; a more rapid circulation of water by the use of steam generator to move the water; a larger fire-hole, so that soft coal can be used and not obstruct the draft; and cheapness.

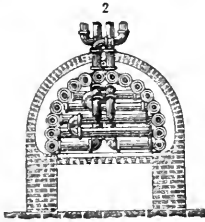

Extracts from the Patent, No. 173,300, Dated February 8th, 1876.

By making the pipes throughout the whole length of the boiler and heater of the same interior diameter there is an even flow through the pipe at all parts, and no shoulders in the pipe to cause any check to the flow.

It is obvious that the boiler-pipes being exactly the same interior size as the radiator and connecting-pipes, a new and quite valuable result is obtained, as the simultaneous movement of the water is insured through the whole series of pipes at the same speed, thus preventing any eddy and dead water.

The U-formed steam water propeller, by descending into the furnace and entering the water-pipe at an inclination, causes a circulation in the water-pipes almost immediately the fire is lighted, and before the water has time to become

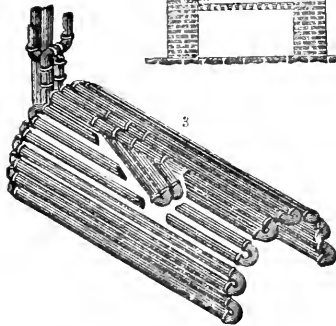

heated in the water-pipes. The end bends of the water-pipes, which close partially the back of the fire-space, receive the full blast of the products of consumption.

### TRUTHS TO BE CONSIDERED.

If water moves rapidly into and out of the furnace it must carry off the heat rapidly into the room to be heated, thereby saving the fuel. The front is of iron and can be easily removed to clean out dust, &c.

### SETTING THE BOILER.

Build foundation wall 12 inches wide, so the pipes will set about 1½ inches inside the walls, and 3 inches above the grate bars; let the boiler rest on one fire brick at front and one at rear. Let the rear bridge wall for the grate bars be heavy and raise above the grate bars about 10 inches to one foot, and of fire brick. The Chimney should be started from the bottom of the furnace, and be at least 25 feet high, and an opening at least one foot square.

### PRICE OF BOILERS (OF WROUGHT IRON, WITH IRON FRONT AND GRATE BARS.)

Small boilers without grate bars or iron front... \$25 to \$50 each.	No. 4 to heat 1900 to 2000 feet of pipe.....	\$175.00 each
No. 1 to heat 500 to 750 feet of pipe.....	" 5 " " 2000 " 3000 " " ".....	225.00 "
" 2 " " 750 " 1000 " " ".....	" 6 " " 3000 " 5000 " " ".....	300.00 "
" 3 " " 1000 " 1500 " " ".....	Valves for 4 inch pipe.....	10.00 "

Large boilers made to order. Where no iron front or grate bars are wanted, 10 per cent. deducted.

Water-pipe and all kinds of fittings at present 30 per cent. off the card prices.

Men furnished to put up the furnace and contracts taken to heat any building, and can be placed where hot air furnace has been used.

We have had seventeen years experience in handling water heaters, and can guarantee our work.

## JORDAN & BRO.,

612 Olive Street, St. Louis, Mo.

# S. B. PARSONS & SONS,

## Kissena Nurseries,

### Near KISSENA STATION, FLUSHING, N. Y.,

OFFER a very large assortment of TREES and PLANTS of all the best families. Nearly all of them have been two years transplanted, and their roots are thus in the very best possible condition for a second transplanting.

Some of their best specimens can now be seen at the CENTENNIAL GROUNDS. The whole or part of the large collection there is now for sale, to be delivered at the close of the Exposition. A list of the sorts will be furnished on application. Any one purchasing this entire collection will have an assortment of trees and shrubs rarely equalled.

Their Catalogue of

## New and Rare Hardy Trees and Shrubs

is now **READY**, and will be sent on application. It contains some 65 varieties of **NEW**

### JAPANESE PLANTS,

including the remarkable **JAPANESE MAPLES**, and also a large number of new Hardy Plants from Europe. They think themselves safe in asserting that so rich a collection has not before been in this country.

**CAMELLIA JAPONICA** and **AZALEA INDICA** can be advantageously shipped during October, November and December. These plants are carefully formed and trimmed, and their symmetry is recognized by all who see them.

*Estimates will be furnished for Planting Grounds under the care of an experienced Landscape Gardener, and much trouble thus saved to the owner.*

Catalogues will be furnished to applicants by mail, and those who wish to visit the Nurseries will always find either one of the proprietors, or J. R. Trumpy, the well-known propagator of the old establishment. They can take the ferries at 34th Street or James' Slip, which connect with the railroad, leaving the first a quarter of an hour, and the last half an hour before the departure of trains, which make the transit in half an hour. The Nursery is adjoining the Kissena Station and one and a half miles from the other stations, from which carriages are free.

## DUTCH BULBS

AND

## SMALL FRUITS.

Our New Autumn Catalogue of

## Bulbs & Small Fruits,

### ORNAMENTAL IRON AND RUSTIC WORK

FOR WINDOW GARDENS AND HOUSE PLANTS.

Beautifully illustrated with many engravings, is now ready and will be mailed to all applicants enclosing 10 cents. Regular customers supplied gratis. Collections of Bulbs \$3, \$5, \$10, \$20, mailed post-paid, to any address upon receipt of price. Our list of

## SMALL FRUITS;

Comprises every desirable variety of

Strawberries, Raspberries, Grapes, &c.

Bulbs and Plants mailed to any address at Catalogue prices. Address,

## B. K. BLISS & SONS,

SEED, PLANT AND BULB WAREHOUSE,

P. O. BOX 5712.

34 Barclay Street, New York.









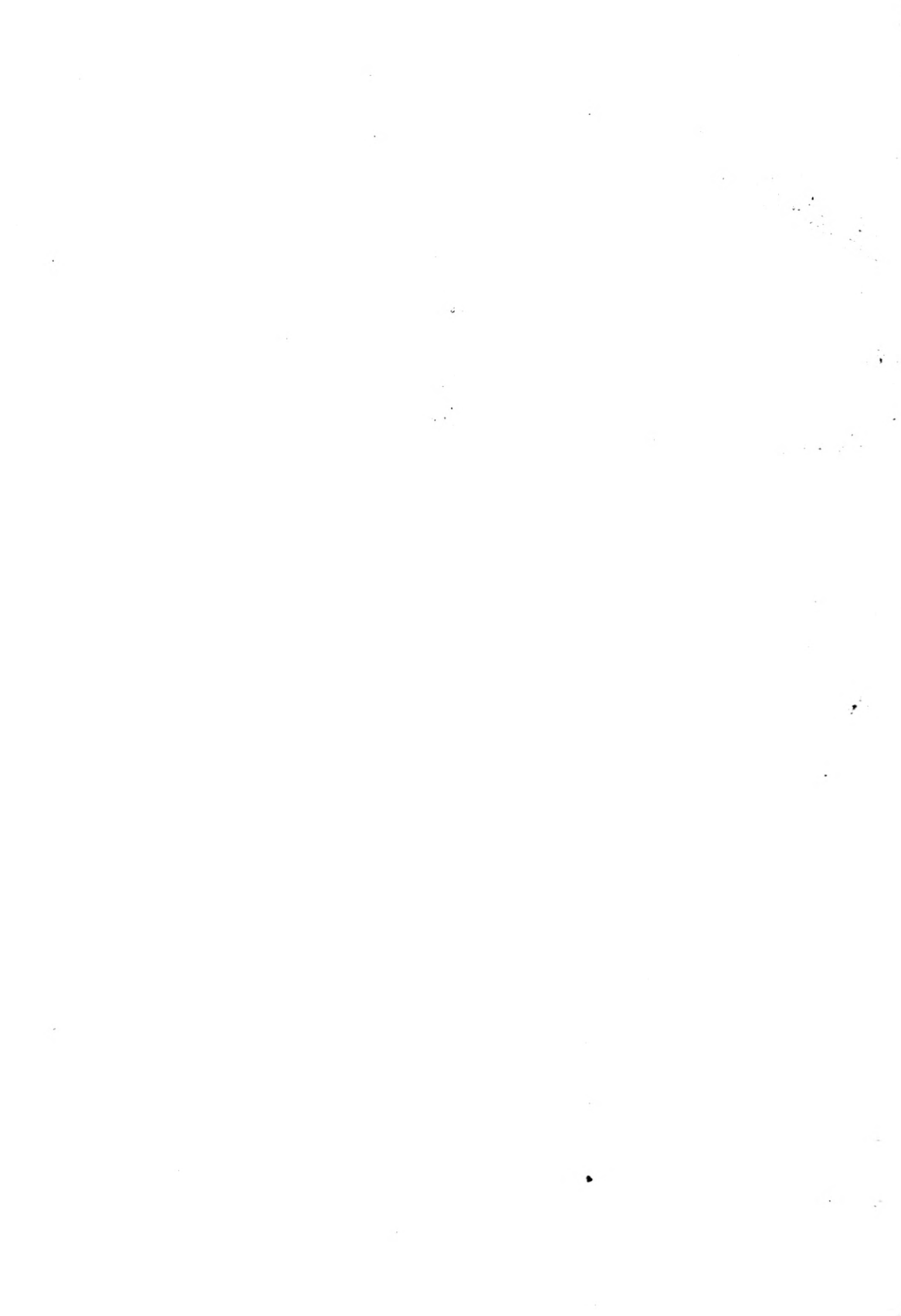

New York Botanical Garden Library



3 5185 00253 4780

