

NYU IFA LIBRARY



3 1162 04538763 7

YPT

CATALOGUE GÉNÉRAL
DES
ANTIQUITÉS ÉGYPTIENNES
DU MUSÉE DU CAIRE

GRAB- UND DENKSTEINE
DES MITTLEREN REICHS

SERVICE DES ANTIQUITÉS DE L'ÉGYPTE

CATALOGUE GÉNÉRAL

DES

DU MUSÉE DU CAIRE

N^{os} 20001—20780

VON H. O. LANGE UND H. SCHAFFER

THEIL IV

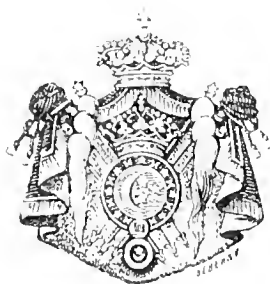

BERLIN
REICHSDRUCKEREI

1902

IM MUSEUM VON KAIRO

No. 20001—20780

VON H. O. LANGE UND H. SCHÄFER

THEIL IV

TAFELN

BERLIN
REICHSDRUCKEREI

1902

VORWORT.

Dem hier als vierter Theil der »Grab- und Denksteine« folgenden Tafelband müssen wir einige Worte zur Verständigung mitgeben, damit Niemand von seinem Inhalt mehr verlange als er leisten kann und soll.

Die Tafeln I—LIX enthalten kleine Abbildungen von mehr als der Hälfte der in Theil I und II aufgeführten Grabsteine. Es lag nahe, statt unserer ganzen Arbeit einfach von sämmtlichen Grabsteinen grössere Lichtdruckabbildungen zu geben, nach denen sich ein Jeder selbst Copien hätte herstellen können. Wir sind aber überzeugt, dass damit in Wirklichkeit Niemand gedient gewesen wäre. Gerade bei solchen, zum grossen Theil äusserst nachlässig gearbeiteten, Inschriften, kann eine Photographie niemals eine lebendige Copie nach dem Original völlig ersetzen. Zudem wäre eine solche Veröffentlichung todes Material gewesen. Ein jeder Benutzer wäre gezwungen gewesen, die ganze Arbeit, die uns Monate gekostet hat, für sich selbst zu machen. Denn diese Inschriften verlangen, dass man sich durch andauernde Arbeit in ihren Charakter hineinlebt, so wie wir es haben thun müssen, die wir gezwungen waren, uns über jedes Wort und jedes Zeichen der 780 Inschriften Rechenschaft zu geben. Das Ideal wäre es gewesen, ausser den Abschriften noch grosse mechanische Abbildungen zu geben. Das verbot sich aber von selbst, da die ohnehin schon beträchtlichen Kosten der Arbeit nicht in's Unendliche gesteigert werden konnten.

Die kleinen Abbildungen nun, die wir auf diesen Tafeln geben, sind nicht dazu bestimmt, dass man danach selbst Lesungen anstelle. Sie wollen nichts Selbständiges sein, sondern nur eine Ergänzung zu dem Theil I und II bilden, die das vor Augen führt, was keine Beschreibung durch Worte geben kann, den Stil der Grabsteine. Dazu werden die kleinen Bilder, zu denen die Aufnahmen von uns Beiden

und Frau JONNA LANGE gemacht sind, vollauf genügen. Bei der Auswahl¹⁾ haben wir möglichste Mannigfaltigkeit in den Grabsteintypen angestrebt, vollständig aber nur die Denksteine aus dem ersten Abschnitt der Zeit berücksichtigt, die wir hier als mittleres Reich betrachten.

Die Abbildungen sind nach der Nummer der Grabsteine geordnet. Die geringen Abweichungen von der Reihe, die manchmal nicht zu vermeiden waren, werden nicht weiter stören; zur Erleichterung der Übersicht aber ist doch noch eine Liste beigegeben.

Auf den Tafeln LX—CXIX findet sich systematisch geordnet das, was die Darstellungen der Grabsteine an Material zu einer Geschichte der Tracht, der Geräte, Gefässe u. s. w. enthalten. Die Zeichnungen dazu sind von SCHÄFER vor den Originalen gefertigt und für die Reproduction von einem Zeichner genau gepaust. Wir glauben mit dieser Zusammenstellung auch Jedem, der nach uns Grabsteine des mittleren Reichs zu veröffentlichen hat, einen Dienst zu erweisen, da ein einfacher Hinweis manche Beschreibung oder Skizze ersparen kann.

Da die Zeichnungen erst am Ende der Arbeitszeit angefertigt werden konnten, war es nicht möglich, bei den Beschreibungen in Theil I und II auf diese Skizzen zu verweisen. Zwei Listen, von denen die erste (A) von den Skizzen, die zweite (B) von den Grabsteinen ausgeht, sollen diesem Übelstand wenigstens zum Theil abhelfen und eine Übersicht über das Material geben. Die Gliederung des Stoffes in Liste A musste oft von etwas mechanischen, rein äusserlichen Unterscheidungen ausgehen. Es handelt sich eben nicht um eine Verarbeitung, sondern um eine Sammlung des Materials. Wir glauben jedoch, dass das angewandte Schema dazu geeignet ist, auch bei Erweiterungen der Sammlung als Grundlage zu dienen.

Kopenhagen und Berlin, im November 1902.

H. O. LANGE und H. SCHÄFER.

¹⁾ Photographirt haben wir alle Grabsteine. Die Platten, die die Grösse 9×12 cm haben, befinden sich im Besitze des Kaiserlich Deutschen Generalconsulats in Kairo, durch dessen wissenschaftlichen Attaché Abzüge auch von den hier nicht veröffentlichten Aufnahmen zu erhalten sind.

VERZEICHNISS DER STELEN, DEREN AB-
BILDUNGEN SICH AUF TAFEL I—LIX
FINDEN.

20001	20051	20092	20144	20193	20257	20331
20005	20052	20093	20145	20194	20263	20335
20006	20053	20094	20146	20196	20264	20336
20007	20054	20096	20148	20197	20265	20338
20010	20055	20097	20150	20198	20271	20339
20011	20056	20098	20153	20199	20272	20341
20012	20057	20100	20154	20208	20273	20343
20013	20058	20101	20155	20209	20274	20345
20014	20059	20104	20157	20210	20277	20346
20018	20062	20105	20160	20212	20278	20348
20019	20063	20106	20163	20214	20281	20350
20020	20064	20108	20164	20216	20282	20352
20021	20065	20115	20165	20217	20284	20353
20022	20066	20121	20166	20218	20285	20356
20023	20067	20122	20169	20220	20288	20357
20027	20068	20124	20172	20221	20290	20359
20028	20070	20125	20174	20222	20291	20360
20029	20071	20126	20177	20228	20293	20364
20031	20072	20127	20178	20231	20295	20366
20032	20076	20128	20179	20232	20297	20368
20033	20077	20129	20180	20233	20300	20370
20034	20078	20131	20183	20234	20302	20374
20035	20079	20132	20184	20235	20309	20375
20038	20081	20135	20185	20239	20311	20379
20039	20082	20136	20186	20240	20313	20382
20042	20083	20137	20187	20243	20314	20383
20044	20084	20138	20188	20248	20315	20385
20045	20085	20139	20189	20249	20323	20392
20047	20088	20140	20190	20251	20324	20393
20048	20089	20141	20191	20255	20325	20397
20050	20090	20142	20192	20256	20329	20399

20400	20470	20533	20568	20617	20680	20726
20404	20472	20534	20569	20622	20682	20727
20405	20475	20535	20571	20623	20684	20729
20407	20476	20536	20572	20629	20686	20730
20408	20497	20537	20573	20638	20687	20731
20410	20499	20538Vs.	20577	20641	20689	20732
20415	20500	20538Rs.	20578	20642	20691	20736
20423	20501	20539Vs.	20581	20644	20692	20737
20425	20504	20539Rs.	20588	20645	20693	20740
20427	20506	20541	20589	20646	20694	20742
20430	20507	20542	20592	20649	20697	20745
20431	20509	20544	20593	20651	20701	20746
20434	20510	20548	20594	20654	20702	20747
20435	20514	20550	20596	20656	20704	20748
20440	20515	20552	20598	20659	20706	20750
20445	20516	20553	20601	20664	20708	20751
20446	20518	20554	20602	20665	20709	20752
20448	20520	20555	20603	20666	20710	20753
20451	20521	20556	20605	20670	20714	20754
20456Vs.	20522	20557	20606	20671	20715	20756
20456Rs.	20524	20559	20608	20672	20718	20762
20459	20525	20561	20612	20676	20719	
20461	20526	20563	20613	20677	20720	
20462	20527	20565	20614	20678	20722	
20467	20531	20566	20615	20679	20725	

NACHWEIS DER GRABSTEINE, VON DENEN
DIE SKIZZEN AUF TAFEL LX—CXIX
ENTNOMMEN SIND.

LISTE A.

ZUERST STEHT DIE NUMMER DER SKIZZE, DANN DIE DES
GRABSTEINS.

1. Männerfrisuren.	15	20011	Mit Stirnband.
	16	20546	30 20501
a. Grosse, die Ohren freilassende Perücke.	17	20436	Zweistrahlig, ähnlich der Frauenfrisur.
		20456 Rs.	
		20460	31 20562
	18	20455	
Mit glatter Vorderkante.	19	20507	b. Grosse, die Ohren deckende Perücke.
1 20105		20513	Mit glatter Vorderkante.
2 20500	20	20092	32 20185
3 20620	21	20446	20296
4 20457	22	20459	20338
5 20456 Vs. u. Rs.	23	20004	33 20239
	24	20470	34 20423
		20476	20457
	25	20693	20594
6 20440	26	20309	35 20670
7 20140		20756	36 20288
8 20063	Andere s. bei Nr. 398,		37 20127
9 20007	399, 419, 420.		38 20606
10 20014			39 20135
11 20708	Mit abgetreppter Vorder-		20435
	kante.		40 20467
12 20360	27 20425		41 20516
	28 20440		Andere s. bei Nr. 1007.
	29		
13 20103			
14 20009			

Mit abgetreppter Vorderkante.

42	20124
43	20163
	20589
	20606
44	20163
45	20090
46	20566
47	20153

c. Kurze Perücke.
Von *d* oft nicht zu scheiden.

Mit glatter Vorderkante.

48	20599
49	20630
50	20335
51	20148
52	20394
53	20172
54	20751
55	20473
	20729
56	20561
57	20504
58	20123
59	20256
60	20566
61	20343
62	20285
	20457
63	20531
64	20750
65	20212
66	20508
67	20473
68	20235
69	20190

Andere s. bei Nr. 1009.

Mit abgetreppter Vorderkante.

70	20363
71	20458

Zur Hälfte kahlgeschoren?

72	20103
----	-------

d. Geschorener Kopf.
Von *c* oft nicht zu scheiden.

73	20473
74	20433
75	20231
	20309
	20451
	20456 Rs.
	20458
76	20392
77	20138
78	20009
79	20706
80	20549
81	20360
82	20092
	20595
	20679

Andere s. bei Nr. 188, 189, 341, 403, 406, 427, 465, 548, 555, 974—976, 993.

e. Wolliges Haar.

83	20440
84	20138
85	20755

f. Haarbänder

s. bei Nr. 30, 85.

g. Feder im Haar

s. bei Nr. 85.

2. Knabenfrisuren.

a. Mit Zopf an der Seite.

86	20163
87	20523
88	20515
89	20559
90	20599
91	20756
92	20308
93	20550
94	20031
95	20308
96	20692

b. Mit Zopf am Hinterkopf.

97	20290
98	20331
99	20679 (nackt)
100	20440
101	20346 (mit weitem Knieschurz)
102	20394
103	20629
104	20672

Mit Zopf am Hinterkopf und Büschel auf der Stirn.

105	20126
-----	-------

c. Nur mit Büschel auf dem Wirbel.

106	20193
-----	-------

3. Frauenfrisuren.

a. Zweisträhnig.

107	20285
	20457
108	20729
109	20473

110	20476	137	20468	<i>b. Mit einem Zopf.</i>	
	20724		20596		
111	20437	138	20386		Zopf an der Seite.
112	20456 Rs.	139	20313		160 20226
113	20456 Vs.	140	20545		161 20568
114	20451	141	20163		162 20261
115	20456 Rs.	142	20005		
116	20664	143	20507		Zopf hinten.
117	20470	144	20123		163 20709
	20708	145	20001		164 20706
118	20013	146	20123		165 20694
119	20537	147	20501		166 20731
120	20300	148	20469		167 20376
	20750	149	20746	168 20747	
121	20565	150	20185	169 20736	
122	20440	151	20232	170 20504	
123	20505		20592	Andere s. bei Nr. 784, 959.	
124	20010	152	20713		
125	20605	153	20621	Zopf hinten und Büschel	
126	20754	154	20689	auf der Stirn.	
127	20394	155	20163	171 20123	
128	20236	156	20649	172 20596	
129	20227	Andere s. bei Nr. 431, 432, 452, 454, 457, 525, 558, 559, 996.			
	20236	<i>c. Mit zwei Zöpfen.</i>			
	20588			173 20236	
130	20342	Die Strähne gelockt.			
Andere s. bei Nr. 455, 456, 463(?), 464, 523, 556, 969, 1008.		157	20687	174 20515 <small>(nackt)</small>	
Die Strähnen gelockt.		<i>c. Hoch aufgebun-</i>			
131	20550	dene Dienerinnen-			
		frisur.			
		158	20346	175 20426	
		<i>d. Haarbänder</i>			
<i>b. Einsträhnig.</i>		s. bei Nr. 126, 127 <small>(mit Uräus)</small> ,			
132	20267	128, 129, 130, 156, 431.			
	20349	4. Mädchenfrisuren.			
	20749	<i>a. Geschorener</i>			
133	20694	Kopf ohne Zöpfe.			
134	20709	159	20568	176 20226	
135	20347	Mit zwei Zöpfen und			
136	20747	Büschel auf der Stirn.			
137	20456 Rs.	180 20257			
		181 20610			
		182 20394			
		Mit zwei Zöpfen und			
		Uräus.			
		183 20058			

d. Mit drei Zöpfen.

184 20613
185 20039

Mit drei Zöpfen und
Büschel auf der Stirn.

186 20394
187 20677

5. Bärte.

188 20627
189 20701
190 20468
191 20451
192 20756

Andere s. bei Nr. 3, 10, 11,
13, 21, 24, 51, 65, 399.

**6. Halskragen, Ketten
u. ä.****a. Kragen.**

193 20459
194 20455
195 20468
196 20090
197 20003
198 20708
199 20002
200 20440
201 20007
202 20024
203 20212

Andere s. bei Nr. 10, 21,
47, 48, 51, 76, 88, 126,
145, 172, 226, 348, 401
bis 403, 405—407, 409
bis 415, 419, 426—428,
431, 432, 437, 453 bis
458, 463(?), 465, 556, 558,
559.

b. Ketten.

204 20024
205 20752
206 20024

Andere s. bei Nr. 86, 89.

c. Amulette u. ä.

207 20539

Anderes s. bei Nr. 93.

7. Arm- und Fussringe.

208 20755
209 20505
210 20197
211 20451
212 20754
213 20024

8. Männerschurze.**a. Doppelter Schurz
bei Sitzenden.**

Enger Knieschurz, weiter
Wadenschurz.

214 20406
215 20310
216

Andere s. bei Nr. 424.

Enger Knieschurz mit
Zwischenstück, weiter
Wadenschurz.

217 20614
218 20183
219 20549
220 20313
221 20102 (als Kleid
des Veziers)

Weiter Knieschurz mit
aufrechtstehendem Zipfel,
weiter Wadenschurz.

222 20550

223 20164

Andere s. bei Nr. 425.

Enger Knieschurz, weiter
Knieschurz.

224 20138

**b. Doppelter Schurz
bei Stehenden.**

Enger Knieschurz, weiter
Wadenschurz.

225 20498

Enger Lendenschurz mit
Zwischenstück, weiter
Wadenschurz.

226 20243

Enger, vorn abgerundeter
Lendenschurz ohne Zwi-
schenstück, enger Knie-
schurz.

227 20009

**c. Enger Waden-
schurz bei Sitzenden.**

228 20458

20465

229 20440

230 20013

**d. Weiter Waden-
schurz bei Sitzenden.**

Mit gerader Unterkante.

231 20683

232 20126

233	20064	Mit gerader Unterkante	273	20033			
234	20182	und Diagonallinie.	274	20180			
235	20231	252	20308	275	20086		
	20347		20474	276	20736		
	20452		20645	277	20360		
	20586	253	20074	Andere s. bei Nr. 225, 403,			
236	20749	254	20348	424.			
237	20148	255	20163	f. Enger Knieschurz			
Andere s. bei Nr. 214, 215,		Andere s. bei Nr. 410.		bei Sitzenden.			
217.		Mit gerader Unterkante		Ohne Diagonallinie.			
Mit vorn herabhängendem		und Überschl.ig.		278		20399	
Zipfel.		256		20153		20729	
238	20340	257		20619		279	20756
	20402	258		20749		280	20456 Rs.
	20431	Mit vorn herabhängendem		281		20133	
239	20730	Zipfel, ohne Überschl.ig.		282		20003	
240	20238	259		20240		283	20543
241	20459	260		20267		284	20007
242	20435	261		20670		285	20518
243	20135	262		20309		Andere s. bei Nr. 214, 216.	
244	20679			20328		Mit Diagonallinie.	
245	20690 ^(als Kleid des Veziers)			20671		286	20436
Andere s. bei Nr. 216, 217,		263		20472		20589	
219, 220—223, 425, 560.		Andere s. bei Nr. 226, 402,		417, 993.		287	20594
e. Weiter Waden-		Mit vorn herabhängendem		288		20457	
schurz		Zipfel und Überschl.ig.		289		20300	
bei Stehenden.		264		20310		20566	
Mit gerader Unterkante,		265		20608		290	20750
ohne Diagonallinie und		266		20440		291
Überschl.ig.		267		20459		292	20063
246	20344	Mit Zipfel zwischen den		293		20470	
247	20473	Beinen.		294		20475	
248	20451	268		20683		295	20283
249	20747	269		20404		296	20455
250	20462	270		20014		20456	
251	20239	271		20338		297	20120
Andere s. bei Nr. 401, 409.		272		20538		20151	

298	20137
299	20751
300	20145
301	20708
302	20138
303	20309
	20392
304	20476
305	20630
306	20395
307	20436
Andere s. bei Nr. 217—	
	221, 419.

g. Weiter Knieschurz
bei Sitzenden.

308	20453
Andere s. bei Nr. 224.	

Mit aufrechtstehendem
Zipfel.

309	20714
310	20009
	20507
311	20531
312	20430
313	20294
314	20336
315	20119
316	20227
317	20748
318	20549
319	20022
Andere s. bei Nr. 222, 223,	
	425.

h. Enger Knieschurz
bei Stehenden.

Ohne Diagonallinie und Überschlag.	
320	20454

320	20474
	20755
321	20543
322	20543
Andere s. bei Nr. 227, 404,	
	411, 412, 416, 418, 424.

Mit Diagonallinie.

323	20165
	20456 Rs.
	20474
324	20729
	20738

Andere s. bei Nr. 225.

Mit Überschlag.

325	20288
	20748
326	20697
327	20389
328	20704
329	20566

Mit Zwischenstück.

330	20572
	20621
331	20009
332	20007
333	20011
Andere s. bei Nr. 226.	

i. Weiter Knieschurz
bei Stehenden.

Mit gerader Unterkante
ohne Diagonallinie und
Überschlag.

334	20290
	20451
	20456 Rs.
	20465
335	20395
	20711

336	20256
337	20732
338	20138
339	20218
340	20138
341	20504

Andere s. bei Nr. 406—
408, 413, 414, 421, 423.

Mit gerader Unterkante
und Diagonallinie.

342	20306
343	20140
344	20456 Rs.
	20474
345	20425
	20476
346	20315
	20458
	20729
347	20755
348	20515
349	20007
350	20762
351	20594
352	20456 Rs.
353	20621
354
355	20751
356	20647

Andere s. bei Nr. 415, 420,
422.

Mit gerader Unterkante
und Überschlag.

357	20654
358	20541
359	20009
360	20164
361	20425
362	20290
363	20654

Mit vorn herabhängendem
Zipfel ohne Diagonallinie
und Überschlag.

364 20343
365 20125

Mit vorn herabhängendem
Zipfel und Diagonallinie.

366 20725

Mit vorn herabhängendem
Zipfel und Überschlag.

367 20165
20589
368 20063
369 20039

Mit Zipfel zwischen den
Beinen.

370 20139
371 20457
372 20391
373 20606
374 20566
375 20300
376 20750
377 20285
378 20589
379 20589
380 20029
381 20006

Andere s. bei Nr. 1007.

k. Gesässschurz und
Lendenschurz.

382 20725
383 20397
384 20024

Andere s. bei Nr. 227.

l. Schurze
bei Knieenden.

385 20514
386 20602
387 20368
388 20724
389 20394
390 20129
391 20588
392 20426
393 20103
394 20193
395 20599
396 20637
397 20430

m. Das »Gewand
der Todten«.

398 20331
399 20200

n. Kleidung des
Veziers.

Siehe bei Nr. 221, 245.

o. Oberer Saum eines
Wadenschurzes.

400 20446

9. Pantherfelle.

401 20221
402 20103
403 20681
404 20457
405 20088
406 20102
407 20062
408 20718

10. Brustbänder u. ä.

a. Mit Rückenstück
vom Band zum
Schurz.

409 20561
410 20611
411 20128
412 20088
413 20128
414 20751
415 20516
416 20523

Andere s. bei Nr. 348.

b. Ohne Rücken-
stück.

417 20177
418 20185
419 20075
420 20571
421 20352
20724
422 20439
423 20185
424 20332
425 20599
426 20090

Andere s. bei Nr. 226, 269,
404.

c. Zwei gekreuzte
Bänder.

427 20755

d. Mäntelchen.

428 20281

**10a. Zeugstreifen (Rang-
abzeichen).**

Siehe bei Nr. 221, 242,
244, 319, 419, 425,
1009.

11. Frauenkleider.

a. Die gewöhnliche
enge bis zu den
Knöcheln reichende
Form des Gewandes
ist nicht aufgenommen.

b. Langes weites
Gewand
bei Stehenden.

429 20234
430 20747
431 20549
432 20501
433 20642
434 20267
435 20511

c. Langes Gewand
bei Schreitenden.

436 20456 Rs.

d. Kurzes Gewand
bei Stehenden.

437 20346
438 20011

e. Weites Gewand
bei Sitzenden.

439 20232
440 20346

441 20452
442 20754
443 20618
20709

f. Kurzes Gewand
bei Sitzenden.

444 20012

g. Gewandung bei
Knieenden.

445 20565
446 20122
20724
447 20637
448 20326
20424
449 20452
450 20746
451 20430
452 20035

h. Tragbänder und
oberer Rand des
Gewandes.

453 20343
454 20346
455 20572
456 20706
457 20319
458 20436
459 20105
460 20138
461 20007
462 20505
463 20436

Andere s. bei Nr. 429, 431,
432, 434, 435, 437.

i. Das »Gewand
der Todten«.

464 20331

12. Tätowirung.

465 20138

13. Sandalen.

466 20566
467 20009
468 20542 (Diener
mit Sandalen, Handtuch und Stock)
469 20009

14. Salbgefäße.

470 20754
471 20460
472 20476
473 20516
474 20748
475 20459
476 20470
477
478 20319
479 20226
480 20004
481 20543
482 20545

Andere s. bei Nr. 728.

15. Schminktöpfe.

a. Mit Griffel.

483 20151
484 20372
20662
485 20672
486 20649
487 20137

<i>b.</i> Ohne Griffel.	513	20552	543	20513
488 20409	514	20288	544	20508
	515	20390	545	20382
16. Schminkbeutel.	516	20751	546	20747
489 20563	517	20708	547	20562 (Stab)
490 20476			Andere s. bei Nr. 226, 341.	
491 20459	19. Kasten.		22. Waffen.	
492 20082	518 20505		<i>a.</i> Krieger mit Schild, Speer und Beil.	
493 20459	519 20009		548 20732	
17. Spiegel.	520 20664		<i>b.</i> Bogen und Pfeil- bündel.	
<i>a.</i> Ohne Tasche.	521 20535		549 20343	
494 20004	522 20516		(wagerecht getragen)	
495 20505	523 20024		550 20355	
496 20070	524 20459		(senkrecht getragen)	
<i>b.</i> Mit Tasche.	525 20070		551 20501	
497 20515	526 20004		(senkrecht getragen)	
498 20470	527 20007		552 20355	
499 20664	528 20514		(wagerecht getragen)	
500 20534	529 20504		553 20501	
501 20516	530 20448		(wagerecht getragen)	
502 20535	531 20435			
503 20012	532 20561		<i>c.</i> Handgelenk- schutz zum Bogen- schossen.	
504 20541			554 20343	
505 20042	20. Wedel.		<i>d.</i> Rolle für das Har- punenseil.	
506 20017	533 20009		555 20774	
<i>c.</i> »Spiegelgriffe«.	534 20681		23. Musikinstrumente.	
507 20007	535 20210		<i>a.</i> Harfen.	
508 20505	20394		556 20257	
18. Waschgeräte.	20460		557 20121	
509 20723	536 20711		558 20732	
510 20459	537 20334			
511 20009	538 20718			
512 20317	539 20459			
	Andere s. bei Nr. 398, 399.			
	21. Scepter und Stäbe.			
	540 20755			
	541 20407			
	542 20007			

b. Kegel hinter einer
Sängerin.

559 20732

24. Stühle.

a. Mit geraden Beinen.
Dabei auch die würfel-
förmigen Stühle.

Ohne Lehne.

560 20431

561 20346

562 20232

Mit niedriger Lehne.

563 20388

564 20298

20431

565 20629

566 20714

567 20201 (der
eigentliche Sitz ist roth, nicht
schwarz; der Überhang schwarz)

568 20440

569 20593

570 20137

571 20227

572 20359

573 20588

Mit hoher Lehne.

574 20599

575 20346

b. Mit Löwenbeinen.

Ohne Lehne.

576 20507

577 20345

Mit niedriger Lehne.

578 20026

579 20470

580 20505

581 20009

582 20458

583 20003

584 20162

585 20457

20750

586 20183

587 20010

588 20690

589 20350

20459

20465

590 20231

591 20428

592 20672

593 20514

594 20543

595 20456 Rs.

596 20745

597 20751

598 20460

599 20197

600 20729

601 20423

602 20399

603 20294

604 20709

605 20435

606 20402

607 20347

608 20406

609 20392

610 20668

Andere s. bei Nr. 505,
1008, 1009.

Mit hoher Lehne.

611 20453

612 20530

613 20562

614 20434

615 20732

616 20232

617 20587

618 20591

619 20394

20409

20450

620 20537

20549

621 20037

Einzelheiten von Vorder-
beinen.

622 20263

623 20476

624 20001

625 20592

626 20552

627 20007

628 20093

Einwärtsgestellte Vorder-
beine.

629 20506

c. Mit Rinderbeinen.

630 20504

631 20736

632 20166

633 20182

634 20342

635 20752

636 20499

d. Doppelsitziger
Stuhl mit einwärts-
gekrümmten Beinen.

637 20013

25. Tische,
d. h. einbeinige Tische.

638
639	20475
640	20470
641	20162
	20457
642	20436
643	20342
644	20309
	20456
645	20459
646	20543
647	20460
	20465
648	20596
649	20725
650	20294
651	20182
652	20381
653	20319
654	20754
655	20349
656	20694
657	20240
658	20559
659	20096
660	20505
661	20411
662	20585
663	20672 (steht unter dem grossen Tisch)
664	20528
665	20348
	20454
666	20122
667	20323
668	20299
669	20012
670	20431
671	20152
672	20501

673	20281
674	20148
675	20746
676	20690
677	20557
678	20121
679	20153
680	20235
681	20132
682	20756
683	20163
684	20303
685	20085
686	20320
687	20383
688	20526
689	20217

Andere s. bei Nr. 736,
737, 746.

Getragen.

690	20473
-----	-------

26. Gestelle, d. h. auch
vierbeinige Tische.

a. Mit fester Platte.

691	20070
692	20324
693	20345
694	20500
695	20070
696	20678
697	20365
698	20672
699	20535
700	20752
701	20506
702	20605
703	20698
704	20454

705	20462
706	20324
	20468
	20755
707	20398
708	20542
709	20172
710	20566
711	20542
712	20722
713	20532
714	20756
715	20543
716	20510
717	20456 Rs.
718	20516
719	20386
720	20344
721	20561
722	20267
723	20011

Andere s. bei Nr. 514, 515.

b. Mit durchbroche-
ner Platte.

724	20242
725
726	20172
727	20026
728	20748
729	20750
730	20396

c. Getragen.

731	20755
732	20535
733	20398
734	20024

d. Ganz eigentümlicher Fuss.

735 20701

Siehe auch Nr. 981.

e. Gestell und Tisch vereinigt.

736 20448

737 20014

27. Säulen.

738 20101

739 20009

740 20101

28. Gefässe.

A. Schalen.

741 20137

742 20313

743 20672

744 20460

745 20476

746 20672

747 20433

748 20460

20595

749 20435

750 20641

751 20398

752 20427

753 20712

754 20456 Rs.

20592

755 20473

756 20345

757 20427

20473

758 20473

759 20456 Rs.

760 20504

761 20473

762 20516

763 20314

764 20714

765 20473

766 20009

767 20456 Rs.

768 20454

769 20346

770 20430

771 20262

772 20390

20672

773 20545

774 20462

775 20747

776 20368

777 20754

778 20347

779 20257

780 20151

781 20596

782 20546

783 20543

784 20736

785 20403

786 20561

787 20344

788 20473

789 20024

790 20571

791 20016

792 20566

793 20148

794 20523

795 20232

Andere s. bei Nr. 489,
491, 493, 506, 676, 688,
706—708, 731, 734,
949—951.

B. Krüge.

796 20541

797 20660

798 20750

799 20011

800 20011

801 20456

802 20476

803 20750

804 20456 Rs.

805 20513

806 20589

807 20357

808 20347

809 20470

810 20752

811 20009

812 20381

20459

813 20256

814 20543

815 20319

816 20435

817 20459

818 20460

819 20406

820 20409

821 20562

822 20549

823 20093

824 20519

825 20456 Rs.

826 20348

827 20457

828 20750

829 20456

830 20697

831 20354

832 20455

833 20455

834	20163	876	20011	916	20031
835	20026	877	20141	917	20005
836	20024	878	20350	918	20746
837	20399	879	20477	919	20528
838	20563	880	20009	920	20641
839	20452	881	20649	921	20082
840	20452	882	922	20729
841	20016	883	20406	923	20596
842	20660		20725	924	20099
843	20625	884	20591	925	20455
844	20693	885	20267	926	20593
845	20350	886	20693	927	20593
846	20403	887	20606	928	20004
847	20591	888	20672	929	20615
848	20672	889	20436	930	20082
849	20476	890	20324	931	20084
850	20349	891	20473	932	20725
851	20608	892	20436	933	20561
852	20754	893	20342	934	20088
853	20460	894	20456 Rs.	935	20473
854	20559	895	20312	936	20504
855	20390	896	20462	937	20473
856	20399	897	20294	938	20342
857	20435	898	20296	939	20592
858	20307	899	20369	940	20725
859	20281	900	20354	941	20024
860	20654	901	942	20220
861	20396	902	20592	943	20515
862	20465	903	20473	944	20725
863	20133	904	20357	945	20543
864	20455	905	20256	946	20362
865	20349	906	20454	947	20412
866	20346		20755	948	20346
867	20593	907	20428	949	20231
868	20383	908	20385	950	20672
869	20392	909	20516	951	20262
870	20607	910	20747	Andere s. bei Nr. 482, 693	
871	20119	911	20303	bis 696, 698, 700, 702,	
872	20119	912	20549	709—712, 715—721,	
873	20611	913	20009	724—727, 730, 734,	
874	20637	914	20327	736, 737, 741, 997, 999,	
875	20723	915	20400 <small>(hknw)</small>	1000, 1001.	

29. Körbe.

952	20468
953	20009
954	20654
955	20007
956	20151
957	20439
958	20400
959	20747
960	20515
961	20515
962	20248
963	20024
964	20024
965	20185
966	20362
967	20549
968	20345
969	20158
970	20515
971	20459
972	20774

Andere s. bei Nr. 506,
691, 699, 703.

30. Tragen.

973	20345
974	20519
975	20725

976 20725

977 20516

31. Räucherpfannen.

978	20754
979	20476
980	20376
981	20559
982	20088
983	20017
984	20515
985	20126
986	20528
987	20544
988	20346
989	20092
990	20331
	20748
991	20331

32. Schreibzeug.

992	20005
993	20075

Siehe auch Nr. 420, 993.

33. Mahlsteine.

994	20725
995	20725
996	20007

34. Melken.

997 20514

35. Kochen.

998 20725

36. Brauen.

999 20725

1000 20725

1001 20592

Siehe auch Nr. 932.

**37. Symbol des Gottes
Min.**

1002 20240

1003 20188

1004 20612

1005 20089

38. Unbestimmbar.

1006 20638

(steht unter dem Tisch)

**39. Figuren mit Pro-
portionslinien.**

1007 20131

1008 20003

1009 20003

LISTE B.

ZUERST STEHT DIE NUMMER DES GRABSTEINS, DANN
DIE DER SKIZZE.

20001	145. 624	20063	8. 292. 368
20002	199	20064	233
20003	197. 282. 583. 1008. 1009	20070	496. 525. 691. 695
20004	23. 480. 494. 526. 928	20074	253
20005	142. 917. 992	20075	419. 993
20006	381	20082	492. 921. 930
20007	9. 201. 284. 332. 349. 461. 507. 527. 542. 627. 955. 996	20084	931
20009	14. 78. 227. 310. 331. 359. 467. 469. 511. 519. 533. 581. 739. 766. 811. 880. 913. 953	20085	685
20010	124. 587	20086	275
20011	15. 333. 438. 723. 799. 800. 876	20088	405. 412. 934. 982
20012	444. 503. 669	20089	1005
20013	118. 230. 637	20090	45. 196. 426
20014	10. 270. 737	20092	20. 82. 989
20016	791. 841	20093	628. 823
20017	506. 983	20096	659
20022	319	20099	924
20024	202. 204. 206. 213. 384. 523. 734. 789. 836. 941. 963. 964	20101	738. 740
20026	578. 727. 835	20102	221. 406
20029	380	20103	13. 72. 393. 402
20031	94. 916	20105	1. 459
20033	273	20119	315. 871. 872
20035	452	20120	297
20037	621	20121	557. 678
20039	178. 185. 369	20122	446. 666
20042	505	20123	11. 58. 144. 146. 171
20058	183	20124	42
20062	407	20125	365
		20126	105. 232. 985
		20127	37
		20128	411. 413
		20129	390
		20131	1007
		20132	681
		20133	281. 863
		20135	39. 243

20137	298. 487. 570. 741	20236	128. 129. 173
20138	77. 84. 224. 302. 338. 340. 460. 465	20238	240
20139	370	20239	33. 251
20140	7. 343	20240	259. 657. 1002
20141	877	20242	724
20145	300	20243	226
20148	51. 237. 674. 793	20248	962
20151	297. 483. 780. 956	20256	59. 336. 813. 905
20152	671	20257	180. 556. 779
20153	47. 256. 679	20261	162
20158	969	20262	771. 951
20162	584. 641	20263	622
20163	43. 44. 86. 141. 155. 255. 683. 834	20267	132. 260. 434. 722. 885
20164	223. 360	20281	428. 673. 859
20165	323. 367.	20283	295
20166	632	20285	62. 107. 377
20172	53. 709. 726	20288	36. 325. 514
20177	417	20290	97. 334. 362
20180	274	20294	313. 603. 650. 897
20182	234. 633. 651	20296	32. 898
20183	218. 586	20298	564
20185	32. 150. 418. 423. 965	20299	668
20188	1003	20300	120. 289. 375
20190	69	20303	684. 911
20193	106. 394	20306	342
20197	210. 599	20307	858
20200	399	20308	92. 95. 252
20201	567	20309	26. 75. 262. 303. 644
20210	535	20310	215. 264
20212	65. 203	20312	895
20217	689	20313	139. 179. 220. 742
20218	339	20314	763
20220	942	20315	346
20221	401	20317	512
20226	160. 176. 479	20319	457. 478. 653. 815
20227	129. 316. 571	20320	686
20231	75. 235. 590. 949	20323	667
20232	151. 439. 562. 616. 795	20324	692. 706. 890
20234	429	20326	448
20235	68. 680	20327	914
		20328	262
		20331	98. 398. 464. 990. 991

20332	424	20396	730. 861
20334	537	20397	383
20335	50	20398	707. 733. 751
20336	314	20399	278. 602. 837. 856
20338	32. 271	20400	915. 958
20340	238	20402	238. 606
20342	130. 634. 643. 893. 938	20403	785. 846
20343	61. 364. 453. 549. 554	20404	269
20344	246. 720. 787	20406	214. 608. 819. 883
20345	577. 693. 756. 968. 973.	20407	541
20346	101. 158. 437. 440. 454. 561. 575. 769. 866. 948. 988	20409	488. 619. 820
20347	135. 235. 607. 778. 808	20411	661
20348	254. 665. 826	20412	947
20349	132. 655. 850. 865	20423	34. 601
20350	589. 845. 878	20424	448
20352	421	20425	27. 345. 361
20354	831. 900	20426	175. 392
20355	550. 552	20427	752. 757
20357	807. 904	20428	591. 907
20359	572	20430	312. 397. 451. 770
20360	12. 81. 277	20431	238. 560. 564. 670
20362	946. 966	20433	74. 747
20363	70	20434	614
20365	697	20435	39. 242. 531. 605. 749. 816. 857
20368	387. 776	20436	17. 286. 307. 458. 463. 642. 889. 892
20369	899	20437	111
20372	484	20439	422. 957
20376	167. 980	20440	6. 28. 83. 100. 122. 200. 229. 266. 568
20381	652. 812	20446	21. 400
20382	545	20448	530. 736
20383	687. 868	20450	619
20385	908	20451	75. 114. 191. 211. 248. 334
20386	138. 719	20452	235. 441. 449. 839. 840
20388	563	20453	308. 611
20389	327	20454	320. 665. 704. 768. 906
20390	515. 772. 855	20455	18. 194. 296. 832. 833. 864. 925
20391	372	20456	296. 644. 801. 829
20392	76. 303. 609. 869		Vs.: 5. 113
20394	52. 102. 127. 182. 186. 389. 535. 619		
20395	306. 335		

20456	Rs.: 5. 17. 75. 112. 115. 137. 280. 323. 334. 344. 352. 436. 595. 717. 754. 759. 767. 804. 825. 894	20514	385. 528. 593. 997
20457	4. 34. 62. 107. 288. 371. 404. 585. 641. 827	20515	88. 174. 348. 497. 943. 960. 961. 970. 984
20458	71. 75. 228. 346. 582	20516	41. 415. 473. 501. 522. 718. 762. 909. 977
20459	22. 193. 241. 267. 475. 491. 493. 510. 524. 539. 589. 645. 812. 817. 971	20518	285
20460	17. 471. 535. 598. 647. 744. 748. 818. 853	20519	824. 974
20462	250. 705. 774. 896	20523	87. 416. 794
20465	5. 228. 334. 589. 647. 862	20526	688
20467	40	20528	664. 919. 986
20468	137. 190. 195. 706. 952	20530	612
20469	148	20531	63. 311
20470	24. 117. 293. 476. 498. 579. 640. 809	20532	713
20472	263	20534	500
20473	55. 67. 73. 109. 247. 690. 755. 757. 758. 761. 765. 788. 891. 903. 935. 937	20535	502. 521. 699. 732
20474	252. 320. 323. 344	20537	119. 620
20475	294. 639	20538	272
20476	24. 110. 304. 345. 472. 490. 623. 745. 802. 849. 979	20539	207
20477	879	20541	358. 504. 796
20498	225	20542	468. 708. 711
20499	636	20543	283. 321. 322. 481. 594. 646. 715. 783. 814. 945
20500	2. 694	20544	987
20501	30. 147. 432. 551. 553. 672	20545	140. 482. 773
20504	57. 170. 341. 529. 630. 760. 936	20546	16. 782
20505	123. 209. 462. 495. 508. 518. 580. 660	20549	80. 219. 318. 431. 620. 822. 912. 967
20506	629. 701	20550	93. 131. 222
20507	19. 143. 310. 576	20552	513. 626
20508	66. 544	20557	677
20510	716	20559	89. 658. 854. 981
20511	435	20561	56. 409. 532. 721. 786. 933
20513	19. 543. 805	20562	31. 547. 613. 821
		20563	489. 838
		20565	121. 445
		20566	46. 60. 289. 329. 374. 466. 710. 792
		20568	159. 161
		20571	420. 790
		20572	330. 455
		20585	662
		20586	235

20587	617	20671	262
20588	129. 391. 573	20672	104. 485. 592. 663. 698.
20589	43. 286. 367. 378. 379. 806		743. 746. 772. 848. 888.
20591	618. 847. 884		950
20592	151. 625. 754. 902. 939. 1001	20677	187
20593	569. 867. 926. 927	20678	696
20594	34. 287. 351	20679	82. 99. 244
20595	12. 82. 748	20681	177. 403. 534
20596	137. 172. 648. 781. 923	20683	231. 268
20599	48. 90. 395. 425. 574	20687	157
20602	386	20689	154
20605	125. 702	20690	245. 588. 676
20606	43. 38. 373. 887	20692	96
20607	870	20693	25. 844. 886
20608	265. 851	20694	133. 165. 656
20610	181	20697	326. 830
20611	410. 873	20698	703
20612	1004	20701	189. 735
20613	184	20704	328
20614	217	20706	79. 164. 456
20615	929	20708	11. 117. 198. 301. 517
20618	443	20709	134. 163. 443. 604
20619	257	20711	335. 536
20620	3	20712	753
20621	153. 330. 353	20713	152
20625	843	20714	309. 566. 764
20627	188	20718	408. 538
20629	103. 565	20722	712
20630	49. 305	20723	509. 875
20637	396. 447. 874	20724	110. 388. 421. 446
20638	1006	20725	366. 382. 649. 883. 932.
20641	750. 920		940. 944. 975. 976. 994.
20642	433		995. 998. 999. 1000
20645	252	20729	5. 55. 108. 278. 324. 346.
20647	356		600. 922
20649	156. 486. 881	20730	239
20654	357. 363. 860. 954	20731	166
20660	797. 842	20732	337. 548. 558. 559. 615
20662	484	20736	169. 276. 631. 784
20664	116. 499. 520	20738	324
20668	610	20745	596
20670	35. 261	20746	149. 450. 675. 918

20747	136. 168. 249. 430. 546. 775. 910. 959	20754	126. 212. 442. 470. 654. 777. 852. 978
20748	317. 325. 474. 728. 990	20755	85. 208. 320. 347. 427. 540. 706. 731. 906
20749	5. 132. 236. 258	20756	26. 91. 192. 279. 682. 714
20750	64. 120. 290. 376. 585. 729. 798. 803. 828	20762	350
20751	54. 299. 355. 414. 516. 597	20774	555. 972
20752	205. 635. 700. 810		



20001



20005



20006



20007



20010



20012



20018

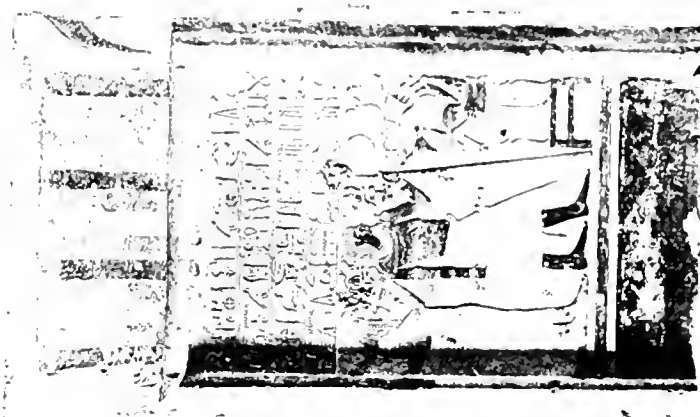

20014



20011



20013



20019



20020

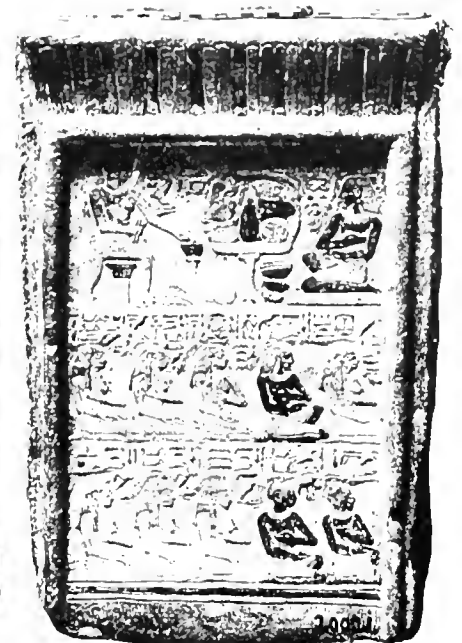

20021



20027



20023



20022



20028



20029



20031



20032



20033



20034



20035



20038

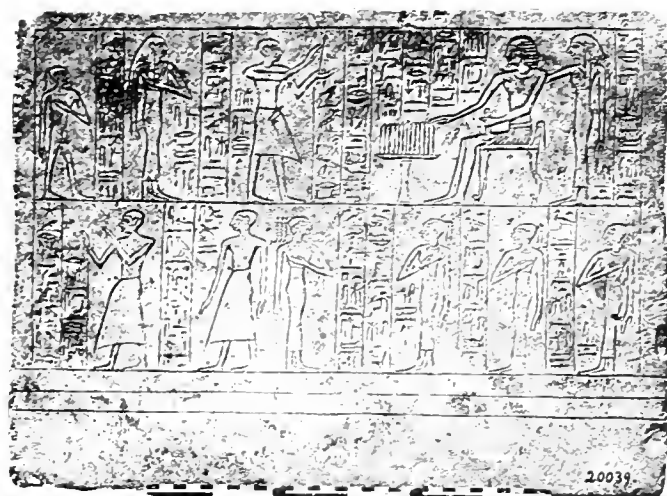

20039



20042



20044



20045



20047



20048



20050



20051



20052

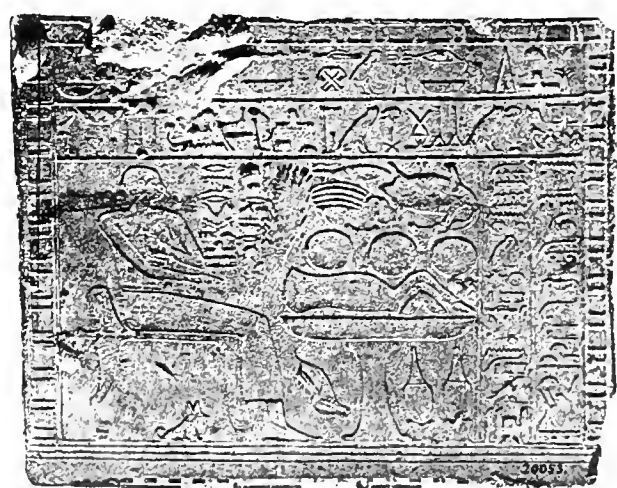

20053



20054



20055

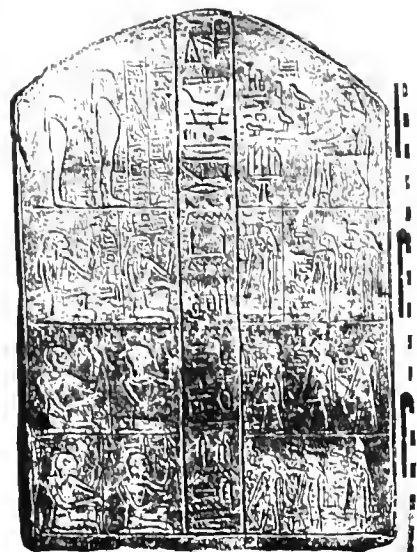

20056



20058



20057



20059

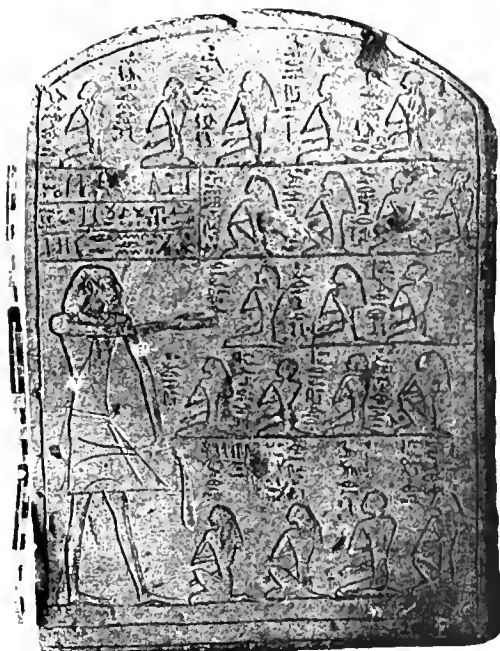

20062



20064



20063



20065



20066



20067



20068



20070



20071



20072



20076

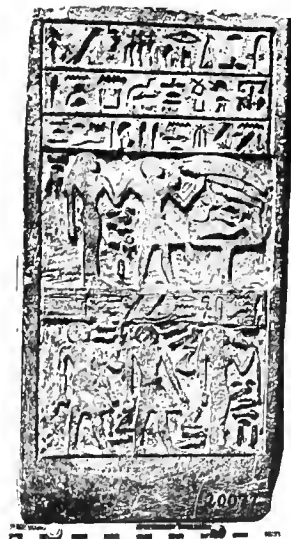

20077

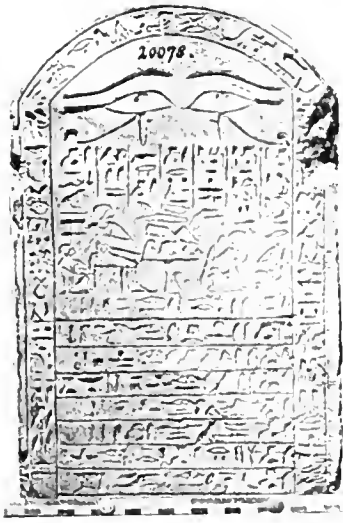

20078



20079



20081



20083



20082



20084



20085

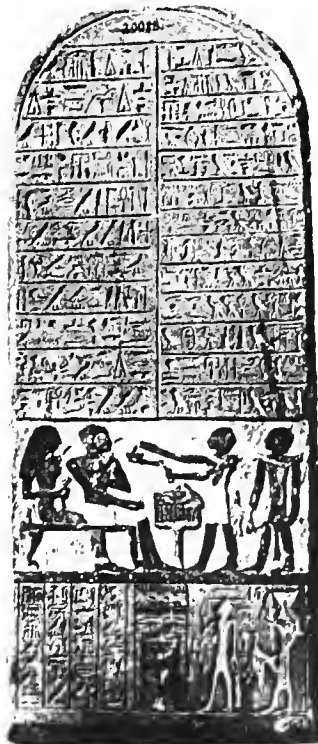

20088

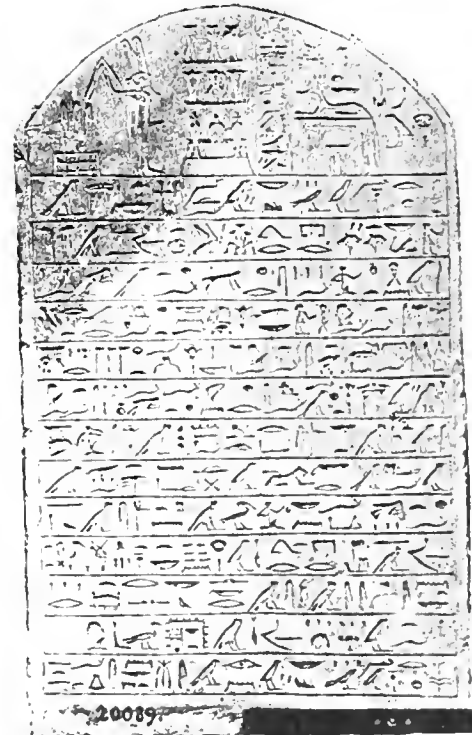

20089

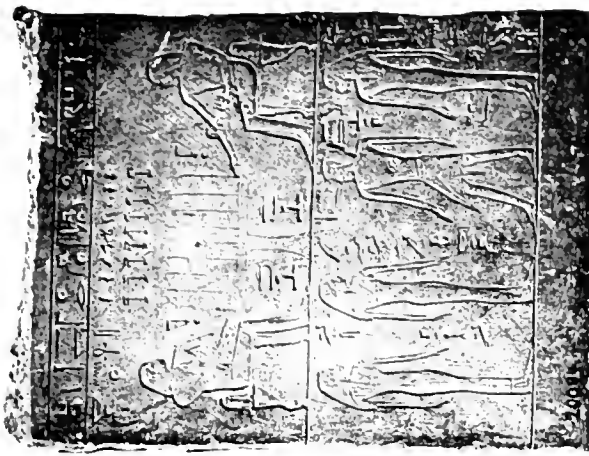

20094

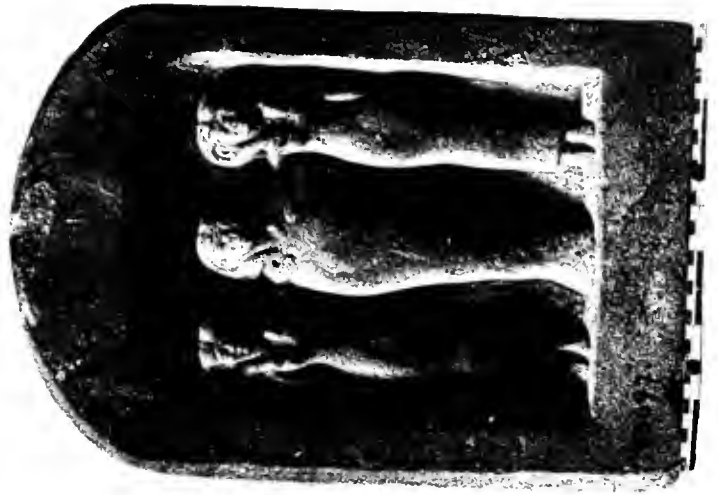

20097

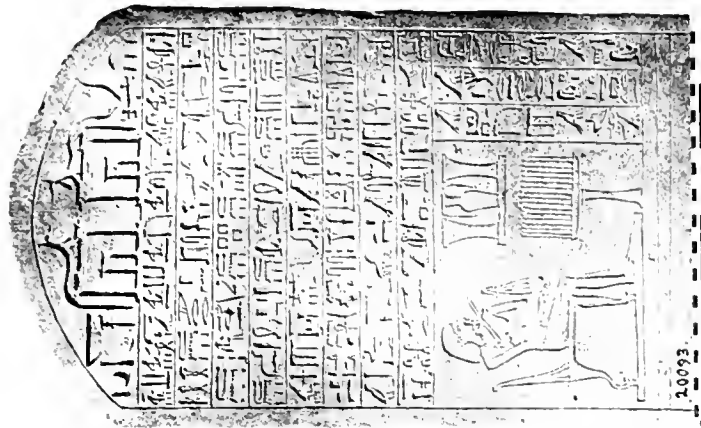

20093

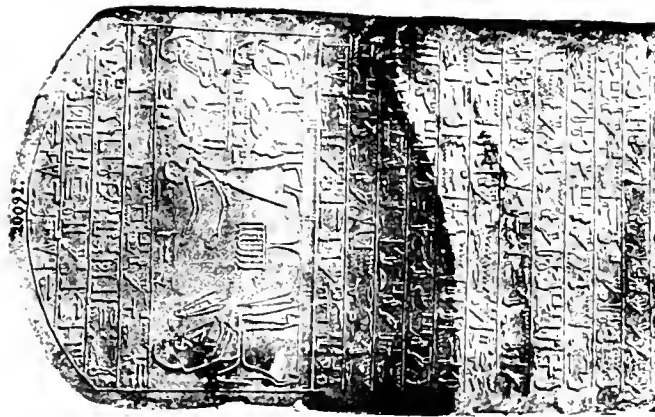

20092



20090



20096



20098



20100



20101



20104

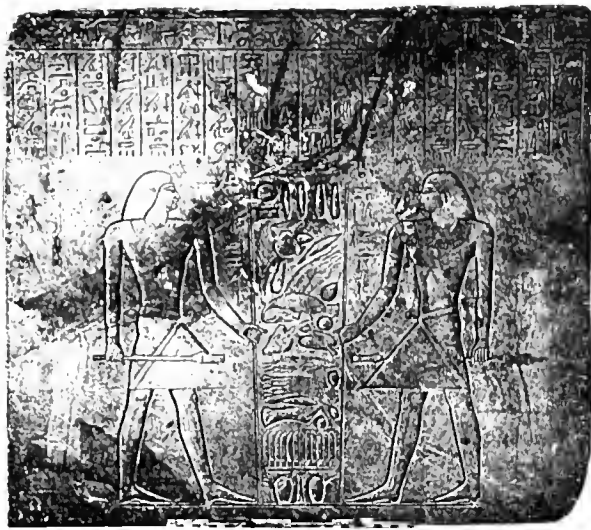

20105



20106



20108



20115



20121



20122



20124



20125

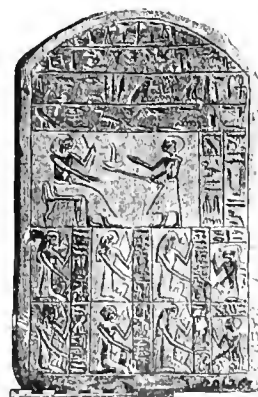

20126



20127



20128



20129



20131



20132



20135



20136



20137



20138



20139



20140



20141



20142



20144



20145



20146



20148



20150

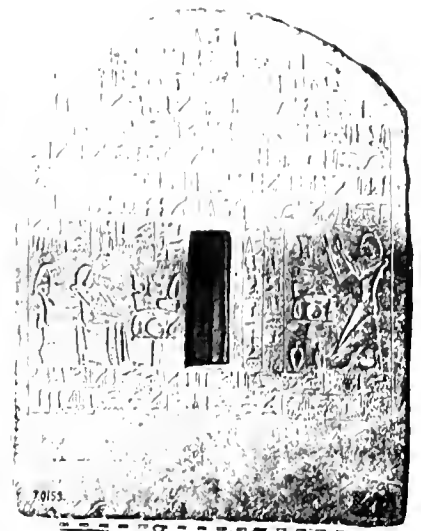

20153



20154



20155

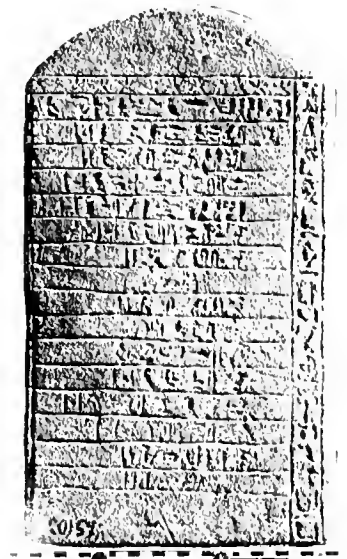

20157



20160



20163



20164



20165



20166



20169



20172



20174



20177



20178



20179



20180



20183



20184



20185



20186



20187



20188



20189



20190



20191



20192



20193



20194



20196



20197



20198



20199



20208



20209



20210



20212



20214



20216



20217



20218

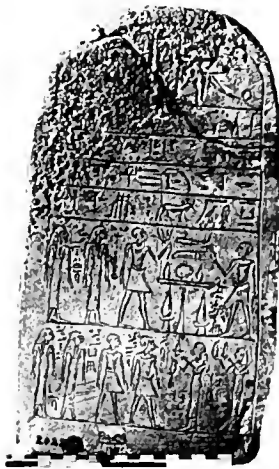

20220



20221



20222



20228



20231



20232



20233



20234



20235



20239

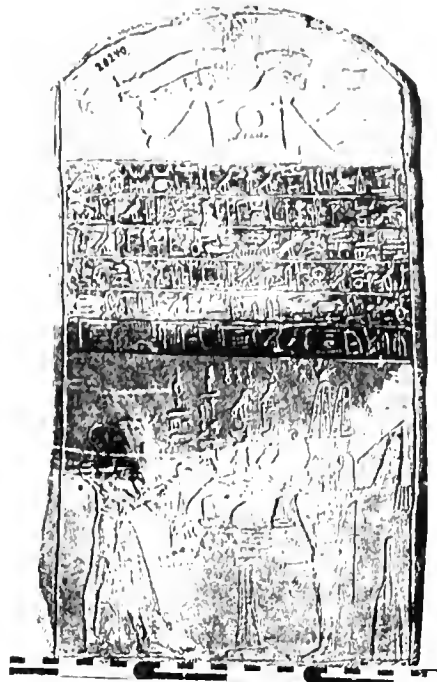

20240



20243



20248



20249



20251



20255



20257



20256



20263



20264



20265

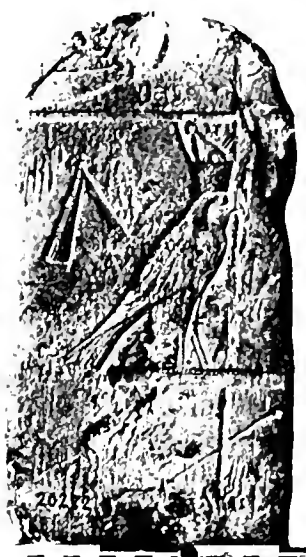

20272



20271



20273

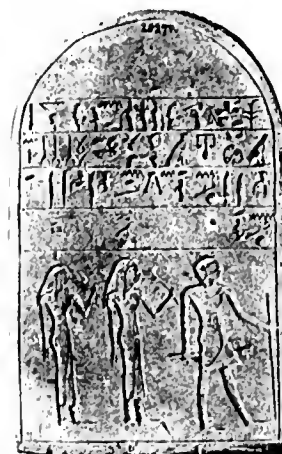

20274



20277



20278



20281



20282



20284

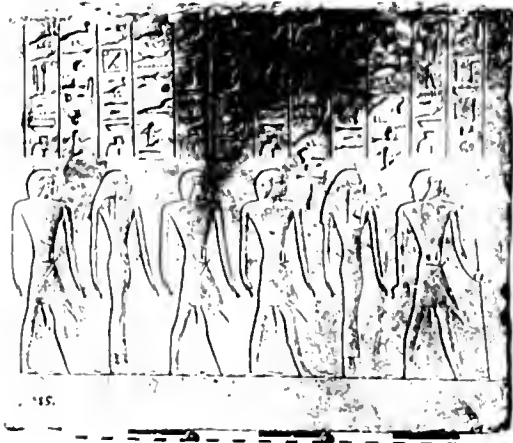

20285



20288



20290



20291



20293



20295



20300



20297

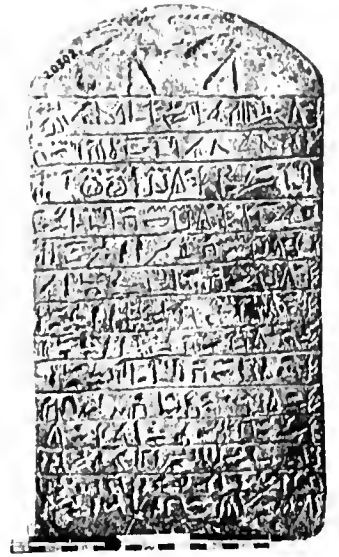

20302



20309



20311



20313



20314

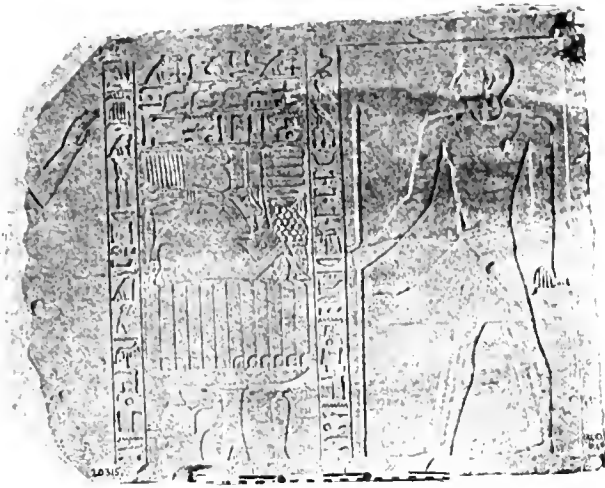

20315



20323



20324



20325



20329



20331



20335



20336



20338



20339



20341



20343

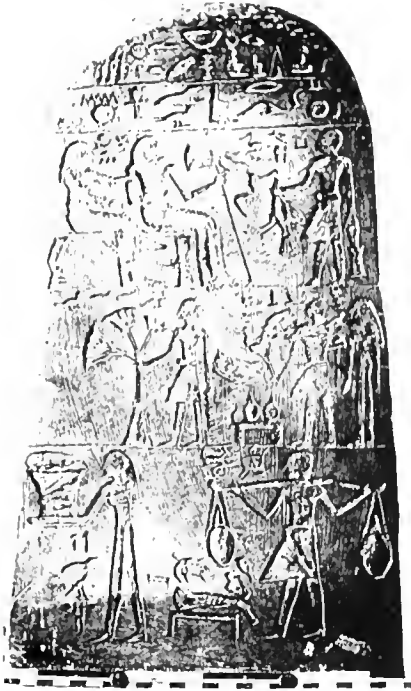

20345



20346



20348

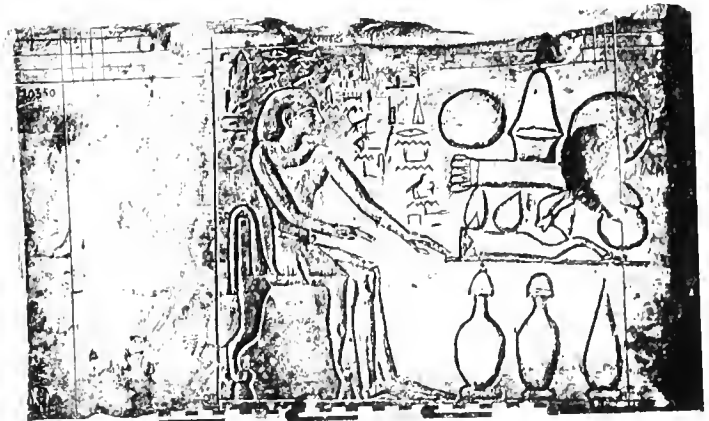

20350



20352



20353



20356

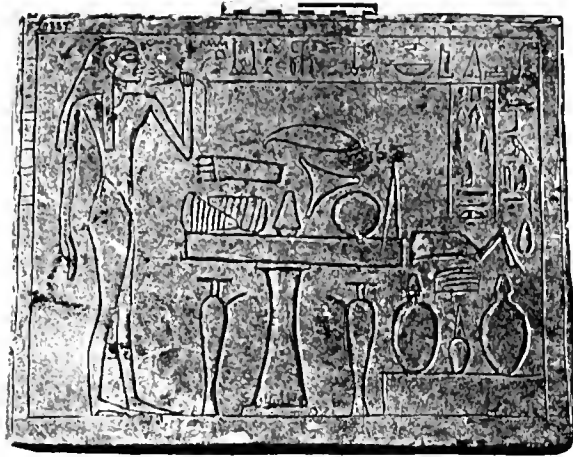

20357



20359



20360



20364



20366



20368



20370



20374



20375



20379



20382



20383



20385



20392



20393



20397



20399



20400



20404



20405

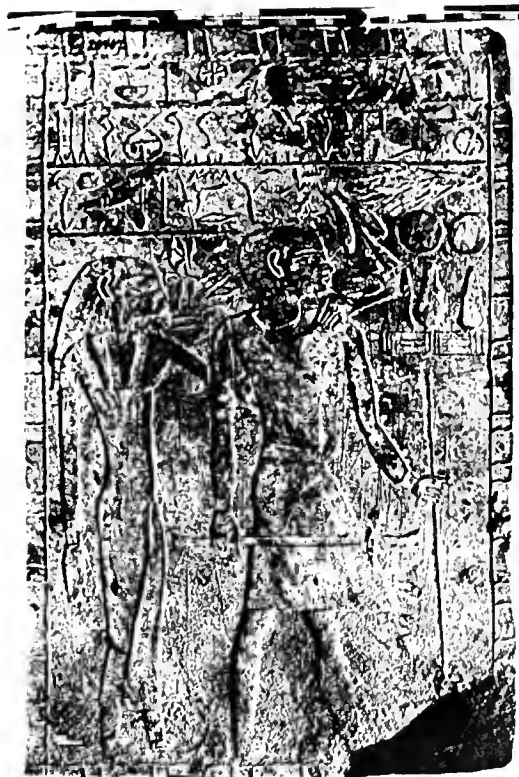

20407



20408

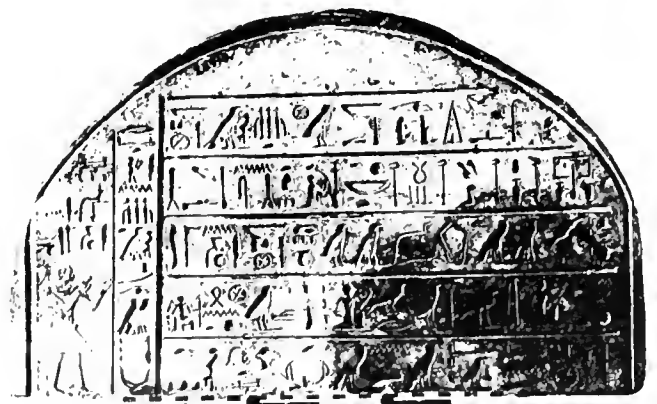

20410



20415



20423



20425

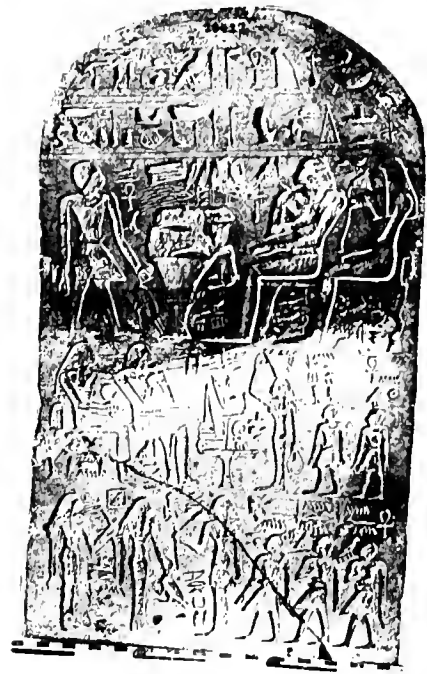

20427



20430



20431



20434

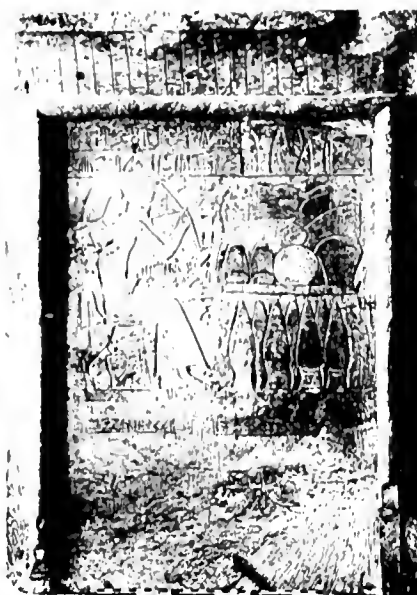

20435



20440



20445



20446



20448



20451



20456 Rs.



20456 Vs.



20459

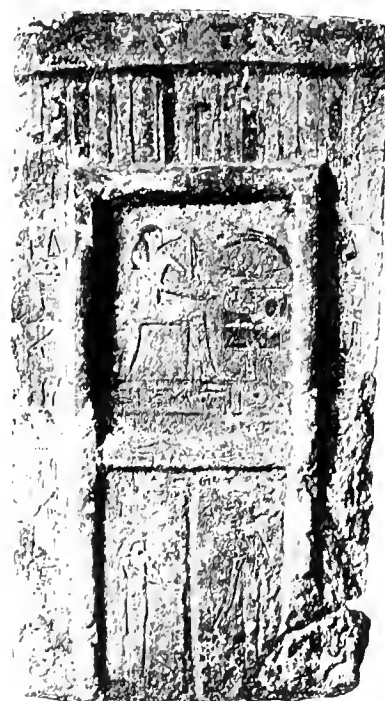

20461



20462



20467



20470



20472



20475



20476



20497

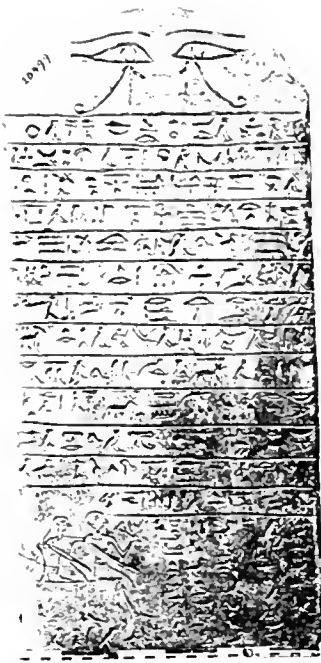

20499



20500



20501



20504



20506



20507



20509



20510



20514



20515

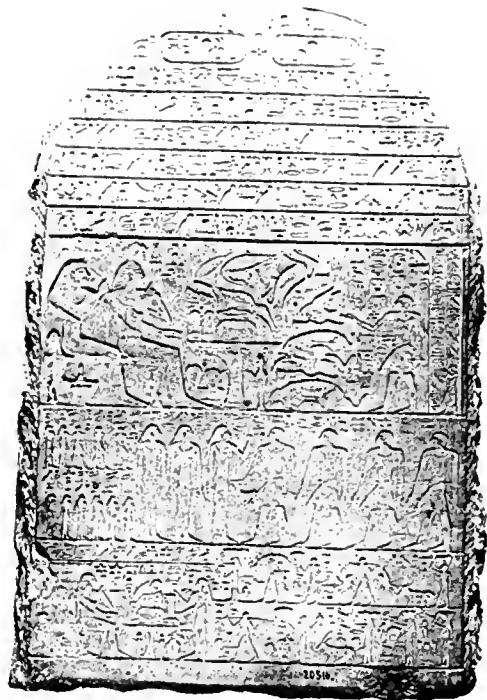

20516



20518

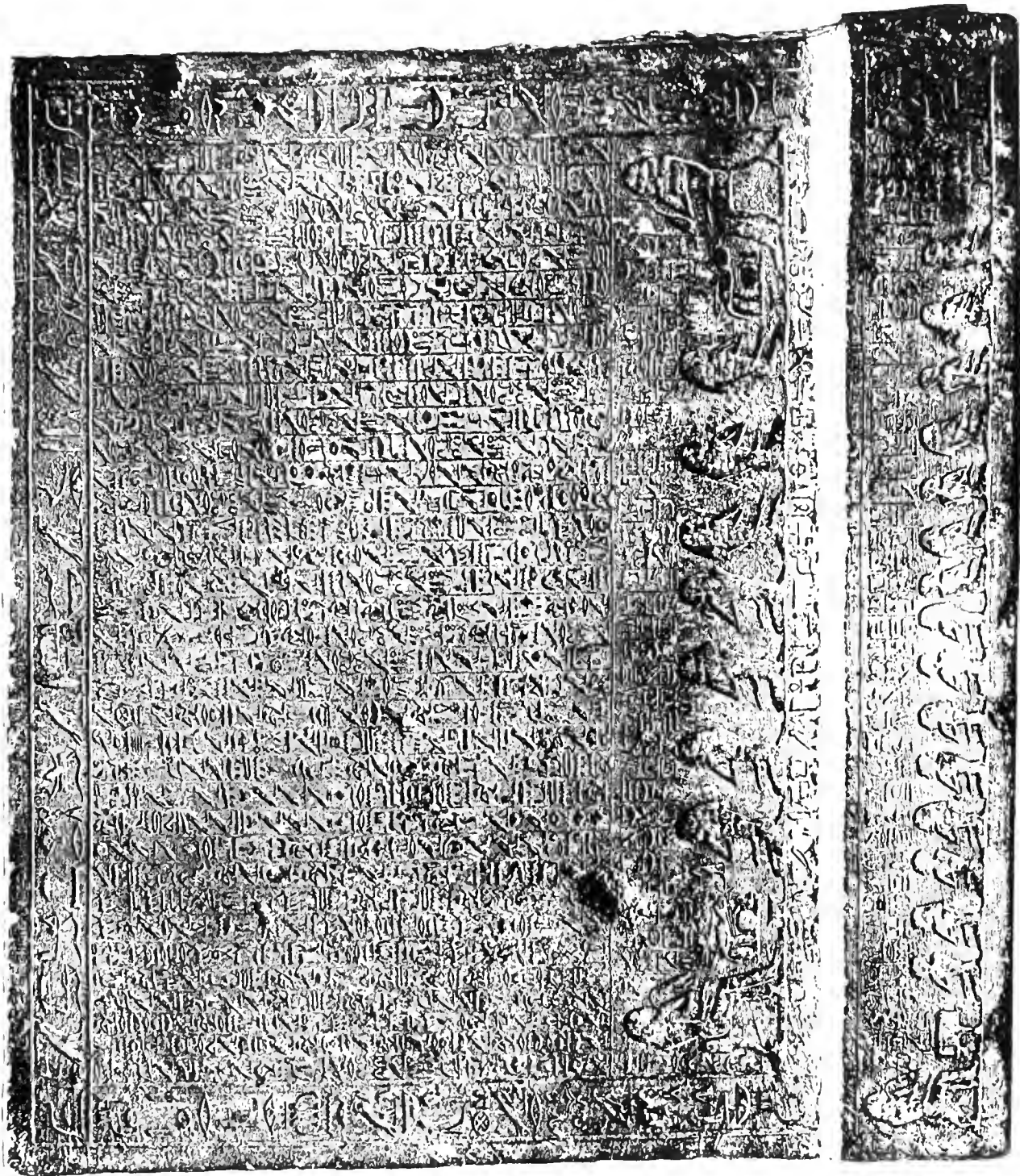

20520



20521



20522



20524



20525



20526



20527



20531

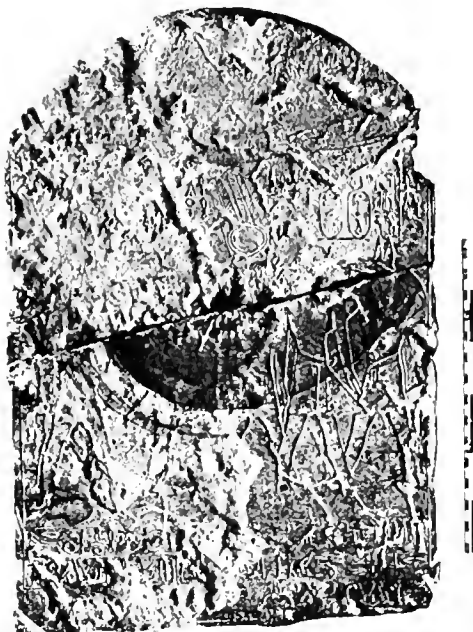

20533



20534



20535



20536



20537



20541

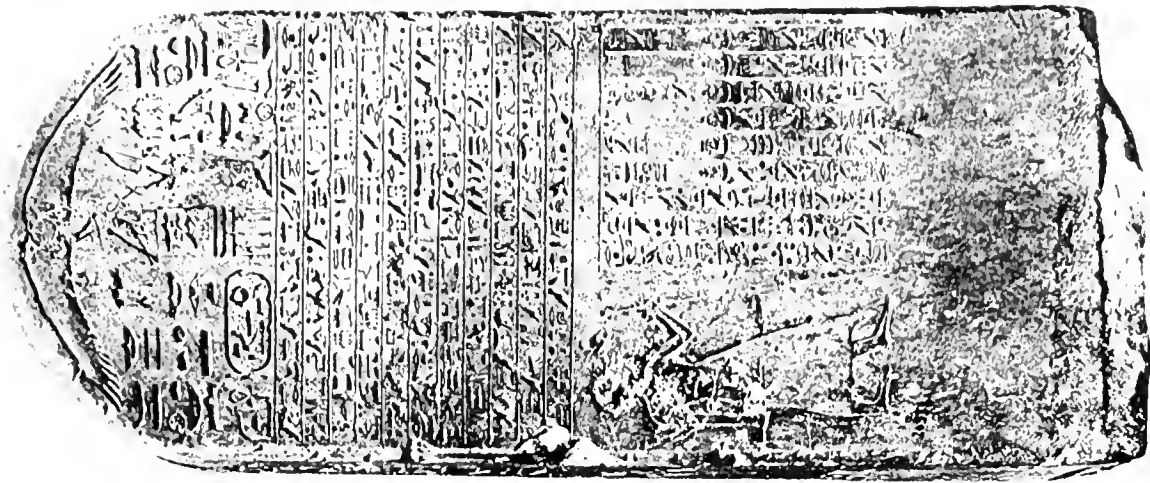

20538

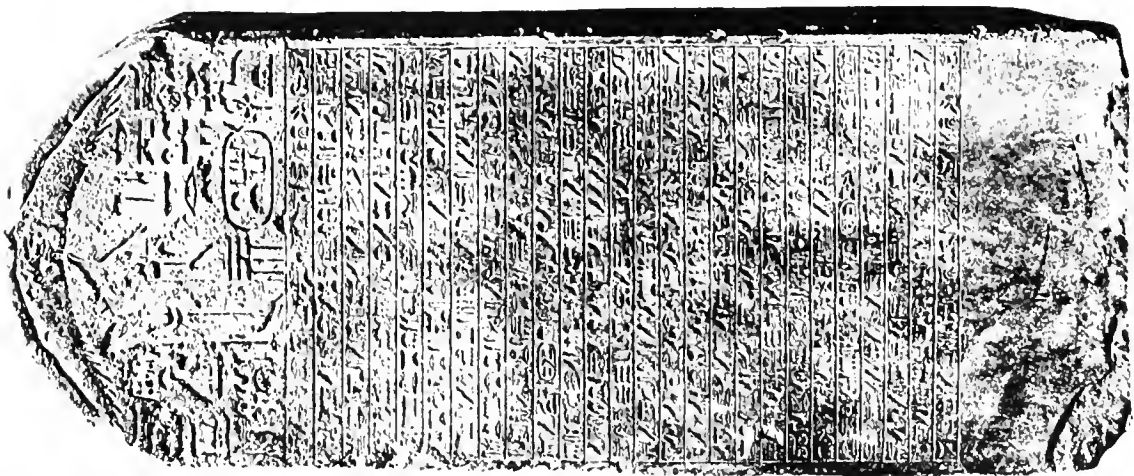

20538

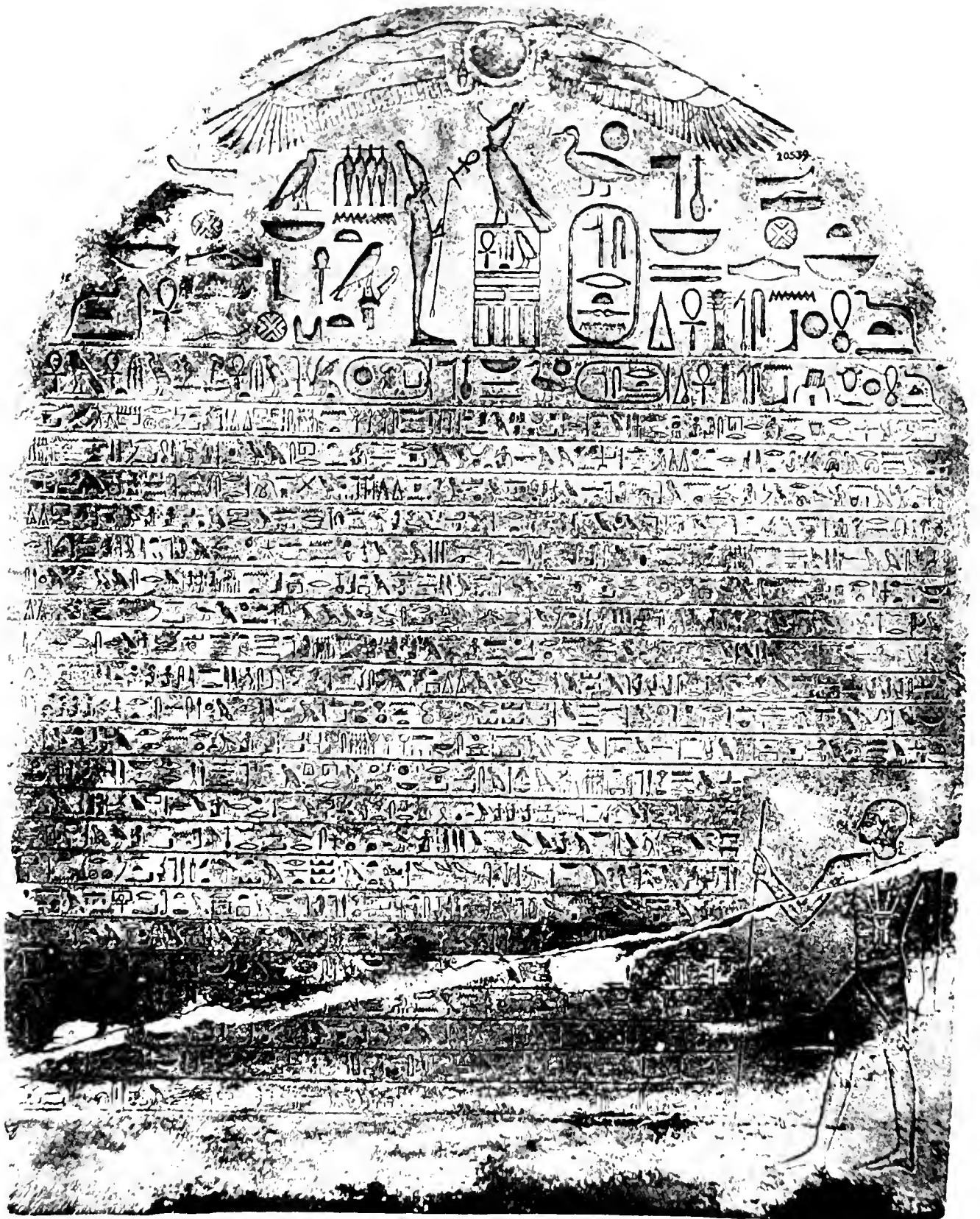

20539 Vs.



20539 Rs.



20542



20544



20548



20550

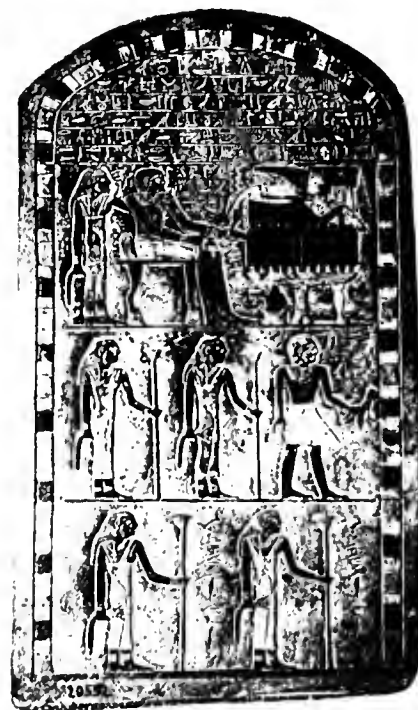

20552



20553



20554



20555



20556

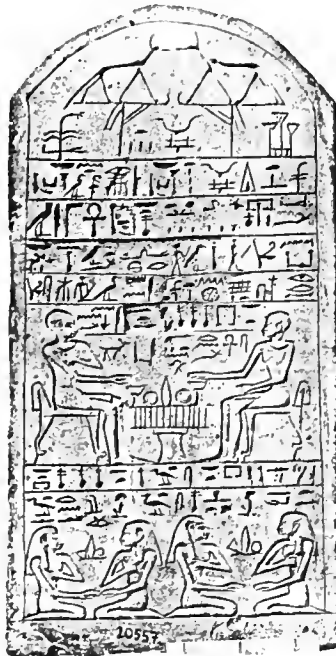

20557



20559

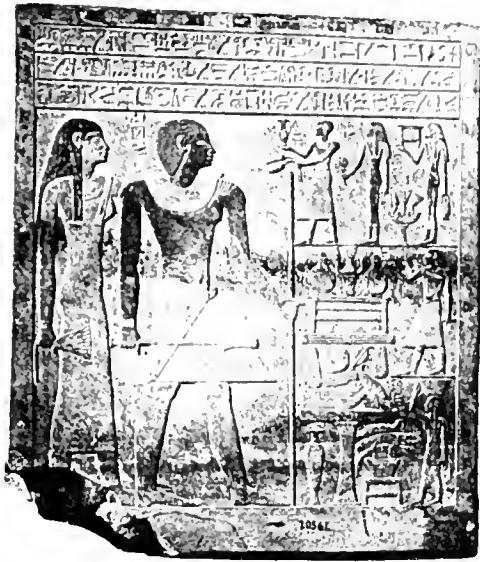

20561



20563



20565

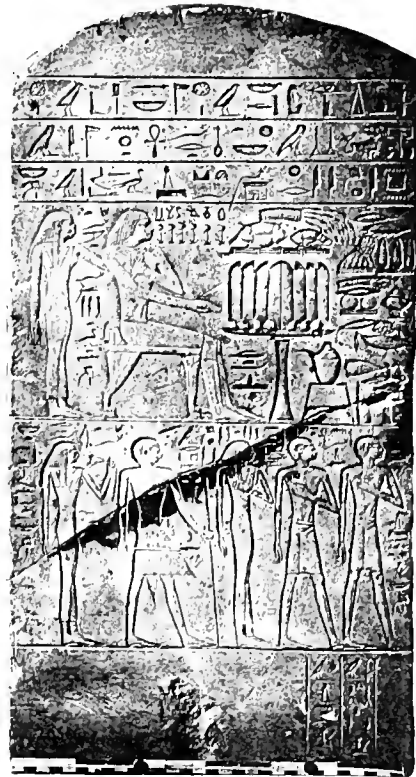

20566



20568



20569



20573

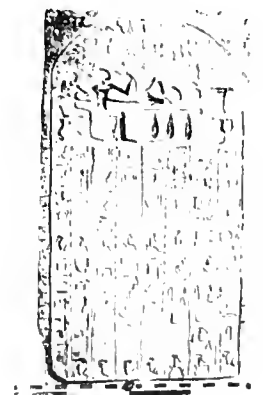

20577

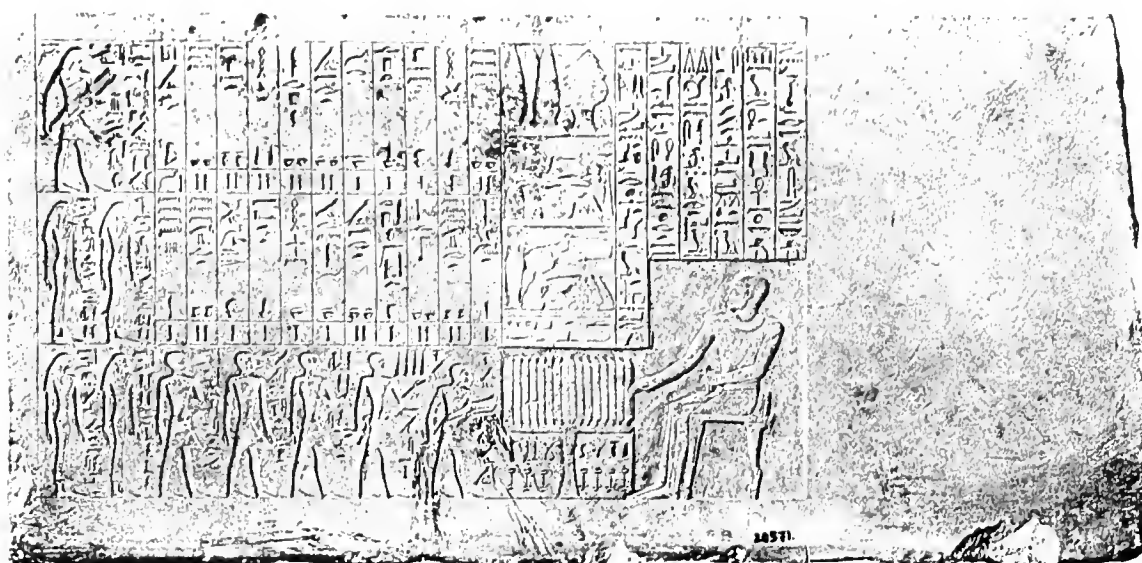

20571



20572



20578



20581



20588

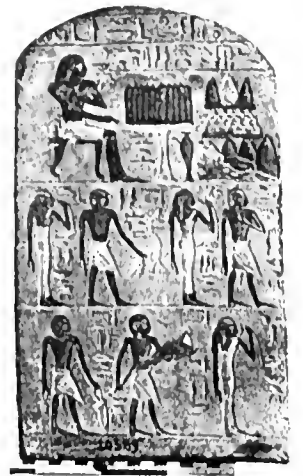

20589



20592



20593



20594



20596



20598



20601



20602



20603

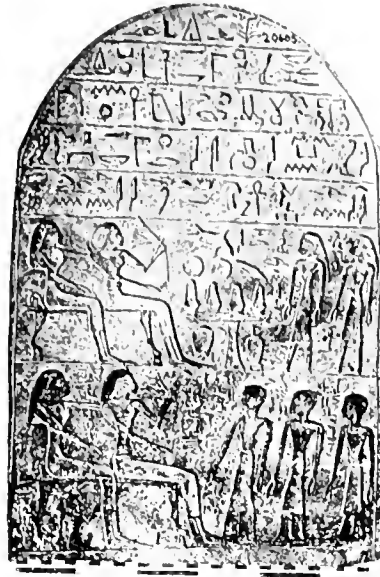

20605



20606



20608



20612

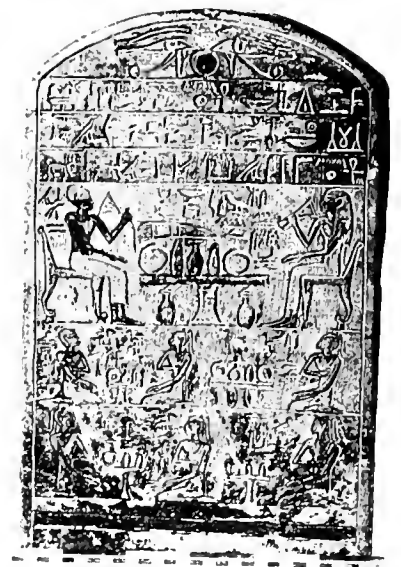

20613



20614



20615



20617



20622

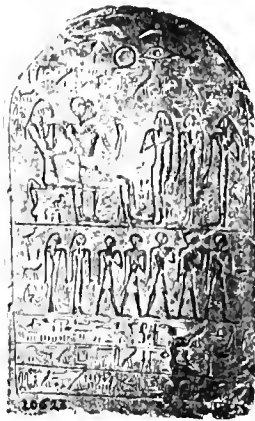

20623



20629



20638



20641



20642



20644



20645



20646



20649



20651



20654



20656



20659



20664



20665



20666



20670



20671



20672

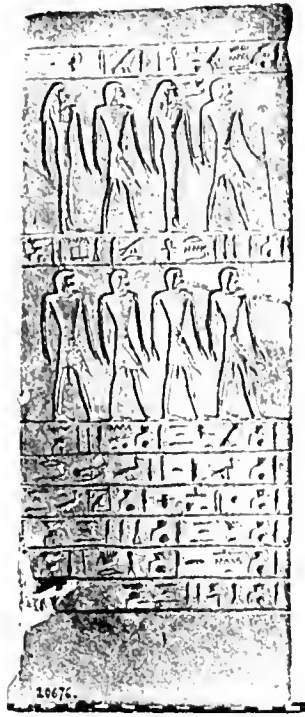

20676



20677

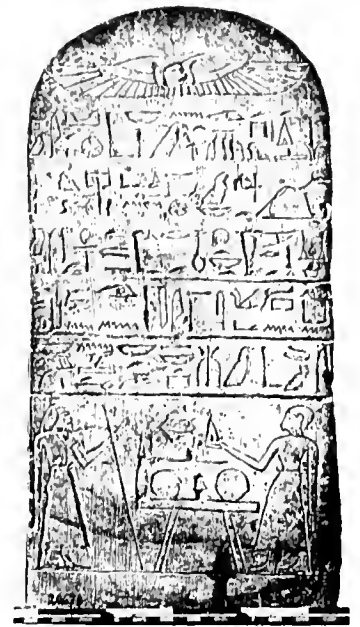

20678

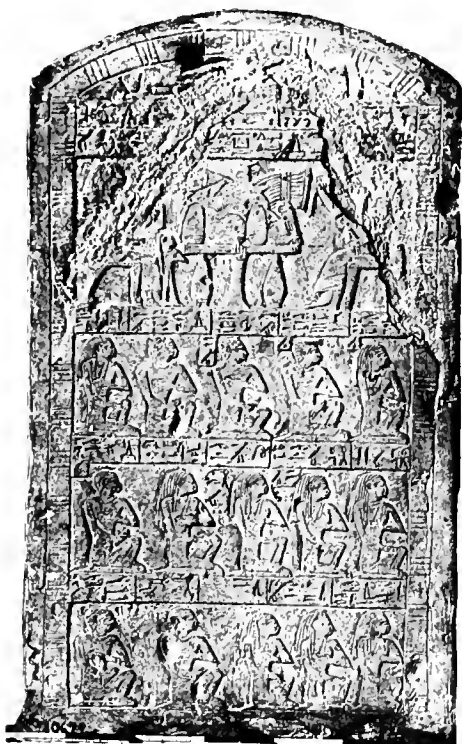

20679



20680



20682



20684



20686



20687



20689



20691

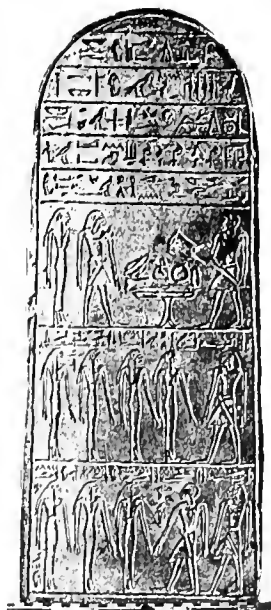

20692



20693



20694



20697



20701

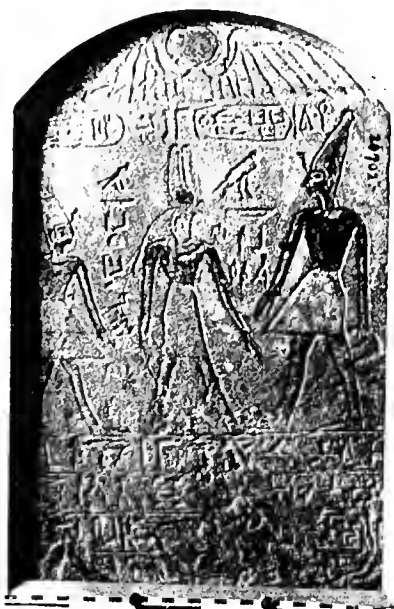

20702



20704



20704



20706

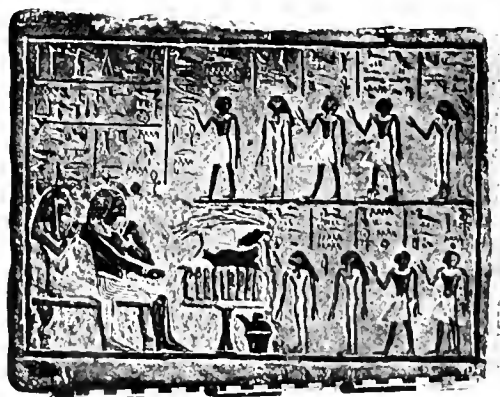

20708



20709



20710



20714



20715

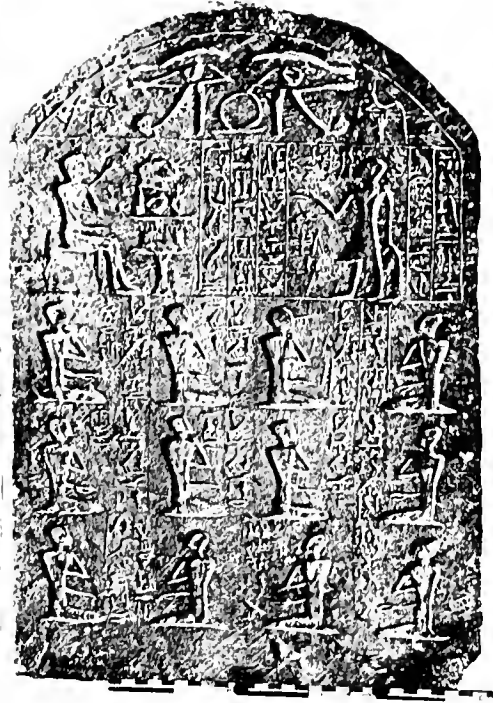

20718

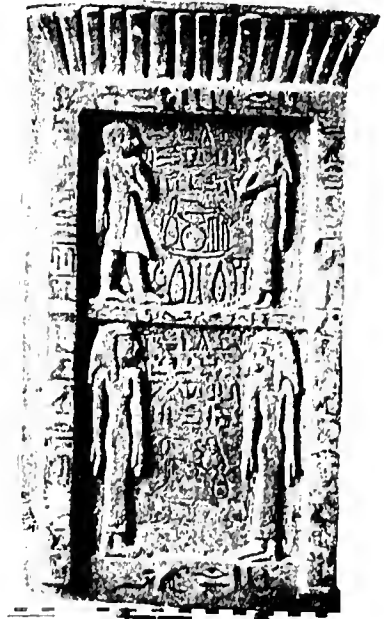

20719



20720



20722



20725



20726



20727



20729

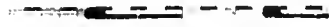

20726



20730



20731



20732



20736



20737

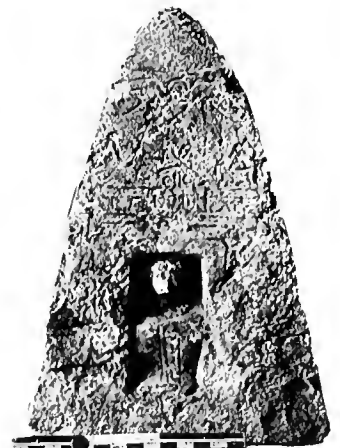

20740

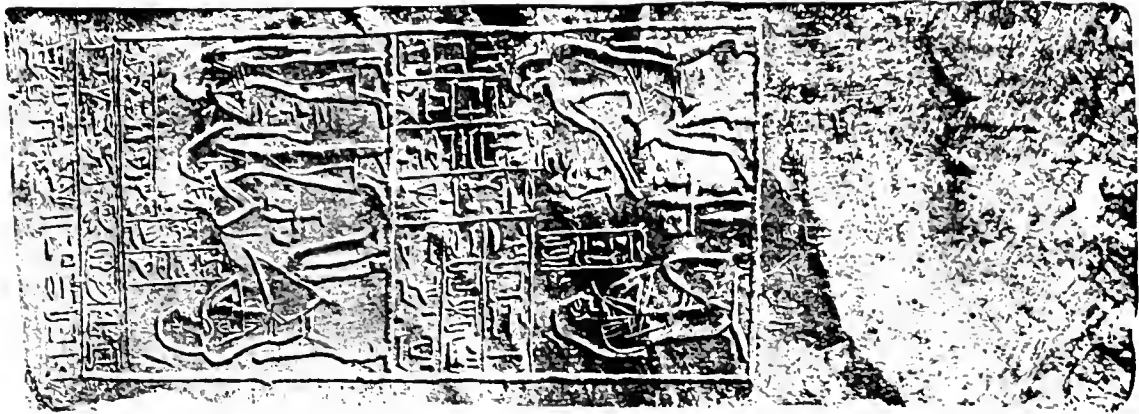

20742

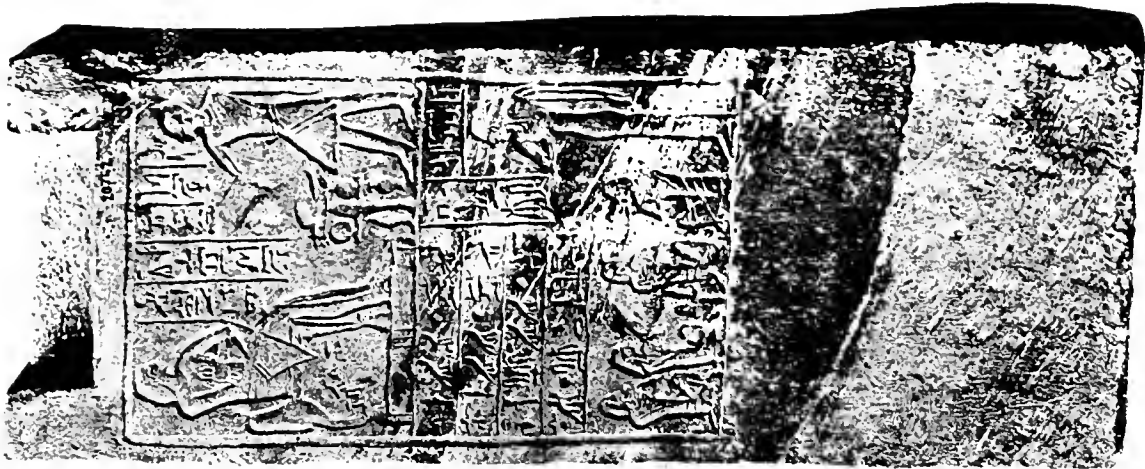

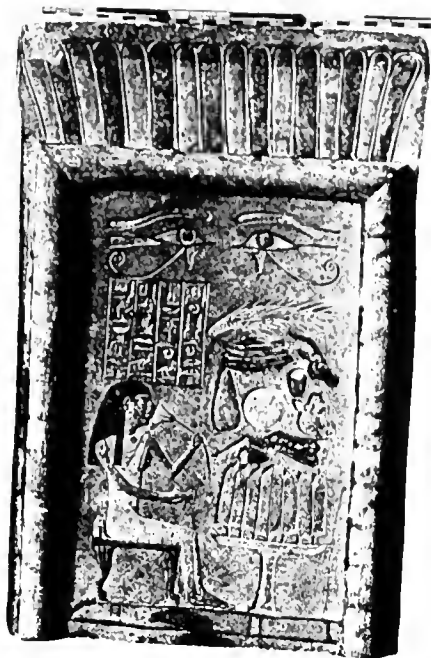

20745



20746



20747



20748

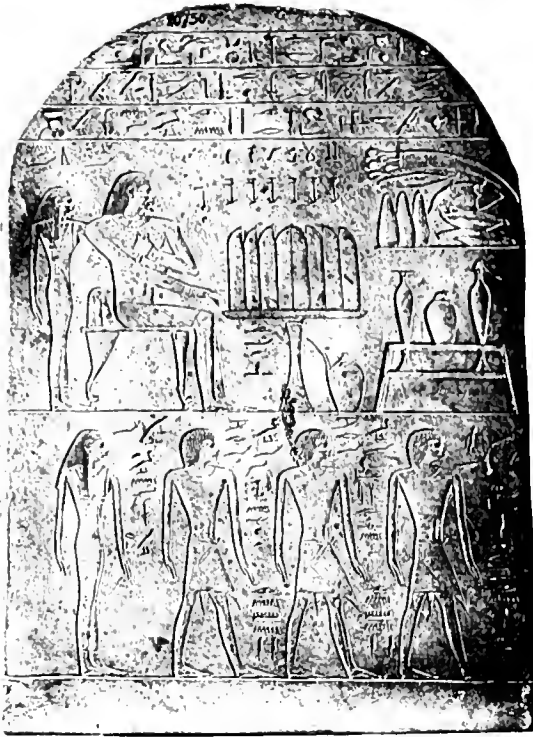

20750



20751



20752



20753

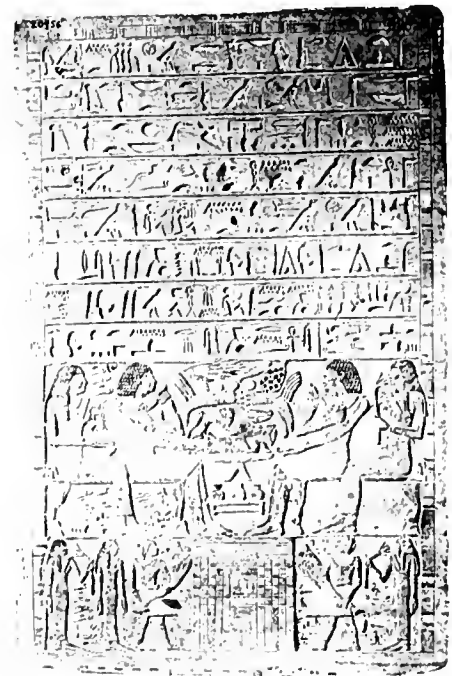

20756



20754

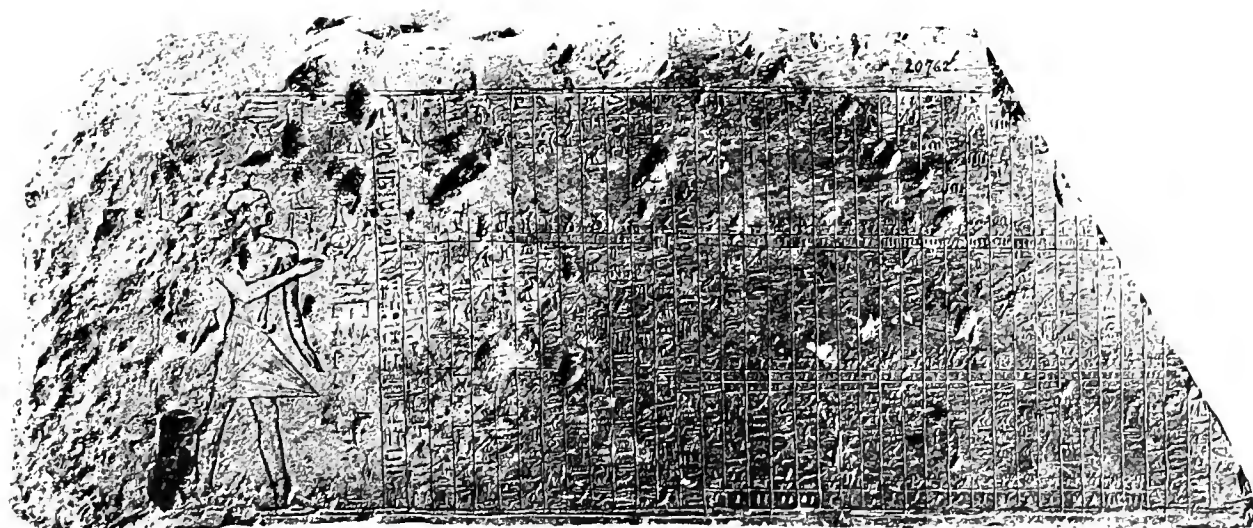

20762

I. MÄNNERFRISUREN.

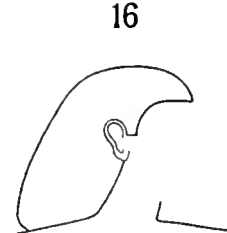
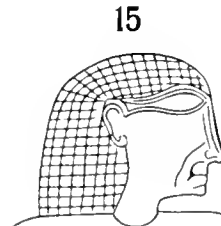
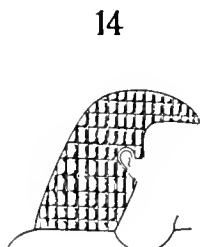
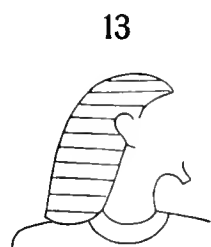
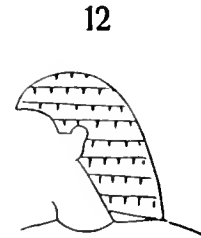
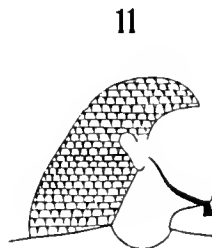
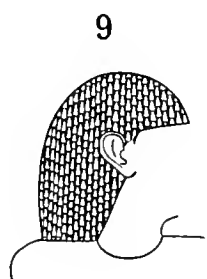
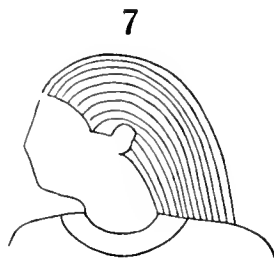
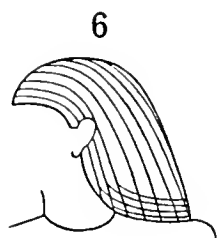
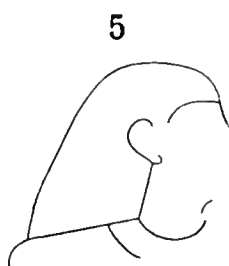
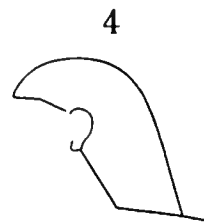
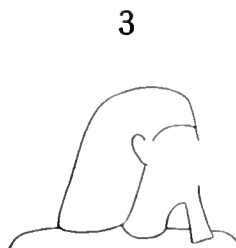
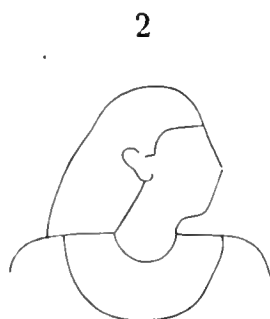
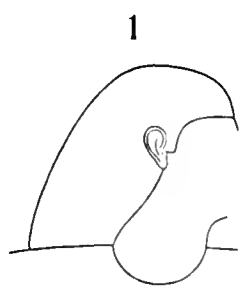

1. Männerfrisuren.

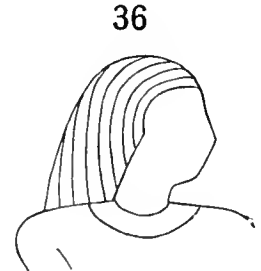
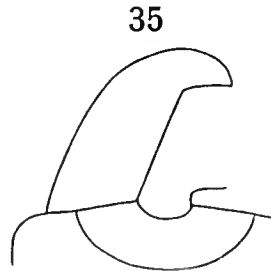
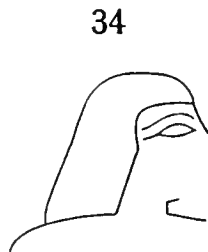
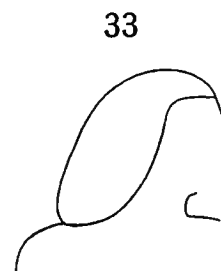
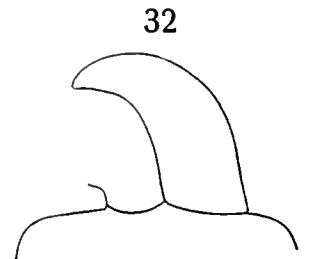
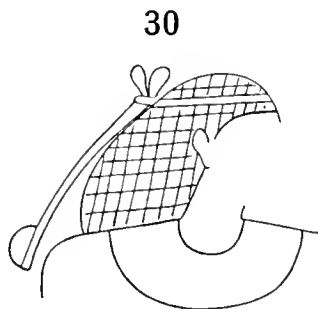
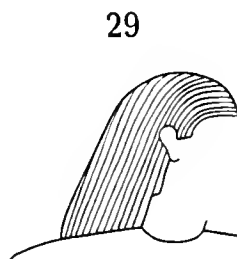
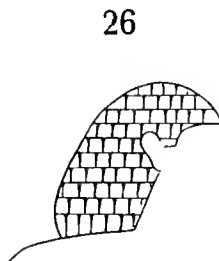
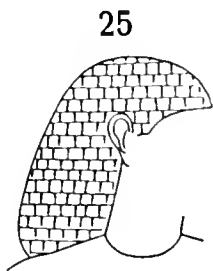
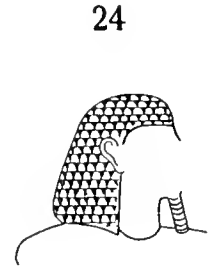
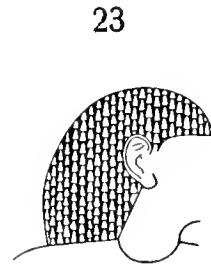
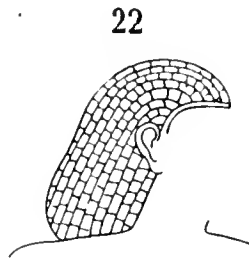
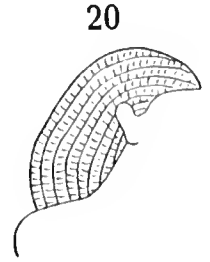
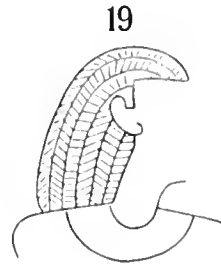
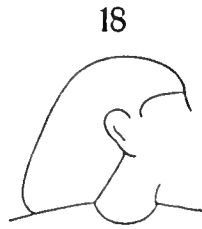
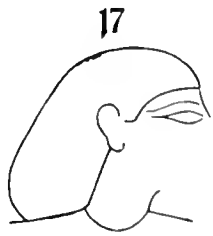

1. Männerfrisuren.

37



38



39

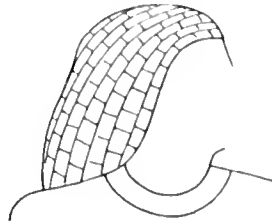

40



41

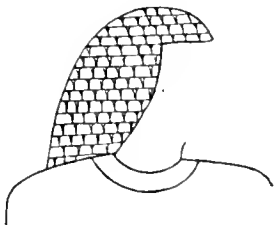

42



43



44

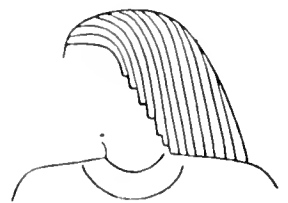

45

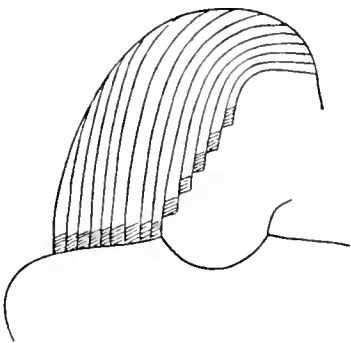

46

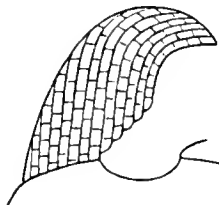

47

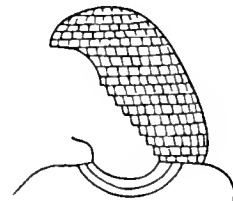

48



49



50



51



52



53



54



55



56



57

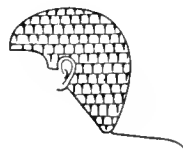

58



59

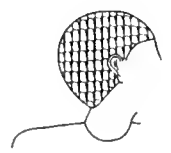

1. Männerfrisuren.

60

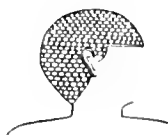

61



62



63



64



65

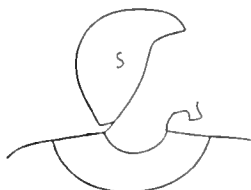

66



67



68



69



70



71



72



73



74



75



76



77



78



79



80

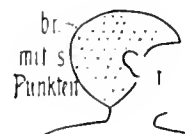

81



82



83



84



85



2. KNABENFRISUREN.

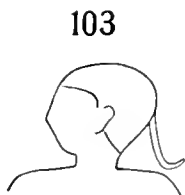
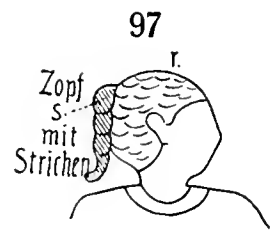
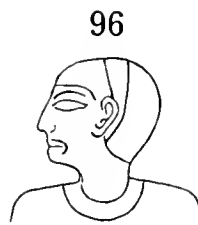
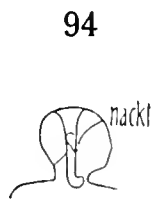
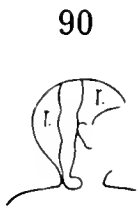
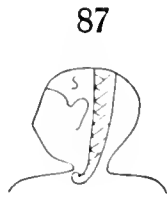
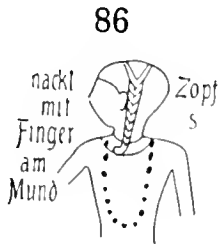

3. FRAUENFRISUREN.

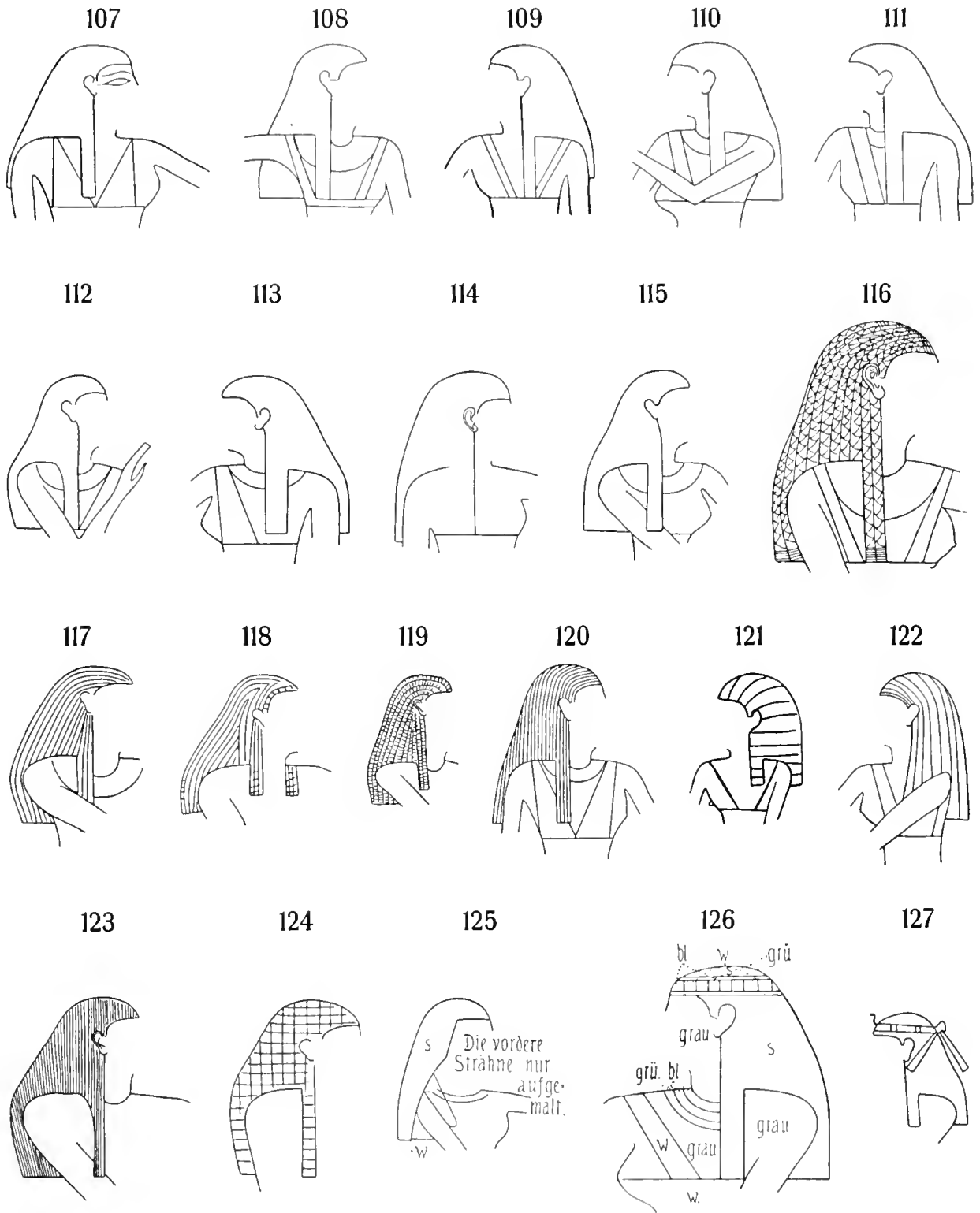

3. Frauenfrisuren.

128



129



130



131



132



133



134



135



136

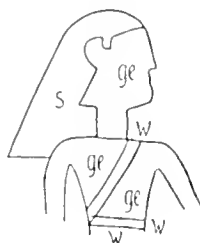

137



138



139



140



141



142

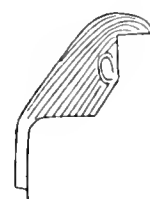

143



144



145



146



147

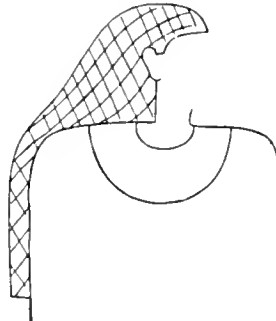

148



3. Frauenfrisuren.

149

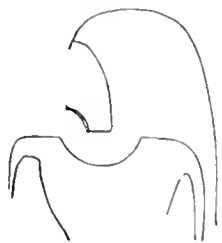

150



151



152



153



154

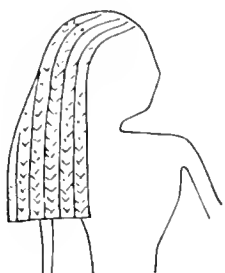

155



156



157

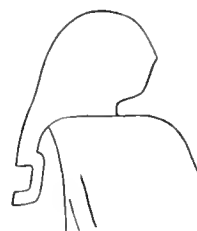

158



4. MÄDCHENFRISUREN.

159



160



161



162



163

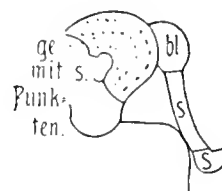

164



165



166



167

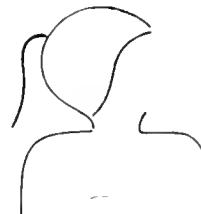

168



4. Mädchenfrisuren.

169



170



171



172



173



174



175



176



177



178



179

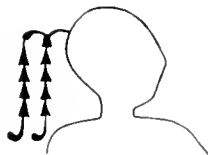

180



181



182



183



184



185

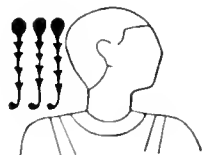

186



187



5. BÄRTE.

188



189



Bis zu $\frac{1}{2}$ von oben die Umrisse s, unterhalb davon - r Augen und Barts

190



191



192



6. HALSKRAGEN U. Ä.

193



194



195

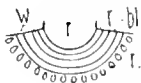

196



197



198



199



200



201

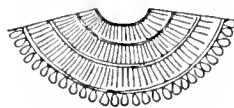

202

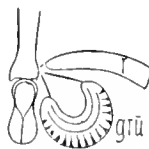

203

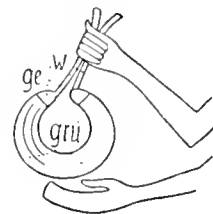

204

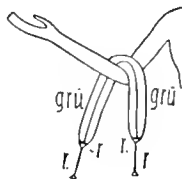

205



206

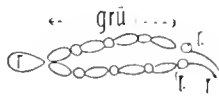

207



7. ARMBÄNDER.

208



w mit s
Zeichnung

209



210



211



212



213



8. MÄNNERSCHURZE.

214

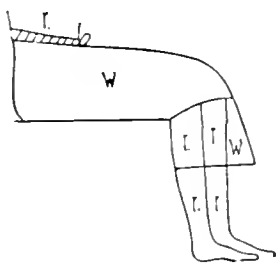

215

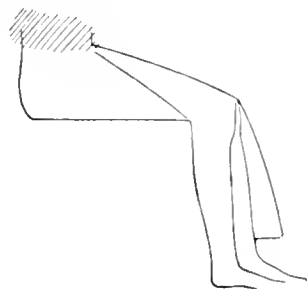

216

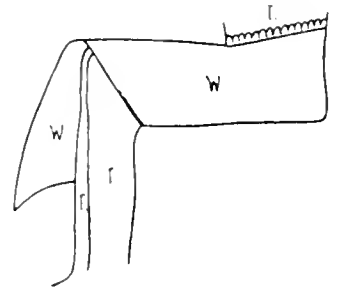

217

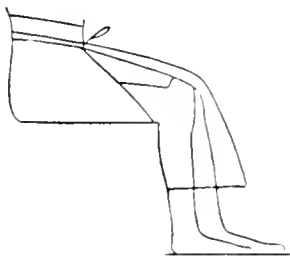

218

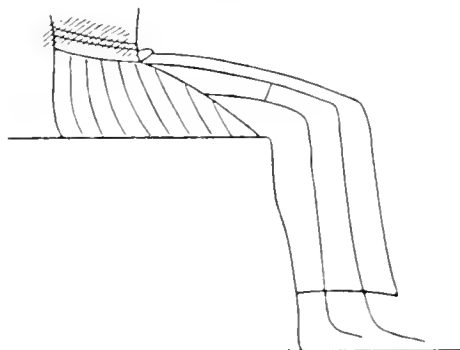

219

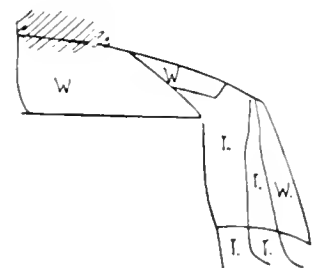

8. Männerschurze.

220

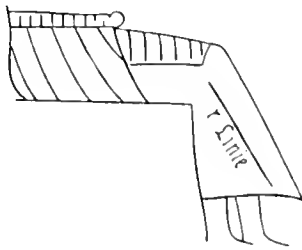

221

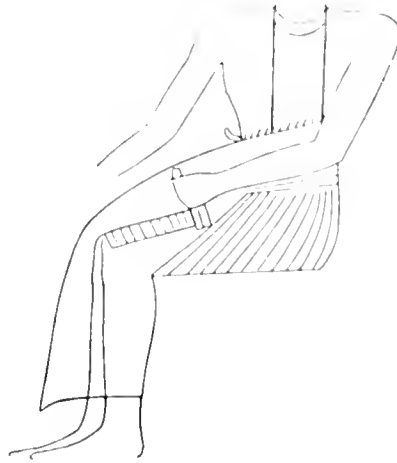

222



223

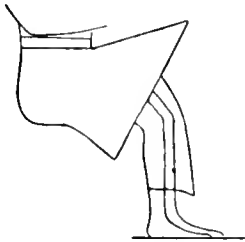

224

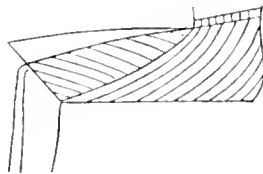

225

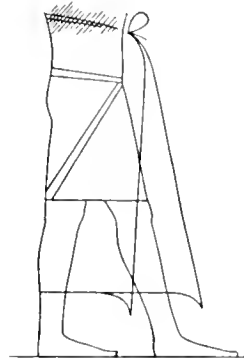

226



Kragen und Brustband rot übermalt, aber deutlich erkennbar.
w mit aufgemalten blauroten Strichen.

227



228

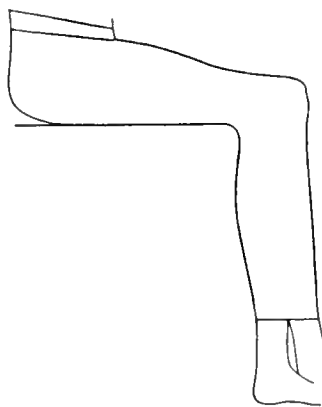

229

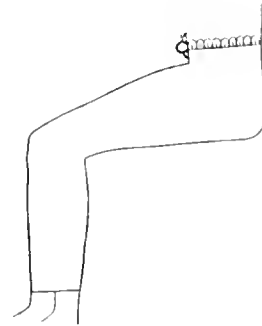

230

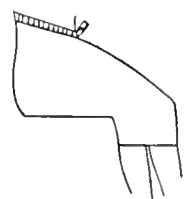

8. Männerschurze.

231

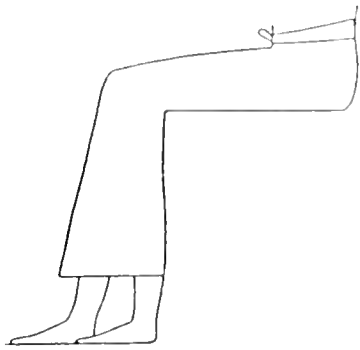

232

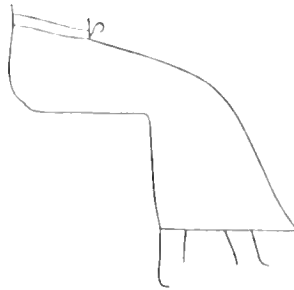

233

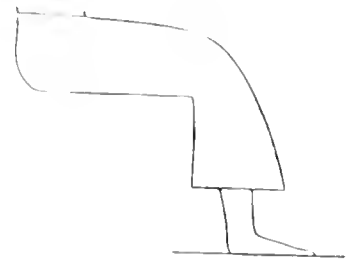

234

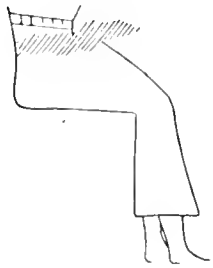

235

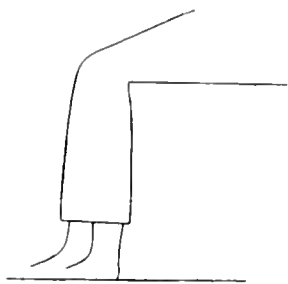

236

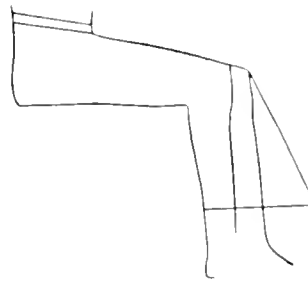

237

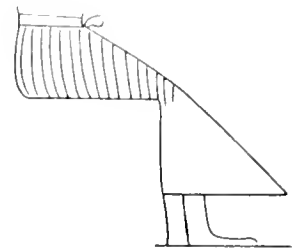

238

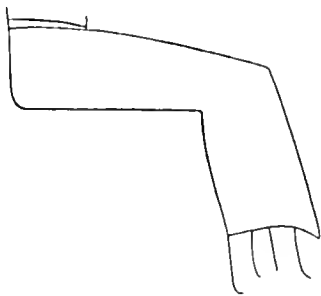

239

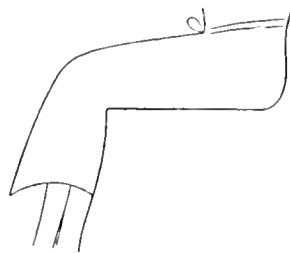

240

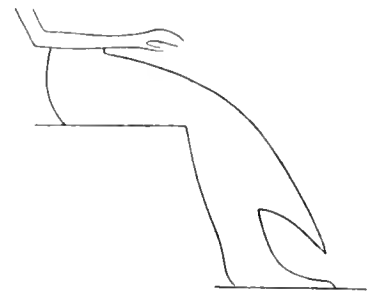

241



242

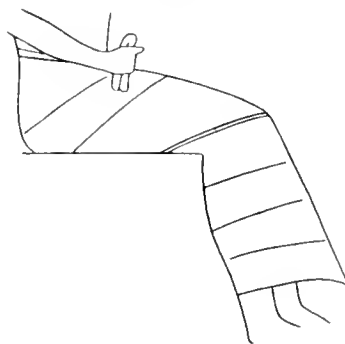

243

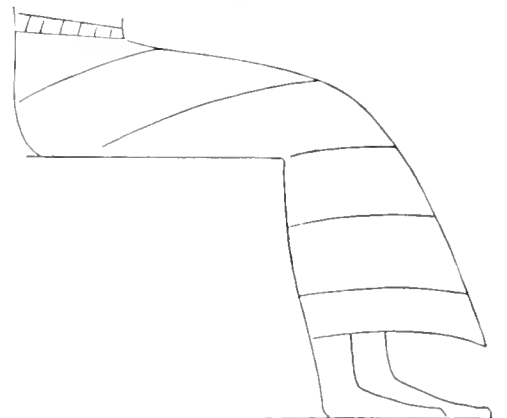

8. Männerschurze.

244

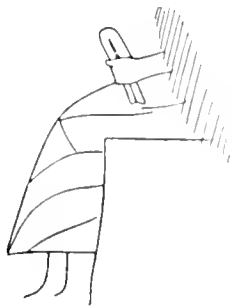

245

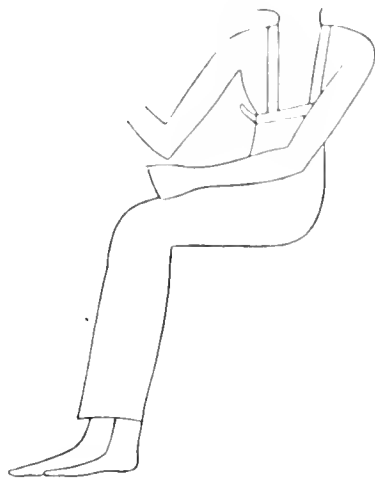

246

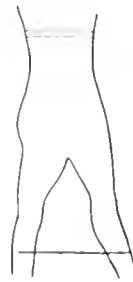

247

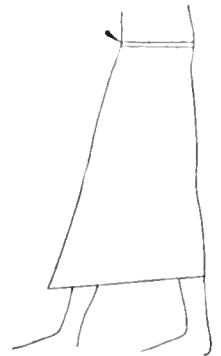

248

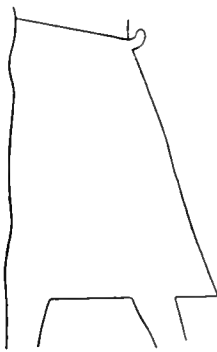

249

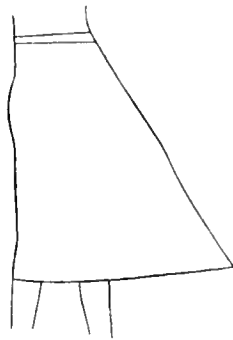

250

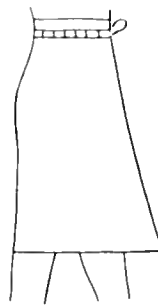

251

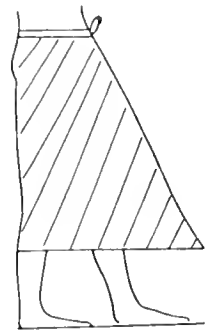

252

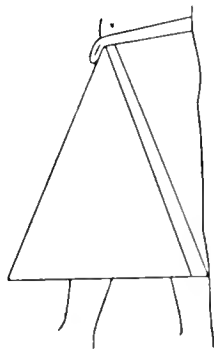

253



254

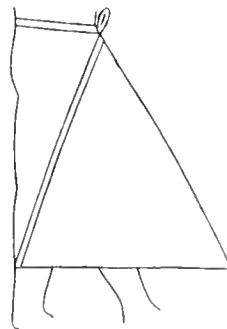

255

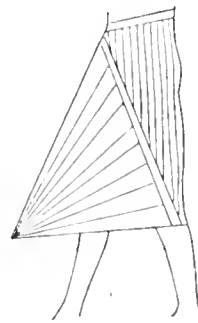

256

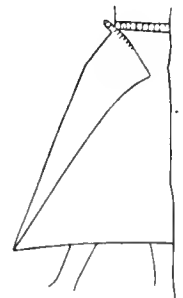

8. Männerschurze.

257



258

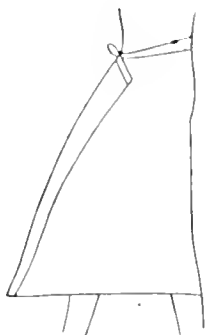

259

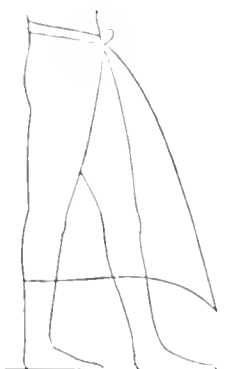

260

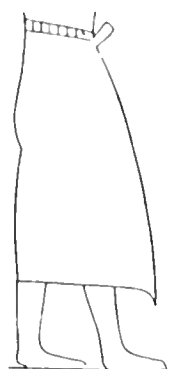

261

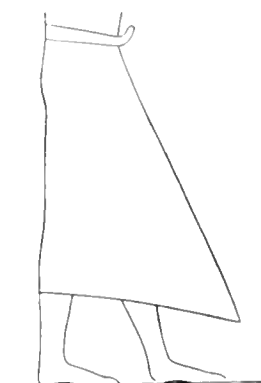

262

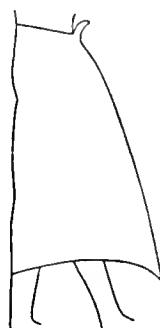

263

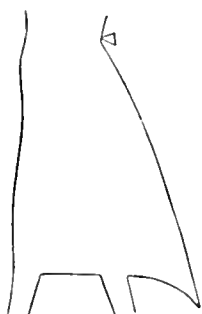

264



265



266



267

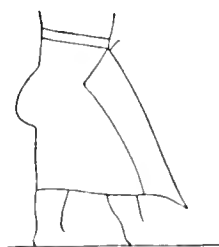

268

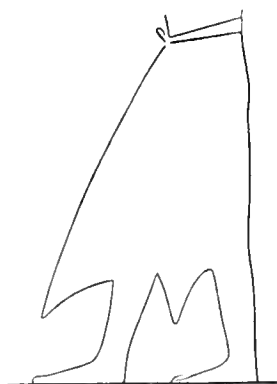

269

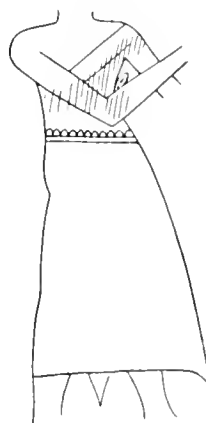

270

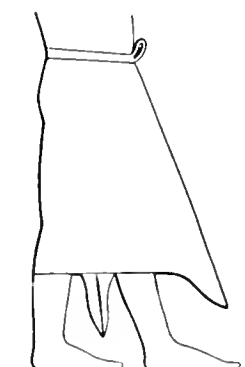

8. Mänerschurze.

271

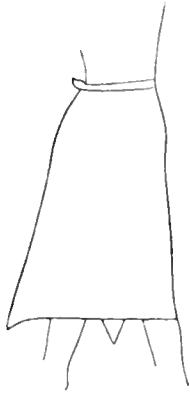

272



273

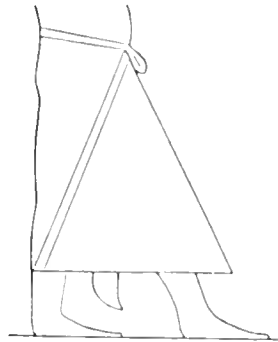

274

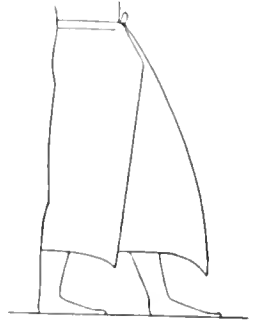

275

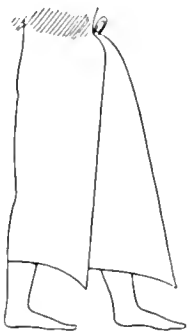

276

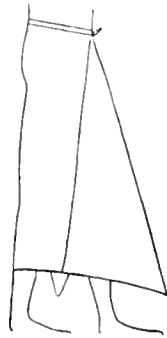

277

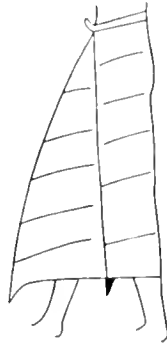

278

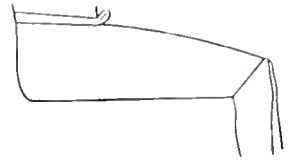

279

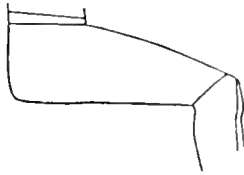

280

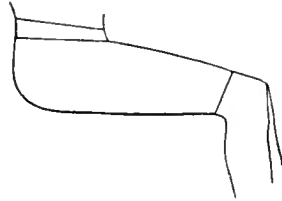

281

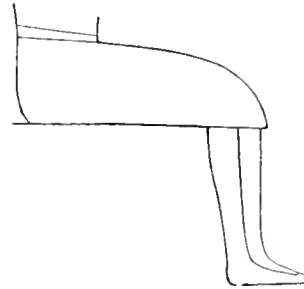

282

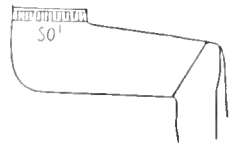

283

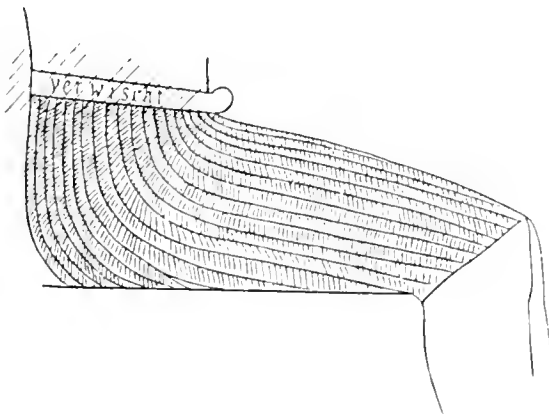

284

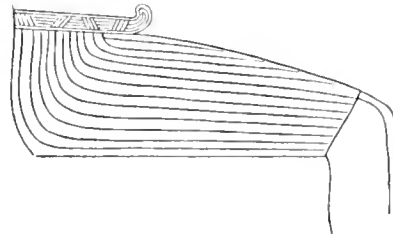

285

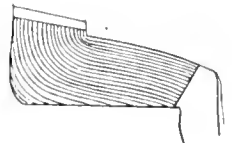

8. Männerschurze.

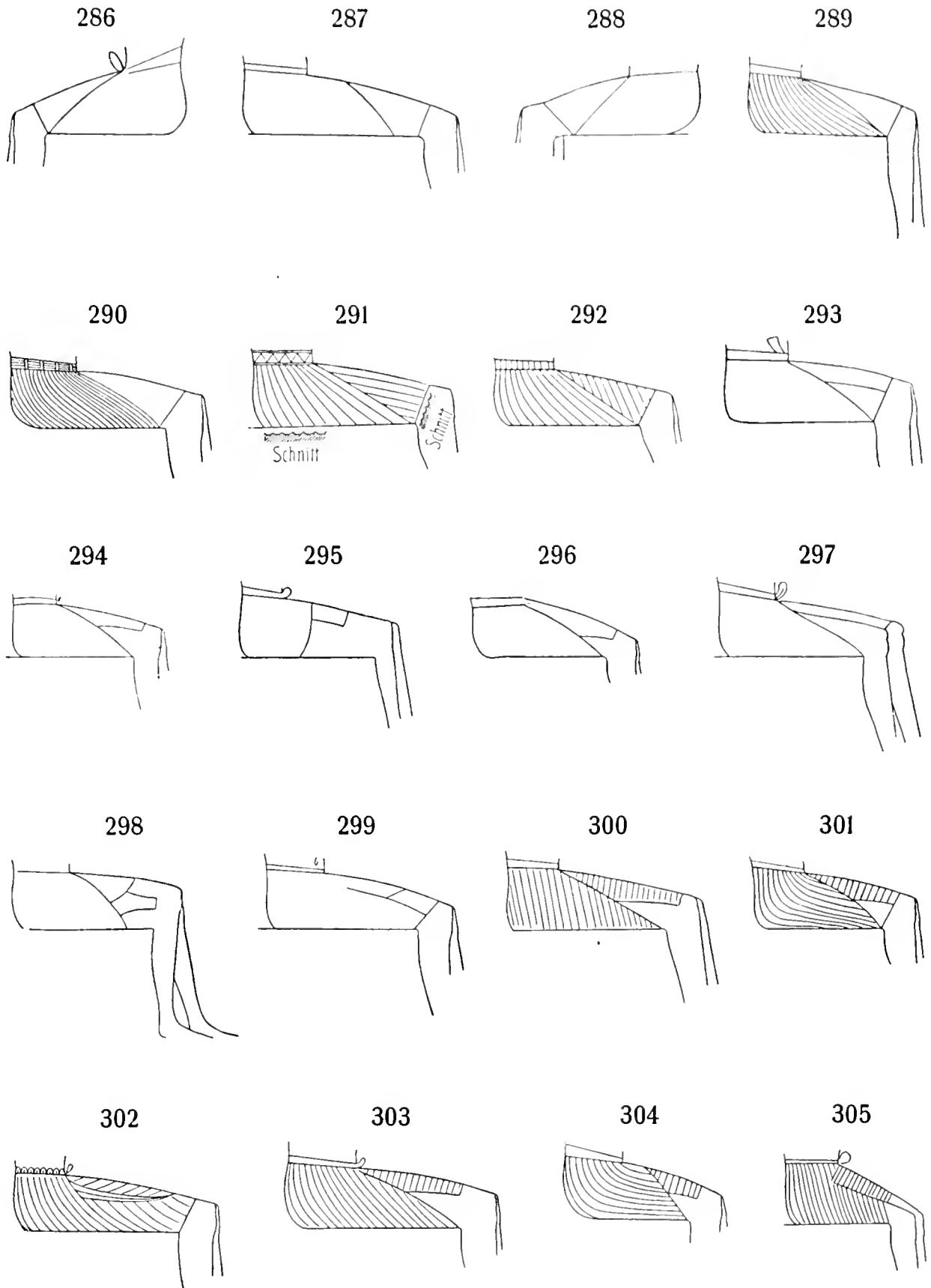

8. Männerschurze.

306

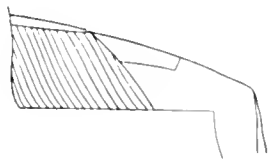

307

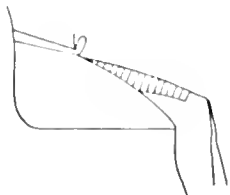

308



309



310

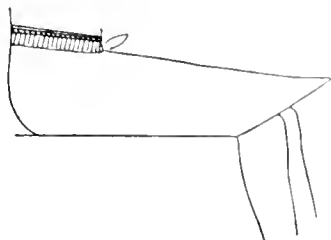

311

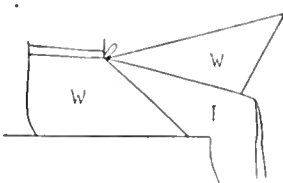

312

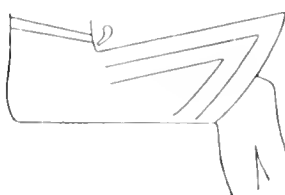

313

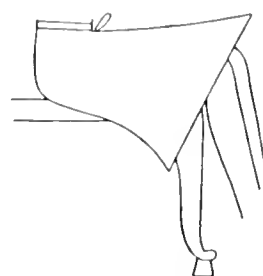

314

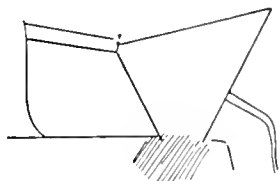

315

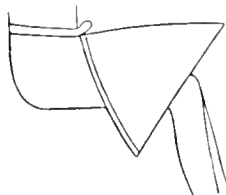

316

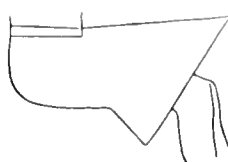

317

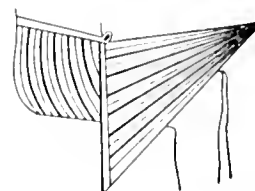

318

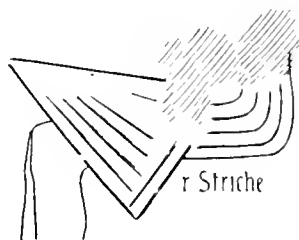

319

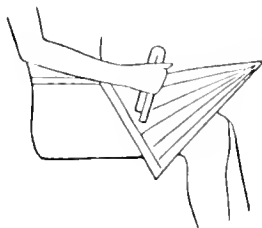

320



321

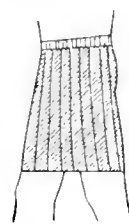

322



323

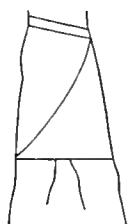

324



325



326

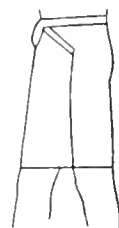

327



8. Männerschurze.

328

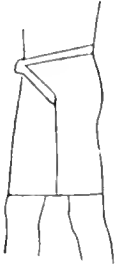

329

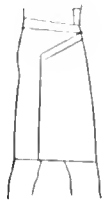

330



331



332

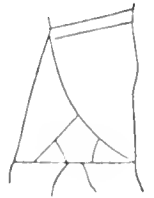

333



334

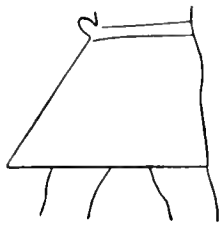

335



336

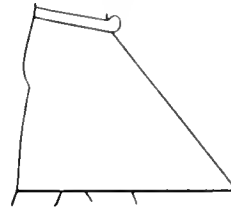

337



338



339



340



341

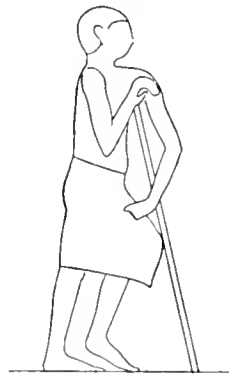

342

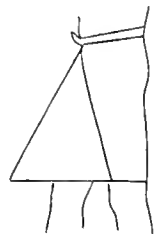

343

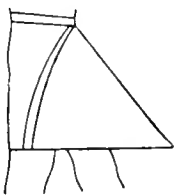

344

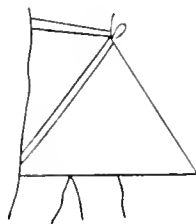

345

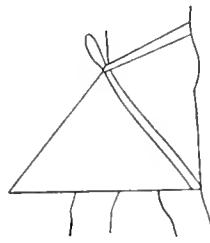

346

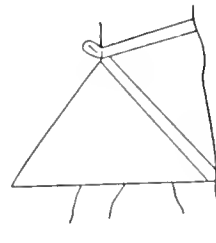

347

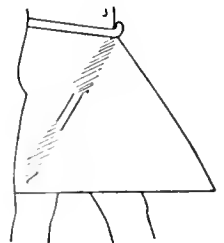

8. Männerschurze.

348

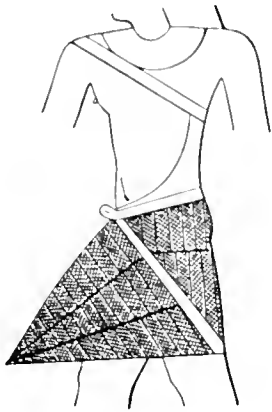

349

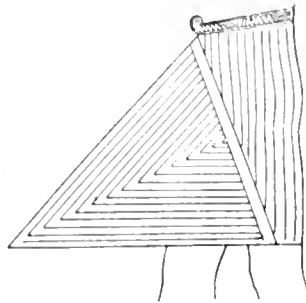

350

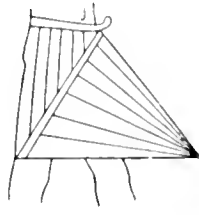

351

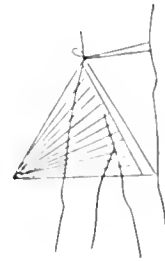

352

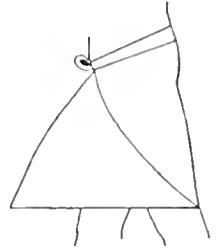

353



354

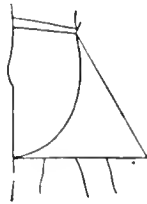

355

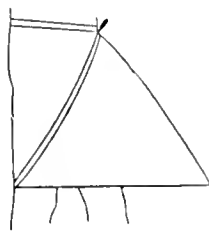

356



357

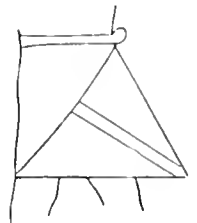

358

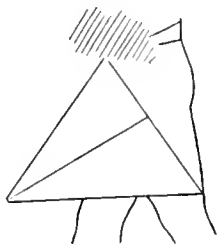

359

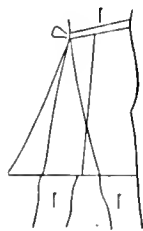

360

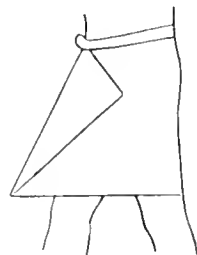

361

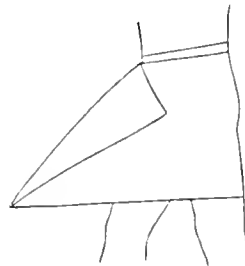

362

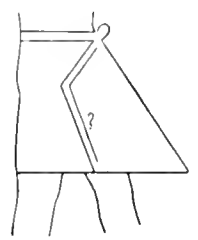

363

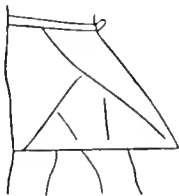

364

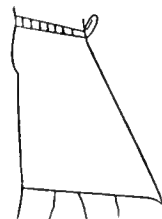

365



366



367

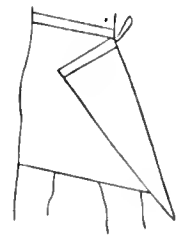

8. Männerschurze.

368



369



370



371



372



geritzte
Linien
Wohl kein
Zufall

373

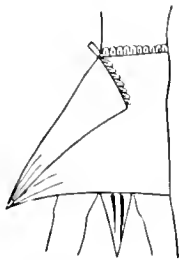

374



abgerie-
ben

375

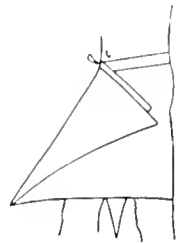

376

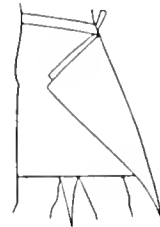

377



378

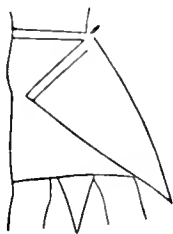

379



380



381



382



383



384

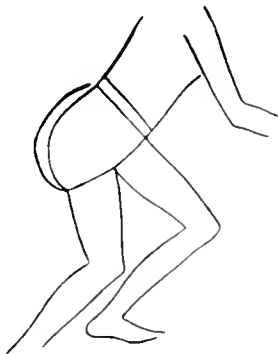

385

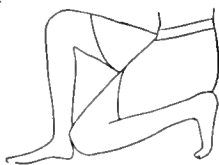

386



387

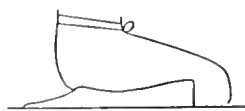

388



8. Mäpperschurze.

389

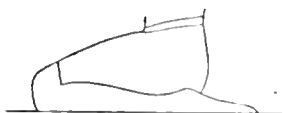

390



391



392



393

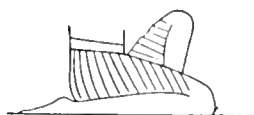

394



395

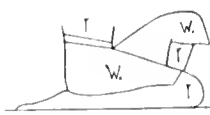

396



397



398



399



400

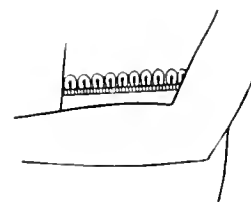

9. PANTHERFELLE.

401

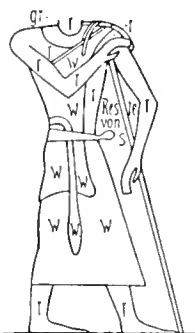

402

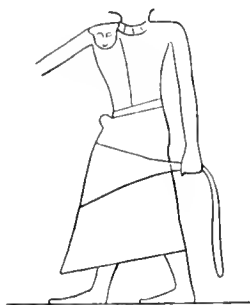

403



404



9. Pantherfelle.

405

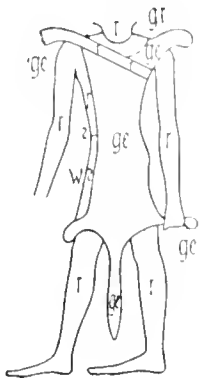

406



407

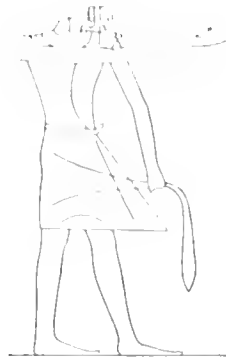

408

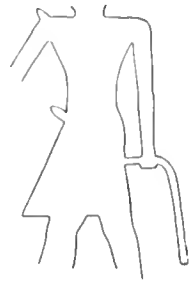

10. BRUSTBÄNDER.

409

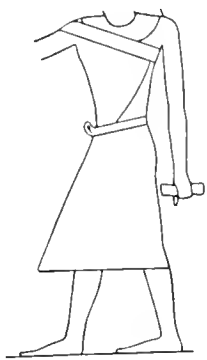

410



411

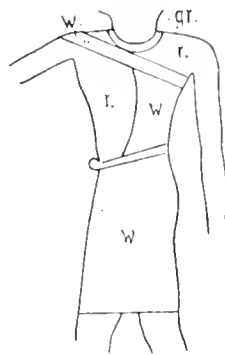

412

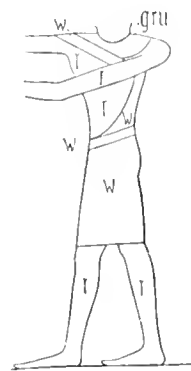

413

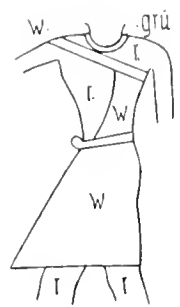

414

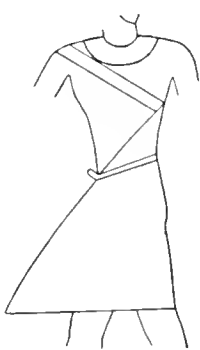

415

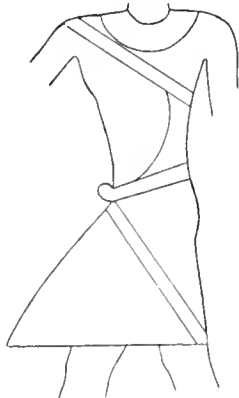

416

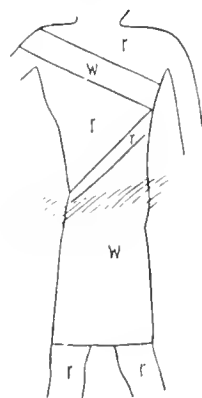

417



418

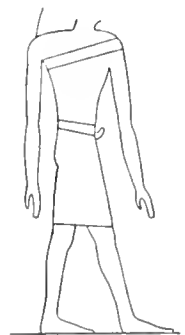

10. Brustbänder.

419

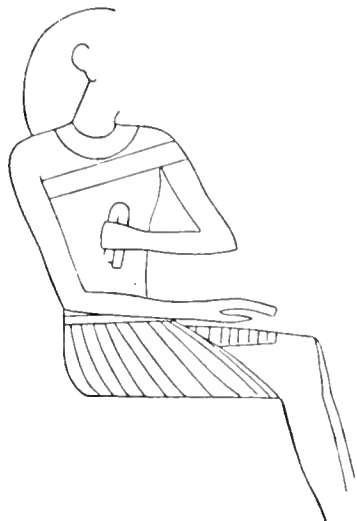

420



421



422



423

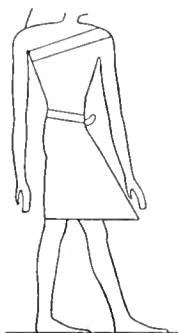

424



425

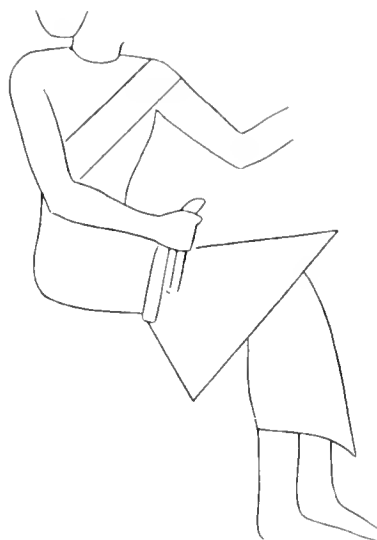

426

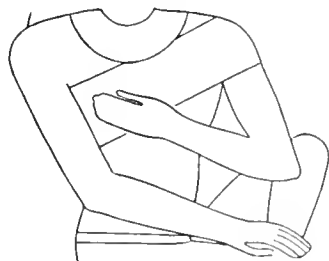

427

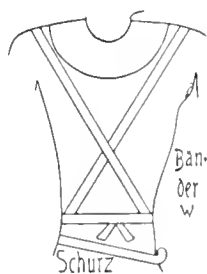

428



II. FRAUENKLEIDER.

429

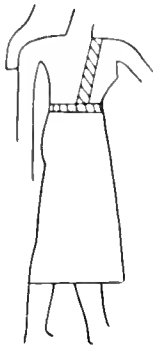

430



431

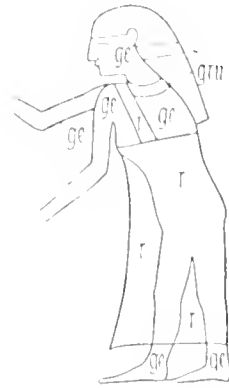

432



433



434



435



436

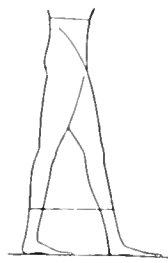

437

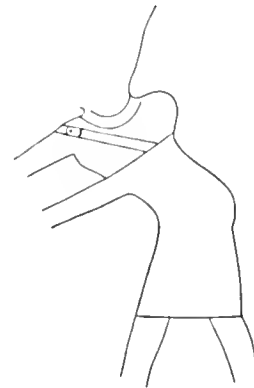

438



439

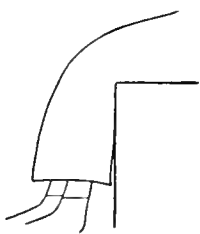

440

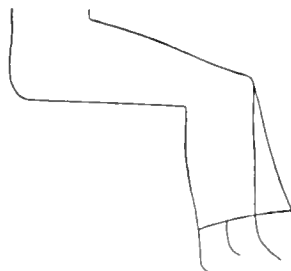

441



442



443

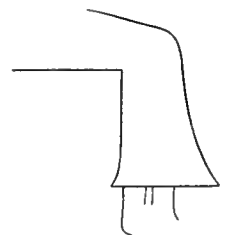

II. Frauenkleider.

444

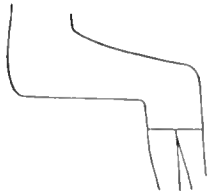

445



446



447

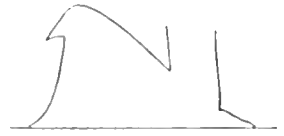

448

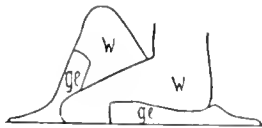

449

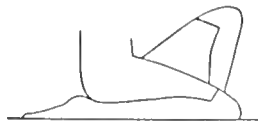

450



451



452



453

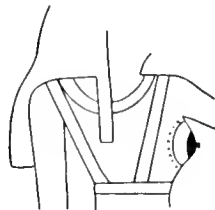

454

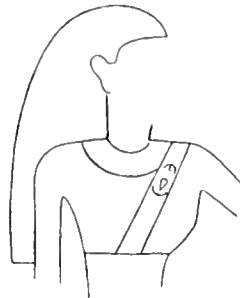

455



456

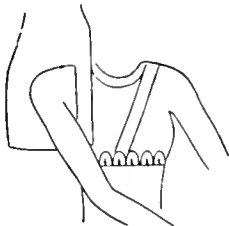

457

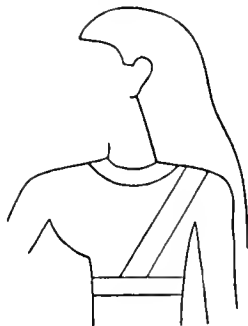

458

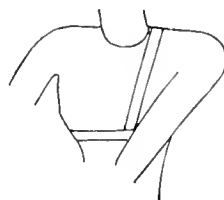

459

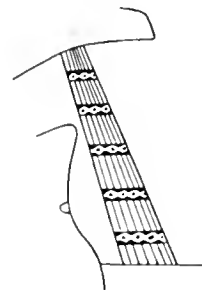

460



461

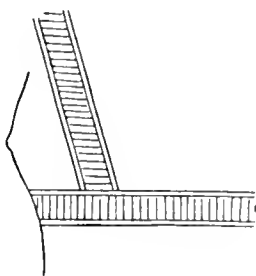

462

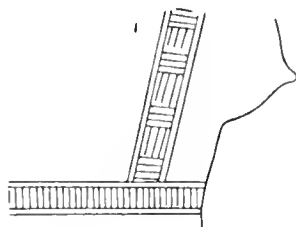

463

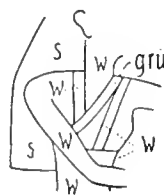

464

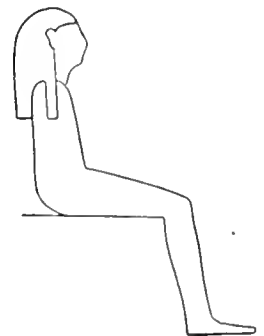

12. TÄTOWIRUNG.

465



13. SANDALEN.

466



467



468

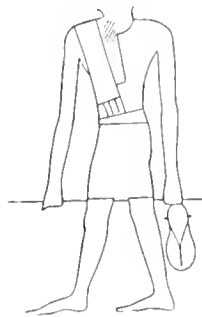

469



14. SALBGEFÄSSE.

470



471

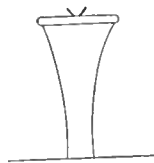

472



473

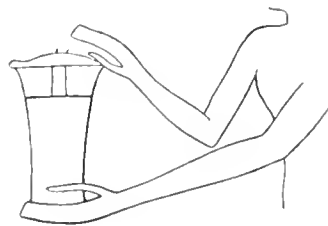

474

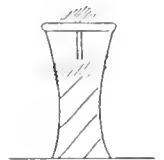

14. Salbgefäße.

475

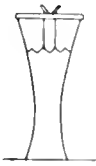

476



477



478

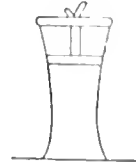

479



480



481



482

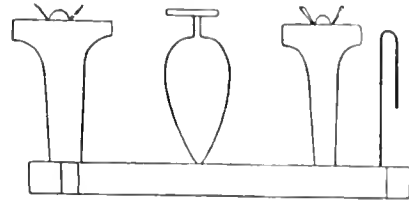

15. SCHMINKTÖPFE.

483

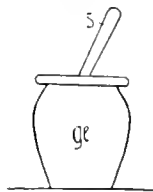

484

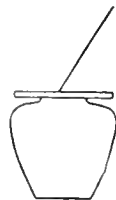

485

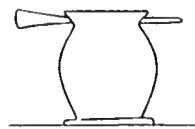

486



487



488

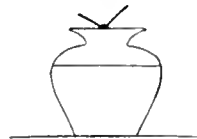

16. SCHMINKBEUTEL.

489



490



491



492



493



17. SPIEGEL.

494



495

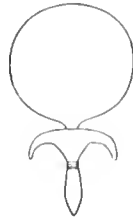

496

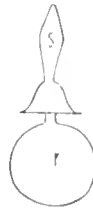

497



498

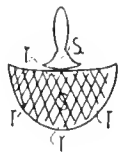

499

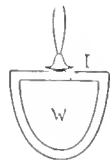

500



501



502



503



504

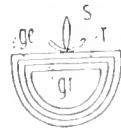

505

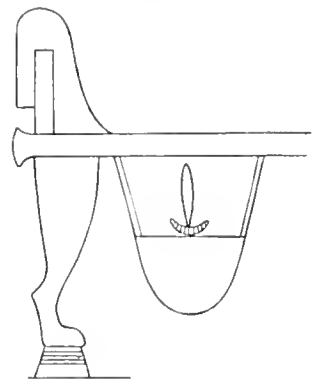

506

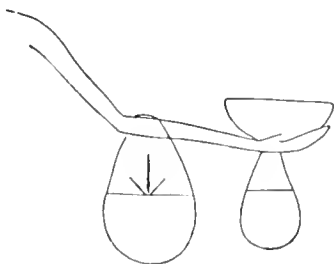

507

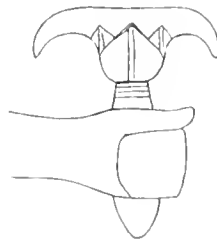

508

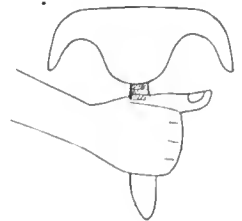

18. WASCHGERÄTIE.

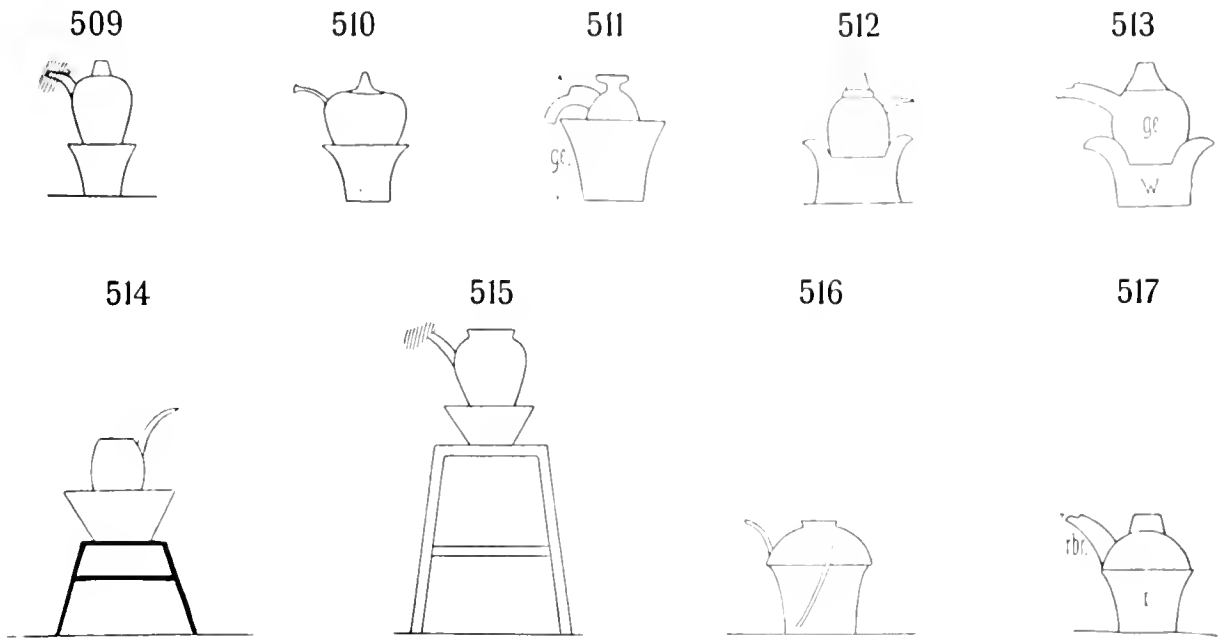

19. KASTEN.

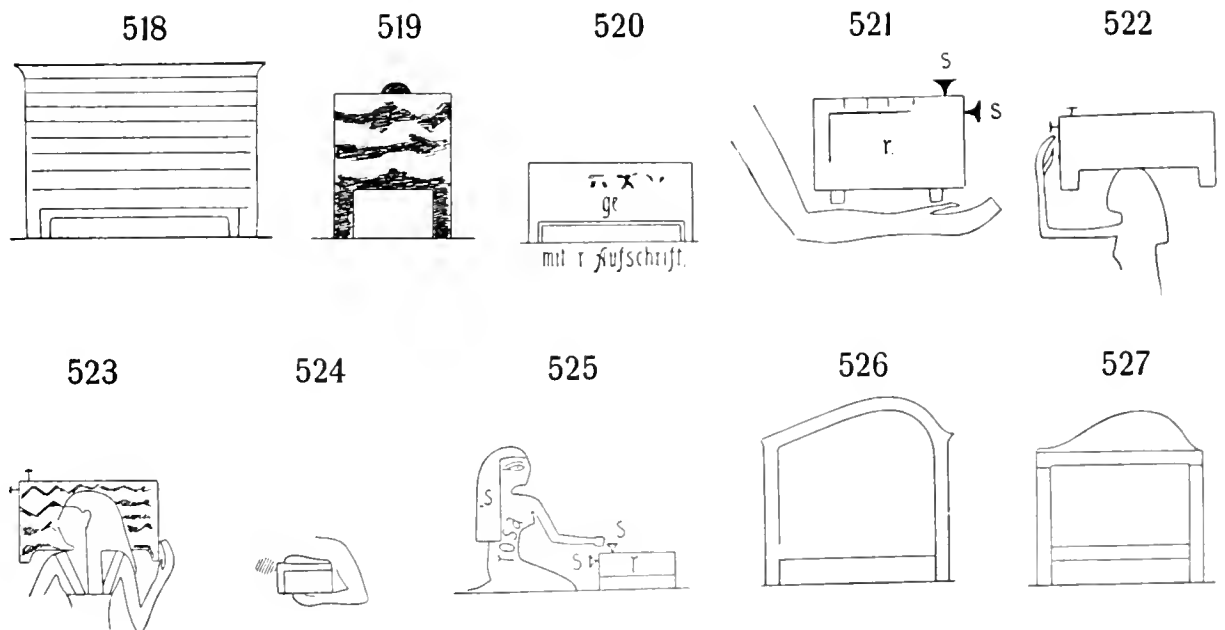

19. Kasten.

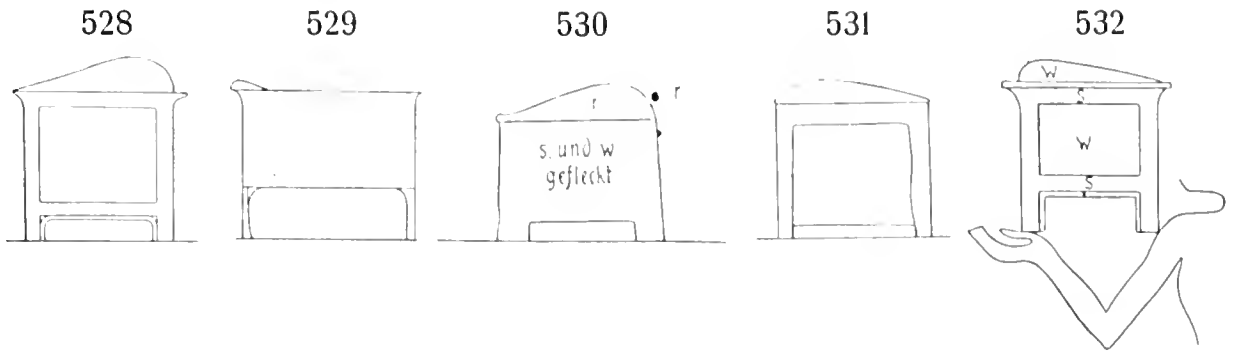

20. WEDEL.

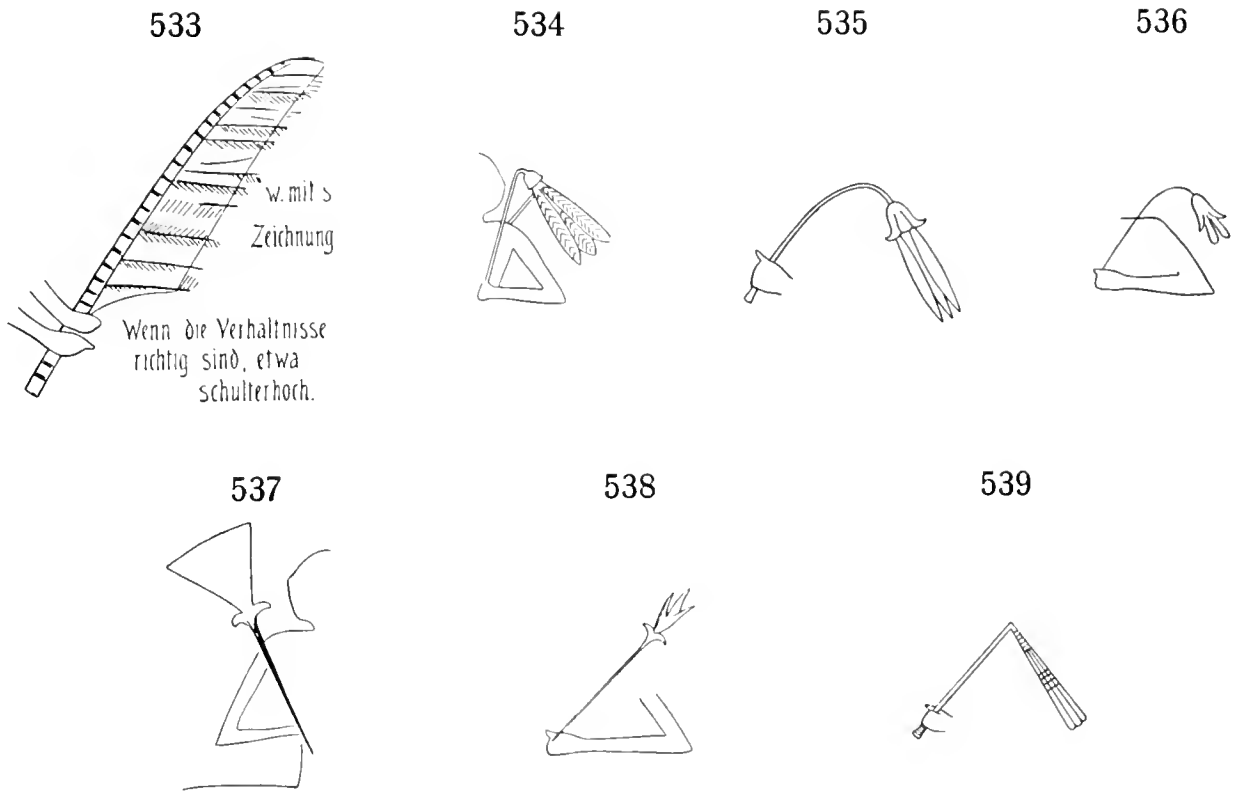

21. SCEPTER.

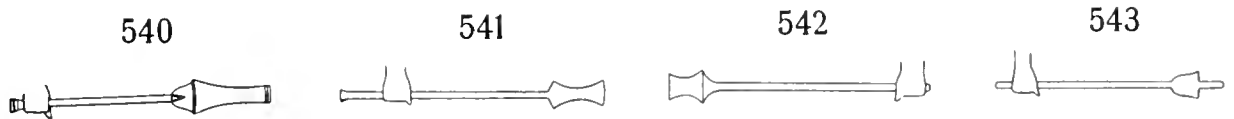

21. Scepter.

544



545



546



547



22. WAFFEN.

548

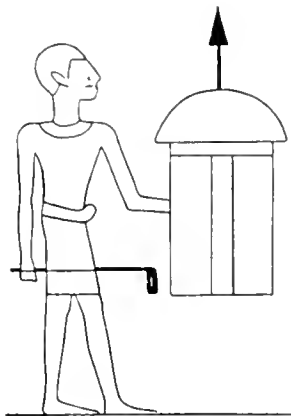

549

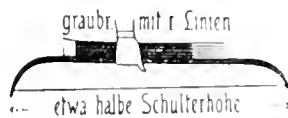

550



551



552



553

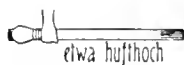

554



555



23. MUSIKINSTRUMENTE.

556



557



558

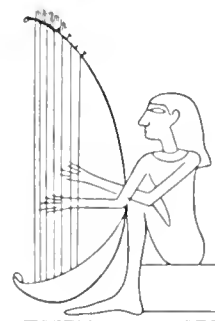

559



24. STÜHLE.

560

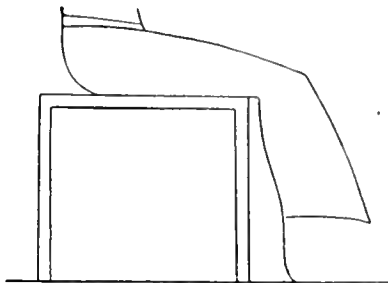

561

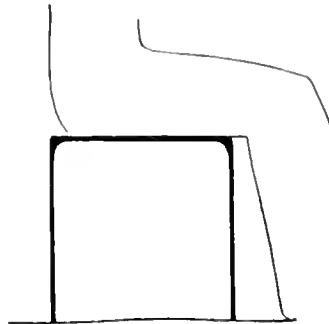

562

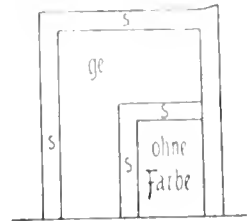

563

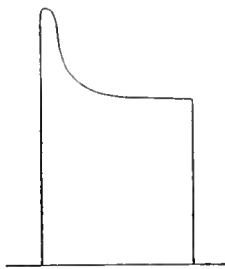

564

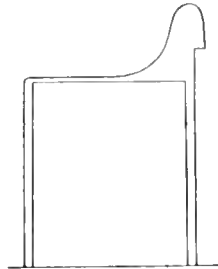

565

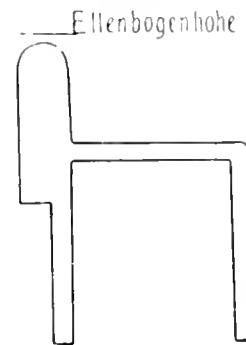

566

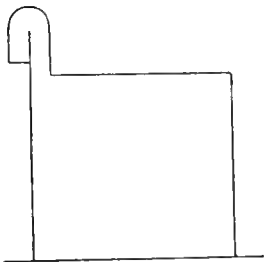

567

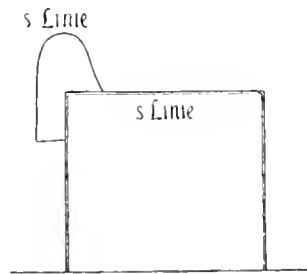

568

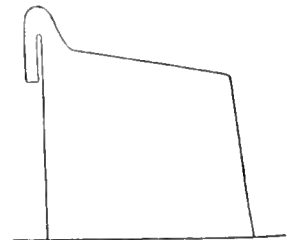

569

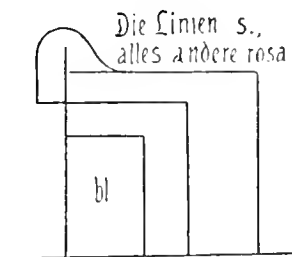

570

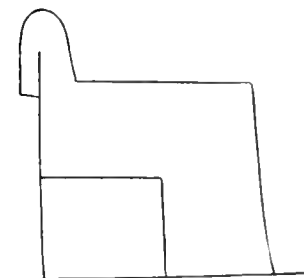

571

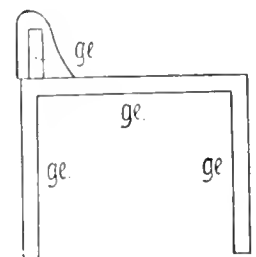

24. Stühle.

572

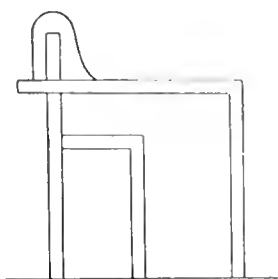

573

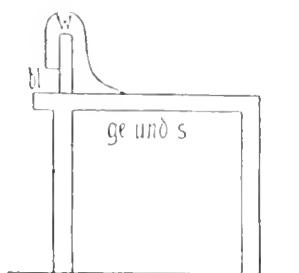

574

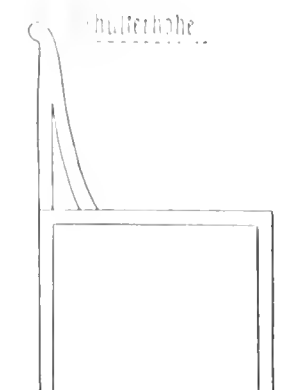

575

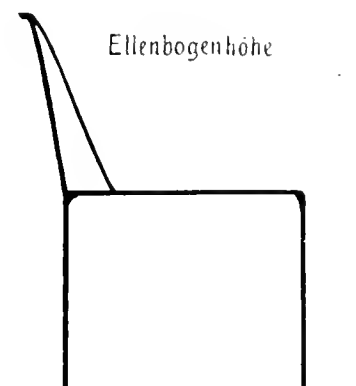

576



577

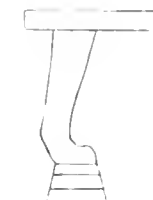

578

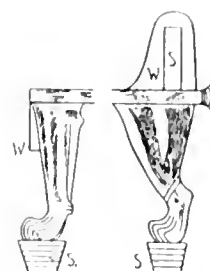

579

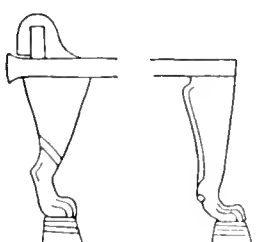

580

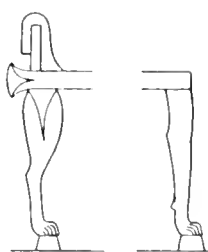

581

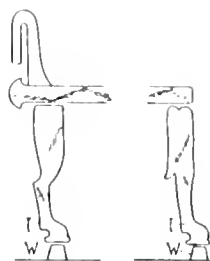

582

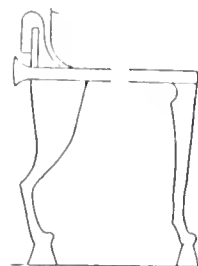

583

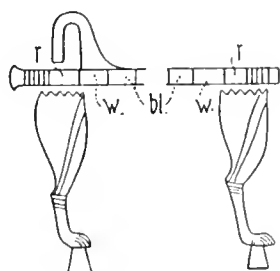

584

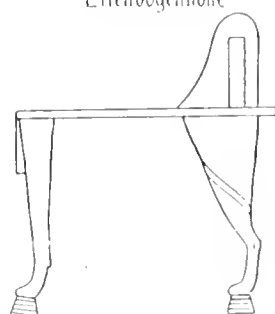

585

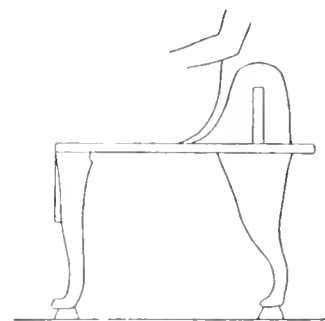

24. Stühle.

586

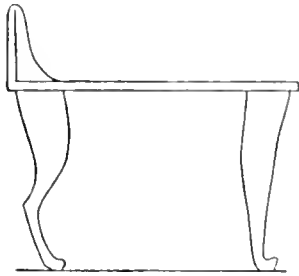

587

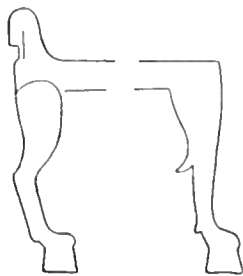

588

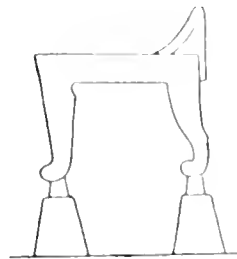

589



590

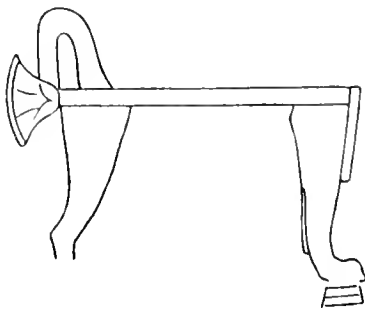

591

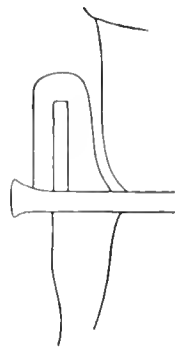

592

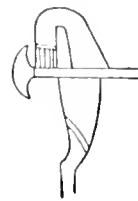

593

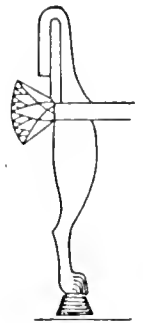

594

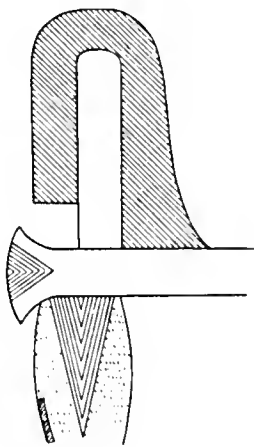

595

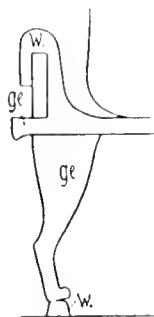

596



597

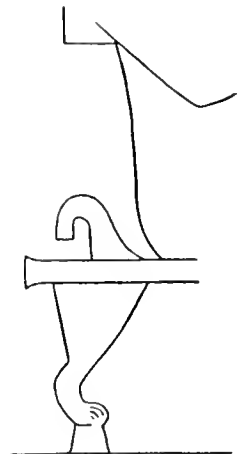

598

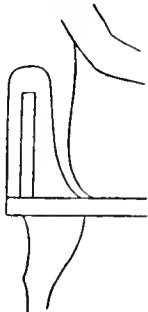

599

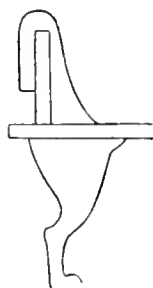

600

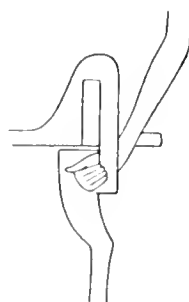

601

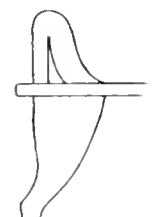

24. Stühle.

602

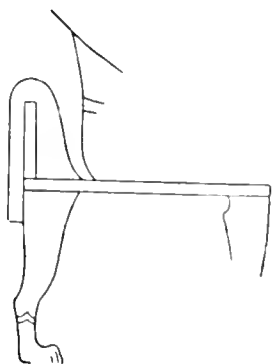

603

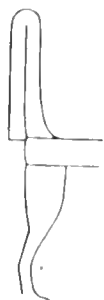

604



605

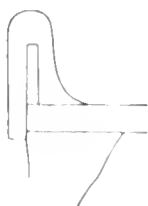

606



607

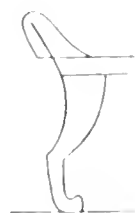

608

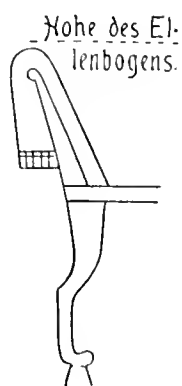

609

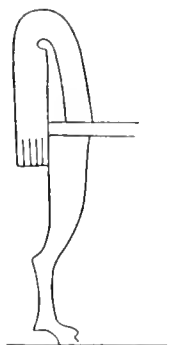

610

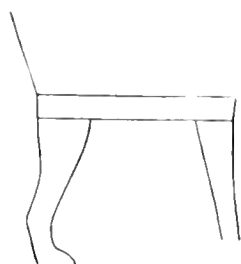

611

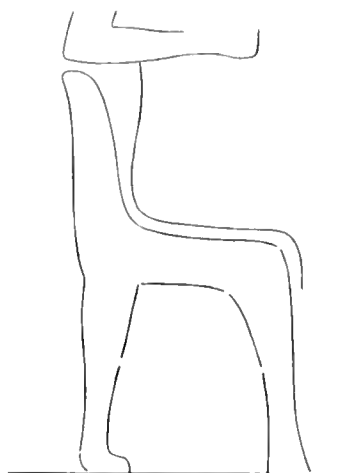

612

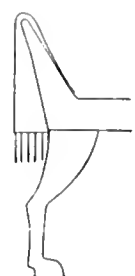

613

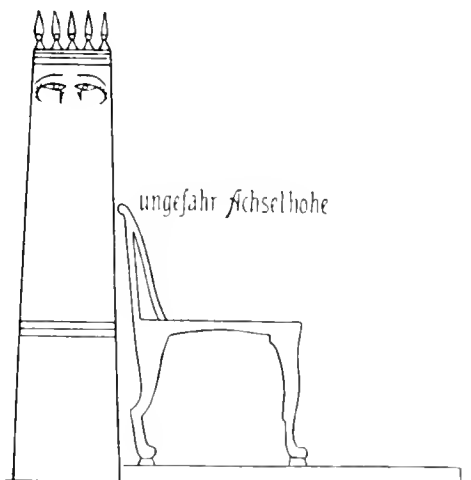

614

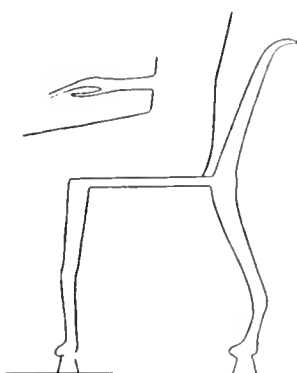

615

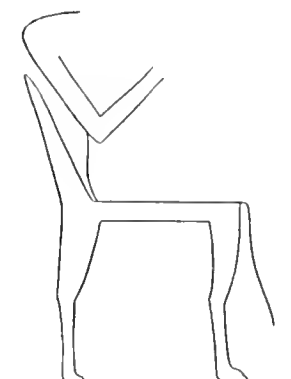

24. Stühle.

616

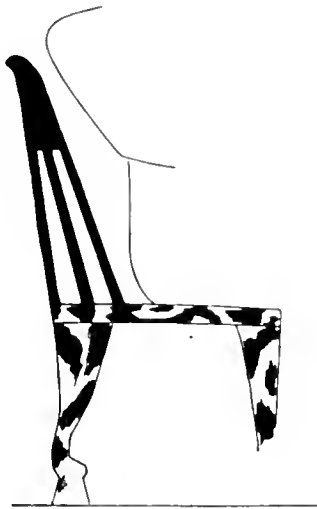

617

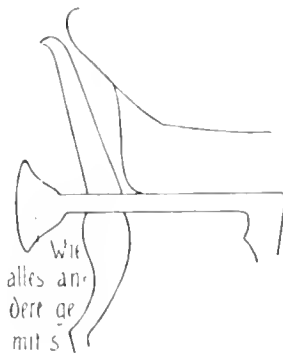

618



619

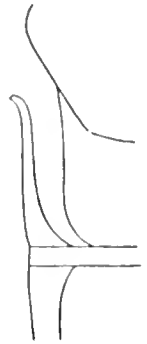

620

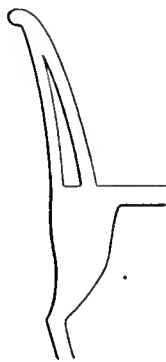

621

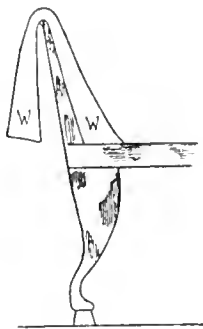

622



623

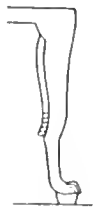

624



625



626

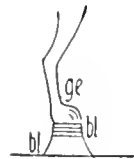

627



628

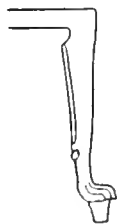

629

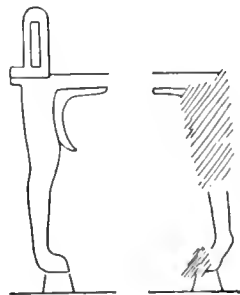

630



631

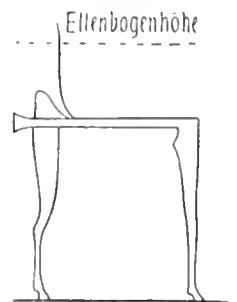

24. Stühle.

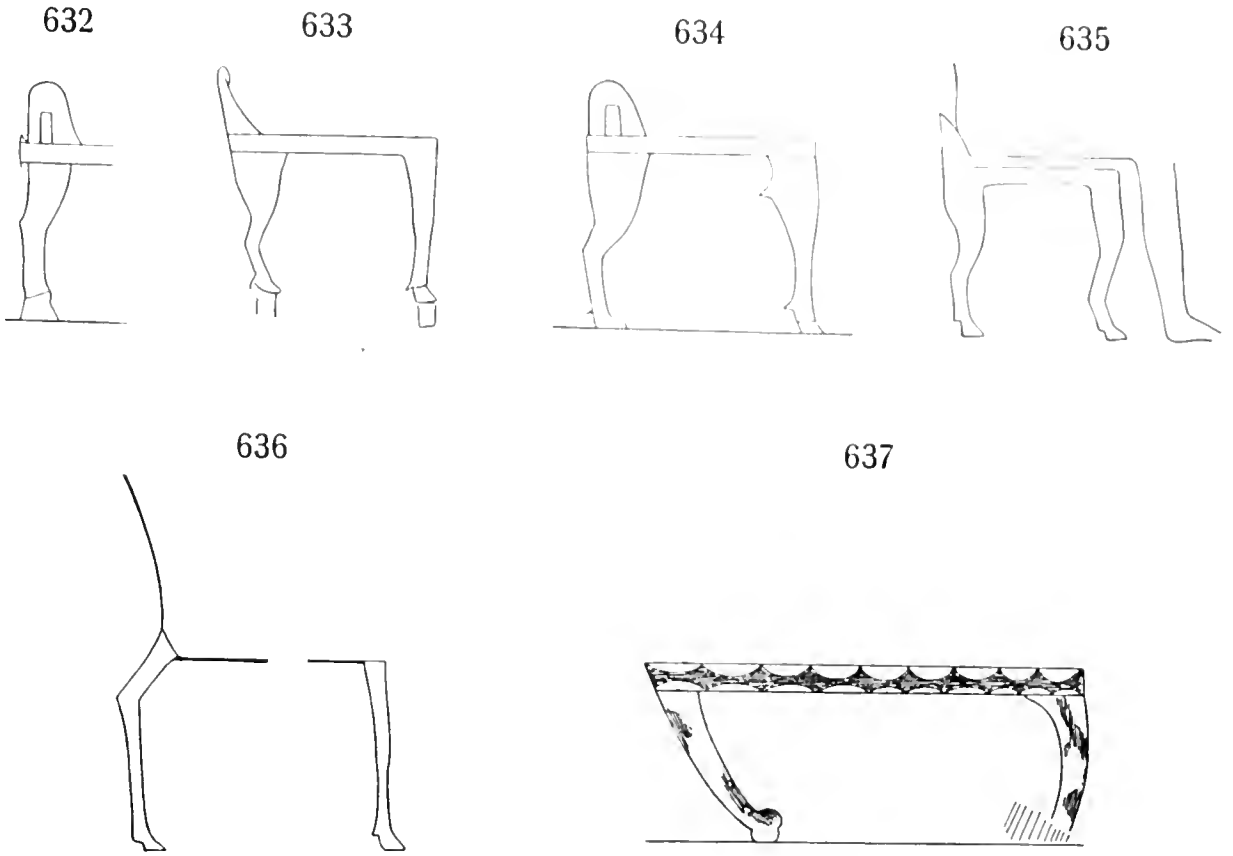

25. TISCHE.

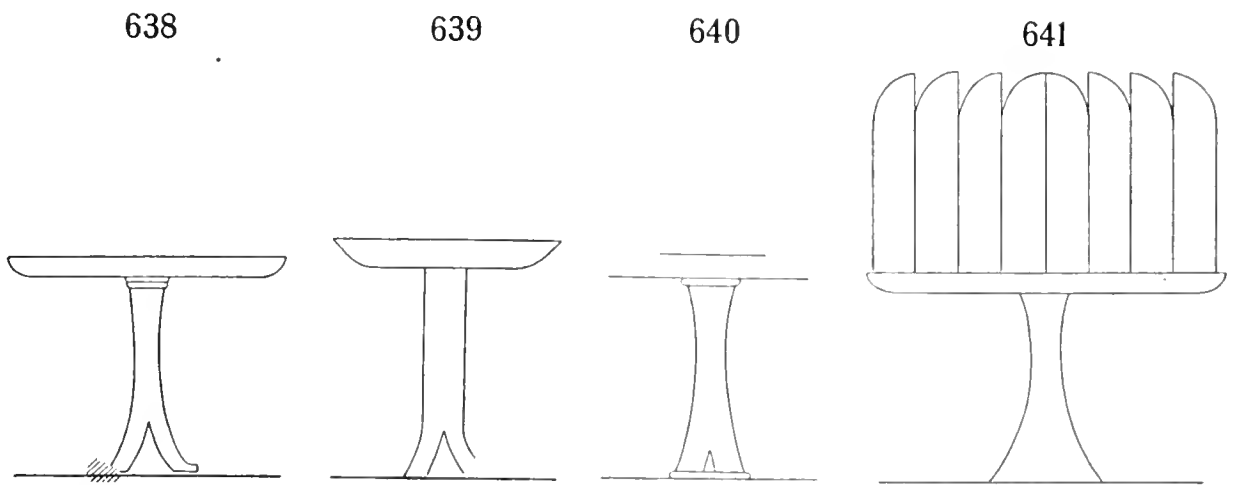

25. Tische.

642

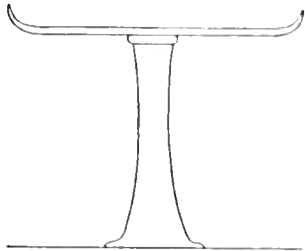

643

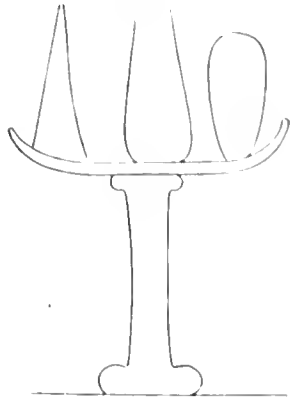

644

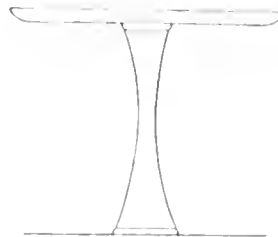

645

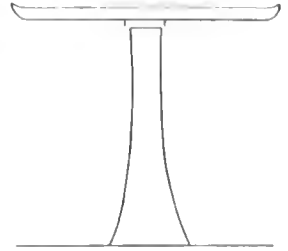

646

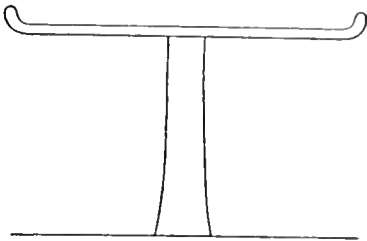

647

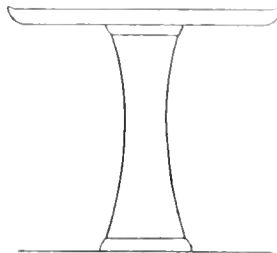

648

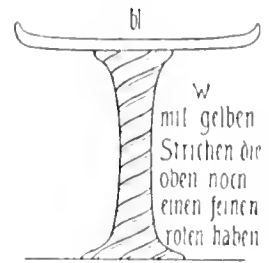

649

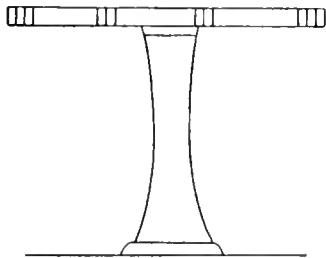

650

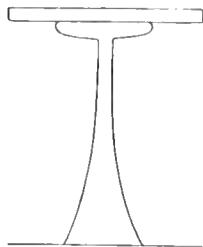

651

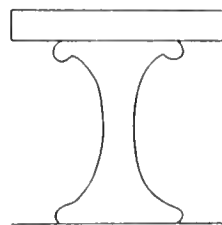

652

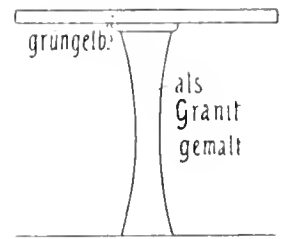

653

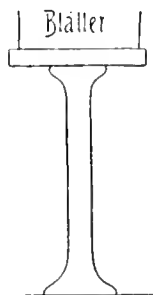

654

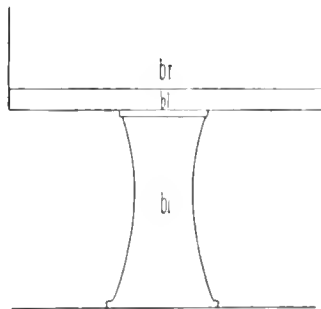

655

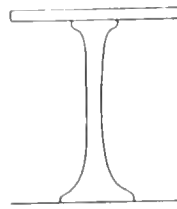

656

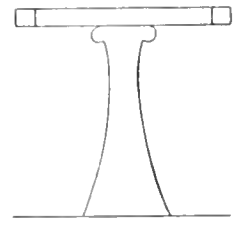

25. Tische.

657

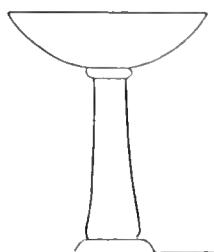

658

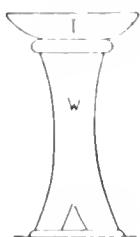

659

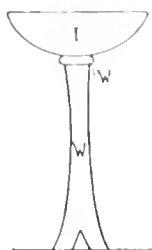

660

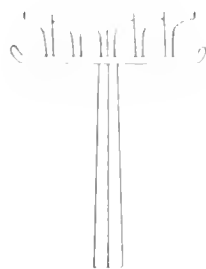

661

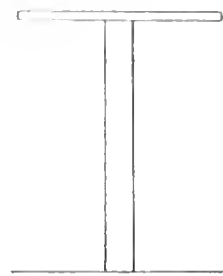

662

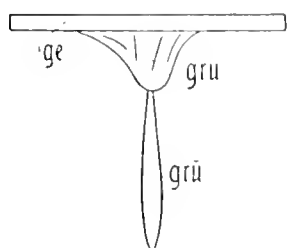

663

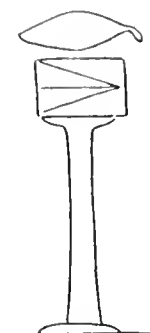

664

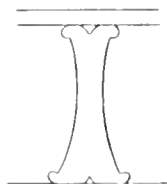

665

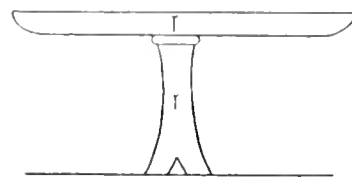

666

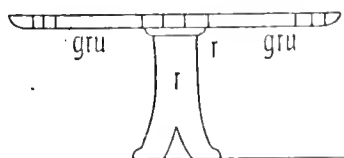

667

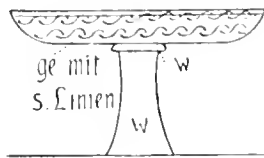

668

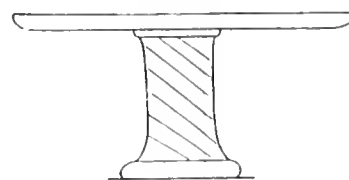

669

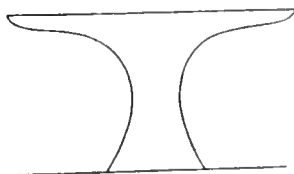

670

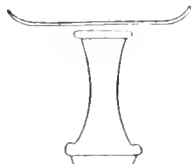

671

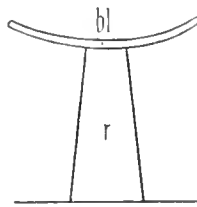

672

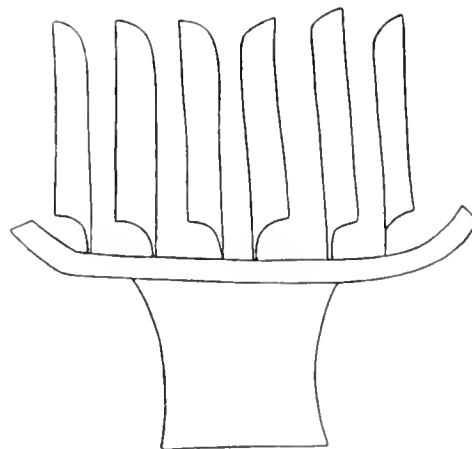

25. Tische.

673

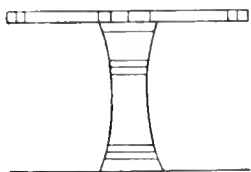

674

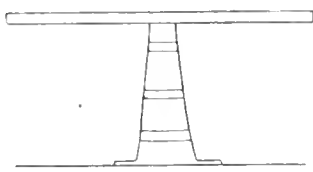

675

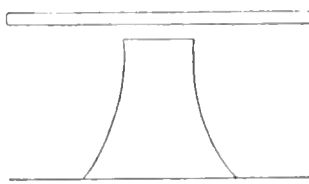

676

Rinderkeule, Gans - usw

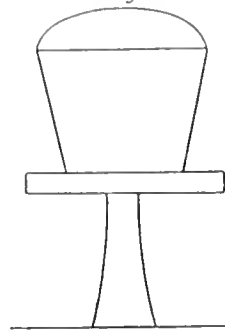

677

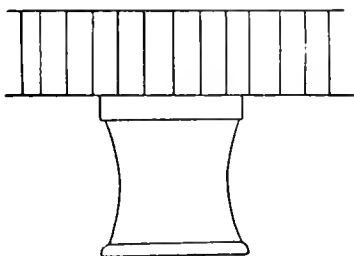

678

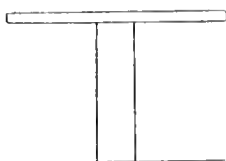

679

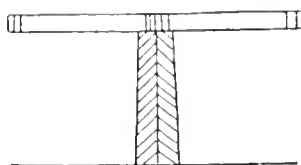

680

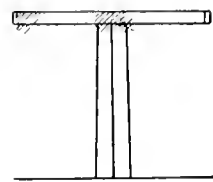

681

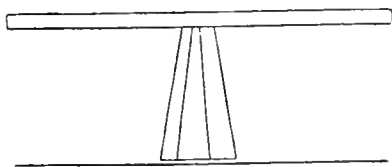

682



683

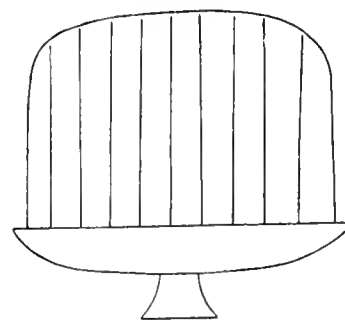

684

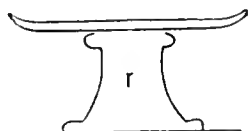

685

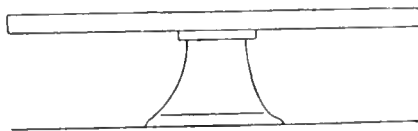

686

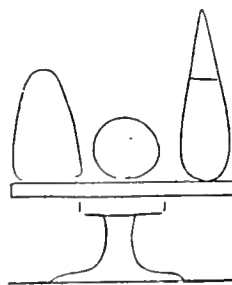

687

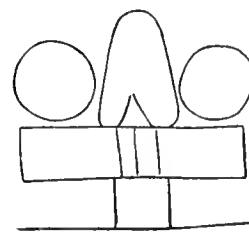

25. Tische.

688

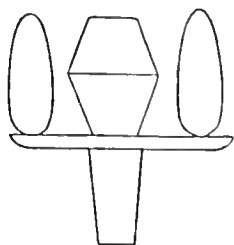

689



690

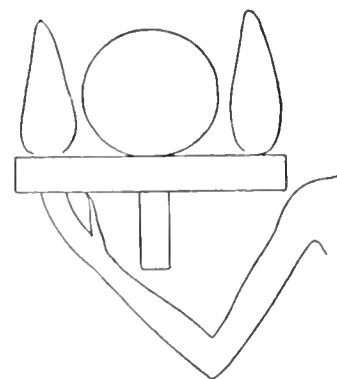

26. GESTELLE.

691

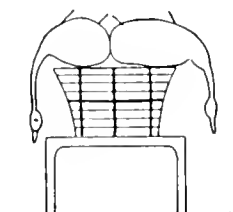

692



693

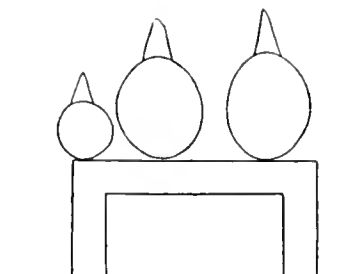

694

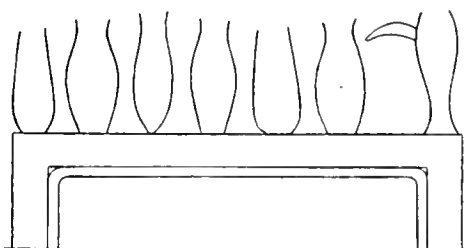

695

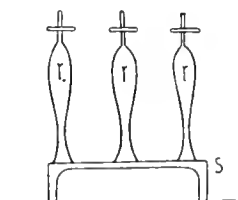

696

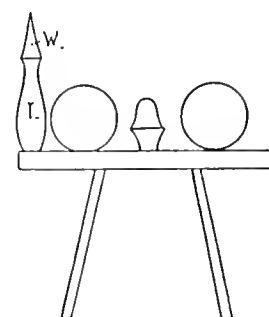

697

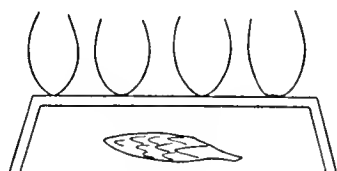

698



699

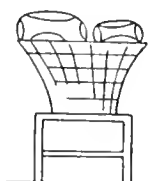

700

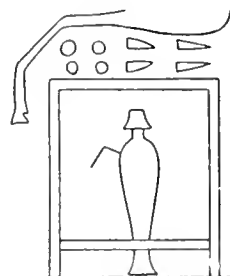

701



26. Gestelle.

702



703

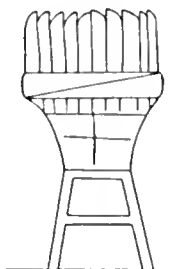

704

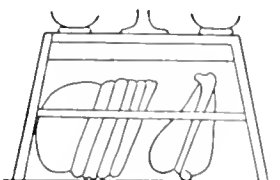

705

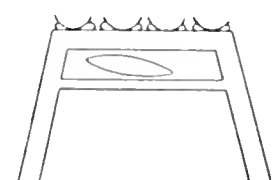

706

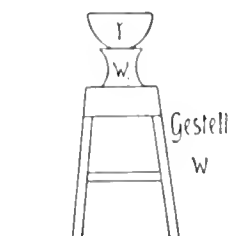

707

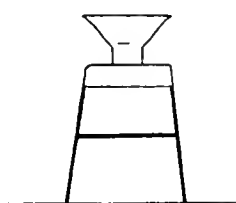

708

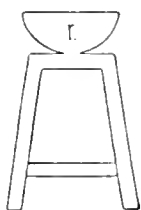

709

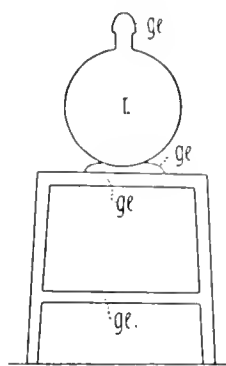

710



711

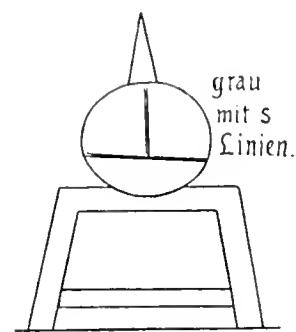

712

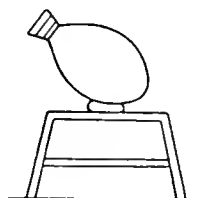

713

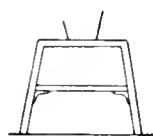

714



715

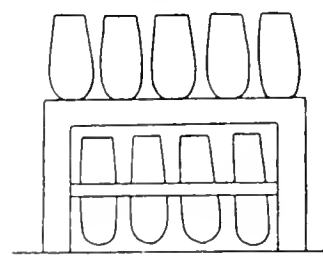

716

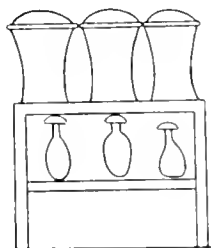

717

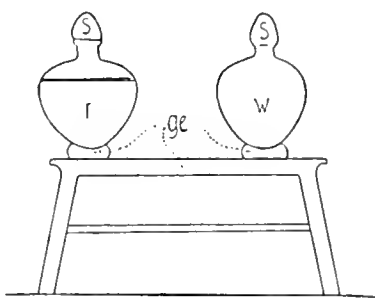

718

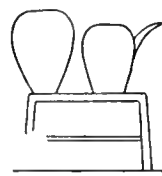

719

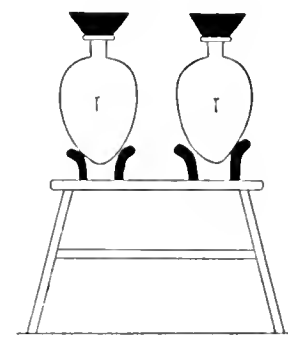

26. Gestelle.

720

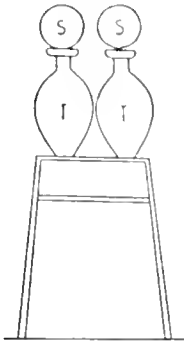

721

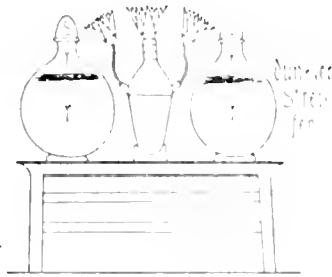

722

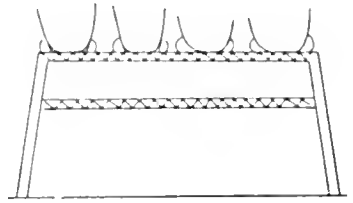

723

Spitzbrote

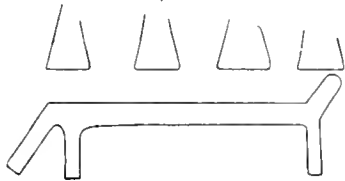

724

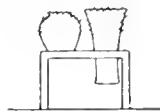

725

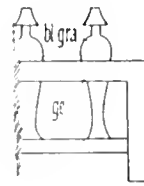

726



727

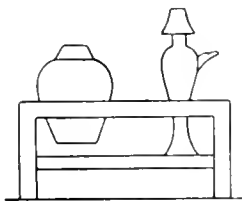

728



729

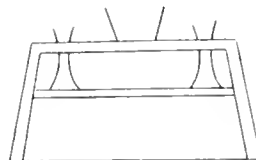

730



731

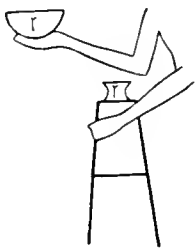

732

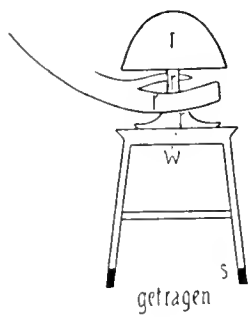

733



734

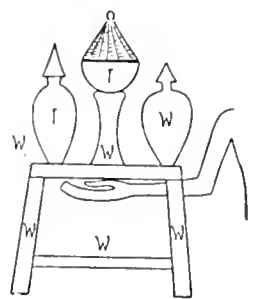

26. Gestelle.

735

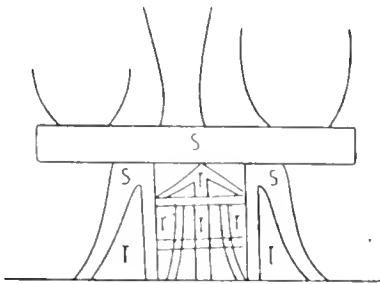

736

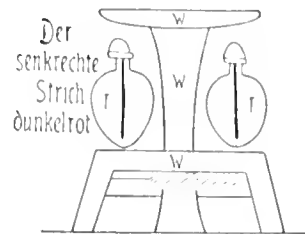

737

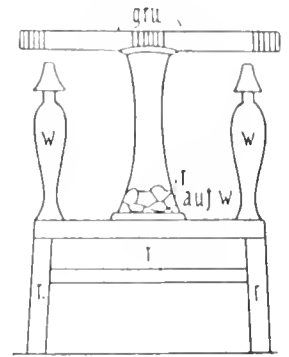

27. SÄULEN.

738



739

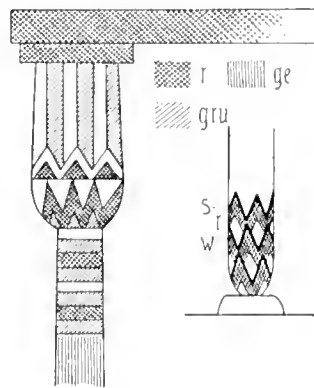

740

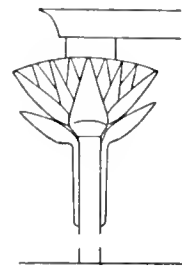

28. GEFÄSSE.

A. SCHALEN.

741

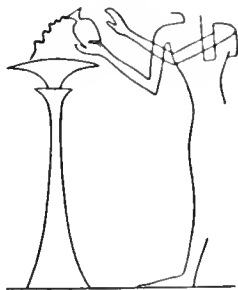

742



743



744

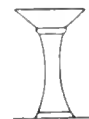

745

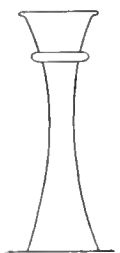

28. Gefäße. A. Schalen.

746

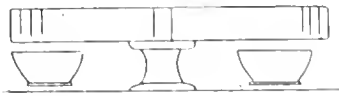

747



748



749



750

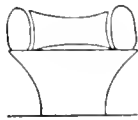

751



752



753

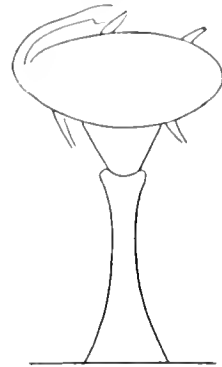

754

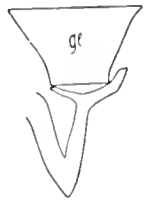

755



756



757



758



759

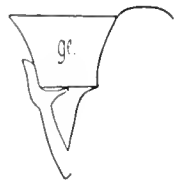

760

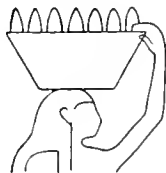

761



762

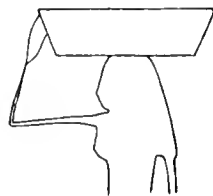

763



764

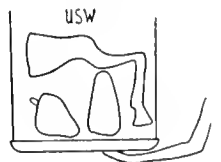

765



766



767



768



769



28. Gefässe. A. Schalen.

770



771



772

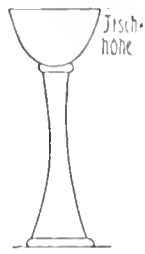

773



774



775

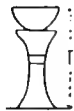

776



777

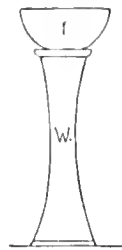

778



779

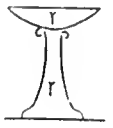

780

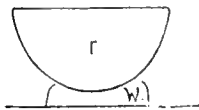

781



782



783



784



785

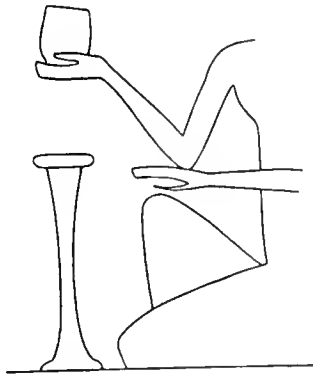

786



787



788



789

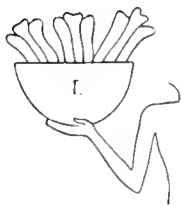

790

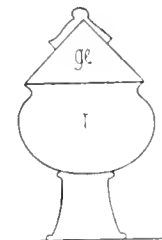

791

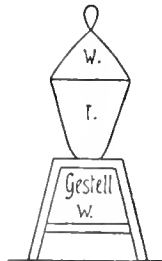

792

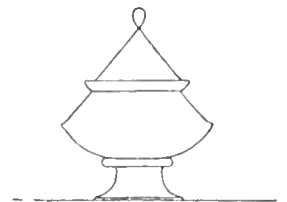

28. Gefässe. A. Schalen.

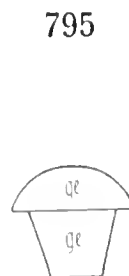
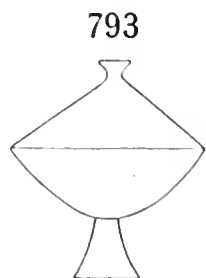

B. KRÜGE.

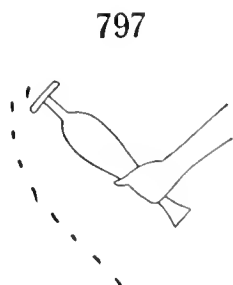
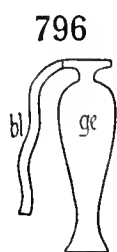

801



802



803



804



805



806

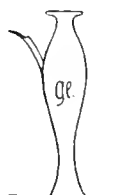

807



808

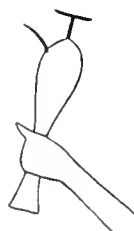

809



810



811

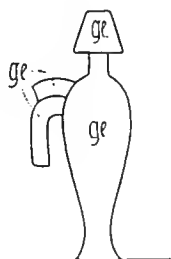

812



813



814

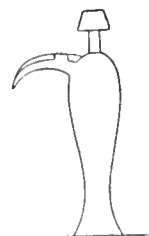

815



28. Gefässe. B. Krüge.

816

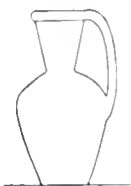

817



818

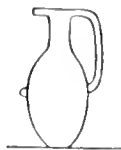

819



820



821

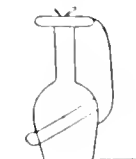

822



823

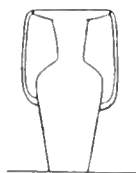

824



825



826



827



828



829



830



831

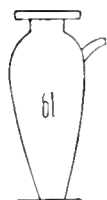

832

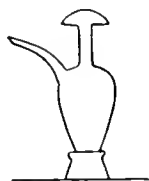

833



834

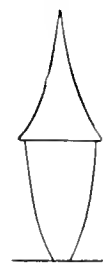

835

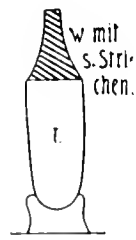

836

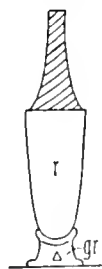

837

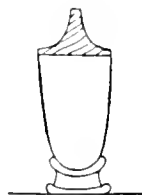

838

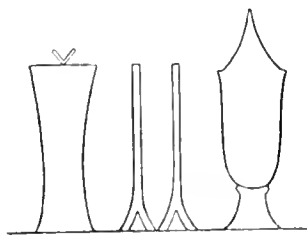

839



28. Gefässe. B. Krüge.

840



841

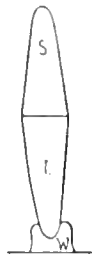

842

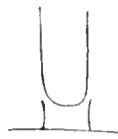

843

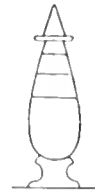

844



845



846

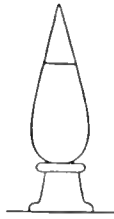

847

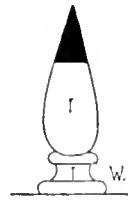

848

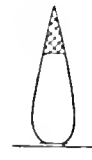

849

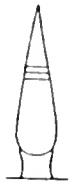

850



851



852

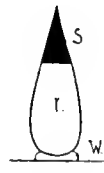

853



854

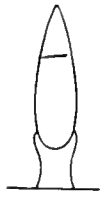

855

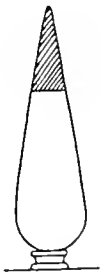

856



857

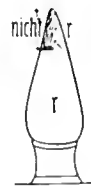

858

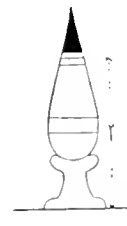

859



860



861

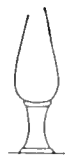

862

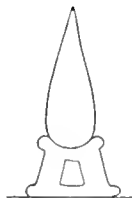

863

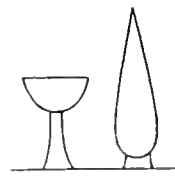

864



28. Gefässe. B. Krüge.

865

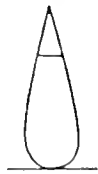

866

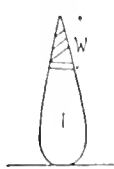

867



868



869

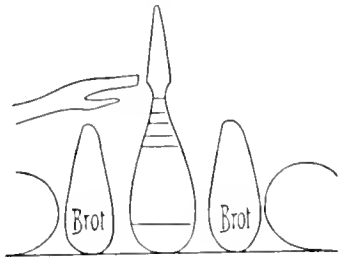

870



871

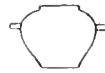

872



873

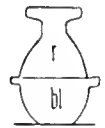

874



875

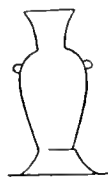

876



877



878

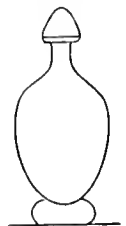

879

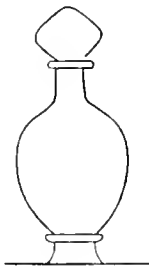

880

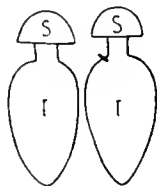

881

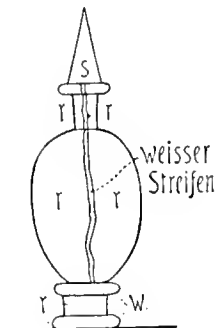

882

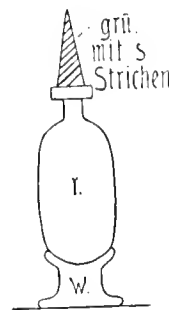

883

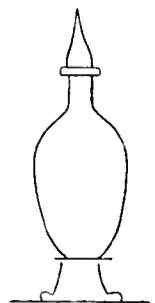

884

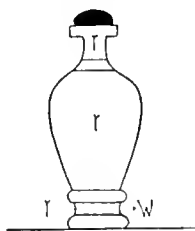

885

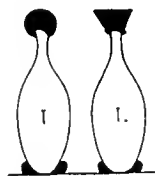

886



887



888

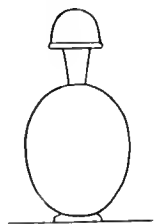

28. Gefässe. B. Krüge.

889

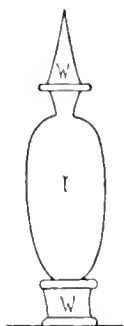

890



891



892



893

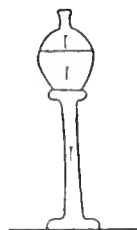

894



895



896



897



898

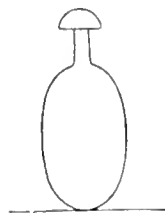

899

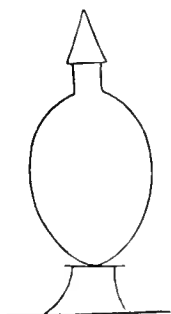

900

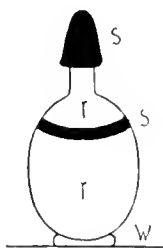

901



902



903



904



905



906

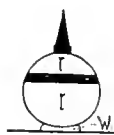

907



908



28. Gefässe. B. Krüge.

909



910

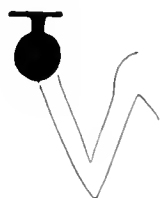

911



912



913

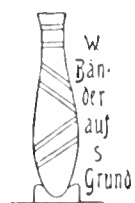

914



915



916



917

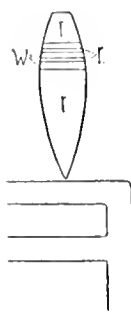

918

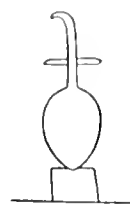

919



920



921

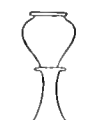

922



923

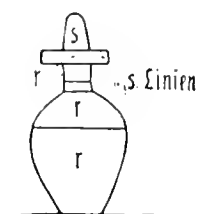

924



925

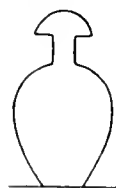

926



927



928

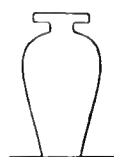

929



930



931

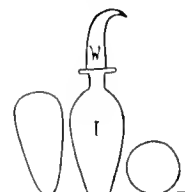

932



933



28. Gefäße. B. Krüge.

934



935



936



937



938

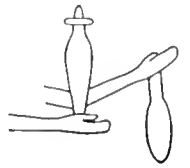

939



940



941

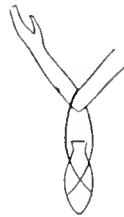

942



943



944



945



946



947



948

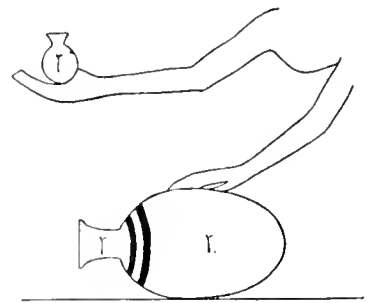

949



950

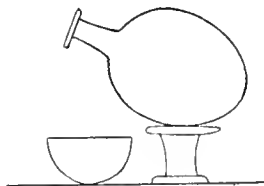

951

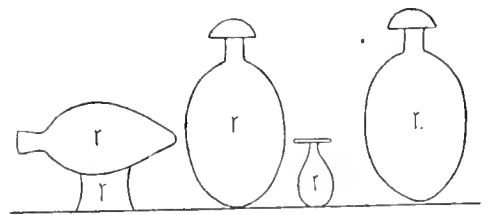

29. KÖRBE.

952

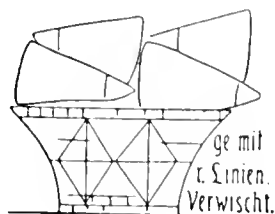

953

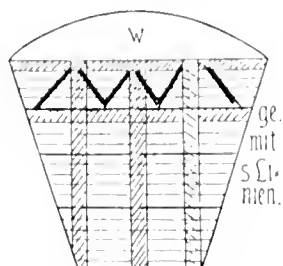

954



955



956



957

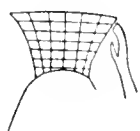

958



959

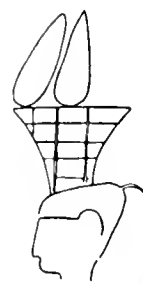

960



961



962



963



964

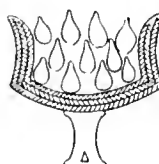

965



966

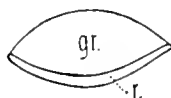

967



968



29. Körbe.

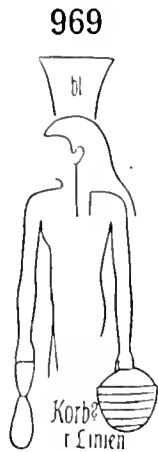

30. TRAGEN.

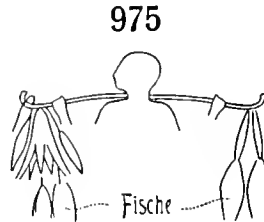
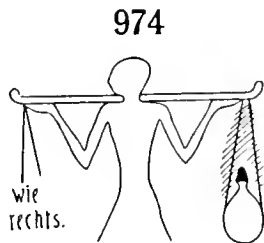
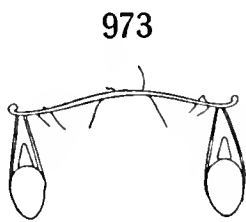

31. RÄUCHERPFANNEN.

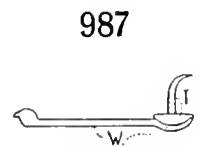
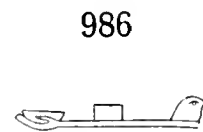
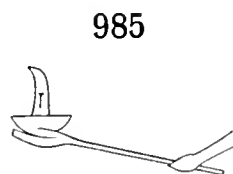
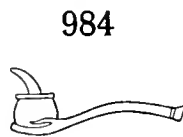
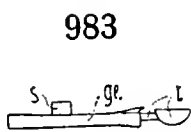
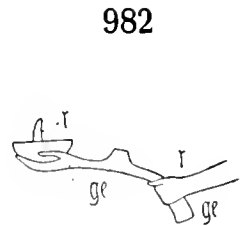
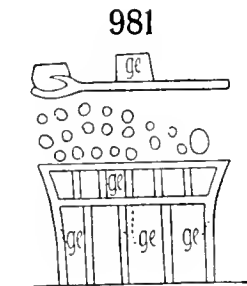
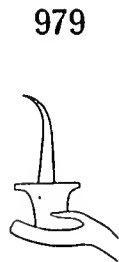

31. Räucherpfannen.

988



989



990



991

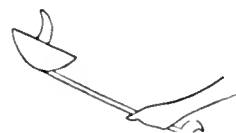

32. SCHREIBZEUG.

992

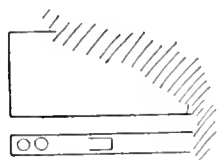

993



33. MAHLSTEINE.

994

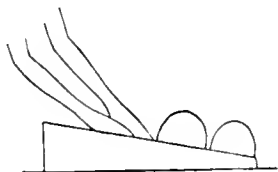

995

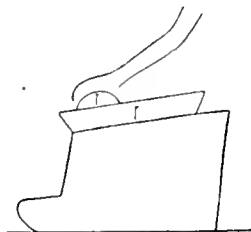

996

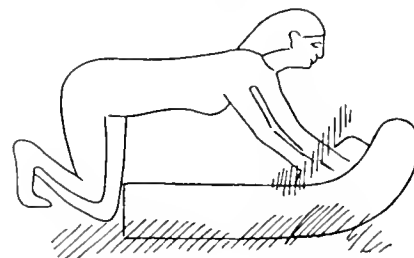

34. MELKEN.

997

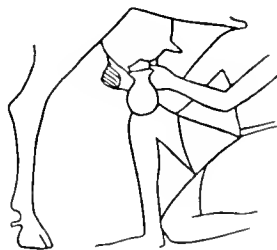

35. KOCHEN.

998

Kochkessel.



36. BRAUEN.

999

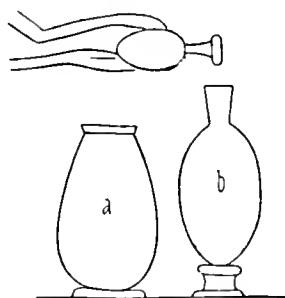

1000

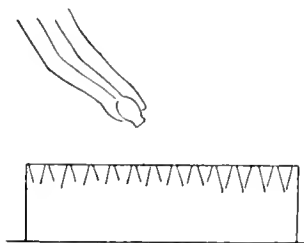

1001

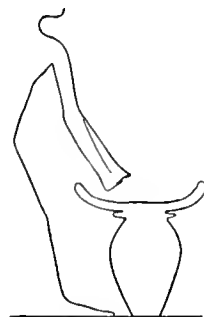

37. SYMBOL DES GOTTES MIN.

1002

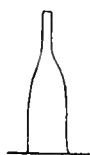

1003



1004



1005

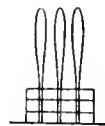

38. UNBESTIMMBAR.

1006



39. FIGUREN MIT PROPORTIONSLINIEN.

1007

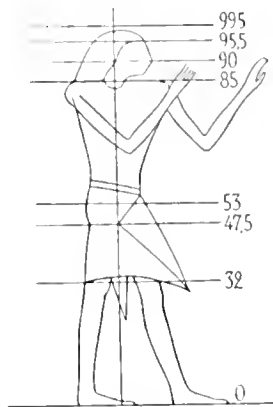

1008

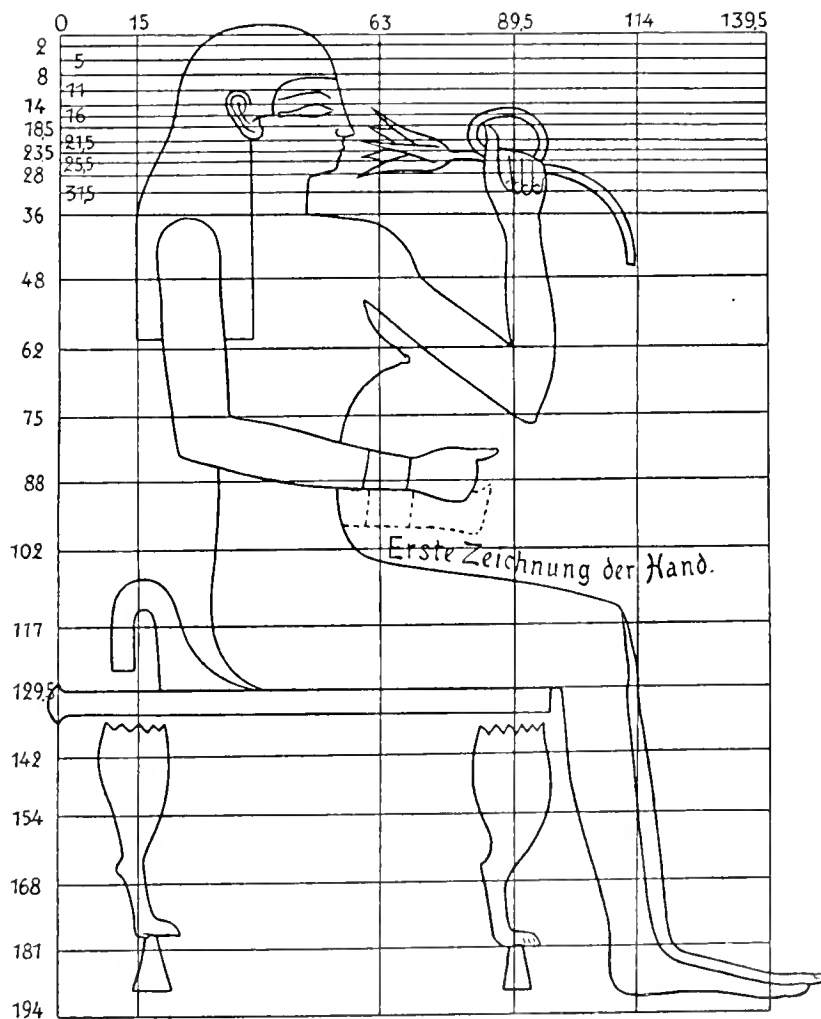

39. Figuren mit Proportionslinien.

1009

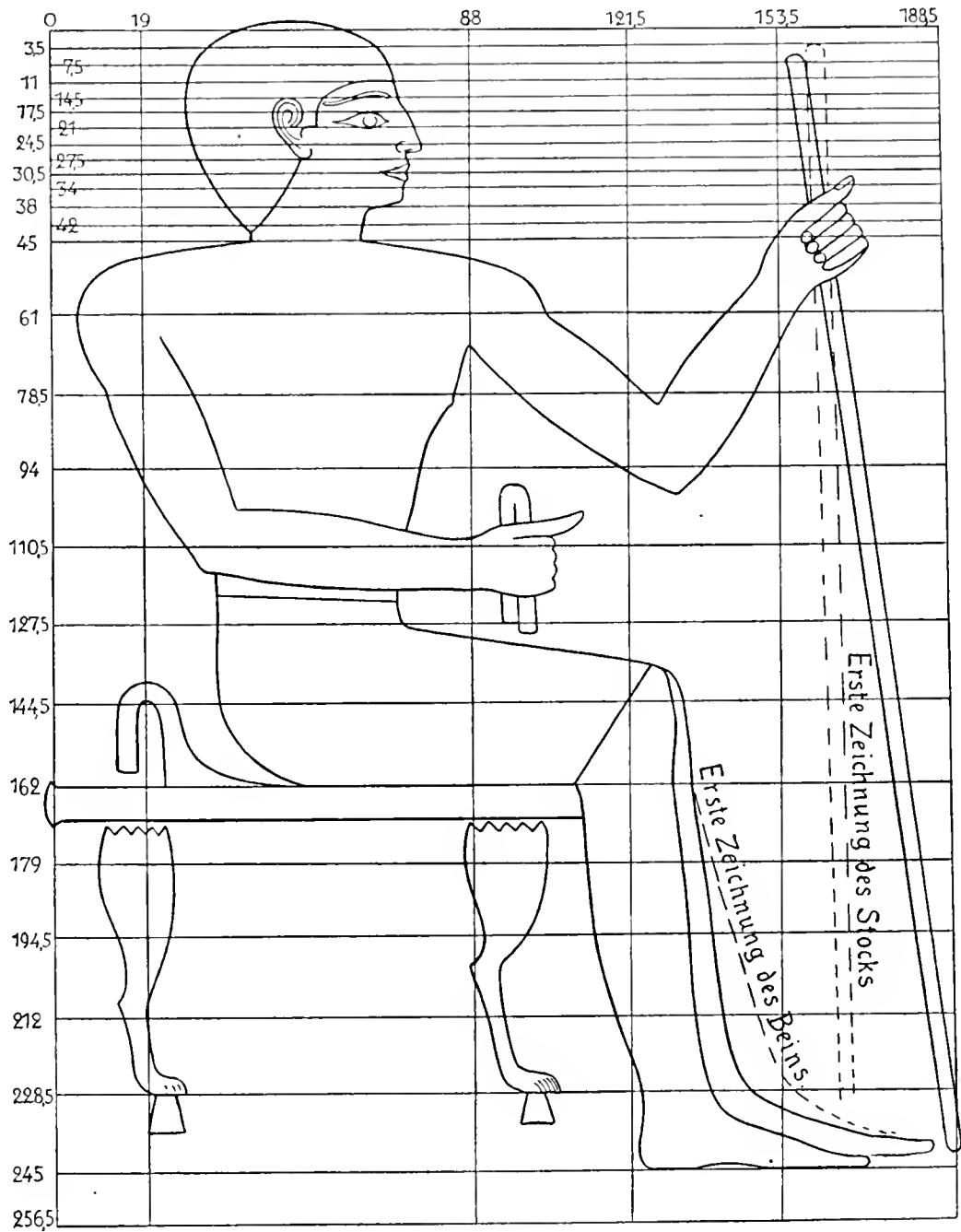

IN COMPLIANCE WITH CURRENT
COPYRIGHT LAW
OCKER & TRAPP INC.
AND
NYU-INSTITUTE OF FINE ARTS
PRODUCED THIS REPLACEMENT VOLUME
ON WEYERHAEUSER COUGAR OPAQUE NATURAL PAPER,
THAT MEETS ANSI/NISO STANDARDS Z39.48-1992
TO REPLACE THE IRREPARABLY
DETERIORATED ORIGINAL. 1999

INSTITUTE OF FINE ARTS LIBRARY
3 1162 02389 4539

LIT