

## Historic, archived document

Do not assume content reflects current scientific knowledge, policies, or practices.



# Griffith 1894 Turner & Co.

Established 1860

## Farm & Garden SUPPLIES



205 207 N. PACA ST.

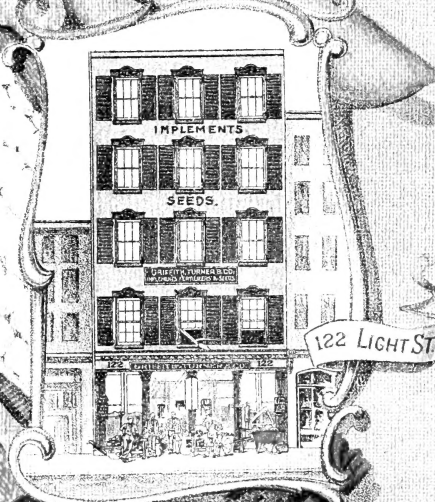

122 LIGHT ST.

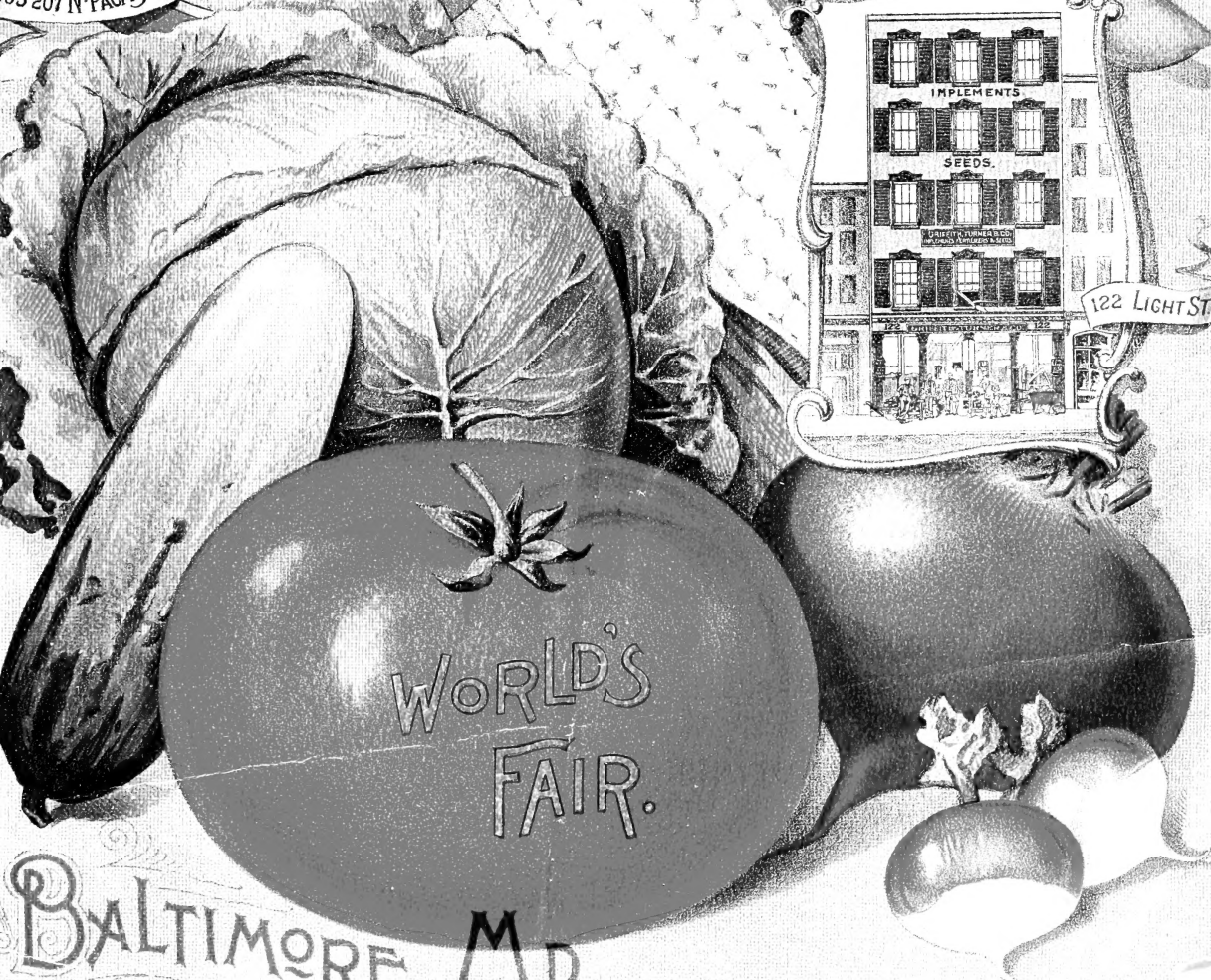

WORLD'S  
FAIR.

# BALTIMORE, MD.



# INDEX.



## NOVELTIES & SPECIALTIES . 2-10

### *Vegetable Seeds.*

Artichoke . . . . .	11
Asparagus . . . . .	11
Beans . . . . .	12, 13
Beets . . . . .	13, 14
Brussels Sprouts . . . . .	14
Broccoli . . . . .	14
Cabbage . . . . .	14, 15, 16
Cauliflower . . . . .	16
Carrot . . . . .	16, 17
Celery . . . . .	5, 17
Corn . . . . .	18
Corn Salad . . . . .	16
Cress . . . . .	18
Cucumber . . . . .	5, 19
Egg Plant . . . . .	7, 19
Endive . . . . .	20
Herbs . . . . .	30
Kale . . . . .	20
Kohl Rabi . . . . .	20
Leek . . . . .	20
Lettuce . . . . .	20, 21
Melon, Water . . . . .	22
Melon, Canteloupe . . . . .	21
Mushroom . . . . .	22
Mustard . . . . .	22
Nasturtium . . . . .	22
Okra . . . . .	23
Onions . . . . .	23
Parsley . . . . .	23, 24
Parsnip . . . . .	24
Peas . . . . .	24, 25
Pepper . . . . .	26
Potatoes . . . . .	26
Pumpkin . . . . .	26
Radish . . . . .	27
Rhubarb . . . . .	27
Salsify . . . . .	27
Spinach . . . . .	28
Squash . . . . .	28
Tomato . . . . .	28, 29
Turnip . . . . .	30
Vegetable Plants . . . . .	30

### *Dairy Goods.*

Butter Boxes . . . . .	93
Butter Color . . . . .	93
Butter Ladles . . . . .	92
Butter Paddles . . . . .	92
Butter Paper . . . . .	93
Butter Prints . . . . .	93
Butter Workers . . . . .	92, 93
Creameries . . . . .	91
Churns . . . . .	90
Milk Pails . . . . .	92
Milk Strainer . . . . .	93
Thermometers . . . . .	92

### *Implements, Wagons, Etc.*

Asparagus Buncher . . . . .	11
Axle Grease . . . . .	77
Back Bands . . . . .	102
Baskets . . . . .	86
Binders, Deering . . . . .	88
Binder Twine . . . . .	88

Binder Repairs . . . . .	89
Bolster Springs . . . . .	73
Bolts and Washers . . . . .	94
Breed's Universal Weeder . . . . .	63
Budding Knives . . . . .	85
Buggies Daytons, Etc. . . . .	98
Calf Weaners . . . . .	86
Carts, Farm . . . . .	97
Carts, Road . . . . .	100, 101, 102
Cider Mills . . . . .	67
Cold Chisel . . . . .	89
Corn Harvester . . . . .	63
Corn Planters . . . . .	61
Corn Shellers . . . . .	76
Cultivators and Wheel Hoes . . . . .	50, 51, 52, 56, 57
Cultivator Points . . . . .	52
Dibbers . . . . .	87
Double Trees . . . . .	83
Drills, Corn . . . . .	61, 62, 63
Drills, Fertilizer . . . . .	58, 62
Drills, Grain . . . . .	58
Drills, Pea . . . . .	62, 63
Drills, Seed . . . . .	50, 59, 60, 62
Drill Tubes . . . . .	60
Drill Points . . . . .	60
Edging Knives . . . . .	85
Feed Cutters . . . . .	64, 65, 66
Feed Mills . . . . .	74, 75
Field Rollers . . . . .	67
Fodder Yarn . . . . .	33, 77
Force Pumps . . . . .	73
Fruit Pickers . . . . .	86
Garden Reels . . . . .	87
Grafting Wax . . . . .	33
Grass Edger . . . . .	85
Grass Hooks . . . . .	85
Grain Cradles . . . . .	81
Grain Fans . . . . .	81
Grindstones . . . . .	87
Hames . . . . .	77
Harness . . . . .	103, 104
Harness Menders . . . . .	87
Harrow . . . . .	52, 53, 54, 55
Harrow Teeth . . . . .	54
Hay Carriers . . . . .	68, 69
Hay Knives . . . . .	85
Hay Loader . . . . .	71
Hay Press . . . . .	94
Hay Rakes . . . . .	70, 71
Hay Rake Teeth . . . . .	71
Hay Tedders . . . . .	70
Hay Tedder Forks . . . . .	71
Hay Tool Supplies . . . . .	68, 69
Horse Boots . . . . .	46, 47
Horse Brushes . . . . .	77
Horse Radish Grater . . . . .	87
Horse Powers . . . . .	75
Hot Bed Sash . . . . .	87
Knife Grinders . . . . .	81
Knives . . . . .	79
Ladders . . . . .	87
Lawn Mowers . . . . .	46, 47, 48, 49
Lawn Rakes . . . . .	86
Lawn Rollers . . . . .	67
Manure Spreader . . . . .	94
Marling . . . . .	33

Mowers, Deering . . . . .	88
Oils . . . . .	77
Oil Cans . . . . .	77
Plow Handles . . . . .	81
Plows and Repairs . . . . .	44, 45
Post Hole Digger . . . . .	87
Potato Cutter . . . . .	63
Potato Planter . . . . .	63
Potato Plows . . . . .	87
Pruning Knives . . . . .	85
Pruning Saws . . . . .	85
Pruning Shears . . . . .	85
Pumps . . . . .	72, 73, 79
Punches . . . . .	89
Push Carts . . . . .	80
Riding Cultivators . . . . .	56, 57
Rollers . . . . .	67
Root Cutters . . . . .	87
Rope . . . . .	77
Row Marker . . . . .	81
Scales . . . . .	91
Scuffle Hoes . . . . .	85
Scythes . . . . .	86
Scythe Stones . . . . .	85
Scrapers, Steel . . . . .	82
Seed Sowers . . . . .	58, 59, 60
Shears . . . . .	85
Shovel Plows and Steels . . . . .	52, 57
Singletrees . . . . .	83
Spray Pumps . . . . .	73, 79
Sprinklers . . . . .	31, 33
Steel Chains . . . . .	84
Step Ladders . . . . .	87
Store Trucks . . . . .	81
Tree Pruners . . . . .	85
Trowels . . . . .	84
Twine . . . . .	77
Wagons, Farm . . . . .	95, 96
Wagons, Road . . . . .	99
Wagon Jacks . . . . .	83
Washing Machines . . . . .	80
Watering Pots . . . . .	87
Water Trucks . . . . .	78, 79
Weeding Hooks & Forks . . . . .	86, 87
Wheelbarrows . . . . .	82
Whiffletrees . . . . .	83
Wire Fencing . . . . .	82
Wood Saws . . . . .	66

### *Miscellaneous.*

Bird Seeds . . . . .	34
Bulbs and Roots . . . . .	35
Clover Seeds . . . . .	32, 33
Fertilizers . . . . .	31, 42, 43
Field Seeds . . . . .	32
Flower Seeds . . . . .	36-41
Garden Syringes . . . . .	33
Grass Seeds . . . . .	32, 33
Horse Powders . . . . .	34
Insect Destroyers . . . . .	33
Insect Powder Bellows . . . . .	33
Lawn Seeds . . . . .	31
Lawn Sprinkler . . . . .	31
Mole Traps . . . . .	33
Plant Bed Cloth . . . . .	33
Plant Sprinkler . . . . .	33
Poultry Supplies . . . . .	34

## To Florists and Amateurs.

Pot Labels.			Light Plant Stakes.			Heavy or Dahlia Stakes.				
	Plain.	Painted.		Each.	Doz.	Per 100.		Each.	Doz.	Per 100.
4 inch per 1000,	\$.50	\$.65	1 1/2 feet,	\$.02	\$.20	\$.90	3 feet,	\$.06	\$.65	\$4.00
5 inch per 1000,	.65	.90	2 "	.03	.30	1.75	4 "	.08	.85	5.50
6 inch per 1000,	.75	1.00	2 1/2 "	.05	.45	2.25	5 "	.10	1.00	7.00



## To Our Friends and Patrons.

The close of the season of 1893 finds us with a greatly increased number of customers, which is an evidence that we are accomplishing the end desired, viz.—that our goods are pleasing the purchasers. In order to conduct a successful business, it is necessary that the same should be pleasant as well as profitable, and this condition of things can only be realized when our customers feel that they have gotten the value of their money and desire to continue the existing relations ; we are glad to say that our patrons all express themselves as thoroughly satisfied.

Asking your consideration of the articles enumerated in our *Catalogue* for 1894, where will be found a complete line of Seeds and Agricultural Goods, meeting all the demands of the Dealer, Farmer, Market Gardener, Florist, and Amateur, we remain,

Very truly,

*January 2, 1894.*

GRIFFITH, TURNER & CO.

---

## A Good Family Garden.

But few farmers seem to realize the value of a good garden, and yet there is scarcely anything more essential to the comfort of a Farmer's Home ; hence, no family living in the country should be without one.

First provide a suitable plat of ground, thoroughly manure, or use a first-class chemical fertilizer which is better, as it will give the desired result without producing weeds, which invariably follow an application of manure.

The ground should be thoroughly ploughed and pulverized before planting. Provide a small hot-bed, say 6x6 feet (which can be done at little expense), and sow in February or March, Egg Plant, Tomato, Cabbage and Pepper for early plants. If this is not convenient a few boxes of rich earth in a warm window will provide plants for early use. As soon as the ground is open plant Onion Sets, Early Peas, Beets, Radish and Lettuce ; also prepare and sow beds of Cabbage, Tomato and Celery to raise plants for later use.

In April plant Sugar Corn, Beans, Cabbage, Cauliflower, Cucumber, Lettuce, Onion Seed, Parsnip, Parsley, Peas for second crop, Radish, Salsify and Squash. A succession of Peas may be planted till last of May, and of Corn up to last of July. Lettuce and Radish may be sown every two weeks during Spring. In the Fall sow a small patch of Spinach and Kale and you will have an abundance of Spring greens. The garden should be laid off so that the work may be done with a horse, or if this is impracticable, let the rows be wide enough to work with a wheel hoe and cultivator operated by hand.

One of the members of our firm, who was educated to do all the work in the garden with a hand hoe, is now living in the suburbs of Baltimore and works his garden with horse power, and has most delicious vegetables for his table during the entire year from his own garden. The same can be done by every farmer at a very moderate expense.

205, 207 AND 213 N. PACA STREET.  
BRANCH HOUSE, 122 LIGHT STREET.

GRIFFITH, TURNER & CO.  
BALTIMORE, MD.

## Mammoth White Asparagus.

A very valuable and entirely distinct variety of this highly esteemed Vegetable.

It produces shoots which are white and remain so as long as fit for use and from 80 to 90 per cent. of the plants come true from seed. This grand result has not come by chance, but is the legitimate outcome of years of patient work and careful selection by the originator.

In addition to the marvelous advantage of its white color, the Columbian Mammoth White Asparagus is even more robust and vigorous in habit and throws larger shoots and fully as many of them as the Conover's Colossal. When we add to these the immense advantage of its needing no earthing up in order to furnish the white shoots so much sought after, we think it evident that it is superior to any sort now in cultivation and that no Asparagus grower can afford to plant seed of any other kind. Our claims are not mere theory, but are substantiated by actual experience. A field grown by one of the largest and best Asparagus growers in this country yielded an equal weight of cuttings with his best field of any other variety and brought 20 per cent. more, not in a fancy market or as a novelty, but at a canning factory, where it was put up under a special brand and brought enough more to warrant the packers in paying extra for it.

Market gardeners, growers for canners and amateurs should give this great acquisition a thorough trial.

Per packet, 10c.; oz., 40c.;  $\frac{1}{4}$  lb., \$1.25; lb., \$4.00 postpaid. Roots, \$1.25 per 100; \$10.00 per 1000, mail post-paid.

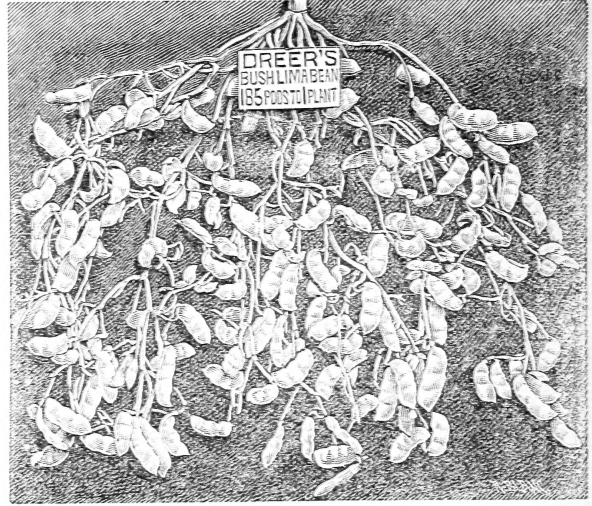

## Dreer's Bush Lima Beans.

This is a dwarf variety of the Dreer's Improved Lima, and possesses all the good qualities of that well-known sort, grows about two feet high, producing pods in great abundance and ripens about ten days earlier than the Pole Lima.

Pkt., 15 cts.;  $\frac{1}{2}$  pt., 25 cts.; Pint, 40 cts., qt., 75 cts.; by mail post-paid.



## Burpee's Bush Lima Beans.

The grower says: The bushes grow eighteen to twenty inches high, stout growth and always erect, yet *branching so vigorously that each plant develops into a magnificent circular bush, from two feet to three feet in diameter.* It is an immense yielder, each bush bearing from 50 to 200 of the handsome large pods well filled with very large beans, which are identical in size and luscious flavor to the well-known large pole Limas. The largest and best Lima Beans can now be raised in quantity at small cost, without the expense and labor attached to the use of poles. Pkts., 15 cts.;  $\frac{1}{2}$  pt., 25 cts.; pt., 40 cts.; qt., 75 cts.; by mail post paid.

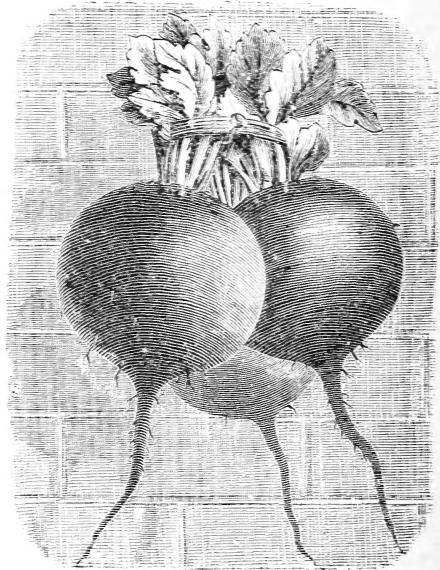

## Eclipse Beet.

This new extra early Beet is remarkable for its fine quality and rapid growth, is of deep red color and handsome shape; as an early market sort it is unrivaled. We have never known a market gardener to try it, but who wanted it again.

Pkts., 5 cts.; oz., 10 cts.;  $\frac{1}{4}$  lb., 20 cts.; lb., 50 cts.

not one plant in a thousand showing any disposition "to run."



## Select Early Jersey Wakefield Cabbage.

The very best early Cabbage, and grown more extensively by market gardeners than any other variety. The heads are pyramidal in shape, very large and solid, and having but few outside leaves, the plants can be set close together. We secured our Seed from a grower of the best Wakefield Cabbage in the country, and it is giving good results wherever it is used; so much so that our sales of this sort the past season were far ahead of previous years.

Pkts., 5 and 10 cts.; oz., 25 cts.;  $\frac{1}{4}$  lb., 75 cts.; lb., \$2.50.

**AUTUMN KING, or World Beater Cabbage.**—One of the largest and hardiest heading of the late varieties. The large broad heads are very thick through, slightly rounded at the top; fine grained and tender; has a short stalk and is a rapid grower. Pkt., 10 cts.; oz., 25 cts.;  $\frac{1}{4}$  lb. 75 cts.; lb. \$2.50.



## All-Head Early Cabbage.

This is the **earliest** of all large Cabbages, —being at least a week earlier than any of the various strains of *Early Summer Cabbage*.

It is fully one-third **larger** than the *Early Summer*, and therefore much more profitable to the Market Gardener.

The **All-Head Early** is unquestionably the nearest approach to a **thoroughbred Cabbage** of any variety yet introduced, both as regards size and uniformity of development. The deep flat heads are *remarkably solid and uniform in color* as well as in shape and size.

Tenderness is the result of rapid growth, and as the **All-Head Early** comes in quicker than any of the other flat Cabbages it is consequently more tender.

While **All-Head Early** is all that can be desired for earliness, it is also *valuable for a late or Winter Cabbage*.

By reason of the *compact habit of growth* of the **All-Head Early** and absence of loose leaves, fully one thousand more heads can be obtained to the acre than of most other varieties of good size. Per pkt., 10 cts.; oz., 20 cts.;  $\frac{1}{4}$  lb., 60c.; per lb, \$2.00.

## Early Summer Cabbage.

This sort is constantly growing in favor as a second early cabbage. It is about ten days later than the Wakefield, heads large and flat, very solid, few outside leaves, and uniform in character. It is very popular with the truckers.

Pkts., 5 and 10 cts.; oz., 20 cts.;  $\frac{1}{4}$  lb., 65 cts.; lb., \$2.00.

Gentlemen :

Your Wakefield and Early Summer Cabbage were very fine. I don't want any better.

MICHAEL HEINLE,  
Baltimore Co., Md.



Special Prices to Cannerns, Gardeners and Farmers, in Large Quantities.



### Boss Flat Dutch Cabbage.

In again calling the attention of Market Gardeners and Truckers to this magnificent cabbage, we would say that it has fully met the claims we made for it upon its introduction. When we ask our customers how they like it, their answer is "splendid," or "elegant," "everything heads," "you can scarcely find any that don't head."

Mr. W. W. Phelps, Odenton, Md., says:—"The Boss Flat Dutch Cabbage Seed I had from you last year beat anything I ever saw, I don't believe there were three in a thousand that did not head."

The heads are large, hard, thick and flat, the leaves lapping across the centre, making it the most desirable winter variety in cultivation. Try it and be convinced of its superior qualities. Pkts., 5 and 10 cts.; oz., 25 cts.;  $\frac{1}{4}$  lb., 75 cts.; lb., \$2.50.

### Perfection Drumhead Savoy Cabbage.

Heads large and finely curled, short stalk, compact growth, and an excellent keeper. In size similar to Drumhead, with the curled leaves and fine flavor of the Savoy. Far superior to the ordinary kinds. When boiled in Winter it is in tenderness and flavor almost equal to Cauliflower.

Savoy Cabbage grown from our stock was the finest ever seen in the Baltimore Market. It certainly holds a high place in the estimation of growers.

Mr. Jesse Biddison, of Baltimore Co., Md., says:—"The Savoy Cabbage I had from you was very superior; it was the best I ever had."

Pkts., 5 and 10 cts.; oz., 20 cts.;  $\frac{1}{4}$  lb., 60 cts.; lb., \$2.00.

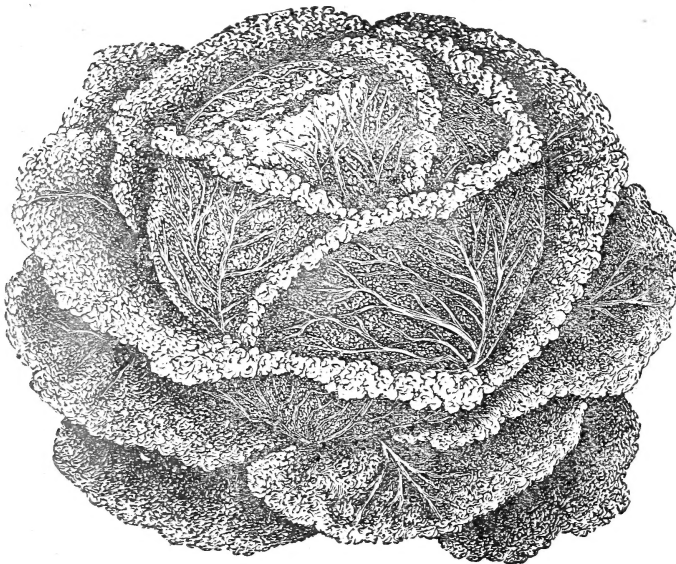

Special Prices to Cannerymen, Gardeners and Farmers, in Large Quantities.



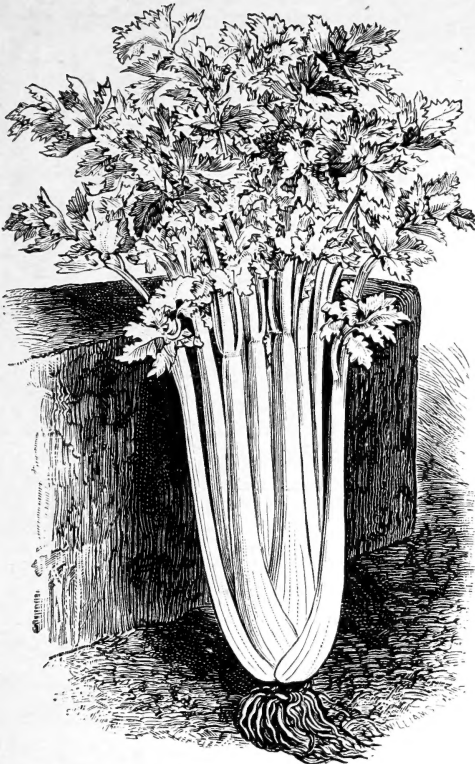

### Paris Golden Self-Blanching Celery.

This cannot be too highly recommended, as after being thoroughly tested, it has fulfilled all that has been claimed for it. *It is decidedly the very best and most profitable Celery in cultivation*; it is very early and entirely self-blanching. The beautiful appearance of the plant, its close habit, compact growth, straight, vigorous stalks, solid, crisp brittle ribs, fine quality and delicious flavor commend it to all lovers of Celery. No variety can surpass, if indeed equal the *Paris Golden Self-Blanching* in striking appearance and delicious flavor.

Mr. Wm. Jasper, Putty Hill, Md., says:—"I had your Golden Self-Blanching Celery last year, and I had the prettiest Celery in Bel-Air Market."

Pkts., 5 and 10 cts.; oz., 30 cts.; ¼ lb., 85 cts.; lb., \$3.00.

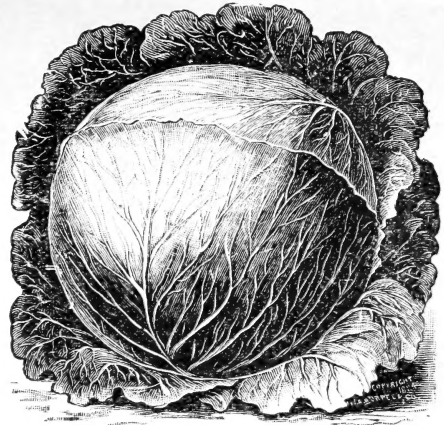

### Succession Cabbage.

This is one of the best sorts in existence to-day, coming in about one week later than the Early Summer, almost double the size, and so finely bred that nearly every head is a perfect specimen. We can without any hesitation recommend it to the Trucker and Market Gardener for a second early crop.

Pkts., 5 and 10 cts.; oz., 20 cts.; ¼ lb., 60 cts.; lb., \$2.00.

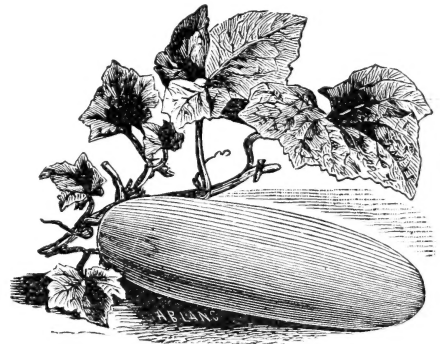

### White Wonder Cucumber.

The **WHITE WONDER** surpasses the *White Pearl*, both in handsome appearance and fine quality, while its strong, vigorous, extremely healthy habit of growth enables the vines to produce a large crop of perfect fruit, even under adverse conditions. Its strong constitution is exceptional. The cucumbers are thickly set throughout the length of the vine and are remarkably uniform in color, shape and size; they average about eight inches long by two to two and a half inches through; the skin is extremely thin, but very tough, and the pearly white flesh is *exquisitely fine in quality*, very brittle, and remains solid for a long time. The color is always ivory white. Owing to its unusual hardness of constitution, the **WHITE WONDER** can be planted earlier than most other Cucumbers, and is also a *sure cropper*.

Per pkt., 10 cts.; per oz., 35 cts.; ¼ lb., \$1.00.



### Improved White Spine Cucumber.

This is the best Cucumber for early planting, because it will retain its green color longer than any other sort. It is of good size and shape, and the popular variety with the Truckers around Baltimore and Norfolk, as well as the Growers from Virginia to Florida.

Pkts., 5 and 10 cts.; ¼ lb., 20 cts.; bl., 60 cts.

## Ne Plus Ultra Sugar Corn.

We call special attention to this new variety of Sugar Corn, also known as "Shoepeg," "Little Gem," and "Quaker Sweet." It is very desirable as an early sort. The ears are from five to seven inches long, deep kernel, very prolific, generally bearing three to five ears to the stalk, and matures a little before Stowell's Evergreen, being much sweeter and more sugary than that well-known variety.

Qt., 20 cts., by mail, 30 cts.; peck, 85 cts.

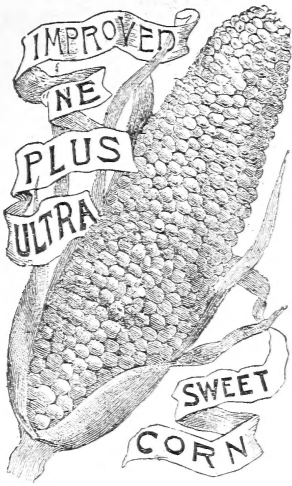

## Baltimore Nutmeg Canteloupe.

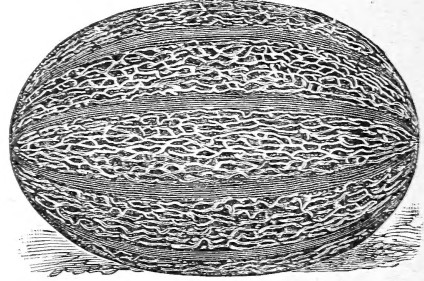

## Country Gentleman Sweet Corn.

This is one of the finest Sweet Corns for private use. The ears are of good size, produced in great abundance, and the Corn of delicious quality. It is a selection from the Ne Plus Ultra, the ears being larger; in other respects they are similar. Pt., 15 cts.; qt., 20 cts.; by mail, 30 cts.; peck, 90 cts.

Well known and very popular with Market Gardeners and Truckers around Baltimore. It well deserves the praise it has received. It is of good size and shape, of rich flavor and a splendid shipper. Our seed is from select stock.

Pkt., 5 cts.; oz., 10 cts.; ¼ lb., 25 cts.; lb., 70 cts.; 5 lbs., \$3.00.

## Truckers' Early Sugar Corn.

This is the most desirable variety of Sugar Corn for Truckers and Gardeners to plant early. It is ten days earlier than Evergreen, very productive, growing two to four ears to the stalk. The ears set low, are large and well filled, the grain long and narrow, similar to Evergreen, but smaller. It is one of the most productive varieties in cultivation.

Qt., 20 cts.; pk., \$1.00; bushel, \$3.50.

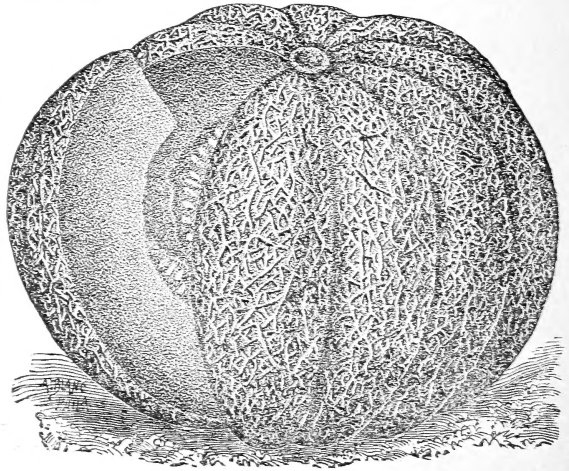

## Early Burlington Hybrid Corn.

This Corn has been grown for several years by a few Truckers for the Philadelphia Market, and as they kept it among themselves, they had almost the entire control of the early markets. While it is as early as the Adams, the ears are very much larger, and their resemblance to the Sugar Corn makes it a great seller. It is not a true Sugar Corn, but a hybrid, or mixture, between the Sugar Corn and the Adams' Early. Qt., 20 cts.; peck, 85 cts.; bushel, \$3.00.

## Anne Arundel Canteloupe.

This handsome melon has for several years been a special favorite with a number of the leading growers of Anne Arundel County, Md. Knowing its value we secured the stock and introduced it last year. It has met every promise we made for it upon its introduction. One grower says: "It is in all respects one of the best of Melons." Another says:

"Portsmouth, Va., Oct. 28, '03.

Dear Sirs.—The Anne Arundel Canteloupe was perfectly satisfactory, just what it is claimed to be; it proved to be early, of good size, and gave me a large yield."

It is very large, nearly round, deeply netted and of good flavor. A wagon load of them at once attracts the buyer's attention, and when piled up on a market stall they are irresistible. No large grower's stock is complete without this superb melon.

Pkts., 5 and 10 cts.; ¼ lb., 30 cts.; lb., \$1.00.

Special Prices to Cannerymen, Gardeners and Farmers, in Large Quantities.



### Baltimore Cabbage Lettuce.

This new Lettuce which we introduced two years ago, and claimed to be one of the best ever put on the market, has produced quite a sensation among some of the large growers who have tried it. As soon as they discovered its merits they came for more seed, and recommended it to all their friends, these in turn were delighted with their crops, as the result more than justified all we claimed for it. The above illustration represents a field of about 2400 plants, only one of which did not head, and this was but a sample of what we could have procured on a number of farms. Another grower at Gardenville, Maryland, says: "I had three thousand heads of your Baltimore Cabbage Lettuce, and they all headed but one; they are slow to run to seed." The heads are large and solid, color pretty light green, and very slow to seed. In fact, it is just what the Truckers and Gardeners want.

Pkts., 5 and 10 cts.; oz., 25 cts.; ¼ lb., 65 cts.; lb., \$2.00.

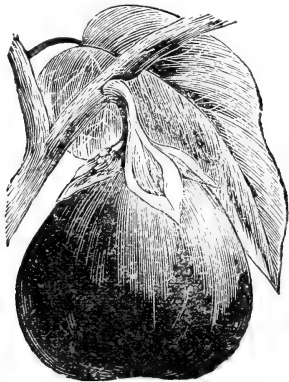

### Improved Large Purple Egg Plant.

The improved Large Purple Egg Plant is decidedly the best and most profitable sort in cultivation; it is large, thornless, of a handsome purple color and beautiful shape. Our stock of this has for several years been giving unqualified satisfaction. We have never seen finer specimens of Egg Plant than those grown from our seed.

Pkts., 10 and 25 cts.; oz., 45 cts.; ¼ lb., \$1.25; lb., \$4.25.

### The Dixie Watermelon.

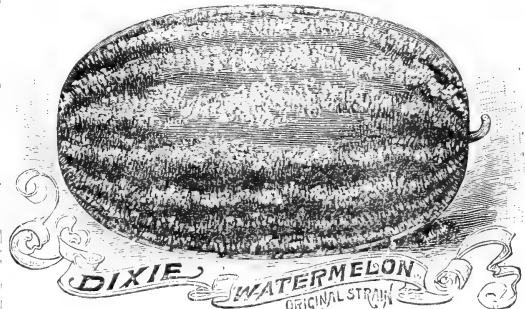

This new melon came to us with the highest recommendations as to its productive and shipping qualities, and our experience with it has fully borne out all that was claimed for it. After a trial of two years we unhesitatingly recommend it to any grower of melons. Its eating quality is equal to the best. It is earlier and larger than the well-known and popular Kolb Gem, and in color a darker green, with beautiful stripes, making it one of the handsomest Melons on the market. Flesh deep red, sugary and melting.

Pkt., 5 cts.; oz., 10 cts.; ¼ lb., 20 cts.; lb., 50 cts.; 5 lb., \$2.00.



## French Canner Peas.

Introduced in 1886, and largely used by Cannerymen ever since, who have upon them made a high reputation for the quality of their goods. Cannerymen who have used it claim that it does not blacken under processing. It is a small Pea, produced in long, slim pods, containing on an average seven Peas to the pod. The vines grow from three to three and a half feet high, and should be planted four feet apart. This is one of the most profitable Peas to plant. Comes in about ten days later than our Extra Early.

Pt. 15 cts.; qt., 30 cts.; pk., \$1.25; bush., \$4.00.

Baltimore, Md., Nov. 30, 1892.

Messrs. Griffith, Turner & Co.

Gentlemen:—Having packed the "French Canner" variety of Peas, we do not hesitate to recommend them as a most superior article, in appearance, color and flavor. This combined with the fact that they show a better yield, make them, in our opinion, the most desirable variety of Peas for packers' use.

J. S. FARREN & CO.

Baltimore, June 24, 1893.

Messrs. Griffith, Turner & Co.

Gentlemen:—We sowed 10 bushels "French Canner Peas," just to give them a trial; you claimed it would "ripen between Early June and the Marrowfat," "that the Cannerymen sought for it on account of its uniformity and heavy shelling;" "and it would produce with any Pea." We are glad to be able to say it turned out just as you claimed for it. We believe the coming Pea is here, and are fully convinced that those who plant the "French Canner" will find money in it. You have our order already entered for 1894.

FRANKLIN DAVIS NURSERY CO.

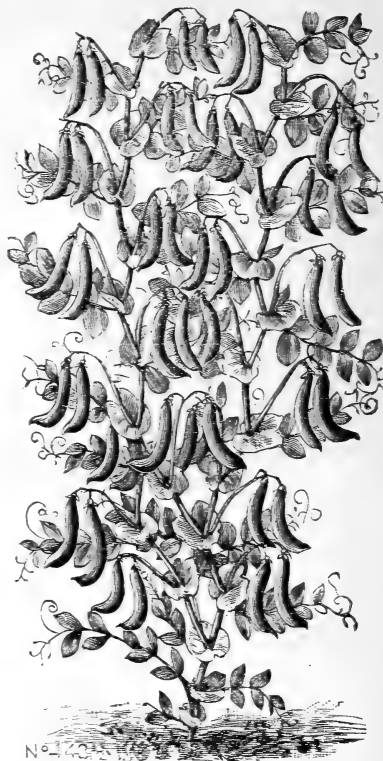

FRENCH CANNER PEAS.

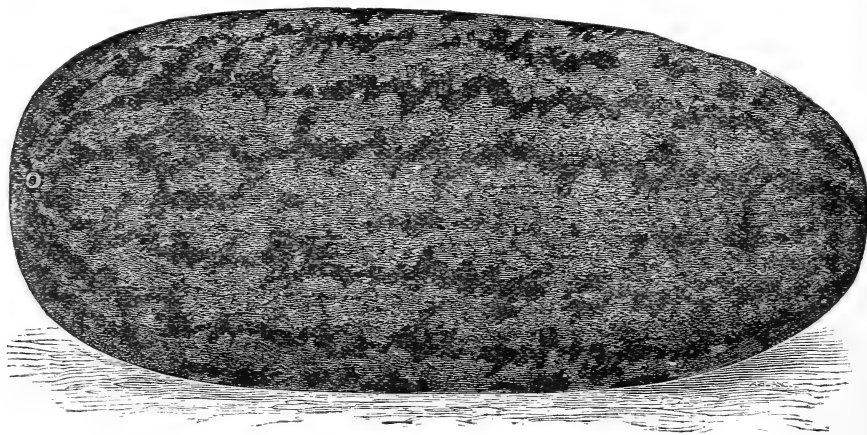

## Lord Baltimore Watermelon.

We wish to call special attention to this splendid and delicious melon. It is early, very large, of oblong shape, and the flesh is of handsome crimson color, deliciously sweet, and extending close up to the rind; it has a thin hard rind, beautifully mottled, light and dark green. Its perfect shape, faultless color, fine texture and excellent flavor combine to make it one of the very best melons that grows. It is a good shipper, and beats all others as a seller.

Pkt., 10 cts.; oz., 15 cts.;  $\frac{1}{4}$  lb., 35 cts.; lb., \$1.25.

Special Prices to Cannerymen, Gardeners and Farmers, in Large Quantities.

## Griffith, Turner & Co.'s World's Fair Tomato.

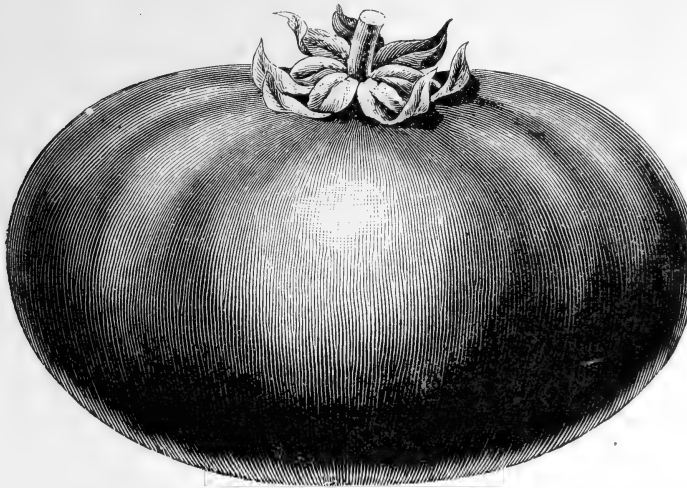

This NEW TOMATO which we introduced two years ago, is constantly gaining friends wherever known, and deservedly so, because of its many good qualities. Our sales of seed of this sort the past season were far beyond our expectation. It is without exception one of the best for Cannerns, Market Gardeners or private use, because of its solidity, symmetrical shape, handsome bright red color, uniformity of ripening and freedom from rot. Its shipping and keeping qualities are unexcelled. The Gentleman who superintends the growing of this seed for us says:—"I desire to call especial attention to this stock; it is particularly solid and of fine flavor, the fruit is good size, smooth and certainly attractive. I venture to say, without fear of contradiction, that your Tomato would bear off the Palm for quality and flavor in the hands of impartial Judges. Parties around here who saw some of the fruit said they had never seen any better

Tomato." The testimonials given below bear us out in all we say about this excellent Tomato.

Pkt., 10 cts.; oz., 25 cts.;  $\frac{1}{4}$  lb., 75 cts.; lb., \$2.50.

Mess. Griffith, Turner & Co.,  
Baltimore, Aug. 15, 1892.

Gentlemen:—Your World's Fair Tomato is extra fine, cuts solid, handsome in shape and good in all respects, in fact all your seeds did well.

M. L. GROFF.

Gentlemen:  
Catonsville, Md., Aug. 12, 1892.

The World's Fair Tomato I got from you were the finest I ever saw, beautiful in shape and color, solid, and splendid bearers.

CHAS. A. SMITH.

Mess. Griffith, Turner & Co.,  
The World's Fair Tomato are splendid, I was delighted with them.

ALBAN ABRAHAM.

Gentlemen:  
Baltimore Co., Aug. 27, 1892.

I consider the World's Fair Tomato the best ever grown, beautiful color, smooth, and ripens clear round to the stem.

WM. STOFFER.

Baltimore Co., Md., Aug. 27, 1892.

Mess. Griffith, Turner & Co.,  
Your World's Fair Tomato are the finest I ever saw, they can't be beat.

LEWIS RYAN, Gardener.

Mess. Griffith, Turner & Co.,  
Anne Arundel Co., Md.

Gentlemen:—Your World's Fair Tomato are superior; they were the best on the *Washington Market*.

J. W. DISNEY & CO.

Mess. Griffith, Turner & Co.,  
Catonsville, Md., Sept., 1893.

Your World's Fair Tomato beat anything I ever have seen; they were very large, solid and of beautiful color.

J. F. CONRAD.

Mess. Griffith, Turner & Co.,  
Finksburg, Md., Oct., 1893.

Gentlemen:—Your World's Fair Tomato is the best I ever grew; large, perfectly smooth, delightful flavor, and also free from rot.

M. D. WILSON.

North Point, Md., Sept. 9, 1893.  
Your World's Fair Tomato is certainly splendid; I don't wish them any better.

PETER J. FISHER.

Mess. Griffith, Turner & Co.,  
Gents:—I had eight acres planted in your World's Fair Tomato, and my crop was excellent. The Tomatoes are large, smooth, very solid, and of beautiful color.

GEO. C. KRACH, Balto. Co., Md.

**NOTICE.**—Because of the well-known superior quality of this splendid Tomato, and the increasing demand for the seed, other parties are cataloguing a Tomato under the same name. In order to protect those who want the pure article *we give notice* that we shall only sell the "World's Fair Tomato" in sealed packages. Ask for Griffith, Turner & Co's World's Fair Tomato, and don't take any but in sealed packages with Griffith, Turner & Co., printed on them.

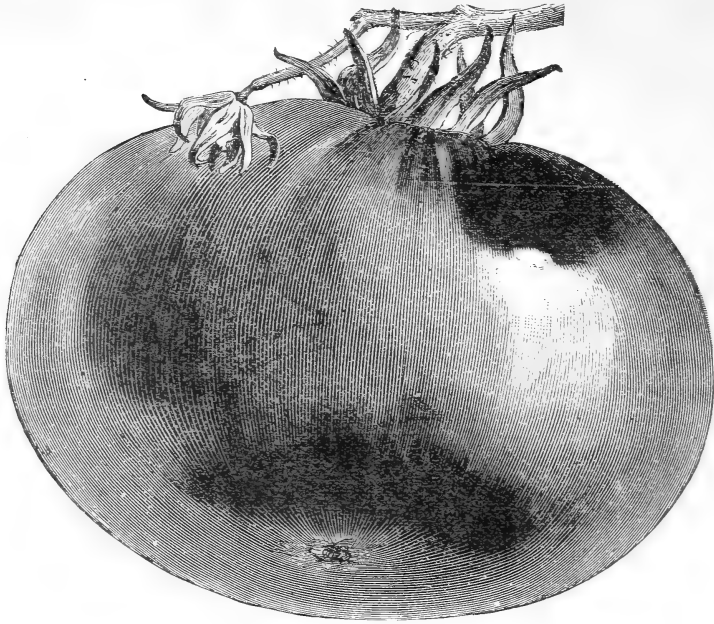

### Prize-Winner Tomato.

In this new sort we have the Prince of Market Tomatoes. In color somewhat resembling the Beauty, but much larger, very solid, ripens earlier than the Word's Fair, and with us was the best keeper we have seen; as an early Tomato it is first-class, selling for the highest market price, and a remarkably full bearer; it is smooth and uniform in shape, and in quality it cannot be surpassed. No Trucker or Market Gardener should fail to try at least a small quantity of the seed of this candidate for popular favor among Tomato Growers, and private families will find it to their advantage to add this to their list of good things for the table.

Pkt., 10 and 25 cts.; oz., 60 cts.;  $\frac{1}{4}$  lb., \$2.25.

### Buckeye State Tomato—New.

The originator of this new Tomato describes it as the largest fruited variety he has ever sent out, and in addition to its large size, represents it as smooth and uniform; it is abundant in fruitage, the tomatoes borne in immense clusters of four to eight fruits; in solidity and meatiness it has no equal, while in luscious quality none surpass it. The color is much the same as the Beauty, but somewhat darker, and this with its large size, makes it very showy when displayed for sale.

Pkt., 10 cts.; oz., 40 cts.;  $\frac{1}{4}$  lb., \$1.50; lb., \$5.00.

Gardenville, Md.

Gentlemen:

The First Early Peas I had from you were the best in our neighborhood.

Yours respectfully,

JESSE BIDDISON.

Quantico, Md.

The Queen Tomato we had from you gave us perfect satisfaction. I have been in the packing business seven years, and it was the best I ever had.

R. B. TAINTER.

# SEEDS FREE.

## PARTIES ORDERING BY MAIL, PLEASE OBSERVE THE FOLLOWING:

**Seeds** in our 5 and 10 cent flat papers, ounces and  $\frac{1}{4}$  lb. packages, will be mailed Free of Postage to the purchaser at catalogue prices.

**Seeds by Mail** on which the purchaser must pay the postage.—Peas, Beans and Corn, 8 cts. per pint; Small Seeds in quantities over  $\frac{1}{4}$  lb., at the rate of 8 cts. per lb.

**Remittances.**—Remit by Draft, Postal Money-order or Postal Note; or, if under One Dollar, in Postage Stamps.

**Orders from Unknown Correspondents** must be accompanied with the Cash.

**NOTICE.**—The greatest care is taken to supply every article true to name and of the very best quality; at the same time it is understood that we do not warrant our seeds, and that we are not in any respect responsible for any loss or damage arising from any failure thereof.

**OBSERVE** that on account of short crops in many varieties of seeds, prices are subject to advance without notice.

**SPECIAL.**—Thirteen 5-cent Papers Vegetable Seeds for 50 cents, or Six 10-cent Papers for 50 cents, mailed free on receipt of price.

GENTS:

I have the first complaint to hear from next year, think I could do better with them.

MILL GREEN, MD., JULY 13, 1893.

your seeds, would like to handle them again  
J. M. HOFF.

### Artichoke.

**Green Globe.**—Cultivated for the flower heads, which are cooked like Asparagus. Pkt. 10 cts.; oz., 30 cts.

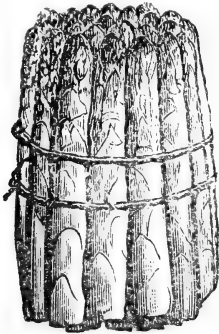

### Asparagus.

This is one of the earliest spring vegetables, and should be in universal use. Many persons think it is difficult to grow, but we consider this a mistake, and believe it can be produced as cheaply and easily as any vegetable on the list.

Sow the seed in the seed bed late in the fall or in the early spring, as soon as the ground can be worked, in drills one foot apart, covering the seed about one inch deep. Thin the plants to three inches in the row. The roots may be removed to the permanent bed when one or two years old.

**New—Mammoth White.**—See specialties page 2. Pkt., 10 cts.; oz., 40 cts.;  $\frac{1}{4}$  lb., \$1.25; lb., \$4.00.

**Barr's Mammoth.**—A new variety, highly recommended for its many good qualities. The stalks are very large and retain their thickness completely up to the top of the shoots, stalks are very tender and succulent, grow very quickly and are light in color. Pkts., 5 cts.; oz., 10 cts.;  $\frac{1}{4}$  lb., 30 cts.; lb., \$1.00

**Palmetto.**—This sort is growing in favor in many localities. It is now being extensively grown by a few Southern Truckers for the New York and Philadelphia markets, where it sells at very high prices. Pkts., 5 cts.; oz., 10 cts.;  $\frac{1}{4}$  lb., 25 cts.; lb., 75 cts.

**Conover's Colossal.**—The old and well-known variety. Pkt., 5 cts.; oz., 10 cts.;  $\frac{1}{4}$  lb., 20 cts.; lb., 50 cts.

**ASPARAGUS ROOTS—Barr's Mammoth.**—Per 100, 70 cts.; per 1,000, \$4.50.

**Palmetto.**—Per 100, 60 cts.; per 1,000, \$4.00.

**Colossal.**—Per 100, 60 cts.; per 1,000, \$4.00.

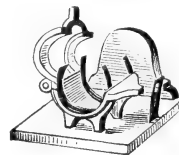

**ASPARAGUS BUNCHER.**—\$2.50.

## Beans—Dwarf, Snap or Bush.

1 quart will plant 100 feet of drill.

Add 8 cts. per pint or 15 cts. per quart on all Beans if to be sent by mail.

Select light, warm soil, and plant when danger from frost is past, in the spring, in drills two to two and a half feet apart, dropping the beans about two inches apart in the drills, and cover one inch deep. On account of short crop of beans, all prices are subject to change without notice.

**First in Market.**—This is well named, being the earliest Bean in existence, and therefore very profitable to the Market Gardener, and desirable to the Private Gardener as well. The pods are long, broad, green and very showy, reaching maturity in thirty days from germination, and the habit of vine very productive. Pt., 20 cts.; qt., 35 cts.; peck, \$1.75; bushel, \$6.00.

**Long Yellow Six Weeks.**—Very early, hardy Bean. Pt., 10 cts.; qt., 20 cts.; peck, \$1.00; bushel, \$3.50.

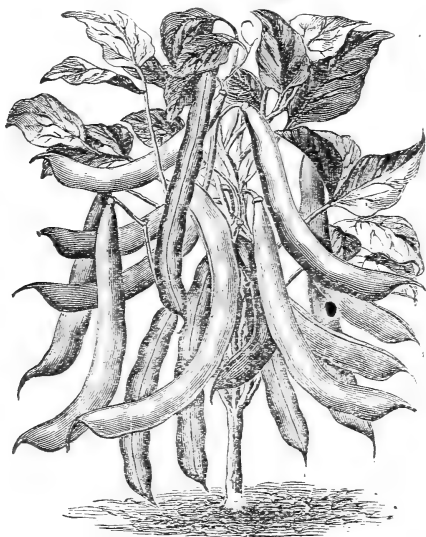

**Earliest Red Valentine.**—Ten days earlier than the ordinary Red Valentine Bean, and therefore the best for Truckers and Market Gardeners. It is without doubt the very best and earliest green Snap Short Bean. The habit of vine is dwarf and very uniform. Color of pods light green, round, curved, succulent, prolific, continuing long in edible condition. Qt., 20 cts.; peck, \$1.00; bushel, \$3.75.

**White Valentine.**—Seed white, very desirable both for Private and Market Gardeners. Pt., 15 cts.; qt., 25 cts.; peck, \$1.35; bush, \$5.00.

**Dwarf Prolific Black Wax.**—Yellow pod; a very superior snap short, ripening among the first earlies and having the best characteristics. Pt., 15 cts.; qt., 25 cts.; peck, \$1.50; bush., \$5.50.

**White Wax.**—White pod; among the second early varieties. Pint, 15 cts.; qt., 25 cts.; peck, \$1.50.

**Improved Rust-Proof Golden Wax.**—This is the earliest, handsomest and hardiest of all the Wax Beans. The pods are straight, long and thicker than the ordinary Golden Wax, much superior in quality, absolutely rust proof and sure to become the favorite Wax Beans; in fact, it has already gained great popularity with growers. Pt., 15 cts.; qt., 25 cts.; peck, \$1.50; bushel, \$5.50.

**Golden Wax.**—Rich, tender, early, delicious. Pt., 15 cts.; qt., 25 cts.; peck, \$1.40; bushel, \$5.00.

**Kidney Wax.**—This is one of the best of the wax sorts. The vines are remarkably vigorous, hardy and productive. The pods are very large, smooth, showy, tender, perfectly stringless, and of unusually fine quality. Pt., 15 cts.; qt., 25 cts.; peck, \$1.50; bushel, \$5.50.

**New Golden-Eyed Wax.**—This fine new bush Bean is very early; the vine grows vigorously about one and a half feet high, holding the pods off the ground. The pods are handsome, long, straight and flat, remarkably free from rust, and keep bright and crisp long after other sorts are wilted and unsalable. Pt., 15 cts.; quart, 25 cts.; peck, \$1.50; bushel, \$5.50.

**White Marrowfat or Cranberry.**—Valuable when dry for winter use. Qt., 20 cts.; peck, \$1.00; bushel, \$3.50.

**White Navy.**—Very prolific, ripening early and all at once; beans small, oval, white, handsome and of superior quality. Qt., 20 cts.; peck, 80 cts.; bushel, \$3.00.

**Dwarf Horticultural.**—A very fine green podded Bean, also suitable for winter use. Pt., 15 cts.; qt., 25 cts.; peck, \$1.15; bushel, \$4.25.

**Best of All.**—One of the most valuable green podded sorts for family or market use. The pods are six inches long, very fleshy, succulent, stringless, and of rich flavor; they are produced early and abundantly. Qt., 20 cts.; peck, \$1.25; bushel, \$4.50.

## Bush Lima.

The Bush Lima Beans are rapidly gaining friends, and have evidently come to stay.

**Dreer's Bush Lima.**—See description on page 2. Pkt., 15 cts.; ½ pt., 25 cts.; pint, 40 cts.; qt., 75 cts.; postpaid.

**Burpee's Bush Lima.**—See description on page 2. Pkt., 15 cts.; ½ pt., 25 cts.; pt., 40 cts.; qt., 75 cts.; postpaid.

**Henderson's Dwarf Lima.**—These are valuable, because they do not need poles, and being so dwarf can be planted close together. They are very early and prolific, continuing to bear until frost. Pt., 15 cts.; qt., 30 cts.; peck, \$1.75.

**Beans.—Continued.**

**Pole, or Running Varieties.**

Set the poles three or four feet apart, and plant six to eight beans, with the eyes downward, around each pole, thinning to four healthy plants when they are up. They require the same soil and treatment as the dwarf varieties, with the exception that they crave stronger soil, and do best in a sheltered location.

**Extra Early Lima.**—This variety is two weeks earlier than other sorts; the pods are large and numerous. Qt., 30 cts.; peck, \$1.75; bushel, \$6.50.

**Dreer's Improved Lima.**—An excellent variety, of superior quality and very productive. Qt., 30 cts.; peck, \$1.50; bushel., \$5.50.

**Extra Large Lima.**—As a shell bean surpasses all in quality, and is the favorite with most people; the Beans are very large, tender and of delicious flavor. Qt., 30 cts.; peck, \$1.75; bushel, \$6.50.

**Large Lima.**—Qt., 25 cts.; peck, \$1.50; bushel, \$5.50.

**King of the Garden Lima.**—Pods very large and productive. Qt., 35 cts.; peck, \$1.75; bushel, \$6.00.

**Speckled Horticultural, or Cherry.**—Very productive; used with or without pods. Qt., 25 cts.; peck, \$1.50; bushel, \$5.00.

**Cherry.**—Great favorite; used with or without pods. Pt., 15 cts.; qt., 25 cts.

**Golden Cluster Wax.**—A splendid white sort, exceedingly productive; of large, golden, wax pods, borne in clusters and continuing in bearing until stopped by frost. ½ pt., 15 cts.; pt., 30 cts.; qt., 50 cts.

**English Beans.—Broad Windsor.**—Matures in fifty days after germination. Should be planted very early. Qt., 25 cts.; peck, \$1.60.

**Beet.**

[One Ounce of Seed will sow one hundred Feet of Drill.]

Select a deep, rich, sandy loam, and manure with well decomposed compost or a good Chemical Fertilizer. Sow in drills, fourteen to sixteen inches apart, and cover one inch deep. When the young plants appear, thin to four or five inches apart. For early use, sow as soon as the ground can be worked in the spring; for autumn use, about the middle of May; and for winter use, during June or July, according to variety; the LONG varieties requiring more time to mature than the ROUND, EARLY kinds.

**Very Early Forcing.**—A remarkably fine sort, distinct from all others. Pkt., 5 cts.; oz., 10 cts.; ¼ lb., 20 cts.; lb., 60 cts.

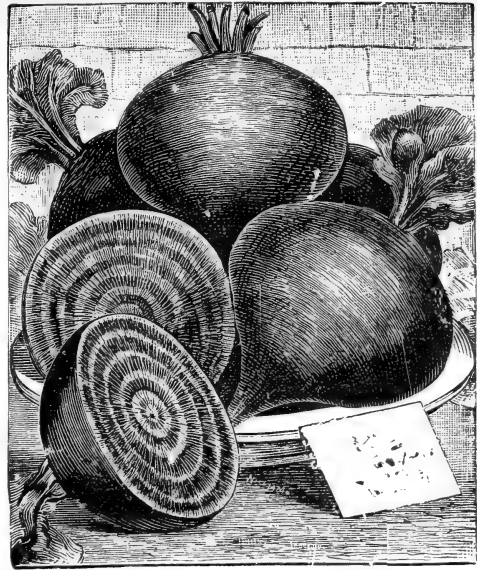

EARLY BLOOD TURNIP BEET.

**Early Blood Turnip.**—In shape like a turnip, deep red color, and best for general use. We have been selling this stock of Beet for a number of years, and it has given unqualified satisfaction. Pkt., 5 cts.; oz., 10 cts.; ¼ lb., 20 cts.; lb., 45 cts.

**Early Eclipse.**—Extra early, deep red color and beautiful shape, best market sort. It is, to a large extent, superseding the Egyptian, being earlier in development, more attractive in appearance, and of superior quality for the table. Pkt., 5 cts.; oz., 10 cts.; ¼ lb., 20 cts.; lb., 50 cts.

**Early Egyptian.**—This is a flat Beet, very early and deep red color. Pkt., 5 cts.; oz., 10 cts.; ¼ lb., 20 cts.; lb., 50 cts.

**Bassano, or Extra Early Turnip.**—Pkt., 5 cts.; oz., 10 cts.; ¼ lb., 20 cts.; lb., 45 cts.

**Edmond's Red Turnip.**—The most uniform of all Turnip Beets. It is of handsome round shape, good marketable size and deep blood color. ¼ lb., 20 cts.; lb., 50 cts.

**Large Long Blood.**—A large and desirable variety. Pkt., 5 cts.; oz., 10 cts.; ¼ lb., 20 cts.; lb., 45 cts.

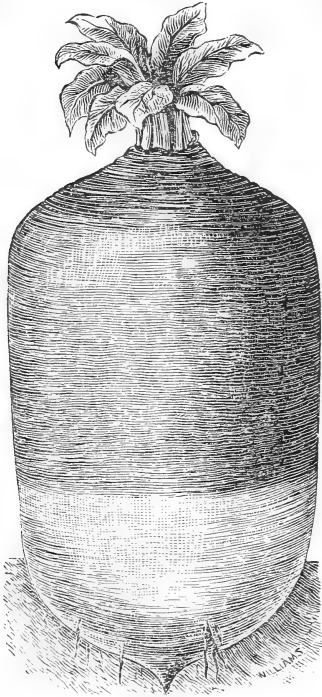
**Beet.**—Continued.

GOLDEN TANKARD MANGOLD.

**Beets for Stock.**

(SOW FOUR POUNDS TO THE ACRE.)

**Mangold Wurzels** are grown for stock, and as they grow larger than other Beets require more room. They should be sown from April to June, in drills two and a half feet apart, and the plants thinned to twelve or fifteen inches in the row. The attention of farmers to the growing of Beets for stock feeding has rapidly increased, but it should be grown more generally, and will show the results in the health and condition of the stock. It supplies good rich food for cattle during the winter.

**Golden Tankard Mangold.**—The best type of Mangold; small top, broad shoulders, smooth rich skin, very solid fleshed, golden stemmed; heavy producer. It has already taken the lead of other varieties in England, and is much relished by milch cows and sheep. Pkt., 5 cts.;  $\frac{1}{4}$  lb., 15 cts.; lb., 40 cts.

**Long Red Mangold Wurzel.**—The well-known large, long variety; grows well out of ground; color light red. Very productive. Pkt., 5 cts.;  $\frac{1}{4}$  lb., 15 cts.; lb., 40 cts.

**White Sugar Beet.**—A large growing sort, and used for feeding stock. Pkt., 5 cts.;  $\frac{1}{4}$  lb., 15 cts.; lb., 40 cts.

**Brussels Sprouts.**

(One Ounce of Seed to 100 Yards of Row.)

A class of plants allied to the Cabbage family, producing a great number of small heads for sprouts on the main stem of the plant, which are used in the manner of Cabbage. Plant in rich soil, in hills two feet apart each way. Pkt., 10 cts.; oz., 20 cts.;  $\frac{1}{4}$  lb., 60 cts.

**Broccoli.**

(One Ounce of Seed to 100 Yards of Row.)

The Broccoli are closely allied to the Cauliflower family. They require similar cultivation and treatment to Cauliflower.

**Early Purple Cape.**—Large, compact. Pkt., 10 cts.; oz., 20 cts.

**Large Early White.**—Head white, like Cauliflower; the best. Pkt., 10 cts.; oz., 40 cts.

**Cabbage.**

(One Ounce of Seed to 100 Yards of Row.)

Cabbage will thrive on any good corn land, though the stronger the soil the better they will develop. New land is preferable. Plow deep and manure very liberally, as cabbage is a strong feeder and will repay for the care bestowed upon it. The early sorts bear planting from eighteen inches to two feet apart in the rows, with the rows from two to two and a half feet apart. The larger varieties to be from two to four feet apart in the rows, with the rows from two and a half to four feet apart, the distance varying with the size. It does not pay to buy cheap Cabbage seed. Ours is American grown, and from the best stock in the country.

**King of Earlyes.**—An excellent early sort. Heads formed like a Wakefield, but ten days earlier. Habit vigorous, short stem, and proof against sun. Pkts., 5 and 10 cts.; oz., 25 cts.;  $\frac{1}{4}$  lb., 75 cts.; lb., \$2.50.

**Large Early York.**—One of the earliest. Pkts. 5 and 10 cts.; oz., 20 cts.;  $\frac{1}{4}$  lb., 50 cts.; lb., \$1.75.

**Large Early Summer.**—The earliest summer variety. Heads large and flat; short stemmed, few outside leaves, uniform in character; very popular with Market Gardeners as a second early sort. Pkts., 5 and 10 cts.; oz., 20 cts.;  $\frac{1}{4}$  lb., 65 cts.; lb., \$2.00.



**Cabbage.—Continued.**

**World Beater, or Autumn**

**King.**—This is a very superior late Cabbage. It produces enormous heads, very solid, beautiful dark green color, and one of the best keepers we know. Pkt., 5 and 10 cts.; oz., 25 cts.; lb., \$2.50.

**Select Very Early Jersey**

**Wakefield.**—Wonderfully fine; used very extensively by Market Gardeners. It is, without exception, the best early Cabbage grown. Pkts., 5 and 10 cts.; oz., 25 cts.; ¼ lb., 75 cts.; lb., \$2.50.

**Early Succession.**—This has given satisfaction wherever grown. It follows ten days after the Early Summer, and comes off with much larger and heavier heads. Pkts., 5 and 10 cts.; oz., 20 cts.; ¼ lb., 60 cts.; lb., \$2.00.

**Surehead.**—This popular Cabbage is rightly named Surehead, as it never fails to make a fine large, solid head, with few outer leaves. It is a strong, vigorous grower, and very uniform in size and color. Always brings the highest price in our markets. Pkts., 5 and 10 cts.; oz., 20 cts.; ¼ lb., 60 cts.; lb., \$2.00.



PREMIUM FLAT DUTCH.

**Premium Large Late Flat Dutch.**—

Large and excellent for winter, very extensively grown. The head is broad, thick and flat, well covered in by leaves lapping across the centre, outside leaves feathered to the base of the leaf stem. Pkts., 5 and 10 cts.; oz., 20 cts.; ¼ lb., 50 cts.; lb., \$1.50.

**Early Dwarf Flat Dutch.**—An

old standard variety which stands the sun and produces fine large heads. Pkts., 5 and 10 cts.; oz., 20 cts.; ¼ lb., 65 cts.; lb., \$2.00.

**All Head Early.**—This is the earliest of all large Cabbage, fully one-third

larger than Early Summer, making it a profitable sort. Pkts., 5 and 10 cts.; oz., 20 cts.; ¼ lb., 65 cts.; 1 lb., \$2.00.

**Reedland Early Drumhead.**—

This is short stemmed, flat headed, large and very early for a flat headed sort. In all localities a favorite variety, and recommended by all experienced Cabbage growers. It will do for first, second and third early, intermediate and late. Pkts., 5 and 10 cts.; oz., 40 cts.; ¼ lb., \$1.00; lb., \$3.00.

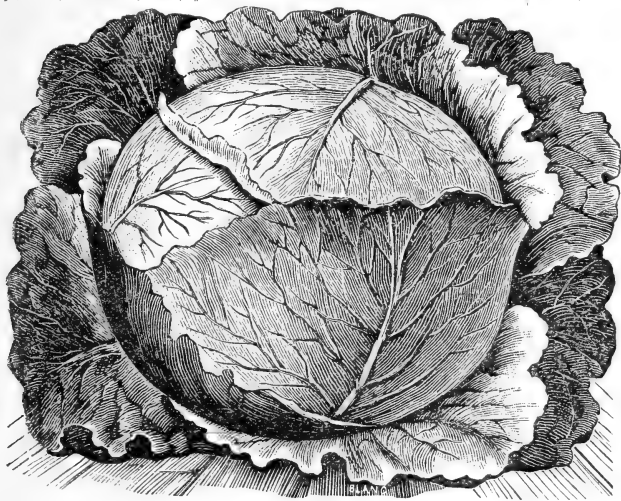

BOSS FLAT DUTCH.

**Boss Flat Dutch.**—A magnificent type of Flat Dutch Cabbage, growing very large and making solid and handsome heads. See description, page 4. Pkts., 5 and 10 cts.; oz., 25 cts.; ¼ lb., 75 cts.; lb., \$2.50.

**All Seasons.**—This forms a fine, large head, of superior quality, nearly as early as the Early Summer. Suitable for planting at any season. Pkts., 5 and 10 cts.; oz., 20 cts.; ¼ lb., 65 cts.; lb., \$2.00.

**Early Winningstadt.**—Head large, cone-shaped and solid. Pkts., 5 and 10 cts.; oz., 20 cts.; ¼ lb., 50 cts.; lb., \$1.75.

**Large Drum Head.**—Solid heads, resembles

Flat Dutch. Pkts., 5 and 10 cts.; oz., 20 cts.; ¼ lb., 50 cts.; lb., \$1.50.

**Perfection Drum Head Savoy.**—An

excellent variety of fine quality. The best Savoy Cabbage grown. Heads are very large, resembling the Drumhead, solid and beautifully curled. When properly cooked, is almost equal to Cauliflower. Pkts., 5 and 10 cts.; oz., 20 cts.; ¼ lb., 60 cts.; lb., \$2.00.

## Cabbage.—Continued.

**Large Red Dutch.**—The head is large, round, solid and a deep red color, the best of the Red Cabbages. Pkts., 5 and 10 cts.; oz., 25 cts.;  $\frac{1}{4}$  lb., 75 cts; lb., \$2.50.

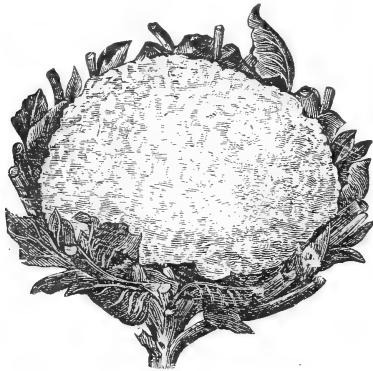

EARLY SNOWBALL.

(One Ounce of Seed will Produce 2000 Plants.)

## Cauliflower.

The most delicate and delicious of all the Cabbage family and requiring the same culture and treatment, but being more delicate, the good culture and richness of the soil recommended for Cabbage is absolutely necessary for the Cauliflower. For early crop sow in hot-bed or cold frame in February or March. For late crop sow and treat like late Cabbage. Cauliflower can only be grown on rich, well tilled, and well watered soil.

**Early Snowball.**—Snowball Cauliflower is, and deserves to be the standard everywhere for quality, with the Seedsman, the Market Gardener, and the Amateur. It is the earliest of all Cauliflowers, nearly every plant will form a perfect snow-white head and its close growing, compact habit enables one-third more to be planted on the same space of ground. Our Snowball is from the best stock grown. Pkts., 25, 50 and \$1.00; oz., \$2.50.

**Select Early Dwarf Erfurt.**—Long the standard of highest excellence, and still holding its own with a great many people. Pkts., 25 and 50 cts.; oz.; \$2.25.

**Early Paris.**—A most excellent early sort. Pkt., 10 cts.; oz., 50 cts.

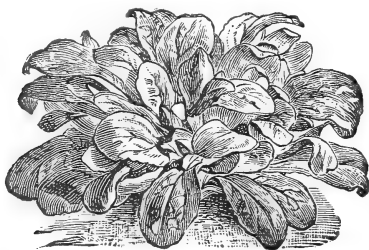

CORN SALAD.

## Corn Salad.

(Three Ounces of Seed to One Hundred Feet of Row.)

A favorite salad plant and very hardy. Sow in August or September, and protect with leaves during the winter; it can be gathered in the spring very early. Sown in April it is soon ready for use. The leaves are sometimes boiled and served as Spinach. Pkt., 5 cts.; oz., 10 cts.;  $\frac{1}{4}$  lb., 20 cts.; lb., 60 cts.

## Carrot.

GERMAN MOHRE.

(One Ounce of Seed to 100 Feet of Row.)

Carrots thrive best in rather a light, rich loam. The ground should be well manured with fine, well-rotted or composted manure, and be thoroughly worked quite deep. Sow in rows fourteen inches apart and thin plants to five or six inches in the row. Sow from middle of April to middle of May. For late crop sow in June.

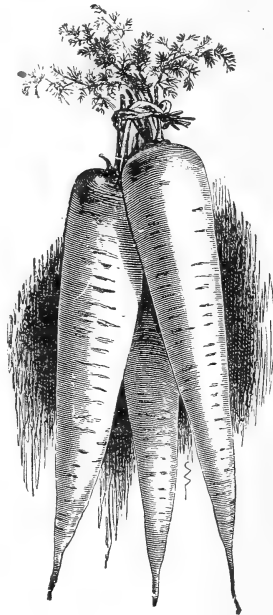

**Long Orange.**—Deep orange color, long, smooth, fine for either Garden or Field culture. All who have cattle should raise a surplus of this Carrot for feeding milch cows during winter. It increases the flow of milk and imparts to the butter a delicious flavor and a rich golden color. Pkt., 5 cts.; oz., 10 cts.;  $\frac{1}{4}$  lb., 25 cts.; lb., 75 cts.

**Extra Early Forcing.**—Ten days ahead of all others. Pkt., 5 cts.; oz., 10 cts.;  $\frac{1}{4}$  lb., 30 cts.; lb., \$1.00.

**Early Scarlet Horn.**—Blunt-rooted, early, good. Favorite sort for early crop. Pkt., 5 cts.; oz., 10 cts.;  $\frac{1}{4}$  lb., 25 cts.; lb., 75 cts.

**Carrot.**—Continued.



**Half-Long Orange Danvers.**—A decided acquisition of the half-long type, broad-shouldered, cylindrical, admirable in color, fixed in habit, a wonderful producer. It is a first-class Carrot for all soils. Pkt., 5 cts.; oz., 10 cts.;  $\frac{1}{4}$  lb., 25 cts.; lb., 75 cts.

**Ox Heart.**—A new French variety, intermediate in length, of fine quality; excellent table sort. The shape is nearly oval, and the color and quality all that can be desired. Pkts., 5 and 10 cts.; oz., 15 cts.;  $\frac{1}{4}$  lb., 30 cts.; lb., \$1.00.

**Celery.**

GERMAN SELERI.  
(1 Ounce for 2000 Plants.)

Plant seed in hot-bed or very early in open ground. Transplant four inches apart when three inches high, in rich soil finely pulverized; water and protect until well rooted. In June or July transplant into rows either on surface or in well-manured trenches a foot in depth, half filled with well-rotted manure. Set the plants from six to eight inches apart. To blanch, draw earth around the plants from time to time, taking care not to cover the tops of the centre shoots.



**Golden Heart.**—This old standard variety still holds a high place in the estimation of Market Gardeners; and is largely used, always giving satisfaction. A showy sort, solid, of fine flavor, and a good keeper. Pkts., 5 and 10 cts.; oz., 25 cts.;  $\frac{1}{4}$  lb., 65 cts.; lb., \$2.00.

**Paris Golden Self-Blanching.**—This cannot be too highly recommended. It is of beauti-

ful golden color, self-blanching, solid and crisp and of a rich, nutty flavor, very showy, easily blanched, consequently early. Pkts., 5 and 10 cts.; oz., 30 cts.;  $\frac{1}{4}$  lb., 85 cts.; lb., \$3.00.

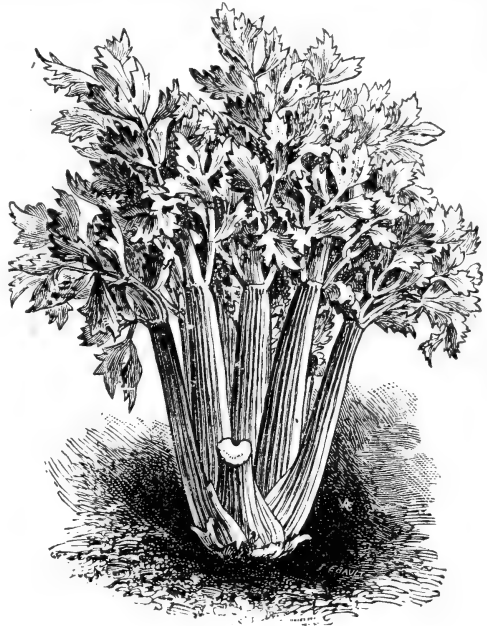

**Giant Pascal.**—New. A selection from the well known Self-Blanching Celery. It partakes of the best qualities of that variety, is somewhat larger and an excellent keeper. Some of our Market Gardeners prefer it above all others. Pkts., 5 and 10 cts.; oz., 25 cts.;  $\frac{1}{4}$  lb., 65 cts.; lb., \$2.00.

**White Plume.**—An early, handsome, self-blanching variety, growing in popularity every year. Pkts., 5 and 10 cts.; oz., 25 cts.;  $\frac{1}{4}$  lb., 75 cts.; lb., \$2.50.

**Perfection Heartwell.**—The best flavored, most crisp and tender of the white varieties. The stalks are clear and attractive in color, very popular in the New York Markets. Pkts., 5 and 10 cts.; oz., 25 cts.;  $\frac{1}{4}$  lb., 75 cts.; lb., \$2.50.

**Boston Market.**—Short, compact and solid; a favorite of many. Pkts., 5 and 10 cts.; oz., 25 cts.;  $\frac{1}{4}$  lb., 65 cts.; lb., \$2.00.

**White Solid.**—A large, standard sort. Pkts., 5 and 10 cts.; oz., 25 cts.;  $\frac{1}{4}$  lb., 65 cts.; lb., \$2.00.

**Flavoring Celery.**—For soup. Pkt., 5 cts.;  $\frac{1}{4}$  lb., 10 cts.;  $\frac{1}{2}$  lb., 15 cts.; lb., 25 cts.

**Celeriac,**

OR TURNIP ROOTED CELERY.

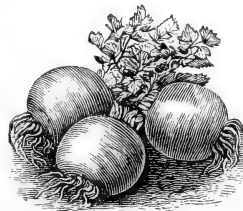

5 and 10 cts.; oz., 20 cts.;

**Large Smooth Prague.**—The largest, smoothest and best of the Celeriacs. Pkts., 5 and 10 cts.; oz., 20 cts.;  $\frac{1}{4}$  lb., 60 cts.; lb., \$2.00.

**New Apple-Shape.**—Small foliage, large, round, smooth. Pkts.,  $\frac{1}{4}$  lb., 60 cts.; lb., \$2.00.

## CORN—For Table Use.

GERMAN WELSCHKORN.—When corn is wanted to be sent by mail, add 8 cts. per pt. to pay postage.

Sugar Corn may be planted in rows three to four feet apart and the seeds placed about eight inches apart in the rows, or planted in hills three to four feet apart each way, according to variety grown or richness of soil. Don't leave more than three plants remain in each hill. It can be planted in this vicinity from first of May to last of July for succession of crop.

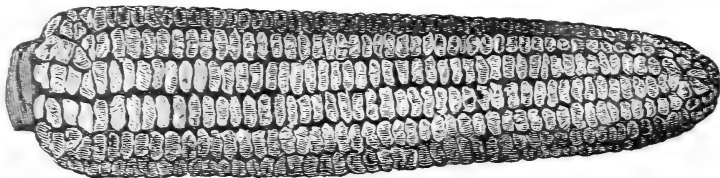

LATE MAMMOTH.

**First of All.**—A selection from the cory, the ears about same size as cory, lighter in color and earlier. Qt., 20 cts.; peck, 85 cts.

**Extra Early Baltimore.**—The earliest of all. Can be planted earlier than sugar corn. Ear, 5 cts.; doz., 40 cts.; qt., 20 cts.;  $\frac{1}{4}$  bush., 85; bush., \$3.00.

**Extra Early Adams.**—Ear, 5 cts.; doz., 25 cts.; qt., 20 cts.;  $\frac{1}{4}$  bush., 75 cts.; bush., \$2.50.

**Adams' Early.**—A favorite in the South. Ear, 5 cts.; doz., 25 cts.; qt., 20 cts.;  $\frac{1}{4}$  bush., 65 cts.; bush., \$2.25.

**Early Landreth Market.**—Qt., 20 cts.; peck, 95 cts.

**Early Burlington Hybrid.**—Not a true Sugar Corn, but a hybrid, or mixture, between the Sugar Corn and the Adams' Early. The ear, when in proper condition for the table, resembles the Sugar Corn. Those who have tried it want it again. Qt., 20 cts.; peck, 85 cts.; bushel, \$3.00.

**Truckers' Early.**—This is, as its name indicates, the best Sugar Corn for Truckers to plant early. It is a week earlier than Evergreen, very productive and showy. Every Market Gardener should grow it. Qt., 20 cts.; peck, 90 cts., bush., \$3.00.

**Early Minnesota Sugar.**—One of the first early among Sugar Corn. Qt., 20 cts.; peck, 85 cts.

**Crosby.**—Qt., 20 cts.;  $\frac{1}{4}$  bush., 85 cts.

**Improved Ne Plus Ultra, or Shoe Peg Corn.**—The sweetest and most delicious flavored of all the Sugar Corn. Early, good sized ear and deep grain. Pt., 15 cts.; qt., 25 cts.; peck, \$1.00.

**White Cory Sweet.**—Earliest Sweet Corn known; of superior merit. Qt., 20 cts.;  $\frac{1}{4}$  bush., 75 cts.; bush., \$2.50.

**Country Gentleman.**—A new sort, se-

lected from the Ne Plus Ultra, and is highly recommended for its many good qualities. Pt., 15 cts.; qt., 25 cts.; peck, \$1.00.

**Stowell's Evergreen.**—So well known that it scarcely needs description. Excellent, keeps green till cold weather, ears large; one of the best. Ear, 5 cts.; doz., 40 cts.; qt., 20 cts.; peck, 85 cts.; bush., \$3.00.

**Mammoth Sweet.**—The largest variety grown; very fine for market purposes. Ear, 5 cts.; doz., 50 cts.; qt., 20 cts.; peck, 85 cts.; bush., \$3.00.

**Hickox.**—A very handsome and excellent variety of Sugar Corn, large, white grain and sweet. Ear, 5 cts.; doz., 40 cts.; qt., 20 cts.; peck, 85 cts.; bush., \$3.00.

**Early Mammoth.**—Large ear and splendid early market sort. Ear, 5 cts.; doz., 40 cts.; qt., 20 cts.; peck, 75 cts.; bush., \$2.50.

**Egyptian.**—Ears long, sweet and tender. Qt.; 20 cts.; peck, 75 cts.; bush., \$2.50.

**Landreth's Sugar.**—Remarkably productive; two to three ears on stalk. The introducer says: "It will afford Market Gardeners more baskets of marketable ears than any other variety." Qt.; 20 cts.; peck, 90 cts.; bush., \$3.25.

**Black Mexican Sugar.**—The Black Corn is especially rich in sugary qualities. Qt., 20 cts.;

**Sugar Corn.**—For Fodder. \$2.00 per bush.

### FOR FIELD VARIETIES OF CORN,

see page 32.

### Cress, or Pepper Grass.

Used as a small salad. Sow very thickly in shallow drills on a smooth surface, at short intervals throughout the season.

**Curled.**—Pkt., 5 cts.; oz., 10 cts.;  $\frac{1}{4}$  lb., 20 cts.; lb., 60 cts.

**Water Cress.**—Pkt., 10 cts.; oz., 30 cts.

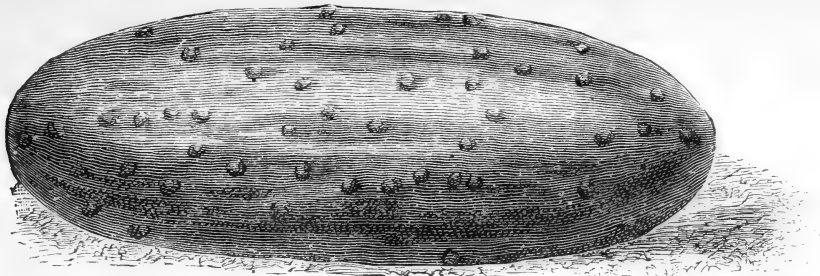

JERSEY PICKLE CUCUMBER.

## Cucumber.

GERMAN, GURKE.

(1 oz. of Seed will plant 50 hills, two pounds will plant an acre.)

The vines require a warm location for early Cucumbers. Plant after the ground has become warm, in hills four feet apart for the smaller varieties and five feet for the larger sorts. For pickling sow from middle of June to last of July. Manure with ashes, fertilizer or some well-rotted composts, working the manure just under the surface. Sprinkle the vines with slug-shot, plaster or air-slacked lime to protect from bugs.

**Improved White Spine, or Peerless.**—The Truckers' favorite early cucumber, a great bearer; excellent for early forcing or for out-door cultivation. Exceedingly popular with growers everywhere, and its popularity shows its worth. Pkt., 5 cts.; oz., 10 cts.;  $\frac{1}{4}$  lb., 20 cts.; lb., 60 cts.

**Early Arlington White Spine.**—A new sort, originating near Boston, and well recommended. Pkts., 5 and 10 cts.;  $\frac{1}{4}$  lb., 25 cts.; lb., 75 cts.

**Early Green.**—Early short, prolific. Quality of fruit good. Pkt., 5 cts.; oz., 10 cts.;  $\frac{1}{4}$  lb., 20 cts.; lb., 60 cts.

**Early Cluster.**—A short, prickly variety, bearing in clusters near the root. A great bearer. Pkt., 5 cts.; oz., 10 cts.;  $\frac{1}{4}$  lb., 20 cts.; lb., 60 cts.



**Long Green.**—Has long been a favorite with growers; dark green, firm and crisp. Supe-

rior for pickles and for market. Pkt., 5 cts.; oz., 10 cts.;  $\frac{1}{4}$  lb., 20 cts.; lb., 60 cts.

**Jersey Pickle.**—This is the most popular sort with the market gardeners around Baltimore and Philadelphia for pickling. Said to green better than any other variety. Pkt., 5 cts.; oz., 10 cts.;  $\frac{1}{4}$  lb., 20 cts.; lb., 60 cts.

**Gherkin or Burr.**—Used for pickles only. Pkts., 5 cts.; oz., 20 cts.;  $\frac{1}{4}$  lb., 60 cts.

## Egg Plant.

GERMAN EIERPFLANZE.

(One Ounce of Seed will Produce 1000 Plants.)

Sow the seed in March, in a hot-bed, or for family use in flower pots, in a warm window. Transplant in open ground after weather has become warm and settled, in rows three to four feet apart each way. They require a rich soil and as favorable location for warmth as the garden will afford.

**Improved Large Purple.**—The leading market variety, and the best sort grown, of large size; skin a deep purple, thornless, and of handsome shape. Pkts., 10 and 25 cts.; oz., 45 cts.;  $\frac{1}{4}$  lb., \$1.25; lb., \$4.25.

## Endive.

### GERMAN ENDIVIEN.

(One Ounce of Seed to 150 Feet of Row).

For early use, sow as soon as the ground can be worked in the Spring, in drills fifteen inches apart, and thin plants to six or eight inches in the row. To blanch the leaves, gather them carefully together, when perfectly dry, and tie with matting or soft fibrous material. Another method is to invert flower pots over the plant. The leaves are very highly esteemed for use as salads.

*Green Curled.*—Very popular; the best sort in use. Pkt., 5 cts.; oz., 20 cts.; ½ lb., 50 cts.; lb., \$1.50.

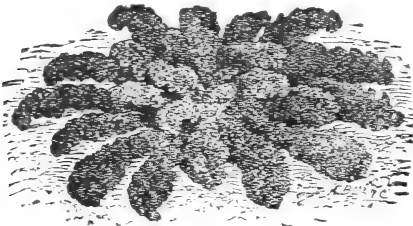

DWARF GERMAN.

## Kale.

### GERMAN BLATTER-KOHL.

#### *Dwarf German Greens or Sprouts.*—

This variety sow in September, broadcast, and gather in early Spring, like Spinach. Pkt., 5 cts.; oz., 10 cts.; ¼ lb., 20 cts.; lb., 50 cts.

*Norfolk.*—A variety used by the Truckers of Norfolk, for shipment North; light green color and leaves much curled. ¼ lb., 30 cts.; lb., \$1.00.

**BORECOLE.**—This is grown by all the leading Market Gardeners, and is by many called *Broccoli*. Sow early in Spring and transplant to deep, rich soil and cultivate same as Cabbage. Very spreading, nicely curled and hardy; frost improves it. Pkts., 5 and 10 cts.; oz., 15 cts.; ½ lb., 30 cts.; lb., \$1.00.



## Kohl Rabi.

(One Ounce of Seed to 150 Feet of Row).

*White Vienna.*—Bulb light green, flesh white, very rapid in growth, early in maturity fine in texture and symmetrical in form; superior. Pkts., 5 and 10 cts.; oz., 25 cts.; ¼ lb., 70 cts.; lb., \$2.50.

## Leek.

### GERMAN LAUCH.

(One Ounce of Seed to 150 Feet of Row).



Select good Onion soil, manure liberally, plant in April in drills six to eight inches deep and eighteen inches apart, and thin to nine inches apart in the drill. Gradually draw the earth around the plants until the drills are filled level with the surface. Draw for use in October. To be used in soups or boiled as Asparagus.

*Extra Large.*—A large and strong plant, hardy, the best Pkt., 5 cts.; oz., 15 cts.; ¼ lb., 45 cts.; lb., \$1.50.

*Musselburgh.*—Oz., 20 cts.; ¼ lb., 60 cts.; lb., \$2.00.

## Lettuce.

### GERMAN LATTICH.

(One Ounce of Seed to 150 feet of Row).

Lettuce requires a rich and rather moist soil. The rows should be about twelve inches apart, and the plants thinned to ten or twelve inches apart for the leading varieties. The more rapid the growth the better the quality. Some varieties are peculiarly adapted for early culture, others for summer growth.

*Early Curled Simpson, Black Seed.*—Very early, excellent for salads; forms a compact mass of leaves. Pkts., 5 and 10 cts.; oz., 15 cts.; ¼ lb., 30 cts.; lb., \$1.00.

*Defiance.*—Stands summer heat better than any other variety; one of the finest large growing Lettuce. It forms very large solid heads, so firm, they have to be cut open to allow the flower heads to come through. Pkts., 5 and 10 cts.; oz., 15 cts.; ¼ lb., 50 cts.; lb., \$1.50.

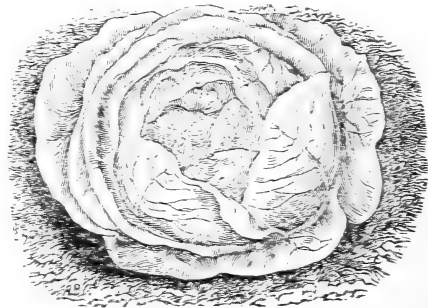

ROYAL CABBAGE, OR LOAF.

*Royal Cabbage, or Loaf.*—Large compact head, very fine for frames or out-door; well-known to the Truckers around Baltimore and Norfolk. Pkts., 5 and 10 cts.; oz., 15 cts.; ¼ lb., 45 cts.; lb., \$1.50.

Special Prices to Cannerymen, Gardeners and Farmers, in Large Quantities.



**Lettuce.—Continued.**

**Early Forcing.**—The best for hot-beds or frames. Pkts., 5 and 10 cts.; oz., 25 cts.;  $\frac{1}{4}$  lb., 70 cts.

**Baltimore Cabbage.**—Introduced by us two years ago and pronounced by a number of growers to be the finest heading Lettuce they have ever seen. See description page 7. Pkts., 5 and 10 cts.; oz., 20 cts.;  $\frac{1}{4}$  lb., 65 cts.; lb., \$2.00.

**Bloomsdale Butter,** Black Seed.—Fine for frames and out-door planting. Pkts., 5 and 10 cts.; oz., 15 cts.;  $\frac{1}{4}$  lb.; 45 cts.; lb., \$1.50.

**Tennis Ball,** Black Seed.—A favorite forcing variety; very hard head. Pkts., 5 and 10 cts.; oz., 15 cts.;  $\frac{1}{4}$  lb., 30 cts.; lb., \$1.00.

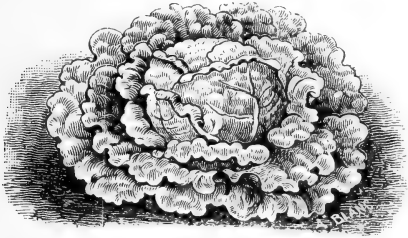

EARLY WHITE CABBAGE, OR BUTTER.

**Early White Cabbage, or Butter.**—A broad leaved, vigorous heading sort; white, showy and desirable. Pkts., 5 and 10 cts.; oz., 15 cts.;  $\frac{1}{4}$  lb., 30 cts.; lb., 90 cts.

**Boston Market.**—A celebrated variety in New England, of good heading habit, small, early and compact; quite desirable. Pkts., 5 and 10 cts.; oz., 15 cts.;  $\frac{1}{4}$  lb., 30 cts.; lb., \$1.00.

**Hanson.**—A variation of the India, forming a half-closed head. Pkts., 5 and 10 cts.; oz., 15 cts.;  $\frac{1}{4}$  lb., 30 cts.; lb., 90 cts.



**Paris White Cos.**—Differs entirely in shape from the other varieties, the head being elongated and of conical form, eight or nine inches in height, and five or six inches in diameter. The outer coloring of this variety is yellowish green. It is very hardy and of good flavor. To blanch perfectly it must be tied up. It is the great favorite of the London market. Try it. Pkt., 5 cts.; oz., 15 cts.;  $\frac{1}{4}$  lb., 30 cts.; lb., \$1.00.

**Melon=Cantaloupe.**

GERMAN MELONE.

(One Ounce of Seed to 50 Hills).

Sow about the last of Spring or first of Summer, in hills of light, rich, sandy soil, four feet apart, allowing but three plants to grow in each hill; after they have grown about a foot long, pinch off the points of shoots, which causes the vines not only to become stronger, but makes them produce lateral branches, and prove more productive and mature earlier. It should not be grown near Squashes, Cucumber or Pumpkins.

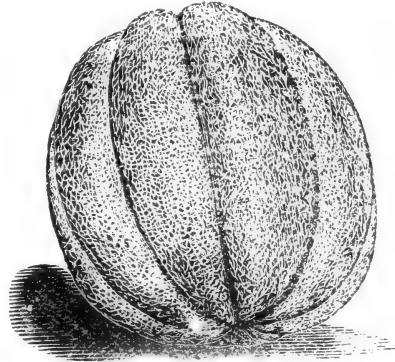

EARLY NUTMEG.

**Early Nutmeg.**—Is one of the best old varieties, very early, green fleshed, finely netted, flavor rich and sugary. Pkt., 5 cts.; oz., 10 cts.;  $\frac{1}{4}$  lb., 25 cts.; lb., 70 cts.

**Baltimore Nutmeg.**—Well known and extensively used for years by many of the largest growers in the country. It has attained greater popularity than any Cantaloupe ever introduced. Large, thick, green, sweet flesh; fine flavor and an excellent shipper. Pkt., 5 cts.; oz., 10 cts.;  $\frac{1}{4}$  lb., 25 cts.; lb., 70 cts.; 5 lbs., \$3.00.

**Anne Arundel.**—This new Melon has been grown by a number of leading shippers in Anne Arundel Co., Md., for several years, and is growing in favor because of its many good qualities. It is large, round, well netted and very showy. A good seller and shipper. Pkts., 5 and 10 cts.;  $\frac{1}{4}$  lb., 30 cts.; lb., \$1.00

**Extra Early Hackensack.**—Netted green flesh and excellent; very showy market variety; ten days earlier than the Old Hackensack. Pkt., 5 cts.; oz., 10 cts.;  $\frac{1}{4}$  lb., 25 cts.; lb., 75 cts.

**Jenny Lind.**—A small early variety of surpassing good quality, highly recommended for family garden; deliciously sweet. Pkt., 5 cts.; oz. 10 cts.;  $\frac{1}{4}$  lb., 25 cts.; lb., 75 cts.

**Emerald Gem.**—Meat salmon color, exceedingly sweet and delicious; very early and prolific. One of the best for family use. Pkt., 5 cts.; oz. 10 cts.;  $\frac{1}{4}$  lb., 30 cts.; lb., \$1.00.



## Watermelon.

### GERMAN WASSER MELONE.

(One Ounce of Seed to 30 Hills.)

Watermelons require a rich, sandy soil for best development. Cultivate the same as for Canteloupes, except that the hills should be eight to ten feet apart.

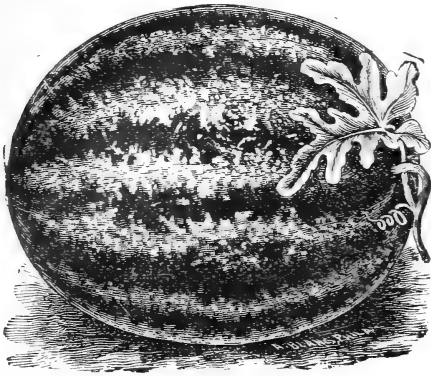

KOLB'S GEM.

**Kolb's Gem.**—This is one of the largest, most productive, best keeping and best shipping Melons grown. Sells readily at the highest market price. In fact, it is so well known that it speaks for itself. Our stock of this comes direct from the original grower. Pkt., 5 cts.; oz., 10 cts.;  $\frac{1}{4}$  lb., 15 cts.; lb., 40 cts. Special prices on large quantities.

**Dixie.**—New. Of large size, delicious flavor and a most excellent shipper. This Melon is destined to lead all others, as it is first-class in all respects. Pkt., 5 cts.; oz., 10 cts.;  $\frac{1}{4}$  lb., 20 cts.; lb., 50 cts.; 5 lb., \$2.00.

**Lord Baltimore.**—This new melon is early, very large, delicious red meat and a good shipper. See description page 8. Pkt., 10 cts.;  $\frac{1}{4}$  lb., 35 cts.; lb., \$1.25.

**Seminole.**—Extra early, enormously productive, extra large and of delicious flavor. Try it. Pkt., 5 cts.; oz., 10 cts.;  $\frac{1}{4}$  lb., 20 cts.; lb., 60 cts.

**Boss Melon.**—A new Watermelon of rare quality; skin dark green. Pkt., 5 cts.; oz., 10 cts.;  $\frac{1}{4}$  lb., 20 cts.; lb., 50 cts.

**Florida Favorite.**—This we consider the richest and sweetest flavored Melon grown, of medium size and prolific. The best of all for family garden. Pkts., 5 and 10 cts.;  $\frac{1}{4}$  lb., 20 cts.; lb., 50 cts.

**Citron.**—Used in preserving. Pkt., 5 cts.; oz., 10 cts.;  $\frac{1}{4}$  lb., 25 cts.

**Girardeau's Favorite.**—This is an improvement on the Florida Favorite, resembling it very much, but larger. Pkts., 5 cts.; oz., 10 cts.;  $\frac{1}{4}$  lb., 25 cts.; lb., 75 cts.

## Mushrooms.

Mushrooms can be readily grown in cellars, stables, sheds or pits. Many are successful grown on a shelf in an ordinary cellar and yield sufficient crops to compensate the grower for his effort. The space under greenhouse benches or stagings will

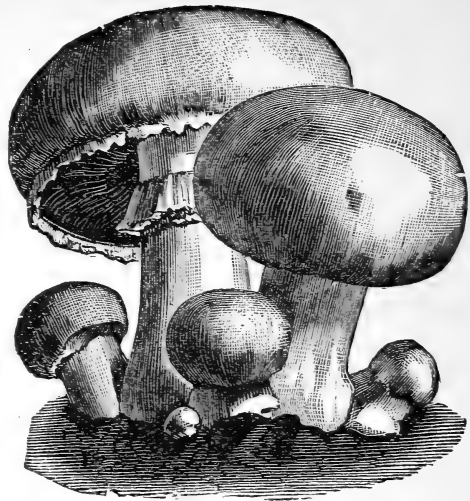

suit them exactly, using materials in same manner as described.

### CULTIVATION.

The cultivation of the Mushroom is a very simple matter and requires only ordinary intelligence and care. The materials needed are fresh horse manure, good soil and live spawn. The manure should not be too short, as it does not combine the necessary qualities. Long strawy litter, plentifully mixed with short manure, makes by far the best beds, as it does not heat too violently, decomposes slowly and retains its heat for a long period. Put in a heap and turn every three or four days to permit the escape of noxious gases and prevent burning. When ready for use it should be as hot as can be borne comfortably by the hand, and should also be moist. Make the beds 3 feet wide at the base, 2 $\frac{1}{2}$  feet high, and of any desired length. The manure, when in proper condition, should be quickly handled to prevent the loss of heat and be beaten down to make the heap firm and compact, and cover with long litter; when the heat has decreased to 90°, the bed is ready to receive the spawn, which is done by raising the manure with the hand and inserting pieces of spawn 2 inches square, 9 inches apart each way. At the expiration of a few days the bed may be covered with soil to the depth of about two inches. If the soil is poor add a liberal quantity of bone meal.

Best English Spawn, 12 cents per lb.; 10 lbs. for \$1.00.

## Mustard Seed.

Pkt., 5 cts.;  $\frac{1}{4}$  lb., 10 cts.; lb., 25 cts.

## Nasturtium.

Plant in May, the climbing varieties to cover arbor or fence, and the dwarf for beds or hanging-baskets. The leaves are used for salad, and the seeds, when soft enough to be easily penetrated by the nail, for pickles.

**Tall.**—An ornamental climber. Pkt., 5 cts.; oz., 15 cts.;  $\frac{1}{4}$  lb., 35 cts.; lb., \$1.25.

**Dwarf.**—Pkt., 5 cts.; oz., 15 cts.;  $\frac{1}{4}$  lb., 35 cts.; lb., \$1.25.

## Okra, or Gumbo.



Select warm location and rich soil and plant when the ground becomes warm, in rows three feet apart, thinning plants a foot apart in the row. As the seed are liable to rot, they should be sown thickly. The pods are used to thicken soup, being

gathered when young. It is one of the most wholesome vegetables in use.

**Dwarf Prolific.**—Of dwarf habit and an abundant bearer; the best sort in use. Pkt., 5 cts. oz., 10 cts.;  $\frac{1}{4}$  lb., 20 cts.; lb., 50 cts.

**White Velvet.**—It is very distinct, and the pods are perfectly round, smooth, of an attractive white velvet appearance, and of superior flavor and tenderness. The pods are of extra large size, and produced in great abundance. Pkt., 5 cts.; oz., 10 cts.;  $\frac{1}{4}$  lb., 20 cts.; lb., 60 cts.

## Onions.

*To grow large Onions from Seed.*—The seed should be sown as early as possible in the Spring, as they will not do well in hot weather.

*For Sets.*—Have a clean and very rich soil, which should be thoroughly cultivated, or it will not do well enough to pay for the trouble. The most successful growers work their ground several times in the Fall to kill out the weeds, and get ground in nice condition. Use well-rotted manure freely, and be sure to get the seeds in as early as possible in the Spring, no matter if it is ever so cold or unpleasant, and keep the soil mellow and clear of weeds, and if seed is good you will have a large crop of Onions. On no other condition can you hope for success. Disturb the roots of the Onion as little as possible, either in thinning or hoeing, and never hoe earth towards them to cover or hill, as we do most other things.

**Prizetaker.**—This is the large, beautiful onion that is seen every Fall offered for sale at the fruit stores in Baltimore and other large cities. They are a rich straw color and of enormous size. Although of such large size, it is very hardy and an excellent keeper. The flavor is mild and delicate, making the Prizetaker a favorite variety for salads. Pkt., 10 cts.; oz., 35 cts.;  $\frac{1}{4}$  lb., \$1.00; lb., \$3.50.

**American Extra Early White Pearl.**—Earliest of all, growing with the rapidity of a summer radish. Pearly white, waxy and transparent. Form flat and broad; flavor very mild and

it can be eaten raw almost like an apple; on rich soil it will grow very large. Pkt., 10 cts.; oz., 30 cts.;  $\frac{1}{4}$  lb., 90 cts.; lb., \$3.25.

**Extra Early Red.**—Onions of fit size for table use may be raised from the black seed the first season. Pkts., 5 and 10 cts.; oz., 20 cts.;  $\frac{1}{4}$  lb., 60 cts.; lb., \$2.00.

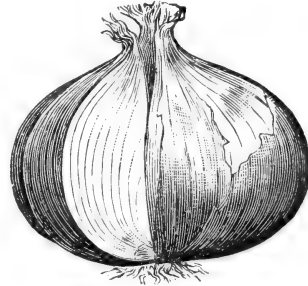

WHITE SILVER SKIN.

**White Silver Skin.**—White, mild flavored and a good keeper. The best white onion to grow in quantities for sets. Pkts., 5 and 10 cts.; oz., 30 cts.;  $\frac{1}{4}$  lb., 85 cts.; lb., \$3.00.

**White Portugal.**—Pkts., 5 and 10 cts.; oz., 25 cts.;  $\frac{1}{4}$  lb., 85 cts.; lb., \$3.00.

**Southport White Globe.**—A large, showy variety. Pkts., 5 and 10 cts.; oz., 25 cts.;  $\frac{1}{4}$  lb.; 75 cts.; lb., \$2.50.

**Large Red Wethersfield.**—An old well-known sort. Pkts., 5 and 10 cts.; oz., 15 cts.;  $\frac{1}{4}$  lb., 50 cts.; lb., \$1.50.

**Large Yellow Strasburg.**—Very fine, a good keeper; the kind used very largely by those who grow onion sets for market. Pkts., 5 and 10 cts.; oz., 20 cts.;  $\frac{1}{4}$  lb., 50 cts.; lb., \$1.50.

**Danver's Yellow.**—A very handsome round yellow onion, a large yielder, and splendid keeper. We unhesitatingly recommend it for growing either sets or large onions. Pkts., 5 and 10 cts.; oz., 15 cts.;  $\frac{1}{4}$  lb., 50 cts.; lb., \$1.50.

**Onion Sets.**—White, qt., 25 cts.; yellow, qt., 20 cts. If wanted by mail add 10 cents per quart to pay postage. By the bushel, at market prices.

*Write us for quotations.*

## Parsley.

Select rich soil; sow the seed in drills one foot apart, covering half an inch deep. It would be well to firm the soil with the foot after sowing the seed. As the seed is usually from fifteen to twenty-five days in vegetating, it will be necessary to sow early. Thin plants to four inches apart when two inches high. The beauty of the plant may be increased by several successive transplantings. It is used principally for flavoring soups, etc., and for garnishing in its natural state.

**Moss Curled.**—A very select crimped variety. Pkt., 5 cts.; oz., 10 cts.;  $\frac{1}{4}$  lb., 25 cts.; lb., 85 cts.

## Parsley.—Continued.



DOUBLE CURLED.

**Double Curled.**—The most beautiful and valuable variety in use. Of a handsome, bright green color, finely crimped and beautifully curled. Pkt., 5 cts.; oz., 10 cts.;  $\frac{1}{4}$  lb., 25 cts.; lb., 85 cts.



## Parsnips.

The Parsnip will flourish best and give the longest, largest and smoothest roots in a very deep rich soil—one that has been made rich from manure the previous year. *Fresh manure makes the roots somewhat ill-shaped.* Sow as early in the Spring as the ground can be made ready, pretty thickly in drills from 12 to 18 inches apart and about an inch deep. Thin the plants to five or six inches apart.

**Hollow Crown, or Sugar.**—The Hollow Crown is superior in quality to all other varieties, and the preferred kind with Baltimore Gardeners; smooth, tender, handsome shape and early. Pkt., 5 cts.; oz., 10 cts.;  $\frac{1}{4}$  lb., 20 cts.; lb., 50 cts.

## Peas.

**NOTICE.**—In ordering Peas to be sent by mail, please add 15 cts. per quart to pay postage.

The dwarf varieties should be liberally manured; the tall sorts will run too much to vine if heavily manured, it being better to depend on the richness of the land that was previously in good condition. Plant the dwarf in rows two feet apart; those varieties attaining the height of from two to three feet, in rows three feet apart, and the rows of the tallest sort four feet apart. Bush the tall kinds when six inches high, or poles set every six or eight feet, with twine fastened to them about four inches apart, answer finely.

### Extra Early Dwarf.

These varieties require no sticking.

**American Wonder;** height 12 inches.—The earliest wrinkled Pea; very productive and sweet. Pt., 15 cts.; qt. 30 cts.;  $\frac{1}{4}$  bush., \$1.75; bush., \$6.00.

**Premium Gem;** height 15 inches.—An improvement upon the Little Gem. Very luscious in flavor; try it. Qt., 25 cts.;  $\frac{1}{4}$  bush., \$1.25; bush., \$4.75.

**Blue Peter, or Blue Tom Thumb.**—One of the earliest and hardiest of the dwarf varieties. Blue seed, dark green pods, large Peas, of excellent quality. Pt., 15 cts.; qt., 25 cts.; peck, \$1.50.

### Extra Early Medium Height.

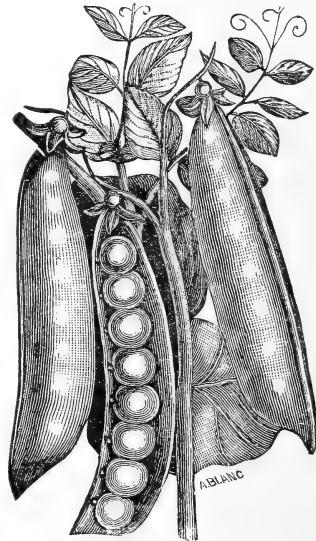

GRIFFITH, TURNER & CO.'S FIRST EARLY.

**Griffith, Turner & Co.'s First Early;** height, 2 $\frac{1}{2}$  feet.—Earliest of all and most profitable market Pea, because most uniform in growth and maturity. Grown from selected stock, under our own supervision. Largely used by truckers,

**Peas.—Continued.**

as well as private families. Our sales of this sort increase rapidly each year. Pt., 15 cts.; qt., 25 cts.;  $\frac{1}{4}$  bushel, 90 cts.; bushel, \$3.00.

**Landreth's Extra Early**; height,  $2\frac{1}{2}$  feet.—This is a very early variety used largely by market gardeners. Pt., 15 cts.; qt., 25 cts.;  $\frac{1}{4}$  bushel, \$1.00; bushel, \$3.25.

**Rural New Yorker**; height,  $2\frac{1}{2}$  feet.—Sealed. In maturity it is among the first early. Qt., 20 cts.;  $\frac{1}{4}$  bushel, 90 cts.; bushel, \$3.00.

**Rural New Yorker**; height,  $2\frac{1}{2}$  feet.—Unsealed. Qt., 20 cts.; peck, 75 cts.; bushel, \$2.75.

**First and Best**; height,  $2\frac{1}{2}$  feet.—Grown with special care; one of the early varieties. Qt., 20 cts.; peck, 75 cts.; bushel, \$2.75.

**Alaska**; height, 26 inches.—The earliest Blue Pea, very uniform in growth; the dark green color of pods make this a most desirable sort for canners and shippers. Qt., 25 cts.; peck, \$1.25; bushel, \$4.00.

**Kentish Invicta**; height, 30 inches.—An early Blue Pea of good flavor and productive. Qt., 20 cts.; peck, \$1.15; bushel, \$4.00.

**Dexter**.—Qt., 20 cts.; peck, 75 cts.; bushel, \$2.75.

**Triumph**.—Qt., 20 cts.; peck, 75 cts.; bushel, \$2.50.

**Second Early and Late Varieties.**

GARDENERS' FAVORITE.

**Gardeners' Favorite**; height, 30 to 36 inches.—A wrinkled variety named and introduced by us, and which is constantly gaining friends; of most delicious flavor, prolific bearer, specially suited for the market garden trade; give it a trial. Pt., 15 cts.; qt., 25 cts.;  $\frac{1}{4}$  bushel, \$1.25; bushel, \$4.50.

**French Canner**; height,  $3\frac{1}{2}$  feet.—The celebrated Pea used in France by the Canners. It

is wonderfully prolific, bearing an abundance of long pods containing seven to nine Peas of excellent flavor. Qt., 25 cts.; peck, \$1.35; bushel, \$5.00. See illustration, page 8.

**Yorkshire Hero**; height,  $2\frac{1}{2}$  feet.—A wrinkled variety, productive and of a very superior flavor. Qt., 20 cts.;  $\frac{1}{4}$  bushel, 90 cts.; bushel, \$3.25.

**Advancer**;  $2\frac{1}{2}$  feet.—A green wrinkled variety, introduced some years ago and has always given satisfaction. Qt., 20 cts.; peck, \$1.00; bushel, \$3.25.

**Abundance**; height 30 to 36 inches.—An excellent half dwarf, medium early variety, pods three and a half inches long, containing six to eight large wrinkled Peas of excellent quality. Qt., 20 cts.; peck, \$1.00; bushel, \$3.50.

**Everbearing**.—Vines about two feet high, of a branching character, forming as many as ten stalks from a single root stalk. Peas large and of fine quality. Qt., 20 cts.; peck, \$1.00; bushel, \$3.50.

**Stratagem**; height  $2\frac{1}{2}$  feet.—A large wrinkled Blue Pea of excellent quality; very long, large filled pods; one of the best. Qt., 30 cts.; peck, \$1.75 cts.; bushel, \$6.00.

**Horsford's Market Garden**; height  $2\frac{1}{2}$  feet.—A medium early wrinkled variety, highly recommended. Qt., 20 cts.; peck, \$1.00; bushel, \$3.75.

**Champion of England**; height 4 feet.—An old favorite, rich flavored and very productive. Qt., 20 cts.; peck, 75 cts.; bushel, \$2.75.

**Telephone**; height 3 to 4 feet.—Large wrinkled seeds; pods large and well filled. Qt., 25 cts.; peck, \$1.25; bushel, \$4.50.

**Dwarf White Marrowfat**; height  $3\frac{1}{2}$  to 4 feet.—Standard market variety. Pt., 10 cts.; qt., 15 cts.; peck, 50 cts.; bushel, \$1.75.

**Improved Sugar Marrows**; height  $3\frac{1}{2}$  feet.—Sealed. Grows a strong vine, bears in abundance large, filled pods. The Truckers' favorite; have never been able to get enough to fill our orders. Sold out.

**Melting Sugar—Edible Pods**.—This new variety is ahead of all other Sugar Peas, not only in size of pod and prolific bearing, but also for its delicious flavor. It grows to the height of five feet, bears a profusion of very large, broad, handsome, light green (nearly white) pods, which are generally found in pairs, and are so brittle that they snap without any strings. Sweet and tender, and is cooked like wax beans. Pt., 25 cts.; qt., 40 cts.

**Dwarf Grey Sugar**.—Edible pods; cooked in the pods same as Snap Bean. Pt., 20 cts.; qt., 35 cts.

## Pepper.

Capsicum, or Pepper, is cultivated mainly for Pickles. It is used as a seasoning in many ways, and sometimes medicinally. Sow the seed early in a hot bed, if possible; if not, select a warm place in the garden for a seed bed and sow as soon as the soil is warm. Transplant when three or four inches high, in rows 18 inches apart.

**Cayenne.**—Small, long and tapering; very hot; best for seasoning pickles. Pkts., 5 and 10 cts.; oz., 25 cts.;  $\frac{1}{4}$  lb., 75 cts.

**Large Sweet Spanish, or Mountain.**—Very large and excellent for Mangoes or Stuffed Pickles. Pkts., 5 and 10 cts.; oz., 25 cts.;  $\frac{1}{4}$  lb., 70 cts.; lb., \$2.00.

**Bull Nose, or Bell.**—Good for pickling; very hot. Pkts., 5 and 10 cts.; oz., 25 cts.;  $\frac{1}{4}$  lb., 70 cts.; lb., \$2.00.

**Ruby King.**—An excellent sort of large size and mild flavor. Pkts., 5 and 10 cts.; oz., 25 cts.;  $\frac{1}{4}$  lb., 70 cts.

**Golden Queen.**—In shape and size similar to Bull Nose, and of mild flavor, color yellow. Pkts., 5 and 10 cts.; oz., 25 cts.;  $\frac{1}{4}$  lb., 70 cts.

## Pumpkin.

Plant in May, in hills eight feet apart. Allot ten seeds to each hill, as bugs often destroy the young plants, but only allow two or three healthy plants to remain in each hill. They are usually planted in fields with Corn or Potatoes.

**Maryland Sweet Potato.**—This is the best table Pumpkin in cultivation; in shape and

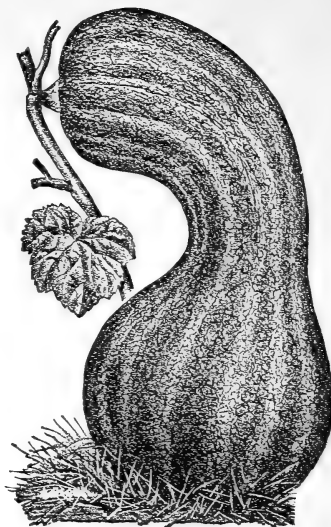

MARYLAND SWEET POTATO.

size it somewhat resembles the Cashaw, smooth skin, flesh fine grained, flavor delicious, color green and white striped. Pkt., 5 cts.; oz., 10 cts.;  $\frac{1}{4}$  lb., 25 cts.; lb., 75 cts.

**Large Cheese.**—Skin reddish orange, flesh thick, fine and sweet. Pkt., 5 cts.; oz., 10 cts.;  $\frac{1}{4}$  lb. 20 cts.; lb., 50 cts.

**Cashaw, or Crookneck.**—Solid flesh, fine and sweet, keeps well. Pkt., 5 cts.; oz., 10 cts.;  $\frac{1}{4}$  lb., 20 cts.; lb., 50 cts.

**Connecticut Field.**—Very productive, and grown for feeding stock. It is so well-known that it does not need description.  $\frac{1}{4}$  lb., 10 cts.; lb., 25 cts.; 5 lbs., \$1.00

## Potatoes.

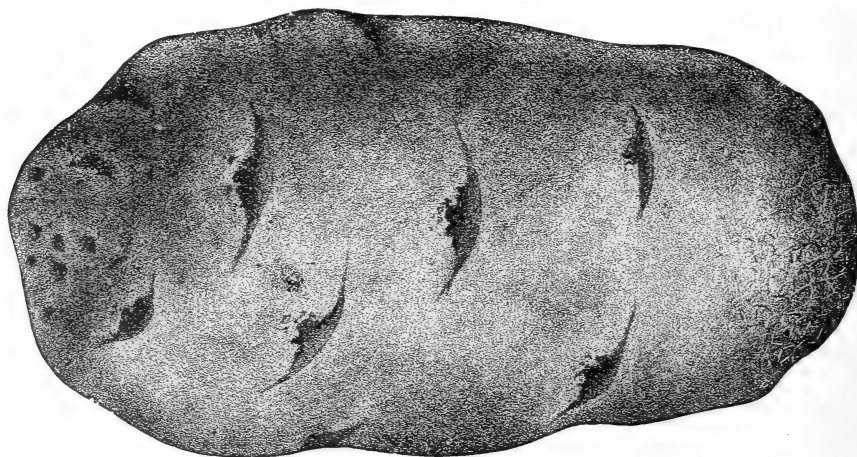

The leading varieties of Potatoes, such as Ohio Junior, Early Ohio, Charles Downing, New York Early Rose, Burbank, Puritan, Brownell's Winner, etc. **Prices on application.**

Special Prices to Cannerymen, Gardeners and Farmers, in Large Quantities.

## Radish.

For an early supply sow in hot-bed, in February. For a successive supply sow from middle of March to September. Radishes thrive best in a light, rich, sandy loam.

The Radish must make a rapid growth to be fit for use; it will then be crisp and tender, and of mild flavor. If it grows slowly, it will be hard, fibrous and disagreeably pungent.

**Early Scarlet or Prussian Globe.**—A new sort and very choice, root round and crimson colored, early, very attractive and desirable; fine for forcing. Pkt., 5 cts.; oz., 10 cts.;  $\frac{1}{4}$  lb., 30 cts.; lb., \$1.00.



Early Red Turnip.

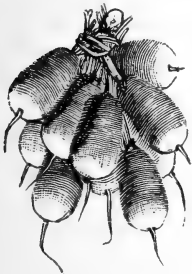

French Breakfast.  $\frac{1}{4}$  lb., 20 cts.; lb., 50 cts.

**White Olive.**—Quite salable in market. Pkt., 5 cts.; oz., 10 cts.;  $\frac{1}{4}$  lb., 25 cts.; lb., 75 cts.

**Scarlet Olive-Shaped.**—A showy, half-long variety, of pretty shape, and bunches beautifully. Pkt., 5 cts.; oz., 10 cts.;  $\frac{1}{4}$  lb., 25 cts.; lb., 75 cts.



Large White Summer.

**Early White Turnip.**—For forcing. Pkt., 5 cts.; oz., 10 cts.;  $\frac{1}{4}$  lb., 20 cts.; lb., 60 cts.

**Early Red Turnip.**—Turnip-shaped, skin red; for forcing. Pkt., 5 cts.; oz., 10 cts.;  $\frac{1}{4}$  lb., 20 cts.; lb., 60 cts.

**White Tip Scarlet Turnip.**—Red skin, fine flavor, very pretty. Pkt., 5 cts.; oz., 10 cts.;  $\frac{1}{4}$  lb., 25 cts.; lb., 75 cts.

**French Breakfast.**—Of oval form, color scarlet, white tipped. Pkt., 5 cts.; oz., 10 cts.  $\frac{1}{4}$  lb., 20 cts.; lb., 65 cts.

**Long Scarlet American.**—Short top, deep scarlet roots, crisp, fine. Pkt., 5 cts.; oz., 10 cts.;  $\frac{1}{4}$  lb., 20 cts.; lb., 60 cts.

**Long Scarlet.**—Imported.

**Large White Summer.**—This is the most popular White Radish, for summer use, with the gardeners around Baltimore, because of its handsome appearance and ready sale, and its well-known quality of being slow to run to seed. Pkt., 5 cts.; oz., 10 cts.;  $\frac{1}{4}$  lb., 20 cts.; lb., 50 cts.

**Golden Globe.**—The best summer Radish. Slow to run to seed, shape globular, bright yellow color, and mild flavor. Pkt., 5 cts.; oz., 10 cts.;  $\frac{1}{4}$  lb., 20 cts.; lb., 60 cts.

**Chartier.**—A good variety for private or market garden purposes; stands long before going to seed, and is tender and crisp. Pkt., 5 cts.; oz., 10 cts.;  $\frac{1}{4}$  lb., 20 cts.; lb., 60 cts.

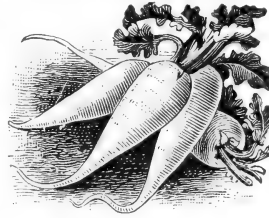

White Strasburg.

**Giant Stuttgart.**—A splendid, new variety of excellent quality; withstands summer heat. Pkt., 5 cts.; oz., 10 cts.;  $\frac{1}{4}$  lb., 25 cts.; lb., 75 cts.

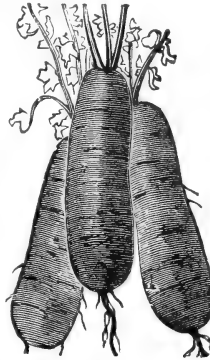

Chinese Rose Winter.

**Black Spanish.**—Good late variety; black; keeps through the winter. Pkt., 5 cts.; oz., 10 cts.;  $\frac{1}{4}$  lb., 25 cts.; lb., 75 cts.

**Large White Spanish Winter.**—Fine keeping quality. Pkt., 5 cts.; oz., 10 cts.;  $\frac{1}{4}$  lb., 25 cts.; lb., 75 cts.

**Chinese Rose Winter.**—Remarkably fine for winter use. The best of the winter sorts. Pkt., 5 cts.; oz., 10 cts.;  $\frac{1}{4}$  lb., 25 cts.; lb., 75 cts.

## Rhubarb, or Pie Plant.

Sow in April, in drills one inch deep and one foot apart. When plants are large enough, thin to ten inches apart and cultivate. In the Fall or following Spring transplant into deep rich soil three feet apart each way. Pkt., 10 cts.; oz., 15 cts.;  $\frac{1}{4}$  lb., 45 cts.; lb., \$1.50.

## Salsify, or Vegetable Oyster.

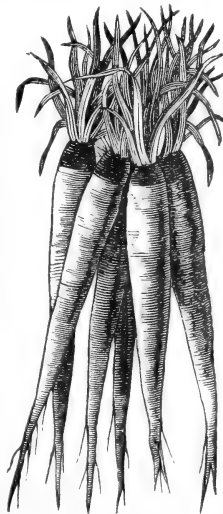

Sow in early Spring, on light, rich soil, in drills fourteen inches apart, and thin the plants to six inches in the row. The roots will be ready for use in October, and will sustain no injury by being left in the ground during the winter. When cooked the flavor somewhat resembles the oyster, and is a good substitute for it.

**Large White.**—The old, well-known variety. Pkts., 5 and 10 cts.;  $\frac{1}{4}$  lb., 25 cts.; lb., 90 cts.

**Sandwich Island Mammoth.**—This new Salsify grows fully twice the size of the old sort, and is superior in quality. Invaluable to market gardeners. Pkts., 5 and 10 cts.; oz., 15 cts.;  $\frac{1}{4}$  lb., 35 cts.; lb., \$1.25.



## Spinach.

This is quite an important crop with market gardeners, and one easily managed.

For summer use, sow early in spring, in drills eight inches to one foot apart, covering the seed one inch deep. Select rich soil and manure liberally. A succession may be obtained by sowing at intervals of two weeks through the season. For very early spring use, sow in August, and protect the plants through the winter by a thick covering of clean straw or some similar light covering. Spinach is used principally as greens for boiling, and is very highly esteemed for this purpose.

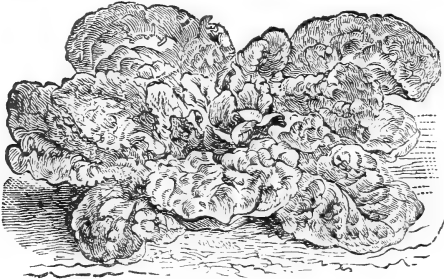

CURLED SAVOY.

**Curled Savoy, or Bloomsdale.**—Leaves extra curled, large and thick. By far the best and most productive Spinach in cultivation. The kind most generally used by the truckers and large growers around Baltimore, Washington, Norfolk and other large cities. Our sales of this sort increase rapidly each year. Pkt., 5 cts.;  $\frac{1}{4}$  lb., 10 cts.; lb., 25 cts.

**Round Savoy.**—20 cents per pound.

**Bloomsdale Spinach.**—In sealed packages. Well known and popular with market gardeners. Pkt., 5 cts.; oz., 10 cts.;  $\frac{1}{4}$  lb., 15 cts.; lb., 40 cts.



LONG STANDING.

**Long Standing.**—Best for spring sowing; slow to seed. Pkt., 5 cts.;  $\frac{1}{4}$  lb., 10 cts.; lb., 25 cts.; 5 lbs., \$1.00.

## Squash.

The Squashes are all quite tender, and therefore no progress can be made in starting them



until the weather becomes somewhat warm and settled.

Plant in hills five feet apart each way for the bush varieties, and eight feet for the running varieties; allot eight seeds to the hill, but don't allow over three to stand.

**Early White Bush Scalloped.**—A desirable and marketable sort. Best known and most productive of all the summer sorts. Pkt., 5 cts.; oz., 10 cts.;  $\frac{1}{4}$  lb., 20 cts.; lb., 50 cts.

**Summer Crook Neck Early.**—Fine flavor; a desirable table sort. Pkt., 5 cts.; oz., 10 cts.;  $\frac{1}{4}$  lb., 20 cts.; lb., 60 cts.

**Winter Crook Neck.**—Flesh red, fine flavor; largely grown for winter use. Pkt., 5 cts.; oz., 10 cts.;  $\frac{1}{4}$  lb., 20 cts.; lb., 60 cts.

**Boston Marrow.**—For autumn use. Fine for pies or baking. Pkt., 5 cts.; oz., 10 cts.;  $\frac{1}{4}$  lb., 20 cts.; lb., 50 cts.

**Hubbard.**—Fine and desirable for winter use. Pkt., 5 cts.; oz., 10 cts.;  $\frac{1}{4}$  lb., 20 cts.; lb., 60 cts.

**Sibley, or Pike's Peak.**—Shell is pale green in color, very thin and smooth, flesh solid and thick, brilliant orange color and of rich delicate flavor; a good keeper. Pkts., 5 and 10 cts.;  $\frac{1}{4}$  lb., 20 cts.; lb., 60 cts.

**Vegetable Marrow.**—A delicious English sort; skin greenish white, flesh white, soft, and of a rich flavor; a heavy cropper, quite distinct from the other sorts. Pkt., 5 cts.; oz., 10 cts.;  $\frac{1}{4}$  lb. 30 cts.; lb., \$1.00.

## Tomato.

Beware of CHEAP TOMATO SEEDS, saved in Canning Houses, as it is sure to be a mixture of different sorts. Ours are grown with special care.

For early fruit, sow the seed in March or April, in the hot-bed, or in pots in a sunny exposure in the house. When the plants are about three or four inches high they should be set out four or five inches apart, in another hot-bed or cold frame, or removed into small pots, allowing a single plant to a pot. Expose to the air as much as possible to harden, and about the middle of May set the plants in the open ground, at a distance of four or five feet each way. Water freely at the time of transplanting, and shelter from the sun for a few days, until the plants are established. Sufficient plants for a small garden may be had by sowing a few seeds in a shallow box or a flower pot, and placing in a sunny window in the house. Cultivate thoroughly as long as the vines will permit.

Tomatoes will admit of training to stakes or trellis of various kinds, and the fruit is very much improved, both in appearance and quality. This mode of cultivation is now quite common among gardeners who grow for early market. The usual method is to set one strong plant to a stake, using stakes five to seven feet in height, tying the plants up with wool or other strong, soft twine, pruning out quite freely as the vines advance in growth. By adopting this method the plants may be set much closer than in the ordinary way.



**Tomato.—Continued.**

**Prizewinner.**—Novelty for 1894. For description see page 10. Pkts., 10 and 25 cts.; oz., 75 cts.; ¼ lb., \$2.50.

**Paragon.**—Here we have a variety—the perfection of a Tomato, large, solid, smooth as an apple, and handsome, deep red color. It is superb. No praise can be too high. Extensively used by canners all over the country. Pkts., 5 and 10 cts.; oz., 20 cts.; ¼ lb., 50 cts.; lb., \$1.50.

**World's Fair.**—New. Introduced and named by us two years ago. It has fully stood the test as being first-class in every respect. Beautiful in color, handsome in shape, solid and good keeper. See description and testimonials page 9. Pkt., 10 cts.; oz., 25 cts.; ¼ lb., 75 cts.; lb., \$2.50.

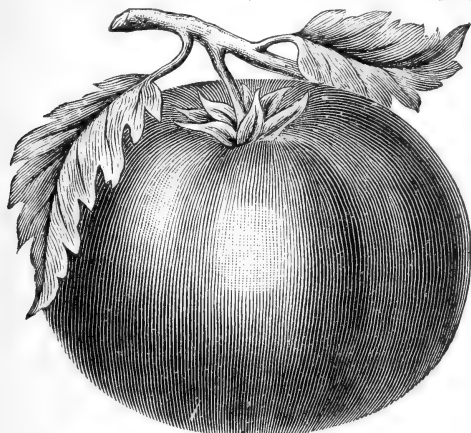

BEAUTY.

**Beauty.**—For early market and shipping this cannot be excelled, because of its solidity and toughness of skin. It is well known and very largely used by our gardeners. Pkts., 5 and 10 cts.; oz., 20 cts.; ¼ lb., 50 cts.; lb., \$1.50.

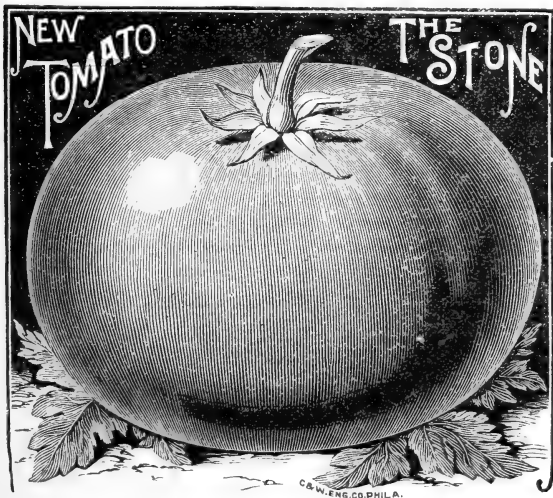

**New Stone.**—A new sort, of good color, size and shape; highly recommended. Pkts., 5 and 10 cts.; oz., 20 cts.; ¼ lb., 50 cts.; lb., \$1.75.

**Acme.**—Of superlative merit, early, medium size, shape slightly oval, smooth and of a pink-purple color. Pkts., 5 and 10 cts.; oz., 20 cts.; ¼ lb., 50 cts.; lb., \$1.50.

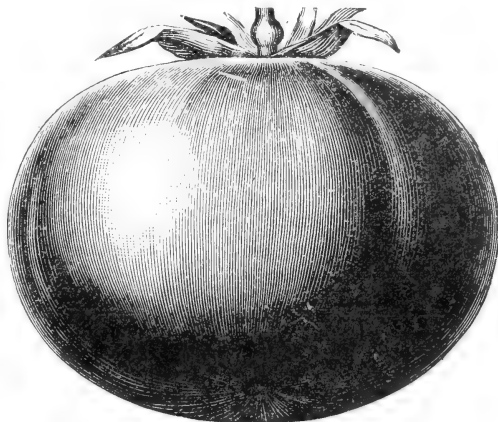

**Queen.**—Fruit somewhat resembles Paragon in appearance. Favorite among canners. Pkts., 5 and 10 cts.; oz., 20 cts.; ¼ lb., 50 cts.; lb., \$1.40.

**Favorite.**—This is a large, perfect shaped Tomato. One of the best. Pkts., 5 and 10 cts.; oz., 20 cts.; ¼ lb., 50 cts.; lb., \$1.50.

**Prize Taker.**—A very desirable early sort, large, of handsome shape, and deep crimson color. Pkts., 5 and 10 cts.; oz., 20 cts.; ¼ lb., 50 cts.; lb., \$1.40.

**Royal Red.**—A new Tomato, much resembling the Favorite in form and color. A good sort. Pkts., 5 and 10 cts.; oz., 20 cts.; ¼ lb., 50 cts.; lb., \$1.75.

**Buckeye State.**—New. This new Tomato comes to us as being a superior market variety, very large, solid, handsome and productive. Pkt., 10 cts.; oz., 40 cts.; ¼ lb., \$1.50; lb., \$5.00.

**Dwarf Champion.**—Entirely distinct from any other variety; plant grows stiff and upright, so that it may be planted closer than other varieties, very desirable for a small garden as it requires so little room; bears throughout the entire season. The fruit resembles the Acme, and is smooth and attractive in appearance. Pkts., 5 and 10 cts.; oz., 25 cts.; ¼ lb., 75 cts.; lb., \$2.50.

**Golden Queen, or Sunrise.**—A bright yellow, large and solid; ripening well up to the stem; a good keeper, and, all things considered, the best Yellow Tomato ever introduced; very productive. Pkts., 5 and 10 cts.; oz., 20 cts.; ¼ lb., 65 cts.; lb., \$2.00.

**Pear Shaped Yellow.**—Sometimes known as the Yellow Egg, or Plum. Used for preserves and pickles. Of extraordinary productiveness. Pkts., 5 and 10 cts.; oz., 25 cts.; ¼ lb., 60 cts.

**Pear Shaped Red.**—Similar to the above, except in color. Pkts., 5 and 10 cts.; oz., 25 cts.; ¼ lb., 70 cts.

## Turnip.

For early use, sow the small sorts as soon as the ground can be worked in the spring, in drills fourteen inches apart, the Rutabagas thirty inches. As the seed is very fine, it should be covered but slightly, excepting in very dry weather. Select light, and, if possible, new soil, and manure with plaster and ashes or phosphates. Should the young plants be troubled with insects, a sprinkling of slug shot will be beneficial. For fall and winter use, the early kinds should be sown from the middle of July to the middle of August, and the Rutabagas from the middle of June to first of July, using from one to one and a half pounds of seed to the acre.

**Extra Early Purple Top Milan.**—The earliest and handsomest Flat Turnip in cultivation; none equal to it for spring sowing. Pkt., 5 cts.;  $\frac{1}{4}$  lb., 20 cts.; lb., 60 cts.

**Early Red Top.**—Flat. Fine, sweet, mild, rapid grower, very early and popular. Pkt., 5 cts.;  $\frac{1}{4}$  lb., 15 cts.; lb., 40 cts.

**Early White Flat Dutch.**—Differs from Red Top only in color. Pkt., 5 cts.;  $\frac{1}{4}$  lb., 15 cts.; lb., 40 cts.

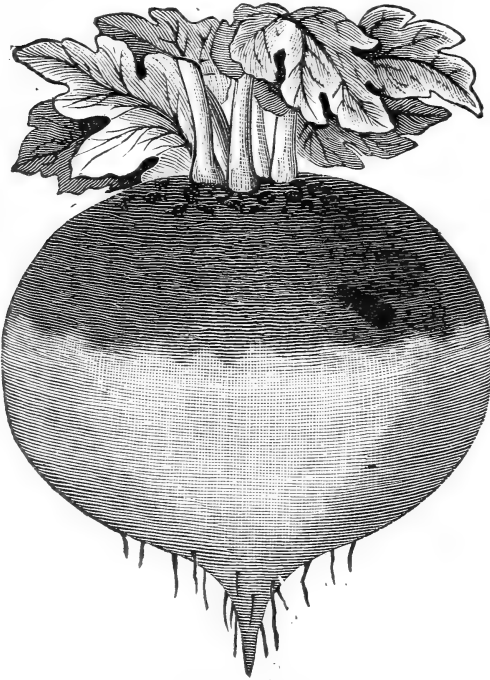

RED TOP GLOBE.

**Large Early Red Top Globe.**—A variety of recent introduction; of large size, rapid growth unusually attractive; approved and admired by all who have seen it. A very much heavier producer than either of the preceding and quite as early as the Flat Red Top. We confidently recommend it as an acquisition. Very few market gar-

deners will have any other kind. Pkt., 5 cts.;  $\frac{1}{4}$  lb., 15 cts.; lb., 40 cts.

**Early White Egg.**—A new variety of rapid growth; egg-shaped and white, as its name indicates. Pkt., 5 cts.;  $\frac{1}{4}$  lb., 15 cts.; lb., 40 cts.

**Yellow Aberdeen, or Scotch Yellow.**—This is a highly approved CATTLE TURNIP, attaining a large size. It is solid, nutritious, good keeper and in every respect reliable. Pkt., 5 cts.;  $\frac{1}{4}$  lb., 15 cts.; lb., 40 cts.

**Large Yellow, or Amber Globe.**—Grows to a large size, flesh yellow, firm and fine-grained. Pkt., 5 cts.;  $\frac{1}{4}$  lb., 15 cts.; lb., 40 cts.

**Seven Top.**—For greens and salads. Used largely in the Southern states. Pkt., 5 cts.;  $\frac{1}{4}$  lb., 15 cts.; lb., 40 cts.

HARFORD CO., MD., May 28th, '92.

GENTLEMEN:—I am pleased to say all your Seeds came up well.

W. H. WATERS.

## Rutabaga, or Swede Turnip.

The Swede Turnips, or Rutabagas, grow much larger in size, and are of greater value for stock-feeding than ordinary turnips. Every farmer and stock-raiser should grow Rutabagas and Stock Beets for winter feeding; it will pay.

**Improved Purple Top.**—Yellow fleshed. A standard field variety for stock and fine for family use. This splendid Swede is the hardiest, most productive and most nutritious variety in cultivation. Pkt., 5 cts.;  $\frac{1}{4}$  lb., 15 cts.; lb., 40 cts.

## Sweet and Pot Herbs.

A little collection of Sweet Herbs is a treasure to the cook and nurse. A small place in the garden will give all the herbs needed in any family. Cut when in flower and dry in the shade.

**Basil.**—Pkt., 5 cts.; oz., 20 cts.

**Caraway.**—Pkt., 5 cts.; oz., 15 cts.

**Chervil.**—Pkt., 5 cts.; oz., 25 cts.

**Coriander.**—Pkt., 5 cts.; oz., 15 cts.

**Dill.**—Pkt., 5 cts.; oz., 10 cts.;  $\frac{1}{4}$  lb., 25 cts., lb., 75 cts.

**Lavender.**—Pkt., 5 cts.; oz., 20 cts.

**Marjoram.**—Pkt., 5 cts.; oz., 20 cts.;  $\frac{1}{4}$  lb., 60 cts.; lb., \$2.00.

**Sage.**—American. Pkts., 5 and 10 cts.; oz., 20 cts.;  $\frac{1}{4}$  lb., 60 cts.; lb., \$2.00.

**Summer Savory.**—Pkts., 5 and 10 cts.; oz., 15 cts.

**Thyme.**—Broad-Leaved English. Pkts., 5 and 10 cts.; oz., 30 cts.;  $\frac{1}{4}$  lb., \$1.00.

## Plants in Season.

Cabbage, Celery, Tomato, Pepper and Egg Plants. Fixed price given on application and full remittance required. We will not ship Plants C. O. D. Shipment at purchasers' risk.

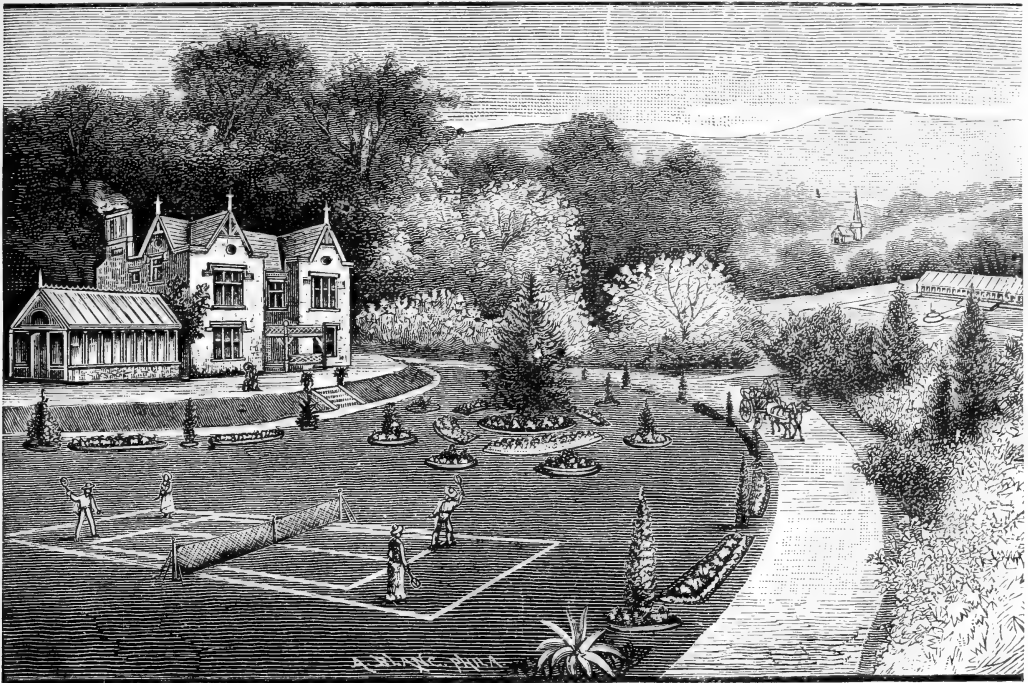

**GRIFFITH, TURNER & CO.'S EVERGREEN LAWN GRASS.**

There is nothing prettier around a home than a well kept lawn; it brightens up the surroundings and adds loveliness to the landscape. In order to make or preserve a pretty lawn, Grass Seed should be liberally used, and for this purpose our Evergreen Lawn Grass is the most desirable. This is a first-class mixture prepared by ourselves and containing nothing but choice seeds—just the thing for tennis, croquet and ball grounds—remaining green and fresh during the hot summer months. Widely known and extensively used on the finest private and public grounds around Baltimore and elsewhere with the most satisfactory results. Pt., 15 cts.; qt., 25 cts.; peck, \$1.25; bushel, \$4.50.

**PREPARATION AND CARE OF LAWNS.**

The ground should be thoroughly drained and well enriched before sowing. Work the soil until well pulverized, and have the surface as level as possible, so that the grass may present an even appearance. After sowing, cover seed lightly and follow with roller. The best results are obtained by using plenty of seed—four bushels to the acre being about the right quantity. One quart is sufficient for 300 square feet. Let the grass obtain a good start before cutting, and then it should be trimmed with a lawn mower about every ten days. *Old Lawns* may be improved and renewed by the application of fertilizers, and seeding about half the quantity of seed required for new Lawns.

**THE ARC LAWN SPRINKLER.**

We claim this is the most perfect Sprinkler in existence. It is simple, will not wear out nor clog up, is well made and handsomely nickeled, is boxed singly with full directions how to use. Its merits are, without question, pre-eminently superior to any other.

Price, . . . . \$1 75.  
Price by mail, . . 1 90

**HUSTLER LAWN SPRINKLER.**

A first-class article at a moderate cost.

Price, . . . . \$1 00  
Price by mail, . . 1 15

Gem Nozzle Holder, 25 cts.  
Gem Nozzle Holder,  
by mail, . . . 30 cts.

**PARK LAWN GRASS.**

Although this mixture does not contain so much of the high-priced varieties as are found in our Evergreen Lawn Grass, this will make a beautiful sod. Sow four bushels to the acre. Qt., 20 cts.; peck, \$1.00; bushel, \$3.00.

**LAWN FERTILIZER.**

This is specially adapted for Lawns or Garden Plots. A most desirable article for supplying the soil with the requisite food for a luxuriant growth of grass. 5 lbs., 25 cts.; 10 lbs., 40 cts.; 100 lbs., \$3.00.

**FLORISTS' FAVORITE FERTILIZER.**

After a careful test of several years, we recommend this as the best Fertilizer for pot plants or green-house purposes. 5 lbs., 25 cts.; 10 lbz., 40 cts.

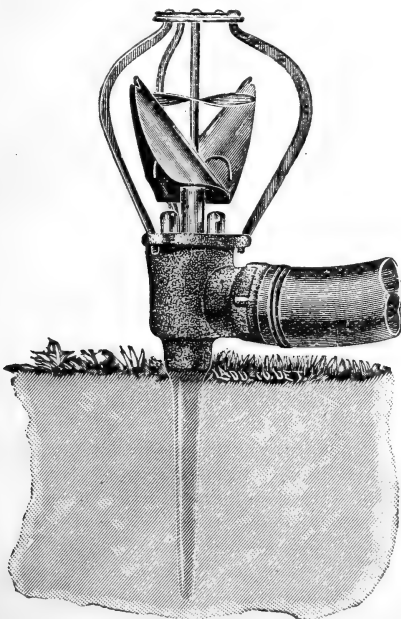

# SELECTED FARM SEEDS, &c.

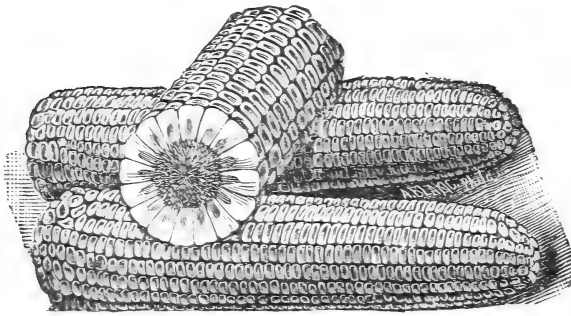

IMPROVED MARYLAND YELLOW DENT.

## Seed Corn.

**Improved Maryland Yellow Dent.**—Our *Maryland Dent Corn* has taken first premium over all other Field Corn wherever exhibited. The grains are unusually deep, ears large, stalks grow from seven to ten feet high; does not exhaust the soil so much, and will stand drought better than a large stalk.

This corn will yield five to ten bushels per acre more than any other Corn generally planted. Yields as good on thin land as any other Corn. A strong and vigorous grower. Qt., 10 cts.; peck, 50 cts.; bushel, \$1.50.

**Maryland White.**—The most productive and showy White Corn, makes splendid meal. Qt., 10 cts.; peck, 50 cts.; bushel, \$1.50.

**Early Leaming.**—An early selected variety of Yellow Corn, small grain, weighty and productive. Highly esteemed in Maryland and Pennsylvania. The earliest Yellow Corn in cultivation. Qt., 10 cts.; peck, 50 cts.; bushel, \$1.50.

**Golden Beauty.**—A large, broad-grained Yellow Corn with ears of perfect shape and very small cob. The richness of color and the quality of the grain make it a very superior variety. Qt., 10 cts.; peck, 50 cts.; bushel, \$1.50.

**Champion White Pearl.**—A new early White Dent Corn. It ripens in ninety to one hundred days from time of planting. The grain is large and cob small; makes a good sized ear. Qt., 10 cts.; peck, 50 cts.; bushel, \$1.50.

**Blunt's Prolific.**—Remarkably prolific, producing from three to five good sized ears on a stalk and growing very large fodder; is frequently used for ensilage. Qt., 10 cts.; peck, 50 cts.; bushel, \$1.50.

**Hickory King.**—The largest grained and smallest cobbled pure White Dent Corn in cultivation; ripens medium early; well adapted to planting on thin ground. Qt., 10 cts.; peck, 50 cts.; bushel, \$1.50.

**Rice Pop Corn.**—The best kind for popping. Lb., 8 cts.; 4 lbs., 25 cts.

**Corn Poppers.**—10 cts. each.

## Seed Oats.

Our Oats are grown specially for Seed purposes. Samples and prices mailed on application.

**Clydesdale.**—A very early and productive variety of extraordinary weight. Per bushel (32 lbs.) \$1.25.

**Welcome.**—An excellent variety; very productive and heavy. Per bushel (32 lbs.) 90 cts.

Other varieties, carefully selected, at market prices.

## Wheat and Rye.

Write us August 1st for Special Prices on Seed Wheat and Rye for Fall Sowing.

## Buckwheat.

**Japanese.**—The plants are large and vigorous, maturing their seed early, and resisting drought and blight remarkably well, while the grain is much larger and at the same time has a thinner hull than the Common or the Silver Hull. We recommend this especially for well drained or sandy land, and the dry climate of the western plains.

**Silver Hull.**—This improved variety is much better than the old sort. It is in bloom longer, matures sooner, and yields double the quantity per acre. The husk is thinner, the corners less prominent, and the grain of a beautiful, light gray color.

## Broom Corn.

**Improved Evergreen.**—This is the favorite sort, has a fine brush, yields well and keeps green. Qt., 20 cts.; bushel, \$2.50.

## Flax Seed.

Lb., 10 cts.; 20 lbs., \$1.00; bushel, \$2.50.

## Clover and Grass Seed.

Common Red Clover, Timothy, Hungarian Grass and German Millet at *lowest market prices*.

**Crimson, or Scarlet Clover** (*Trifolium Incarnatum*.)—This popular Clover Seed is grown successfully in Delaware, Maryland and Virginia. The yield of fodder is immense. Its growth is very rapid and luxuriant, and therefore it is valuable as a fertilizer to turn under. It is fast becoming a popular crop in the Middle States and South, and is finding its way into Pennsylvania and the West. It is used on poor and rich land. It is seeded in this country in June, July, August, September and October, and will produce an enormous crop early in the following Spring, suitable either for consumption as green food or for hay. 10 or 15 pounds should be sown to the acre, according to quality of ground. 12 cts., per lb. Write for prices in quantity.



Scarlet Clover.

**Clover and Grasses.—Continued.**

**Lucerne Clover.**—One of the most valuable among Clovers, resisting drought and remaining green when other sorts are dried up. Sow on rich, moist loam or sandy soil. Prepare the land thoroughly and sow 15 lbs. to the acre. Pound, 15 cts.



Lucerne or Alfalfa.

**White Dutch Clover.**—The best to sow with lawn grass, and valuable in permanent pastures. ¼ lb., 10 cts.; lb., 30 cts.; 100 lbs., \$25.00.

**German or Golden Millet.**—An improved variety, medium early, growing three to five feet high. The heads are closely condensed though the spikes are very numerous. Market prices.

**Orchard Grass.**—Extra heavy tested seed. One of the most desirable pasture grasses. Market prices.

**Kentucky Blue Grass.**—(Fancy, triple cleaned). Valuable for pasture when mixed with other varieties. Bushel (14 lbs.) \$1.75.

**Herd or Red Top Grass (Agrostis vulgaris).**—A valuable native permanent grass, as a mixture in meadows, pastures or lawns, growing in almost any soil, moist or dry, and standing our hot climate. 14 lbs. to the bushel; 2½ bushels to the acre; per bushel, \$1.00.

**Pasturage Grass Mixture.**—Special mixture for upland; bushel (14 lbs.), \$2.25.

Special mixture for low ground; bushel (14 lbs.), \$2.25.

**Plant Bed=Cloth.**

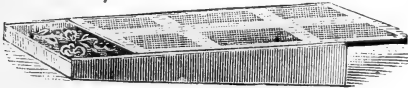

**Waterproof Plant-Bed Cloth.**—Equal to glass as a covering for hot beds and cold frames, and at so moderate a cost, that it is largely used by florists and gardeners all over the country. Cloth is 36 inches wide; pieces contain from 40 to 60 yards. Light, per yard, 6 cts.; medium, per yard, 9 cts.; heavy, per yard, 12 cts.; special prices for large quantities.

**Marling.**

Hand-made, for hot-bed mats. Lb., 15 cts.; 5 lbs., 65 cts.

**Fodder Yarn.**

For tying Fodder. 7 to 10 cts. per pound.

**Grafting Wax.**

First quality in bars. ¼ lb., 10 cts.; ½ lb., 20 cts.; lb., 35 cts.

**Plant Sprinkler.**

For sprinkling cut flowers, seedlings, plants, clothes, etc., etc.

Price \$1.00; by mail \$1.10



**INSECT DESTROYERS, &c.**

**Slug Shot.**

A non-poisonous powder and a very popular insecticide—it requires no further mixing or preparation—easily applied and not injurious or dangerous to animals, the person applying it, or fruits and vegetables treated. Very effectual in destroying potato bugs and beetles, green and black fly, slugs, worms, caterpillars, etc. Price, in 10 lb. packages, each, 45 cts.; 5 lb. packages, 25 cts.

It will be necessary, however, to apply it occasionally, for it does not kill the eggs or prevent them from hatching; The best time to apply it is early in the morning, particularly for potato bugs, as they do not feed during the night.

Apply with duster, bellows or gun. 10 to 40 lbs. is sufficient for an acre.

**Paris Green.**

¼ lb., 10 cts.; ½ lb., 15 cts.; lb., 25 cts.

**Pure White Hellebore.**

The cheapest and best preparation for destroying Rose Slugs, Currant Worms, etc. ¼ lb., 10 cts.; lb., 35 cts.; by mail, 55 cts.

**Whale Oil Soap.**

Makes an elegant wash for Trees and Plants, kills insects on Trees and Bark; also destroys Slugs on Roses. Cake, 10 cts.; lb., 15 cts. Large quantities at Special Prices.

**Tobacco Stems.**

For fumigating green-houses. 5 cts. lb.; large quantities, 3 cts. per lb.

**Tobacco Dust.**

Largely used by market gardeners for destroying the cabbage fly and louse. 5 lbs., 25 cts.

**Insect Powder Bellows.**



This is the best article known for destroying insects in conservatory, garden or field.

- No. 1, 3½ in. wide, 15 in. long, holds 2 oz. Powder, .85
- No. 2, 4½ in. wide, 16 in. long, holds 3 oz. Powder, \$1.00
- No. 3, 5½ in. wide, 20 in. long, holds 4 oz. Powder, \$1.25
- No. 4, 7½ in. wide, 24 in. long, holds 8 oz. Powder, \$1.75

**Brass Garden Syringes.**



- No. A, 1 Stream and Spray Rose, 12 x 1 inch, \$2.50
- " 10, 1 " 2 " 18 x 1½ " 5.50
- " 12, 1 " 2 " 14 x 1 " 3.50
- " H, Full Length Spray Valve, 18 x 1½ " 2.00

**The Model Mole Trap.**

This, while possessing all the good qualities of other traps, is specially adapted for setting under glass. Price \$1.75.

**Hale's Mole Trap.**

Price, . . . . . \$2.00



# Poultry Supplies, Horse Powders, &c.

## EGGS AT ALL SEASONS.

—BY USING—

### RUST'S EGG PRODUCER.

TRADE (THE HEN PERSUADER) MARK.

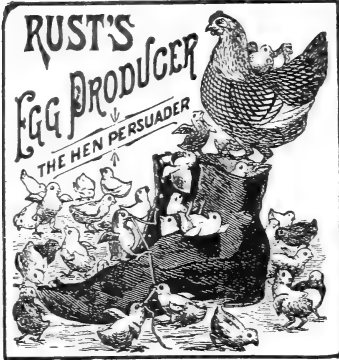

### Rust's Egg Producer.

This has given our customers universal satisfaction. It supplies those substances which produce Eggs, growth and development. So moderate in price it should be used winter and summer. 1 lb. packages, 25 cts.; if to be sent by mail, add 15 cts per lb. to prepay postage. 6 lb box, \$1.00.

### HAVEN'S ROUP PILLS.

Cures Roup, Catarrh, Cold, etc. Box, 25 cts.

### SUNFLOWER.

Highly recommended for Poultry as one of the best Egg Producing Foods Known. Qt., 15 cts.; peck, 75 cts.; bushel, \$2.00.

### CRACKED BONE.

FOR FOWLS.

Made from white selected bone and reduced to about the fineness of cracked Corn. Lb., 5 cts.; 30 lbs., \$1.00; bag (167 lbs.), \$4.00.

### POULTRY NETTING,

FOR ENCLOSING POULTRY YARDS.

The Wire we offer is all No. 19 double twist, 2-inch mesh, thoroughly galvanized after weaving. Sold in bales of 150 running feet.

#### PRICES, 2-INCH MESH.

12 in. wide, . . .	150 sq. ft. . . . .	\$1 00 per bale.
18 " " . . .	225 " " . . . . .	1 55 " "
24 " " . . .	300 " " . . . . .	2 10 " "
36 " " . . .	450 " " . . . . .	3 10 " "
48 " " . . .	600 " " . . . . .	4 25 " "
60 " " . . .	750 " " . . . . .	5 25 " "
72 " " . . .	900 " " . . . . .	6 25 " "

Prices for less quantity, 1 cent per square foot.

## Haven's Climax Condition Powders.

FOR STOCK AND POULTRY.



The only positive preventive and cure for Gapes and Poultry Cholera and a most excellent medicine for young Turkeys that have been exposed to the weather; also an excellent medicine for Horses, Cattle, Sheep and Hogs. All who have used Haven's Climax Condition Powders once, will have it again. Package, 25 cts.

### ERB'S HORSE and CATTLE POWDERS.

For the cure of diseases that affect Horses, Cattle, Swine, Sheep and Fowls. Growing in popularity, and sales constantly increasing.

Package, 15 cts.; 2 packages, 25 cts.

### GLOBE FOOD.

FOR HORSES, COWS, HOGS, &c.

Globe Food is an excellent article for healthy animals, as well as a splendid tonic for sick stock. It contains nothing detrimental to the digestive organs—on the contrary, it is beneficial in every particular as an article of food. Put up in 12 lb. bags, 75 cts. per bag.

### WILSON'S BONE AND SHELL MILLS

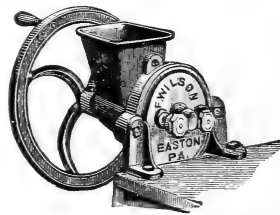

grind oyster or clam shells and dried bones. and is an excellent mill and largely used. Will also grind corn. Price, \$5.00.

### BIRD SEED.

Clean Seed in Cartoons. Special prices to the trade.

Mixed Bird Seed, . . . . .	10 cts. per lb.
Canary Seed, . . . . .	10 " "
Rape Seed, . . . . .	10 " "
Hemp Seed, . . . . .	10 " "

Special Prices to Cannerymen, Gardeners and Farmers, in Large Quantities.



# Summer Flowering Bulbs.



**GLADIOLUS.**

The cultivation of the Gladiolus is very simple, as they will thrive in any good garden soil, but will amply repay one for careful cultivation. A succession of bloom may be had from July to September by planting at intervals from April to June.

**Mixed**, all colors.—Doz., 25 cts.; 100, \$1.75.  
**Mixed**, White and Light colors.—Doz., 40 cts.; 100, \$2.50.

When ordered by mail, add 10 cts. per dozen for postage.

## TUBEROSE.

One of the most fragrant and popular of the summer flowering bulbs; may be started early in hot-beds or pots, or planted in open ground after first of May. Each, 5 cts.; doz., 40 cts.; 100, \$2.00. Special prices for larger quantities. Tuberose by mail, 10 cts. per dozen extra.



Tuberose.

## CANNAS.

Great improvement has been shown in this plant the last few years. We have a nice assortment of various colors.

**Crozy's Dwarf French Cannas.**—Each, 20 cts.; by mail, 25 cts.; doz., \$2.00.

**Cannas.**—General collection. Each, 10 cts.; by mail, 15 cts.; doz., \$1.00.

## CALADIUM.—*Esculentum.*

Very effective and showy foliage plants. Each, 15 to 25 cts. By mail, 5 cts. extra.

## DAHLIAS.

**Mixed.**—Each, 10 cts.; doz., \$1.00.

**Named Colors.**—Each, 15 cts.; doz., \$1.50.

## LILIES.

**Auratum** (*Golden Band Lily*).—The finest Lily in cultivation. Immense white flowers, golden yellow band, edged with maroon, very sweet fragrance. Each, 20 cts.; by mail, 30 cts.

**Rubrum.**—White, spotted with red. Each, 20 cts.; by mail, 30 cts.

**Roseum.**—Rose spotted. Each, 20 cts.; by mail, 30 cts.

Our Annual Catalogue of  
 CHOICE DUTCH BULBS  
 for Fall planting



Double Hyacinths.



Tulips.

Ready in September.  
 Mailed Free on  
 application.



Roman Hyacinth.

## Choice Flower Seeds.

*Eight 5c. Papers for 25 cts., or Four 10c. Papers for 25 cts.*

(1) **Ageratum—Mixed.**

Suitable for beds, and especially nice for cut flowers and bouquets. Pkt., 5 cts.

(2) **Amaranthus—Mixed.**

Showy blooming plants; with long racemes of curious looking flowers, and brilliant foliage; half-hardy annuals. Pkt., 5 cts.

(3) **Aster—China.**

Well known and beautiful flowers; should be in every garden. Pkt., 5 cts.



(4) **Aster—German.**

All colors and shades of the best German sorts. Sow seed early and transplant to rich soil. Pkt., 5 cts.



(4½) **Aster—Truffaut's Perfection.**

A very favorite class; thrifty, upright growers; flowers large, almost perfectly round with incurved petals. The florists' preference; height, 1½ to 2 feet. Pkt., 10 cts.

(5) **Bachelor's Button or Blue Bottle.**

(*Centaurea Cyanus.*)

A very old favorite garden annual with handsome flowers of various colors. It does best if sown in a hot-bed; half-hardy annuals; 2 feet. Pkt., 5 cts.

(6) **Balsams Double Mixed.**

(*Lady Slipper, or Touch-Me-Not.*)

The well known Balsams are one of the finest summer blooming annuals; free bloomers and highly colored. By transplanting them once or twice, the flowers are apt to be more double. Pkt., 5 cts.



(7) **Candytuft—Mixed.**

Well known favorite; hardy annuals; very pretty in beds or masses; useful for bouquets. Seeds may be sown in the fall for early flowering. Pkt., 5 cts.

(8) **Candytuft—White.**

Treated and used same as the Mixed. Pkt., 5 cts.

(9) **Canna Mixed—Crozy's New Varieties.**

The Cannas are desirable, not only for the beauty of their spikes of scarlet flowers, but for their highly ornamental leaves. They make superb beds for the lawn. Soak the seeds thoroughly before planting, and keep in a warm spot. Very slow to germinate. Pkt., 5 cts.

(10) **Canterbury Bells.**

(*Campanula.*)

A highly attractive class of plants, combining richness of color with stately growth; valuable for beds and borders. Sow early, and transplant in light rich soil. Pkt., 5 cts.

**Carnation.**—*See Pinks.*

(11) **Castor Oil Bean.**

(*Ricinus.*)

Ornamental plants of stately growth and picturesque foliage; fine for lawns, massing or centre plants for ribbon beds; half-hardy annuals. Pkt., 5 cts.



(12) **Centaurea.**

(*Candidissima.*)

Extensively used for margins, beds and vases; very graceful silver foliage. Pkt., 5 cts.

(13) **Chrysanthemum.**

(*Paris Daisies, or Marguerites.*)

Showy and effective garden favorites; extensively grown for cut flowers. The hardy annuals are summer flowering border plants; good for pot culture, and quite distinct from the autumn-flowering varieties. Pkt., 5 cts.

(14) **Cineraria.**

(*Dusty Miller.*)

Fine for bedding, ribbon beds and margins; prized for their beautiful downy silvery foliage; half-hardy perennials; 2 feet. Pkt., 5 cts.

(14½)

**Cineraria  
Hybrida—Choicest  
Mixed.**

Very attractive, free blooming plants, producing large and brilliant flowers. Pkt., 25 cts.



# Choice Flower Seeds.

*Eight 5c. Papers for 25 cts., or Four 10c. Papers for 25 cts.*

(15) **Clarkia—Mixed.**

An old favorite hardy annual plant, growing in any garden soil, and producing freely its cheerful flowers early in the season; 1¼ feet. Pkt., 5 cts.

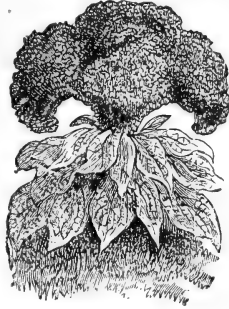

(16) **Cockscombs.**

(*Celosia Cristata.*)

Very popular annuals of the easiest culture; highly ornamental for decoration of the greenhouse, drawing-room and garden. Half-hardy annuals. Pkt., 5 cts.

(17) **Convolvulus, Tricolor Minor.**

(*Dwarf Morning Glory.*)

A beautiful class of hardy annuals, affording a large showy mass of flowers from July to October. Pkt., 5 cts.

(18) **Coreopsis.**

(*Calliopsis.*)

Very handsome and showy plants, with numerous flowers of brilliant colors and of long duration in bloom. Pkt., 5 cts.

(18½) **Cosmos.**

Sow early in spring, and transplant when danger from frost is past. The flowers are borne profusely, and present a charming appearance when in full bloom, being covered through the autumn months with hundreds of showy blossoms. They are very easily raised and make a grand display. Pkt., 5 cts.

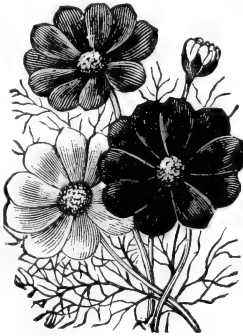

**Dianthus.—See Pinks.**

(19) **Eternal Flower.**

(*Helichrysum.*)

These are very popular and desirable for winter decoration, bouquets, wreaths, etc. They should be cut when they come into full bloom, tied into bunches and dried in the shade with their heads downward. Pkt., 5 cts.

(20) **Feverfew (Golden Feather).**

(*Pyrethrum Aureum.*)

A highly ornamental golden yellow foliage plant, unexcelled for bedding. Hardy perennial; 1½ feet. Pkt., 5 cts.

(21) **Forget-Me-Not.**

(*Myosotis.*)

Neat and beautiful little plants with star-like flowers; succeeding best in a shady, moist situation; half-hardy perennials; blooming the first year from seed if sown early. Pkt., 10 cts.

(22) **Foxglove.**

(*Digitalis.*)

A handsome and highly ornamental, hardy perennial plant of stately growth, fine for shrubberies and other half-shady places; 3 feet. Pkt., 5 cts.

(23) **Gilia—Mixed.**

Very pretty dwarf plants, early, free blooming, fine for massing and rock work; hardy annuals; 1 foot. Pkt., 5 cts.

(24) **Heliotrope,**

These are deliciously fragrant flowers, remaining in bloom a long time; fine for pot culture or bedding; 1½ feet. Half-hardy annual. Pkt., 5 cts.



(25) **Hollyhock.**

(*Allhea Rosea.*)

This is one of the oldest inhabitants of our gardens, and now ranks as one of the finest autumn flowers. Pkt., 5 cts.

(26) **Joseph's Coat.**

(*Amaranthus Tricolor.*)

Red, yellow and green foliage; 2 feet. Pkt., 5 cts.

(27) **Larkspur.**

(*Delphinium.*)

One of our most showy and useful plants, possessing almost every requisite for adornment of the garden. Pkt., 5 cts.

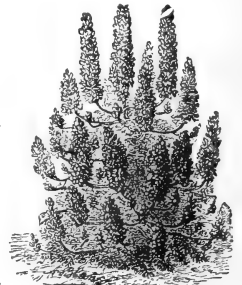

(28) **Lobelia.**

A beautiful and popular flower, very desirable for pot culture, beds, or hanging-baskets, because of its trailing habits. Grows easily and does well in beds and rockeries. Bears a profusion of blue and white flowers. Annual. Pkt., 5 cts.

# Choice Flower Seeds.

*Eight 5c. Papers for 25 cts., or Four 10c. Papers for 25 cts.*

(29)

## Love Lies Bleeding.

(*Amaranthus Caudatus.*)

Graceful and handsome flowers of blood red hue. Pkt., 5 cts.



(30)

## Lupins—Mixed.

The Lupins are very pretty, showy plants, with pea-shaped blossoms. They grow readily from seed. Pkt., 5 cts.

(31)

## Marigold—Double African.

A well-known free flowering plant, of easy culture, with rich and beautiful double various colored flowers. Pkt., 5 cts.

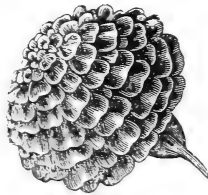

(31 1/2)

## Marigold—Double French.

Of compact habit. with numerous bright, showy flowers. Very fine. Pkt., 5 cts.



(32)

## Marvel of Peru, or Four O'clock.

(*Mirabilis Jalapa.*)

A very pretty annual of vigorous growth. The flowers are brilliant, singularly mixed and varied on the same plant; 2 feet. Pkt., 5 cts.

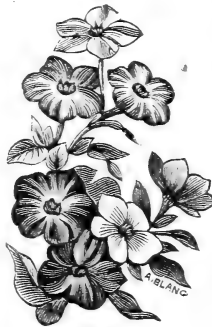

(33)

## Mignonette—Sweet.

(*Reseda Odorata.*)

A well known and universal garden favorite, and one that requires no extra instructions for growing. Hardy annual. Pkt., 5 cts.; oz., 15 cts.

(34)

## Mignonette—Pyramidal.

(Large Flowered.)

The largest flowered of all Mignonettes. Annual. Pkt. 5 cts.; oz., 15 cts.

(34 1/2)

## Machet Mignonette.

Well adapted for pot culture; dwarf pyramidal growth; bearing numerous flower stalks; one of the best. Pkt., 10 cts.; oz., 60 cts.

## (35) Nasturtium—Dwarf.

The dwarf varieties of Nasturtium are among the most useful and beautiful of annuals for bedding, massing, etc., owing to their compact growth, richness of color and profusion of bloom. Pkt., 5 cts.; oz., 15 cts.



## (36 a) Pansy—Hearts-ease.

(*Viola Tricolor.*)

Choice Mixed.

An old but universally admired plant, producing an endless variety of color, marking and texture. They may be treated as annuals, as they flower the first season from seed; 6 inches. Pkt., 10 cts.



## (36 b) Pansy—Giant Trimardeau.

Remarkable for the extra large size of the flowers, and an endless variety of beautiful shades. Pkt., 10 cts.

## (36 1/2) Pansy—Extra Blotched.

This is the richest mixture ever sent out, containing the finest blotched varieties: Pkt., 15 cts.; 2 pkts., 25 cts.

## (37) Petunia.

Favorite, half-hardy perennials, succeeding well in any rich soil. For the brilliancy and variety of their colors, and the long duration of their blooming period, they are indispensable in any garden. Pkt., 5 cts.

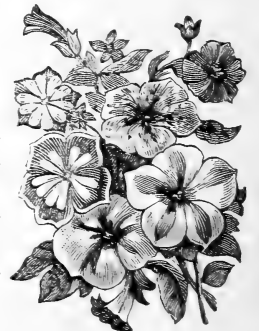

(37 1/2)

## Double Petunia.

About 30 per cent. will produce double flowers. Pkt., 25 cts.

# Choice Flower Seeds.

Eight 5c. Papers for 25 cts., or Four 10c. Papers for 25 cts.

(38) **Phlox  
Drummondii.**

A most brilliant and beautiful hardy annual, about one foot high, well adapted for bedding, making a dazzling show through the whole season.



It succeeds well on almost any soil. Pkt., 5 cts.

(39) **Pink—Carnation or Picotee.**  
(*Dianthus Caryophyllus.*)

Carnation and Picotee Pinks are generally favorites for their delicious fragrance, richness of colors, and profuse bloom. Perennial. Pkt., 5 cts.

(40) **Pink—China.**  
(*Dianthus Chinensis.*)

Free bloomers, and a general favorite for bouquets; also a useful bedding plant. Pkt., 5 cts.



(41) **Pink—Hedewigii.**

Beautiful double flowers in a great variety of colors, with fringed white edges. Pkt., 5 cts.

(42) **Portulaca.**  
(*Mexican Rose.*)

One of our finest hardy annual plants, of easy culture, thriving best in a rather rich, light loam, or sandy soil; the single flowering varieties are large and brilliant, of the richest shades of color, and produced throughout the summer in great profusion; fine for massing in beds, edgings, or rock work. Pkt., 5 cts.

(42½) **Double Portulaca.**  
Pkt., 10 cts.

(43) **Poppy—Carnation.**  
(*Papaver.*)

A showy and easily cultivated hardy annual, with large brilliant colored flowers, growing freely in any garden soil. Pkt., 5 cts.

(43½) **English Primrose.**  
(*Primula Vulgaris.*)

No collection of spring flowers is complete without a few of these charming little plants; a little covering in the late fall will protect them from the severe weather of winter, and the great number of flowers produced will more than repay you for the extra trouble. They are not as generally grown as they should be. Pkt., 10 cts.

(44) **Scarlet Sage.**  
(*Salvia Splendens.*)

A favorite greenhouse and bedding plant, bearing long spikes of flowers in great profusion from July to October; half-hardy perennial, blooming the first year from seed; 3 feet. Pkt., 5 cts.

(45) **Sensitive Plant.**  
(*Mimosa.*)

Curious and interesting plants, with pinkish white flowers; the leaves close in and droop when touched or shaken; tender annual. Pkt., 5 cts.

(46) **Snap Dragon.**  
(*Antirrhinum.*)

One of our most useful and showy border plants. The recently improved varieties have large, finely shaped flowers of brilliant colors. Perennial. Pkt., 5 cts.

(47) **Ten Weeks Stocks.**  
(*Gilliflower.*)

A world wide favorite, brilliant and varied in color, equally well adapted for massing, bedding; edging or pot culture. Very profuse bloomers; should be grown in rich soil. Pkt., 10 cts.

(48) **Sunflower.**  
(*Helianthus.*)

Remarkable for the stately growth, size and brilliancy of their flowers, making a very good effect among shrubbery and for screens. The seed is also good for feeding poultry. Pkt., 5 cts.

(49) **Sweet Alyssum.**

The Sweet Alyssum has pretty little white flowers, useful in making small bouquets, and its fragrance, while sufficiently pronounced, is very delicate. The Alyssum grows freely from seed; blooms the whole season. Pkt., 5 cts.

(50) **Sweet Rocket.**  
(*Hesperis.*)

Very pleasing, early spring flowering, profuse blooming plants, with fragrant flowers, growing freely in any light rich soil. Pkt., 5 cts.,

151) **Sweet William.**  
(*Dianthus Barbatas.*)

A well-known, free flowering, popular favorite; the great improvements upon the old varieties, made within the last few years, have rendered it still more desirable. Hardy, perennials. Pkt., 5c.



## Choice Flower Seeds.

*Eight 5c. Papers for 25 cts., or Four 10c. Papers for 25 cts.*

(52) **Sweet Violet.**

Deservedly much in demand, because of their profusion of bloom and delicate sweet odor. Pkt., 10 cts.

(53) **Verbena.**

One of the most popular and useful bedding plants. Verbenas delight in sunny situation, a rich soil, and thorough cultivation. Pkt., 5 cts.



(54) **Wallflower—Double.**

Well-known, deliciously fragrant plants, with large spikes of double flowers, similar to the Gilliflower. Succeed in light, rich soil, in a moist atmosphere. Perennials., Pkt. 10 cts.



(55) **Zinnia Elegans.**

*(Youth and Old Age.)*

This in one of the most brilliant of annuals, and has long been a general favorite. The flowers are large, finely formed, in great variety of colors, and continue to bloom the entire season. Half-hardy annuals. Pkt., 5 cts.



(55½) **Henderson's "Curled and Crested" Zinnias.**

*New, Odd and Superb.* Petals twisted, curled and crested into fantastic contortions and graceful forms. A magnificent variety of colors. Pkt., 15 cts. 2 Pkts. for 25 cts.

(56) **Balsam Apple.**

*(Momordica.)*

Very curious trailing vines, with ornamental foliage, fruit golden yellow, when ripe opens, showing the seeds and its brilliant carmine interior. Pkt., 5 cts.

(57) **Balloon Flower.**

*(Love in a Puff.)*

A rapid growing plant; succeeds best in a light soil and warm situation; flowers white; half-hardy annual. Pkt., 5 cts.

(58) **Canary Bird Flower.**

*(Peregrinum.)*

With yellow, canary-like flowers; very ornamental and beautiful foliage; half-hardy annual. Pkt., 10 cts.

(59) **Cypress Vine—Red.**

*(Ipomœa Quamoclit.)*

One of our most popular vines, with very delicate, fern-like foliage, and masses of beautiful, small star-shaped flowers. Sow last of May; 15 feet. Pkt., 5 cts.

(60) **Cypress Vine—White.**

Usually grown with the red, making a handsome effect. Pkt., 5 cts.

(61) **Maurandya.**

*(Barclayana.)*

These charming climbers cannot be too highly praised for their beautiful flowers and foliage; they are admirably adapted for hanging baskets, vases or trellis-work. Pkt., 5 cts.

(62) **Mixed Gourd.**

*(Cucurbita.)*

Rapid growing, interesting plants, with ornamental foliage and varieties of singular shaped fruit. Annual. Pkt., 5 cts.

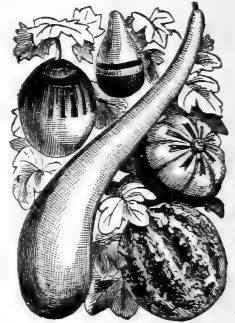

(63) **Nest Egg Gourd.**

White fruit, shaped like an egg. Pkt., 5 cts. Used as a substitute for nest eggs.

(64) **Mock Orange.**

Fruit shaped like an orange. Pkt., 5 cts.

(65) **Morning Glory.**

*(Convolvulus Major.)*

One of the most free flowering and rapid growing plants in cultivation, thriving in almost any situation; the beauty and delicacy of their brilliant flowers are unsurpassed; hardy annuals. Pkt., 5 cts.

(66) **Moon Flower.**

*(Ipomea Noctiflora.)*

Charming and popular blooming climbers, of rapid growth and showy effects; warm, rich soil, with a sunny exposure, suits them. Pkt., 5 cts.

(67) **Tall Nasturtium.**

*(Tropæolum Major.)*

Elegant, profuse flowering plants, constantly growing in favor for verandas, trellis, etc. The seed pods can be gathered while green and tender for pickling. Pkt., 5 cts.

(68) **Scarlet Runners.**

Rapid growing vine, producing beautiful scarlet flowers in abundance. Pkt., 5 cts.



# SWEET PEAS.

(*Lathyrus Odoratus.*)

The wonderful advance made in the size, substance and variety of colors in Sweet Peas in the past few years, have placed it in the first rank among flowering plants. But few plants are easier grown, and grown in masses of separate colors or in mixture their beauty and fragrance cannot be surpassed.

**CULTURE.**—Sweet Peas should be sown in drills, *as early as possible in spring*, in rich, friable soil. Prepare the bed thoroughly; working in a quantity of well rotted manure, if it can be done. Making a furrow four to six inches deep. In this sow the seed and cover two inches deep. As soon as the plants begin to show through, fill in the furrow. This will secure a deep planting without the bad effect of deep covering of the seed at first, and so enable the plant to bloom continuously through the heat of summer. As fast as the flowers come into full bloom or fade, they should be cut off, for if the pods are allowed to form, the plants will stop blooming.

## Boreatton.

A very fine dark Pea with bold, stout flowers; color deep maroon. Distinct and beautiful. Pkt., 5 cts.; oz., 25 cts.

## Blanche Ferry or Improved Painted Lady.

The demand for this magnificent variety continues unabated, which proves the wonderful hold it has on the popular favor. Color, standard brightest pink, keel and wings white. Pkt., 5 cts.; oz., 10 cts.; lb., \$1.00.

## Princess Beatrice.

A vigorous grower and free bloomer; flowers a clear and beautiful carmine-rose, slightly shaded; one of the best. Pkt., 5 cts.; oz., 15 cts.; lb., \$1.00.

## Butterfly.

New and ranks among the very best of this unrivalled class of plants. Very floriferous, color lavender blue; shading into white on the lower petals. Pkt., 5 cts.; oz., 15 cts.; lb., \$1.25.

## Princess of Wales.

New and a vigorous grower; color, white ground shaded and tinged with mauve, making a very pleasing impression. Pkt., 5 cts.; oz., 15 cts.

## Indigo King.

A strong growing and very prolific sort, bearing a profusion of large flowers with dark maroon standard and clear indigo blue wings. Very handsome. Pkt., 5 cts.; oz., 15 ct.; lb., \$1.25.

## Invincible Scarlet.

Plant vigorous; flowers of intense and brilliant scarlet-pink, of the largest size; the most brilliant variety yet produced. Pkt., 5 cts.; oz., 15 cts.

## Invincible White.

The stock we offer produces very large flowers of fine form and pure white color. Pkt., 5 cts.; oz., 15 cts.

## Lottie Eckford.

New and a free bloomer; color lavender, shaded with pink and white. Very handsome. Pkt., 5 cts.; oz., 20 cts.; lb., \$1.50.

## Queen of the Isles.

Scarlet mottled and flaked with purple and white. Pkt., 5 cts.; oz., 20 cts.

## Queen of England.

Grand pure white flowers of extra large size, specially choice. Pkt., 5 cts.; oz., 20 cts.

**One Ounce of each of the above select varieties of Sweet Peas, making 11 ounces in all, for \$1.50.**

## Extra Fine Mixed.

This is a splendid Mixture of our own, which includes nearly all the above varieties. Pkt., 5 cts.; oz., 10 cts.; ¼ lb., 25 cts.; lb., 75 cts.

## Emily Henderson.

Very early, color, pure white, fragrance most delicious. The plants are robust, very branchy, and of compact habit; flowers large, broad and round, and its abundance of bloom is phenomenal. Pkt., 15 cts.; oz., 50 cts.

## NOVELTIES.

We ask special attention to the following new varieties of Flower Seeds, which are worthy of a trial:

### Pansy—Extra Blotched.

The richest mixture ever sent out, and containing the finest blotched varieties in large proportion; very effective. Pkt., 15 cts.; 2 pks., 25 cts.

### Pansy—Giant Trimardeau.

A beautiful class of Pansies. The plants are of vigorous, compact growth; the flowers of good form and of enormous size. Pkt., 10 cts.

One pkt. of each of the above four varieties mailed for 40 cts.

### Aster—Truffaut's Perfection.

The florists' favorite; one of the most perfect and popular of all Asters. Pkt., 10 cts.

### Zinnia—Henderson's Curled and Crested.

*New, odd and superb.* Petals twisted, curled and crested into fantastic contortions and graceful forms. A magnificent variety of colors. Pkt., 15 cts.; 2 pkts., 25 cts.

## GRIFFITH, TURNER & CO.'S ANIMAL BONE PHOSPHATE

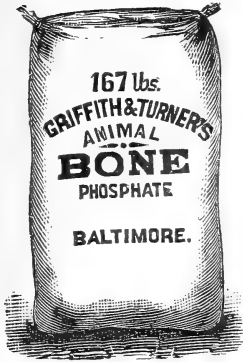

Has always headed our list, and after numerous tests we have found nothing to take its place. It is very carefully made according to a formula which never fails when Nature does her part.

We do not claim that the Animal Bone Phosphate will produce a good crop if the season is unfavorable, but we do claim that if the ground is properly prepared and the season is a good one, the Animal Bone Phosphate will perform its part of the work in a creditable manner. This is a special favorite for Peas and extra early crops requiring a high grade of goods. Made largely from Pure Animal Bone, in combination with Potash and high-grade Ammoniates, this brand has always made large crops of grain and grass, and every year brings back some farmers (who owe the fertility of their farms to this article alone) who have been led astray by dealers who recommend low-priced goods. Price, \$32.00 per ton.

## AMMONIATED ALKALINE PLANT FOOD.

Our principal Fertilizer for Summer crops, including Corn, Oats, Potatoes, etc. This is not as high grade of goods as the Animal Bone Phosphate, but for crops which are subjected to the hot summer suns, it has given the very best results, particularly when we have a very dry season. As a Potato Fertilizer the Plant Food has a most excellent reputation wherever it has been sold. A complete Manure, containing Ammonia, Potash and available Phosphoric Acid in such proportions as to insure a good crop, under favorable circumstances, in excellent condition, made from first-class materials only. Price, \$28.00.

## AMMONIATED BONE PHOSPHATE.

Highly ammoniated; a good "all around" Fertilizer, used principally for Wheat and Grass. Its constantly increasing sales are an evidence that it is appreciated by both farmers and dealers.

The base of this most excellent brand is our No. 1 Dissolved Bone, ammoniated, in connection with Potash; in other words this is a high grade ammoniated goods and "fills the bill" for people who want to buy a good grade of goods. Price, \$28.00.

## BUTCHER'S BONE PHOSPHATE.

Made from our No. 1 Dissolved Bone combined with Potash; a popular brand at a popular price. Price, \$25.00.

## AMMONIATED SOLUBLE BONE

To farmers wanting a complete fertilizer, but not so highly ammoniated as above, we offer this brand ; there are a number of farmers who, while they want a high grade phosphate, claim that they do not want as much Ammonia as is found in our most costly Fertilizers, to such we recommend the Ammoniated Soluble Bone ; it has been used largely in Maryland and Pennsylvania with the most satisfactory results. Price, \$24.00.

### No. 1 DISSOLVED BONE.

Made from soft Slaughter House Bone, containing some little Meat and Blood, thoroughly soluble, in splendid mechanical condition ; equal in its effects to Pure Dissolved Bone, to which it is preferred by many practical farmers, at the same time costs a little less money. To farmers wanting Dissolved Bone we unhesitatingly offer this article, feeling assured that they will be more than satisfied. Price \$28.00.

### SOFT GROUND BONE.

Collected from slaughter houses in Baltimore and vicinity. Unquestionably the best and cheapest Bone on the market at the price ; so soluble that a very large portion is taken up by the first crop. There is no doubt that for permanent results there is nothing like Ground Bone, and when you can combine solubility with permanency, as in Soft Bone, there can be no question about the results. Very largely increased sales this season show conclusively that the article has real merit, and in point of sales has increased equal to any other brand. Price \$30.00.

### PURE DISSOLVED BONE.

Made from Pure Bone and Acid. \$30.00 per ton.

### SOLUBLE BONE PHOSPHATE.

For a cheap Fertilizer it is among the first. A good cheap Manure always pleases the buyer who wants something at a low figure. Price \$18.00.

### HIGH GRADE ACID PHOSPHATE.

Fine ground South Carolina Rock, treated with Acid. \$16.00 per ton. 6

Peruvian Guano, Ground Plaster, Kainit, Muriate of Potash, Dried Blood, Tankage, etc., always on hand at Lowest prices.

### LAWN AND FLOWER FERTILIZERS.

Made from material specially suited to the growth of Flowers and Lawns. 5 lb. pkg., 25 cts. ; 10 lb. pkg., 40 cts. ; special prices for large quantities on application.

## The No. 40 Full Chilled, Sloping Landside, Both Right and Left Hand.

FULL LINE OF ONE, TWO AND THREE HORSE PLOWS AND PARTS.

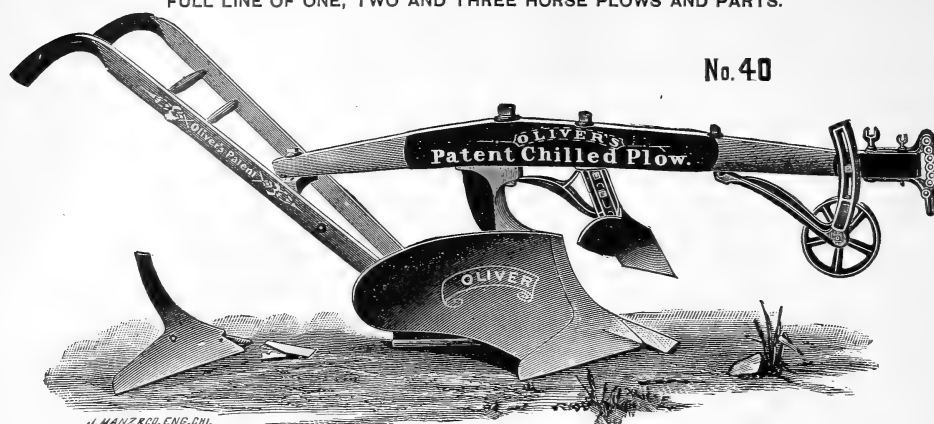

These patterns are better known, having reached a large sale, have proved more popular and given better satisfaction than any plows on the face of the globe. They are durable, easily handled, easy running, perfect in their work, economical in repairs and have done more to advance the science of farming than any other agency ever employed. They are made only of Oliver's celebrated chilled metal, and are made both right and left hand, and every plow has the name "Oliver" on beam, handles, and wearing parts. They are the best general purpose plows in the world, have had the longest run, and their reputation has been maintained from first to last. They are fitted with the new share and reversible slip point shown on the next page, and also with the regular share so well known and so often counterfeited. They will continue to hold their places in public favor in spite of all the opposition brought against them, and the farmer who wants the best plow made will make no mistake in buying the "Oliver." In buying shares and other extra wearing parts, be sure that the name "Oliver" is cast on them. All others are imitations, and not to be depended on in any respect.

Buy the Genuine Oliver Chilled Plows and Castings. Do not allow yourselves to be persuaded to buy low priced imitations, as nothing is as cheap as the genuine. If your storekeeper does not keep them, consult our price list below (which are our cash prices delivered on cars or boat in Baltimore,) and send post-office order for what you need in this line. We make no charge for drayage.

For the accommodation of those who want the imitation castings, we keep the Nos. 19, 20 and 40 shares in stock, and sell them at the extremely low price of 30 cents each—ground, fitted and resembling the genuine castings.

### Complete Price List of Genuine Goods.

	Plain Plows.	Standards.	Mould Boards.	Landsides.	Shares.	Beams.
A . . . . .	\$4.50	\$1.25	\$1.25	.40	.25	\$1.00
B . . . . .	6.00	1.50	1.75	.60	.25	1.00
No. 10 . . . . .	7.00	2.00	2.00	.60	.35	1.00
No. 13 . . . . .	8.00	2.25	2.25	.65	.35	1.25
No. 17 . . . . .	8.50	2.25	2.50	.75	.40	1.25
No. 20 . . . . .	9.00	2.25	2.75	.75	.40	1.25
No. E . . . . .	9.50	2.50	3.00	.75	.40	1.25
No. 40 . . . . .	9.50	2.50	3.00	.75	.40	1.25

Prices on Plows do not include Wheels and Jointers, which are extra. Wheels, \$1.00; Jointers, \$2.00 each.

ALL KINDS OF MACHINERY REPAIRED.

## OLIVER'S PATENT SLIP NOSE SHARE.

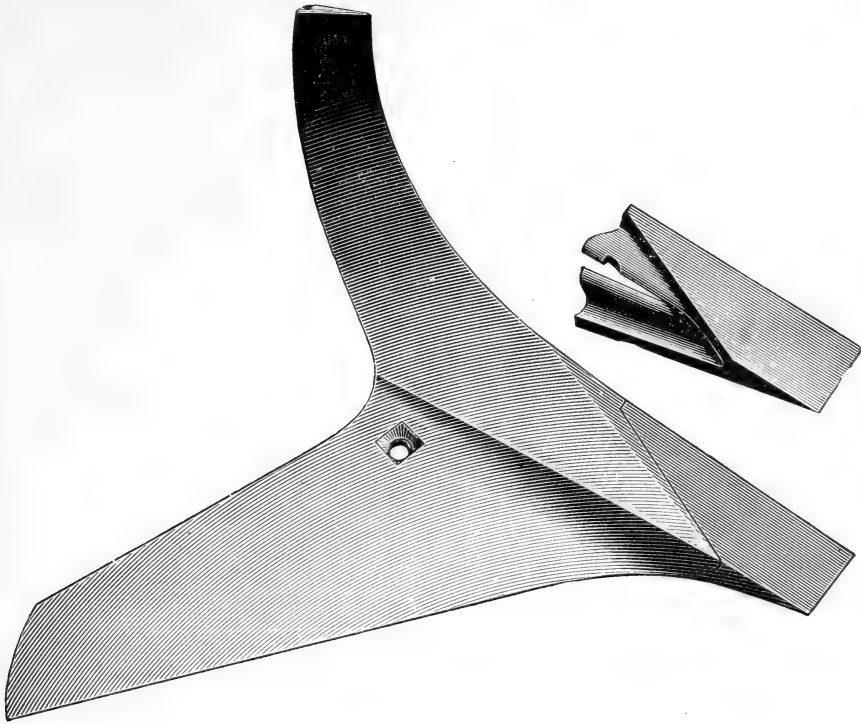

Price of Share and Point, complete, 50 cents.

Special attention is directed to the new Share in the cut above shown. It is called "Oliver's Patent Slip Nose Share," and represents the grandest improvement in the way of a saving device ever offered to the tillers of the soil. It is a well known fact that the nose of any share wears off more rapidly than any other portion, and is more liable to breakage in rough or stony ground. In the new Slip Nose Share these annoyances are overcome, for the point can be removed, reversed or replaced readily, and a new share is practically the result. Both the Share and the Slip Point are made heavy where they join, and being fastened with a nail, key, or even piece of wood, the arrangement is so simple that any one can easily make the changes.

This new share is adopted to use on all the No. 40 series, which embraces the 10-O, 13, 19, 20, E and 40 Plows. In fact, all Oliver Chilled Plows, outside the "Combination" series, will be so fitted, and will have this advantage when Cast Shares are used.

Users of our plows will appreciate the fact that this Share and point can be used on their old plows, which have done such good service, and they will not have to buy a new plow to get their benefits. We offer this device as a practical, sensible and economical invention, and one that will give thorough satisfaction upon trial and use.

In addition to the above, we can furnish castings for most of the other plows made, as follows, viz.:—*Syracuse, South Bend, Roland, Farmers' Friend, Dixie, Minor & Horton, Chesapeake*, and many others.

ALL KINDS OF MACHINERY REPAIRED.





**PHILADELPHIA HAND AND HORSE LAWN MOWERS.**

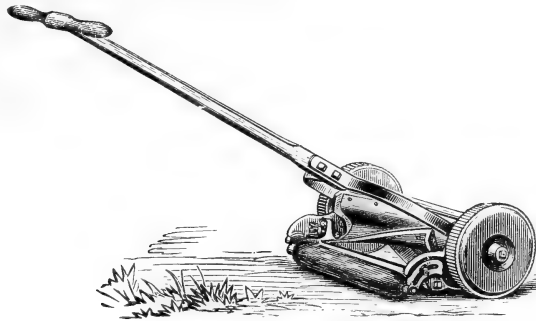

**Philadelphia Hand Mower.**

Simple in construction ; durable and light running—therefore cheap. Full stock of Machines and Repairs always on hand. This is a favorite, and always pleases the buyer. Write for special circular.

Prices Style M, or Solid Cylinder.

	Retail Price.	List Price.
10 inch . . . .	\$5.50	\$13.00
12 inch . . . .	6.25	15.00
14 inch . . . .	7.00	17.00
16 inch . . . .	7.75	19.00
18 inch . . . .	8.50	21.00

Style S, or Open Cylinder.

	Retail Price.	List Price.
14 inch . . . .	\$7.00	\$17.00
16 inch . . . .	7.75	19.00
18 inch . . . .	8.50	21.00

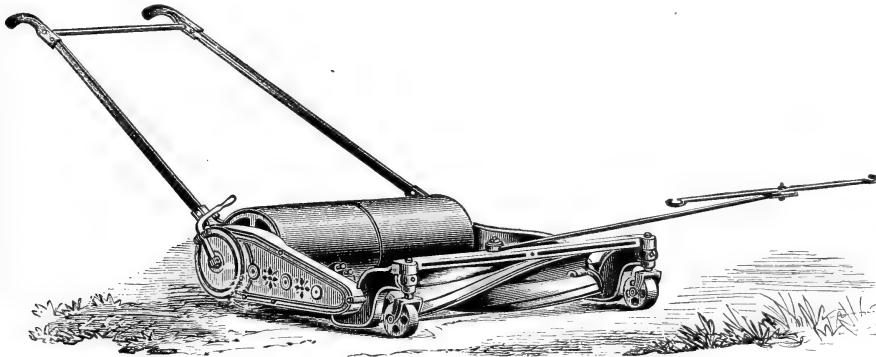

**Philadelphia Horse Mower.**

In use at Druid Hill, Patterson and Riverside Parks, and on a large number of lawns in this vicinity.

This machine has stood the test for years, and has given perfect satisfaction. Always on hand at lowest prices.

Price :—30 in., with Draft Rod, \$65 ; 30 in., with Shafts and Seat, \$80.

**Horse Boots for use on Lawns, per set, \$9.00.**

**ALL KINDS OF MACHINERY REPAIRED.**

WE ARE GENERAL AGENTS FOR THE CELEBRATED  
**Excelsior and New Model Horse and Hand Lawn Mowers.**



NEW MODEL HIGH WHEEL MOWER.

For simplicity, durability and quality of work, these Mowers are second to none; the New Model machines are made in two styles, viz:—Regular, or style generally used, and High Wheel machines. The Excelsior Roller Hand Mower is particularly valuable for cutting borders and uneven lawns.

Prices are as follows:

	Retail.	List.
10 in. Regular Mower,	\$5.50	\$13.00
12 " " "	6.00	15.00
14 " " "	6.75	17.00
16 " " "	7.50	19.00
18 " " "	8.25	21.00
20 " " "	9.00	23.00
<hr/>		
14 in. High Wheel Mower,	10.00	20.00
16 " " "	11.00	22.00
18 " " "	12.00	24.00
20 " " "	13.00	26.00
<hr/>		
10 in. Roller Mower,	7.80	13.00
12 " " "	9.00	15.00
14 " " "	10.20	17.00
16 " " "	11.40	19.00
18 " " "	12.60	21.00

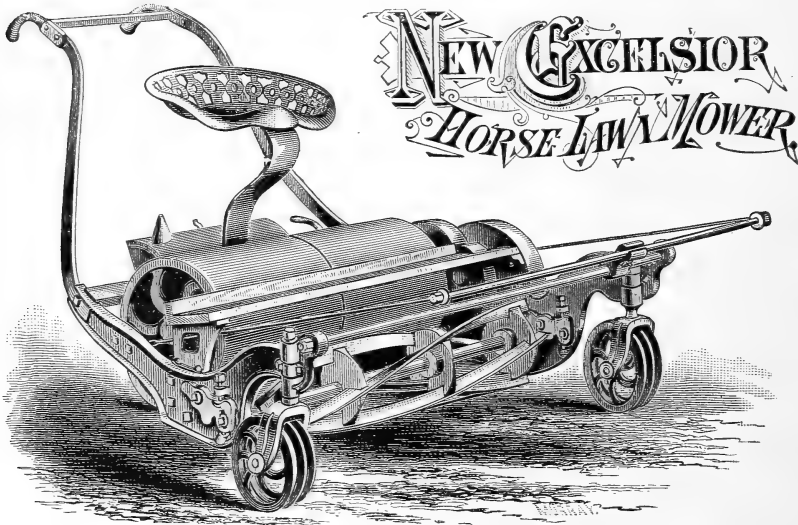

**NEW EXCELSIOR**  
 HORSE LAWN MOWER.

	Retail.	List.		Retail.	List.
25 in. with Draft Rod,	\$45.00	\$ 65.00	30 in. with Shafts and Seat,	\$70.00	\$110.00
30 " " " "	65.00	100.00			

Special prices on 35 and 40 inch machines on application. Less \$5.00 from retail prices on Horse Mowers for cash.

The Supt. of Department of Public Works, New York City, wrote as follows:—We are pleased to say that the six Horse Lawn Mowers that you shipped this department at the beginning of the season, have been thoroughly tested and we consider them superior to any we have used. The *side Draft Attachment* and the *New Sectional Caster Wheels* fully meet our expectations and prove very valuable additions. We have adopted your Mowers in preference to all others.

**Horse Boots for use on Lawns, per set, \$9.00.**

## CONTINENTAL HIGH WHEEL MOWER.



A distinct type of machine in popular favor. Owing to the demand for a High Wheel Mower for uneven lawns, we have secured what we consider one of the best machines of the kind made. Every customer is more than satisfied with the Continental. In use at Patterson Park and on the lawns of Messrs. Robert Garrett, William H. Whitridge, R. B. Smith, German H. Hunt, Edward A. Griffith, at Church Home, the Woman's College of Baltimore City and many others.

Splendidly built. A full stock of machines and repairs always on hand. Write for special circulars and prices.

Retail prices : 15 inch, \$12.50 ; 17 inch, \$14.00 ; 19 inch, \$15.50 ; 21 inch, \$17.00.

List prices : 15 inch, \$25.00 ; 17 inch, \$28.00 ; 19 inch, \$31.00 ; 21 inch, \$34.00.

## PENNSYLVANIA HIGH WHEEL MOWER.

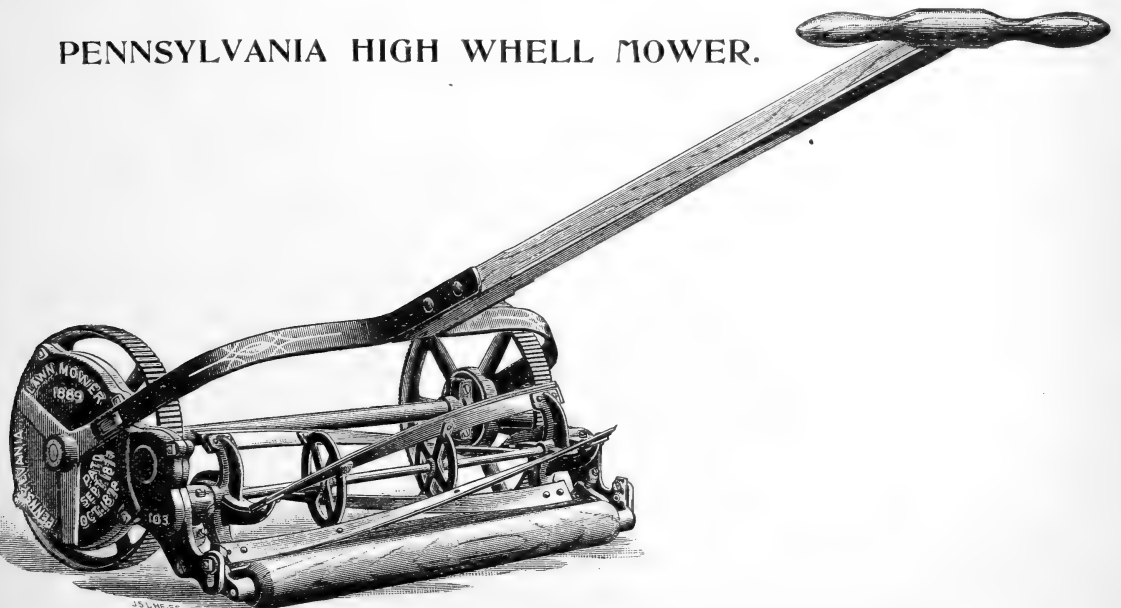

Retail prices : 15 inch, \$12.50 ; 17 inch, \$14.00 ; 19 inch, \$15.50 ; 21 inch, \$17.00.

List price : 15 inch, \$25.00 ; 17 inch, \$28.00 ; 19 inch, \$31.00 ; 21 inch, \$34.00.

**HORSE BOOTS FOR USE ON LAWNS, PER SET, \$9.00.**

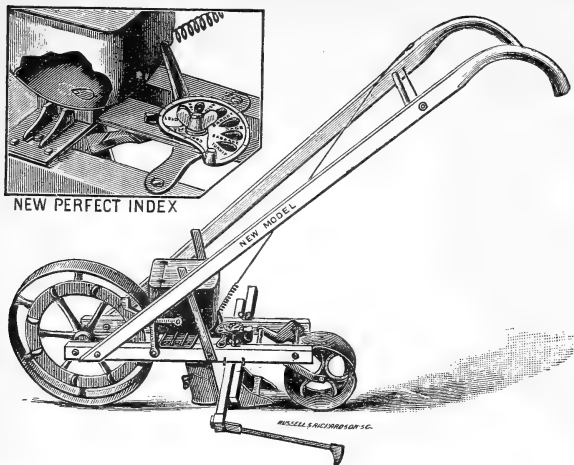

## THE NEW MODEL SEED DRILL.

**GUARANTEED TO BE THE MOST  
PERFECT DRILL IN AMERICA.**

Thoroughly tested and fully endorsed  
by all the leading seedsmen of the country.

Each year emphasizes the fact that it is  
still at the head of the line.

PRICE, \$7.50.

## THE GEM WHEEL HOE.

**AN OLD TOOL, BUT NOTHING BEATS IT YET.**

PRICE, \$4.50.

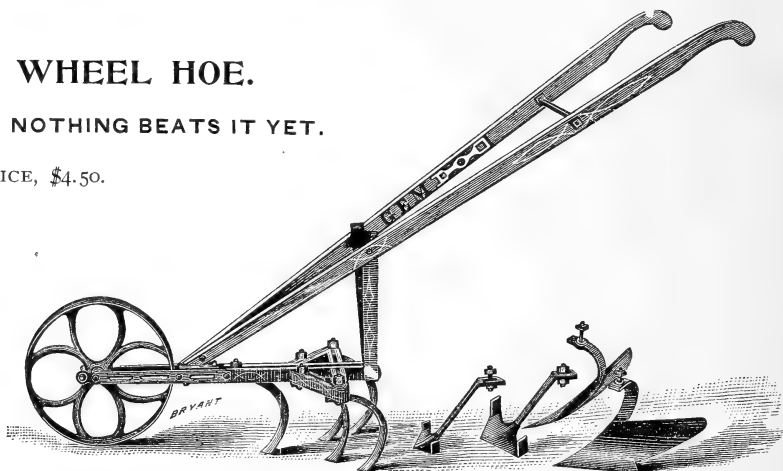

## The Jewel Double Wheel Hoe and Cultivator Combined.

**WEIGHS ONLY 22 POUNDS.**

All Malleable Iron and Steel, with the ex-  
ception of wheels and handles. Adjustable in  
every way.

PRICE, \$5.00.



## THE JEWEL WHEEL PLOW.

Malleable Iron and Steel. Very light and convenient. A grand little tool for the garden. Price, \$2.50.

**ALL KINDS OF MACHINERY REPAIRED.**

**THE IRON AGE HORSE HOE.**

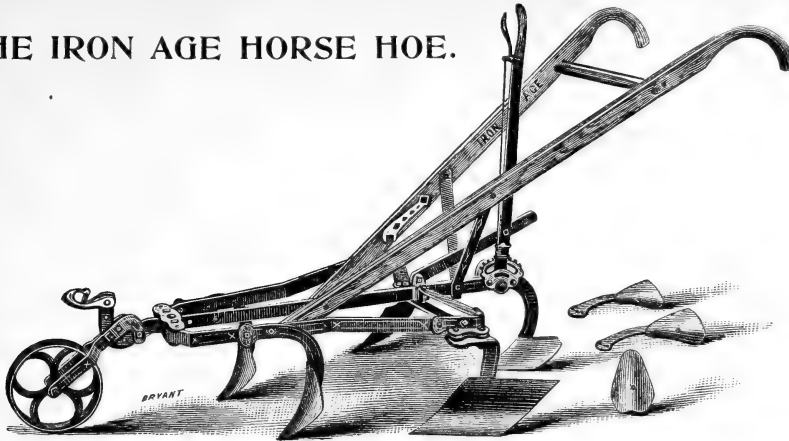

WHEEL AND CULTIVATOR COMBINATION, WITH AND WITHOUT LEVER ADJUSTER.

One of the most satisfactory implements, for a reasonable price, ever made on this continent. Probably no tool has been so widely imitated as the "IRON AGE" Cultivator, the original of this style of implement, and we are quite sure no other tool has kept so far ahead of its imitators. All Steel Frames. New shape Side Bars. A grand, good thing. Sold with or without Lever Adjuster.

Iron Age Cultivator, plain. . . . .	\$4 00
Iron Age Cultivator, with Lever. . . . .	5 00
Iron Age Horse Hoe and Cultivator, plain. . . . .	5 50
Iron Age Horse Hoe and Cultivator, with Wheel. . . . .	6 25
Iron Age Horse Hoe and Cultivator, with Lever and Wheel. . . . .	7 25
Iron Age Corn Coverer, plain. . . . .	5 00
Iron Age Corn Coverer, with Lever. . . . .	6 00
Iron Age Horse Hoe, Cultivator and Corn Coverer combined, plain. . . . .	7 25
Iron Age Horse Hoe, Cultivator and Corn Coverer combined, with Lever. . . . .	8 25

**Farmers' Favorite and Old Dominion Horse Hoe and Cultivator Combined.**

The only difference between the Farmers' Favorite and Old Dominion Cultivators is that the latter is a little lighter.

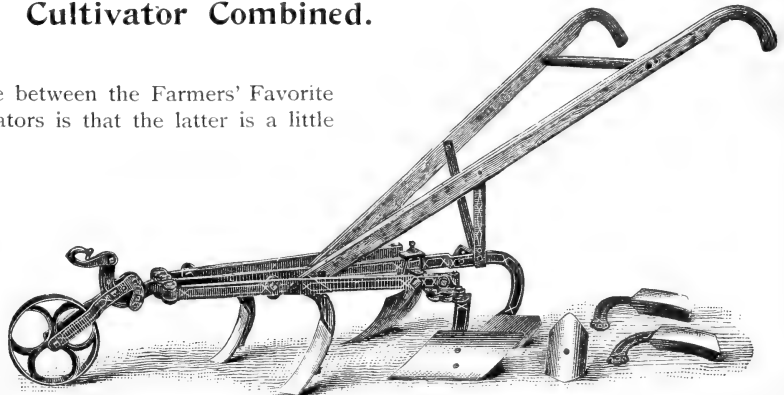

Farmers' Favorite Cultivator. . . . .	\$3 25
Baltimore Cultivator. . . . .	3 25
Farmers' Favorite Horse Hoe and Cultivator combined, plain. . . . .	4 50
Farmers' Favorite Horse Hoe and Cultivator combined, with Wheel. . . . .	5 25
Old Dominion Cultivator. . . . .	3 00
Old Dominion Cultivator and Horse Hoe, plain. . . . .	4 25
Old Dominion Cultivator and Horse Hoe, with Wheel. . . . .	5 00

ALL KINDS OF MACHINERY REPAIRED.



# IRON AGE COMBINED HARROW AND CULTIVATOR.

STEEL TEETH, DIAMOND SHAPE.

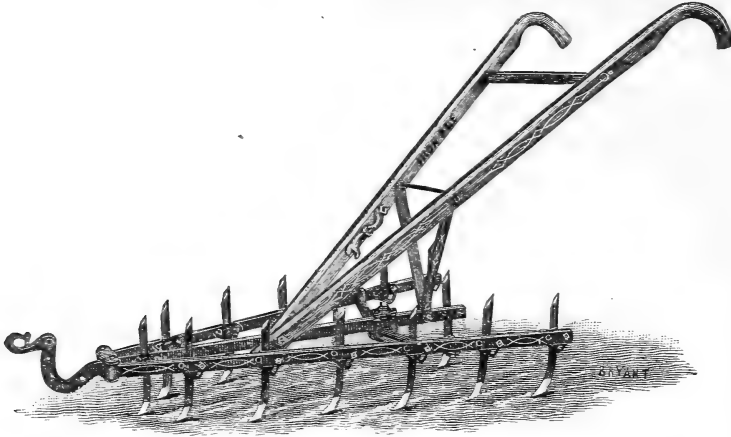

A comparatively new implement, but one every way worthy of purchase by all wide-awake farmers. They cannot afford to do without it. Four positions of teeth, doing good work in all crops. This is not to be compared with low priced Harrows, similar in appearance, but made of common material. Price \$4.50. Baltimore Harrow, \$4.00.

## CULTIVATOR POINTS AND STEELS.

PRICES ON APPLICATION.

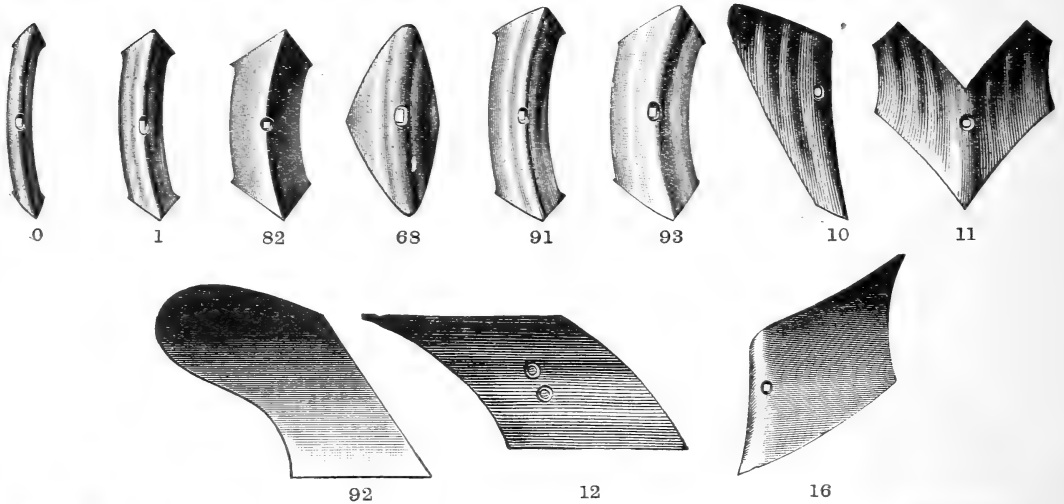

## MALTA AND FARMERS' FAVORITE SHOVEL PLOW STEELS

ALWAYS ON HAND.

STEELS FOR IRON AGE RIDING CULTIVATORS.

STEELS FOR MALTA WALKING AND RIDING CULTIVATORS.

ALL KINDS OF MACHINERY REPAIRED.

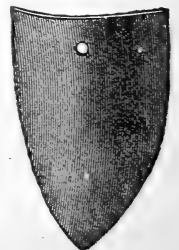
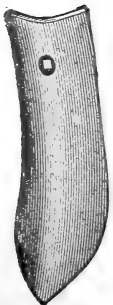

## ADJUSTABLE STEEL FRAME LEVER HARROW.

BEST SMOOTHING HARROW MADE.

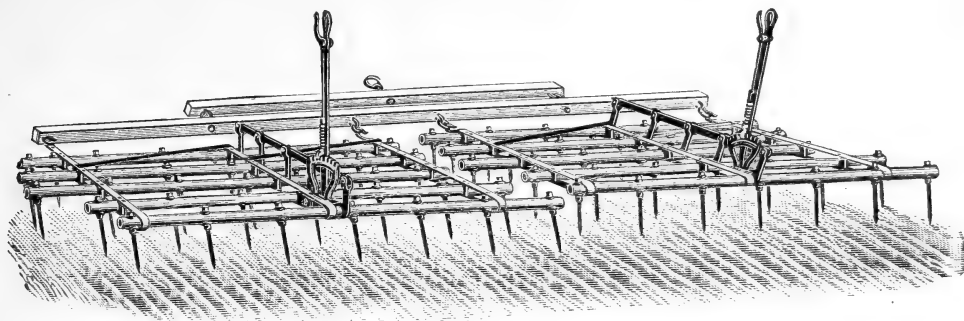

It can be used as a straight tooth pulverizing Harrow, or a slanting tooth smoothing Harrow. By means of the lever the teeth can be set straight or to any desired slant. The beams are made of iron tubes and the teeth pass through the same and are threaded and held firmly in place by a tap. If stalks or trash accumulate on the teeth, when used as a straight tooth Harrow, the teeth can be changed in a moment, by means of a lever, to a slanting position for cleaning off the same. As a smoothing Harrow it never clogs, all rubbish being cut in two, or passing down and off the ends of the teeth and is completely buried; for cultivating young corn in its early stage it is unequalled. It thoroughly pulverizes the soil and destroys the weeds, while the young corn remains uninjured. Specially adapted to cultivating wheat in the spring. Price, \$16.00.

## THE EVANS TRIPLE HARROW.

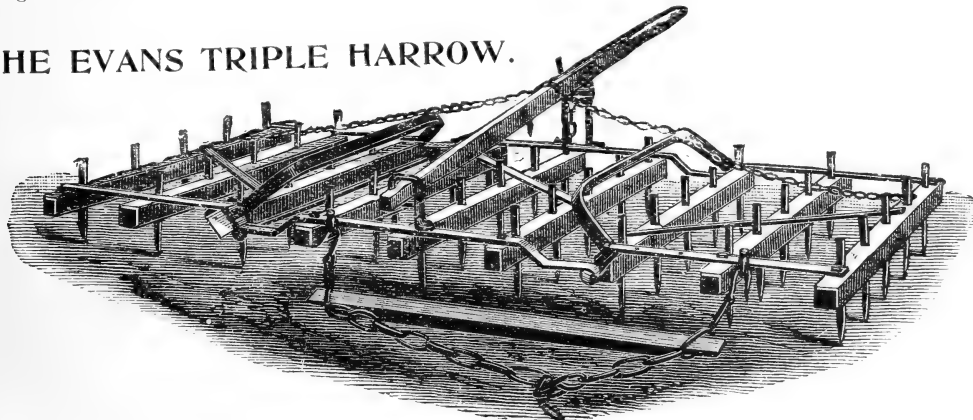

Has runners ready for the road without unhitching the team. Has a Lever attachment, by aid of which each section can be raised clear of the ground and cleaned of stalks or trash, or passed over stones or stumps without stopping the team, and is so easily handled, a boy can operate it. Price, \$15.00

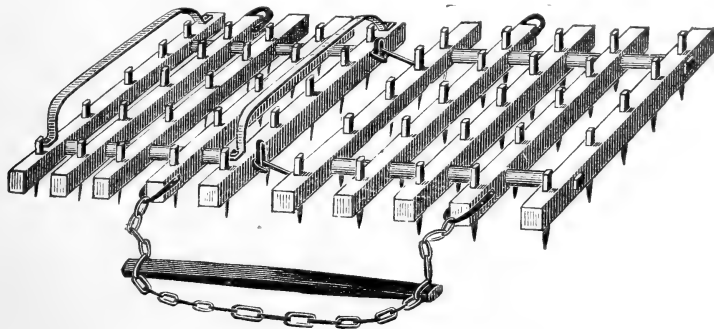

## DOUBLE HINGE HARROW.

Price, . . . . . \$12.00

The most perfect Two Section or Double Hinge Harrow made; has runners, the value of which any good farmer will appreciate. Price, \$12 00.

## GARDENERS' HARROW, \$7.00.

ALL KINDS OF MACHINERY REPAIRED.

## STEVENS' SPRING-TOOTH HARROWS.

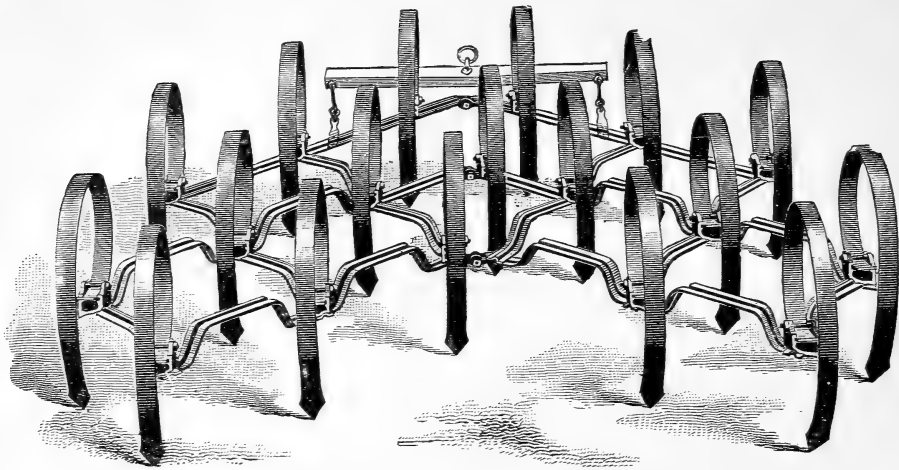

STEVENS' ARCHED FRAME.  
Best Non-Lever Harrow made.

## BLAKER LEVER SPRING-TOOTH HARROW.

The most satisfactory Lever Harrow on the market; gives perfect satisfaction.

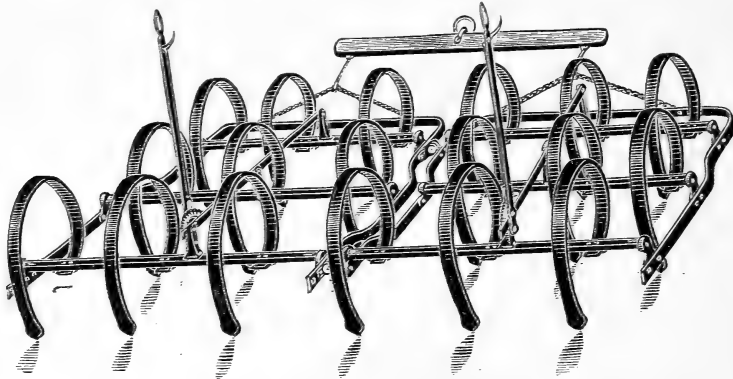

BLAKER HARROW.

### PRICES

Of both Stevens and Blaker Harrows. Blaker is not made larger than 18-tooth size.

Fourteen-tooth . . . . .	\$15 00
Sixteen-tooth . . . . .	16 00
Eighteen-tooth . . . . .	18 00
Twenty-tooth . . . . .	20 00
Twenty-two-tooth . . . . .	22 00

### SPRING HARROW TEETH

For all leading Spring-Tooth Harrows, including  
Stevens, Blaker, Perry, Childs' U. T. K., Tiger, Buffalo Pitts, Etc., Etc.

PRICE . . . . . 65 cts. each.



ALL KINDS OF MACHINERY REPAIRED.

## BELL'S CENTRE-CUT DISC HARROW.

The only Harrow that reaches the centre ridge and pulverizes the ground from outside to outside, leaving a smooth surface behind it. The importance of this sure cultivation to an even depth and leaving no ground uncultivated cannot be overestimated; there will be no hard ridge, there will be no row of weeds between the grain, as this harrow cuts *all* of the roots below the surface and thoroughly pulverizes all of the soil.

NO WEIGHT ON HORSES' NECKS.

NO SIDE DRAFT.

If it Cultivates 12 per cent. More and  
Pulls 30 per cent. Lighter Draft than  
any other Solid Disc Harrow, How  
Much More is it Worth?

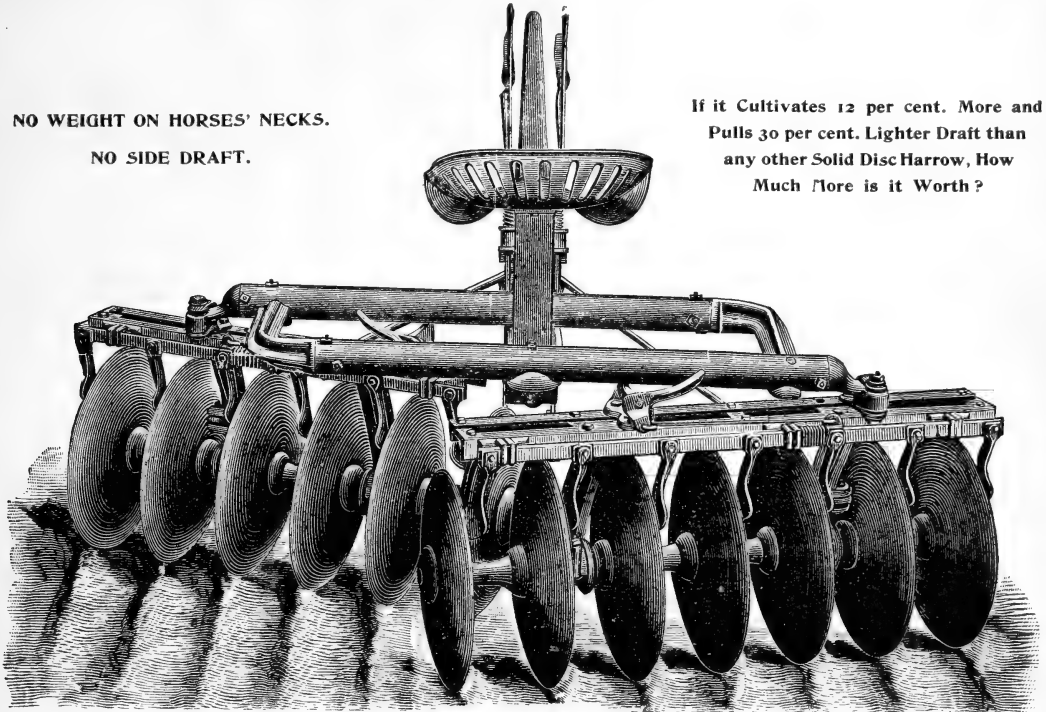

### PRICES:

- Bell's Centre-Cut Harrow, with 13 Discs, Steel Frame, Neck Yoke and 3 Horse Eveners, \$35.00
- O. R. C. Wood Frame Disc Harrow, with Neck Yoke and Three Horse Eveners . . . . . 27.50
- O. R. C. Harrow, without Neck Yoke and Three Horse Eveners . . . . . 25.00

## CLARK'S NEW ENGLAND CUTAWAY HARROW.

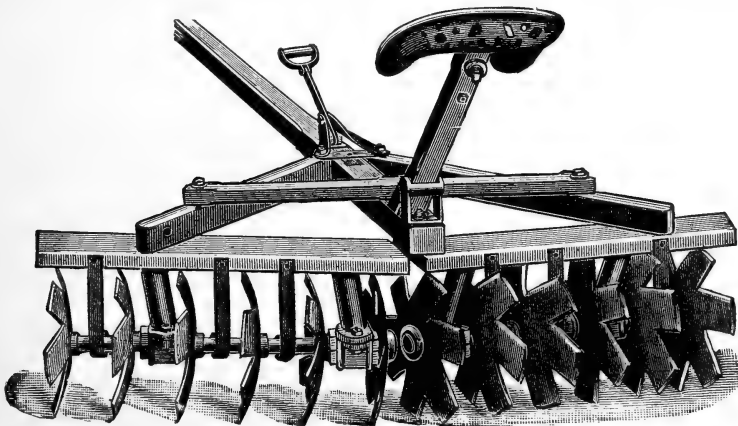

One of the most complete disc harrows made; will not ridge the ground; impossible to clog; cuts the weeds and trash, at the same time mixing them with the soil. Besides cutting and slicing, the implement tears and twists the sod and mixes the soil, putting that which is on the top under, and bringing up the lower earth so far as it reaches. This can be regulated by weighting the drag. With all this motion, there is but little of the side displacement of soil that is so objectionable and damaging a feature of old harrows. Considering these movements, one cannot fail to reason what a perfect seeder it must prove. A perfect peach orchard cultivator.

12 Discs, 16 inches, price \$30.00.

We have in stock a few Morgan Spading Harrows that we will sell at very low prices.

ALL KINDS OF MACHINERY REPAIRED.

## THE IRON AGE RIDING CULTIVATOR.

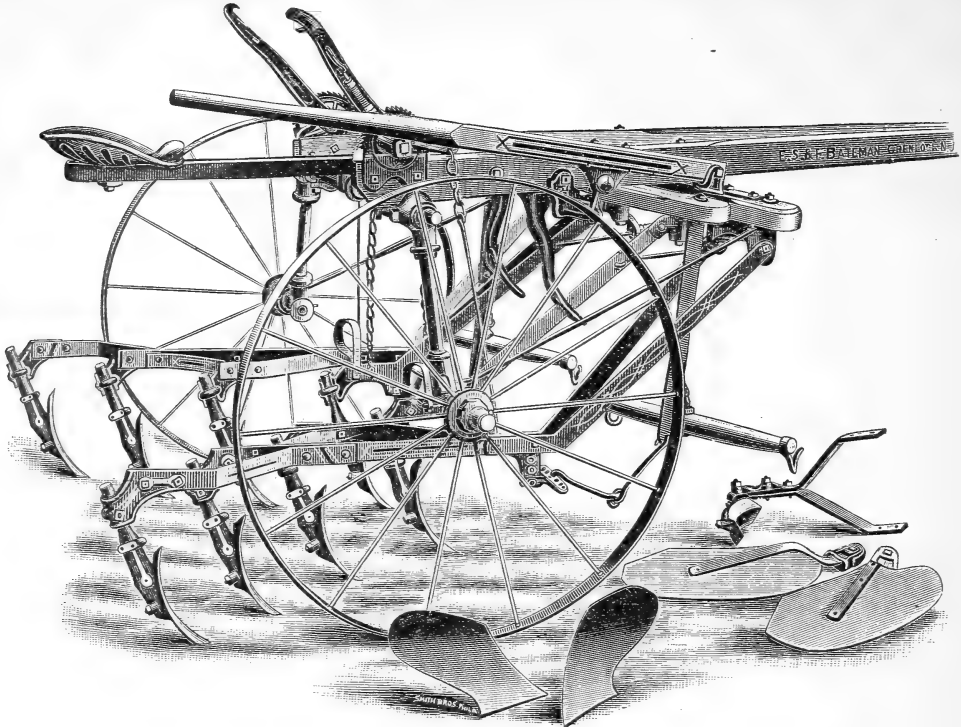

The purchaser of a Cultivator, one or two-horse, stamped with the trade-mark "Iron Age," may rest assured he is getting the *very best* the market affords, and this assurance particularly applies to the tool shown above. It is, comparatively, a new member of the family of "Iron Ages," but we find it well deserves the name, as during the past season it has given the most unqualified satisfaction, and the manufacturers were unable to supply the demand. It is not only a first-class tool for the corn-field, but is designed expressly for the cultivation of "truck" of all kinds.

It possesses some decidedly novel features that are found on no other tool of its kind. The wearisome work of guiding the teeth with the feet is entirely avoided by the unique arrangement of a *single lever*, by the use of which all misplaced hills are dodged, or if desired, the space between the hills can be thoroughly worked.

We call attention to the manner of attaching the teeth, having a steel standard which can be instantly adjusted in depth or angle of cut, or removed altogether. Farmers tell us it is "sensible," and "just the thing." Plows are furnished with the Cultivator, but by this adjustment the teeth can be set at such a sharp angle and the soil cast to or from the crop so strongly as to render the plows almost superfluous.

As shown by the cut, the outside teeth, with their section of frame, can be quickly removed, reducing the Cultivator to six teeth.

The axle—steel of course—is one straight piece, and held in place by a single bolt, giving the farmer an opportunity of replacing same, when worn, with but little trouble or expense. A Cultivator, to do good and satisfactory work in small plants, should run steadily and not sway from side to side on worn-out axles.

List price, \$35.00; retail price, \$30.00; including a pair of Turning Plows, Shields and Fallow Attachment.

### IN USE AND RECOMMENDED BY

Charles E. Howard, Monkton, Baltimore Co., Md.	Dr. Nelson, Eosley P. O., Baltimore Co., Md.
B. R. Howard, " " "	George Stansbury, Canton P. O., " " "
Peter Fisher, North Point, " " "	W. S. Treadwell, " " "
Jesse Martell, Canton P. O., " " "	J. W. Sparks, Canton P. O., " " "
Mrs. George Page, Catonsville, " " "	And many others.

ALL KINDS OF MACHINERY REPAIRED.

## GENUINE MALTA SINGLE AND DOUBLE SHOVEL PLOWS AND STEELS.



### PRICES:

Malta Double Shovel Plow . . . . .	\$3 25
Malta Single Shovel Plow . . . . .	3 00
Farmers' Favorite Double Shovel Plow . . . . .	2 75
Three Shovel Iron Drag or Farmers' Favorite Triple Shovel Plow . . . . .	3 00
Farmers' Favorite Single Shovel Plow . . . . .	2 50
No. 1 Double Shovel Plow . . . . .	2 50
No. 1 Single Shovel Plow . . . . .	2 25

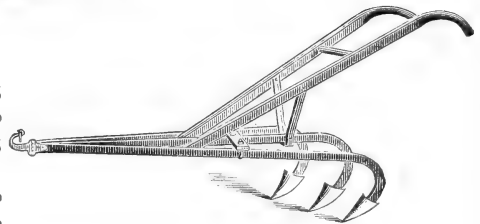

THREE SHOVEL IRON DRAG OR FARMERS' FAVORITE TRIPLE SHOVEL PLOW.

## MALTA WALKING AND RIDING CULTIVATORS.

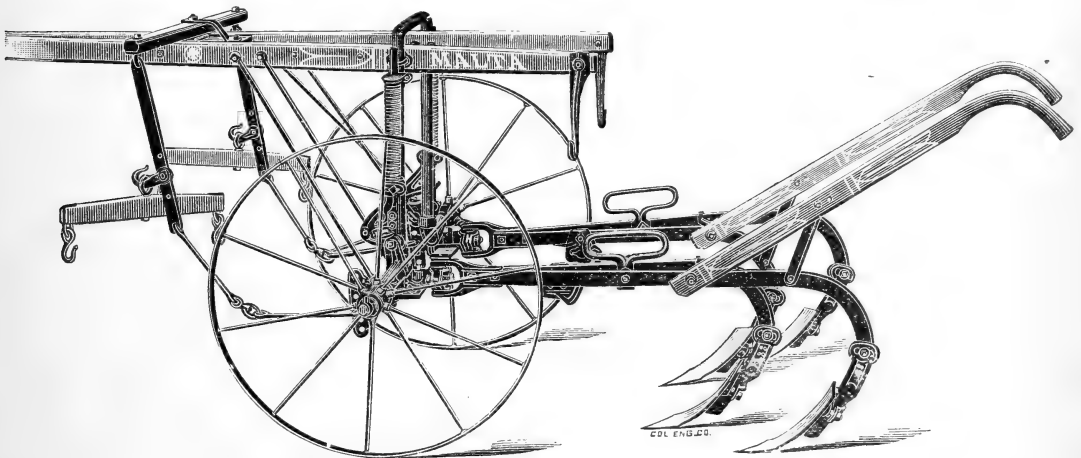

Its numerous adjustments, combined with neatness, strength and durability, make it a favorite. One of the most useful implements in use. The Malta has been sold in this section for years and has proven itself worthy of the reputation it enjoys throughout the country.

	LIST PRICES.	RETAIL PRICES.
Malta Rider . . . . .	\$35 00	\$30 00
Malta Walker . . . . .	30 00	25 00

ALL KINDS OF MACHINERY REPAIRED.



## CAHOON PATENT BROADCAST SEED SOWER,

FOR SOWING WHEAT, OATS, HEMP, BARLEY, RYE, BUCKWHEAT,  
GRASS SEED, RICE, ETC.

SPECIAL GATE FOR

GRASS SEED.

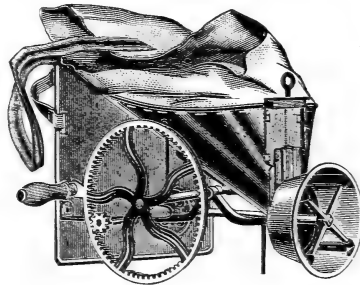

STRONGLY BUILT,

LASTS FOR YEARS.

PRICE, \$4.00.

Sows from four to eight acres per hour at an ordinary walking gait, throwing wheat about forty feet wide. Warranted to give perfect satisfaction and save their cost in a very short time.

The acknowledged superiority of these machines has already placed them in the front rank of labor-saving implements. A saving of four-fifths of the labor and one-third of the seed is effected by their use, and a person entirely unused to sowing by hand can use this machine with perfect success.

**To Sow Thicker or Thinner without changing the Slide.**—Having set the index to sow the desired quantity per acre—taking the average of the field—the operator can easily sow a little *thicker* upon those places where the *soil is richer*, by taking *shorter steps* and thus *not going so fast*, and upon the *proper spots of ground* it can be sown *thinner* by taking *longer steps*, and consequently passing more rapidly forward.

**About Sowing in the Wind.**—Any one familiar with the use of the machine can sow satisfactorily in a much stronger wind than will admit of sowing well by hand; but as the ordinary work of a day can easily be done with the Sower in two or three hours, that time may be chosen early in the morning or late in the evening—when it is usually calm, or nearly so.

**For Sowing in Standing Corn** the machine will be found of the greatest utility—nothing can ever equal it for this purpose—but it will not sow as wide as on fallow ground, in consequence of the obstruction which the corn offers to the seed. A broader lap is therefore required, by making the passages nearer together. (*See Directions*).

The breadth of the cast will be according to the weight of the seed. The heavier the seed the greater the distance to which it is thrown. The passages ordinarily should be as follows:

Wheat and Rye, 30 to 36 feet.	Oats, 21 to 25 feet.
Barley, 27 to 33 feet.	Clover, Millet, Hungarian Seed, 20 to 24 feet.
Hemp, 27 to 30 feet.	Timothy, 15 to 18 feet.

### DIRECTIONS FOR GAUGING THE MACHINE.

The large gate is to be used when sowing grain, and the small gate in the larger one for grass seed only.

First *close the slide or gate tight*, then fix the *lower edge of the index point* against the scale of inches on the *slide* for the different seeds as follows:

**FOR WHEAT AND RYE.**—To sow two bushels to the acre, at 1 inch. To sow one and a half bushels to the acre, at  $\frac{3}{4}$  of an inch.

**FOR BARLEY.**—To sow two bushels to the acre, at 1 inch. To sow one and one-eighth bushels to the acre, at  $\frac{3}{4}$  of an inch.

**FOR HEMP.**—To sow one bushel to the acre, at  $\frac{1}{2}$  of an inch. To sow one and a quarter bushels to the acre, at  $\frac{3}{4}$  of an inch.

**FOR OATS.**—To sow two bushels to the acre, at  $1\frac{1}{2}$  inches. To sow one and a half bushels to the acre, at  $1\frac{1}{4}$  inches.

When ready to sow, *first commence turning*, and with the *left hand* raise the slide until the *nib* on the slide comes against the *index point*. Be careful to *walk and turn*, as above directed. To *close the slide*, do it with a *quick pressure of the left hand*.

To sow *Wheat or Rye in standing corn*, two bushels to the acre, set the *index* at five-eighths of an inch, and sow five or six rows at a time, according as they are *wide or narrow*.

**FOR GRASS SEED.**—To sow one peck of Grass Seed to the acre, raise the small gate  $\frac{3}{4}$  of an inch; half a bushel,  $\frac{3}{4}$  of an inch.

ALL KINDS OF MACHINERY REPAIRED.

## THOMPSON'S CLOVER AND GRASS SEEDER.

Sows 12 or 14 feet wide, any amount desired per acre. Will sow 20 to 25 acres per day.

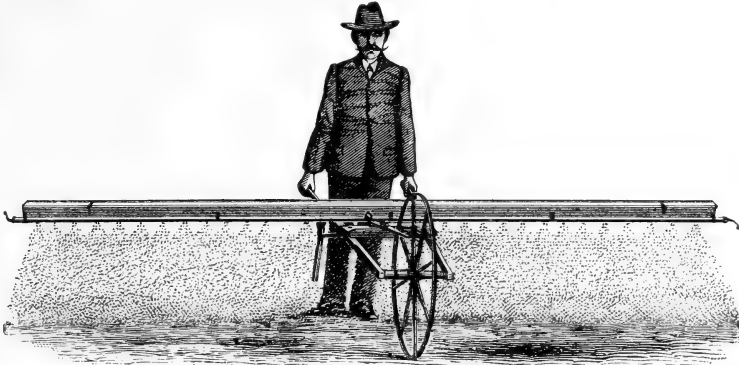

### FEATURES.

This Grass Seeder is simple, without gearing, cams or intricate machinery; it cannot get out of order.

It is strong, yet light, weighing but forty pounds. Perfection feed is attained by making it absolutely positive, yet a non-leaking carrier when thrown out of connection.

The quantity of seed to the acre is accurately shown by the index plate. You place the pin, the machine measures the seed.

Clover, Timothy, Red Top, Hungarian, Millet, Flax, Orchard Grass, Fancy Blue Grass, Alsike and chaffy seeds are alike sown by it. In this it has no rival.

It cannot clog. The wheel may be covered with mud, yet its working will not be affected.

Working near the ground, even strong winds have no effect upon its accuracy.

A manilla rope passes through a groove in the bottom of the box, fastened at the ends to a rod moved back and forth by a lever. This is operated by the revolution of the wheel, upon each of the eight spokes of which is fastened a casting. These castings strike alternately V-shaped irons on the feed levers. The length of stroke governs the quantity of seed sown, and is regulated by the pin which forms a fulcrum at any distance desired from the driving point. The plate for this pin is accurately marked in figures indicating the quantity of seed sown per acre. By use of a thumb-screw the lever can be thrown out of connection, when all sowing stops, the feed-rope covering the holes in the bottom of the hopper through which, when at work, it forces the seed.

Manilla rope is used because it is better than wire or any substitute. It does not wear the groove, bruise the seed or fail in its work—*wire rope will*. Being scorched and chemically treated, our rope is weather proof. It is provided with an iron wedge at one end of the feed rod, so that it may be loosened when not in use.

OFFICE OF OLIVER CHILLED PLOW WORKS,

SOUTH BEND, IND., *December 11, 1886.*

O. E. THOMPSON:

*Dear Sir:*—The Seeder purchased of you has had my personal examination, and I am pleased to say that I regard it as being most complete in every respect. The reputation it enjoys is fully merited, and were I to need another I would not hesitate to buy yours. In fact, I would have nothing else. Wishing you all possible success in its manufacture, I remain,

Yours truly,

JAMES OLIVER.

### PRICE LIST—LESS 20 PER CENT. FOR CASH.

- |   |         |
|---|---------|
| No. 1.—Complete Clover and Grass Seeder, the most popular style . . . . .   | \$10.00 |
| No. 2.—Complete Seeder with Double Hopper for Red Top, Orchard Grass, Blue }<br>Grass, Lawn Grass, as well as Clover, &c. . . . . } | 12.00   |

ALL KINDS OF MACHINERY REPAIRED.

## THE SUPERIOR FERTILIZER DRILL.

MARK'S FEED FERTILIZER ATTACHMENT  
WITH ENAMELED CUPS.

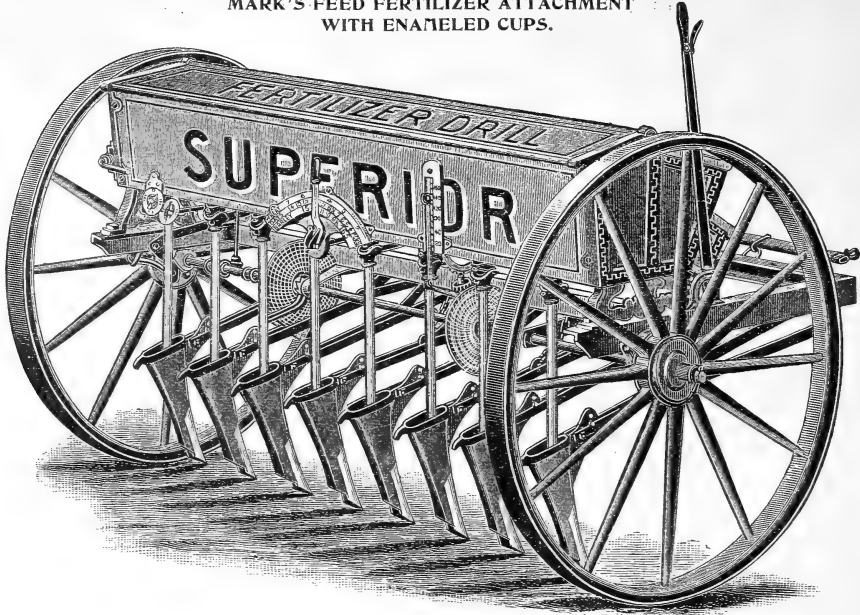

This Drill is supplied with our new Double Distributor and the seeding of grain and grass seed is regulated and controlled by means of Sliding Pinion and Disc Wheel.

The Grain, Grass Seed and Fertilizer Disc Wheels are all on the axle near the centre of the drill under the hopper. By this improved device a change in quantity of grain or fertilizer may be obtained in an instant of time and without change of parts.

The Disc Wheel Fertilizer attachment enables the user to sow the fertilizer or refrain from doing so in fields of varying fertility, the change being accomplished in a second of time, by dropping or raising a lever.

The universally satisfactory Mark's Feed Fertilizer attachment is used on all Superior Fertilizer Drills, which insures the fertilizing material being fed in an even, continuous stream from each distributor, without clogging or pasting.

### GRAIN DRILL TUBES.

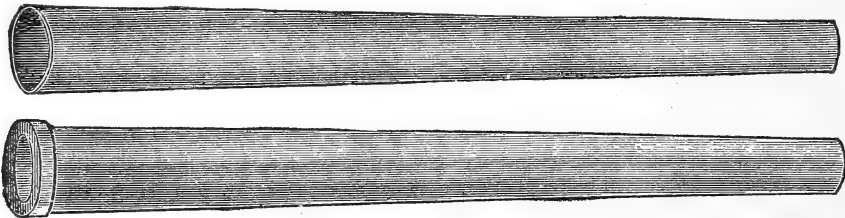

For all leading Grain Drills, including Superior, Pennsylvania, Bickford & Huffman, Hoosier, Buckeye; etc. Price, 40 cts. each.

### GRAIN DRILL POINTS.

For Superior, Pennsylvania, Bickford & Huffman, and all leading Drills,  
in Double and Single Points.

Price, 20 cts. each.



ALL KINDS OF MACHINERY REPAIRED.

**THE L. C. EVANS STEEL FRAME COMBINED DRILL AND CORN PLANTER.**

**EVANS' LATEST INVENTION.**  
**Durability, Simplicity and Accuracy Combined.**

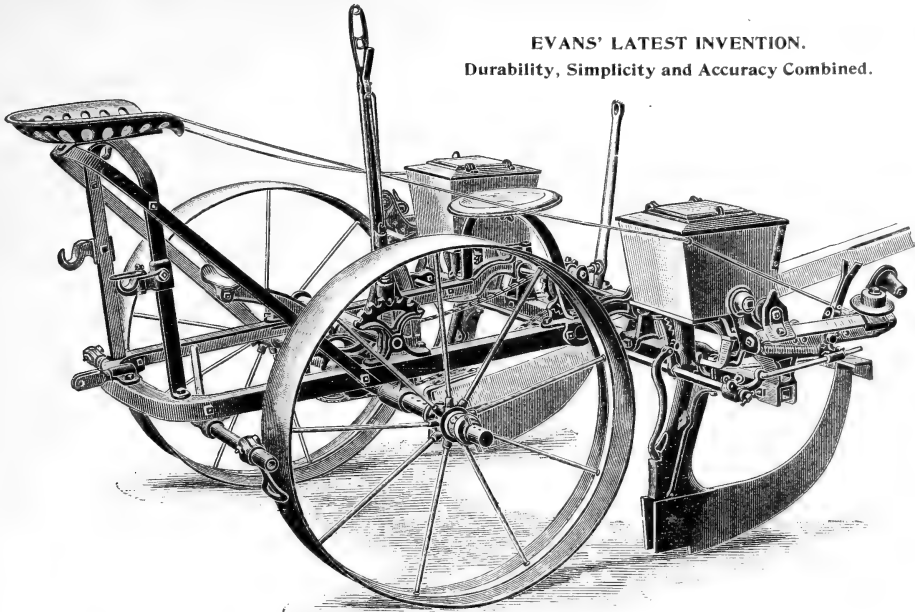

It is the same in principle, with a few improvements, as the L. C. Evans Wood Frame Combined Planter of last year. Using the machine as a drill it can be changed to drop 10, 12, 14 or 16 inches apart.

Will also plant in hills from two to six grains.

**Novel Connection to Couple Front to Back.**—The arms connecting to the boxes on the Plant-beam are slotted so that the Planter has a perfect floating motion, and is adapted to all conditions of the ground. This feature is found on no other combination Planter.

The machine is adjustable in width, being so arranged that it will plant 3 ft.; 3 ft. 2 in.; 3 ft. 4 in.; 3 ft. 6 in.; 3 ft. 8 in., or 3 ft. 10 in. apart. Wheels will run on or off the rows, as desired.

**Special Machines with Covering Shovels.**—For localities where covering shovels are desired, we make a machine coupled further apart, for using covering shovels.

The driver can see the corn dropping from the top of the tube. He thus knows the feed is working properly.

PRICE OF PLANTER, \$35.00; PLANTER WITH COVERING SHOVELS, \$37.50; CHECK ROWER, \$15.00.

**THE EVANS TWO-ROW CORN PLANTER.**

WITH AND WITHOUT FERTILIZER ATTACHMENT.

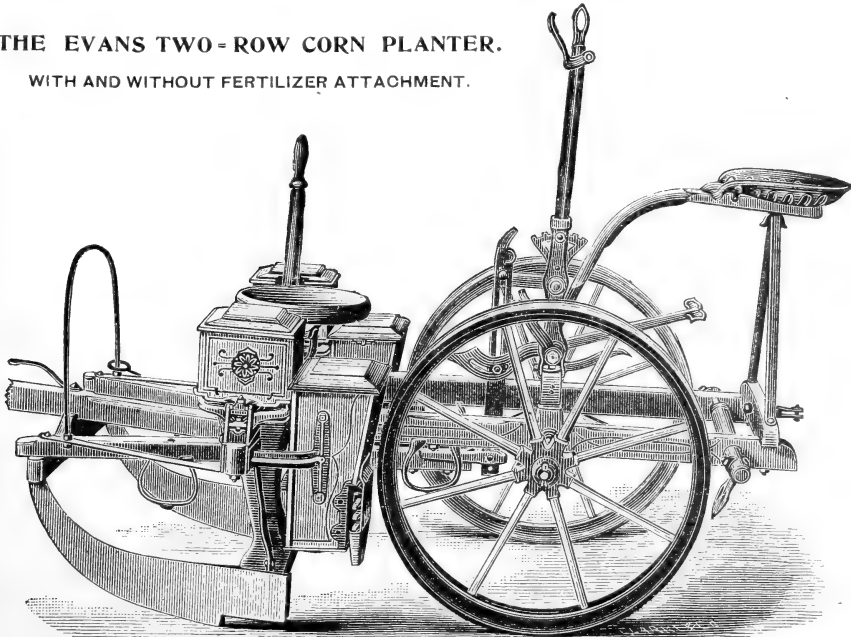

The fertilizer distributor has a positive force feed. Each movement of the drop lever deposits both the corn and fertilizer in such a way that a thin layer of dirt is allowed to cover the corn before the fertilizer is dropped, without allowing the two to come in direct contact. Can be regulated to sow any amount from 100 to 400 pounds per acre.

PLAIN PLANTER, \$30.00; WITH FERTILIZER ATTACHMENT, \$45.00; EVANS CHECK ROWER, \$15.00.

## THE NEW EVANS CORN DRILL,

WITH AND WITHOUT FERTILIZER ATTACHMENT,  
ALSO ARRANGED FOR PLANTING PEAS.

Plain Drill . . . . . \$15.00  
With Fertilizer Attachment . . . . . 20.00

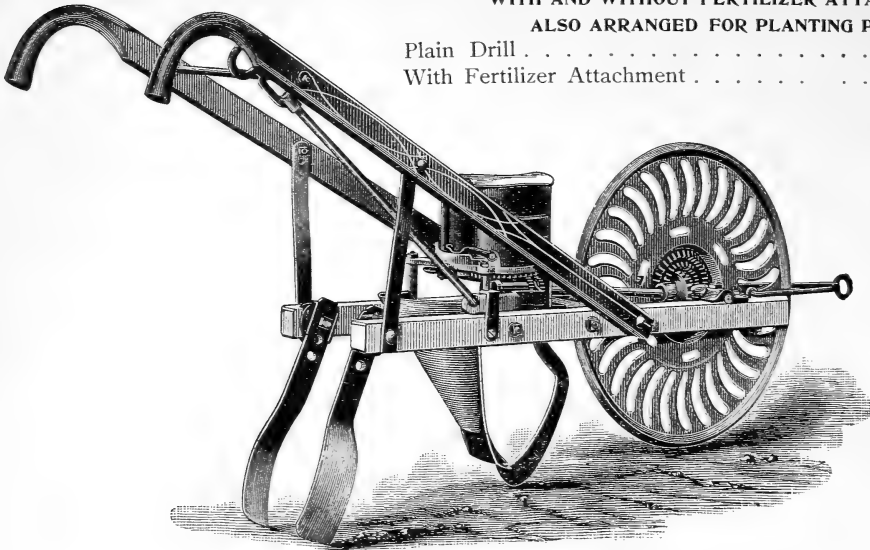

### THE ADVANTAGE OF PLANTING CORN IN DRILLS

is that the grains are dropped separately, and some distance apart, thus giving each plant an opportunity to grow to full maturity.

#### SOME POINTS OF SUPERIORITY.

1. Our gearing is chilled in such a manner that it is very hard, therefore durable.
2. The lever for placing the pinion in or out of gear is placed between the handles close to the operator. This makes the Evans the most easily handled drill on the market.
3. The rotary drop will drill accurately 8, 12, 16 or 20 inches apart, as may be desired, dropping one grain at a time.
4. Has a heavy drive-wheel, which makes the Drill run steadier, and is less liable to slip.
5. The shares are held by malleable iron clamps which give more strength than cast ones.

### THE NEW EVANS ONE-HORSE CORN DRILL WITH FERTILIZER ATTACHMENT

has a positive force feed that will drill any of the popular fertilizers now in use.

Worth four times its cost for one season's use to any farmer who uses fertilizers, as with it he can plant his corn and put in the fertilizer at the same time.

No one who contemplates purchasing a Corn Drill should fail to examine the EVANS.

### ADVANCE PEA AND FERTILIZER DRILL.

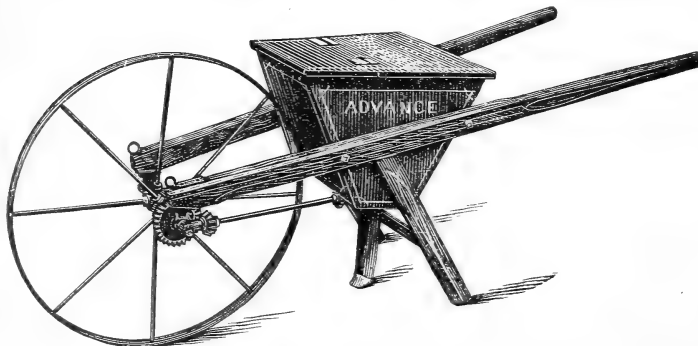

The distributing disc being of wrought iron and galvanizd can neither break nor rust, thus entirely obviating the faults of glass and iron.

The agitator is also new, being of steel, in the form of two knife-shaped arms sweeping around under the mass of the fertilizer and throwing it upon the revolving disc below. A shut-off has lately been added whereby the waste of fertilizer is stopped

when turning at ends of rows. As shown in cut, loops are bolted to frame for the purpose of attaching a horse. We cannot too strongly recommend this Drill to pea growers as being one of the very best tools for sowing peas. The same can be said of it in regard to sowing fodder corn or ensilage. Price, \$9.00.

ALL KINDS OF MACHINERY REPAIRED.

## • ASPINWALL POTATO PLANTER.

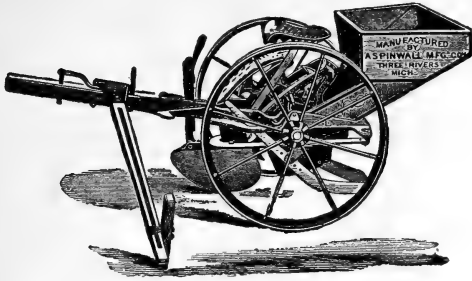

Distributes fertilizers. It marks, it furrows, it drops, it covers, all in one operation. Absolutely guaranteed. Plain Planter, \$65.00; Planter, with Fertilizer Attachment, \$80.00.

In use and recommended by many of our best farmers. Send for special catalogue.

## ASPINWALL CORN AND PEA DRILL.

It plants peas and covers them slightly with dirt before dropping the fertilizer, which is also covered, the only satisfactory way to plant peas.

This is one of the best and cheapest riding planters made.

Its capacity is from 10 to 12 acres per day. Can be changed from a corn planter to a pea

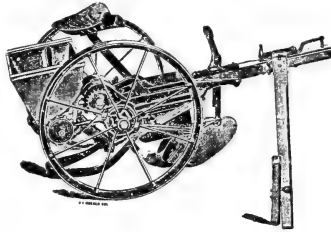

planter instantly. Extra slides for planting different kinds and quantities of seed with every machine.

The above cut shows machine with Fertilizer Attachment. The capacity of this attachment is from 200 to 1000 pounds per acre. It has a most positive feed and can be governed at will. Price, \$25.00.

## THE DAISY CORN HARVESTER.

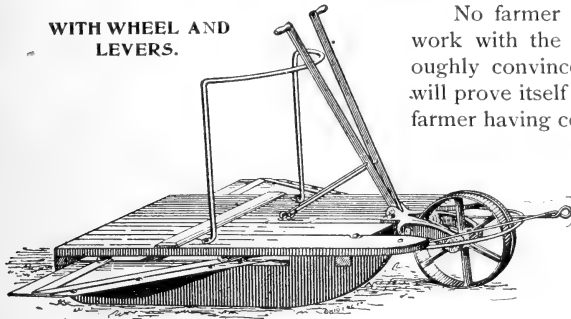

WITH WHEEL AND LEVERS.

No farmer can afford to do without one. A few hours' work with the Daisy Corn Harvester and you will be thoroughly convinced that we can substantiate our claims, as it will prove itself an implement that will be welcomed by every farmer having corn to cut. The price being within the reach of all, the ease and rapidity of the work it will do, the excellent satisfaction it gives, the simplicity of construction, the large amount of work that can be accomplished, ease of management and advantages it possesses over all others, makes the Daisy one of the most desirable tools for a farmer to use and a dealer to sell. Price, \$25.00.

## BREED'S UNIVERSAL WEEDER AND CULTIVATOR.

For weeding Corn, Potatoes, Beans, etc., also putting in Grain, Grass Seed, Millet, etc. One of the greatest labor-saving inventions in use.

It is well-known that corn roots run in the surface, making a complete network of roots in the soil. Yet we put in the cultivator and break every root that is sent out between the rows. This deep stirring of the soil is to *kill the weeds only*, for no farmer will claim that since planting his corn the soil needs lifting in this way. Is it wise thus to root-prune the corn at this stage of its growth to *kill surface weeds*? The answer comes in the negative from hundreds of farmers who have tried the new method of weed-killing. Price of removable tooth weeder, \$12.00.

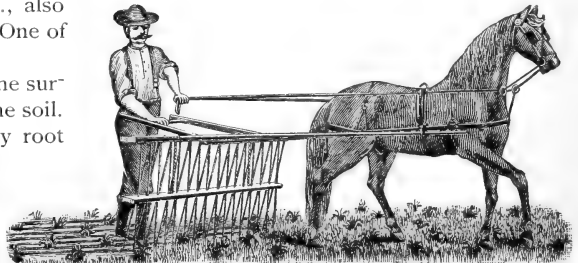

## POTATO CUTTER.

A boy can operate it. Cuts potatoes for seed faster than eight men can by hand. Will pay for itself in one day. Fully warranted.

It consists of a series of knives secured in an opening of the table. The potato is placed above the knives, and by a plunger the potato is cut at a single stroke and the eyes divided in a most satisfactory manner. The screen below frees the seed from dirt and prepares for planting. Price, \$10.00.





## SILVER'S OHIO FEED CUTTERS AND CARRIERS.

The cut represents our new "Ohio" Hand Feed Cutter, which was made to supply a long felt want for a Hand Cutter that could be sold at a moderate price and combine the qualities of lightness and strength, ease of operation, convenience, and simplicity of construction.

### SIZES AND PRICES.

- No. 7, one 7-inch knife, . . . . . \$18 00
  - No. 7, two 7-inch knives, . . . . . 20 00
  - No. 8½, two 8½-in. knives. cuts ¼, ⅓, ¾ in. 25 00
- Less 20 per cent. retail.

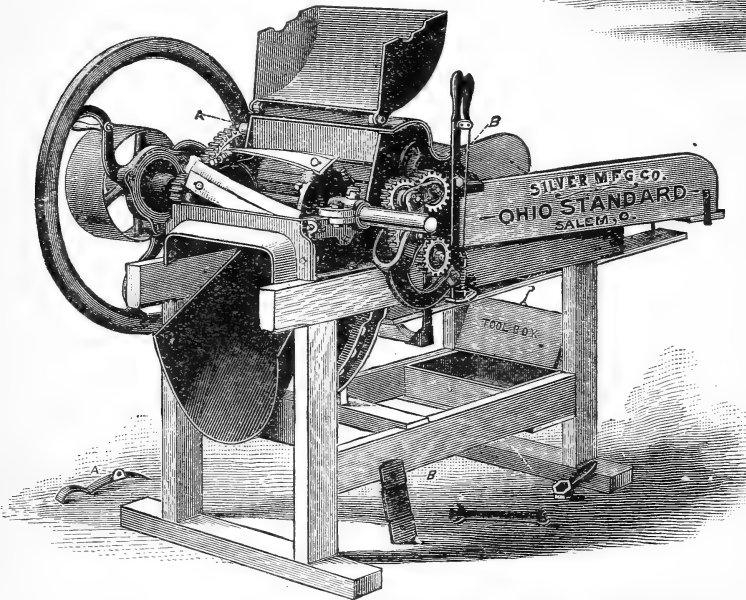
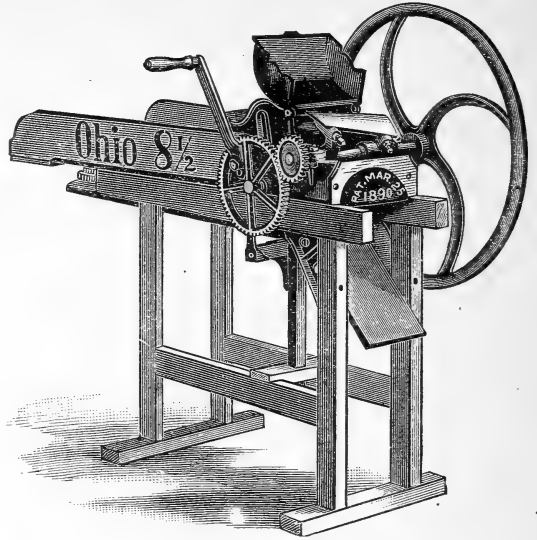

The Ohio Standard Feed Cutter has long been known as one of the best "general purpose" Power Cutters manufactured. This cut represents our New Ohio Standard Cutter, which has been rebuilt, strengthened and improved throughout, and now stands unrivaled as a model of durability, simplicity and efficiency.

KNIVES.	FLY-WHEEL.	TWO KNIVES.		FOUR KNIVES.	
		LENGTHS CUT.	PRICE.	LENGTHS CUT.	PRICE.
No. 9. 9-inch.	Common.	½, 1, 1½, 2 in.	\$32 00.	¼, ½, ¾, 1 in.	\$40 00
No. 9. 9-inch.	Safety.	½, 1, 1½, 2 in.	35 00.	¼, ½, ¾, 1 in.	45 00
No. 11. 11-inch.	Safety.	½, 1, 1½, 2 in.	40 00.	¼, ½, ¾, 1 in.	65 00
No. 13. 13-inch.	Safety.	½, 1, 1½, 2 in.	58 00.	¼, ½, ¾, 1 in.	90 00
No. 16. 16-inch.	Safety.			¼, ½, ¾, 1 in.	120 00
No. 18. 18-inch.	Safety.			¼, ½, ¾, 1 in.	200 00
No. 20. 20-inch.	Safety.			¼, ½, ¾, 1 in.	250 00
No. 24. 24-inch.	Safety.				

Less 20 per cent. retail.

Can also furnish a full line of carriers for any of the different sizes Ohio Cutters ; prices on application.

Our 24-inch Cutter is in use and recommended by Messrs. Evans & Evans, of Baltimore, one of the largest manufacturers of cut hay in the United States.

ALL KINDS OF MACHINERY REPAIRED.

**DOCTOR BAILEY ENSILAGE AND DRY FORAGE CUTTERS.**

**PRICES.**

9-inch, . . .	\$ 28 00
10-inch, . . .	35 00
12-inch, . . .	55 00
14-inch, . . .	75 00
16-inch, . . .	95 00
20-inch, . . .	120 00

A discount of 10 per cent. to farmers from above prices.

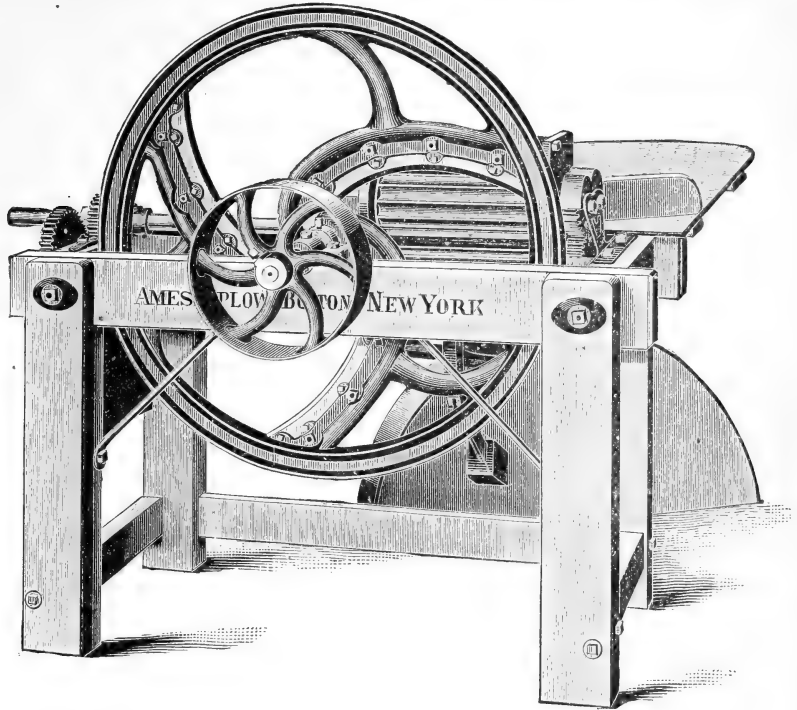

The Dr. Bailey Ensilage Cutters have many advantages possessed by no other ensilage machine or cutter. Strength, durability, simplicity and rapidity of work are among the qualifications. They are giving entire satisfaction, and the ever increasing demand shows their great popularity.

There are six sizes. The size with 10-inch knives is for hand use; the 12-inch machine is for use by hand or horse-power; the 14-inch machine is for one horse-power, while with a one horse-power the 16-inch machine (illustrated above) will cut much more than any cutter having convex knives.

Upon a careful test at "Winning Farm," the Dr. Bailey 20-inch machine cut green corn fodder at the rate of 7 tons per hour,  $\frac{3}{8}$  of an inch long, and at the rate of 15 tons per hour,  $\frac{3}{4}$  of an inch long.

The 12, 14, 16 and 20-inch machines cut ten different lengths:  $\frac{3}{8}$ ,  $\frac{1}{2}$ ,  $\frac{3}{4}$ , 1,  $1\frac{1}{4}$ ,  $1\frac{1}{2}$ ,  $1\frac{3}{4}$ , 2 and  $2\frac{1}{2}$  inches. The 10-inch machine cuts four different lengths:  $\frac{3}{8}$ , 1,  $1\frac{1}{2}$  and  $2\frac{3}{8}$  inches.

**BALTIMORE LEVER CUTTERS.**

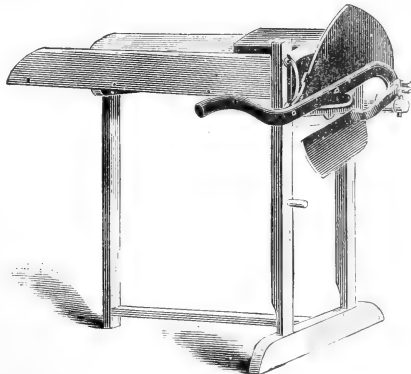

We are making these Cutters of the best material and with best possible device for adjusting the knife; there is also incorporated in above every good feature that could be suggested. The knife is readily adjusted, and any farmer can sharpen it with ease. Every cutter has a gauge-plate which regulates the length of cut. Price, with gauge-plate, \$5.00.

**ALL KINDS OF MACHINERY REPAIRED.**

**CELEBRATED ROSS CUTTERS AND CARRIERS.**

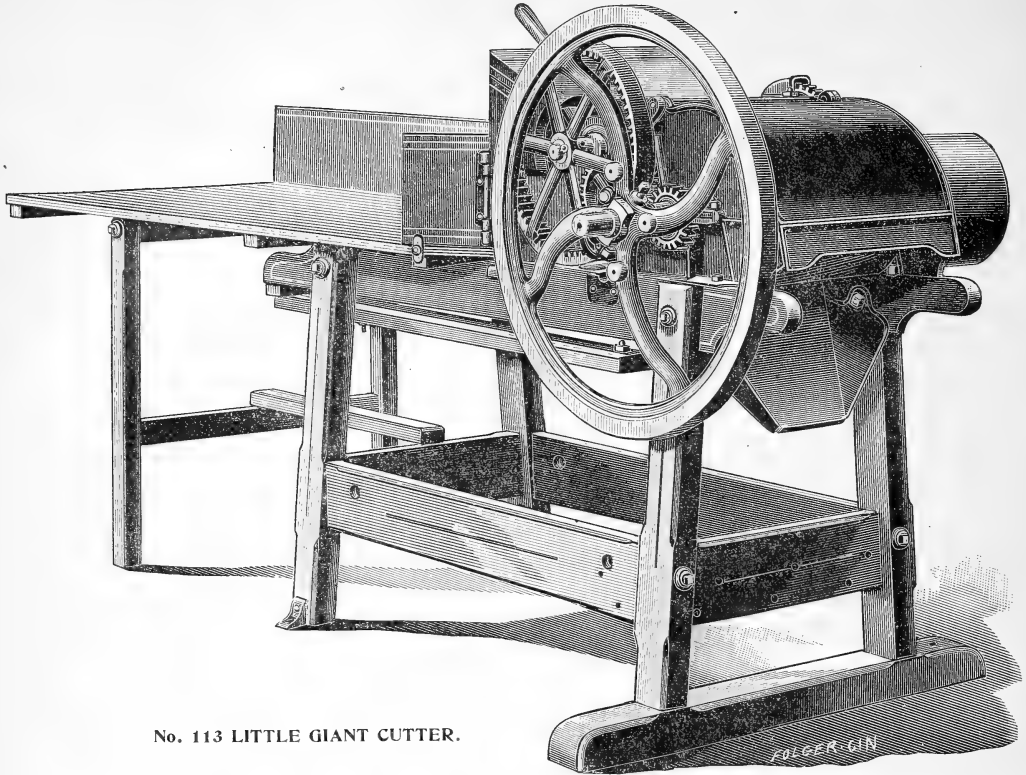

No. 113 LITTLE GIANT CUTTER.

Some of the characteristics of this popular machine are, first: The Upward cut, whereby the knife shaft rests naturally on its bearings.

By the Upward Cut the edges of the knives and the cutting plate are both in full view, so that after sharpening and grinding, the knives can be adjusted accurately and easily.

By a perfect arrangement the feeding roller can open either parallel or obliquely, and at the same time retains all parts in perfect position; and by opening obliquely will feed heavily on one side and less on the other; they are self-feeding and cannot clog or stop.

**Prices of Ross Cutters.**

Lever Cutters, Net, . . . . .	\$ 5 00	No. 9 A or 90, Cylinder Hand Cutter, .	\$35 00
No. 7, Cylinder Hand Cutter, . . . . .	16 00	No. 111, with Patent Table, . . . . .	50 00
No. 7½, Cylinder Hand Cutter, . . . . .	18 00	No. 113 & 13 A, Cylinder Power Cutter,	65 00
No. 8½, Cylinder Hand Cutter, . . . . .	25 00	No. 116 & 14 A, Cylinder Power Cutter,	90 00

From prices on Cylinder Cutters we make a discount of 20 per cent. to the farmers. The price on Lever Cutter is net.

**WOOD SAW.**

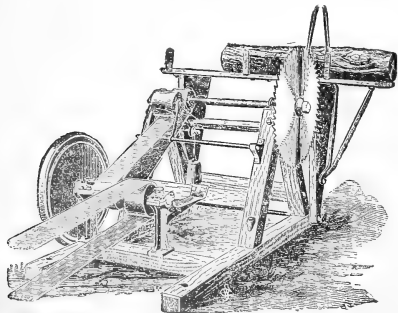

Our saw, as shown in cut, has *Balance Wheel under the Table*, where it will be out of the way in sawing poles. Farmers and others who use saws can at once appreciate the great convenience of this machine. It has a swing table, which is the best style for cutting cord wood and poles. The balance wheel is entirely out of the way, being placed under and to one side of the saw shaft. A short belt with automatic tightener transmits power from balance wheel shaft to saw shaft. This device is simple but very effective. One man can do the work on this saw as readily as two men on the regular style saw. Weight, 350 lbs. Price, \$50.00.

**THE BALTIMORE CIDER MILL.**

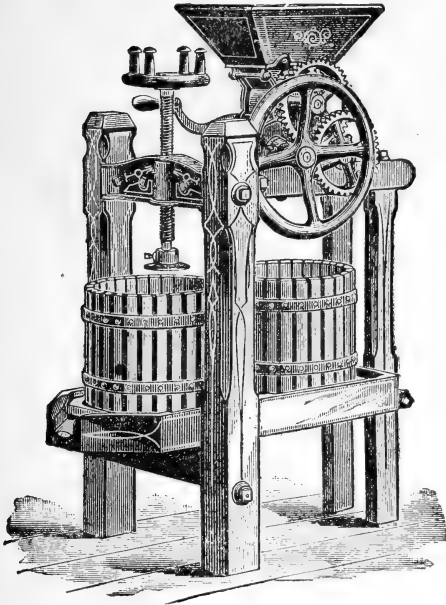

Our Cider Mills are first-class in every particular, are unsurpassed in quality, durability and capacity, and are made of best material in both wood and iron. The grinding apparatus is of the most satisfactory pattern and is made adjustable so as to grind both small and large fruit equally well.

- Junior Double Cage Mill . . . . . \$15 00
- Medium Double Cage Mill . . . . . 20 00
- Senior Double Cage Mill . . . . . 25 00
- No. 0, Hutchinson Single Cage Mill... 10 00
- No. 1, Hutchinson Single Cage Mill... 12 00

**LAWN AND FIELD ROLLERS.**

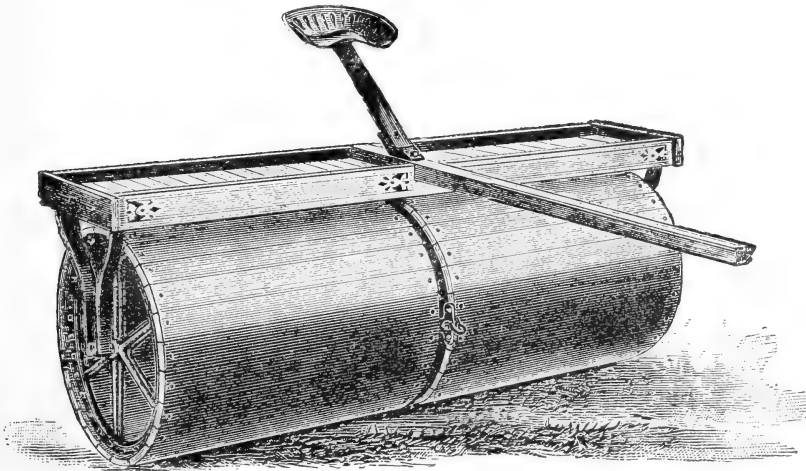

**LAWN SIZES AND PRICES.**

- No. 0, two sections, each 6½-inch face, 10 inches in diameter, weight 130 lbs . . . . . \$ 7 50
- No. 1, two sections, each 9-inch face, 12 inches in diameter, weight 200 lbs . . . . . 9 00
- No. 2, two sections, each 11-inch face, 15 inches in diameter, weight 300 lbs . . . . . 12 00
- No. 3, three sections, each 12-inch face, 25 inches in diameter, weight 700 lbs., complete with shafts and seat . . . . . 36 00

**FIELD SIZES AND PRICES.**

- Wood Field Rollers, 27 inches in diameter, two sections as above . . . . . \$30 00
- Wood Field Rollers, 27 inches in diameter, one section . . . . . 20 00
- Iron Field Rollers, five sections, 12-inch face, 20 inches in diameter . . . . . 45 00

**ALL KINDS OF MACHINERY REPAIRED.**

**SINGLE RAIL STEEL TRACK AND CARRIER.**

SOLID STEEL RAIL. NO HOLES. JOINT CLAMPS, STOP AND HANGERS, PERFECTLY ADJUSTABLE.

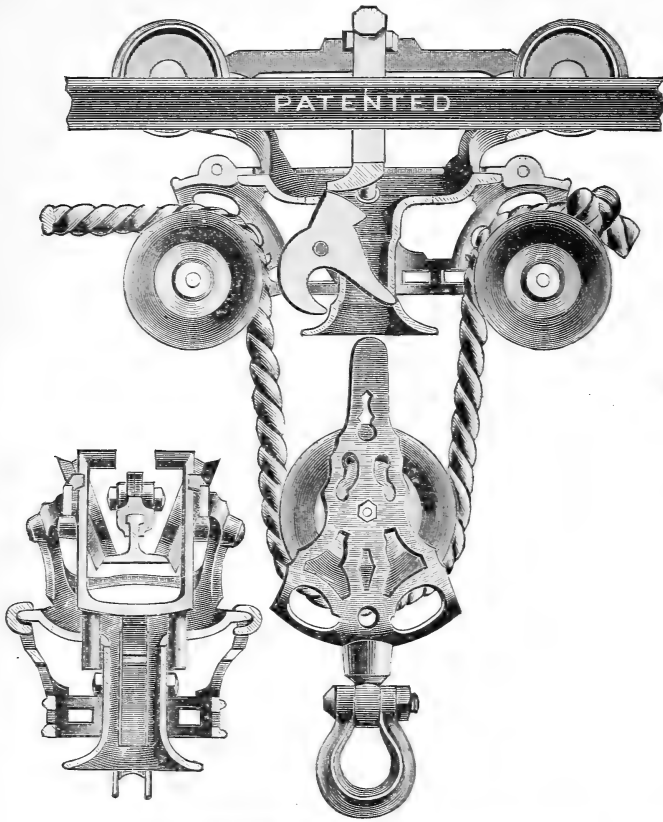

DOUBLE HARPOON HAY FORK.

PRICE. . . . \$1 25.



RAFTER BRACKET.

PRICE, 10 CTS.



HANGING HOOK.

PRICE, 10 CTS.

No more holes drilled in tracks. Everything solid, and yet perfectly adjustable. The very latest. The simplest Lock yet invented; only two pieces. All malleable. Examine.

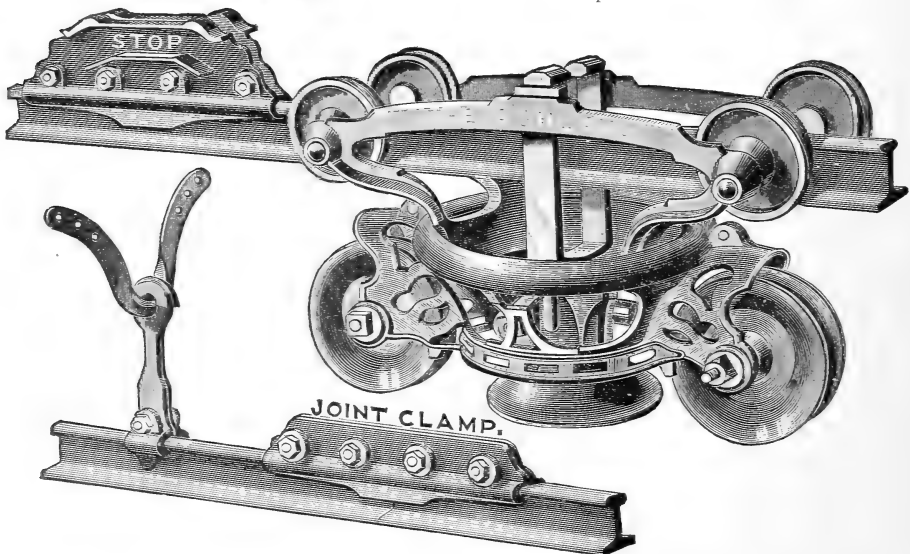

Our experience with this Hay Carrier has been satisfactory in every respect, and we not only pronounce it the best that we have ever handled, but the best Steel Rail Carrier made; during the season just past we were unable to fill orders very much of the time, and every man who purchased one (so far as we can learn) is thoroughly satisfied with its work. If in need of a carrier, we unhesitatingly advise the purchaser to buy this machine, and are confident that he will be pleased with the same. Price, \$6.00.

ALL KINDS OF MACHINERY REPAIRED.

## GRIFFITH, TURNER & CO.'S COMBINATION REVERSIBLE CARRIER.

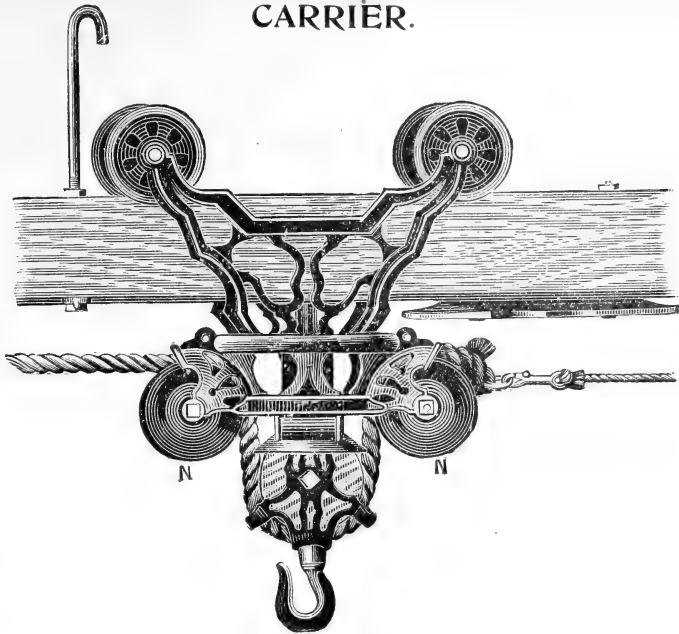

The above illustration shows our New Combination Carrier. This Carrier is a straight reversible, having all the valuable features and advantages of our Double Lock. It has the same reversible Trips and Stops and, when used as a reversible Carrier, operates the same way and is reversed in the same manner. The new feature in this Carrier is that the two rope pulleys, Marked N N, are hung on a turn-table, which adds to this Carrier all the advantages found in a Swivel Carrier, in addition to those of any Reversible Carrier in the market. It is made entirely of malleable iron from a neat pattern, and is strong and well finished. It cannot fail to meet all requirements of the dealer and has every advantage and convenience the user can ask for. Price, \$5.00.

## HAY TOOL SUPPLIES.

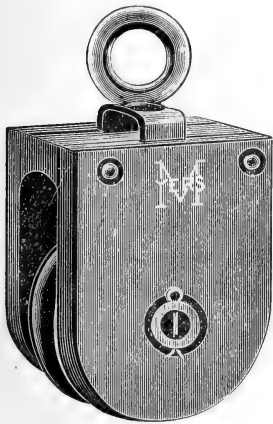

**Iron Strapped Pulley.**  
PRICE 50 CTS.



**Malleable Frame Knot Passing Pulley.**



End view Mal. Knot Passing Pulley.

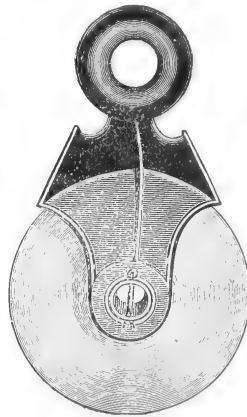

**The Maple Sheave Pulley.**

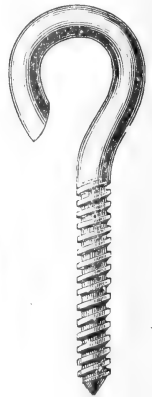

**Floor Hook.**  
PRICE, 10 CTS.

### MALLEABLE FRAME KNOT PASSING PULLEYS.

The sheave is hard maple and the frame of the best annealed malleable iron; is neat and strong. It will pass a large knot or splice and is less liable to wear out rope than any other pulley. Price, 50 cts.

### THE MAPLE SHEAVE PULLEY,

shown in the accompanying cut, has a deeply grooved wooden sheave made of the best well seasoned maple, and is nicely finished in oil. The case is heavy, strongly ribbed, and has swivel eye. Price, 35 cts.

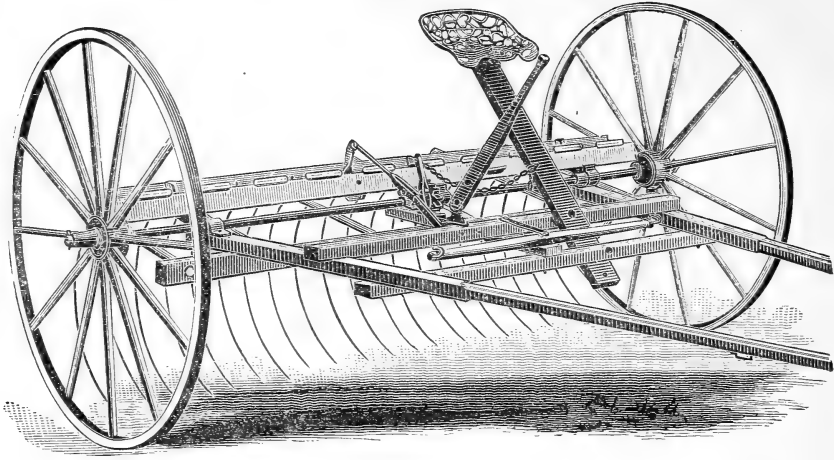

**BALTIMORE SELF-DUMP RAKE.**

Above cut represents the Baltimore, one of the best Self-Dump Rakes made.

Baltimore Self-Dump, . . . . .	\$22 50
Baltimore Hand-Dump, . . . . .	20 00

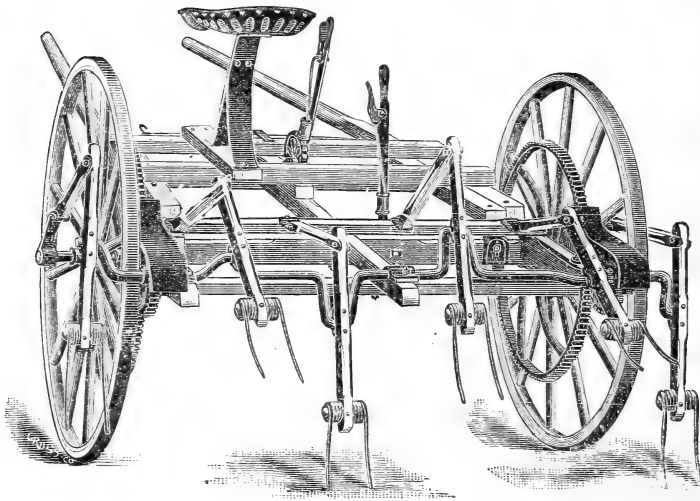
**BALTIMORE TEDDER.**

With Combination Shafts and Tongue ; with Outside Fork and Shields over gearing.

Price, . . . . . \$33 00

ALL KINDS OF MACHINERY REPAIRED.

## RAKES AND TEDDERS.

We are also general agents for rakes and tedders made by the following well-known Manufacturers :

### OHIO RAKE COMPANY.

INCLUDING

O. R. C. Tedders, . . . . .	\$33 00
Gazelle Self-Dump Rakes, . . . . .	22 50
Dayton Hand-Dump Rakes, . . . . .	20 00

### THOMAS MANUFACTURING CO.

Thomas Hay Tedder, . . . . .	40 00
Thomas Imperial Hay Tedder, . . . . .	35 00
Thomas Hay Rake, . . . . .	25 00
Thomas Royal Self-Dump Rake, . . . . .	23 00
Thomas Imperial Rake, . . . . .	22 50

Stock of repairs for both of the above lines always on hand ; buy your goods where you can get repairs at short notice when you need them.

## HAY RAKE TEETH.



For all leading Hay Rakes, including Baltimore, Thomas, Gazelle, Tiger, Taylor, Dayton, Red Bird, etc. Plain and with coil. When ordering always be very careful to state whether you want plain or coil teeth, right or left hand, and if there are several different styles of teeth used on the same make of rake, it is the best plan to send a drawing, giving as near as possible the exact curve of old tooth. Price, 40 cts. each.

## HAY TEDDER FORKS.

Always on hand, stock of Forks for leading styles of Hay Tedders, including Baltimore, Ohio, Thomas, Bullard, Tiger, etc.

## THE OHIO HAY LOADER.

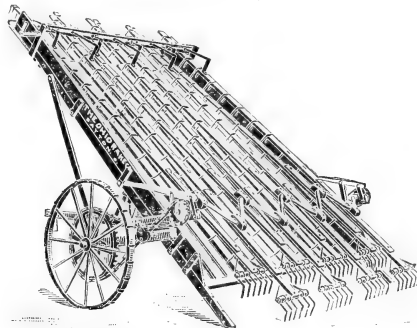

There is no implement used in saving hay that is more economical than a good Hay Loader, and there is no machine made that will give you better satisfaction than the Ohio ; it rakes 8 feet in the clear and compresses and delivers it through a 6½ foot top ; it elevates and delivers the hay higher than any other loader in America ; it can place a ton of hay on the wagon in 8 minutes from land producing two tons per acre ; it has the longest adjustable extension enabling it to load closer to the wagon and higher up than any other loader ; has the only truss-supported bottom made, and the only practical centre axle support ; in short, it is the best loader on the market. Price, \$65.00.

ALL KINDS OF MACHINERY REPAIRED.



## MYERS FORCE AND LIFT PUMPS.

No. 1 Force Pump, 3 inch brass cylinder, 4 feet below platform, for 1¼ inch pipe, \$13.00. This is for wells under 25 feet deep.

No. 4 Force Pump, 2½ inch brass cylinder, 5 feet below platform, 1¼ inch pipe, \$15.00. This is for wells from 30 to 150 feet deep.

No. 101 Lift Pump, 2½ inch brass cylinder, 4 feet below platform, for 1¼ inch pipe, \$10.00.

## BUCKET BRASS SPRAY PUMPS.

Constructed of material that is not affected by the poisonous arsenites used in the different formulas for spraying fruit trees, etc. All of the working parts are brass; has rubber ball valves, Combination Spray Nozzle, and will throw a spray as fine as mist. The pump differs from the old line pumps of this class and is arranged so that the heavy work is done on the down stroke of the plunger.



Brass Bucket Spray Pump, . . . . \$ 5 00  
 Barrel Pump for Water Carts, . . . 6 00  
 Perfected Galloway Knapsack  
 Sprayer, . . . . . 15 00

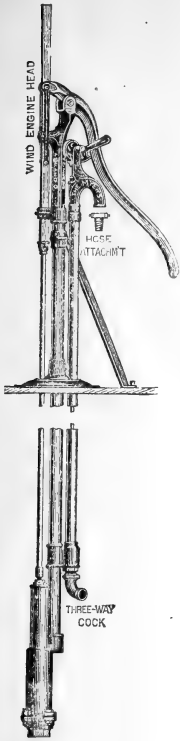

## BOLSTER SPRINGS.

These goods are growing in popular favor more and more every year, and, in fact, no farmer can afford to be without them; will pay for themselves in a short time; wagon will last longer, will carry load in much better condition, particularly fruit or produce that is likely to become bruised, etc., and will make the load run much easier to the horses. We are general agents for the North and the Belle City, both of which have given our customers perfect satisfaction.

### THE NORTH PATENT ADJUSTABLE BOLSTER SPRING. IMPROVED PATENT, OCTOBER 19, 1888.

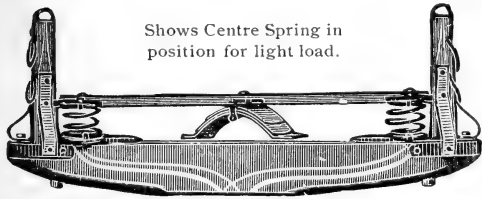

Shows Centre Spring in position for light load.

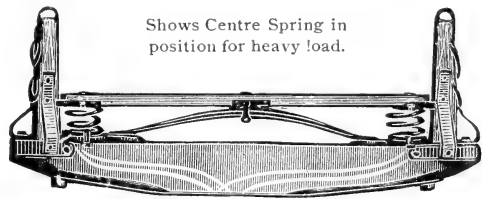

Shows Centre Spring in position for heavy load.

#### PRICE LIST.

To carry 1000 lbs. . . . . \$4 00	To carry 3000 lbs. . . . . \$ 8 00	To carry 5000 lbs. . . . . \$11 00
To carry 1500 lbs. . . . . 6 00	To carry 4000 lbs. . . . . 10 00	To carry 6000 lbs. . . . . 12 00
To carry 2000 lbs. . . . . 7 00		

### BELLE CITY BOLSTER SPRING.



#### PRICE LIST.

No. 0 —1000 lbs. cap'ty . \$4 50	No. 1½—3000 lbs. cap'ty . \$6 50	No. 2½—5000 lbs. cap'ty . \$8 00
No. 0½—1500 lbs. cap'ty . 5 00	No. 2 —4000 lbs. cap'ty . 7 50	No. 3 —6000 lbs. cap'ty . 8 50
No. 1 —2000 lbs. cap'ty . 5 50		

In ordering give the distance between Bolster Stakes.

# THE WALDRON & SPROUT VERTICAL FRENCH BURR MILL.

THE BEST BURR STONE MILL EVER OFFERED TO THE TRADE.

The Celebrated Vertical French Burr Mills, Suitable for Grain or any Material that may be Ground in a Mill.

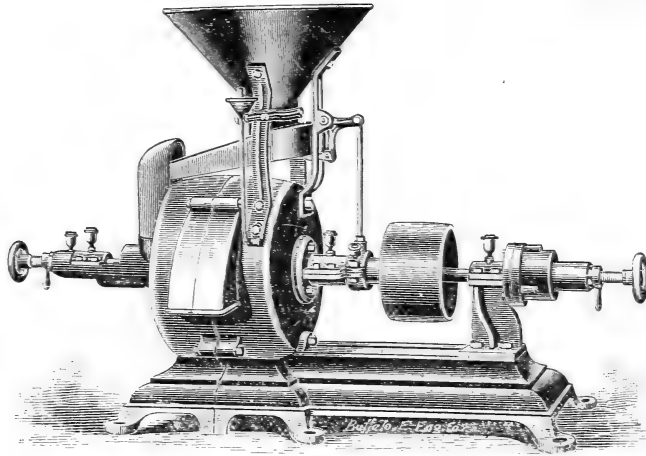

**12-inch Mill.**—Dimensions: Length over all, 56 inches; width, 22 inches; height, 31 inches; driving pulley 8 inches in diameter, 5-inch face, covered with leather; weight, 430 pounds; should be run 1000 to 1200 revolutions per minute; grinding capacity, 5 to 15 bushels per hour, according to fineness of meal or feed and power used; power required to operate above, 6 to 8 horse-power engine. Price, \$100.

**16-inch Mill.**—Length over all, 64 inches; width, 24 inches; height, 36 inches; floor space, 22 x 45 inches; driving pulley, 10 inches in diameter, 6-inch face, covered with leather; weight, 800 pounds; should be run 1000 revolutions per minute; grinding capacity, 10 to 30 bushels per hour; power required to run this mill satisfactorily, 8 to 12 horse-power. Price, \$160.

**20-inch Mill.**—Length over all, 77 inches; width, 30 inches; height, 41 inches; floor space, 24 x 54 inches; driving pulley, 12 inches in diameter, 10-inch face, covered with leather; weight, 1200 pounds; should be run 900 revolutions per minute; grinding capacity, 15 to 60 bushels per hour; 10 to 15 horse-power engine required. Price, \$200.

**24-inch Mill.**—Length over all, 81 inches; width, 32 inches; height, 51 inches; floor space occupied by base, 27 x 57 inches; driving pulley, 16 inches diameter, 8-inch face, covered with leather; weight, 1800 pounds; should run 800 revolutions per minute; grinding capacity, 15 to 75 bushels per hour, according to fineness of feed and meal required and power used. This mill is adapted to any place where it can have from 15 to 25 horse-power. It has the *end motion silent shoe feed*, and is filling the place of the 30-inch in many places, as it will do almost as much work with less power, and is easier to handle. Price, \$275.

**30-inch Mill.**—Length over all, 78 inches; width, 39 inches; height, 55 inches; floor space, 30 x 53 inches; driving pulley, 20 inches in diameter, 10-inch face, covered with leather; weight, 2500 pounds; grinding capacity, 25 to 100 bushels per hour; should be run 700 revolutions per minute; power required, 20 to 30 horse power. Price, \$350.

## IMPROVED CRUSHERS—TWO SIZES.

No. 1 will crush 20 to 35 bushels of corn on the ear per hour; weight, 350 pounds; driving pulley, 16 inches diameter, 4-inch face; should be run 300 to 400 revolutions per minute; power required, 2 horse-power. Price, \$40.

No. 2 will crush 60 to 90 bushels of corn on the ear per hour; weight, 500 pounds; driving pulley, 20 inches diameter, 4-inch face; should be run 200 to 300 revolutions per minute; power required, 3 horse-power. Price, \$60.

It will pay you to write for catalogue and prices before purchasing elsewhere.

GRIFFITH, TURNER & CO., General Agents.

ALL KINDS OF MACHINERY REPAIRED.

# STAVER BUCKEYE FEED MILL AND POWER COMBINED.

THE FARMERS' FRIEND.

**PRICES.**

Staver Buckeye Combined Mill and Power, \$70 00  
 Big S. Power Mill..... 70 00  
 Less \$5.00 for cash.  
 Extra Lever for Staver Buckeye Mill, \$5.00 net.

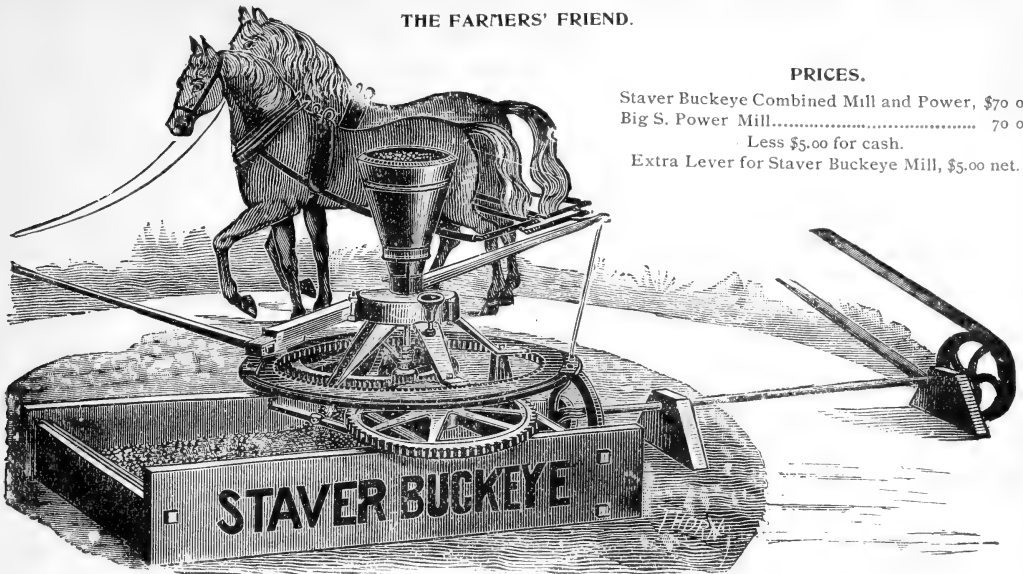

For grinding corn and cob or shelled grain. Can also be used as a separate two horse-power for running other machinery. The combination of a Feed Mill and a Horse-Power in One Machine makes a great reduction in the cost and furnishes a light running machine, which meets with general favor.

The Staver Buckeye is a rapid grinder, yet light running and just right for two horses.

The sweep is so constructed as to utilize end pressure and apply it to turning the master wheel, making a saving of twenty per cent. in draft. It can be attached quickly, without using wrench or bolts. Used and recommended by thousands of farmers throughout the country.

## TRIPLE-GEARED SWEEP POWERS.

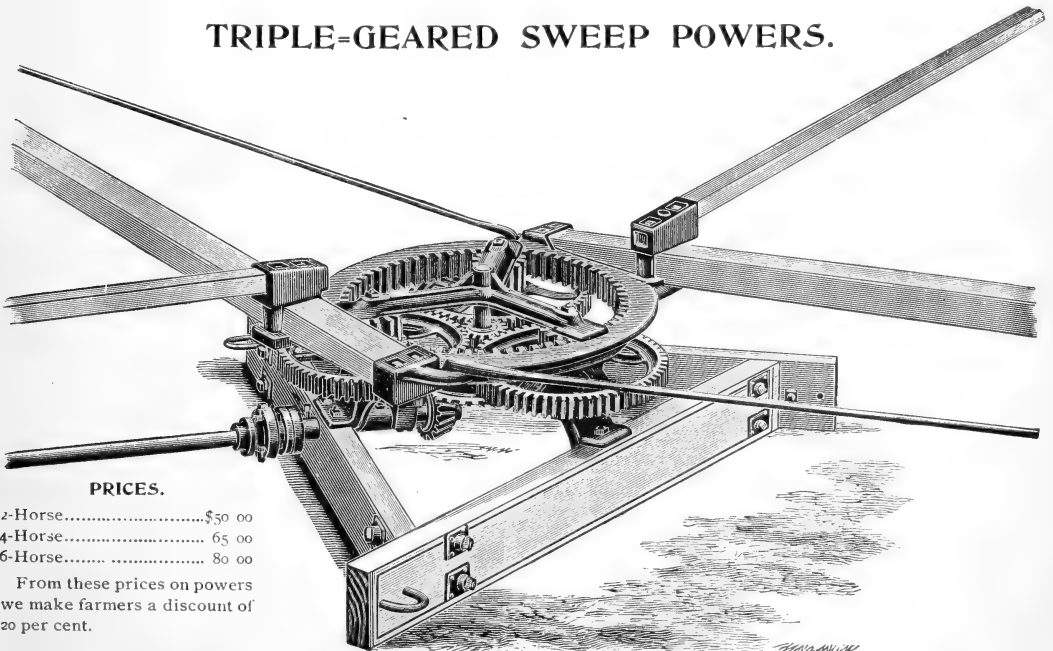

**PRICES.**

2-Horse.....\$50 00  
 4-Horse..... 65 00  
 6-Horse..... 80 00

From these prices on powers we make farmers a discount of 20 per cent.

A perfect working, triple-geared power; furnished with 20, 22, 24 or 30-inch pulley, with 5 1/2 inch fall, complete with sweeps, lead bars and draw rods. On 2 horse powers the tumbling rod makes 58 revolutions to one turn of the horses, or a speed of 200 revolutions per minute.



## FARMERS' FAVORITE SINGLE SPOUT CORN SHELLER.

DESCRIPTION.—The frame is of seasoned hard wood, mortised and pinned together, perfectly true to a square so that all parts work smoothly. The gears are all inside and no danger to any one because of outside gearings. The shafts are all lathe turned and the gearing of the best wrought and gray iron. It has a steel spring adjuster in the hopper and is easily adapted to large or small ears of corn. It has a large balance wheel with wrought iron spokes, weighing 35 pounds, is easy to run and shells the cob cleanly. It separates the corn and cobs and with the fan will clean for market or grinding. The corn is discharged beneath the sheller, the cobs at the end. It is well made, nicely painted, striped and varnished. Warranted first-class in every respect.

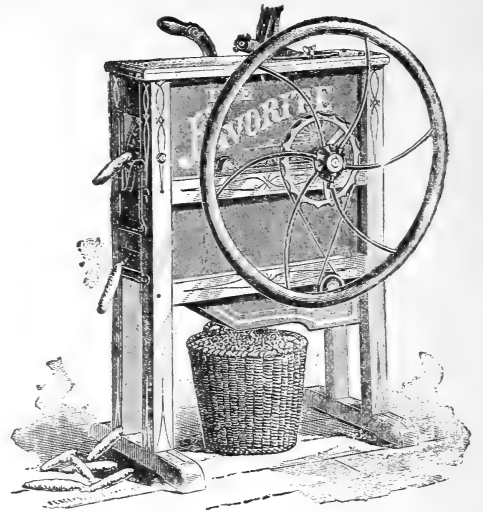

- Plain Sheller, . . . . . \$8 00
- Sheller, with Fan, . . . . . 9 00

We have also a line of low-priced Shellers.

We also have in stock a small Hand Corn Sheller. Price, 25 cts.; by rail, 40 cts.

## FARMERS' FAVORITE DOUBLE SPOUT SHELLER.

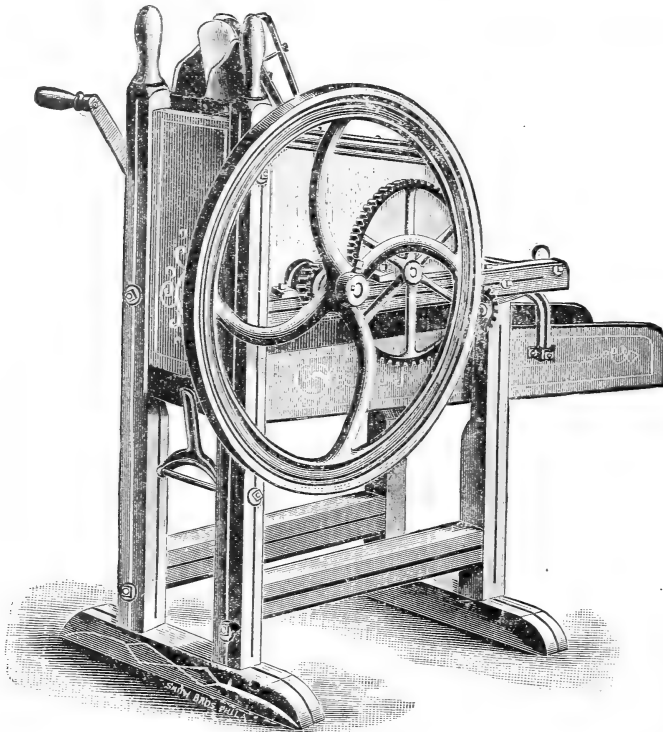

Steel shafts, heavy fly wheel. Fly wheel shafts shou'd run 240 revolutions per minute. Capacity by power, 500 to 600 bushels per day; capacity by hand, 200 bushels per day.

Price, with Shaker . . . . . \$16 00      Price, without Shaker . . . . . \$15 00

ALL KINDS OF MACHINERY REPAIRED.

**Manufacturers' Agents for full line of Hames.**

We handle nearly the entire production of our Root Hame manufacturer, and can offer this line of goods to the trade at especially low figures.

Retail Prices, per pair.

Loudon Patent . . . . .	\$1.00	Star Hames . . . . .	\$.65
Loudon Tie. . . . .	.75	Sawed Patent . . . . .	.50
Taylor Root Patent . . . . .	.60	Sawed Tie. . . . .	.30
Taylor Root Tie. . . . .	.50		

Special Prices to both Wholesale and Retail Dealers.



**ROPE, TWINE AND FODDER YARN.**

Manilla, No. 1 Manilla, Sisal and Mixed Grades of Rope.

We make a specialty of 3/4 and 7/8 Hay Fork Rope.

Complete line of Twines and Fodder Yarn always on hand.

Binder Twine in all grades a Specialty.

**Oil Cans for all kinds of Farm Machinery,  
PRICE, 20 CENTS.**

**OILS AND AXLE GREASE.**

Headquarters for a fine line of Lubricating Oils.

Farmers' Favorite Harvester Oil, a first-class article, pronounced by all who have used it to be the best. Price, 65 cts. per gallon, in one gallon cans.

Amber Harvester Oil, similar in appearance and said to be equal in its effects to Lard Oil. Price, 65 cts. per gallon.

No. 1 Castor Oil, price 75 cts. per gallon.

Special Prices in Barrel and Half-Barrel Lots.

**AXLE GREASE.**

Farmers' Favorite, made from lard oil, black oil and plumbago. The best. Per box, 10 cts.

Old Dominion, either light or dark. Per box, 8 cts.; per bucket, \$1.00.

Crown, Frazier, Diamond and Gold Axle Grease always in stock.

Special Prices in quantities on any of above grades.

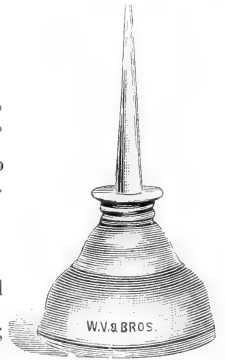

**BRUSHES.**

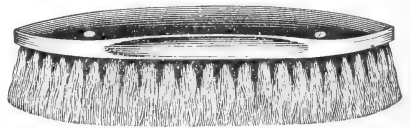
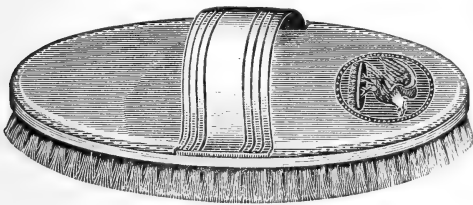

No. 20 Dandy Brushes . . . . .	each \$	.30
No. XX Palmetto Dandy . . . . .	"	.40
No. XH Dandy . . . . .	"	.45
No. 7000 Dandy Brushes made of selected fine root . . . . .	"	.60

All of above are put up six in a box.

London Dandy, with Leather protection side pieces . . . . .	"	.75
No. 707 Grenelle Brushes, our best brush . . . . .	"	.90

**Leather Back Brushes.**

No. 57 Leather Back Brush . . . . .	each \$	.50
No. 41 Leather Back Brush . . . . .	"	.75
No. 303 Leather Back Brush . . . . .	"	1.00
No. 300 Leather Back Brush . . . . .	"	1.25
No. 270 made of Black Bristle and has Black Grained Leather Back, put up 6 in a box . . . . .	"	1.75
No. 600 made of White Russian Bristle; has Russet Grained Leather Back and Handle . . . . .	"	2.50

ALL KINDS OF MACHINERY REPAIRED.

**COMBINATION OF BARREL, TRUCK, HAND CART, SPRINKLER AND BARREL FORCE PUMP.**

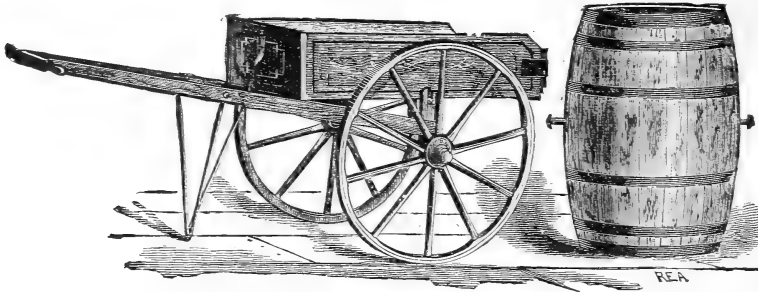

When we consider the almost innumerable uses to which the Combined Truck and Hand Cart can be applied, its handiness, and the immense amount of time and hard labor saved by its use, it is not a matter of surprise that it is steadily growing into favor. It is one of those articles that causes the user to wonder how he ever did without it, as it really becomes indispensable when once used.

The barrel is raised from the ground, carried to the place desired and instantly detached, all without handling. The weight being balanced over the axle, no lifting or down pressure is needed in transportation.

Other barrels for various purposes can be used as needed, extra trunnions being furnished, if desired, which can be readily attached to any oil or spirit barrel, thus increasing indefinitely the value of the truck.

We have wheels of 1½, 2½ and 4-inch tread, but always send truck with wheels 1½-inch tread, unless otherwise specified.

We also supply a box, with trunnions and spring catch, making a very superior dumping Hand Cart. Very stiff, compact, handsome, and low in price. Furnished with or without barrel or box, as ordered. A first-class force pump, sprinkling attachment and leaf rack furnished as attachments. Just the things for washing windows and carriages, and for spraying trees; also for sprinkling lawns: the leaf rack is a very useful article for moving leaves, etc., from the lawn.

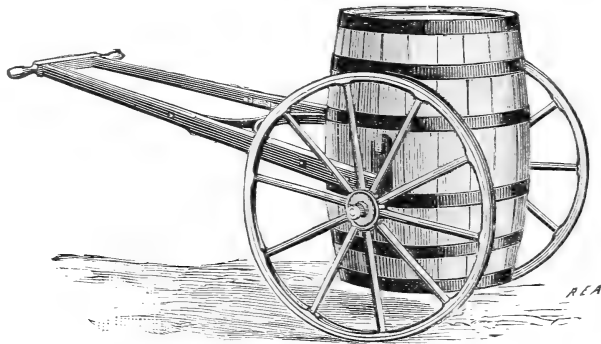

**PRICES.**

Water Truck, . . . . .	\$ 6 75
Water Truck and Barrel, . . . . .	9 00
Water Truck and Box, . . . . .	9 00
Water Truck, Barrel and Box, . . . . .	10 00
Force Pump Attachment, . . . . .	6 00
Sprinkling Attachment, . . . . .	3 00
Leaf Racks, . . . . .	4 00

For 2½-inch tires on trucks, add to the above prices \$1.50. For 4-inch tires on trucks, add to the above prices \$2.00.

**ALL KINDS OF MACHINERY REPAIRED.**

## IMPROVED BARREL WATERING CART,

For Watering Gardens, Lawns, Etc., and Spraying Fruit Trees.

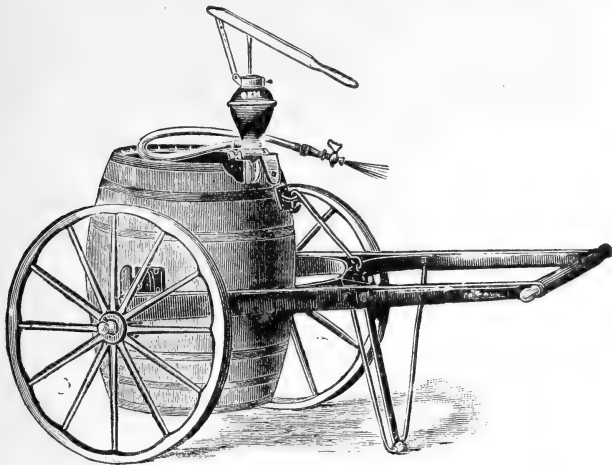

"Gem" Spray Pump with Barrel Cart.

This cut represents our Barrel Cart, with "Gem" Brass Spray Pump. This is a convenient combination, and may be found useful in various ways: such as watering gardens, spraying fruit trees, etc.

The Barrel Cart and Pump may be ordered separately and arranged together to suit the purchaser. The Barrel Cart may be wheeled about when filled with water to supply sprinkling cans for watering flowers and vegetable gardens. When the running gear or truck is ordered without barrel, the trunnions may easily be fastened to any good water-tight barrel by any person with ordinary mechanical ability.



### SIZES AND PRICES.

Running Gear only, without Barrel or Pump. . . . .	\$ 6 75
Barrel Cart complete, with Barrel and Pump . . . . .	15 00
Price of Plain New Barrel. . . . .	2 25
Price of Plain Pump . . . . .	6 00
Price of Sprinkling Attachment . . . . .	3 00

Above cut shows Barrel with Sprinkling attachment.

## THE PERFECTED GALLOWAY KNAPSACK SPRAYER.

RIGHT OR LEFT HANDED.

*Copper Tank and Brass Pump. Indestructible Valves.*

PRICE, - - - - - \$15.00



The annexed cut represents the perfected Galloway Knapsack Sprayer. It consists of a copper tank arranged to strap on the back, and a brass pump, which is operated by a rod attachment to the lever. The Sprayers are made in one size only, 5 gallon capacity.

The pump is so constructed that all leakage from the stuffing box will drip back into the tank; also, if it becomes necessary, the entire pump can be taken out for repairs without the least trouble. The pump is fastened firmly in the tank, and being placed in the center of the same is supported by the central casting (brass), admitting of its use for either the right or left hand without shifting position of the straps. It would not be possible to make a more rigid support for the pump. The discharge is provided with six feet of the best quality 3/8 inch rubber tubing; also, the "Deming" Improved Spray Nozzle with Lance and Degorger. This nozzle makes very fine mist-like spray.

The Perfected Galloway Knapsack Sprayer is much used by grape growers, florists, gardeners, and by fruit growers generally. Nothing can be more convenient than one of these outfits for spraying grape vines, potato plants and small orchards, where the work is necessarily done by one man. A man can spray, with one of these

outfits, five or six acres of vines in a day.

A strainer is arranged at top of the tank to prevent any deleterious material from entering the tank and pump.

## THE IMPROVED PAN-AMERICAN WASHER.

THE MOST SUCCESSFUL WASHER ON THE MARKET.

It is Supplied with the Latest Improved Gearing. Sold on its Merits. Guaranteed to Give Satisfaction.

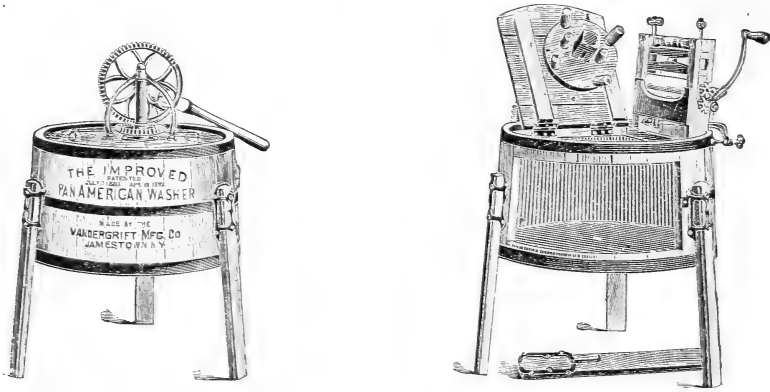

The above cuts show the exterior and interior of our Improved Pan-American Washer. The machine is constructed of clear pine, and is stronger, more nicely finished, and as large as any round machine now on the market. The inside of the machine is fully corrugated, similar to a washboard, there being no nails or blocks of any kind on the inside.

The machine is made with the large end of the tub down, allowing plenty of room for water and clothes. The hoops are made of extra heavy hoop iron and warranted not to break. The brackets that hold the legs of the machine are so arranged that the leg is self-adjusting, thereby always insuring the machine to stand solid on the floor.

The machine closes tight, and retains the heat in the water for a long time, and prevents the odor of foul steam from the clothes. The washer can be used on a carpet without soiling the same. It has a large, convenient place for holding the wringer, which need not be removed while using the machine. Our Pan-American Washers are guaranteed to be perfect in every respect. If they do not prove all that we claim for them, they can be returned to us and the amount paid will be refunded. All we ask is a trial.

PRICE, . . . . . \$6 00.

For sale by Griffith, Turner & Co., General Agents, Baltimore, Md.

## PUSH CARTS.

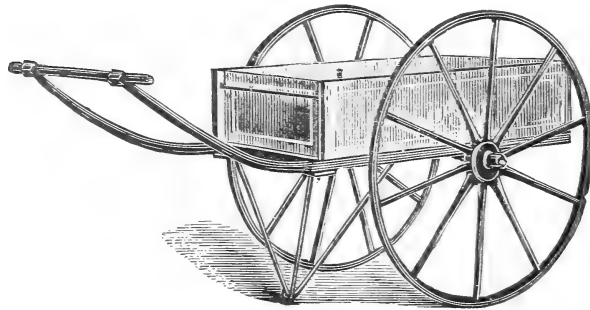

No. 11.—Two wheeled; size of box, 24x44, 10 inches deep; wheels 36 inches high. Retail Price, \$9.00. List Price, \$10.00.

ALL KINDS OF MACHINERY REPAIRED.

## HAND MADE GRAIN CRADLES.

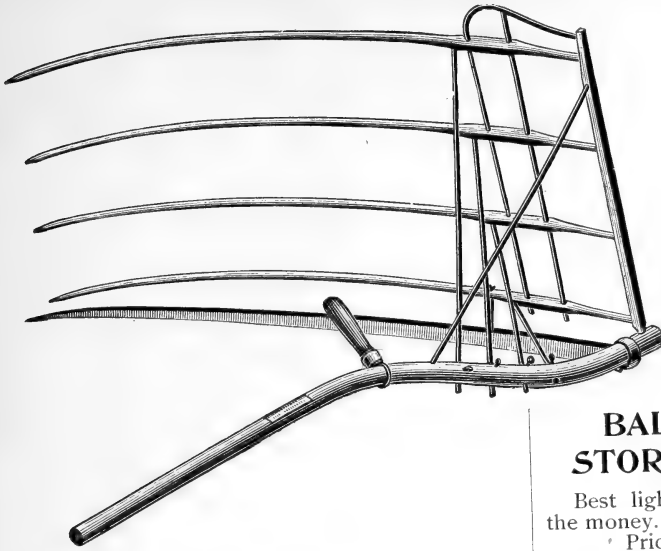

Made from best material with English and American Blades.

### PRICES.

Baltimore Cradle, American Blade, . . . . . \$4 00  
 Mallonee Cradle, English Blade, 5 00  
 Factory Made Cradle, American Blade, . . . . . 3 00

## IMPROVED GRAIN FAN.

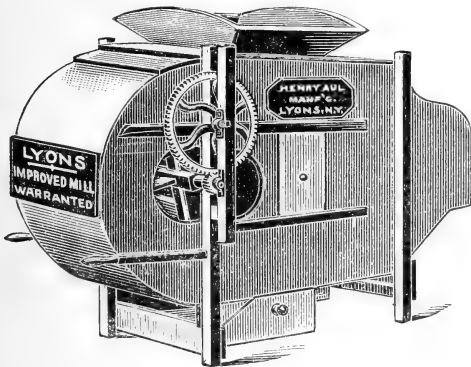

PRICE, \$20.00.

## DUTTON MOWER KNIFE GRINDER.

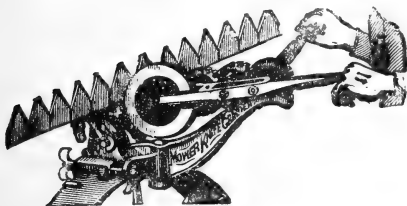

The Wheel is made of Corundum and is hollow. Fill the wheel with water before using. When in motion the water is forced out through the wheel, which is porous. This keeps the knife cool. No gumming; no loss of temper, either on the part of the knife or its owner. Price, \$5.00.

## BALTIMORE STORE TRUCK.

Best light Truck made for the money.

Price, \$2.00 net.

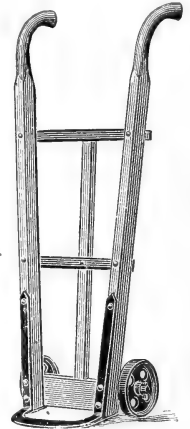

## Boston Pattern STORE TRUCK.

No. 1, . . . . . \$ 6 50  
 No. 2, . . . . . 8 50  
 No. 3, . . . . . 11 00  
 No. 4, . . . . . 15 00

Less 30 per cent. retail.

## PLOW HANDLES.



1 1/8 x 2 in., 5 feet long, . . . . . per pair, 35 cts.  
 1 1/4 x 2 1/4 in., 5 feet long, . . . . . " 40 "

## DARNELL'S PATENT FURROWER AND ROW MARKER.

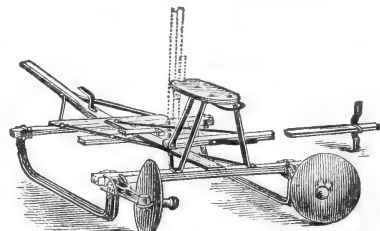

Price, \$18.00.

ALL KINDS OF MACHINERY REPAIRED.



# THE BALTIMORE.

MADE IN FOUR SIZES, Nos. 3, 4, 5 AND 6.

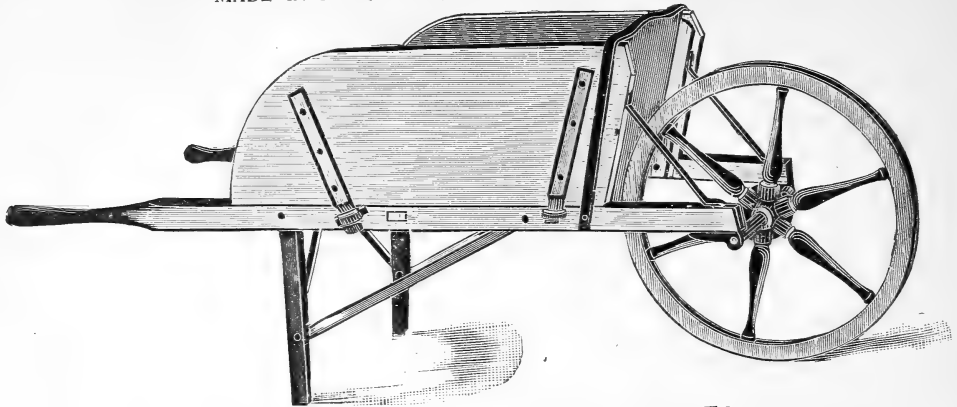

## SPECIAL FEATURES AND ADVANTAGES.

Extra Heavy Wheel, with Iron Hub. Solid Iron Axle. Heavy Iron Strap extending over entire Front. Well-Braced, Extra Strong and Durable. NICELY PAINTED AND VARNISHED.

No. 3 has 18 inch wheel; inside measurement of body as follows, viz., 22 inches long, 21 inches wide in rear and 17 inches wide in front. Price \$3.25.

No. 4 has 20 inch wheel; is 27 inches long, 22 inches wide in rear and 18 inches wide in front. Price, \$3.50.

No. 5, very large size, has 22 inch wheel. Price, \$4.00.

No. 6, extra large size, has 22 inch wheel. Price, \$4.50.

## CANAL BARROWS.

Best, . . . . . \$2.50

Second Grade, . . . 2.00

Plain Polted, . . . 1.50

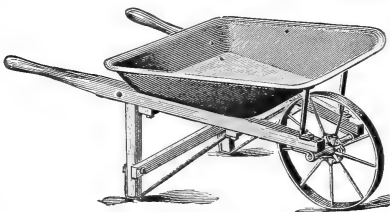
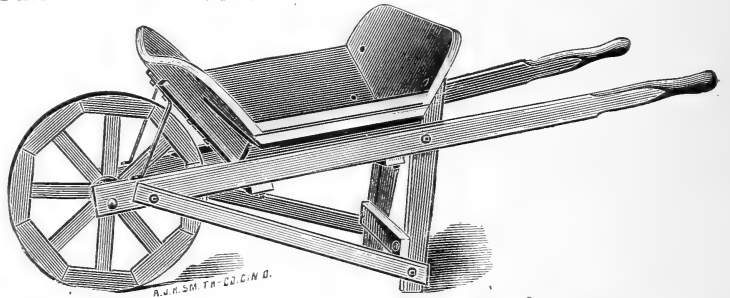

*Steel Tray Contractors Barrow.* Price, \$5.00



*All Steel Barrow.* Price, \$6.00

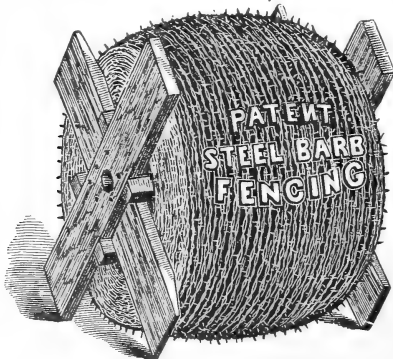

*Wire Fencing.* Prices on application.  
Barbed Wire. Ribbon Wire. Buckthorn Sawtooth Wire.

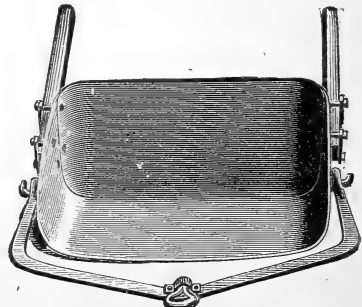

*STEEL SCRAPER.*  
Price, \$8.00

**SINGLE, DOUBLE AND TRIPLE TREES.  
IRONED COMPLETE.**



30 inch Pennsylvania Single Tree, . . . . .	\$ 50
32 inch Pennsylvania Single Tree, . . . . .	60
34 inch Pennsylvania Single Tree, . . . . .	60
28 and 30 inch Extra Nailed Single Trees, . . . . .	40

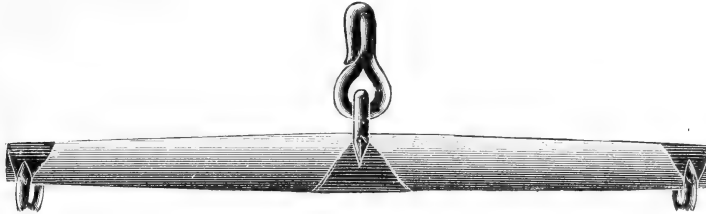

36 inch Pennsylvania Heavy Double Trees, . . . . .	\$1 00
40 inch Pennsylvania Heavy Double Trees, . . . . .	1 10
36 inch Southern Double Trees, . . . . .	75
Extra Heavy Triple Trees, . . . . .	2 50

Lap Rings, 10 cts. each.

Open Links, 30 cts per doz.

The celebrated Flatau, Steel Single, Double and Triple Trees are lighter and stronger than other trees because the patented combination of the truss shape and T bars gives the greatest possible strength with the least possible weight; the lightest tree will stand a strain of 2,500 lbs. All of these trees are furnished with patent hooks, which can be manipulated with ease, but which are *absolutely non-detachable by accident*. Send us your order for a few sample sets of above, and we are confident that you will want the agency on sight. A most novel Triple Tree arrangement can be made out of one No. 5, two No. 2, and three No. 1 trees, at a cost of \$3.80 for the complete set, and at the same time all of the parts can be used separately for single and double trees.

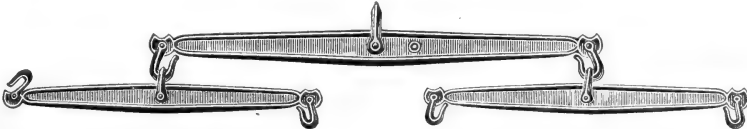

No. 1, 26 inch Steel Single Trees, . . . . .	\$ 50
No. 2, 30 inch Steel Single Trees, . . . . .	65
No. 3, 34 inch Steel Single Trees, . . . . .	75
No. 3, 34 inch Steel Double Trees, . . . . .	75
No. 5, 42 inch Steel Double Trees, . . . . .	1 00

Price of Triple Tree complete with Single and Double Trees, \$3.80.

**Miller's Improved Wagon Jack.**

IT IS MADE IN THREE SIZES.

No. 1, adapted for Buggies or Light Work. Capacity 2000 lbs. . . . .	\$1 25
No. 2, for Heavy Wagons, Transfer Wagons, Trucks, &c. Capacity from 3000 to 5000 lbs . . . . .	1 50
No. 3 . . . . .	2 25

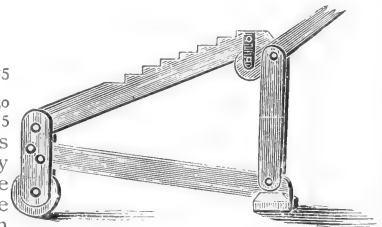

It is made of selected Ash wood, put together with bolts. Its weight is respectively 9 and 14 pounds each for Nos. 1 and 2. They are very strong and durable as the strain comes parallel with the grain of the wood; the weight is shared throughout the entire machine. Some of the advantages of this Jack *over all others* on the market are: It is so constructed that you do not have to make ANY ADJUSTMENTS FOR DIFFERENT HEIGHT AXLES, as that is regulated by the notch bar. The notch bar raises perpendicular, which keeps the vehicle from pushing forward or backward and thereby doing away with blocking or scotching. You do not, in placing it under a spring wagon or truck, have to get down under the bed to place it under the axle. It will work on any kind of surface. The eccentric lever with the moving bars gaining on every pound lifted, makes it a good lever by which a boy ten years of age can lift the heaviest wagon. This Jack is an improvement which combines SIMPLICITY, PRACTICABILITY and EFFICIENCY.

This is the Best Jack made!

Gives entire satisfaction!

Why not try it!

**ALL KINDS OF MACHINERY REPAIRED.**

### STEEL CHAINS.



No. 3-0 Ohio Pattern Cow Ties, 30 cts. each.

No. 4-0 Ohio Pattern Cow Ties, 35 cts each.

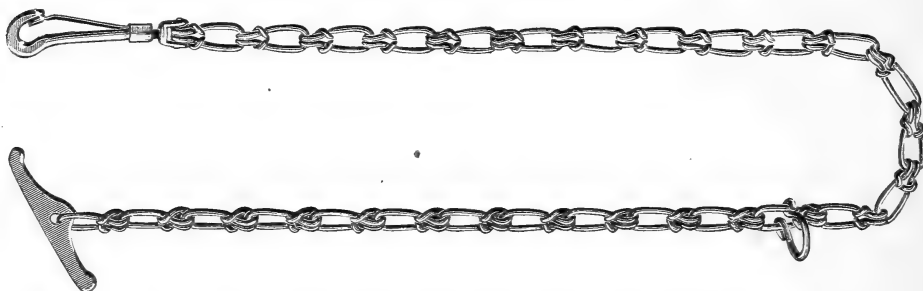

No. 3-0 6 ft. Halter Chains . . . . .	\$.30
No. 6 20 ft. Tethering Chains . . . . .	1.20
No. 5-0 7 ft. Trace Chains . . . . .	60
No. 6-0 7 ft. Trace Chains . . . . .	75
No. 2 6 ft. Kennel Chains . . . . .	40

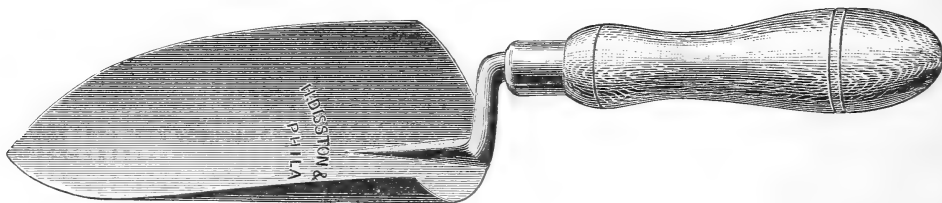

Above cut represents one of the best Trowels ever offered to the trade. Is made of steel, is strong and durable. 6 inch size, 50 cts. 7 inch size, 60 cts.

### THE NEW GARDEN IMPLEMENT.



#### A SOLID STEEL TROWEL.

This handy digger was originally intended for digging plantains and other weeds from lawns; its slim blade, made strong by its angular form, being suited for prying and twisting. It has also found great favor among the ladies as a flower cultivator, for loosening the soil in pots, and among young plants for transplanting. The blade and shank are of one solid piece of best steel, set firmly in a nice handle.

- No. 1, "STANDARD," 8 inch blade, 40 cts. each.
- No. 2, "MEDIUM," 7 inch blade, 30 cts. each.
- No. 3, "DAISY," 5 inch blade, 20 cts. each.

TRADE PRICES ON APPLICATION.

For the Lawn—a Plantain digger. For the Greenhouse—a Transplanter. For the Conservatory—a Cultivator. For the Garden—an all around handy digger. Try it.

**HEDGE SHEARS.**

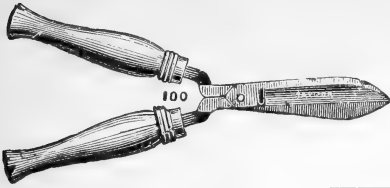

8 in., \$1.75  
 9 in., 2.00  
 10 in., 2.25  
 With Notch, 25 c. extra.

**LOPPING SHEARS.**

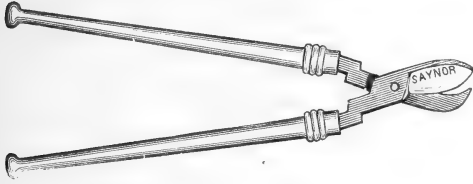

Small, \$1.25; medium or No. 2, \$3.50; large or No. 3, \$4.00. Extra large, \$4.50.

**PRUNING KNIVES.**

50 cts.,  
 75 cts.,  
 \$1.00.



**BUDDING KNIVES.**

Price . . . . . 75 cents.



**SCUFFLE HOES.**

6 inches, 60 cents.  
 7 " 65 "  
 8 " 70 "  
 9 " 75 "  
 10 " 80 "

**SCYTHE STONES.**



Price, 5, 10, 15 and 20 cents.



**LIGHTNING HAY KNIFE.**

Price . . . . . \$1.00.

**EDGING KNIVES.**

9 inch American . . . 50 cents.  
 10 inch American . . . 60 cents.  
 8 inch English . . . . \$1.25  
 9 inch English . . . . . 1.50

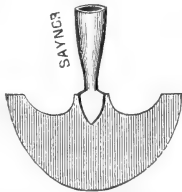

**GRAPE SCISSORS.**

Price, 75 cts.



**GRASS EDGER.**

Without Wheel . . . . . Price, \$3.00  
 With Wheel . . . . . " 3.50

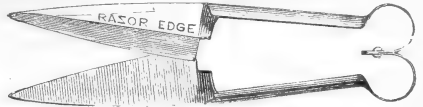

*Horse Shears and Scissors*, 50 cts.,  
 60 cts., \$1.25.

*Sheep Shears*, . . . . . 50, 75, \$1.00.  
*Grass Shears*, . . . . . 50, 75, 1.00.

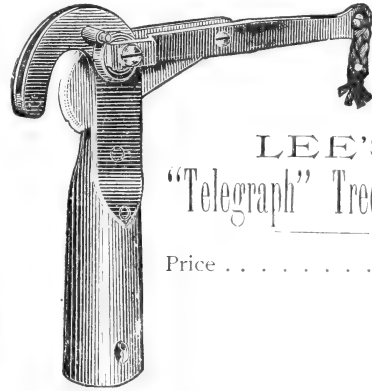

**LEE'S "Telegraph" Tree Pruner.**

Price . . . . . \$1.25

**HAND PRUNING SHEARS.**

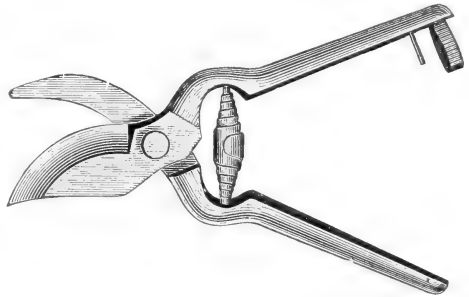

Most Improved Kind.  
 Price, 75 cents, \$1.00 and \$1.25.



4 feet long . . . 85 cents.  
 6 feet long . . . \$1.00  
 8 feet long . . . 1.15  
 10 feet long . . . 1.25  
 12 feet long . . . 1.50

Extra Knives, 20 cts.

**PRUNING SAWS.**

Price, 80 cts.



**SCYTHES.**



American, 65 and 75 cts; English T. Waldron, \$1.25; Snath or Handle, 35 50 and 75 cts Scythe Stones, 5, 10 and 20 cts.



English Hedge Hooks, 60 to 75 cents.

**GRASS HOOKS.**

American . . . 40 cts.  
German . . . 45 cts.  
English . . . 50 cts.

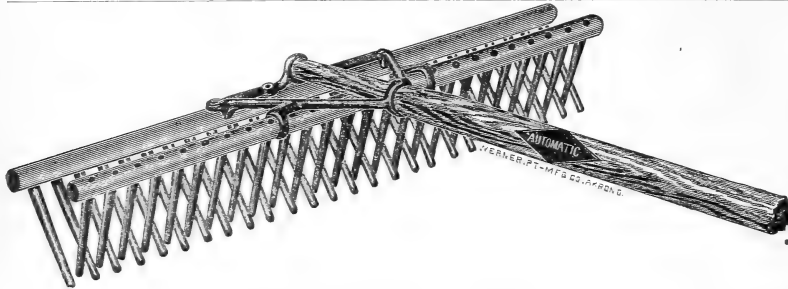

**Automatic  
Self - Cleaning  
Lawn Rakes.**

With 22 teeth, . . 75 cents.  
With 26 teeth, . . 85 cents.

**Hustler Lawn Rake.**

With 24 Steel Teeth, reversible, 75 cts.

The single teeth are used for taking up cut grass, and double teeth for leaves and rubbish.

Gibbs' Lawn Rakes . . . . . 75 cts  
Canton Lawn Rakes. . . . . 50 cts.

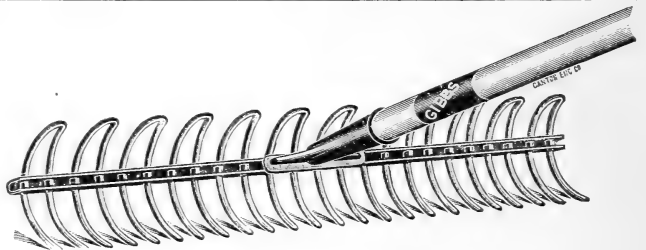

**Boss Garden Rake.**

With 18 Steel Teeth . . . . . 50 cents.

The Teeth are made from tough steel rods and *will not break*, therefore are superior to forged teeth. They are solidly held in place. The Socket is secured firmly to head without rivets or weld.

The double teeth extending above the head are rare in any other rake.

for breaking clods and will pulverize the ground finer and more quickly than with any other rake. It is also well adapted for small lawn as a lawn rake, for stable use and on gravel walks.

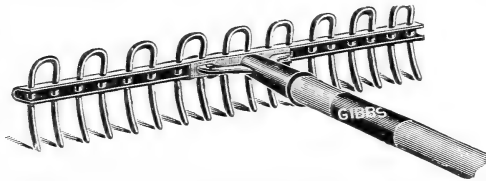

**EUREKA HAND WEEDER.**

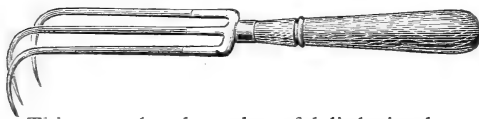

This very handy and useful little implement is the best hand weeder yet put upon the market, and is a great improvement on the clumsy weeders made of malleable iron heretofore offered. The tines are made of the best forged steel, sharply pointed and will not break. It will do very effective work in deep cultivation of rose and carnation beds and in all other work for which a hand weeder is necessary. Price, 25 cents each. Price with long handle, 35 cts.

**DIAMOND MARKET BASKET. FRUIT PICKER.**

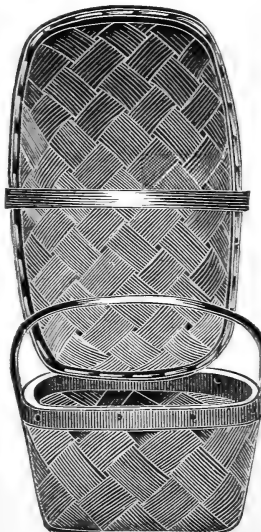

Price, 10 cents.

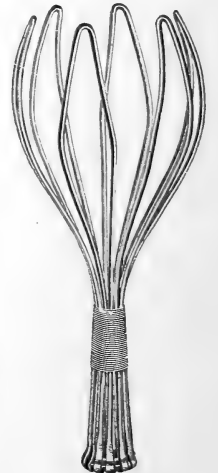

Price, 50 cts.

**RICE'S CALF WEANERS.**

And to prevent Cows from Sucking themselves.

No. 1, for Calves, 30 c.  
By mail, 35 cts.  
No. 2, for Heifers, 50 c.  
By mail, 56 cts.  
No. 3, for Cows, 75 c.  
By mail, 85 cts.





**GIBBS' POST HOLE DIGGER.**  
PAT'D.

**GIBBS' POST HOLE DIGGER.**  
The Best Post Hole Digger Made. Price, \$2.50.



**BANNER ROOT CUTTER.**

Price, \$12.00.

**ROSS ROOT CUTTERS.**

- No. 1, for Kraut. . . . . \$ 8 00
- No. 2, Hand-Power size, for roots, . . . . . 12 00
- No. 3, Horse-Power size, for roots, . . . . . 17 00



**DIGGER.**

For transferring Plants. By far the best thing for the purpose ever introduced. Price, \$1.00.



**WATERING POTS.**  
50 cts. to \$1.50.



**POTATO PLOWS.**

Price, \$8.00.

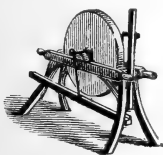

**GRIND STONES.**  
MOUNTED.

- No. 1, \$4.50. No. 2, \$4.
- No. 3, \$3.50.

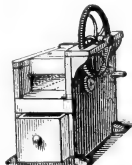

**HORSE RADISH GRATER.**

Price, \$6.50.  
With Steel Pin, \$7.50.

**"RAPID" HARNESS MENDERS.**

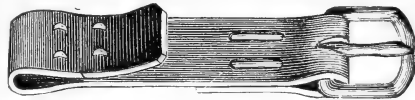

Patented February 2, 1886; March 27, 1888.

The finest way of applying a buckle known. Any part of a harness can be mended in a very short time—no riveting, no sewing to rot away, and no special tools required. Price, 25 cts. per gross; by mail, 35 cts.



FIG. 2

CHICAGO-ENG-CO

**STEP LADDERS.**—25 cts. per foot.  
**EXTENSION LADDERS.**—18 to 25 cts. per foot.

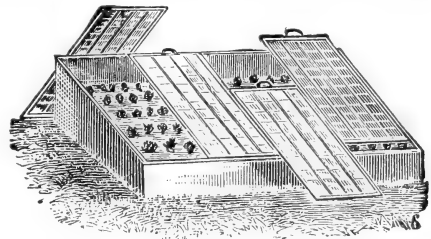

**HOT BED SASH AND GLASS.**

**HAND WEEDER.**

Steel, 20 c. Malleable, 10 c.



**GARDEN REELS.**

Price, 75 cts. to \$1.25.

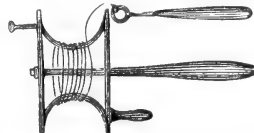

**EXCELSIOR WEEDING HOOK.**

Price, 10 cts.



**ALL KINDS OF MACHINERY REPAIRED.**



**DEERING BINDERS, MOWERS AND BINDER TWINE.**

Light weight and light draft in combination with great strength and durability are so well known to be the very foundation qualities of a good harvester and binder that every farmer who wishes to purchase a machine demands these qualities and will be satisfied with no machine that does not possess them.

Such a machine is the Deering.



**THE DEERING MOWERS  
A SUCCESS.**

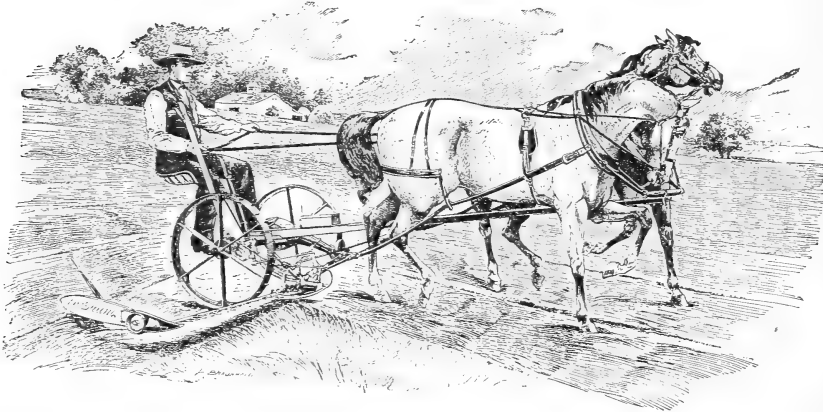

The Deering Mowers are a success in every sense of the word, and the farmer who does not know it is merely a little behind the times and not as well posted as he should be. The enormous number of Deering Mowers sold each year proves clearly that the vast majority of American farmers are not behind the times by any means, but that, on the contrary, they are well posted and their judgment is sound.

**DEERING TWINES FROM THE EARTH TO THE MOON AND BACK 5 TIMES**

ENOUGH TWINE WAS MADE AND SOLD BY  
W<sup>M</sup> DEERING & CO. IN 1890 TO REACH FROM THE  
EARTH TO THE MOON AND BACK

**5 TIMES**

238,800 MILES. DAISY  
LILY  
GOLDEN-ROD  
BUTTER-CUP  
AND OTHER FLOWER  
BRANDS



**THE  
DEERING BINDER TWINE  
RUNS MORE FEET  
TO THE POUND**

**IS STRONGER AND SMOOTHER  
THAN ANY OTHER TWINE MADE**

**ALL KINDS OF MACHINERY REPAIRED.**

WE ARE GENERAL AGENTS FOR A FULL LINE OF  
**Knives, Sections, Guards, Rivets, Knife Heads, Steel Punches,**  
**Cold Chisels, &c.,**

For all the Leading Mowers, Reapers and Binders on the market.

Agents wanted for the sale of these goods throughout Maryland, Delaware, Virginia, West Virginia, Pennsylvania and the South. Write us for prices, terms, etc.

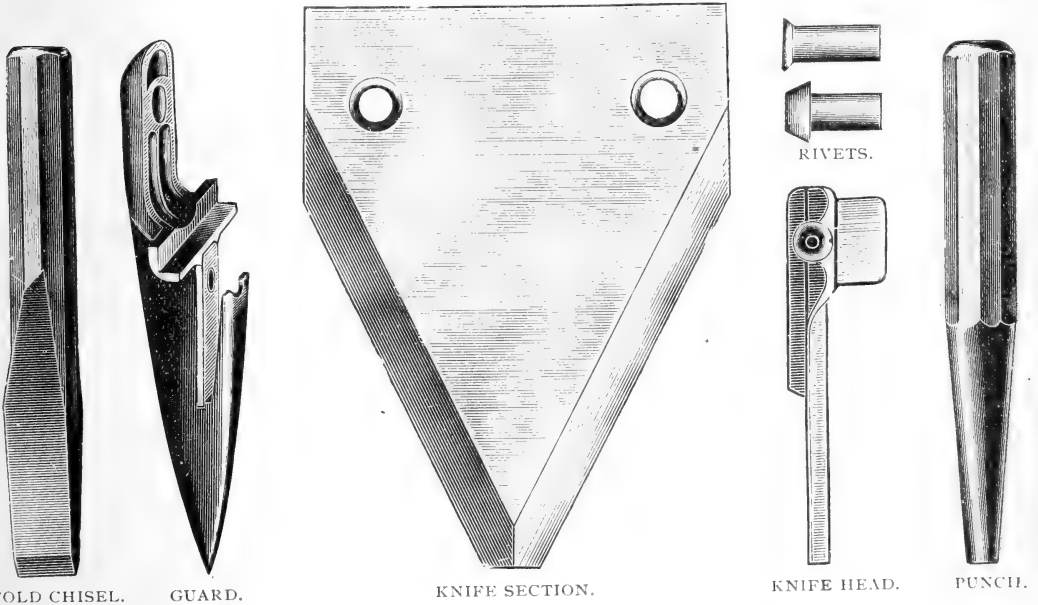

COLD CHISEL.

GUARD.

KNIFE SECTION.

RIVETS.

KNIFE HEAD.

PUNCH.

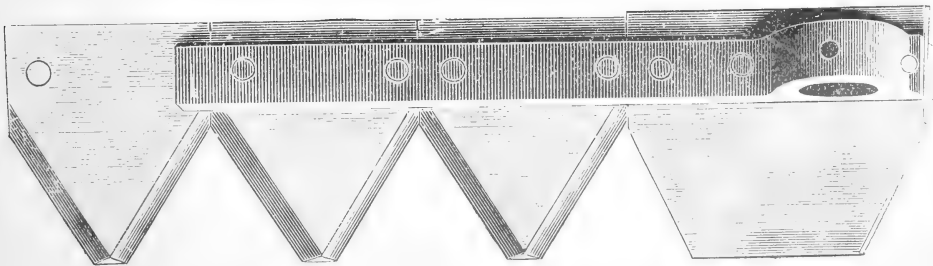

SECTIONS AND KNIFE HEAD.

ALL KINDS OF MACHINERY REPAIRED.

# Superior Dairy Goods.

Don't buy a poorly-made churn because it's cheap ; buy the best,

## THE STODDARD CHURN,

the most perfect on the market, as attested by sales. Made in nine sizes for dairy or factory, with or without pulleys. The principle is concussion and not friction. Has no floats or paddles. Cover removed instantly. Has best fastener made. Send for prices. We can furnish full line of Dairy Supplies.



### PRICES.

No. 1	—Ten Gallon Churn, churns from one to four gallons cream, . . . . .	\$ 8 00
No. 2	—Fifteen Gallon Churn, churns from two to seven gallons cream, . . . . .	9 00
No. 3	—Twenty Gallon Churn, churns from three to nine gallons cream, . . . . .	10 00
No. 4	—Twenty-five Gallon Churn, churns from four to twelve gallons cream, . . . . .	12 00
No. 5	—Thirty-five Gallon Churn, churns from five to sixteen gallons cream, . . . . .	14 00
No. 5½	—Forty-five Gallon Churn, churns from five to twenty gallons cream, . . . . .	17 00
No. 6	—Sixty Gallon Churn, churns from six to twenty eight gallons cream, . . . . .	20 00
	Pulleys for power extra. 12-inch Iron Pulley, including extra heavy frame, . . . . .	3 00
	Cone Pulley Attachment for Dog Power, . . . . .	3 00

## SPAIN'S PATENT CHURN.



	Without Stand.	With Stand.
No. 1—Churns 9 quarts, . . . . .	\$4 25	\$4 75
No. 2—Churns 15 quarts, . . . . .	4 65	5 40
No. 3—Churns 20 quarts, . . . . .	5 00	5 80
No. 4—Churns 24 quarts, . . . . .	5 75	6 65
No. 5—Churns 32 quarts, . . . . .	6 50	7 50
No. 6—Churns 44 quarts, . . . . .	7 50	8 60

Made of White Cedar and bound with Galvanized Iron Hoops. A special form of dasher arranged to produce the best effect. A large opening through which the dasher can be removed, admitting of thorough cleansing and ventilation of both dasher and churn.

NOTE.—The churning capacity is given above, representing one half the full capacity of churns.

## IMPROVED CYLINDER CHURNS.

	Retail Prices.	List Prices.
No. 1— 2¾ gallons, . . . . .	\$2 00	\$2 50
No. 2— 4 gallons, . . . . .	2 50	3 00
No. 3— 7 gallons, . . . . .	3 00	3 50
No. 4—10½ gallons, . . . . .	3 50	4 00
No. 5—15 gallons, . . . . .	4 00	4 50

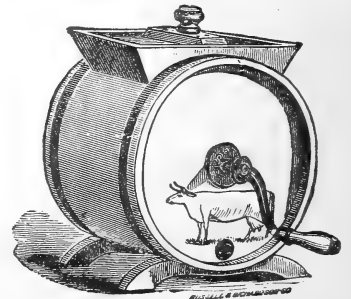

## FULL LINE OF THERMOMETER CHURNS.

ALL KINDS OF MACHINERY REPAIRED.

## STODDARD CREAMERY.

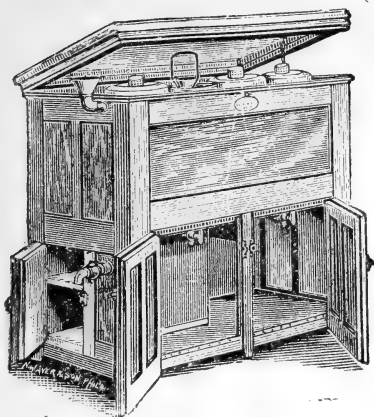

WITH OR WITHOUT SPECIAL REFRIGERATOR

THOROUGH IN CONSTRUCTION.

SIMPLE IN OPERATION.

ACCURATE IN ITS WORKING.

Combining more points of merit than any other cream raising apparatus on the market.

Made in sizes to suit any dairy from one to fifty cows. Used with or without ice, and adapted to summer or winter dairying.

### PRICE LIST.

Price in first column is for the Plain Creamery. The second column is price with Special Refrigerator Compartment lined with zinc and having slate shelves. Both styles have the lower compartment with doors.

#### FAMILY CLASS.

	No. of Cans.	No. of Cows.	Plain Creamery.	With Special Refrigerator.
No. 2 . . . . .	2	2	\$20 00	
No. 3 . . . . .	3	3 to 4	26 00	\$31 00
No. 4 . . . . .	4	5 to 6	32 00	37 00

Each can holds two and one-half gallons.

#### DAIRY CLASS.

	No. of Cans.	No. of Cows.	Plain Creamery.	With Special Refrigerator.
No. 2 . . . . .	2	5 to 6	\$25 00	
No. 3 . . . . .	3	7 to 9	31 00	\$36 00
No. 4 . . . . .	4	10 to 12	37 00	42 00
No. 5 . . . . .	5	13 to 15	43 00	48 00
No. 6 . . . . .	6	15 to 18	49 00	54 00
No. 8 . . . . .	8	20 to 24	61 00	66 00
No. 10 . . . . .	10	25 to 30	73 00	78 00
No. 12 . . . . .	12	30 to 36	85 00	90 00

Each can holds five gallons.

No. 2 Family Class and No. 2 Dairy Class are not made with the separate refrigerating compartment unless so ordered, as they are so small it would occupy nearly all the space in the lower compartment.

The above prices do not include partitions, nor more than one water faucet. If partition or extra water faucet is wanted they will be furnished at \$1.00 each.

## BUTTER AND PLATFORM SCALES.

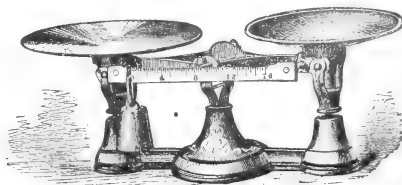
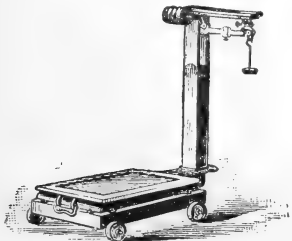

ALL KINDS OF MACHINERY REPAIRED.

## THE WATERS' BUTTER WORKER.

The Tray is removable, and thus takes the place of a butter bowl. Will work butter in any condition satisfactorily. Made in sizes to suit any dairy or factory.

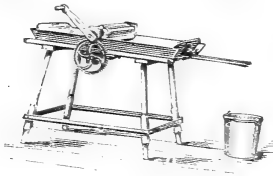

Size No.	Length of tray.	Width of tray.	Capacity.	No. of Cows.	Price.
0	27 in.	14 in.	1 to 15 lbs.	1 to 4	\$ 7 00
1	36 in.	15 in.	5 to 30 lbs.	4 to 8	8 00
2	36 in.	18 in.	5 to 40 lbs.	8 to 12	9 00
3	39 in.	20 in.	5 to 50 lbs.	12 to 18	10 00
4	48 in.	22 in.	10 to 75 lbs.	18 to 30	12 00

Practical. Efficient. Durable. It combines more advantages than any other.

### AMONG THE IMPORTANT ADVANTAGES WHICH ARE CLAIMED FOR THIS WORKER ARE :

Simplicity of construction—its parts are few and simple.

It is provided with legs of its own ; no extra table is needed.

The tray is not encumbered with gearing or metal to come in contact with\*the butter or render the tray heavy or bulky.

*When desired the tray may be readily taken from off the frame for setting the butter away; or for any other purpose. The tray takes the place of a butter bowl.*

The roller is made from a solid piece, which is turned and grooved so as to leave floats most suited to the work—there are no cracks about it to accumulate buttermilk.

It may be instantly drawn out of gear at any point, which is frequently a great convenience, enabling the operator to work certain portions of the butter more than others, if necessary.

It is readily adjusted to run close or otherwise, as desired.

The gearing and parts liable to wear may be taken up if required.

The principle which involves a moving tray below the butter roller is the right one, and the one employed in the workers used in the largest creameries and dairies.

In the WATERS' BUTTER WORKER the tray moves back and forth below the roller at such a relative rate as to secure ease in running and thoroughness in work, without injury to the grain of the butter.

The trays are thoroughly nailed with tinned nails, and in addition they are strengthened and tightened by iron rods, passing through the sides outside the end pieces.

These workers are manufactured from the best hard wood lumber, well seasoned, and are made in a thorough and workmanlike manner.

The Butter Worker has come to be a necessity in all dairy rooms, whether the amount of butter made is great or small. Because good butter has been made worked by hand, it does not follow that there is not a better, easier and more economical method. Working the butter is a most difficult and important part of the process. Buyers and consumers insist that butter shall be worked without bringing the hands in contact with it.

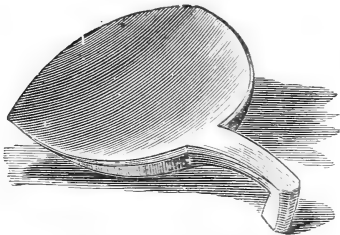

**BUTTER LADLE.**  
Price, 15 and 25 cts. each.



**BUTTER PADDLE.**  
Price, 10 cts. each.

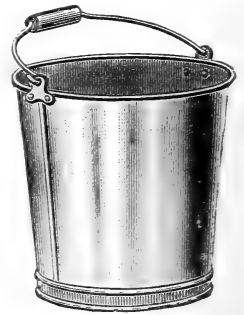

**MILK PAIL.**  
Made from best XXXX tin.



**FLOATING GLASS THERMOMETERS.**  
Price, 35 cts. each.

ALL KINDS OF MACHINERY REPAIRED.

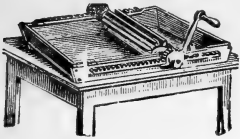

### Reid's Butter Worker.

Probably there is no work that a farmer's wife has to perform that so endangers the health as that of the dairy or spring house. Any invention, therefore, that will lessen the labor and shorten the time that she is thus employed is certainly worthy of consideration.

This is a machine that is very efficient in its work, simple in its construction, and convenient to handle. It will work a batch of butter in from three to five minutes, according to the condition of the butter, working out the buttermilk and thoroughly mixing in the salt, doing the work far quicker and better than it can be done by hand. It consists of a tray and a roller with paddles, which is turned by a crank and traverses from end to end of tray. It acts on the butter on precisely the same principle as a ladle in the hands of a person, but with perfect uniformity and without injuring the grain. The machines are all built of the best material, the iron part is galvanized, preventing rust.

#### PRICE LIST.

No. 1—Size 23x36 inches, and 2½ inches deep inside, capacity 50 lbs., weight 45 lbs . . . . .	\$10 00
2— " 20x36 " " 2½ " " " " 30 " " 29 " . . . . .	8 00
3— " 17x27 " " 2½ " " " " 20 " " 25 " . . . . .	7 00
4— " 14x23 " " 2½ " " " " 10 " " 20 " . . . . .	6 00

Three pounds can be worked in any of the above machines, as well as a larger quantity. In buying a machine you should choose a size that will work the largest quantity that you will be likely to want to work at a time.

Larger sizes, specially designed for mixing, reworking and coloring, or for creamery use.

No. 0—Size 23x37 inches, and 3 inches deep inside, capacity 75 lbs., weight 60 lbs . . . . .	\$12 50
00— " 23x56 " " 3 " " " " 112 " " 80 " . . . . .	15 00
000— " 23x72 " " 3 " " " " 150 " " 100 " . . . . .	18 00

When desired we can send legs along with any size machine, for \$4 extra, which can be set up after arrival at destination.

### Butter Boxes.

Are made of well seasoned lumber, iron bound at the edges and capped at the corners, as shown in the engraving. Malleable detachable hinges and corner plates combined, giving greater strength and durability than any other box, to which especial attention is called. The trays for the butter are let down into the box, one upon another, and may be put in or lifted out with the butter in them. A movable ice box is placed in the centre; when this is not used a strip, provided for the purpose, may be placed in the bottom of each tray to fill up the space. The four sides of the trays are surrounded by a non-conducting air space, which is valuable in preserving the temperature and saving the ice. Malleable iron chest handles, well secured to the sides of the box, make it convenient to carry. These boxes are specially suited for square or oblong prints. Nearly all the recent inventions in butter printing machines have adopted this shape, and it is generally conceded to be the best for transportation. If you have a uniform good article, and would get the best price for it, see that you get a Reid Shipping Box, which will carry it to its destination in good condition summer or winter, and it will soon pay for itself.

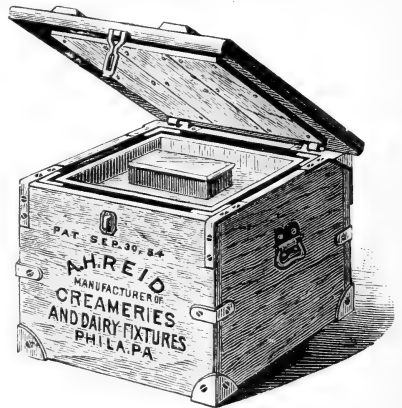

#### PRICE LIST.

Capacity 20 Pound Prints . . . . .	\$3 75	Capacity 36 Half-Pound Prints . . . . .	\$4 50
" 30 " . . . . .	4 25	" 64 " " . . . . .	5 25
" 40 " . . . . .	4 75	" 80 " " . . . . .	5 50
" 56 " . . . . .	5 00	" 100 " " . . . . .	6 00
" 80 " . . . . .	5 50	" 140 " " . . . . .	7 00
" 96 " . . . . .	5 75		
" 120 " . . . . .	6 00		

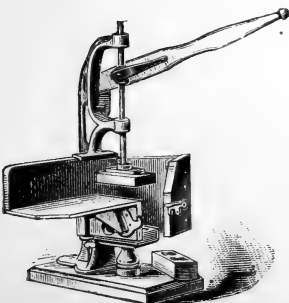

**Self-Gauging Print.** Price, \$10.00.

**Butter Prints and Moulds.** All sizes and styles. Round, 15 and 35 cts.; square, 60 cts., \$1.00, \$1.25 and \$2.50 each.

**More's Pyramidal Milk Strainer.** With Rest, \$1.50; without Rest, \$1.35.

**Wells, Richardson & Co.'s Butter Color.** Will not Color the Butter Milk. Price, 25 cts., 50 cts. and \$1.00 per Bottle.

**Parchment Butter Paper.** Is air proof, tasteless and odorless. Does not stick to the butter, and prevents shrinkage. Is purer, neater, cleaner and cheaper than cloth. Price, 30 cts. per lb., or 4 lbs. for \$1.00.



## Dederick's Patent Reversible Continuous Hay Presses.

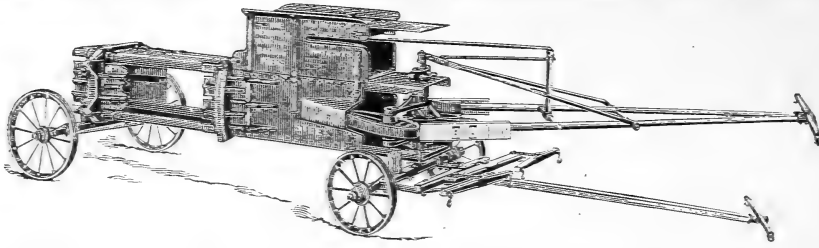

Patent steel case press with patent bale chamber, patent friction adjustment, patent loose reversible horse lever with patent adjustable short movement attachment, patent double acting power, with patent bumpers and patent friction rebound stop, patent condensing hopper, patent folder roller scaffold, truck, double trees, neck yoke, two wrenches, and oil can. Price complete, \$300.00.

Same as above, with tray hopper as used on other presses, \$275.00.

Patent wood frame, iron and steel press, with patent bale chamber, patent friction adjustment, patent loose reversible horse lever, patent double acting power and patent friction rebound stop, patent condensing hopper, patent folder roller scaffold, truck, double trees, neck yoke, two wrenches and oil can. Price complete, \$275.00.

Same as above, with tray hopper as used on other presses, \$250.00.

All orders understood to mean with condensing hopper, unless otherwise stated.

Hoppers are made 17 x 22, or 14 x 18, as desired.

## KEMP MANURE SPREADER.

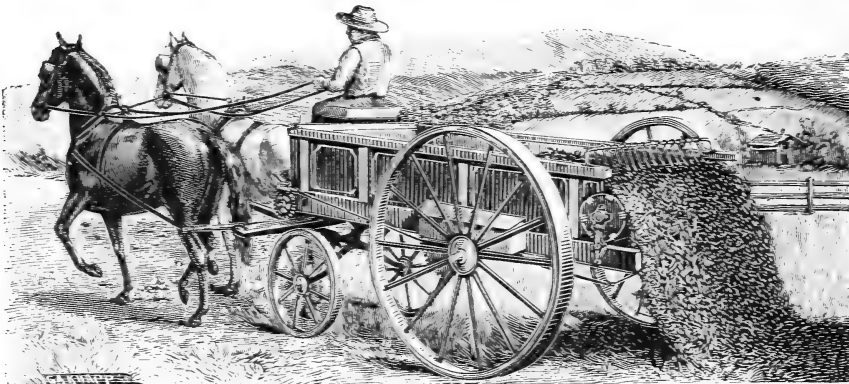

Above cut shows the Spreader at work, covering every square inch with finely pulverized manure in one-tenth the time required with shovels and forks, and doing the work fully ten times as well. Price:—No. 1 Machine on two wheels, capacity thirty bushels, \$85.00; No. 1 on four wheels, \$110.00; No. 2 Machine on four wheels, capacity forty bushels, \$120.00.

## CARRIAGE, MACHINE AND PLOW BOLTS OF EVERY DESCRIPTION. WASHERS OF ALL SIZES.

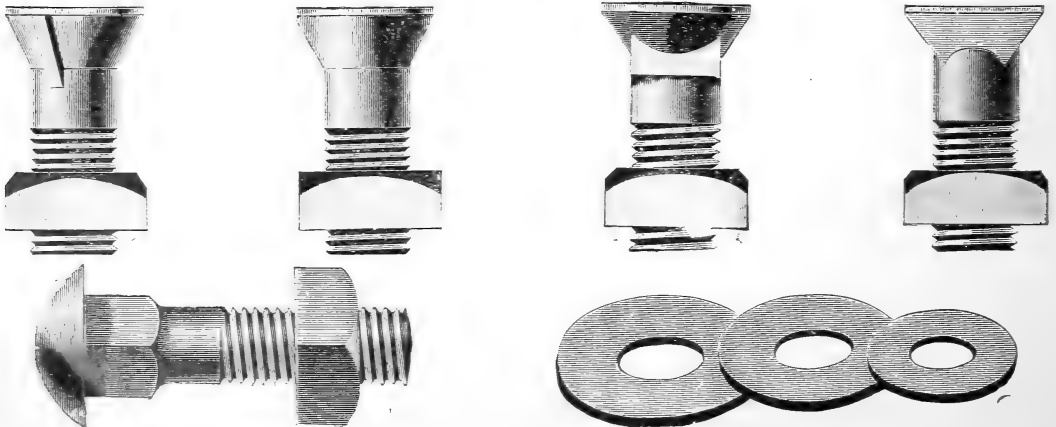

## THE BROWN WAGON.

### Reasons for its Superiority.

Oil Boiled Felloes, shutting out all moisture, preventing rot and keeping tires tight. Stay Chains with springs to control the wheels, which destroy largely the switching of the tongue.

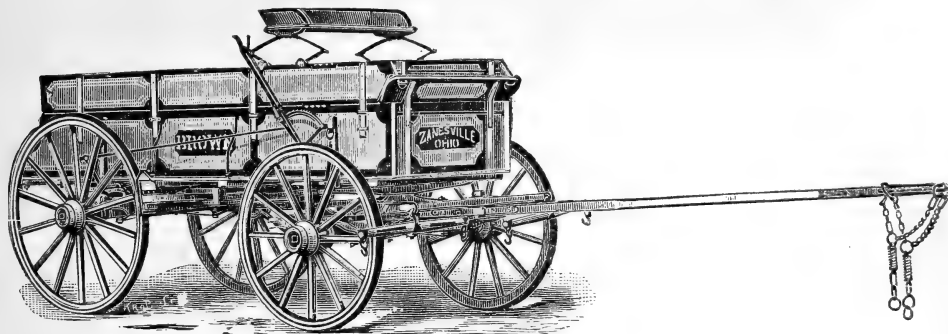

To overcome the objections in tongue chains, as commonly used, we have applied Coil Springs to ease the draft on the team's neck, when the chains are forced to control the tongue or hold back. We also add a Branch Chain to each tongue chain. The Branch Chain is to destroy, as far as possible, the side jerking, and to protect the horses from the whipping motion of the tongue. The Coil Springs yield to either the pull of the chain, or branch, saving the team at all times from the sudden jerking of the tongue, protecting both horses and harness. The Branch Chains have a tendency to prevent side motion of the tongue—same as neck yoke, but less cramping for the horses—while the Coil Springs supply the place of the vibrating of the neck yoke to ease the team's necks. Only wagon with Yielding Tongue Chains with Check Branches.

### Skein and Axle Different from all Others.

Our Extension Shoe Skein is one of the greatest improvements on wagons during the last fifty years, as it protects the axle as well as the skein, allowing the axle to be made of less material. The shoe of the skein supports the axle where it has the greatest load to bear, and is superior to the steel skein, as it allows a greater quantity of the axle to enter the shoe of the skein.

The Skein is also chilled on its face, and will wear longer than a steel skein. The steel skein has no temper in it, and is as soft as iron, as it is required to be welded to make it.

### Number, Size and Capacity of Wagons.

No. 000—Capacity, 1800 to 2000 lbs. . . . .	Price, \$ 67 00
No. 00—Is a 2¼x8½ in. skein; 7½x8½ in. hub; 1½x½ in. tire; body 9 ft. by 12 to 14 in. deep inside, with brake, top box and seat. Capacity, 2000 to 2500 lbs. . . . .	“ 68 00
No. 1—Is a 3x9 in. skein; 8x9 in. hub; 1½x⅝ in. tire; body 9 to 9½ ft. long; 13 to 15 in. deep inside, with brake, top box and seat. Capacity, 3000 lbs. . . . .	“ 75 00
No. 2—Is a 3¼x10 in. skein; 8½x10 in. hub; tire 1⅝x⅝ or ¾; body 10 ft. long by 15 to 16 in. deep inside, with brake, top box and seat. Capacity, 3500 lbs. . . . .	“ 78 00
No. 3—Is a 3½x11 in. skein; 9x11 in. hub; 1¾x⅝ or ¾ in. tire; body 9½ or 10 ft. long, and 15 to 18 in. deep inside, with brake, top box and seat. Capacity, 4500 lbs. . . . .	“ 80 00
One-Horse Wagon—Is a 2½x8 in. skein; 7x8 in. hub; tire 1⅜x7-26 in. Capacity, 1800 lbs. Has brake, top box and seat . . . . .	“ 60 00

In addition to above line of wagons, the Company are building for us a special line of steel skein lynch pin Gears, with 4 inch tires. Prices, &c., as follows, viz.:

No. 3—3½x11 skeins; capacity, 5000 lbs. . . . .	Price, \$ 85 00
No. 4—3¾x12 skeins; capacity, 6000 to 7000 lbs. . . . .	“ 90 00
No. 5—4x12 skeins; capacity, 7000 to 8000 lbs. . . . .	“ 100 00

Depth of body given on all wagons above does not include top box, which is 6, 8, 10 or 12 inches deep. Tubular Axle Wagons furnished upon application. When 4-inch tires are wanted, add \$12.00 to above, net; when 3-inch tires are wanted, add \$7.00 to above, net; when wagon gears only (without body) are wanted, deduct \$10.00 from above prices.

**THE BALTIMORE FARM WAGON.**

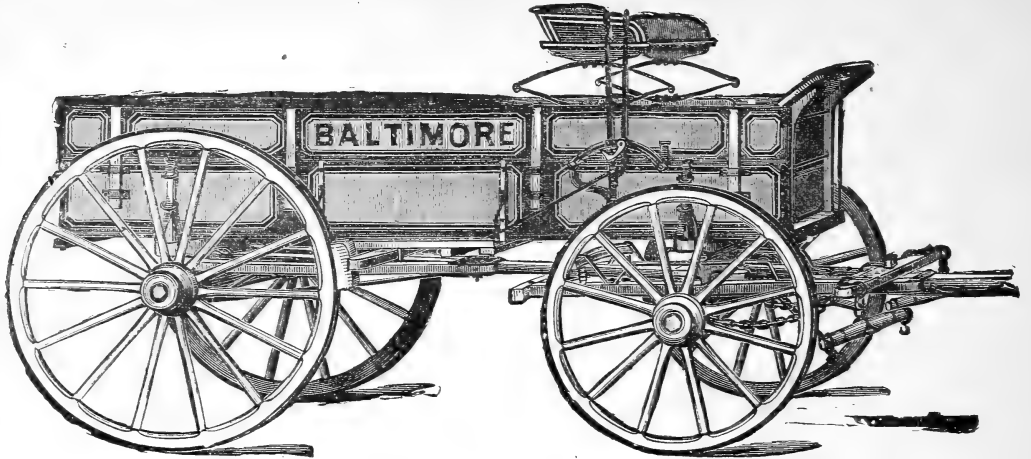

**A First-Class Farm Wagon, built of Good Material; made with Cast Skeins, Steel Skeins, Tubular or Iron Axles; but only the Skein Wagons carried in Stock.**

**PRICES AS FOLLOWS:**

2 3/4 x 8 1/2 Skein, 1 3/8 x 7-16 Tire, 2000 to 2500 lbs. capacity, . . . . .	\$62 50
3 x 9 Skein, 1 1/2 x 1/2 Tire, 2500 to 3000 lbs. capacity, . . . . .	65 00
3 1/4 x 10 Skein, 1 1/2 x 9-16 Tire, 3500 lbs. capacity, . . . . .	67 50
3 1/2 x 11 Skein, 1 3/8 x 9-16 Tire, 4500 lbs. capacity, . . . . .	70 00
3 3/4 x 12 Skein, 1 3/4 x 3/4 Tire, 5500 to 6000 lbs. capacity, . . . . .	73 00
4 x 12 Skein, 2 x 3/4 Tire, 6500 to 7000 lbs. capacity, . . . . .	76 50
One-Horse Wagon, 1 1/4 Iron Axle, 1000 lbs. capacity, . . . . .	37 50

Prices on wagons with Steel Skeins or Tubular Axles on application.  
 For Wide Tires add to above prices on wagons as follows, viz.:

For 4-inch tires, add . . . . .	\$12 00
For 3-inch tires, add . . . . .	7 00
For 2 1/2-inch tires, add . . . . .	6 00
For 2-inch tires, add . . . . .	5 00

Above retail prices in Two-Horse Wagons include Gear Brake on the hounds, with Side Lever on body and also Rear Side Lever; the One-Horse Wagons have Body Brake only.

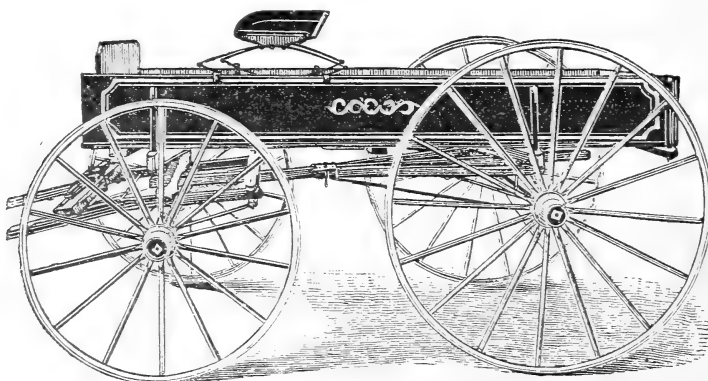

**BALTIMORE ONE-HORSE WAGON.**

**ALL KINDS OF MACHINERY REPAIRED.**

**BALTIMORE FARM AND CONTRACTORS' CARTS.**

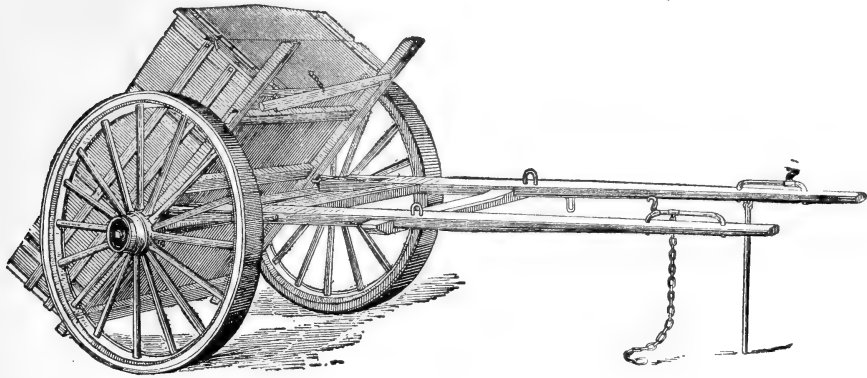

Made of first-class materials, in both wide and narrow tires, with  $1\frac{1}{2}$ ,  $1\frac{3}{4}$  and 2-inch iron axles. Dimensions of No. 2 Cart: Height of body,  $10\frac{1}{2}$  inches; height of top box or side boards,  $6\frac{1}{2}$  inches; width of Cart in front, 37 inches; width in rear,  $38\frac{1}{2}$  inches, inside measurement.

	Retail Price.	List Price.
No. $1\frac{1}{2}$ Cart, having $1\frac{1}{2}$ in. axle and 2 in. tires, . . . . .	\$35 00	\$55 00
No. $1\frac{3}{4}$ Cart, having $1\frac{3}{4}$ in. axle and 2 in. tires, . . . . .	37 00	60 00
No. 2 Cart, having 2 in. axle and 2 in. tires, . . . . .	38 00	65 00
No. 2 Cart, having 2 in. axle and $3\frac{1}{2}$ in. tires, . . . . .	40 00	67 00

Can furnish any of the above sizes in both wide and narrow tires at short notice.

Used and recommended by a large number of farmers and contractors.

Of all the implements or vehicles in use on the farm there is none more necessary than the Farm Cart. In the "Baltimore" we have incorporated all of the best features of the old style home-made cart and have today, beyond any question of doubt, the best article of the kind made.

Our Contractors' Carts are strong and durable, well braced and specially made for heavy work.

In all of our Carts we retain the old trap stick, as you will see from above, and for which there has never been any good substitute made.

Having sold these goods extensively throughout Maryland, Pennsylvania, New York and the South, we are prepared to say that we have just what the Farmers and Contractors need, and believe that we can offer as much for the money as any other manufacturers in the country.

# Carriage Department.

Embracing a full line of BUGGIES, SURREYS, DAYTONS, ROAD CARTS, ETC. Buggies \$50.00 and upwards. Road Cars \$10.00 and upwards. Dayton and McCall Wagons at Lowest Prices.

## Brewster Spring Piano Box Buggy.

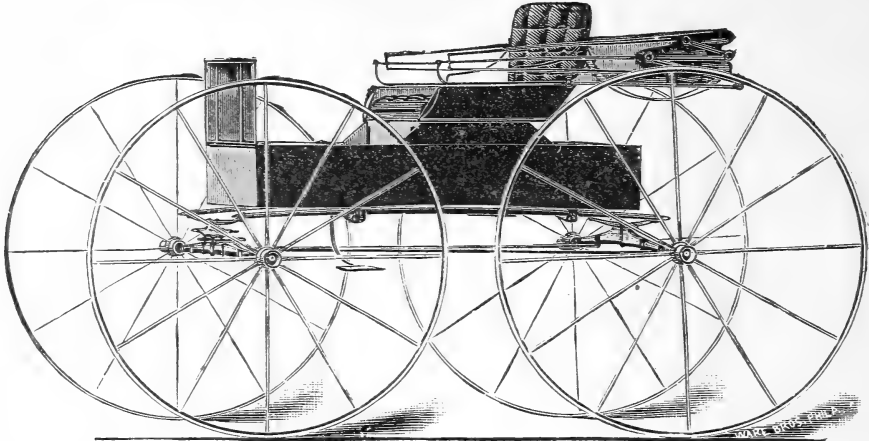

	Retail Price.	List Price.
No. 0—Buggy, with Rubber Top . . . . .	\$50 00	\$ 90 00
No. 1—Buggy, with Leather Quarter Top . . . . .	55 00	100 00
G. & T. Grade Buggy, with Rubber Top . . . . .	60 00	105 00
G. & T. Grade Buggy, with Leather Quarter Top . . . . .	65 00	110 00
G. & T. Grade Buggy, with Full Leather Top, except rubber side curtains . . . . .	70 00	120 00
G. & T. Grade Buggy, with Full Leather Top . . . . .	75 00	125 00
Baltimore Grade Buggy, with Leather Quarter Top . . . . .	75 00	130 00
Baltimore Grade Buggy, with Leather Top and Rubber Side Curtains . . . . .	80 00	140 00
Baltimore Grade Buggy, with Full Leather Top . . . . .	90 00	150 00

## Three Spring and Brewster Side-Bar Dayton Wagons.

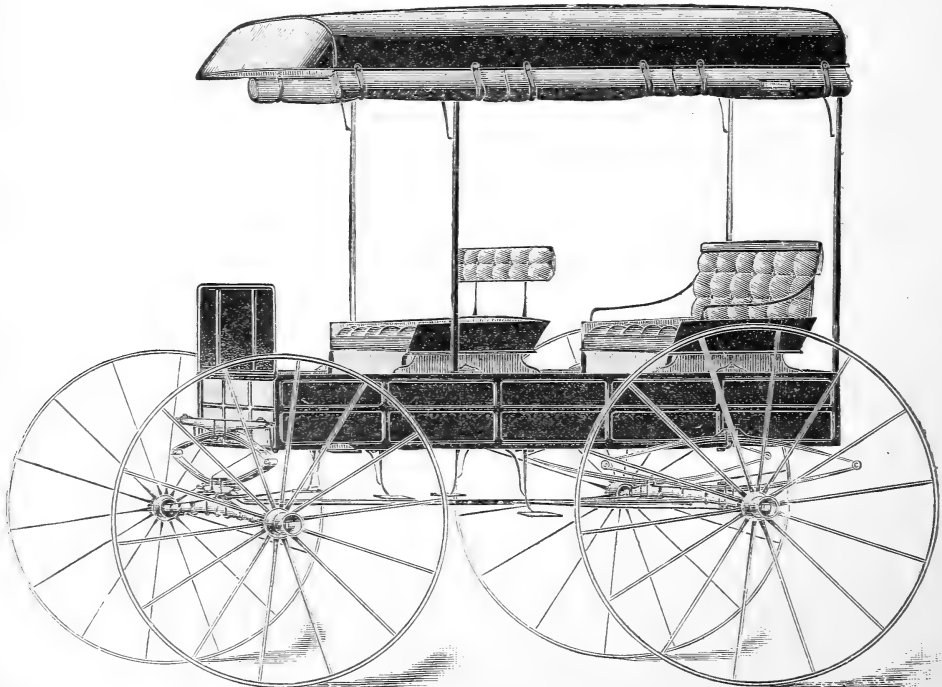

<b>PRICES.</b> —No. 1. Dayton Wagon . . . . .	Retail Price.	List Price.
Higher grades of Dayton Wagons made to order specially.	\$65 00	\$110 00

**G. & T. Grade Road Wagon.**

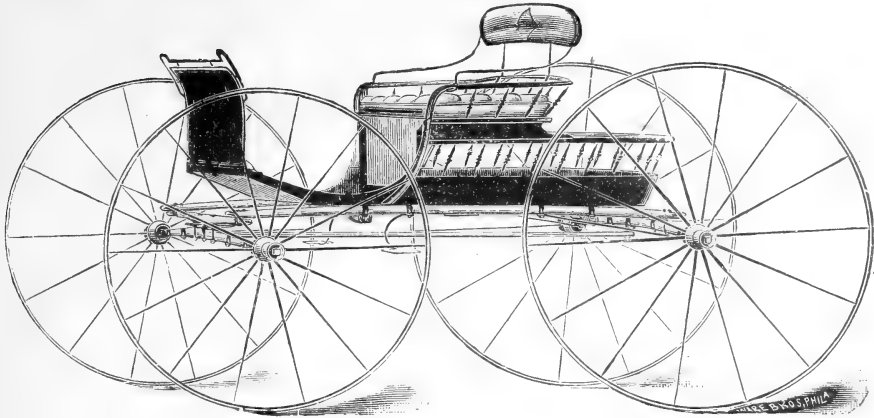

	Retail Price.	List Price.
G. & T. Grade Road Wagon, . . . . .	\$35 00	\$60 00

This Wagon is made with Warner Wheels exclusively, unless specially ordered otherwise ; is nicely finished and is an exceedingly nice job for the money.

**Baltimore Road Wagon.**

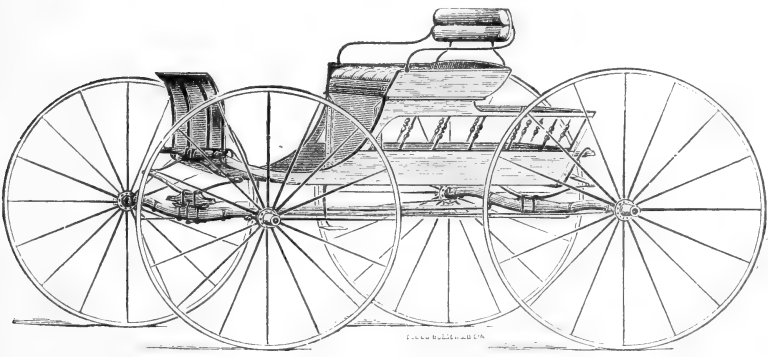

This wagon proved to be a great favorite during the past season, and are pleased to state that we have not had one single complaint from the many people who are using them.

Can furnish above in either Steel Band or Sarven Wheels, Gears selected Hickory, Double Collar Steel Axles, Best Oil Tempered Springs, Clips and Bolts all Norway Iron, Bodies made from best quality of Yellow Poplar and white Ash, thoroughly glued and screwed. This is the same grade of work as the Baltimore Buggies.

	Retail Price.	List Price.
Baltimore Road Wagon, . . . . .	\$40 00	\$70 00



### The Baltimore Cart, No. 45.

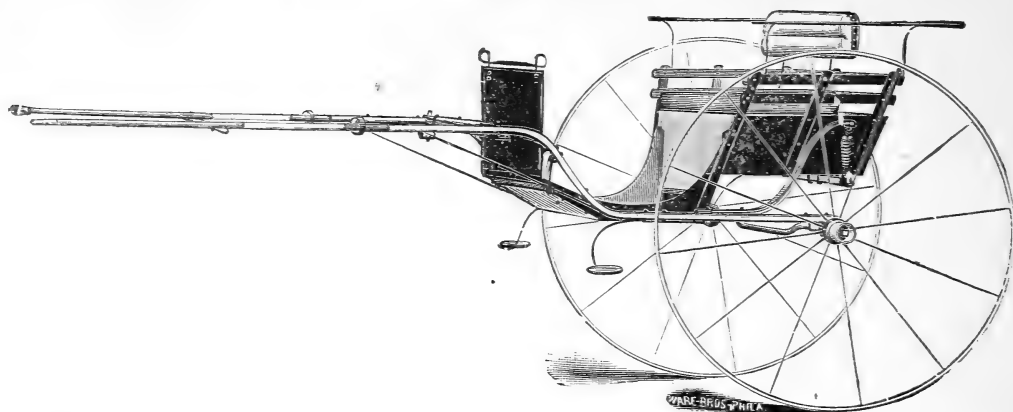

With and without Top; has combination semi-elliptic springs; entrance from the front; a most beautiful cart and an easy rider; one of the most salable vehicles on the market; finished in oak, and in every respect a beauty.

Retail price, with top . . . . .	\$45 00	List price . . . . .	\$70 00
"    without top . . . . .	35 00	"    . . . . .	55 00

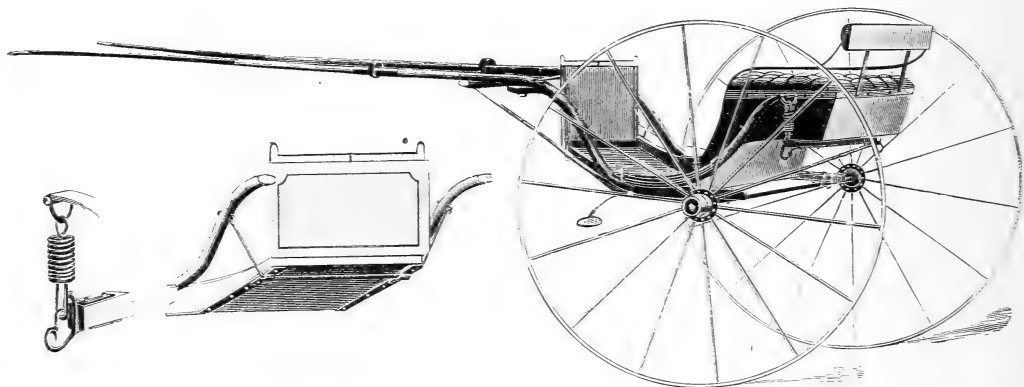

	Retail Price.	List Price.
--	---------------	-------------

No. 35—Same spring arrangement as in No. 45—has entrance in front . . . . .	\$30 00	\$48 00
---	---------	---------

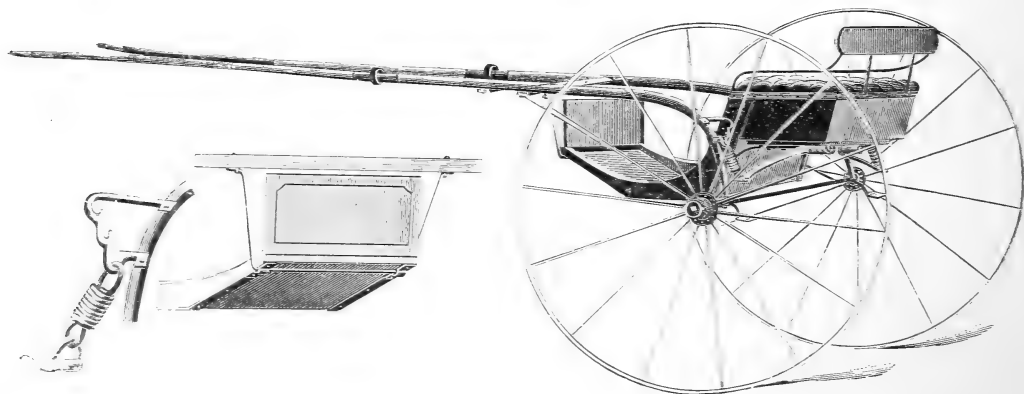

	Retail Price.	List Price.
--	---------------	-------------

No. 20 has combination of Coil Torsion and Spiral Springs—an exceptionally easy rider . . . . .	\$27 50	\$45 00
---	---------	---------

### X Phaeton Cart.

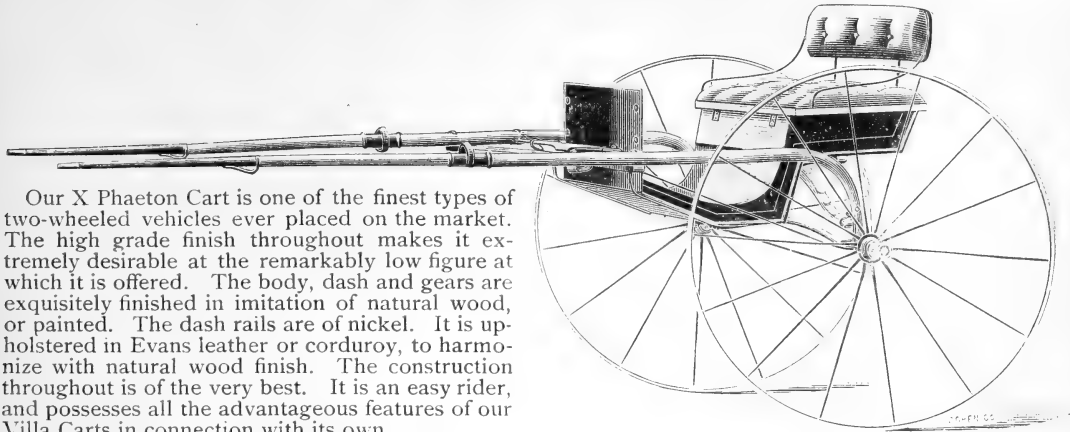

Our X Phaeton Cart is one of the finest types of two-wheeled vehicles ever placed on the market. The high grade finish throughout makes it extremely desirable at the remarkably low figure at which it is offered. The body, dash and gears are exquisitely finished in imitation of natural wood, or painted. The dash rails are of nickel. It is upholstered in Evans leather or corduroy, to harmonize with natural wood finish. The construction throughout is of the very best. It is an easy rider, and possesses all the advantageous features of our Villa Carts in connection with its own.

Retail price, \$20.00 ; list price, \$31.00.

### XX Body Cart.

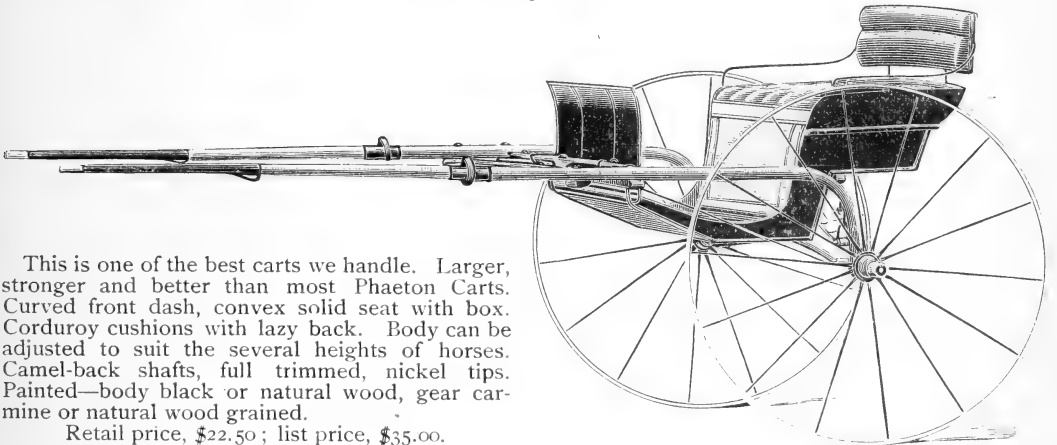

This is one of the best carts we handle. Larger, stronger and better than most Phaeton Carts. Curved front dash, convex solid seat with box. Corduroy cushions with lazy back. Body can be adjusted to suit the several heights of horses. Camel-back shafts, full trimmed, nickel tips. Painted—body black or natural wood, gear carmine or natural wood grained.

Retail price, \$22.50 ; list price, \$35.00.

### No. 0 Body Cart.

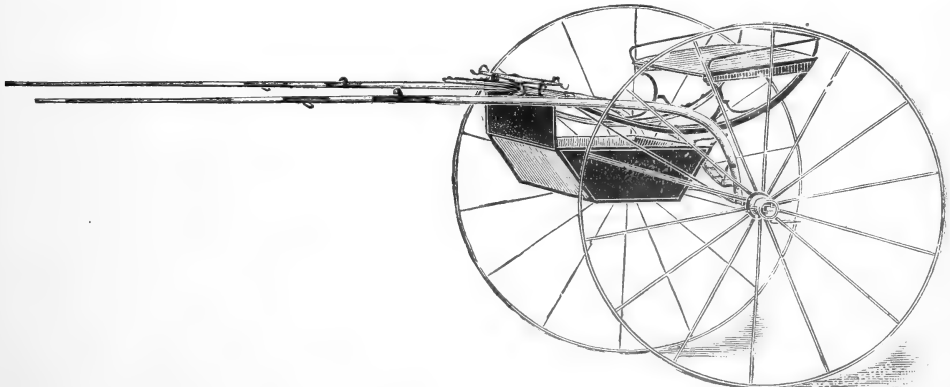

Has a Box Foot Rack, which is interchangeable with the Slat Foot Rack:

Retail price, \$20.00 ; list price, \$31.00.

ALL KINDS OF MACHINERY REPAIRED.

### Old Dominion Road Cart.

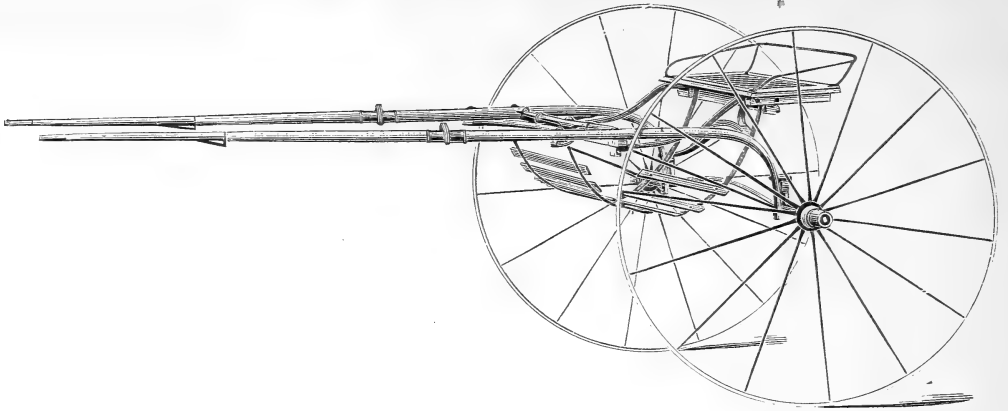

Wood Riser from Spring to Seat. Finish—Varnished on Natural Wood or Painted. With Closed Foot Rest. Retail price, \$10.00; list price, \$18.00.

### Farmers' Favorite Road Cart.

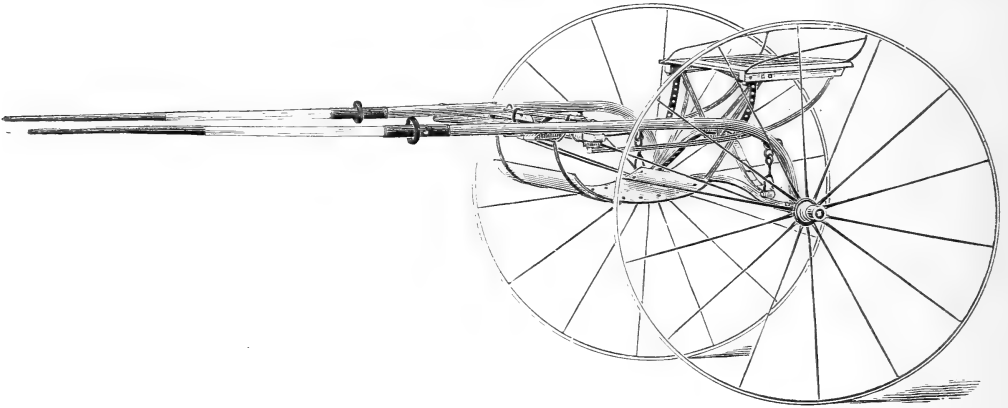

Steel Seat Supports. End of Spring hung on Long Swinging Shackle. Painted Red, Wine, Green, or Natural Wood Varnish. Retail price, \$12.50; list price, \$21.00.

### Folded Duck Back Bands, Patent Hooks.

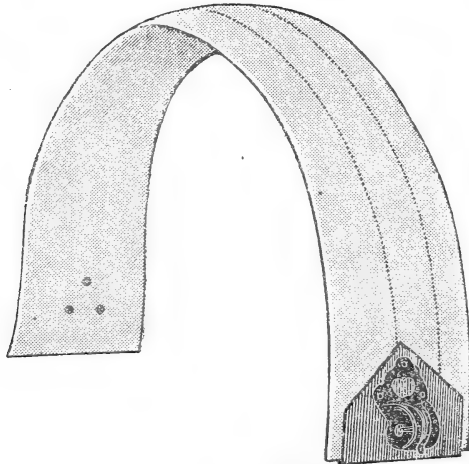

Can be used with either Chain or Rope Traces. Price, 65 cts.

## HARNESSES.

### No. 1, Single Buggy.

Bridles,  $\frac{5}{8}$  inch; Traces, 1 inch; Saddle,  $2\frac{1}{2}$  inches; Breast Collar and Breeching, folded; Flat Lines; X-C Mounting. Price, with Collar and Hames, \$7.00; with Breast Collar, \$6.50.

### No. 2, Single Buggy.

Bridle,  $\frac{5}{8}$  inch, with Fly Terrets; Trace,  $1\frac{1}{8}$  inch; Saddle, 3 inches, with Nickel Hook and Terrets; Breast Collar and Breeching, Folded with Straight Lay; Round Hip Strap; Flat Lines; X-C Mounting; Imitation Hand Stitched. Price, with Collar and Hames, \$10.00; with Breast Collar, \$9.00.

### No. 3, Single Buggy.

Bridle,  $\frac{5}{8}$  inch; Traces,  $1\frac{1}{8}$  inch; Saddle, 3 inches; Breast Collar and Breeching, Folded with Straight Lay; Flat Lines; Nickel or Imitation Rubber Mounting; Imitation Hand Stitched; Price, with Collar and Hames, \$11.75; with Breast Collar, \$10.25.

### No. 4, Single Carriage.

Bridle,  $\frac{5}{8}$  inch; Traces,  $1\frac{1}{4}$  inch; Saddle,  $3\frac{1}{2}$  inch; Breast Collar and Breeching, Folded with Straight Lay; Flat Lines; X-C Mounting; Imitation Hand Stitched. Price, with Collar and Hames, \$12.25; with Breast Collar, \$10.75.

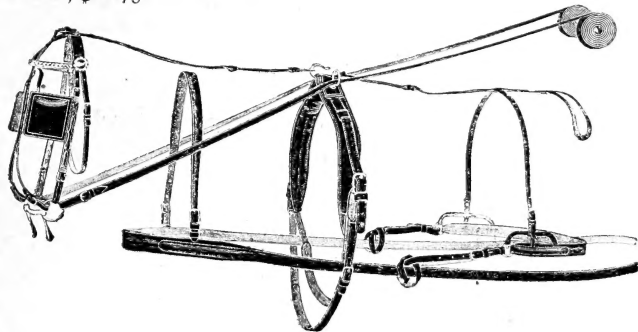

### No. 5, Single Carriage.

Bridle,  $\frac{3}{4}$  inch, Chain Front; Traces,  $1\frac{1}{4}$  inch; Saddle, 4 inches; Breast Collar and Breeching, Folded with Straight Lay; Flat Lines; Nickel Hook and Terrets, and balance of Mounting, X-C; Imitation Hand Stitched. Price, with Collar and Hames, \$14.00; with Breast Collar, \$12.50.

### No. 6, Single Buggy.

Bridle,  $\frac{5}{8}$  inch, Chain Front; Trace,  $1\frac{1}{8}$  inch; Saddle, 3 inches, Hand Laced, Leather Lined; Breast Collar and Breeching, Folded with Wave Lay; Flat Lines; Full Nickel or Imitation Rubber Mounting; Imitation Hand Stitched. Price, with Collar and Hames, \$17.50; with Breast Collar, \$15.00.

### No. 7, Hand-Made Single Buggy.

Bridle,  $\frac{5}{8}$  inch; Traces,  $1\frac{1}{8}$  inch; Saddle, 3 inches, Hand Laced, Leather Lined; Breast Collar and Breeching, Folded with Wave Lay; Flat Lines; Full Nickel or Imitation Rubber Mounting; Hand Stitched. Price, with Collar and Hames, \$22.50; with Breast Collar, \$20.00.

### No. 100, Express.

Bridle,  $\frac{3}{4}$  inches; Traces,  $1\frac{1}{4}$  inches; Saddle, 4 inches; Red Wood Hames, with X-C Ball Top; Folded Breeching, with Straight Lay; Double Hip Straps; X-C Mounting. Price, \$15.00.

### No. 101, Express.

Bridle,  $\frac{3}{4}$  inch; Traces,  $1\frac{1}{4}$  inch, with Cockeyes; Saddle, 4 inches, with Kersey Lining; Red Wood Hames with Brass Ball Top; Folded Breeching, with Straight Lay, Double Hip Straps; Brass Mounting; Imitation Hand Stitched. Price, \$20.00.

### No. 102, Express.

Bridle,  $\frac{3}{4}$  inch; Traces,  $1\frac{1}{2}$  inch, to buckle to Hames, or with Heel Chains and attached to Hames; Saddle, 5 inches, with Kersey Lining; Folded Breeching, with Straight Lay; Double Hip Straps; Brass or Nickel Mounting; Imitation Hand Stitched. Price, \$25.00.

### No. 200, Double Buggy.

Bridles,  $\frac{5}{8}$  inch; Traces, 1 inch; Fancy Bound Pads;  $1\frac{1}{4}$  inch Pieces and Folded Bellybands Turnbacks,  $\frac{3}{4}$  inch; Hip Strap,  $\frac{5}{8}$  inch, with Patent Leather Drops; Flat Lines; Kip Collars; X-C Mounting. Price \$18.00.

### No. 201, Double Buggy.

Bridles,  $\frac{5}{8}$  inch, Imitation Chain Front; Traces,  $1\frac{1}{8}$  inch; Plain Pads, with Leather Housings under same;  $1\frac{1}{4}$  inch Side Pieces and Folded Bellybands; Turnback,  $\frac{3}{4}$  inch; no Hip Strap; Flat Lines; Patent Leather Collars; Full Nickel Mounting; Imitation Hand Stitched. Price, \$25.00.

### No. 202, Double Buggy.

Bridles,  $\frac{5}{8}$  inch; Traces,  $1\frac{1}{8}$  inch; Plain Pads, with Leather Housings under same;  $1\frac{1}{4}$  inch Side Pieces: Folded Bellybands; Turnback,  $\frac{3}{4}$  inch, waved;  $\frac{5}{8}$  inch Hip Strap, with Patent Leather Drop; Flat Lines; Patent Leather Collars; Nickel or Imitation Rubber Mounting; Imitation Hand Stitched, nicely Finished. Price, \$35.00.

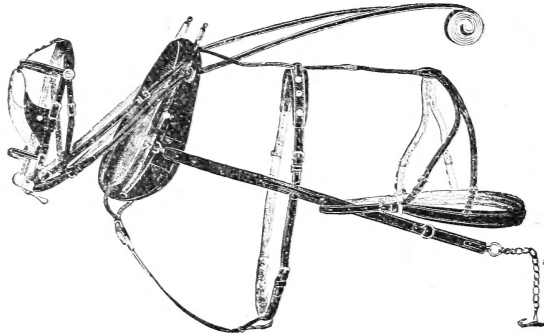

### No. 300, Double Wagon.

Bridle,  $\frac{3}{4}$  inch; Harness Leather Winkers; Iron Bound Hames;  $1\frac{1}{2}$  inch Traces, riveted to Hames, with Chain Ends; Folded Pad and Breeching;  $\frac{3}{4}$  inch Double Hip Strap; Kip Face Collars; Flat Lines. Price, \$20.00.

### No. 301, Double Wagon.

Bridle,  $\frac{3}{4}$  inch, Patent Leather Winkers; Red, Iron Bound Hames;  $1\frac{1}{2}$  inch Traces, riveted to Hames, with Chain Ends; Folded Pads and Breeching;  $\frac{7}{8}$  Double Hip Strap; Kip Collars; Flat Lines; Imitation Hand Stitched. Price, \$26.50.

### No. 302, Heavy Double Wagon.

Bridle,  $\frac{3}{4}$  inch, Patent Leather Winkers, Box Loop Cheeks; Brass Ball Top Hames; 2-inch Traces, riveted to Hames, with Chain Ends; Heavy Pads and Breeching; 1-inch Double Hip Strap; Kip Collars; Flat Lines; Imitation Hand Stitched. Price, \$35.00.

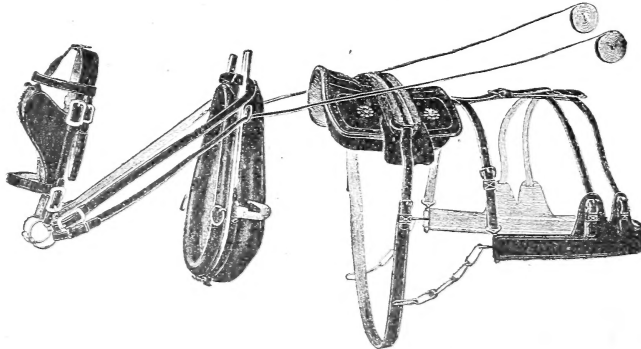

### No. A, Dump Cart.

Bridle,  $\frac{7}{8}$  inch; Lines,  $\frac{7}{8}$  inch; Freeching, 3 inches; No. 5 Saddle, Leather Covered; No. 62 Iron Bound Hames,  $\frac{7}{8}$  Hame Straps; Tug Chains; Kip Team Collar. Price, \$12.50.

Prices on cheap Cart Harness on application.

# SEED TABLET.

## THE QUANTITY OF SEED USUALLY SOWN TO AN ACRE.

Asparagus . . . . .	5 lbs.	Melon, Musk . . . . .	1½ to 2 lbs.
Barley, broadcast . . . . .	2 to 3 bush.	Melon, Water . . . . .	2 to 3 lbs.
Beans, dwarf, in drills . . . . .	1 to 1½ bush.	Mustard, broadcast . . . . .	12 to 16 qts.
Beans, pole, in hills . . . . .	8 to 10 qts.	Mangold Wurzel . . . . .	4 to 6 lbs.
Beet, in drills . . . . .	4 to 6 lbs.	Oats, broadcast . . . . .	2 to 2½ bush.
Broom Corn, in hills . . . . .	4 to 6 qts.	Onions, in drills, to make large Onions. . . . .	6 to 8 lbs.
Buckwheat, broadcast . . . . .	¾ bush.	Onion Seeds, for small sets . . . . .	40 to 60 lbs.
Cabbage, in beds, to transplant . . . . .	¼ lb.	Parsnip, in drills . . . . .	4 to 6 lbs.
Carrot, in drills . . . . .	2 to 3 lbs.	Peas, Early, in drills . . . . .	1 bush.
Celery, to transplant . . . . .	½ lb.	Peas, Marrowfat, in drills . . . . .	1¼ bush.
Corn, in hills . . . . .	8 qts.	Peas, broadcast . . . . .	2 to 3 bush.
Corn, for soiling . . . . .	2 to 3 bush.	Potato, cut tubers, in drills . . . . .	8 bush.
Clover, Alsike . . . . .	12 lbs.	Radish, in drills . . . . .	6 to 8 lbs.
Clover, red, alone . . . . .	15 lbs.	Radish, broadcast . . . . .	10 lbs.
Clover, white, alone . . . . .	12 lbs.	Rye, broadcast . . . . .	1 bush.
Clover, white, with other seeds . . . . .	4 lbs.	Salsify, in drills . . . . .	6 to 8 lbs.
Clover, Lucerne, alone . . . . .	15 lbs.	Sorghum . . . . .	10 to 12 lbs.
Clover, scarlet . . . . .	12 lbs.	Spinach, in drills . . . . .	12 to 15 lbs.
Cucumber, in hills . . . . .	2 lbs.	Squash, (bush varieties,) in hills . . . . .	4 to 6 lbs.
Flax, broadcast . . . . .	1 to 2 bush.	Squash, (running varieties,) in hills . . . . .	3 to 4 lbs.
Grass, blue, alone . . . . .	28 lbs.	Turnip, in drills . . . . .	1 lb.
Grass, Hungarian . . . . .	1 bush.	Turnip, broadcast . . . . .	2 to 3 lbs.
Grass, Lawn . . . . .	3 to 4 bush.	Tomato, to transplant . . . . .	¼ lb.
Grass, Orchard . . . . .	28 lbs.	Vetches, broadcast . . . . .	2 to 3 bush.
Grass, Red Top . . . . .	28 lbs.	Wheat, broadcast . . . . .	1½ to 2 bush.
Grass, R. I. Bent . . . . .	3 bush.	Wheat, in drills . . . . .	1 bush.
Timothy . . . . .	¼ bush.	Clover, { together } . . . . .	8 lbs. Clover.
Kale . . . . .	4 to 6 lbs.	Timothy, { for } . . . . .	10 lbs. Timothy.
Millet . . . . .	1 bush.	Ted Top, { one acre. } . . . . .	14 lbs. Red Top.

## QUANTITY OF SEEDS REQUIRED FOR A GIVEN NUMBER OF PLANTS, NUMBER OF HILLS OR LENGTH OF DRILLS.

Asparagus . . . . .	1 oz. to 50 ft. drill.	Pole Beans . . . . .	1 qt. to 150 hills.
Beet . . . . .	1 oz. to 50 ft. "	Corn . . . . .	1 qt. to 200 "
Celery . . . . .	1 oz. to 100 ft. "	Cucumber . . . . .	1 oz. to 50 "
Carrot . . . . .	1 oz. to 100 ft. "	Watermelon . . . . .	1 oz. to 30 "
Endive . . . . .	1 oz. to 150 ft. "	Muskmelon . . . . .	1 oz. to 60 "
Egg Plant . . . . .	1 oz. to 300 ft. "	Pumpkin . . . . .	1 oz. to 40 "
Lettuce . . . . .	1 oz. to 150 ft. "	Early Squash . . . . .	1 oz. to 50 "
Okra . . . . .	4 oz. to 100 ft. "	Marrow Squash . . . . .	1 oz. to 16 "
Onion . . . . .	1 oz. to 100 ft. "	Cabbage—1 oz. of seed will pro-	
Onion Sets, small . . . . .	1 qt. to 100 ft. "	duce . . . . .	2000 plants.
Parsley . . . . .	1 oz. to 150 ft. "	Cauliflower—1 oz. of seed will	
Parsnip . . . . .	3 oz. to 100 ft. "	produce . . . . .	2000 "
Radish . . . . .	2 oz. to 100 ft. "	Celery—1 oz. of seed will produce	3000 "
Salsify . . . . .	1 oz. to 70 ft. "	Egg Plant—1 oz. of seed will pro-	
Spinach . . . . .	2 oz. to 100 ft. "	duce . . . . .	1000 "
Turnip . . . . .	1 oz. to 150 ft. "	Lettuce—1 oz. of seed will pro-	
Peas . . . . .	1 qt. to 100 ft. "	duce . . . . .	3000 "
Dwarf Beans . . . . .	1 qt. to 100 ft. "	Pepper—1 oz. of seed will produce	1000 "
Leek . . . . .	1 oz. to 100 ft. "	Tomato—1 oz. of seed will produce	1500 "

## To Country Merchants.

We put up Vegetable Seeds in papers for the Country Trade, in quantities to suit purchasers. Our Seeds are all select and tested.

We also place Seeds with reliable merchants on consignment, allowing commission on all papers sold.

Beans, Peas, Corn, etc., in bulk, at lowest wholesale rates.

If you have placed your order for small papers for this year, we will be pleased to fill any shortage you may have, and solicit your patronage for another season.





Varieties  
of SWEET PEAS.