



MBL/WHOI



0 0301 0012074 7

Growth in Living Systems

Growth in Living Systems

PROCEEDINGS OF AN INTERNATIONAL SYMPOSIUM
ON GROWTH HELD AT PURDUE UNIVERSITY
ON JUNE 16, 17, AND 18, 1960

edited by

M. X. Zarrow

assisted by

Harry Beevers, Irving Tessman

Leon E. Trachtman, Joe L. White

BASIC BOOKS, INC.

Publishers New York

© 1961 by Basic Books Publishing Co., Inc.
Library of Congress Catalog Card Number 61-13666
Manufactured in the United States of America

PREFACE

We encounter a paradox, frustrating yet exhilarating, in the realization that the areas of knowledge of the life processes are becoming, at the same time, both more widely separated and more deeply interrelated. While we see each discipline in the life sciences demanding an ever-increasing narrowness of concentration by the specialists working within it, it becomes more and more evident that really to comprehend the significance of each specialized field, we must treat the whole body of our biological knowledge as a complex, dynamic, and cohesive entity, not as a collection of relatively independent areas of thought and learning.

This paradox is a real stumbling block, for as the degree of our specialization increases, we find that we are progressively less able to communicate easily with one another across disciplinary boundaries. Yet, in our intellectual isolation, we sense the nearness of one another and the ultimate interdependence of all our thought and our work.

Most symposia and scientific meetings must, of course, concern themselves with specialized fields of research. From one end of the scientific spectrum to another, groups of scholars closely allied within disciplines meet together to discuss the progress of research in their own fields. Far too seldom are workers in a variety of disciplines able to meet at a single symposium to deepen their understanding of how and to what degree their own work fits in with new knowledge emerging in other areas.

It seemed appropriate that a symposium of this sort—a symposium on a subject to whose understanding many disciplines must contribute—should be chosen for the dedication of Purdue University's new Life Science Building. The building was conceived and constructed on the premise that contemporary scientific disciplines are not distinct entities which should be cultivated separately. It houses, therefore, academic departments concerned with the broad areas of the plant, animal, and

soil sciences. They include specifically the disciplines of microbiology, soil chemistry and soil physics; plant and animal genetics, nutrition, physiology, and pathology; molecular biology and biophysics; ecology; taxonomy; soil conservation; land use; and crop and animal production.

The subject which was chosen for the dedicatory symposium was Growth. Growth, the essential and peculiar characteristic of all living matter, is by definition a subject of critical interest to workers in all the disciplines accommodated by the new Life Science Building.

Growth can be studied and understood at many levels. It can be thought of at the levels of nucleic-acid chemistry or the aggregation of cells, in terms of the development of individual organisms or as a phenomenon involving interrelationships between the organism and its environment. Because of its breadth, it seemed particularly suitable as the subject of a symposium which could bring together leaders in a variety of fields, both from this country and abroad, to present papers concerning recent developments in their own and others' research.

It was clearly impossible to give truly comprehensive coverage to the subject of growth within the space of a three-day symposium. This was not the aim of the Purdue symposium. Its aim, rather, was to offer to scientists in a variety of disciplines some insights into the important work being done in areas other than their own. It was also the purpose of the symposium to suggest the impossibility of understanding so massive and all-encompassing a subject as growth through the approach of a single discipline.

The speakers, representatives of six nations, offered a penetrating look at the phenomenon of growth in plants, animals, and microorganisms, and they provided a searching review of the many unanswered questions which still confront us in this most complex subject. In general, the symposium was planned as a survey of current research progress at three levels: growth as a molecular phenomenon, growth at the cellular and tissue level, and growth of the whole organism. The first two days of the symposium were occupied by general sessions planned for the entire audience. On the third day, simultaneous papers were delivered in sections more specifically concerned with aspects of animal, plant, and microbial growth and plant-soil relationships.

The first day's program included the following papers: "Macromolecules and Natural Selection," by F. H. C. Crick, Cambridge University; "The Synthesis of Proteins," by M. B. Hoagland, Massachusetts General Hospital; "The Plan of Cellular Reproduction," by Daniel Mazia, University of California; and "Aspects of Mammalian Cell Growth in Tissue Culture," by Theodore T. Puck, University of Colorado Medical Center. The papers by Crick and Hoagland set a basic

theme which was repeated throughout the symposium: the relationships between nucleic acids and proteins. Assuming natural selection as a fundamental evolutionary mechanism, Crick postulated in his paper some essential characteristics for any chemical system upon which evolutionary selection has acted. He demonstrated that nucleic acids satisfy the need of a living system to replicate geometrically to some extent and to mutate to stable forms that can be copied, while proteins provide the versatility needed for the performance of many chemical tasks. Hoagland carried this relationship between nucleic acids and proteins forward in his outline of recent progress in elucidating the detailed mechanisms of protein synthesis.

The symposium moved to the consideration of growth at the cellular level with the papers of Mazia and Puck. Mazia considered two possible schemes for cellular reproduction: (1) fission, wherein every cell element has the power of self-replication, and (2) generative reproduction, wherein only a few elements are capable of self-reproduction but contain the information necessary for generation of many other non-self-replicating elements. He presented evidence which suggests that the second scheme is the one used by growing plant and animal cells.

In his paper, Puck showed the extreme sensitivity of the mammalian cell to radiation. He reported experiments showing survival curves of mammalian cells in tissue culture which demonstrated that the lethality was due to action on the chromosomes. He also pointed out that all cell functions studied thus far other than those which involve the function of the chromosomes (mitosis, DNA synthesis) are from tens to hundreds of times more resistant to X-rays than is cell reproduction itself.

Puck discussed a medium for cell growth which contains only two purified macromolecular fractions. One of these (fetuin) is present in calf fetal serum and seems necessary for morphological changes which are a prelude to reproduction. This substance may be present in the alpha globulin fraction of adult mammalian serum and may be involved in wound healing and in whole-body response to ionizing radiation.

The cellular level of growth continued to be the focus of attention during the second day of the symposium, when the following papers were read: "Tissue Reconstruction from Dissociated Cells," by A. A. Moscona, University of Chicago; "Cellular Differentiation in the Slime Mold," by M. Sussman, Brandeis University; "The Role of Ribonucleic Acid and Sulfhydryl Groups in Morphogenesis," by J. Brachet, Université Libre de Bruxelles; "Growth and Development of the Inflorescence and Flower," by C. W. Wardlaw, Manchester University; "Origin

of the Plant Tumor Cell," by Armin C. Braun, the Rockefeller Institute; and "Regeneration in Vertebrates: The Role of the Wound Epithelium," by Marcus Singer and Miriam Salpeter, Cornell University.

Moscona discussed the ability of dissociated cells to aggregate to form tissues and organs. He demonstrated clearly the existence of consistent patterns of aggregation for various types of cells and, in addition, showed the dependency of cell-aggregation patterns on the age of the tissue and on temperature. Moscona also indicated that one of the main prerequisites of cell aggregation is a cellular product of mucoidal nature, much like intercellular ground substance.

Sussman described his work with the slime mold myxamoebae, a typical unicellular organism. When growth of the individual slime mold cell ceases, individual cells collect in multicellular aggregates. Sussman described the patterns of aggregation and postulated the existence of two types of cells during the unicellular part of a mold's existence. He further suggested the function of each of these two types of cells in the pattern of cell aggregation.

Brachet discussed the role of ribonucleic acid and sulfhydryl groups in the growth and differentiation of the embryo. Noting that ribonucleic acid is definitely involved in the synthesis of specific proteins, he raised the question as to what inducing substance or evocator stimulates morphogenesis. Brachet's studies show that the distribution and concentration of ribonucleic acid correlate highly with morphogenesis in the embryo. There is still no clear evidence, however, that ribonucleic acid is the only significant constituent of the ribonucleoprotein particle. In addition, Brachet pointed out the importance of the sulfhydryl group in morphogenesis, discussed the utilization of sulfhydryl reagent in current research, and emphasized the need for more work in this important area.

Wardlaw demonstrated in his paper the extreme range of floral types and morphogenetic patterns encountered in the angiosperms. He showed that information already at hand makes it possible to unify and simplify the theories of the inception and development of flowering, and he discussed some of the problems for which solution is still required. Braun examined the question of what fundamental changes occur in the onset of plant tumors. He suggested that the change from the normal to the neoplastic condition involves a return from the normal precisely directed plant metabolism to a more "primitive type" of metabolism, but he noted that this change appears to be a perfectly reversible one. Reversal from tumorous to normal metabolism apparently results from reimposition of a restraint on particular metabolic areas of the "primitive" neoplastic cell type.

Singer's thesis was that during the healing process epidermis serves (1) to remove debris (cellular, particulate, and molecularly-disbursed

substances) from the underlying developing blastema, and (2) to secrete or discharge a substance, possibly protein-enzyme in nature, which contributes to the early histolysis seen in a wound before healing occurs.

In an evening paper delivered to a general session of the symposium, James Bonner, of the California Institute of Technology, presented an overview of what is currently known about essential aspects of plant biology. He reviewed recent gains in knowledge about the basic mechanics of plant growth and metabolism and assessed the problems that still confront us. A critical question raised by Bonner was: How is the use of genetic information programmed? He postulated the existence of a mechanism which controls the activity of genes within the nucleus, and then raised a series of questions about the action of this presumed control system.

On the third day of the symposium, sections concerned with more specialized aspects of animal, plant, and microbial growth and plant-soil relationships met simultaneously. In general, the papers delivered at these sections considered growth in terms of the development of the whole organism rather than growth at the molecular or cellular levels. In both the plant and the plant-soil section, consideration was given to problems of growth in terms of the relationship between the developing organism and its environment.

The symposium ended Saturday evening with an address by Ancel Keys of the University of Minnesota. Keys noted the difficulties encountered in drawing a distinction between growth and aging; he defined both as descriptions of progressive biological changes along a time axis. In a description of the relationship between aging and age-related diseases, he noted that discussions of the one almost inevitably turn out to be discussions of the other. He went on to examine the relationship between environmental influences and factors inherent in the tissues of the organism in the production of some age-related diseases, particularly coronary heart disease.

Progress in understanding so complex and enigmatic a phenomenon as growth is necessarily slow and tortuous. The subject is so vast that it is being approached from many different points of view; most of these were represented at the Purdue symposium. It is the hope of the sponsors of the symposium that a meeting of this sort, enabling workers in a variety of disciplines to come together for a mutual interchange of information, will have the effect of emphasizing the many areas of common interest. The purpose of the symposium will have been thoroughly satisfied if those attending it were enabled to derive from it a sharpened sense of the ultimate unity of their subject.

Leon E. Trachtman

List of Contributors

G. E. Blackman, Department of Agriculture, Oxford University, England

James Bonner, Division of Biology, California Institute of Technology

Jean Brachet, Faculté des Sciences, Université Libre de Bruxelles, Belgium

Armin C. Braun, The Rockefeller Institute, New York City

Seymour S. Cohen, Department of Biochemistry, School of Medicine, University of Pennsylvania

Francis H. C. Crick, Department of Physics, Cavendish Laboratory, University of Cambridge, England

Pierre Dansereau, Botanical Institute, University of Montreal; now Assistant Director, New York Botanical Garden

Victor A. Drill, Director, Division of Biological Research, G. D. Searle & Company, Chicago

Harriett Ephrussi-Taylor, Laboratoire de Génétique Physiologique du Centre National de la Recherche Scientifique, Gif-sur-Yvette, France

H. Orin Halvorson, Department of Bacteriology, University of Illinois

Sir John Hammond, School of Agriculture, University of Cambridge, England

Mahlon B. Hoagland, John Collins Warren Laboratories, Huntington Memorial Hospital, Harvard University

Hans Jenny, Department of Soils and Plant Nutrition, University of California, Berkeley

Thomas H. Jukes, Agricultural Division, American Cyanamid Company, New York City

Ancel Keys, Director, Laboratory of Physiological Hygiene, University of Minnesota

Ernst Knobil, Department of Physiology, Harvard Medical School; now Department of Physiology, University of Pittsburgh School of Medicine

- C. Edmund Marshall*, Department of Soils, University of Missouri
Daniel Mazia, Department of Zoology, University of California,
Berkeley
A. A. Moscona, Department of Zoology, University of Chicago
A. G. Norman, Department of Botany, University of Michigan
Aaron Novick, Institute of Molecular Biology, University of Oregon
Arthur B. Pardee, Department of Biochemistry and Virus Laboratory,
University of California, Berkeley
Gregory Pincus, Worcester Foundation for Experimental Biology,
Shrewsbury, Mass.
Glenn S. Pound, Department of Plant Pathology, University of
Wisconsin
Theodore T. Puck, Department of Biophysics, Florence R. Sabin Lab-
oratories, University of Colorado Medical Center, Denver
Morell B. Russell, Department of Agronomy, University of Illinois
Miriam M. Salpeter, Department of Zoology and Laboratory of Elec-
tron Microscopy, Department of Engineering Physics, Cornell
University
Marcus Singer, Department of Anatomy, School of Medicine, Western
Reserve University, and Laboratory of Electron Microscopy, De-
partment of Engineering Physics, Cornell University
F. C. Steward, Department of Botany, Cornell University
Maurice Sussman, Department of Biology, Brandeis University
Claude W. Wardlaw, Department of Botany, University of Manchester,
England
Frits W. Went, Director, Missouri Botanical Garden, St. Louis
Carroll M. Williams, The Biological Laboratories, Harvard University
Joseph T. Woolley, U.S. Department of Agriculture Agricultural Re-
search Service, and Department of Agronomy, University of Illinois
Erik Zeuthen, Biological Institute of the Carlsberg Foundation,
Copenhagen

Contents

Preface	v
List of Contributors	xi

I—Molecules, Viruses, and Bacteria

1. Macromolecules and Natural Selection <i>Francis H. C. Crick</i>	3
2. The Synthesis of Proteins <i>Mahlon B. Hoagland</i>	9
3. Virus-Induced Acquisition of Metabolic Function <i>Scymour S. Cohen</i>	17
4. Recombination Analysis in Microbial Systems <i>Harriett Ephrussi-Taylor</i>	39
5. The Role of Enzyme Regulation in Metabolism <i>Arthur B. Pardee</i>	77
6. Bacteria with High Levels of Specific Enzymes <i>Aaron Novick</i>	93
7. The Formation of Spores by Bacteria <i>H. Orin Halvorson</i>	107

II—Cells, Tissues, and Organisms

8. Synchronized Growth in Tetrahymena Cells <i>Erik Zenthen</i>	135
9. The Plan of Cellular Reproduction <i>Daniel Mazia</i>	159
10. Mammalian Cell Growth in Tissue Culture <i>Theodore T. Puck</i>	181

11. Tissue Reconstruction from Dissociated Cells <i>A. A. Moscona</i>	197
12. Cellular Differentiation in the Slime Mold <i>Maurice Sussman</i>	221
13. The Role of Ribonucleic Acid and Sulfhydryl Groups in Morphogenesis <i>Jean Brachet</i>	241
14. Regeneration in Vertebrates: The Role of the Wound Epithelium <i>Marcus Singer and Miriam M. Salpeter</i>	277
15. Insect Metamorphosis: An Approach to the Study of Growth <i>Carroll M. Williams</i>	313
16. Growth in Size and Body Proportions in Farm Animals <i>John Hammond</i>	321
17. Vitamins, Antibiotics, and Growth <i>Thomas H. Jukes</i>	335
18. The Pituitary Growth Hormone: Some Physiological Considerations <i>Ernst Knobil</i>	353
19. Steroids and Growth <i>Victor A. Drill</i>	383
20. Steroid Hormones and Aging in Man <i>Gregory Pincus</i>	407
21. Changes with Aging <i>Ancel Keys</i>	421
<i>III—Plant Growth and Plant Communities</i>	
22. The Biology of Plant Growth <i>James Bonner</i>	439
23. Organization and Integration: Plant Cell Growth and Nutrition <i>F. C. Steward</i>	453
24. Growth and Development of the Inflorescence and Flower <i>Claude W. Wardlaw</i>	491
25. Responses to Environmental Factors by Plants in the Vegetative Phase <i>G. E. Blackman</i>	525

26. Effects of Light and Temperature on Plant Growth <i>Frits W. Went</i>	557
27. The Origin and Growth of Plant Communities <i>Pierre Dansereau</i>	567
28. The Origin of the Plant Tumor Cell <i>Armin C. Braun</i>	605
29. Growth Aspects of Plant Virus Infections <i>Glenn S. Pound</i>	621
30. The Biological Environment of Roots <i>A. G. Norman</i>	653
31. Plant Root-Soil Interactions <i>Hans Jenny</i>	665
32. Transport Processes in the Soil-Plant System <i>Morell B. Russell and Joseph T. Woolley</i>	695
33. Colloid Chemistry of the Soil in Relation to Plant Nutrition <i>C. Edmund Marshall</i>	723
Glossary	737
Index	745

PART ONE

*Molecules, Viruses,
and
Bacteria*



— 1 —

MACROMOLECULES AND NATURAL SELECTION

Francis H. C. Crick

UNIVERSITY OF CAMBRIDGE

There is a very real sense in which the nucleic acids and the proteins are the key molecules of living systems. This is not to deny that carbohydrates, lipids, coenzymes, and other small molecules are important. What criterion, then, justifies us in putting this emphasis on proteins and nucleic acids? If one leaves theory aside and notes simply what we observe, then the viruses provide the most telling evidence. Many viruses consist only of protein and nucleic acid and very little else; no natural virus exists without them. However, I wish to give theoretical reasons why this should be so, and this forces me to consider the basic properties of living systems.

Here again one cannot say that some properties are all-important while others are merely trivial. For example, a living system must obtain free energy from its environment; this necessarily involves metabolism, and it is not unreasonable to put metabolism as an essential property. But I wish to stress a different point of view. As I see it, a living system, as we find it today, exists only because it has evolved, and in the long run it will continue to "exist" (that is, to have descendants) only as long as it is capable of evolving further, or at least while it can counteract the unavoidable tendency to make "mistakes." In a word, a living system implies natural selection. It is thus worthwhile to consider what general properties are essential to a living system. We can then ask, in a naive way, whether the properties of the macromolecules concerned are related in any rather direct manner to these theoretical requirements. Surprisingly, it turns out that there does appear to be such a connection; it is this connection that I wish to examine.

Of course, it would be more prudent to defer such an examination until we were more certain of the roles of protein and nucleic acid—that is, until we had such detailed knowledge that we would run little risk of mistaking the principles involved. However, it seems to me that we can already make intelligent guesses about the sort of way the molecules function, and that it will do no harm to open the subject for discussion.

I shall assume, then, that there is some validity in the current ideas about molecular biology: that almost every biochemical process is catalyzed by a special enzyme; that all enzymes are proteins; that proteins (with the exception of cross-linking by S-S bonds) are unbranched polypeptides, made from a standard set of 20 amino acids; and that each one has its own precisely determined amino-acid sequence and is folded in a special manner which is essential for its activity. As to the nucleic acids, I shall follow the current “fashionable” ideas: that they constitute the most important part, if not the sole part, of the genetic material; that DNA is replicated by the complementary pairing mechanism; that the genetic information lies mainly in the exact sequence of bases of the nucleic acid; and that its main function is to control, in some way not yet understood, the amino-acid sequence of proteins. And I shall assume that the reader is tolerably familiar with all this (see the general references).

Let us first examine what properties we need for natural selection to operate. It is probably impossible to give an exhaustive set of abstract postulates; rather we will generalize from the type of system that nature has actually produced.

The first requirement appears to be for specific replication—that is, at some stage there must be a rather exact copying process. This need not necessarily be *direct*: *i.e.*, *A* might produce a copy *B*; *B* a copy *C*; and then *C* a copy like *A*. But I do not think it can be entirely “arithmetical.” By this I mean it is not enough just to have a master copy, from which are made subsidiary copies which cannot themselves be copied. It is not enough to have a printing press producing newspapers. There must be a mechanism by which the newspaper can be copied back into type. This kind of copying, in which a copy can itself be copied, I call “geometrical,” and for natural selection to operate, the process must be “geometrical” to some extent. The reason is obvious. Natural selection has two functions. It is in part a device to enable errors to be corrected (especially errors of replication), and since some errors are inevitable, the population must be able to eliminate them. But this very process of protecting against a downward drift gives the necessary mechanism for a positive evolution—*i.e.*, not merely a stabilization of the status quo but a progressive improvement in “fitness.” In order to do either of these jobs, the organism must replicate geometri-

cally so that errors can be eliminated without eventually diminishing the size of the population to zero.

The second requirement is that the mechanism should be able to copy a "mutation"—that is, to copy a special kind of mistake.

This property might not seem essential if an organism merely had to preserve the status quo, but it is necessary if the organism is to evolve. As I shall show, a rather simple way of doing this follows from the next requirement.

This third requirement is not quite as obvious as the first two, and yet it seems to me to be in the long run just as important. This is the requirement for "versatility." The population, if it is to survive in a hostile or indifferent world, must be able to perform a variety of functions, and in particular it must be able to carry out a great variety of chemical reactions. Thus the "genetic material"—the part of the organism that is copied geometrically—must be able to express itself chemically in many different ways; this is what I mean by "versatility." It obviously includes, among other things, the ability to metabolize.

It is not surprising, therefore, that in order to do this, organisms have evolved a "language." The genetic material must contain "information" to enable the organism to carry out its chemical acts, and it must contain a lot of it. A very efficient way of conveying information is to have a small number of different symbols, and to allow the linear *order* of the symbols to constitute the information: that is, by a language rather than, say, by a picture. The simplest copying process for a piece of such a language is one in which a copy is made letter by letter, without much reference to adjacent letters. This implies that if a mistake is made, and one letter is accidentally *substituted* for another, then this mistake is of such a type that it in its turn can be copied. This, as we saw, was the essential requirement for a "mutation" if it is to provide the raw material upon which selection can operate.

I think there is at least one further requirement for natural selection: it does seem as if the genetic material and at least some of its products must stay together in one place, so that they can act as a unit. This brings us to the idea of a "cell," with an outside and an inside; this implies membranes and, in molecular terms, lipids, but since they are outside my topic, I shall not pursue this further here.

Let us now look at the matter from the other angle—that of the macromolecules. Now I do not wish entirely to traverse familiar ground (for example that already covered in Crick, 1958). It is now widely appreciated that proteins and nucleic acids do indeed have some of the properties we expect of a language. Each is made from a small number of symbols (monomers) joined together in a linear order. The symbols (four for each of the nucleic acids, 20 for proteins) are universal throughout nature (with minor exceptions). For the proteins, at least,

the order of the monomers appears to be very precisely determined, and we have some grounds for believing that this is true for the nucleic acids. Thus if we concentrate on the *chemical* bonds of the macromolecules, we see that their "structure" is like that of a linear language.

What I want to consider here, however, is not the chemical bonding (their "primary structure") but the secondary and tertiary structure due to weaker bonds, such as hydrogen bonds, salt linkages, van der Waal forces, etc. In short, how they fold up and how the ways they can fold are related to their function.

Let us first consider the nucleic acids. We know rather little about the structure of RNA, but we have as evidence the double helix of DNA and the structure of the RNA-like polymers—the synthetic polyribotides—such as polyadenylic and polyuridylic acids, etc. An early review of the evidence is given in Crick (1957) and a more recent one by Rich (1959).

The remarkable fact emerges that so far there is no simple regular structure for nucleic acid *having only one chain*. We can have regular helices with two chains or with three chains wound helically around one another (so far none is known for certain to have four chains). Of course, a single chain might take up a "two-chain" type of structure by folding back on itself, but for the moment I am excluding such complications. Moreover, in all these structures, as far as we know, the chains are held together merely by weak bonds between bases on different chains.

When we come to consider proteins and synthetic polypeptides, we find just the opposite picture. No simple two-chain structure is known. We have one three-chain structure—that of collagen—but the chains are not held together very firmly, and there is some restriction on the amino-acid sequence (every third one must be glycine). In particular, interactions between the backbones are what mainly hold the structure together, though the interaction between pyrrolidine rings appears to help. It seems unlikely that the structure of collagen could ever be the basis for a simple, precise replication mechanism, based on the pairing of side-chains.

What we *do* find for polypeptides is that the simplest regular structure is of a *single* chain coiled helically on itself—the well-known alpha-helix—and we now have no doubt, thanks mainly to the work of Kendrew and his colleagues (1960), that the alpha-helix is important in globular proteins.

The significant point about the alpha-helix, however, appears to be its stability. The backbone itself is, in a loose sense, only marginally stable in water. That is, many sequences of side-chains will fold up into an alpha-helix, but it is possible, by the interaction of side-chains,

to interrupt the regular fold. This fact, and the existence of 20 types of side-chain rather than only four, allows the polypeptide chain to take up an enormous variety of different folds, depending at least in part on the amino-acid sequence. (Whether the fold depends on anything else remains to be seen.) Thus upon a rather simple chemical ground plan it is possible to build many different well-defined structures, and it is this that gives the proteins, as a class, their enormous versatility.

Can nucleic acid take up defined but complicated folds? Unfortunately we do not know, though we suspect not. What we do know is that the *functions* of nucleic acid appear rather limited (though this may, of course, merely reflect our ignorance), whereas the functions of proteins are extremely various and very delicately adjusted to any particular job. When we know just how DNA and RNA control the synthesis of proteins, as we believe they do, we shall be in a better position to assess the limitations imposed by the folding of polynucleotides.

It is easy to see, then, that with nucleic acid alone or with protein alone we would have great difficulty in meeting efficiently the demands of natural selection. With protein alone, the replication mechanism would have to be more complicated, since we cannot form a two-chain complementary structure—at least not, as far as we know, with the present side-chains. With nucleic acid alone, we could probably replicate quite nicely, but it would be difficult to use the nucleic acids as the basis for a vast family of enzymes. Life as we know it appears to be a symbiosis between these two very different families of polymers. Each—protein and nucleic acid—contributes its own particular capabilities, and the kinds of ways they can fold turn out to be a rather significant part of these capabilities.

When our knowledge of the biosynthesis and functions of these polymers is much more complete, and when we know the manner in which the nucleic acids and the proteins are linked symbiotically (the problems of protein synthesis, “coding,” etc.), it is reasonable to expect that other key features of biology will be explainable by basic molecular properties. For example, I have said nothing about the necessity for “particulate” rather than “blending” inheritance. Again, it seems highly likely that the general absence of the inheritance of acquired characteristics can be explained by the *irreversibility* of RNA and protein synthesis, produced by the large flow of free energy into the process needed to minimize mistakes. At bottom, it is the simplicity and universality of the basic operations of biochemistry that encourage one to look for the explanation of the general features of biology in simple molecular properties.

References

For general references, the reader is referred to the articles in the following works:

1. Oncley, J. L., ed., "Biophysical Science—A Study Program," *Review of Modern Physics*, January and April, 1959. Also in book form as *Biophysical Science* (N. Y., Wiley, 1959).
 2. *Structure and Function of Genetic Elements*, Brookhaven Symposium No. 12 (Upton, N. Y., Brookhaven National Laboratory, 1959).
 3. Anfinsen, C. B., *The Molecular Basis of Evolution* (N. Y., Wiley, 1959).
- Crick, F. H. C., 1957. "The Structure of the Nucleic Acids and Related Substances," in Allfrey, V. G., *et al.*, eds., *Cellular Biology, Nucleic Acids and Viruses*, N. Y. Academy of Sciences Special Publication No. 5 (N. Y., N. Y. Acad. of Sci.).
- Crick, F. H. C., 1958. "On Protein Synthesis," in "The Replication of Macromolecules," *Symp. Soc. Exp. Biol.* 12, 138.
- Kendrew, J. C., Dickerson, R. E., Strandberg, B. E., Hart, R. G., Davies, D. R., Phillips, D. C., and Shore, V. C., 1960. "Structure of Myoglobin," *Nature* 185, 422.
- Rich, A., 1959. "Polynucleotide Interactions and the Nucleic Acids," in *Structure and Function of Genetic Elements* (see reference 2, above), p. 17.

THE SYNTHESIS OF PROTEINS*

Mahlon B. Hoagland

MASSACHUSETTS GENERAL HOSPITAL

Galileo, at the end of his great work, *Discourses Concerning Two New Sciences*, wrote: "The door is now opened, for the first time, to a new method, fraught with numerous and wonderful results which in future years will command the attention of other minds." Workers in molecular biology today often find themselves experiencing a similar sense of awed awareness that doors are opening and that their new methods afford impressive power to explore what lies beyond. The discovery of bacterial transformation, the postulation and growing experimental verification of the structure of DNA, the deepening understanding of bacterial and viral genetics and of the specific influence of mutation on protein structure, and the increased understanding of the mechanism of nucleic acid and protein biosynthesis—these are exciting manifestations of a new era.

Protein may be said to be the ultimate expression of the genetic information residing in DNA, and an understanding of the mechanism by which DNA governs its synthesis is the goal of much of today's work in molecular biology. Generally, there are two broad ways of attacking the problem. One may examine natural or artificially induced alterations in an organism's DNA and note the resulting changes in the constitution of its protein, obtaining increasingly refined structural correlations. Or one may try to tease out the individual chemical events along the path of protein synthesis. The first approach starts from the

* Based on studies supported by grants from the U.S. Public Health Service, the U.S. Atomic Energy Commission, and the American Cancer Society. Publication No. 1041 of the Cancer Commission of Harvard University.

ends and works toward the middle (without necessarily asking questions about mechanism); the latter works in the opposite direction. Recent discoveries resulting from the study of protein synthetic mechanisms, concerning the role of RNA in protein synthesis, have helped to bring workers in these two areas of research much closer together. I would like to discuss these findings briefly today.

Let me first make some statements about protein synthesis which will serve to orient us. Substantiation for them may be found in the many reviews on the subject that have recently appeared. Particularly pertinent are the articles of Crick (1958), Chantrenne (1958), Zamecnik (1959), Gros (1960); and Hoagland (1960).

Kinetic studies in whole cells and in subcellular systems of both microbial and mammalian origin appear clearly to establish that amino acids appear first in peptide linkage in close association with the ubiquitous cellular particles, the ribosomes. Protein synthesized by ribosomes appears to be quickly removed to supply the cells' needs and free the synthetic site for further synthesis.

Ribosomes consist almost entirely of protein and RNA in equal amounts and have a molecular weight of the order of 4,000,000. Magnesium ions and, to a lesser extent, calcium ions are important to the maintenance of the structural integrity of these bodies, and in their absence the ribosomes dissociate to smaller subunits. The physiological significance of ribosomal dissociation is unknown, but even in the subunits the RNA is relatively highly polymerized (perhaps of molecular weight 500,000). The bulk of ribosomal protein is not that in process of synthesis, and hence it is thought to serve to maintain in some way the structure of the particle.

Ribosomes may carry out protein synthesis in the absence of a direct influence of DNA. This is borne out by studies on enucleated cells (*cf.* the review by Chantrenne, 1958). Ribosomal RNA and presumably the ribosome itself is metabolically a relatively stable cellular component, at least in certain rapidly growing cells (Scott and Taft, 1958), and, once made, it apparently is autonomous in supplying information for protein synthesis. Since DNA is the ultimate molecular repository of an organism's genetic constitution, information from DNA must in some way be supplied to the ribosomes. The most widely accepted current working hypothesis is that the linear order of the four nucleotide units of DNA in some way determines the linear order of the four nucleotide units of ribosomal RNA, which in turn specifies the linear order of the 20 amino acids in protein. It is implicit in this theory that the amino-acid sequence in a protein, *i.e.*, its primary structure, is the key determinant of the protein's genetic specificity. The simplest mechanism for bringing about this passage of information from DNA

to RNA would be a direct synthesis of ribosomal RNA on DNA in the nucleus in a manner analogous to the duplication of DNA itself.

The second step, the transfer of the genetic information of ribosomal RNA to protein, is the phenomenon I should like to focus upon, however. Amino acids must be activated before they are able to condense to form peptides, and it is now well established that this event is catalyzed in living systems by a group of amino-acid-activating enzymes, probably one for each of the 20 amino acids. The reaction involves the formation, from ATP and amino acid, of an aminoacyl adenylate compound, firmly bound to its specific activating enzyme, as shown in Figure 1. It is highly probable that this is the first step in protein biosynthesis.

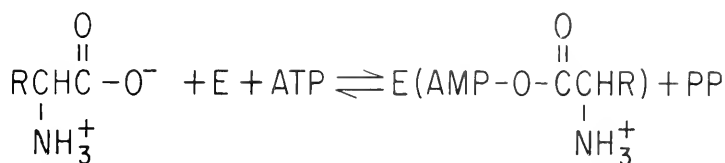

Figure 1.

These aminoacyl adenylate-enzyme complexes then participate in a reaction with a particular kind of cellular RNA, called transfer RNA (or soluble RNA), to bring about attachment of the activated amino acid to the RNA. This reaction may be formulated as shown in Figure 2.

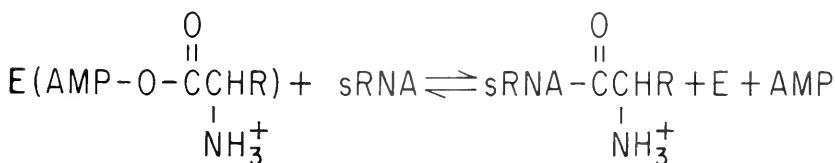

Figure 2.

During the past three years much of the detail of this presumed second step in protein synthesis has been brought to light. Transfer RNA appears to be a heterogeneous collection of RNA species, of molecular weight 15,000-40,000, each specific for a particular amino acid. The amino acids are linked to the terminal nucleotide residues of each RNA by esterification on the 2' or 3' ribose hydroxyl group. This linkage is of the "high-energy" type, since the two reactions by which the ester is formed are reversible (Figures 1 and 2). Thus the amino acids remain in the activated state.

It is known that the three terminal nucleotide residues of the transfer-RNA molecules are cytidylic acid-cytidylic acid-adenylic acid.

the amino acid being attached to the end adenylic acid. This grouping seems to be common to all of the transfer-RNA species, and therefore the specificity of amino-acid attachment must be governed by features of the molecules other than the common terminal grouping.

Transfer RNA, when charged with amino acids labeled with carbon 14, will serve as a source of these amino acids in ribosomal protein under appropriate experimental conditions. This reaction requires, besides ribosomes and transfer-RNA amino acid, GTP and soluble enzyme(s). (The role of GTP is still completely unknown.) Thus transfer RNA fulfills certain criteria for an intermediate in protein synthesis. This role is further supported by *in vivo* studies which show that transfer RNA becomes labeled with carbon 14-amino acids earlier than other cellular RNA or protein fractions (Hoagland *et al.*, 1958; Lacks and Gros, 1959); that this order of events is reversed when previously labeled cells are exposed to the unlabeled analogue of the labeled amino acid (Zamecnik, 1960); that the rate of labeling of transfer RNA is determined by the rate of protein synthesis, *i.e.*, the more rapidly amino acids are removed from transfer RNA by protein synthesis, the more rapidly new amino acids can attach to transfer RNA (Lacks and Gros, 1959).

None of these experiments, taken individually or as a whole, proves that transfer RNA is an obligatory intermediate in protein synthesis. However, the evidence is impressive enough to tempt one to think that such may be the case, and a working hypothesis has been offered to account for this finding (Crick, 1958; Hoagland *et al.*, 1959). The "adaptor" hypothesis states that amino acids, before entering the ribosomes, first react chemically with specific small polynucleotide molecules. These adaptor molecules accompany the amino acids into the particles and are responsible for properly locating them on the particle RNA. This is accomplished by pairing of the adaptor bases with complementary base sequences on the particle RNA. Having accomplished their mission, the adaptors then return to the soluble milieu. This hypothesis accounts for the specific attachment of amino acids to individual RNA molecules. It accounts for the fact that these events precede the appearance of amino acids in protein. It accounts for the ability of transfer RNA to serve as a source of amino acids in newly formed protein.

Most important, it offers a chemically attractive explanation for the precision of protein synthesis: the accuracy with which the amino-acid sequence is determined. For it makes the highly specific interaction of base pairs in nucleic acid responsible for locating the amino acid.

Two important implications of the transfer-RNA story need emphasis. The first is that the specific chemical interaction of amino acids and

nucleic acids for the first time presents a possible opportunity to attack directly the "coding" problem. Since transfer RNA is a linear polymer of four bases, it is a reasonable guess that the specificity of reaction with amino acids is a function of a sequence of bases somewhere in the molecule. If this is so, then it should ultimately be possible to relate the base sequence to amino-acid binding, to decipher the code in nucleic acid that defines each amino acid. The first step in the experimental approach is to fractionate transfer RNA into its component amino-acid-reacting species. Very encouraging progress is being made in this approach (Holley and Doctor, 1960; Zamecnik *et al.*, 1960). Once the pure species are isolated, the second step will be the degradation of the molecules to obtain base-sequence information.

The second implication of the transfer-RNA story is that it suggests, through the adaptor hypothesis, a reasonable chemical mechanism by which coded fragments of RNA might be used to arrange amino acids in a specific sequence in protein. The theory is being put to experimental test in a number of ways. One approach is a study of the species specificity in the interaction of transfer RNA and ribosomes. Since transfer RNA deals directly with amino acids and is not capable by itself of determining an amino-acid sequence, ribosomes of a given species should be able to make their own specific proteins using transfer RNA from any other species. Preliminary studies with ribosomes from reticulocytes appear to support this prediction (Lamfrom, 1960; Bishop *et al.*, 1960).

Another approach is to determine whether the transfer-RNA molecules actually accompany their bound amino acids into the ribosomes during the course of protein synthesis. This matter is actively under investigation, and it may be said that the amino-acid-bearing transfer-RNA molecules do appear to pass through the ribosomes (*i.e.*, become briefly indistinguishable from ribosomal RNA) during the course of the incorporation of the amino acids into protein (Zamecnik, 1960; Hoagland and Comly, 1960). C^{14} -amino acids attached to transfer RNA are also found transiently associated with ribosomal RNA during the incorporation process (presumably still attached to their transfer-RNA adaptors). There is, furthermore, no evidence of any substantial fragmentation of transfer RNA during the course of protein synthesis. More detailed kinetic analysis of the interaction of transfer RNA and ribosomes using transfer-RNA-amino acid labeled with P^{32} in its RNA moiety and C^{14} in its amino-acid moiety suggests that substantially all of the transfer-RNA molecule accompanies its attached amino acid into the ribosome. The picture is thus far consistent with the adaptor hypothesis.

It should also be possible to study the nature of the chemical linkage between transfer RNA and ribosomal RNA. Is there evidence of

hydrogen bonding between the two, does the transfer RNA actually polymerize in the ribosomes, and with which component is the amino acid associated before it enters peptide linkage?

It has frequently been noted that transfer RNA is of an unwieldy size for carrying out its adaptor role. Why should nature require so many nucleotides to specify the locus of one amino acid in a peptide chain? One appealing suggestion is that nature may require considerable redundancy of information in order to avoid errors (Yoshikawa, 1960). Were transfer RNA of too small a size, it would be unusually vulnerable to mutational change. This would be an intolerable situation, for transfer RNA deals only with amino acids, and a mutation in one of its species would affect the synthesis of all protein containing that amino acid. By requiring that many nucleotides specify the amino-acid locus, nature reduces the danger resulting from a mutational change of a single nucleotide.

It is clear that more questions can be raised than can be answered. It is also clear, however, that biology has advanced beyond the descriptive stage and that, at the molecular level, we may formulate hypotheses and subject them to increasingly critical experimental tests.

Note Added in Proof. The statements made in the foregoing require modification in the light of a series of new discoveries which suggest that ribosomes themselves are able to synthesize protein only in the presence of a "messenger RNA." This RNA is presumed to be a product of a structural gene determining the amino-acid sequence of a given protein. The messenger enters the cytoplasm and lays out its base sequence pattern on a ribosome, thereby conferring specificity on the latter. It is upon this messenger template that the protein is then made. Many of the observations are consistent with the postulate that the messenger has a brief functional period of existence. Thus a dynamic control is exerted by DNA over the process of protein synthesis.

We may briefly summarize the evidence supporting this new hypothesis. (1) It has long been observed that the base composition of the ribosomal RNA of a given species frequently does not reflect the base composition of its DNA. If most of the ribosomal RNA were involved in template function, one might expect a correlation between its structure and that of the DNA from the same source. (2) Upon phage infection of bacteria, there is a cessation of synthesis of bacterial (ribosomal) RNA, in spite of a rapid synthesis of new phage-specific protein. Concomitantly there is a sharp rise in turnover rate of an RNA component, existing in low concentration, having sedimentation properties different from either transfer RNA or ribosomes. This special RNA fraction reflects the base compositions of the invading phage DNA. It can also be shown, under appropriate conditions, to be reversibly associated with the ribosomes of the infected bacteria. (3) Numerous ex-

periments on the kinetics of induced enzyme formation in bacterial zygotes suggest that the rapidity of formation of new enzyme is far in excess of the rate at which new ribosomal RNA could be synthesized. The existence of a rapidly-turning-over messenger RNA, whose synthesis was initiated by the newly entering DNA, would account for the results. (4) 5-fluorouracil brings about a rapid alteration of the pattern of proteins synthesized by bacteria, before there is detectable incorporation of the analogue into ribosomal or transfer RNA. It is, however, rapidly incorporated into an RNA component having the properties described above. (5) Further study by Lamfrom of the hemoglobin synthetic system alluded to earlier reveals that the mixing of soluble components of reticulocytes from one species with ribosomes of another species results in the formation of *two* kinds of hemoglobin, each characteristic of the species from which the fractions were derived. This suggests that not only ribosomes, but also a factor not sedimenting as readily as ribosomes, has genetic determinative potentiality.

These findings taken together indicate that there may be an important step in protein synthesis, interposed between the soluble RNA-amino acid and the ribosome. The ribosome may function as a relatively non-specific platform upon which the true genetic message finds a favorable structural framework for performing its template function. It would then perhaps be the messenger RNA on the ribosome with which the transfer-RNA molecules interact. The ability of certain protein synthetic systems to function in the absence of DNA speaks for a certain degree of stability of the messenger RNA in its ribosomal locus. (For a more detailed discussion of these matters the reader is referred to the reviews of Jacob and Monod, 1961, and Berg, 1961).

References

- Berg, P., 1961. "Specificity in Protein Synthesis," *Ann. Rev. Biochem.* (in press).
- Bishop, J., Allen, E., Leahy, J., Morris, A., and Schweet, R., 1960. "Stages in Hemoglobin Synthesis in a Cell-Free System," *Fed. Proc.* 19, 346.
- Chantrenne, H., 1958. "Newer Developments in Relation to Protein Synthesis," *Ann. Revs. Biochem.* 27, 35.
- Crick, F. H. C., 1958. "On Protein Synthesis," in "The Replication of Macromolecules," *Symp. Soc. Exp. Biol.* 12, 138.
- Gros, F., 1960. "Biosynthesis of Proteins in Intact Bacterial Cells," in Chargaff, E., and Davidson, J. N., eds., *The Nucleic Acids*, Vol. III (N. Y., Academic Press).
- Hoagland, M. B., 1960. "The Relationship of Nucleic Acid and Protein Synthesis as Revealed by Studies in Cell-Free Systems," in Chargaff, E., and Davidson, J. N., eds., *The Nucleic Acids*, Vol. III (N. Y., Academic Press).
- Hoagland, M. B., and Comly, L. T., 1960. "Interaction of Soluble Ribonucleic Acids and Microsomes," *Proc. Nat. Acad. Sci.* 46, 811.
- Hoagland, M. B., Stephenson, M. L., Scott, J. F., Hecht, L. I., and Zamecnik,

- P. C., 1958. "A Soluble Ribonucleic Acid Intermediate in Protein Synthesis," *J. Biol. Chem.* 231, 241.
- Hoagland, M. B., Zamecnik, P. C., and Stephenson, M. L., 1959. "A Hypothesis Concerning the Roles of Particulate and Soluble Ribonucleic Acids in Protein Synthesis," in Zirkle, R. E., ed., *A Symposium on Molecular Biology* (Chicago, U. of Chicago Press).
- Holley, R. W., and Doctor, B. P., 1960. "Countercurrent Distribution of Amino Acid-Acceptor Ribonucleic Acids," *Fed. Proc.* 19, 348.
- Jacob, F., and Monod, J., 1961. "Genetic Regulatory Mechanisms in the Synthesis of Protein," *J. Mol. Biol.* (in press).
- Lacks, S., and Gros, F., 1959. "A Metabolic Study of the RNA-Amino Acid Complexes of *Escherichia coli*," *J. Mol. Biol.* 1, 301.
- Lamfrom, H., 1960. "Factors Determining the Specificity of Hemoglobin Synthesized in a Cell-Free System," *Fed. Proc.* 19, 350.
- Scott, J. F. and Taft, E. B., 1958. "The Conservation of Ribonucleic Acid by Ehrlich Ascites Tumor Cells," *Biochim. Biophys. Acta* 28, 45.
- Yoshikawa, S., personal communication.
- Zamecnik, P. C., 1960. "Historical and Current Aspects of the Problem of Protein Synthesis," in *Harvey Lectures, Series 54* (N. Y., Academic Press).
- Zamecnik, P. C., Stephenson, M. L., and Scott, J. F., 1960. "Partial Purification of Soluble RNA," *Proc. Nat. Acad. Sci.* (in press).

VIRUS-INDUCED ACQUISITION OF METABOLIC FUNCTION*

Seymour S. Cohen

UNIVERSITY OF PENNSYLVANIA

The detailed chemical study of the course of bacterial virus multiplication has been in progress slightly less than 15 years, antedating the chemical study of the multiplication of animal and plant viruses by about a decade. This pioneering role for the bacteriophage systems stems from their exceptionally favorable attributes in such matters as ease of cultivation and assay of host and virus, establishment of the time and multiplicity of infection, etc. Of some historical interest is the fact that the bacterial viruses subjected to the most detailed chemical exploration (*i.e.*, the T-even phages T2, T4, and T6) are biochemical freaks. The unique properties of these phages have contributed to their extreme virulence, which in itself has facilitated the study of these viruses.

In my laboratory our problems were posed initially in the somewhat trivial terms of the molecular mechanism of the extremely virulent activity of the T-even phages of *Escherichia coli*. Many other laboratories have developed their problems in the more general terms of the molecular bases of inheritance for these same phages. In the last three years, the problems of virulence in these systems have been more or less solved in terms of the discovery of a series of rapid syntheses of many enzymes and proteins controlled by the insertion of viral DNA into the infected bacterium. Thus the problems of the virulence of these phages can now be posed in the terms and problems of molecular genetics. Our progress in this area has now catapulted us into the same pot of molecular biology in which almost everyone else is stewing. In this paper we shall summarize the unifying studies of the

* *The work performed in the author's laboratory has been aided greatly by grants from the Commonwealth Fund and the Upjohn Company.*

past few years on virus-controlled synthesis of enzymes and some other proteins in infected *E. coli*.

Early data on polymer synthesis in infected cells

Until 1952 it was thought that the T-even viruses might merely redirect the existing metabolic machinery of the bacterium to the production of virus by replacing a set of critical bacterial templates with viral templates. Thus infected cells could no longer divide, nor could they be induced to produce β -galactosidase (Monod and Wollman, 1947). Nevertheless, respiration and assimilation into polymeric substance appeared to continue at the same rate after infection as before infection (Cohen and Anderson, 1946). If one concentrated on the fate of assimilated P, for example, this now was directed almost entirely toward the production of viral DNA, while the net synthesis of RNA, the nucleic acid present in largest amount in the bacterium, stopped. The discovery of the new and unique pyrimidine HMC, 5-hydroxymethyl cytosine (Wyatt and Cohen, 1952, 1953), for the first time led to the suspicion that the virus might be contributing another qualitatively new element, *i.e.*, the ability to control a metabolic function which perhaps did not exist at all in the uninfected bacterium.* This function was one essential to viral duplication in providing a new base, a pyrimidine without which viral DNA could not be made.

Almost from the beginning of chemical study it had been appreciated that there was a mystery in protein synthesis in infected cells. As shown in Figure 1, protein synthesis continued from the inception of infection (Cohen, 1947); however, very little of the protein which was formed before viral DNA synthesis began appeared in the virus eventually liberated (Hershey *et al.*, 1954; Watanabe, 1957). Was this bacterial protein which continued to be synthesized? For example, it is known that infection causes a leak in the permeability barrier of the cell and that there is a subsequent repair (Puck and Lee, 1955). It was possible that this repair involved protein synthesis.

It was demonstrated first by means of the specific analogue, 5-methyl tryptophan (Cohen and Fowler, 1947; Burton, 1955) and subsequently with chloramphenicol (Tomizawa and Sunakawa, 1956;

* Although it had been known that deoxyribonuclease is markedly increased in amount after infection with certain viruses, and that this increase is inhibited by chloramphenicol and thienylalanine (Pardee and Williams, 1952; Kunkee and Pardee, 1956), this effect was most frequently attributed to the activation of pre-existing enzyme rather than to a *de novo* synthesis of the enzyme (Kozloff, 1953; Kunkee and Pardee, 1956). This preference probably reflected in large part the intellectual climate at the time of these problems, although evidence for both possibilities had been obtained. Whether one or the other or both are correct has not yet been established.

Hershey and Melechen, 1957) that the early synthesis of protein was essential to the synthesis of viral DNA. Indeed, once this protein was made, the inhibition of further protein synthesis did not block the production of functionally active viral DNA (Burton, 1955; Hershey and Melechen, 1957). It could therefore be asked what function was fulfilled by this early protein, which was not itself a component of virus but was nevertheless essential to the production of viral DNA. One obvious suggestion was that the early protein was involved in the formation of HMC. Having conceded the possibility of the expansion of the metabolic machinery, it could also be suggested that other enzymes might be made, particularly those which might account for the enormous stimulation of DNA synthesis observed on infection.

In Figure 1 it can be seen that there is no net synthesis of RNA. The use of radioactive phosphorus (P^{32}) then showed an incorporation of this isotope into the RNA fraction which was only 2 per cent of the incorporation into DNA (Cohen, 1947). This result has been confirmed many times, but although it was initially concluded that this amount of isotope in the RNA fraction reflected a contamination of the RNA, Volkin and Astrachan (1957) have shown rigorously that the labeled phosphorus is indeed in RNA. This newly synthesized material is a

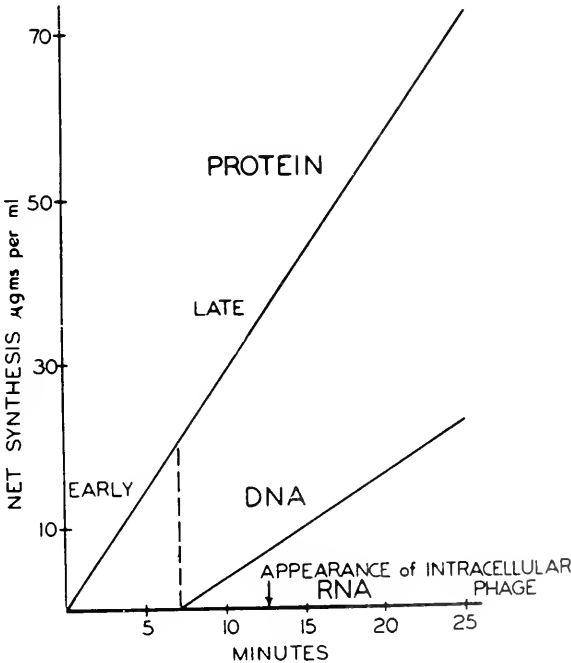

Figure 1. Time course of polymer syntheses in *E. coli* infected by T-even phages.

chemically unique type of RNA whose base composition mimics that of viral DNA. In addition, this RNA has an active turnover, in which the ribose nucleotides are converted to deoxyribonucleotides of viral DNA (Volkin and Astrachan, 1957). It has been a difficult problem to demonstrate a function for this RNA, but it has now been shown that the early steps of phage multiplication, which exclude DNA synthesis, require pyrimidines and adenine, presumably for RNA (Pardee and Prestidge, 1959; Volkin, 1960).

It can be seen in Figure 1 that DNA synthesis in infected cells stops for some minutes. DNA synthesis resumes at a markedly stimulated rate which in some media (*e.g.*, lactate) appears to compensate for the RNA which no longer accumulates (Cohen, 1947). The new DNA made after infection is entirely viral, containing HMC and lacking cytosine (Hershey *et al.*, 1953; Vidaver and Kozloff, 1957).

The significance of HMC

The existence of the new base in viral DNA, and the lack of cytosine found normally in bacterial RNA and DNA, suggested that hydroxymethylation of cytosine to HMC converted the former base to a form unsuitable for normal bacterial synthesis. As we shall see, dCTP essential to the synthesis of bacterial DNA is indeed converted very efficiently in infected cells to dCMP, the precursor of the HMC deoxyribonucleotide, dHMP. Virulence and parasitism in this system are thus exhibited at the molecular level by appropriating a normal essential nucleotide for the formation of a unique viral metabolite. It should be noted that the host DNA is degraded in infection and the dCMP therein contained is freed and converted to viral pyrimidine (Kozloff *et al.*, 1951; Weed and Cohen, 1951).

In the studies on the isolation of HMC derivatives from viral DNA, it was soon observed that nucleotides containing this base were present in a structure which resisted enzymatic release (Cohen, 1953). Several workers (Volkin, 1954; Sinsheimer, 1954; Jesaitis, 1957) then showed that in viral DNA, HMC was glucosylated at the hydroxymethyl group. It appears that the presence of glucose does indeed protect to a considerable extent phosphodiester bonds involving dHMP. Thus viral DNA carries a significant molecular mechanism for self-protection when present in the DNase-rich medium in the infected cell. However, this may not be the sole reason for the survival of viral DNA.

In addition, we can note that although the base compositions of the HMC viruses, T2, T4, and T6, are essentially identical (Wyatt and Cohen, 1953), the glucose contents of these viruses differ considerably (Jesaitis, 1957). Thus, T6 contains mainly large amounts of diglucosyl derivatives of HMC plus non-glucosylated HMC; T4 contains only the

monoglucosyl HMC; while T2 contains mainly monoglucosylated and non-glucosylated HMC. HMC has thereby been implicated in mechanisms of parasitism and virulence, survival, and speciation among the T-even viruses.

The biosynthesis of thymine and hydroxymethyl cytosine. In exploring the biosynthesis of viral pyrimidine, it was found that exogenous orotic acid and pyrimidine of host DNA could be converted to viral HMC and thymine. The $-CH_2OH$ and $-CH_3$ of the latter bases were derived from the β -carbon of serine (Cohen and Weed, 1954). The methyl group of thymine did not come from the methyl of methionine (Green and Cohen, 1957). A series of nutritional experiments with bacterial mutants and competition experiments with infected cells then revealed that the addition of the one-carbon fragments to form viral bases did not occur at the level of free bases or nucleoside. In order to test the syntheses at the nucleotide level it was necessary to study these possible reactions in cell-free extracts.

Friedkin and Kornberg (1957) demonstrated the presence of an enzyme, thymidylate synthetase, in extracts of normal *E. coli* which produced thymidylate (dTMP) from deoxyuridylate (dUMP), formaldehyde, and tetrahydrofolic acid (THFA), as presented in Figure 2. Testing for similar reactions with deoxycytidylate (dCMP) in normal and T2-infected *E. coli*, it was possible to show that with dCMP

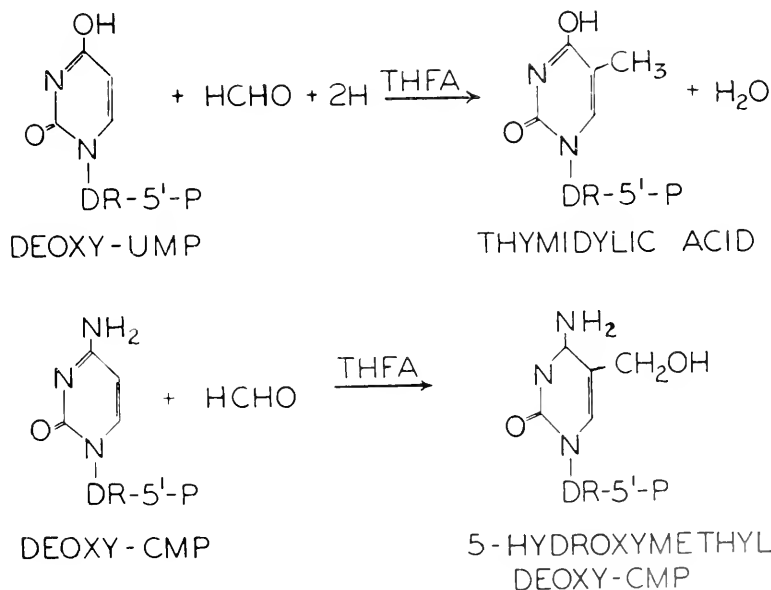

Figure 2. The utilization of formaldehyde in the enzymatic synthesis of thymidylate and 5-hydroxymethyl deoxycytidylate.

as a substrate, only extracts from infected cells were capable of fixing C^{14} -formaldehyde in an acid-stable form to yield hydroxymethyl deoxycytidylate (dHMP), as in Figure 2 (Flaks and Cohen, 1957, 1959a).

Although thymidylate synthetase was indeed present in uninfected *E. coli* strain B, it was shown to be markedly increased in phage-infected bacteria (Flaks and Cohen, 1957, 1959b). The mechanism of the reaction forming thymidylate does not appear to involve a free hydroxymethyl derivative, unlike the reaction which produces dHMP (Friedkin, 1959; Flaks and Cohen, 1959b). However, it was observed that hydroxymethyl deoxyuridylate and thymidylate were generated to a small extent during the conversion of dCMP to dHMP (Flaks and Cohen, 1959b). This has been shown to be due to the appearance of a third enzyme, dCMP deaminase, in infected cells (Flaks, unpublished results) which not only deaminated dCMP but also deaminated dHMP. The appearance of this enzyme in virus infection has also been described recently in another laboratory (Keck *et al.*, 1960).

Properties of the dCMP hydroxymethylase. Three assays have been developed for the enzyme, based on the fixation of C^{14} -HCHO to dCMP to form radioactive dHMP (Pizer and Cohen, 1960a). The ion-exchange method developed by Somerville *et al.* (1959) is the simplest and most accurate of the three and is the method of choice at present in following purification and other properties of the enzyme. The hydroxymethylase is completely inactive on cytosine ribonucleotide; however, cytosine arabinonucleotide appears to possess of the order of 0.6 per cent of the substrate activity of dCMP (Pizer and Cohen, 1960b). Using a purified enzyme preparation, the following K_m values have been determined: 6×10^{-4} M for dCMP, 1.5×10^{-3} M for formaldehyde, and 1×10^{-4} M for THFA.

The separation of the hydroxymethylase and the thymidylate synthetase may be effected easily; the former enzyme is far more stable (Flaks and Cohen, 1959b). A much greater degree of purification of the hydroxymethylase was accomplished on a diethylaminoethyl (DEAE) cellulose column, as described by Kornberg *et al.* (1959) and in some greater detail by Pizer and Cohen (1960a). Figure 3 presents the elution from the column of the protein and enzyme derived from infected cells in 40 liters of Biogen culture containing 10^9 infected bacteria per ml. Phage multiplication was stopped at 15 minutes by addition of chloramphenicol to the culture, which was expelled onto ice, and the cells were collected by centrifugation. The infected cells (40 to 50 gms. wet weight) were frozen and thawed and extracted twice in the Waring Blendor for one minute in 250 ml. 0.05 glycylglycine buffer pH 7.2 (0.001 M with respect to glutathione). The extract, containing about four grams of protein, was centrifuged at 30,000 rpm for 30 minutes, and after removal of nucleic acids by precipitation with strepto-

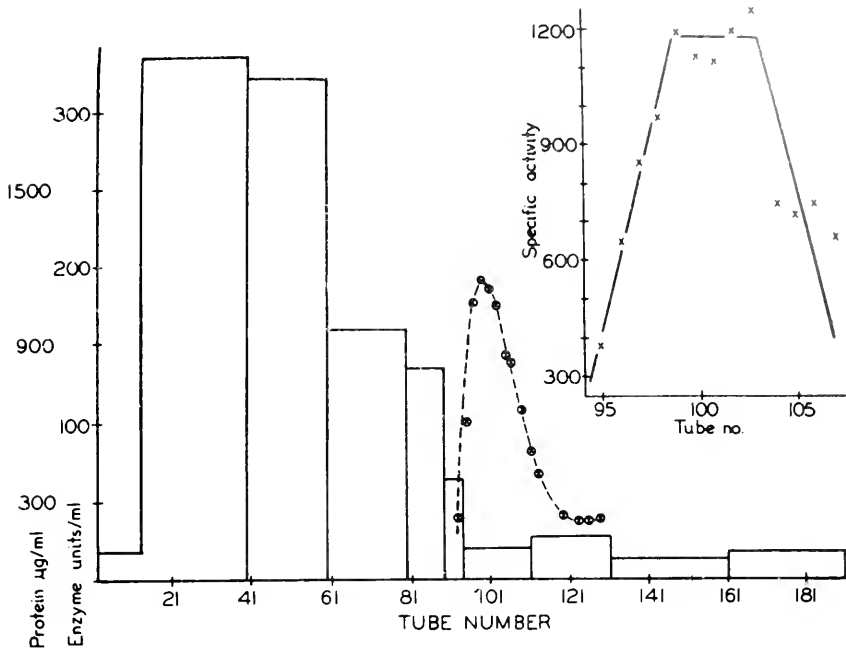

Figure 3. The isolation of the deoxycytidylate hydroxymethylase by elution from a DEAE column. Dotted line = enzyme.

mycin, the fractionation of DEAE cellulose was effected using two linear-gradient elutions with phosphate buffer.

As can be seen in Figure 3, a peak of enzyme activity is obtained at a low point in the protein elution, and the central tubes of this peak have a constant specific activity. The values presented in the graph were obtained for the purified fractions in this peak about 16 days after infection, and about nine days after separation on the column. Specific activities of 2,200 were obtained by the column assay for key tubes eight days before the time for the assays indicated on the chart. Extrapolation to the earliest point in the fractionation suggests specific activities for the enzyme of the order of 5,000, a value slightly lower than that obtained by Kornberg *et al.* (personal communication), which was 6,000, using the original, less reliable assay of Flaks and Cohen (1959a).

The peak tubes were pooled, concentrated, and examined by analytical ultracentrifugation and electrophoresis in 0.02 M KPO_4 buffer pH 7.4, 0.1 M with respect to KCl. Two components of 85 per cent and 15 per cent were observed in both analyses. The major component had an $S_{20,w}$ of 4.4 and mobility of -5.4×10^{-5} cm² volts⁻¹ sec⁻¹. The minor component had an $S_{20,w}$ of 25 and a mobility of -9.3×10^{-5} cm² volts⁻¹

sec⁻¹. Analysis of the specific activities in the peak of enzyme elution indicates that the enzyme would probably be a major protein component. From the $S_{20,w}$ for this component, assuming a frictional ratio of 1, a molecular weight of 49,000 and a turnover number of the order of 125 moles dCMP per mole of enzyme per minute have been calculated.

With these numbers we may estimate the number of enzyme molecules per cell. In the Biogen experiment, 10^{10} infected cells gave rise to about a milligram of extract protein capable of converting 0.3 micromole of dCMP in 20 minutes. It can be calculated that an infected cell contains about 8,300 molecules of hydroxymethylase in 15 minutes or produces about nine molecules of enzyme per second over a 15-minute interval. Since the appearance of enzyme occurs at almost a constant rate, it can be calculated that at the time DNA synthesis begins (about seven minutes), the hydroxymethylase content of the cells can maintain a rate of dHMP synthesis sufficient to produce 120 T2 virus particles per cell if continued for 14 minutes. This value is quite close to the usual yield of a T-even phage per cell in a one-step growth experiment in the media used.

We can now ask whether any active enzyme is to be found in uninfected cells. In order to test this, it has been necessary to run assays with approximately 2×10^7 cpm per assay tube or 2.4 micromoles of C¹⁴-H₂O at 7 μ c per micromole. Extracts of uninfected cells were prepared and amounts of protein (1.6 to 4.7 mg.) were used derived from 8.2×10^9 to 2.6×10^{10} cells. Among the blanks used were the reaction mixture minus protein, and the reaction mixture with an extract lacking added dCMP. In another control, the reaction mixture was run with an extract of infected cells. The expected activity of enzyme was obtained in spite of unusual radioactivity of HCHO used. After 20 minutes, 0.55 micromole dHMP was added as carrier, and this substance was purified initially on Dowex 50 - H⁺ and subsequently by paper chromatography in isobutyrate-NH₄OH. The nucleotide was hydrolyzed, and the free HMC was purified by paper chromatography in butanol-NH₄OH and isopropanol-HCl. The purification steps for carrier HMC are summarized in Table I. It can be seen that after the final chromatography, the activity present in carrier HMC in all assays was far less than could be expected on the hypothesis that the cells contained at least one molecule of dCMP hydroxymethylase per cell. Furthermore, there was no suggestion of a trend in fixation as the amount of cell protein was increased. It may be remarked that the exclusion of activity for one molecule of enzyme in any auxotroph or otherwise "deficient" bacterium does not seem to have been reported previously.

Biosynthesis of dCMP hydroxymethylase. Enzyme cannot be detected in uninfected cells, but it is found in large amount in all infected cells (8,300 molecules per cell, or 0.7 per cent of the protein extracted

TABLE I
Exclusion of active dCMP hydroxymethylase in *E. coli*

Assay Tube mg. protein*	Chromatography			Expected cpm for 1 molecule of enzyme per cell
	Nucleotide	Free base		
	Isobutyrate - NH ₄ OH	Butanol - NH ₄ OH	Isopropanol - HCl	
	cpm per 0.55 micromole			
0	6020	960	67	0
1.56	5060	440	34.5	251
3.12	5220	288	8.5	502
4.68	3780	332	15.5	753
3.12 + 0 dCMP	1560	120	1.2	0

* 1 mg. of protein = 5.6×10^9 cells. One molecule of enzyme (TN 125) per cell would produce 2.3×10^{-5} micromoles of dHMP per mg. of protein per 20 minutes. Formaldehyde -C¹⁴ was used at 7×10^6 cpm per micromole.

at 15 minutes), since each infected cell can give rise to virus containing HMC. Several possibilities can be visualized concerning the appearance of the enzymatic activity.

1. The virus injects the enzyme. In addition to the fact that we have been unable to detect enzyme in disrupted virus preparations (Flaks *et al.*, 1959), it can be calculated that the weight of the enzyme found in infected cells (7×10^{-16} gm.) approximates the entire weight of a T-even phage ($5 - 7.5 \times 10^{-16}$ gm.). This hypothesis does not appear reasonable.

2. The enzyme is present in uninfected bacteria in an inhibited state. We have disrupted bacteria in a variety of ways without revealing enzymatic activity. In addition, we have mixed and incubated extracts of infected and uninfected cells without inhibiting enzymatic activity or producing an increase in this activity (Flaks *et al.*, 1959). This shows the absence of excess inhibitor in uninfected cells and the absence of a system in extracts of infected cells capable of activating the hypothetical inhibited complex in uninfected cells.

3. The enzyme is synthesized after insertion of the phage contents into the bacterium. The conditions required for the appearance of the dCMP hydroxymethylase bear on this hypothesis.

- a. Infection must be effected with a T-even phage; enzyme is not formed during infection with other T phages, such as T1 or T5, or after induction of a lysogenic system such as K12-lambda (Flaks *et al.*, 1959). Thus infection with HMC phage is required for the development of the activity.

- b. Osmotically shocked ghosts of T-even phages, although capable of adsorbing to the bacteria and affecting bacterial metabolism, cannot induce enzyme. The contents of the phage head are therefore essential for the appearance of enzyme. These contents consist mainly of DNA and small amounts of a specific internal protein (Levine *et al.*, 1958), a polypeptide (Hershey, 1957), and polyamines (Ames *et al.*, 1958). The polyamines may be replaced by other cations in the phage without affecting phage viability (Ames and Dubin, 1960).
- c. The contents of the phage head do not contain free pyrimidine deoxyribonucleotides (Flaks *et al.*, 1959), which might be imagined to induce the biosynthesis of the hydroxymethylase.
- d. As presented in Figure 4, ultraviolet-irradiated phages induce the appearance of the enzyme in normal amount under conditions (15 hits, virus:cell = 4) in which virus cannot multiply* nor induce the formation of DNA (Flaks *et al.*, 1959). This work has been extended to a study of single infection with irradiated phage using the column assay. It appears that the site in the phage that controls the appearance of enzyme has a sensitivity to ultraviolet light about 1/20 that of all the sites that control

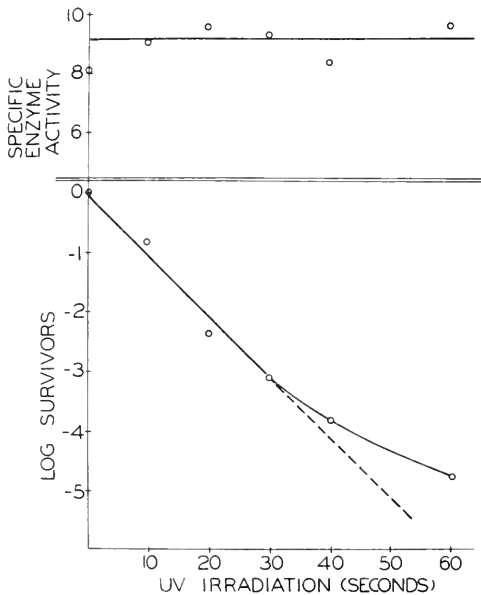

Figure 4. The effect of ultraviolet irradiation of virus on hydroxymethylase formation. Cells were multiply infected with virus irradiated to varying levels of survival. The enzyme contents of such infected cells were determined.

* *E. coli* strain W will adsorb T2 and be killed by this phage without giving rise to DNA and virus (Fowler, unpublished results; Cohen, 1953). Despite the abortive quality of the infection, this strain will produce dCMP hydroxymethylase (Pizer and Cohen, unpublished results).

virus multiplication (N. Delihias, personal communication). Assuming that the target for ultraviolet inactivation is phage DNA, all the major portions of which are equally sensitive to radiation, it may be suggested that the portion of DNA controlling hydroxymethylase synthesis is a small fraction (perhaps about 1/20) of the total DNA; but nevertheless this site is quite large (about 10,000 nucleotide pairs, or a molecular weight of about 6×10^6).

It is essential, therefore, to insert a large viral polynucleotide into the bacterium. Unfortunately, this cannot yet be done with isolated DNA. Once the DNA has entered the cell, enzyme appears at an almost constant rate for ten to 15 minutes. It has been shown that protein synthesis is essential for enzyme production (Flaks *et al.*, 1959). Thus, if protein synthesis is blocked by 5-methyl tryptophan, as in Figure 5, or by deprivation of an amino-acid-requiring mutant, enzyme production does not occur. Enzyme synthesis can be started by later supplying the appropriate amino acid to the inhibited or deprived cell. Thus the prerequisite of protein synthesis prior to synthesis of viral DNA is indeed explained in part by the requirement of protein synthesis for the appearance of the dCMP hydroxymethylase. Nevertheless, it can still be supposed that the protein synthesized is not the enzyme itself but rather a protein necessary to free the pre-existing inhibited enzyme or otherwise activate an inactive or incomplete enzyme. Although we do

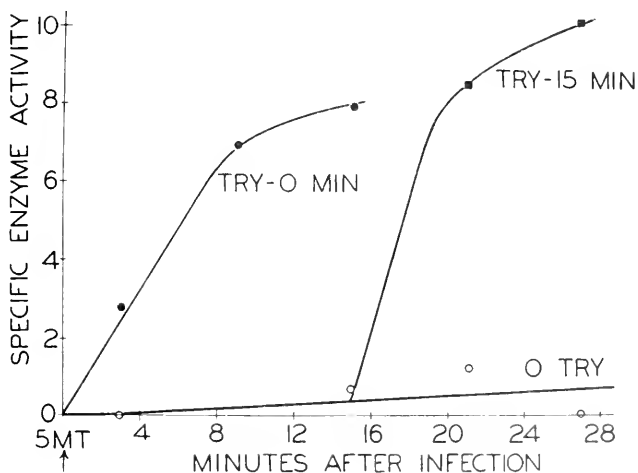

Figure 5. The effect of 5-methyl tryptophan on formation of hydroxymethylase. 5 MT = 5 methyl tryptophan. Try = tryptophan. Cells were infected in the presence of 5 MT, and tryptophan was added in two systems at different times and omitted in a third system. The development of the hydroxymethylase was determined.

not think that this is likely, we are currently attempting to disprove this by demonstrating a *de novo* synthesis of the enzyme from metabolites supplied exogenously after infection.

Biosynthesis of thymidylate synthetase. Our studies with this enzyme originated in part as a result of the similarities of the early methods of assay for synthetase and hydroxymethylase (Flaks and Cohen, 1957). Measuring the fixation of acid-stable $C^{14}H_2O$, it was shown that: (1) this enzyme was normally present in *E. coli* capable of synthesizing thymine; (2) the enzyme rapidly increased six- to seven-fold during infection of strain B with T2; (3) the increase did not occur on infection with ghosts; (4) the increase of enzyme required protein synthesis (Flaks and Cohen, 1959b).

Extending this work, we explored thymine-requiring mutants, which had been observed to synthesize thymine after infection with T2 (Barner and Cohen, 1954) and T5 (Crawford, 1959). Using a sensitive carrier assay, it was shown that although the extracts of thymine-requiring strains lacked the synthetase, infection with T2 or T5 resulted in the extensive production of the synthetase (Barner and Cohen, 1959). It was found that in infections with T5, a virus which does not contain HMC, production of the synthetase occurs without a concomitant production of the dCMP hydroxymethylase. Indeed, production of the synthetase in T5-infected cells exceeds that in T2-infected cells.

We have obtained two very active inhibitors for this enzyme, which is crucial in the economy of most cells. In the absence of thymidylate synthesis and exogenous thymine, a normal synthesis of DNA cannot occur. The unbalanced cell growth which then ensues results in the irreversible loss of the ability to multiply, or "thymineless death" (Barner and Cohen, 1954). Such a situation can be provoked by 5-fluorouracil deoxyriboside in many cells, including tumors, since the nucleotide, fluorodeoxyuridine-5'-phosphate (F-dUMP) is a potent inhibitor for thymidylate synthetase (Cohen *et al.*, 1958). Fluorouridine-5'-phosphate is essentially inactive.

In the search for a fluorouracil nucleoside which is less readily degraded by the mammal, Dr. J. Fox of the Sloan-Kettering Institute has synthesized D-arabinofuranosyl 5-fluorouracil, and we have prepared the 5'-phosphate of this nucleoside by an enzymatic method. This new nucleotide (F-aUMP) is also an inhibitor of thymidylate synthetase, although 1/100 as potent as F-dUMP. In the study of compounds which can provoke thymineless death by this mechanism, T2 or T5 virus-infected bacteria are easily the best source of the thymidylate synthetase.

The production of thymidylate synthetase can be controlled by three chemically different DNAs. These are the cytosine-containing DNA of strain B, the HMC-containing DNA of T-even phages used to

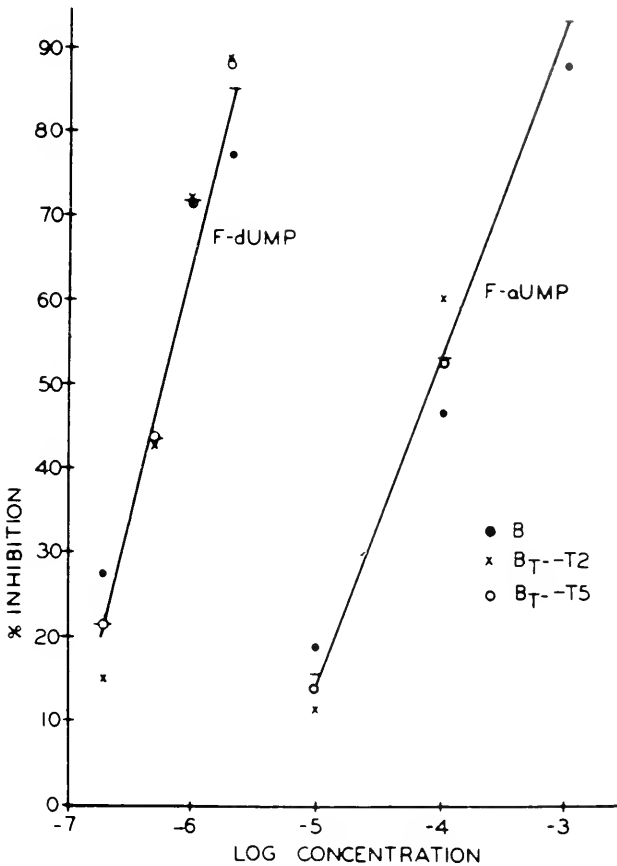

Figure 6. The inhibition of two fluorouracil nucleotides on thymidylate synthetases induced by chemically different DNAs. F-dUMP = Fluorodeoxyuridine-5'-phosphate. F-aUMP = D-arabinofuranosyl fluorouracil-5'-phosphate.

infect strain B_T, and the cytosine-containing DNA of T5.* It was therefore of interest to see if the three forms of the enzyme were different, and the two inhibitors, F-dUMP and F-aUMP, were used to compare the sensitivities of the active sites of the enzyme in extracts of strain B and of virus-infected B_T. Miss H. D. Barner has recently improved the assay very considerably for these experiments. As can be seen in Figure 6, the active sites of the bacterial enzyme and two

* Of course we cannot state that there are chemical differences between the fractions of *E. coli* DNA and T5 DNA which control the production of this enzyme, but the over-all compositions of the total DNAs of these forms are quite different (Wyatt and Cohen, 1953).

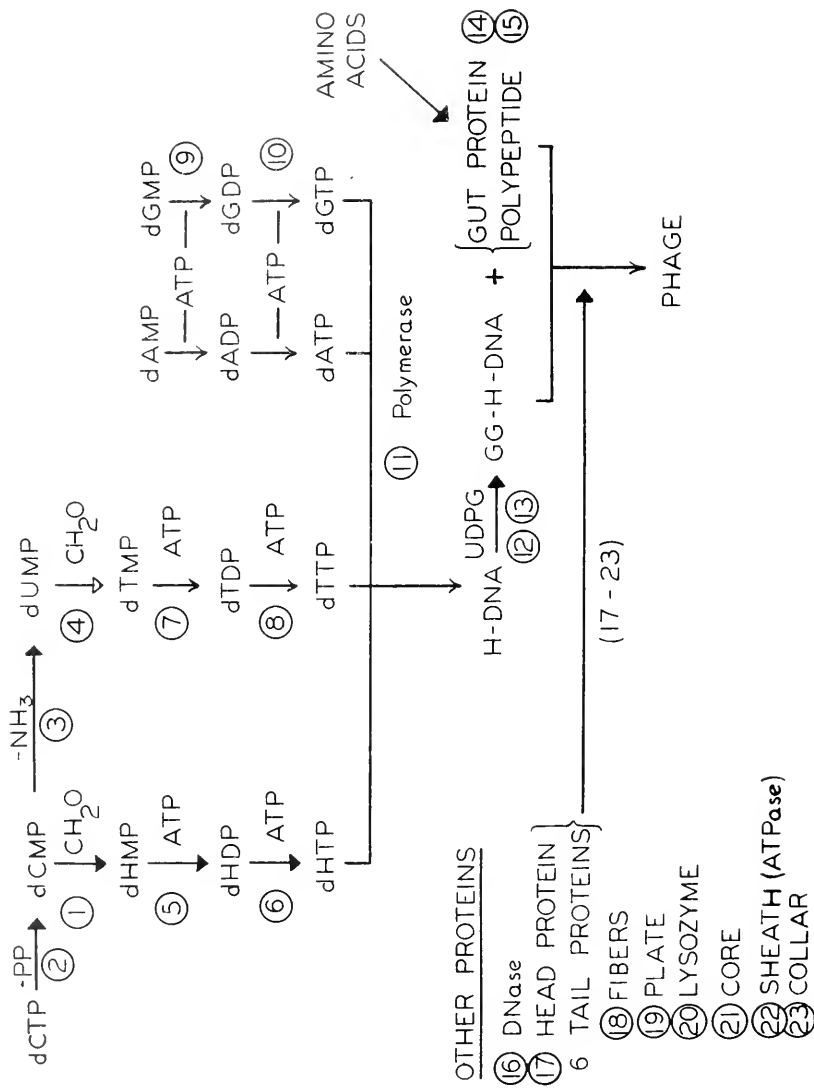

Figure 7. New and stimulated reactions in T6 infection. Circled numbers = new or stimulated units. Filled-in arrows = new proteins. Hollow arrows = either stimulated or new enzyme.

viral-induced types of thymidylate synthetase are indistinguishable by this test.

Other virus-induced enzyme and protein syntheses. In Figure 7 is presented a summary of new and stimulated syntheses induced in infection by a T-even phage. After the initial description of the appearance of the three systems presented above, dCMP hydroxymethylase, thymidylate synthetase, and dCMP deaminase, a number of other laboratories undertook to study a cellular system in which the insertion of a chemically unique viral DNA induced the rapid production in all cells of many unique enzymes essential to the rapid multiplication of the viral DNA and many other viral-specific proteins. Many questions could still be posed concerning the exclusion of cytosine and the steps involving purine nucleotides, DNA polymerase, glucosylation, etc., in the synthesis of virus DNA.

In testing to see whether the DNA polymerase of T2-infected cells was specific for HMC nucleotides, it was observed that infected cells elaborated a specific dCTPase, which removed pyrophosphate from dCTP to form dCMP (Kornberg *et al.*, 1959; Koerner *et al.*, 1959; Somerville *et al.*, 1959). Thus a compound essential for the formation of bacterial DNA was eliminated, *i.e.*, dCTP, providing the dCMP essential for the formation of dHMP via the hydroxymethylase. The dCTPase is not produced in T5 infection.

According to Koerner (personal communication), the activity of dCTPase in T2-infected cells is ten times as much as is necessary to generate the dCMP as a substrate for hydroxymethylation. It may be pointed out as well that this is also consistent with the possibility that all deoxyribotides are derivable via cytosine nucleotides.

Several laboratories (Somerville *et al.*, 1959; Kornberg *et al.*, 1959) have also described the phosphorylation of dHMP and the production of dHDP and dHTP. Although I have presented this as two new steps, in this reaction and indeed in the activation of all the deoxyribonucleotides to the triphosphate level, it is not certain that two separate specific enzymes are involved. The dCMP kinase of *Azotobacter vinelandii* forms only the diphosphate (Maley and Ochoa, 1958), and the conversion of dCDP to dCTP can be effected by phosphoenol pyruvate and pyruvic kinase. It would be of interest to know whether pyruvic kinase fulfills this role in infected cells for other deoxynucleoside diphosphates. The dCMP kinase is not produced in *E. coli* after T2, T3, and T7 infections; however, a marked increase in activity appears in T5 infection (Kornberg *et al.*, 1959, Bessman, 1959).

Ten- to twenty-fold increased activities have also been observed in T2, T4, T6, and T5 infection for dCMP kinase and dTMP kinase but not for dAMP kinase. The last appears to be present in uninfected cells in excess (Kornberg *et al.*, 1959, Bessman, 1959). The increase in

thymidylate kinase is blocked by chloramphenicol, suggesting the synthesis of protein (Bessman, 1959). As in the case of the thymidylate synthetase described above, it may be asked whether the increase in these kinases represents more of the old enzymes or of new types of polypeptides having similar active sites. Bessman and van Bibber (1959) have reported that the dGMP kinase formed after infection no longer has the requirement for K^+ that is characteristic of the kinase formed before infection.

Given the dHTP and the other normal triphosphates, several groups (Kornberg *et al.*, 1959; Koerner *et al.*, 1959) have studied the polymerase present after infection and its activity in the synthesis of a DNA-containing HMC. About a ten-fold increment has been seen in the DNA polymerase, and the purified enzyme of both uninfected and infected cells appears to be able to handle dCTP as well as dHTP. In these tests heated DNA derived from T2 or calf thymus can be used interchangeably.

Koerner *et al.* (1959) have prepared a monoglucosyl dHTP and have observed that this does not participate in the reaction with DNA polymerase. On the other hand, DNA-containing HMC, generated from dHTP and DNA polymerase, can be monoglucosylated in part by UDPG in the presence of a new enzyme formed in bacteria infected by T2 (Kornberg *et al.*, 1959). Extending this important observation (A. Kornberg, personal communication), it appears that two separable enzymes are formed in T4-infected cells—one which adds on a small amount of glucose to T2 DNA and a second which converts T2 DNA to a form in which all HMC is completely monoglucosylated. Two separable enzymes are also present in T6 infected cells—one like that in T2-infected cells and a second which does not monoglucosylate but adds a second glucose to T2 DNA and T4 DNA.

With the apparent synthesis of 13 enzymes in the first minutes after infection, we are finally in a position to account, in outline at least, for the stimulated DNA synthesis observed so many years ago (Cohen, 1947). These phage-infected bacteria are evidently a source par excellence for the study not only of the individual enzymes, since they are present in extraordinarily high concentration, but also of the specific control and kinetics of protein synthesis by specific DNA. However, in addition there are many other problems which remain in this system: *e.g.*, when are the other viral proteins produced and how are these syntheses related to the production of viral DNA?

Of the viral proteins, the internal "gut" protein of Levine *et al.* (1958) is unique in appearing with the enzymes of DNA synthesis. Using an immuno-chemical method, this specific protein is detectable two to three minutes after infection (Murakami *et al.*, 1959). As with the hydroxymethylase, infection with ultraviolet-irradiated phage in-

duces its formation despite the prevention of DNA synthesis. This synthesis of internal protein is not blocked by proflavine but is prevented by chloramphenicol. It appears significant that if this inhibitor is added at various times early in infection, a correlation appears to exist between DNA synthesized and internal protein formed prior to addition of the agent. When the inhibitor is added ten minutes after infection, the rate of DNA synthesis remains high until the phage equivalents of DNA approach that of internal protein. At this point, the rate of DNA synthesis falls (Murakami *et al.*, 1959).

The formation of the polypeptide, but not the polyamines, is also blocked by chloramphenicol (Hershey, 1957). The recent studies of Kellenberger *et al.* (1959), showing the late formation of a chloramphenicol-sensitive principle essential to the condensation of elements of the DNA pool, raises the problem of the possible relation of this polypeptide to the condensing principle and its mechanism of action.

Following the condensation of phage DNA between nine and eleven minutes after infection, it appears that centers are produced on which may be constructed the numerous structures (at least seven) of the phage head and tail. Of these, at least two possess enzymatic activity essential for the penetration of phage DNA into the bacteria. These are lysozyme (Koch and Dreyer, 1958) and an ATPase (Dukes and Kozloff, 1959). It has not been reported when these enzymes are elaborated or whether the appearance of the activity and the phage structure take place simultaneously.

Concluding remarks

The phenomena of the appearance of new enzymes described above will certainly not be confined to the T phages. The development of a polysaccharidase in *Klebsiella* infected by a phage was described some years ago (Park, 1956; Adams and Park, 1956). In this interesting case, the polysaccharidase, which hydrolyzed the bacterial capsule, was found both in a soluble form in the lysate and associated with the phage. The enzyme thus appears to facilitate attachment of the phage to the bacterium.

Several similar phenomena have been described in animal virus systems. The appearance of neuraminidase in myxovirus-infected cells is well known, although inadequately explored. More recently, Rogers (1959) has described the appearance of arginase in rabbit epithelium infected by rabbit papilloma virus. Thus the acquisition and/or increase of metabolic function as a result of the addition of the viral genome to the infected cell will have the widest significance in explaining not only parasitic mechanisms but also the possible mode of action of tumor viruses as well.

We have indicated the existence of 23 proteins whose production is controlled by the insertion of T-even phage DNA. Unquestionably a number of other enzymes will be found to be increased: *e.g.*, the formation of deoxyribose, etc. On the other hand, other systems, such as amino-acid activation, appear not to be increased, and these can be conceived as rate-determining in the system as a whole.

Since bacterial DNA is degraded very soon after infection, it is reasonable to suppose that the code determining the amino-acid sequence in each new protein is contained within the nucleotide sequence of viral DNA. Although HMC and its glucosylated derivatives can readily be conceived as equivalent to cytosine in this sequence, it is unlikely that all the elements for this sequence controlling a single protein will be functionally identical for all amino acids, and it is quite reasonable to imagine that bacterial and virus-induced proteins will not be entirely identical in amino-acid sequence. Whether this is true remains to be determined. The solution of this question is only the first step pointing to one of the fundamental questions of molecular biology: *i.e.*, the correlation of the nucleotide sequence in DNA with the amino-acid sequence in the protein whose structure is controlled by the DNA.

The problem of the intermediate steps in the control of protein synthesis by viral DNA is also of the utmost importance. It can be inferred, although proof can scarcely be considered adequate, that the early RNA synthesis is functionally related to the synthesis of the new enzymes and other proteins. It is a general phenomenon in these early protein syntheses that they come to a halt about 15 minutes after infection. Why do they stop? Is there a competition for amino acids between enzymes and viral-coat proteins, or is there a destruction of the specific RNA templates by conversion of component ribonucleotides to the deoxyribonucleotides of viral DNA, or both? Is the turnover of RNA templates and competitive relation to protein and DNA a general phenomenon which may account for the fact that differentiated cells elaborating specific proteins do not normally produce DNA and duplicate chromosomes?

Although in a technical sense these systems are admirable for the exploration of these questions, it is now evident that the T-even phages contain too much DNA and too much information, that too many proteins are produced, and that multiplication in cells infected by these phages requires too many parallel events. This system is too complicated to permit us to relate 1/20 of the genome in chemical terms to one of the new proteins. Of course if we could insert a defined portion of the genome at will, we would be in a much better position. However, *E. coli* has never been transformed, nor has the DNA of a T-even phage ever been reproducibly fractionated.

It may be suggested that the pursuit of these problems requires an infectable cell transformable at high efficiency and a tiny phage possessing a bare minimum of DNA necessary for the inheritable transmission of virulence. Is the bare minimum of DNA that in ϕ x 174, and how many proteins does the DNA complement of this phage control? If only a single polypeptide chain is controlled in infections by ϕ x 174, we may cease to worry about the requirement for transformability. However, if this DNA determines the biosynthesis of several different polypeptides, we shall wish to fractionate the DNA and introduce the determinants separately (as in bacterial transformation). We are at the stage, therefore, at which the study of the molecular relations of DNA as a genetic determinant and the protein produced as the expression of this determinant will be markedly facilitated by finding new and more simple biological systems to replace our old friend, T2.

References

- Adams, M. H., and Park, B. H., 1956. "An Enzyme Produced by a Phage-Host Cell System, II: The Properties of the Polysaccharide Depolymerase," *Virology* 2, 719.
- Ames, B. N., Dubin, D. T., and Rosenthal, S. M., 1958. "The Presence of Polyamines in Certain Bacterial Viruses," *Science* 127, 814.
- Ames, B. N., and Dubin, D. T., 1960. "The Role of Polyamines in the Neutralization of Bacteriophage Deoxyribonucleic Acid," *J. Biol. Chem.* 235, 769.
- Barner, H. D., and Cohen, S. S., 1954. "The Induction of Thymine Synthesis by T2 Infection of a Thymine-Requiring Mutant of *Escherichia coli*," *J. Bact.* 68, 80.
- Barner, H. D., and Cohen, S. S., 1959. "Virus-Induced Acquisition of Metabolic Function, IV: Thymidylate Synthetase in Thymine-Requiring *Escherichia coli* Infected by T2 and T5 Bacteriophages," *J. Biol. Chem.* 234, 2987.
- Bessman, M. J., 1959. "Deoxyribonucleotide Kinases in Normal and Virus-Infected *Escherichia coli*," *J. Biol. Chem.* 234, 2735.
- Bessman, M. J., and Van Bibber, M. J., 1959. "A Change in the Properties of Deoxyguanylate Kinase of *E. coli* Caused by Viral Infection," *Biochem. Biophys. Research Commun.* 1, 101.
- Burton, K., 1955. "The Relation between the Synthesis of Deoxyribonucleic Acid and the Synthesis of Protein in the Multiplication of Bacteriophage T2," *Biochem. J.* 61, 473.
- Cohen, S. S., 1947. "The Synthesis of Bacterial Viruses in Infected Cells," *Cold Spring Harbor Symp. Quant. Biol.* 18, 35.
- Cohen, S. S., 1953. "Studies on Controlling Mechanisms in the Metabolism of Virus-Infected Bacteria," *Cold Spring Harbor Symp. Quant. Biol.* 18, 221.
- Cohen, S. S., and Anderson, T. F., 1946. "Chemical Studies on Host-Virus Interactions, I: The Effect of Bacteriophage Adsorption on the Multiplication of Its Host, *Escherichia coli* B." (With an appendix giving some data on the composition of the bacteriophage, T2.) *J. Exp. Med.* 84, 511.
- Cohen, S. S., Flaks, J. G., Barner, H. D., Loeb, M., and Lichtenstein, J., 1958. "The Mode of Action of 5-Fluorouracil and its Derivatives," *Proc. Nat. Acad. Sci.* 44, 1004.

- Cohen, S. S., and Fowler, C. B., 1947. "Chemical Studies on Host-Virus Interactions, III: Tryptophan Requirements in the Stages of Virus Multiplication in the *Escherichia coli* T2 Bacteriophage System," *J. Exp. Med.* 85, 771.
- Cohen, S. S., Lichtenstein, J., Bamer, H. D., and Green, M., 1957. "Studies on the Biosynthesis of Bacterial and Viral Pyrimidines, IV: Utilization of Pyrimidine Bases and Nucleosides by Bacterial Mutants," *J. Biol. Chem.* 228, 611.
- Cohen, S. S., and Weed, L. L., 1954. "Some Precursors of the 5-Hydroxymethyl Cytosine of T6r+ Bacteriophage," *J. Biol. Chem.* 209, 789.
- Crawford, L. V., 1959. "Nucleic Acid Metabolism in *Escherichia coli* Infected with Phage T5," *Virology* 7, 359.
- Dukes, P. P., and Kozloff, L. M., 1959. "Phosphatases in Bacteriophages T2, T4, and T5," *J. Biol. Chem.* 234, 534.
- Flaks, J. G., and Cohen, S. S., 1957. "The Enzymic Synthesis of 5-Hydroxymethyl Deoxycytidylic Acid," *Biochim. Biophys. Acta* 25, 667.
- Flaks, J. G., and Cohen, S. S., 1959a. "Virus-Induced Acquisition of Metabolic Function, I: Enzymatic Formation of 5-Hydroxymethyl Deoxycytidylate." *J. Biol. Chem.* 234, 1501.
- Flaks, J. G., and Cohen, S. S., 1959b. "Virus-Induced Acquisition of Metabolic Function, III: Formation and Some Properties of Thymidylate Synthetase of Bacteriophage-Infected *Escherichia coli*," *J. Biol. Chem.* 234, 2981.
- Flaks, J. G., Lichtenstein, J., and Cohen, S. S., 1959. "Virus-Induced Acquisition of Metabolic Function, II: Studies on the Origin of the Deoxycytidylate Hydroxymethylase of Bacteriophage-Infected *E. coli*," *J. Biol. Chem.* 234, 1507.
- Friedkin, M., 1959. "Speculations on the Significance of Thymidylic Acid Synthesis in the Regulation of Cellular Proliferation," in Stohlman, F. R., *The Kinetics of Cellular Proliferation* (N. Y., Grune & Stratton).
- Friedkin, M., and Kornberg, A., 1957. "The Enzymatic Conversion of Deoxyuridylic Acid to Thymidylic Acid and the Participation of Tetrahydrofolic Acid," in McElroy, W., and Glass, B., eds., *The Chemical Basis of Heredity* (Baltimore, Johns Hopkins Press).
- Green, M., and Cohen, S. S., 1957. "Studies on the Biosynthesis of Bacterial and Viral Pyrimidines, I: Tracer Studies," *J. Biol. Chem.* 225, 387.
- Hershey, A. D., 1957. "Some Minor Components of Bacteriophage T2 Particles," *Virology* 4, 237.
- Hershey, A. D., Dixon, J., and Chase, M., 1953. "Nucleic Acid Economy in Bacteria Infected with Bacteriophage T2, I: Purine and Pyrimidine Composition," *J. Gen. Physiol.* 36, 777.
- Hershey, A. D., Garen, A., Fraser, D. K., and Hudis, J. D., 1954. "Growth and Inheritance in Bacteriophage," Carnegie Institution of Washington Year Book No. 53, p. 210.
- Hershey, A. D., and Melechen, N. E., 1957. "Synthesis of Phage-Precursor Nucleic Acid in the Presence of Chloramphenicol," *Virology* 3, 207.
- Kellenberger, E., Schaud, J., and Ryter, A., 1959. "Electron Microscopical Studies of Phage Multiplication, IV: The Establishment of the DNA Pool of Vegetative Phage and the Maturation of Phage Particles," *Virology* 8, 478.
- Keck, K., Mahler, H. R., and Fraser, D., 1960. "Synthesis of Deoxycytidine-5'-Phosphate Deaminase in *Escherichia coli* Infected by T2 Bacteriophage," *Arch. Biochem. Biophys.* 86, 85.
- Koch, G., and Dreyer, W. I., 1958. "Characterization of an Enzyme of Phage T2 as a Lysozyme," *Virology* 6, 291.
- Koerner, J. F., Smith, M. S., and Buchanan, J. M., 1959. "A Deoxycytidine Triphosphate Splitting Enzyme and the Synthesis of the Deoxyribonucleic Acid of T2 Bacteriophage," *J. Amer. Chem. Soc.* 81, 2594.

- Kornberg, A., Zimmerman, S. B., Kornberg, S. R., and Josse, J., 1959. "Enzymatic Synthesis of Deoxyribonucleic Acid, VI: Influence of Bacteriophage T2 on the Synthetic Pathway in Host Cells," *Proc. Nat. Acad. Sci.* 45, 772.
- Kozloff, L., 1953. "Origin and fate of bacteriophage material," *Cold Spring Harbor Symp. Quant. Biol.* 18, 209.
- Kozloff, L. M., Knowlton, K., Putnam, F. W., and Evans, E. A., Jr., 1951. "Biochemical Studies of Virus Reproduction, V: The Origin of Bacteriophage Nitrogen," *J. Biol. Chem.* 188, 101.
- Kunke, R. E., and Pardee, A. B., 1956. "Studies in the Role of Deoxyribonuclease in T2 Bacteriophage Development," *Biochim. Biophys. Acta* 19, 236.
- Jesaitis, M. A., 1957. "The Nucleic Acids of T2, T4, and T6 Bacteriophages," *J. Gen. Physiol.* 106, 233.
- Levine, L., Barlow, J. L., and Van Vunakis, H., 1958. "An Internal Protein in T2 and T4 Bacteriophages," *Virology* 6, 702.
- Maley, F., and Ochoa, S., 1958. "Enzymatic Phosphorylation of Deoxycytidylic Acid," *J. Biol. Chem.*, 233, 1538.
- Monod, J., and Wollman, E., 1947. "L'inhibition de la croissance et de l'adaptation enzymatique chez les bactéries infectées par le bactériophage," *Ann. Inst. Pasteur* 73, 937.
- Murakami, W. T., Van Vunakis, H., and Levine, L., 1959. "Synthesis of T2 Internal Protein in Infected *Escherichia coli*, strain B," *Virology* 9, 624.
- Pardee, A. B., and Prestidge, L. S., 1959. "A Requirement for Pyrimidines in the First Few Minutes of T2 Bacteriophage Development," *Biochim. Biophys. Acta* 37, 544.
- Pardee, A. G., and Williams, I., 1952. "The Increase in Deoxyribonuclease in Virus-Infected *E. coli*," *Arch. Biochem. Biophys.* 40, 222.
- Park, B. H., 1956. "An Enzyme Produced by a Phage-Host Cell System, I: The Properties of a *Klebsiella* Phage," *Virology* 2, 711.
- Pizer, L. I., and Cohen, S. S., 1960a. "Deoxycytidylate Hydroxymethylase," in Colowick, S. P., and Kaplan, N. O., eds., *Methods in Enzymology*, Vol. VI (N. Y., Academic Press).
- Pizer, L. I., and Cohen, S. S., 1960b. "Metabolism of Pyrimidine Arabinonucleosides and Cyclonucleosides in *E. coli*," *J. Biol. Chem.* in press.
- Puck, T. T., and Lee, H. H., 1955. "Mechanism of Cell Wall Penetration by Viruses, II: Demonstration of Cyclic Permeability Change Accompanying Virus Infection of *Escherichia coli* B Cells," *J. Exp. Med.* 101, 151.
- Rogers, S., 1959. "Induction of Arginase in Rabbit Epithelium by Rabbit Papilloma Virus," *Nature* 183, 1815.
- Sinsheimer, R., 1954. Nucleotides from T2r+ Bacteriophage," *Science* 120, 551.
- Somerville, R., Ebisuzaki, K., and Greenberg, G. R., 1959. "Hydroxymethyl Deoxycytidylate Kinase Formation after Bacteriophage Infection of *Escherichia coli*," *Proc. Nat. Acad. Sci.* 45, 1240.
- Tomizawa, J., and Sunakawa, S., 1956. "The Effect of Chloramphenicol on Deoxyribonucleic Acid Synthesis and the Development of Resistance to Ultraviolet Irradiation in *E. coli* Infected with Bacteriophage T2," *J. Gen. Physiol.* 39, 553.
- Vidaver, G., and Kozloff, L. M., 1957. "The Rate of Synthesis of Deoxyribonucleic Acid in *Escherichia coli* B Infected with T2r+ Bacteriophage," *J. Biol. Chem.* 225, 335.
- Volkin, E., 1954. "The Linkage of Glucose in Coliphage Nucleic Acids," *J. Am. Chem. Soc.* 76, 5892.
- Volkin, E., 1960. "Biologic Activity of RNA in T2 Infection," *Fed. Proc.* 19, 305.

- Volkin, E., and Astrachan, L., 1957. "RNA Metabolism in T2-Infected *Escherichia coli*," in McElroy, W., and Glass, B., eds., *The Chemical Basis of Heredity* (Baltimore, Johns Hopkins Press).
- Watanabe, I., 1957. "Formation of Non-Phage-Antigenic Protein in *E. coli* Infected with T2 Phage," *Biochim. Biophys. Acta* 25, 665.
- Weed, L. L., and Cohen, S. S., 1951. "The Utilization of Host Pyrimidines in the Synthesis of Bacterial Viruses," *J. Biol. Chem.* 192, 693.
- Wyatt, G. R., and Cohen, S. S., 1952. "A New Pyrimidine Base from Bacteriophage Nucleic Acids," *Nature* 170, 1072.
- Wyatt, G. R., and Cohen, S. S., 1953. "The bases of the Nucleic Acids of Some Bacterial and Animal Viruses: The Occurrence of 5-Hydroxymethyl Cytosine," *Biochem. J.* 55, 774.

RECOMBINATION ANALYSIS IN MICROBIAL SYSTEMS*

Harriett Ephrussi-Taylor

NATIONAL CENTER FOR SCIENTIFIC RESEARCH (FRANCE)

Structural and functional properties of living organisms are so diverse that unifying principles are difficult to discern at the biological level. One of the main aims of experimental biology in our century has therefore been the description of biological processes in terms of the laws of physics and chemistry, in a search for universal principles applying to all kinds of living forms. The border-line science of biochemistry has provided a certain unification of biology, demonstrating fundamental similarities in the chemical structure of living matter on the one hand and general principles in the way in which chemical energy is made available to cells on the other. The science of genetics has long been recognized as the most general of the truly biological sciences. Phenomena of heredity are the same when described by Mendel in a plant or by Morgan in an animal. It is thus not surprising that we are witnessing today the development of a new unifying biological principle in the branch of genetics referred to as molecular genetics. While classical genetics knew no boundary between the plant and animal kingdoms, molecular genetics scarcely admits a separation between the science of polymer chemistry and all of genetics, be it plant or animal, viral or human.

The molecular theory of genetics states that any given heritable structure is a specific cellular product whose properties are determined with great precision by a particular sequence of bases in the deoxyribo-

* This work was aided by a grant from the Rockefeller Foundation to the *Laboratoire de Génétique Physiologique du C.N.R.S.*

I am indebted to Mr. G. Prevost, Dr. F. Sherman, and Professor B. Ephrussi for valuable discussions and suggestions in the course of preparation of this report, and to Professor Ephrussi for criticism of the manuscript.

nucleic acid (DNA) of the chromosomes of a cell or a virus. Thus far the only exceptions to this rule are the viruses containing ribonucleic acid (RNA), and here it is the RNA that is presumed to carry the genetic code. All heritable differences can be ascribed to differences in the base sequence of the nucleic acids of cells. The base sequence of genetic DNA or RNA is perpetuated during the replication of the macromolecule. An ingenious mechanism for this replication was proposed by Watson and Crick (1953) concomitantly with their formulation of the structure of DNA. Considerable evidence suggests that their proposal is correct (Levinthal, 1956; Meselson and Stahl, 1958; Taylor, Woods, and Hughes, 1957).

The genetic phenomena of intrachromosomal recombination and gene mutation are assumed to be due to alterations of base sequences by one of several possible processes. This theory implies that any genetic unit of structure or function can be defined in terms of a nucleotide sequence of a given quality or length. Clearly, many types of units can be expected to be found. There may be a minimum length of sequence which can undergo replication, or a minimum sequence for determining the structure of a particular macromolecule. In the synthesis of a protein, for example, there is reason to believe that short sequences determine the incorporation of each amino acid in a polypeptide chain; each such sequence is a small functional unit. The sum of all these sequences, in proper order, determines the polypeptide chain as a whole. Thus, the nucleic-acid code spells out "words" and also fits those words together to make "sentences." In higher organisms, in which differentiation and aging take place, there is a time sequence of events which may also be, in part or totally, controlled by the nucleic-acid code. To what kind of organization of sequences this may be due, we cannot even guess as yet.

The tool with which a geneticist dissects the genome of an organism is called recombination analysis. The first task of the molecular geneticist is to understand recombination in terms of molecular structure. There is no mystery as to why genes situated on different, non-homologous chromosomes are reassorted independently at meiosis: each pair of homologous chromosomes is an independent physical entity, and it is distributed independently at meiosis. The recombination that interests us is the one called crossing-over (reciprocal exchanges between a pair of homologous chromosomes), for this kind of recombination informs us how the chromosome is organized and, perhaps, how it is duplicated. Ten years ago, crossing-over was a dead subject; the group of cytologists led by C. D. Darlington had offered a complete explanation of the phenomenon. Their explanation was essentially mechanical. At meiotic pairing, which is visible cytologically, each homologue of a pair is already double, but the two strands do not

separate. A meiotic pair thus consists of four closely associated strands of hereditary material, or chromatids, each of which will give rise to a chromosome when the reduction divisions are complete. The four strands are seen to be tangled in places as they separate during meiotic division, and breakage and fusion occur. If the broken ends of the crossed strands fuse so that there is an exchange of segments, reciprocal crossing-over is produced.

Today the whole problem of crossing-over is a completely open one and has become one of the most exciting aspects of genetics. Indeed, the genetic studies on microorganisms which have given birth to the molecular theory of genetics have reopened the subject of recombination and infused it with new ideas. Recombination has become a problem in growth—the formation through growth of chromosomes, or even DNA molecules, which are hybrid with respect to two (or more) parental chromosomes or parental DNA molecules. The present paper, written mainly for biologists with no special knowledge of genetics, will be an account of one aspect of this revolution: namely, the interpretation of quantitative recombination data in terms of molecular structure.

Classical recombination theory

Let us review briefly the quantitative rules that operate in classical recombination studies. Genes that show a tendency to be inherited together are located on a single chromosome and are called linked genes. A pair of linked genes may, however, become separated from each other through crossing-over, as mentioned above (see Figure 1). The frequency with which linked genes recombine through crossing-over is

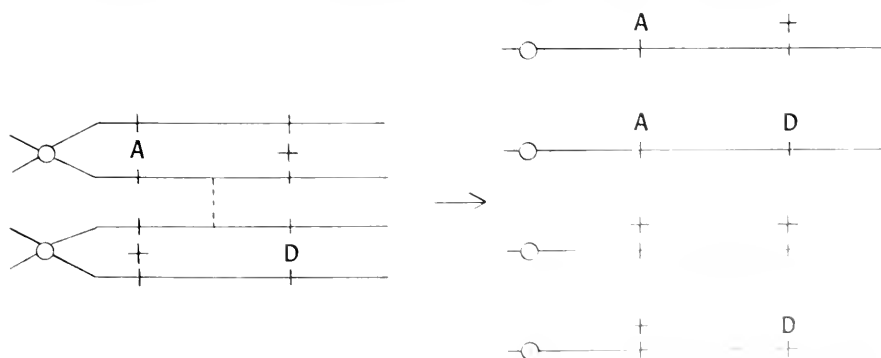

Figure 1. Reciprocal recombination through crossing-over between two non-sister chromosome strands at meiosis. The dotted line indicates one of the possible positions of the cross-over which would yield the four chromosomes at the right after division of the centromere.

a function of the length of the chromosome segment separating them. Consequently, the distance between two linked genes can be measured in terms of the frequency with which they are separated by crossing-over. The genetic unit of length, or Morgan unit, is that distance separating two points on a chromosome which recombine at meiosis 1 per cent of the time.

Two difficulties are encountered in measuring with this genetic ruler:

1. If a chromosome is marked at several points by mutants *A*, *B*, *C*, and *D*, the sum of the distances *AB*, *BC*, and *CD* is usually greater than that measured by the frequency of recombination between *A* and *D*. This is generally attributed to the occurrence of more than one cross-over in the interval *AD*. If multiple cross-overs occur, and their number is odd, recombination of *A* and *D* will be observed. If, however, the number is even, linkage between *A* and *D* is maintained and the resulting chromosome is scored as non-recombinant. Thus the total number of cross-overs in the large interval is systematically underestimated.

2. If a cross-over occurs in one region of a pair of chromosomes, this will diminish the occurrence of additional cross-overs in the same pair. This phenomenon, called interference, tends to diminish the mapping errors due to multiple cross-overs.

The question naturally arises: To what physical length does the Morgan unit correspond? With the development of new kinds of genetic systems in which crosses involve pairing and hybridization of DNA molecules, recombination of linked markers can be seen to be a phenomenon extending down to the molecular scale (Ephrussi-Taylor, 1951; Hershey and Rotman, 1948). Therefore, in terms of molecular genetics, the question which we have just stated is equivalent to asking: To what length of nucleotide sequence does the Morgan unit correspond? If the Morgan unit could be measured by direct means, then the length of sequence involved could be readily calculated, for the dimensions and structure of DNA are well established. This is not, however, possible. What we can do is estimate the total number of recombination units and the total DNA content in a particular genome. From the ratio of these two values, we obtain the length of sequence per Morgan unit. When this is done for such unrelated genomes as those of *Aspergillus nidulans* and bacteriophage T4, the Morgan unit in the former is found to represent a linear sequence of 40,000 nucleotides, while in the latter it represents only 1,000 (discussed in Pritchard, 1960). It is clear that the Morgan unit is not the same in all organisms, and one can conclude that frequency of crossing-over is not determined by DNA structure and replication alone.

This is a serious complication for a unified molecular theory. Striking as they are, these calculations only demonstrate a phenomenon of which geneticists have been aware for years—namely, that distances expressed in terms of recombination frequency are far from constant. A given segment delimited by mutants *AB* will yield different recombination frequencies of *A* and *B*, depending upon the genetic composition of the remainder of the parental genome. On the one hand, the less closely related the two parents of a cross are, the lower, in general, will be the recombination frequency at meiosis. On the other hand, if an inversion is present in one chromosome, recombination frequencies in independent chromosomes will be markedly increased (Schultz and Redfield, 1951). Finally, the relative distances separating a series of markers may not be the same in meiotic as in mitotic recombination (Pontecorvo and Käfer, 1958). These last facts are more weighty than calculations in suggesting that the Morgan unit may not be related to a fixed length of nucleotide sequence.

There are two ways of reacting to this situation. One is to consider as untenable the notion that recombination in all organisms can receive a unifying explanation in terms of molecular genetics. The second is to consider that recombination is indeed a molecular phenomenon, just as transformation and phage genetics so strongly suggest, but that additional modifying phenomena intervene when DNA is organized into the chromosomes of higher organisms. The second attitude is positive and leads to re-examination of existing data and to the performance of new experiments. This is the attitude adopted in the present discussion.

Clearly, the first matter to settle is: What is this yardstick used by geneticists? Is it long enough to measure long distances and finely enough subdivided to measure short ones? Is its variability real, or is it due only to our applying it in too crude a fashion? Our success in defining various types of functional and structural units of chromosomes in molecular terms will depend upon our finding a satisfactory answer to these questions. This is why understanding recombination has become the central problem of genetics today, after having been considered a dead subject for some 20 years.

Let us now turn to a consideration of the new genetic data provided by microbial systems. First we shall trace the major changes these data have dictated concerning chromosome structure and recombination. Second, a model will be presented, developed for the special case of bacterial transformation, in order to show the ultimate consequence of current recombination theories. Although developed for transformation, this model may well be applicable to all forms of genetic recombination in which the distance between two markers is less than a linear sequence of 10,000 nucleotides.

Recombination with equal parental participation

In a search for characters that could be defined in biochemical terms, Beadle and Tatum (1941) turned to the ascomycete *Neurospora crassa*, which can be cultivated on a medium containing sugar, inorganic salts, and biotin. They selected mutations which suppressed the ability of the mold to synthesize one or another growth factor, an amino acid, or a nitrogenous base. Many such characters proved to show simple inheritance and to be due to the loss of the ability to synthesize a single enzyme.

Geneticists quickly saw the great advantage of this material for use in recombination studies. Hybridization is of a classical type, in that two haploid nuclei fuse to form the zygote. However, the diploid nucleus does not persist as such but immediately undergoes meiosis, forming the sexual ascospores. Each spore, upon germination, produces a mycelium populated with haploid nuclei of a single type. Thus all of the products of a single meiotic division can be recovered in a pure haploid state. In some species of molds, *Neurospora* for one, these spores are even aligned in proper order in the ascus. Thus, by dissecting an ascus and germinating the spores separately, each meiotic strand of a given chromosome can be recovered and characterized. As a consequence, recombination can be studied with far greater accuracy, and mapping can be performed on fewer progeny than in the diploid organisms of classical genetics. A second very important quality of such material is that, with nutritional markers, selective media can be employed, and under appropriate conditions very rare recombination events can be detected and studied (Pontecorvo, 1952). Thus the "resolving power" of recombination analysis is enormously enhanced; the microbial geneticist can often analyze segments of chromosomes which are 1/10,000 to 1/1,000,000 of a Morgan unit long. In other words, he can detect events which occur in one out of 10,000 to 1,000,000 meiotic divisions.

Similar resolution is obtained in quite another genetic system—that of crosses between bacteriophage particles. A bacterium infected with two or more very similar but recognizably different phage particles will give rise to viral progeny some of which are like the parents and some of which are hybrid. By using markers affecting host specificity, one can, here again, select rare recombinant types (Benzer, 1955). The principal difference between phage systems and Mendelian ones, such as *Neurospora* and *Aspergillus*, is that between the moment of infection of a cell with two viral particles and the moment of liberation of viral progeny through lysis of the bacterium, a number of matings occurs between increasing numbers of intracellular particles. Further, not all of the genomes formed during growth of the viral population give

rise to complete virus, and those that do not are not recovered. Thus it is impossible to isolate the products of a single mating event. On the other hand, phage systems offer great advantages. One is that the crosses can be performed and progeny scored with great rapidity. More important is the fact that the phage chromosome is very short, compared to the chromosomes of higher organisms, and it therefore contains fewer genes and fewer recombination units than any other hybridizing system with an equal biparental contribution. Its length in terms of nucleotide sequence is established (Thomas, 1959).

Fine structure of the gene

When a chromosome is examined in the detail that these systems permit, new features of its structure and behavior become apparent. The validity of considering the gene as an ultimate corpuscle had already been questioned in the experiments of Dubinin (1929), Serebrovsky (1930), and Lewis (1945), working with *Drosophila*, and of Stadler (1954), working with maize. With the high-powered analysis in the systems just described, the gene could be seen to be divisible into numerous subunits. If one selects, in *Aspergillus* or *Neurospora*, for example, a number of independent mutations having identical phenotypes and affecting a single character, crosses between pairs of mutants will regularly give rise to rare recombinant chromosomes which are normal with respect to the character in question. In many instances the character involved has been shown to be the synthesis of a single enzyme, and there is therefore no doubt that the different mutants are allelic forms of a single gene locus. Nonetheless, recombination can occur between them, producing a non-mutant (wild-type) chromosome on the one hand, and a doubly mutant chromosome on the other, as a result of recombination.

With most crosses between non-identical alleles, such recombination is rare, and if one were to set about to find it either by dissecting asci and determining the nature of each meiotic chromatid, or by the analysis of randomly selected spores from a given cross, one would succeed only by analyzing 100,000 to several millions of spores. A case in point is described by Calef (1957) for two adenineless alleles in *Aspergillus*. The varieties of recombinant chromosomes found by plating 406 spores and determining the genetic constitutions of the chromosomes of the spores in crosses, shown in Figure 2, are indicated as "unselected recombinants." In none has a cross-over occurred between *ad₁₅* and *ad₁₇*. If, now, instead of choosing spores at random, one makes a suspension of a large number of spores and plates them on a medium lacking adenine, the only spores that will grow will be those having a genetic constitution enabling them to synthesize adenine. These could

arise by two processes: reverse mutation of one of the alleles and recombination between alleles. Appropriate controls show, in Calef's case, that spontaneous mutation is of the order of 10^{-9} . However, for each million spores, three are able to grow on adenine-free medium. These must, therefore, arise by recombination, since mutation is 3,000 times less frequent. When the genetic constitutions of the chromosomes bearing the adenine locus are examined, one obtains the recombinant

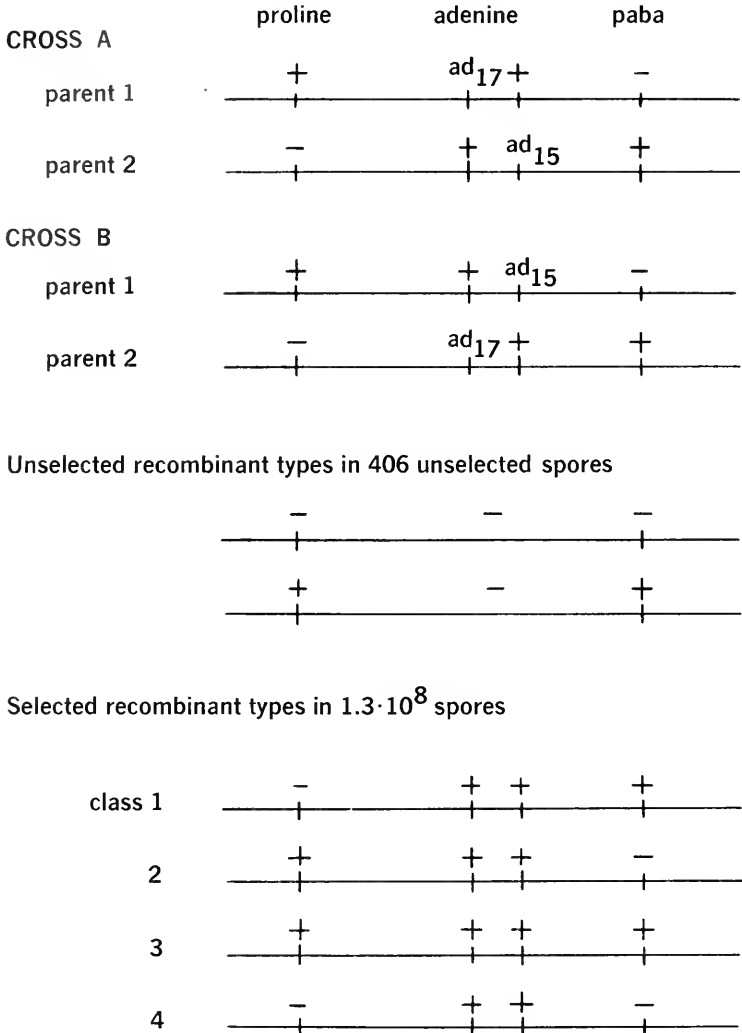

Figure 2. Recombination between adenine alleles in *Aspergillus* (Calef, 1957). Crossing-over within the adenine locus is so rare that it is detected only by selection of adenine spores. The reciprocal recombinant, ad_{15} - ad_{17} , which presumably occurs, cannot be recovered by selection.

types indicated in Figure 2 as "selected recombinants." In order to observe these types by non-selective methods, one would have had to characterize many millions of spores. As long as the spontaneous reversion rates of markers are low, exceedingly rare recombination events can be studied by such selective methods. Experiments have shown, in microbial systems of all types including phage, that as a rule independent mutations affecting a single functional unit of the chromosome almost always show recombination when crossed; they must, therefore, have different locations on the chromosome.

These results are readily interpreted in terms of the molecular theory of the structure of genes. It is supposed that the primary gene product is determined by a linear sequence of nucleotides whose length is variously estimated as lying between 1,000 and 8,000 nucleotides (Pontecorvo and Roper, 1956). This sequence comprises the functional gene. An alteration of one or a few nucleotides at any one of many points in the sequence would give rise to a mutant gene. However, a genic alteration will be detected only if it leads to a quantitative or qualitative modification of the gene product, or phenotype. Insofar as an enzyme is concerned, an alteration in base sequence leading to a change in composition of the protein will be detected only if a critical aspect of protein structure is affected. In view of the structural restrictions imposed for an enzyme to be active, most alterations in critical regions of an enzymatic protein would lead to total or partial inactivation or loss. Thus if one selects independent loss mutations affecting a single gene product, very often these will be the result of changes of sequence at different positions in the functional gene, even though the phenotypes selected are identical. The fact that such alleles show recombination means that the recombination process may be initiated at any one of many points along the functional gene sequence. We therefore distinguish the functional unit, which is a long sequence, from mutational sites, which may be very small indeed and may be situated at any one of many points in the functional gene sequence. We can distinguish also the recombination unit, which is much smaller than the functional gene sequence. The smallest unit of recombination may even be a single nucleotide (Benzer, 1957). Two mutations are said to occupy the same site when no recombination is found to occur between them and different sites when recombination does occur. The term gene locus is reserved to specify the functional gene sequence.

Limitations of fine-structure analysis

Clearly there are as many possible positions at which sequence can be altered as there are nucleotides in a sequence. However, not all nucleotides of a functional sequence necessarily determine a critical as-

recombination would be established; and the mutational sites could be distinguished. If, however, recombination cannot occur in a space smaller than three or four nucleotides, then the two mutations of Figure 3 would be scored as involving identical sites. Calculations suggest, however, that recombination may be possible between sites only one nucleotide apart (Benzer, 1957; Chase and Doermann, 1958).

We can satisfy ourselves for the moment that the functional gene contains multiple mutational sites by a simple calculation, taking an example from a Mendelian organism, *Aspergillus nidulans* (Pontecorvo and Roper, 1956). In a locus controlling the synthesis of adenine, four independent adenineless mutations were isolated. The most distant mutational sites among these four recombine with a frequency of 1.8/1,000. The closest pair recombine with a frequency of 1.2/100,000. If we suppose a linear relationship between recombination frequency and map distance, then the gene locus can be considered to contain a minimum of 1,800 recombination units. If we suppose further that the recombination frequency of 1.2/100,000 is the smallest that can be measured, we obtain from the ratio of these two values the minimum number of points at which a change of sequence can occur and be separated by recombination. This ratio is 150, and it is a minimum estimate for two reasons. First, the locus may, in fact, be larger than is indicated by the two most distant markers; second, the shortest distance within which recombination can occur may be smaller than that indicated from the closest sites.

A geneticist is not always in the agreeable position of knowing, for each mutant of a given phenotype, what enzyme (or primary gene product) is being affected. He has, however, a genetic test of the identity of the functions affected by independent mutations: the *cis-trans* test, developed by Lewis (1951) for *Drosophila* and subsequently extended to microbial systems, largely as a result of the work of Benzer (1957) on phage T4. This test consists in comparing the phenotypes obtained from two kinds of crosses involving two mutational sites of apparently identical phenotypic effect. One cross forms a diploid hybrid, or heterocaryon, in which each parental chromosome carries one of the two mutated sites under examination. In the second cross, both mutated sites are in the chromosome of one parent, while the chromosome of the second parent is normal. In these two kinds of hybrids, the same total amounts of mutated and normal chromosome are present. It is only the relative positions of mutated and normal regions that differ. In the first cross, the two mutational sites are in the *trans* position, while in the second they are in the *cis* position (see Figure 4). If the two mutational sites are in different functional genes linked together, the phenotype of the hybrid will be normal, whatever the arrangement of the mutational sites in the hy-

A. One mutated site in each of two loci

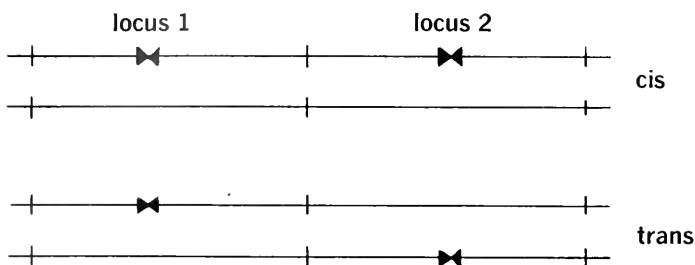

B. Two mutated sites in one locus

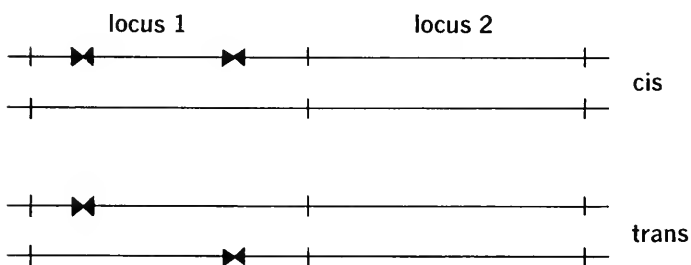

Figure 4. Diagram of the *cis-trans* test for allelism. In A, the phenotype will be non-mutant in both *cis* and *trans* arrangements. In B, the *cis* arrangement alone gives a non-mutant phenotype.

brid, for in either the *cis* or the *trans* position each locus is present in normal state in one or the other of the chromosome pair. However, if the two mutated sites are in the same functional gene, the phenotype of the hybrid will be normal only if the mutated sites are in the *cis* position, for it is only in this position that the hybrid will contain one normal gene. Thus when two mutations involve the same gene locus, the phenotype of the hybrid will depend upon the relative positions of the mutational sites, and a *cis-trans* effect will be observed.

The *cis-trans* test has proved very useful in that it has compelled us to take into account the difference between the functional gene and the mutational sites. It has exerted a powerful influence in crystallizing our ideas concerning the various sorts of units of which the chromosome is composed. In practice it proves not to be a clear-cut definition of functional units of the chromosomes, for fairly often two mutants

in the same functional gene placed in the *trans* position in a hybrid will yield a phenotype which is wild, or intermediate between mutant and wild. This phenomenon, called complementation, is probably due to the fact that more than one step intervenes between the gene and the end product measured—an enzyme, for example—and that interaction between the primary products produced by the damaged genes gives rise, in some instances, to a normal end product in small amounts. Investigations of the nature of complementation in microbial systems will no doubt furnish extremely valuable information concerning gene structure and the mechanism of formation of specific gene products (Giles, Partridge, and Nelson, 1957; Fincham and Pateman, 1957; Woodward, 1959).

Thus the gene has emerged from the status of an abstract notion to that of a structure defined in terms of an extended nucleotide sequence. Since it is composed of a large number of chemically defined units—the nucleotides—the complex phenomena of mutation and recombination can be harmoniously interpreted in terms of chemical subunits.

Keeping in mind these essential concepts of the structural basis of mutation and recombination, let us now consider quantitative aspects of genetic recombination. As mentioned, microbial genetics has forced a radical reconsideration of the theory of the relationship between chromosome structure and recombination frequency. It is to this aspect of recombination that the remainder of this report will be devoted.

We have seen that classical genetic theory predicts that the closer two mutated sites are to each other, the more truly the recombination frequency will reflect the linear distance separating them. Therefore, as we place genetic markers closer and closer together, we would expect the observed recombination frequencies to decrease linearly as soon as the distance becomes sufficiently small to render multiple cross-overs very infrequent. In classical genetics, map distances usually are additive when they are of the order of a few units of recombination. What has been found in microbial systems, by selecting rare cross-over events between two very closely linked mutated sites, is that crossing-over is, in fact, very frequent on either side of the site of the selected recombination event. In other words, recombination frequency decreases proportionally with distance until these distances are of the order of a unit of recombination or less, and then it increases instead of decreasing.

This phenomenon, called negative interference, was first clearly demonstrated by Pritchard (1955) and has since been found in every system in which selection of rare recombinants can be performed. Indeed, using phage T4 and the extremely rich series of mutant alleles

developed by Benzer (1955), Chase and Doermann (1958) have presented an extraordinary body of data demonstrating this phenomenon. Crosses were performed with markers in various patterns along the pairing chromosomes. Three of the simpler types of crosses are shown in Figure 5. Because of the large number of alleles in the series, it is possible to vary not only the patterns of the markers *a*, *b*, and *c* but also the distances separating them. The frequency of formation of a non-mutant chromosome is scored by selective plating in which only non-mutant phage particles give progeny. One readily sees that the formation of a wild type chromosome requires the same cross-over event in crosses 1 and 2. However, in Cross 2, a second cross-over between locus *b* and locus *c* would place mutant *c* in the lower chromosome, and thus both chromosomes would be mutant. Consequently, the frequency of formation of non-mutant particles will be the same in the two crosses only if the occurrence of two cross-over events in this small region is rare. Experiments show that Cross 2, performed with a variety of different markers, almost invariably gives fewer wild-type progeny. Thus the probability of a second cross-over in the region between *b* and *c* is very high indeed. In Cross 3, two cross-overs are required in order to produce a non-mutant chromosome. The predicted frequency of both events occurring in a single pair of mating chromosomes can be calculated from the observed frequency of the single events, measured in crosses of type 1. The ratio between the observed and predicted values, known as the coincidence, should be one if the two events are really independent, greater than one if the occurrence of

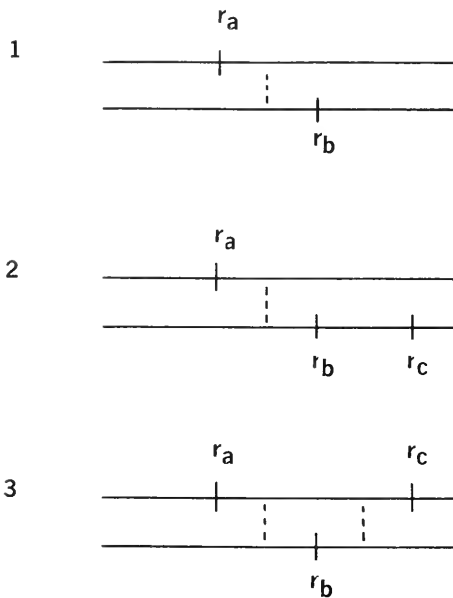

Figure 5. Types of crosses in T2 performed by Chase and Doermann (1958). The various mutational sites are in a single gene locus. The dotted lines indicate the positions of cross-overs which will produce a wild-type recombinant chromosome.

one event increases the probability of the second, and less than one if the occurrence of the first decreases the probability of the second. The coincidence values of Cross 3 range from four to about 30 in the different experiments of Chase and Doermann, proving that the occurrence of a first cross-over enormously increases the probability of a second with a neighboring segment of the chromosome.

Thus recombination appears to obey two different laws, depending upon the distances between markers. In other words, the recombination yardstick is not constant: its units shrink when we try to measure long distances and expand when we try to measure short ones. Therefore, when different orders of distance are considered, diametrically opposed behavior is observed with respect to the influence of one cross-over event upon a second. Interference occurs when distances are measured in terms of unitary values of recombination, but when small distances are under study, not only is there no interference, but there is a high incidence of multiple exchanges.

The theory of effective genetic pairing

Clearly, the theory that recombination frequency is a linear function of the distance between two points on the chromosome is untenable, at least without substantial modification. A simple modification of the classical theory has been proposed by Rothfels (1952) and has received development and substantial support from the work of Pontecorvo (1958) and Pritchard (1955, 1959). This consists of supposing that pairing in the genetic sense is not equivalent to cytologically observable pairing; that genetic pairing precedes cytological pairing and, far from being complete, involves only small regions of homologous chromosomes. It is supposed to occur as a random encounter of corresponding regions of homologous chromosomes, prior to or during chromosome duplication. According to the theory of partial genetic pairing, crossing-over is a phenomenon of the very growth process that forms a new chromosome; it is not a mechanical accident.

The theory of partial pairing states that two distinct events are involved in crossing-over, and with these two variables a complete account can be made of the genetic phenomena observed. There is on the one hand the probability of an effective pairing occurring in a particular chromosome interval. This probability would be determined by the length of the interval, for one thing, because a long interval would provide more sites for pairing than a short one. The probability could also be determined in part by the degree of similarity of the homologues involved. Further, when one region of a chromosome becomes effectively paired, this may give rise to interference, since the paired chromosomes are no longer free to pair in a second region. There is, on the other hand, the actual recombination process, which will take place within

the paired segments. In this second process, it is supposed that as the chromosome duplicates, the duplicate chromatid is copied first off one parental strand and then off the other. Reciprocal recombinant structures are formed because two new chromatids cannot be copied off the same parental strand at the same time. Thus if one chromatid switches in the copying process, the second is obliged to make a reciprocal switch. There takes place a fairly frequent switching back and forth in the copying, and this is what we call negative interference. It is the switching process that really describes the intimate process of crossing-over and its frequency. If we study events which involve distances longer than the effectively paired segments, we underestimate the switching back and forth, because we include regions which are unpaired and which, therefore, cannot contribute to recombination.

This theory of recombination is satisfying in many respects, and no experimental results are in critical conflict with it. Most crosses in classical genetics have dealt exclusively with the probability of effective pairing occurring in regions delimited by genetic markers. Only in systems in which "high resolution" is possible can we study the second process. While the probability of effective pairing may be a fairly simple function of the linear dimension of a given segment of chromosome, it remains to be demonstrated that there is a linear relationship between distance and recombination frequency within the effectively paired region. In general, map distances between mutated sites within a single functional gene are only poorly additive. This suggests that there may not be a simple relationship between map distance and recombination frequency within the paired region—a point to which we shall return.

Setting this difficulty aside for the moment, it should be noted that the model has several qualities. Not only does it provide an explanation for the fluctuations of the genetic yardstick in a single kind of organism, according to the scale of the events under study, but it also explains why constancy of the genetic yardstick throughout the plant and animal kingdoms—which might be expected in view of the apparent universality of DNA as the coding substance—is not, in fact, observed. Indeed, as mentioned above, calculations show that the length of nucleotide sequence per map unit is 1,000 for phage, and 40,000 for the mold *Aspergillus*. If, however, experiments are set up to measure recombination in effectively paired regions alone, these values become 100 and 270 respectively, which is surprisingly close agreement (see Pritchard, 1960).

Non-reciprocal recombination

Before we consider more closely the nature of recombination in

the effectively paired region, a new recombination phenomenon, revealed by microbial systems, should be mentioned. This is the phenomenon of non-reciprocal recombination, or gene conversion (Mitchell, 1955; Roman, 1956; Case and Giles, 1958). Where all four products of meiosis can be routinely recovered and identified, as in the ascomycetes, abnormal segregations can be readily recognized. Figure 6 shows the type of rare, irregular, non-reciprocal segregation that has been observed in quite a few instances in crosses involving markers in a single gene locus. A reciprocal recombination event in the locus would have produced one non-mutant recombinant and one doubly mutant one. The segregation in Figure 6, A, could be explained by supposing that the normal a_1 site of the second parental chromosome has been copied twice, and that the extra copy of this region has been inserted in the place of the mutant a_1 site in the new chromatid initiated from the Parent 1 chromosome. This is imagined to occur as shown in figure 6, B. During replication, the two new chromatids are postulated to grow at slightly unequal rates. The more advanced chromatid switches to the Parent 2 chromosome, copies from it for a short distance, and then returns to the Parent 1 chromosome. Following this, the more

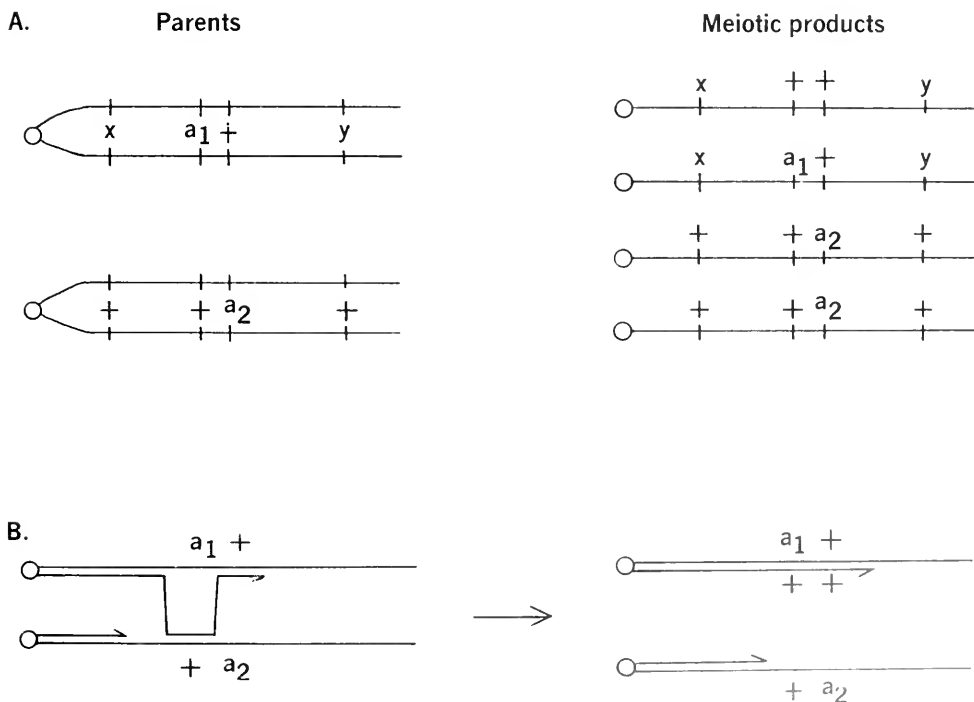

Figure 6. Diagram of the results of a non-reciprocal recombination between two closely linked markers, a_1 and a_2 .

advanced chromatid separates from the Parent 2 template, leaving the latter free for the delayed chromatid to copy along the same region.

When non-reciprocal allelic recombination occurs, outside markers may recombine. When they do, it is always reciprocally. Using three outside markers, Stadler (1959) has recently performed an experiment in *Neurospora* designed to test whether reciprocal and non-reciprocal recombination can be considered to arise from a single event. It will be recalled that when reciprocal recombination occurs at one point along a pair of chromosomes, we observe the suppression of crossing-over at distant sites. In terms of the partial pairing theory, this means that when a region of effective pairing is formed, there will be few or no additional paired regions at other points of the two chromosomes involved. This interference with crossing-over was used by Stadler to perform his test. His marking of chromosomes is essentially as in Figure 6, except that an additional marker z , to the right of y , is present. Recombinant chromosomes containing a normal a locus are selected and divided into two classes. In one class, the recombination between a_1 and a_2 , which yielded a normal a locus, has not been accompanied by reciprocal recombination of x and y , while in the second class, x and y are recombined. The two categories obtained are then examined to see if crossing-over between y and z is normal or reduced. It is found that interference in the y - z segment occurs only if x and y have been recombined (as well as a_1 and a_2). Now, the majority of recombinations yielding a normal a locus are non-reciprocal. Thus Stadler's experiment shows that if allelic recombination, which is essentially non-reciprocal, is the only recombination occurring in the x - y interval, interference is not observed. This result suggests that reciprocal and non-reciprocal crossing-over do not result from the same primary event. In terms of the partial pairing theory, this would mean that non-reciprocal recombination does not require effective pairing. We find ourselves in the situation of supposing either (1) that non-reciprocal recombination results from the diffusion of an extra copy of a small segment of one replicating chromosome to a second replicating chromosome, where it is incorporated in the linear structure of the new chromatid, or (2) that some kind of pairing other than "effective pairing" occurs.

One simple way out of this dilemma is to introduce the factor of time into models in a much more significant way than has been done in the past. We can, for example, suppose that the lack of synchrony in the synthesis of the new chromatids, postulated in Figure 6, B, creates the essential condition for effective pairing. Pairing occurs as a consequence of lack of synchrony, a cross-over takes place as shown in Figure 6, B, and this is the initial phase of all recombination within chromosomes. Effective pairing may then be supposed to be highly unstable at the outset and to tend to end shortly after it has begun. If it ends

very soon, the leading chromatid will be pulled away from the lower parental chromosome (Figure 7, A) and will resume its growth along the upper parental chromosome. The lagging chromatid will be synthesized as though no pairing had occurred. This will lead to non-reciprocal recombination. If pairing lasts a little longer, the lagging chromosome will reach the cross-over point (Figure 7, B) and will be obliged to shift to the upper parent in order to copy from an existing structure. If pairing is disrupted after the lagging chromosome has copied beyond the position of a_2 , both new chromatids will be obliged to resume copying along their initial templates. The result will be a reciprocal interallelic recombination. If, however, effective pairing lasts somewhat longer, it may become relatively stable, giving rise to multiple reciprocal cross-over events. As a consequence of the stability of the paired region, a restriction is imposed on the formation of further paired regions. Thus Stadler's results can be explained by supposing that the pairing which gives rise to all events is the same, but that its early interruption releases the chromosomes from the constraint that prevents further cross-overs. It is thereby possible to reconcile experi-

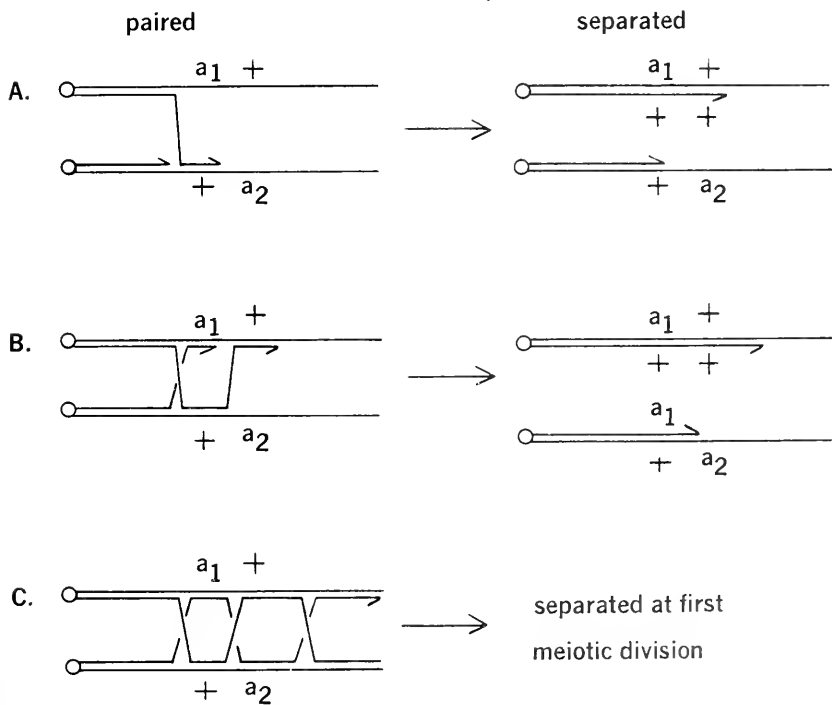

Figure 7. Model of reciprocal and non-reciprocal cross-over events supposing that effective pairing is at first unstable. A and B: early rupture of pairing. C: persistence of pairing, giving rise to a stable, effectively paired region.

mental results with a single, unified theory of crossing-over. Furthermore, different degrees of stability of the initial phase of effective pairing could account for the very different frequencies with which non-reciprocal recombination occurs in different organisms.

It is evident from the discussion above that recombination is intimately associated with chromosome duplication in our thoughts about the subject today. On the other hand, chromosome duplication appears to be primarily a problem of DNA replication (Taylor, 1958). Very interesting models of recombination have been constructed, taking into account what is at present known of the mechanism of DNA replication (Taylor, 1958; Freese, 1958). However, we cannot enter into the details of these models here, except to remark that they involve critical assumptions about how the DNA is organized into a chromosome, and that these will require experimental verification.

Recombination with unequal parental participation

The diversity of the experimental possibilities in microbial systems is due not only to the factors mentioned above but also to the discovery of unexpected hybridization mechanisms. The first new system to be discovered was that of bacterial transformation, in which a bacterial cell absorbs DNA of high molecular weight, endowed with genetic activity (Avery, MacLeod, and McCarty, 1944). The second was genetic recombination in *E. coli*, and the third was transduction (Lederberg and Tatum, 1946; Zinder and Lederberg, 1952). In bacterial recombination, two cells of a particular constitution pair, and the chromosome of the cell serving as the male is injected into the cell serving as the female (see the recent review of Hayes, 1960). The conjugation is fragile, and much of the time only a portion of the male chromosome is transferred before all pairing is interrupted. One obtains zygotes of varying degree of partial diploidy, in which recombination occurs during the course of subsequent cell division.

Because the degree of partial diploidy is highly variable in a single mating population, this system is of limited use in recombination analysis; in addition to the statistical properties of the recombination process, one must deal also with the statistical properties of the transfer mechanism. Nevertheless, the two essential characteristics of chromosomes, mentioned above, have been clearly demonstrated in this system (high frequency of crossing-over in small regions of the chromosome, Rothfels, 1952; multiple mutational sites in the functional gene, E. Lederberg, 1958). In transduction, a virus or virus-like entity grown on a cell of one genetic constitution introduces genes of the host upon which it was cultivated into a subsequent host. All of these systems are characterized by one feature: the genetic contributions of the parents

may be, or perhaps always are, unequal. In the case of bacterial recombination, the male parent may occasionally contribute a complete genome, but more often it does not. In transformation, the DNA donor contributes one molecule, or about 1/200 of the bacterial genome. In transduction, in which the phage vector carries DNA of bacterial origin in place of some or all of its own DNA, the degree of participation of the donor parent is more often than not still smaller than in transformation. Let us see now what recombination looks like in transformation, where the molecular characteristics of the donor cell's contribution are fairly well defined, and where the absence of viral genome offers a somewhat simpler situation.

In the first place, genetically active DNA does not multiply as such in the bacteria that absorb it. This can be inferred from the experiments of Ravin (1954), who studied the clonal distribution of transformants in an instance where two distinct kinds of recombinants are formed after uptake of a single kind of DNA molecule. His data show that either one or the other kind of transformation occurs within the clone formed by a cell which has picked up the molecule, but not both. There is, thus, a unique event which gives rise to a single recombinant genome, a result which would be impossible if the donor molecule replicated prior to recombining. This result is confirmed by recent experiments in which the donor markers are titered at different intervals after DNA uptake by the recipient cells; the measurements are made by breaking open the latter, extracting the total DNA of the cells, and titering it on an appropriate detector strain (Voll and Goodgal, 1961).

In the second place, it is established that the recombination event in transformation may involve the transfer of only part of the specificity of the inducing molecule to a recombinant bacterial genome (Ephrussi-Taylor, 1951), and, indeed, that partial transfer is the rule rather than the exception (Hotchkiss and Marmur, 1954; Hotchkiss and Evans, 1958). In other words, the recombinations detected as transformations are due to events which are formally analogous to a double cross-over involving a very small segment of the donor DNA molecule. Since the donor molecule comprises approximately 1/200 of the donor genome, this cross-over can involve only a very small segment indeed of the total bacterial genome, and the region involved is thus comparable to the effectively paired segments of the genetic systems described above. Therefore, in transformation we should expect to observe high cross-over frequencies in this region and also to find the poor additivity of map distances that is observed with intragenic markers.

In the third place, the genome of the cell that picks up a transforming molecule is not itself transformed. A transformed genome is formed in the course of one of the cell divisions after DNA uptake.

(Ephrussi-Taylor, 1958). Thus recombination seems to be a consequence of growth and the synthesis of a new chromosome in the presence of the acquired DNA molecule.

Experiments have also indicated that some kind of pairing must occur between the acquired molecule and the recipient cell's genome (Schaeffer, 1958).

Only one detailed study of recombination in transformation has been performed (Lacks and Hotchkiss, 1960). In *Pneumococcus*, eight mutations were obtained for the loss of the ability to synthesize amylo-maltase, an enzyme permitting the cell to grow on maltose. Since other factors besides recombination frequency play a part in determining a particular transformation frequency in a given experiment, a method is required to correct for these irrelevant influences. This consisted in marking each donor DNA not only with a particular configuration of the maltose locus, but also with an unlinked marker, streptomycin resistance. Recombination frequency is expressed as a ratio of amylo-maltase-positive cells to streptomycin-resistant cells, and for any given type of recombination this ratio is reasonably constant.

Each mutant treated with wild-type DNA is found to have a characteristic specific probability of being transformed back to maltase plus, as can be seen from the first column of Table I. Further, cross

TABLE I

Recipient strain	Donor DNA								
	m+S	m _c S	m _d S	m _e S	m _f S	m _g S	m _h S	m _i S	m _j S
m _c	1.27	—	0.34	0	0.38	0.19	0.13	0	0.34
m _d	0.61	0.07	—	0	0	0	0.05	0	0
m _e	0.13	0	0	—	0	0	0	0	0
m _f	0.99	0.33	0	0	—	0.12	0.15	0.33	0.05
m _g	1.90	0.55	0	0	0.25	—	0.17	0.48	0.10
m _h	0.80	0.18	0.14	0	0.17	0.11	—	0	0.12
m _i	0.46	0	0	0	0.05	0.02	0	—	0.02
m _j	0.41	0.12	0	0	0.02	0.02	0.06	0.08	—

Recombination in the amylo-maltase locus of pneumococcus (after Lacks and Hotchkiss, 1960). Values are for the ratio of amylo-maltase-positive to streptomycin-resistant cells. Standard deviations have been published only for transformation of mutants by wild-type DNA. They are, for the mutants in alphabetical order, 0.18, 0.10, 0.03, 0.28, 0.20, 0.33, 0.05, and 0.22.

testing was performed in order to construct a map of the mutants. That is, each mutant was used as a receiver and also, after it was marked with streptomycin resistance, as a donor with respect to every

other mutant. Where mutants are non-identical and not overlapping, maltose-positive recombinants are formed. Table I shows the results of these crosses, from which an approximate arrangement of the mutants can be made by rapid inspection. Mutant *e* gives no recombination to wild type with any other mutant, while mutant *d* gives recombinations only with *c* and *h*. On the other hand, mutant *i* gives recombination with mutants *g*, *f*, and *j* but not with the others. It may be supposed that mutants *d*, *e*, and *i* are either deficiencies or extended mutant sequences, carrying the segments occupied by the mutants with which they show no recombination. One obtains, thus, a first general arrangement of the mutated sites.

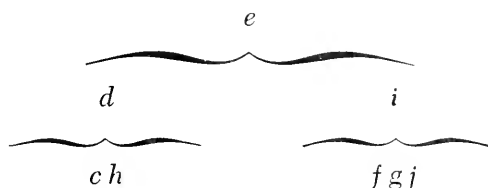

An idea of the order of *c*, *h*, *g*, *f*, and *j* is obtained if one examines the wild-type frequencies yielded when a given recipient strain is treated by DNA of each of the other mutants. In all instances the order appears to be *c*, *h*, *g*, *j*, and *f*.

Closer inspection of the table reveals, however, some striking features. Most of the crosses do not give the same result in reciprocal arrangements. For example, when mutant *c* is the recipient and *j* the donor, one observes the production of 0.34 per cent wild type by recombination. However, when *j* is recipient and *c* the donor, the per cent wild type is only 0.12. This difference is too great, and the incidence of this kind of result too frequent, to be devoid of significance. What will be done now is to consider this feature of recombination in transformation as an intrinsic property of the mechanism by which recombination takes place, and we shall let it dictate a model for recombination at the molecular level.

A model of recombination in transformation

The first task is to try to discern a general principle related to these asymmetries in reciprocal recombination frequencies. Mutants *d* and *i*, which give wild-type recombinants with certain other mutants, but not all, clearly involve large segments of the locus; *d* covers at least three mutational sites, and *i* covers at least two. In crosses involving these mutants, very low frequencies of wild recombinants are encountered whenever the "large" mutant, *d* or *i*, is in the recipient cell. One

cannot assume that the non-overlapping mutants c , h , f , g , and j are point mutations; some of these, too, may involve relatively extended nucleotide sequences. This is what we shall suppose. Then we shall assume that asymmetrical results between pairs of these mutants are obtained whenever the mutants involved are sites having distinctly different sizes. If the larger mutated site is in the recipient cell, formation of wild-type recombinants is depressed.

The question arises next as to whether the "large" mutated sites are deficiencies or extended altered nucleotide sequences. Clearly, the ability of a mutant to revert to wild type will not distinguish between these two possibilities. If we suppose that mutants such as d and i are deficiencies, and that pairing between a deficient molecule and its non-deficient homologue is the same as between a deficient and non-deficient chromosome, we see no reason why recombination frequencies should depend on whether the deficiency is in the donor as opposed to the recipient cell. If, on the other hand, we suppose that the "large" mutated sites are not deficiencies but extended altered sequences, we can construct a model which explains the asymmetries, using current notions of negative interference.

This model supposes the following:

1. That pairing in the amyloamylase locus, if not in the entire DNA molecule, is complete and effective.

2. That transformation is the result of multiple cross-over events in the paired region. We score as recombinant any double cross-over whose effect is to substitute the normal sequence of the donor DNA molecule in the chromosome for the mutated sequence of the recipient cell's DNA. If the complementary event occurs, *i.e.*, insertion of the normal sequence of the recipient cell in place of the mutant sequence of the donor DNA molecule, it is undetected, since the donor DNA molecule, or a copy thereof, is an incomplete genome and cannot be recovered in a viable cell.

3. The first cross-over event will be supposed to occur at random. It establishes the "point of attack" on the donor DNA molecule.

4. The second cross-over event determines the point of return to the recipient cell's DNA sequence, and it will be supposed to have a high probability of occurring, once a point of attack has been established. The points of attack and points of return define the lengths of donor sequence included in the recombinant structures, and these lengths fall in some kind of distribution.

5. We shall assume that the lengths of donor sequence inserted in the recombinant structures, after attacks starting at any given point, are distributed normally.

Let us now see what kind of quantitative results such a model yields. We examine the simplest case—that of transformation of a mutant cell by a normal DNA homologue. Figure 8 is a diagram of the recombination events in such a transformation. While a polarity of the recombination process is assumed in the drawing, this is merely to simplify the drawing and is not an essential feature of the model. Several possible points of attack are shown. These may be supposed to correspond to one or both sugar-phosphate bonds linking each nucleotide into the chain. Each point of attack is followed by a return, and the probable length of sequence involved is shown by the normal curve drawn from each point of attack. Clearly, the farther the point of attack is from the mutational site, the longer must be the donor sequence included in the recombinant, in order to exclude the mutational site in the recipient cell. However, any given point of attack gives rise to very few recombinants in which a long donor sequence is present. Thus, distant points of attack will yield few wild-type recombinants. If the point of attack is closer to the recipient cell's mutated site, points of return delimiting shorter sequences will be effective in yielding wild-type recombinants. Finally, the point of attack just to the left of the

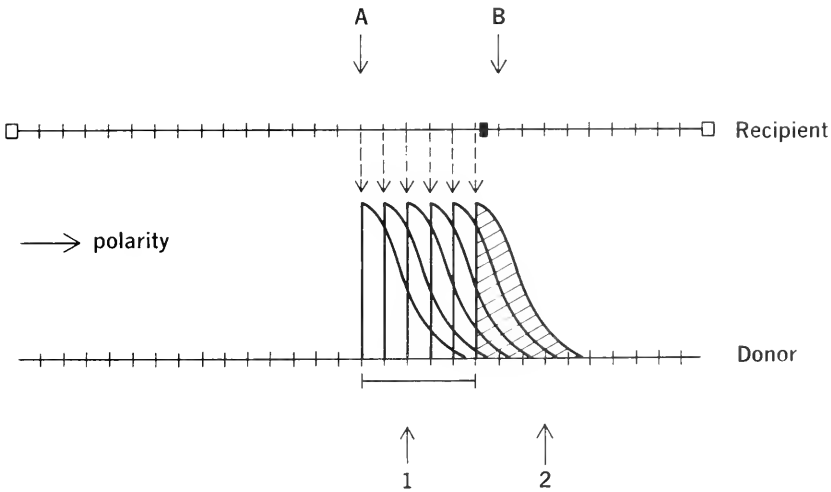

Figure 8. Diagram of a recombination model for transformation of a mutant recipient cell by wild-type donor DNA. The black rectangle marks the position of the mutation. Dotted arrows indicate different points of attack of the donor sequence. Curves describe the frequency distribution of the lengths of donor sequence determined by a return to the recipient cell's DNA. The scale below the donor sequence corresponds to two sigmas of the distribution; for any point of attack to the left of two sigmas, there is a 95 per cent or greater chance of the return occurring before exclusion of the mutant site.

mutant site will give rise to a family of recombinants, all of which exclude the mutant site.

Examination of Figure 8 thus shows that the closer the point of attack to the position of the mutant site, the greater will be its contribution to the wild-type recombinant class. If we take the sum of all of the recombination events capable of yielding wild types, we obtain a frequency distribution which has a maximum in the region of short lengths of sequence but is skewed in the direction of long sequences. In other words, the most probable length involved in giving the wild type is short, but a considerable number of total recombinants do arise from the insertion of long sequences, owing to the contribution of the more distant attack points.

Let us now examine what happens if the mutated sequence in the recipient cell has an appreciable linear dimension. By appreciable linear dimension we shall mean that several points of attack or return are possible within the mutant sequence, *i.e.*, that the mutant sequence is larger than the minimum unit of recombination, which we can assume to be a nucleotide. If a mutant containing such a sequence rather than a point mutation is treated by wild-type DNA, fewer wild-type recombinants will be recovered, for any return falling within the mutant sequence will yield a recombinant chromosome which is still mutant. An extension of the mutant sequence prevents events involving short lengths of donor sequence from contributing to the wild-type category of recombinants. Since this is a large proportion of the total of effective recombination events falling around the region of the mutation, the recombination frequency will be appreciably reduced. If the mutated site is increased from one minimum unit of recombination to two, a large class of recombination events will now yield mutant structures instead of wild-type, for they will include one of the altered nucleotides of the mutant site. If the site is increased from two to three units, another increment of mutant recombinants will be produced, but this increment will be smaller than that obtained in passing from one to two. In other words, each additional increase beyond two will convert a smaller and smaller proportion of recombinant structures into mutant ones. In summary, recombinations yielding the wild type will be lowered by any increase in the dimensions of the mutational site, but this decrease will not be proportional to the linear dimensions of the mutational site.

Accordingly, the differences in the ease with which the eight mutants at the amyloamylase locus are transformed back to wild type may be considered to reflect the linear extension of the mutant sites. Their size order, judging from the first column of Table I, would be $g < c < f < h < d < i < j < e$. However, if we take into account the errors of the determinations (see the legend of Table I), it turns out that we

cannot really distinguish between c , f , and h . Further, there is one obvious error in the order, which can be ascribed to the extremely high error in the determination of the recombination frequency of j with wild-type DNA. Mutant d covers mutants g , j , and f , yet in the above size order, mutant j comes out bigger than d . Clearly, either the linkage relationship of j is wrong, or the determination of the wild-type recombination frequency of j by wild-type DNA must be wrong. The latter is far more likely, since the linkage relationship is consistent in all crosses of mutant by mutant involving j . Thus j may be presumed to be smaller than d , is certainly larger than g , and possibly larger than c . We may assume the size order to be as follows, taking these considerations into account: $g < c = f = h < j < d < i < e$.

Let us consider next what is involved in obtaining wild-type recombinants when different mutated sites are present in the donor and the recipient cell. Let us start from the simplest situation, in which a point mutation is introduced into the donor DNA molecule. If it is in position 1 of Figure 8, all sequences beginning to the left of the donor mutation will contain the mutant site and will not yield wild-type recombinants. The effect of this will be to eliminate only very few of the total recombination events that would yield wild type had the donor mutant site not been present. If we place the donor mutation in position 2, again only a few of the potential wild-type recombinants will be eliminated: those starting just to the left of the mutated site of the recipient cell and extending beyond the mutated site of the donor. Thus the effects of a mutant site at either position will be small and tend to diminish only slightly the wild-type recombinants arising from insertion of long sequences.

As the position of the mutant site of the donor approaches that of the recipient cell, the reduction of the recombination events capable of yielding the wild type will become increasingly severe. It is evident that such a model cannot lead to proportionality between the distance separating two mutant sites and the frequency of wild-type recombinants.

If, instead of bringing the mutant sites closer, we separate them, the mutant site in the donor molecule will cease to limit the frequency of wild-type recombinants. Their number will approach that observed when a mutant is transformed by wild-type DNA. Thus there will be a limit to the distances which can be measured by double cross-over events of the type assumed.

Let us now examine what happens if one of the two mutant sites has an appreciable linear dimension. As stated above, by a site of appreciable linear dimension we shall mean one in which several points of attack or return are possible within the mutant sequence. Figure 9 shows a pair of reciprocal transformation experiments involving a large

mutant, such as m_d or m_i , and a small mutant, such as m_g . It can be seen that the dimensions of the mutated site in the donor molecule are without consequence for the yield of wild-type recombinants, because any point of attack beginning in the mutant sequence of the donor will of necessity include the extreme right portion of the mutant sequence of the donor. Thus wild-type recombinants will be formed only from points of attack to the right of the end of the mutant sequence of the donor. Consequently, irrespective of the size of the mutated site in the donor DNA molecule, the frequency of wild-type recombinants will be determined by the length of segment separating the donor and recipient cells' mutational sites. If, however, it is the recipient cell that contains the extended mutant sequence, then the number of wild-type recom-

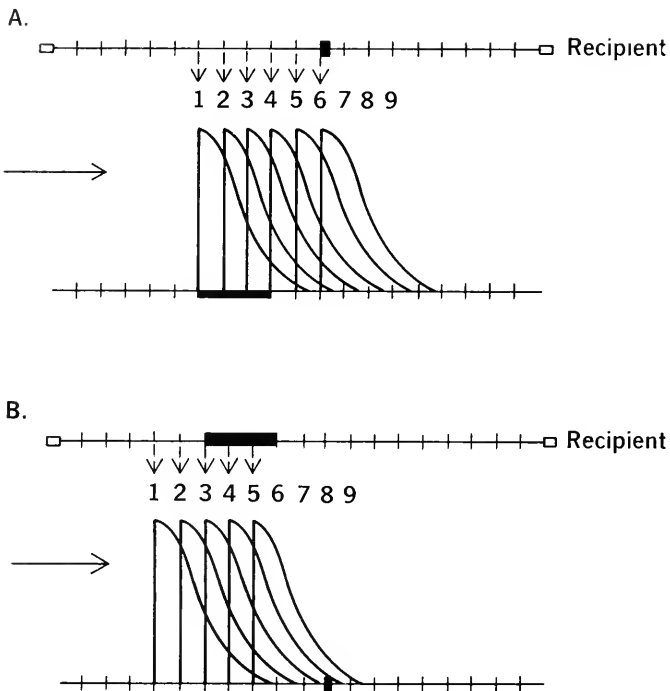

Figure 9. Model of transformations involving two mutants of unequal dimensions. A: The size of the marker has no effect on the number of wild type recombinants, since any point of attack starting to the left of position 4 will necessarily include the last of the mutated sequence in any segment ending to the right of the mutant site of the recipient cell. B: The size of the marker has a drastic effect on the numbers of wild type recombinants, since the short lengths provided by points of attack 2 and 3 will contain mutant portions of the recipient site. It is these attack points that normally contribute most heavily to the formation of wild-type recombinants when the recipient cell contains a point mutation.

binants will be markedly reduced. It is the points of attack nearest the mutated site of the recipient cell (positions 2 and 3 in Figure 9) that give rise to most wild-type recombinants when the recipient cell's site is a point mutation; most of these recombinations will be mutant, not wild, when the site is extended, because of the large number of returns within the mutant sequence. In Figure 9, the only effective recombinations will be those beginning in positions 2 and 3 and ending in positions 6, 7, and 8.

The same depression in frequency of wild-type recombinants is observed irrespective of whether the mutant sequence in the recipient cell is to the right or to the left of the mutant site of the donor. This is why the assumption of polarity is unessential. Thus the lack of agreement between recombination frequency in reciprocal crosses is perfectly understandable in terms of this model.

There are, however, conditions under which extended mutant sequences will give identical results in reciprocal crosses. First, if both the donor and the recipient cells are marked with extended mutant sequences of approximately equal size, not only will reciprocal crosses give equal frequencies of wild-type recombination, but also these frequencies will be extremely low. Consequently, the fact that mutants m_i and m_a show no recombination in Table I does not necessarily mean that they are overlapping. Second, reciprocal crosses between a long marker and a point mutation will give indistinguishable numbers of wild-type recombinants if the most frequent length of sequence involved in recombination is very large with respect to the length of the extended marker. However, the very fact that the size of the mutated site is clearly influencing recombination frequency could mean precisely that the length of donor sequence most frequently inserted in the recombinant structure is small—of the same order of magnitude as the length of a small mutational site.

If we now examine Table I, we see that all markers give asymmetrical results with mutant m_g . In terms of the model, this means that all markers are longer mutant sequences than m_g and are large with respect to the most frequent length of sequence involved in recombination. We should furthermore be able to order the mutants with respect to size, according to the degree of discrepancy observed in reciprocal crosses. To do this, we can consider all of the crosses involving any single mutant both as donor and as recipient. We can then calculate for any given cross of x by y the ratio of the recombination frequencies observed when the mutant is the recipient and when it is the donor. For example, for mutant g :

$$\frac{f(g \text{ by DNA } c)}{f(c \text{ by DNA } g)} = 2.9 \text{ and } \frac{f(g \text{ by DNA } h)}{f(h \text{ by DNA } g)} = 1.55, \text{ etc.}$$

If any given mutant is the same size as g , according to our hypothesis this ratio will be 1. If, on the contrary, a mutant is smaller than g , this ratio will be less than 1. A mutant larger than g yields a ratio greater than 1. We can thus construct a size order for the mutants which give recombination with other mutants, considering each mutant in turn as the reference mutant.

When this is done, one observes the orders shown in Table II. Note

TABLE II

The Ordering of Mutant Sites with Respect to their Size.

Reference mutant	Size order of mutants
m_g	$g < h < f < c < j < i$
m_c	$g < h < c < f < j < d$
m_h	$g < h < f < c < j < d$
m_f	$g < c = h < f < j < i$
m_j	$g < c < f < h < j < i$
m_i	$g < f < j < i$
m_d	$c < h < d$
crosses of mutant by wild DNA	$g < c = f = h < j < d < i$

first of all that since c , f , and h cannot be distinguished from one another unless greater precision can be obtained in the measurement of recombination frequencies, we cannot expect to order them with respect to each other. They form a single size class which is larger than that of g . Note finally that in no instance can we order both d and i in the same cross, and we cannot distinguish them from each other. We have, then, the possibility of ordering four classes: g , chf , j , and d or i . The orders agree in all cases, and this is probably more than a happy accident.

In setting up this model, we have considered two variables: the distance between markers and the linear dimensions of these markers. We have supposed that the donor DNA molecule is uniformly paired with the corresponding molecule in the recipient cell's chromosome. We have thereby eliminated pairing as a variable. Only an experimental test of the model will show whether pairing is not in reality a variable also. However, regardless of this question, it is clear that the position of a mutant site with respect to the ends of a DNA molecule will very much influence its recombination behavior: If the recipient cell contains a site which is near one end of the molecule, recombination frequency will be depressed, for the probability of a point of attack occurring in the region between the site and the end of the molecule will be

small. Indeed, non-equivalent recombination frequencies in reciprocal crosses would be obtained in crosses involving two point mutations, one of which was situated very near an end. The data of Lacks and Hotchkiss (1960) cannot be explained in this way, though in crosses involving a terminal marker (*c* or *f*) this factor may be operating for one of the two terminal markers. The strongest reason for excluding the distance from an end of the DNA molecule as the sole cause of the asymmetries of the data on the amyloamylase locus is the fact that the center mutant *g* gives asymmetrical results, and in the same direction, with both terminal markers. Unless we suppose that the locus occupies the entire DNA molecule, *c* and *f* cannot both be near ends. Current estimates of the size of a locus argue against this. Thus the model taking the size of mutant sites into account has unique explanatory properties, in that it explains asymmetries regardless of the positions of markers with respect to the ends of the DNA molecule.

A mathematical formulation of this recombination model has been elaborated by Prevost (unpublished), and its usefulness in mapping in transformation is under investigation. The mutants discussed above are too few in number to provide a critical test of the model. In particular, the series contains too few "point" mutants to be very useful in a quantitative test. Therefore we must first obtain a new series of mutants which, on the basis of as many criteria as possible, can be considered to be point mutations. For the present, rather than enter into further details of the model, its limitations, and its points of oversimplification, it seems more worthwhile to discuss to what extent this model may be applicable to other genetic systems.

Applicability of the model to other systems

The principal reason for believing that the model may generally describe recombination on the molecular scale is that the basic assumption made is essentially that advanced to explain the high frequency of recombination observed in fine-scale analysis of chromosomes in other genetic systems. This assumption is that when chromosomes or DNA molecules are effectively paired, multiple cross-over events will occur in the paired structure or in progeny patterned on it. The present model goes farther only in giving a concrete form to these cross-over events. It thereby provides a theory which can be tested experimentally. It may seem strange that a detailed model has been presented only for transformation, in view of the fact that recombination data in this type of system are still very fragmentary. However, transformation (or transduction, for that matter) offers a unique analytical situation in two respects. The "male" element of a cross is only part of a genome—an isolated DNA molecule. Because of this, only one kind of recombina-

tion event is scored in a given cross: the transfer of donor specificity to the recipient-cell genome. The reverse transfer is not detected because if it occurs, the resultant molecule cannot form the genome of a viable cell. Thus, in order to study such an event, we must reverse the cross by making a DNA from the recipient cell and transform the donor of the first cross. A second consequence of the incompleteness of the "male" element of crosses in transformation is that, because this element is a single DNA molecule, a sharp upper limit is imposed on the length of the paired structures that give rise to recombinants. Both of these factors have served in the building of a model. The first factor is the very reason for the detection of the unequal frequencies with which the two kinds of recombinations give rise to wild-type recombinants, for each kind of recombination event is obtained in pure form in one of the two reciprocal transformations possible between two marked strains. *The absence of symmetry of the crosses of the amylo maltase mutants is the restriction that indicates absence of proportionality between map distance and recombination frequency.* The second factor—namely, a limitation of the size of the paired structures—justifies making a simple model in which pairing is not a variable. Experiments will reveal whether this simplification is valid.

In crosses involving two complete genomes, as in *Aspergillus* or phage, selected recombinants arise from what may formally be considered the same two kinds of recombination events mentioned above. For example, in cross A shown in Figure 2 the selected recombinants that are wild type for adenine are formed by two basic events.

1. The new chromatid synthesized along parent 1 may switch over to parent 2, copy the normal sequence opposite the ad_{17} site, and return, or not, to copy again along the parent 1 chromosome.
2. The chromatid synthesized along the parent 2 chromosome may switch over and copy the normal sequence opposite the ad_{15} site, and return, or not, to copy again along the parent 2 chromosome.

Translated into the terms used for transformation: In the first instance the parent 1 chromatid is serving as the "recipient" and the parent 2 as the "donor"; in the second instance parent 2 is the "recipient" and parent 1 the "donor." If we are to examine the applicability of the transformation model to other genetic systems, we must be able to recognize these two categories of events. A step in this direction can be made if additional markers are present outside the locus of the recombining alleles. The selected recombinants can be classed according to the outside markers present in the recombinant chromosomes, as is done in Figure 10 for the crosses described in Figure 2.

Let us now try to assign an origin to each type of recombinant chromosome. If we regard the largest class in each cross, the single

cross-over class, it is clear that the origin of the chromosome can be determined only if we know from which end duplication begins, and have a marker near that end. The same is true for the triple cross-over class (or indeed for any odd number of switches). On the other hand,

CROSS A

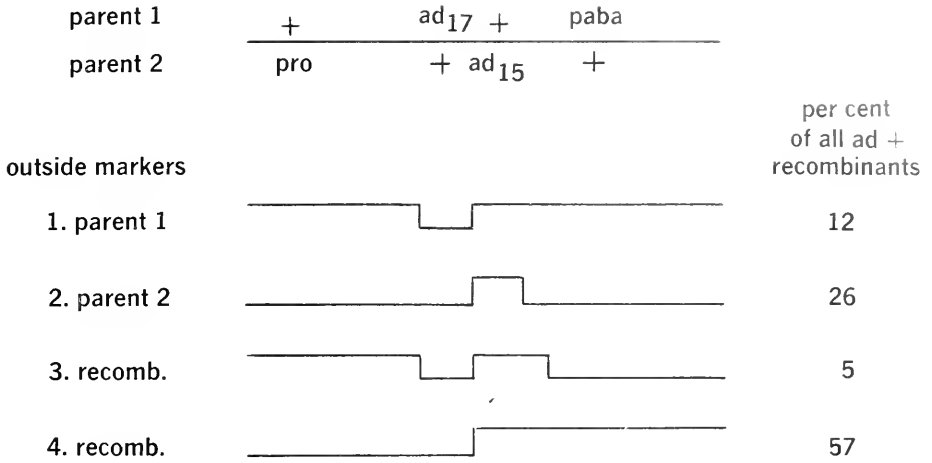

CROSS B

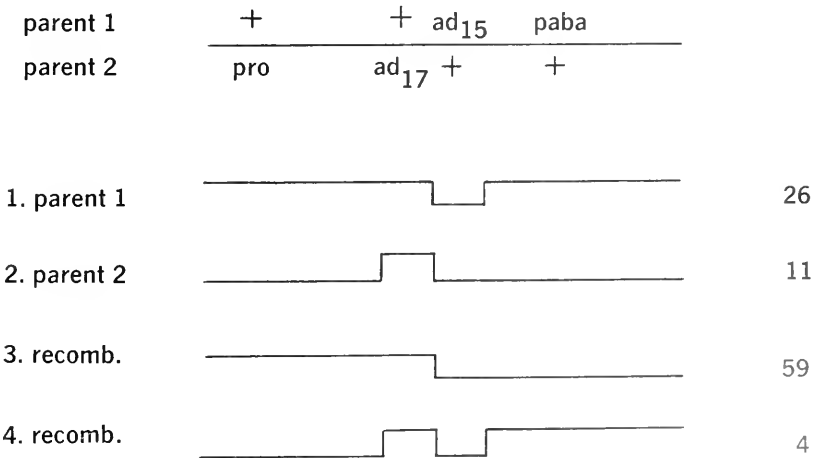

Figure 10. Diagram of the formation of wild-type recombinants in crosses involving two adenine alleles in *Aspergillus* (Calef, 1957). Recombinants are grouped in classes according to whether the outside markers are in parental arrangements or recombined. These are the four classes of selected recombinants shown in Figure 2.

the double cross-over classes show clearly the origins of the recombinant structures. When the outside markers are as in parent 1, recombination has taken place by a double cross-over in which a parent 1 chromatid has included a short region of parent 2 sequence. When, on the other hand, the outside markers are like those of parent 2, it is a parent 2 chromatid which has included a short segment of parent 1 sequence. In other words, when the outside markers are like those of parent 1, it is a parent 1 chromatid which is the "recipient," and when the outside markers are like those of parent 2, it is a parent 2 chromatid which is the "recipient."

In cross A, the frequencies of these two events are not the same (see Figure 10). The double cross-overs in which parent 2 is the "recipient" are twice as successful in producing a wild-type adenine locus as are the double cross-overs in which parent 1 is the "recipient." Now the closest outside marker is the *paba* marker, and it is a thousand times farther away from the adenine locus than are *ad₁₅* and *ad₁₇* from each other. Therefore, we would not expect the positions of the outside markers to have much influence on the quantitative results. If there were such an influence, we would expect class 2 recombinants in cross A to be the less frequent, for the switch to the right of *ad₁₅* might be expected to fall to the right of *paba* some of the time, rather than between *ad₁₅* and *paba*. Class 2 is, however, the more frequent of the double cross-over classes.

If we now examine cross B, it is evident that the outside markers indeed do not influence the frequencies of classes 1 and 2, for here the *ad₁₅* and *ad₁₇* sites have been interchanged. We see that there is a two-fold difference in the relative frequencies of the two classes, but it is now the class in which the outside markers are from parent 2 in which the frequency is low. *In other words, when the *ad₁₇* site is in the "recipient" chromatid, recombination frequency is low.* In terms of the transformation model, this would mean that the *ad₁₇* mutant site is a more extended site than the *ad₁₅* site. In other words, *ad₁₇* comprises more minimum recombination units than does *ad₁₅*.

Many examples of the sort just described can be found, in data obtained with other loci in *Aspergillus*, with *Neurospora*, and with *Saccharomyces*. Thus the crosses discussed are far from being an isolated case. The analogies between such data and transformation data are too striking not to be significant. To the extent that they indicate identity of recombination mechanism in transformation as well as in systems of equal parental participation, one can conclude that recombination events observed in the fine-structure analysis of chromosomes involve crossing-over between segments of chromosomes which are of the same order of magnitude as the markers themselves, and that the dimensions of the very markers employed to analyze chromosomes at the molecular level can no longer be neglected, as they have been in the

past. Further, it seems unlikely that a clear understanding of recombination mechanism will be possible in systems of equal parental contribution until a clear distinction is made between the two basic types of recombination which are at the origin of a single type of selected recombinant.

How, finally, stands the problem of relating genetic maps to the lengths of nucleotide sequences? Clearly, it will be at an impasse until a verified theory of recombination at the molecular level is evolved. Today classical mapping procedures seem to pertain to the fulfillment of the primary condition that must be met if crossing-over is to occur—*i.e.*, effective pairing—rather than to the process of crossing-over itself. When we examine recombination in transformation, in which we are certain that the hybridizing element is DNA, and where—owing to the very fragmentary nature of the “male” genome of the cross—selection recovers only a single type of recombination event, the observed results can be explained best in terms of a model in which the relation between the map distance and the recombination frequency is non-linear. Further, when we examine data obtained by selection of rare recombination events in Mendelian systems, we find, again, definite indications that recombination frequency may not be a simple function of distance between sites. It is time, therefore, to question the wisdom of employing classical assumptions in mapping the fine genetic structure of chromosomes.

If this lengthy discussion has not left the impression that genetics is a science of unifying principles, it is because the limitations of space have confined us to preferential consideration of microbial systems. However, many of the newer features of chromosome behavior about which this paper is written were foreshadowed in experiments with maize and *Drosophila*. Such striking similarities of genetical behavior in viruses, bacteria, fungi, and higher plants and animals we suppose to be due to the common molecular structure of genetic material throughout all living organisms on this earth. Accordingly, all aspects of recombination must be due to the way in which DNA replicates and functions. Even though remarkable progress has been made in understanding the structure of DNA, its synthesis, and replication, we are still very far from understanding recombination mechanisms in these terms. Thus, while the proposed model is at the molecular scale, it is not a molecular model. We can hope, however, that the formal genetic description of recombination at the molecular scale will provide valuable parameters for the construction of a truly molecular theory of recombination.

References

- Avery, O. T., MacLeod, C. M., and McCarty, 1944. “Studies on the Chemical Nature of the Substance Inducing Transformation of Pneumococcal Types.

- Induction of Transformation by a Desoxyribonucleic Acid Fraction Isolated from Pneumococcus Type III," *J. Exp. Med.* 79, 137.
- Beadle, G. W., and Tatum, E. L., 1941. "Genetic Control of Biochemical Reactions in *Neurospora*," *Proc. Nat. Acad. Sci.* 27, 499.
- Benzer, S., 1955. "The Fine Structure of a Genetic Region in Bacteriophage," *Proc. Nat. Acad. Sci.* 41, 344.
- Benzer, S., 1957. "The Elementary Units of Heredity," in McElroy, W., and Glass, B., eds., *The Chemical Basis of Heredity* (Baltimore, Johns Hopkins Press).
- Calef, E., 1957. "Effect on Linkage Maps of Selection of Cross-Overs Between Closely Linked Markers," *Heredity* 11, part 2, 265.
- Case, M. E. and Giles, N. H., 1958. "Recombination Mechanisms at the Pan-2 Locus in *Neurospora crassa*," *Cold Spring Harbor Symp. Quant. Biol.* 23, 119.
- Chase, M., and Doermann, A. H., 1958. "High Negative Interference over Short Segments of the Genetic Structure of Bacteriophage T4," *Genetics* 43, 332.
- Dubinini, N. P., 1929. "Allelomorphentreppen Bei *Drosophila melanogaster*," *Biol. Zbl.* 49, 328.
- Ephrussi-Taylor, H., 1951. "Genetic Aspects of Transformations of Pneumococci," *Cold Spring Harbor Symp. Quant. Biol.* 16, 445.
- Ephrussi-Taylor, H., 1958. "The Mechanism of Desoxyribonucleic-Acid-Induced Transformations," in Tunevall, G., ed., *Recent Progress in Microbiology* (Springfield, Ill., C. C. Thomas).
- Fincham, J. R. S., and Pateman, J. A., 1957. "Formation of an Enzyme through Complementary Action of Mutant 'Alleles' in Separate Nuclei in a Heterocaryon," *Nature* 179, 741.
- Freese, E., 1958. "The Arrangement of DNA in the Chromosome," *Cold Spring Harbor Symp. Quant. Biol.* 23, 13.
- Giles, N. H., Partridge, C. W. H., and Nelson, N. J., 1957. "The Genetic Control of Adenylosuccinase in *Neurospora crassa*," *Proc. Nat. Acad. Sci.* 43, 305.
- Hayes, W. H., 1960. "The Bacterial Chromosome," in Hayes, W. H., and Clowes, R. C., *Microbial Genetics* (N. Y., Cambridge U. Press).
- Hershey, A. D., and Rotman, R., 1948. "Linkage among Genes Controlling Inhibition of Lysis in a Bacterial Virus," *Proc. Nat. Acad. Sci.* 34, 89.
- Hotchkiss, R. D., and Evans, A. H., 1958. "Analysis of the Complex Sulfanoamide Resistance Locus of Pneumococcus," *Cold Spring Harbor Symp. Quant. Biol.* 23, 85.
- Hotchkiss, R. D., and Marmur, J., 1954. "Double Marker Transformations as Evidence of Linked Factors in Desoxyribonucleate Transforming Agents," *Proc. Nat. Acad. Sci.* 40, 55.
- Lacks, S., and Hotchkiss, R. D., 1960. "A Study of the Genetic Material Determining an Enzyme Activity in *Pneumococcus*," *Biochim. Biophys. Acta* 39, 508.
- Lederberg, E., 1958. "Fine Structure of the Gal Loci in *Escherichia coli* K-12," *Proc. Tenth Int. Cong. Genet.* 2, 161.
- Lederberg, J., and Tatum, E. L., 1946. "Novel Genotypes in Mixed Cultures of Biochemical Mutants of Bacteria," *Cold Spring Harbor Symp. Quant. Biol.* 11, 115.
- Levinthal, C., 1956. "The Mechanism of DNA Replication and Genetic Recombination in Phage," *Proc. Nat. Acad. Sci.* 42, 394.
- Lewis, E. B., 1945. "The Relation of Repeats to Position Effect in *Drosophila melanogaster*," *Genetics* 30, 137.
- Lewis, E. B., 1951. "Pseudoallelism and Gene Evolution," *Cold Spring Harbor Symp. Quant. Biol.* 16, 159.

- Meselson, M., and Stahl, F., 1958. "The Replication of DNA in *Escherichia coli*," *Proc. Natl. Acad. Sci.* **44**, 671.
- Mitchell, M. B., 1955. "Aberrant Recombination of Pyridoxine Mutants of *Neurospora*," *Proc. Nat. Acad. Sci.* **41**, 215.
- Pontecorvo, G., 1952. "The Genetical Formulation of Gene Structure and Action," *Adv. Enzymol.* **13**, 121.
- Pontecorvo, G., 1958. *Trends in Genetic Analysis*. (N. Y., Columbia U. Press).
- Pontecorvo, G., and Roper, J. A., 1956. "Resolving Power of Genetic Analysis," *Nature* **178**, 83.
- Pontecorvo, G., and Kafer, E., 1958. "Genetic Analysis Based on Mitotic Recombination," *Adv. in Genetics* **9**, 71.
- Pritchard, R. H., 1955. "The Linear Arrangement of a Series of Alleles in *Aspergillus nidulans*," *Heredity* **9**, 343.
- Pritchard, R. H., 1959. "Localized Negative Interference and its Bearing on Models of Gene Recombination," *Genet. Res.* **1**, 1.
- Pritchard, R. H., 1960. "The Bearing of Recombination Analysis at High Resolution on Genetic Fine Structure in *Aspergillus nidulans* and the Mechanism of Recombination in Higher Organisms," in Hayes, W. H., and Clowes, R. C., *Microbial Genetics* (N. Y., Cambridge U. Press).
- Ravin, A. W., 1954. "A Quantitative Study of Allogenic and Autogenic Transformation," *Exp. Cell Res.* **7**, 58.
- Roman, H., 1956. "Studies of Gene Mutation in *Saccharomyces*," *Cold Spring Harbor Symp. Quant. Biol.* **21**, 175.
- Rothfels, K. H., 1952. "Gene Linearity and Negative Interference in Crosses of *Escherichia coli*," *Genetics* **37**, 297.
- Schaeffer, P., 1958. "Interspecific Reactions in Bacterial Transformation," *Symp. Soc. Exp. Biol.* **12**, 60.
- Schultz, J., and Redfield, H., 1951. "Sister Chromosomal Effects on Crossing-Over in *Drosophila*," *Cold Spring Harbor Symp. Quant. Biol.* **16**, 175.
- Serebrovsky, A. S., 1930. "Untersuchungen über treppenallelomorphismus. IV. Trangenation sute - 6 und ein fell des "Nicht - allelomorphismus" von geiedern einer allelomorphenreihe bei *Drosophila melanogaster*," *Arch. Entwmech.* **122**, 88.
- Stadler, D. R., 1959. "The Relationship of Gene Conversion to Crossing-Over in *Neurospora*," *Proc. Nat. Acad. Sci.* **45**, 1625.
- Stadler, L. J., 1954. "The Gene," *Science* **120**, 811.
- Taylor, J. H., 1958. "The Organization and Duplication of Genetic Material," *Proc. Tenth Int. Cong. Genet.* **1**, 63.
- Taylor, J. H., Woods, P. S., and Hughes, W. L., 1957. "The Organization and Duplication of Chromosomes as Revealed by Autoradiographic Studies using Tritium-Labeled Thymidine," *Proc. Nat. Acad. Sci.* **43**, 122.
- Thomas, C. A., 1959. "Effect of Shear on M. W. of Phage DNA," *J. Gen. Physiol.* **42**, 503.
- Voll, M. J., and Goodgal, S. H., 1961. "Recombination during Transformation in *Haemophilus influenzae*," *Proc. Nat. Acad. Sci.* **47**, 505.
- Watson, J. D., and Crick, F. H. C., 1953. "The Structure of DNA," *Cold Spring Harbor Symp. Quant. Biol.* **18**, 123.
- Woodward, D. O., 1959. "Enzyme Complementation *in vitro* between Adenylosuccinacless Mutants of *Neurospora crassa*," *Pro. Nat. Acad. Sci.* **45**, 846.
- Zinder, N. D., and Lederberg, J., 1952. "Genetic Exchange in *Salmonella*," *J. Bact.* **64**, 679.

THE ROLE OF ENZYME REGULATION IN METABOLISM

Arthur B. Pardee

UNIVERSITY OF CALIFORNIA, BERKELEY

The problem of metabolic regulation

The ability to achieve and maintain specific end results of form and function amid a variety of perturbing influences, physical and chemical, is one of the greatest wonders of living things. It must be apparent, to a chemist at least, that to understand how a living cell regulates its processes and adjusts itself automatically to influences in its environment, it is necessary to describe the external controlling factors and the cell's response processes in chemical terms.

As a beginning in this direction it seems profitable to look into the phenomena which at present can be discussed in the language of chemistry. Such processes are the formation of the large and small molecules which are the substance and the currency of living cells. We will speak here of "regulation" and "regulated metabolism," by which we will mean production of molecules only to the extent to which they are to be used for growth or function. Can we discover the methods of regulation whereby these billions of molecules are formed each hour in the amounts required for one cell's efficient growth and function according to the pattern of its kind? Some of these regulatory mechanisms have been discovered only in the last few years, and it will be the objective of this article to present and discuss them.

Since enzymes catalyze chemical reactions in living cells, the rate at which each reaction proceeds must depend both on the number of catalyzing enzyme molecules and on the rate at which each enzyme molecule can act. Correspondingly, there are two possible sorts of regulatory processes: one kind determines the number of molecules of

an enzyme produced, the second the rate at which each enzyme molecule functions. Mechanisms to regulate both amounts and activities have been found within the past half-dozen years. We will provide examples of these processes. Then an attempt will be made to correlate the two sorts of regulatory processes with information regarding the functioning of metabolic pathways, in order to synthesize a model of metabolic regulation. This subject was extensively reviewed at an earlier date (Pardee, 1959).

Almost all of the work to be discussed here was done with *Escherichia coli*; unless otherwise stated, it will be assumed that this organism was employed.

Enzyme induction

That the quantity of an enzyme in a living cell can vary considerably under different environmental conditions has been known for some time. In particular, the increase in the specific rate of enzyme synthesis upon addition of some nutrient, usually the substrate of the enzyme, has been studied extensively under the name of enzyme induction or adaptation (Pollock, 1959). Tryptophan, for instance, can increase the specific rate of synthesis of tryptophanase in *Escherichia coli* almost immediately by several hundred times (Figure 1). Data of this

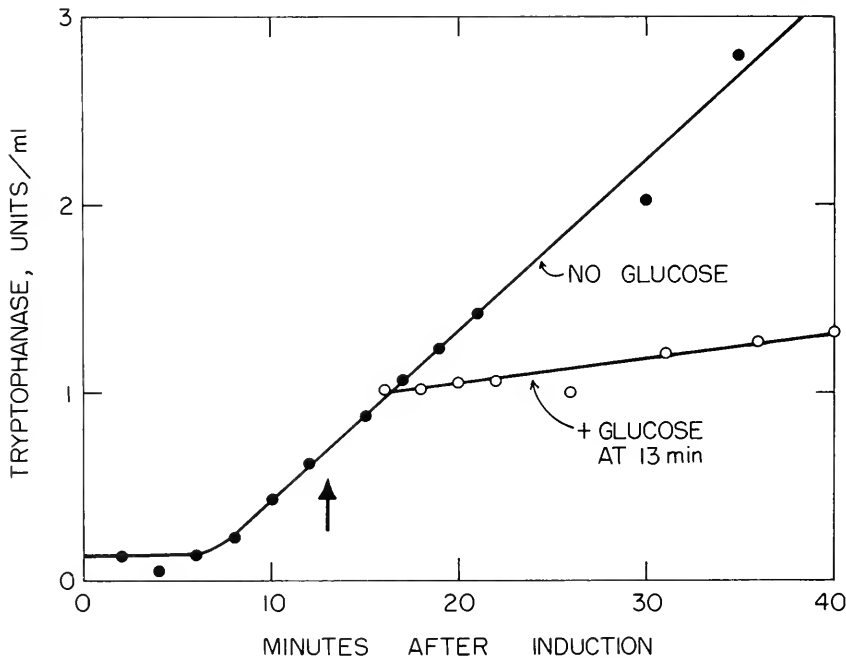

Figure 1. Induction of tryptophanase and the effect of glucose.

sort suggest that the amounts of some enzymes are determined by the concentrations of their substrates, those enzymes being made in largest amounts whose substrates are most plentiful. A consequence of induction is that if a substrate were to stimulate enzyme formation sufficiently, the enzyme would reduce the substrate level inside the cell to a value too low to induce further enzyme synthesis; thus the level of that enzyme could not increase indefinitely but would be determined by the rate at which its substrate became available. Eventually a steady state would be reached in which supply and removal were balanced. Induction could thus provide a means of regulating synthesis of enzymes so as to provide ample (but not excess) enzyme, as measured by the availability of its substrate.

Known inducible enzymes are almost invariably catalysts of processes by which energy is obtained from externally supplied nutrients. Two limitations of induction as a means of regulating such processes are apparent. First, there is no obvious way of limiting enzyme production to a level which just meets the requirements of the cell for the products of the enzyme action. Indeed, inducible enzymes can be produced under "gratuitous conditions" (Monod and Cohn, 1952) in which the cell does not require them at all. Second, induction *per se* allows the formation of the enzyme even when an alternative, more readily used, source of energy is available. In certain instances of this sort, however, the well-known phenomenon of diauxie (Monod and Cohn, 1952) does limit the induction of catabolic enzymes. For example, when glucose is added to a culture producing tryptophanase, enzyme formation ceases abruptly (Figure 1), and therefore tryptophan is no longer used as a source of energy. In spite of much effort, the mechanism of diauxie is not understood. Perhaps the most reasonable explanation is that the bacteria can form a variety of low-molecular-weight compounds from glucose, each of which specifically prevents production of enzymes involved in the synthesis of that compound (Magasanik, 1957). This concept is based on enzyme repression, which will be discussed later.

The subject of induction cannot be presented without mentioning the enzyme-like factors (named permeases) that permit the entry and concentration of metabolites within cells (Cohen and Monod, 1957). These must play a role in metabolic regulation. Entry of a nutrient into the cell is generally the first step in its metabolism. Permeases make available at high intracellular concentrations nutrients present at low concentrations in the environment and thereby permit the nutrients to be metabolized rapidly by a limited amount of enzyme. Permeases, therefore, play a role in the economy of the cell by diminishing the requirements for enzymes. However, to avoid expenditure of energy in the formation of the permeases themselves, it would seem beneficial

that they, like occasionally used enzymes, be inducible, and some of them are.

Sequential induction (Stanier, 1951) permits the extension of the ideas of induction to enzymes that are required for the metabolism of biosynthetic intermediates as well as those that act on externally supplied nutrients. In sequential induction the added compound A induces an enzyme, E_a , which converts A to B . Then B induces E_b , and the product of this enzyme induces E_c , and so on. Chains of up to a dozen enzymes can be induced in this fashion. From our point of interest, it is apparent that enzyme levels can be regulated by induction even though the inducer is not supplied as a nutrient. These findings on sequential induction suggested some time ago that biosynthetic enzymes could be regulated in amount by induction, with biosynthetic intermediates as inducers (Pollock, 1953; Cohn and Monod, 1953).

Repression of enzyme synthesis

Induced formation of a biosynthetic enzyme seemed to be directly demonstrated when an "arginine-requiring" mutant of *E. coli* was found to produce considerably more acetylornithinase (an enzyme of arginine synthesis) when the bacteria were grown on acetylornithine rather than on arginine (Vogel and Davis, 1952). However, this was later discovered to be due to prevention of formation of the enzyme by arginine rather than to a stimulation by acetylornithine (Vogel, 1957). The name "repression" was given to this phenomenon. Several other examples of inhibition of enzyme synthesis by metabolic end products had been noted some years ago. These included repression of tryptophan synthetase by tryptophan (Cohn and Monod, 1953), of methionine synthesis from homoserine by methionine (Cohn and Monod, 1953; Wijesundera and Woods, 1953), of constitutive β -galactosidase formation by lactose (Cohn and Monod, 1953), and of valine synthesis by valine (Adelberg and Umberger, 1953). In each case, production of the enzyme was found to be blocked by the end product of the reaction or reaction pathway.

The increase in repressible enzyme requires the synthesis of new enzyme protein. This is shown by studies with aspartate transcarbamylase involving incorporation of an amino acid labeled with carbon 14 into the enzyme and by the inhibition of enzyme formation by anti-metabolites or by conditions that blocked protein synthesis (Yates and Pardee, 1957).

Recently several instances of repression have been described in somewhat more detail. In these cases, as with the acetylornithinase repression, the repressor was a compound at the end of the metabolic pathway, rather than the direct product of the enzyme reaction itself.

Furthermore, not one enzyme alone but several enzymes of the pathway were repressed. Thus, arginine not only repressed acetylornithinase formation but also the next two enzymes of the pathway—ornithine transcarbamylase (Gorini and Maas, 1957) and argininosuccinase (Gorini and Maas, 1958). The level of the transcarbamylase was measured after growth of arginine-requiring mutants on limiting amounts of arginine; the supply of arginine rather than the growth rate was the important factor.

In another extensively studied case, formation of the first three enzymes of the pyrimidine biosynthetic pathway of *E. coli* was repressed by an excess of added or endogenously formed pyrimidines (Yates and Pardee, 1957)—see Figure 2. Under normal conditions of growth the concentrations of these enzymes are far lower than the maximal abilities of the bacteria to synthesize them. About 50 molecules of the first enzyme, aspartate transcarbamylase, are normally found per bacterium, whereas if growth conditions are arranged so that repression is released, the rate of enzyme synthesis relative to total protein synthesis rises at least 2,000-fold. The enzyme finally makes up as much as 7 per cent of the total protein (Shepherdson and Pardee, 1960). The rate of enzyme

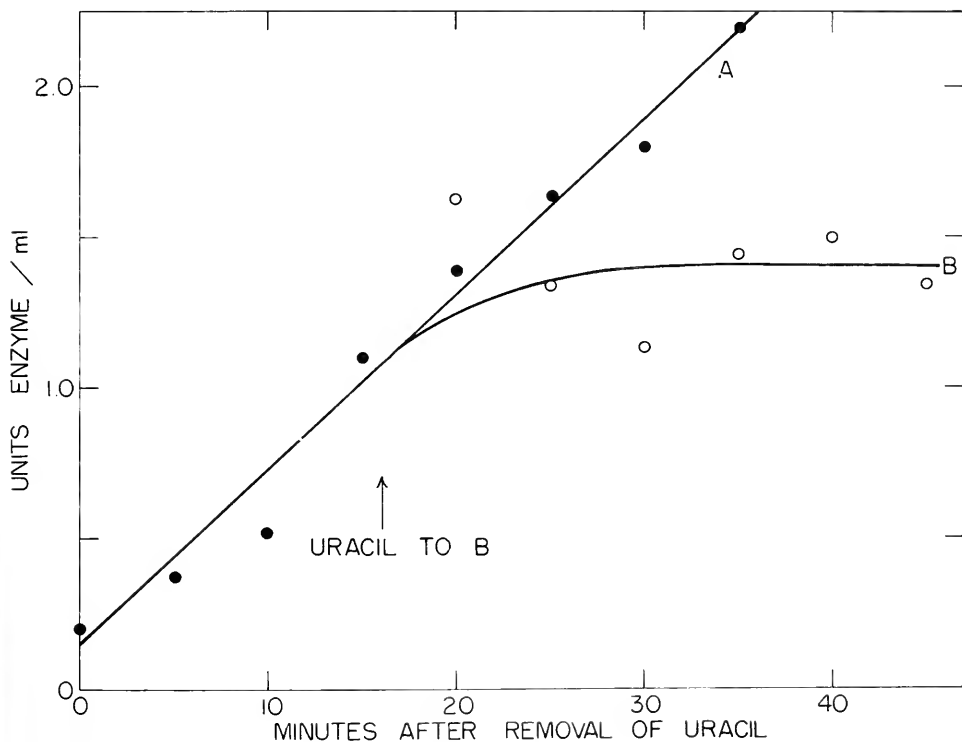

Figure 2. Kinetics of aspartate transcarbamylase repression and its release.

synthesis correlates inversely with the supply of pyrimidines available to the bacteria.

Another recent, striking instance of enzyme repression is found with alkaline phosphatase of *E. coli*. This enzyme, normally present in a minute amount, increases enormously when the concentration of phosphate in the medium is reduced, and under certain conditions can reach several per cent of the cell protein (Horiuchi *et al.*, 1959; Torriani, 1960).

Inducers are now thought to act by reversing the action of an intracellular repressor. This is suggested by experiments on the formation of β -galactosidase by bacterial zygotes which contain both the active and inactive forms of a gene that controls repressor formation (Pardee *et al.*, 1959). The gene present in inducible bacterial was dominant over that found in constitutive bacteria; therefore the former appears to be the active allele and appears to produce a repressor of enzyme synthesis. The competition of inducer and repressor for the control of enzyme formation has been strikingly and directly demonstrated for ornithine transcarbamylase, which is repressed by arginine. Ornithine can reverse arginine's effect (Gorini, 1960). One visualizes an active site which prevents protein synthesis when bound by a repressor but permits enzyme synthesis when combined with an inducer.

When such a controlling site is not bound by either inducer or repressor, enzyme is formed. Therefore, constitutive formers of the enzyme are thought to be organisms which cannot make repressor (Pardee *et al.*, 1959). Mutants in which the binding site is so modified as not to accept the repressor are also constitutive (Jacob and Monod, 1959). In addition to constitutive producers of β -galactosidase and amyloamylase (Cohen-Bazire and Joliet, 1953) and penicillinase (Pollock, 1959), investigators have recently isolated mutants constitutive for the production of tryptophan-synthesizing enzymes (Cohen and Jacob, 1959), aspartate transcarbamylase (Shepherdson and Pardee, 1960), and ornithine transcarbamylase (Gorini, 1960).

Evidence has appeared that a set of related enzymes can be repressed as a group: four enzymes of histidine synthesis are all repressed in proportion if histidine is present (Ames and Garry, 1959). The enzymes are separate proteins; hence the repressor cannot function by blocking synthesis of a complex, multifunctional enzyme particle. Furthermore, the genes that guide the synthesis of these enzymes are closely linked, providing the interesting speculation that the binding site of the repressor is on the genetic material. Similarly, a locus on the chromosome adjacent to the set of genes involved in β -galactoside metabolism is thought from genetic evidence to bind a repressor capable of affecting all of these genes (Jacob *et al.*, 1960). Concepts

regarding genetic control of gene action are in a state of rapid development.

The balance between inducer and repressor seems to provide a flexible system for regulation of enzyme synthesis. The amount of enzyme would depend on both the supply of substrate and the concentration of end product present in the cell. Substrate would be utilized at a high rate when available, but only when an excess of the end product was not already present.

If repression and induction functioned efficiently, one would anticipate that the activities of the enzymes *in vivo* would be nearly as fast as their maximum possible rates of action; *i.e.*, the enzymes would not be in large excess. Relatively few comparisons have been made between maximum activity *in vitro* and enzyme activity *in vivo* (conveniently measured by the rate of end product formation). Therefore there is little to tell us how well such regulatory processes actually function. Some data (Pardee, 1959) suggest that the enzymes of biosynthesis are often present in only a few times the minimum amount that would be required for *in vivo* functioning if these enzymes operated at full capacity.

Repression is beneficial not only because it avoids the expenditure of metabolites for formation of an unnecessary surplus of enzyme molecules, but also because it prevents damage to the cells which can occur when large amounts of certain enzymes are present. Excess alkaline phosphatase, for instance, appears to be toxic to *E. coli* (Torriani, 1960). Theoretically almost any enzyme in excess should remove a metabolite required for another pathway and thereby upset growth of the cell. It is worth considering, too, that if more than about two dozen enzymes were made in the amounts in which β -galactosidase, alkaline phosphatase, and aspartate transcarbamylase can be produced (5 per cent each), a bacterium could not hold all of them.

Feedback inhibition

Induction-repression alone would not seem sufficient for regulation of the rate of formation of small molecules, because processes controlling enzyme formation are slow compared to those involved in the synthesis of small molecules. Let us suppose that repression is released for a minute or so, and a ten-fold excess of an enzyme is formed. Even though repression operates almost at once (Figure 2), and no more enzyme is produced after repression is re-established, the enzyme already present would function at an excessive rate for more than three generations, or until growth diluted it to the normal level. This situation could come about if the bacteria were subjected to some sudden

change of conditions, or if the intracellular concentrations of metabolites were to vary considerably during a bacterial division cycle. In such cases, the enzyme formed at one time might not be required to function at the same rate shortly thereafter. In brief, induction-repression, which should usually suffice to regulate large-molecule synthesis, could only approximately adjust the synthesis of small molecules to the needs of the cell.

Another independent means of metabolic regulation has been found. This is known as feedback inhibition (Umberger, 1956; Yates and Pardee, 1956). It is an inhibition of enzyme *function* by end products of metabolism rather than of enzyme *formation*. For example, in the presence of a surplus of compound *D* (Figure 3), the conversion of *A* to *B* can be feedback-inhibited, while at the same time the formation of E_a from amino acids can be repressed.

Feedback inhibition and repression can both function to regulate the rate of a single metabolic step. This situation has been discovered in several instances; however the functional relation between the two processes has been little studied.

A unique investigation of the interaction of feedback and repression has been presented in the case of the arginine biosynthetic pathway (Gorini, 1958). The degree of repression of ornithine transcarbamylase was used to estimate the intracellular concentration of arginine. Various extracellular concentrations of arginine provided in the chemostat were employed. The intracellular arginine concentration (equivalent to the degree of repression) must have been constant and low as long as extracellular arginine was provided more slowly than total arginine could be incorporated into cell proteins (Figure 4). At the point where arginine was provided more rapidly than it was bound into protein, the intracellular arginine concentration rose sharply, to

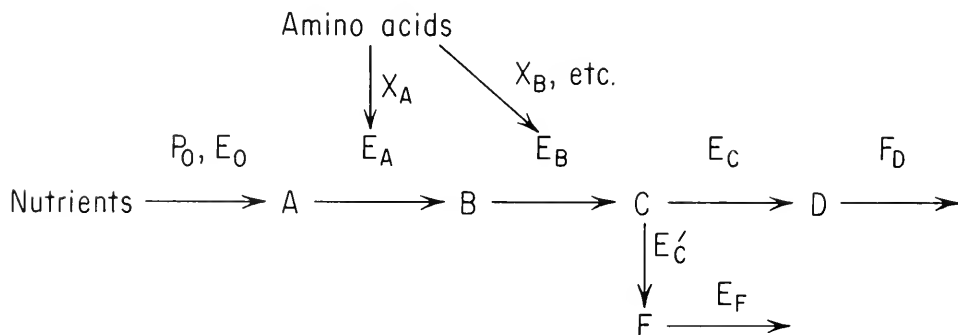

Figure 3. Schematic representation of a metabolic pathway. P_0 is a permease; *A* to *F* are metabolites; E_0, E_A , to E_F are enzymes; and X_A, X_B , etc., are the "systems" for synthesis of E_A, E_B , etc.

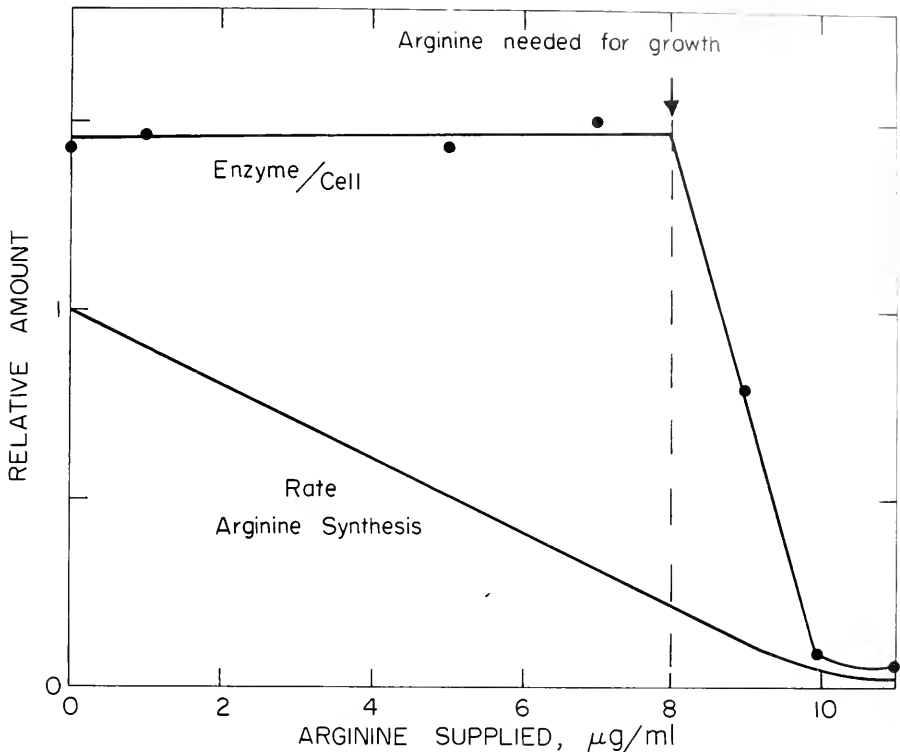

Figure 4. Feedback and repression in the arginine pathway (after Gorini, 1958).

cause a much stronger repression. One can conclude that feedback inhibition regulates the intracellular arginine concentration and limits the *de novo* synthesis of arginine to just the rate necessary to make up the difference between externally added arginine and the amount required for protein synthesis. Repression takes effect strongly only when arginine is available in excess of growth requirements. Repression is therefore a secondary control in this instance.

A number of earlier observations strongly indicated that feedback inhibition mechanisms existed. Among these were chemostat studies on production of an indole-like compound by a tryptophan-requiring *E. coli* mutant (Novick and Szilard, 1954). This compound was produced only when the supply of tryptophan limited the growth rate of the organism. Since it was almost certainly a by-product created at the metabolic block of the tryptophan pathway, tryptophan must have inhibited the pathway at some earlier point—actually prior to anthranilic acid (Pardee and Prestidge, 1958). Data were presented to show that tryptophan, rather than something else connected with the rate of

growth, was responsible for blocking production of the intermediate; also, the change in rate of production of the metabolite upon altering the tryptophan concentration was immediate, showing the regulation to be at the level of enzyme action rather than of enzyme synthesis.

Similarly, in the purine biosynthetic pathway, purines blocked the production by purine-requiring mutants of metabolic intermediates such as 5-amino-4-imidazole-carboxamide (Gots, 1957). The end product of the metabolic sequence must here also block an early step. Recently such an inhibition has been demonstrated with a purified enzyme. The earliest specific step in the pathway—the reaction of phospho-ribosyl-pyrophosphate with glutamine to produce phospho-ribosylamine—is strongly inhibited by various purine nucleoside di- and tri-phosphate compounds which are a dozen steps removed from the reaction (Wyngaarden and Ashton, 1959).

Other feedback controls interact at a later stage of purine synthesis in such a way as to partition inosinic acid between adenylic and guanylic acids (Magasanik, 1958). Guanylic-acid formation is regulated by its ability to inhibit inosinic acid dehydrogenase, an enzyme required for guanylic acid formation. ATP, a product of the alternative pathway, is required for the production of guanylic acid, and conversely, in the other branch of the pathway, GTP is required for the formation of adenylic acid from inosinic acid. These and similar controlling factors provide a most elegant explanation of how, in this case, feedback permits partitioning of a metabolite between alternative pathways.

Feedback inhibition *in vivo* and *in vitro* has been demonstrated in the pyrimidine pathway (Yates and Pardee, 1956). *In vivo*, the pyrimidine uracil was found to block the formation of orotic acid by pyrimidine-requiring mutants of *A. aerogenes* (Brooke *et al.*, 1954) or of carbamyl aspartate in *E. coli* (Yates and Pardee, 1956). As Figure 5 shows, production of orotic acid by a mutant of *E. coli* was negligible until the bacteria had utilized the available uracil, whereupon the metabolite was rapidly produced. Inhibition was shown for aspartate transcarbamylase, the first enzyme of the pathway; its activity could be inhibited in whole cells and in broken-cell preparations. With the latter, inhibition was obtained with various cytidine compounds but not with uracil derivatives. More recent studies of this feedback inhibition have been performed with the highly purified enzyme (Gerhart and Pardee, 1961). Cytidine triphosphate was the strongest inhibitor (Table I). The strength of inhibition depended on the structures of all three parts of the molecule (base, sugar, and phosphate). These data suggest that a part of the enzyme molecule comparable in size to the entire inhibitor binds the latter. Since the inhibitor competes with the much smaller substrate (aspartic acid), the enzyme seems to have sites to receive the inhibitor which are independent of the sites designed to

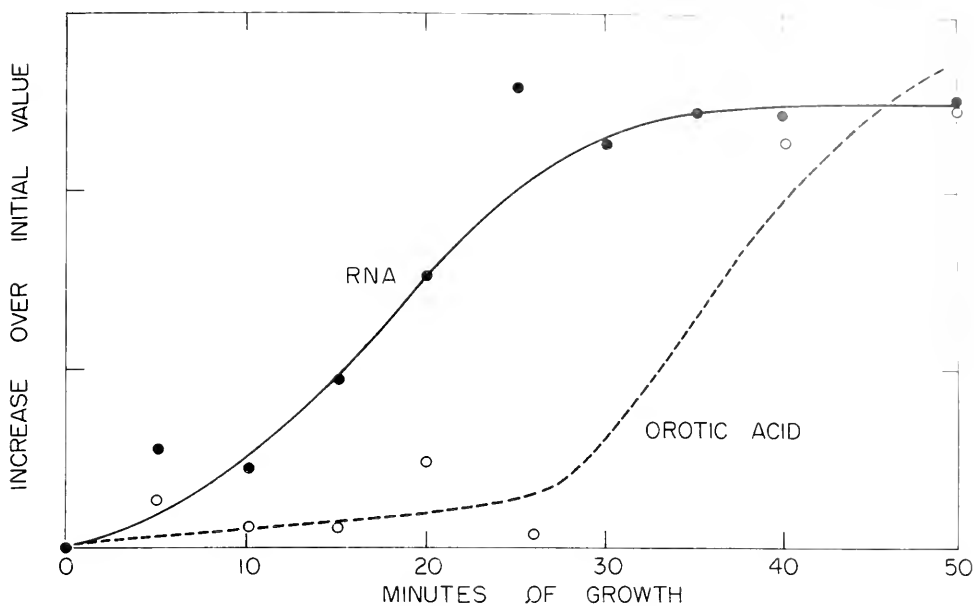

Figure 5. Production of orotic acid by a pyrimidineless mutant upon depletion of uracil.

receive the substrates. Presumably the advantages for growth provided by feedback inhibitions caused a selection of organisms which made enzymes with the built-in feedback feature.

How frequently does one find feedback inhibition in biosynthetic pathways? There are about a dozen well-substantiated cases of feedback inhibition. Also there is a general sort of experiment which suggests that feedback inhibitions are to be found in most major biosynthetic pathways. If bacteria are grown on a radioactive carbon compound (glucose) plus a non-radioactive amino acid, virtually all of that

TABLE I
Inhibition of Aspartate Transcarbamylase

Inhibitor	Molar Concentration	Inhibition (per cent)
Cytidine	0.002	25
CMP	"	40
CDP	"	70
CTP	"	100
Deoxycytidine	"	25
UTP	"	10
TTP	"	0

amino acid isolated from the bacterial protein or the medium is non-radioactive (Roberts, 1955), indicating that the externally supplied amino acid must have blocked the synthesis of more molecules of itself.

As one would expect from numerous observations on inhibition of enzyme function *in vitro* and *in vivo*, feedback inhibition responds very rapidly to the presence or absence of the inhibitor. Thus, in the *in vivo* inhibition of production of a tryptophan intermediate, the addition of tryptophan caused a change in the rate of production of the intermediate within 10 minutes, which was as rapid a response as could be measured by the available methods (Novick and Szilard, 1954). Inhibition of orotic acid production disappeared virtually as soon as the growth medium became deficient in pyrimidines (Yates and Pardee, 1957). Feedback inhibition would therefore seem to be highly sensitive to transient shifts in the concentrations of metabolites.

Interrelation of pathways

Repression and induction govern the rates of individual pathways but do not explain how the numerous pathways are related to one another. One possibility for the regulation of sets of pathways is through the synthesis of macromolecules. Consider the synthesis of nucleic acids; this requires both purine and pyrimidine nucleotides. The rate of removal of the nucleotides from the intracellular pool will depend largely on the rate of nucleic-acid formation. If one nucleic-acid component is synthesized or provided at a rate greater than is required for its utilization, feedback inhibition should inhibit the synthesis of more of this compound. The rate of its production would thereby be correlated with that of other bases to correspond to its proportion in the nucleic acids. Similarly, in protein synthesis, which requires the presence of all the amino acids, any single amino acid would not be formed faster than it is required for incorporation into the protein; feedback inhibition would limit its production. Since protein and nucleic acids together comprise about 80 per cent of the carbon of a bacterium, these processes would seem adequate to provide considerable controls against wasteful production of an excess of carbon compounds.

Furthermore, the syntheses of proteins and of nucleic acids are closely coupled in the normally growing cell. Synthesis of protein, like the synthesis of nucleic acid, requires purines, and pyrimidines, as Table II indicates (Pardee, 1954); presumably these are required for activation and for transfer of the activated amino acids. Conversely, as the table also shows, the formation of nucleic acid requires amino acids, the building blocks of protein (Pardee and Prestidge, 1956; Gros and Gros, 1958), for reasons as yet unknown. Therefore the pathways of the small molecules leading to these macromolecules could be interre-

TABLE II
 Synthesis of Protein and Nucleic Acids
 by Fully Fed and by Starved Mutants

Growth Requirement Absent	Increase in one hour (per cent)		
	Protein	RNA	DNA
none	~120	~120	~120
uracil	+6	-6	-10
leucine	+6	+15	+32
tryptophan	0	-3	+20

lated at the point of their connection to produce the macromolecules; *i.e.*, a deficiency in an amino acid would limit protein synthesis, which in turn would diminish nucleic-acid synthesis and thereby reduce the rate of utilization of purines and pyrimidines, which in turn would decrease the rates of synthesis of the latter.

Other problems

As might be expected, and certainly as would be desired, the findings to date raise many more problems than they answer. The questions that arise are of varied sorts and relate to methods, systems, external influences, and internal mechanisms. Methods for study of these phenomena depend at present mainly on measurement of the amounts of products formed under a variety of conditions brought about by genetic blocks, inhibitors, nutrient additions, and combinations of these. One can, for example, examine overproduction of intermediary or terminal metabolites or enzymes in a growing culture, or determine competition of small molecules provided as nutrients or formed *de novo* for incorporation into macromolecules. One can study the maximum rate of production of a metabolite *in vitro* and compare it with the rate calculated from *in vivo* measurements of end-product formation. Feedback inhibition already can be studied *in vitro*, and evidence for enzyme synthesis *in vitro* is accumulating rapidly enough to give hope that cell-free systems will permit induction-repression as well to be investigated with isolated parts of the synthetic apparatus of the cell.

The systems so far studied have been almost entirely those dealing with components produced in large amounts—amino acids and nucleic-acid bases. Are there also similar regulatory processes for synthesis of components made in minute quantities? Production of coenzymes is only about 1/1000 as great as that of amino acids. How efficiently are these compounds formed? Unpublished findings (Wilson, 1960) on the

synthesis of flavins by *E. coli* show that the rate of flavin synthesis is almost constant, relatively independent of the rate of growth or protein synthesis, under a variety of conditions of inhibition or nutritional supplementation. A considerable portion of the flavins, perhaps half, is excreted into the medium by the growing cells. Such results suggest that mechanisms of control of flavin production must differ, at least quantitatively, from those so far found to regulate the synthesis of components present in larger amounts.

It is worthy of note that almost all data on metabolic regulation in bacteria have been obtained with *E. coli*. Do similar mechanisms exist in other microorganisms? What of the relatively large pools of amino acids in some organisms—yeasts, for example? To what extent does one find these regulatory processes in higher organisms?

The influence of external factors other than substrates could well be exerted through repression or feedback mechanisms. Analogs of natural metabolites inhibit growth, but often they are readily overcome by very small amounts of the compounds they resemble. If such an analog was not able to prevent *de novo* synthesis of the natural compound, the analog could not be toxic, because the endogenous natural product would reverse its effect. Therefore it is probable that such analogs function, in part at least, by feedback inhibition of pathways for synthesis of their natural relatives. Examples of this phenomenon are known: inhibition of tryptophan synthesis by tryptophan analogs (Trudinger and Cohen, 1954; Pardee and Prestidge, 1958), synthesis of histidine (Moyed and Friedman, 1960), inhibition of purine synthesis by purine analogs (Gots and Gollub, 1959), and inhibition of pyrimidine synthesis by 6-azauracil (Handschumacher, 1958).

Finally, one must mention a series of problems hardly touched upon in this article—the question of the mechanism of these effects, especially of induction and repression. Foremost are questions such as the nature of the repressor and the site of binding of the repressor and inducer in the cell. Answers to these problems, of great interest in themselves, should help us understand the ways in which regulatory processes function in the living cell.

References

- Adelberg, E. A., and Umberger, H. E., 1953. Isoleucine and Valine Metabolism in *E. coli*, V: α -Ketoisovaleric Acid Accumulation," *J. Biol. Chem.* 205, 475.
- Ames, B. N., and Garry, B., 1959. "Coordinate Repression of the Synthesis of Four Histidine Enzymes by Histidine," *Proc. Natl. Acad. Sci.* 45, 1453.
- Brooke, M. S., Ushiba, D., and Magasanik, B., 1954. "Some Factors Affecting the Excretion of Orotic Acid by Mutants of *Aerobacter aerogenes*," *J. Bact.* 68, 534.
- Cohen, G., and Jacob F., 1959. "Sur la répression de la synthèse des enzymes in-

- tervanant dans la formation du tryptophane chez *E. coli*," *Compt. Rend. Acad. Sci.* 248, 3490.
- Cohen, G. N., and Monod, J., 1957. "Bacterial Permeases," *Bacteriol. Revs.* 21, 169.
- Cohen-Bazire, G., and Jolít, M., 1953. "Isolation by Selection of *E. coli* Mutants which Spontaneously Synthesize Amylomaltase and β -Galactosidase," *Ann. Inst. Pasteur* 84, 937.
- Cohn, M., and Monod, J., 1953. "Specific Inhibition and Induction of Enzyme Biosynthesis," in Gale, E. F., and Davies, R., eds., *Adaptation in Microorganisms* (N.Y., Cambridge U. Press).
- Gerhart, J. C., and Pardee, A. B., unpublished.
- Corini, L., 1958. "Régulation en retour [feedback control] de la synthèse de l'arginine chez *E. coli*," *Bull. Soc. Chim. Biol.* 40, 1939.
- Corini, L., 1960. "Antagonism by the Substrate to End-Product Repression of the Formation of a Biosynthetic Enzyme, Ornithine-Transcarbamylase," *Proc. Natl. Acad. Sci.* 46, 682.
- Corini, L., and Maas, W. K., 1957. "The Potential for Formation of a Biosynthetic Enzyme in *E. Coli*," *Biochim. Biophys. Acta* 25, 208.
- Corini, L., and Maas, W. K., 1958. "Feedback Control of the Formation of Biosynthetic Enzymes," in McElroy, W., and Glass, B., eds., *The Chemical Basis of Development* (Baltimore, Johns Hopkins Press).
- Gots, J. S., 1957. "Purine Metabolism in Bacteria, V: Feedback Inhibition," *J. Biol. Chem.* 228, 57.
- Gots, J. S., and Gollub, E. C., 1959. "Purine Analogs as Feedback Inhibitors," *Proc. Soc. Exptl. Biol. Med.* 101, 641.
- Gros, F., and Gros, F., 1958. "Rôle des acides aminés dans la synthèse des acides nucléiques chez *E. coli*," *Exp. Cell Res.* 14, 104.
- Horiuchi, T., Horiuchi, S., and Mizuno, D., 1959. "A Negative Feedback Phenomenon Controlling Formation of Alkaline Phosphomonoesterase in *E. coli*," *Nature* 183, 1529.
- Handschumacher, R. E., 1958. "Bacterial Preparation of Orotidine-5'-Phosphate and Uridine-5'-Phosphate," *Nature* 182, 1090.
- Jacob, F., and Monod, J., 1959. "Gènes de structure et gènes de régulation dans la biosynthèse des protéines," *Compt. Rend. Acad. Sci.* 249, 1282.
- Jacob, F., Perrin, D., Sanchez, C., and Monod, J., 1960. "L'opéron: groupe de gènes à expression coordonnée par un opérateur," *Compt. Rend. Acad. Sci.* 250, 1727.
- Magasanik, B., 1957. "Nutrition of Bacteria and Fungi," *Ann. Rev. Microbiol.* 11, 221.
- Magasanik, B., 1958. "The Metabolic Regulation of Purine Interconversions and of Histidine Biosynthesis," in McElroy, W., and Glass, B., eds., *The Chemical Basis of Development* (Baltimore, Johns Hopkins Press).
- Monod, J., and Cohn, M., 1952. "La biosynthèse induite des enzymes (Adaptation enzymatique)," *Adv. Enzymol.* 13, 67.
- Moyed, H. S., 1960. "A Compensatory Response to a False Feedback Inhibitor," *Fed. Proc.* 19, 140.
- Novick, A., and Szilard, L., 1954. "Experiments with the Chemostat on the Rates of Amino Acid Synthesis in Bacteria," in Boell, E. J., ed., *Dynamics of Growth Processes* (Princeton, N. J., Princeton U. Press).
- Pardee, A. B., 1954. "Nucleic Acid Precursors and Protein Synthesis," *Proc. Natl. Acad. Sci.* 40, 263.
- Pardee, A. B., 1959. "The Control of Enzyme Activity," in Boyer, P. D., Lardy, H.,

- and Myrback, K., eds., *The Enzymes*, 2nd ed., Vol. I (N. Y., Academic Press).
- Pardee, A. B., Jacob, F., and Monod, J., 1959. "The Genetic Control and Cytoplasmic Expression of 'Inducibility' in the Synthesis of β -Galactosidase by *E. coli*," *J. Mol. Biol.* 1, 165.
- Pardee, A. B., and Prestidge, L. S., 1956. "The Dependence of Nucleic Acid Syntheses on the Presence of Amino Acids in *E. coli*," *J. Bact.* 71, 677.
- Pardee, A. B., and Prestidge, L. S., 1958. "Effects of Azatryptophan on Bacterial Enzymes and Bacteriophage," *Biochim. Biophys. Acta* 27, 330.
- Pollock, M. R., 1953. "Stages in Enzyme Adaptation," in Gale, E. F., and Davies, R., eds., *Adaptation in Micro-organisms* (N. Y., Cambridge U. Press).
- Pollock, M. R., 1959. "Induced Formation of Enzymes," in Boyer, P. D., Lardy, H., and Myrback, K., eds., *The Enzymes*, 2nd ed., Vol. I (N. Y., Academic Press).
- Roberts, R. B., Abelson, P. H., Cowie, D. B., Bolton, E. T., and Britten, R. J., 1955. "Studies of Biosynthesis in *E. coli*," Carnegie Institution, Washington, D. C.
- Shepherdson, M., and Pardee, A. B., 1960. "Preparation and Crystallization of Aspartate Transcarbamylase," *J. Biol. Chem.* 235, 3233.
- Stanier, R. Y., 1951. "Enzymatic adaptation in bacteria," *Ann. Rev. Microbiol.* 5, 35.
- Torriani, A., 1960. "Influence of Inorganic Phosphate in the Formation of Phosphatases by *E. coli*," *Biochim. Biophys. Acta* 38, 460.
- Trudinger, P. A., and Cohen, G. N., 1956. "The Effect of 4-Methyltryptophan on Growth and Enzyme Synthesis of *E. coli*," *Biochem. J.* 62, 488.
- Umberger, H. E., 1956. "Evidence for a Negative-Feedback Mechanism in the Biosynthesis of Isoleucine," *Science* 123, 848. Also in *J. Biol. Chem.* 233, 415 (1958).
- Vogel, H. J., and Davis, B. D., 1952. "Adaptive Phenomena in a Biosynthetic Pathway," *Fed. Proc.* 11, 485.
- Vogel, H. J., 1957. "Repression and Induction as Control Mechanisms of Enzyme Biogenesis: the "Adaptive" Formation of Acetylornithinase," in McElroy, W., and Glass, B., eds., *The Chemical Basis of Heredity* (Baltimore, Johns Hopkins Press).
- Wijesundera, S., and Woods, D. D., 1953. "The Effect of Growth on a Medium Containing Methionine on the Synthesis of this Amino Acid by *Bact. coli*," *Biochem. J.* 55, viii. Also in *J. Gen. Microbiol.* 22, 229 (1960).
- Wilson, A. C., unpublished data.
- Wyngaarden, J. B., and Ashton, D. M., 1959. "The Regulation of Activity of Phosphoribosylpyrophosphate Amidotransferase by Purine Ribonucleotides: A Potential Feedback Control of Purine Biosynthesis," *J. Biol. Chem.* 234, 1492.
- Yates, R. A., and Pardee, A. B., 1956. "Control of Pyrimidine Synthesis by a Feedback Mechanism in *E. coli*," *J. Biol. Chem.* 221, 757.
- Yates, R. A., and Pardee, A. B., 1957. "Control by Uracil Formation of Enzymes Required for Orotate Synthesis," *J. Biol. Chem.* 227, 677.

BACTERIA WITH HIGH LEVELS OF SPECIFIC ENZYMES*

Aaron Novick

UNIVERSITY OF OREGON

Bacteria have the capacity to regulate over a wide range the rate at which they make their various constituents. The rate of synthesis of an amino acid, for example, can be varied from essentially zero to some maximum rate which may be five times higher than would be needed at the fastest known growth rates (Novick and Szilard, 1954). This control is established by the cell in two ways: (1) by regulating the rate at which an enzyme functions as catalyst of a given reaction, and (2) by regulating the rate at which the enzyme itself is formed. The rate of functioning of an enzyme has been found in the cases studied to be controlled by the concentration of the end product of the biochemical pathway in which the enzyme plays a role (Umberger and Brown, 1958; Yates and Pardee, 1957). The rate of formation of an enzyme appears in general to be controlled by the concentration of specific repressors (often the end product of the biosynthetic pathway) and inducers (substrates of the enzyme). Apparently, when a repressor is absent or when an inducer is present at saturating levels, the enzyme is formed at some maximum rate (Pardee, Jacob, and Monod, 1959).

It would be interesting to understand what determines the maximum rate of formation of a given enzyme.† Is the rate ultimately lim-

* This work was supported in part by contract ONR 2771 with the Office of Naval Research, in part by U.S.P.H.S. research grant E2807, and in part by U.S.P.H.S. training grant 2A-14 (P.B.).

† The rate of formation of an enzyme is defined here in relation to the rate of formation of all materials formed by the cell. In the steady state the rate of formation of an enzyme defined in this way is measured by the fraction of the cell represented by this particular protein.

ited by the amount of the DNA (gene) that specifies this enzyme? Or is there some unknown control mechanism which limits the maximum rate of formation of an enzyme, independent of the number of gene copies in a cell? To find the answer, investigation has been initiated of the physiology and genetics of bacterial mutants that make exceptional quantities of certain enzymes. Such mutants may be used to even greater advantage in obtaining information about the mechanism of protein synthesis and its control. In the usual cell many different proteins are being made, and it is difficult to identify chemically or physically any component of the cell specifically involved in the synthesis of a particular enzyme. But in a cell so specialized that it makes largely only a single protein, such identification becomes possible.

It would be particularly advantageous to have a situation in which the enzyme made at a high rate is inducible, *i.e.*, is formed only in the presence of a specific inducer. We could then compare a bacterium that makes the enzyme with a counterpart that does not. The two cells could be identical in all respects except the features concerned specifically with the synthesis of this enzyme. This would allow an opportunity to identify those parts of a cell specifically associated with the formation of a specific enzyme.

The hope for positive results in such a study rests in part on the assumption that changes in the cell which are associated with this synthesis can be detected. If, for instance, the apparatus necessary for synthesis of the enzyme is normally present in a cell and the only effect of the inducer is to activate this apparatus, it will not be possible to find any distinguishing feature in the synthesizing cell, aside from the presence of the product enzyme itself. Likewise, the difference between a synthesizing and a non-synthesizing cell will be difficult to detect if the synthesizing apparatus constitutes only a small fraction of all the similar material present.

However, if positive differences between the cells can be found, many important questions regarding the mechanism and control of protein synthesis may be answered.

In preparation for such a search, techniques have been developed for the isolation of bacterial strains which make very large amounts of certain inducible enzymes. The present discussion is concerned with a description of the techniques for the isolation of suitable strains and a discussion of the properties of some of the strains that have been obtained.

Isolation of bacteria with high enzyme levels

Two cases are already known in which bacteria apparently can produce substantial quantities of a single enzyme. Melvin Cohn (1957)

has reported that β -galactosidase can comprise as much as 6.6 per cent of the bacterial protein in fully induced *Escherichia coli* bacteria. And Garen and Levinthal (1959) have found that during phosphate starvation, where there is complete removal of repression of alkaline phosphatase formation (Horiuchi, Horiuchi, and Mizuno, 1959; Torriani, 1960), this enzyme amounts to as much as 5 per cent of the total protein produced. Levinthal (personal communication) suggested that this represented the maximum rate at which any enzyme is made when its synthesis is completely unrepressed. However, it remained possible that there were mutants which could make a specific enzyme at an even higher rate, and we decided to search for such mutants.

It was realized that the chemostat (Novick and Szilard, 1950a) might be employed to establish conditions which would select for strains of bacteria that make large amounts of a specific enzyme. In the chemostat, bacteria are limited in their growth rate by the low concentration of some required nutrient. Bacterial mutants able to grow faster at these low concentrations would outgrow the original bacteria and thus replace them as the prevailing population. In the chemostat, then, one may observe a succession of bacterial populations, each successive one being able to grow faster at a given concentration of the substrate (or at the same rate at a lower concentration of the substrate). For example, a case was observed in which a tryptophan-requiring *E. coli* strain was grown for several hundred generations on a medium limited in tryptophan (Novick and Szilard, 1950b; Novick, 1958). During this time there emerged some five or six successive populations, each of which was able to grow more rapidly than its predecessor. It was possible to establish the fact that the succeeding strains were able to grow more rapidly at low concentrations of tryptophan, but it was never discovered in what other way the faster growing bacteria differed from the slower. Presumably they were able to capture tryptophan more effectively than the slower strains because they had either a better tryptophan permease system or a better system for converting tryptophan to some product which could not escape from the cell.

In thinking about what direction such an evolution would take in a chemostat limited in the sugar lactose, Milton Weiner (personal communication) realized that, among other things, the conditions would favor the selection of strains which could make β -galactosidase in the absence of an inducer. He argued that for the wild-type strain, which requires the presence of an inducer for the formation of both β -galactosidase and galactoside permease, the effect of the lactose concentration in the chemostat in controlling the growth rate would depend upon the ability of lactose to act as an inducer for formation of β -galactosidase and galactoside permease. A mutant capable of forming the enzymes

without an inducer would be able to grow at the same rate at a lower lactose concentration because it would maintain maximum levels of β -galactosidase and galactoside permease no matter how low the concentration of lactose. These expectations were verified when Weiner observed that in a chemostat with lactose as the controlling growth factor, an inducible strain was replaced after about ten days, by a constitutive strain (one not requiring the inducer).

The principles involved in the selection of such strains in the chemostat may be explained more fully as follows. When a bacterium is growing in the chemostat at a growth rate which is determined by some low concentration of a required nutrient, the rate-limiting step is the capture of a nutrient molecule by the bacterium, *i.e.*, conversion of the molecule to a chemical form which cannot escape from the cell. Probably this capture is effected by a permease or by some enzyme which attaches a charged or large group to the molecule.

Two kinds of behavior can be expected, depending on whether the enzyme involved in the capture step is inducible or constitutive.

1. If the capturing enzyme is constitutive, *i.e.*, if its level is independent of the concentration of the substrate, then the growth rate falls linearly with a decrease in the concentration of substrate at low growth-rate-limiting concentrations. This appears to be the case when tryptophan is used as the controlling growth factor for a tryptophan-requiring strain (Novick and Szilard, 1950b). When a chemostat is operated for a long period, strains are selected which grow faster at the low concentrations of tryptophan in the chemostat. This selection can be understood from the curves in Figure 1, which give the growth rate as a function of the concentration for the original strain in the chemostat and for one of the strains that replaced it. In both cases the growth rate falls linearly with the concentration of tryptophan, but the growth rate of the later strain is higher at a given low concentration of substrate. Thus selection occurs because initially, when the original strain is predominant, the bacteria of what later becomes the predominant strain have a higher growth rate, (α_f) than the washout rate (α_0) at the concentration of tryptophan (c_1) established by the first strain. When the faster strain becomes large in numbers, its growth rate must fall to a value equal to the washout rate. The concentration of tryptophan then falls to c_2 , where the original strain grows at a rate (α_s) much less than the washout rate. As a result, the original strain is diluted out of the population.

2. If the amount of the capturing enzyme formed by the bacteria depends on the substrate concentration, *i.e.*, if it is an inducible enzyme, different results are to be expected. At low concentrations of the substrate the growth rate will fall off very rapidly with a decrease in the

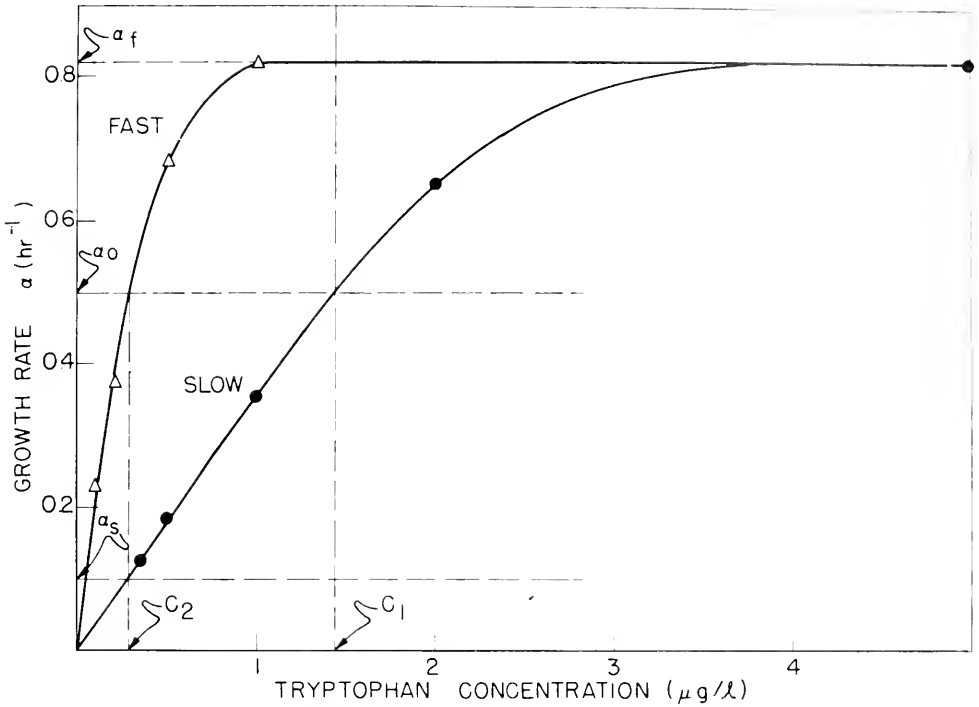

Figure 1. Growth-rate constants for two tryptophan-requiring strains (B/1, t) of *E. coli* as a function of the concentration of tryptophan.

concentration of the substrate if this concentration is too low to maintain the maximum rate of enzyme formation. Here a fall in concentration of the substrate means not only a decrease in the rate at which the cell encounters substrate molecules; it means also a decrease in the fraction of the encountered substrate molecules which are captured. How rapidly the growth rate falls with decreasing concentration of substrate depends on how much the rate of formation of the capturing enzyme decreases.

In the case where the capturing enzyme is inducible, several kinds of mutations to fitter strains can be expected. A strain in which the substrate is a more effective inducer of the enzyme would be favored, because it would have a higher level of capturing enzyme at a given low concentration of substrate. But a constitutive mutant would be even more favored, since it would have maximum levels of the capturing enzyme independent of the concentration of substrate. The mechanism of selection in this case can be understood from Figure 2. Here two hypothetical curves for growth rate versus concentration of substrate are given—one for an inducible and one for a constitutive strain. When

the original strain is inducible, the concentration of substrate in the chemostat growth tube will be relatively large. It can be seen that a constitutive mutant would have a much higher growth rate and that only a relatively short time would be required for its selection. This procedure provides a method which has been used many times, in this laboratory and in others, for the isolation of mutant strains able to make β -galactosidase constitutively. This system of selection should be applicable in the case of any inducible enzyme, under conditions in which the growth rate depends on the level of the enzyme.

The question remains: What mechanism gives one constitutive strain the advantage over another, as in the case of the tryptophan-requiring strains? Does the later strain simply have a higher level of the capturing enzyme, or does it have an enzyme with a higher affinity for the substrate or a higher turnover number?

For example, in a discussion Ephraim Racker raised the question of what happens upon continued operation of a chemostat in which bacteria are grown on limited rations of lactose. After the selection of

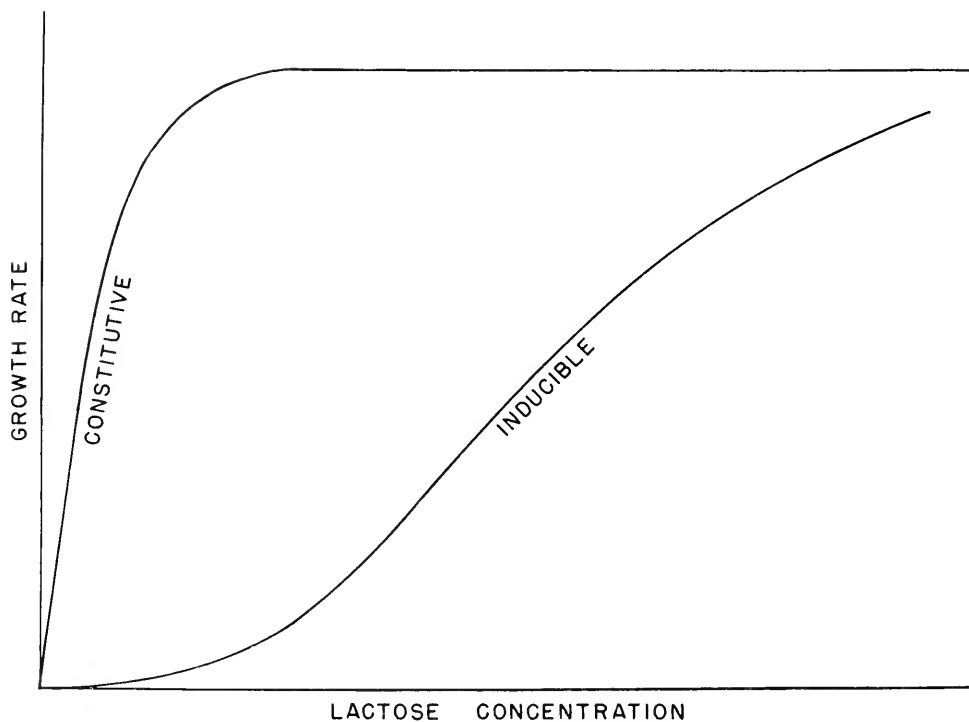

Figure 2. Hypothetical relationship between the growth-rate constants and the concentration of substrate when the growth-rate-limiting enzyme is constitutive and when it is inducible by the substrate.

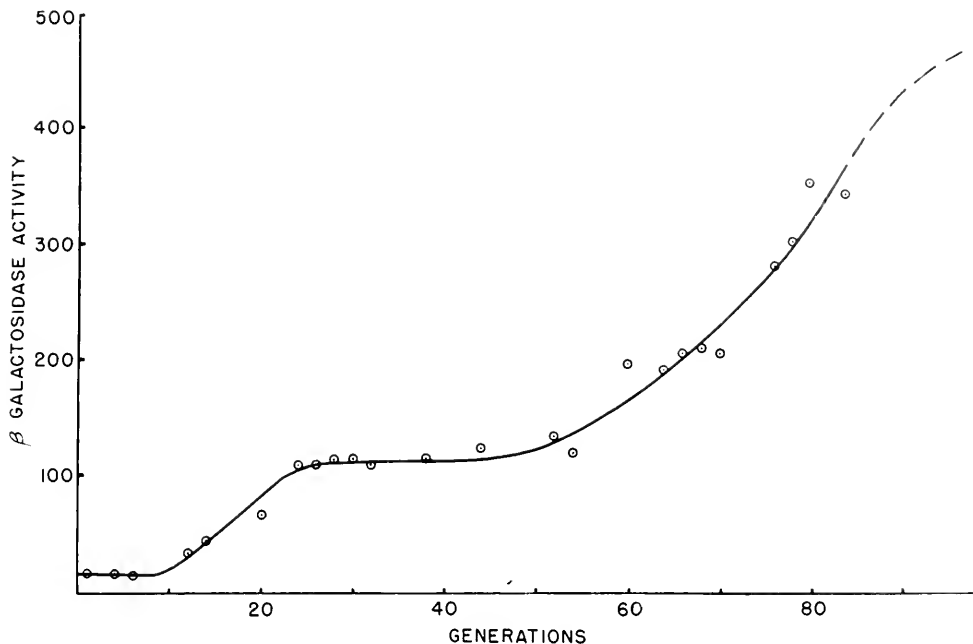

Figure 3. Rise in β -galactosidase activity of a strain of bacteria (E102) growing in a lactose-controlled chemostat. Enzyme activity is given in units of millimicromoles of ONPG hydrolyzed per minute per microgram of bacterial nitrogen at 28° C. at pH 7 in M/10 sodium phosphate buffer.

a constitutive strain, is there eventual selection of a strain with an altered enzyme having a higher affinity for lactose or a higher turnover number? Or will selection favor strains which simply have larger quantities of the enzymes needed for lactose consumption?

Such an investigation was started, and by now a number of cases have been observed in which bacteria have been grown for long periods at growth-rate-limiting concentrations of lactose. The general pattern of results is like that illustrated by the experiment described in Figure 3. In this case an *E. coli* K-12 strain, E102, was inoculated into a lactose-limited chemostat and cultured there for over 80 generations. (This strain is an Hfr variant of *E. coli* K-12 isolated by J. Tomizawa from the Cavalli Hfr, CS 101, described by Garen and Skaar [1958]). E102 is genetically $i^+z^+y^+St^sPr^+T6^s$, i.e., it forms β -galactosidase (z^+) and galactoside permease (y^+) only when a suitable inducer is present (i^+); it is sensitive to streptomycin (St^s), can make its own proline (Pr^+), and is sensitive to phage T6 ($T6^s$). At first a relatively low

β -galactosidase^{*} level was observed. After about 20 generations the enzyme level rose to 115, which corresponds to the usual maximum levels found in constitutive mutants. Samples of these bacteria, when subcultured outside the chemostat in a lactate or succinate medium, continued to form β -galactosidase at this rate, thus establishing that the strain is constitutive for the synthesis of this enzyme. Presumably, with the appearance of this strain there is a fall in the concentration of lactose in the growth tube of the chemostat, because this strain—having a higher β -galactosidase level (and probably a higher level of galactoside permease as well) grows at the rate defined by the chemostat flow rate at a lower concentration of lactose than the original inducible strain.

At this point some account of the role of galactoside permease in this selection must be taken. It is known that simultaneously with the induction of β -galactosidase there is formation of a mechanism (galactoside permease) which increases the cell's permeability to galactosides and can concentrate galactosides within the cell (Cohen and Monod, 1957). Unfortunately, no significant measurements of permease have yet been made with the present strains. It is quite likely that the constitutive strain described above is also constitutive for galactoside permease, since the induction of the enzyme and the permease almost always occur together (Jacob, Perrin, Sanchez, and Monod, 1960). In fact, it is probable that the presence of high levels of the permease is what gives the constitutive strain the advantage here over the inducible one; thus the appearance of strains constitutive for β -galactosidase reflects the selection of strains constitutive for the permease.

Continued operation of the chemostat led to the appearance of bacteria with higher and higher levels of β -galactosidase. These high rates of enzyme formation occurred constitutively: high enzyme levels were maintained when the bacteria were subcultured in the absence of lactose.

Continued growth at a limiting concentration of lactose finally gives rise to strains which seem to have some maximum level of β -galactosidase, because extensive further growth does not yield higher levels. This "maximum" is at a specific activity of over 500, or about five times that usually found in constitutive strains. Even after more than two years (~ 1500 generations) of growth in a chemostat with lactose

^{*} β -galactosidase activity in toluene-treated bacteria was determined by the hydrolysis of ortho-nitro-phenyl- β -D-galactoside (ONPG) by the procedure described by Novick and Weiner (1957), except that 0.5 mg/ml of sarcosyl (at the suggestion of Arthur Pardee) was added instead of sodium desoxycholate with the toluene. The enzyme level is expressed in units of millimicromoles of ONPG hydrolyzed per minute per microgram bacterial nitrogen at 28° C. at pH7 in M/10 sodium phosphate buffer.

limitation, the β -galactosidase level in the *E. coli* strain remains at about this value.

Properties of bacteria with high β -galactosidase activity

We believe that in these strains with high β -galactosidase activity there is actually a corresponding high level of enzyme in the cell rather than an altered enzyme with a higher turnover number. The principal reason for believing this to be the case comes from ultra-centrifugal studies being made by Burton Guttman. He has examined the sedimentation pattern in the Spinco analytical ultra-centrifuge of cell extracts made by breaking bacteria suspended in cold buffer containing 10^{-3} M Mg^{++} in a French press. A series of strains varying from high to low β -galactosidase levels were used, and he detected a sedimentation boundary at about 16 S which he ascribed to β -galactosidase. He found that the amount of material present, computed from the Schlieren peak, is proportional to the measured β -galactosidase activity for strains having different levels of β -galactosidase, thus showing that more enzyme activity results from more enzyme.

Less convincing but plausible evidence for this conclusion comes from studies of the "stability" of cultures with high specific activities. Subculture of the very active strains away from the highly selective conditions imposed by the chemostat usually leads to the appearance of strains of lower β -galactosidase activity. In this sense many of the high-level strains are unstable. For example, subculture for some 50 generations in nutrient broth medium, or in synthetic medium with lactate or succinate as the carbon source, frequently yields cultures which have a β -galactosidase activity equal to or less than that of the normal constitutive strain. This change occurs, it appears, because bacteria with unusually high enzyme activity have a lower growth rate than bacteria having less enzyme, and are thus outgrown by them. The lower growth rate might result from the burden of producing the substantial—but in these conditions useless—amounts of protein represented by the β -galactosidase in the high-activity strains. It would not be expected that a bacterium producing an altered enzyme not needed for growth would necessarily have a lower growth rate.

Measurement of the Michaelis constant for the substrate ortho-nitro-phenyl galactoside of the enzyme in extracts from bacteria of high activity invariably yields a value around 1.3×10^{-4} M, which is the value normally observed for β -galactosidase (Lederberg, 1950). This is another reason to believe that there is nothing unusual about the β -galactosidase of strains with high levels of the enzyme.

To estimate the actual relative amount of β -galactosidase in the bacteria, we used the specific activity for β -galactosidase reported by

Cohn (1957): namely, 2,100 millimicromoles of ONPG hydrolyzed per minute (pH7 in M/10 sodium phosphate buffer) per microgram of nitrogen. The nitrogen content of the bacteria was determined by the Kjeldahl procedure, and the enzyme was assayed by the procedure described earlier, which is identical to that employed by Cohn. The maximum activities observed in the high-producing strains is about 500 millimicromoles per minute per microgram of Kjeldahl nitrogen, although one strain was observed to have an activity of 750 millimicromoles per minute per microgram of nitrogen. Hence the usual maximum level indicates that 24 per cent of the bacterial nitrogen is β -galactosidase; the one exceptional case has 36 per cent.

This estimate is almost certainly an upper limit, since Cohn's value for the specific activity of β -galactosidase must be a minimum value. But it cannot be far from the correct value: Cohn's preparations cannot contain very much inactive material, because of the high yields he obtained in his enzyme isolations and because he demonstrated that his preparations contained very little protein other than β -galactosidase.

As has been mentioned earlier, a feature of the strains with high activity is their relative instability. Some strains are so easily lost that often one subculture (20 generations) leads to a strain of much lower activity. Some of the strains are more stable, one having been subcultured for more than 30 generations with no apparent loss in activity.

The relative instability of the high-activity strains makes for serious difficulty in their use, but some help is found when the cultures are grown under conditions in which there is some inhibition of enzyme formation. The presence of glucose (0.5 per cent) in the culture medium will lower the rate of production of β -galactosidase by constitutive strains (Monod and Cohen-Bazire, 1953; Cohn and Horibata, 1959) and will cut the highly active strains' production of the enzyme to less than one-half. This reduction in the rate of β -galactosidase formation, no doubt relieving the highly active strains' burden of synthesizing protein, may explain why they are not so quickly outgrown under these conditions by bacteria with lower levels of the enzyme.

A curious feature of the high-activity strains, first observed by Arthur Dalby, is the extremely toxic effect that lactose and other galactosides have on them. When aliquots of a suspension of bacteria possessing high levels of β -galactosidase are plated on a nutrient broth medium and on an EMB lactose medium, the number of colonies on the lactose-containing plate varies, depending on the strain, from one-tenth down to one-ten millionth of the number found on the nutrient broth plate. A number of other galactose derivatives, including thiomethyl- β -D-galactoside (TMG) and galactose, also are effective in

preventing the growth of the strains with high enzyme levels, although they are generally much less effective than lactose in this regard.

Genetic basis of high production rates

Genetic analysis of the strains with high levels of β -galactosidase is made difficult by their sensitivity to lactose: lactose-containing media cannot be used to select lactose-positive bacteria resulting from some genetic exchange, since most of the bacteria of high β -galactosidase would be lost. Some information about the genetic basis of the high rate of β -galactosidase production has nevertheless been obtained by Tomizawa, using crosses between Hfr strains with high levels of the enzyme and F^- strains.

Genetic control of the formation of β -galactosidase is determined by a set of closely linked loci lying between a locus for proline requirement and one for resistance to bacteriophage T6. The most recent interpretation of these loci and their functions has been given by Jacob, Perrin, Sanchez, and Monod (1960). They note that there is one gene (cistron), z , which provides the necessary information for the structure of β -galactosidase, and one gene, y , which provides for the structure of the galactoside permease. Also, there is a gene, i (regulator), which by its control of the formation of a specific repressor substance determines whether the bacterium is inducible or constitutive for the synthesis of β -galactosidase and galactoside permease. To account for some of their recent observations, these authors propose a fourth gene, o (operator), as part of the control mechanism.

In this scheme they imagine that the formation of β -galactosidase and galactoside permease is controlled in the following way. Genes z and y are controlled as a unit (operon) in such a way that synthesis of both β -galactosidase and galactoside permease is turned off or on together. The on-off switching is controlled by the o gene (operator), which determines the function only of the genes located in the operon adjacent to it. The operator has no effect on the lac operon located on another chromosome within the cell. The state of the o gene (off or on) is controlled by the repressor substance, whose formation is determined by the i gene.

Let us use a symbol, H, to denote the attribute of making β -galactosidase: bacteria making normal levels of it will be labeled H^+ and those making high levels H^- .

In one case Tomizawa crossed an Hfr strain which was able to make proline, was sensitive to phage T6 and to streptomycin, and was constitutive for a high level of β -galactosidase and presumably permease, with an F^- bacterium which required proline, was resistant to

phage T6 and to streptomycin, made β -galactosidase only when an inducer was present, and could not form galactoside permease. In symbols, this cross is represented as:

$$\text{Hfr (Pr}^+ \text{T6}^s \text{St}^s \text{i}^- \text{z}^+ \text{y}^+ \text{H}^-) \times \text{F}^- (\text{Pr}^- \text{T6}^R \text{St}^R \text{i}^+ \text{z}^+ \text{y}^- \text{H}^+)$$

It was planned to see if H behaved as a single gene character, and, if so, whether it was linked with any of the other markers. Recombinants were selected on the basis of being Pr^+ and St^R and were scored for the other characters. Of 80 Pr^+ offspring tested, 74 were found to have high levels (H^-) of β -galactosidase and six were found to have normal levels (H^+). Of the 74 H^- bacteria, 73 were found to be constitutive (i^-) and one inducible (i^+). These results show that the genetic alteration leading to high levels of enzyme production behaves as if it were a genetic change closely associated with the region near the Pr locus, probably because it occurs in the lac region. Moreover, this alteration is apparently not in the *i* gene.

Proof of closer association of the H character with the lac region than that shown by the crosses just described comes from experiments on the genetic transduction of this character being performed by T. Horiuchi. He grows phage P1kc on strains ($\text{H}^- \text{z}^+ \text{y}^+$) which produce high levels of β -galactosidase, and he uses the phage produced to transduce a lac-minus strain ($\text{H}^+ \text{z}^+ \text{y}^-$) to a lac-positive strain. Although it is difficult to isolate relatively rare lac-positive organisms when they are H^- and thus inhibited by lactose, Horiuchi has succeeded; he finds that a large fraction of the lac-positive transductants do make β -galactosidase at a high rate. Thus, the H character is determined by the state of some part of the lac region; but, so far, except for establishing that the property does not reside in the *i* region, Horiuchi has not mapped it more accurately.

Conclusion

One obvious explanation of the ability of these strains to make so much β -galactosidase is that there has been some kind of a duplication of the genetic determinant for this enzyme. One might expect that if the proportionate number of copies of a given gene is increased over the numbers of the other genes, relatively more of the enzyme determined by this gene will be produced. This appears to be the case for bacteria carrying extra copies of the lac genetic region attached to the fertility factor F, where a three- or four-fold increase of the β -galactosidase level has been reported (Jacob, Perrin, Sanchez, and Monod, 1960).

The increase in the number of gene copies might occur either by an

increase in the number in the chromosome itself or by incorporation of the lac genes into an autonomous unit replicating independently of the chromosome, such as an episome. At present there is no reason to believe that the presumed extra lac genes in the strains isolated here are associated with the F factor. Moreover, it will be difficult to establish their episomic character if the episome is not transferable from cell to cell.

It is possible that the high rates of β -galactosidase observed here result from mutations which cause the individual galactosidase genes to function more rapidly in the processes leading to protein synthesis, whatever this means. But obviously a decision cannot be made, from the present evidence, between this and the other possible explanations suggested here. Further studies of the genetics and physiology of these bacteria are required.

References

- Cohen, G. N., and Monod, J., 1957. "Bacterial Permeases," *Bact. Revs.* 21, 169.
- Cohn, M., 1957. "Contributions of Studies on the β -Galactosidase of *Escherichia coli* to Our Understanding of Enzyme Synthesis," *Bact. Revs.* 21, 140.
- Cohn, M., and Horibata, K., 1959. "Physiology of the Inhibition by Glucose of the Induced Synthesis of the β -galactoside Enzyme System of *Escherichia coli*." *J. Bact.* 78, 624.
- Garen, A., and Levinthal, C., 1959. "A Fine Structure Genetic and Chemical Study of the Enzyme Alkaline Phosphatase of *E. coli*," *Biochim. Biophys. Acta* 38, 470.
- Garen, A., and Skaar, P. D., 1958. "Transfer of Phosphorus-Containing Material Associated with Mating in *Escherichia coli*," *Biochim. Biophys. Acta* 27, 457.
- Horiuchi, T., Horiuchi, S., and Mizuno, D., 1959. "A Possible Negative Feedback Phenomena Controlling Formation of Alkaline Phosphomonoesterase in *E. coli*," *Nature* 183, 1529.
- Jacob, F., Perrin, D., Sanchez, C., and Monod, J., 1960. "L'Opéron: groupe de gènes à expression coordonnée par un opérateur," *Compt. Rend. Acad. Sci.* 250, 1727.
- Lederberg, J., 1950. The Beta-D-Galactosidase of *Escherichia coli*, Strain K-12." *J. Bact.* 60, 381.
- Monod, J., and Cohen-Bazire, G., 1953. "L'effet inhibiteur spécifique des β -galactosides dans la biosynthèse 'constitutive' de la β -galactosidase chez *E. coli*," *Compt. Rend. Acad. Sci.* 236, 417.
- Novick, A., and Szilard, L., 1950a. "Description of the Chemostat," *Science* 112, 715.
- Novick, A., and Szilard, L., 1950b. Experiments with the Chemostat on Spontaneous Mutations of Bacteria. *Proc. Nat. Acad. Sci.* 36, 708.
- Novick, A., and Szilard, L., 1954. "Experiments with the Chemostat on the Rates of Amino Acid Synthesis in Bacteria," in Boell, E. J., ed., *Dynamics of Growth Processes* (Princeton, N. J., Princeton U. Press).
- Novick, A., 1958. "Some Chemical Bases for Evolution in Microorganisms," in Buzzati-Traverso, A. A., ed., *Perspectives in Marine Biology* (Berkeley, U. of California Press).

- Novick, A., and Weiner, M., 1958. "Enzyme Induction as an All-or-None Phenomenon," *Proc. Nat. Acad. Sci.* 43, 553.
- Pardee, A. B., Jacob, F., and Monod, J., 1959. "The Genetic Control and Cytoplasmic Expression of 'Inducibility' in the Synthesis of β -galactosidase by *E. coli*," *J. Mol. Biol.* 1, 165.
- Torriani, A., 1960. "Influence of Inorganic Phosphate in the Formation of Phosphatases by *Escherichia coli*," *Biochim. Biophys. Acta* 38, 460.
- Umbarger, H. E., and Brown, B., 1958. "Isoleucine and Valine Metabolism in *E. coli*, VII: A Negative Feedback Mechanism Controlling Isoleucine Biosynthesis," *J. Biol. Chem.* 233, 415.
- Yates, R. A., and Pardee, A. B., 1957. "Control by Uracil of Formation of Enzymes Required for Orotate Synthesis," *J. Biol. Chem.* 227, 677.

THE FORMATION OF SPORES BY BACTERIA*

H. Orin Halvorson

UNIVERSITY OF ILLINOIS

Our interest in the bacterial spore problem has been motivated by a desire to gain an insight into the mechanism whereby spores obtain their resistance to heat and other unfavorable environmental conditions. The work reported here is directed toward this through a study of some of the biochemical changes that take place during sporogenesis. This approach is a rather recent attack, since in all of our former work we attempted to cast light on the problem through a study of germination and related problems. In this new work, we have taken advantage of findings in other laboratories and our own work on germination and enzyme studies. A brief review is therefore desirable to understand the logic behind the experiments.

Three crucial observations have, in my opinion, stimulated many of the recent researches on spores. One was the observation by Hills (1949) that spores will germinate rapidly in the presence of a mixture of amino acids and nucleosides; another was the discovery in our laboratory that spores contain active heat-resistant enzymes (Stewart and Halvorson, 1953; Lawrence and Halvorson, 1954; Nakata, 1956); the third was the observation by Powell (1953) that dipicolinic acid

* This investigation was supported by grants from the Office of Naval Research and the National Institutes of Health. The results reported herein should not be credited to any one individual but to a research team in which the following have been my co-workers: Dr. Krishnamurty Gollakota, Research Associate and Assistant Professor of Research; Dr. Robert Collier and Dr. Herbert Nakata, former graduate students who have completed research for their theses on some phase of this problem; Ivan Goldberg and John DePinto, current graduate students; Francis Engle, laboratory assistant; and Mrs. Leena Narasimhan, research assistant. These individuals are to be considered as co-authors.

is a major constituent of spores. I want to discuss each of these observations.

From early studies it was known that spores suspended in a growth medium would lose their resistance to heat in a relatively short time. In looking into this further, Hills (1949) found that yeast extract had the same effect upon spores. He then proceeded to fractionate this to determine what nutrients were responsible for this effect, and he discovered that spores would germinate in a few minutes in the presence of a few amino acids, with or without nucleosides and glucose. L-alanine and adenosine were found to be sufficient for some species. This was studied in more detail by the late Joan Powell (1956) and co-workers. They found that a large percentage of the spores in a suspension (in the presence of the proper nutrilites) would simultaneously lose their heat resistance and refractility, and at the same time would become stainable. Many investigators have confirmed these findings since they were made early in 1950. In addition, the minimal germination requirements for other species have been determined. In most cases germination can be initiated by a few amino acids along with nucleosides, although some species will germinate with glucose only.

As a result of the studies on the germination requirements, we have also gained a fairly good insight into the effect of environmental factors upon germination. It is necessary, at this point, to indicate that "germination" is used here in a somewhat different sense from that commonly meant in the past. In the older literature the word was used to describe all of the changes taking place during the development from the spore to the fully grown vegetative cell. But because the changes observed by Hills and later by Powell and other workers occur very early in the process, bacteriologists have now come to use the term germination to encompass these early changes only, and to use the word "outgrowth" to represent all the other changes.

A number of investigators have shown that many species of spores require a heat shock as a sensitizing mechanism before they will respond to germination nutrients. The length of the time of heating and the temperature required vary with different species, with the age of the spores, and with the conditions of storage. Freshly grown spores of *Bacillus cereus* can be adequately sensitized by heating to 65° C. for about 15 minutes. On the other hand, spores of *Bacillus stearothermophilus* have to be heated to 100° C. or more for an equivalent length of time (Ordal, personal communication). Most workers in the field believe that this heat sensitization initiates biochemical reactions which either release compounds to stimulate germination or alter the permeability of the spore wall. In any event, precise information as to what actually does happen is not available.

The rate of germination is notably influenced by the temperature.

Most of the investigators have been observing germination at room temperature, and it has been their common observation that it will not take place in a refrigerator or at a lower temperature, nor will it occur at 60° C. (Stewart and Halvorson, 1953). On the other hand, Wynne (1957) claimed that spores from some species of anaerobes germinated at 75° C. when they were suspended in a solution containing glucose that had been autoclaved in an alkaline medium. Recently Foster (1959) reported that *Bacillus megaterium* spores will germinate at temperatures between 70° and 100° C. In our own laboratories we find that spores of *Bacillus cereus* will germinate rapidly in the presence of L-alanine and adenosine at room temperature but will not do so in the same menstruum if kept at 65° C.

The germination requirements are also affected by aging. Freshly produced and thoroughly cleaned spores have the most rigid requirements, but as they age, the requirements generally become less rigid. The rate at which these changes take place depends upon the temperature of storage. Spores stored in a frozen state can remain unchanged for a very long period, whereas those stored in a refrigerator will change more rapidly. There is a marked difference in different species as to the rate at which these changes can take place. One of the most noticeable effects of aging is the disappearance of the need for heat sensitization. The changes that take place during aging are probably of the same type as those that occur during heat shock. The only difference is one of time. In our own laboratories we have detected free L-alanine in the same supernatant liquor in which spores have been stored and aged, but this amino acid cannot be found in the supernatant liquor from freshly prepared clean spores (Halvorson, 1958). Probably alterations that occur within the spore during aging result in the release of chemicals required for germination. This is the reason that aged spores will germinate with a lower concentration of L-alanine than fresh spores require, and in some cases will germinate with alanine alone and no adenosine or with adenosine alone and no L-alanine.

Various metals have a marked effect upon germination. Some metal ions, such as cobalt and nickel, will inhibit the process, whereas calcium and magnesium ions are helpful. (Gollakota, unpublished data). We encountered this phenomenon in a batch of spores which had been produced for us in a pilot plant where the fermenters were made from metal. The spores we obtained from this pilot plant failed to germinate unless we added to the suspension some chelating agent such as versene or heavy concentrations of phosphate (Murty and Halvorson, 1957a). Observations made by Brown (1956) are of interest in this connection. He found that spores of the putrefactive anaerobe 3679 could germinate with versene only. It appeared that these spores could germinate spontaneously, except for the presence of certain metal ions

that inhibited the process. Upon the addition of versene, the toxic metal ions were removed and germination proceeded. Dr. Riemann of Denmark, working in Ordal's laboratory, has made an even more interesting observation. He has been able to germinate most spores with an equimolecular mixture of calcium and dipicolinic acid (personal communication). He observed this while making some studies on the effect of chelating agents on germination. Knowing that dipicolinic acid is a fairly effective chelating agent, he tried to use this in place of versene and found that it would bring about germination only in the presence of calcium ions. The most rapid change was obtained when he had an equimolecular mixture of the two.

It is apparent from the above that the discoveries made by Hills can be looked upon as forerunners of many important advances in our knowledge of the germination of spores.

The second observation that I mentioned above—namely, the demonstration of active enzymes in intact spores—was made in connection with some of our studies on germination. We observed, as others have, that when spores germinate in the presence of L-alanine and adenosine, or, as a matter of fact, with any of the other combinations of germination ingredients, not all of the spores in a suspension will do so. From 90 to 98 per cent germinate, but the rest remain heat-stable and unchanged. The question naturally arises: Why do these remaining spores fail to behave like the rest? Is it because they are different, or because something has happened to the menstruum?

To answer this question, we examined the solution in which the spores had germinated to see whether the L-alanine or the adenosine, or both, had been used up. We found no apparent change in the concentration of either during the germination process. If either of these chemicals was used for germination, the amount was too small to be detected by our methods of analysis. It appeared that nothing had happened to the solution. One would be tempted to assume, therefore, that the few spores that failed to germinate might be different from the great majority that did germinate. In order to throw light upon this problem, we centrifuged the suspension at the conclusion of the germination and added to the supernatant some fresh spores. None of these germinated. This clearly demonstrated that something had happened to the menstruum. Since there was no change in the total amount of alanine present, we examined the L-alanine to see if some had been converted to D-alanine. This appeared reasonable because Hills (1950) had previously demonstrated a D-alanine interference with germination brought about by L-alanine. A racemic mixture of L and D was found after less than one hour's contact with the spores. This prompted us to look for the enzyme racemase; fortunately, this was very easily found (Stewart and Halvorson, 1954). It proved to be

an interesting enzyme, because it was active in the intact spore and was heat-resistant, withstanding temperatures up to 100° C. Upon more careful study we found that the enzyme remained heat-resistant even after the spores germinated. Furthermore, this enzyme was attached to some colloidal particles. Upon separation from the carrier by means of sonic oscillation, it became heat-sensitive.

These observations stimulated us and others to look for more enzymes in spores. Prior to this time most bacteriologists had assumed that spores were devoid of enzymes, because most studies had resulted in negative findings. A variety of enzymes similar to the racemase have now been found in the spores of aerobic bacilli (Lawrence, 1955; Nakata, 1956). A heat-resistant catalase is present in most aerobic spores, and also a heat-resistant ribosidase—an enzyme which hydrolyzes adenosine into adenine and ribose. Ribosidase has also been shown to be associated with a colloidal particle; the heat-resistant catalase, however, does not appear to be particulate. There is strong evidence to suspect the existence in spores of other heat-resistant enzymes, particularly proteolytic enzymes (Levinson, 1957). These may, in fact, be the ones responsible for the changes occurring during storage and also during heat shock, for if these are like racemase, they will not be destroyed by the temperatures used for heat sensitization, and the reactions they bring about may be materially speeded up at these higher temperatures.

Various dormant enzymes have since been found to exist in spores, in addition to those mentioned above. These become activated when the spores germinate or are ruptured mechanically. In the dormant state they must be resistant to heat, because such enzymes can be found in spores which are germinated after heating. In fact, it appears from the work of Church and Halvorson (1955) that a higher activity may be obtained from spores exposed to heat shock than from unheated spores. Although these enzymes are resistant to heat in the dormant state, they are heat-sensitive after germination and after mechanical rupture of the spores. The mechanisms involved in conferring heat resistance on spores also appear to render them inactive.

The third observation I mentioned above—namely, that spores contain the chemical dipicolinic acid—also has proved to be a very powerful stimulus to researchers in spore physiology. This observation, as well as the one concerning the heat-resistant enzymes, was a natural consequence from Hills' early discovery. Powell and her co-workers (1953-54), while studying germination, detected a number of organic compounds which had been secreted during the process. They then proceeded to examine the supernatants from germinated spore suspensions, and they discovered that dipicolinic acid, along with other materials, was released from the spores during germination. Among

the other materials were calcium ions and a spore peptide. The occurrence of dipicolinic acid was of special interest because it was the first time this chemical had been reported in a natural product. A follow-up of these studies has shown that dipicolinic acid is a normal constituent of all spores of bacteria (both aerobes and anaerobes), and that it is present in considerable quantities, varying from 6 per cent to 12 per cent of the dry weight of normal spores. As soon as these announcements were made, all the workers in spore research examined their spores for this chemical and were able to confirm the observation of Powell.

Further studies on this chemical have brought out a number of interesting points in connection with the physiology of the bacterial spore. Nearly all the dipicolinic acid is released into the outside medium when the spores germinate. The release of this acid correlates almost perfectly with the loss in heat resistance, the loss in refractivity, and the gain in stainability; this provides good circumstantial evidence that dipicolinic acid plays an essential role in the unique heat-resistant properties of spores. Studies made on the activation of the dormant enzymes through heat shock, germination, or mechanical rupture also show a very good correlation between the release of the dipicolinic acid and the activation of these enzymes (Murty and Halvorson, 1957b). This gives further circumstantial evidence for the importance of dipicolinic acid in the protection of these enzymes in the intact spore. The acid is also released from the spores when they are killed by heat (Lund, personal communication). This fact has been demonstrated in a number of laboratories. The temperature that is required is dependent upon the heat tolerance of the spores themselves. For instance, the spores of thermophilic organisms must be heated to a higher temperature to release the dipicolinic acid than those of some less resistant aerobic organisms. In a recent announcement, Foster (1959) reported that dipicolinic acid can be released from spores of *Bacillus megaterium* at temperatures ranging from 70° to 100° C. As the temperature is increased, less time is required.

These numerous observations have led investigators in this area of study to believe that spores are made heat-resistant and their enzymes are protected by a complex colloidal structure involving a polymer formed from dipicolinic acid, calcium, and special peptides. It would be interesting indeed to know more about the nature of this complex. So far it has remained obscure, because no means has yet been found to rupture the spore and retain the complex. Any form of mechanical rupture breaks up the complex and releases the dipicolinic acid in the same way that germination does. The breaking of this complex during germination may well be an enzymatic process, and the enzymes may be activated by mechanical rupture as well, so that when spores are

broken up by mechanical means, the complex is again decomposed through the same mechanism that occurs during germination.

It is evident from the above that we have reached an impasse in our attempts to isolate and study the structure of the complex involved in the stabilization of the enzymes in the spores. It seems to us that further attempts to get at this through a study of germination will not be rewarding. We have, therefore, for the time being at least, suspended our studies on germination and focused our attention on the process of sporulation, hoping this may be more fruitful.

The various factors that control sporulation have been studied by a number of investigators, so I shall not attempt to give a comprehensive review here; the topic has been reviewed by Grelet (1950, 1951, and 1952), by Murrell (1955), and by Nakata (1959). Hardwick and Foster (1952) studied the requirements for sporulation by removing the vegetative cells from the growth medium and suspending them in distilled water. They found that if the cells had been properly nourished, they would sporulate normally when suspended in distilled water. By this study they were able to gain some insight into the requirements for sporulation. The technique has been criticized, because of the possibility that some cells may lyse or may otherwise release materials which make growth possible for others in the medium—that is, they may supply outside nutrients for the sporulation of those cells.

Although Perry and Foster (1954) claim to have effectively answered this criticism, we felt that it would be better to study the process of sporulation in the growth medium by developing synchronous cultures, so that the process of vegetative cell growth could be separated in relation to the process of sporulation.

Although most of our work is based upon studies of *Bacillus cereus*, an aerobic sporeformer, the investigation had its beginnings in studies made in our laboratory on the anaerobe *Clostridium roseum* (Collier, 1958). When we began the study on this anaerobe, we were unable to obtain a good yield of spores. This was due to a recycling phenomenon in the culture. Spores produced early in the growth cycle would germinate in the same stew in which they were produced. This resulted in a culture having cells in all stages of development, including freshly germinated spores, actively growing vegetative cells, sporulating cells, and spores just released from their sporangia. In such a mixture it was virtually impossible to isolate clean spores. To overcome this difficulty we developed a technique of growing the organisms under semi-synchronous conditions. This was done by inoculating the medium with a very heavy inoculum from an actively growing synchronous culture. The result was a population in which nearly all of the cells began to produce spores at about the same time. We were thus able to harvest clean spores containing a minimum of vegetative cells and freshly

germinated spores. We found that in such cultures sporulation set in very early; in fact, the process was complete in about seven hours. By staining an hour or so before any dipicolinic acid was synthesized, we obtained what appeared to be normal spores. Furthermore, the synthesis of dipicolinic acid was complete, or nearly so, before any of the spores had developed heat resistance. Heat resistance developed approximately an hour after the synthesis of DPA. The development of a spore-like structure (this study would indicate) occurs independently of the synthesis of DPA, and this precedes the development of heat resistance. This is shown graphically in Figure 1.

When we attempted to repeat this with the aerobe *B. cereus*, our cultures would lyse about the time they should be producing spores. Investigation showed this was due to a lack of oxygen (Nakata, 1959). By using a very heavy inoculum we developed a condition in which the demand for oxygen exceeded our ability to dissolve oxygen in the water. This prompted us to make a study of the oxygen demand of cultures during various stages of growth and sporulation. The results of this study are shown in Figure 2. This shows that the oxygen demand curve is bimodal. The first peak in this curve occurs about the

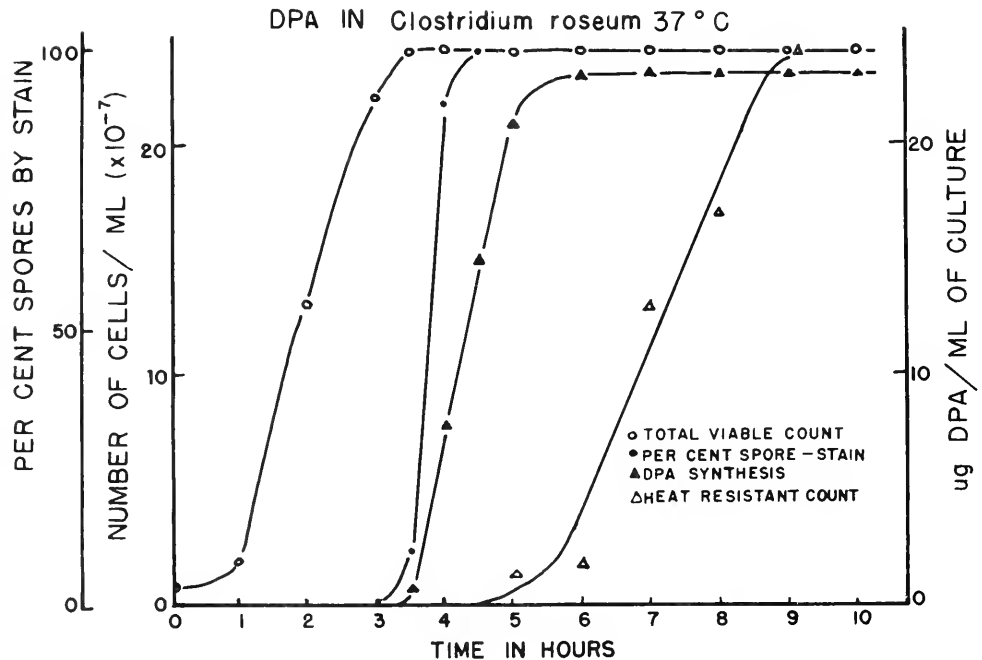

Figure 1. The relationship of heat resistance—total viable count—spores by stain—synthesis of DPA in *Clostridium roseum* 37° C.

time the maximum population of vegetative cells is reached. I should mention that the oxygen demand was determined by measuring the rate of disappearance of dissolved oxygen from an aliquot sample of the culture by means of a dropping mercury electrode and a polarograph. By making frequent measurements of the dissolved oxygen content in such a sample we could plot a curve showing the change in con-

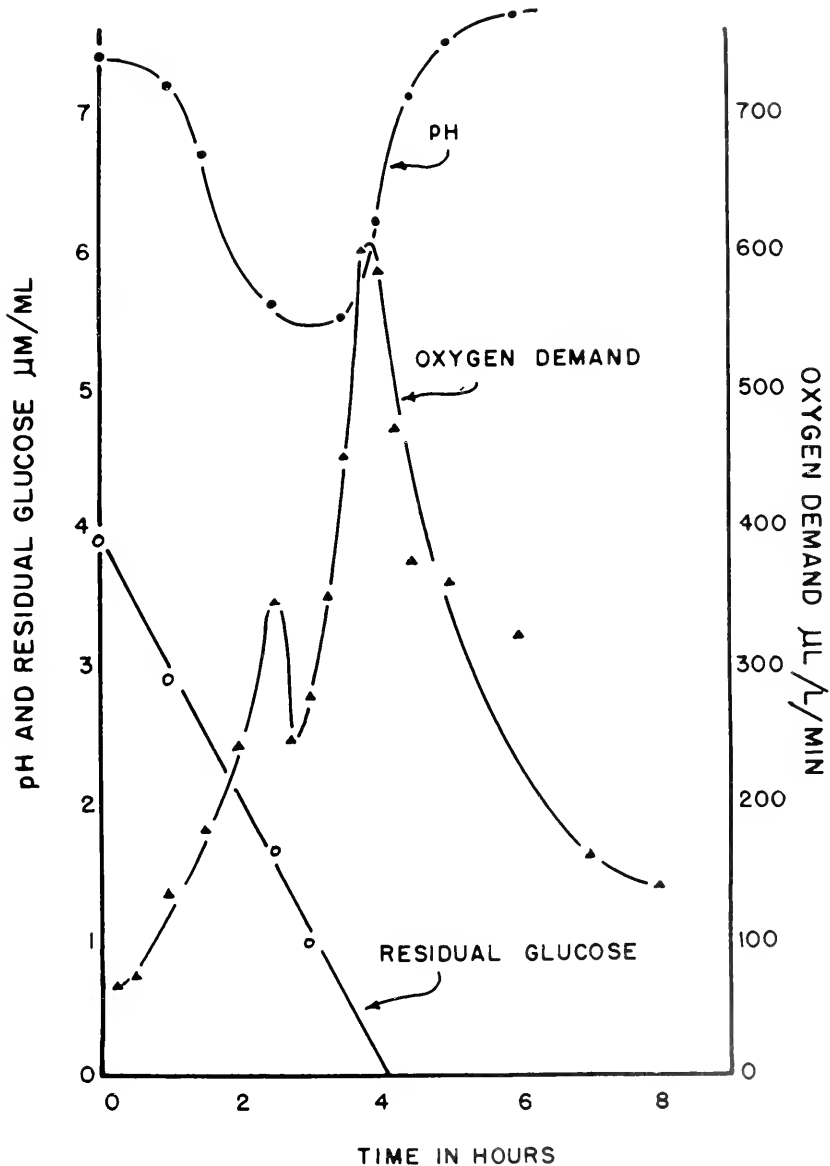

Figure 2. pH, oxygen demand, and residual glucose vs. time.

centration of dissolved oxygen versus time; we considered the slope of this curve the measure of the oxygen demand.

As is apparent from the above, we reached the first peak in the oxygen demand curve at the same time that we obtained the minimum in the pH curve. Shortly thereafter the pH begins to rise, and with this rise a very sharp rise in the oxygen demand occurs. A new enzyme system has apparently developed to utilize the acids responsible for the lowering of the pH. As these acids are oxidized, a very high demand for dissolved oxygen develops. In fact, the oxygen demand at this stage far exceeds the demand during vegetative growth. During this second rise in the oxygen demand curve and the corresponding rise in the pH curve, we began to observe in the rods morphological changes which were typical of presporulation. Spores themselves do not actually appear until much later. The actual time of onset of sporulation is shown in Figure 3.

We also investigated the nature of the acids released during the early vegetative cell growth. We found that only two acids formed—pyruvic and acetic (Nakata, 1959). The pyruvic acid appears first and is subsequently converted to acetic acid. This is illustrated in Figures 4 and 5. These acids appear quite stable during the period of vegetative cell growth but begin to disappear as the pH begins to rise; presumably it is the oxidation of the acetic acid that creates the high demand for dissolved oxygen just preceding sporulation. Our failure to obtain

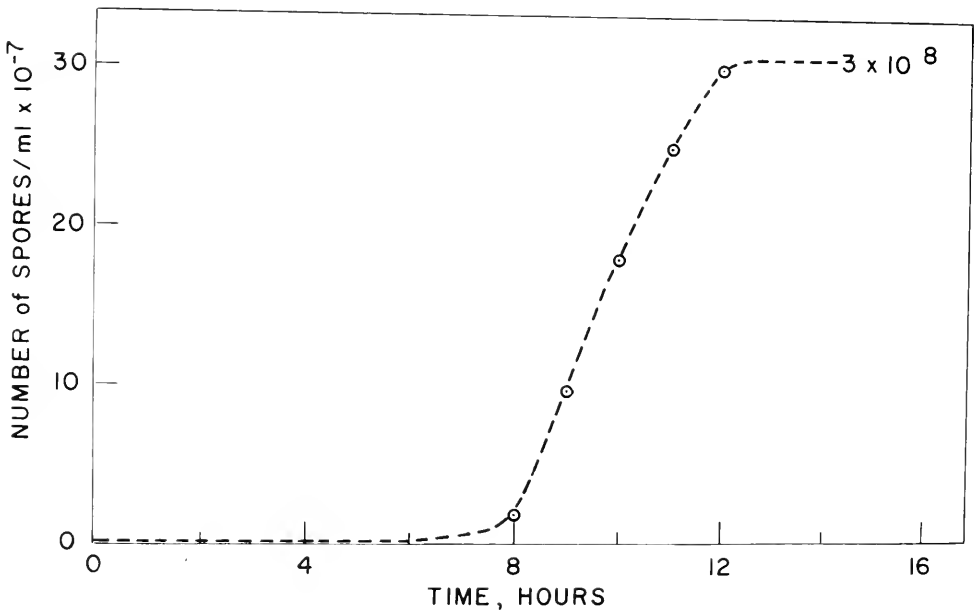

Figure 3. Time of sporulation in an active culture of *Bacillus cereus* T.

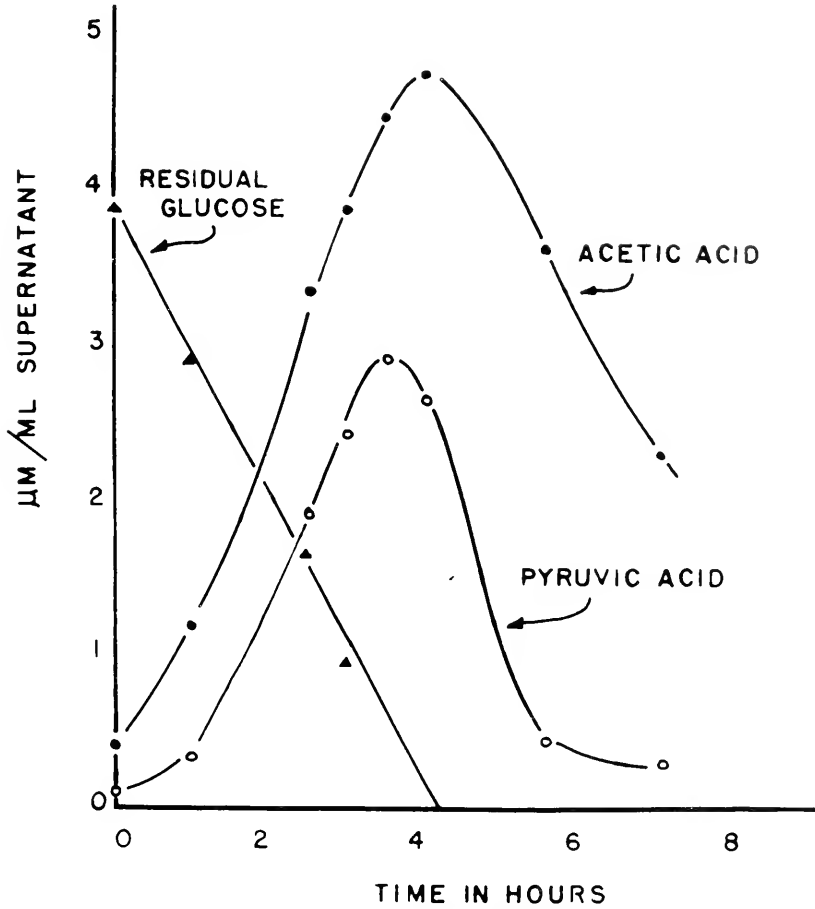

Figure 4. Pyruvic and acetic acid production vs. time.

spores in our initial experiment was attributable to the fact that the air supply was not sufficient to satisfy the oxygen demand in this stage of the development of the culture. This difficulty can be overcome in one of two ways: by improving the efficiency of aeration, or by reducing the concentration of the glucose, so that less acid is formed and consequently less oxygen is needed. The latter course also reduces the final spore crop. The metabolic processes going on during vegetative cell growth must, therefore, be quite different from those that take place in the culture just before sporulation. During the growth of the vegetative cells, the glucose is broken down to acids, but the acids are not utilized. Apparently when the glucose is completely gone, an adaptive enzyme forms for the utilization of the acids. This accounts for the rise of the pH curve. One may also assume that the oxidation

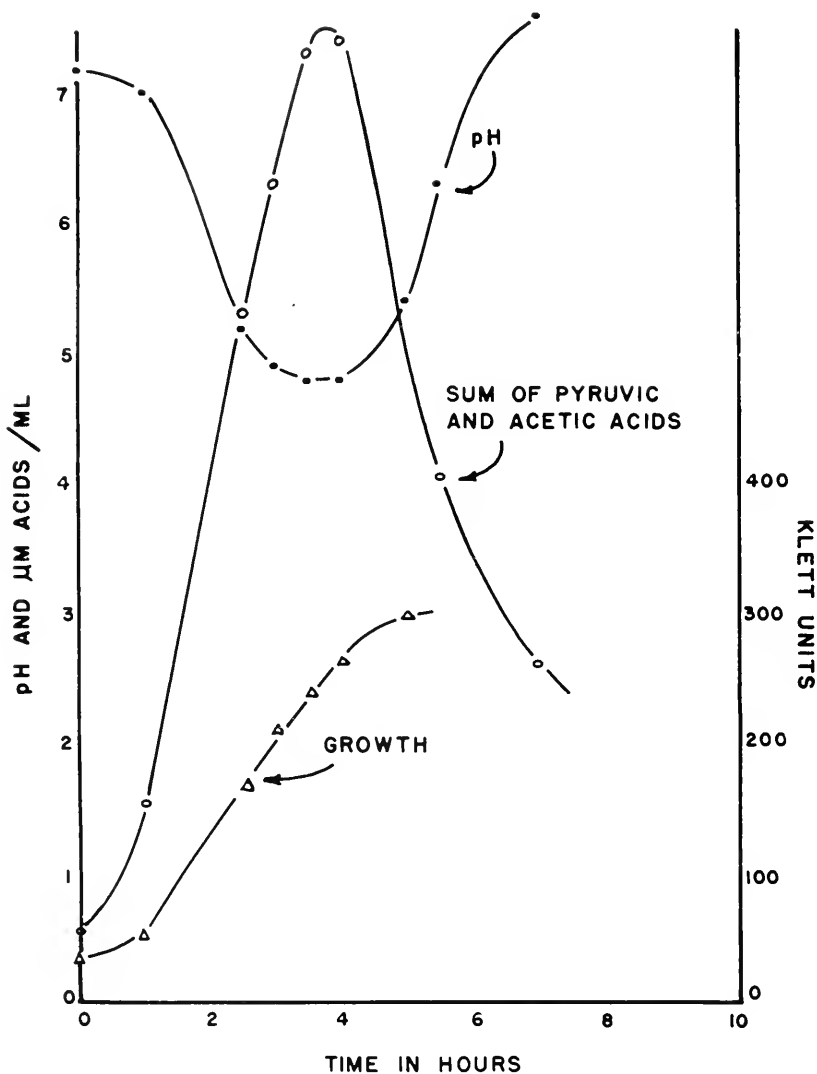

Figure 5. pH and sum of pyruvic and acetic acids vs. time.

of these acids supplies the energy needed for the synthesis of the spore material.

These observations led us to investigate various inhibitors to see if compounds that would inhibit the utilization of intermediates might also interfere with sporulation. The first one we studied was α -picolinic acid (Collakota and Halvorson, 1960). It is obvious why we selected this one. We believed that it might serve as an analogue for dipicolinic acid and might interfere with its synthesis and thus interfere with the production of the spores. The results obtained with this inhibitor were

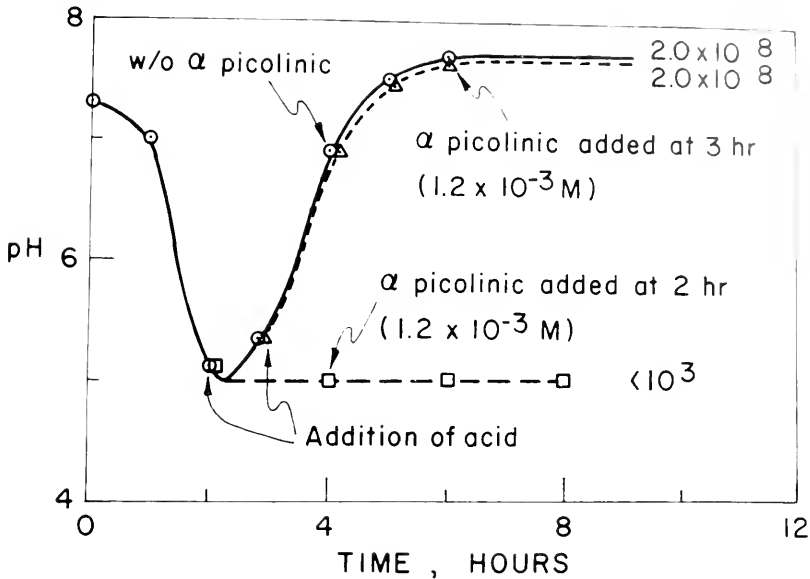

Figure 6. Effect of α -picolinic acid on the sporulation of *Bacillus cereus* T.

quite surprising (see Figure 6). An examination of this figure will show that α -picolinic acid, when added to the culture while the pH is still dropping, interferes with the subsequent utilization of the acids, while the pH remains low and no spores result. If this material is added to the culture after the pH begins to rise, there is no effect; the pH rises normally, and the result is a normal spore crop. This inhibitor may, therefore, interfere with the development of the adaptive enzyme required for the utilization of the acetic acid.

In view of the unexpected result with α -picolinic acid, we felt that we should try other pyridine carboxylic acids. Table I gives the results: α -picolinic acid was the only acid able to inhibit sporulation.

TABLE I

Effect of Pyridine-Carboxylic Acids on the Sporulation of *Bacillus cereus* T.

Compound Added	Sporulation
None	+
Nicotinic Acid (Pyridine 3-Carboxylic Acid)	+
Isonicotinic Acid	+
Quinolinic Acid	+
Pyridine 2:4 Dicarboxylic Acid	+
Pyridine 2:5 Dicarboxylic Acid	+
Dipicolinic Acid (Pyridine 2:6 Dicarboxylic Acid)	+
α -Picolinic Acid (Pyridine 2-Carboxylic Acid)	-

In Figure 7 we show the effect of succinic acid on the inhibition of sporulation by α -picolinic acid. Succinic acid reverses the inhibition, even when it is added as late as five hours after growth starts. In view of this, we have tested a large number of other acids, including some amino acids, for their ability to reverse this inhibition. The results are shown in Table II. It is to be noted that all of the intermediates in the TCA and the glyoxalic-acid shunt reverse this inhibition except fumaric acid, ketoglutaric, and glyoxalic acid. In addition, the inhibition is reversed with a number of other acids. Most of these can readily enter the cycles mentioned. Succinic acid proved to be the best reversing agent, in that it would reverse the inhibition in concentrations smaller than any of the other substances tested. Among the amino acids, aspartic acid and asparagine were the only ones that proved effective.

From the above results we were led to suspect that the glyoxalic acid shunt was the one needed for the synthesis of spore protein and dipicolinic acid. By these findings we were encouraged to investigate other inhibitors to see if we could cast further light upon this problem and get further indications as to whether or not the tricarboxylic-acid cycle or the glyoxalic shunt was involved.

Before pursuing this problem, we investigated the effect of metals on the inhibition with α -picolinic acid, because this compound is a strong chelating agent and its effect may be due to the removal of some essential metal ion. In order to interpret these experiments one needs

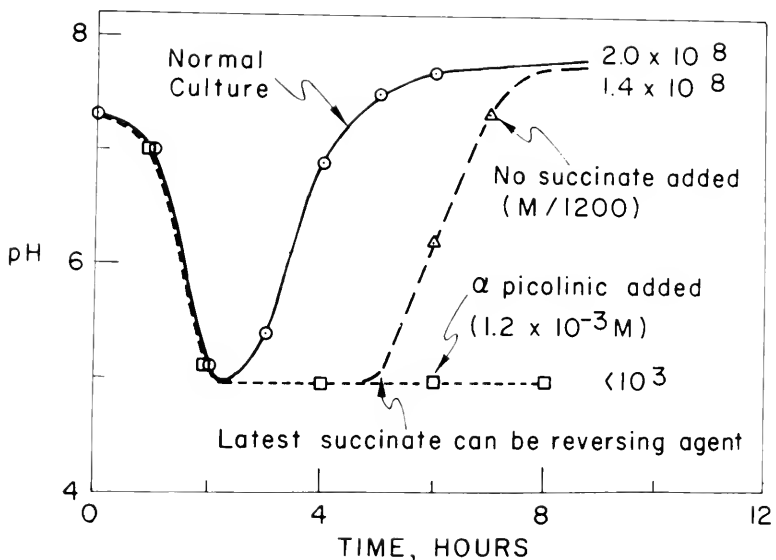

Figure 7. Reversal by succinate of the inhibition of sporulation of *Bacillus cereus* T. by α -picolinic acid.

TABLE II

Effects of Some Organic Acids on the Inhibition of Sporulation by
 α -Picolinic Acid (1.2×10^{-3} mole)

Compound Added	Concentration (mg/ml)	Sporulation
α -Ketoglutaric	2	—
Fumaric	4	—
Glyoxylic	1	—
Pyruvic	1	+
Acetic	1	+
Citric	1.5	+
Cis-Aconitic	1.5	+
Isocitric	1.5	+
Succinic	0.5	+
Malic	1	+
Oxalacetic	1	+
Formic	1	+
Malonic	1	+
Propionic	1	+
Methyl Malonic	1	+
Pimelic	2	+
α -Ketopimelic	2	+
Oxalic	2	—
Adipic	2	—
Glutamic	2	—
Mesotartaric	2	—
Lactic	2	—
Pipecolic Acid	2	—
α -Aminopimelic	2	—
α -Hydroxyglutaric	2	—
Di α -Methyl Glutamic	4	—
Glycollic Acid	1	—
β -Hydroxybutyric	2	—
<i>Amino Acids</i>		
Aspartic Acid	1	+
Asparagine	1	+
Alanine	1	—
Arginine	1	—
Citrulline	1	—
Cysteine	1	—
Cystine	1	—
Diaminopimelic Acid	1	—
Glutamic Acid	1	—
Glutamine	1	—
Glycine	1	—
Histidine	1	—
β -Hydroxyglutamic	1	—

to know the composition of the medium in which the spores are grown and in which the α -picolinic acid is producing its effect. Therefore, I indicate at this point the composition of the medium—see Table III.

TABLE III
Medium Used for Growth and Sporulation
of *Bacillus Cereus T.*

Compound	Percentage
FeSO ₄ •7H ₂ O	0.00005
CuSO ₄ •5H ₂ O	0.0005
ZnSO ₄ •7H ₂ O	0.0005
MnSO ₄ •H ₂ O	0.005
MgSO ₄	0.02
(NH ₄) ₂ SO ₄	0.2
CaCl ₂ •2H ₂ O	0.08
K ₂ HPO ₄	0.5
Yeast Extract	0.2
Glucose	0.1
Final pH 7.25-7.45	

Table IV shows the effect of added metal ions on the inhibition with α -picolinic acid. The only mineral ions that reverse the inhibition are zinc, cobalt, and nickel. It is to be noted that manganese, magnesium, calcium, iron, and copper do not have this effect. Nor can we reverse the inhibition by increasing the normal minerals of the medium four-fold. From these data one might conclude that α -picolinic acid does bring about its inhibition by removing some essential ion. If this is so, then the ion must be bound more firmly than the ions of manganese,

TABLE IV
Effects of Minerals on the Inhibition of Sporulation
of *Bacillus Cereus T.* by α -Picolinic Acid

Mineral Added	Sporulation
Mn ⁺⁺	—
Mg ⁺⁺	—
Ca ⁺⁺	—
Fe ⁺⁺	—
Cu ⁺⁺	—
Zn ⁺⁺	+
Co ⁺⁺	+
Ni ⁺⁺	+

magnesium, calcium, iron, or copper, but less firmly than zinc, cobalt, or nickel ions. In the light of these results, we also tried versene. Versene, added to the extent of 1.5 mg. per ml., also interferes with sporulation, but the effect of the versene can be overcome by doubling the concentrations of the minerals normally present in the growth medium. A general chelating agent such as versene must therefore have a different effect from the α -picolinic acid. If α -picolinic acid is producing its effect through a chelating action, it must have a rather specific effect upon some special mineral. It would be interesting to pursue this further, but in view of other interesting problems we have not taken the time to do so.

As other possible inhibitors of sporulation we have tried the esters of acids in the TCA cycle. The results are indicated in Table V. In this

TABLE V

Effects of Some Esters on Sporulation of *Bacillus Cereus* T.

Compound Added	Concentration (Moles)	Sporulation
Ethyl Pyruvate	1.5×10^{-2}	—
Ethyl Acetate	7×10^{-2}	+
Triethyl Citrate	2.4×10^{-2}	+
Ethyl Succinate	2×10^{-2}	—
L-Glutamic Acid Diethyl Ester	1×10^{-2}	+
Ethyl Malonate	1.3×10^{-2}	—
Ethyl Formate	7×10^{-2}	+
Diethyl Oxalacetate	1.2×10^{-2}	—
Ethyl Propionate	3×10^{-2}	+
None (Control)		+

table, failure to get spores shows that the ester is serving as an inhibitor, whereas a normal spore crop shows that no such inhibition takes place. Ethyl pyruvate, diethyl succinate, ethyl malonate, and diethyl oxalacetate inhibited sporulation, but ethyl acetate, triethyl citrate, ethyl succinate, diethyl L-glutamate, ethyl formate, and ethyl propionate did not.

Figure 8 shows the effect produced by ethyl malonate. It is obvious from this that ethyl malonate behaves differently than α -picolinic acid. This inhibitor prevents sporulation whether it is added before the pH begins to rise or afterward. This inhibitor, therefore, probably does not interfere with the formation but instead interferes with the function of some essential enzyme. With this inhibitor, the pH rises for a while as if the culture were normal but finally falls to the low level produced with α -picolinic acid. We know from other carefully controlled experi-

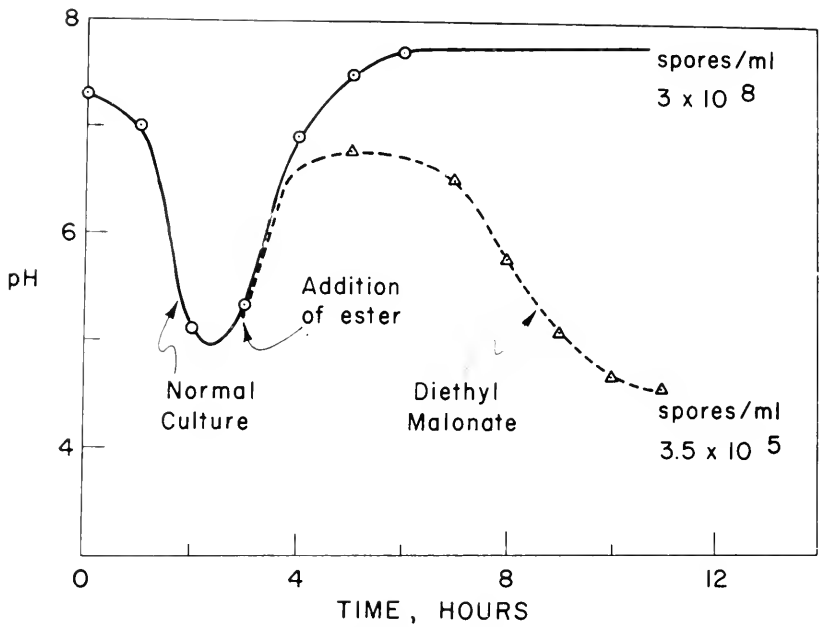

Figure 8. The effect of diethyl malonate (1.3×10^{-2} M) on the pH and sporulation of a culture of *Bacillus cereus* T.

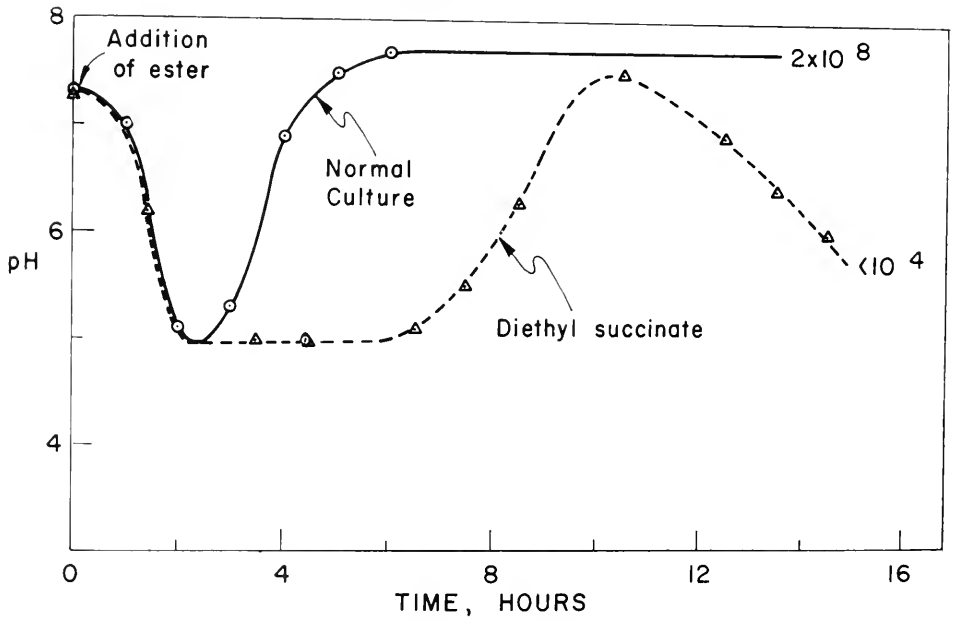

Figure 9. The effect of diethyl succinate (2×10^{-2} M) on the pH and sporulation of *Bacillus cereus* T.

ments that the interference with sporulation in this case is due not to a drop in the pH but rather to a specific effect of ethyl malonate.

Figure 9 shows the effect produced with diethyl succinate as an inhibitor. Here again the inhibition occurs whether the inhibitor is added before or after the pH begins to rise. Here also, as in the case of the ethyl malonate, the pH rises for awhile and then drops. Figure 10 shows the effect produced with ethyl pyruvate. Here also, the inhibitor functions whether it is added before or after the pH begins to rise, indicating that this inhibitor, as well as the other two, probably interferes with the functioning of some enzyme system rather than with the production of an adaptive enzyme. The ethyl pyruvate acts somewhat differently from the two inhibitors cited above, because in this case the pH rises and stays high. Nevertheless, no spores are formed. We have also investigated the effect of various organic acids upon the reversal of inhibition of these ethyl esters. I am not going to take time to discuss the details of all these experiments; suffice it to say that these inhibitors were reversed by all of the intermediates in the glyoxylic-acid shunt but were not reversed by fumarate or other intermediates in the TCA cycle not common to the glyoxylic-acid shunt.

We realize it is dangerous to rely upon inhibitors alone for the verification of a definite pathway in a fermentation, but the circumstantial evidence we had for the involvement of the glyoxylic-acid shunt led us to conduct further experiments to see if we could get additional support for this conclusion. We therefore investigated two other possible

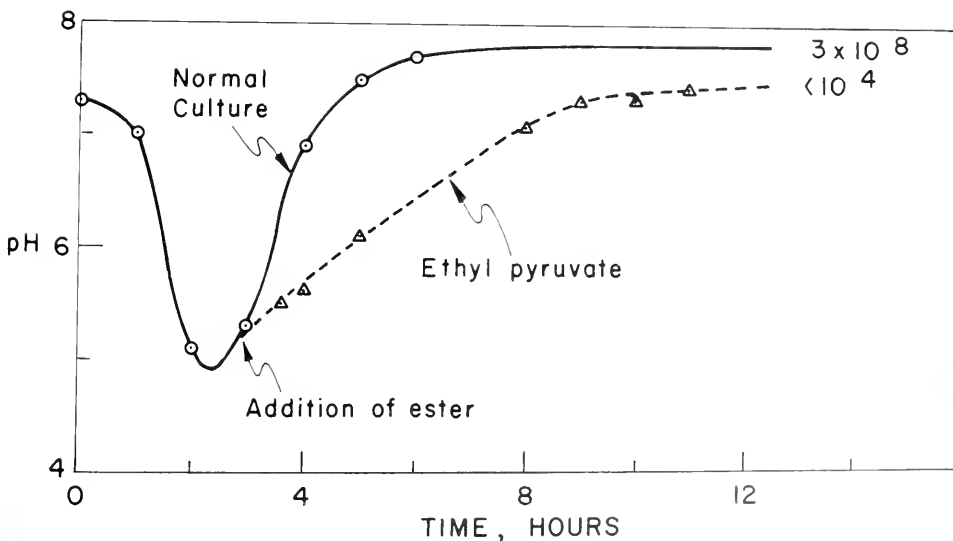

Figure 10. The effect of ethyl pyruvate (1.5×10^{-2} M) on the pH and sporulation of *Bacillus cereus* T.

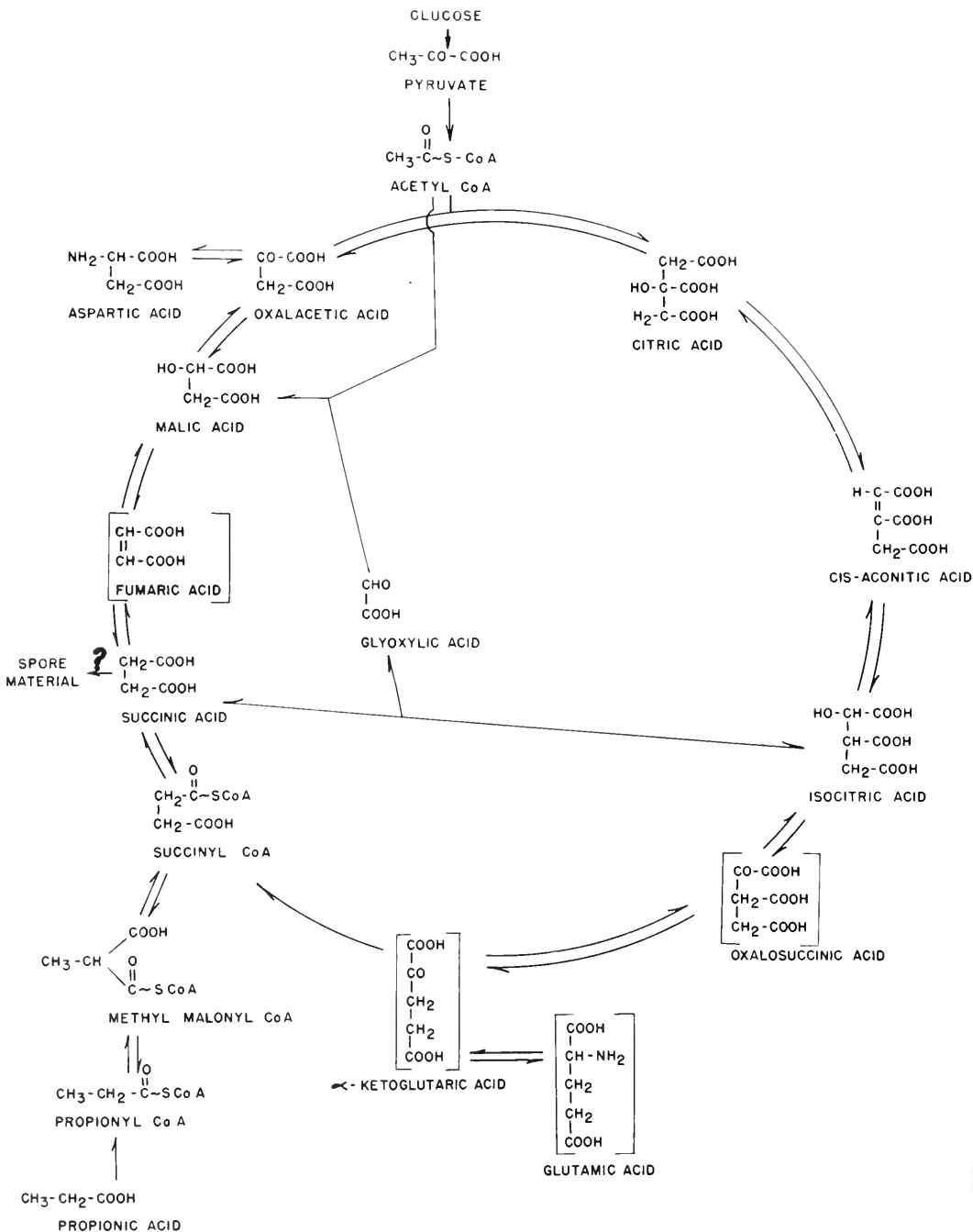

Figure 11. Tricarboxylic-acid cycle with the glyoxylic-acid shunt.

inhibitors. If either the TCA or the glyoxylic shunt (the cycles are shown in Figure 11) is involved, fluoroacetic acid should also be an effective inhibitor, inasmuch as this material interferes with the enzyme that converts citrate to isocitrate. We found this acid to be an effective inhibitor of sporulation. It did not interfere with the growth of the vegetative cells. Thus it functions very much like the esters we reported above. This inhibitor was reversed by citrate, isocitrate, succinate, and malonate but not by fumarate, acetate, pyruvate, or alpha-ketoglutarate.

We also tried sodium bisulphite as an inhibitor, reasoning that, if the glyoxylic-acid shunt is involved, bisulphite should tie up the glyoxylic acid because of its aldehyde group, and thus break the cycle; of course, it may also tie up the ketone group of the oxalacetate, which is common to both the glyoxylic-acid shunt and the TCA cycle. In any event, we found that bisulphite did effectively interfere with sporulation but did not interfere with the growth of the vegetative cells. This inhibitor was reversed by citrate, cis-aconitate, isocitrate, succinate, methyl malonate, malonate, and glyoxylate. It was not reversed by pyruvate, acetate, alpha-ketoglutarate, aspartate, or malate. The reversal by glyoxylic acid and ketoglutarate was to be expected, since the aldehyde and ketone groups would tie up the bisulphite and thus remove it from the sphere of action. The fact that malate does not reverse the inhibition of the bisulphite may indicate that bisulphite is also tying up the oxalacetate and thus breaking the cycle at that point.

The glyoxylic-acid shunt may be needed for sporulation, but as yet we do not have convincing proof. At the present time we are pursuing this investigation with radioactive tracers, and hope by this technique to get conclusive proof or denial. Regardless of the cycle involved, all of the inhibitors we have studied are reversed by succinate, and succinate has proved to be the most effective reversing agent because it will reverse these inhibitors in smaller concentrations than any of the others. This leads us to suspect that succinic acid is an intermediate in the synthesis of spore material and also, perhaps, in the synthesis of DPA. There is some evidence against this conclusion; Martin and Foster (1958), when they studied the incorporation of various types of labeled compounds into DPA, obtained little evidence for the incorporation of succinate. In their experiments there may have been an abundant supply of succinate within the cell so that the cell did not utilize succinate added from the outside. You may recall from the data on the anaerobic culture that we could separate the formation of the heat-sensitive spore from the synthesis of DPA and from the development of heat resistance. We have not been able to obtain such a separation in the case of the aerobes. We have therefore investigated other inhibitors to see if we could find some substance which would

permit the synthesis of the spore structure but not the synthesis of DPA and thus would prevent the production of a heat-resistant spore. B. D. Church and Harlyn Halvorson (1959) were able to do this with phenylalanine. We have succeeded in obtaining this result with two inhibitors—ethyl oxamate and diethyl pimelate.

To pursue this study one needs some mechanism to differentiate between heat-sensitive spores, vegetative cells, and germinated spores. It cannot be done by heating, but octyl alcohol proved to be a suitable agent. This alcohol is very toxic to vegetative cells, killing them almost instantly, and it will also destroy germinated spores almost equally fast. Spores are extremely resistant to this chemical, and, as will be shown later, the heat-sensitive spores also are resistant. Table VI shows the effect of octyl alcohol upon germinated spores and vegetative cells of

TABLE VI
Effect of Octyl Alcohol on the Viability of Spores,
Germinated Spores, and Vegetative Cells of *Bacillus Cereus* T.

Type of Cells	Without Octyl Alcohol		With Octyl Alcohol
	Viable	Heat-Stable	Viable
Spores	3×10^8	2.5×10^8	3×10^8
Germinated Spores	1.6×10^8	10^5	10^5
Vegetative Cells	6×10^7	<100	<100

B. cereus. Table VII shows the effect of ethyl oxamate upon the production of heat-resistant spores of *B. cereus*. It is to be noted from this that ethyl oxamate interferes with the formation of heat-resistant spores whether it is added in the beginning or before or after the pH has started to rise. If one waits, however, until the pH has gone up to 7.1 or higher, it has no effect. Apparently by this time the synthesis of

TABLE VII
Effect of Time of Addition of Ethyl Oxamate ($10^{-2}M$)
on the Production of Heat-Stable Spores

Type of Culture Used	Octyl-Stable (Cells/ml)	Heat-Stable (Cells/ml)
Spore Inoculum	2×10^8	6×10^5
Active Culture at 0 Time	4×10^8	8×10^5
Active Culture pH 5.2 (falling)	7×10^8	1.5×10^5
Active Culture pH 5.8 (rising)	6×10^8	6×10^5
Active Culture pH 7.1 (rising)	1.5×10^9	1.4×10^8
Active Culture pH 7.9 (rising)	8×10^8	2×10^8

DPA has already progressed to the point where heat-resistant spores have been formed. We have examined the inhibited cultures for DPA and find that very small amounts are present. It is to be noted that a few heat-resistant spores are formed, so that the ethyl oxamate does not block the synthesis of DPA completely, but it does interfere with the synthesis enough so that more than 95 per cent of the spores that are formed are heat-sensitive. The amount of DPA found in such preparations is slightly more than one would expect if one assumes that the heat-resistant spores have their normal content and the heat-sensitive spores have none. It is possible, therefore, that some DPA may be present also in the heat-sensitive spores.

Somewhat similar results are obtained with diethyl pimelate. This inhibitor, however, interferes with the development of normal vegetative cells if it is added to the culture at 0 time, or very early in the growth of the vegetative cells. The vegetative cells look abnormal, and, in fact, many of them lyse before they can begin to produce spores. This inhibitor may very well interfere with the synthesis of cell walls. If the inhibitor is added after the pH has started to rise (at which time the production of vegetative cells has been completed and presumably there is no further synthesis of cell wall), we find that the inhibitor does not interfere with the production of spores, but the spores produced are heat-sensitive, as shown in Table VIII. In fact, the results are almost identical to those obtained with ethyl oxamate. Here again, better than 95 per cent of the spores are heat-sensitive. These heat-sensitive spores appear to be perfectly normal, as far as staining

TABLE VIII

The Effect of Time of Addition of Diethyl Pimelate (M/100)
on Sporulation

pH of Culture at Time of Addition	After 24 hours Incubation at 30°C. on Shaker			pH
	Viable (cells/ml)	Octyl Alcohol- Stable (cells/ml)	Heat-Stable (cells/ml)	
4.9 (falling)	<100	<100	<10	4.85
5.3 (rising)	10 ⁸	1.3 × 10 ⁸	5 × 10 ⁶	5.4
6.3 (rising)	1.3 × 10 ⁸	1.7 × 10 ⁸	2.5 × 10 ⁶	5.45
7.3 (rising)	1.3 × 10 ⁸	1.5 × 10 ⁸	1.5 × 10 ⁶	5.4
7.8 (rising)	4 × 10 ⁸	2.5 × 10 ⁸	1.5 × 10 ⁶	5.45

For purposes of counting, cells were spun down and resuspended in M/100 phosphate buffer, pH 7.2.

Vegetative cells and germinated spores are killed immediately on exposure to octyle alcohol (0.06ml/100ml H₂O).

is concerned. They are refractile, like normal spores; they undergo germination with ordinary germination nutrients, as ordinary spores will; and they are resistant to octyl alcohol. They are extremely sensitive to heat, most of them being killed at 65° C. in less than 15 minutes. Their heat resistance is no greater than that of vegetative cells.

Both of these inhibitors can be reversed by dipicolinic acid added from the outside as much as seven to nine hours later. In the presence of DPA, the spores produced are heat-resistant. A similar experiment cannot be made with diethyl pimelate, because this substance cannot be added to the cultures at the beginning. But if this is added to the culture at seven hours, we find that most of the spores are heat-sensitive, whereas if we add dipicolinic acid at the same time, all of the spores are heat-resistant.

To summarize our data, they seem to indicate that the glyoxylic-acid shunt may be involved in the synthesis of spore material and dipicolinic acid. Apparently some of the enzymes needed in this shunt are not present in vegetative cells but are produced as adaptive enzymes after the sugar has been used up. Succinic acid appears to be important as an intermediate in the synthesis of the spore material, and perhaps also in the synthesis of dipicolinic acid. The synthesis of spore material and the production of spore-like structure can occur independently of the synthesis of dipicolinic acid. The only function that the dipicolinic acid plays in the process is to produce a structure which can protect the enzymes and make the spore heat-resistant. Heat resistance cannot develop until after the DPA has been synthesized. This lends further circumstantial evidence to the theory that dipicolinic acid is involved in the formation of a complex which serves to protect the enzymes and make them heat-resistant.

References

- Brown, W. L., 1956. "The Production and Germination Requirements of Putrefactive Anaerobe 3679 Spores," unpublished doctoral thesis, University of Illinois.
- Church, B. D., and Halvorson, H., 1955. "Glucose Metabolism of Resting Spores of Aerobic Bacilli," *Bact. Proc.* 41.
- Church, B. D., and Halvorson, Harlyn, 1959. "Dependence of the Heat Resistance of Bacterial Endospores on Their Dipicolinic Acid Content," *Nature* 183, 124.
- Collier, R., 1958. "A study of Sporogenesis in *Clostridium roseum*," unpublished doctoral thesis, University of Illinois.
- Foster, J. W., 1959. "Dipicolinic Acid and Bacterial Spores," lecture given at the University of Maryland. Sponsored by American Cyanamid Co., Chas. Pfizer and Sons, and Merck and Co.
- Gollakota, K. G., and Halvorson, H. Orin, 1960. "Biochemical Changes Occurring During Sporulation of *Bacillus cereus*. Inhibition of Sporulation by Alpha Picolinic Acid," *J. Bact.* 79, 1.

- Gollakota, K. G., Unpublished data.
- Grelet, N., 1950. "Culture d'une souche de *Bacillus megatherium* sur Milieu Synthétique Glucose Sporulation par penurie de Zinc en Presence de Calcium," *Ann. Inst. Pasteur* 78, 423.
- Grelet, N., 1951. "Le Déterminisme de la Sporulation de *Bacillus megatherium*, I: L'effet de l'épuisement de l'Aliment Carbone en Milieu Synthétique," *Ann. Inst. Pasteur* 81, 430.
- Grelet, N., 1952. "Le Déterminisme de la Sporulation de *Bacillus megatherium*, II: L'effet de la Penurie des Constituants Minéraux du Milieu Synthétique," *Ann. Inst. Pasteur* 82, 66.
- Grelet, N., 1952. "Le Déterminisme de la Sporulation de *Bacillus megatherium*, III: L'effet d'une acration limitante sur les Cultures Agitées de deux Variants d'une meme Souche," *Ann. Inst. Pasteur* 82, 310.
- Grelet, N., 1952. "Le Déterminisme de la Sporulation de *Bacillus megatherium*, IV: Constituants Minéraux du Milieu Synthétique Nécessaires a la Sporulation," *Ann. Inst. Pasteur* 83, F1.
- Halvorson, H. Orin, 1958. *The Physiology of the Bacterial Spore* (Technical University of Norway).
- Hardwick, A., and Foster, J. W., 1952. "On the Nature of Sporogenesis in Some Aerobic Bacteria," *J. Gen. Physiol.* 35, 907.
- Hills, G. M., 1949. "Chemical Factors in the Germination of Sporebearing Aerobes: The Effect of Yeast Extract on the Germination of *Bacillus Anthracis* and its Replacement by Adenosine," *Biochem. J.* 45, 353.
- Hills, G. M., 1950. "Chemical Factors in the Germination of Sporebearing Aerobes: Observations on the Influence of Species, Strain, and Conditions of Growth," *J. Gen. Microbiol.* 4, 38.
- Lawrence, N. L., 1955. "The Cleavage of Adenosine by Spores of *B. cereus* Var. *Terminalis*," *J. Bact.* 70, 577.
- Lawrence, N. L., and Halvorson, H. Orin, 1954. "Studies on the Spores of Aerobic Bacteria, IV: A Heat Resistant Catalase From Spores of *Bacillus terminalis*," *J. Bact.* 68, 334.
- Levinson, H. S., 1957. "Non-oxidative Enzymes of Spore Extracts," *Spores* (Proceedings of the Allerton Spore Conference), Publication No. 5, A.I.B.S., Washington, D. C.
- Lund, A., personal communication.
- Martin, H. H., and Foster, J. W., 1958. "Biosynthesis of Dipicolinic Acid in *Bacillus megatherium*," *J. Bact.* 76, 167.
- Murrell, W. G., 1955. *The Bacterial Endospore*. (Sydney, Australia, University of Sydney).
- Murty, G. C. K., and Halvorson, H. Orin, 1957a. "Effect of Enzyme Inhibitors on the Germination and Respiration of and Growth from *Bacillus cereus* Var. *terminalis* Spores." *J. Bact.* 73, 230.
- Murty, G. C. K., and Halvorson, H. Orin, 1957b. "Effect of Duration of Heating, L-alanine, and Spore Concentration on the Oxidation of Glucose by Spores of *Bacillus cereus* Var. *terminalis*," *J. Bact.* 73, 235.
- Nakata, H. M., 1956. "Studies on the Enzymatic Cleavage of Adenosine by the Spores of *Bacillus cereus*," unpublished master's thesis, University of Illinois.
- Nakata, H. M., 1959. "Biochemical Changes Occurring During Growth and Sporulation of *Bacillus cereus*," unpublished doctoral thesis, University of Illinois.
- Ordal, Z. John, personal communication.
- Perry, J., and Foster, J. W., 1954. "Non-involvement of lysis during sporulation of *Bacillus mycoides* in distilled water," *J. Gen. Physiol.* 37, 401.

- Powell, J. F., 1953. "Isolation of Dipicolinic Acid (Pyridine, 2: 6, Dicarboxylic Acid) From Spores of *Bacillus megatherium*," *Biochem. J.* 54, 210.
- Powell, J. F., 1956. "Chemical Changes Occurring During Spore Germination," *Spores* (Proceedings of the Allerton Spore Conference), Publication No. 5, A.I.B.S., Washington, D. C.
- Powell, J. F., and Strange, R. E., 1954. "Hexosamine-containing Peptides in Spores of *Bacillus subtilis*, *B. megatherium*, and *B. cereus*," *Biochem. J.* 58, 80.
- Riemann, H., personal communication.
- Stewart, B. T., and Halvorson, H. Orin, 1953. "Studies on the Spores of Aerobic Bacteria, I: The Occurrence of Alanine Racemase," *J. Bact.* 65, 160.
- Stewart, B. T., and Halvorson, H. Orin, 1954. "Studies on the Spores of Aerobic Bacteria, II: The Properties of An Extracted Heat-stable Enzyme," *Arch. Biochem. Biophys.* 49, 168.
- Wynne, E. S., 1957. "Symposium on Bacterial Spore Germination," *Bact. Rev.* 21, 259.

PART TWO

*Cells, Tissues,
and
Organisms*



SYNCHRONIZED GROWTH IN TETRAHYMENA CELLS*

Erik Zeuthen

CARLSBERG FOUNDATION

For the study of the chemical events by which the cell prepares for division and which take the cell through division, the synchronous systems are exceedingly useful. First, because enough material is available for chemical analysis, and second, because one sample of a population serves as a control for other samples in which division is interfered with experimentally. Finally, a synchronous mass population can be considered a tremendously amplified model of a single cell, a model which—unlike the single cell—can be sampled at intervals without interfering with the cyclical changes of the cell. Nature has supplied us with only a few naturally synchronized cell systems. The fertilized marine eggs and the anthers of lily flowers are among the best known.

The system

Mass population of *Tetrahymena pyriformis*, strain GL, can be brought into division synchrony by a series of temperature shocks (Scherbaum and Zeuthen, 1954; Zeuthen and Scherbaum, 1954; Scherbaum and Zeuthen, 1955). At some point of logarithmic growth at 28° C. (optimum), when the population density has not yet exceeded 50,000 cells/ml, a series of shifts of the temperature between 28° C. (30 minutes) and 34° C. (30 minutes) is initiated. This “standard procedure” blocks division but permits continued growth to oversized cells.

* *Results not yet published will be fully reported in the Compt. Rend. Lab. Carlsberg by the author alone and in association with Magister Lcif Rasmussen and (for the data on glycogen) with Miss Birgit Hegner.*

After transfer to constant 28° C. or to room temperature, the block is released after a well-defined lag. The population then goes through one, two, or more consecutive divisions in first excellent, later deteriorating, synchrony (Figure 1). Provided the population density does not get too high, the system gradually reverts to logarithmic growth with smaller cells (Figure 2). It may be re-synchronized with the standard procedure. The effects of the cycling temperature are thus fully reversible.

Figure 3 shows a population before (A) and during (B) the first synchronous division at 28° C. The degree of synchrony is a function of the cultural conditions. It is better in a 10-ml. shallow and non-shaken culture than in 150-ml. or 700-ml. shaker-flasks (previous review by

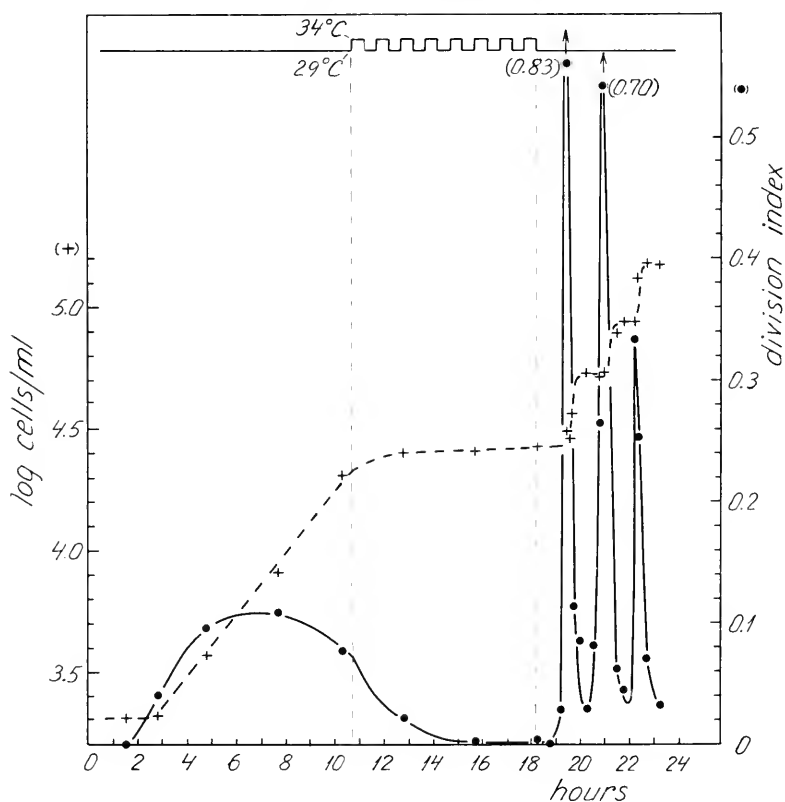

Figure 1. The solid-line curve represents the division index (cells in cytokinetic stages of division as a fraction of all cells counted). The broken curve represents cell counts. The standard experimental procedure was a shift in temperature every 30 minutes between 28° C. and 34° C., with eight exposures to the high temperature. The medium was 2 per cent proteose-peptone plus 0.1 per cent liver fraction L (medium B). (From Zeuthen and Scherbaum, 1954.)

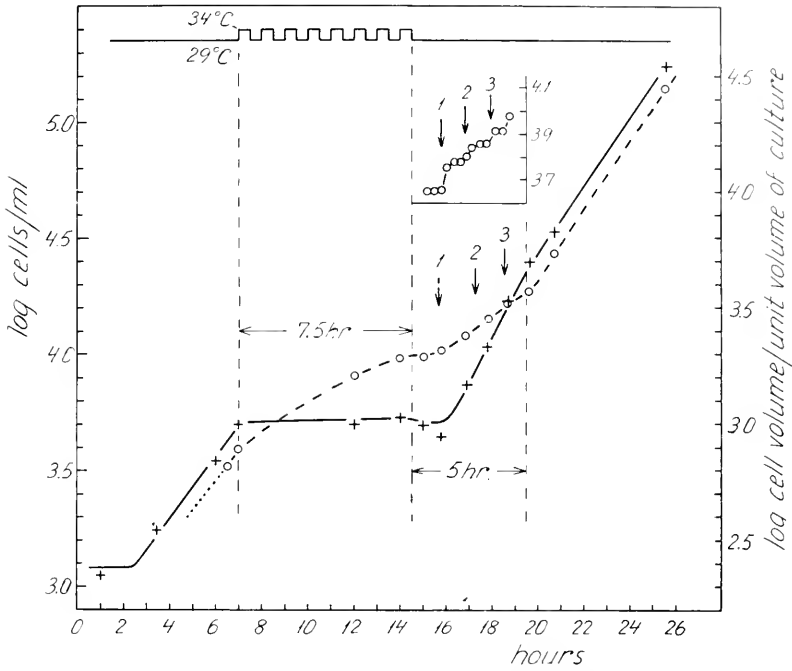

Figure 2. The solid-line curve represents cell counts; the broken curve represents volume of cells per unit volume of culture. Standard procedure. (From Zeuthen and Scherbaum, 1954.)

Zeuthen, 1958). Furthermore, the division maxima build up (Figure 4) with fewer shocks—therefore in shorter time—the richer the medium is. Medium A is 2 per cent proteose peptone; medium B is further enriched with 0.1 per cent, and medium C with 0.4 per cent, liver fraction L. In all cases the synchronization is in 150-ml. shaker-flasks, and the division indices are visually estimated on live samples removed from the flasks. In this case periods of 20 minutes at 34° C. alternate with 40 minutes at 28° C.

With continued temperature cycling, the synchronous system tends to break down again. This, too, occurs fastest on the richest medium. The effects shown in Figure 4 are paralleled by those of Figure 5, which shows the times between the last temperature shock (E.H. = end of heat) and the first division maximum, between the first and the second, and between the second and the third maximum, all as functions of the number of the temperature shocks. Both figures exhibit broad optimal ranges for the number of shocks that must be applied to give best synchrony. These ranges are shifted slightly towards fewer shocks when the medium is rich. Under the best conditions it is seen more clearly than from Figures 4 and 5 that the richer media give rise

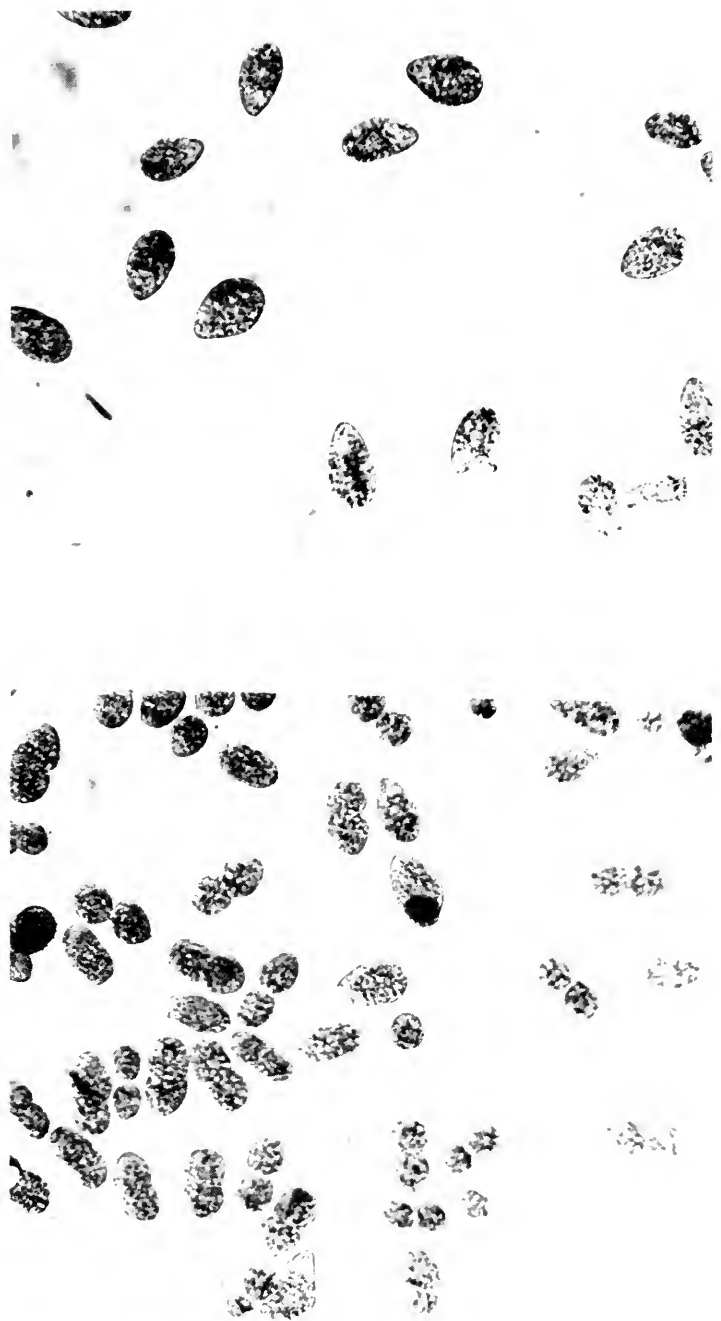

Figure 3. Synchronized cells before (top) and during (bottom) the first division at 28° C. Standard procedure.

Figure 4. Relation between the number of temperature shocks applied and the percentage of cells participating synchronously in the first, second, and third divisions. Medium for A: 2 per cent proteose-peptone. For B: Same plus 0.1 per cent liver fraction L. For C: Same plus 0.4 per cent liver fraction L. Temperature shocks, each of 20 minutes to 34° C., were separated by somewhat extended periods (40 minutes) at 28° C. Division was at constant 28° C.

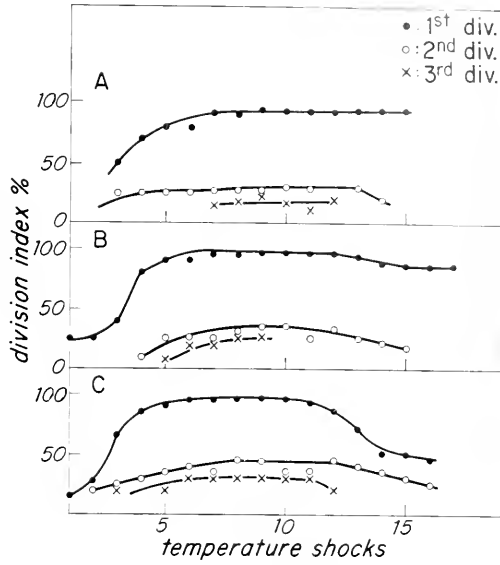
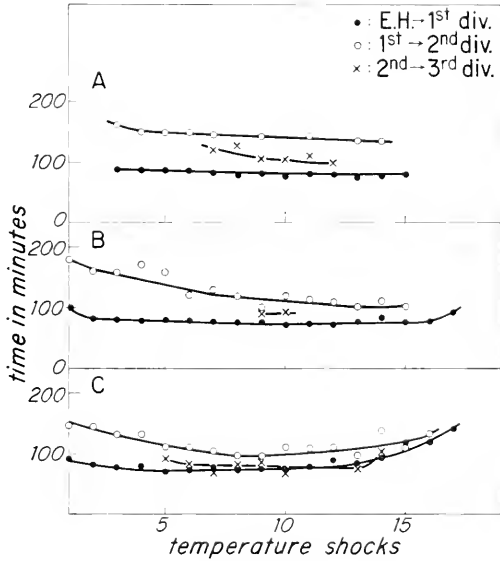

Figure 5. The same experiments as in Figure 4. The time intervals indicated are from "end of heat treatment" (E.H.) to division 1, from division 1 to 2, and from division 2 to 3. E.H. is the time when the clock switches the control from the 34° C. to the 28° C. thermometer.



to longer-sustained synchrony (three, four, five divisions, *cf.* later Figure 12) than the poorer media do.

Sooner or later temperature cycling, if continued, leads to poorer synchrony. This has two causes (*cf.* Figure 6): some of the cells adapt to, and divide (3, 4) at the cycling temperature, others (7) do not divide until after many (perhaps 24) hours at constant 28° C. This latter effect is a function of excessive growth without division and of

time rather than of the temperature shocks as such. It comes earlier on the richer (B, C) than on the poorer (A) media. In the case of the experiment of Figure 6 (medium C), growth has come to a standstill after shock 9, and late-dividing monsters develop between shocks 9 and 18. The monsters may have one to three macronuclei of uneven size and more than one anarchic mouth anlagen. During the cycling temperature, when there is no division, the cells grow much faster the richer the

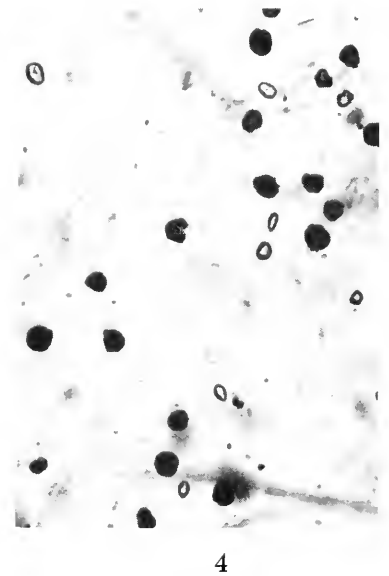
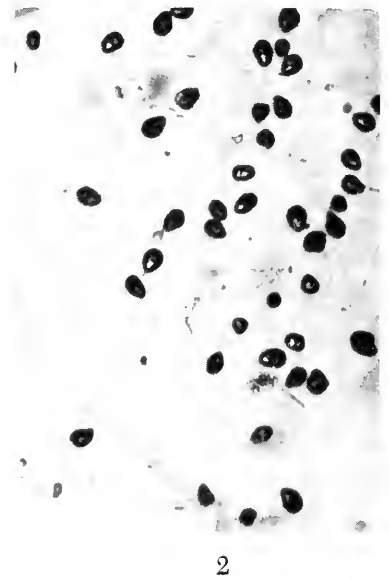
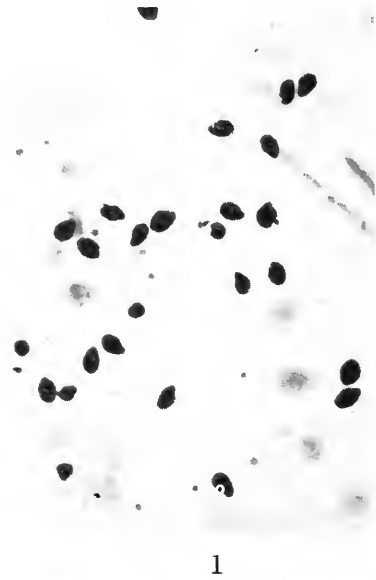



Figure 6. Synchronization by the modified procedure described for Figure 4. The growth medium was C. Mass growth has come to a standstill after nine shocks (1), at which time the cells are perhaps eight times larger than the logarithmic cell (8). When released from the heat treatment after nine or ten shocks (1, 2), all the cells split to logarithmic sizes within less than 18 or 17 hours (5, 6). When the release came after 12 shocks (3), many cells failed to divide within 15 hours (7). Some cells adapted to and divided during the cycling temperature after 12 shocks (3) or after 18 shocks (4).

medium is. After nine shocks the average cell size may be 1.5 to two on medium A, two to four on medium B and perhaps six to ten on medium C. The average logarithmic cell has size one. This dramatic effect on growth is only to a relatively small degree reflected in the results of Figures 4 and 5.

For synchrony to be induced, the average cell must grow some. But the synchrony is not a simple function of the size increase of the cells during the cycling temperature or of the number of temperature shocks applied per unit time or per unit growth. The results are compatible with the view that, depending on the quality of the medium, the average cell performs enough growth during three, five, or seven temperature cycles (Figure 6, C, B, A) to permit at least one synchronous division in all, or almost all, cells. The total growth may be taken as a rough measure of the synthesis of a number of molecular—mostly macromolecular—substances essential for division. We can list protein (Christensson, 1959), both of the nucleic acids (Scherbaum, 1957b; Iverson and Giese, 1957), DNA—also nuclear volume, whatever this represents in terms of molecules (Zeuthen and Scherbaum, 1954)—and nucleoside-triphosphates (Plesner, 1956, 1958a, 1958b). Even though there are suggestions to the contrary (with regard to DNA: Scherbaum, Louderbach, and Jahn, 1959), the present author sees no strong evidence (*cf.* Hamburger and Zeuthen, 1960, and text for Figure 13) that any of these groups of substances limits division. After the cycling heat, the cell carries more than double the normal average amount of them all. Still, the population divides synchronously at constant 28° C. only after a lag of about 80 minutes. The possibility remains that the syntheses of small fractions or molecular segments are specifically interfered with by the intermittent heat, so that qualities rather than quantities change. In both cases, the cycling heat would bring the system out of balance, so that one or more chemical or physical conditions for division fail to mature. At 28° C., maturation for division occurs in standard time also in cells which before the final shock are transferred to tap water or to a simple inorganic medium. It is interfered with in the same way by heat in both media (Hamburger and Zeuthen, 1957).

From what has been said, it is clear that the first synchronous division may be, or even is likely to be, special. More about this later. Holz (1960) studied mating type I, variety I, and found that the structural events between the *first* and the *second* synchronous division follow the same time-course as in the logarithmic cell. Also, he pointed out that, except for the absence of a micronucleus in strain GL, the time-course of the structural events is similar in GL and in mating type I, variety I, both non-synchronized.

Still, in strain GL the simple measurement of times between suc-

cessive synchronous divisions suggests that the system is fully balanced only when, after several generations, it has reverted to logarithmic growth. In a large material the time (at room temperature) from E.H. to the first division maximum was 99 ± 12.6 minutes. The second division maximum came 127 ± 14.5 minutes after the first, the third 110 ± 20 minutes after the second, and the fourth 135 ± 8.8 minutes after the third. (Medium C, temperature cycles as in Figure 4.)

Physiological mechanisms in the induction of synchrony

Synchrony is not obtained because the *rate of advance* towards division is differently influenced in cells of different ages. On the contrary (Zeuthen and Scherbaum, 1954; Thormar, 1959) all temperature changes, even the smallest, *make a cell lose, not gain, time* in its preparation for its next division.

Take two logarithmic cells which have completed their previous division at the same time. Let the first go on through the next division at the same temperature ($28\text{-}29^\circ\text{ C.}$) at which both were reared. At 100 to 110 minutes after a division, expose the second cell to a new temperature for a short time (say 30 minutes) and return to 28° C. The second cell will always be, or tend to be, delayed. If the new temperature is around 22° C. or about 30° C. , the treated cell makes no advance in time at all at this temperature. It therefore divides exactly 30 minutes later than the control. If the cell is exposed for 30 minutes to temperatures in the interval $22\text{-}30^\circ\text{ C.}$, it advances some, but less than one would have expected on examination of the relation between temperature and growth over generations at the different temperatures. The cell is thus delayed, but less than 30 minutes. If exposure is made to temperatures below 22° C. or above 30° C. , the delay is more than the 30 minutes spent at the new temperature, sometimes much more. Thus (*cf.* Figure 7), depending on the shock temperature, the cell appears to be either slowed ($22\text{-}30^\circ\text{ C.}$), blocked (22 or 30° C.), or more severely influenced ($<22^\circ\text{ C.}$ or $>30^\circ\text{ C.}$). In the latter case, time for reconstitution at constant 28° C. is required. We have used the neutral terms "excess-delay" (Thormar, 1959) or "setback" (Zeuthen, 1958) for this time. We might simply call it the "repair time," or "recovery time," for the division-preparing machinery.

When Thormar studies the course of events at any new temperature to which the 100-110-minutes-old logarithmic cells are transferred, he gets results which are illustrated in Figure 8. With increasing length of exposure to any of the temperatures represented, the setback, or the recovery time at 28° C. , first (31° C. and 33° C.) increases to a maximum and then slowly again decreases. At 34.1° C. the setback increases, initially as fast as at the lower temperatures, but the increase

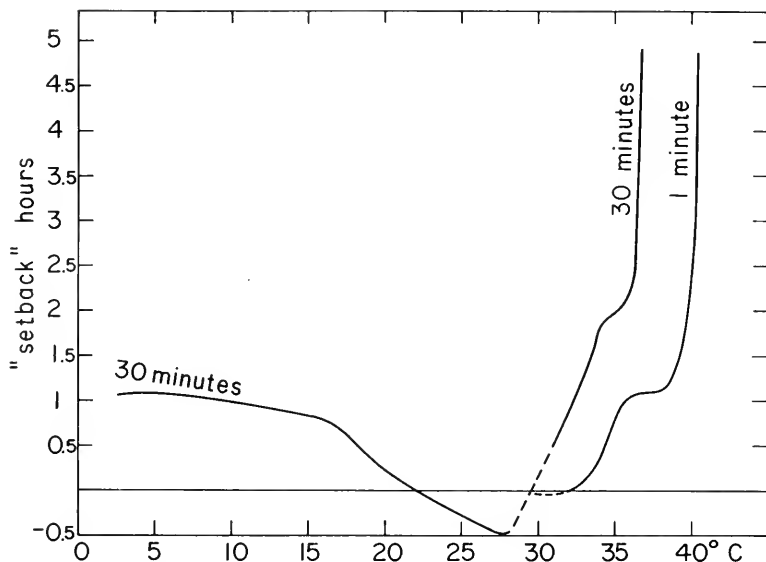

Figure 7. *Tetrahymena* grown at 28.5° C. Cells 100 to 110 minutes old were exposed to temperatures between 3° and 37° C. for 30 minutes. The setback (*cf.* text for Figure 9) changes in a continuous manner with temperature on both sides of the growth temperature, except around 34 to 35° C. In this region the curve for an exposure of one minute to temperatures above the growth temperature is merely shifted in position to show the level part of the curve more clearly. (Data by Thormar, 1956.)

continues longer and a constant level is reached after 20 to 30 minutes. At the higher temperatures (35°, 36°, 37°, and 38° C.) the setback continues to increase with the time for which the exposure lasts, but the shape of the curves suggests a phase of unsuccessful counter-regulation against this development. It is only at the two lowest temperatures mentioned that this counter-regulation, or adaptation, is effective. At constant 31° C. the cells divide after some time, and continued cultural growth is possible at this temperature. At 33° C. the cells divide after a long lag but only once. The divided cell continues to grow for some time. At 34° C. there will never be a division, but the heated cell continues to grow, and after twelve hours (Thormar, 1961) it reaches about double size. At the higher temperatures viability is influenced—at 35° C. after twelve hours, at 36, 37, and 38° C. much sooner.

Curves which relate age and setback of logarithmic cells are presented in Figure 9. Single cells of varying ages are exposed to temperature shocks at 9.3° C. for 30 minutes, at 31.1° C. for 20 minutes, and at 34.0° C. for 15 minutes. Cells less than 30 minutes of age are

blocked by 9.3° C., continue to advance at 31.1° C., and are set back when exposed to 34° C. All cells older than 60 minutes are set back by all three kinds of shocks. For each temperature there is a smooth transition from young cells with low reaction to old cells with strong reaction to the temperature shocks. Just before the macronuclear stretching and cytoplasmic division, there is an abrupt change in response to the increased temperature. The cells are either lightly set back, blocked, or (as shown by the points below the zero line) go

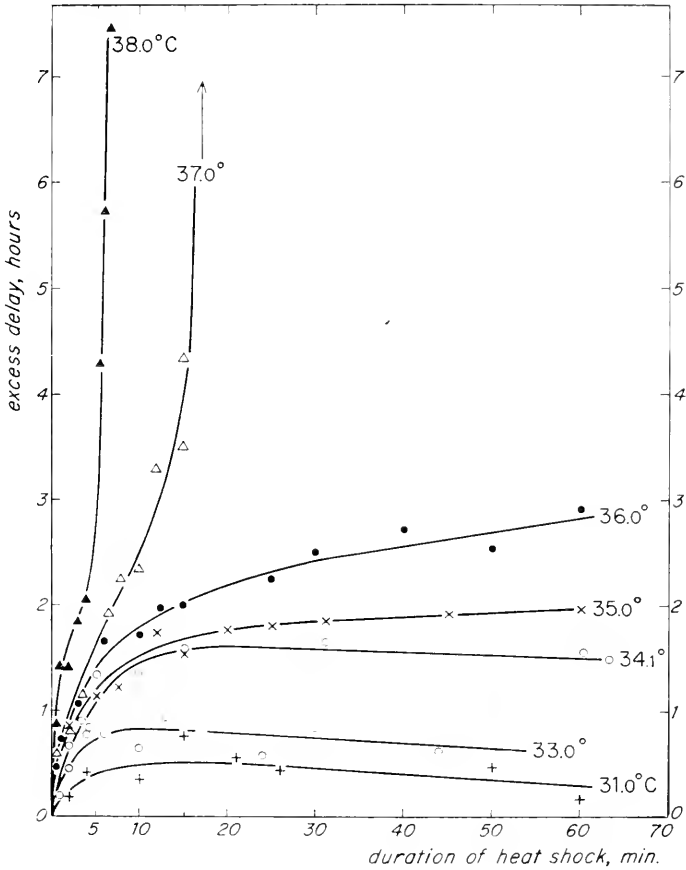

Figure 8. *Tetrahymena pyriformis* grown at 28.5° C. and shocked at the age of 100 to 105 minutes. The graph shows the relation of the excess delay (ordinate) to the duration of the temperature shock (abscissa). Upon exposure to 34.1° C., the excess delay reaches a maximum of about 100 minutes after 20 minutes. At lower shock temperatures the excess delay reaches an earlier and lower maximum and shortens upon longer exposure. This is evidence of adaptation to the shock temperature. At higher shock temperatures the curves suggest at least two effects—separable on the time scale—of the elevated temperature. (From Thormar, 1959).

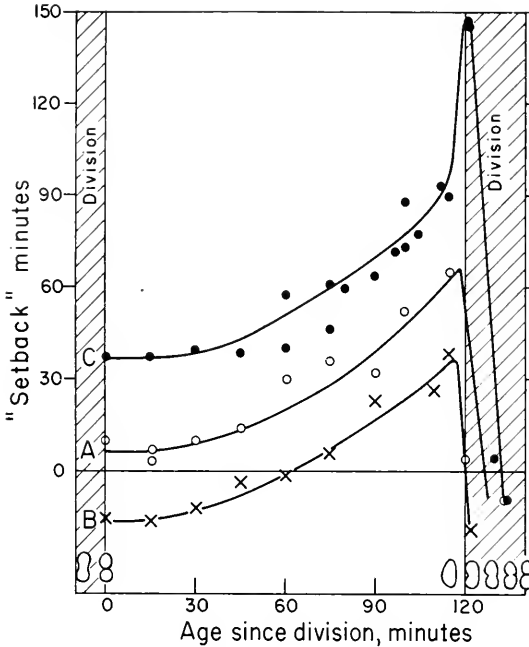

Figure 9. Tetrahymena single cells of varying age are exposed to temperature shocks. A: Exposed to 9.3° C. for 30 minutes. B: Exposed to 31.1° C. for 20 minutes. C: Exposed to 34.0° C. for 15 minutes. The growth temperature is 28.5° C. The figure shows the setback in time of division as a function of the age of the cell when exposed to the shock. During a temperature shock a cell may continue to advance toward division, or remain blocked, or may suffer a setback in time. In the first case, the cell is closer to division after than before the shock, and readings will be below the zero line in the figure. In the second case, readings will be on the zero line; and in the third case, the cell is farther away from the next division after than before the shock and the readings are above the zero line. (From Thormar, 1959.)

slowly through division at the new temperature. In the logarithmic mass population, cells of all ages are present in statistical numbers. When the population is hit by a temperature shock, the older cells lose enough time to be grouped with younger cells, so that after a lag many cells go through division together. And this is so whether the population is hit by a temperature increase or by a temperature decrease. It would seem that synchronization could possibly be worked out on many temperature schemes. Empirically we have found that the schedule already mentioned is the best.

To Scherbaum (1957a) and to Thormar (1956, 1959, 1961) the temperature setbacks reflect inactivation of a single enzyme. Its reactivation occurs in a standard time at 28° C. and is responsible for

the observed division synchrony. Some of Thormar's evidence (1959) suggests that high activation energies are or may be involved in the damage by heat. The following more general considerations are compatible with, and almost invited by, the observations presented. It is clear that whenever we change the temperature in a growing biological system, the rates of a great number of chemical reactions change. Each reaction has its own temperature increment. The relative concentrations of a great number of low-molecular intermediaries must change, and the relative rates of formation of various more permanent macromolecular products may change. It is only because the biological system is capable of a great deal of counterregulation that the Tetrahymena cell remains Tetrahymena at all temperatures from almost zero up to 33 or 34° C.—the upper limit for viability in our strain. That this counter-regulation, or adaptation, is incomplete at the highest temperatures is apparent from some of the information already given (Figure 8). That it is *never* complete is suggested by the observations, also by Thormar (1956), listed in Table I. In the whole biotic range the size of the cells is a function of the growth temperature, in this as in many other organisms. This suggests that a balance between two metabolic patterns (Hamburger and Zeuthen, 1957; Thormar, 1961), of which the one supports general growth, the other division, depends on the temperature. At the optimum temperature for population growth (28-29° C.) it is shifted maximally toward division. At this temperature there is less growth between divisions than at any other temperature. Above 33° C. and at low temperatures the balance is shifted far to the opposite side: at 34.1° C., say, preparation for division is never successful.

Holz, Scherbaum, and Williams (1957) synchronized the thermo-

TABLE I

Relative Volumes of *Tetrahymena pyriformis* Grown for Five Generations at the Temperatures Indicated. Fixation Just Prior to Division. (Thormar, 1956).

Temperature (centigrade)	Volume
32.0	152
29.2	109
26.4	100
22.7	98
19.3	110
15.4	118
10.6	132

philic and micronucleate mating type I, variety I. This strain requires five alternate exposures to 42.6° and 35° C. The cycling heat catches the cells in the formation of the second mouth. The necessary multiplication of the kinetosomes of this region occurs during the cycling heat, but the organization of the kinetosomes into a new mouth is blocked. The micronucleus is caught in the mitotic anaphase. It is only 40 to 50 minutes after the return to constant 35° C. that the micronuclear division and the stomatogenesis are resumed. The first cell division occurs after 50 to 60 minutes at 35° C.; the second comes 65 to 75 minutes later. So, after the heat (42.6° C.), the cells spend perhaps 75 per cent of the time before maximum division in preparing the kinetic phases of the later cell division. The guess can be made (see also Holz *et al.*, 1957) that the cycling temperature blocks or severely slows the formation of specific proteins which play their part in division by supplying, or conditioning the operation of, the kinetic machinery.

Biochemical mechanisms in the induction of division synchrony

When the large synchronized cells are returned from the last temperature shock to constant temperature conditions, we can assume that the division-promoting metabolic pattern is maximally disorganized. We can expect to interfere either with its reorganization or with new products formed by its activity if we let the cells recover in the presence of defined metabolic antagonists. If the normal counterpart of a metabolic analogue is involved in the preparation of the first synchronous division, then this division will be delayed.

For the present studies we synchronize strain GL the standard way. The cells are then transferred by three washings to an inorganic medium. An extra heat shock is applied so that we can operate from the very moment when the temperature is returned to constant 28° C. and up to the time of the first division maximum. Parallel samples are removed at intervals for incubation at 28° C. or, more simply, at room temperature. To one or more samples an anti-metabolite is added; one sample is kept as a control. The samples are inspected at intervals for the percentage of cells in stages of cytokinesis. Curves through the estimated points allow us to fix in time the point of maximum division activity with an accuracy of about ± 3 minutes. Possible differences between the control and a sample which is incubated with a drug is a measure of the division-delaying effect of the anti-metabolite. Thirty or more samples are easily handled in one day. In this study we consider differences of more than ten minutes between samples significant.

The synchronized cells are exceedingly sensitive to the presence of analogues to amino acids. Figures 10 and 11 illustrate an experiment

in which the washed cells are incubated at various times with DL p-fluorophenylalanine in concentrations which cover a range of 10,000 (5.5×10^{-8} to 5.5×10^{-4} M). Figure 10 shows the division maxima as

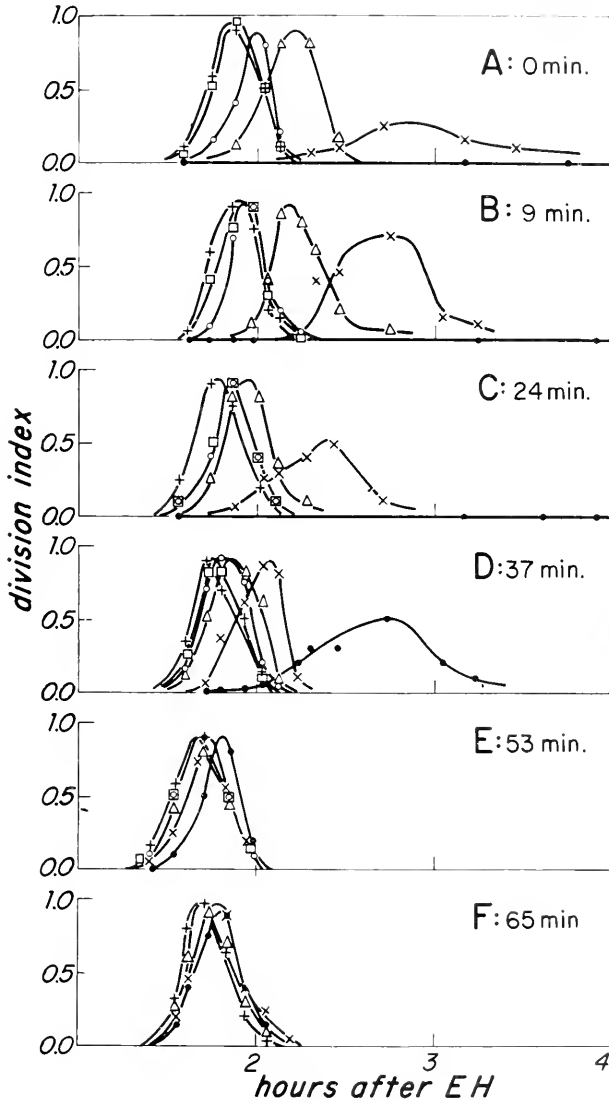

Figure 10. Delays of the first synchronous division (washed cells) by p-fluorophenylalanine. In the strongest concentration, 5.5×10^{-4} M (\bullet), there is no division when the continuous exposure starts at 0, 9, or 24 minutes after E.H. There is delay when the exposure begins at 37 minutes, but no delay when the cells are exposed at 53 and 65 minutes after E.H. The other concentrations are 5.5×10^{-5} M (\times); 5.5×10^{-6} M (Δ); 5.5×10^{-7} M (\circ); 5.5×10^{-8} M (\square). The controls are marked +.

they develop and again disappear in the controls (+) and in the samples with the drug. The first samples (A) are incubated at the time when the last temperature shock ends. The last samples (F) are incubated at 67 minutes. These F-cells, in other words, are exposed during the last 33 minutes before maximum division takes place (at 100 minutes) in the last control. The later the samples are removed, the earlier the controls divide. This is simply because the bottle is incubated at 28° C., whereas the samples are incubated and inspected at room temperature. Samples E and F are both incubated after a critical point. Even the strongest concentrations of the drug are without effect. This is more clearly seen when the delays relative to the controls are plotted as in Figure 11. The time from E.H. to maximum division varies some from one experiment to another. Following Plesner (1961, in press), we assign to it the value 100, so that we can refer events in the cells' time to a scale which goes from 0 (E.H.) to 100 (division).

The effect of the drug depends on its concentration and on how early it is added. When it is added after 50 to 60 time units, the cells go through the first division without delay, but they do not divide again. The blocked cells are viable for at least 24 hours in the drug. These results strongly suggest that the synchronized cells, in order later to divide, must perform a certain amount of protein synthesis. This takes them beyond a critical point, after which they divide in standard time. The washed cells depend either on the presence of free intracellular amino acids or on simultaneous breakdown of their own proteins for new synthesis. In cells which remain in the proteose-peptone during the synchronous division, higher concentrations of p-fluorophenylalanine are required to delay division. However, with such concentrations (8×10^{-3} M), the cycle of sensitivity from E.H. to the first

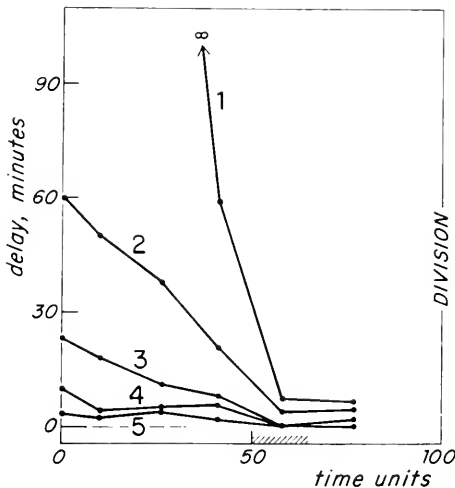
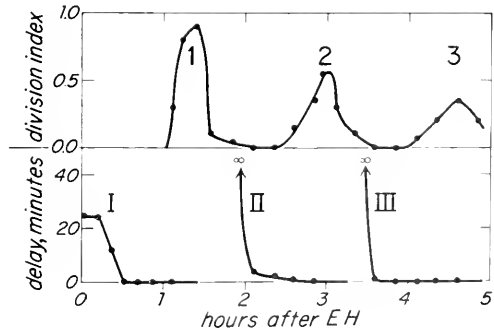

Figure 11. Another plot of the same experiments as in Figure 10. The successive concentrations of the drug from 1 to 5 are: 5.5×10^{-4} M, 5.5×10^{-5} M, 5.5×10^{-6} M, 5.5×10^{-7} M, and 5.5×10^{-8} M. The delay in division (ordinate) is plotted against the time of immersion in the drug. The drug is without effect after a critical point around 50 time units.

division can be seen to repeat itself from division one to two, and from division two to three (Figure 12). Thus the synchronous divisions two and three are conditioned by the synthesis of proteins, perhaps before, but at least during and shortly after, the previous division. Figure 12 strongly suggests it is the tail of this synthesis that is blocked by the cycling temperature. Experiments with short-time exposures to p-fluorophenylalanine clearly indicate that the conditioning of a division begins as early as around the time when the cell has passed the critical phase before the previous division. This is our best evidence—and it seems strong—that we are not simply faced with variations in the permeability of the cell. The analogue p-fluorophenylalanine is completely antagonized by phenylalanine, only incompletely by tyrosine.

There is, or may be, a block for the growth of the whole cell in every period when the cell conditions itself for a following division—that is, immediately after E.H. and before, during, and after a division (*cf.* Figure 13, from Hamburger and Zeuthen, 1960). The possibility clearly exists that the limited protein synthesis which conditions division is separate from other syntheses by which the cell lays down its bulk proteins. In *Tetrahymena* the microsomes and the “mitochondria” (the latter fraction includes all particles other than the microsomes) are separate protein synthesizers, according to Mager and Lipmann (1958) and Mager (1960). The kinetosomes, too, are capable of protein synthesis (Seamann, 1960).

Figure 12. Delay of synchronous divisions 1, 2, and 3 by DL p-fluorophenylalanine at 8×10^{-3} M. The cells are synchronized in and remain in medium C (*cf.* Figure 4). The upper curve gives the division index in the main control. The lower curves, I, II, and III, give the delays of divisions 1, 2, and 3 when immersion in the drug is at the times indicated by the points. Incubation immediately after E.H. delays division 1. Incubation during and after division 1 blocks division 2, and incubation during and after division 2 blocks division 3. In the drug, the cells never perform more than one division.



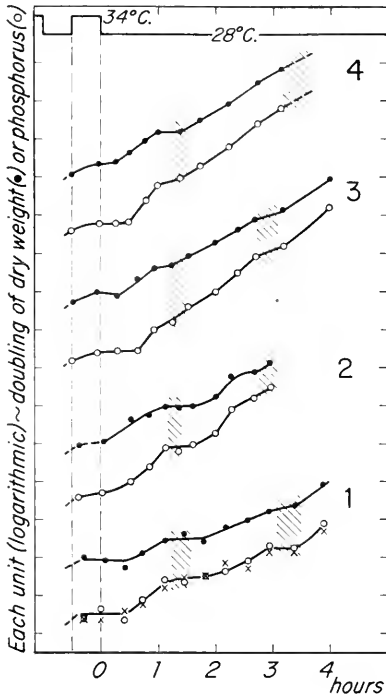

Figure 13. Synchronous cells produced by the standard procedure (*cf.* text for Figure 1). Growth in the broth is periodic for dry weight and for phosphorus. During the cycling temperature the cells suffered a loss of 20 to 25 per cent in the ratio of phosphorus to dry weight. The percentage loss was identical for all fractions. This figure shows that correction after E.H. is gradual through several division cycles. (From Hamburger and Zeuthen, 1960.)

If the washed synchronized cells are exposed to a new temperature shock before 50 to 60 time units, the system becomes resensitized to amino-acid analogues (ethionine, thienylalanine, p-fluorophenylalanine). This is a direct demonstration that heat induces the need for the new synthesis of protein which, at 28° C., conditions a later division. Heat will reduce the rate of incorporation of labeled histidine, showing that it acts by reducing the rate of synthesis without necessarily increasing the rate of hydrolysis of proteins.

In protein synthesis, nucleic acids and low-molecular co-factors are required. RNA'se (Sigma) in high concentrations (100 $\mu\text{g}/\text{ml}$, boiled) is a strong inhibitor of cell division in the washed cells. There is at present no evidence from experiments with anti-metabolites that the cycling heat produces such damage to or causes such shortage of any of the nucleic acids that repair or new synthesis is required before division can take place: Certain drugs used—azathymine (5×10^{-4} M), 5-bromouracil ($0.3 - 16 \times 10^{-4}$ M), 5-fluoro-2'-desoxyuridine ($0.25 - 3.8 \times 10^{-4}$ M), a-denopterin ($6 - 13 \times 10^{-4}$ M), 5-fluorouracil ($20 - 4 - 0.8 \times 10^{-4}$ M)—did not have significant delaying effects on the first synchronous division when they were added to the washed cells immediately after E.H. or later (see Figure 14). Later experiments in

this laboratory by Dr. G. G. Holz Jr. showed that of the five substances mentioned the three latter are strong inhibitors of logarithmic growth in a chemically defined medium.

On the level of the co-factors the system is strongly influenced by the cycling heat, as first demonstrated by Plesner (1956, 1958a, 1958b). At the end of the last temperature shock the contents by dry weight of ATP and GTP in *Tetrahymena* are much increased relative to what is observed in the logarithmic cell (see Table II). This is partly reversed at the time of the first synchronous division. Immediately before the division there is a transitory and impressive rise in the concentration of nucleoside triphosphate (Plesner, 1958, a, b).

Some drugs, namely 6-methylpurine and 8-azaguanine, do delay division if they are added before 50 time units (see Figure 14). We shall discuss the results on the basis of the suggestion that in our system these anti-metabolites interfere with the co-factors containing adenine and guanine. The bulky literature on 8-azaguanine (Chantrenne, 1958; Mandel and Markham, 1958; Way and Parks, 1958) is rather in support of this view. If the cells are incubated with 6-methylpurine before 50 time units, then the first synchronous division is blocked or delayed. If incubation is later, then the drug delays or blocks only the later divisions. In the course of 24 hours, stronger concentrations of 6-methyl-

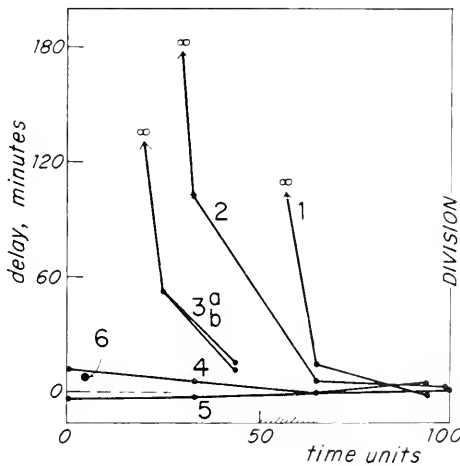

Figure 14. Delay of the first synchronous division in washed cells by

- (1) 8-azaguanine 3.5×10^{-4} M
- (2) 8-azaguanine 0.7×10^{-4} M
- (3a) 8-azaguanine 4.0×10^{-4} M
- (3b) 6-methylpurine 1.6×10^{-3} M
- (4) 5-fluoro-2'-desoxyuridine 4.0×10^{-4} M
- (5) a-denopterin 1.3×10^{-4} M
- (6) 5-bromouracil 1.6×10^{-3} M

The exposure to a drug is continuous from the time indicated by a point.

TABLE II
Relative Amounts of Nucleotides in the Cell Before and
After Heat Shock^a

	1 ^a	2 ^b	3 ^c
ATP	8	31	25
GTP	7	79	32

^a These amounts were determined by chromatography of norite eluates of acetone powder extracts (Plesner, 1956, 1958a, 1958b, and personal communication, 1958); all values are for identical dry weights.

^a Logarithmic-phase population.

^b At the time of completion of the last synchronizing heat shock.

^c Immediately after the first synchronous division.

purine are killing. The killing, blocking, or delaying effects are antagonized fully by adenine, to a lesser extent by adenosine, and hardly at all by adenylic acid. Guanine antagonizes 6-methylpurine, but less effectively than adenine does. Guanosine and guanylic acid are poor releasers. In *Tetrahymena*, guanine is readily transformed into adenine, but the reverse is not possible (Kidder and Dewey, 1948; Flavin and Graff, 1951), so we conclude that 6-methylpurine antagonizes adenine. Sometimes 8-azaguanine delays the first synchronous division, but only if it is added before 50 time units, as we have seen; this drug is antagonized by guanine, guanosine, guanylic acid, and by the corresponding adenine compounds. The desoxyribosides also are effective. The cells can be sensitized to 8-azaguanine by heat (6-methylpurine was not studied).

Interpretations

A population of *Tetrahymena* cells can be induced to undergo one or more synchronous divisions in a constant temperature environment if first it is exposed to a series of temperature shocks. A shock is defined as a relatively short period of stay at a temperature different from the growth temperature (28° C.). Cold and heat shocks have similar effects, only the latter seems slightly more effective (Zeuthen & Scherbaum, 1954). For that reason they are applied in the standard synchronization procedure. Qualitatively, a single heat shock does the same as a series of shocks. The series only induces sharper synchrony.

Studies in which single cells from the logarithmic growth phase are exposed to single temperature shocks (Thormar, 1959) led to the view (*cf.* review by Zeuthen, 1958) that the temperature shocks disturb equilibrium reactions which the cell pushes in one direction as it

goes from one division to the next. As a result there is a piling up of products to be used in later division. The temperature shocks thus far studied all represent changes from an optimum growth temperature (28° C.) to higher and to lower temperatures. As far as the simple measurement of time can tell us, all shocks tend to undo some preparation which the cell has previously made toward a division. Thus, it is argued, the shocks push the equilibrium reactions back, thereby counteracting the continuous piling up of products essential for division, or even reducing in amounts such products present at the time when the shock is initiated. A cell, when exposed to a temperature shock, therefore becomes set back in biological time which is measured on a scale which goes from division to division. Figures 7, 8, and 9 are selected to illustrate these points. Figure 8 shows that partial or complete adaptation to the shock temperature may take place during an extended shock: the cell is first set back, but it may again push toward division. It is part of the views developed that division and temperature shocks have similar effects, in the sense that the cell needs a long time to recover from both events before it can divide again. During this recovery it changes from a state when it cannot be set back by a temperature shock, to a state when it can be maximally set back, in all cases to a very early time-point of its recovery from either division or the previous temperature shock. Synchrony is induced because in a mass population a heat shock, or (better) a series of shocks, pushes all cells back to a common biological time. In the paper this aspect is dealt with under the heading "Physiological Mechanisms."

Any suggestion concerning biochemical or biophysical mechanisms in the induction of the division synchrony must take into account the closely similar physiological response to cold and to heat. It must also touch upon the strikingly continuous changes in the response of the cells to a temperature change, both when the age of the cell is varied and when the temperature of the shock is selected over a wide range. It is for these reasons that the present account stresses the word "balance" and avoids the term "denaturation." The analysis with amino-acid analogues and with base analogues point toward an absolute or relative deficiency of the newly synchronized cells with respect to proteins essential for division. If the normal preparation for division, from division to division, requires that various proteins are synthesized in accurate balances, then one could visualize that temperature shocks change this balance—in a different way depending on the nature of the shock, but with the common result that recovery by more protein synthesis must take place in a constant temperature environment.

The suggested temperature effects on the balance of proteins might be primary effects or they might be secondary to temperature effects on many levels. We need not necessarily suggest thermal inactivation

of enzymes. Another possible suggestion, in fact made before (Zeuthen, 1958), is focused around the suggestion that the products which pile up from division to division, and thereby condition division, are structurally complex, hydrogen-bonded, and in their folding very sensitive to temperature changes. Heat or cold might make a developing structure useless by different physical mechanisms: cold might cause overfolding and heat might disrupt enough weak bonds to make a structure useless forever, or for some time. But heat and cold might also work on separate structures, both of which are essential in cell division. Before a synchronous division there is a rather critical time-point when the addition of p-fluorophenylalanine, 6-methylpurine, and 8-azaguanine no longer stops or delays division. We have assumed that these agents interfere with protein synthesis and that they do so rather immediately. The critical time-point therefore signals completion of protein synthesis in preparation for the following division.

We have recently observed that in the synchronized cell there is a sharp drop in sensitivity to heat shocks around the same critical point at which the cells cease to be sensitive to the three analogues. In our laboratory this has been confirmed by Dr. Joseph Frankel, who has also found that the sensitivity to cold shocks (8° C., 40 minutes) follows the same time pattern. It is an obvious possibility that at the critical point two macromolecules, of which at least one is a protein, combine. For this reaction to take place, the structural configuration of both molecules is critical. The coiling or folding of both may be sharp functions of temperature only with different transition points (*i.e.*, from folded to unfolded) on the temperature scale. At increased temperature the one partner is unsuitably unfolded; at decreased temperature the other is too folded. In both cases reaction between the two is inhibited. The combined molecule is insensitive to temperature changes, thus structurally far more stable than the two molecules from which it is composed. It conditions the later division and first visibly expresses itself by causing oriented movements of the kinetosomes at the level of the new mouth. At division it would dissociate, otherwise dissolve, or become incorporated in the structure of the new cells.

References

- Chantrenne, H., 1958. "Nucleic-Acid Metabolism and Induced Enzyme Formation," *Recueil des Trav. Chim. des Pays-Bas* 77, 586.
- Christensson, E., 1959. "Changes in Free Amino Acids and Proteins During Cell Growth and Synchronous Division in Mass Cultures of *Tetrahymena pyriformis*," *Acta Physiol. Scand.* 45, 339.
- Flavin, M., and Graff, S., 1951. "Utilization of Guanine for Nucleic Acid Biosynthesis by *Tetrahymena geleii*," *J. Biol. Chem.* 191, 55.
- Hamburger, K., and Zeuthen, E., 1957. "Synchronous Divisions in *Tetrahymena*

- pyriformis* as Studied in an Inorganic Medium. The Effect of 2,4-Dinitrophenol," *Exp. Cell Res.* 13, 443.
- Hamburger, K., and Zeuthen, E., 1960. "Some Characteristics of Growth in Normal and Synchronized Populations of *Tetrahymena pyriformis*," *Compt. Rend. Lab. Carlsberg* (in press).
- Holz, G. G., Jr., 1960. "Structural and Functional Changes in a Generation of *Tetrahymena*," *Biol. Bull.* 118, 84.
- Holz, G. G., Scherbaum, O. H., and Williams, N., 1957. "The Arrest of Mitosis and Stomatogenesis during Temperature-Induction of Synchronous Division in *Tetrahymena pyriformis*, Mating Type I, Variety I," *Exp. Cell Res.* 13, 618.
- Iverson, R. M., and Giese, A. C., 1957. "Nucleic Acid Content and Ultraviolet Susceptibility of *Tetrahymena pyriformis*," *Exp. Cell Res.* 13, 213.
- Kidder, G. W., and Dewey, V. C., 1948. "Studies on the Biochemistry of *Tetrahymena*. The Activity of Natural Purines and Pyrimidines," *Proc. Nat. Acad. Sci.* 34, 566.
- Mager, J., 1960. "Chloramphenicol and Chlortetracycline Inhibition of Amino Acid Incorporation into Proteins in a Cell-Free System from *Tetrahymena pyriformis*," *Biochim. Biophys. Acta* 38, 150.
- Mager, J., and Lipmann, F., 1958. "Amino Acid Incorporation and the Reversion of its Initial Phase with Cell-Free *Tetrahymena* Preparations," *Proc. Nat. Acad. Sci.* 44, 45.
- Mandel, H. G., and Markham, R., 1958. "The Effects of 8-Azaguanine on the Biosynthesis of Ribonucleic Acid in *Bacillus cereus*," *Biochem. J.* 69, 297.
- Plesner, P. E., 1956. "Incorporation of ^{32}P into the Purine Ribonucleotides of *Tetrahymena pyriformis* in Heat-Treated Cultures," *Acta Chem. Scand.* 10, 161.
- Plesner, P. E., 1958a. "Content of Nucleoside Triphosphates during the Division Cycle in *Tetrahymena pyriformis*," in *Supplement to International Abstracts of Biological Sciences*, Fourth International Congress of Biochemistry, Vienna (London, Pergamon Press).
- Plesner, P. E., 1958b. "The Nucleoside Triphosphate Content of *Tetrahymena pyriformis* during the Division Cycle in Synchronously Dividing Mass Cultures," *Biochim. Biophys. Acta* 29, 462.
- Plesner, P. E., 1961. "Nucleotide Metabolism during Synchronized Cell Division in *Tetrahymena pyriformis*," *Compt. Rend. Lab. Carlsberg* (in press).
- Scherbaum, O., 1957a. "Studies on the Mechanism of Synchronous Cell Division in *Tetrahymena pyriformis*," *Exp. Cell Res.* 13, 11.
- Scherbaum, O., 1957b. "The Content and Composition of Nucleic Acids in Normal and Synchronously Dividing Mass Cultures of *Tetrahymena pyriformis*," *Exp. Cell Res.* 13, 24.
- Scherbaum, O. H., Louderback, A. L., and Jahn, T. L., 1959. "DNA Synthesis, Phosphate Content and Growth in Mass and Volume in Synchronously Dividing Cells," *Exp. Cell Res.* 18, 150.
- Scherbaum, O., and Zeuthen, E., 1954. "Induction of Synchronous Cell Division in Mass Cultures of *Tetrahymena pyriformis*," *Exp. Cell Res.* 6, 221.
- Scherbaum, O., and Zeuthen, E., 1955. "Temperature-Induced Synchronous Divisions in the Ciliate Protozoon *Tetrahymena pyriformis* Growing in Synthetic and Proteose-Peptide Media," *Exp. Cell Res. Suppl.* 3, 312.
- Seamann, G. R., 1960. "Large-Scale Isolation of Kinetosomes from the Ciliate Protozoon *Tetrahymena pyriformis*," *Exp. Cell Res.* 21, 292.
- Thormar, H., 1956. "Temperaturens og temperaturændringers indflydelse på

- celleformering og cellevækst hos ciliaten *Tetrahymena pyriformis*," paper submitted to the Faculty of Science, University of Copenhagen.
- Thormar, H., 1959. "Delayed Division in *Tetrahymena pyriformis* Induced by Temperature changes," *Compt. Rend. Lab. Carlsberg* 31, 207.
- Thormar, H., 1961. *Exp. Cell Res.* (in press).
- Way, J. L., and Parks, R. E., Jr., 1958. "Enzymatic Synthesis of 5'Phosphate Nucleotides of Purine Analogues," *J. Biol. Chem.* 231, 467.
- Zeuthen, E., 1958. "Artificial and Induced Periodicity in Living Cells," *Adv. Biol. Med. Physics* VI, 37.
- Zeuthen, E., and Scherbaum, O., 1954. "Synchronous Divisions in Mass Cultures of the Ciliate protozoon *Tetrahymena pyriformis*, as Induced by Temperature Changes," in Kitching, J. A., ed., *Recent Developments in Cell Physiology* (N. Y., Academic Press).

THE PLAN OF CELLULAR REPRODUCTION*

Daniel Mazia

UNIVERSITY OF CALIFORNIA, BERKELEY

A cell is at once the most perishable and the most enduring of natural objects. As an individual, its allotment of time may be much shorter than that of a mountain or a continent, but its character merges with a future and a past which may be very long even when measured by the geologists' time scales. The secret of biological immortality, which provides not merely for survival but also for evolution, is not the durability of the substances on which it is based, but rather the ability of organized living units, of which the simplest is the cell, to recreate their characteristic structure and composition more rapidly than the dumb forces of thermodynamics can destroy them.

With high fidelity, cells can reproduce their characteristic kinds of molecules, can reproduce strange molecules which are introduced to them as infectious entities, and, above all, can reproduce themselves. I define the reproduction of a cell as a qualitatively precise doubling—a cycle beginning with a cell of a given kind and ending with two which are identical to the original. The completion of a full reproductive cycle, archetypically at least, must include both division and growth. In practice these are separated in time; the daughters of a division grow and then divide. As we shall see, the period of growth includes events which are prerequisite to division, and division refreshes the capacity for growth.

* *The author's own researches on this subject have been supported for various periods by the American Cancer Society, the University of California Cancer Research Coordinating Committee, the Office of Naval Research, and the National Institutes of Health. He has had the benefit of discussions with many of those who have built our present knowledge of the cell cycle, notably Dr. Erik Zeuthen and Dr. J. M. Mitchison.*

Theoretically this is not the only possible meaning of reproduction. We may imagine, for instance, that a cell will replace in a precise way all of its molecules, so that one "old" cell gives rise to one "new" one. Indeed, such a thought is implicit in the somewhat unclear concept of the "dynamic state" of cell constituents. If a cell were perfectly dynamic in this sense, we might expect that it could survive indefinitely as an individual, without dividing. In practice, we know that "turnover" is quite variable. Some kinds of molecules, such as the DNA of the primary genetic material, are thought to turn over very little (*e.g.*, Brachet, 1957, p. 228), although reasons for suspecting a degree of turnover of genetic substances have been developed recently (*e.g.*, Ryan, 1959). In other cases, such as the proteins, the intensity of turnover seems to vary greatly with functional circumstances.

Schemes of reproduction

We can imagine at least two general schemes for the reproduction of a system composed of many elements. In one of these, which I shall call a *fission* model, every element has the power of self-replication and is directly involved in the making of copies of itself; the copies have the same powers of self-reproduction as the original; and changes are propagated in future generations of copies. Such a model may be represented simply by

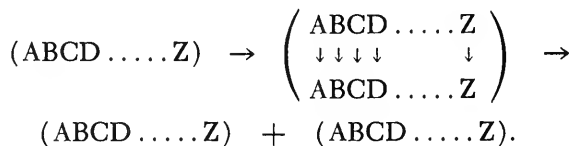

The capital letters symbolize all of the elements of the system possessing specificity. Each produces a copy of itself, and when all the copies are made, the two sets cleave to produce two independent systems.

At the other extreme is what we may call a *generative* scheme of reproduction, in which only one or a few elements of the system are capable of self-reproduction, and these direct the assembly of a second system:

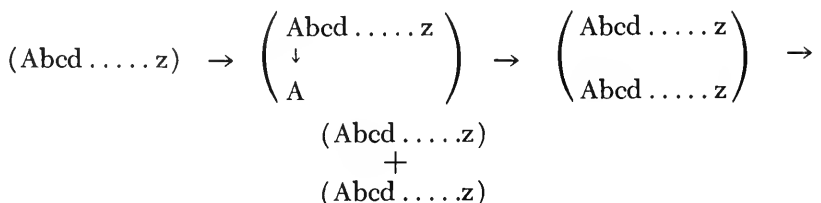

In this case, only *A* is self-reproducing, and it contains the information necessary for the generation of elements *b* to *z*.

It is easy enough to understand why the reproduction of a plant or animal is a generative process. It would be grotesquely complicated for all of the molecular elements of a human being to replicate and sort themselves out into two human beings. The mysteries of the actual process whereby the chromosomes reproduce themselves, some going into gametes which in turn generate new complete individuals, seem simple by comparison. In any event, that is the way the reproduction of very complex systems goes: by a sequence of conception, development, and parturition. In cell reproduction, the replication of the genetic system provides the conditions for doubling the cytoplasm, after division, which in turn makes further division possible (Figure 1). The whole cycle contains the elements of conception, development, and parturition. A complete bacteriophage particle reproduces generatively; its DNA replicates itself and directs the synthesis and assembly of the protein constituents of the "soma" of the virus particles, these not being produced by self-replication.

The only examples of replication by a fission process that we can cite involve the replication of molecules, nucleic acids, or nucleoproteins. It is conceivable that the fission scheme is restricted to molecular dimensions. If not, we must discover a mechanism of coding in two or three dimensions (Danielli, 1958) to supplement the contemporary ideas about coding through one-dimensional sequences. If generative reproduction prevails at all levels higher than the ultimate molecular sources of information, we may not need to face such coding problems, substituting for them problems of directed synthesis and assembly.

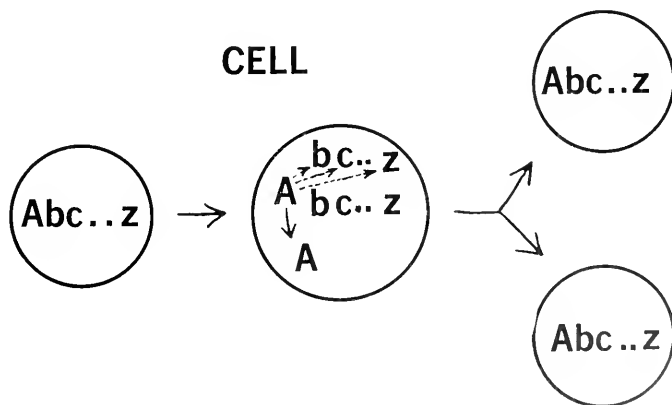

Figure 1. The scheme of cell reproduction, viewed as a form of generative reproduction. The genetic material (*A*) directs the production of the various cell constituents *b z* and also reproduces itself.

Reproductive events of the cell cycle

We are sure of the existence of one set of events in the reproductive cycle of the cell that involves genuine self-replication—the reproduction of the genetic elements of the chromosomes. For the present, let us assume that this is primarily the replication of DNA; if this is a mere hypothesis, it is surely one of the most stimulating hypotheses in the history of biology. In higher organisms, at least, the genetic operations are carried out by chromosomes, which are complex and contain a good deal more than DNA. We shall have to consider the character of the reproduction of the chromosome as a whole.

A second example of self-reproduction in the cell cycle is the multiplication of centrioles. This clearly is essential for the reproduction of animal cells, many protozoan cells, and some lower plants. I shall not discuss the controversy about the presence of centrioles or their functional equivalents in higher plants, having dealt with it at length in another place (Mazia, 1961). Suffice it to mention that many of the phenomena attributed to the centrioles in animal cells are also observed in the division of plant cells, but the corresponding physical particles have yet to be observed in plant cells.

Present-day theory about cell reproduction in general does not *require* any other self-reproducing elements. Additional elements meeting some or all of the specifications of self-reproducing particles are known—for example, plastids in plants and kinetosomes in flagellates and ciliates—and others have been invoked to account for special cases.

Reproduction of centrioles

The name first given to the centrioles by Van Beneden—“polar corpuscle”—describes their significance more vividly than the name that has come into common use. They are indeed the physical embodiments of the poles of mitosis, and mitosis would make no sense if it were not polarized. The centrioles define the destinations of the chromosomes when they move apart to form two separate daughter nuclei. The basic principle of mitosis is that sister chromosomes move to different centrioles, normally to sister centrioles, and never to the same one. If we add that the plane of mitotic division is exactly midway between the centrioles and exactly at right angles to the axis connecting the centrioles—and both of these generalizations are valid for normal division of animal cells—we can see that the existence of a “polar corpuscle” has a profound meaning for cell division. The idea of a “pole” in this context is richer than the physical abstraction to which we ordinarily apply the term, being represented by distinct particles having the

power of self-reproduction and moving in very regular paths after their reproduction.

That centrioles arise from pre-existing centrioles is a fact of observation. It was demonstrated a long time ago (Boveri, 1903) that the multiplication of centrioles may proceed in the absence of the nucleus. We are unable to apply one important criterion of self-reproduction—mutability—to the centrioles, because we can give no meaning, at present, to the mutation of a pole. The statement that centrioles are self-reproducing units is surely more than an interesting hypothesis.

Where the structure of centrioles has been resolved by electron microscopy, they appear as cylindrical bodies, about 1500 angstroms in diameter and 300 to 500 angstroms long, the "wall" of the cylinder being made up of nine groups of tubules, each tubule about 150 to 200 angstroms in diameter. This structural pattern has been observed in a variety of cells (summarized by Bernhard and deHarven, 1960), but much more complex structures may be associated with the centriolar function in other cases—the flagellates, for instance (Cleveland, 1957).

Here we have a genuine self-reproducing particle, large in relation to molecular dimensions but possessing a relatively simple structure so far as we can tell. In mitosis its function is to organize a pole, but here we may be seeing only one of its functions. There are good reasons for relating it to the kinetochores, and to the basal particles or kinetosomes of cilia and flagella and through the latter, to a variety of structural specializations of cells, such as those that have been detected in visual receptors. It would not be surprising if we were dealing with the archetype of the cytoplasmic self-reproducing particles which have so often been invoked in the theory of differentiation (*e.g.*, Lwoff, 1950).

Let us consider some of the reproductive habits of the centriole. One interesting finding of many microscopic observers is that it is generally a paired structure. The electron microscope supports this (Bernhard and deHarven, 1960). There are two centriolar units at each mitotic pole, and the reproduction might be described as a 2-4 doubling rather than a 1-2 doubling. This might mean that the double unit is actually required for the function of establishing a mitotic pole. Let me describe some recent experiments leading to quite a different interpretation.

Studies on the chemistry of the mitotic apparatus (Mazia, 1955) had suggested that sulfur bonding was important in its organization. It was predicted that an excess of -SH, introduced experimentally, would interfere with sulfur-bonding of the proteins forming the mitotic apparatus, and therefore would block division. The agent selected was mercaptoethanol, and the prediction was borne out. But it was also observed that if the cells—sea-urchin and sand-dollar eggs—were blocked at metaphase, were permitted to remain blocked in mercaptoethanol

for some time, and then were returned to a normal medium (sea water), they did not merely recover from the block but divided directly into four cells. Thus the blockage was not only reversible but appeared to yield a small profit. The superficial image of what was happening to bring about this four-way mitosis is shown in Figure 2. Here we see that the centers at each pole of the original mitotic figure split, and the

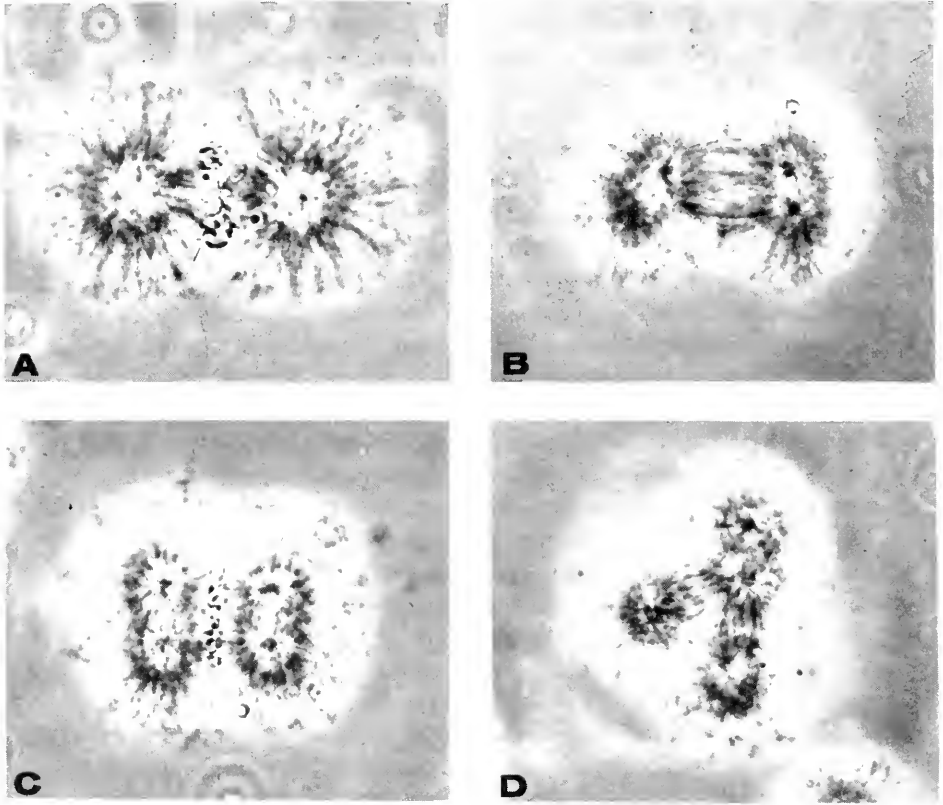

Figure 2. Formation of a 4-polar mitotic figure in sea-urchin eggs blocked at metaphase by mercaptoethanol. After various times in mercaptoethanol, the eggs were removed to sea water for ten minutes, then "fixed" for isolation of the mitotic apparatus. The figures showed isolated mitotic apparatus in phase contrast.

- A: 15 minutes in mercaptoethanol. No visible splitting of centers.
- B: 30 minutes in mercaptoethanol. Centers have begun to split.
- C: 45 minutes in mercaptoethanol. Four poles well defined. Chromosomes in metaphase plate.
- D: 60 minutes in mercaptoethanol. A fully developed tetrapolar figure, three poles in focus.

(After Mazia, Harris, and Bibring, 1960.)

units separated to form a four-pole mitotic figure. When the conditions for mitotic movement of the chromosomes were restored, the four-polar figure functioned to divide the cell into four.

The first interpretation of these observations was that the centrioles had undergone an extra replication in mercaptoethanol, while the chromosomes remained arrested at metaphase. But further observation showed dramatically that this was not the case. My colleague Thomas Bibring observed the further history of the cells produced by quadripartition and observed that when they first made a mitotic figure, the figure had only one pole (Figure 3B). Division with one pole is impossible, and so this mitotic cycle was abortive; the cells re-entered interphase, presumably completed another cycle of replication of the centers, and now entered mitosis the second time with two poles and divided normally. The interpretation is simple. These four cells, produced by the four-way mitosis, have received only the total number of centriolar units that ordinarily would have been passed on to two cells. Each had half the normal centriolar inheritance, and therefore could only make half a mitotic apparatus! The conclusion, therefore, is that the centers did not duplicate during the mercaptoethanol block. Rather, two units which already existed at each pole split apart and separated. Two poles composed of four potential poles were given a chance to form four actual poles.

From these observations we deduce: (1) that the doubleness of the centers is not actually required for their mitotic operation; (2) that the splitting and separation of the paired centers is quite a different process from the synthetic determination of new centers, the former being insensitive to mercaptoethanol; and (3) that the minimum requirement for obtaining the four actual poles from the two pairs of poles is the provision of time. That is, we need not suppose that the mercaptoethanol block served any function other than to arrest the division while the development and splitting of the centers proceeded.

If these deductions are correct, they lead to the conclusion that the over-all reproduction of the centrioles is a generative kind of reproduction (Figure 3A). We imagine that the first event, an event which involves genuine molecular replication and may be designated as the *conception* of a new center, gives rise to a unit which is not a functional center but is capable of developing into one. This event may be inhibited by mercaptoethanol, but once it has taken place, the further development has different properties and is no longer so inhibited. The time lapse between the conception of a unit and its parturition (that is, its becoming able to function independently) is that required for the development of the daughter unit; the relation between the products of the reproduction is not that of sisters but of mother and daugh-

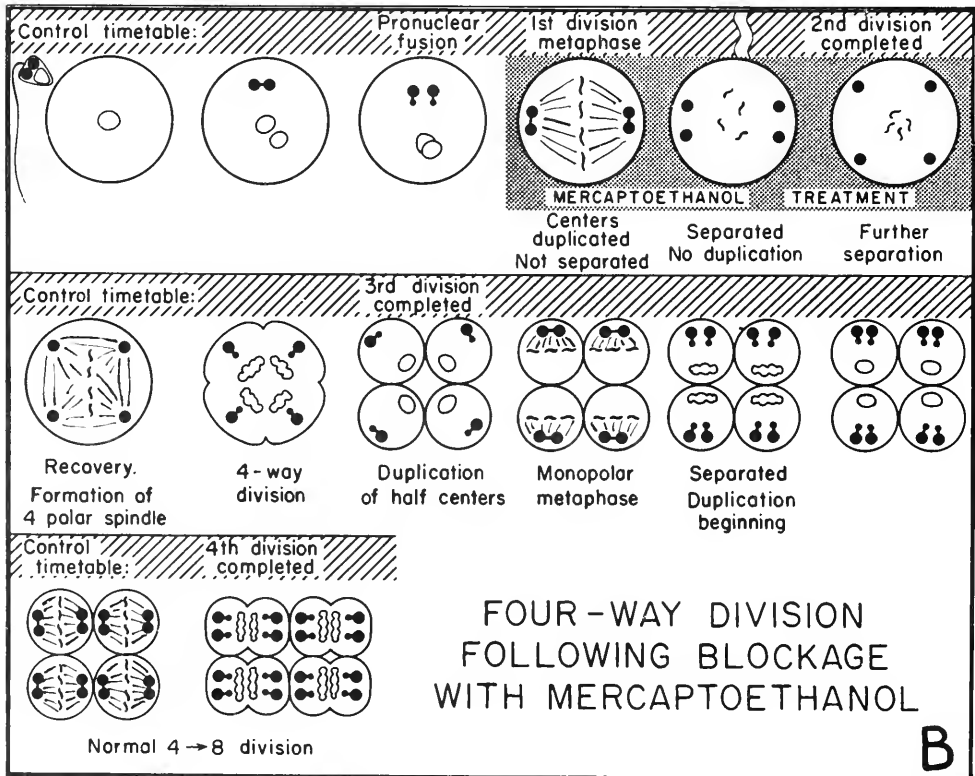
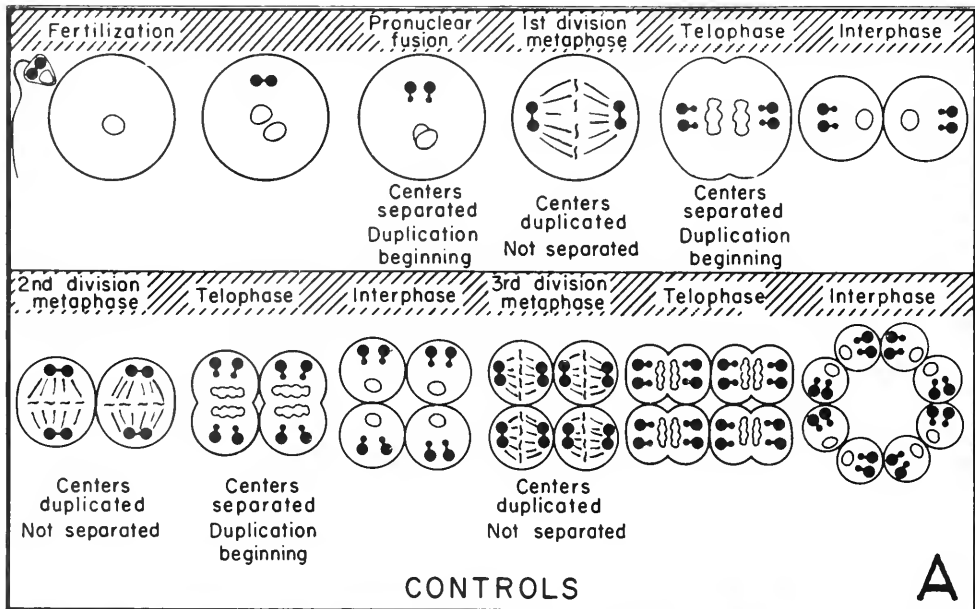

ter. This generative model explains the normal twoness of the centrioles, which, as we have seen, does not appear to be a necessity for forming a pole. The explanation is simple and familiar: If reproduction proceeds generatively, and there is a period of development between conception, parturition, and the next conception, obviously at least two generations have to be in existence simultaneously. This is one way to explain structures which are consistently double. All that was done in the quadripartition experiment was to suspend the operations of the older generation while the newer one grew and could operate.

It is implied that only a small part of the centriole is capable of self-replication—that its replication plants the “seed” for the assembly of a second unit. Admittedly such a differentiation has not been observed in the structure of the centriole, but it has been observed (microscopic observations of Cleveland, 1957; Bernhard and deHarven, 1960; and the remarkable conclusion by Heidenhain, 1907, that the centrioles reproduce by “budding”) that centrioles do *not* undergo binary fission but do give rise to “baby” daughters. In molecular terms, the question would focus on the presence and distribution of nucleic acids, if we feel compelled to associate reproduction with nucleic acids. There are scattered observations of staining of the centers for nucleic acids in the literature. In our laboratory we have tried every way we could find to demonstrate that the self-reproducing centers were foci of nucleic-acid activity by means of staining methods and by autoradiography employing a variety of tritiated precursors of high specific activity. So far as sea-urchin eggs are concerned, the results have been negative so far. But the centriole is a rather simple structure, and we need not imagine that it calls for much structural information. It can be imagined that only a few nucleic-acid molecules are involved in the replicative events of the conception of a new center, that most of what we see with the microscope is the “soma” that has developed from this seed.

So far as the reproductive plan of the cell as a whole is concerned, it is of interest to consider the timing of the events in the reproduction

Figure 3. (See opposite page.) A. A diagrammatic representation of the generative reproduction of centrioles. Bars connecting the units imply that the daughter units have not yet split away from the parent units. Chromosomes are shown only to identify the stages, and the figure is not meant to represent the reproductive cycle of the chromosomes as discussed in the text.

B. An interpretation of the experiments discussed in the text. The diagrams show the behavior of the centers during blockage, the four-way division after removal of the block, the following monopolar mitosis, and the bipolar mitosis resulting in the division of the four cells to eight.

(After Mazia, Harris, and Bibring, 1960.)

of the centers, for we shall have to fit this into our timetable of the cell cycle. The details of the experiments have been published (Mazia, Harris, and Bibring, 1960), and I need only consider the essential experimental designs and the conclusions. In the quadripartition experiments on sea-urchin and sand-dollar eggs, we interpreted the four-way mitosis as indicating that four potential centers were already in existence at metaphase. We also interpreted the events following four-way division as suggesting that mercaptoethanol blocked the conception of new potential centers. If these interpretations are correct, then we should be able to find a time before metaphase at which blockage would be followed not by four-way division but by two-way division—a time when the new units have not yet been conceived. With this experimental design we were able to show that the conception of new centers takes place at about the time of anaphase or telophase. That is, the conception of new centers for the next division is taking place during later stages of the previous division. In fact, this is the earliest event we can assign to a given division.

We can also, using the same experimental system, establish the time when the daughter centers become capable of splitting from their parents and forming poles. Essentially, the experiment is given by Figure 2, where we see that after a certain time following metaphase, the double units at the poles of the blocked cell begin to split apart. Interestingly enough, the time is about the same as the time of conception of the new centers, and this conclusion is included in the general reproductive scheme shown in Figure 3A. Normally, new centers are conceived at about the time of parturition of the old, but we cannot say that the two processes are connected causally. Clearly, parturition can take place without simultaneous conception, but we do not know whether the reverse is true.

Finally, Dr. Bucher and I (Bucher and Mazia, 1960) investigated the possibility that the reproduction of the centers, which precedes the reproduction of DNA, as we shall see, was involved in the control of the latter. The answer was negative. When we blocked the conception of new centers with mercaptoethanol, this had no effect on DNA synthesis. Thus the two main reproductive events of the cell cycle do not seem to be linked causally, even though they must be coordinated in the normal course of events.

The study of the reproduction of the centers is of particular interest to the student of cell reproduction for a number of reasons. Obviously it is an absolute prerequisite to division, in animal cells at least, and therefore we must know its place on the time map of the cell cycle. But it is also a model for the reproduction of cytoplasmic particles, and it may be more than just a model if all of the important self-reproducing particles of the cytoplasm are related, as they may well be.

Reproduction of chromosomes

A number of the important questions regarding the reproduction of the chromosomes have been solved by considering DNA to be a tracer of the genome. I might add, lest we forget, that the pioneer cytochemical studies on the relation between chromosomal DNA contents and genetic constitution were an important factor in the growth of confidence in DNA as the carrier of genetic information. Some of the main generalizations are: (1) DNA doubles between divisions—there is no DNA synthesis during the mitotic period when the chromosomes are fully condensed; (2) the time of DNA synthesis between divisions varies—there may be a considerable delay between division and the beginning of DNA doubling or between the completion of DNA doubling and the next division; (3) in cells not destined to divide, *e.g.*, many differentiated cells, there is no DNA synthesis—the DNA content is that received at the last division; (4) DNA tends to be metabolically stable, although there are some regions of chromosomes in which it is not.

But these important discoveries have their limitations. The chromosome as it goes through the whole cell cycle is not just a test tube full of DNA, or, if it is, we have to solve the problem of the reproduction of the tube as well as of its contents. There have been some important additional advances; for example, the discovery that the basic proteins—*e.g.*, histones—associated with DNA generally double exactly in parallel to the DNA (summary by Alfert, 1958). But this is still not the whole story. There are proteins other than histones; there is the nucleolus viewed as a part of the chromosome complex, and there are the kinetochores, the elements by which the chromosomes move in mitosis. What can we say about the plan of reproduction of the whole chromosome—the processes whereby we go from one complete chromosome to two?

Again, it is interesting to note that the chromosomes have been regarded as multiplex units by many cytologists. There have been many reasons, chiefly direct observations and interpretations of radiation-induced breakage, for thinking that a chromosome is at all times composed of at least two equivalent strands, which we may call, noncommittally, chromonemata. For example, this two-stranded structure has often been resolved in chromosomes at anaphase, a stage where the units produced during the previous interphase are being separated without further synthesis of DNA. There is also some evidence that the bipartite chromosome may be further subdivided into strands. The literature on the multiplicity of chromosomes has recently been summarized by Steffenson (1959). The multiplicity of the chromosomes, if true, may merely reflect advantages to the cell in carrying around a supply of spare genetic parts. It may also be a functional necessity;

there may be some reason why it takes more than one gene of a given kind to produce a gene product. But it may also be a reflection of the reproductive habits of chromosomes, as we think it is in the case in centrioles.

In the last few years the study of the distribution of newly synthesized DNA at mitosis by Plaut and Mazia (1956), Taylor *et al.* (1957), LaCour and Pelc (1959), and others has led to rather conflicting conclusions. The disagreements perhaps have been given undue importance because of the seeming implications for the theory of the replication of DNA molecules, even though all of the experimenters have insisted that their work was concerned with the chromosomal level, not with DNA as such. In terms of a generative model of chromosome reproduction, the controversy whether "old" and "new" chromosome elements can separate at the division following an interphase during which DNA is labeled might not be related to DNA synthesis at all. Under conditions where the "new" unit was not completed and separable from its parent before division, the division would separate pairs of strands consisting of one "old" and one "new." If the conditions happened to be such that development and parturition took place before division, the four units could split at random. These conditions are not hard to imagine, in view of the simplicity of the experiments with mercaptoethanol. Any condition that delayed division without delaying the development of the daughter units would suffice.

Preparations for division

So far as we know, the reproduction of the chromosomes and of the mitotic centers are the only truly reproductive events within the cycle of cell reproduction, and even the latter is doubtful in plant cells. If only these two events take place, we will make cells with many nuclei (or polyploid or polytene nuclei) and many centrioles, but we will not get many cells. What are the further conditions of cell reproduction?

In the long run, one of these is growth in its narrow sense—the production of additional cytoplasmic structure and of additional enzymatic machinery. This is not strictly a requirement for a given division. Division without growth, producing cells of abnormally small size, is a common enough phenomenon, as in egg cells or in cells under certain conditions of nutritional limitation. But it cannot go on indefinitely; cells cannot divide without growth until they vanish. On the other hand, growth is not a sufficient condition of division. There are many cases where nuclear endoreproduction is accompanied by cytoplasmic growth, as in the production of "giants" following irradiation of animal cells in culture (Puck and Marcus, 1956).

In order that cell division follow the reproductive events we have

discussed, certain specific preparations for division are required. One of these is the provision of proteins involved directly in the division process—the proteins of the mitotic apparatus. A glance at a dividing cell shows that the working elements of the mitotic process—the spindle, etc.—are rather large, and our studies on the chemistry of the mitotic apparatus show that it is composed of proteins with which RNA is associated and which amount to a large portion (10 per cent in the case of the sea-urchin egg) of all the proteins of the dividing cells. Dr. Hans Went has shown that these proteins may be characterized immunologically, and that they are present in the sea-urchin egg before the visible onset of division. Dr. Ellen Dirksen has investigated the possibility that the RNA component of the mitotic apparatus was synthesized in the course of division, and has obtained negative results. E. W. Taylor (1959) has shown that chloramphenicol will inhibit the formation of the mitotic spindle in newt fibroblasts if applied some time before the spindle actually begins to form, but the drug is ineffective at the time when the spindle is forming. In short, we have reasons to think that the preparation of the molecules which will be assembled into a mitotic figure takes place some time before mitosis and is a prerequisite to division.

A second rather definite preparation for division, in some cells at least, is the provision of an “energy reservoir,” as Swann (1958) calls it, for the division process. It is a remarkable fact, in many cases, that inhibitors of oxidations and phosphorylations have little or no effect on division once it has begun but can prevent it if applied before a certain “point of no return,” which occurs some time before division. A great deal of the experimental work on this question has been done by Dr. Zeuthen, and perhaps he will discuss it in more detail in this symposium. The general idea that the energetic price of division has to be paid in advance has a great deal of evidence behind it, and it must appear on any timetable and balance sheet of cell reproduction.

A good many other specific preparations for division could be hidden away in the interphase period, mixed up with those growth processes that are not specifically related to division. For example, we know nothing about the pre-conditions of the changes in the nucleus, such as the coiling of the chromosomes, which we can detect only when they reach a rather obvious stage but which must be set in motion much earlier.

To summarize the emerging view of the plan of the reproductive cycle of the cell, I have constructed a time map (Figure 4) which cannot be very precise when applied to all cells but might be very precise if it were drafted for a single kind of cell. The important point is that the “stimulus” to the actual cell division process *need* be nothing more than the completion of the last prerequisite preparation for division.

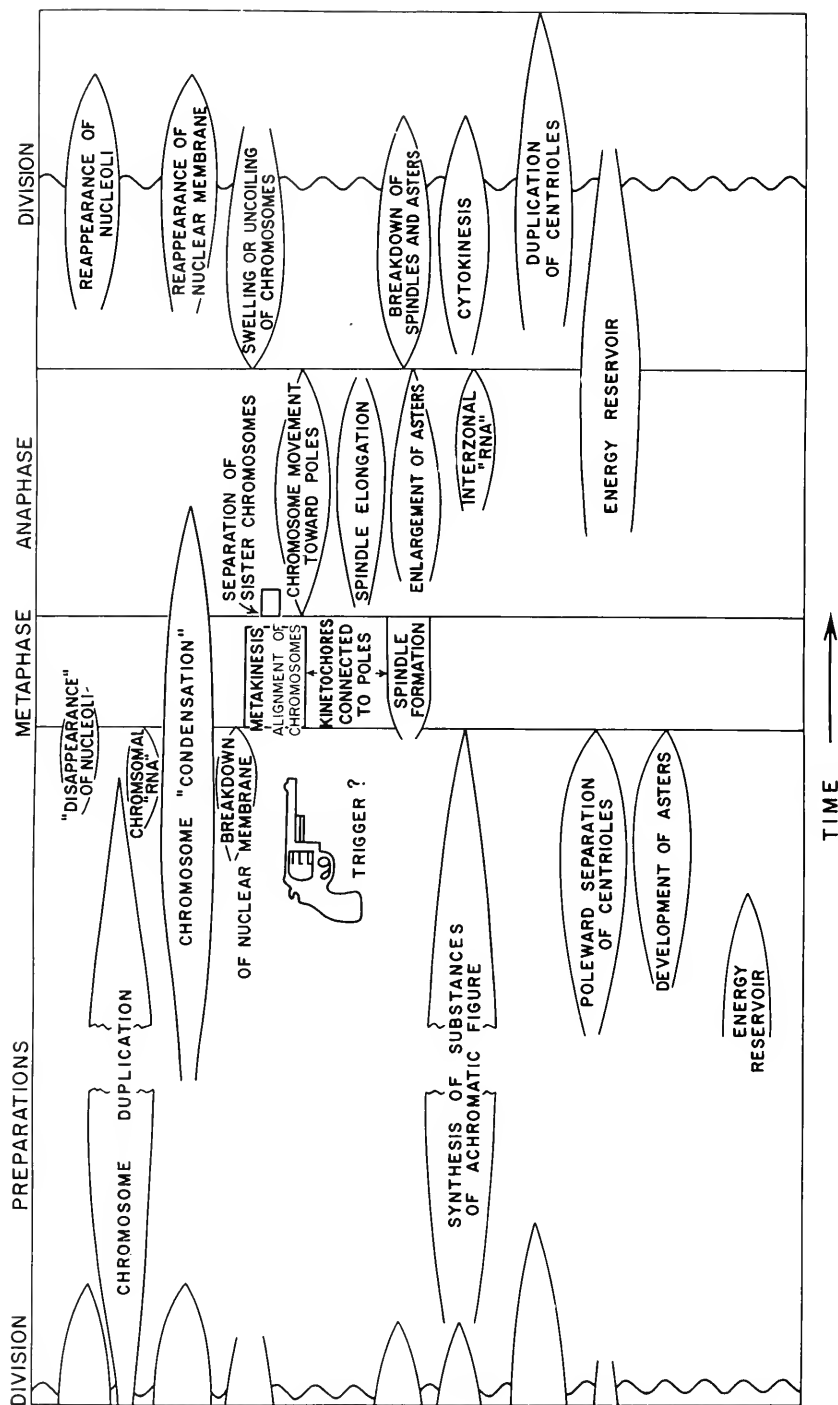

Figure 4. A generalized "Time Map" of the cell division cycle, showing the periods during which the various events take place and, especially, illustrating the view that the cell must complete a number of prerequisites, which run in parallel, before entering the phase of active mitosis.

The existence of a specific "trigger" or stimulus is questionable; it remains to be proved. Like our university students, the cell may need only to complete the right number and kinds of courses for credit in order to graduate; a final examination may be unnecessary.

Controls and stimuli

The time map of mitosis implies that the various preparations for division, reproductive and synthetic, run parallel to one another; it also implies that they may be dissociable. That they are dissociable is a fact. Chromosomes may reproduce if centrioles have not reproduced. Centrioles may reproduce independently of chromosomes. The work of Zeuthen and Scherbaum on the synchronization of *Tetrahymena* shows that preparations for division, not all of which have been specified, are actually set back in time without much effect on DNA synthesis or growth. There is no reason to think that the synthesis of the protein molecules which will make up the mitotic apparatus is related to the filling of the mitotic "energy reservoir," although it is possible to suppose that the assembled mitotic apparatus is an activated structure and is itself the energy reservoir. This last point is discussed elsewhere (Mazia, 1960). Obviously the various preparations normally have to be coordinated to some degree, but they are at least experimentally separable.

This way of looking at cell reproduction leads to an attitude toward its suppression, stimulation, and control which is rather obvious, once stated, but is by no means implicit in most of the past expressions on the subject. It is simply this: that every cell may be regarded as being on the way to division, that reproduction is an immanent tendency of all cells. Cells which are not reproducing are viewed as being blocked with respect to one or more of the preparations for division. It can be any one of them, since the condition of division is the meeting of all of the prerequisites. In practice, the blockage of chromosome reproduction is the most common feature of cells whose division is suppressed, but it is by no means the only one. For example, Gelfant (1958) has shown that the epidermis of the rabbit ear contains a population of cells which have already completed the doubling of DNA but are thrown into division only by some biochemical consequence of wounding the tissue. This release of the cells into division has been interpreted by Bullough (1955) in terms of the energy supply, although Gelfant (1960) criticizes this particular interpretation.

Just as the natural inhibition of division could operate on any one of a number of the prerequisites, so there could be any one of a number of targets for action of anti-mitotic agents. Similarly, the "stimulation" of division would be viewed as the release of a blocked prepara-

tion, and it could be any one of the preparations shown on our time map, or one as yet undiscovered.

The only merit such a formulation of the control of division can claim is that it takes advantage of the progress we have made in the analysis of cell reproduction. "Reproduction" and "division" become terms for groups of processes and have value only for abstract discussions. "Stimuli" and "controls" act not on "cell division" but only on processes that can be studied individually. Obviously such a treatment of the problems is what we have been striving for, and my point is that we have reached a stage where a more analytical treatment is possible and indispensable.

Physiological reproduction

Each daughter cell ideally repeats the history of its mother; together, the two of them transform twice as much of the matter of the outer world into the matter of the biological world. In every cell generation the *growth potential* doubles.

This may seem obvious, and easy to explain in terms of the reproductive events of the cell cycle, which we have already discussed. For example, we might merely echo the litany of what Dr. Crick has called the Central Dogma. If DNA makes RNA and RNA makes protein and the proteins as enzymes govern the rate of biochemical transformation, then the rate of growth might follow the rate of increase in DNA. It does in a larger sense, but not in a way that describes what happens in the life of a single cell. As we have seen, the DNA doubles during the period between divisions, at least in plant and animal cells. But the growth rate at the time it has completed its doubling is not necessarily twice that at the time before it has begun to double. It may remain about the same, as in Mitchison's studies (1957) showing a linear growth rate in the yeast *Schizosaccharomyces pombe*, or in Zeuthen's (1953) study of the increase in respiratory machinery in *Tetrahymena*, or in Prescott's (1960) measurements of protein synthesis in *Tetrahymena* from division to division. The instantaneous growth rate of the individual cell may even be declining during the interphase period when DNA is increasing, as in Prescott's (1955) studies on *Amoeba*. It can double between divisions, as in *Paramecium* (Kimball *et al.*, 1959) but even here it appears not to parallel DNA increase in any intelligible way (Kimball and Barka, 1959).

In short, we have no reason to think that the doubling of the growth potential, which I call "physiological reproduction," does parallel genetic reproduction if DNA measures genetic reproduction. In those cases in which the growth rate does not increase exponentially (Mitchison, Zeuthen, Prescott), it doubles suddenly around the time

of division. Even where it does increase exponentially, we do not suppose that the increase would continue indefinitely without the intervention of nuclear division, although this is difficult to test. As an hypothesis, let us try out the idea that physiological reproduction is associated with the events taking place at the time of division.

It obviously does not require the physical distribution of the genetic material into two nuclei, for the growth rate of giant cells with polyploid nuclei may be logarithmic, as the collective growth rate of daughter cells is when division proceeds normally (Whitmore *et al.*, 1958, and other studies). We have to assign physiological reproduction to something less obvious in the events of cell division.

One of the appealing hypotheses has invoked the ribosomes—the cytoplasmic centers of protein synthesis. There is no good evidence that they are self-replicating, and we are more inclined these days to trace their active RNA to the nucleus, rather than to autonomous self-replication. In any event, we simply do not observe a sudden doubling of cytoplasmic RNA anywhere in the cell cycle (Mitchison and Walker, 1959; Prescott, 1960). We could make the hypothesis that the non-RNA portions of the ribosomes reproduce, doubling the number of potential sites of synthesis. This has not been tested. Or we could imagine that an event accompanying cell division doubles the number of active ribosomes without doubling the total number. This begs the question, in the light of our further discussion, but it is not in itself unreasonable.

The alternative is to re-examine the nucleus with the thought that DNA itself may not be an adequate measure of the physiological capabilities of the genetic control center. We have already considered the idea that the replication of the DNA is the act of conception of a new chromosome unit, and that completion of its development to the point where it can separate from its parent unit may take some time. We might suppose that the new unit could not function until it had cut the maternal apron strings. If so, the time when the instantaneous growth rate doubles in some kinds of cells may be the time of completion of the new chromosomes (Figure 5A). We will not have been iconoclasts so far as the Central Dogma is concerned; we will merely have introduced some conditions to be met before new DNA goes to work.

One even more specific hypothesis is possible. The nucleoli have been viewed as regular parts of the chromosome complement, associated with specific chromosome regions. (This view has to be expanded somewhat in view of recent evidence that a characteristic nucleolar component, unidentified chemically but recognized by its affinity for silver under certain conditions, is also associated with the chromosome arms—Tandler, 1959; Das and Alfert, 1960. The classical nucleoli, associated with the “nucleolus organizer regions,” are major but not exclusive foci of the characteristic chemistry of the nucleolus.) But the

reproduction of the nucleolus does not parallel the reproduction of DNA exactly. During interphase, when the DNA doubles, the nucleoli do not double. Rather, they remain constant in number, disappear during mitosis, and reappear in double numbers at the end of division (Figure 5B). The hypothesis, then, is that physiological reproduction is completed only when the chromosome set has produced two chromosome sets, complete with nucleoli.

No one acquainted with contemporary currents of thought in cell biology will be alarmed by the implication that the nucleolus may be a limiting factor in the direction of cytoplasmic synthesis by the nucleus. The idea that the role of the nucleolus is that of a "middle man" between nucleus and cytoplasm (or between DNA and cyto-

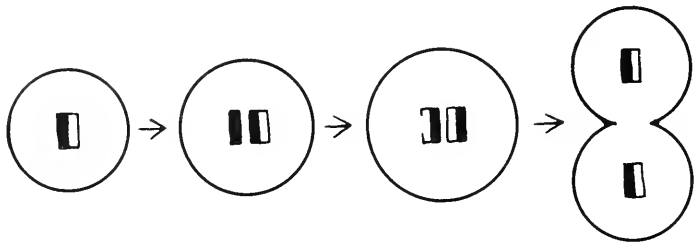

A. PHYSIOLOGICAL REPRODUCTION (NUCLEAR)

▬ = Genetic Material

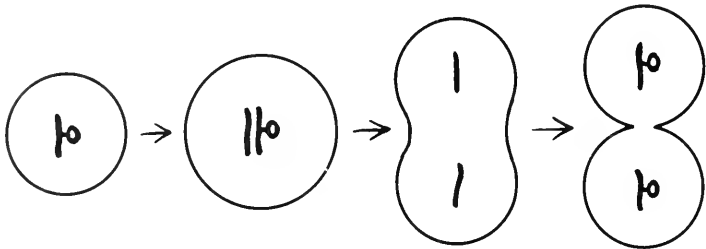

B. NUCLEOLAR REPRODUCTION

Figure 5. Speculative models of physiological reproduction in which the reproduction of the nucleus is stressed. A. A general model, according to which the primary genetic material, shown as black bars, reproduces during interphase, but the second nucleus is not completed until the time of division. B. The nucleolar cycle: If the nucleolar equipment is a part of the chromosome complement which may limit its physiological functions, it would follow that the growth potential will not have doubled until the end of division.

plasmic protein synthesis) seems reasonable, appealing, and consistent with many facts, though it certainly has no rigorous foundations.

One peculiarity of nucleolar reproduction is that the nucleolus (or at least much of its mass and all of its normal staining characteristic) disappears during division. Moreover, Drs. Das and Alfert have shown that the silver-staining nucleolar component is lost from the chromosome arms as well as the compact nucleoli during division and reappears on them around the end of anaphase. Thus nucleolar reproduction is not describable as a $1 \rightarrow 2$ reproduction but, so far as we can see, as a $1 \rightarrow 0 \rightarrow 2$ reproduction. This is not strange, for cytologists do not think of the nucleolus as a whole as a self-reproducing body but rather as a product of sites on the chromosomes which are self-reproducing.

If we are dealing with a $1 \rightarrow 0 \rightarrow 2$ reproduction of material limiting the growth rate of cells, we may expect to find that cells do not grow during the period of division. And this is indeed the finding in many cases. Again, I shall refer to Dr. Zeuthen's talk at this symposium, because he has done so much of the work demonstrating a "block for protein synthesis around division." In the fission yeast, Mitchison found an interruption of growth in volume but not of growth in mass during division. The amoebae studied by Prescott (1955) did not grow during division. Studies on this question are now being made by our laboratory and others, especially on cells in which the chromosomal cycle can be followed. Meanwhile, it remains an interesting hypothesis that physiological reproduction, the doubling of the growth potential, is based on the reproduction of the chromosome conception, and that perhaps the completion of the nucleolar cycle, where it occurs, is a visual expression of the completion of the reproductive process.

Conclusions

In speaking of a "plan" of cell reproduction, I may be using a misleading word. All I mean is that the cell, a discrete body of matter which involves many kinds of molecules and much structural precision, does reproduce itself very exactly and must do so in the face of the limitations of what molecules can do. The solution of the problem depends on the activities of a relatively few molecules which can actually reproduce themselves and can at the same time direct the synthesis and assembly of other molecules which cannot reproduce themselves. From these two properties of a limited number of special molecules, we can hope to derive the generative reproduction of multi-molecular "organs" such as centrioles and chromosomes and the generative reproduction of the cell as a whole. The latter includes biosynthetic growth, the mobilization of energy, the preparations for division, and

the apparatus for division. In short, one feels that the central trend of contemporary molecular biology, concerning which others have spoken at this symposium, is not a fad or a bandwagon idea exploiting the aesthetics of oversimplification but is genuinely the foundation for the study of the progress of the cell as a whole through time.

The complexity of the plan of cell reproduction that I have been discussing is not that of a rigidly integrated system, which collapses when we tamper with one element. To a surprising extent, the complexity involves a system of parallel processes which may be dissociated from each other and which may proceed in a different order in different kinds of cells. It may be more difficult in the end to understand this flexible integration of processes which are not rigidly interdependent, but this is the problem, characteristically biological. We shall certainly have to pay more attention to the *timing* mechanisms of events in the cell cycle, but this becomes possible now that a little more is known about the control of the qualitative and quantitative character of cellular processes.

Finally, it must be said that the plan we have been considering was addressed to the reproduction of the "higher" kinds of cells, those of plants and animals. It may not apply at all to bacteria and some other groups of microorganisms. Many of the special features of the plan are governed by the exigencies of chromosomal and mitotic mechanisms, and we are forewarned by a number of recent discoveries in microbiology that the reproductive equipment may be organized differently in bacteria.

References

- Alfert, M., 1958. "Variations in Cytochemical Properties of Cell Nuclei," *Exp. Cell Res.*, Suppl. 6, 227.
- Bernhard, W., and deHarven, E., 1960. "Verhandlung," *IV Intern. Cong. f. Elektronmikroskopie*, Vol. II (Berlin-Göttingen-Heidelberg, Springer Verlag).
- Boveri, T., 1903. "Ueber Mitosen bei einseitiger Chromosomenbindung," *Jenaische Zeitschr.*, 37, 401.
- Brachet, J., 1957. *Biochemical Cytology* (N. Y., Academic Press).
- Bucher, N. L. R., and Mazia, D., 1960. "Deoxyribonucleic Acid Synthesis in Relation to Duplication of Centers in Dividing Eggs of the Sea Urchin, *Strongylocentrotus purpuratus*," *J. Biophys. Biochem. Cytol.* 7, 651.
- Bullough, W. S., 1955. "Hormones and Mitotic Activity," *Vitamins and Hormones* 13, 261.
- Cleveland, L. R., 1957. "Types and Life Cycles of Centrioles of Flagellates," *J. Protozool.* 4, 230.
- Das, N., and Alfert, M., 1960. *Proc. 1st Intern. Cong. of Histochem. and Cytochem., Paris* (in press).
- Gelfant, S., 1958. "Antephase and DNA Doubling," *Exp. Cell Res.* 15, 423.
- Gelfant, S., 1960. "A Study of Mitosis in Mouse Ear Epidermis *in vitro*, IV: Effects of Metabolic Inhibitors," *Exp. Cell Res.* 19, 72.

- Heidenhain, M., 1907. *Plasma und Zelle, Teil 1* (Jena, G. Fischer).
- Kimball, R. F., and Barka, T., 1959. Quantitative Cytochemical Studies on *Paramecium Aurelia*, II: Feulgen Microspectrophotometry of the Macronucleus during Exponential Growth," *Exp. Cell Res.* 17, 173.
- Kimball, R. F., Caspersson, T. O., Svenson, G., and Carlson, L., 1959. "Quantitative Cytochemical Studies on *Paramecium Aurelia*, I: Growth in Total Dry Weight Measured by the Scanning Interference Microscope and X-ray Absorption Methods," *Exp. Cell Res.* 17, 160.
- LaCour, L. F., and Pelc, S. R., 1959. "Effect of Colchicine on the Utilization of Thymidine Labelled with Tritium during Chromosomal Reproduction," *Nature* 183, 1455.
- Lwoff, A., 1950. *Problems of Morphogenesis in Ciliates* (N. Y., Wiley).
- Mazia, D., 1955. "The Organization of the Mitotic Apparatus," *Symp. Soc. Exp. Biol.* 9, 335.
- Mazia, D., 1960. *Ann. N. Y. Acad. Sci.* (in press).
- Mazia, D., 1961. "Mitosis and the Physiology of Cell Division," in Brachet, J., and Mirsky, A. E., eds., *The Cell*, Vol. III, in press (N. Y., Academic Press).
- Mazia, D., Harris, P. J., and Bibring, T., 1960. "The Multiplicity of the Mitotic Centers and the Time-Course of Their Duplication and Separation," *J. Biophys. Biochem. Cytol.* 7, 1.
- Mitchison, J. M., 1957. "The Growth of Single Cells," *Exp. Cell Res.* 13, 244.
- Mitchison, J. M., and Walker, P., 1959. "RNA Synthesis during the Cell Life Cycle of a Fission Yeast *Schizosaccharomyces pombe*," *Exp. Cell Res.* 16, 49.
- Plaut, W., and Mazia, D., 1956. "The Distribution of Newly Synthesized DNA in Mitotic Division," *J. Biophys. Biochem. Cytol.* 2, 573.
- Prescott, D. M., 1955. "Relations between Cell Growth and Cell Division, I: Reduces Weight, Cell Volume, Protein Content, and Nuclear Volume of *Amoeba proteus* from Division to Division," *Exp. Cell Res.* 9, 328.
- Prescott, D. M., 1960. "Relations between Cell Growth and Cell Division, IV: The Synthesis of DNA, RNA, and Protein from Division to Division in *Tetrahymena*," *Exp. Cell Res.* 19, 228.
- Puck, T., and Marcus, P. I., 1956. "Action of X-rays on Mammalian Cells," *J. Exp. Med.* 103, 653.
- Ryan, F. J., 1959. "Bacterial Mutation in a Stationary Phase and the Question of Cell Turnover," *J. Gen. Microbiol.* 21, 530.
- Steffenson, D., 1959. *In Structure and Function of Genetic Elements*, Brookhaven Symposia in Biology No. 12, pp. 103-124.
- Swann, M. M., 1957. "The Control of Cell Division: A Review," *Cancer Res.* 17, 727.
- Tandler, C. J., 1959. "The Silver-Reducing Property of the Nucleolus and the Formation of Prenucleolar Material during Mitosis. *Exp. Cell Res.* 17, 560.
- Taylor, E. W., 1959. "Dynamics of Spindle Formation and its Inhibition by Chemicals," *J. Biophys. Biochem. Cytol.* 6, 193.
- Taylor, J. H., Woods, P., and Hughes, W., 1957. "The Organization and Duplication of Chromosomes as Revealed by Autoradiographic Studies using Tritium-Labelled Thymidine," *Proc. Nat. Acad. Sci.* 43, 122.
- Whitmore, G. F., Till, J. E., Gwatkin, R. B. L., Simonovitch, L., and Graham, A. F., 1958. "Increase of Cellular Constituents in X-irradiated Mammalian Cells," *Biochim. Biophys. Acta* 30, 583.
- Zeuthen, E., 1953. "Growth as Related to the Cell Cycle in Single-Cell Cultures of *Tetrahymena pyriformis*," *J. Embryol. Exp. Morphol.* 1, 239.

MAMMALIAN CELL GROWTH IN TISSUE CULTURE*

Theodore T. Puck

UNIVERSITY OF COLORADO

Within the last several decades, the intimate structures and functions of the living cell have achieved a clarity of definition which would hardly have been conceivable 50 years ago. The nuclear, genetic determinants have been resolved into molecules of DNA, each of which has its informational content carefully stored in the specific linear sequence of its one or two thousand base pairs. This information is transmitted to the cytoplasm by large RNA molecules, which are stored in the several hundreds of thousands of ribosomes that are strung on a succession of parallel layers extending from the cell membranous wall throughout the cytoplasm. Each such RNA molecule presumably brings about the synthesis of a specific protein, whose component amino acids are transported to the final assembly site on the large RNA template by small, carrier RNA molecules, each of which specifically binds a particular amino acid, provided it has been properly activated.

Delicately balanced feedback mechanisms, operating either to prevent this gene-controlled biosynthesis of any given protein, or to inhibit its action biologically, serve to regulate the cell's metabolic activities, in accordance with the needs imposed by its environment. Many of the proteins that constitute the enzymes are stored in the mitochondrial particles, much larger and fewer in number than the ribosomes, and these carry on the major chemical work of forming and liberating energy from the small molecules whose flow maintains metabolism (Figure 1). While many obscurities still remain—such as the role played in

* *Contribution No. 116 from the Department of Biophysics, Florence R. Sabin Laboratories, University of Colorado Medical Center, Denver. This work was supported by a grant from The National Foundation.*

various cells by non-nuclear genetic determinants—the recognition that all of the biological specificities of organisms ultimately reside in the structures of specific macromolecules, and that these molecules are synthesized in accordance with the general plan here outlined, has resulted in an enormously simplified picture of the cellular economy.

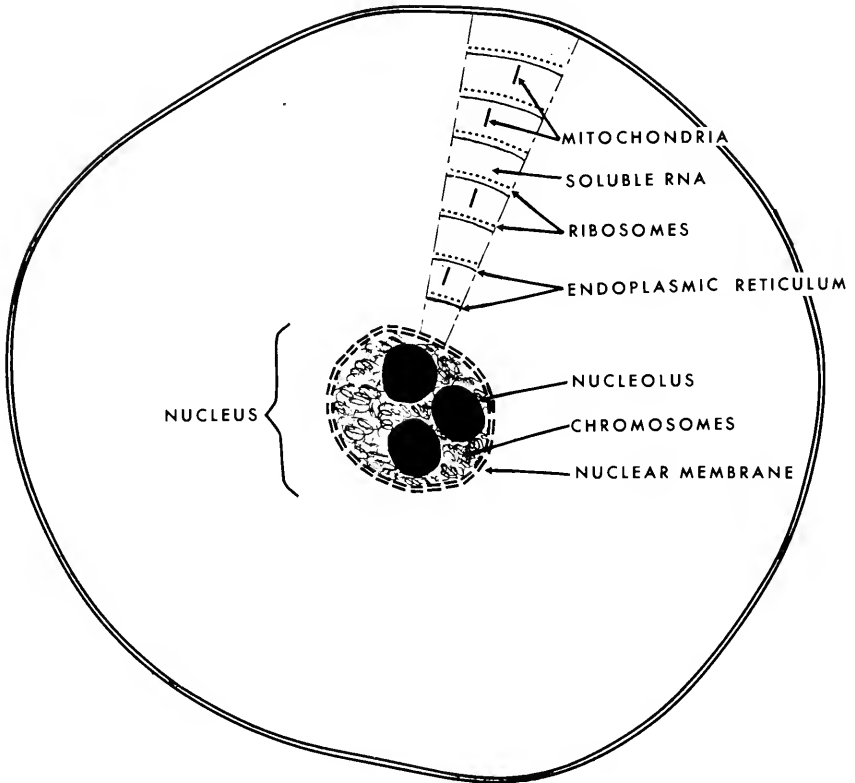

Figure 1. Highly diagrammatic picture of the components involved in cellular biosynthesis. The genes, which are deoxyribonucleic acid (DNA), reside on the chromosomes in the nucleus. Each gene, possessing the information that spells out the structure of a single protein, transmits this structural message to a molecule of RNA, which may be stored temporarily in a nucleolus but eventually finds its way into cytoplasmic ribosomes attached to the endoplasmic reticulum that forms a connected series of labyrinths in the cytoplasm. Small molecules of "transport RNA," each carrying a specific activated amino acid, are lined up along particular large RNA molecules so as to form the sequence of specific peptide bonds corresponding to a given protein structure. Many of the enzymes so synthesized are stored in the mitochondrial particles, where they carry on the chemical work of the cell. Some of these steps are not as yet fully substantiated, but the general outline seems well established.

Most of the individual advances that led to this specific molecular scheme arose from studies of unicelled microorganisms, and viruses, in which the ease of genetic and biochemical manipulation has permitted experimenters to ask precise questions, often in quantitative fashion, of their materials. The mammalian organism would appear to be susceptible to the same kind of experimental analysis, if one could study its component somatic cells as independent microorganisms. In this way one might hope to establish the pathways of the transfer of information and the concomitant control of biochemical synthesis which make up the totality of each individual cell's chemical potentiality. Such analysis might be expected to: identify individual mammalian genes, most of which are still unknown; map their positions accurately on the chromosomes; establish their equivalent biochemical operations; and permit tests for genetic operations such as transformation, transduction, mitotic crossing-over, and mutagenesis.

Recent developments in the technological aspects of growth and manipulation of mammalian cells *in vitro* now appear to make possible such an experimental program. For example, refinements in tissue culture now permit the following operations as routine procedures:

1. Routine establishment of euploid cell cultures from any individual of a number of animal species, including man (Puck, Cieciura, and Robinson, 1958).

2. Growth of such cultures for long periods, and storage at low temperatures, without the gross changes in chromosomal constitution which had been the rule in earlier tissue culture procedures (Puck *et al.*, 1958; Puck, 1958-59).

3. Plating of single cells under conditions where virtually every cell produces a discrete colony. Such colonies can be counted to yield a quantitative measure of the capacity for growth (Puck, 1959).

4. Ready isolation of clones, establishment of mutants with desirable markers, and scoring of mutagenesis (Puck, 1959).

5. Routine delineation of the chromosomes of such somatic cells (Tjio and Puck, 1958).

6. Use of tritiated thymidine to label DNA synthesis in mammalian chromosomes and thus establish the major periods of the cell's reproductive cycle (Painter, Drew, and Hughes, 1958).

7. Formulation of a defined medium in which at least certain mammalian cell strains can grow as single cells, with virtually 100 per cent plating efficiencies (Fisher, Puck, and Sato, 1959).

These new methods have made possible many kinds of studies which focus on the potentialities of the mammalian cell as an independent microorganism. Thus, on the genetic side, mutant clones of cells have been established, and at least a beginning has been made in

the analysis of their biochemical activities (Puck and Fisher, 1956; Puck, 1958a). The actions of a variety of mutagenic agents have been studied and found to parallel to a considerable degree their actions on other living forms (Puck, 1957; Szybalski and Smith, 1959). The great tendency of mammalian cells cultivated *in vitro* to become hyperploid and aneuploid under certain conditions has been noted (Moore *et al.*, 1956). The fact that this process is preventable by institution of very careful monitoring of the physical and chemical environment has led to the proposal that this chromosomal derangement is a result of a mitotic inhibition occurring after the DNA has doubled, so that a polyploid cell is produced which subsequently has an appreciable probability of dividing unequally (as by a tri-polar mitosis) to produce aneuploid progeny (Puck, 1960a). Study of the metabolic requirements of the euploid diploid *vs.* the aneuploid hyperploid forms has revealed the latter to be much more self-sufficient nutritionally, and more resistant to the action of inhibitory agents (Fisher, Puck, and Sato, 1959; Puck, Cieciora, and Fisher, 1957). Thus the greater selective advantage of these aneuploid cells appears to explain their ability to overwhelm tissue cultures in which they have once secured a foothold. It appears a definite possibility that some tumors may owe their ability to overgrow normal cells to this process.

The chromosome number of normal man has now been definitely ascertained to be 46, and the earlier claims for numbers like 47 and 48 appear to be unsubstantiated (Tjio and Levan, 1956; Ford and Hamerton, 1956; Tjio and Puck, 1958). *In vitro* techniques have made possible grouping and identification of the human chromosomes (see Figures 2 and 3). While some of the autosomes are closely similar, small differences in arm length can be detected, provided that a sufficiently large number of mitotic figures is available for examination and these have been prepared with maximum control of the conditions so as to insure the uniformity of state of the chromosomes. One of the most interesting features of the human karyotype is the large difference in size in the sex chromosomes, the X being one of the largest, while the Y is close to the smallest. This is consistent with the relatively large number of sex-linked genetic defects in man, known to be carried on the X chromosome. The large size-differential of these two chromosomes results in the human female having 4 per cent more chromosomal material than the male in each cell, a fact which has been suggested as a possible explanation for the greater longevity of the human female (Tjio and Puck, 1958b). Moreover, X-containing sperm which yield female progeny would be more massive than those containing a Y chromosome, and this differential effect could easily confer a greater motility on Y-bearing sperm which could give them a slight but appreciable competitive advantage over those containing an X chromosome. Hence

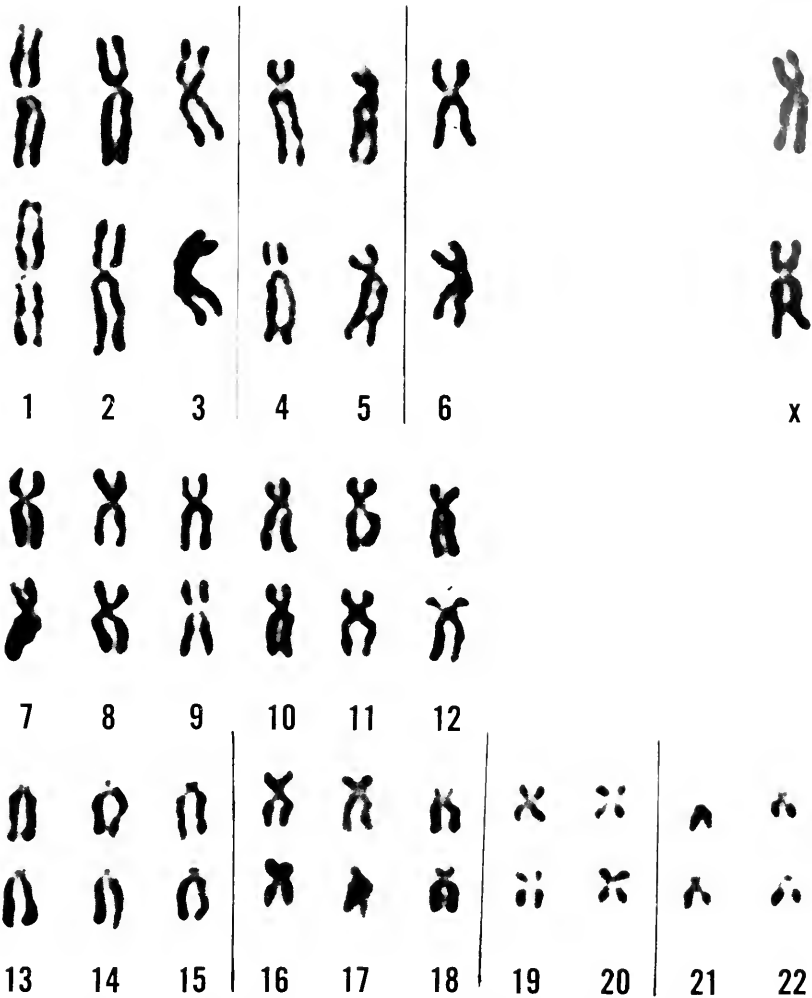

Figure 2. Idiogram of normal human female chromosomes.

two of the long-recognized and intriguing aspects of the differential vital statistics of the sexes in man appear to have at least a plausible explanation in the structures of the human sex chromosomes.

While in the first complete analysis of the human karyotype only four satellited chromosomes were described, subsequent study has revealed the existence of another satellited pair (Figure 4), and it is conceivable that still more such structures may exist (Tjio, Puck, and Robinson, 1960). An international study group, assembling in Denver in 1960, agreed on a common system of chromosomal nomenclature which is eliminating much of the confusion arising from the different systems that had been used by different workers (Robinson, 1960).

Study of the chromosomes of somatic cells of a number of human patients has revealed an astonishingly large number of disease conditions to be due to chromosomal aneuploidy. Thus diseases such as mongolism (Lejeune, Turpin, and Gautier, 1959), gonadal dysgenesis (Ford, 1959; Tjio, Puck, and Robinson, 1959), and Klinefelter's syndrome (Jacobs and Strong, 1959) are now, for the first time, understandable in terms of their underlying cellular defects, all of these representing conditions of aneuploidy due to possession of an excess or deficiency of a single, specific chromosome in each case. The mech-

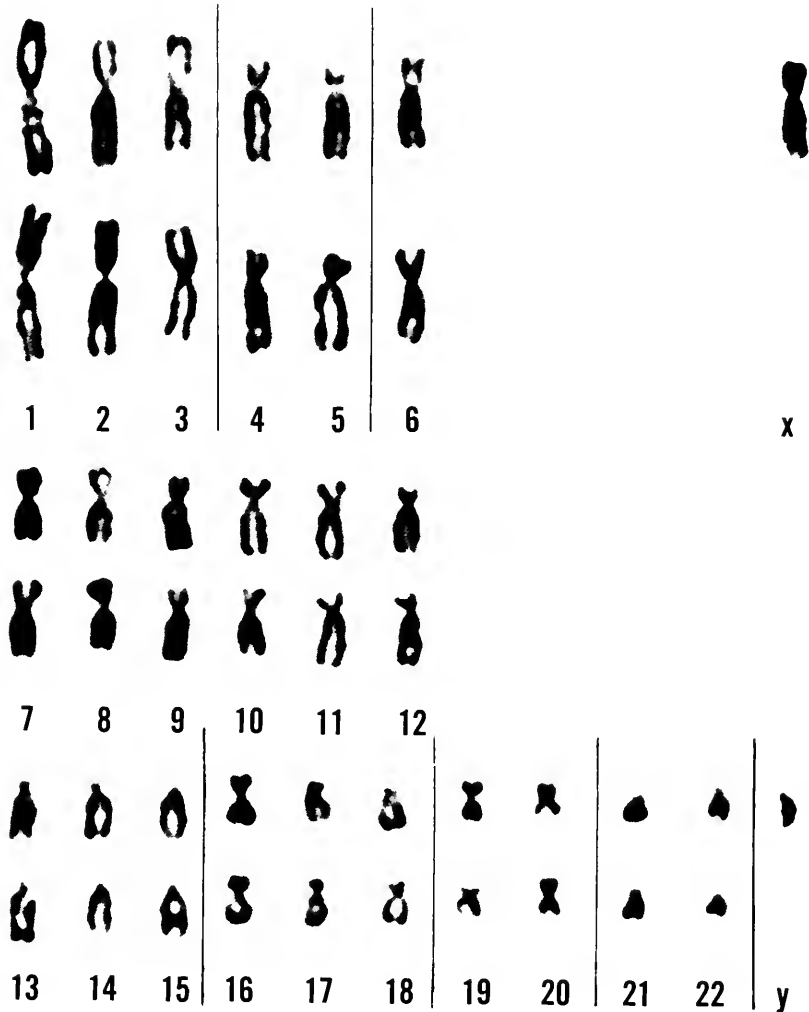

Figure 3. Idiogram of normal human male chromosomes.

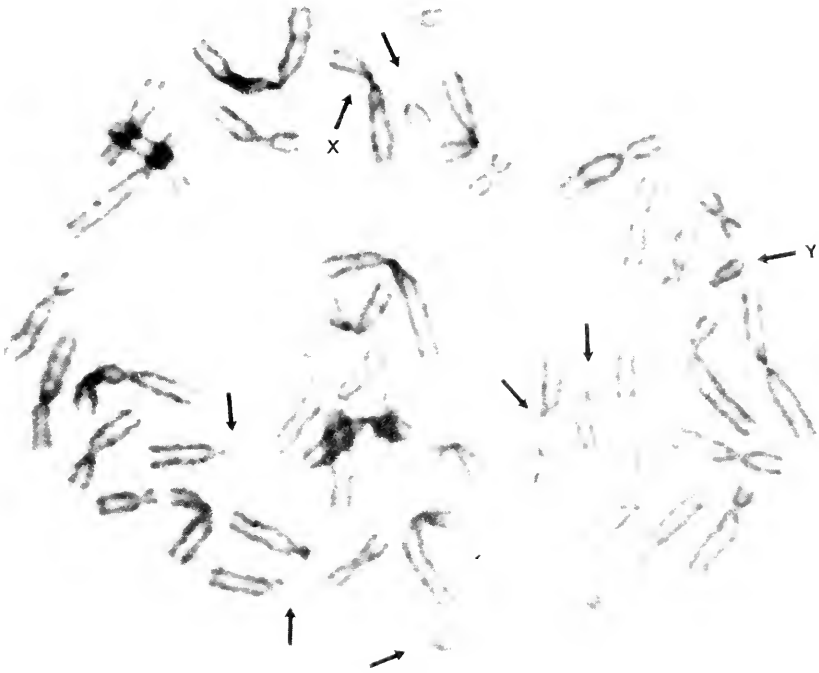

Figure 4. Somatic chromosomes of a human cell, showing the sex chromosome and the six satellited members.

anism of sex determination of man has been demonstrated by these studies to have definite differences from that of *Drosophila*, the animal previously considered to be a model system in this connection.

These techniques have made possible a new approach to the problems of mammalian cell radiobiology. Because methods utilizing massive cell populations tend to confuse the reversible delay in reproduction with irreversible killing, mammalian cells have often been considered to be resistant to irreversible radiation damage until doses of thousands of roentgens had been administered (Pomerat, 1958; Stroud and Bruez, 1954). Hence the mammalian radiation syndrome has often tended to be interpreted as largely due to effects other than the reproductive death of the individual somatic cells, and cellular genetic damage has tended to be discounted as an appreciable factor in mammalian radiobiology (Mole, 1959). However, when the quantitative methodologies here described were applied to this problem, it was demonstrated that the mammalian somatic cell is one of the most radiosensitive cells yet studied. The mean lethal dose for the reproductive function of all mammalian cells so far reported is included within the

range of 50 to 150 roentgens (Puck and Marcus, 1956), or 60 to 200 rads, if correction is made for back-scattering effects (Morkovin and Feldman, 1959). This value for D° , the mean lethal cell dose, is tens to hundreds of times smaller than previous estimates.

The amount of energy absorption from an ionizing beam that is sufficient to kill a mammalian cell reproductively is equivalent to a temperature rise of less than 0.001°C . This astonishing sensitivity of the mammalian cell has been linked to its chromosomal volume, in which radiation damage has now been demonstrated at doses readily able to account at least for the gross effects so far observed (Puck, Morkovin, and Marcus, 1957). Thus, as little as 25 to 50 roentgens is sufficient to introduce a microscopically visible chromosome break into a normal human cell *in vitro*, provided that the cells are fixed and stained before the breaks have had time to reseal. When doses sufficient to introduce several breaks into the same cell are administered, the complex chromosomal translocations and abnormal recombinations, familiar from cytogenetic studies in simpler organisms, become plentiful in mammalian cells irradiated *in vitro* (Puck, 1958b). Some investigators have reported a lower yield of chromosomal breakage per roentgen, in irradiated euploid human cells of a type differing morphologically from those we have described (Bender, 1959). However, it appears to the present author that this apparent divergence may be best explained by the action of factors which prevent the scoring of all of the breaks or aberrations introduced. Such factors, which could cause the number of chromosome breaks scored to appear much smaller than the actual number introduced, have been discussed in detail elsewhere (Puck, 1958; Wolff, 1960); they are strongly dependent on the metabolic conditions, which may vary with the physical and chemical environment, and on the morphological and biochemical state of the cells employed. Dr. E. H. Y. Chu (1959) has confirmed the high chromosomal radiosensitivity we reported for normal human cells grown *in vitro*.

The demonstration that mammalian cells are extremely sensitive to reproductive death as a result of X-irradiation has gone far in the last few years to explain many of the phenomena of mammalian radiobiology. The survival curve for a number of mammalian cell types *in vivo*, including normal bone marrow (McCulloch and Till, 1960), mouse leukemia cells (Hewitt and Wilson, 1958), and, at least to a first approximation, the fertilized ovum of the mouse (Puck, 1960b; Russell and Russell, 1954), have been shown to correspond very closely to the single-cell survival curve of the mammalian cell *in vitro* (Puck and Engelberg, 1960). Thus the contribution of cellular reproductive damage to the total complex of the pathology constituting mammalian radiation syndrome appears to bear out the earlier predictions of its

importance. The applications of these considerations to the problem of treatment of cancer by ionizing radiation also appears to be assuming practical importance (Scott, 1958; Puck, 1960c; Elkind and Sutton, 1959). The combination of the intrinsic radiosensitivity of the cellular reproductive apparatus, the contribution of back-scattering to the actual dose received by different cell components (Hood, 1960), the oxygen tension in equilibrium with the cell, the number of malignant cells that must be sterilized before a tumor can be considered eradicated, and the effects due to the presence of radiation cell-protective compounds (Morkovin and Puck, 1958)—all these now appear to be readily measureable parameters whose effects will help to elucidate greatly the course and degree of hopefulness of cancer therapy. The extent to which the host's reaction, as by immunological defense mechanisms, may also contribute to the success of radiation procedures remains to be delineated. It is important to note that, whereas, to a first approximation, most mammalian cells so far studied quantitatively have similar, high sensitivities to reproductive death by ionizing radiation, at least some differences do exist. Even a small difference in D° value may have a profound effect on the outcome of high doses of radiation. Hence it now becomes of great importance to measure as precisely as possible the effects of the various parameters that can affect cell survival.

From a consideration of several theoretical aspects of the survival curve of the S3 HeLa cell it was deduced that the principal seat of the lethal action lay in the chromosomes. Moreover, because the survival curve was multiple-hit in form, it was postulated that death must require, at least in a significant proportion of such events, interaction between simultaneously hit chromosomes. Hence it was suggested that chromosomal bridges, known to occur in other living forms, may be an important concomitant of irradiation in mammalian cells at these dose levels, and may make an important contribution to the cell-lethal mechanisms. Direct observation of such irradiated cells by means of time-lapse cinephoto micrography in our own laboratory and by other investigators (Whitfield *et al.*, 1959) has amply borne out this prediction. Chromosome bridges are observed in an appreciable proportion of the cells irradiated with doses two to five times the D° value.

Because a number of investigators have questioned the chromosomal role of the X-ray lethal process, it may be worth while to summarize the evidence. (1) The cell-lethal dose parallels closely the chromosome-damaging dose. The parallelism is not complete, because of the complexity of the process involved (Puck, 1960), but the correspondence is more than sufficient for chromosomal damage to constitute the primary step leading, by a variety of pathways which have been described, to cell-reproductive death. (2) Demonstration of the

formation of chromosomal bridges at doses in the range of two or more D° values is perhaps the most direct experimental verification of this picture. (3) The chromosomal hypothesis is able to explain satisfactorily the high sensitivity of mammalian cells to X-irradiation, as compared to the lower sensitivity of microorganisms such as bacteria, yeasts, and viruses (Puck, 1959). (4) All cell functions so far studied, other than those directly involving the functions of the chromosomes and their contained genes (such as mitosis and DNA synthesis), have been found to be tens to hundreds of times more resistant to X-irradiation than cell reproduction is. In this category are included the abilities of mammalian cells to transport actively the vital dyes, to metabolize glucose, and to biosynthesize specific viruses. (5) The chromosomal picture originally was proposed on purely theoretical grounds which included, among others, the multiple-hit nature of the S3 survival curve. Scott later predicted on this basis that cells irradiated with doses sufficient only to encompass the shoulder region of the survival curve would, if allowed to recover before a subsequent irradiation, require virtually again as much radiation to be killed as if the preliminary exposure had not taken place. Exactly this behavior was demonstrated by Elkind in a quantitative study of the irradiation of Chinese hamster cells *in vitro*. (6) Elegant experiments by Painter and his co-workers have recently demonstrated that mammalian cell reproduction is exceedingly sensitive to destruction by the radiation resulting from tritium-labeled thymidine, but only when the tritium is actually incorporated into the nuclear DNA (Drew and Painter, 1959).

In addition to reproductive killing, which is essentially irreversible, ionizing radiation is known to produce a delay in mitosis which is temporary and presumably leaves no permanent change in the cell so affected. It has been assumed that this reversible effect on cell division involves an action of the radiation on non-genetic structures. However, our recent studies make it at least equally probable that this reversible reproductive delay also results from a primary damage to chromosomal structures. The nature of this evidence is as follows: (1) Studies on mammalian cells indicated that exceedingly small doses, in the order of 25 to 50 roentgens, are sufficient to cause demonstrable, temporary, mitotic inhibition in the majority of a cell population cultured *in vitro*. The small size of this dose indicates that the volumes of the sensitive sites involved must be quite large, and comparable to the chromosomal volume. (2) Disappearance of mitotic figures in cells irradiated with such low doses occurs within 30 minutes or less after administration of the radiation. This would appear to indicate that the cells affected are in the pre-mitotic state. (3) The number of chromosome breaks observed in irradiated normal human cells is maximal in the period immediately following radiation. Such cells display a break

efficiency as high as one chromosome break per 20 roentgens per cell. The incidence of such breaks drops steadily as the time between irradiation and fixation is increased.

On the basis of these observations, it appears likely that the reversible lag of mitosis represents an inhibition due to chromosome breakage which prevents the normal coiling of the chromosomes during the stage just preceding the onset of mitosis. Cells in which the coiling process has been virtually completed can go on into mitosis despite the presence of these breaks, which then become visible when the mitotic figures are examined. Those cells that are a little further removed from mitosis are prevented by the chromosome breaks from attaining the requisite degree of coiling needed to initiate mitosis. Hence these cells experience a lag until metabolic processes enable the breaks to become resealed. In cells which receive a relatively small number of breaks, the healing processes usually proceed so as to permit reproduction to occur, and the effect of the radiation on reproduction is temporary unless a lethal gene mutation has accompanied the chromosomal damage. When many breaks occur, the result is abnormal chromosome recombinations, loss of chromosomal fragments, and other abnormalities, which render a large proportion of the cells incompetent to form a colony. This view offers a unitary picture of the nature of radiation damage which may explain both the reversible and the irreversible effects on cell reproduction.

By means of tritiated thymidine, the major time relationships of the cell life cycle have been elucidated (Painter and Drew, 1959). The times required for the various phases of the cell life cycle (*i.e.*, mitosis, postmitotic resting phase, DNA synthesis, and the premitotic resting phase) have been elucidated for the hyperploid HeLa cell and for normal human cells (Yamada and Puck, 1961). These methodologies permit comparison of the phases of the growth cycle for cells in different states of differentiation and should make possible intimate study of molecular dynamics of the differentiation process, as well as of the effects of specific drugs, hormones, and other agents on the metabolisms of normal and malignant cells. We have found by this technique that small, non-lethal doses of X-irradiation in the S3-Hela cell produce only a reversible block in G₂, the period immediately preceding mitosis. Similar irradiation of the normal human cell, however, produces a block not only in G₂, but also in G₁, the period preceding the synthesis of DNA.

Advances in the understanding of cell nutrition have been carried out in many laboratories. The elucidation of a medium containing only two purified macromolecular fractions, which permits the quantitative growth of single cells into large colonies, has opened up many possibilities for biochemical studies. One of these macromolecular frac-

tions, fetuin, has properties of particular interest. It exercises a highly specific effect on mammalian cells in causing them to attach to glass and stretch out to assume the characteristic morphology which is a prelude to reproduction under the conditions of study. This interesting protein fraction fetuin, which is necessary for the growth of isolated mammalian cells under these conditions, is present in particularly high concentration in calf fetal serum, and it has been studied intensively with respect to its physico-chemical properties. So far it has not been possible to fractionate this material into any components with activity equal to or greater than the original material. While the electrophoretic and ultracentrifugal characteristics of this protein fraction reveal a high degree of homogeneity with respect to these characteristics, it cannot yet be excluded with certainty that the observed biological activity is due to a relatively minor constituent. Analysis of the molecular nature of this activity has shown that an enzyme such as neuraminidase, which hydrolyzes sialic acid from glycoproteins like fetuin, causes complete loss of fetuin's biological activity. Recently the amino-acid composition of fetuin has been determined (Fisher and Puck, 1960); it is shown in Table I.

All of the physical, chemical, and biological properties of fetuin so far studied are consistent with the thesis that the alpha-globulin fraction of adult mammalian serum contains an appreciable amount of the same material. It has been observed that processes such as extensive wound-healing, which require an appreciable increase in cell division, are accompanied by a rise in the alpha-globulin content of mammalian serum. On the basis of the foregoing discussion concerning the effect of ionizing radiation in inhibiting the reproduction of somatic mammalian cells, one might have expected that whole-body radiation would also cause the body to respond with an increase in alpha-globulin, so as to maximize reproduction of the cell survivors. Just such an increase has now been reported in experiments carried out on mice.

While early experiments on mammalian cell nutrition disappointingly emphasized the apparent sameness of the nutritional requirements of cells from diverse animal species (Eagle, 1955) and normal or malignant tissues, studies with single-cell techniques have uncovered a highly variegated spectrum of nutritional differences (Puck, Cieciora, and Fisher, 1957; Fisher, Ham, and Puck, 1960). In general, hyperploid cells such as the malignant S3 HeLa strain are much more nutritionally self-sufficient than those of normal diploid cells—a fact which may well be associated with the malignancy of the former. Normal human cells are readily differentiated nutritionally from strains of the Chinese hamster. Mutants of both Chinese hamster and HeLa cells with altered nutritional characteristics are isolable with ease. An absorbing field of biochemical genetic study of mammalian cells *in vitro* appears to be available for intensive study.

TABLE I
The Amino-Acid and Sugar Constituents of Fetuin

	Micromoles per Milligram of Protein	Nearest Integral Number of Residues per Mole of Protein	Calculated Molecular Weight
Aspartic acid	0.53	23.	44,200
Threonine	0.32	13.	46,400
Serine	0.40	15.	45,000
Glutamic acid	0.59	27.	45,000
Proline	0.64	28.	45,000
Glycine	0.35	14.	45,000
Alanine	0.58	22.	44,900
Valine	0.55	28.	45,000
Isoleucine	0.23	10.	43,500
Leucine	0.54	21.	45,600
Tyrosine	0.17	7.	44,100
Phenyl alanine	0.20	8.	43,000
Histidine	0.20	8.	45,400
Lysine	0.31	13.	43,800
Arginine	0.26	12.	45,900
Tryptophan	0.042	2.	46,000
Cystine	0.15	—	—
Hydroxy proline	0.047	3.	43,000
Methionine	essentially none	—	(300,000)
Sialic acid	6%	9.	45,000
Hexose	8.0%	—	—
Hexosamine	5.4%	—	—

An especially intriguing aspect of the growth of diploid mammalian cells is a response to traumatic conditions which produces a marked change in their growth pattern (Puck, Cieciura, and Fisher, 1957; Ham, 1960). Alteration of the physical or chemical environment so as to depart from the optimal growth conditions often serves to convert the cell population to a form which reproduces much more slowly. The cell usually becomes enlarged, and the generation time, which may be increased two-fold or more, can remain at this new value for weeks or months, despite restoration of the optimal conditions for growth. The nature of this poorly reversible change is not yet understood, and it recalls the conversion of bacteria to their L forms, or of paramecia to a new type of ciliary antigen. It is quite possible that changes which characterize normal differentiation are related to this process.

Possibly differentiation is the key mystery of the mammalian organism. By this time, a large number of model processes, many of which have been studied in detail in microorganisms, are available for test in

connection with various types of mammalian differentiation. These include gene and chromosome alterations, specific changes in cytoplasmic genetic determinants of non-random kinds, induction of non-constitutive enzyme activities in response to specific inducers, achievement of new cellular steady states which persist despite restoration of the external environment, as demonstrated so elegantly in the experiments of Novick and his co-workers (1959), heritable changes such as those in the ciliary antigen type of paramecium (Sonneborn, 1948), and genetic changes produced by external agents, as in the case of transduction and transformation. Tools by which processes like these can be searched for effectivity are now at hand. It seems probable that different types of normal and abnormal differentiation processes in mammals will involve different mechanisms. Thus on the one hand, meiosis and the formation of red cells in mammals constitute differentiation processes attended by gross but specific changes in the chromosomal constitution; on the other hand, it can be demonstrated with reasonable probability that some cells with similar chromosomal constitution have different antigens. Therefore, whereas cells arising from the skin have a chromosomal constitution similar to that of the white blood cells, skin homografts between persons of the same blood type cause intense immunologic reactions, while repeated blood transfusion does not. Other experimental studies have also demonstrated the existence of cell antigens which are tissue-specific (Pressman, 1949).

It is evident that study of the biology of the mammalian cell has barely begun. It is easy to foresee several results: the establishment of conditions for control of processes such as meiosis and fertilization *in vitro*; the setting up of cell banks in which a person's own cells can be used for re-injection in case of traumatic accident, or for treatment of diseases such as leukemia or perhaps even normal aging, thus restoring cells to depleted tissues without the complications of immunologic rejection; the detection in cultured cells of obscure or recessive gene defects; even the use of processes such as specific transformation to change the genetic constitution of germ cells. Both the fundamental and the applied facets of such advances will bring tremendous new possibilities for control of biological processes in man and other mammals.

References

- Bender, M. A., 1959. "X-Ray-Induced Chromosome Aberrations in Mammalian Cells *in Vivo* and *in Vitro*," *Spec. Suppl., Int. J. Rad. Biol.* 104.
- Chu, E. H. Y., 1959. Discussion, in *Spec. Suppl. Int. J. Rad. Biol.*, 13.
- Drew, R. M., and Painter, R. B., 1959. "Action of Tritiated Thymidine on the Clonal Growth of Mammalian Cells," *Rad. Res.* 11, 535.

- Eagle, H., 1955. "The Specific Amino Acid Requirements of a Mammalian Cell (Strain L) in Tissue Culture," *J. Biol. Chem.* 214, 839.
- Elkind, M. M., and Sutton, H., 1959. "X-Ray Damage and Recovery in Mammalian Cells in Culture," *Nature* 184, 1293.
- Fisher, H. W., Puck, T. T., and Sato, G., 1959. "Molecular Growth Requirements of Single Mammalian Cells, III: Quantitative Colonial Growth of Single S3 Cells in a Medium Containing Small Molecular Constituents and Two Purified Protein Fractions," *J. Exp. Med.* 109, 649.
- Fisher, H. W., and Puck, T. T., 1960. "Further Studies on Fetuin: Amino Acid and Sugar Constituents; Action of Antibodies," *Animal Cell Info. Scs.* 2, 2.
- Fisher, H. W., Ham, R. G., and Puck, T. T., 1960. "Macromolecular Growth Requirements of Single, Diploid, Mammalian Cells," *Fed. Proc.* 19, 387.
- Ford, C. E., and Hamerton, J. E., 1956. "The Chromosomes of Man," *Nature* 178, 1020.
- Ford, C. E., *et al.*, 1959. "Chromosome Studies in Human Leukemia," *Lancet*, 732.
- Ham, R. G., 1960. "Small Molecule Requirements for Clonal Growth of Single, Diploid, Chinese Hamster Cells," *Fed. Proc.* 19, 387.
- Hewitt, H. B., and Wilson, C. W., 1958. "Observations Concerning the Eradication of Mouse Leukemia Using Whole-Body Irradiation," *Brit. J. Radiol.* 31, 340.
- Hood, S., 1960. In press.
- Jacobs, P. A., and Strong, J. A., 1959. "The Case of Human Intersexuality Having a Possible XXY Sex-Determining Mechanism," *Nature* 183, 302.
- Lejeune, J., Turpin, R., and Gautier, M., 1959. "Le Mongolisme: Premier Exemple d'Abberation Autosomique Humaine," *Ann. Genet.* 1, 41.
- McCulloch, E. A., and Till, J. E., 1960. "The Radiation Sensitivity of Normal Mouse Bone Marrow Cells, Determined by Quantitative Marrow Transplantation into Irradiated Mice," *Rad. Res.* 13, 115.
- Mole, R. H., 1959. "Some Aspects of Mammalian Radiobiology," *Rad. Res.* 10, 124.
- Moore, A., *et al.*, 1956. "Neoplastic Changes Developing in Epithelial Cell Lines Derived from Normal Persons," *Science* 124, 127.
- Morkovin, D., and Puck, T. T., 1958. "Single Cell Techniques in the Study of Radioprotective Action" (abstract), *Rad. Res.* 9.
- Morkovin, D., and Feldman, A., 1959. "Dosimetry in Living Cells Irradiated on Glass: A Correction," *Brit. J. Radiol.* 32, 282.
- Novick, A., and Weiner, M., 1959. "The Kinetics of β -Galactosidase Induction," in Zirkle, H. A., ed., *A Symposium on Molecular Biology* (Chicago, U. of Chicago Press).
- Painter, R. B., Drew, R. M., and Hughes, W. L., 1958. "Inhibition of HeLa Growth by Intracellular Tritium," *Science* 127, 1244.
- Painter, R. B., and Drew, R. M., 1959. "Studies on Deoxyribonucleic Acid Metabolism in Human Cancer Cell Cultures (HeLa)," *J. Lab. Invest.* 8, 278.
- Pomerat, C. M., 1958. "Cellular Changes Indiced by Radiation," *Ann. N. Y. Acad. Sci.* 71, 1143.
- Pressman, D., 1949. "The Zone of Activity of Antibodies as Determined by the Use of Radioactive Tracers," *Trans. N. Y. Acad. Sci.* 11, 203.
- Puck, T. T., 1957. "The Mammalian Growth Cell as Microorganism," in Rudnick, D., ed., *Rhythmic and Synthetic Processes in Growth* (Princeton, N. J., Princeton U. Press).
- Puck, T. T., 1958-1959. *Squibb Centennial Lectures* (N. Y., Putnam).
- Puck, T. T., 1958a. "Growth and Genetics of Somatic Mammalian Cells *in Vitro*," *J. Cell and Comp. Physiol.* 52, 287.

- Puck, T. T., 1958b. "Action of Radiation on Mammalian Cells, III: Relationship between Reproductive Death and Induction of Chromosome Anomalies by X-Irradiation of Euploid Human Cells *in Vitro*," *Proc. Nat. Acad. Sci.* 44, 772.
- Puck, T. T., 1959. "Quantitative Studies on Mammalian Cells *in Vitro*," *Rev. Mod. Phys.* 31, 2.
- Puck, T. T., 1960a. "Cell Culture Studies Applied to Human Genetics." In press.
- Puck, T. T., 1960b. "Radiation and the Human Cell," *Sci. Amer.* 202, 4.
- Puck, T. T., 1960c. "In Vitro Studies on the Radiation Biology of Mammalian Cells," *Prog. Biophys. and Biophys. Chem.* 10, 237.
- Puck, T. T., and Fisher, H. W., 1956. "Genetics of Somatic Mammalian Cells, I: Demonstration of the Existence of Mutants with Different Growth Requirements in Human Cancer Cell Strain (HeLa)," *J. Exp. Med.* 104, 427.
- Puck, T. T., and Marcus, P. I., 1956. "Action of X-Rays on Mammalian Cells," *J. Exp. Med.* 103, 653.
- Puck, T. T., Ciciura, S. J., and Fisher, H. W., 1957. "Clonal Growth *in Vitro* of Human Cells with Fibroblastic Morphology," *J. Exp. Med.* 106, 145.
- Puck, T. T., Morkovin, D., Marcus, P. I., and Ciciura, S. J., 1957. "Action of X-Rays on Mammalian Cells, II: Survival Curves of Cells from Normal Human Tissue," *J. Exp. Med.* 106, 485.
- Puck, T. T., Ciciura, S. J., and Robinson, A., 1958. "Genetics of Somatic Mammalian Cells, III: Long-Term Cultivation of Euploid Cells from Human and Animal Subjects," *J. Exp. Med.* 108, 945.
- Puck, T. T., and Engelberg, 1960. "Application of Single Cell Survival Curves for Radiation Processes *in Vitro*," *Rad. Res.* 12, 4.
- Robinson, A., 1960. "Human Chromosomes," *Amer. J. Dis. Child.* In press.
- Russell, W. L., and Russell, L. B., in Hollaender, A., ed., *Radiation Biology* (N. Y., McGraw-Hill).
- Scott, O. C. A., 1958. "Some Aspects of Ionizing Radiation on Tumors in Experiment Animals," *Adv. Biol. Med. Physics* 6, 121.
- Sonneborn, T. M., 1948. "The Determination of Hereditary Antigenic Differences in Genetically Identical Paramecium Cells," *Proc. Nat. Acad. Sci.* 34, 413.
- Szybalski, W., and Smith, M. J., 1959. "Genetics of Human Cell Lines, I: 8-Azaguanine Resistance, a Selective 'Single-Step' Marker," *Proc. Soc. Exptl. Biol. Med.* 101, 662.
- Tjio, J. H., and Levan, A., 1956. "The Chromosome Number of Man," *Hereditas* 42, 1.
- Tjio, J. H., and Puck, T. T., 1958a. "Genetics of Somatic Mammalian Cells, II: Chromosomal Constitution of Cells in Tissue Culture," *J. Exp. Med.* 108, 259.
- Tjio, J. H., and Puck, T. T., 1958b. "The Somatic Chromosomes of Man," *Proc. Nat. Acad. Sci.* 44, 1229.
- Tjio, J. H., Puck, T. T., and Robinson, A., 1959. "The Somatic Chromosomal Constitution of Some Human Subjects with Genetic Defects," *Proc. Nat. Acad. Sci.* 45, 1008.
- Tjio, J. H., Puck, T. T., and Robinson, A., 1960. "The Human Chromosomal Satellites in Normal Persons and in Two Patients with Marfan's Syndrome," *Proc. Nat. Acad. Sci.* 46, 532.
- Whitfield, J. F., et al., 1959. "Cytological Consequences of Chromosome Bridges in X-Irradiated L Strain Mouse Cells," *Exp. Cell Res.* 18, 591.
- Wolf, S., 1960. "Radiation Studies on the Nature of Chromosome Breakage," *Amer. Nat.* 94, 85.
- Yamada, D., and Puck, T. T., 1961. In press.

TISSUE RECONSTRUCTION FROM DISSOCIATED CELLS*

Aaron A. Moscona

UNIVERSITY OF CHICAGO

One of the characteristic features of embryonic development is that, throughout its course, cells and cell groups are frequently in motion, shifting positions or moving to new sites. Cells leave their places of origin and move—individually or in swarms—by migrating through tissues or by way of the blood stream to new, specific areas; there they reunite, regroup, and, by interacting with other cells, form new functional entities. Their movements and associations arise as if in response to highly specific signals and means of recognition; their collective activities provide the blueprints and the frameworks for the structural and functional shaping of tissues and organs. Though these cell maneuvers and the developmental processes tied in with them are one of the main themes of embryology, relatively little is known about such activities at the cellular level, and even less about the operational laws basically involved in the grouping, association, and ordering of cells into histogenetic systems. By tradition and for technical reasons, embryologists have long been concerned with “potentialities” of rather complex, multicellular parts of the embryo, with tissues, regions, and organ-rudiments. The characteristics displayed by such cell masses are obviously composite effects, in that they reflect the functions of diverse constituents and do not readily permit a clear distinction between the properties of units and of groups. More recently, interest has been shifting toward the opposite end of the structural scale—toward various sub-cellular and molecular aspects of embryonic systems—in a quest for chemical answers to the problems of development.

* *Most of the author's work reported here has been aided by grants from the National Cancer Institute and the Dr. Wallace C. and Clara A. Abbott Fund of the University of Chicago.*

However, it is becoming increasingly clear that a full account of developmental processes cannot be expected without considerably more information about the *cellular level* of organization—about the functional properties of the living units that make up living fabrics—their behavior, their molecular requirements, and their products under various conditions, *i.e.*, their spectrum of reactions and interaction. In this connection there is also a growing recognition that investigation of developmental phenomena solely by dissection, isolation, and analysis—morphological or biochemical—can result, at best, only in partial notions; that, by analogy with the methodology of chemical sciences, analysis of developmental processes must go hand in hand with synthesis, with attempts to construct orders of higher complexity from simpler units. As Conklin (1951) optimistically pointed out: “If we are ever to comprehend the nature of life, we must employ synthesis as well as analysis.” Thus, in searching for the basic laws and factors involved in bonding and organization of cells into tissues one might, perhaps, strike fastest at the core of these problems by attempting to combine living cells into tissues—to synthesize multicellular systems from individual units. In the past few years we have attempted to translate these intentions into concrete experimental propositions, to learn the fundamentals of cell interactions, and thus to pursue a cellular approach to the study of tissue development. Some of the results of this exploratory spadework provide the background for this discussion.

Self-aggregation of cells

We might begin by briefly recalling the evidence that first suggested to us that attempts in this general direction were feasible. The main impetus was provided by the phenomenon of *self-aggregation* of dissociated embryonic cells. Some years ago it was found that various tissues and organ-rudiments of mouse and chick embryos could be readily dissociated into individual, viable cells in suspension by treatment with cation-depleting agents and with enzymes (Moscona, 1952). Such dispersed cells, when maintained in an appropriate liquid culture medium, did not remain separate. Having settled on the floor of the culture container, they moved about, colliding and joining into numerous small clusters or aggregates. These primary aggregates increased in size by accretion of free cells and by fusion, some of them reaching, in less than 24 hours, macroscopic dimensions. Their rate of formation varied with different types of cells, the cell concentration, the culture-medium composition, and various environmental and cellular conditions, which were not always easy to define, standardize, or control. There was thus considerable variability in the details of the process. However, on the whole the major result was always consistent: having

become reconnected in aggregates, the cells rapidly established functionally effective associations and became organized into tissues capable of typical development (Moscona and Moscona, 1952; Moscona, 1959a).

This tendency of dispersed cells to reunite *in vitro* and to reconstruct tissues raised a diversity of questions and possibilities. But primarily it indicated that a proper application of this phenomenon under adequately controlled conditions might, indeed, enable one to compound cells into histogenetic fabrics and, by way of such experimental synthesis of tissue, to examine some of the principles involved in tissue formation and development. It also suggested that, by extending such studies to cells in different states and functions, normal and pathological, to various physiological and environmental conditions, a useful inventory of cell reactions could be obtained.

The pursuit of these propositions in terms of precise tests hinged upon the availability of an adequately controllable experimental framework for such studies. For reasons referred to above, and others, self-aggregation, while meeting the initial aims of this work, did not quite fit the more rigorous requirements. For one thing, in depending on cell movements upon the floor of the container it revolved around a cell function, in itself highly variable and susceptible to extrinsic influences. Furthermore, it involved relatively extended exposure of the individual cells to the effects of the medium and of the floor-medium interface. It is known that unless such exposure is brief, the cells do not remain unaffected, and that various cell functions may become thereby markedly and differentially modified (Moscona, 1959a; Holtzer, *et al.*, 1960). Consequently, the possibility arose that cell behavior in such self-aggregating cultures, instead of representing predominantly first-order reactions, reflected to a considerable extent intermedial, secondary reactions of complex nature and unknown causality. For precise study, this was obviously not a very suitable situation. Therefore, one needed a different cell-aggregation procedure, which would be based on readily reproducible and controlled conditions and yield consistent results in a manner suitable for precise assessment.

Rotation-mediated aggregation

To meet these requirements, an aggregation procedure was developed in which the initial amassing of the dispersed cells was not dependent on their active movements (Moscona, 1961). The cells are brought together by continuous, gentle rotation of the Erlenmeyer flasks in which they are cultured. The swirling liquid forms a central vortex, within which, under appropriate conditions, all cells accumulate rapidly and, if capable of aggregation, become incorporated into loosely bound masses (see Figures 1-3).



Figure 1. A cell suspension of 7-day chick embryo neural-retina.



Figure 2. The initial phase of aggregation in a gyrating flask. There is an accumulation of cells and intercellular materials in the vortex of the liquid culture medium.

These masses increase in compactness and soon form cell aggregates. By means of this simple procedure, the settling down of cells prior to aggregation is practically eliminated, while their clustering is greatly expedited. Cells of various origins and kinds can be rapidly co-aggre-

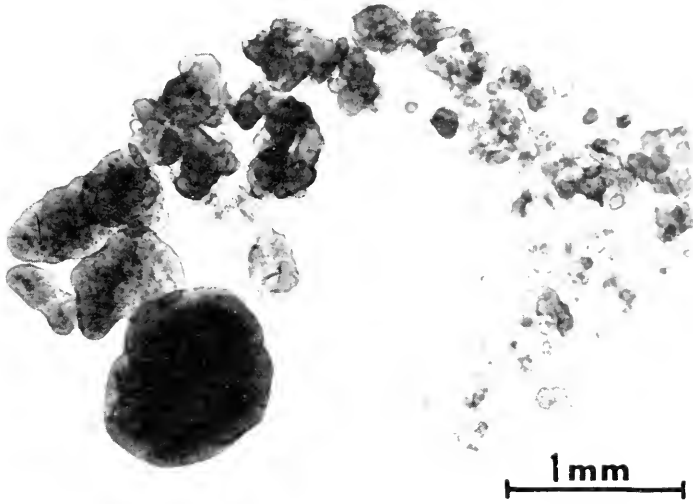

Figure 3. A later stage of rotation-compounded aggregates, showing compact aggregates at the "head" of the spiral and continuing aggregation toward the "tail."

gated and their mutual reactions tested. But the major advantage of this system is that, since it is based on simple experimental parameters, it lends itself to rigorous control. It yields highly consistent, reproducible results in a form amenable to quantitative assessment. Indeed, it represents an encouraging initial step toward a more precise study of various aspects of cell interactions.

Aggregation patterns

The first striking result obtained with this rotation-mediated aggregation procedure was that cells from different tissues, when compounded by rotation under identical conditions, varied conspicuously and consistently in their manner of aggregation, each kind of cell population yielding a characteristic aggregation product. The major features by which these cell-type characteristic aggregates differed represented the *aggregation pattern* of the cells in testing, typical for the given conditions. These features included the number, size distribution, shape, and internal structure of aggregates produced in 24 hours, in a standard culture medium^o at 70 rpm, and 38° C. For example, dis-

^o Composition of *standard medium*: Eagle's Basal Medium (+ 1 per cent glutamine) with 10 per cent unfiltered horse serum, 2 per cent fresh chick embryo extract, and penicillin-streptomycin (50 units per ml. each).

sociated liver-forming cells from 7-day chick embryos coalesced consistently into a single spherical or oblong aggregate; neural-retina cells from the same embryo formed a number of aggregates of characteristic shape; mesonephros cells from the same source produced numerous diversely sized cell clusters; cartilage-forming cells from 4-day embryo

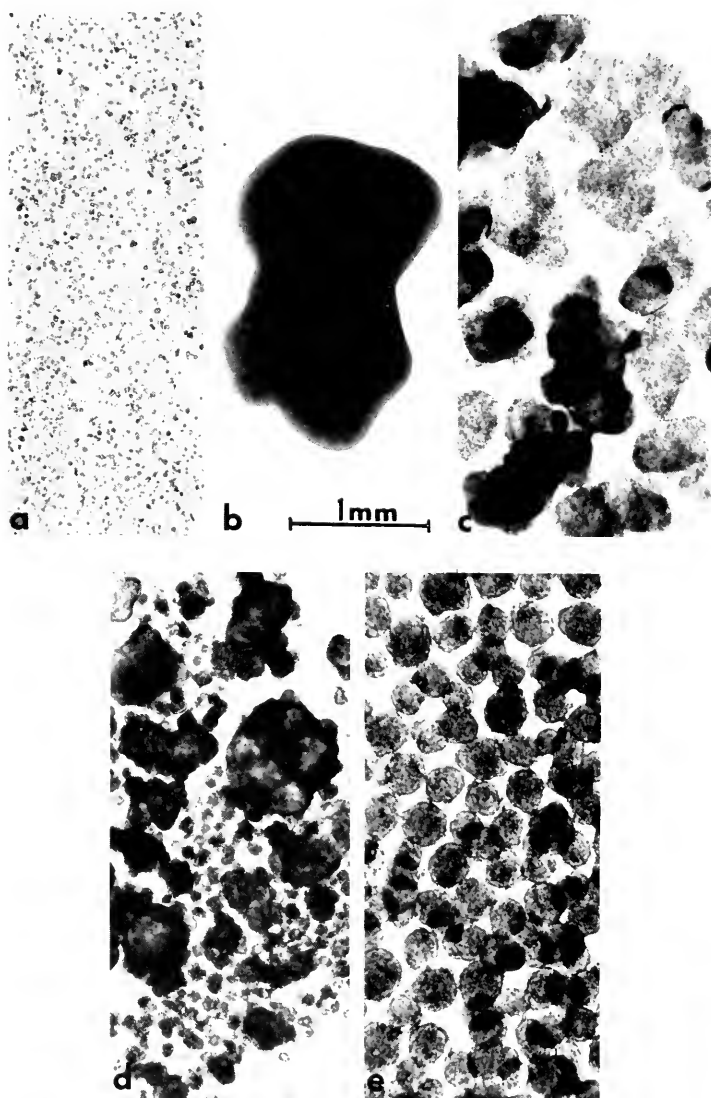

Figure 4. Aggregation patterns of rotation-compounded dissociated cells (24-hour aggregates in standard medium). a. Cell suspension, liver (7-day chick embryo); b. liver aggregate; c. neural-retina aggregates; d. mesonephros aggregates; e. limb (4-day embryo) cell aggregates.

limb-buds aggregated into numerous regular spheroids (see Figure 4). Thus, in spite of the identity in environmental conditions and of the mechanical forces acting upon the cells, each type of cells or each cell population displayed diagnostically distinct grouping properties and patterns of association.

The interest in these differential aggregation patterns and their significance was considerably amplified by the finding that their major features were remarkably little affected by gross differences in cell concentration (Moscona, 1961). For instance, the average diameter of retina cell aggregates was not appreciably altered across a concentration range from six million to 60,000 cells per three ml. of culture medium; the total number of aggregates fell, of course, accordingly (Figure 5). In the case of liver cells, which under the observed conditions aggregated into a single cluster per culture, the aggregate diameter decreased relative to the fall in cell concentration, but its typical shape was not altered.

Of equal interest was the finding that the major features of aggregation patterns were not narrowly species-specific, *i.e.*, that embryonic mouse cells and embryonic chick cells, if derived from similar tissues at a comparable stage of development, produced strikingly similar

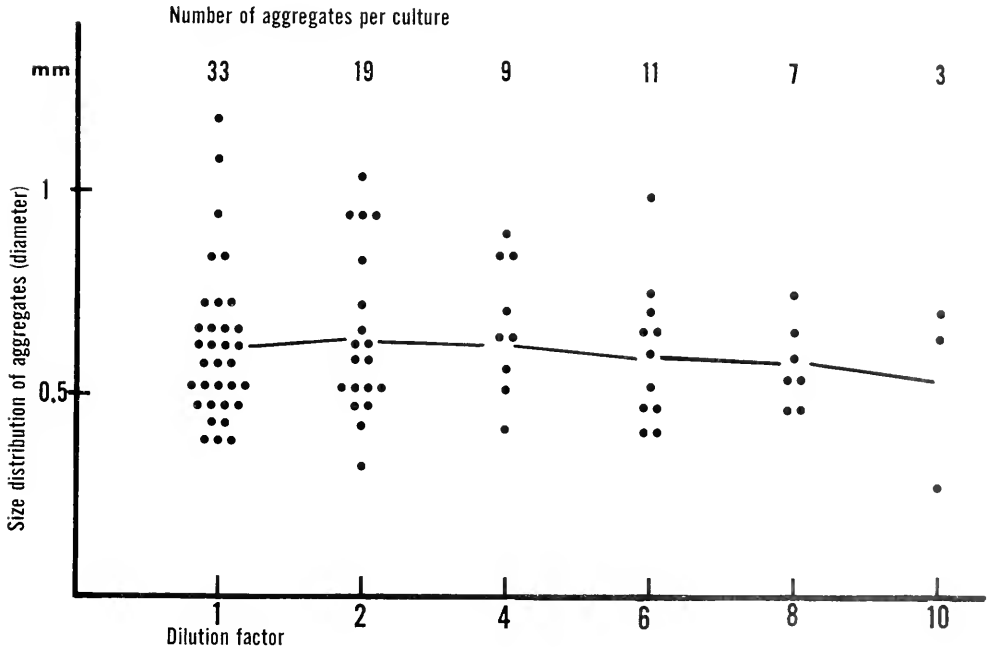

Figure 5. Cell concentration and size distribution of aggregates: neural-retina cells, 7-day chick embryo. All cultures in a standard medium, 70 r.p.m., at 38° C. for 24 hours.

aggregation patterns. This resemblance applied both to internal architecture and to external diagnostic features—as if the properties or signals that guide cells in establishing these collective systems were operationally homologous in histogenetically similar cells, regardless of differences in generic derivation.

We shall return to this problem later. The points to be stressed here are that the patterns established by aggregating cells represent critical equilibrium products between cell-intrinsic factors, group properties, and environmental effects; that they are characteristic for a given cell population and consistently diagnostic for a specified set of conditions. As such, they provide reliable base lines for precise testing of selected variables—cellular and environmental—chosen to examine various aspects of cell bonding and histogenetic interaction.

A particularly striking example of correlation between cell-dependent factors and aggregation patterns is the effect of age, *e.g.*, of the developmental stage of the cells in testing. By comparing the aggregation of cells from similar tissues at different stages of development, it was found that cells from progressively older embryos showed a continuous decline in mutual cohesiveness (Moscona and T. Weis, 1961). This age-dependent change expressed itself as a progressive decrease in the size of the aggregate, so that cells dissociated toward the end of embryonic development were mostly unable to become functionally reconnected. Figures 6 and 7 illustrate the aggregation patterns of dissociated neural-retina cells from chick embryos at various stages of development, tested under identical conditions. Such developmentally progressive changes in cohesiveness and aggregability were found to occur consistently and in a highly regular manner in cells from all the tissues tested, though the rates of change and the resulting patterns differed according to the type of tissue.

How can we interpret this new information: that cells dissociated from older, more differentiated tissues are less capable of cohering and reconstructing formative frameworks than cells from younger tissues? No firm statements can presently be made; however, it is not unlikely that these changes, as a feature of development, are closely related to the main theme of differentiation, *i.e.*, to the progressive restriction and channeling of metabolic processes in maturing cells toward specific functions. If so, the possibility suggests itself that the competence of dispersed cells to become reconnected into a functional continuum depends on metabolic sequences or products which are available in young cells but become altered or shut off as the synthetic economy of the cells is restrictively committed. This would point to a possible involvement of cellular products in the mechanisms of cohesion and histogenetic bonding of cells—a proposition of considerable conceptual and practical interest.

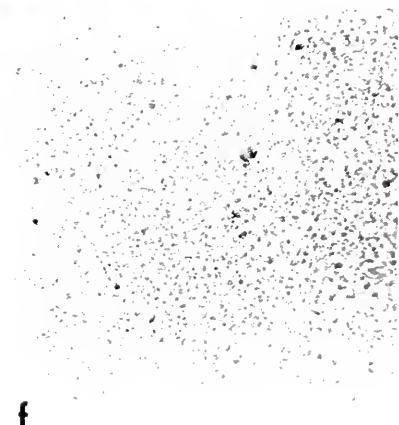
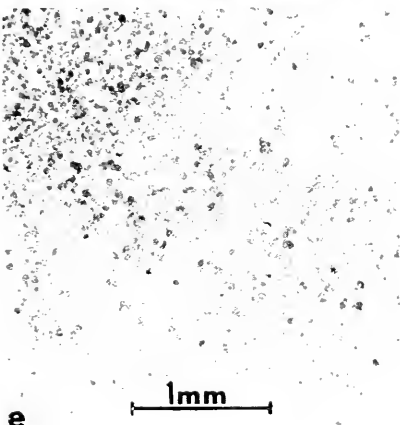
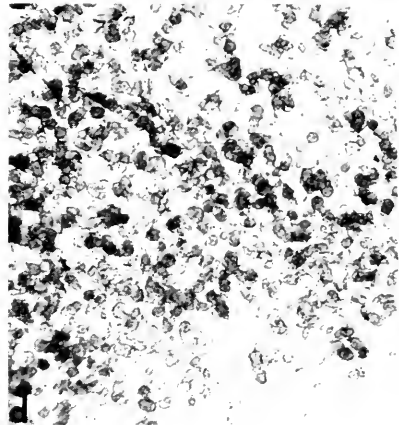
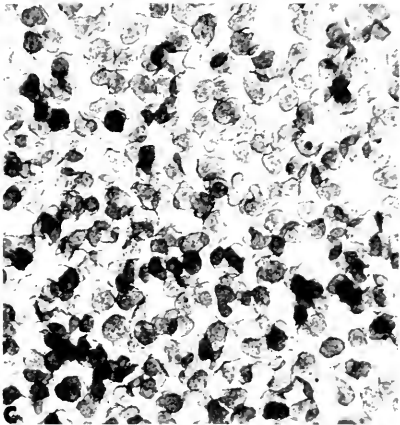
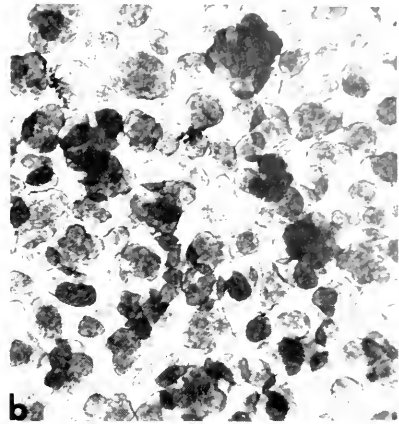
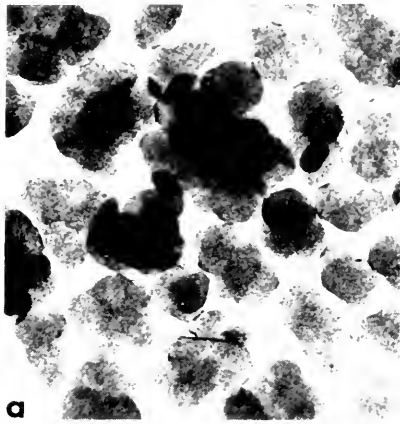

1mm

Figure 6. Aggregation patterns of neural-retina cells from chick embryos at 7, 9, 11, 14, 17, and 19 days of incubation. (In order, a to f.) Equal cell concentrations, standard medium, 70 r.p.m., 24 hours.

Temperature and aggregation

Some support for such assumptions can be readily drawn from the finding that cell-cohesion and aggregation processes are temperature-sensitive. Taking aggregation patterns at 38° C. as basal, it is found that the tendency of normally cohesive cells to aggregate decreases sharply at lower temperatures. There is, thus, a distinct reduction in the size of aggregates, and eventually cell-bonding and aggregation are completely inhibited, though the cells are brought in contact by rotation. For instance, neural-retina cells from 7-day chick embryos which cohere readily at 38° C. remain completely dissociated at 15° C., in spite of medium and rotation conditions conducive to aggregation. If continuously rotated at this temperature, the cells remain alive for several days, and when transferred to 38° C. they aggregate. As might be expected, aggregation-limiting temperatures vary somewhat with different types of cells and with the stage of development.

This correlation between temperature and aggregability invites certain obvious questions. Consider, for instance, in the light of this information, the well-established role of calcium ions in cell-bonding (Steinberg, 1958). At temperatures around 15° C., which effectively

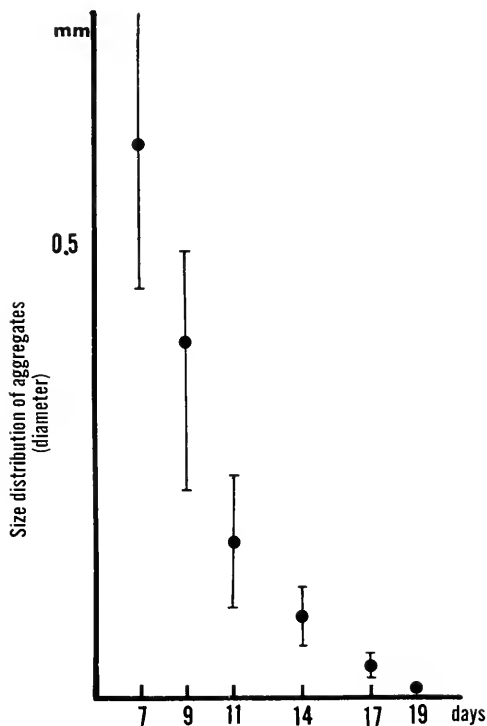

Figure 7. Age of cells at dissociation and size of aggregates: neural-retina cells, embryos at 7, 9, 11, 14, 17, and 19 days.

interfere with aggregation of the cell types tested, simple cationic reactions are not expected to be persistently inhibited. Yet the cells, though brought together by rotation in a culture medium with optimal calcium concentration, did not cohere. Therefore it seems likely that cations, though unquestionably essential for normal cell-cohesion, represent only one of the requirements or the constituents in the mechanism of cell-bonding. Whatever the nature of the other constituents, under the conditions tested they were not available or not effective. In view of the thoroughly adequate composition of the culture medium, the possibility suggests itself that, in addition to external requirements, processes which are intrinsic to the cell and sensitive to temperature may be implicated in the formation of histogenetically effective cell bonds. This brings us back to the discussion in the preceding section.

The validity of these postulations is currently being studied. The working concept adopted is that histogenetic bonding of cells, in aggregates and in normal tissues, involves accumulation at the cell surface, or between cells, of specific cellular products (Moscona, 1959a). The molecular make-up or the effective function of these extracellular materials includes divalent cations (see L. Weiss, 1960). At dissociation, these materials are largely removed, and tissue reconstruction requires their resynthesis. It is probable that in mature cells with specialized functions, metabolic facilities for these synthetic processes are not operational. In cells earlier in development, these processes are active but are temperature-dependent; as they do not proceed effectively at suboptimal temperatures, the cells remain dispersed when cooled. These are, in all likelihood, gross oversimplifications. However, support for the notion that bonding of cells depends on metabolic activities seems to be forthcoming. There is recent information that RNA may be involved in maintaining intercellular links in early embryonic tissue (Curtis, 1958; Brachet, 1959). And there is strong evidence indicating elaboration by embryonic cells of extracellular materials (Weiss, 1945; Grobstein, 1954). In this connection it should be stated that cell-bonding may be just one of the functions of such extracellular products, and that they may also be involved in other cell interactions (Grobstein, 1954; Niu, 1956; Weiss, 1958; Edds, 1958; Moscona, 1959a; Moss, 1960).

Molecular requirements and cell aggregation

Additional insight into these problems was sought by defining more closely some of the nutritional and molecular requirements of cells in relation to aggregation. Early in this work it was found that an essential prerequisite for orderly aggregation of freshly dissociated embryonic cells was the presence of serum protein or of tissue extracts in the culture medium. In the case of synthetic culture media consisting solely

of micromolecules, addition of horse serum at a concentration of 5 to 10 per cent was required. The aggregation-supporting activity of whole serum could not be replaced by serum dialysates or by various non-proteinaceous macromolecular additives. Therefore a preliminary survey was made to determine the ability of various serum fractions to support histogenetic cohesion of dissociated cells in synthetic culture media in rotating cultures. It was found that in the presence of 0.5 mg/cc of fraction IV-1 of adult bovine serum, containing alpha-1-globulin and lipid protein ("Alpha Lipoprotein" of Nutritional Biochemicals Corp., Cleveland) as the only macromolecular additive to the medium, there was rapid cohesion of cells and typical histogenesis of the ensuing aggregates. It cannot yet be stated conclusively whether this is the only serum fraction capable of effectively supporting histogenetic bonding of cells; nor is it clear whether only one or both of the major constituents are involved, or whether the effect might or might not be due to an "impurity." It is of interest that "fetuin," the alpha-1-globulin fraction of fetal calf serum which promotes adhesion of adult cells to glass (Fisher, *et al.*, 1958), has been found by us to enable mutual cohesion of embryonic cells in rotating cultures, albeit at concentrations higher than the alpha-lipoprotein preparation. Both of these serum derivatives are known to be physically heterogeneous (Lieberman *et al.*, 1959; Fisher *et al.*, 1959), and therefore a comparison of their specific functions on cells must await further analysis. Similarly, the nature of their aggregation-promoting function remains to be determined: whether they act as cell-surface stabilizers, or assist in transport of molecules, or supply essential metabolites. It is, however, of some interest that lipid and globular proteins, which have long been thought to contribute to the constitution and activities of cell surfaces (Danielli, 1958; Willmer, 1961), may also be involved in supporting the establishment of functional contacts between cells.

Further light on this area is being shed by collateral information. Thus it has been found that in cultures maintained at 15° C. in optimal concentrations of these proteins the cells do not cohere, though brought together by rotation. It is also known that in the absence of calcium, at otherwise optimal conditions of temperature and protein concentration, dissociated cells do not cohere. Glucose is another essential requirement for morphogenetically effective aggregation of embryonic cells—presumably as a source of energy for cell activities bearing on this process. All these indications point to a missing link in this series of requirements and unavoidably draw us to the already postulated notion that this pivotal prerequisite for cell cohesion and aggregation may be a cellular product. As a matter of fact, an extracellular material (ECM) has been found to accumulate between cells in early phases of aggregation and is chiefly responsible for holding together the newly bunched

cells. It provides the framework within which the compacting of cells into coherent aggregates takes place (Moscona, 1959a). This ECM is of mucoidal nature and resembles in many respects the intercellular ground substance of normal embryonic tissues. The possibility that it represents the postulated cellular products prerequisite for cell-bonding and aggregation suggests itself strongly. Work toward clarifying this question is now in progress.

Histogenesis in aggregates

Let us pass on now to firmer ground and review briefly the behavior of cells after their merger into multicellular aggregates. The first question is whether the discrete cells, bunched together at random by mechanical forces, are able to establish developmentally functional associations and to reconstruct normal tissue patterns. The answer to this is affirmative.

A characteristic feature of freshly formed aggregates is that the cells, though closely packed, are in constant motion relative to one another—like bees in a swarm. Cell contact does not lead in this case to static cohesion or immobilization (but see Abercrombie, 1958; Weiss, 1958) but, rather, sets off new kinetic activities. As mentioned later, these activities are in all likelihood instrumental in bringing about the progressive ordering of the randomly assembled cells and their organization into histogenetic fabrics. In early aggregates the cells are packed without definable order; later, as their kinetic activity subsides, they are found arranged in histologically identifiable tissues.

In Figure 8, photograph *b* shows a twelve-hour aggregate produced by cells from the cartilage-forming zone of 4-day chick embryo limb-buds. At the time of dissociation the cells are fibroblastic in shape; in early aggregates they show no clear arrangement or indication of their prospective fate. Yet in a few more hours this lump of cells becomes typical cartilage (*c* in Figure 8). Similarly, aggregates of liver-forming cells from 7-day chick embryos become organized into typical liver parenchyma. It may be argued that cartilage and liver are tissues with a relatively simple, easily rebuilt architectural organization. However, cells from tissues considerably more complex structurally display even more remarkable capacities for tissue restitution.

The neural retina of the 7-day chick embryo consists of several layers of cells ordered according to their prospective roles in the differentiation of this tissue. At this stage of development the cells are already diversified in appearance, and the over-all organization of this tissue appears quite complex. When brought into suspension, retinal cells form aggregates within which they promptly become arrayed in concentric layers. Each of these centers—or rosettes—represents essen-

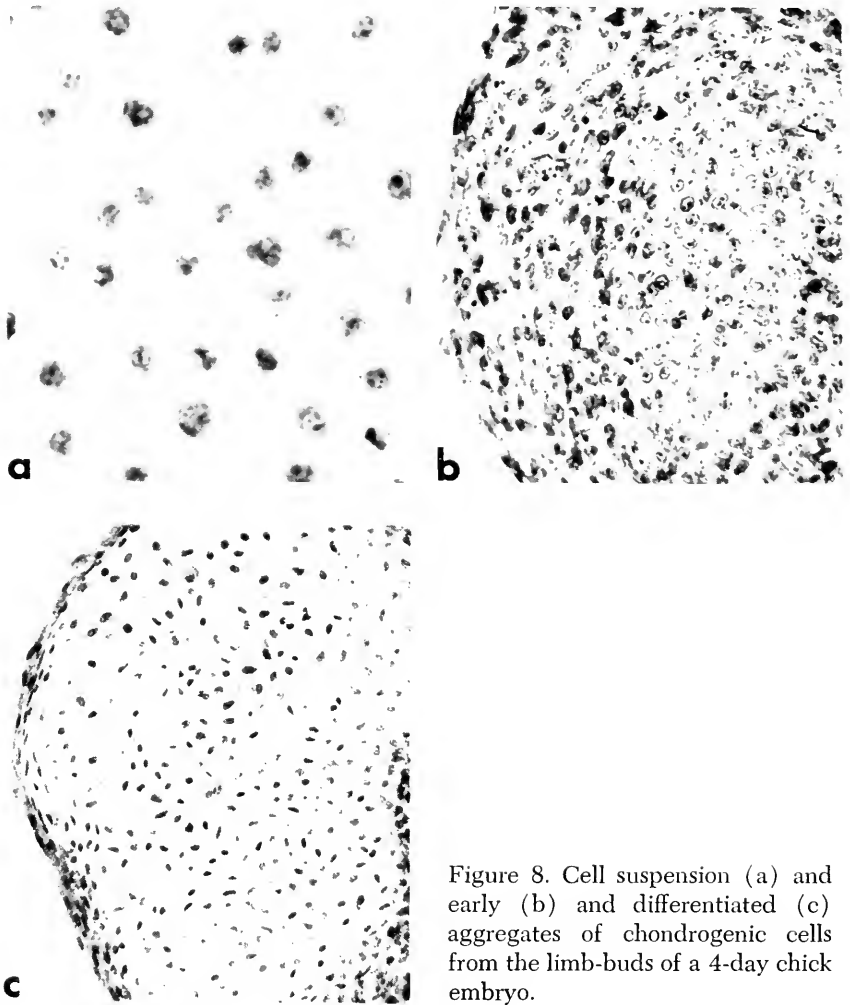

Figure 8. Cell suspension (a) and early (b) and differentiated (c) aggregates of chondrogenic cells from the limb-buds of a 4-day chick embryo.

tially a miniature neural retina; the cells differentiate into sensory elements and into ganglion cells with axons and, upon further cultivation, give rise to masses of neuro-retinal tissue (see Figure 9).

An equally striking example of the ability of dispersed cells to rebuild tissues derives from studies on kidney cells. The kidney (mesonephros) in an 8-day chick embryo is a complex structure comprising a variety of cell types which originate in different regions of the embryo, develop at different rates, and perform various specific functions. In normal development these diverse cells become structurally and functionally organized by a succession of tightly integrated events and interactions. When such a tissue is broken up into individual cells, all this intricate epigenesis appears voided. Yet not only are the dispersed

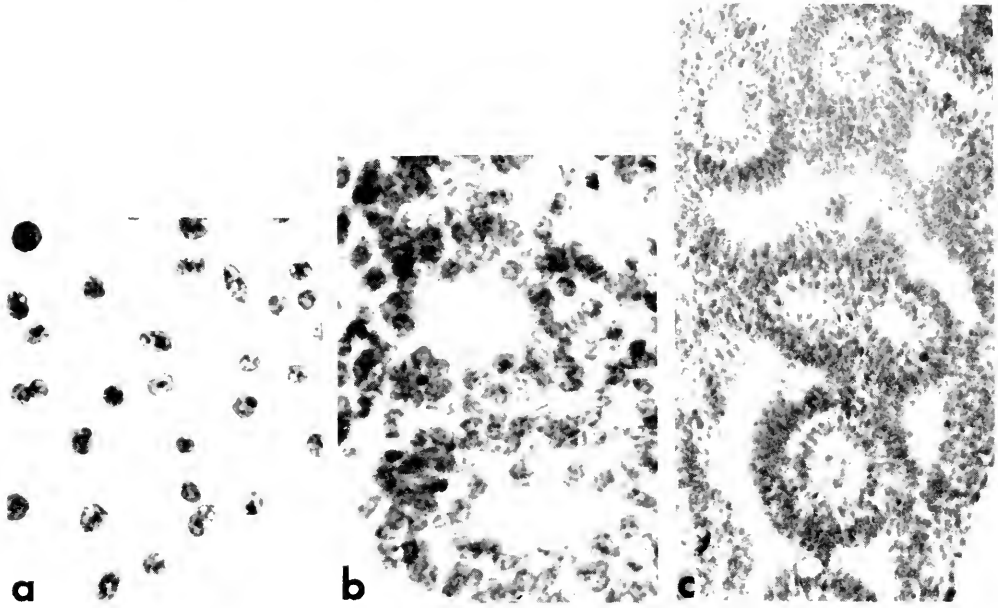

Figure 9. Histogenesis in neural-retinal aggregates. a. A stained preparation of cell suspension. b. A section through a 24-hour aggregate. c. A section through a 56-hour aggregate, showing advanced differentiation of neural-retinal tissue.

cells capable of self-aggregating, or of being compounded by rotation into coherent fabrics, but they promptly reconstruct replicas of their original tissues (Figure 10).

How is this structural and functional organization of the various types of cells achieved within the aggregate? We have here cells which, at the time of dissociation, were presumably already differentiated, *i.e.*, committed to a definitive set of activities. Do they retain, throughout the events of dissociation and aggregation, their original identities and functional commitments, or do they relapse into a more neutral, more "flexible," state? Theoretically it is possible that the randomly bunched cells in newly formed aggregates differentiate in accordance with their chance locations within the re-established clusters; their development in the new system might thus be a function of position. The opposite possibility is that the eventual positions and functions of the cells are dependent on and determined primarily by their original, pre-dissociation identities; this implies that the aggregated cells, though first associated at random, become rearranged and organized in accordance with their native properties and functional kinships.

Such alternatives might be adequately examined and resolved if the cells were to differ sharply enough to be traced within aggregates



Figure 10. Section through a 24-hour aggregate of mesonephros cells from a 7-day chick embryo.

and identified as to origin. In the situations discussed above, where all cells originated in one organ or in one tissue, this was, for obvious reasons, not feasible.

Heterotypic cell aggregates

The simplest attempt to solve this difficulty was to mix together cells from two quite different tissues—for instance, kidney-forming cells with cartilage-forming cells—expecting that within the composite aggregates thus obtained the tributary elements might be identified by their architectural products. This expectation rested upon two assumptions. First, that such histogenetically alien cells, when lumped together, would not interfere with one another's activities so as to remain chaotically conglomerated. Second, that the cells would retain their original functional identities, cells from each source becoming assorted and grouped independently of the others, so that an aggregate would eventually contain two different tissues. The results of such experiments conformed with these expectations (Moscona, 1956). Aggregates compounded of interspersed cells from cartilage- and kidney-forming tissues were indeed found to consist of both these types of tissue (Figure 11). The different cells, though closely intermingled in the initial suspension, were evidently able to become disentangled, sorted out, and grouped according to histogenetic identities and properties. Cartilage cells formed lumps of cartilage, usually in the center of aggregates; kidney cells formed nephric epithelium, usually as an outer layer, with an intermediate zone of connective tissue presumably of dual origin.

The general validity of this result was substantiated by extensive observations on a variety of such heterotypic cell combinations. The over-all evidence led to the conclusion that cells in composite aggregates went through a process of reshuffling and became sorted out into distinct groupings in accordance with cell-type specificities and functional affiliations. However, persuasive as this evidence was, it was indirect, and its firm acceptance hinged upon further proof of the basic premise: that the cells persisted, indeed, in their original identities throughout dissociation and aggregation; that what appeared to be a result of selective grouping was not actually a site-dependent transformation of cells around centers of morphogenetic influence or dominance. The possibility was not to be disregarded that relatively young embryonic cells, though presumably determined, might, when removed from the stabilizing effects of their tissue and assimilated in a new framework, become diverted in novel directions (Grobstein and Zwilling, 1953; Trinkaus, 1956; Moscona, 1957b). Needed was a marking system—a means of localizing cells and identifying them as to their origins, not only by their ultimately collective performance but also individually, throughout the course of aggregation and tissue formation. However,



Figure 11. Section through a group of composite aggregates compounded from mesonephros and cartilage-forming cells. Note the central core of cartilage and outer capsule of nephric epithelium.

the basic similarity between all types of cells in the chicks embryo, when dispersed or freshly aggregated, seemed to bar further progress with this issue.

Heterologous cell aggregates

The obstacle was overcome, and the analysis of the whole problem was encouragingly advanced, by the finding that cells from mouse embryos could be co-aggregated with cells from chick embryos and compounded into chimaeric tissues (Moscona, 1957, 1959a, 1961). Due to various morphological differences between cells from these two species (Wolff, 1954), they could be individually identified even when completely commingled. Cells from one species thus served as markers against those of the other. Simultaneously this system offered a means for examining how generally valid the postulated premises were—whether the cell properties involved were in principle comparable even across generic differences.

The practical expectation in taking up these heterologous systems was that, within the intergeneric cell compounds, the cells would associate in accordance with histological identities and kinships, irrespective of different generic derivations, *i.e.*, that cells from like tissues—though from different species—might join to form a mutual fabric, while cells from different tissues would form separate groupings. If borne out, this would not only confirm our premise but might also suggest further means of inquiry, particularly into the nature of the cues and recognition mechanisms that guide cells in their histogenetic maneuvers.

The following tests were carried out. First, co-aggregates were compounded of mouse and chick cells derived from *similar* tissue (heterologous-isotypic combinations), and their architecture was examined. It was, indeed, found that cells from both species cooperated in constructing chimaeric tissues. For example, aggregates compounded of intermingled neural-retina cells from chick and mouse embryos of comparable stages of development consisted of tissue made up of cells from both species (Figure 12). Evidently generic distance did not adversely affect the ability of these histogenetically affiliated cells to establish mutually acceptable, chimaeric fabrics. This point was fully borne out in other heterologous combinations in which it was possible to match the cells as to functional kinship and stage of development. For instance, intermingled cartilage-forming cells from both species produced typically identifiable cartilage in which the cells from both animals were closely interspersed and bound by a common matrix (Figure 13). Such histochimaeras were maintained in culture for several weeks without noticeable incompatibility between the cells.

In another series of experiments the alternative situation was

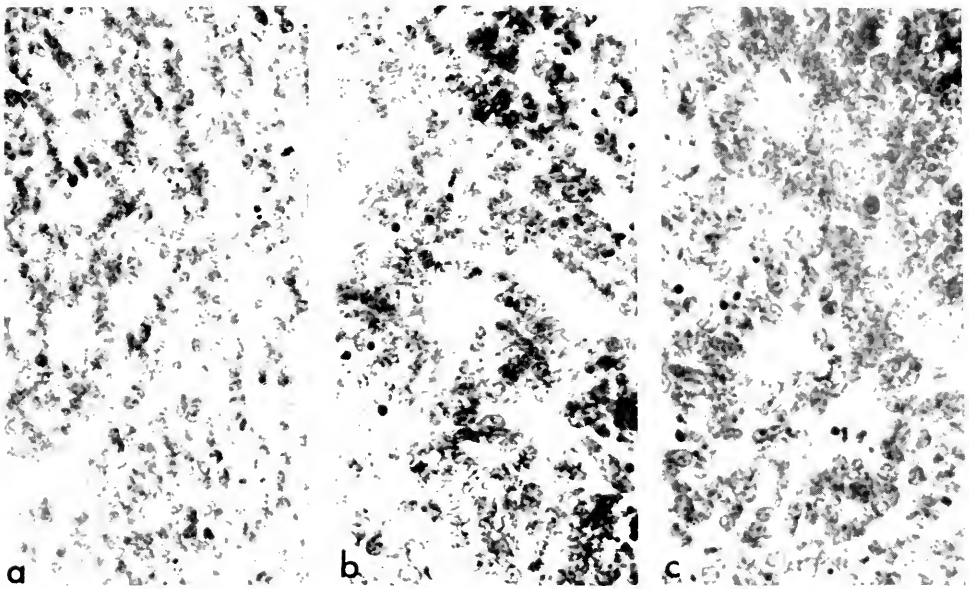

Figure 12. Histological sections through neural-retina cell aggregates compounded of chick embryonic cells (a), mouse embryonic cells (c), and intermingled cells from both (b). The mouse-cell nuclei are larger and stain darker.

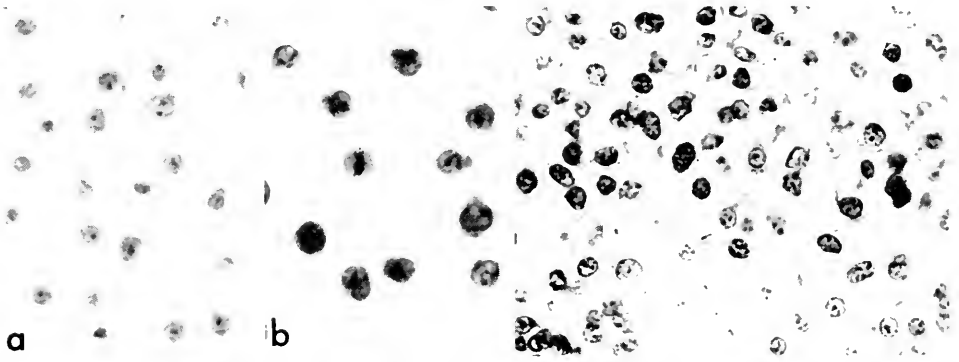

Figure 13. a. Chick cartilage-forming cells; b. mouse cartilage-forming cells; c. section through a composite aggregate, showing chimeric cartilage.

tested. Cells from two *different* tissues—one tissue from chick embryos, the other from mouse (heterologous-heterotypic combinations)—were mixed and compounded in rotating cultures. In all such combinations the cells from each tissue invariably became grouped separately. Although in early aggregates the cells were completely interspersed without recognizable order, in 24 hours they were found grouped and arranged in distinct regions. For example, in composite aggregates compounded of chick kidney cells and mouse cartilage-forming cells,

the chick cells became organized into kidney tubules; the mouse cells formed cartilage (Figure 14). In other words, cells of each type—and, in this case, of each species—congregated separately into functional groupings. Careful examination revealed no noticeable interconversion of cells from one type into the other; in spite of the close intermingling, the cells retained their original histogenetic identities and grouping preferences (Moscona, 1957a; Auerbach and Grobstein, 1958; see also Scott, 1959).

These results with rotation-compounded aggregates parallel completely those previously obtained in self-aggregating systems, and they may be considered as firmly supporting the thesis that motivated the tests. In confirming the retention by cells—under the conditions employed—of pre-established developmental traits, they solidly support the conclusions about selective sorting out and grouping of compounded cells. They also disclose that the cellular activities and the intercellular mechanisms involved in bringing about preferential grouping and regional assortment reflect the type-identities of cells more closely than their generic affiliations. It might be pointed out here that the interpretation of cellular grouping in terms of preferential, type-specific interactions conforms well with data from studies on the distribution of cells injected into the organism (Weiss and Andres, 1952), and particularly with the results of repopulation of radiation-injured tissues (Billingham, 1959). The successful implantation of rat blood cells in the bone marrow of irradiated mice (Ford *et al.*, 1956) suggests that not only under conditions of culture but in the organism as well the properties involved in selective grouping of cells may be effective across generic distances.

At this point a parenthetical note seems indicated regarding the retention by dispersed and aggregated cells of their pre-dissociation identities and prospective functions. The material dealt with here relates to cells at stages of development at which their developmental fate had presumably been stabilized. Therefore the possibility must not be excluded that with cells from earlier stages different results

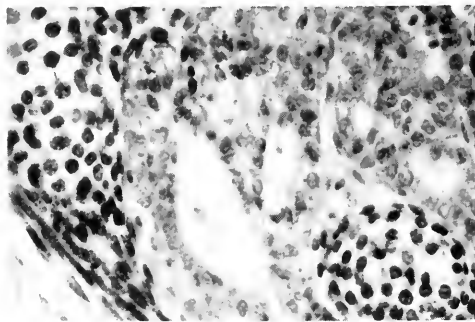

Figure 14. Part of an aggregate compounded of mouse cartilage-forming cells and chick mesonephros cells. Note the grouping of cells from each species according to their histogenetic function.

might obtain. Furthermore, the experimental procedures described here in connection with work on histogenesis of aggregates were designed for minimal interference with the normal range of cellular reactions. There is growing evidence that exposure of cells to conditions capable of profoundly interfering with certain aspects of their metabolic functions can elicit reactions normally not displayed (Fell, 1956; Weiss and James, 1955; Murray, 1957; Wilde, 1958; Bridges and Pritchard, 1958; Flickinger, 1959; Moscona, 1957b, 1959b; Barth and Barth, 1959; Benitez *et al.*, 1959; Ebert, 1959; Selye *et al.*, 1960).

Of particular interest are the mechanisms involved in selective cell groupings—the signals by means of which cells “communicate” and “recognize” each other (Burnet, 1961) and are caused to converge preferentially in distinct regions. This applies, naturally, not only to the processes in cell aggregates but also to comparable events in the embryo. Such cell activities must be presumed to involve interactions across a distance, and therefore to require the presence of a suitable continuum between the cells through which the signals may be transmitted or exchanged. In considering a practical approach to these at present largely hypothetical matters, the question arises of a possible distinction between the specific cell-affecting stimuli and the means of their transmission, *i.e.*, between the signals and the cell-interconnecting communication system. Such a distinction, if true, would be methodologically very useful. This, however, may be an oversimplified expectation. Starting with the working assumption that the cell-linking continuum is represented by the extracellular material (ECM), it is, of course, possible that this material functions merely to bind cells together and provides a mechanical substratum for their movements. However, taking into account the available snippets of pertinent information referred to above, one is led to assume that this may be only a part of its function—that, in linking and interconnecting cells, ECM provides also the intercellular continuum by which stimuli may be transferred and activities of cells coordinated. Such stimuli may have a simple chemical basis, such as differentials in the concentration or diffusion of cell-affecting molecules, or they may derive from the physico-chemical characteristics of ECM (Grobstein, 1954; Moscona, 1959a). Being a cell product, ECM may be endowed with cell-specific traits, and its molecular architecture and composition may thereby vary with differences in cellular derivation. Thus ECM may carry to the intercellular environment some of the marks responsible for identities or diversities of cells, and play a role in their mutual “recognition” and histogenetic interactions.

The purpose of these entirely speculative notions is primarily heuristic. The chief justification for advancing them now is that, being admissible in the light of available knowledge, they direct us to experi-

mental steps toward the study of cell interactions and organization; and that the means for their exploration are available in the methodology of tissue synthesis from dissociated cells.

In summary: *In vitro* methods afford advantageous experimental approaches to various aspects of cellular interactions in relation to histogenetic processes. Recently available procedures make it feasible to compound dissociated cells, in various combinations and under rigorously controllable conditions, into developmentally effective multicellular systems. The events of the process and the products of cellular aggregation can be evaluated in precise terms. Cell aggregates vary characteristically and consistently with different types of cells and stages of development. Histogenetic cohesion of cells has been found to depend on thermo-sensitive processes. It is suggested that morphogenetic cell contacts are mediated by specific products elaborated by cells and accumulating between them. It is further proposed that such extracellular materials may be involved in the processes of sorting out, preferential convergence, and type-specific grouping of cells in aggregates, by providing a cell-linking continuum through which distance interactions may take place.

References

- Abercrombie, M., 1958. "Exchanges between Cells," in McElroy, W., and Glass, B., eds., *The Chemical Basis of Development* (Baltimore, Johns Hopkins Press).
- Auerbach, R., and Grobstein, C., 1958. "Inductive Interaction of Embryonic Tissues after Dissociation and Reaggregation," *Exp. Cell Res.* 15, 384.
- Barth, L. G., and Barth, L. J., 1959. "Differentiation of Cells of the *Rana pipiens* Gastrula in Unconditioned Medium," *J. Embryol. Exp. Morph.* 7, 210.
- Benitez, H., Murray, M. R., and Chargaff, E., 1959. "Heteromorphic Change of Adult Fibroblasts by Ribonucleoproteins," *J. Biophys. Biochem. Cytol.* 5, 25.
- Billingham, R., 1959. "Reaction of Grafts against Their Hosts." *Science* 130, 947.
- Brachet, J., 1959. "Nouvelles Observations sur les Effets de la Ribonucléase *in vivo* sur les Oeufs de Batraciens." *Acta Embryol. Morph. Exp.* 2, 107.
- Bridges, J. B., and Pritchard, J. J., 1958. "Bone and Cartilage Induction in the Rabbit," *J. Anat.* 92, 28.
- Burnet, F. M., 1961. "Immunological Recognition of Self," *Science* 133, 307.
- Conklin, E. G., 1951. "Cleavage and Differentiation in Marine Eggs," *Ann. N. Y. Acad. Sci.* 51, 1282.
- Curtis, A. S. G., 1957. "The Role of Calcium in Cell Aggregation of *Xenopus* Embryos," *Proc. Roy. Phys. Soc. Edin.* 26, 25.
- Danielli, J. F., 1958. *Surface Phenomena in Chemistry and Biology* (N. Y., Pergamon).
- Ebert, J. D., 1959. "The Formation of Muscle and Muscle-Like Elements in the Chorioallantoic Membrane following Inoculation of a Mixture of Cardiac Microsomes and Rous Sarcoma Virus," *J. Exp. Zool.* 142, 587.
- Edds, M. V., 1958. "Origin and Structure of Intercellular Matrix," in McElroy, W., and Glass, B., eds., *The Chemical Basis of Development* (Baltimore, Johns Hopkins Press).

- Fell, H. B., 1957. "The Future of Tissue Culture in Relation to Morphology," *J. Nat. Cancer Inst.* 19, 643.
- Fisher, H. W., Puck, T. T., and Sato, G., 1958. "Molecular Growth Requirements of Single Mammalian Cells: The Action of Fetuin in Promoting Cell Attachment to Glass," *Proc. Nat. Acad. Sci.* 44, 4.
- Fisher, H. W., Puck, T. T., and Sato, G., 1959. "Molecular Growth Requirements of Single Mammalian Cells, III: Quantitative Colonial Growth of Single S3 Cells in a Medium Containing Synthetic Small Molecular Constituents and Two Purified Protein Fractions," *J. Exp. Med.* 109, 649.
- Flickinger, R. A., 1959. "A Gradient of Protein Synthesis in *Planaria* and Reversal of Axial Polarity of Regenerates," *Growth* 23, 251.
- Ford, C. E., Hamerton, J. L., Barnes, D. W. H., and Loutit, J. F., 1956. "Cytological Identification of Radiation-Chimaeras," *Nature* 177, 452.
- Grobstein, C., 1954. "Tissue Interaction in the Morphogenesis of Mouse Embryonic Rudiments *in vitro*," in Rudnik, D., ed., *Aspects of Synthesis and Order in Growth* (Princeton, N. J., Princeton U. Press).
- Grobstein, C. G., and Zwilling, E., 1953. "Modification of Growth and Differentiation of Chorio-Allantoic Grafts of Chick Blastoderm Pieces after Cultivation at a Glass-Clot Interface," *J. Exp. Zool.* 122, 259.
- Holtzer, H., Abbott, J., Lash, J., and Holtzer, S., 1960. "Loss of Phenotypic Traits by Differentiated Cells *in vitro*," *Science* 132, 1494.
- Lieberman, I., Lamy, F., and Ove, P., 1959. "Nonidentity of Fetuin and Protein Growth (Flattening) Factor," *Science* 129, 43.
- Moscona, A. A., 1952. "Cell Suspensions from Organ Rudiments of Chick Embryos," *Exp. Cell Res.* 3, 535.
- Moscona, A. A., 1956. "Development of Heterotypic Combinations of Dissociated Embryonic Chick Cells," *Proc. Soc. Exptl. Biol. Med.* 92, 410.
- Moscona, A. A., 1957a. "The Development *in vitro* of Chimeric Aggregates of Dissociated Embryonic Chick and Mouse Cells," *Proc. Nat. Acad. Sci.* 43, 184.
- Moscona, A. A., 1957b. "Formation of Lentoids by Dissociated Retinal Cells of the Chick Embryo," *Science* 125, 598.
- Moscona, A. A., 1959a. "Patterns and Mechanisms of Tissue Reconstruction from Dissociated Cells," 18th Growth Symp. (Princeton, N. J., Princeton U. Press), in press.
- Moscona, A. A., 1959b. "Squamous Metaplasia and Keratinization of Chorionic Epithelium of the Chick Embryo in Egg and in Culture," *Dev. Biol.* 1, 1.
- Moscona, A. A., 1960. "Rotation-Mediated Histogenetic Aggregation of Dissociated Cells: A Quantifiable Approach to Cell-Interactions *in vitro*," *Exp. Cell Res.*, 22, 455.
- Moscona, A., and Moscona, H., 1952. "The Dissociation and Aggregation of Cells from Organ Rudiments of the Early Chick Embryo," *J. Anat.* 86, 287.
- Moscona, A. A., and Weis, T., 1961. To be published.
- Moss, M. I., 1960. "Experimental Induction of Osteogenesis," in *Calcification in Biological System*, A.A.A.S. Publication No. 64.
- Niu, M. C., 1956. "New Approaches to the Problem of Embryonic Induction," in Rudnik, D., ed., *Cellular Mechanisms in Differentiation and Growth* (Princeton, N. J., Princeton U. Press).
- Scott, Sr. Florence M., 1959. "Tissue Affinity in *Amarocidium*, I: Aggregation of Dissociated Fragments and Their Integration into One Organism," *Acta Embryol. Morph. Exp.* 3, 209.
- Selye, H., Lemire, Y., and Bajusz, E., 1960. "Induction of Bone, Cartilage and Hemopoietic Tissue by Subcutaneously Implanted Tissue Diaphragms," *Roux' Arch. Entw. Med.* 151, 572.

- Steinberg, M. S., 1958. "On the Chemical Bonds between Animal Cells: A Mechanism for Type-Specific Association," *Amer. Nat.* 93, 65.
- Trinkaus, J. P., 1956. "The Differentiation of Tissue Cells," *Amer. Nat.* 90, 273.
- Weiss, L., 1960. "The Adhesion of Cells," *Inter. Rev. Cytol.* 9, 187.
- Weiss, P., 1945. "Experiments on Cell and Axon Orientation *in vitro*: The Role of Colloidal Exudates in Tissue Organization," *J. Exp. Zool.* 100, 353.
- Weiss, P., 1958. "Cell Contact," *Inter. Rev. Cytol.* 7, 391.
- Weiss, P., and Andres, G., 1952. "Experiments on the Fate of Embryonic Cells (Chick) Disseminated by the Vascular Route," *J. Exp. Zool.* 121, 449.
- Weiss, P., and James, R., 1955. "Skin Metaplasia *in vitro* Induced by Brief Exposure to Vitamin A," *Exp. Cell Res. Suppl.* 3, 381.
- Wilde, C. E., 1958. Differentiation in Response to the Biochemical Environment," in Rudnik, D., ed., *Cell, Organism, and Milieu* (N. Y., Ronald Press).
- Willmer, E. N., 1961. "Steroids and Cell Surfaces," *Biol. Rev.* 36, in press.
- Wolff, E., 1954. "Potentialités et affinités des tissus révélées par la culture *in vitro* d'organes en associations hétérogènes et xénoplastiques," *Bull. Soc. Zool.* 79, 357.

CELLULAR DIFFERENTIATION IN THE SLIME MOLD*

Maurice Sussman

BRANDEIS UNIVERSITY

In one respect, at least, the cellular slime molds are schizoidal organisms. (Some would gaily extend the classification to cover their investigators as well; I shall not.) As long as slime-mold myxamoebae continue to grow, they remain typical Protista, independent of one another to the same extent as the members of any microbial population. Each cell can act individually as the functional unit of existence, of reproduction, genetic transmission, selection, and, indeed, of evolution. But once having ceased to grow, the cells collect in multicellular aggregates and assume a metaphytic or metazoan (depending on one's bias) condition. They submerge their individuality in an organized multicellular structure which becomes the new functional unit of existence.

In *Dictyostelium discoideum*, each aggregate is transformed into a slug-shaped pseudoplasmodium which migrates over the substratum and ultimately constructs a fruiting body composed of a spore mass and a stalk and basal disc. The cells inhabiting these regions are morphologically and functionally distinguishable and display a degree of phenotypic heterogeneity qualitatively commensurate with what one would ordinarily call cellular differentiation in a higher plant or animal (Raper, 1941; Raper and Fennell, 1952). Phenotypic heterogeneity is also apparent much earlier in the morphogenetic sequence, as the cells proceed through the stages of aggregation and pseudoplasmodial migration (Bonner, 1949, 1952, 1957; Bonner *et al.*, 1955; Krivanek and Krivanek, 1956, 1958; Raper, 1940, 1941). These events are accompanied by the appearance of antigenically active macromolecules

* The work reported in this paper was supported by grants from the National Cancer Institute and the National Science Foundation.

(Gregg, 1956, 1960; Sonneborn *et al.*, 1960) and by dramatic changes in enzyme activities (Wright and Anderson, 1958, 1959).

Recently Drs. Raquel Sussman, H. L. Ennis, and I have been involved in the study of an example of phenotypic heterogeneity among exponentially growing myxamoebae—that is to say, long before the onset of the morphogenetic sequence. When strain NC-4, a haploid representative of *D. discoideum*, is grown in association with *Aerobacter aerogenes* or *Escherichia coli* on a variety of media, one can recognize two cell types on the bases of size, flatness, vacuolation, and motility. They have been termed I-cells and R-cells and have been found to be present throughout the log phase in a steady-state ratio of about 1:2000, respectively (Ennis and Sussman, 1958a; Sussman and Ennis, 1959; Sussman *et al.*, 1960).

Although the definition of the two cell types rests only upon morphological grounds and is independent of other attributes, the differentiation extends to their morphogenetic capacities as well. Specifically, a high proportion of I-cells can initiate the formation of aggregates among their neighbors, whereas the R-cells, under identical test conditions, cannot. Finally, the I-cells demonstrate remarkable genetic properties, as yet only partly understood, which point to a sexual or parasexual function.

In what follows I shall attempt to summarize the information bearing upon the aforementioned properties, but with the qualification that the information is in some respects fragmentary and in all respects incomplete.

The morphological distinctions

Typical I-cells and R-cells are shown in Figure 1, and the gamut of morphological differences thus far observed is summarized in Table I. The initial distinction is made by surveying myxamoebae at 100X magnification. Most of the cells are small (about 10 to 20 microns in mean diameter) and are hemispherical in contour, but occasionally one's attention is caught by a large (about 30 to 50 microns), very flat, and highly vacuolated myxamoeba. Examination under 400X magnification confirms the identification of the I-cell by revealing its heavy granulation and extreme and characteristic pseudopodial activity. Although present in small proportion, these cells can be recognized and enumerated by independent observers with high precision.

As Table I indicates, other differences exist. I-cells frequently engulf their neighbors—a practice reminiscent of the plasmodia of true slime molds. An appreciable number are multinucleate, as many as five nuclei having been detected in a single cell, whereas R-cells are uninucleate (or binucleate immediately prior to cell division). When uni-

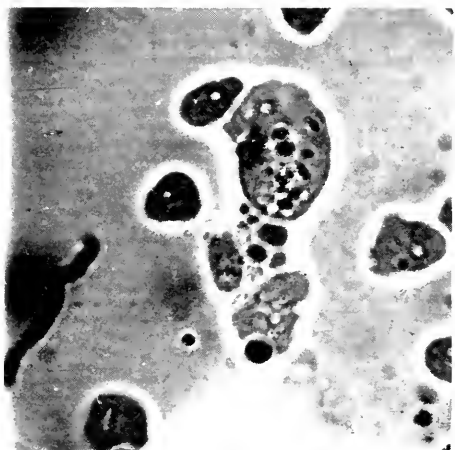

a



b



d

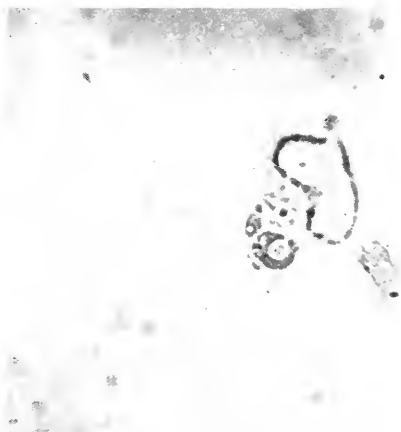

e

Figure 1. Photomicrographs of I-cells and R-cells. a. The cells had adhered to a glass surface under a layer of salt solution. c. The cells were pressed between a cover slip and agar. Note that the I-cell has engulfed one of its neighbors. b, d, and e. The cells had adhered to an agar substratum.

TABLE I

Differences between I-cells and R-cells

Criterion	I-Cells	R-Cells
Morphology	Large, flat, heavily granulated and vacuolated	Small, hemispherical, lightly granulated and vacuolated
Motility	Very active, with explosive pseudopodia and lobopodia	Much less active
Inclusions	Engulfed cells very common	Engulfed cells very rare
Nuclear constitution	One large or two to five small nuclei	One small nucleus or two small nuclei, immediately before cell division
Modes of cell division	Ternary or quaternary fissions to yield three or four daughters, observed very frequently	Only binary fissions were observed
Morphogenetic Potential	Under identical test conditions, I-cells display a high capacity to initiate centers of aggregation, whereas R-cells display a low or negligible one.	
Genetic stability	All of the clones derived from R-cells and about 90 per cent of those from I-cells attain identical phenotypic compositions with respect to size distribution, ploidy, I-cell frequency, and aggregative performance. But 10 per cent of the clones derived from I-cells are heritably anomalous with respect to these criteria.	

nucleate, the I-cell nucleus is considerably larger than that of R-cells or multinucleate I-cells. R-cell metaphase figures fixed with osmic acid and stained with aceto-orcein by the method of Ross (1959) invariably display the haploid number (7) of chromosomes. The ploidy of the I-cells is still unknown, but the technical problems attendant upon isolating an I-cell, fixing it at metaphase, and staining it can probably be solved so as to yield an unequivocal answer.

At present it is unclear whether the I-cells and R-cells are discrete entities or merely represent extremes in a continuum of cell sizes and correlated properties. A crucial distinction between these alternatives ought to be provided by the determination of the size distribution of a few hundred thousand myxamoebae, but this is not technically feasible now. In any event, the setting aside of the I-cells as objects of special study, whether chosen on arbitrary grounds or not, has shown them to differ from the remainder of the population in many interesting and apparently important ways which demand further elucidation. On this

basis alone, the distinction between the two classes would seem to be justified.

Morphogenetic capacities of I-cells and R-cells

Figure 2 shows a series of time-lapse photomicrographs of a typical aggregation carried out by cells on washed agar. The arrow in the first photograph points to the centrally located I-cell, initially approached by only one of its nearest neighbors but later by others until a clump has formed about it. Meanwhile peripheral clumps have appeared—a situation not encountered during the pre-aggregative period. Suddenly myxamoebae within and outside the clumps elongate, ramified streams take shape, and the aggregative pattern now emerges with clarity. The center of the aggregation is seen to coincide with the last recognizable position of the I-cell. About 50 per cent of the aggregates studied have shown an identical course of events. The remaining 50 per cent were quite similar, save that the center formed very near to but not at the I-cell.

The possibility that I-cells can initiate centers of aggregation, suggested by these photographs, could be confirmed in a more direct manner. When replicate samples of 250 myxamoebae were incubated at high density on agar, only about 10 per cent of them aggregated. The addition of an I-cell to each sample increased the incidence to about 70 per cent (80 per cent in the best experiment), whereas the addition of R-cells left the background incidence of aggregates unaffected. The data supported two general conclusions:

1. That a single cell can initiate the formation of an aggregate—a conclusion strongly indicated by prior results (Sussman and Noel, 1952; Sussman, 1952, 1956) but established directly for the first time in these experiments.

2. That under identical conditions of assay, I-cells possess a high level of initiative capacity and R-cells do not.

Given this degree of morphogenetic heterogeneity, one can ask if the presence of I-cells does not account for all the aggregates that a population of myxamoebae can produce. Under some conditions, at least, the I-cells do appear to account for all the observed aggregations. Thus, when NC-4 myxamoebae, harvested from the stationary phase and washed free of bacteria, are dispensed on washed agar, the number of aggregative centers (one per 2,200 cells) is in close agreement with the number of I-cells (one per 1,940 cells). The incidence of aggregates among small population samples can be predicted with extremely high accuracy on the basis of whether an I-cell is present or not. Removal of I-cells, if done early enough, appears to stop aggregation (Ennis and Sussman, 1958a).



Figure 2. Time-lapse photomicrographs of an aggregation. The arrows point to the position of the I-cell (Sussman and Ennis, 1959).

Nevertheless, conditions can be arranged in such a way that aggregation need not require the presence of an I-cell. Thus a given number of myxamoebae, dispensed on washed agar to which had been added a cell-free extract obtained from cells already in the act of aggregation, formed more than ten times the number of centers ordinarily seen in the absence of the extract (Ennis and Sussman, 1958b). Yet a corresponding increase in the number of I-cells was not detected. The same result was obtained when wild-type myxamoebae were placed on one side of a thin agar membrane and, on the other, a huge number of cells of an aggregateless mutant strain, themselves unable to aggregate spontaneously. Again a multiplicity of centers was formed by the wild type without a corresponding increase in the number of I-cells.

Most interesting was the finding that R-cells, although unable to initiate centers among their developmental contemporaries (except under the special conditions described above), could still induce their developmental juniors to aggregate (Sussman and Ennis, 1959). Populations of R-cells, devoid of I-cells, were incubated on agar for 12 hours, a time by which aggregation would ordinarily have commenced. Single R-cells were abstracted and micro-manipulated to test populations newly laid down upon the agar (*i.e.*, 12 hours junior to the cells to be tested). After an additional 12 hours' incubation, about one of four of these test populations was found to have been induced to aggregate by the addition of older R-cells. Yet the samples from which the older R-cells were taken still displayed no signs of aggregation!

The fact that experimental conditions can be arranged so that myxamoebae other than I-cells initiate centers of aggregation raises the question of how important the latter may be under "natural conditions," *i.e.*, in the normal ecological niches occupied by *D. discoideum*. Unfortunately, very little of ecological significance is known about the cellular slime molds, save that they live in the soil, are associated with bacteria, and can be found in the forests of Virginia, the heaths of England, the golf courses of Wilmette, Illinois, and on the dung of white rabbits from Atlanta, Georgia (Raper and Thom, 1932; Sussman, 1956; Cohen, 1953). Only one micropedological photograph, taken by accident, attests to the fact that slime molds actually aggregate and fruit in nature (albeit, one could not conceive that they would not). Consequently it is impossible at present to assess this point.

Nevertheless, these results have suggested that the difference between the two cell types with respect to initiative capacity is not a qualitative but only a quantitative one. Perhaps the superior capacity of the I-cells is simply a reflection of their considerably greater size and possibly higher rate of general metabolic activity (as judged by motility, pseudopodial protrusions, vacuolar contraction). Experiments have demonstrated that the initiative signal can be conducted over consider-

able distances (Sussman and Ennis, 1959), and that the I-cell need only be in contact with its neighbors for a remarkably short time in order to exert its effect and make its subsequent removal irrelevant to the subsequent course of aggregation (Ennis and Sussman, 1958a). These and other experiments, as yet at a preliminary stage and unpublished, all point to the supposition that initiation involves the deposition of a diffusible substance which, taken up by the responder cells, induces the onset of aggregation. Though this is by no means certain and must be considered with great caution at present, it does seem the most likely mechanism. The different initiative capacities of I-cells and R-cells could then be ascribed to differential rates of production of the "initiator substance." Thus, at the cessation of growth and the start of the pre-aggregative period, the I-cells would produce the material at a high rate and the R-cells at a low or negligible one. The rates of production by all the cells would increase with time. If, then, a local discontinuity in the concentration of the substance were necessary in order to signal the start of aggregation, the amount deposited by an I-cell would be discernible over the general noise level contributed by the R-cells. In contrast, the production of initiative material by no single R-cell would be sufficient to be distinguishable above the noise level of its developmental contemporaries, but it might be if that R-cell were in the presence of its developmental juniors.

At the moment these considerations are extremely speculative and can do nothing more than suggest what investigative approaches might be fruitful in the immediate future. It seems to us that they point compellingly to the need for a biochemical definition of the initiative act. Several possible bioassay systems are available for the detection of the hypothetical initiator substance and could be employed in its purification and identification.

Genetic properties

The phenotypic composition of clones derived from R-cells. Clones derived from R-cells have been examined with respect to four criteria. They are: general cell size distribution, I-cell frequency, ploidy, and aggregative performance. The latter term refers to how many aggregative centers given numbers of cells can form under certain specified conditions, and at what population densities they can do so.

Thus far, all those examined have appeared to be identical with one another and with the carried stock of *D. discoideum* NC-4 (haploid), which is itself maintained in a homogeneous state by periodic re-isolation from single, randomly selected clones. Figure 3 illustrates the size distribution observed among vegetative myxamoebae, and Figure 4 shows corresponding data for spores taken from the fruits.

Histograms of a stable diploid strain (RA) of *D. discoideum* are included for purposes of comparison. The NC-4 amoebae are seen to be unimodally distributed about a mean diameter of 16 microns, with a scattering of a few cells far up into the diploid size range. The frequency of individuals classifiable as I-cells remains at a steady-state level of 1:2000 in both the R-cell clones and the carried NC-4 stock. Ploidy was determined by the examination of metaphase figures fixed

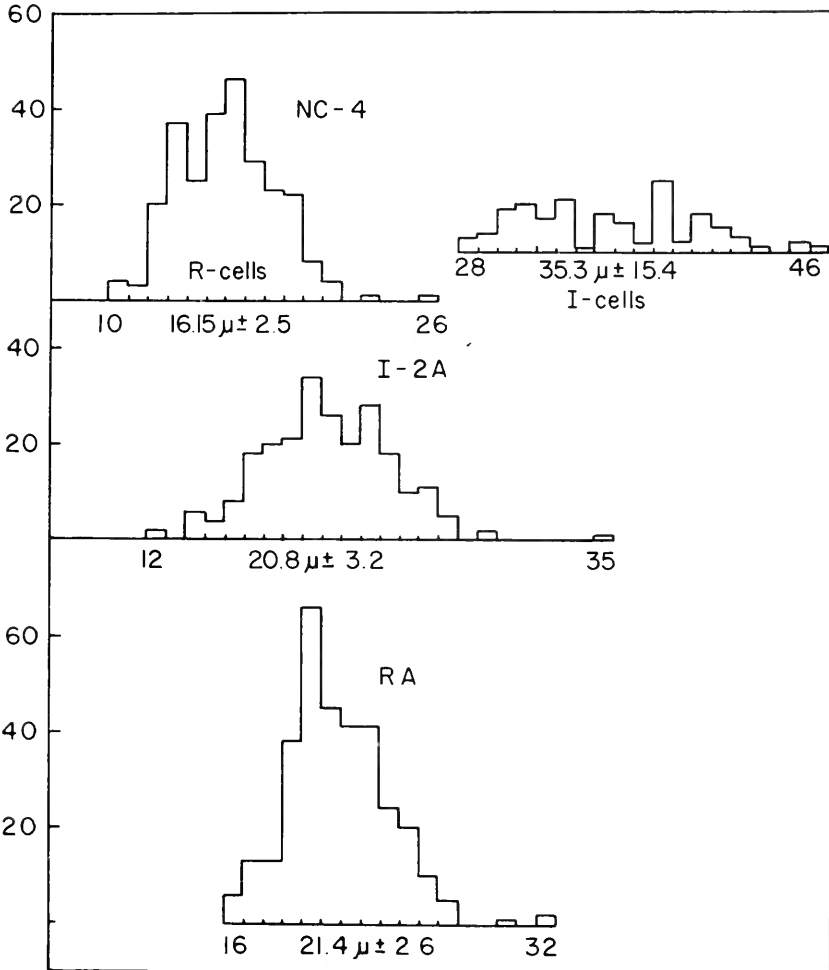

Figure 3. Size distributions of myxamoebae (Sussman *et al.*, 1960). Abscissae: mean cell diameters. Ordinates: number of cells. The means of mean diameters and standard deviations are given for each strain. The insert at the upper right is a histogram of those cells first recognized as I-cells by inspection and then sized. The dotted line at the upper left was obtained by random sampling in the usual manner.

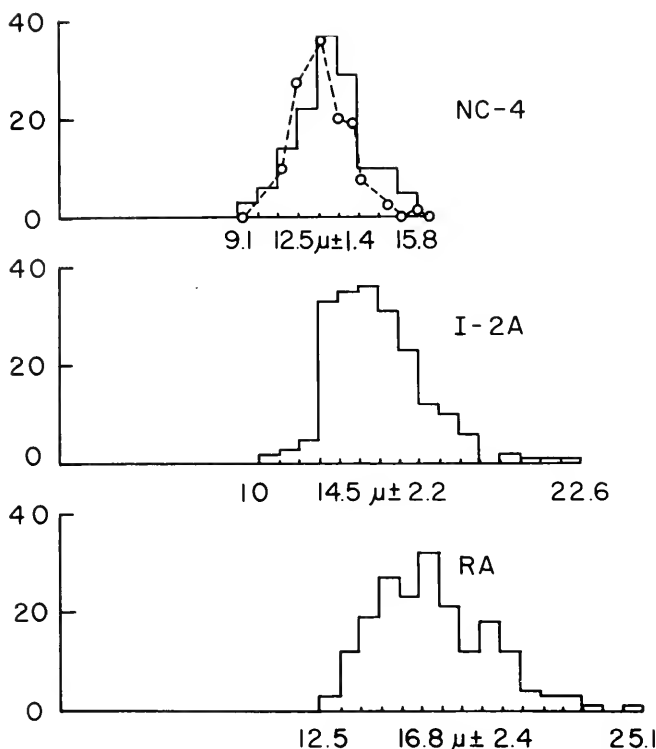

Figure 4. Size distributions of spores. Abscissae: the sums of major and minor diameters. Ordinates: numbers of spores. The mean sums and standard deviations are given for each strain. The histogram at the top was redrawn from data published by Bonner and Frascella (1953) for NC-4.

and stained with aceto-orcein (Ross, 1959). Only haploid chromosome sets were detected in the R-cell clones and the carried stock (as against only diploid sets in strain RA). The aggregative performances of a typical R-cell clone (R-3) and of the carried stock are shown in Figure 5. In both the response of center-formation to population density was the same, with the optimal density falling at about 200 cells per square millimeter. The ratio of centers formed at the optimal density to cells present was about 1:2100 in both instances.

The foregoing results indicate that I-cells arise from and during the growth of R-cells and attain a steady-state ratio of 1:2000 under the particular cultural conditions employed. Other and related properties (cell size, ploidy, aggregative performance) also follow an invariant pattern under these conditions.

The rate of appearance of the I-cells was crudely estimated by the null method of Luria and Delbruck (1943). For this purpose, one

grows replicate microcultures, each one starting from a very small inoculum of R-cells. After growth the replicates are scored for the presence of I-cells. From the proportion of those without I-cells and the mean number of cells per culture, one can calculate the rate of appearance. Seven experiments of this kind yielded a mean value of 2.2×10^{-4} I-cell appearances per R-cell division cycle. In other words, one I-cell appears during the time it takes 1,600 R-cells to grow and divide into 3,200.

The phenotypic composition of clones derived from I-cells. The progeny of I-cells, cultivated in clonal isolation, have been followed during the first five to ten generations of exponential growth by serial observations at frequent intervals or by time-lapse cinematography and once again after many generations and several subcultures. The results of this survey are:

1. The I-cell phenotype was lost by cell division only. About 10 to 15 per cent of the I-cells yielded no issue at all, and others experienced a lag of many hours before division. Such cells moved normally, fed

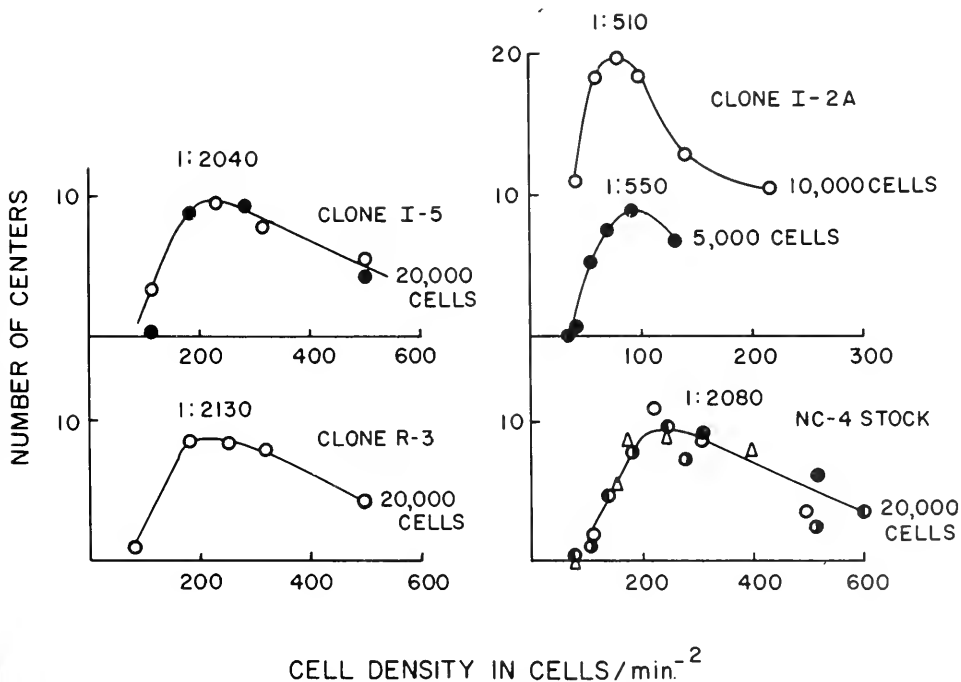

Figure 5. Aggregative performances of the working stock, NC-4, and clones derived from I-cells and an R-cell. The data for clone I-5 were obtained in two separate experiments, and the data for NC-4 in five experiments, and they illustrate the reliability of the assay. (Sussman *et al.*, 1960.)

upon bacteria, and even increased in size. They were never seen to revert to the R-cell phenotype except through cell division.

2. Cell division caused the I-cells to revert at a very high rate. Rarely did they breed true for a generation and yield two I-cell daughters. More commonly they bred "semiclonally" to give one daughter of each phenotype. The remainder reverted in the first generation by producing only R-cell daughters or cells of a size intermediate between the two (*i.e.*, in the diploid range seen in Figure 4).

3. Because of this instability, by the time the clones had reached the size of a few hundred individuals the proportion of I-cells declined to zero in practically all or to 1 to 2 per cent in just a few. Subsequent development caused 90 per cent of the clones to become indistinguishable from those derived from R-cells. That is, I-cells began to reappear as the clonal size exceeded 500 to 1,000 cells, and the ratio of I-cells to R-cells ultimately reached the usual steady-state level of 1:2000. The general cell-size distributions were the same as those shown for NC-4 in Figures 3 and 4. Aceto-orcein-stained squashes revealed the presence of haploid chromosome sets only. The aggregative performances, one example of which is seen in Figure 5, were indistinguishable from those of the R-cell clones or of the carried stock.

In contrast, 10 per cent of the clones derived from I-cells displayed anomalous properties. The anomalies:

1. Ploidy: Chromosome counts revealed that these clones were a mixture of haploid and diploid cells.

2. Size distribution: The presence of diploid cells was reflected in the altered size distributions both of spores and myxamoebae. For example, histograms of anomalous I-cell clone I-2A, shown in Figures 3 and 4, are seen to straddle both the haploid and diploid size ranges.

3. I-cell frequency: The proportion of amoebae classifiable as I-cells increased markedly. In clone I-2A the ratio is approximately 1:100; in others the frequency is somewhat less.

4. Aggregative performance: The anomalous clones formed many more centers of aggregation than the normal I-cell clones or clones derived from R-cells or the carried NC-4 stock. Moreover, they did so at markedly lower population densities. Figure 5 illustrates this.

It must be emphasized that these anomalies are inherited in very stable fashion through many subcultures and clonal reisolations; *i.e.*, the anomalous I-cell clones are true variant strains. The ploidal mixture can be derived from any cell in the population. That is to say, each cell possesses the genetic potential for yielding a population in which there is a rapid shuttling back and forth between the haplo-phase and the diplo-phase. Thus the anomalous I-cell clones inherit in very stable fashion a penchant for instability! Experiments have indicated that the

increased I-cell frequency stems partly from the increased stability of the phenotype in the immediate progeny of the anomalous I-cells but mostly from a ten-fold increase in the rate of appearance of I-cells during the growth of the anomalous R-cells. It is both interesting and comforting to note that the alteration of the I-cell frequency is accompanied by a change in the aggregative performance.

In summary, approximately one of 20,000 amoebae is an anomalous I-cell, and its descendants possess potentialities for ploidal transformation and aggregative performance which differ from those displayed by the descendants of all the other I-cells and R-cells. The proportion of anomalous cells is so low that it contributes negligibly to the over-all phenotypic make-up of the population, but it does represent a reservoir of genetic variation (particularly for the genesis of diploid cells) which could be of considerable importance.

Ross has recently reported the existence of stable haploid and diploid strains of *D. discoideum*, as evidenced by direct chromosome counts (1959). The anomalous I-cell clones are seen to constitute a third kind of population in which both haplophase and diplophase are represented in appreciable numbers and in which transformation between the two occurs at a high rate. It may thereby act as a bridge between the two stable varieties, permitting the selection of either from either.

Modes of cell division. The fission cycles of 35 or 40 I-cells and a few hundred R-cells have been recorded by time-lapse cinematography. The films divulged a most remarkable difference between the two, and this is illustrated by the frames reproduced in Figure 6. The recorded R-cell divisions were normal binary fissions without any exceptions, and about 50 per cent of the I-cell divisions were also of this nature, but the remainder were trinary or quaternary fissions to yield three or four daughters! The binary I-cell divisions yielded daughters one or both of which retained the parental phenotype. The multiple fissions resulted in the appearance of R-cell progeny.

Sex?

For the greater part of their existence as objects of biological investigation, the cellular slime molds have been thought to be celibate organisms. An early report of syngamy in *D. mucoroides* (Skupienski, 1918) was dismissed, largely on the basis of associated observational errors. In recent years Wilson (1952, 1953) published cytological data purporting to demonstrate the existence of syngamy and meiosis in *D. discoideum*, and he proposed a mandatory sexual addendum to its life cycle. Arguments raised by others (Sussman, 1955, 1956) and subsequent observations by Wilson and Ross (1957) were followed by a

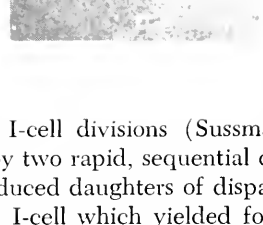
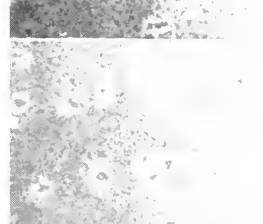
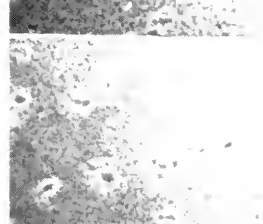
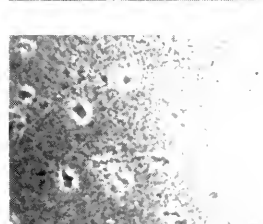
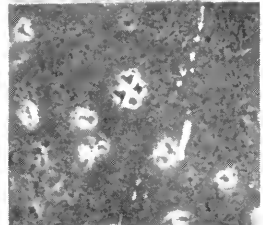
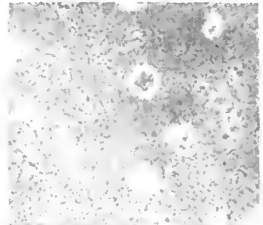
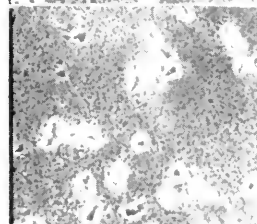
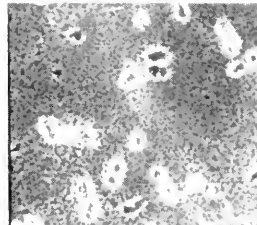
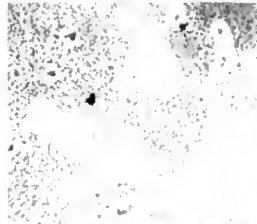
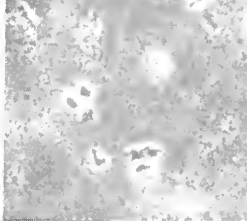
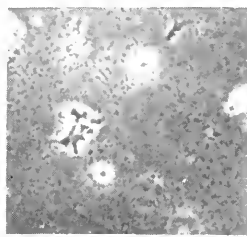

Figure 6. Examples of ternary and quarternary I-cell divisions (Sussman *et al.*, 1960). a. An I-cell yielded four daughters by two rapid, sequential divisions. One of the divisions was unequal and produced daughters of disparate size. b. Two rapid, sequential divisions of an I-cell which yielded four equal-sized daughters. c. A quarternary fission which yielded four equal-sized daughters. d. A ternary fission. The division at first appeared to be quarternary, but one of the fissions was abortive and the two halves remained as one cell.

modified scheme which assumed occasional syngamy and meiosis, only coincidental with and not causally related to the fruiting process, and perhaps requiring special conditions of cultivation (as is the case for a wide variety of fungi). These suppositions, too, have met with criticism (Bonner, 1959; Shaffer, 1958). Nevertheless, the cytological data, admittedly incomplete and to some extent equivocal, cannot be gainsaid simply by syllogistic pronouncements; they demand further elucidation, particularly at the genetic level.

Our own involvement in this problem at first centered upon attempts to test whether or not the morphogenetic sequence was coupled mandatorily to a sexual cycle, and the answer appeared to be that it was not. In the course of these investigations, a systematic search was carried out for evidence of genetic recombination. The mutants that were employed differed from the wild type by fruit morphology or pigmentation or by the possession of morphogenetic deficiencies (*i.e.*, aggregateless, fruitless). Unfortunately the primitive state of nutritional control precluded the selection of adequate biochemically deficient stocks, and initial attempts to obtain drug-resistant mutants yielded only unstable dauermodifikationen. Thus it was impossible to select for recombinants by methods used so successfully in *Neurospora*, *E. coli*, and other Protista, and examination of clones by random population sampling remained as the only feasible method. The mutant stocks were grown together or allowed to form mixed fruiting bodies under a variety of environmental conditions. The clones obtained from the samples of these mixtures were invariably of either parental type and displayed no sign of recombination. It was concluded that if sexuality did operate, zygotes and recombinants must be exceedingly rare ($<10^{-4}$ cells), or there must be mating types which we did not possess, or all our genetic markers were infertile aberrations (Sussman, 1956).

The discovery of the anomalous I-cell clones provided the impetus to make another attempt at finding genetic recombination. The rapid shift between the haplo-phase and diplo-phase in these clones made it likely that if sexuality were operative as a rare event, zygotes and recombinants would be encountered at higher frequency here than in the total myxamoeboid population. A precedent is found in strains (Hfr) of *Escherichia coli* which display a high frequency of genetic recombination and are derived from the low-frequency (F^+) stocks. Accordingly, anomalous clones were obtained from mutant strains by micromanipulation of I-cells in order to employ them as parents in crossing attempts. The results of the initial experiment will be described.

Mutant stock br-1 (brown) aggregates and fruits normally, and the spore masses accumulate the normal yellow pigment. However, it produces an additional, soluble, red-brown pigment which deeply colors

the agar and subsequently turns the spore masses brown. The genotype can be designated $Y^+ br^-$. Mutant wh-1 (white) also aggregates and fruits normally but fails to produce the wild-type (yellow) pigment. Its genotype is therefore $Y^- br^+$. An anomalous I-cell clone was isolated from each mutant, and these were grown in mixed culture. A random sample was plated, and one clone of about 2,600 was wild type. This was presumed to be a heterozygote ($Y^+Y^- br^+br^-$) in which presence of the yellow pigment and absence of the brown were dominant. Replating this stock yielded an overwhelming majority of wild-type clones but also a low frequency of segregants (about 0.1 per cent). These were of three phenotypes: the parental brown ($Y^+ br^-$); the parental white ($Y^- br^+$); and a recombinant type which produced white spore masses at first and then the red-brown pigment afterward ($Y^- br^-$). The fourth segregant would be $Y^+ br^+$ (*i.e.*, wild type) and hence indistinguishable from the heterozygote. Upon subculture, the segregant clones bred true to type, but the heterozygote continued to throw segregants at low frequency. The plating of either of the parental stocks and of stable haploid or diploid wild-type strains has never produced comparable variation.

Chromosome counts and the size distributions of spores and myxamoebae support the idea that the foregoing represents genetic recombination. Figure 7 summarizes the spore and myxamoeboid size distributions obtained from the parental stocks, the heterozygote, and segregant isolates. By comparison with the original mutants, the anomalous I-cell clones derived from them are seen to contain an appreciable contingent of cells in the diploid size range, and this fact is confirmed by chromosome counts of stained preparations. The presumed heterozygote distribution is well over toward the diploid range, as it obviously would have to be to maintain a largely wild phenotype by hiding the recessive markers, and this too is confirmed by chromosome counts. Two of the segregant clones, in contrast, appear to be stable haploid stocks like the original mutants, and the third apparently remained anomalous.

To recapitulate the experimental findings: Wild-type clones are undetectable in pure cultures of the original brown and white mutant stocks or in mixed cultures of the two; wild-type revertants have not been observed in pure cultures of the anomalous I-cell clones derived from these mutants; however, clones bearing the wild phenotype are derivable from mixed cultures of the anomalous clones; such wild-type stocks are not stable but throw segregant clones at low frequency, and these bear either of the parental phenotypes or a recombinant phenotype. Taken together with the chromosome counts and cell-size distributions, the data seem to us to suggest compellingly that a sexual or parasexual system is operative here. Obviously, more genetic markers

and multiple marked stocks will have to be employed before this conclusion can be accepted without reservation. It will then be of interest to learn at what times of the life cycle and under what conditions syngamy, karyogamy, and reduction divisions occur. Is the system complicated by the existence of mating types or fertility factors? Does the reduction in ploidy that leads to the appearance of parental segregants and recombinants operate via a meiotic or a parasexual process? At this writing, mating stocks with conveniently scorable genetic markers are being synthesized, and we hope to provide the answers to these questions in the near future.

References

- Bonner, J. T., 1949. "Demonstration of Acrasin in the Later Stages of Development of the Slime Mold, *D. discoideum*," *J. Exp. Zool.* 110, 259.
- Bonner, J. T., 1952. "The Pattern of Differentiation in Amoeboid Slime Molds," *Amer. Nat.* 86, 79.
- Bonner, J. T., 1957. "A Theory of the Control of Differentiation in the Cellular Slime Molds," *Quart. Rev. Biol.* 32, 232.
- Bonner, J. T., 1959. *The Cellular Slime Molds*, pp. 38-41. (Princeton, N. J., Princeton U. Press).
- Bonner, J. T., and Frascella, E., 1953. "Variations in Cell Size During Development of *D. discoideum*," *Biol. Bull.* 104, 297.
- Bonner, J. T., Chiquoine, A. D., and Kolderie, M. Q., 1955. "A Histochemical Study of Differentiation in the Cellular Slime Molds," *J. Exp. Zool.* 130, 133.
- Cohen, A. L., 1953. "The Isolation and Culture of Opsimorphic Organisms, I," *Ann. N.Y. Acad. Sci.* 56, 938.
- Ennis, H. L., and Sussman, M., 1958a. "The Initiator Cell for Slime Mold Aggregation," *Proc. Nat. Acad. Sci.* 44, 401.
- Ennis, H. L., and Sussman, M., 1958b. "Synergistic Morphogenesis by Mixtures of *D. discoideum* Wild Type and Aggregateless Mutants," *J. Gen. Microbiol.* 18, 433.
- Gregg, J. H., 1956. "Serological Investigations of Cell Adhesion in the Slime Molds," *J. Gen. Physiol.* 39, 813.
- Gregg, J. H., 1960. "Surface Antigen Dynamics in the Slime Mold, *D. discoideum*," *Biol. Bull.* 118, 70.
- Gregg, J. H., and Trygstad, C. W., 1958. "Surface Antigen Defects in Aggregateless Variants of the Slime Mold, *D. discoideum*," *Exp. Cell. Res.* 15, 358.
- Krivanek, J. O., and Krivanek, R. C., 1956. "Alkaline Phosphatase Activity in the Developing Slime Mold, *D. discoideum*," *J. Exp. Zool.* 133, 459.
- Krivanek, J. O., and Krivanek, R. C., 1958. "Histochemical Localization of Certain Biochemical Intermediates and Enzymes in the Developing Slime Mold, *D. discoideum*," *J. Exp. Zool.* 137, 89.
- Luria, S. E., and Delbruck, M., 1943. "Mutations of Bacteria from Virus Sensitivity to Virus Resistance," *Genetics* 28, 491.
- Raper, K. B., 1940. "Pseudoplasmodium Formation and Organization in *D. discoideum*," *J. Elisha Mitchell Sci. Soc.* 56, 241.
- Raper, K. B., 1941. "Developmental Patterns in Simple Slime Molds," *Growth* 5, 41.
- Raper, K. B., and Thom, C., 1932. "Distribution of *Dictyostelium* and other Slime Molds in Soil," *J. Wash. Acad. Sci.* 22, 93.

- Raper, K. B., and Fennell, D., 1952. "Stalk Formation in *Dictyostelium*," *Bull Torrey Bot. Club* 79, 25.
- Ross, I. K., 1959. "Studies on Diploid Strains of *D. discoideum*," *Am. J. Bot.* 47, 54.
- Shaffer, B. M., 1958. "Integration in Aggregating Cellular Slime Molds," *Quart. J. of Microscop. Sci.* 99, 103.
- Skupiński, F. X., 1918. "Sur la sexualité de *D. mucoroides*," *C. R. Acad. Sci. Paris* 167, 960.
- Sonneborn, D. R., Levine, L., and Sussman, M., 1960. Unpublished results.
- Sussman, M., 1952. "An Analysis of the Aggregation Stage in the Development of the Slime Molds, *Dictyosteliaceae*, II: Aggregative Center Formation by Mixtures of *D. discoideum* Wild Type and Aggregateless Variants," *Biol. Bull.* 103, 446.
- Sussman, M., 1955. "The Developmental Physiology of the Amoeboid Slime Molds," in Hutner, S., and Lwoff, A., eds., *Biochemistry and Physiology of the Protozoa*, Vol. II (N. Y., Academic Press).
- Sussman, M., 1956. "The Biology of the Cellular Slime Molds," *Ann. Rev. Microbiol.* 10, 21.
- Sussman, M., and Noel, E., 1952. "An Analysis of the Aggregation Stage in the Development of the Slime Molds, *Dictyosteliaceae*, I: Populational Distribution of the Capacity to Initiate Aggregation," *Biol. Bull.* 103, 259.
- Sussman, M., and Ennis, H. L., 1959. "The Role of the Inhibitor Cell in Slime Mold Aggregation," *Biol. Bull.* 116, 304.
- Sussman, R. R., Sussman, M., and Ennis, H. L., 1960. "Appearance and Inheritance of the I-cell Phenotype in *D. discoideum*," in *Developmental Biology*. In press.
- Wilson, C. M., 1952. "Sexuality in the Acrasiales," *Proc. Nat. Acad. Sci.* 38, 659.
- Wilson, C. M., 1953. "Cytological Study of the Life Cycle of *Dictyostelium*," *Am. J. Bot.* 40, 714.
- Wilson, C. M., and Ross, I. K., 1957. "Further Cytological Studies on Acrasiales," *Amer. J. Bot.* 44, 345.
- Wright, B., and Anderson, M., 1958. "Enzyme Patterns during Differentiation in the Slime Mold," in McElroy, W., and Glass, B., eds., *The Chemical Basis of Development* (Baltimore, Johns Hopkins Press).
- Wright, B., and Anderson, M., 1959. "Biochemical Differences in the Slime Mold," *Biochim. Biophys. Acta* 31, 310.

**THE ROLE OF RIBONUCLEIC ACID
AND SULFHYDRIL GROUPS
IN MORPHOGENESIS**

Jean Brachet

UNIVERSITÉ LIBRE DE BRUXELLES

A good deal of evidence has accumulated in favor of the view that ribonucleoproteins and perhaps ribonucleic acid (RNA) itself play a very important role in morphogenetic processes, especially in the induction of the nervous system in amphibian embryos. This evidence will be reviewed here in some detail.

In the author's opinion, the role played by RNA in morphogenetic processes is only a special case of a more general and fundamental activity of this nucleic acid—its direct intervention in the synthesis of specific proteins. Since the role played by RNA in protein synthesis has been discussed in detail by the author many times (see especially Brachet, 1957) and since this role is now accepted by a vast majority of biochemists and cytologists, this problem will be left out of the present review, which will deal strictly with morphogenetic processes.

But in morphogenesis—and even in the embryonic development of the vertebrates—induction does not explain everything. Other important factors, such as mitotic activity, cell movements and adhesion, and capacity to react to an inducing stimulus (competence), also play essential parts. We shall see that these processes can be, to a large extent at any rate, controlled by the equilibrium between thiol (-SH) and disulfide (-SS-) in the surrounding medium. Although the action mechanism of this equilibrium remains obscure from the biochemical viewpoint, as we shall see, a very likely explanation of present results is that it acts on the structure of proteins directly involved in morphogenetic processes. If so, the results obtained in studies on the role of

both the RNA and the -SH groups in morphogenesis could be linked together and they might lead to a common conclusion: that fundamentally morphogenesis is a problem of specific protein synthesis.

The role of ribonucleoproteins and RNA in induction

Ever since Bautzmann *et al.* (1932) showed that organizers killed with alcohol, heating, or freezing are still capable of inducing a neural tube, it has been realized that induction must be a chemical process, and attempts have been made to identify and isolate the "active" inducing substance in pure form. Experiments by Wehmeier (1934) and Holtfreter (1935) showed that the "inducing substance" (also called the "evocator") is a very widespread one. Almost all tissues of adult vertebrates and invertebrates, especially if they have been killed beforehand, induce neuralization of the ectoblast if they are grafted into the blastocoel cavity of young gastrulae.

The next step was to try to isolate the inducing substance from an adult tissue—for instance, liver. The results, however, were disappointing, since it soon became clear that many chemically unrelated substances (sterols, glycogen, nucleotides, fatty acids, etc.) can induce neural differentiation in ventral ectoderm (see Brachet, 1944, for a detailed review of this work).

It was suggested by the author (1944) that ribonucleoproteins might play a leading role in neural induction on the following grounds: ribonucleoproteins extracted from different tissues (liver microsomes, for instance) are better neural inducers than proteins with a lower RNA content; tobacco mosaic virus, a pure ribonucleoprotein, is a very good inducer (see Figure 1); furthermore, removal of RNA from the active ribonucleoproteins by a ribonuclease digestion leads to a decrease in the inducing activity.

The strong inducing power of ribonucleoproteins (liver microsomes or tobacco-mosaic virus, for instance) has been confirmed by many workers (Brachet *et al.*, 1952; Kuusi, 1953; Yamada, 1958 a, b; etc.). But, on the other hand, it has been impossible to confirm the inhibitory effect of ribonuclease on abnormal inducers in later experiments (Brachet *et al.*, 1952; Kuusi, 1953; Yamada and Takata, 1955a; Engländer and Johnen, 1957; etc.). The reason for the discrepancy between our first results in 1944 and those of the more recent workers is now clear; as shown by Hayashi (1958), a short treatment of the ribonucleoprotein with proteolytic enzymes, such as pepsin or trypsin, is enough to destroy the inducing power. At the time of our first experiments, no crystalline ribonuclease was available, and there is little doubt that the "purified" preparations used in those experiments were contaminated with proteolytic enzymes. That the active substance in

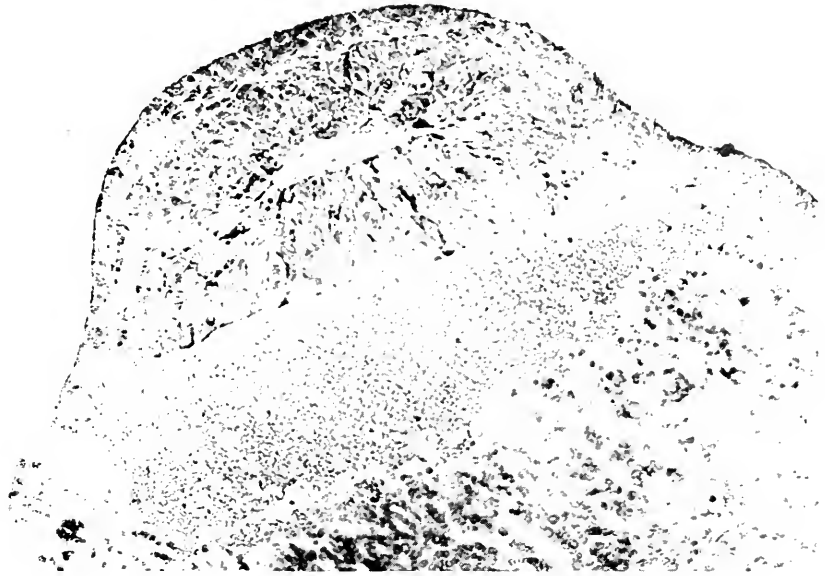

Figure 1. Large neural tube induced after implantation of tobacco-mosaic virus into the blastocele cavity of an axolotl gastrula (Brachet, 1950).

ribonucleoprotein is probably protein rather than RNA is further suggested by the fact that RNA isolated by mild methods (Yamada and Takata, 1955b; Tiedemann and Tiedemann, 1956) from various tissues, including embryos, is a poor inducer. These negative experiments, however, carry no great weight, in view of the difficulty often experienced in isolating non-denatured, biologically active RNA.

Although there is, as we have just seen, some evidence for the view that the active portion in ribonucleoproteins is protein rather than RNA, the question should not yet be considered completely answered in view of the recent work of Niu (1956, 1958 a, b). He was able to show that explants of the chordomesoblast (organizer) produce ribonucleoproteins in the surrounding medium; the latter—which Niu calls a “conditioned medium”—induces neuralization in explanted ectoblastic fragments. This neuralization, according to Niu, cannot be explained on the basis of a release of an inducing or toxic substance by cytolyzing cells. Furthermore, ribonuclease inactivates the neuralizing factor produced by the explanted organizer in *Axolotl* and *Triturus torosus*; the enzyme has no inhibitory action, however, in the case of *Triturus rivularis*.

Niu's most recent papers show how controversial the question of the role of RNA in induction remains. Working with small, explanted

ectoblastic fragments, he studied the inducing activity of ribonucleoproteins and purified RNA extracted from various sources, especially thymus. He found that these preparations are active and that a treatment with trypsin inactivates them, but the effect of trypsin apparently is not on the nucleoprotein but on the explanted cells themselves, since it can be suppressed by the addition of soya-bean trypsin inhibitor. In contrast to Hayashi's claim (1959), treatment of the extracts with ribonuclease produces only *partial* removal (40 to 70 per cent) of the RNA and reduces the inducing activity.* Niu's conclusion is exactly the opposite of that of Yamada: he believes that there is a correlation between the amount of RNA and the frequency of embryonic differentiation. Obviously, much more work is required before a definite and general conclusion can be reached, besides the well-established one that ribonucleoproteins are very active inducing agents.

In the foregoing discussion, only facts related to neural induction have been presented. The general conclusion that the inducer is a ribonucleoprotein is not valid any more for the induction of mesodermal tissue, which is so conspicuous when caudal (and not cephalic) regions are induced: all the available evidence suggests that the caudal organizer is of a purely protein nature (Yamada, 1958, a, b).

If we wish to summarize present knowledge concerning the inducing substance, all we can say is that its chemical nature remains obscure and that it will be an exceedingly difficult task to try to elucidate it along the lines just discussed. The menace of a non-specific release of a neuralizing substance already present in the ectoblast in a masked form will always loom up before the experimenter. The more complex the experiments become, the more difficult is their interpretation. For instance, inhibition of induction by agents such as ribonuclease, proteolytic enzymes, etc., may be due to an effect on the ectoblast cells themselves rather than to the blocking of a specific chemical group in the inducing substance. The reacting system—*i.e.*, the ectoblast—may be directly affected by changes in the surrounding medium in two opposite ways: (1) stimulation of neural differentiation (spontaneous neuralization), or (2) loss of competence, which would make the ectoblast incapable to react to inducing stimuli.

In view of these uncertainties and the difficulty of solving them, another approach must be used. This is why many investigators have preferred to study RNA distribution and metabolism in intact eggs, placed either in normal or in experimentally changed conditions.

* According to a private communication of Dr. Niu, his joint experiments with Hayashi have led to the conclusion that about 30 per cent of the RNA initially present in ribonucleoproteins resists ribonuclease digestion; if so, the experiments showing no loss in inducing activity after ribonuclease treatment would lose a good deal of their meaning and interest.

Distribution of RNA in normal amphibian eggs

Precise observations, because of the quality of the available cytochemical methods, can be made in the case of RNA distribution during development of the amphibian egg (Brachet, 1942, 1944). As shown in Figure 2, a polarity gradient is already visible in the unfertilized or freshly fertilized eggs; it decreases from the animal to the vegetal pole and remains intact during cleavage (Figure 3). At gastrulation (Figure 4), a secondary RNA gradient, decreasing from dorsal to ventral, superimposes itself upon the initial animal-vegetal gradient. As a result of RNA synthesis and morphogenetic movements, the two gradients inter-



Figure 2. Distribution of RNA in a fertilized amphibian egg (Brachet, 1957).

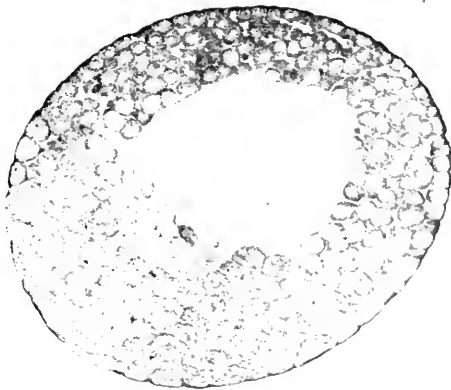

Figure 3. Distribution of RNA in an amphibian blastula (Brachet, 1957).

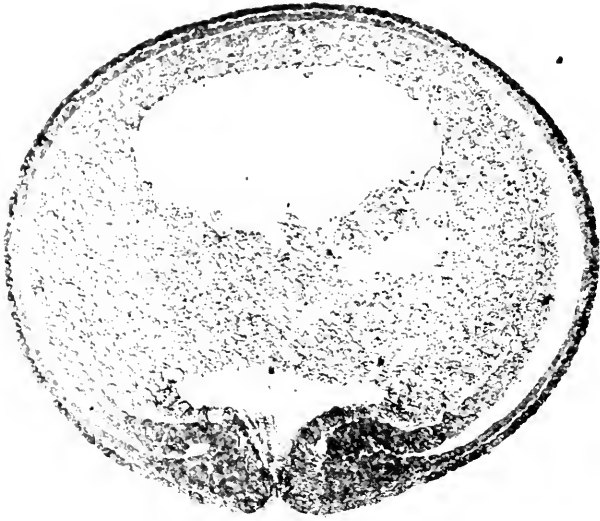

Figure 4. Distribution of RNA in a late amphibian gastrula. Note the stronger basophilia in the dorsal (right) than in the ventral (left) half (Brachet, 1957).

act with each other. The outcome is the appearance, in the late gastrula and the early neurula (Figure 5), of very well-defined antero-posterior (cephalo-caudal) and dorso-ventral gradients; the latter is especially apparent in the chordomesoblast.

When sections of late gastrulae or early neurulae are examined under high power, a high RNA content is found at the boundary separating the young medullary plate from presumptive chorda. It looks as if, at the very time of induction, RNA accumulates precisely at the points where inductor and reacting system are in close contact. Similar observations have been made more recently in chick embryos (Lavarack, 1957).

At later stages of embryonic development, the RNA content of every organ increases just before its differentiation begins. Differentiation itself (for instance, vacuolization of the notochord or formation of neurones in the nervous system) often results in a drop in the RNA content of the individual cells, except when the latter belong to an actively-protein-synthesizing organ (the liver or pancreas, for instance).

Enough experimental work has been done to demonstrate the reality of these gradients (Brachet, 1942; Steinert, 1951; Takata, 1953; Flickinger and Blount, 1957). In particular, the work of Flickinger and Blount, who used tracer methods with radioactive phosphorus 32, leads

to the important conclusion that new RNA is being synthesized in morphogenetically active regions during differentiation.

It should be pointed out, however, that gradients similar to those just described for RNA have been detected and described for other substances as well, such as -SH groups bound to the proteins, to which we shall return (Brachet, 1940). In particular, the distribution of reducing systems (Piepho, 1938; Fischer and Hartwig, 1936; Child, 1948) follows the now-familiar pattern of dorso-ventral and antero-posterior gradients. The same pattern has also been found in oxygen consumption (Sze, 1953), the incorporation of amino acids into proteins (Eakin *et al.*, 1951), and the incorporation of labeled carbon dioxide into nucleic acids and proteins (Flickinger, 1954).

Since mitochondria play a leading part in all processes linked to energy production, it appears likely that these cell organelles are distributed, together with the microsomes, along gradients which superimpose themselves on the morphogenetic gradients. One can therefore hardly avoid the conclusion that the latter represent regions where the yolk reserves are transformed into "true" cytoplasm (ergastoplasm and mitochondria) at a faster rate than elsewhere. Looking at them from another angle, these gradients may be considered as gradients in the

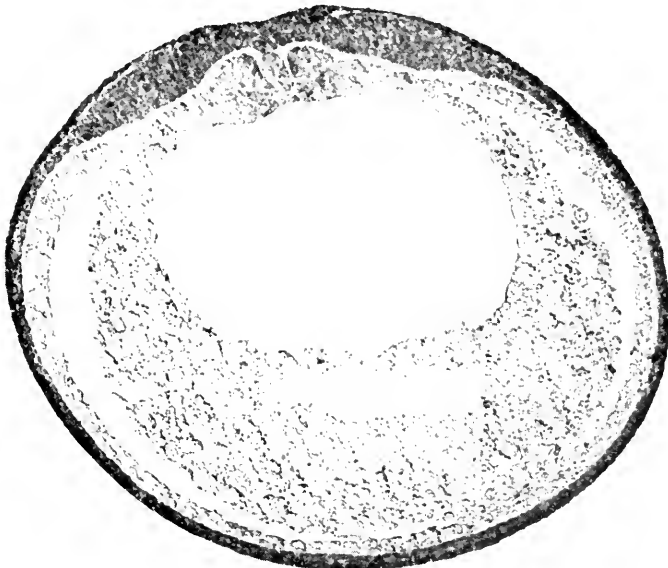

Figure 5. Distribution of RNA in a young amphibian neurula (Brachet, 1957).

distribution of such cytoplasmic fractions as RNA-rich ergastoplasmic granules or vesicles, and mitochondria. Such a conclusion is reinforced by the recent electron-microscope studies of Karasaki (1959); they clearly show that, after gastrulation, the structure of the mitochondria and the ergastoplasm becomes more and more complicated as differentiation progresses.

Before we can consider these gradients as important factors in morphogenesis, one important question should be answered: Are there similar gradients in vertebrate eggs other than those of the amphibians?

The most complete study of RNA distribution in chick embryos is that of Gallera and Oprecht (1948), who showed that node center cells exhibit greater cytoplasmic basophilia than neighboring cells; these results have been confirmed by Spratt (1952), who used toluidine blue as a stain for RNA detection.

Gradients in RNA distribution essentially similar to those described for the amphibians have also been observed in embryos of the fishes (Brachet, 1940) and the reptiles (Pasteels, 1953).

It is beyond the scope of the present review to present the results obtained with mammalian eggs, because they are too different from those of the other vertebrates. It can be said, however, that the cytochemical studies of Dalcq and his school (1957) have clearly shown that definite patterns in RNA distribution and synthesis occur during early development of mammalian eggs, and that RNA synthesis in them, as in other vertebrates, is especially marked in the mesoblast and the induced parts of the ectoblast.

In short, the cytochemical data obtained in the cases of fishes, reptiles, birds, and mammals agree very well with the general conclusions we have drawn from the study of amphibian eggs: that RNA is accumulated and is most actively synthesized in the regions of the embryo which have the greatest importance for morphogenetic processes.

We shall now try to answer another important question: What happens to the ribonucleoprotein gradients when morphogenesis or RNA synthesis is experimentally modified?

Experimental effects on RNA gradients in amphibian eggs

If synthesis of RNA along animal and vegetal gradients is really an essential factor in morphogenesis, inhibition of RNA synthesis by treatment with chemical analogues of purines and pyrimidines should lead to the cessation of development or to abnormal development.

This expectation has been fulfilled, as was first shown by the author (1944) in the cases of barbituric acid, benzimidazole, and acriflavine. These early studies have been considerably extended by Bieber (1954), Bieber and Hitchings (1955), and Liedke *et al.* (1954, 1957

a, b). They used a considerable number (more than one hundred) of chemical analogues of purines, pyrimidines, and nucleosides, and they found, as a rule, inhibition of development at a definite stage. This fact suggests the possibility that new enzymatic mechanisms for RNA synthesis appear at definite stages of development.

In chick embryos, inhibitors of RNA synthesis also impair morphogenesis. For instance, Fox and Goodman (1953) found that abnormal synthetic nucleosides, in which ribose was replaced by another sugar (glucose, for instance), inhibit the development of explanted chick embryos. Waddington *et al.* (1955) found that the regions most sensitive to chemical analogues (such as benzimidazole or azaguanine) are precisely those that show the highest incorporation of methionine into proteins. Once more, RNA synthesis, protein synthesis, and morphogenesis appear very closely linked in developing eggs.

Finally, Hisaoka and Hopper (1957) have been working on zebra fish eggs and have used barbituric acid as a tool for experimentation; they concluded from their studies that there is a link between morphogenesis and RNA synthesis in fish eggs as well as in those of amphibians and of the chick.

Substances other than purine and pyrimidine analogues have comparable effects. For instance, two well-known inhibitors of oxidative phosphorylation, dinitrophenol and usnic acid, completely inhibit morphogenesis. The inhibition can be largely reversed if the treated eggs are returned to the normal medium; however, abnormalities (such as persistent yolk plug and microcephaly) can often be found in these cases (Brachet, 1954). Cytochemical (Brachet, 1954) and quantitative (Steinert, 1953) studies clearly have shown that inhibition of development and RNA synthesis always go hand in hand: when the dinitrophenol-treated embryos are brought back to normal medium, RNA synthesis is resumed, but only if morphogenesis also is taking place.

Another interesting group of substances is the steroid hormones (stilbestrol, oestradiol, testosterone), which have been studied by Töndury (1947), Cagianut (1949), and Rickenbacher (1956). These substances inhibit cleavage or make it abnormal; furthermore, they also modify the normal gradient of RNA distribution. It seems that, because of alterations of the mitotic apparatus during early cleavage, RNA becomes unevenly distributed in the daughter cells. At later stages, strong abnormalities of development can be found, the most conspicuous being unequal differentiation of the medullary folds, with an asymmetry of the nervous system as a result. It is a very interesting fact, which certainly deserves confirmation, that, according to Cagianut, addition of yeast RNA to the embryos that have been treated with steroid hormones definitely improves their differentiation.

Something should be said about another chemical, which is famous

among embryologists for the fact that it inhibits the development of chorda and produces strong microcephaly. I mean lithium ions, which have been studied in detail, from the viewpoint of morphogenesis, by Lehmann (1938), Pasteels (1954), and Hall (1942). It is now generally admitted, as a consequence of their work, that lithium ions exert their primary effect on the organizer itself, which shows reduced capacity for induction.

Cytochemical and biochemical studies made on lithium-treated amphibian eggs have yielded a number of important results. First of all, Ficq (1954b) found that, in lithium-treated gastrulae, lithium ions were accumulated by the dorsal half. More recent work by Dent and Sheppard (1957) has largely confirmed this conclusion; they also observed a strong accumulation of lithium in the medullary plate. Work by Lallier (1954) and by Thomason (1957) has clearly shown that lithium interferes with RNA distribution and synthesis in amphibian eggs. According to Lallier, lithium decreases the RNA gradients, while in Thomason's work this ion was found to inhibit markedly the incorporation of labeled phosphorus into the nucleoprotein fraction.

We shall now consider the effects of physical treatments, such as centrifugation, heating, or changing the pH of the surrounding medium, on the RNA gradients.

Centrifuging eggs during development is an easy way to modify both the gradient distribution of substances or cell organelles and the morphogenesis of the embryo. The most important experiments in this field are those of Pasteels (1950, 1953), who worked with amphibian eggs. He found that centrifugation of freshly fertilized eggs led to the formation of "hypomorph" embryos; they showed deficiencies in the nervous system which might range from complete absence of the system to strong microcephaly. When gastrulation of these centrifuged embryos is normal, the result is the production of embryos which have an almost normal tail but practically no head. On the other hand, centrifugation of blastulae leads to the formation of double or even triple embryos.

Unpublished studies of Pasteels and Brachet have shown that the centrifugation of both freshly fertilized eggs and blastulae produces profound changes in the distribution of RNA. As shown in Figure 6, ribonucleoproteins accumulate at the animal pole when fertilized, but still uncleaved, eggs are centrifuged. If these eggs cleave normally, the blastoporal lip forms in a normal position. But the material that invaginates and corresponds to the organizer is much poorer in RNA than is the organizer in normal eggs. This reduction in the RNA content of the invaginated material is accompanied by a marked decrease in its inducing activity; the hypomorphoses described by Pasteels are the logical result of such a situation.

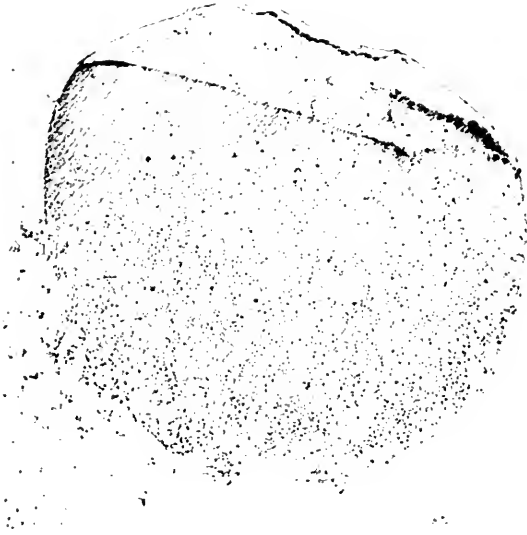

Figure 6. Stratification of a fertilized egg after centrifugation. From top to bottom: fat; RNA-rich hyaloplasm; pigment and yolk (Brachet, 1957).

Very different results are obtained when blastulae are centrifuged. First there is a collapse of the blastocoele roof and an accumulation of RNA-rich material at the centrifugal pole of the cells. Later on, foci of strong RNA synthesis, characterized by very strong basophilia, make their appearance (Figures 7 and 8). Finally, an accessory nervous system forms in each of these basophilic areas. Present evidence thus confirms the view that RNA and morphogenesis are intimately linked.

The same conclusion can be drawn from experiments in which a young amphibian gastrula is submitted to a "heat shock" (*i.e.*, heating for one hour at temperatures ranging from 36° to 37° C., according to the species). We have shown (Brachet, 1948, 1949 a, b) that a mild heat shock produces a reversible inhibition of development; when the latter proceeds again, numerous malformations are found. These abnormalities are essentially similar to those produced by treatment with lithium chloride.

If the temperature chosen is a little higher, the block in development is irreversible, but no cytolysis can be detected for two or three days (Figure 9). If a piece of the blocked gastrula is placed in contact with cells of a normal gastrula, even when they belong to another species, dramatic "revitalization" of the heated cells occurs. As shown

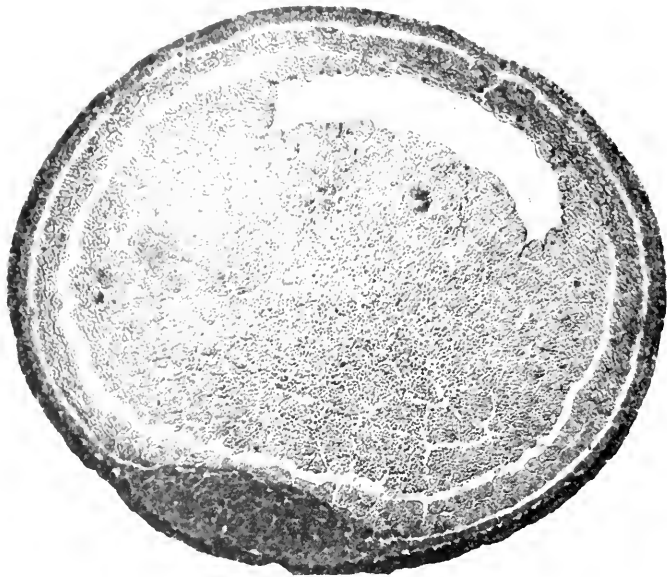

Figure 7. Development of an RNA-rich mass on the ventral side in a neurula originating from a centrifuged blastula (Pasteels and Brachet, unpublished).

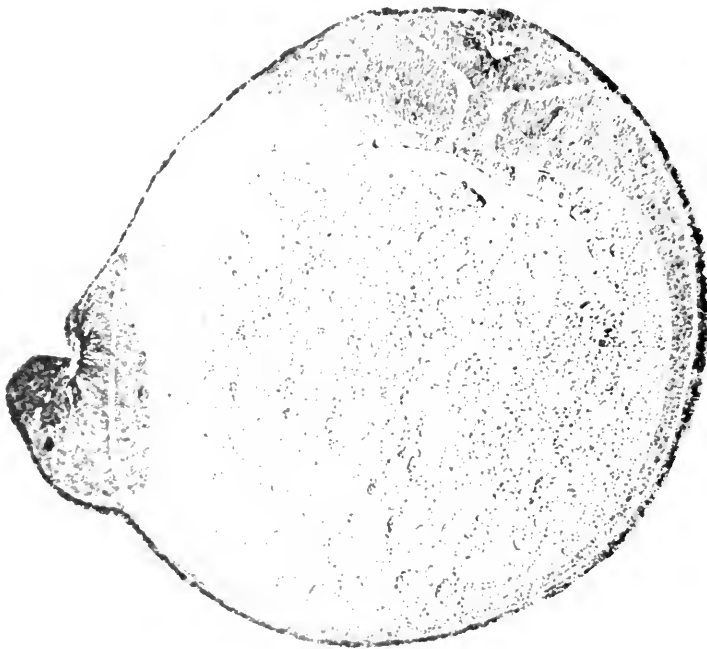

Figure 8. Differentiation of an RNA-rich secondary embryo from a centrifuged blastula (Pasteels and Brachet, unpublished).



Figure 9. Dorsal lip from a gastrula blocked after a heat shock (Brachet, 1957).

in Figure 10, the organizer of a heated frog gastrula becomes almost normal again. Differentiation into a notochord, somites, and an archenteron roof occurs in the graft, as well as induction of a secondary nervous system.

Cytochemical and biochemical studies of gastrulae which had been submitted to an irreversible or a reversible heat shock have disclosed the fact that the RNA gradients are affected in varying degrees according to the severity of the treatment. These gradients become very irregular, while mitotic activity stops and the mitotic apparatus degenerates. When a fragment of the irreversibly heated gastrula is grafted into a normal host, the first sign of healing is an impressive resumption of nucleolar and cytoplasmic basophilia, which precedes the reappearance of mitotic activity. In the case of reversible heat shocks, the abnormalities found in the distribution of the RNA gradients easily explain why further development becomes abnormal.



Figure 10. The organizer of a gastrula blocked by a heat shock has been grafted into a normal host. It has differentiated into chorda and intestinal lumen and has induced somites and neural masses (Brachet, 1957).

Quantitative estimations of the RNA content (Steinert, 1951; Hasegawa, 1955) have shown that, as suggested by cytochemical observations, RNA synthesis is completely inhibited in the irreversibly blocked gastrulae; if the heat shock is too severe, cytolysis begins after three days and the RNA content begins to drop.

However, it is clear that new tools, such as electron microscopy and autoradiography, should be used in the case of heated amphibian gastrulae; electron microscopy could give very valuable information about the alterations that probably occur in the ultrafine structure of the mitochondria and the basophilic cytoplasmic constituents. Autoradiography, on the other hand, might throw useful light on the more dynamic aspects of the synthesis of nucleic acid and protein in heated gastrulae. But whatever the results given by these new methods, the present conclusion will certainly remain valid: changes in morphogenesis and in RNA distribution and synthesis always run parallel in heated embryos.

It is a well-established fact that sublethal cytolysis, produced by shifts in the pH or removal of the calcium ions of the medium, can provoke the spontaneous neuralization of ectoblastic explants (Holtfreter, 1947). Too little is known as yet about the chemical and ultrastructural changes induced by those acid and alkaline shocks to draw any definite conclusions. All that can be said is that they modify the structure of the cells in much the same way as does the centrifugation

of blastulae. As shown in Figure 11, the RNA-rich cytoplasm, in cells that have been exposed to an acid or alkaline medium, accumulates in the form of a basophilic crescent (Brachet, 1946). As we have already seen, the local concentration of RNA at one pole of the cells is a characteristic feature of both normal induction and formation of additional embryonic axes in centrifuged blastulae; it can therefore be supposed that the crescent-shaped accumulation of RNA-rich cytoplasm in cells that have been submitted to acid or alkaline shocks has something to do with spontaneous neuralization.

A good correlation between morphogenesis and RNA synthesis is also found when an egg is fertilized with a spermatozoon belonging to another species and produces a lethal hybrid, or is fertilized with more than one spermatozoon (polyspermy). RNA synthesis stops when development of the lethal hybrid is blocked, usually as a gastrula; there is a resumption of this synthesis when a fragment of the lethal hybrid becomes "revitalized" after it has been transplanted into a normal host (Brachet, 1944, 1957).

Finally, dispermic eggs are often formed of a diploid and a haploid half. If the two halves are equally well developed, their RNA content is the same, but when the haploid half is underdeveloped, its RNA content is lower than that of the diploid half. In the case of dispermic eggs, it is clear that RNA synthesis is linked not to the diploid



Figure 11. RNA-rich, basophilic crescents forming in ectoderm cells which have been exposed to an alkaline shock (Brachet, 1957).

or haploid condition *per se* but to the degree of morphogenesis attained by diploid and haploid organs (Brachet, 1944).

In summary, all the evidence we have concerning RNA distribution and synthesis in normal and experimental embryos shows that these phenomena are always closely linked to morphogenesis. One should not forget, however, that RNA is only one of the many constituents of ribonucleoprotein particles. There is no proof, for the time being, that RNA in itself is more important for morphogenesis than the proteins and lipids with which it is associated in ergastoplasmic structures. Therefore, experiments designed to demonstrate in an unambiguous way the role of RNA itself in morphogenetic processes are highly desirable.

Brachet and Ledoux (1955) and Brachet (1959) have attempted to attack this important point in a direct way—by treating living amphibian eggs with ribonuclease. It was hoped that the enzyme might penetrate into the living cells, inactivate or break down the RNA they contained, and exert important morphogenetic effects. As we shall see, these hopes have not been entirely fulfilled, because of the poor penetration of ribonuclease into amphibian eggs once cleavage is over.

It is easy to demonstrate that ribonuclease quickly inhibits cleavage in amphibian eggs and that the nuclei are usually blocked in interphase. However, because the penetration of the enzyme is slow and incomplete, only the blastomeres forming the outer layers of the morula are irreversibly blocked in their development. If the treated morulae are brought back to the normal medium, after a few hours of treatment with ribonuclease, the innermost blastomeres, which surround the blastocele, resume cleavage. They finally migrate through the dying or dead outer blastomeres and form an atypical undifferentiated ectoderm (Figure 12). If the eggs are treated with a mixture of ribonuclease and RNA, or if they are placed in an RNA-containing medium after the ribonuclease treatment, one can occasionally obtain the formation of a nervous system (Figure 13); it lies on a bed of large, blocked cells. The fact that we have never yet obtained a nervous system after treatment with ribonuclease alone, but have obtained several "neurulae" after a ribonuclease-RNA treatment, provides a definite indication of a role for RNA in normal induction.

Penetration of ribonuclease at later stages of development is, as a rule, very poor, and therefore little or no effect on morphogenesis is observed. One can, however, occasionally find ribonuclease preparations which are more active than others; since their effects can be duplicated by adding small amounts of versene (EDTA) to otherwise inactive preparations of ribonuclease, it is probable that the active preparations contain some chelating agent as a contaminant.

When blastulae or gastrulae are treated with ribonuclease rein-



Figure 12. Formation of atypical ectoderm in an amphibian egg treated with ribonuclease at the morula stage (Brachet and Ledoux, 1955).

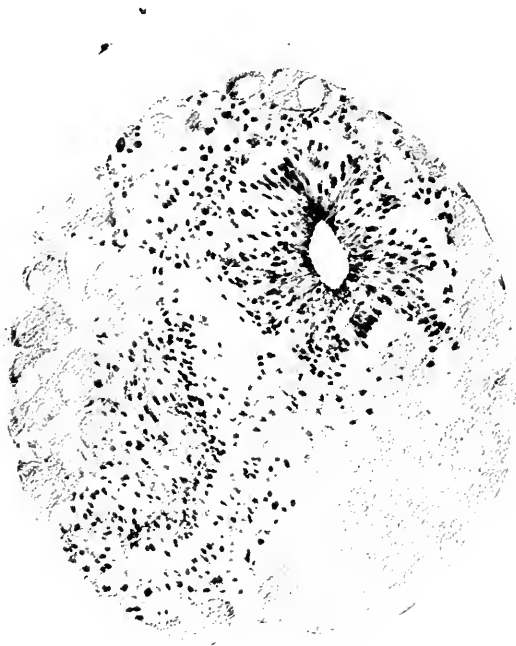

Figure 13. Formation of a nervous system in an amphibian egg treated with a mixture of RNA and ribonuclease at the morula stage (Brachet and Ledoux, 1955).

forced by the addition of versene (at low concentrations in which the latter is inactive by itself), the ectoderm cells dissociate, lose their basophilia, and finally cytolysis (Brachet, 1959). The consequence is the formation of "ectodermless embryos," which have well-differentiated chorda and somites but no nervous system or a very reduced one (Figure 14). It was also found that cells of the organizer exhibit a marked differential susceptibility toward the ribonuclease-versene mixture: an explanted organizer cytolyses much more quickly in this medium than explanted ventral mesoblast does.

The fact that it is possible, after gastrulae have been treated with ribonuclease and versene, to obtain embryos which have no nervous system should not be taken as a proof that RNA is necessary for inductive processes in the normal organizer: in the experiments just described, the absence of induction is simply due to the peeling off of the reacting ectoderm cells.

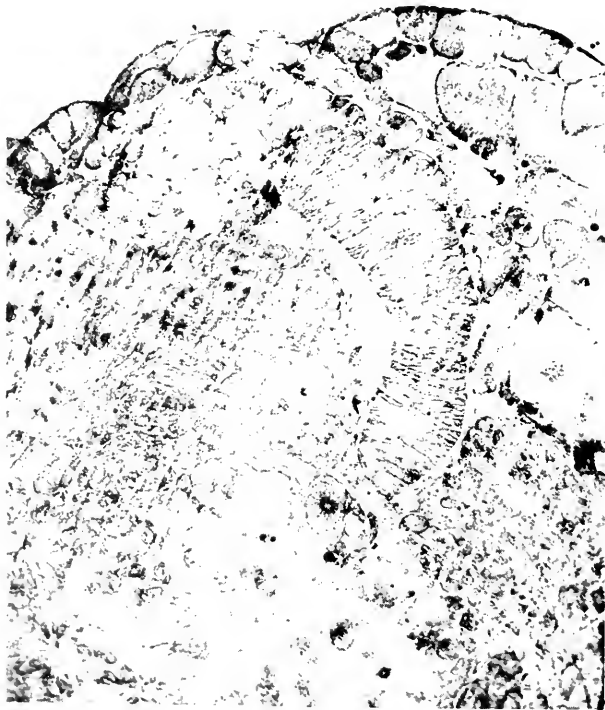

Figure 14. Ectodermless embryo after treatment of a young gastrula by a mixture of ribonuclease and versene. A chorda has differentiated, but the ectoderm cells are blocked and cytolysing (Brachet, 1959).

The possible role of microsomes in induction

We owe to Raven (1938) a demonstration of the important fact that the inducing principle can diffuse from cell to cell: if a non-inducing fragment of presumptive ectoderm is left for some hours in contact with the living organizer, it acquires inducing capacities. These striking experiments of Raven led Dalcq (1941) and Needham (1942) to the very interesting hypothesis that the action of the inducing agent might be similar to that of viruses. The well-known fact that the medullary plate, which has been induced by the organizer, acts as an inducer if it is grafted into the blastocoel of a young gastrula leads to the same conclusion: it looks as if the inducing agent, like a virus, can "infect" the neighboring cells, propagate, and migrate from one cell to another. A further suggestion has been made by the author (1949): the hypothetical "virus" may be identical with the microsomes, which have dimensions and an RNA content comparable to those of many viruses and may therefore possess genetical continuity.

A number of experiments have been performed in recent years to test these hypotheses: as we shall now see, they have so far failed to give clear-cut answers.

The most direct experiment carried out to test the "microsome-virus hypothesis" was the isolation of microsomes by ultracentrifugation of homogenates and the microinjection of these particles into a ventral blastomere of a young morula. Such experiments have been attempted (Brachet and Shaver, 1949; Brachet *et al.*, 1952), but the results were rather disappointing, despite the fact that a local increase of basophilia in the injected blastomeres was often observed. Very few embryos, out of several hundreds, formed a nervous system on the ventral side, and it is likely that this resulted from purely mechanical troubles of the gastrulation movements rather than from true induction. It should, however, be added that the experimental conditions adopted for the isolation of the microsome pellet were far from ideal: the temperature in the ultracentrifuge was relatively high, and saccharose was not added to the homogenization medium.

Very recently Yamada (personal communication) has isolated microsomes under much better isolation conditions from amphibian embryos. Adding them to small ectodermic explants, he found that they have a strong inductive (archencephalic) activity.

Finally, it has been reported, also very recently, by Ebert (1959) that addition of microsomes isolated from muscles can induce the differentiation of nerve fibers in chorio-allantoic membranes of chick embryos, provided that a virus which can infect the chorioallantoic membrane cells is added together with the microsomes. The role of the virus would simply be to facilitate the penetration of the microsomes

into the cells. Needless to say, confirmation of these extremely interesting and important experiments will be awaited with the greatest interest. If they are confirmed, and if they can be extended to other biological systems, they may almost prove the point we made at the beginning of the present paper; namely, that cell differentiation is the consequence of the synthesis of specific proteins, mediated by small RNA-containing particles such as the microsomes or the ribosomes.

It is of interest in this respect to mention recent observations of Rounds and Flickinger (1958) and Flickinger *et al.* (1959), who detected, with chemical and immunological methods, a definite but quantitatively small transfer of nucleoproteins from mesoderm to ectoderm. Of special interest are experiments in which *Taricha* ectoderm was cultivated in contact with *Rana* mesoderm. Serological tests showed the presence of *Rana* antigens in the *Taricha* ectoderm, indicating again a passage of nucleoproteins from the mesoderm to the ectoderm. It certainly would be very interesting to follow this process cytochemically with methods using labeled antibodies.

On the other hand, the work of Grobstein (1955, 1956) has shown that direct contact between inducing and reacting cells is not always required for induction. Working on the induction of tubules in metanephrogenic mesenchyme, he found that the inducing stimulus is not stopped by the interposition of a "millipore" membrane. Such a membrane has large pores, as compared with those of a cellophane membrane which completely stops neural induction (Brachet and Hugon de Scoeux, 1949). Its pores are not large enough to allow the passage of free cells, but they can become filled with long pseudopodia, which apparently never come in direct contact (Grobstein, 1955, 1956; Grobstein and Dalton, 1957). The active substance, which cannot cross a cellophane membrane, can act at a distance of more than 80 microns (Grobstein, 1958). For all these reasons Grobstein believes that induction is mediated not through direct contact or diffusion of a small-molecular-weight substance but through the matrix uniting the cells.

From the embryological viewpoint, the intercellular matrix of Grobstein is a development of Holtfreter's (1943) surface coat—a material which is soluble in alkaline media and presents a marked elasticity. This material is already present in the cell cortex in the fertilized egg, and it holds the cell together, thus acting as an intercellular cement. The surface coat becomes reinforced, at the time of gastrulation, in the dorsal lip; at the neurula stage it is still further developed in the neural plate. Dissolution of the surface coat by weak alkalis (KCN, for instance) results in separation of the cells that form the embryo.

Very recent experiments of Curtis (1960) show that, as had been deduced on theoretical grounds by Dalcq and Pasteels (1938), this

surface-coat material may very well be of paramount influence for egg development. For instance, Curtis succeeded in adding surface-coat material on the ventral side of amphibian eggs and obtained, as a result, the formation of double embryos. In other words, the surface-coat material behaves exactly as the "grey crescent" of experimental embryologists, and it must play a most important role in morphogenesis.

Very little is known, unfortunately, about the chemical nature of the surface coat or the intracellular matrix. Treatment with the calcium complexing agent versene (EDTA) produces the separation of the gastrula cells. This effect of versene, as we have seen earlier, is greatly enhanced by the addition of small amounts of ribonuclease (Brachet, 1959), and we have seen that this enzyme easily penetrates into the eggs during cleavage (Brachet and Ledoux, 1955). It is also known that proteolytic enzymes (trypsin, for instance) easily dissociate the cells of the amphibian gastrula. After dissociation by various means, a ribonucleoprotein is liberated (Curtis, 1958); this fact suggests that the intercellular matrix (surface coat) is of a ribonucleoprotein nature, although cytolysis of part of the cells would easily explain the results obtained on dissociated cells by Curtis. Cytochemical studies, however, favor Curtis' conclusion that the intercellular cement is a ribonucleoprotein: in amphibian eggs and embryos, cell membranes give very strong reactions for RNA. Pending further, more precise work, it seems safe to conclude that the intercellular matrix is made of a ribonucleoprotein, associated with calcium ions and, possibly, mucopolysaccharides. If RNA is really involved in the composition of the intercellular matrix, its role in induction becomes still more probable and easier to understand.

Obviously the next task for the chemical embryologists will be to isolate and try to identify the chemical nature of the surface coat material.

The role of sulfhydryl groups

The importance of sulfhydryl (thiol, or -SH) groups for morphogenesis has often been emphasized. In the amphibians, for instance, it has been suggested (Brachet, 1944; Rapkine and Brachet, 1951) that the morphogenetic movements characteristic of gastrulation and neurulation are closely linked to the reversible denaturation of fibrous, myosin-like proteins. Oxidation of -SH into -SS- groups would transform the fibrous molecule into its globular form; as a result, the shape of the cells would change. That such fibrous macromolecules really exist in amphibian eggs has been clearly demonstrated by Lawrence *et al.* (1944) and by Ranzi (1955, 1957). It is of special interest that the

surface-coat material, whose embryological importance has just been discussed, presents a very high elasticity, characteristic of many fibrous macromolecules.

The importance of -SH-containing substances for morphogenesis in sea-urchin eggs has also been clearly shown by Runnström and Kriszat (1952), Lallier (1951), and Bäckström (1958, 1959). As Bäckström pointed out, "the -SH metabolism seems to play an important role in the process of animalization and probably also in the antagonizing process of vegetalization."

In the case of amphibian eggs, the effects on morphogenesis of a number of "classical" sulfhydryl reagents (mono-iodoacetic acid, mono-iodoacetamide, chloropicrine, chloracetophenone, oxidized glutathione, arsenite, etc.) have been studied by a number of authors (Brachet, 1944; Beatty, 1949; Rapkine and Brachet, 1951; Lallier, 1951; Barth, 1956; Deuchar, 1957; ten Cate, 1957; etc.). All these agents produce similar effects. The nervous system remains a thick, open plate, while the differentiation of chorda and somites are relatively normal.

More recently the effects on amphibian morphogenesis of new sulfhydryl reagents, introduced in biological research by Mazia (1958, a, b) in his important studies on mitosis in sea-urchin eggs, have been investigated. These agents are β -mercaptoethanol ($\text{HSCH}_2\text{-CH}_2\text{OH}$), which is strongly reducing, penetrates easily into living cells and is relatively non-toxic, and its oxidized counterpart, dithiodiglycol ($\text{HOCH}_2\text{-CH}_2\text{-S-S-CH}_2\text{-CH}_2\text{OH}$), which easily oxidizes -SH groups of proteins. Mercaptoethanol (Brachet, 1958a; Brachet and Delange-Cornil, 1959; Seilern-Aspang, 1959) exerts powerful inhibitory effects on morphogenetic movements during gastrulation and neurulation; it inhibits, in an almost specific way, the closure of the neural plate (Figure 15). Dithiodiglycol, at relatively high concentrations ($M/3,000$), also inhibits the closure of the neural plate (Brachet and Delange-Cornil, 1959), but in a different way: the medullary plates formed in the presence of mercaptoethanol are thin, while those formed in embryos treated with dithiodiglycol are exaggeratedly thickened (Figure 16). Generally speaking, dithiodiglycol (which, at these concentrations presumably acts by oxidizing thiol groups in the egg proteins), behaves very much like the "classical" sulfhydryl reagents, such as iodoacetamide, chloropicrine, or arsenite.

It is interesting to note that mercaptoethanol also exerts strong inhibitory effects on morphogenesis in the unicellular alga *Acetabularia mediterranea* (Brachet, 1958b). At $M/300$ concentration it completely inhibits "cap formation" in entire algae or non-nuclear fragments, but without interfering with growth or production of sterile whorls.

The fact that mercaptoethanol inhibits morphogenesis in biological systems as different as amphibian eggs and *Acetabularia* suggests the

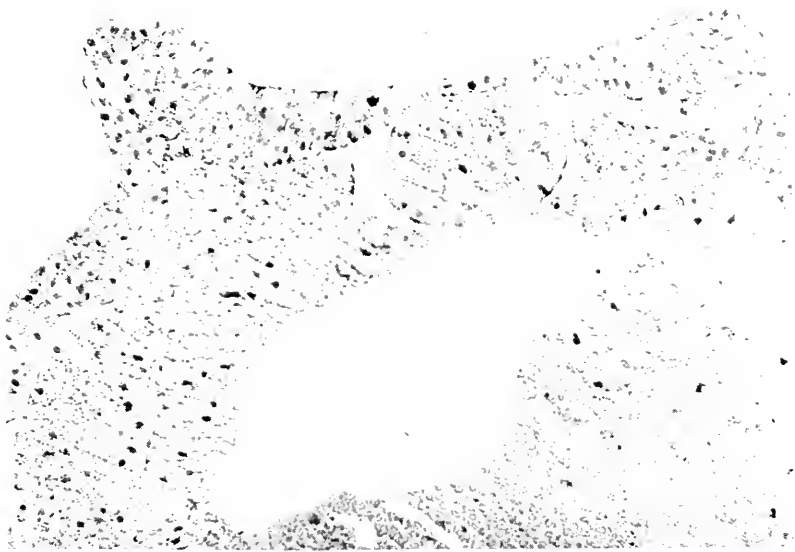

Figure 15. Flat medullary plate obtained by treating advanced gastrulae with mercaptoethanol (M/300) for two to three days. Chorda and somites are normal (Brachet and Delange-Cornil, 1959).



Figure 16. Thickened nervous system in a frog embryo treated with dithiodiglycol (Brachet and Delange-Cornil, 1959).

hypothesis that a biochemical system involving -SH and -SS- groups may play a key role in morphogenetic processes. In order to test this hypothesis, we have compared the effects of mercaptoethanol and dithiodiglycol on a number of biological systems—amphibian eggs, nucleate and anucleate fragments of *Acetabularia mediterranea*, regeneration of the tail of tadpoles, and regeneration of the head in planarians (Brachet, 1960).

As already mentioned, the most conspicuous result obtained when amphibian gastrulae or neurulae are treated with mercaptoethanol (M/100 to M/300) is the complete cessation of morphogenetic movements. However, mercaptoethanol is relatively non-toxic, especially during neurulation (see Figure 15), and the blocked embryos survive for several days. Experiments in which mercaptoethanol-treated organizers were put together with normal ectoderm fragments and *vice versa* disclosed the fact that mercaptoethanol acts more effectively on the competence of the ectoderm than on the inducing power of the organizer. These observations stand in good agreement with those made on whole embryos, in which the neural plate fails to form or close while chorda and somites differentiate relatively well (Brachet, 1958a, 1960; Brachet and Delange-Cornil, 1959).

At lower concentrations of mercaptoethanol (M/300 or M/1,000, for instance) development proceeds further; after three or four days of continuous treatment, one obtains strongly microcephalic embryos which are more or less delayed in their development. A striking feature of these embryos is an almost complete absence of melanophores and a complete lack of pigmentation of the retina. Mercaptoethanol, probably by virtue of its reducing properties, thus exerts a *profound inhibition of pigment formation, in the eye as well as in the skin*. The results in the case of *Xenopus* are especially striking: the tadpoles that form in the presence of mercaptoethanol have blue eyes. Obviously mercaptoethanol inhibits the formation of melanin in a fairly specific way.

The strong toxicity of dithiodiglycol, as compared to mercaptoethanol, is especially remarkable in the case of *Pleurodeles* neurula stages. In a M/10,000 solution, cytolysis may occur within 24 hours. But, in contrast to mercaptoethanol, dithiodiglycol does not markedly delay or modify development before it exerts its lytic effects. At lower concentrations (M/30,000 to M/100,000), dithiodiglycol has, if anything, a slightly stimulating effect; in particular, the head sometimes shows overdevelopment, and the tail may be longer than in the controls. The tadpoles always show a higher degree of motility than the controls. There is thus no doubt that *mercaptoethanol and dithiodiglycol exert opposite effects in all respects*. The absence of mitoses, the microcephaly, the elongation of the body, which are characteristic of the embryos treated with mercaptoethanol, are replaced after treatment

with dithiodiglycol by intense mitotic activity, overdevelopment of the head, reduction of the body, and lordosis. Dithiodiglycol has no particular effect, in contrast to mercaptoethanol, on pigment formation. Obviously many biological activities in amphibian embryos, at the cellular as well as at the organismal level, are controlled by the sulfhydryl-disulfide equilibrium.

Let us now examine an entirely different biological material, the alga *Acetabularia mediterranea*. As already mentioned, mercaptoethanol (M/100) exerts a striking inhibitory effect on cap formation in *Acetabularia*, especially in anucleate fragments (Brachet, 1958b, 1959, 1960). The algae, whether they are nucleate or anucleate, grow steadily in the presence of M/300 mercaptoethanol, but they never form caps (Figure 17). If small caps are present at the time of the section, they never grow to an appreciable extent in anucleate fragments. On the other hand, the production of the sterile whorls, which should normally give rise to caps, proceeds almost unhampered.

Since mercaptoethanol so strongly inhibits morphogenesis (*i.e.*, cap formation) in *Acetabularia* as well as in amphibian embryos, it becomes of interest to study the effects of dithiodiglycol on this alga. The results of these experiments were fairly clear: while mercaptoethanol inhibited cap formation without exerting ill effects on the production of whorls, dithiodiglycol (M/10,000) had exactly the opposite effect of



Figure 17. Anucleate fragments of *Acetabularia* have formed only sterile whorls after a 4-week treatment with M/300 mercaptoethanol.

stimulating cap production and inhibiting the formation of the sterile whorls (Figure 18). The two processes are obviously antagonistic, and the outcome seems to be regulated, among other things, by the sulfhydryl-disulfide equilibrium.

In order to test further this view that the sulfhydryl-disulfide equilibrium regulates a morphogenetic process (cap or whorls formation), the effects of some of the "classical" sulfhydryl reagents on the regeneration of nucleate and anucleate *Acetabularia* fragments have been studied. Two of them, p-chloromercuribenzoate ($10^{-7}M$) and p-iodosobenzoic acid ($10^{-5}M$) exerted definitely favorable effects on cap formation in anucleate fragments, but iodoacetamide did not. These observations thus confirm the view that an excess of thiol groups is detrimental to the production of caps, and that a decrease of these groups is favorable for morphogenesis (as in amphibian embryos).

Similar observations can be made in the case of the regeneration of the tail of tadpoles (Brachet, 1959, 1960); it is completely inhibited by mercaptoethanol M/300 (Figures 19 and 20). Four days after the section, there is almost no regenerating blastema and the tadpoles are still unable to swim properly. Since mitoses are far from absent, the inhibition of blastema formation is probably due to a reduction of cell migration and, possibly, to an incapacity of the sectioned chorda to elongate normally in the presence of mercaptoethanol.



Figure 18. Same experiment as in figure 17, but treatment with M/10,000 dithiodiglycol. These fragments show good cap formation.

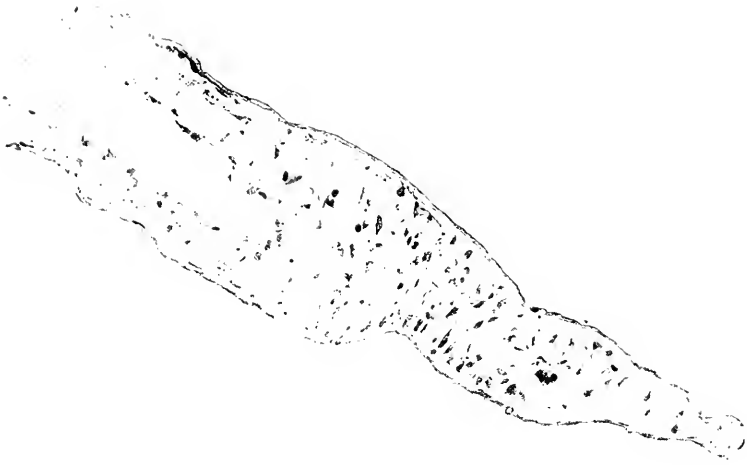

Figure 19. Axolotl tadpole, showing regeneration of blastema four days after section (control).

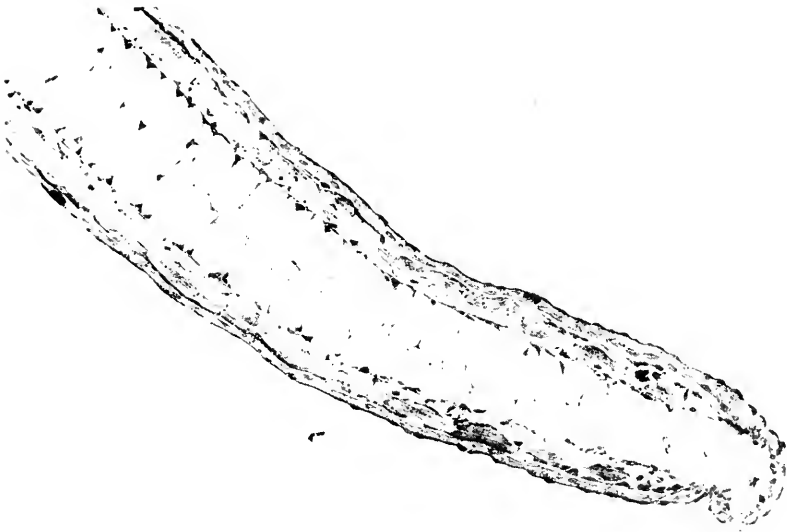

Figure 20. Same experiment as in figure 19, but with treatment during the four days after section with M/300 mercaptoethanol. No regeneration of blastema.



Figure 21. Regeneration of blastema in planarian three days after section of the head (control).

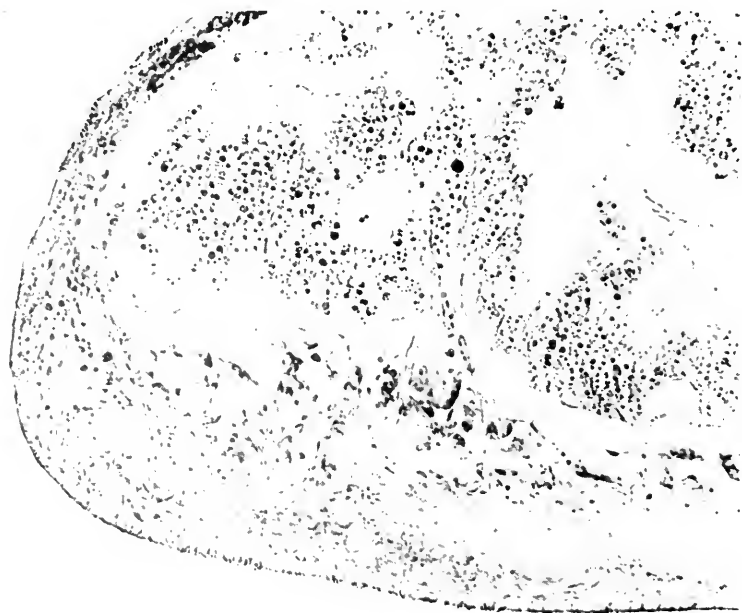

Figure 22. Same experiment as in figure 21, but with treatment during the three days after section with M/100 mercaptoethanol. No regeneration of blastema, and selective cytolysis of the gut.

Dithiodiglycol (M/1,000), on the other hand, does not at all prevent regeneration; it may even occasionally be faster than in the controls. The mesenchyme of the regenerating tail is particularly basophilic, and mitotic activity is high.

Finally, the effects of the SH-SS equilibrium have also been studied on the regeneration of the head in planarians (Brachet, 1959, 1960). Despite some difficulties, the following general conclusions can be drawn. Mercaptoethanol (M/300 to M/1,000) again exerts a considerable inhibitory effect on the regeneration of planarians that have been sectioned ahead of the pharynx. In most cases no formation of blastema can be seen on the living organisms or on sections (Figures 21 and 22). Once more, the inhibition of blastema formation is presumably due to inability of the cells to migrate rather than to a block in mitotic activity.

Here too, dithiodiglycol is more toxic than mercaptoethanol; it had to be used at concentrations of the order of M/3,000 to M/10,000. Under these conditions, regeneration proceeds normally, except that the pigmentation of the regenerated head is definitely slowed down, if not completely inhibited.

The results of these experiments on the role of the thiol-disulfide equilibrium in morphogenesis have been presented in some detail because they are too recent to allow us to draw any precise conclusion. It is our hope that this presentation will encourage other workers interested in morphogenesis to test the effects of such useful reagents as mercaptoethanol and dithiodiglycol on other biological systems than the ones we studied. It certainly would be of importance to know whether, as the present data suggest, the SH-SS equilibrium of the surrounding medium (and probably the internal SH-SS equilibrium, as a consequence) always is a factor of primary importance for morphogenesis.

One would also, of course, very much like to know how mercaptoethanol acts on the cell biochemically. This question is now under study in our laboratory. Although it is too early to draw any conclusions, it can be said that mercaptoethanol almost certainly does *not* exert its inhibitory effects by any common sort of mechanism. It does not reduce markedly the oxygen consumption or the ATP content of the cell; it does not activate proteolytic enzymes which might counterbalance protein synthesis; it does not quickly inhibit the synthesis of nucleic acids or proteins, as judged by autoradiography studies on the incorporation of labeled precursors into these substances.

To find out what it actually does remains a task for the future. But it can be hoped fairly confidently that the reagent inhibits a rather specific biochemical process (perhaps the contractility of a fibrous protein) which must be of major importance for morphogenesis in widely different biological systems.

Summary

The following points have been presented and discussed in the present paper:

1. The role of ribonucleic acid, ribonucleoproteins, and microsomes in the induction of the nervous system has been examined in the light of grafting and explantation experiments. The relative role of ribonucleoproteins and proteins in archencephalic (neural) and spinocaudal (mesodermic) inductive processes has also been discussed.

2. The existence of gradients in ribonucleic acid and protein distribution and synthesis has been demonstrated.

3. The results of experimental modifications of ribonucleic acid synthesis on morphogenesis, and their effects on the ribonucleic acid gradients in amphibian eggs, have been discussed in some detail. In particular, the effects on development of chemical analogues of purines and pyrimidines, of specific inhibitors of oxidative phosphorylations, of centrifugation at various developmental stages, of heat shocks, of sublethal cytolysis, of lethal hybridization, and of ribonuclease have been examined.

4. Finally, another important factor in morphogenesis, namely the role of -SH-containing compounds, has been studied. The effects of various -SH and -SS- reagents on morphogenetic processes in materials as different as amphibian eggs, regenerating tadpoles, planarians, and the unicellular alga *Acetabularia mediterranea* have been presented. The importance of a thiol-disulfide equilibrium in morphogenetic processes such as neural-plate formation, pigment-cells differentiation, "cap" production in *Acetabularia*, and head or tail regeneration has been emphasized.

References

- Bäckström, S., 1958. "The Inhibitory Effect of Glutathione on Some Processes of Animalization," *Exp. Cell Res.* 14, 426.
- Bäckström, S., 1959. "Studies on Sulfhydryl-Containing Substances in Sea Urchin Embryos of Various Developmental Trends," *Exp. Cell Res.* 16, 165.
- Barth, L. J., 1956. "Selective Inhibition of Cleavage to Different Regions of the Frog Egg by Sulfhydryl Inhibitors," *J. Embryol. Exp. Morpho.* 4, 73.
- Bautzmann, H., Holtfreter, J., Spemann, H., and Mangold, O., 1932. "Versuch zur Analyse der Induktionsmittel in der Embryonalentwicklung," *Naturwiss.* 20, 971.
- Beatty, R. A., 1949. "Analysis of Heteroploidy Produced by Chloracetophenone," *Nature* 163, 644.
- Beth, K., 1953. "Experimentelle Untersuchungen über die Wirkung des Lichtes auf die Formbildung von kernhaltigen und kernlosen *Acetabularia*-zellen Z.f.," *Naturforschg.* 8b, 334.

- Bieber, S., 1954. "Analogues of Nucleic Acid Derivatives and the Growth and Development of *Rana pipiens*, I: The Cyclic Inhibition of the Development of *Rana pipiens*," *J. Cell. and Comp. Physiol.* 44, 11.
- Bieber, S., Hitchings, G. H., 1955. "The Developing Frog Embryo and Growth Inhibitors," *Cancer Res., Suppl.* 3, 80.
- Brachet, J., 1940. "Étude histochimique des protéines au cours du développement embryonnaire des Poissons, des Amphibiens et des Oiseaux," *Arch. Biol.* 51, 167.
- Brachet, J., 1941. "La localisation des acides pentosenucléiques dans les tissus animaux et les oeufs d'Amphibiens en voie de développement," *Arch. Biol.* 53, 207.
- Brachet, J., 1944. *Embryologie chimique*, in Desoer, Liège and Masson, eds., Paris.
- Brachet, J., 1946. "Evolution de l'acide ribonucléique au cours de la cytolysé chez les oeufs d'Amphibiens," *C. R. Soc. Biol.* 140, 1125.
- Brachet, J., 1948. "Les effets d'un choc thermique sur la morphogénèse des oeufs de Batraciens," *Experientia* 4, 353.
- Brachet, J., 1949a. "Quelques effets biochimiques d'un choc thermique sur les oeufs de Batraciens en voie de développement," *Bull. Soc. Chim. Biol.* 31, 724.
- Brachet, J., 1949b. "L'hypothèse des plasmagènes dans le développement et la différenciation," *Pubbl. Staz. Zool. Napoli* 21, 77.
- Brachet, J., 1954. "Constitution anormale du noyau et métabolisme de l'embryon chez les Batraciens," *Arch. Biol.* 65, 1.
- Brachet, J., 1957. *Biochemical Cytology* (N. Y., Academic Press).
- Brachet, J., 1958a. "Effects of Mercaptoethanol on Morphogenesis in Amphibian Eggs," *Nature* 181, 1736.
- Brachet, J., 1958b. "New Observations on Biochemical Interactions between Nucleus and Cytoplasm in *Amoeba* and *Acetabularia*," *Exp. Cell Res., Suppl.* 6, 78.
- Brachet, J., 1959a. "Nouvelles observations sur les effets de la ribonucléase *in vivo* sur les oeufs de Batraciens," *Acta Embryol. Morph. Exp.* 2, 107.
- Brachet, J., 1959b. "Thiol Groups and Morphogenesis," *Nature* 184, 1074.
- Brachet, J., and Delange-Comil, M., 1959. "Recherches sur le rôle des groupes sulfhydryles dans la morphogénèse," *Dev. Biol.* 1, 79.
- Brachet, J., Gothié, S., and Kuusi, T., 1952. "Une étude comparative du pouvoir inducteur en implantation et en microinjection des acides nucléiques et des constituants cellulaires nucléoprotéiques," *Arch. Biol.* 63, 429.
- Brachet, J., and Hugon de Scoeux, F., 1949. "Remarques sur le mode d'action de l'organisateur chez les Amphibiens," *J. cyto-embryol. belgo-néerland.* p. 56.
- Brachet, J., and Ledoux, L., 1955. "Action de la ribonucléase sur le développement embryonnaire des Batraciens, II: Etude cytotologique et cytochimique des effets de la ribonucléase chez le Pleurodèle," *Exp. Cell Res., Suppl.* 3, 27.
- Brachet, J., and Shaver, J., 1949. "The Exposition of Chorioallantoic Membranes of the Chick Embryo to Granules from Embryonic Tissues," *Experientia* 5, 235.
- Cagianut, B., 1949. "Zur Wirkung von Sexuallhormonen auf die Primitiventwicklung von *Triton alpestris*. Die Beeinflussung der hormonale Störung durch Nucleinsäure," *Z. Zellforsch.* 34, 471.
- Child, C. M., 1948. "Patterns of Indicator Oxidation in *Triturus* Development," *J. Exp. Zool.* 109, 79.
- Curtis, A. S. C., 1958. "A Ribonucleoprotein from Amphibian Gastrulae," *Nature* 181, 185.

- Curtis, A. S. G., 1960. *J. Embryol. Exp. Morpho.* In press.
- Dalcq, A., 1941. *L'Oeuf et Son Dynamisme Organisateur* (Paris, Masson).
- Dalcq, A., 1957. *Introduction to General Embryology* (N. Y., Oxford U. Press).
- Dalcq, A., and Pasteels, J., 1938. "Potentiels morphogénétiques, régulation et 'axial gradients' de Child," *Bull. Acad. Roy. Med. Belgique* 3, 261.
- Dent, J. N., and Sheppard, G. W., 1957. "The Distribution of Lithium in Amphibian Gastrulae Autoradiographically Demonstrated," *J. Exp. Zool.* 135, 587.
- Deuchar, E. M., 1957. "The Effects of Chloro-Acetophenone on *Xenopus laevis* Embryos," *Roux'Arch. Entwicklungmech. Organ* 149, 565.
- Eakin, R. M., Kutsky, P. B., and Berg, W. E., 1951. "Protein Metabolism of Amphibian Embryo, III: Incorporation of Methionine into Protein of Gastrulae," *Proc. Soc. Exp. Biol. Med.* 78, 502.
- Englander, J., and Johnen, A. G., 1957. "Experimentelle Beiträge zu einer Analyse der spezifischen Induktionsleistung heterogener Induktoren," *J. Embryol. Exp. Morpho.* 5, 1.
- Ficq, A., 1954. "Localisation et dosage du lithium dans les embryons d'Amphibiens," *J. Embryol. Exp. Morpho.* 2, 204.
- Fischer, F. G., and Hartwig, H., 1936. "Die Vitalfärbung von Amphibienkeimen zur Untersuchung ihrer Oxydation-Reduktions-Vorgänge," *Z. Vergl. Physiol.* 24, 1.
- Flickinger, R. A., 1954. "Utilization of C¹⁴O₂ by Developing Amphibian Embryos, with Special Reference to Regional Incorporation into Individual Embryos," *Exp. Cell Res.* 6, 172.
- Flickinger, R. A., and Blount, R. W., 1957. "The Relation of Natural and Imposed Electrical Potentials and Respiratory Gradients to Morphogenesis," *J. Cell. and Comp. Physiol.* 50, 403.
- Flickinger, R. A., Hatton, E., and Rounds, D. E., 1959. "Protein Transfer in Chimaeric *Taricha rana* Explants," *Exp. Cell Res.* 17, 30.
- Fox, J. J., and Goodman, I., 1953. "Competitive Inhibitory Effects of Some Unnatural Cytosine Nucleosides on the *in vitro* Development of the Early Chick Embryo," *Biochim. Biophys. Acta* 10, 77.
- Gallera, J., and Oprecht, O., 1948. "Sur la distribution des substances basophiles cytochimiques dans le blastoderme de la poule," *Rev. Suisse Zool.* 55, 243.
- Grobstein, C., 1955. "Tissue Interaction in the Morphogenesis of Mouse Embryonic Rudiments *in Vitro*," in Rudnik, D., ed., *Aspects of Synthesis and Order in Growth* (Princeton, N. J., Princeton U. Press).
- Grobstein, C., 1956. "Trans-Filter Induction of Tubules in Mouse Metanephrogenic Mesenchyme," *Exp. Cell Res.* 10, 424.
- Grobstein, C., 1957. "Some Transmission Characteristic of the Tubule Inducing Influence on Mouse Metanephrogenic Mesenchyme," *Exp. Cell Res.* 13, 575.
- Grobstein, C., and Dalton, A. J., 1957. "Kidney Tubule Induction in Mouse Metanephrogenic Mesenchyme without Cytoplasmic Contact," *J. Exp. Zool.* 135, 57.
- Hall, T. S., 1942. "The Mode of Action of Lithium Salts in Amphibian Development," *J. Exp. Zool.* 89, 1.
- Hasegawa, H., 1955. "Effect of Thermal Shock on the Nucleic Acids in Toad Embryos during Early Stages of Development," *Nature* 175, 1031.
- Hayashi, Y., 1958. "The Effects of Pepsin and Trypsin on the Inductive Ability of Pentose Nucleoprotein from Guinea Pig Liver," *Embryologia* 4, 33.
- Hayashi, Y., 1959. "The Effect of Ribonuclease on the Inductive Ability of Liver Pentose Nucleoprotein," *Dev. Biol.* 1, 247.
- Hisaoka, K. K., and Hopper, A. F., 1957. "Effects of Barbituric and Diethylbarbi-

- turic Acids on the Development of the Zebra Fish, *Brachydanio rerio*," *Anat. Rec.* 129, 297.
- Holtfreter, J., 1935. "Morphologische Beeinflussung von Urodelcnektoderm bei xenoplastischer Transplantation," *Roux' Arch. Entw. Med.* 133, 367.
- Holtfreter, J., 1943. "Properties and Functions of the Surface Coat in Amphibian Embryos," *J. Exp. Zool.* 93, 251.
- Holtfreter, J., 1947. "Neural Induction in Explants Which Have Passed Through a Sublethal Cytolysis," *J. Exp. Zool.* 106, 197.
- Karasaki, S., 1959. "Electron Microscopic Studies on Cytoplasmic Structures of Ectoderm Cells of the *Triturus* Embryo During the Early Phase of Differentiation," *Embryologia* 4, 247.
- Kuusi, T., 1953. "Sur les effets des acides nucléiques et des protéines dans l'induction hétérogène," *Arch. Biol.* 64, 189.
- Lallier, R., 1951. "Recherches sur le rôle des groupes sulfhydriles dans la morphogénèse, II: Effets de quelques agents oxydants et réducteurs sur la développement d'explantats dorsaux et ventraux de jeunes gastrulas d'Amphibiens," *Bull. Soc. Chim. Biol.* 33, 439.
- Lallier, R., 1954. "Chlorure de lithium et biochimie du développement de l'oeuf d'Amphibien," *J. Embryol. Exp. Morpho.* 2, 323.
- Lallier, R., 1955. "Animalisation de l'oeuf d'oursin par les colorants azoïques et les bleus d'aniline sulfonés," *Exp. Cell Res.* 8, 232.
- Lavarack, J. O., 1957. "The Behavior of Basophil Cytoplasmic Substances during Neural Induction in the Chick," *J. Embryol. Exp. Morpho.* 5, 111.
- Lawrence, A. S. C., Miall, M., Needham, J., and Shen, Shih-Chang, 1944. "Studies on the Anomalous Viscosity and Flow Birefringence of Protein Solutions," II: On Dilute Solutions of Proteins from Embryonic and Other Tissues," *J. Gen. Physiol.* 27, 233.
- Lehmann, F. E., 1938. "Regionale Verschiedenheiten des Organisators von *Triton*, insbesondere in der vorderen und hinteren Kopfreion, nachgewiesen durch phasenspezifische Erzeugung von Lithiumbedingten und operativ bewirkten Regionaldefekten," *Roux' Arch. Entw. Med.* 138, 106.
- Liedke, K. B., Engelman, M., and Graff, S., 1954. "The Selective Response of Amphibian Embryos to Benzimidazole and Benzotriazole Derivatives," *J. Exp. Zool.* 127, 201.
- Liedke, K. B., Engelman, M., and Graff, S., 1957a. "Embryonic Responses to Structurally Related Inhibitors," *J. Embryol. Exp. Morpho.* 5, 368.
- Liedke, K. B., Engelman, M., and Graff, S., 1957b. "Specificity of Embryonic Response to Chemical Inhibitors," *J. Exp. Zool.* 136, 117.
- Mazia, D., 1958a. "The Production of Twin Embryos in *Dendroaster* by Means of Mercaptoethanol (Monothioethylene glycol)," *Biol. Bull.* 114, 247.
- Mazia, D., 1958b. "-SH Compounds in Mitosis, I: The Action of Mercaptoethanol on the Eggs of the San Dollar *Dendroaster excentricus*," *Exp. Cell Res.* 14, 486.
- Needham, J., 1942. *Biochemistry and Morphogenesis* (N. Y., Cambridge U. Press).
- Niu, M. C., 1956. "New Approaches to the Problem of Embryonic Induction," in Rudnik, D., ed., *Cellular Mechanisms in Differentiation and Growth* (Princeton, N. J., Princeton U. Press).
- Niu, M. C., 1958a. "Thymus Ribonucleic Acid and Embryonic Differentiation," *Proc. Nat. Acad. Sci.* 44, 1264.
- Niu, M. C., 1958b. In McElroy, W., and Glass, B., eds., *The Chemical Basis of Development* (Baltimore, Johns Hopkins Press), pp. 256 and 625.
- Niu, M. C., and Twitty, V. C., 1953. "The Differentiation of Gastrula Ectoderm in Medium Conditioned by Axial Mesoderm," *Proc. Nat. Acad. Sci.* 39, 985.
- Pasteels, J., 1940. "Recherches sur les facteurs initiaux de la morphogénèse chez

- les Amphibiens anoures, IV: Centrifugation axiale de l'oeuf fécondé et insegmenté," *Arch. Biol.* 51, 335.
- Pasteels, J., 1945. "Recherches sur l'action du LiCl sur les oeufs des Amphibiens," *Arch. Biol.* 56, 105.
- Pasteels, J., 1953. "Les effets de la centrifugation sur la blastula et la gastrula des Amphibiens," *J. Embryol. Exp. Morpho.* 1, 3, 5.
- Picpho, H., 1938. "Über Oxydation-Reduktionsvorgänge in Amphibienkeim," *Biol. Zbl.* 58, 90.
- Ranzi, S., 1955. "Le Macromolecole nella Determinazione Embrionale," *Rend. Ist. Lombardo Sci.* 89, 200.
- Ranzi, S., 1957. "Early Determination in Development under Normal and Experimental Conditions," in *The Beginnings of Embryonic Development* (N. Y., A.A.A.S.).
- Rapkine, L., and Brachet, J., 1951. "Recherches sur le rôle des groupes sulfhydriles dans la morphogénèse. L'action des inhibiteurs des groupes -SH sur l'oeuf entier et sur des explantats dorsaux et ventraux chez les Amphibiens. Implantation de protéines sulfhydrilées," *Bull. Soc. Chim. Biol.* 33, 427.
- Raven, C. P., 1938. "Über die Potenz von Gastrulaektoderm nach 24 stündigen Verweilen im äusseren Blatt der dorsalen Urmundlippe," *Roux' Arch. Entw. Med.* 137, 661.
- Rickenbacher, J., 1956. "Effect of Stilbestrol on Chicken Embryos," *Z. Zellforschg.* 45, 339.
- Rounds, D. E., and Flickinger, R. A., 1958. "Distribution of Ribonucleoprotein during Neural Induction in the Frog Embryo," *J. Exp. Zool.* 137, 479.
- Runnstrom, J., and Kriszat, G., 1952. "The Action of -SH Reagents on the Activation Process in the Sea Urchin Egg," *Arkiv Zoologi., Ser. 2,* 4, 165.
- Seilern-Aspang, F., 1959. Die Einwirkung von Mercaptoethanol auf die Gastrulation von *Rana pipiens*," *Roux' Arch. Entw. Med.* 151, 159.
- Spratt, N. T., 1952. "Metabolism of the Early Embryo," *Ann. N. Y. Acad. Sci.* 55, 40.
- Steinert, M., 1951. "La Synthèse de l'acide ribonucléique au cours du développement embryonnaire des Batraciens," *Bull. Soc. Chim. Biol.* 33, 549.
- Steinert, M., 1953. "Contribution à l'étude du métabolisme de l'acide ribonucléique dans le développement embryonnaire," Doctoral thesis, University of Brussels.
- Sze, L. C., 1953. "Respiration of the Parts of the *Rana pipiens* Gastrula," *Physiol. Zool.* 26, 212.
- Takata, K., 1953. "Quantitative Study on the Regional Distribution of Pentose Nucleic Acid in the Gastrula and Neurula of *Triturus*," *Biol. Bull.* 105, 348.
- ten Cate, G., 1957. "L'influence de l'arséniate sur le développement membronnaire," *C. R. Assoc. Anat.*, 44th Réunion (Leyde).
- Thomason, D., 1957. "Effect of Lithium Ions on the Penetration of Phosphate into *Xenopus* Embryos," *Nature* 179, 823.
- Tiedemann, D., and Tiedemann, H., 1956. "Isolation of Ribonucleic Acids from Embryonic Extracts and from Liver and their Behavior in Induction Tests," *Z. Physiol. Chemie.* 306, 132.
- Tondury, G., 1947. "The Effect of Stilbestrol on the Mitotic Divisions of the Axolotl Egg," *Acta Anat.* 4, 269.
- Waddington, C. H., Feldman, M., and Perry, M. M., 1955. "Some Specific Developmental Effects of Purine Antagonists," *Exp. Cell Res., Suppl.* 3, 366.
- Wehmeier, E., 1934. "Versuche zur Analyse der Induktionsmittel bei der Medullarplatteninduktion von Urodelen," *Roux' Arch. Entw. Med.* 132, 384.

- Yamada, T., 1958a. "Induction of Specific Differentiation by Samples of Proteins and Nucleoproteins in the Isolated Ectoderm of *Triturus* Gastrulae," *Experientia* 14, 81.
- Yamada, T., 1958b. "Embryonic Induction," in McElroy, W., and Glass, B., eds., *The Chemical Basis of Development* (Baltimore, Johns Hopkins Press).
- Yamada, T., and Takata, K., 1955a. "Effect of Trypsin and Chromotrypsin on the Inducing Ability of the Kidney and its Fractions," *Exp. Cell Res., Suppl.* 3, 402.
- Yamada, T., and Takata, K., 1955b. "An Analysis of Spino-Caudal Induction by the Guinea Pig Kidney in the Isolated Ectoderm of the *Triturus* Gastrula," *J. Exp. Zool.* 128, 291.

REGENERATION IN VERTEBRATES:
THE ROLE OF
THE WOUND EPITHELIUM*

Marcus Singer and Miriam M. Salpeter †

CORNELL UNIVERSITY

A central problem in the regeneration of body parts in amphibians and other vertebrates is the role that the old tissues of the stump play in the formation of the new structure. In regeneration, unlike the situation in embryonic development, the new part develops in close physical relation with the old. Indeed, the cells of the regenerate arise either directly from stump tissues by morphological dedifferentiation, according to the now-prevalent view, or from scattered embryonic reserve cells. Epidermis gives rise to new epithelium by direct migration; nerve fibers regenerate into the new growth; and blood, containing metabolic products and hormones of the adult body, supplies the developing part. The individual tissues of the stump are important for the new growth, but the precise nature of the role that each plays is as yet unknown. We wish to dwell upon the influence of only one of these tissues, the epidermis, on regeneration of a body part. Our thoughts are in part speculative, but we have some experimental information which we believe lends reason to these theories and makes their consequences worth further evaluation.

Much of our discussion concerns regeneration of the amphibian limb, and so, before assessing the role of epidermis, it may be well to review the sequence of regenerative development of that part in the

* *This work was supported in part by grants from the American Cancer Society and from the National Institutes of Neurological Diseases and Blindness of the National Institutes of Health, U. S. Public Health Service.*

† *Public Health Service Research Fellow of the National Cancer Institute.*

adult newt (see also Singer, 1952, 1959; Schmidt, 1958). A few hours after amputation of the arm the epidermis moves over the wound and within a day completely covers it. In the early days the wound area becomes inflamed and is infiltrated with phagocytes. During the first week and the early part of the second there occurs some dissolution of bone, some histolysis of other tissues, and the formation of a fibrocellular scar under the wound epidermis. The epidermis progressively thickens; by the tenth to the twelfth day it consists of about 15 layers of cells, in contrast to the three or four of normal epidermis. The thickening is maintained during the early formative phases of regeneration; it subsides slowly during later stages. The second week after operation is also characterized by dissolution of the scar tissue and increased histolysis of the muscle and other old tissue of the wound. Simultaneously there appear mesenchymatous cells, also called cells of regeneration. As they emerge from among the dissolving adult tissues, these embryonic-like cells accumulate under the thickened epithelium. Abundant nerve fibers are present among the cells of the early regenerate. Indeed, sprouts growing from the amputated nerve stumps invade the wound area within two or three days after amputation (Singer, 1949a). They increase in great numbers in the phase of accumulation of the blastema and invade the epidermis as well.

The mesenchymatous accumulation, the so-called blastema of regeneration, forms a mound after about two weeks which is grossly visible at the end of the stump and which has been called the early regenerate bud. At this stage the end of the stump and the regenerate are swollen with edema fluid. Rapid growth of the blastema occurs during the next week, due to numerous cellular divisions; the regenerate enlarges to form at first a bulging dome-shaped growth, the medium regenerate bud, and then a conical one, the late regenerate bud. During approximately the fourth week, the end of the regenerate becomes flattened to form the rudiment of the future hand, and the proximal part bends to anticipate the future elbow. At about this time differentiation of the axial skeleton and then of muscle and other tissues is initiated (for further references and diagrams of these stages see Singer, 1952, 1959).

The importance of epidermis

Experimental and other evidence seems to point to an essential role of the epidermis in the production of the new part, although the contrary view is sometimes expressed that "the epidermis is either passive or an inhibitor of regeneration" (Nicholas, 1955). When normal skin, including as it does dermal connective tissue, is sewn over the fresh amputation surface of the tail (Tornier, 1906; Godlewski, 1928; Jefe-

moff, 1931; see also Polezaiev and Faworina, 1935) or of the limb (Taube, 1921), regeneration does not ensue. If the covering is incomplete, a small regenerate grows from the exposed area. Godlewski showed that the skin flap must be viable to suppress growth. He concluded that the dermis was the agent of growth suppression because it constituted a barrier of separation between the epidermis and wound tissues, and not because it mechanically obstructed enlargement of the growing tissues (compare Goss, 1956b). Indeed, regeneration occurred even after chamois was sewed tightly over the fresh wound. Besides, when adult skin was sewed over a wound area which was already covered by a regenerated epithelium of its own, regeneration occurred nevertheless, and the regenerate broke through the overlying skin. It appears, therefore, that a direct contact between epithelium and wound tissues is required for regeneration—a conclusion also reached by Schaxel (1921) and others.

Jefimoff (1933) showed that transplanted skin of certain body regions (for example, belly skin—see Taube, 1921, 1923) but not of others supported limb regeneration. Limb regeneration did not occur when skin of the amputation site was replaced by some taken from the head or back—a result affirmed by Polezaiev and Faworina (1935; see also Luther, 1948; Trampusch, 1959). Polezaiev and Faworina attributed to the epidermis a specific action during the earliest stages of regeneration, but once growth is initiated, the regenerate epithelium may be replaced by another.

Lack of intimate association of the epidermis and wound tissues because of too rapid regrowth of dermal connective tissue was blamed by Rošs (1944; Gidge and Rošs, 1944) for the loss of regenerative capacity in the frog's limb at the time of metamorphosis (see also Komala, 1957). Growth responses of the limb stump were elicited by stripping the skin back from the amputation level to delay the regeneration of dermis. Still other experiments on the importance of epidermis for regeneration have shown that when the regenerate and associated stump are denuded of epithelium and then pushed into a skin pocket in the body wall (Polezaiev and Faworina, 1935; compare Morosow, 1938; Taube, 1921) or into the coelom (Goss, 1956, 1956a; Deck, 1955; Pietrzyk-Walknowska, 1959), growth ceases, although differentiation may continue whether the regenerate is quite young or very advanced.

The histology and cytology of the epithelium and of its relations to the underlying blastema also tend to reflect an important role of the epidermis in regenerative events. The epithelium is thin and stretched as it moves over the fresh wound surface, but then later, as its cells divide, it becomes many-layered and thicker than that of normal skin. During the phases of formation of the blastema in which histolysis of

wound tissues is intense, the thickening reaches a maximum. The number of layers decreases during subsequent phases of growth and differentiation. Naville (1924) was one of the first to remark upon the thickening and called it an epithelial cap forming a hypertrophied neoplasm. Faber (1960) speaks of an epithelial lobe for the Axolotl limb regenerate, which he distinguishes from an epithelial cap in time of appearance, in structure, and in persistence.

The thickened epidermis of the regenerate has attracted considerable comment recently, first in the work of Thornton (1954), who emphasized that the apical cap, as he terms it, is always present during the formative phases of regeneration and therefore may be prerequisite for the development of the regenerate and may reflect an important action of the epithelium in the new formation. Thornton pointed out (1956) that, in a stage of tadpole development in which regenerative powers of the limb are lost, an apical cap does not form, whereas in the earlier tadpole capable of regenerating it always appears. He also found that repeated removal of the apical cap prevented limb regeneration (1957), as did suppression of apical cap formation by daily irradiation with ultraviolet light (1958). In the case of *Amblystoma punctatum*, however, successive daily removals failed to interrupt limb regeneration, because, according to Thornton (1957), of a much faster regeneration of the apical cap in this species—four to five hours.

There are instances where an apical cap is present but no regeneration occurs. An apical cap does appear in tadpoles just at the time when they are losing their regenerative powers (Thornton, 1956). A greatly thickened epidermis is observed in the salamander after deviation of the brachial artery and its associated sympathetic nerves to another wound site than the limb (Taban, 1955), and yet no regeneration ensues. In irradiated, non-regenerating limbs of the Axolotl an abnormally thick epidermal cap develops over the wound (Trampusch, 1959). We have seen a thickened wound epithelium over the amputation stump of the adult newt in cases in which the limb was provided with a pure motor nerve supply, itself inadequate to evoke regeneration.

The distal epithelium also thickens during embryonic development of the limb bud in the amphibian and the bird; in the latter case it appears as a ridge over the end of the bud which is called the apical bud or ridge (Saunders, 1948). Morphogenetic importance has been attached by some to the apical ridge of birds (see Zwilling, 1956; Saunders, Gasseling, and Gfeller, 1958; Saunders, Gasseling, and Cairns, 1959) because after this ridge is removed, the limb or its distal parts fail to develop, even though the wound surface is covered rapidly by adjacent epithelium. Others have denied such a role to embryonic epithelium (Amprino and Camosso, 1955; Bell, Kaighn, and Fessenden,

1959); for example, buds deprived of an ectodermal covering and then implanted in the coelom develop normally. Fewer assertions have been made about the morphogenetic importance of the apical cap in the amphibian embryo; however, a critical developmental role is ascribed to it and to similar formations in other vertebrates by some workers (Saunders, 1948; Tschumi, 1956; Balinsky, 1956). Balinsky proposes that mesenchymal cells are trapped under the naked epithelium, where they interact with it to give rise to the limb rudiment.

Another sign, which conceivably reflects an importance of the epithelium in regrowth of a body part is the fact that during the wound phase and early regenerative stages the epithelium is in immediate contact with wound and regenerate tissues without the intervening barrier of dermal connective tissue or basal membrane that normal skin possesses (see below). However, some observations of Ruben (1958) suggest that its absence is not absolutely prerequisite for growth. He induced supernumerary formations by implanting frog kidney under the skin of larval *Amblystoma* limbs. The dermis separating the implant from the epidermis dissolved, but the basal membrane remained while the supernumerary growth was initiated.

Finally, there is another histological event which signifies, according to some, an important role of the epidermis in the growth process. Nerve fibers invade the apical cap in great numbers (Singer, 1949, 1949a). Since regeneration does not occur without an adequate innervation of the wound area (see reviews by Rose, 1948; Singer, 1952), the massive and unique invasion of the epithelium may reflect a critical interrelation between nerve and epidermis important for the new growth (Singer, 1949a, 1952; Thornton, 1954, 1956, 1957). The significance of the epidermal-nervous relation will be assessed below.

Although there is agreement that epidermis plays an important role in regeneration of a body part, the nature of the action is not known. A number of theories have been suggested, including direct cellular contribution to the blastema, histolysis, phagocytosis, promotion of dedifferentiation, stimulation of regeneration, and maintenance of proper mechanical relations with underlying structures.

The theory that the epithelium contributes cells to form the underlying blastema was advanced first by Godlewski for the *Axolotl's* limb (1928) and affirmed recently by Rose (1948a), Rose, Quastler, and Rose (1955), and Hay (1952) for other urodeles. In Godlewski's view, there is a reserve of indifferent cells located especially in the basal layer of epidermis; they are not definitive epithelial cells but only resemble them topographically and morphologically. They wander out of the epithelium and lose their resemblance to epidermal cells, developing processes and becoming spindly. Absence of dermis and direct contact of the epidermis with wound tissues serve as a stimulus to the

outflow. Rose and Hay do not distinguish a reserve of indifferent cells within the epidermis but do describe the internal movement and the transition of epithelium into mesenchymatous cells of regeneration.

Rose (1948a) stained epidermis supravitaly and then observed the appearance of stained mesenchymatous cells. In ordinary histological sections he also could see occasional small streams or tongues of epidermis extending into underlying parts, which he cited as morphological evidence for inward migration and transformation of epidermal cells. We have also seen such irregularities in normal regeneration but attach other significance to them (see also Hellmich, 1930); they may be quite marked under certain experimental circumstances, as various workers have described. We will survey these circumstances below in the description of our experiments. Another reason for Rose's belief emerged from cell counts of the epidermis and mesenchymatous cells at the time the blastema was being formed. He observed a sudden decrease in epithelial cells which coincided in time with a rapid increase in mesenchymatous cells. Support for the view of an epidermal origin of mesenchymatous tissue was also derived from the fact that regenerative powers of a part suppressed by X-rays may be recalled by transplantation to the stump of non-irradiated skin taken from another extremity (Luther, 1948; Trampusch, 1951; Rose, Quastler, and Rose, 1955). Rose, Quastler, and Rose interpreted the results to mean that non-irradiated epidermal cells were transformed into mesenchymatous cells and in this way initiated regeneration (compare Trampusch, 1958, 1959). The evidence of Hay (1952) in support of Rose was based on the identification of cells from heteroploid skin which had moved into the blastema. Epithelium has also been designated as the source of cells in invertebrate regeneration, in this case by differentiation and internal migration (Cresp, 1957).

The view that epidermis is a source of mesenchymatous tissue in amphibian regeneration has been re-evaluated and discarded by a number of workers (Heath, 1953; Manner, 1953; Chalkley, 1954). The evidence against Rose's view has been weighed carefully by Chalkley (1959) in a recent survey and need not be gone into here. We wish to comment in passing, however, on the historical fact that the idea of an epithelial origin of subepidermal elements has been previously raised in literature other than that on regeneration. Klaatsch (1894) reported that ectoderm gives rise to skeletal elements, and Maurer (1895) asserted that it gives off individual cells into the developing dermis (see also Schuberg, 1908; Saguchi, 1913). Kraus (1906) described the inward movement of cells dissociated from the ectoderm to form dermal elements and, indeed, even somatic musculature and axial skeleton. Retterer (1855, 1904) and others (see review by Schaffer, 1927) described leucocytes and connective tissue arising from epithelial cells

by gradual transformation. Epithelial cells have also frequently been reported to be the source of the basal membrane of epidermis, including its reticular fibers and ground substance (reviewed by Singer and Andrews, 1956).

Another theory of epidermal action in amphibian regeneration is that it calls forth histolysis of the wound tissues, a theory to which Polezaiev and Faworina (1935) lent some weight. They noted the experiments of Bromley that histolysis in tissues of the wound is low when the wound is covered by whole skin but intense when there is no intervening dermis. A fresh wound transecting stump tissues is another precondition of histolysis, because regeneration fails when whole skin, after being transplanted over a wound and allowed to heal in place, is then peeled off, unless the underlying tissue is also freshly damaged. Polezaiev and Faworina concluded that epidermis calls forth a strong histolysis in tissues of the stump, resulting in dedifferentiation and the appearance of cells of regeneration (see also Polezaiev, 1947; Needham, 1952). How the epidermis participates in histolysis was not stated, except that tissue breakdown fails without a covering epithelium (see also Adova and Feldt, 1939). Histolysis in the regenerate under the influence of the epithelium was studied morphologically and biochemically by Orechowitsch and Bromley (1934).

The epidermis itself on occasion has been credited with histolytic and phagocytic abilities. Taban (1955) observed that a blood clot was liquefied by the wound epithelium in the salamander. He also observed debris of various sorts within epidermal cells. Phagocytic activity of regenerate epithelium was seen after amputation of the tadpole tail (Ide-Rozas, 1936); as it grew over the wound, the epithelium picked up red blood cells, cell fragments, and debris of various sorts. It dipped down into the crevices of underlying tissues and was so disrupted that in places it was difficult during the early days to distinguish epithelial from mesenchymatous cells.

Another scheme of the role of wound epidermis was advanced by Goss (1956), based on the view of Thornton that a nerve-epidermal interaction is important for growth: The nerve causes the epidermis to grow, and the expansion of the epidermis in turn provides enough space for increase in the blastema. A number of earlier workers had considered and rejected a possible mechanical role of epidermis, including Tornier (1906), Taube (1921), Schaxel (1921), Godlewski (1928), Jefimoff (1931), and Polezaiev and Faworina (1935). They showed that mechanical pressure, whether of a piece of chamois or normal skin transplanted and secured in such a way as to cover the epithelium of the regenerate, fails to suppress the expansion of the blastema, and that the growing structure makes its own space, so to speak, to which the epidermis adjusts itself continuously.

In addition to these views, there are still others sometimes more casually mentioned or implied. Goss (1957) has ascribed a formative role to the skin, as well as the mechanical one noted above. The epidermis has been said to function in the accumulation of the blastema (for example, Thornton, 1954), to guide regenerative events in some way (Trampusch, 1959), and to function in morphogenesis (for example, Komala, 1957; compare Holtzer, 1958). Finally, Faber (1960) has recently suggested that the apical epidermis may play a role in the establishment of an apical proliferation center among the mesenchymatous cells which is important for regeneration of distal structures.

The structure of the epidermis in the amphibian regenerate

The sheet of epidermis that comes to cover the amputation wound of the limb of the adult newt within the first day after amputation is thin—about one or two layers. It then thickens, and by the fifth day it is approximately five to ten layers thick, whereas in non-regenerating skin it is only about three or four layers. The number of layers may reach about 15 after 10 to 14 days—a time when histolysis, edema, and cellular accumulation are very high. In subsequent stages the thickened epidermis, now called the apical cap, thins slowly. During the stage of the medium or late bud it contains about six to ten layers of cells, and fewer later on. The thickening reflects a period of heightened mitoses preceding a similar outburst in the underlying mesenchymatous accumulation (Inoue, 1956).

Initially the epidermal cells are elongated tangentially to the wound surface, but by approximately the end of a week the cells of all layers except the outermost cornified ones are cuboidal; indeed, the basal layers may even on occasion be low columnar in shape. The cuticular surface is smooth and contains no papillae such as are observed in normal skin. Papillae are differentiated relatively late in regeneration.

The transition from adult epidermis to apical cap at the original amputation line is quite abrupt; a “lip” of regenerate epidermis suddenly protrudes into underlying tissue to delimit the margin of the apical cap. On one side are skin glands, underlying basal membrane and connective tissue of the dermis, but they are absent on the regenerate side. Ide-Rozas (1936) believed that the epidermal cells undergo embryonalization in contact with the wound and the cells of regeneration. The basal epidermal cells are affected first and then the upper layers. The process disappears when the mesenchymatous cells differentiate. According to him, the epidermal cells retain their shape as they become embryonic but acquire some of the morphology of the underlying cells. The nucleus enlarges, stains less deeply, and contains

one or two acidophilic nucleoli, and the cytoplasm becomes very basophilic. At first there is no outer cornified layer, as there is in normal skin, but by about the fifth day cornification sets in and progresses rapidly, so that one or a few layers of cornified epidermis are present on the tenth or twelfth day. The cornified layers are often broken and sometimes ragged as groups of cells slough from them.

Boundaries and spaces between cells of the apical cap, as viewed under the light microscope, appear more frequently than in normal skin, especially among the basal layers. Fraisse (1885), Barfurth (1891), Tornier (1906), Taube (1923), and Naville (1924) remarked upon the apparent loose contact between epidermis cells of the regenerate. Perhaps the loose arrangement of the basal cells is due to the widespread edema of the blastema and adjacent stump that characterizes the early regenerate stages. Reflecting the loose arrangement of the cells of the lower layer is the fact that they may be dissociated easily (Singer, Davis, and Scheuing, 1960). When atropine or another drug was infused into the growth, a large blister formed within the regenerate. Fluid accumulated first between the lower epidermal cells, causing them to separate and float free singly or in clusters. The outer cuticular layers resisted the distending fluid but eventually broke.

We have seen debris of various sorts in the intercellular spaces of the epidermis—for example, pigment granules and other cellular fragments including pycnotic nuclei. We have also seen leucocytes or macrophages, which Fraisse (1885) was among the first to observe in the regenerate as well as the normal epidermis of the amphibian (see also Mettetal, 1939). Sometimes the intercellular spaces are greatly enlarged and contain a coagulum and cellular detritus, as though an epidermal cell or group of cells has perished and is now being cytolysed. Taban (1955) depicted a large lacuna of this sort within the epidermis of the salamander, the contents of which included polynucleated cells and partially lysed epithelial cells. Naville (1924) described similar cavities in the regenerating epidermis of *Rana* and discussed the evidence that pycnotic changes occur along with regenerative ones. He observed considerable chromatolysis and nuclear changes among basal epidermal cells. Fraisse (1885) also reported intercellular lacunae filled with a homogeneous coagulant substance. In the regenerate skin of the salamander, Weber noted (1957) that the epidermis is phagocytic in the early days during and following wound closure removing foreign bodies, dead cells, and fragments. He described cysts which occasionally formed intercellularly and which contained erythrocytes and cell particles of various sorts in addition to phagocytes. In supernumerary formations induced by nerve deviation, lacunae filled with debris appeared in the epithelium at the new site of the nerve (Bodemer, 1958). In addition to small lacunae, we also

encountered enlarged cyst-like structures in the epidermis, such as Taban reported, which seemed to be extensions into the epidermis of subepidermal blisters that sometimes form spontaneously in the regenerate (see below).

In the electron microscope, boundaries between adjacent cells are distinct in normal and regenerate epithelium (see Figures 1 and 2). The border of the cells is irregular (sometimes "oak-leaf"), and the contours of adjacent cells follow each other. Adjacent cells are bound across the intercellular spaces by cytoplasmic bridges, the desmosomes, which appear identical to the intercellular attachments described by Porter (1954) and elaborated upon by Selby (1955) and Odland (1958). The

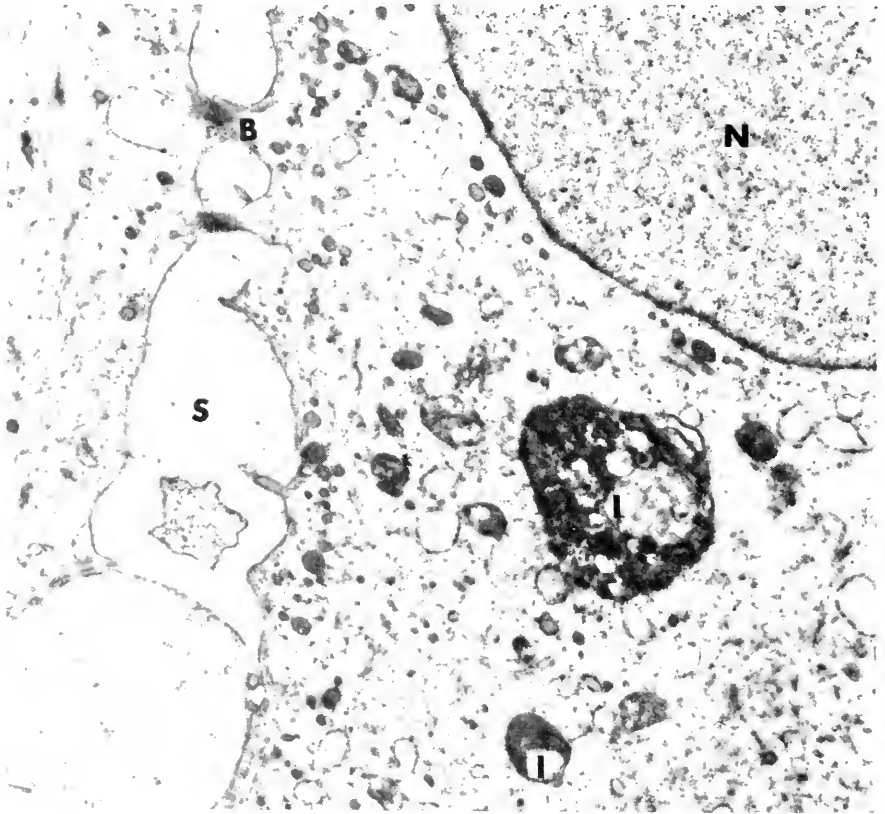

Figure 1. Electron micrograph of part of two epidermal cells ten days after infusion of 0.03 molar beryllium nitrate into a moderate early regenerate amputated ten days previously. Large intracytoplasmic inclusions (*I*) are present. Note the intercellular space (*S*) crossed by cytoplasmic bridges (*B*) containing characteristic plaques. These cells and inclusions are much like those seen in normal regenerate epithelium. Fixation: osmium tetroxide. *N*: nucleus. Magnification: approximately 10,000 X.

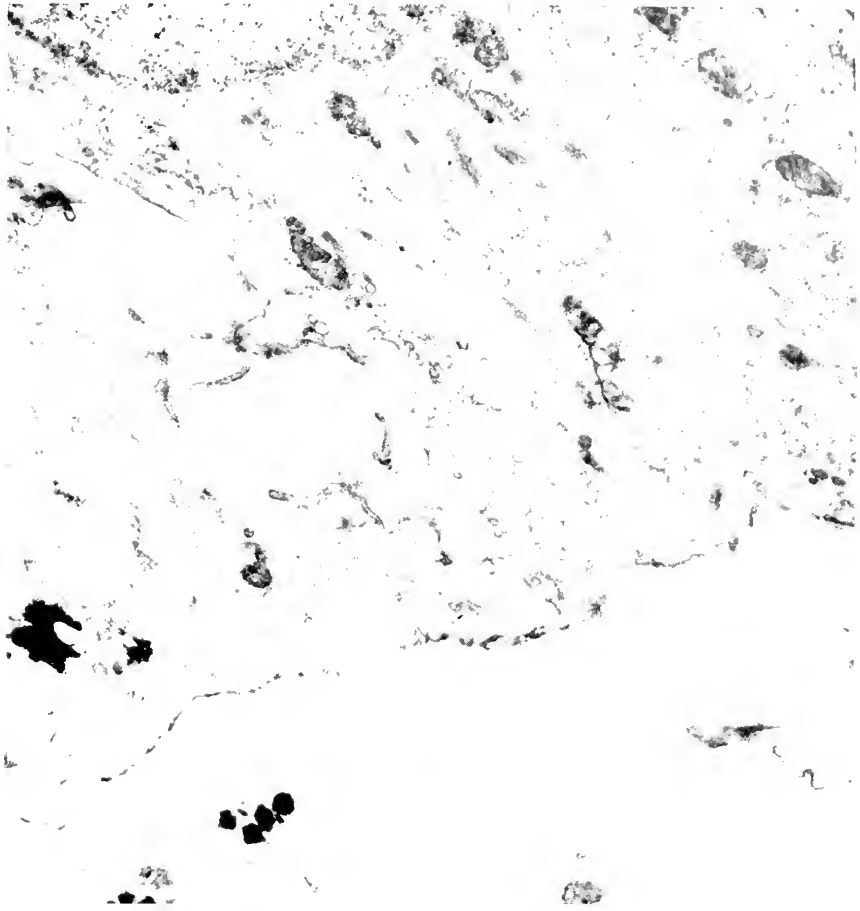

Figure 2. Electron micrograph of two epidermal cells near tip of late regenerate bud. Note the fuzzy accumulation, precursor to the adepidermal membrane, adhering to the underside of the cells. A long fragment of fully formed adepidermal membrane can be seen at the lower left, and small bits throughout. Fixation: osmium tetroxide. Magnification: approximately 17,500 X.

size of the intercellular space varies greatly in the epidermis of the regenerate but not in that of normal skin, where adjacent cellular boundaries follow one another closely with only a minute space between. In some regions of the regenerate the space is as small as that for normal epidermis. In other regions the cellular spaces are many times greater, are more irregular in contour, and adjacent borders only loosely follow one another, although bridges are maintained between the two with their characteristic fine structure. Enlarged intercellular spaces are observed in all layers of the epithelium except in the outer

keratinized ones. At times these enlarged spaces contain particles of various size, nerve fibers, and wandering cells. Wandering cells, squeezed between adjacent epithelial cells, often have large and numerous osmiophilic inclusions and finger-like projections. A feature that helped to distinguish them from epidermal cells is the absence of the distinct plaques characteristic of desmosomes (Figure 1). Epidermal cells sometimes contain as much debris as the phagocytes.

The electron microscope also revealed that numerous epithelial cells possess a cisternal type of endoplasmic reticulum which we have not seen in non-regenerating epithelium. Such a difference bespeaks either a qualitative or quantitative difference in the physiology of the cell. In normal epidermis the reticulum consists of small round or oval profiles scattered in the cytoplasm (see Figure 10 of Salpeter and Singer, 1960). Numerous granules similar to those containing ribonucleoprotein (Palade and Siekevitch, 1956) are found free in the cytoplasm, with some adhering to membranes of the reticulum. In regenerating epithelium the endoplasmic reticulum ranges from the vesicular type, as in the normal cell, to one consisting of many parallel elongated or distended profiles. Granules of ribonucleoprotein are abundant along the membranes of the reticulum. It has been consistently suggested that this type of endoplasmic reticulum is associated with cells engaged in the secretion of a protein-rich product (Palade and Porter, 1954; Howatson and Ham, 1955; reviewed by Haguénau, 1958). And so it may be that the more elaborate reticulum in the epidermal cells of the regenerate denotes a more active synthesis of protein or other substance. In contrast, the activity of the non-regenerating epidermis may be more modest.

The cells of the regenerate epithelium also frequently have a cortical zone which may be quite broad (Figures 2 and 3). It contains no endoplasmic reticulum or mitochondria but consists rather of a uniform, spongy material which is somewhat indistinct. The cortical zone is encountered most frequently among basal cells and least frequently among the outer ones. We have seen such a zone in normal epithelium, but it is less striking and much less frequent. The significance of the zone is unknown; it may represent an area of accumulating secretion which is being discharged gradually through the cytoplasmic membrane.

The relation between epidermis and blastema

The undersurface of the epithelium during the stage of formation of the early regenerate is devoid of a basal membrane, which ends rather abruptly at the original wound level and may even turn inward (Singer and Andrews, 1956). In the light microscope, cytoplasmic

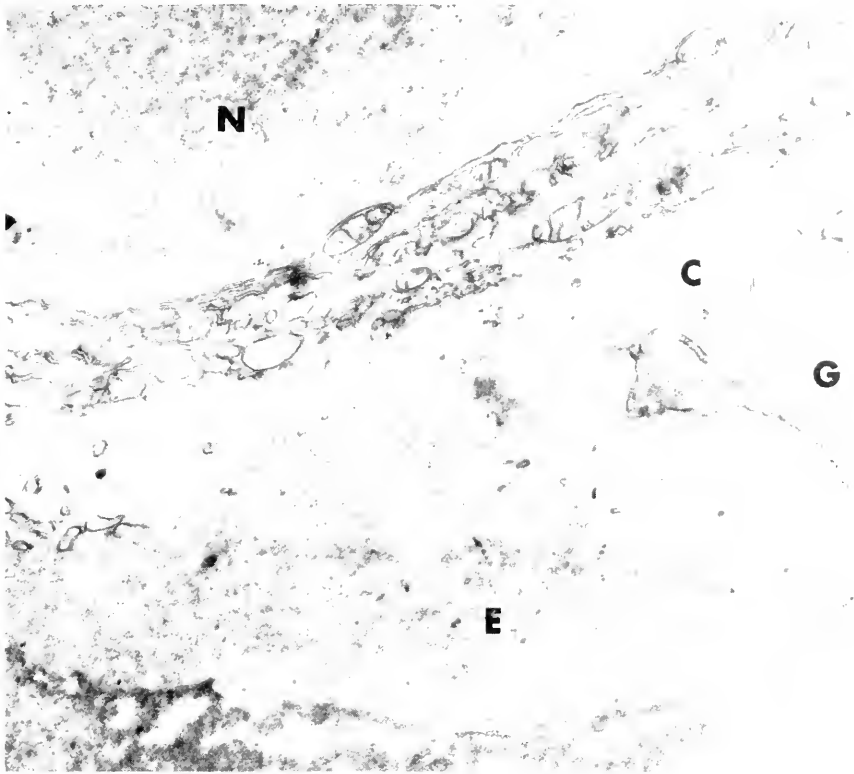

Figure 3. Electron micrograph of part of basal epidermal cell of moderate early regenerate twelve days after amputation, showing surface in contact with blastemal ground substance (G). A large extrusion (E) of the cortical cytoplasm (C) extends into the underlying region. The surface of the extrusion is periodically broken. Note absence of epidermal membrane. Note abundant strands and vesicles of endoplasmic reticulum, oriented around the nucleus (N). Fixative: potassium permanganate. Magnification: approximately 12,300 X.

processes of an occasional regenerate cell seem to contact the basal layer directly, but the undersurface of the epithelium is in general well delimited, and the cells seem to form a continuous line of separation. We have seen no cytological evidence for massive movement of epithelial cells into the blastema as Rose (1948a) has reported.

Electron-microscope studies of the boundary region also show that the ultramicroscopic barrier that exists under normal epidermis is greatly altered or lacking under that of the early regenerate (Figure 2) and under the very tip of the regenerate during subsequent stages of development (Salpeter and Singer, 1960). In the normal skin of various

animals the epidermis is separated from underlying parts by a layer of homogeneous substance (approximately 300 \AA) and then by an uninterrupted membrane (also approximately 300 \AA) (Ottoson *et al.*, 1953; Selby, 1955; Odland, 1958; Salpeter and Singer, 1959). We have called the homogeneous substance the "adepidermal space," and the membrane, the "adepidermal membrane" (Salpeter and Singer, 1959). The adepidermal membrane is not a continuous structure in much of the early regenerate and in the distal tip of more advanced regenerates. It is imperfect, as if in the process of being formed, and there may be a number of adjacent epidermal cells not underlain by even a fragment (Figures 2 and 3). Therefore our studies reveal not only that the basal membrane of light-microscope studies is absent but also that the adepidermal membrane of ultramicroscopic dimensions does not exist as an effective barrier to free exchange between blastema and epidermis. Consequently there is direct communication between the epidermal cells and the ground substance of the blastema. In regions of the regenerate where growth is presumably most rapid this contact and direct communication persist into late stages of regeneration. The adepithelial structures apparently differentiate gradually and are completed in a proximal distal direction, starting near the adult skin along the original wound edge. Individual sectors of the adepidermal membrane and space appear to develop separately in relation to individual epidermal cells. They secondarily unite, eventually to form a continuous structure.

The earliest sign of membrane formation is the appearance of a coarse fuzzy or spongy precipitate at the site of the new membrane (see Figure 3). This loosely organized deposition appears to be the rudiment of the future adepidermal membrane. Then, it seems to be organized under the influence of the epidermis, because the scattered sectors of membrane that first develop conform in orientation with the undersurface of the basal cells. What role the adepidermal membrane normally plays in the activity of epidermis is not known, nor do we know the real significance of its incomplete character during regenerative development. The lack of an unbroken membrane is a notable feature of regeneration, and it may mean that a freer exchange of substances can now occur between epidermis and blastema. The free movement of substances may be essential to the process of growth. In this way epidermis may contribute to the chemical milieu of the blastema and the blastema may pass materials in the other direction.

In regions where the adepidermal membrane is lacking, the cytoplasm of the basal epidermal cell forms one or more surface protrusions. In light-microscope studies the protrusions give to the undersurface of the basal cells a cobblestone appearance. In the electron microscope the protrusions are more clearly visualized (see Figures 3

and 6). The cortical cytoplasm contains one or more polyps which extend into the ground substance that bathes the undersurface of the epithelium. Their size varies; the largest may exceed a micron, and the smallest, often very numerous, constitute only surface irregularities. In some instances the extrusions are shaped like fingers, but more frequently they are rounded with a broad base. Sometimes the entire exposed surface of the cell is involved; in still others, only a part. The very tip of the extensions are often torn or broken, and the marginal cytoplasm appears to merge with the underlying ground substance. The surface break is often multiple, and so the stream is broken here and there by a persistent remnant of the plasma membrane. However, the apparent breaks may not be real but only distortions introduced by fixation and subsequent treatment.

The cytoplasmic protrusions are most abundant in distal-most parts of the early regenerative stages at the time of formation of the blastema, but they are occasionally seen in more advanced stages. They are seen after potassium permanganate or osmium tetroxide fixation, and as we have already noted, the larger ones are observed with the light microscope after fixation in Bouin's fluid. Their presence may be a morphological sign of the participation of epidermal cells in the events of regeneration of the organ. Perhaps the protrusions constitute a secretory contribution to the blastema. We have already suggested that the relatively voluminous endoplasmic reticulum often seen in epidermal cells may reflect increased secretory activity, and that the enlarged spongy cortical zone may represent the accumulated secretion. Perhaps the protrusions are localized eruptions by which substances leave the cell to penetrate underlying regions, and in this way the epidermis may influence regeneration of the body part by means of chemical agents. The possible role of such agents will be speculated upon below.

Concerning the question whether direct physical contact between the bare epidermis and the underlying mesenchymatous tissue is a prerequisite of regeneration, it is important to note at this point that often (approximately 30 per cent of the time) there forms at the boundary between epithelium and mesenchymatous tissue a fluid blister which separates the two, distorts the shape of the regenerate, and persists during the stages of rapid growth (see also Rose, 1948a). The regenerate and adjacent stump are edematous during the formative stages, and the edema fluid is ordinarily dispersed, causing a general swelling in stump and regenerate tissues. Formation of a blister, which seems to occur suddenly, apparently results from localized concentration of the fluid. The boundary is a favored locus of blister formation, and as the vesicle forms, it dissects the margin between epidermis and blastema. Sometimes handling of the animal and mechanical dis-

turbance of the stump seem to be enough to provoke vesiculation. The blisters in about half the instances are very large—many times the volume of the regenerate itself—and stretch the overlying epithelium into a thin, transparent layer of a few cells. The contents of the blister are clear except for occasional bleeding into it. In sections a small amount of debris and occasional cells may be seen within the blister. Although the vesicle effectively separates the epithelium and mesenchymatous parts, regeneration does not cease, nor does it seem to be slowed. Indeed, the vesicle is invaded from below by mesenchymatous cells which gradually replace the fluid. Consequently, immediate contact between the two tissues, at least during the period of early bud formation, is not required for later regenerative events. Blister formation does not, of course, preclude chemical contact between epithelial and mesenchymatous parts by diffusion through the blister fluid.

In summary, our morphological studies, particularly those with the electron microscope, reveal no unbroken barrier to chemical and physical communication between epidermis and blastema. They also show that the epidermal cells of regenerates differ mainly in a quantitative way from that of normal. The endoplasmic reticulum is more elaborate and shows more signs of protein secretion; there are more mitochondria; there is an abundant outer cytoplasmic zone devoid of morphological structure; and the cells are more loosely arranged. Finally, there are morphological signs of chemical contribution of the basal cytoplasmic layer of the epidermis to underlying tissues.

Massive epithelial movements and phagocytosis

A number of workers have remarked upon the fact that irregularities may exist in the deep contour of the epidermis in contact with wound and regenerating tissues. Rose (1948a) considered the irregularities a sign of cellular dissociation and movement of epidermal cells inward to form the blastema. In our experience, irregularities arise especially when the contour of the amputation surface is particularly uneven, since the epidermis in its growth applies itself closely to the wound tissues. Wendelstadt (1904; see also Ide-Rozas, 1936) observed that when bone of the amputation stump protruded from the surface, the epidermis was sometimes unable to cover it but piled up at its base and formed a thick mound of epithelium. Naville (1924) depicted variations in the contour and thickness of the regenerate epidermis. Chalkley (1954, 1959) remarked upon these irregularities and disagreed with Rose that they are areas of cellular dissociation. Taban (1955) observed striking irregularities in the basal layer of epidermis when he deviated the brachial artery and associated sympathetic nerves of the salamander to the body wall. The regenerating epidermis

intruded deeply and encompassed the deviated structures as well as a blood clot that formed at the site of operation. He noticed islets of epidermal cells which he believed had lost contact with the remaining epithelium by internal migration (see also Ide-Rozas, 1936; Roguski, 1953). Taban affirmed Rose's view of internal movement and dissociation of epidermal cells but denied that the cells formed elements of the blastema. More recently Bodemer (1958) saw streamers of epidermis consisting of 30 or 40 cells extending deeply into the underlying musculature in the early stage of supernumerary limb formation in the newt. Roguski (1953) reported that cells became detached from the epithelium as it moved over the amputation wound of *Xenopus* tadpoles and lay in crevices; he believed that the islands do not generate other tissues but, instead, die and disintegrate. "Introverted projections" of the epithelium extending deeply into wound tissues were encountered by Schmidt (1958a) in thyroidectomized animals.

Recent results from our laboratory on beryllium-poisoned regenerates (Scheuing and Singer, 1957) are instructive in the analysis of the relation of epidermis to wound tissues. There was widespread destruction of regenerate and stump tissues but the epidermis itself resisted the poison; indeed, it appeared to be stimulated to high activity and even to participate in the destructive processes. Large projections of epidermis extended deeply within the dying tissues, and it was difficult to determine the boundary between epidermis and other tissues at the ends of these extensions, because the cells of the epidermis appeared to be dissociated and separated by the considerable debris (discussed further below). One might interpret the intermingling of cells and debris to mean that epidermal cells leave the basal layer of the intrusions to move more deeply individually or in clusters. The beryllium studies showed that the thickness, the irregularities in shape, and the over-all disposition of the epidermis are related directly to underlying events.

A striking evidence of the sensitivity of the epidermis to the mechanical and chemical composition of wound tissues and blastema occurs when various tissues or inert substances are implanted into the early regenerate of the newt. The epidermis immediately grows around the foreign object ("seizes" it, so to speak), as though to exclude it, and then sometimes throws it out. For example, implanted spinal ganglia taken from the same animal were almost completely enclosed within a day or two by deep ingrowths of the epidermis (Kamrin and Singer, 1959). But then the response subsided and the projections were retracted. We have obtained the same reaction with pieces of normal and predegenerated nerve and of normal skin (Figure 4). A greater reaction was evoked by dead newt ganglia and ganglia taken from the frog. The epidermis completely encompassed the implant to

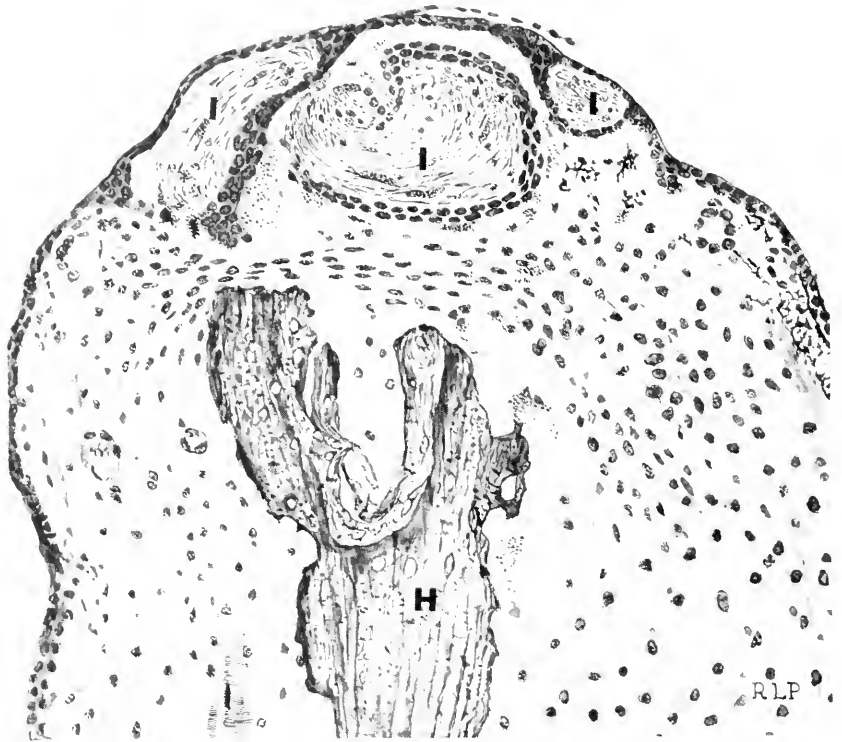

Figure 4. Drawing of longitudinal section of regenerate and stump 16 days after amputation and two days after implantation of pieces of nerve taken from opposite brachial plexus. The epithelium has grown inward to encapsulate the implants almost entirely. Note the continuity of the epithelial sheets and their connections with the surface. In autotransplantation the epithelial reaction subsides before the tissue is thrown out. *H*: humerus; *I*: implant. Animal: IE 186. Bodian silver stain. Magnification: approximately 70 X.

form an epithelial capsule. The outermost layer of the capsule thinned and then separated, and in this way the implant was thrown out of the blastema within one or a few days. During the encapsulation the epidermis seemed to respond to the foreign body as it does to a bare wound, by gliding as one associated structure over it. Scattered debris was observed among the epidermal cells and the cells themselves seemed loosely associated. Implants which excited the epithelium maximally, among others, were pieces of paraffin and surgical cellulose sponges, fragments of celloidin, crystals of chloretone, and surgical thread.

The normal amphibian epidermis also responds to implanted foreign bodies, but much more slowly. We have observed that a num-

ber of weeks are required before implanted paraffin pieces break through the skin. Glass beads and paraffin cones were retained for long periods in the Axolotl (Orechowitsch and Bromley, 1934). When the amputation stump was pushed into a skin pocket of the body wall (Polezaiev and Faworina, 1935), it did not break through the enveloping skin but was retained indefinitely.

Overton (1950) implanted methylcholanthrene crystals, paraffin, and glass beads under the intact skin of the dorsal fin of larval *Amblystoma*. The implants were extruded in most cases within a few days. Histological studies showed early breakdown of the basal membrane, inward migration of cords of epidermal cells, walling off, and extrusion of the implant. During this time there was no increase in mitotic count. The fact that normal epidermis can be excited to throw out a foreign body shows that this reactivity is a common property of epithelia, although more highly developed in that of the regenerate.

Gross epithelial movements in response to the presence of a foreign body, such as we have seen, have also been reported for invertebrates (Lazarenko, 1928; Danini, 1928; Zawarzin, 1927). Zawarzin implanted a small celloidin tube between the epithelial layers of the mantle in the mollusc *Anodonta*; the tube became surrounded by a continuous sheet of epithelium and then was carried to the surface. The epithelial reaction was preceded and partly accompanied by a connective tissue reaction. At first two enveloping layers of connective tissue were deposited, the second of which formed a syncytium. The connective tissue cells degenerated, leaving a ground substance. The capsule evoked an inward growth and a secondary encapsulation by the epithelium. Wounding of the basal membrane was prerequisite for the epithelial response, because it was only from the locus of such damage that the epithelium moved inward. Similar results were obtained in the same laboratory by Lazarenko (1928) on the beetle and by Danini (1928) on the crayfish, and the encapsulated celloidin was expelled in a subsequent molt. In our experiments on the newt the epithelium responded more quickly and did not require a prior connective-tissue response.

In addition to encapsulation of large bodies, the epidermis draws into its intercellular spaces a continuous stream of wandering cells and debris of various sorts, without gross alterations in its contours. In normal limb regeneration we observed debris of various sorts and wandering cells among the epidermal cells. These do not exist in great abundance but are found frequently enough to be seen on occasion even in the restricted field of the electron microscope. The degenerating cells and cellular debris may also be dead epidermal cells and cellular fragments in addition to subepidermal elements.

Other workers have also observed the movement of cells and vari-

ous particles into the epithelium in various vertebrates, including mammals. Bostroem (1928) believed that the cells were converted into epithelial cells, a view shared by Levander (1950). The notion in literature that epidermal cells might arise by transformation from subepidermal elements during epidermal regeneration has been touched upon by Naville (1924) for amphibian regeneration. And the review of Fraisse (1885, pp. 44 and 45) shows that this idea appeared in the earliest histological studies and received some support from Virchow, Cohnheim, and Recklinghausen, among other well-known histopathologists. Fraisse believed that the invading phagocytes remove intercellular debris and nourish the epidermal cells with the products of digestion. He depicted these cells as then falling apart and the fragments condensing to form new nuclei in the general plasm of the epidermis. Ide-Rozas (1936) described intercellular bridges formed with epidermal cells by invading lymphocytes in tadpole tail regeneration. Andrew and Andrew (1949) reported the transformation of infiltrating lymphocytes into epidermal cells and reviewed the information available then on wandering cells within the epidermis. Andreasen (1952) reported, however, that invading lymphocytes degenerate within the epithelium, and he suggested, among other possibilities, that epithelium may serve as an organ of disposal of lymphocytes. Pinkus (1954) described the movement of particulate matter into the epidermis and noted: "The life-cycle of the epidermal cells, which moves newly formed cells gradually outward, also causes any extraneous matter that enters the epidermis from below to be moved to the surface." He also presented a photograph (p. 598) showing "elastic fibers incorporated in various layers of the epidermis over an old scar, and . . . assumed that they are being eliminated in this manner." Moreover, he also recorded the movement of granules of melanin, absorbed by basal epidermal cells from subepidermal melanocytes and carried thence to the surface. Freudenthal (1930) reported the movement of amyloid and blood cells into epitheliomata. The growing epithelium at first surrounded the amyloid-containing connective tissue; then the connective tissue was dissolved, leaving the more resistant amyloid, clumps of which were caught in the epithelium. The clumps of amyloid were found always between the cells in all layers of the epidermis including the outermost horny ones; they appeared to be carried along in the movement of epidermal cells from the basal layers to the surface.

In one of our experiments we inserted carbon particles into the blastema. Within a few days large concentrations appeared among the epidermal cells. As histological sections showed, much of the carbon accumulated in intercellular lacunae. Some was scattered among and within the cells; the rest was located in the blastema. The movement

of carbon to the surface and then its extrusion were most evident among the larger concentrations but presumably occurred among the scattered granules as well. When Nile-blue sulphate was infused from below into the early regenerate, it was concentrated at first within scattered mesenchymatous cells (Singer and Ray, 1957), but then, after a few days, it appeared within the epithelium located in wandering cells, in debris, and perhaps in epidermal cells. Our experiments showed a movement of materials as in a stream from the blastema into and through the epidermis to the outside.

Ide-Rozas (1936; see also Roguski, 1953) remarked upon the phagocytic activity of tadpole epidermis in the early days after tail amputation. Epidermal cells of the wound contained debris which they gathered as they moved over the wound coagulum. There were no obvious pseudopodial movements seeking out the debris but rather a "passive" sweeping-up of particles encountered on the way. Ide-Rozas injected carmine granules under the skin of young tadpoles and mature animals. Within 24 hours the epidermal cells were charged with granules.

In the induction of supernumerary limb regenerates by deviated nerves in the newt, Bodemer (1958) observed that debris was collected within the intercellular spaces and the cells of the epithelium. He dusted charcoal upon the open wound and found that it was culled by the epidermis as it closed over the wound and then was expelled.

Vilter (1933) described the transfer of melanin granules from melanocytes to epidermal cells. He also showed that Axolotl epidermal cells cultivated in a medium containing scattered melanin granules harvest the granules in large number and concentrate them in a supranuclear zone. There is still other evidence from tissue culture that epithelial cells are phagocytic; for example, Matsumoto (1918) showed that corneal epithelial cells of the frog will concentrate pigment granules, particles of carmine, Chinese ink, and other foreign substances in a perinuclear position (see also Ishikawa and Shimomura, 1927, for epithelium of frog tongue, gall bladder, and urinary bladder).

In our laboratory we and our associates have had occasion to infuse solutions of many substances into the growth (Singer, Weinberg, and Sidman, 1955; Singer, Flinker, and Sidman, 1956; Singer, Davis, and Scheuing, 1960). We have noticed regularly that the melanocytes of the blastema are sensitive to cytolysis (see also Lorincz, 1954), are destroyed, and their granules are scattered in the subepidermal region (Ide-Rozas, 1936). The granules are swept into the epithelium, where they are gathered by the epidermal cells. Perhaps not all of the granules in the epithelium arise from disrupted melanophores; it is possible that the epidermal cells are induced by pathological processes to form others (Billingham and Medawar, 1950). Fraisse (1885) observed the

disruption of melanocytes in the area of amputation of the salamander limb and the appearance of granules in epidermal cells; he considered, then rejected, the possibility that granules from cytolysed melanocytes were incorporated into the epidermis. Ide-Rozas (1936), however, speaks of the epidermal cells as phagocytes of melanin granules (see also Vilter, 1933).

The activity of epidermis in gathering debris and, indeed, cells, such as phagocytes, is especially striking after beryllium poisoning (Scheuing and Singer, 1957). We have already pointed out that beryllium causes a progressive destruction of tissues in a distal proximal direction. Cellular fragments and pools of colloid are present everywhere among the dying tissues. The epidermis thickens greatly under these circumstances, and massive extensions of it intrude deeply into the dying tissues. These intrusions, particularly, but also other parts of the epidermis, are choked with a stream of material moving outward from the dying tissues (Figure 5); the basal layer is often so disrupted that it is difficult to distinguish epidermal from other cellular elements. The fragments within the epidermis range in size from scattered melanin granules to recognizable nuclear and cytoplasmic debris. In the light microscope, some of the debris appears to lie within the cells. The intracellular localization of some detritus was affirmed with



Figure 5. Drawing of histological section through distal epithelium 14 days after infusion of 0.015 molar solution of beryllium nitrate into an early regenerate and stump amputated twelve days previously (B215). Regenerate stopped and resorbed. Note debris and phagocytes scattered in the epithelium. Bodian silver stain. Magnification: approximately 450 X.

the electron microscope (Figures 1 and 6). Epidermal cells were readily identified by, among other criteria, the thickened adhesion plaques characteristic of attachment zones between epidermal cells. Vacuoles were present, ranging in size from occasional large ones that distorted the nucleus to numerous minute ones. Debris in various states of dissolution was seen within many of the vacuoles. Red blood cells and wandering cells packed the intercellular spaces, and some of the inclusions within the epidermal cells resembled fragments of

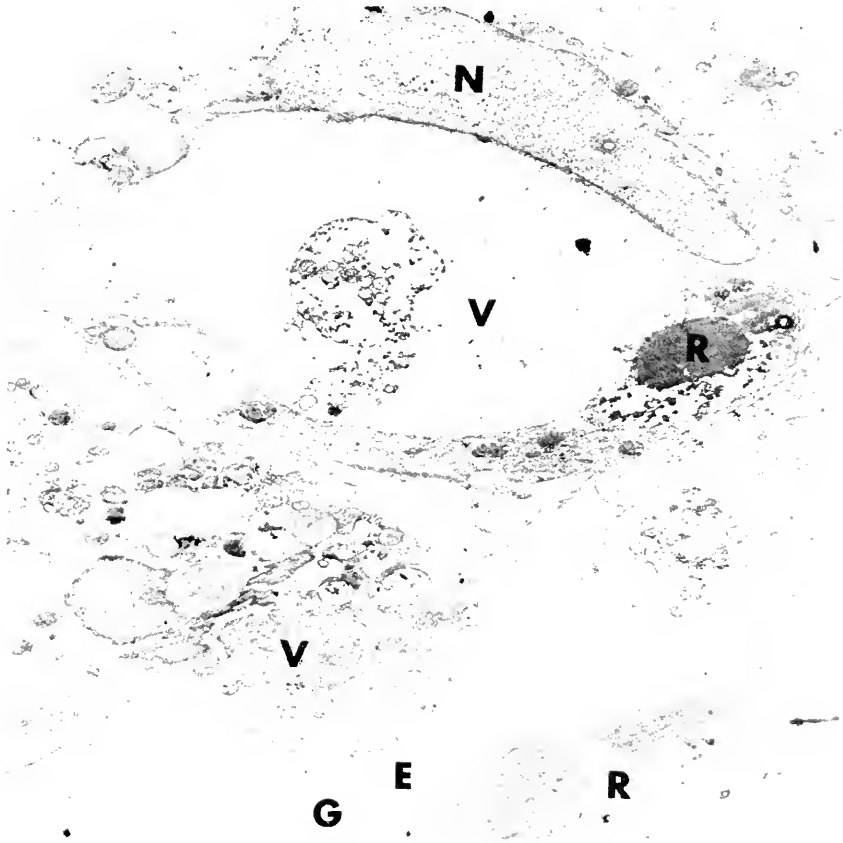

Figure 6. Electron micrograph illustrating great phagocytic powers of epidermal cells. It shows parts of basal epidermal cells and subepidermal region (G) ten days after infusion with 0.03 molar beryllium nitrate into a moderate early regenerate amputated ten days previously. Cells contain inclusions and debris in various stages of dissolution, some being obviously within vacuoles (V). Note large vacuole in upper cell compressing nucleus (N). Smaller one near it appears to contain a fragment of an erythrocyte (R). Note erythrocyte (R) in subepidermal region (G). Note also extrusions of basal cytoplasm (E). Fixative: osmium tetroxide. Magnification: about 3,000 X.

these cells (Figure 6). Concentrations of cellular debris and even erythrocytes have been described within amphibian epidermis by Ide-Rozas (1936) and Taban (1955). Kamrin and Singer (1955) remarked upon the disruption of the epithelium and the presence therein of cellular products in denervated resorbing taste barbels of the catfish.

There is still other experimental evidence from our laboratory (Riddiford, in press) on movement of substances from deep regions into the regenerate epithelium. Tritiated thymidine, infused into the early regenerate, was incorporated widely into dividing mesenchymatous and epithelial cells. The incorporation, identified in radioautography, was evident in the first few days after infusion but then faded with continued cellular division and growth of the regenerate. The opposite control regenerate was completely unlabeled by the localized infusion. Riddiford exchanged the labeled epidermis of one side for the unlabeled one of the opposite. During subsequent days the unlabeled epithelium, now covering labeled blastema, gradually became labeled, presumably by movement of cells and cellular debris into the epidermis from below. Tritiated thymidine, whether released by death of mesenchymatous cells or otherwise, was carried or swept into the epithelium and there incorporated into epidermal cells. The blastema of the opposite side remained unlabeled, although covered with labeled epithelium. Indeed, with the continuous displacement of epidermal cells to the surface, the labeling was gradually washed from the epithelium. She never observed the reverse movement into the blastema from the epithelium. Her results affirm that epithelium continuously receives cellular materials from below and disposes of them. But they do not support the view of cellular movement from epidermis into mesenchymatous tissue.

Role of the epidermis in development of the new part

It is now possible to define more clearly the role that epidermis plays in regeneration of a body part. For one thing, the epidermis collects a steady stream of stuff from the underlying developing blastema. We have seen in our various experiments an apparent progression of transfer of material from inside to outside via the epidermis. The stuff gathered by epidermis consists of various orders of substances. There are, first of all, living and dead cells, among which are active phagocytes. It is possible that the phagocytes enter to remove the debris from the epidermis as they do from elsewhere (Ide-Rozas, 1936) and then return to subepidermal regions. However, the progression of substances outward through the epithelium leads us to the belief that the epidermis serves as a "graveyard," so to speak, for phagocytes and

other cells of the wound and blastema (see also Schaffer, 1927; Andreasen, 1952). It is a means whereby developmentally superfluous cells, and matrix as well, are rendered, completely or partly, and the remains are carried to the outside. Large numbers of cells in various conditions may be disposed of by this route.

Such a route of disposal may explain the fate of resorbing stumps and regenerates after denervation or irradiation with X-rays. In these circumstances the regenerate and even the entire stump may be progressively destroyed and resorbed in a distal proximal direction (Butler, 1933; Schotté and Butler, 1941; Butler and Schotté, 1941). The route of disposal could not be ascertained in these cases. Brunst (1959) believes that giant cells which appear in great numbers after irradiation are largely responsible for the reduction. According to our observations, it is likely that the epithelium plays a major role. Previous results from our laboratory on resorbing denervated barbels of the fish have already suggested such a route (Kamrin and Singer, 1955). Dying cells may be attracted and move into the epithelium, as occurs for phagocytes, or they may contact the epithelium and be drawn into it through some special quality of the epithelium, such as "selectivity affinity" or reactivity of epidermal cells (Weiss, 1958). In the normal development of a part, and in other circumstances such as those above, there may literally be a stream of phagocytes, dead cells, and dying cells entering the intercellular spaces of the epidermis (Figures 1, 5, and 6). The products of their destruction may be utilized by the epithelial cells or carried to the surface and excreted.

In addition to disposing of cellular matter, the epithelium gathers and may render scattered granules and materials of all sorts. Particulate matter and molecularly-dispersed substances presumably are carried outward by a steady stream of fluid which may well up through the epithelium from below. The wound area and the early regenerate are highly edematous, and the fluid pressure may be great enough to promote this movement. Electron-microscopic studies show that there is no morphological barrier to such a stream. The adepidermal membrane is incomplete, and enlarged spaces exist between adjacent epithelial cells. Therefore, the fluid may ooze into the "pores" (Figure 2) between cells of the basal epidermal layer and thence outward through intercellular channels to the surface. As the fluid seeps among the blastemal cells and percolates thence into the epidermis, it would carry along substances of various size. It may be that delicate movements of the epidermal cells assist the movement of the particles into the epithelium. The larger particles may be seized by the epidermal cells upon contact and the smaller move freely deep into the epithelial spaces, where they may be acted upon by chemical emanations of the

epithelial cells. The epidermis may digest and utilize some of the products; the remainder may gradually be moved to the surface, with the continuous movement and loss of epidermal cells.

Normal epidermis may also function, albeit in a less highly active way, in excretion and digestion of debris. A circulation of substances from below into epithelium must exist to satisfy the metabolic needs of the living epidermis. There is evidence in the literature on higher forms that fluid moves through the epidermis from the inside to the out, although the movement is slight (Rothman, 1954), and it may be that particles of all sorts are caught within this flow to the epidermis. Embryonic epithelium is also worth mentioning in passing at this point. The general similarity between embryonic development and regeneration of the amphibian limb suggests that embryonic epithelium, like the regenerating one, may also be phagocytic and function to dispose of cellular breakdown products that accompany development. Indeed Ide-Rozas (1936) has shown that heated yolk granules injected into a young Axolotl embryo are phagocytised by ectodermal cells.

Although our attention has focused upon a distal direction of movement of substances through the epithelium, it is quite possible that the reverse movement occurs at the same time for certain classes of substances of molecular and colloidal dimensions. In some experiments in our laboratory we have observed that relatively large molecules, such as colchicine, do penetrate into the blastema by passage through the epithelium when the stump alone is soaked in a solution of that substance. Movement of substances through normal epidermis to deeper parts is well known in the mammal (reviewed by Rothman, 1954); it is called "percutaneous absorption." Vitamins, fats, hormones, and ions of various sorts move inward when applied to the epidermal surface. It may be that in some way percutaneous absorption and distal flow operate at the same time.

The epidermal function of collecting and disposing of substances of the blastema is not reserved for small particles and individual cells. We have seen large bodies drawn into the epithelium by massive associated movements of epidermal cells. Thus the epidermal response is adjusted to particle size, in one case by gross movements of the epithelial sheet to surround the large particle, in the other case by imperceptible changes in shape to collect smaller particles. The effective stimulus that excites the response may be in part mechanical, due to underlying pressure or contact with an underlying body. It is probably also chemical, whether the chemical interaction involves the molecular interactions of apposed surfaces or the diffusion of substances of "attraction" over a larger distance of separation, because the extent of reaction of the epidermis varies according to the exciting substance. Foreign substances, whether "inert" or tissue taken from another ani-

mal (Kamrin and Singer, 1959), yield the most extreme reaction, whereas bits of tissue from the same animal (such as spleen, liver, muscle, nerve, ganglia) yield the least. Indeed, in the latter cases the reaction eventually subsides, as though some chemical balance is attained between the two, whereas in the former the reaction continues until the body is encapsulated and thrown out.

It is important to note that in the experimental situation we employed to test the response of the epidermis, the epidermis itself was not damaged. A foreign body was implanted into the regenerate from below by way of the stump tissues. Consequently the gross epidermal reaction does not depend on direct damage, nor does it depend on the epidermis moving at the time to close a fresh wound. Instead, the regenerate epithelium appears to be attuned in a delicate way to the underlying tissue, and the equilibrium between the two is easily disturbed. The epidermal response must be initiated in the basal cells first, because one of its surfaces, "unsatisfied" by contact with other epidermal cells and without an intact adepidermal membrane, is in direct equilibrium with the underlying ground substance. When the balance is disturbed, the basal cells move toward the exciting agent and initiate therewith a concerted flow of associated epidermal cells. The quality of the cell that enables it to respond so effectively to alterations in the adjacent environment is not known (see the theories of Weiss, 1958). It must be related in part to the absence of a continuous adepidermal and of a basal membrane; in part it may also be due to a heightened sensitivity and reactivity of regenerate epithelium not shared by the normal.

We cited some morphological evidence of a discharge of secreted epidermal substance, in this case into the ground substances of the blastema. The basal epidermal cells contained cortical extensions whose structure suggested regions of secretory discharge. Although these signs were obvious only the early formative stages of limb regeneration, it may well be that discharge of secreted substances occurs in other stages as well—indeed, even from cells of normal epidermis. Perhaps the epidermis of the early regenerate is only quantitatively more active.

Assuming that such a contribution does occur, the nature of the secreted substance may be speculated upon. Since the adepidermal membrane forms in close orientation to the undersurface of the epidermis, it is possible that the basal secretion influences its formation. The epidermis may contribute the material for the membrane or a substance to pattern the membrane in relation to the undersurface of the epithelium. On the other hand, we have never seen the adepidermal membrane directly beneath the cellular extrusions. And so the secreted substance may prevent the formation of the membrane, and in fact

even dissolve it away, and by this action preserve the intimacy of contact between blastema and apical epidermis. We like to entertain the possibility that the epidermal secretion reflects the histolytic function of the epithelium. It may be that proteolytic enzymes are discharged from the epidermal cells of the regenerate into the intercellular spaces and subepidermal regions. In the latter case, the secretion may contribute to the widespread histolysis of old tissues of the stump that characterizes the early regenerate stages and results in morphological dedifferentiation of adult tissue and the formation of the blastema (Orechowitsch and Bromley, 1934). Jefimoff (1933) and Polezaiev and Faworina (1935), among others, have already attributed a role of the epithelium to initiation of proteolysis. Perhaps the epithelium is itself one of the agents of tissue breakdown and contributes lytic enzymes to the blastema as well as to its fluidy interspaces. This seems a reasonable possibility in the light of the fact that proteolytic activity has been demonstrated a number of times in the epidermis of higher forms (see, for example, Wells and Babcock, 1953; Rothman, 1954). There is one other possible use of epidermal secretion into the blastema. It may serve to attract mesenchymatous cells beneath the epithelium to form the blastema of regeneration.

The extent of the epidermal response to events of regeneration may depend on many factors, one of which is hormonal. For example, Schmidt (1958a) has observed that thyroidectomy causes the epidermis of the adult newt to grow faster and to form an apical cap sooner. Moreover, the epidermis protrudes more deeply than ordinarily into wound tissues.

Invasion of the epidermis by nerve fibers

What initiates epidermal activity and maintains its high state, especially during the formative stages of regeneration, is not known. There is, of course, the excitation of freshly wounded tissues, but within a few days this stimulus should subside as fibrocellular scar tissue is laid down. Yet the excitement appears to become intense ten days or two weeks after wounding, and the epithelium becomes thick and most reactive. It is possible that, in addition to the primary response to wounding, another response, or perhaps a continuation of the primary one, is called forth by underlying regenerative events. In recent years the theory has been advanced that the nerves of the regenerate initiate and maintain activity in the epidermis important for regeneration. The theory arose from the demonstration by one of us that the epithelium of the regenerating forelimb of the newt is invaded by many naked nerve fibers which wander freely among the epidermal cells (Singer, 1949, 1949a). The incursion by nerve fibers was affirmed

subsequently by Taban (1949, 1955), Thornton (1954, 1956), Goss (1956b), and van Stone (1955). Since regeneration of the limb is dependent upon the nerve supply, without which growth cannot occur, the thought was raised originally that the unique epidermal-nerve relation may be of some importance for regeneration (Singer, 1949a, 1952). Thornton (1954, 1956, 1957) suggested that the activity of the epidermis during regeneration of the part is initiated and controlled by this unusual ingrowth of fibers. He implied that the nerve causes the apical thickening which in turn plays a role in the growth. He noticed that the apical cap was absent in anuran tadpoles which had recently lost the power to regenerate, and at the same time few fibers were found in the epithelium. A causal relation between nerve fibers and formation of an apical cap was accepted by Goss (1956b), van Stone (1955), and others. Goss (1956b) advanced an elaborate scheme, in his study of fish barbel regeneration, which pictured the nerve as causing the epidermis to grow and therewith to "provide space" for the accumulation of blastema cells. An epidermis which is not stirred to grow mechanically suppresses the enlargement—a theory upon which we have already commented.

Certain experiments in our laboratories question the significance attributed to the nervous invasion. In some experiments (Sidman and Singer, in press) we observed a condition in which there were few or no fibers in the epidermal cap of the regenerate and yet regeneration proceeded with considerable speed. The forelimb was denervated by ablation of the ganglia and associated sensory and motor roots of the brachial nerves; then adequate time was allowed for motor fibers to regenerate into the field occupied formerly by sensory as well as motor fibers. As a consequence, the motor fibers multiplied and supplied the limb with an excess number. The normal motor supply is not adequate in number to evoke regeneration in the complete absence of sensory neurons, but in the case of the hyperplastic motor innervation, regeneration occurs in about 40 per cent of the instances after amputation (Singer, 1952). Histological examination of these early regenerates seldom showed nerve fibers in the epithelium; instead, the fibers were confined to the blastema.

The fact that the motor fibers avoid the epithelium is interesting in itself. But the important point brought out by this experiment is that the physical presence of nerve fibers within the epithelium is not a prerequisite of regeneration. This does not mean that the nerve does not excite the epithelium. The agent of the nerve action may be a chemical substance, and by this medium the nerve may influence the epithelium without entering it directly. However, it may be that the nerve exerts no special control upon epithelium. Healing of skin wounds and of denervated stumps does not require the presence of

nerves (Singer, 1952, 1959; Lash, 1956). Perhaps only the rate of repair is affected, since the frequency of mitosis appears to be influenced by the nerve (Inoue, 1957; Overton, 1950). The meaning of the nervous invasion may have to be sought elsewhere. The simplest explanation is that nerve fibers assail the epidermis because there are no physical barriers to the invasion. The undersurface of the epidermis is relatively naked, unguarded by a basal and adepidermal membrane, and the intercellular spaces are open to the ground substance of the blastema. The nerve fibers, whose invasive powers are well known, grow with abandon among the epidermal cells. Whatever other service they may perform in regeneration, their presence in the epithelium does render the epithelium highly irritable, and therefore does serve to protect the delicate growth from mechanical harm (Singer, 1949a).

References

- Adova, A. N., and Feldt, A. M., 1939. "Biochemical Peculiarities of Various Regions of the Axolotl's Body Connected with Form-Building under the Action of Organizers," *Compt. Rend. Acad. Sci.* 25, 43.
- Amprino, R., and Camosso, M., 1955. "Le rôle morphogénétique de la crête ectodermique apicale du bourgeon des membres de l'embryon de poulet," *Compt. Rend. Assoc. Anat.* 42, 197.
- Andreasen, E., 1952. "On the Occurrence of the Lymphocytes in the Normal Epidermis," *Acta Dermat.-Venereal.*, Suppl. 29, 32, 17.
- Andrew, W., and Andrew, N. V., 1949. "Lymphocytes in the Normal Epidermis of the Rat and Man," *Anat. Rec.* 104, 217.
- Balinsky, B. I., 1956. "A New Theory of Limb Induction," *Proc. Nat. Acad. Sci. U.S.A.* 42, 781.
- Barfurth, C., 1891. "Zur Regeneration der Gewebe," *Arch. Microsc. Anat.* 37, 406.
- Bell, E., Kaighn, M. E., and Fessenden, L. M., 1959. "The Role of Mesodermal and Ectodermal Components in the Development of the Chick Limb," *Dev. Biol.* 1, 101.
- Billingham, R. E., and Medawar, P. B., 1950. "Pigment Spread in Mammalian Skin," *Heredity* 4, 141.
- Bodemer, C. W., 1958. "The Development of Nerve-Induced Supernumerary Limbs in the Adult Newt, *Triturus viridescens*," *J. Morph.* 102, 555.
- Bostroem, E., 1928. *Der Krebs des Menschen*. (Leipzig, G. Thieme Verlag).
- Brunst, V. V., 1959. "Roentgen Regression and Roentgen Stimulation in Axolotl (*Siredon mexicanum*)," *Acta Union Inter. contre le Cancer* 15, 568.
- Butler, E. G., 1933. "The Effects of X-Radiation on the Regeneration of the Forelimb of *Amblystoma*," *J. Exp. Zool.* 65, 271.
- Butler, E. G., and Schotté, O. E., 1941. "Histological Alterations in Denervated Non-Regenerating Limbs of Urodele Larvae," *J. Exp. Zool.* 88, 307.
- Chalkley, D. T., 1954. "A Quantitative Histological Analysis of Forelimb Regeneration in *Triturus viridescens*," *J. Morph.* 94, 21.
- Chalkley, D. T., 1959. "The Cellular Basis of Limb Regeneration," in C. S. Thomson, ed., *Regeneration in Vertebrates* (Chicago, Chicago U. Press).

- Cresp, J., 1957. "Sur l'histogénèse dans la régénération antérieure de *Salmacina incrustans* (Clap.)," *Bull. Soc. Zool.* 82, 255.
- Danini, E. S., 1928. "Untersuchungen über die regenerativen Eigenschaften des Hautepithels." *Ztschr. f. Mikr. Anat. Forsch.* 12, 507.
- Deck, J. D., 1955. "The Innervation of Urodele Limbs of Reversed Proximo-Distal Polarity," *J. Morph.* 96, 301.
- Faber, J., 1960. "An Experimental Analysis of Regional Organization in the Regenerating Forelimb of the Axolotl (*Ambystoma mexicanum*)," *Arch. Biol.* 71, 1.
- Fraisse, P., 1885. *Die Regeneration von Geweben und Organen bei den Wirbelthieren besonders Amphibien und Reptilien.* Cassel u. Berlin.
- Freudenthal, W., 1930. Amyloid in der Haut. *Arch. Derm. Syph.* 162, 40.
- Gidge, N. M., and Rose, S. M., 1944. "The Role of Larval Skin in Promoting Limb Regeneration in Adult *Anura*," *J. Exp. Zool.* 97, 71.
- Godlewski, E., 1928. "Untersuchungen über Auslösung und Hemmung der Regeneration beim Axolotl." *Arch. Entwmech.* 114, 108.
- Goss, R. J., 1956. "Regenerative Inhibition following Limb Amputation and Immediate insertion into the Body Cavity," *Anat. Rec.* 126, 15.
- Goss, R. J., 1956a. "The Regenerative Responses of Amputated Limbs to Delayed Insertion into the Body Cavity," *Anat. Rec.* 126, 283.
- Goss, R. J., 1956b. "An Experimental Analysis of Taste Barbel Regeneration in the Catfish," *J. Exp. Zool.* 131, 27.
- Goss, R. J., 1957. "The Relation of Skin to Defect Regulation in Regenerating Half Limbs," *J. Morph.* 100, 547.
- Haguenau, F., 1958. "The Ergastoplasm, Its History, Ultrastructure and Biochemistry," *Inter. Rev. Cytol.* 7, 425.
- Hay, E. D., 1952. "The Role of Epithelium in Amphibian Limb Regeneration, Studied by Haploid and Triploid Transplants," *Am. J. Anat.* 91, 447.
- Heath, H. D., 1953. "Regeneration and Growth of Chimaeric Amphibian Limbs," *J. Exp. Zool.* 122, 339.
- Hellmich, W., 1930. "Untersuchungen über Herkunft und Determination des regenerativen Materials bei Amphibien," *Arch. Entwmech.* 121, 135.
- Holtzer, H., 1958. "Lack of Organ-Determining Role of Skin during Regeneration," *Anat. Rec.* 132, 455.
- Howatson, A. F., and Ham, A. W., 1955. "Electron Microscope Study of Sections of Two Rat Liver Tumors," *Cancer Res.* 15, 62.
- Ide-Rozas, A., 1936. "Die cytologischen Verhältnisse bei der Regeneration von Kaulquappenextremitäten," *Arch. Entwmech.* 135, 552.
- Inoue, S., 1956. "Effect of Hypophysectomy upon Mitotic Proliferation in Regenerating Tissue of the Adult Newt," *Endoc. Jap.* 3, 158.
- Inoue, S., 1957. "Epidermal Mitotic Activity and Innervation in the Regenerating Tail of Anuran Tadpole." *Gumma J. Med. Sci.* 6, 81.
- Ishikawa, S., and Shimomura, S., 1927. "Über die Phagozytose und Bewegung der Epithelien der Harnblase, der Gallenblase und der Zunge des Frosches *in vitro*," *Arch. exp. Zellforsch.* 2, 1.
- Jefimoff, M. I., 1931. "Die Materialien zur Erlernung der Gesetzmässigkeit in den Erscheinungen des Regeneration," *Z. Exp. Biol.* (Russ.) 7, 352. (Summarized by Polezaiev and Faworina, 1935.)
- Jefimoff, M. I., 1933. "Die Rolle der Haut im Prozess der Regeneration einer Organs beim Axolotl," *Z. Biol.* (Russ.) 2. (Summarized by Polezaiev and Faworina, 1935.)

- Kamrin, A. A., and Singer, M., 1959. "The Growth Influence of Spinal Ganglia Implanted into the Denervated Forelimb Regenerate of the Newt, *Triturus*," *J. Morph.* 104, 415.
- Kamrin, R. P., and Singer, M., 1955. "The Influence of the Nerve on Regeneration and maintenance of the Barbel of the Catfish, *Ameiurus nebulosus*," *J. Morph.* 96, 173.
- Klaatsch, H., 1894. "Über die Herkunft der Skleroblasten," *Morph. Jahrb.* 21, 153.
- Komala, Z., 1957. "Porównawcze badania nad przebiegiem ontogenezy i regeneracji konczyn kijanek '*Xenopus laevis*' w różnych okresach rozwojowych," *Folia Biol.* 5, 1.
- Krauss, F., 1906. "Der Zusammenhang zwischen Epidermis und Cutis bei Sauriern und Krokodilen." *Arch. Mikr. Anat. Entw.* 67, 319.
- Lash, J. W., 1956. "Experiments on Epithelial Migration during the Closing of Wounds in Urodeles," *J. Exp. Zool.* 131, 239.
- Lazarenko, T. M., 1928. "Experimentelle Untersuchungen über das Hypodermisepithel der Insekten," *Ztschr. Mikr. Anat. Forsch.* 12, 467.
- Levander, G., 1950. "On the Epithelium-Regeneration in the Healing of Wounds," *Acta chir. Scand.* 100, 637.
- Lorincz, A. L., 1954. "Pigmentation," in Rothman, S., ed., *Physiology and Biochemistry of Skin* (Chicago, Chicago U. Press).
- Luther, W., 1948. "Zur Frage des Determinationszustandes von Regenerationsblastemen," *Naturwiss.* 35, 30.
- Manner, H. D., 1953. "The Origin of the Blastema and of New Tissues in Regenerating Forelimbs of Adult *Triturus viridescens* (Rafinesque)," *J. Exp. Zool.* 122, 229.
- Matsumoto, S., 1918. "Demonstration of Epithelial Movement by the Use of Vital Staining, with Observations on Phagocytosis in the Corneal Epithelium," *J. Exp. Zool.* 27, 37.
- Maurer, F., 1895. *Die Epidermis und ihre Abkömmlinge* (Leipzig, Engelmann).
- Mettetal, C., 1939. "La régénération des membres chez la salamandre et le triton. Histologie et détermination," *Arch. Anat. Histol. Embryol.* 28, 1.
- Morgan, T. H., 1908. "Experiments in Grafting," *Amer. Nat.* 42, 1.
- Morosow, I. I., 1938. "Die Hemmung und Wiederherstellung des Regenerationsprozesses der Extremität beim Axolotl," *C. R. (Dokl.) Acad. Sci., URSS*, 20, 207.
- Naville, A., 1924. "Recherches sur l'histogénèse et la régénération chez les Batraciens Anoures (Corde Dorsale et Téguments)," *Arch. Biol.* 34, 235.
- Needham, A. E., 1952. *Regeneration and Wound-Healing*, Monograph (London, Meuthen).
- Nicholas, J. S., 1955. "Regeneration, Vertebrates," in Willier, B. H., Weiss, P. A., and Hamburger, V., eds., *Analysis of Development* (Phila., Saunders).
- Olland, G. F., 1958. "The Fine Structure of the Interrelationship of Cells in the Human Epidermis," *J. Biophys. Biochem. Cytol.* 4, 529.
- Orechowitsch, W. N., and Bromley, N. W., 1934. "Die histolysierenden Eigenschaften des Regenerationsblastems," *Biol. Zbl.* 54, 524.
- Ottoson, D., Sjöstrand, F., Stenström, S., and Svaetichi, G., 1953. "Microelectrode Studies of the E.M.F. of the Frog Skin Related to Electron Microscopy of the Dermoepidermal Junction," *Acta Physiol. Scand., Suppl.* 106, 29, 611.
- Overton, J., 1950. "Mitotic Stimulation of Amphibian Epidermis by Underlying Grafts of Central Nervous Tissue," *J. Exp. Zool.* 115, 521.
- Palade, G. E., and Porter, K. R., 1954. "Studies on the Endoplasmic Reticulum," *J. Exp. Med.* 100, 641.

- Palade, G. E., and Siekevitch, P., 1956. "Pancreatic Microsomes: An Integrated Morphological and Biochemical Study," *J. Biophys. Biochem. Cytol.* 2, 671.
- Pietrzyk-Walknowska, J., 1959. "Regeneration of the Forelimbs of *Xenopus* Inserted into the Body Cavity," *Folia. Biol.* 7, 1.
- Pinkus, H., 1954. "Biology of Epidermal Cells," in Rothman, S., ed., *Physiology and Biochemistry of the Skin* (Chicago, U. of Chicago Press).
- Polezaiev, L. W., 1947. "Regeneration of Limbs in Adult Anura," *Bull. Acad. Sci. URSS, Biol. Series*, No. 4, 539.
- Polezaiev, L. W., and Faworina, W. N., 1935. "Über die Rolle des Epithels in den anfänglichen Entwicklungsstadien einer Regenerationsanlage der Extremität beim Axolotl," *Arch. Entwemch.* 133, 701.
- Porter, K. R., 1954. "Observations on the Submicroscopic Structure of Animal Epidermis," *Anat. Rec.* 118, 433.
- Retterer, E., 1885. "Contribution à l'étude du cloaque et de la bourse de Fabrizius chez les oiseaux," *J. Anat. Physiol.* 21, 369.
- Retterer, E., 1904. "Structure et évolution du tégument externe," *J. Anat. Physiol.* 40, 336.
- Roguski, H., 1953. "Dalsze badania nad regeneracja ogona kijanek 'Xenopus Laevis,'" *Folia Biol.* 1, 277.
- Rose, S. M., 1944. "Methods of Initiating Limb Regeneration in Adult Anura," *J. Exp. Zool.* 95, 149.
- Rose, S. M., 1948. "The Role of Nerves in Amphibian Limb Regeneration," *Ann. N. Y. Acad. Sci.* 49, 818.
- Rose, S. M., 1948a. "Epidermal Dedifferentiation during Blastema Formation in Regenerating Limbs of *Triturus viridescens*," *J. Exp. Zool.* 108, 337.
- Rose, F. C., Quastler, H., and Rose, S. M., 1955. "Regeneration of X-Rayed Salamander Limbs Provided with Normal Epidermis," *Science* 122, 1018.
- Rothman, S., 1954. *Physiology and Biochemistry of the Skin* (Chicago, U. of Chicago Press).
- Ruben, L. N., and Frothingham, M. L., 1958. "The Importance of Innervation and Superficial Wounding in Urodele Accessory Limb Formation," *J. Morph.* 102, 91.
- Saguchi, S., 1913. "Über Mitochondrien (Chondriokonten) und mitochondriale Stränge (= sog. Ebertsche intrazelluläre Gebilde) in den Epidermiszellen der Anurenlarven nebst Bemerkungen über die Frage der Epidermis-Cutisgrenze," *Arch. Mikr. Anat.* 83, 177.
- Salpeter, M. M., and Singer, M., 1959. "The Fine Structure of the Adepidermal Reticulum in the Basal Membrane of the Skin of the Newt, *Triturus*," *J. Biophys. Biochem. Cytol.* 6, 35.
- Salpeter, M. M., and Singer, M., 1960. "Differentiation of the Submicroscopic Adepidermal Membrane during Limb Regeneration in Adult *Triturus*, Including a Note on the Use of the Term, Basement Membrane," *Anat. Rec.* In press.
- Saunders, J. W., 1948. "The Proximo-Distal Sequence of Origin of the Parts of the Chick Wing and the Role of the Ectoderm," *J. Exp. Zool.* 108, 363.
- Saunders, J. W., Gasseling, M. T., and Cairns, J. M., 1959. "The Differentiation of Prospective Thigh Mesoderm Grafted beneath the Apical Ectodermal Ridge of the Wing Bud in the Chick Embryo," *Dev. Biol.* 1, 281.
- Saunders, J. W., Gasseling, M. T., and Gfeller, M. D., 1958. "Interactions of Ectoderm and Mesoderm in the Origin of Axial Relationships in the Wing of the Fowl," *J. Exp. Zool.* 137, 39.
- Schaffer, J., 1927. Das Epithelgewebe. Leukocyten im Epithel. von Mollendorff's Handb. d. mikr. Anat. des Menschen, Springer. Bd 2/1: 91.

- Schaxel, J., 1921. *Untersuchungen über die Formbildung der Tiere. I. Auffassungen und Erscheinungen der Regeneration* (Berlin, Borntraeger).
- Scheuing, M. R., and Singer, M., 1957. "The Effects of Microquantities of Beryllium ion on the Regenerating Forelimb of the Adult Newt, *Triturus*," *J. Exp. Zool.* 136, 301.
- Schmidt, A. J., 1958. "Forelimb Regeneration of Thyroidectomized Adult Newts, I: Morphology," *J. Exp. Zool.* 137, 197.
- Schmidt, J. A., 1958a. "Forelimb Regeneration of Thyroidectomized Adult Newts, II: Histology," *J. Exp. Zool.* 139, 95.
- Schotté, O. E., and Butler, E. G., 1941. "Morphological Effects of Denervation and Amputation of Limbs in Urodele Larvae," *J. Exp. Zool.* 87, 279.
- Schuberg, A., 1908. "Beiträge zur vergleichenden Anatomie und Entwicklungsgeschichte der Lederhaut der Amphibien," *Ztschr. Wiss. Zool.* 90, 1.
- Selby, C. C., 1955. "An Electron Microscope Study of the Epidermis of Mammalian Skin in Thin Section," *J. Biophys. Biochem. Cytol.* 1, 429.
- Singer, M., 1949. "The Invasion of the Epidermis of the Regenerating Forelimb of the Urodele, *Triturus*, by Nerve Fibers," *Anat. Rec.* 103, 506.
- Singer, M., 1949a. "The Invasion of the Epidermis of the Regenerating Forelimb of the Urodele, *Triturus*, by Nerve Fibers," *J. Exp. Zool.* 111, 189.
- Singer, M., 1952. "The Influence of the Nerve in Regeneration of the Amphibian Extremity," *Quart. Rev. Biol.* 27, 169.
- Singer, M., 1959. "The Influence of Nerves on Regeneration," in Thornton, C. S., ed., *Regeneration in Vertebrates* (Chicago, U. of Chicago Press).
- Singer, M., and Andrews, J. S., 1956. "The Apendicular Reticular Network in the Skin of the Newt, *Triturus viridescens*," *Acta Anat.* 28, 313.
- Singer, M., Davis, M. H., and Scheuing, M. R., 1960. "The Influence of Atropine and Other Neuropharmacological Substances on Regeneration of the Forelimb in the Adult Urodele, *Triturus*," *J. Exp. Zool.* In press.
- Singer, M., Flinker, D., and Sidman, R. L., 1956. "Nerve Destruction by Colchicine Resulting in Suppression of Regeneration in Adult *Triturus*," *J. Exp. Zool.* 131, 267.
- Singer, M., and Ray, E. K., 1957. "Cellular Movements in the Early Forelimb Regenerate of the Newt, *Triturus*, and Their Relation to the Nerve," *Anat. Rec.* 128, 623.
- Singer, M., Weinberg, A., and Sidman, R. L., 1955. "A Study of Limb Regeneration in the Adult Newt, *Triturus*, by Infusion of Solutions of Dye and Other Substances Directly into the Growth," *J. Exp. Zool.* 128, 185.
- Taban, C., 1949. "Les fibres nerveuses et l'épithélium dans l'édification des régénérats de pattes (*in situ* ou induites) chez le triton," *Arch. Sci.* 2, 553.
- Taban, C., 1955. "Quelques problèmes de régénération chez les urodèles," *Rev. Suisse Zool.* 62, 387.
- Taube, E., 1921. "Regeneration mit Beteiligung ortsfremder Haut bei Tritonen," *Arch. Entwmech.* 49, 269.
- Taube, E., 1923. "Über die histologischen Vorgänge bei der Regeneration von Tritonen mit Beteiligung ortsfremder Haut," *Arch. Mikr. Anat.* 98, 98.
- Thornton, C. S., 1954. "The Relation of Epidermal Innervation to Limb Regeneration in *Amblystoma* Larvae," *J. Exp. Zool.* 127, 577.
- Thornton, C. S., 1956. "Epidermal Modifications in Regenerating and Non-Regenerating Limbs of Anuran Larvae," *J. Exp. Zool.* 131, 373.
- Thornton, C. S., 1957. "The Effect of Apical Cap Removal on Limb Regeneration in *Amblystoma* Larvae," *J. Exp. Zool.* 134, 357.
- Thornton, C. S., 1958. "The Inhibition of Limb Regeneration in Urodele Larvae by Localized Irradiation with Ultraviolet Light," *J. Exp. Zool.* 137, 153.

- Tornier, G., 1906. "Kampf der Gewebe im Regeneration bei Begünstigung der Hautregeneration," *Arch. Entwicmch.* 22, 348.
- Trampusch, H. A. L., 1951. "Regeneration Inhibited by X-Rays and Its Recovery," *Proc. Nederl. Akad. Wetensch. Ser. C*, 54, 373.
- Trampusch, H. A. L., 1958. "New Experiments about the Effect of X-Rays on the Morphogenetic Field," *Acta Morph. Neer. Scand.* 2, 185.
- Trampusch, H. A. L., 1959. "The Effects of X-Rays on Regenerative Capacity," in Thornton, C. S., ed., *Regeneration in Vertebrates* (Chicago, U. of Chicago Press).
- Tschumi, P. A., 1956. "Die Bedeutung der Epidermisleiste für die Entwicklung der Beine von *Xenopus laevis*," *Rev. Suisse Zool.* 63, 707.
- van Stone, J. M., 1955. "The Relationship between Innervation and Regenerative Capacity in Hind Limbs of *Rana sylvatica*," *J. Morph.* 97, 345.
- Vilter, V., 1933. "Les phénomènes intimes de la pigmentation de la cellule épithéliale chez les vertébrés," *C. R. Soc. Biol.* 113, 1086.
- Weber, W., and Köln, U., 1957. "Experimentelle Untersuchungen über das Problem der Wundheilung bei *Salamandra maculosa* Saur," *Roux' Arch. Entw. Organ.* 149, 528.
- Weiss, P., 1958. "Cell Contact," *Inter. Rev. Cytol.* 7, 391.
- Wells, G. C., and Babcock, C., 1953. "Epidermal Protease," *J. Invest. Dermat.* 21, 459.
- Wendelstadt, H., 1904. "Experimentelle Studie über Regenerationsvorgänge am Knochen und Knorpel," *Arch. Mikr. Anat.* 63, 766.
- Zawarzin, A., 1927. "Über die reaktiven Veränderungen des Epithels bei der Einführung eines Fremdkörpers in den Mantel der Anodonta," *Ztschr. Mikr. Anat. Forsch.* 11, 215.
- Zwilling, E., 1956. "Interaction between Limb Bud Ectoderm and Mesoderm in the Chick Embryo," *J. Exp. Zool* 132, 173.



**INSECT METAMORPHOSIS:
AN APPROACH TO
THE STUDY OF GROWTH***

Carroll M. Williams

HARVARD UNIVERSITY

The complex happenings during embryonic and post-embryonic development have one distant but overriding objective—the production of adult, sexually competent individuals. With the exception of the higher amphibia, most vertebrate animals approach this goal in what may be termed a straight line. So, in the case of the human species, embryonic development gives rise to an infant whose resemblance to the adult is self-evident. The infant is a logical starting point for the construction of the adult.

But among the vast majority of invertebrate animals, especially those that live in the sea, the goals of embryonic development are far different from the formation of diminutive adults. Thus, in most species of marine worms, molluscs, and crustacea, and in all echinoderms and protochordates, embryonic development gives rise to tiny larval forms having little in common with the adults that produced them. As pointed out by Snodgrass (1954), metamorphosis has its roots in this deviation in the course of embryonic development away from the pathway leading to the adult.

Characteristically, in the marine invertebrates and protochordates the larval stage or stages are transient. The larvae are spread about by the current of the sea; their biological role is to be broadcast. Then, still as microscopic objects, they discard their larval organization, metamorphose to parental form, and proceed to grow to adult size

* *The studies described here were supported in part by a grant from the Division of General Medical Sciences of the National Institutes of Health.*

and sexual maturity. Consequently the metamorphosis of the marine invertebrates follows closely on the heels of embryonic development.

It is only among the higher insects and amphibia that one routinely encounters larval stages of prolonged duration. Therefore the provisions for metamorphosis, akin as they are to the developmental mechanisms of the embryo, must be held latent long into the post-embryonic period and then reactivated.

It is easy to see that metamorphosis, whether early or late, challenges our understanding of developmental physiology. Especially in the more advanced forms of insect metamorphosis, larva and adult seem to have little in common—except for their genes.

My present purpose is to emphasize that the metamorphosis of the animal as a whole is the over-all expression of a mosaic of metamorphoses at the level of the individual cells. Moreover, what we see at the cellular level is a coordinated and controlled interplay between nuclear information and cytoplasmic acts.

The molting and metamorphosis of insect integument

The skin of insects proves to be an extremely favorable object for examining these relationships. In all insects it consists of a single layer of living epidermis sandwiched between an overlying cuticle and an underlying basement membrane. The cuticle is synthesized and secreted by the epidermal cell. Each cell contributes a little zone of overlying cuticle. And since the cuticle shows a distinctive structure at each stage in metamorphosis, the cells signal their state of differentiation in terms of the cuticle they secrete.

The secretion of cuticle, as well as virtually all other aspects of insect development, is promoted by a certain hormone which circulates in the blood. This growth hormone is the product of an endocrine organ in the anterior end of the insect—the so-called “prothoracic glands.” The hormone itself has been isolated and crystallized by Butenandt and Karlson (1954). Its empirical formula is $C_{18}H_{30}O_4$. The hormone is termed “ecdysone,” because one of its early and conspicuous effects is to induce a molting, or ecdysis, of the cuticle.

When acted upon by ecdysone, the epidermal cells throughout the body synchronously detach themselves from the old cuticle and proceed to secrete a new one. In the case of a larval molt, the new cuticle shows only minor differences from the one that is shed. Therefore, in terms of the activity of the epidermal cells, it seems necessary to conclude that a larval molt in response to ecdysone corresponds to a renewed bout of activity on the part of synthetic mechanisms already present in the cytoplasm of the larval cells. And it also seems clear

that a conservative mechanism is at work in a larval molt to prevent the flow of fresh genetic information from nucleus to cytoplasm.

The situation is radically different late in larval life, when the molt in response to ecdyson is accompanied by metamorphosis. Here the old larval cuticle is cast off and a completely different pupal cuticle is synthesized and secreted by the same epidermal cells. Still later, ecdyson is again released to initiate the pupal-adult transformation. The pupal cuticle is molted, and the same epidermal cells now synthesize an adult cuticle of distinctive type.

Manifestly the epithelial cells at the time of metamorphosis have at their disposal fresh genetic information prerequisite for the new synthetic acts. This implies a derepression of genes and the passage of new coded information from nucleus to cytoplasm, presumably in the form of ribonucleic acid. Perhaps the day is not far distant when we may speak of larval ribosomes, pupal ribosomes, and adult ribosomes.

The juvenile hormone

In the foregoing analysis I have directed attention to the presence in the larval insect of a conservative agency which stabilizes the larva as a larva by opposing the flow of fresh information from nucleus to cytoplasm. This conservative factor has now been successfully extracted and purified (Williams, 1956; Williams *et al.*, 1959). It is called the "juvenile hormone." It is a relatively small, apolar, heat-stable lactone (Williams, unpublished studies).

As first shown by Wigglesworth (1936), the juvenile hormone is the secretory product of the corpora allata—a pair of tiny endocrine glands in the insect head. In immature larval insects the glands are extremely active in secreting the hormone and thereby preventing metamorphosis. As Bounhiol (1938) and Fukuda (1944) have shown, if one excises the corpora allata and eliminates the source of juvenile hormone, the larva undergoes precocious metamorphosis at the very next molt.

In the normal course of events, the endocrine activity of the corpora allata shows a steady decline during the final larval instar. Consequently toward the end of larval life the brakes are released, and the cells throughout the insect can now tap the fresh information prerequisite for pupation. But in many species one can reapply the brakes by implanting active corpora allata or by injecting juvenile hormone. The net effect is to enforce one or more extra larval instars—a state of affairs which produces insects of giant size (*cf.* Wigglesworth, 1954).

In the *Cecropia* silkworm, pupation occurs in the presence of a low but finite concentration of juvenile hormone (Williams, unpub-

lished studies). If the corpora allata are excised to remove all traces of hormone from the mature larva, then certain of the larval cells acquire an excess of fresh information when acted upon by ecdyson. Consequently these particular cells overshoot the pupal stage and enter at once into a precocious adult differentiation.

In assays of the corpora allata of the *Cecropia* silkworm I find that the glands are totally inactive after the pupal molt and throughout the first two-thirds of adult development. Therefore the metamorphosis of the pupa into the adult is distinguished by the fact that it takes place in what appears to be a total absence of juvenile hormone.

This finding accounts for the extreme sensitivity of the early stage of adult development to the injection of juvenile hormone or the implantation of active corpora allata (Williams, 1959). Thus, if the hormone is injected into a pupa just prior to the initiation of adult development, it prevents the formation of the moth. The net result is that the pupa molts into a second pupal stage. With lower doses of hormone, certain cells are inhibited and others are not. Pupae of this type transform into strange creatures showing a mixture of pupal and adult characteristics.

The critical period for the action of juvenile hormone

The pupa is maximally sensitive to juvenile hormone at the outset of adult development. If the injection is postponed until the fifth day of the 21 days of adult development, it is already too late for juvenile hormone to prevent the formation of a normal adult moth. Evidently, by the fifth day a full set of genetic instructions for the construction of the moth has already been distributed within the individual cells.

These findings direct attention to cytological events, including mitotic divisions, which ecdyson induces at the outset of adult development. Whatever the pertinent cellular or subcellular events may be, we can state that they occur early in adult development, that they show a rapid loss of sensitivity to juvenile hormone, and that, if unopposed by juvenile hormone, they commit the cells to metamorphosis.

Juvenile hormone as an antimitotic agent

In previously unpublished experiments performed in collaboration with Dr. Judith Willis, juvenile hormone was injected into pupae of the *Polyphemus* silkworm in order to cause the formation of a second pupal stage. Disks of integument were then punched from the abdomen to include both the new and the old pupal cuticles. Areas of intersegmental membrane were chosen for study, for these particular

regions faithfully preserve the cuticular plaques secreted by the individual epidermal cells.

When mounted and studied under the microscope, the plaques in the new cuticle were found to be much larger than those in the old cuticle. This signifies that they were secreted by epidermal cells which had undergone a corresponding increase in size under the influence of juvenile hormone. Moreover, the plaques in the new cuticle showed various irregularities attributable to crowding and displacement of cells from the single epithelium.

So for this particular tissue it is clear that juvenile hormone opposes the mitotic activity that normally occurs in response to ecdyson during the pupal-adult metamorphosis. The picture here presented is a suppression of mitosis and a growth by cell enlargement.

At this point it is worth recalling that the growth of larval insects, which normally takes place in the presence of endogenous juvenile hormone, is commonly by cell enlargement. Indeed, in the higher *Diptera* and *Hymenoptera* (*cf.* Wigglesworth, 1954) the growth of all larval tissues is solely by cell enlargement, the same number of cells being present at the end as at the outset of larval life.

These various observations combine to suggest that the suppression of mitotic activity may be one means by which juvenile hormone exercises its conservative function. It is not inconceivable that growth by cell enlargement may, in itself, oppose the flow of information from nucleus to cytoplasm—perhaps by preventing the breakdown of the nuclear membrane.

However, on more mature analysis it is clear that the suppression of mitotic activity can scarcely account for all of the actions of juvenile hormone. For example, the larval growth of insects other than the higher *Diptera* and *Hymenoptera* takes place by mitosis as well as by cell enlargement. Furthermore, even in the higher *Diptera* and *Hymenoptera*, the cells of the imaginal discs grow throughout larval life by mitosis rather than cell enlargement, and yet these imaginal cells are no less sensitive to juvenile hormone than the somatic cells growing by cell enlargement.

Furthermore, if juvenile hormone acts by inhibiting mitosis, it should be possible to mimic the hormone by the use of other antimitotic agents. In unpublished experiments testing this point, Dr. Willis and I have been unable to duplicate any of the actions of juvenile hormone by injecting pupae with colchicine or a number of other antimitotic agents, including a series of nitrogen mustards. Though defects and various abnormalities were produced in many of the experimental animals, in no case did they have any resemblance to the effects of juvenile hormone.

It may be noted, however, that, in contrast to juvenile hormone, colchicine was found to be extremely toxic to insects. Therefore we are unable to state whether mitotic activity was effectively suppressed by sublethal concentrations of colchicine.

Metamorphosis and biological death

Though we speak of ecdyson as a "growth hormone," it is, in fact, a powerful killer of cells when its action is unopposed by juvenile hormone. For example, during the prepupal period one cannot fail to be impressed by the widespread death of cells in specialized larval tissues. Still later, at the outset of adult development, ecdyson acting in the absence of juvenile hormone promotes another great wave of cell death in specialized pupal tissues. At each stage one can accurately predict which cells will develop and which will die. So it is no exaggeration to say that metamorphosis is a tidy blend of birth and death at the cellular level.

Manifestly these happenings are prerequisite for the two-stage renovation of the insect at the time of metamorphosis. Moreover, it is worth recalling that a larva approaching metamorphosis becomes a closed system without any further intake of food or water. Therefore the pupa must be constructed from the biochemical assets of the larva; the adult, from the assets of the pupa. So, in biochemical terms, metamorphosis is a reworking of atoms and molecules in an essentially closed system.

There can be little doubt that the death of specific cells is a part of the "construction manual" for the insect as a whole. The cells that will die have been programmed to do so. Therefore their individual deaths in response to ecdyson represent the decoding and acting out of a fresh, albeit final, bit of genetic information.

Clearly the biochemical mechanism of biological death is a matter worthy of detailed attention. The intracellular, membrane-limited "lysosomes" are of special interest in this connection. As De Duve (1959 a, b) has shown, these organelles in mammalian liver cells are little short of biological "booby-traps." When activated, they release all the enzymes necessary to take a cell apart. Whether lysosomes are present in insect cells, and their possible role in cell death, are matters which urgently require investigation.

Juvenile hormone and biological death

The great waves of cell death are seen only at the time of metamorphosis; that is, when ecdyson acts in the virtual or complete absence of juvenile hormone. Earlier in the life history, when juvenile

hormone is present, the cells destined to die are prevented from acting out their latent lethal programs. Thus the picture presented during successive instars of larval life is one of generalized cellular growth and vitality.

The conservative action of juvenile hormone is documented in a most dramatic way in experiments in which pupae are injected with juvenile hormone. As previously mentioned, the pupa molts and produces not a moth but a second pupal stage. Dissection of these animals reveals the integrity of the fat-body, the prothoracic glands, and all other tissues that routinely break down in the course of adult development. The presence of juvenile hormone prevents, so to say, the genetic "count-down" on the cells that are programmed to die.

Mode of action of juvenile hormone

According to this analysis, juvenile hormone is a conservative agent which blocks the flow of fresh genetic information from nucleus to cytoplasm.

So little is known about the channelization and management of information in animal cells that the analysis can scarcely be pressed beyond this point at the present time. However, by analogy with the simpler and more accessible microbial systems, we find no dearth of mechanisms which could account for the conservative action of juvenile hormone. The hormone could affect one or more systems of positive or negative feedback concerned with the repression or de-repression of specific gene combinations; it could interfere with nucleolar action or the synthesis and coding of new RNA; it could oppose the flow of new RNA from nucleus to cytoplasm; it could selectively cover up and inhibit newly formed ribosomes.

This much we can say with confidence: Juvenile hormone somehow prevents the cytoplasm from receiving or acting on fresh instructions whose ultimate source must be the coded genetic information of the nucleus. Meanwhile the hormone fails to interfere in any way with the use and reuse of the information already at the disposal of the cytoplasm. In the presence of juvenile hormone a cell can read and reread the same chapter in the construction manual. But it cannot press on to the next chapter.

References

- Bounhiol, J. J., 1938. "Recherches Expérimentales sur le Déterminisme de la Métamorphose Chez les Lépidoptères," *Bull. Biol. Suppl.*, 24, 1.
 Butenandt, A., and Karlson, P., 1954. "Ueber die Isolierung eines Metamorphose-Hormons der Insekten in kristallisierter Form," *Z. Naturforsch.* 9b, 389.

- De Duve, C., 1959a. "Some Topographical Aspects of the Regulation of Cell Metabolism," in *Regulation of Cell Metabolism*, Ciba Foundation Symposium (Boston, Little, Brown).
- De Duve, C., 1959b. "Lysosomes, a New Group of Cytoplasmic Particles," in Hayashi, T., ed., *Subcellular Particles* (N. Y., Ronald Press).
- Fukuda, S., 1944. "The Hormonal Mechanism of Larval Molting and Metamorphosis in the Silkworm," *J. Fac. Sci. Tokyo Univ.*, Sec. IV, 6, 477.
- Snodgrass, R. E., 1954. *Insect Metamorphosis*. Smithsonian Inst. Publs., Misc. Collections, 122, No. 9.
- Wigglesworth, V. B., 1936. "The Function of the Corpus Allatum in the Growth and Reproduction of *Rhodnius prolixus* (Hemiptera)," *Quart. J. Micr. Sci.* 76, 91.
- Wigglesworth, V. B., 1954. *The Physiology of Insect Metamorphosis* (N. Y., Cambridge U. Press).
- Williams, C. M., 1956. "The Juvenile Hormone of Insects," *Nature* 178, 212.
- Williams, C. M., 1959. "The Juvenile Hormone, I: Endocrine Activity of the Corpora Allata of the Adult Cecropia Silkworm," *Biol. Bull.* 116, 323.
- Williams, C. M., Moorhead, L. V., and Pulis, J. F., 1959. "Juvenile Hormone in Thymus, Human Placenta and other Mammalian Organs," *Nature* 183, 405.

**GROWTH IN SIZE AND
BODY PROPORTIONS IN
FARM ANIMALS**

Sir John Hammond

CAMBRIDGE UNIVERSITY

Wide variations in size and in body proportions exist within each species of farm animals. In recent years many investigations have been undertaken to determine the causes of these differences and thereby obtain a measure of control over them.

While the factors affecting size and body proportions will be treated separately here, a relationship exists between the various factors within a single breed, in that the larger the animal is for its age the more advanced will be its proportional development. This applies particularly to both sex and nutritional differences in size, examples of which will be given. This relationship, however, does not necessarily apply between breeds, for small breeds, in general, mature earlier in their body proportions than large breeds do. This also holds within a breed over a period of time: for example, a considerable reduction in size has occurred over the last 50 years in our major beef breeds of cattle, which have been selected for early maturation in body proportions.

Growth in size

The intra-uterine period can be divided into three distinct phases, in each of which the mode of nutrition is different. In the first, or *blastocyst* phase, nutrition is derived from the uterine secretion. In the second, or *embryonic* phase, nutrition is derived from the active erosive agency of the fetal trophoblast, while in the third, or *fetal* phase, tro-

phoblastic activity ceases and nutrition is derived by diffusion from the maternal blood stream.

In the blastocyst stage genetic differences in size between different breeds of rabbits have been observed by Gregory and Castle (1931). At a given stage the large breeds have a larger number of blastomeres. Both between species and within a species the amount of some substance or substances in the uterine secretions, possibly in the nature of a growth hormone (Hammond, 1959), limits the number of blastocysts that can develop. For example, if in the ewe, which normally produces a maximum of about three lambs, 30 fertilized eggs (Figure 1) are produced as a result of the injection of pregnant mares' serum, all but about three perish in the blastocyst stage (Robinson, 1951). The fertilized eggs can, however, develop normally if they are transplanted two at a time into other ewes (Rowson and Adams, 1957).

In the embryonic stage, differentiation of the organs and tissues occurs by cell multiplication, and the nutrition for this is provided by the activity of the trophoblast, the cells of which, like cancer cells, have a high priority for nutrients from the blood stream. As a result, the size of the young animal at this stage is not affected by the level of nutrition

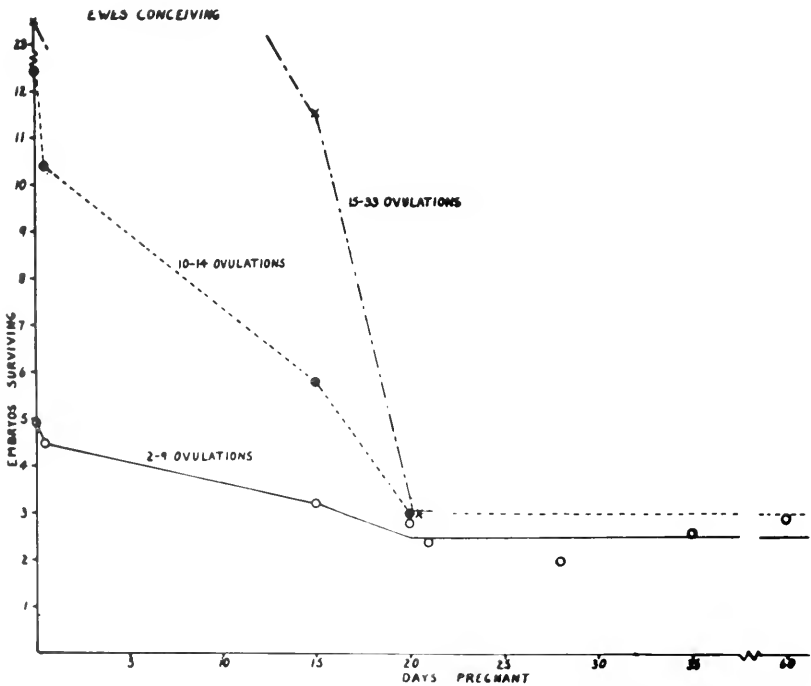

Figure 1. Survival of fertilized ova after normal ovulation and superovulation. In spite of the presence of as many as 30 fertilized ova, all but an average of two or three perished. (Robinson, 1951.)



Figure 2. The effect of the level of nutrition of the ewe on the size of the fetus at different stages of pregnancy. Note that the level of nutrition has no effect up to 91 days of pregnancy, but a marked difference in fetal size appears by the 144th day of pregnancy. All animals were photographed to the same scale and only twin lambs were used. (Wallace, 1948.)

of the mother (Wallace, 1948). At this stage the placenta continues to grow, and the extent of this growth determines the amount of nutrition the young animal will receive at the following fetal stage (see Figure 2), when the trophoblast degenerates and nutrition is maintained by diffusion from the maternal blood stream. Examples of this are seen in the differences in birth weight between lamb singles and twins, caused by the fact that whereas in a single birth the average number of cotyledons in the placenta is 83, in twins the number in each placenta is only 57, so that the weight of the latter is 110 grams, as compared with 538 grams for a single placenta (Wallace, 1948).

Again, the size of the placenta will vary with the size of the uterus, so that the size of the mother will determine the size of the young at

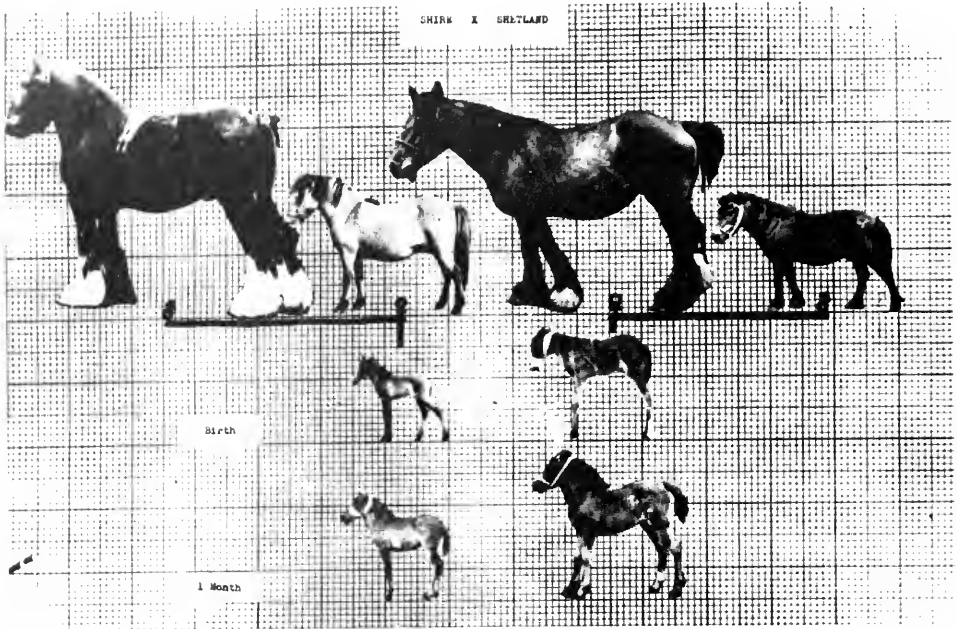

Figure 3. The effect of the mother's size on the size of the foal in reciprocal crosses between the large Shire horse and the small Shetland pony. At the left are the parents and the foal (at birth and at one month) representing the mating of a Shire stallion and a Shetland mare; at the right is the larger foal of a Shire mare and a Shetland stallion. (Walton and Hammond, 1938.)

birth. This has been shown by reciprocal crosses between large and small breeds in horses (Walton & Hammond, 1938), in which the weight of the placenta, and of the foal, of a large mother is three times that of a small mother (Figure 3). This has been also shown for cattle (Hammond and Joubert, 1958) and sheep (Hunter, 1956). The genetics of the sire determine the upper limit of size at birth in the large mother, but the size of the placenta limits it in the small mother. That this is due to maternal nutrition and not to cytoplasmic inheritance is shown by the fact that fertilized eggs reciprocally transplanted between large and small breeds of sheep still show these effects (Figure 4).

The length of time that these maternal influences on size persist is determined by the stage of development at which the young are born. In the horse, where the leg has reached full length (from knee to ground) at birth, differences in birth size persist into adult life (Walton and Hammond, 1938). This can also be seen in the size differences between mules and hinnies. But in sheep, the length of whose cannon bone is not fully developed at birth, maternal effects on size diminish

with age (Hunter, 1956), although weight differences persist for many months (Figure 5).

In the fetal stage, nutrition is derived by transfusion from the maternal bloodstream and so is affected not only by the placental area but also by the level of nutrition of the mother, as we have seen (Figure 2). When the area of the placenta is small, as in twins or triplets in sheep, the level of the mother's nutrition is more important than it is when the area is large, as in singles. At this stage there is very rapid growth in the fetus itself and cessation of the growth of the placenta. In muscle, which by weight is the major body tissue, increase in size, which has hitherto been by increase in cell numbers (Figure 6), now takes place by increase in cell size (Joubert, 1955). In this tissue all the further increase in weight up to adult life is by increase in muscle-cell size. This means that by the beginning of the fetal stage, the maximum adult size of the animal has been fixed, since differences in size between breeds within a species are due to differences in muscle-cell numbers and not to cell size.

This also applies to sex differences in size within a breed. For example, rams and wethers are larger than ewes, so that in young sheep

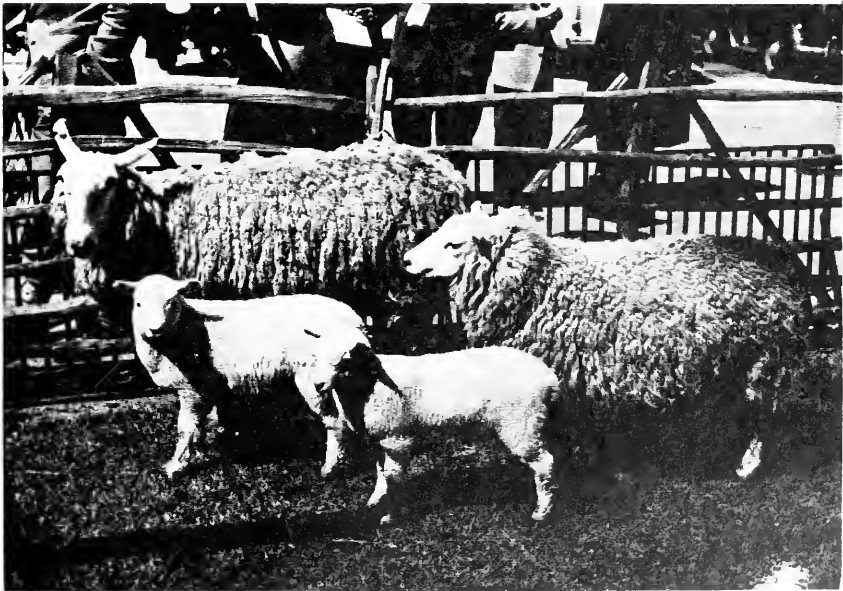

Figure 4. The effect of maternal nutrition on the size of the lamb at birth. At the right is a purebred Welsh lamb with its mother. At the left is a purebred Welsh lamb of the same age which was transplanted as a fertilized egg into a Border Leicester ewe, standing beside it. Despite the same heredity, the lamb incubated by the larger mother is bigger than its normally bred fellow. (Hunter, 1956.)

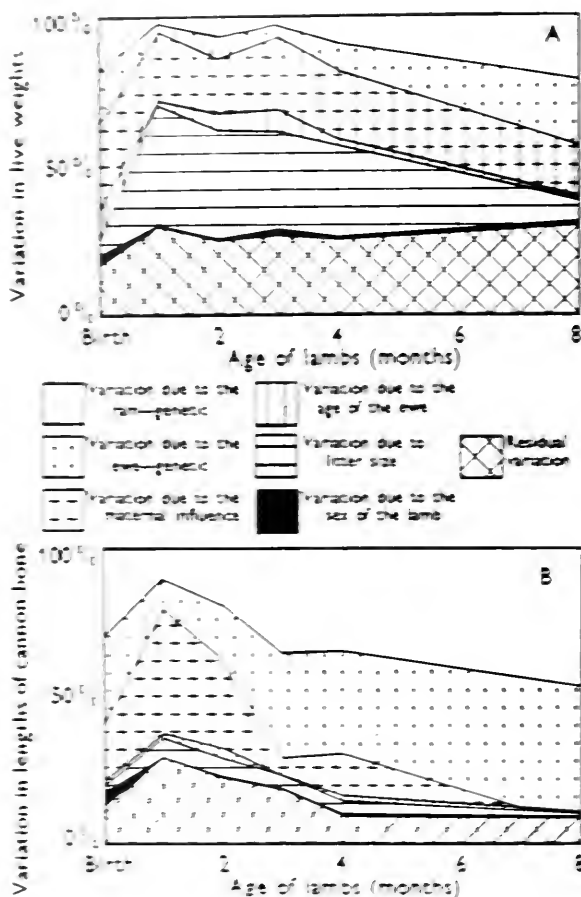

Figure 4. Variations in the growth of lambs— in weight and in bone length— as influenced by heredity, maternal influence, age of the mother, litter size, and sex of the offspring. (Hünner 1956)

Fig. 4. and 5. The lambs born to the ewes have a larger diameter than those born to the heifer (Hünner 1956). This fact accounts for the higher mortality of the great yearlings of the ewe and the heifer, as well as the lower mortality of the ewes.

In the postnatal period, however, lambs can be influenced by certain factors, such as the level of plane of nutrition, reduced production of antibodies, and the presence of parasites (Smith and MacDowell 1955; Smith and MacDowell 1956; Simpson 1955). The most common of these influences is the effect of nutrition (Fredericksen 1953; MacDowell 1955). The permanency of the effect depends on the age of the lamb at the time of weaning and the degree of the low-

level feeding period. McCay et al. (1935) found that in rats the juvenile period could be prolonged considerably by undernourishment and that growth toward adult size could be restored by feeding at a certain level, the length of life depending on the length of the juvenile period. McCance and Widdows (1956) found that interrupted growth in pigs could be advanced by higher feeding after the young pigs had been kept at low body weight for a long period by undernourishment. Both of these species are born at an early stage of development, and it has yet to be determined whether species born at a later stage of development, such as cattle or sheep, behave in the same way. After periods

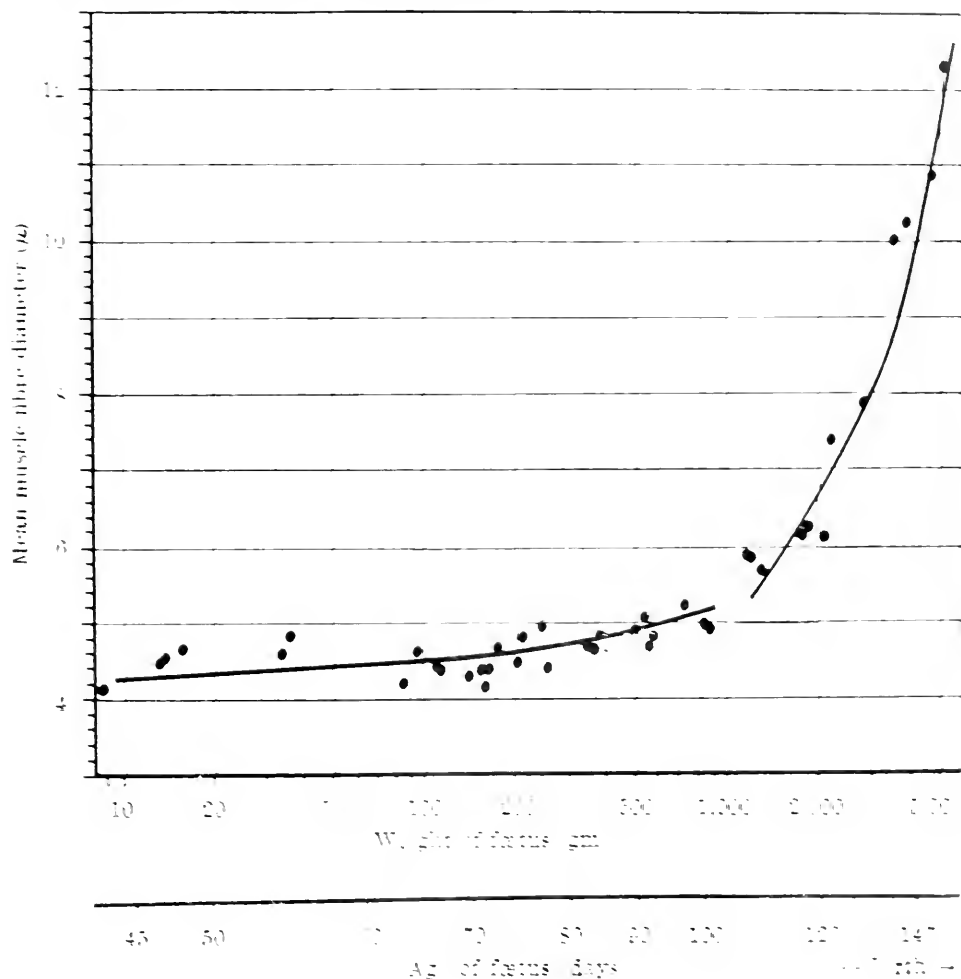

Figure 6. Growth of muscle tissue in fetal sheep. At first, up to the age of 90 to 100 days, the muscle fiber grows by cell division, that is, increase in the number of cells. After 100 days there is a marked increase in the size of the cells. (Lubert, 1955)

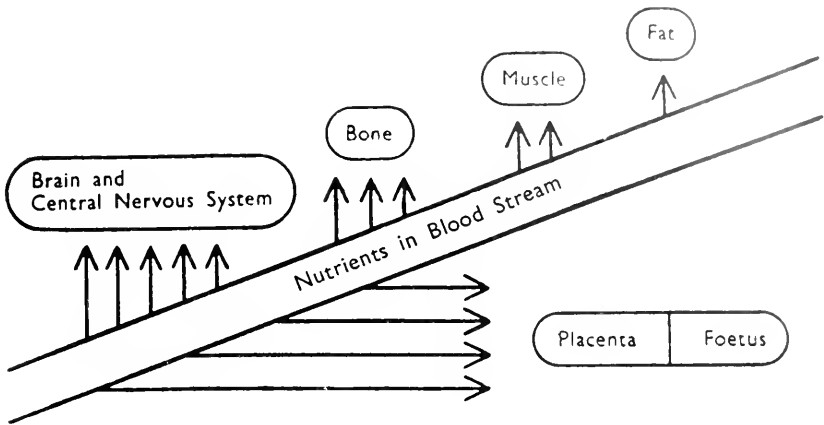

Figure 8. The priorities of various tissues in taking nutrients from the blood stream (denoted by arrows). The uptake depends on the metabolic rates of the respective tissues. When the level of nutrition is reduced moderately (one arrow taken from each tissue) the growth of fat ceases but the brain, bone, and muscle tissues continue to grow, though at a slower rate. During early pregnancy, the placenta and fetus have high priorities. (Hammond, 1944.)

general, the evolution of the species (Hammond, 1952). In horses, cattle, and sheep, whose young are born at an advanced stage of development and have to follow their dam, the maximum proportions of leg length occur at birth, while in rabbits, which are born at a less advanced stage of development, this does not occur until later. In general, the head and the legs form a high proportion of the body weight at birth. With development, the body first lengthens and later deepens. The growth gradients start at the extremities and pass inward to the loin, while the lower parts of the ribs are the latest to develop.

When growth is limited by a low level of nutrition, the earlier developing parts and tissues have priority of supply (Hammond, 1944). The priorities are indicated in Figure 8. When the level of nutrition is high, all the tissues are equally served according to their needs, but when nutrition is lowered (take away one arrow from each tissue in Figure 8), fat ceases to grow, while the other tissues continue to grow but at a slower rate. When nutrition is still further lowered (take away two arrows from each), nerve and bone continue to grow at a slower rate, muscle growth ceases, but fat is removed into the bloodstream (arrow reversed) to assist in the growth of brain and bone. Pomeroy (1941) has shown that if young pigs of 300 pounds are made to lose weight by low-level nutrition, the bones and brain continue to grow at the expense of the later-developing parts, such as muscle and fat.

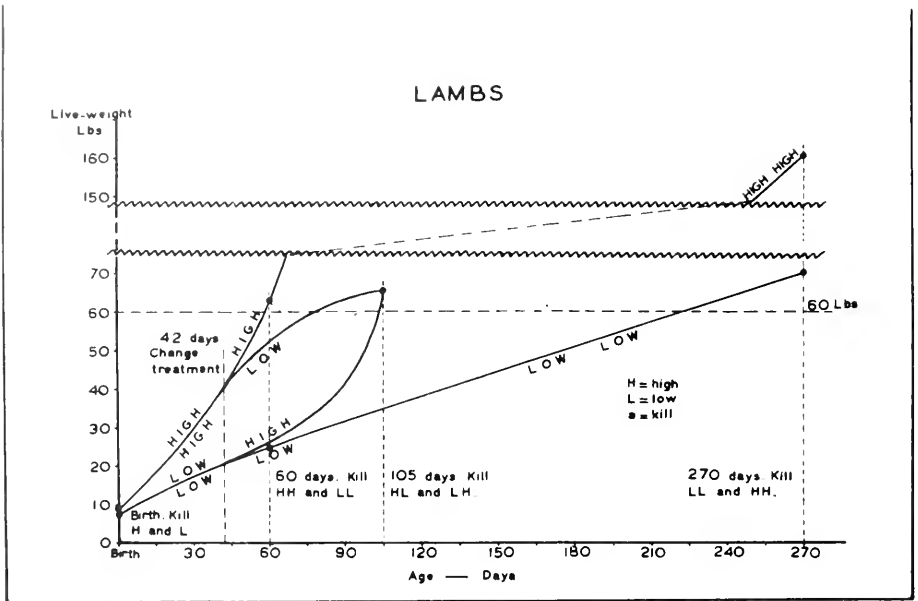

Figure 9. Growth curves of lambs on various schedules of nutrition. (Verges, 1939.)

By differential planes (levels) of nutrition at different periods of the animal's life, the proportions and composition of its body at any given body weight can be changed (Figure 9). Pálsson and Verges (1952) showed that when lambs were fed on a high plane of nutrition throughout, all parts of the body were equally served, so that in a 30-pound carcass a high proportion of fat and muscle to bone was obtained (Figure 10). On a low plane of nutrition throughout, carcasses of this weight, owing to the priority of the early-maturing bone, had a low proportion of fat and muscle as compared to bone. When the nutrition was high in early life, a large-framed animal was produced, but if this was followed by underfeeding, bone continued to grow at the expense of muscle and fat. When nutrition was low in early life, a stunting of bone growth took place, and when such an animal was afterward put on a high plane, fat and muscle grew more rapidly than bone, so that a high proportion of these tissues to bone was produced.

Differences in the shape of bones also can be produced by changes in the plane of nutrition. The reason for this is that growth in length possesses an early-maturing pattern, whereas growth in thickness possesses a late-maturing pattern. On a low plane of nutrition, therefore, length growth continues while thickness growth is slowed down considerably; thus thin bones are produced (Figure 11). This is just

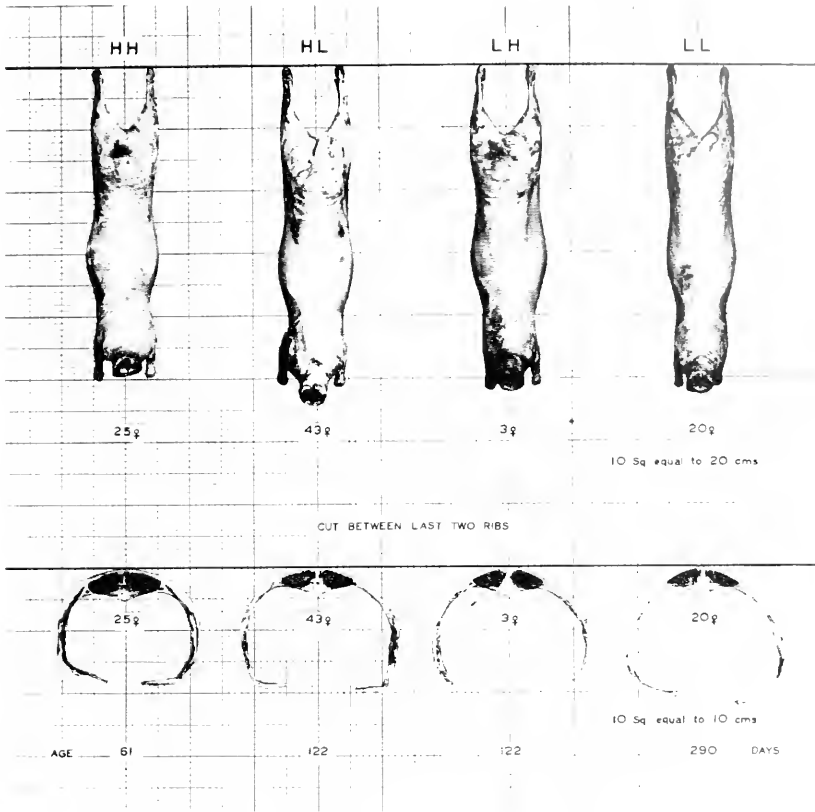

Figure 10. The effects of different feeding levels on relative proportions of fat, muscle, and bone developed in a 30-pound lamb carcass. (Verges, 1939.)

what occurs in unimproved breeds, which have thin bones compared with the relatively thick bones of improved meat breeds (Hammond, 1932).

Similarly, because male cattle and sheep develop to a greater extent than the females, the bones are longer and thicker in the male than in the female. Low-plane nutrition reduces these differences (Pálsson and Verges, 1952). Male characters such as the thickness of bone and the masculinity of the head and neck are caused by testicular hormones, and when the animals are reared on a low plane of nutrition these characters approach those of the female (Fredericksen, 1929). While some of this effect may be due to a lower hormone output, most of it is due to the fact that such characters are late developing and so have a low priority of nutrition.

Such interactions between hormones and nutrition are seen also in those organs that have several life cycles during the life of the animal

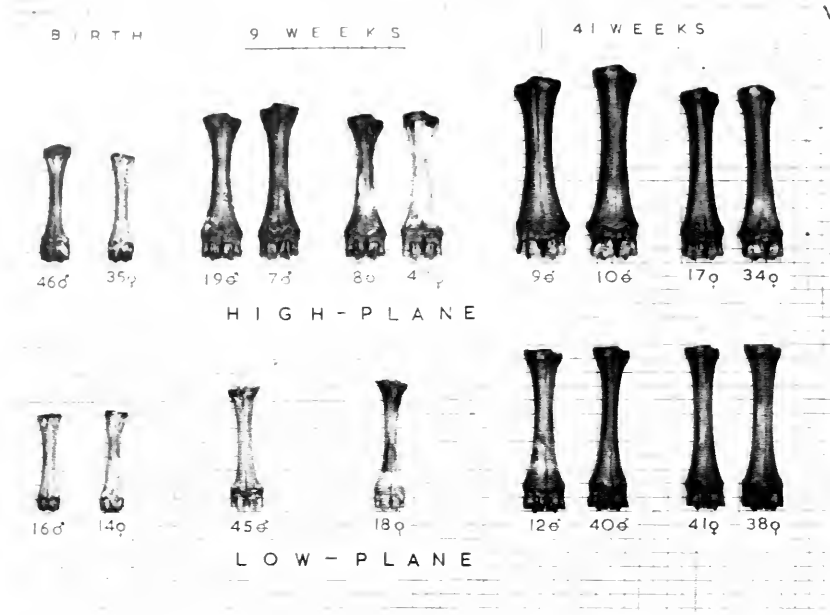

Figure 11. The effect of the plane of nutrition on the growth of bones in lambs at various ages. A low level of nutrition affects the late-developing thickness growth of the bone much more than it does the early-developing length growth, and it affects the wether more than the smaller ewe. (Pålsson and Verges, 1952.)

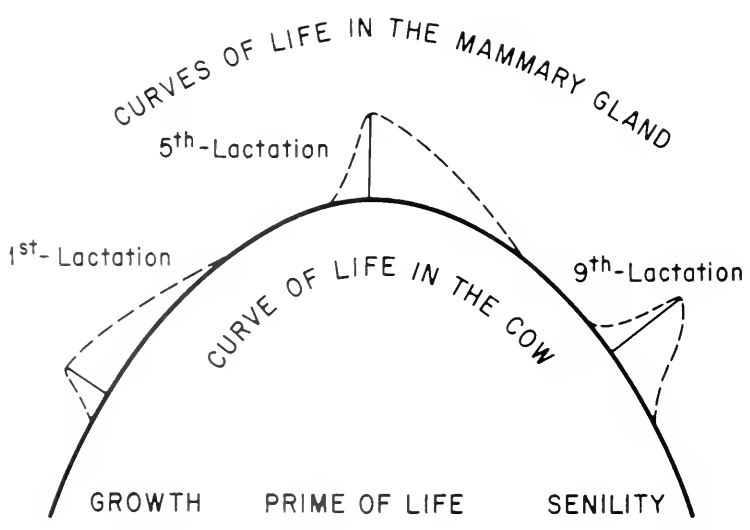

Figure 12. A diagrammatic scheme of the life curves of the mammary gland of the cow during the lifespan of the animal. Note the change in the shape of the lactation curve with the age of the animal. (Hammond, 1947.)

as a whole. Growth of the mammary gland during pregnancy is stimulated by hormones coming from the placenta and the anterior pituitary. These stimulate the alveolar cells and increase their metabolic rate, thus giving them some priority for nutrients from the bloodstream. In a young heifer, in which the other tissues of the body are actively growing, there is strong competition from the other tissues, and so the heifer's maximum daily yield of milk is below that of an adult cow (Figure 12). These differences can be much reduced by high-plane feeding during the last six weeks of pregnancy. In a young animal, however, the aging of the gland is slow, and so its lactation curve is prolonged compared with that of the old cow, in which the growth of the alveolar cells is at a maximum but aging of the cells is rapid (Sanders, 1928).

References

- Fredericksen, L., 1929. "Observations on Some Danish Experiments on Cattle Rearing," *Ber. Nordisk. Landbr. Kongr.* 4, 67.
- Gregory, P. W., and Castle, W. E., 1931. "Further Studies on the Embryological Basis of Size Inheritance in the Rabbit," *J. Exp. Zool.* 59, 199.
- Hammond, J., 1932. *Growth and Development of Mutton Qualities in the Sheep* (Edinburgh).
- Hammond, J., 1944. "Physiological Factors Affecting Birth Weight," *Proc. Nutt. Soc.* 2, 8.
- Hammond, J., 1947. "The Span of Life," *Proc. Roy. Soc. Med.* 40, 641.
- Hammond, J., 1952. *Farm Animals*, 2nd ed. (N. Y., St. Martin's).
- Hammond, J., 1959. *Pregnancy*. Yearbook, Roy. Vet. and Agric. Coll., Copenhagen.
- Hammond, J., and Joubert, D. M., 1958. "A Crossbreeding Experiment with Cattle, with Special Reference to the Material Effect in South Devon-Dexter Crosses," *J. Agric. Sci.* 51, 325.
- Hunter, G. L., 1956. "The Maternal Influence on Size in Sheep," *J. Agric. Sci.* 48, 36.
- Joubert, D. M., 1956. "Growth of Muscle Fibre in the Fetal Sheep," *Nature* 175, 936.
- Joubert, D. M., 1956. "An Analysis of Factors Influencing Post-Natal Growth and Development of the Muscle Fibre," *J. Agric. Sci.* 47, 59.
- Joubert, D. M., 1956. "Relation between Body Size and Muscle Fibre Diameter in the Newborn Lamb," *J. Agric. Sci.* 47, 449.
- McCance, R. A. and Widdowson, E. M., 1956. "The Chemical Structure of the Body," *Quart. J. Exp. Physiol.* 41, 1.
- McCay, C. M., Crowell, N. F., and Maynard, L. A., 1935. "The Effect of Retarded Growth upon the Length of Life Span and upon the Ultimate Body Size," *J. Nutr.* 10, 63.
- Pålsson, H., 1955. "Conformation and Body Composition," in Hammond, J., ed., *Progress in the Physiology of Farm Animals*, Vol. 2 (London).
- Pålsson, H., and Verges, J. B., 1952. "Effects of the Plane of Nutrition on Growth and the Development of Carcass Quality in Lambs, I: The Effects of High and Low Planes of Nutrition at Different Ages," *J. Agric. Sci.* 42, 1.

- Pomeroy, R. W., 1941. "The Effect of a Submaintenance Diet on the Composition of the Pig," *J. Agric. Sci.* 31, 50.
- Robinson, T. J., 1951. "The Control of Fertility in Sheep, II: The Augmentation of Fertility by Gonadotrophin Treatment of the Ewe in the Normal Breeding Season," *J. Agric. Sci.* 41, 6.
- Rowson, L. E., and Adams, C. E., 1957. "An Egg Transfer Experiment on Sheep," *Vet. Rec.* 69, 849.
- Sanders, H. G., 1928. "The Variation in Milk Yields Caused by Season of the Year, Service, Age, and Dry Period, and their Elimination, III: Age," *J. Agric. Sci.* 18, 46.
- Simpson, S., 1913. "Age as a Factor in the Effects Which Follow Thyroidectomy in the Sheep," *Quart. J. Exp. Physiol.* 6, 119.
- Smith, P. E., and MacDowell, E. C., 1930. "An Hereditary Anterior-Pituitary Deficiency in the Mouse," *Anat. Rec.* 46, 247.
- Wallace, L. R., 1948. "The Growth of Lambs before and after Birth in Relation to the Level of Nutrition, II and III," *J. Agric. Sci.* 38, 243.
- Wallace, L. R., 1948. "The Growth of Lambs before and after Birth in Relation to the Level of Nutrition, III: Results," *J. Agric. Sci.* 38, 367.
- Walton, A., and Hammond, J., 1938. "The Maternal Effect on Growth and Conformation in Shire Horse-Shetland Pony Crosses," *Proc. Roy. Soc. B.* 125, 311.

VITAMINS, ANTIBIOTICS, AND GROWTH

Thomas H. Jukes

AMERICAN CYANAMID COMPANY

The vitamins are a small group of organic chemical substances with special nutritional properties. Today we think so much along biochemical lines that it seems obsolete to classify substances in terms of their relationship to nutrition. However, when we think in terms of evolution and ecology, it is still very much to the point to consider the vitamins as a separate biochemical family.

The vitamins are best defined by the effects of their absence. The omission of a vitamin from the diet of an appropriate test animal will result in the appearance of a characteristic deficiency disease. In young animals the disease is usually accompanied by a slowing of growth. The deficiency can be alleviated by adding a suitable molecular form of the missing substance to the diet.

Another way of stating this is as follows: Animals are unable to carry out biochemical reactions which are needed for the synthesis of certain essential organic substances. Hence these substances, or their precursors, must be supplied in the diet. Sometimes all that is needed is a key fragment of the essential substance, or a molecule from which the key fragment can be made in the body. If the fragment or its precursor is not supplied in the diet, the chemistry of the body gets out of order, and a vitamin-deficiency disease develops.

One of the most interesting episodes in research is the story of the vitamins. It was important from the standpoint of public health to discover and synthesize the vitamins. These substances then provided the key to the understanding of a number of biochemical reactions. The solution of a practical problem turned out to be important to the progress of knowledge. For example, folic acid, discovered to be a missing

nutritional substance in studies of anemia, was eventually shown to be the transfer agent for the "single-carbon unit" in the biological synthesis of the purine ring.

The following is a list of the recognized vitamins: vitamins A, C, D, E, and K; thiamine, riboflavin, nicotinic acid, vitamin B₆, pantothenic acid, folic acid, vitamin B₁₂, and biotin. Two other substances sometimes included are choline and inositol. Most of the vitamins are synthesized by bacteria or plants but not by animals. The inference is that during evolution animals lost certain enzyme systems responsible for the synthesis of vitamins, but animals are able to compensate for this by eating food that contains the needed substances.

Much work has been done in isolating, identifying, and synthesizing the vitamins and studying their functions. They often act as co-enzymes in biochemical reactions related to growth, such as the formation of amino acids, purines, and other components of new tissues. It is quite evident that it takes very little interference with the chemistry of the body to produce a cessation of growth. One of the first things that is noticed in vitamin deficiencies is a slowing of food intake, which is sufficient in itself to stop growth.

Since the higher animals have developed complex physiological systems, such as endocrine glands and a central nervous system, it seems paradoxical that they are unable to make certain substances needed for everyday life. One might expect that a species that was unable to carry out such an important function would become extinct. But predators and parasites are resourceful creatures, and they flourish at the expense of their more industrious and thrifty victims. It is most interesting to contemplate the nutritional history of the human race with respect to the vitamins. In the primitive state, man consumed his food raw and in the round: fish, insects, crustacea, mollusks, the eggs and fledglings of wild birds, edible plants, the flesh and entrails of animals. The contribution to the vitamin supply made by spoilage microorganisms should be added to the diverse list. Sometimes coprophagy was practiced, and in many species of animals this makes an important addition to the supply of B-complex vitamins and vitamin K. As mankind developed pastoral and agricultural habits, his food preferences became more refined and sophisticated. This led to the appearance of vitamin-deficiency diseases—beri-beri, scurvy, xerophthalmia, and pellagra. The third chapter in this chronology took place in the past 50 years. A few inquisitive human beings isolated and synthesized the vitamins. This finally enabled us to be independent of a few of our enzymatic defects, but it did not change our parasitic and predatory habits, for we proceeded to raise more domestic animals than ever by adding synthetic vitamins to their food, and our per capita consumption of meat and eggs is at an all-time high.

Still unanswered is the question of why our cells lost the ability to manufacture vitamins. There are experimental observations that bear on this. When the mold *Neurospora crassa* is treated with X-rays or with ultraviolet light, mutants are produced which have lost the ability to synthesize various nutritional essentials. One of these mutants, No. 34486, cannot make choline from methionine. Now a rat can readily make choline from methionine, while a baby chick on a purified diet, without choline but with ample methionine, develops choline deficiency. The chicken under these conditions fails to grow, and its bones become deformed. Perhaps at some time during its evolutionary history, the Archaeopteryx or the Eoomis received a dose of ionizing radiation which damaged the genetic material that makes the enzymes which are responsible for producing choline from methionine, and in this respect the chicken resembles *Neurospora* mutant 34486.

From these speculations let us turn to a review of the most active field of vitamin research today—the biological synthesis of the vitamins. Radioactive tracers have enabled rapid progress to be made in studying the way in which small units such as ammonia, acetic acid, formate, carbon dioxide, and phosphate are assembled into the complex forms of life.

Biological synthesis of certain vitamins

Vitamin A. Animals depend, directly or indirectly, almost entirely upon green plants as the natural source of vitamin A, which is made, of course, from carotene. Vitamin A apparently arises from four isoprenoid units via acetic acid and mevalonic acid (Braithwaite and Goodwin, 1957); see Figure 1.

Although animals can manufacture squalene and cholesterol by making and condensing isoprenoid units, only plants can put these units together to make carotenoid pigments. These pigments have a phototropic function in plants. In animals, vitamin A is involved in the visual process as retinene, a retinal pigment which undergoes a light-induced *cis-trans* shift. Thus both carotene and vitamin A are concerned in photoreception. Vitamin A has other functions which are

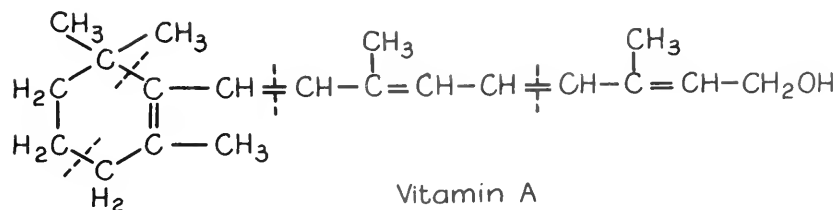

Figure 1. Vitamin A, showing method of origin from four isoprenoid units.

concerned with maintaining the normal status of the mucous membrane, the skin, and other epithelial structures. The biochemistry of these processes is not known. Vitamin A is essential for the normal growth of young animals.

Nicotinic Acid. Nicotinic acid is readily converted by animals to di- and tri-phosphopyridine nucleotides (DPNH and TPNH). These two coenzymes have a seemingly inexhaustible series of roles in biological oxidations and reductions. Recently Arnon (1959) has emphasized the function of DPNH in photosynthesis as the primary transfer agent for oxidizable hydrogen. The discovery that nicotinic acid was the curative agent for blacktongue and pellagra was soon followed by the remarkable finding that tryptophan could function as the biological precursor of nicotinic acid for various animal species, including man. This biochemical peculiarity could not have been anticipated on structural grounds. It places nicotinic acid in a separate class from the other vitamins, for, nutritionally speaking, there is no such thing as nicotinic-acid deficiency; there is only tryptophan deficiency, and although tryptophan can supply the requirement for nicotinic acid, the reverse is not true. Moreover, the conversion of tryptophan to nicotinic acid is mediated by three other B-complex vitamins, thiamine, riboflavin, and vitamin B₆, as Figures 2 and 3 show (Dalgliesh, 1956).

Thus it seems that nicotinic-acid deficiency in animals may be caused by a combined lack of tryptophan and nicotinic acid in the diet. Even if a sufficient supply of tryptophan is present, the deficiency could be caused by a lack of the vitamins that have a coenzymatic function in the conversion of tryptophan to nicotinic acid.

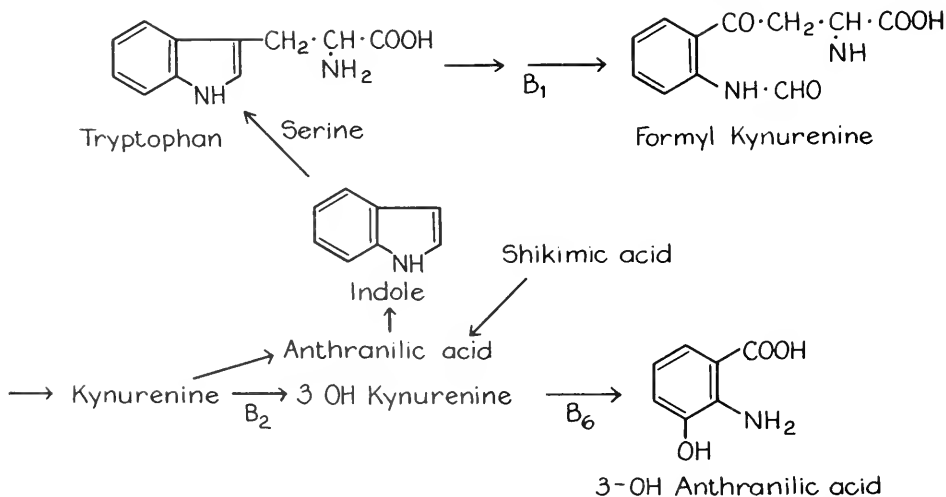

Figure 2. Formation of 3-hydroxyanthranilic acid from tryptophan and regeneration of tryptophan from indole by tryptophan synthetase.

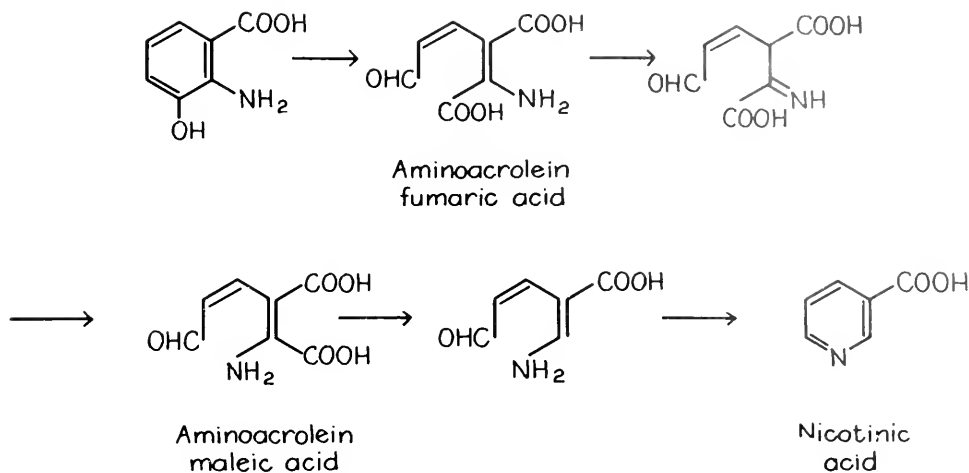
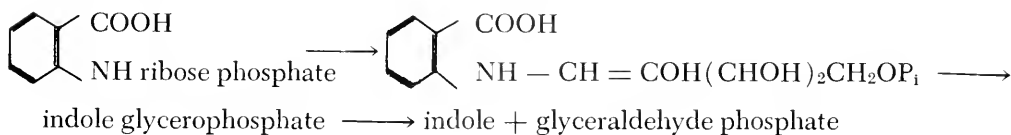
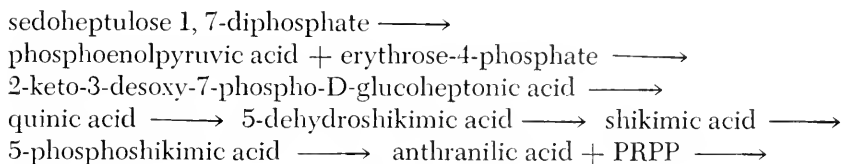

Figure 3. Steps in the formation of nicotinic acid from 3-hydroxyanthranilic acid.

Although tryptophan is an indispensable amino acid for animals, microorganisms have an enzyme system, tryptophan synthetase, for producing tryptophan from indole and serine. Indole can be produced by the following pathway in *E. coli*:



The ability to produce tryptophan can thus be traced back to aromatic biosynthesis through anthranilic acid, which is itself a product of tryptophan metabolism or can be produced from shikimic acid. Animals differ from non-dependent species, therefore, in lacking the tryptophan synthetase system for biosynthesis of tryptophan, the precursor of nicotinic acid.

The symptoms of pellagra and blacktongue are not accompanied by a disappearance of the pyridine nucleotide coenzymes from the tissues, although nicotinic acid promptly relieves these symptoms.

Thiamine. The molecule of thiamine divides readily into two portions: 2-methyl-4-amino-5-hydroxymethylpyrimidine and 4-methyl-5-

betahydroxyethylthiazole. These two portions are synthesized and then joined together by most microbial organisms. Various mutants or special strains need the complete molecule or one or both of the two portions. Animals are unable to couple the pyrimidine and the thiazole to form thiamine. The coupling in microorganisms appears to take place by phosphorylation of the hydroxymethyl group of the pyrimidine compound. This phosphate ester then couples with the thiazole group to form thiamine, as shown in Figure 4, and inorganic phosphate is liberated (Harris, 1957). A second possibility is that the end product may be thiamine monophosphate (Camiener and Brown, 1959). Phosphorylation of thiamine to form the coenzyme thiamine pyrophosphate is readily carried out by living organisms.

Riboflavin. Riboflavin is produced in large quantities by two yeast-like organisms—*Eremothecium ashbyii* and *Ashbya gossypii*. These organisms have provided us with our best information on riboflavin biosynthesis from various investigations, especially those of Plaut and McNutt, who have followed the incorporation of labeled precursors into the riboflavin molecule.

The B and C rings of riboflavin (the two right-hand rings of the structure shown in Figure 5) form a group which is similar to a pteridine or a purine. Forrest and McNutt (1958) found that adenine could serve as a precursor of this group, with the loss of the 8-carbon atom of adenine in the process. An intermediate product, 6, 7-dimethyl-8-ribityl lumazine ("compound G"), is then formed. Then ring A, the

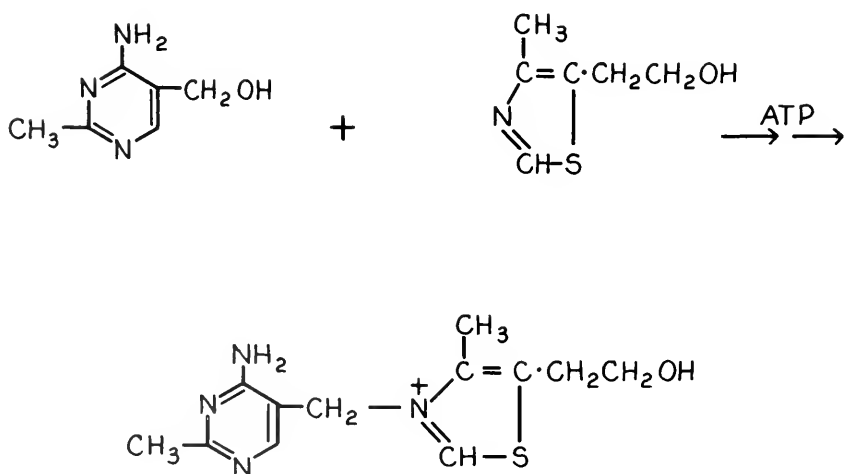

Thiamine

Figure 4. Condensation of the pyrimidine and thiazole portions of the thiamine molecule.

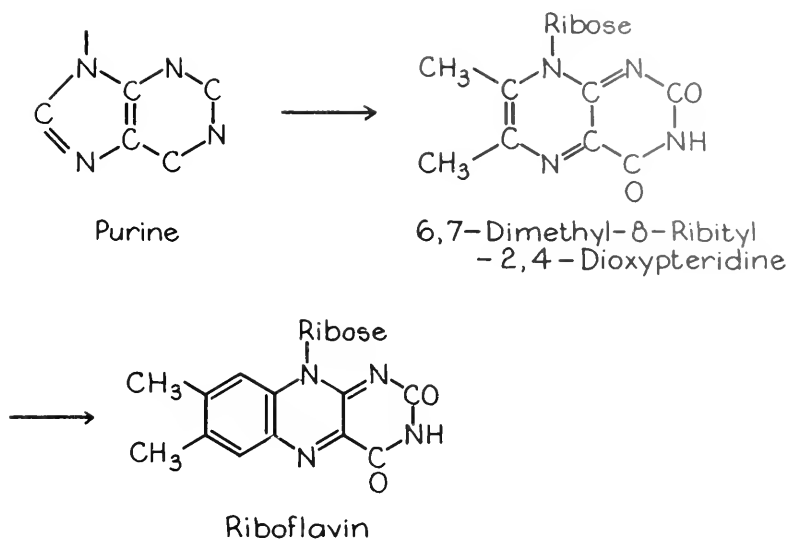
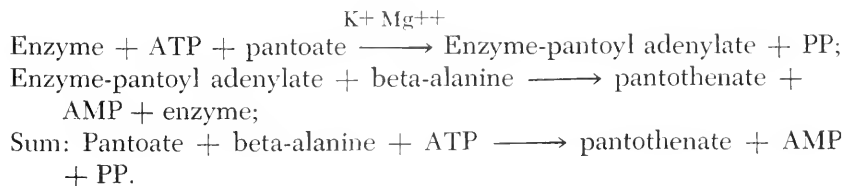

Figure 5. Biological synthesis of riboflavin.

ortho-xylene ring, is added. This can be formed from acetate or, as shown by recent experiments by Plaut (1960), from two additional molecules of compound G, which presumably break down to form the fragments necessary for completion of the ring.

Pantothenic Acid. Pantothenic acid is a vitamin because it is the only portion of the molecule of coenzyme A that cannot be synthesized by animals. Coenzyme A is the only known metabolically functional form of pantothenic acid. Animals are unable to use a mixture of pantoic acid and beta-alanine as a replacement for pantothenic acid, although microbiological systems are able to couple this system to form pantothenic acid. The reaction has been studied by Maas (1955) in cell-free extracts of *E. coli*, and he has outlined the following mechanism for the reaction as carried out by the enzyme pantothenate synthase:



The synthesis of pantoate proceeds in *E. coli* from alpha-keto isovaleric acid ("ketovaline") which is formed from glucose by re-

actions involving coenzyme A. The next step, the hydroxymethylation of ketovaline, can be brought about by formaldehyde in the presence of boiled extracts of *E. coli*. However, it seems more likely that a folic-acid system involving serine may be responsible for the biosynthetic mechanism in living bacterial cells. The steps are summarized in Figure 6.

The formation of beta-alanine can occur from decarboxylation of aspartic acid, from transamination of formylacetic acid, or from propionyl CoA via acrylyl CoA and malonic acid semialdehyde (Stadtman, 1955).

According to present concepts of the biological synthesis of pantoic acid, it seems evident that pantothenic acid participates in its own biosynthesis.

Folic Acid. The distinguishing feature of the molecule of folic acid is its pteridine ring. This has a biogenetic origin somewhat similar to that of the purine ring. Very large quantities of pteridines are synthesized by butterflies for use as wing pigments. The biosynthesis of leucopterin, the white pigment of the wings of the cabbage butterfly, was studied by Weygand and Waldschmidt (1955), who administered various tagged compounds to the larvae of this insect and measured the labeling of leucopterin in the adults. By this means it was found

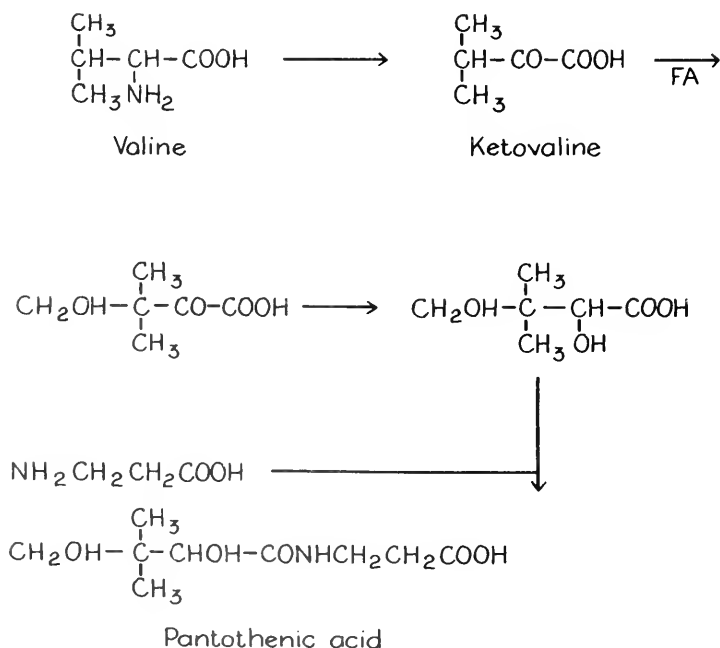

Figure 6. Biological synthesis of pantothenic acid in *E. coli*.

that positions 8a, 4a, and 5 (see Figure 7) were derived from glycine, position 2 from formate, and 4 from carbon dioxide. Folic acid, purines, and pyrimidines did not label leucopterin. Later studies by Jaenicke (1959) with *E. coli* indicated that 6, 7, and 9 were derived from ribose.

In studies with *E. coli*, Brown (1959, 1960) has found that the pteridine ring in a reduced form combines with para-aminobenzoic acid to form dihydropteroic acid and then with glutamic acid to form dihydrofolic acid (see Figure 11). Apparently it is the combination of para-aminobenzoic acid with the reduced pteridine that is inhibited competitively by sulfanilamide. This interpretation fits in with the observation that sulfonamides inhibit the growth of bacteria that synthesize folic acid, but animals require preformed folic acid and are not hurt by the sulfonamides.

The origin of folic acid is thus seen to be predominantly from carbohydrate and tricarboxylic cycle pathways, with the intriguing exception of the 2-carbon atom, which is derived from "formate" and therefore apparently from folic acid itself through 10-formyl tetrahydrofolic acid.

Vitamin B₁₂. Many bacteria and filamentous molds synthesize vitamin B₁₂, but it is not produced by green plants. Animals are dependent upon other animals or microorganisms for their supply of this vitamin, which is remarkable for containing cobalt. The large molecule of vitamin B₁₂ contains the following groupings:

1. A porphyrin-like structure composed of four pyrrole rings, with acetamide and propionamide side-chains similar to uroporphyrin III, except that in ring C a methyl group replaces the acetamide group, and with eight additional methyl groups. This structure is believed to originate from glycine through delta-amino-levulinic acid and porphobilinogen. This is a pathway involving succinyl coenzyme A. The methyl groups are added at a subsequent stage (Figure 8). Cobalt is firmly bound at the center of this structure.

2. A nucleotide containing 5,6-dimethyl benzimidazole with a molecule of ribose-3-phosphate. The dimethylbenzimidazole grouping

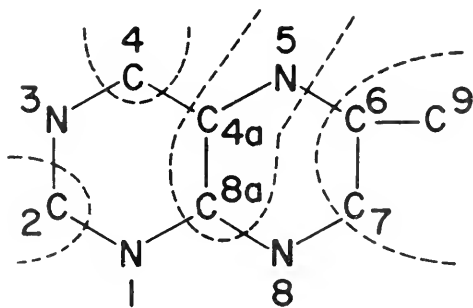

Figure 7. The pteridine ring and its biological synthesis.

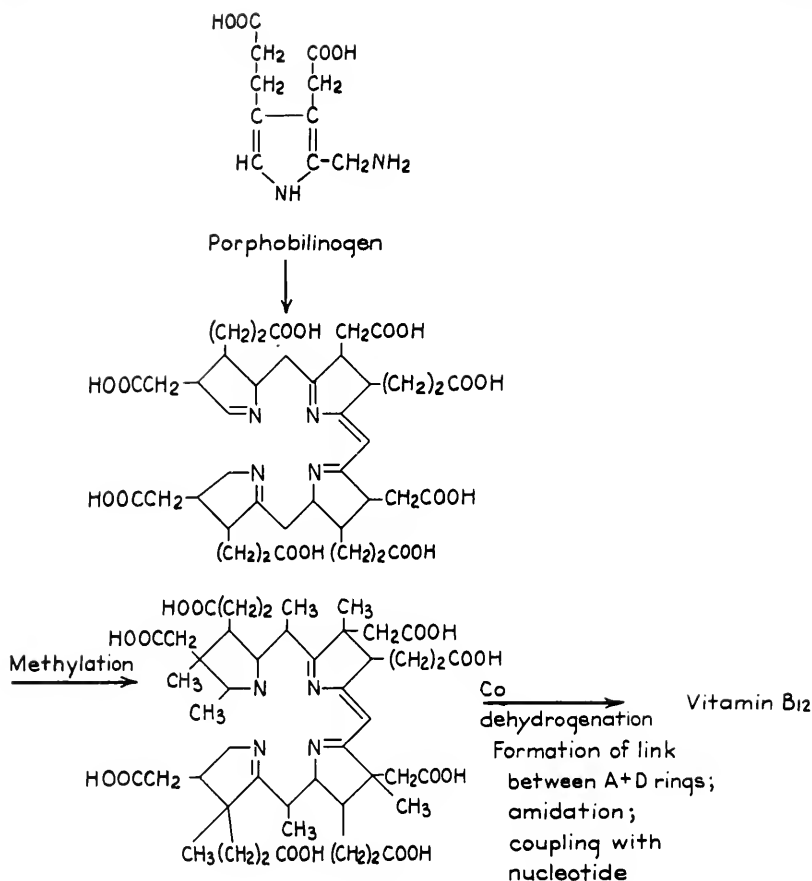

Figure 8. Suggested steps in biosynthesis of Vitamin B₁₂.

resembles the A ring of riboflavin attached to a portion of the B ring. This nucleotide is linked to the ring through a propionamide side chain esterified to phosphoric acid. Animals are unable to link together the component parts of vitamin B₁₂, but certain bacteria can readily add various nucleotides to the porphyrin-like portion of the vitamin B₁₂ molecule. In this way a number of analogs of vitamin B₁₂ have been produced, and a few of these occur naturally in bacterial systems.

Animals apparently can convert vitamin B₁₂ to the coenzymatic form of the vitamin that has been described by Barker and co-workers (1960).

Ascorbic Acid. Ascorbic acid can be formed in plants and in all animals except guinea pigs and primates. It has been shown by labeling experiments with rats that either D-glucose or D-galactose give rise to L-ascorbic acid, and that the carbon skeleton remains intact.

Only four sugar derivatives have been found to be capable of increasing the synthesis of L-ascorbic acid when supplied to germinating seedlings or of increasing the excretion of L-ascorbic acid after injection into rats. These are the gamma lactones of L-gulonic and L-galacturonic acids, the gamma lactone of D-glucuronic acid, and the methyl ester of D-galacturonic acid (Mapson, 1958). None of these four compounds (Figure 9) is effective against scurvy in guinea pigs. The conclusion is that the inability of the guinea pig and presumably of man to synthesize ascorbic acid is due to the absence of the specific enzymes for carrying out the final stage of the reactions shown in Figure 9.

The enzymes in rat liver that convert the lactones of gulonic and galacturonic acids into ascorbic acid are present in the mitochondrial-microsomal fractions. These particles will not oxidize the free acids. The corresponding fraction from guinea-pig liver will not produce ascorbic acid from the two lactones mentioned above.

Further discussions and additional references to the biosynthesis of the vitamins are in the review by Brown (1960).

Vitamins and the growth of human cells

Mammalian cell cultures have been investigated for their requirement for growth factors by Eagle (1959) and others. Eagle's medium contains 29 components, including 13 amino acids, 8 vitamins, 6 inorganic ions, glucose, and 5 to 10 per cent of whole or dialyzed serum protein, which may of course supply any number of "unidentified factors" that are bound to the protein. However, the studies have shown a clear need for the following vitamins in the growth of normal

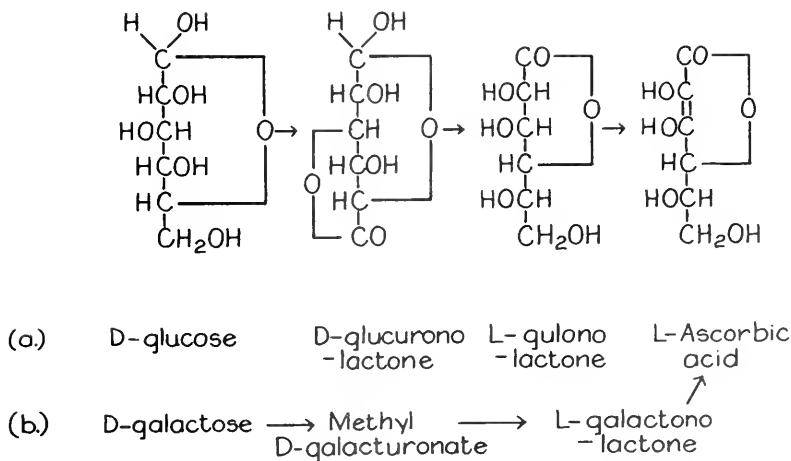

Figure 9. Formation of ascorbic acid from glucose or galactose.

human cells in tissue culture (in addition to any vitamins that may be bound to the serum protein): thiamine, riboflavin, nicotinic acid, vitamin B₆, pantothenic acid, folic acid, inositol, and choline. In experiments with mouse fibroblasts, thiamine pyrophosphate and thiamine were equivalent in activity; riboflavin and riboflavin phosphate were superior to flavin adenine dinucleotide. Nicotinamide, nicotinic acid, and di- and tri-phosphopyridine nucleotides were approximately equal in molar activity, and so were pyridoxine and pyridoxal, but pyridoxamine and pyridoxal phosphate were somewhat less active. Pantothenic acid was about ten times as active as coenzyme A, which other investigators have reported does not readily penetrate mammalian cells. Folic acid was less active than the natural *citrovorum* factor, L(1) 5-formyltetrahydro-pteroylglutamic acid. These findings are illuminating in that they demonstrate the ability of human cells to convert these vitamins to the coenzymatic forms necessary for cellular growth.

The transfer of chemical units by vitamins

A subject related to the growth of animals is the study of biochemical synthetic mechanisms. It has long been evident that living organisms are able to synthesize large and complex molecules from small units. The outstanding example of this is the synthesis of proteins from amino acids. More recently it has become apparent that even these small molecules are put together from a handful of smaller units, such as acetate, ammonia, carbon dioxide, water, hydrogen, and the "single-carbon" unit. Some of the vitamins serve as transfer agents to shuttle these small units into position. Although it was apparent soon after this discovery that the flavin and pyridine coenzymes transferred hydrogen, it was not until later that it was demonstrated that other coenzymes actually participated in reactions in which carbon-containing units were transferred.

One of the earlier observations in this field was that an "incomplete" purine molecule, 4-amino-5-imidazole carboxamide, was produced by *E. coli* grown on a medium containing sulfanilamide. This led Gordon and co-workers (1948) to predict that the formyl group necessary to close the ring was carried by a folic-acid coenzyme which could then be "reformylated" to repeat the procedure. This prediction has been amply fulfilled, and a number of other "single-carbon-transfer" reactions of folic-acid coenzymes have been demonstrated by various pieces of experimental work. Formyl and hydroxymethyl groups are transferred by folic-acid coenzymes in the synthesis of metabolites. In addition, a tetrahydrofolic coenzyme, together with thymidylate synthetase, transfers hydrogen and a single-carbon unit to deoxyuridylic acid to form the methyl group of thymidylic acid, and the tetrahydro-

folic acid is dehydrogenated to dihydrofolic acid in the process. The hydrogen is restored by TPNH to regenerate the tetrahydropteridine ring. From these brief examples we can see that folic acid is essential to the formation of adenine, guanine, and thymine, three of the four bases of DNA. Hence the relation of folic acid to growth is evident.

The existence of a co-factor for acetylation, "coenzyme A," was first noted in experiments with acetylcholine (Nachmansohn, 1946). This coenzyme, formed from the vitamin pantothenic acid and functioning through the terminal sulfhydryl group of thioethanolamine, was shown to transfer acetic acid and other carboxylic acids into larger molecules by means of intermediate thioester compounds which convey the necessary reactivity to the acyl groups. Acyl coenzyme A compounds are the building units for many biological compounds, including fatty acids, components of the tricarboxylic acid cycle, sterols, steroids, terpenes, carotenoids, porphyrins, and a number of amino acids. These syntheses underlie the essential nature of pantothenic acid for growth.

It was suggested in 1943 by Burk and Winzler that biotin acts as a coenzyme for transfer of carbon dioxide and a relation between biotin and carboxylation was repeatedly demonstrated in the ensuing years. In 1959, Lynen and co-workers succeeded in preparing the active molecule of CO₂-biotin and in showing that the carboxyl group replaced hydrogen on one of the imino groups of the ring of the biotin molecule. A carboxylation reaction of biotin is shown in Figure 10. It appears that reactions of this type take place in the carboxylation of acetyl CoA, propionyl CoA, and beta-methylcrotonyl CoA to form malonyl CoA, methyl malonyl CoA, and beta-methylglutaconyl CoA, respectively.

The participation of biotin in the interconversion of pyruvic and oxalacetic acids, propionic and succinic acids, ketoglutaric and oxalo-succinic acids is evidently due to the "biotin CO₂-biotin" transfer. The

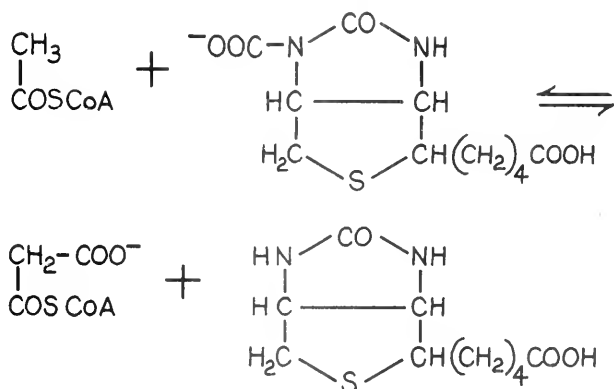

Figure 10. Transfer of carboxyl group by "CO₂-biotin."

involvement of malonyl CoA in the synthesis of fatty acids, and the formation of malonyl CoA by biotin-induced carboxylation of acetyl CoA, are clues to the known relation of biotin to the biological synthesis of fatty acids.

The transfer of amino groups in the keto acid-amino acid transamination process is brought about by a pyridoxamine-pyridoxal enzymatic interchange.

Various examples of the carrier functions of vitamins are summarized in Table I. These examples of reactions in which small molecular units are transferred serve to illustrate one of the most important functions of vitamins in the growth of animals.

TABLE I
Carrier Functions of Vitamins

Vitamin	Carrier	Units Carried
Riboflavin	FAD, phosphate	H
Nicotinic acid	DPN, TPN	H
Pantothenic acid	Coenzyme A	Acetate, other carboxy acids
Folic acid	Tetrahydrofolic acid	CH, CH ₂ , CH ₃ , CH ₂ OH, H
Biotin	Biotin	CO ₂
Vitamin B ₆	Pyridoxal phosphate	NH ₂

Antibiotics and growth

The effect of antibiotics in increasing the growth rate of animals has focused attention on the fact that animals live in a state of nutritional equilibrium with many billions of bacteria in their intestinal tracts. These bacteria may consume part of the food supply of the host, and they may produce toxic substances such as decarboxylated amino acids, which may or may not enter the bloodstream. The bacteria may produce vitamins, such as biotin and vitamin K, which may be absorbed by the host directly through the intestinal wall or secondarily through coprophagy.

Various studies with germ-free animals kept in sterile environments have indicated that the absence of intestinal bacteria leads to a somewhat more rapid growth rate in rats and chicks, provided that the animals have a well-supplemented diet. The addition of common antibiotics to the diet under these conditions does not affect the rate of growth. When the same antibiotics are added to the diet of apparently healthy animals under conventional conditions, a growth response is observed. This is due not to a wholesale elimination of the population

of intestinal bacteria but rather to a change in their type. The exact nature of the change is not known, and the complexity and variability of the normal intestinal flora make it difficult to determine.

Certain antibiotics, such as penicillin and the tetracyclines, have been shown to alleviate partial deficiencies of B-complex vitamins when added to the diets of experimental animals, especially rats. Apparently the change in the intestinal flora produced by the antibiotic results in an increased production of thiamine and other vitamins, so that the deficiency is alleviated. In the case of rats, the increased supply is obtained mainly through coprophagy.

Effects of vitamin antagonists

Chemists have prepared a large number of synthetic compounds which are anti-metabolites, or antagonists of the vitamins. These compounds interfere with the coenzymatic functions of the vitamins by displacing the normal coenzyme from its combination with the apoenzyme. The folic-acid antagonists are some of the most active compounds in the vitamin-antagonist group. Nelson and co-workers (1957) have studied in considerable detail the effects of folic-acid antagonists on embryo development in the rat and have described the deformities produced in rat fetuses. One of the most potent of all vitamin antagonists is aminopterin, 4-aminopteroyl-glutamic acid, which in small doses produces widespread pathological changes in animals, including stomatitis, dermatitis, alopecia, pharyngitis, ulceration of the gastro-intestinal tract and of the buccal, vaginal, and rectal mucosa. The effects of aminopterin are reversed by tetrahydrofolic acid or its 5- and 10-formyl derivatives and the related ring compounds, 5,10-methenyl and 5,10-methylene tetrahydrofolic acid, but they are not reversed to any appreciable extent by folic acid itself. Aminopterin is a powerful and irreversible inhibitor of dihydrofolic reductase, the enzyme that hydrogenates folic acid and dihydrofolic acid. The behavior of aminopterin may be explained by its action in "trapping" dihydrofolic acid, formed in the thymidylate synthetase reaction from deoxyuridylic acid and 5,10-methylenetetrahydrofolic acid, and thus preventing the regeneration of tetrahydrofolic acid from dihydrofolic acid. This is shown in Figure 11. The abbreviations are FAH₄ = tetrahydrofolic acid; 5- (or 10-)CHOFAH₄ = 5- (or 10-)formyltetrahydrofolic acid; 5, 10-CHFAH₄⁺ = 5, 10-methenyltetrahydrofolic acid; FAH₂ = dihydrofolic acid; FA = folic acid; 5-CHNHFAH₄ = 5-formiminotetrahydrofolic acid; 5, 10-CH₂FAH₄ = 5, 10-methylenetetrahydrofolic acid; FIG = formiminoglycine; FIGlu = formiminoglutamic acid; FGlu = formylglutamic acid; GAR = glycynamide ribotide; FGAR = formyl-

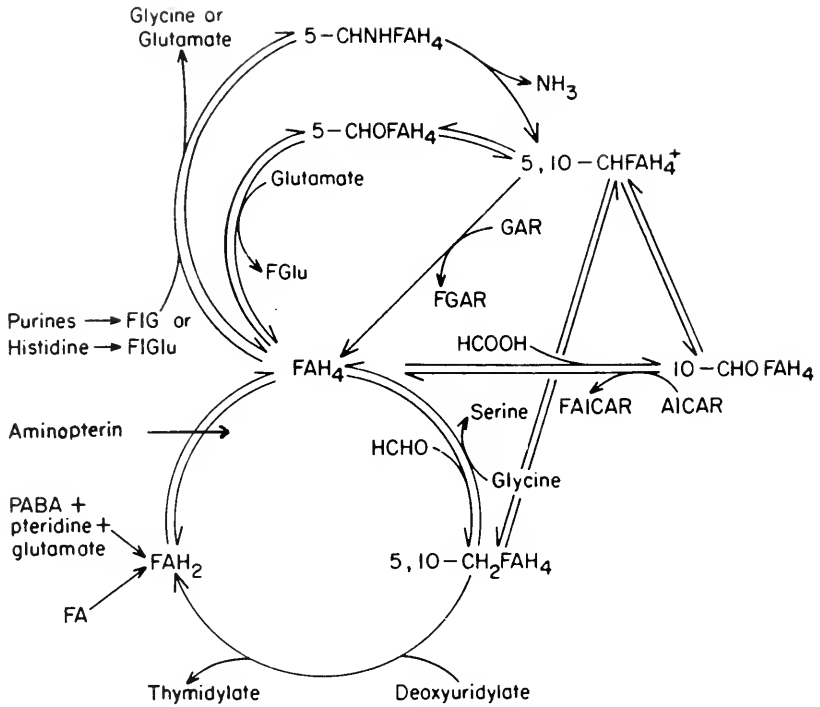

Figure 11. Biochemical transformations of folic-acid coenzymes, showing action of aminopterin in preventing regeneration of tetrahydrofolic acid (FAH_4).

glycinamide ribotide; AICAR = aminoimidazole carboxamide ribotide; FAICAR = formylaminoimidazole carboxamide ribotide; PABA = para-aminobenzoic acid.

The finding at the enzymatic level that aminopterin combines, apparently irreversibly, with dihydrofolic reductase serves to clear up some earlier observations on bacterial growth. It was noted that aminopterin inhibits the growth of *E. coli*, and that this inhibition is reversed by thymidine (Franklin *et al.*, 1949). This may indicate that *E. coli* cannot synthesize tetrahydrofolic acid rapidly enough to renew the supply that is "trapped" by aminopterin when tetrahydrofolic acid is dehydrogenated to form dihydrofolic acid during the synthesis of thymidine. If preformed thymidine is supplied, the thymidylate synthetase reaction may be slowed down, and the *de novo* synthesis of tetrahydrofolic acid by *E. coli* may then be sufficiently rapid to supply the requirement for various reactions, such as the formation of purines.

It was observed with *Leuconostoc citrovorum* that growth on a

purified medium was produced by thymidine or by tetrahydrofolic acid and its formylated derivatives, but folic acid would not produce normal growth except at very high levels. This can perhaps be explained on the basis of the organism being deficient in dihydrofolic reductase, so that the organism's small supply of tetrahydrofolic acid disappears during the synthesis of thymidine, but if thymidine is furnished, then the supply of tetrahydrofolic acid is conserved and is used for the catalytic production of purines and other "single-carbon" metabolites. The same reasoning serves to explain the effect of thymidine in reversing the inhibiting effect of aminopterin for *E. coli*.

Studies of isolated enzyme systems are essential to further understanding of the processes of growth.

References

- Arnon, D. I., 1959. "Conversion of Light into Chemical Energy in Photosynthesis," *Nature* 184, 10.
- Barker, H. A., Smyth, R. D., Weissbach, H., Toohey, J. I., Ladd, J. N., and Volcani, B. E., 1960. "Isolation and Properties of Crystalline Cobamide Coenzymes Containing Benzimidazole or 5, 6-Dimethylbenzimidazole," *J. Biol. Chem.* 235, 480.
- Braithwaite, G. D., and Goodwin, T. W., 1957. "Biosynthesis of β -carotene from DL- β -hydroxy- β -methyl- δ -(12-14 C) Valerolactone by *Phycomyces blakesleeanus* and Carrot Slices," *Biochem. J.* 67, 13P.
- Brown, G. M., 1959. "The Biosynthesis of Folic Acid," *Abstracts Seventeenth Congress of Pure and Applied Chem.* 2, 28.
- Brown, G. M., 1960. "Biosynthesis of Vitamins and Coenzymes," *Physiol. Rev.* 40, 331.
- Brown, G. M., Weisman, R. A., and Molnar, D., 1960. "The Biosynthesis of Folic Acid," *Abstracts Fifth International Congress on Nutrition*, p. 44.
- Burk, D., and Winzler, R. J., 1943. "Heat-Labile, Avidin-Uncombinable, Species-Specific and Other Vitamins of Biotin," *Science* 97, 57.
- Camiener, G. W., and Brown, G. M., 1959. "Biosynthesis of Thiamine," *J. Am. Chem. Soc.* 81, 3800.
- Dalgliesh, C. E., 1956. "Recent Research on Vitamins: Interrelationships of Tryptophan, Nicotine Acid and Other B Vitamins," *Brit. Med. Bull.* 12, 49.
- Eagle, H., 1959. "Amino Acid Metabolism in Mammalian Cell Cultures," *Science* 130, 432.
- Forrest, H. S., and McNutt, W. S., 1958. "Isolation of a Pteridine from *Eremothecium ashbyii* and its Structure," *J. Am. Chem. Soc.* 80, 739.
- Franklin, A. L., Stokstad, E. L. R., Hoffman, C. E., Belt, M., and Jukes, T. H., 1959. "Inhibition of Growth of *E. coli* by 4-aminopteroylglutamic Acid and Its Reversal," *J. Am. Chem. Soc.* 71, 3549.
- Gordon, M., Ravel, J. M., Eakin, R. E., and Shive, W., 1948. "Formylfolic Acid, a Functional Derivative of Folic Acid," *J. Am. Chem. Soc.* 70, 878.
- Harris, D. L., 1957. "Biosynthesis of Thiamine," *Fed. Proc.* 16, 192.
- Jaenicke, L., 1959. Personal communication.
- Lynen, F., Knappe, J., Jutting, G., and Ringelmann, E., 1959. "Die biochemische Funktion des Biotins," *Angew. Chemie.* 71, 481.

- Maas, W. K., 1955. "The Mechanism of the Enzymic Synthesis of pantothenate from β -alanine and pantoate," *Third International Congress of Biochem., Abstr. of Comm.*, p. 32.
- Mapson, L. W., 1958. "The Biosynthesis of L-Ascorbic Acid in Plants and Animals." *Fourth International Congress of Biochem., Symposium No. XI*, p. 1.
- Nelson, M. M., Wright, H. V., Asling, C. W., and Evans, H. M., 1955. "Multiple Congenital Abnormalities Resulting from Transitory deficiency of Pteroyl-glutamic Acid during Gestation in the Rat," *J. Nutr.* 56, 349.
- Plaut, G. W. E., 1960. "Studies on the Stoichiometry of the Enzymic Conversion of 6, 7-dimethyl-8-ribityllumazine to Riboflavin," *J. Biol. Chem.* 235, PC41.
- Stadtman, E. R., 1955. "The Enzymatic Synthesis of β -Alanyl Coenzyme A," *J. Am. Chem. Soc.* 77, 5765.
- Weygand, F., and Waldschmidt, M., 1955. "Über die Biosynthese des Leucopterins, untersucht mit C-markierten Verbindungen am Kohlweissling," *Angew. Chemie.* 67, 328.

**THE PITUITARY GROWTH HORMONE:
SOME PHYSIOLOGICAL CONSIDERATIONS***

Ernst Knobil

HARVARD MEDICAL SCHOOL

The term growth, while seemingly benign to the cellular biologist, has awesome and forbidding implications to the mammalian physiologist, who, though armed with the tantalizing array of information forged by biochemists and microbiologists, is, more often than not, constrained to observe a proverbial "black box." He chips away as best he can with rough tools in the hope of finding a weak spot in the "box" which will yield to the assault of a more sophisticated and delicate armamentarium, which in turn may reveal the processes that transform a small, immature individual into a fully grown one. For lack of a more useful definition, he terms such a transformation "growth." The black box has yielded to a rough tool, the surgeon's knife, and a weak spot has been exposed for further attack: the experimental arrest and restoration of growth.

Role of the pituitary gland

Removal of the pituitary gland during appropriate stages in the development of various vertebrates, from fish to man, results in a striking decrease or, more often, in a complete arrest of somatic growth and development. This result of hypophysectomy is best illustrated by a simple experiment. The monkey on the left (Figure 1) was hypophysectomized in June, 1958, when he weighed 2.7 kg. At that time the unoperated control on the right weighed 2.9 kg. The photograph was

* *The studies herein reported that originated in the author's laboratory were supported by grants from the United States Public Health Service and the American Cancer Society.*

taken two years later. During this interval the hypophysectomized animal grew not at all, while his partner continued to increase in size and to mature in the normal fashion, weighing 8.4 kg. at the time the photograph was taken.

The observation that hypophysectomy leads to an arrest of growth was first made in the dog by Aschner (1912) in a series of carefully conceived and executed experiments. His findings were most convincingly confirmed in the rat by Smith, who in 1926 began a classic series of investigations dealing with the physiology of the pituitary gland (Smith, 1930). Smith's early studies, aided by his development of a relatively simple and reliable surgical technique for hypophysectomy in the rat, created a new sphere in mammalian endocrinology with the pituitary gland at its center.

Not only does the hypophysectomized animal cease to grow, but, if the operation is performed before the onset of puberty, it remains infantile sexually as well as somatically. Its baby fur and deciduous dentition are retained for prolonged periods, while the entire reproductive tract remains undeveloped as a consequence of gonadal inac-



Figure 1. Effects of hypophysectomy in the immature rhesus monkey. (See text for details.)

tivity. Arrest of sexual development is accompanied by an involution of the thyroid and adrenal glands and a concomitant reduction in their secretory functions, with resulting characteristic metabolic deficiencies.

That not the entire pituitary gland was implicated in these profound alterations was evident to Aschner (1912), who was unable to detect skeletal changes in dogs from which only the posterior lobe of the pituitary was removed. This was amply confirmed in subsequent studies, with the conclusion that removal of the anterior lobe or adenohypophysis was responsible for the observed effects of hypophysectomy.

While the pituitary gland appears to be essential for normal growth and development during infancy and adolescence, the astonishingly rapid growth of the mammalian fetus seems to be relatively uninfluenced by its secretions, since the decapitated rat and rabbit fetus continue to grow at normal or nearly normal rates (Jost, 1953). Similarly, removal of the maternal pituitary gland does not interfere in a major fashion with fetal growth (Knobil and Caton, 1953; Smith, 1954). When rats are hypophysectomized in the neonatal period, they continue to increase in size, albeit at a diminished rate, until they reach 30 days of age (Asling *et al.*, 1950). This suggests that the pituitary-independent growth processes of the fetus remain functional for some time after birth, and that at some critical time in post-natal development the pituitary gland assumes the functions which theretofore were exercised by more primitive regulatory mechanisms.

The pituitary growth hormone

Although it was clearly established by the studies of pituitary gland ablation that the hypophysis secretes a substance or substances which sustain the morphological integrity and secretory function of the gonads, the thyroid, and the adrenal and permit normal growth to proceed, it was not at all clear whether the pituitary gland influenced somatic development directly or through the mediation of one or several of its "target" glands. The concept that the anterior lobe of the pituitary gland secretes a specific hormone necessary for growth had its origin in the remarkable observation by Evans and his collaborators (1923) that the administration of saline extracts of bovine pituitary glands to normal rats accelerated the growth rate of these animals, with the eventual production of giant individuals. Similar findings were made in dogs (Evans *et al.*, 1933), with the now classic conclusion that the animals stimulated to achieve supranormal size by the injection of the extract had a conformation resembling that seen in acromegalic patients.

In these early studies, evidences of increased gonadal size and

function were often observed when the experimental giants came to autopsy, but subsequent fractionation of the pituitary extract yielded preparations which were able to stimulate the growth of normal and hypophysectomized rats without producing other notable effects. In succeeding years, concerted efforts to isolate, purify, and characterize the active growth-promoting principle of the adenohypophysis culminated in the preparation of highly purified, crystalline protein fractions (Li *et al.*, 1945; Wilhelmi *et al.*, 1948). These had virtually no activity in stimulating the adrenals, thyroid, or gonads, but they nevertheless exhibited the growth-promoting properties of cruder extracts when injected into normal or hypophysectomized rats. For lack of a better term, this material has been called "growth hormone," but the more sophisticated appellations of "somatotropic hormone" (STH) or "somatotropin" are gaining in favor.

The administration of small quantities of growth hormone for prolonged periods of time to normal and hypophysectomized rats results in a striking increase in body weight and size (Evans, *et al.*, 1948; Simpson *et al.*, 1949). The skeleton undergoes changes characterized by an elongation and widening of the long bones (Simpson *et al.*, 1950) and enlargement of the skull. This increase in skeletal dimensions is accompanied by an increase in the weight and size of the non-endocrine viscera and a marked hypertrophy of the musculature, skin, connective tissues, and lymphoid tissues (see Ketterer, Randle, and Young, 1957, for review). These effects, while modified by the thyroid, adrenals, and gonads, can nevertheless be observed in their absence (see Simpson *et al.*, 1950), thus strengthening the view that growth hormone has a direct action on the tissues it influences.

Curiously, the growth of the central nervous system and its derivatives seems to be relatively independent of the action of growth hormone, since they fail to grow at an accelerated rate when the hormone is administered (Simpson *et al.*, 1949) and continue to grow in very young animals that have been hypophysectomized. The latter situation may lead to lethal brain damage, due to the compression of the growing brain by the cranium, which has ceased to expand (Asling *et al.*, 1952). As noted above, the reproductive organs, as well as the adrenal and thyroid glands, are similarly unaffected by growth hormone in the absence of other, more specific hormonal stimuli.

The body composition of animals treated with growth hormone, when compared with that of their pair-fed controls, characteristically reveals an increase in the proportion of protein and water and a reduction in the proportion of fat (Li and Evans, 1948) with a resultant carcass composition resembling that seen in very young animals. There can be no doubt that the accretion in body size occasioned by the administration of the hormone is indeed due to the synthesis of new tissue

rather than the mere deposition of fat and the sequestration of salts and water.

Species specificity

The many convincing demonstrations of the potent growth-promoting properties of pituitary extracts in experimental animals prompted a number of clinical investigators to assay these preparations in cases of human dwarfism. These early trials with rather crude preparations of ox pituitary glands were disappointing. When highly purified preparations of ox and pig pituitary growth hormone became available, attempts to demonstrate their physiological actions in man were renewed. For the most part these attempts were unsuccessful, and they led to the rather unsatisfactory conclusion that the available growth-hormone preparations were ineffective in man. Exhaustive studies with bovine and porcine growth hormone in normal and hypophysectomized rhesus monkeys led to similar conclusions: namely, that these preparations were inactive in this species, as judged by a large number of morphologic and metabolic criteria (Knobil and Greep, 1959). Similarly, these growth-hormone preparations, which were highly active in rats, dogs, and cats, were reported to be ineffective in the guinea pig (Mitchell *et al.*, 1954; Knobil and Greep, 1959). These findings led to considerable speculation regarding the underlying reasons for the apparent inefficacy of bovine and porcine growth-hormone preparations in these species, but the matter was clarified with the finding that growth-hormone preparations isolated from monkey pituitary glands were highly effective in the rhesus monkey (Knobil *et al.*, 1957) and in man (see Raben, 1959). Similarly, growth hormone prepared from human pituitary glands is active in man (Raben, 1959) and the rhesus monkey (Knobil and Goodman, 1959). These primate growth-hormone preparations are as active in the rat as they are in man and the monkey; thus they differ fundamentally from ox and pig preparations, which are inactive in primates but fully effective in the rat. The latter species, however, is refractory to fish growth hormone, a preparation which shares with bovine growth hormone the ability to stimulate the growth of fish (Wilhelmi, 1955). Further studies have revealed that the physicochemical characteristics of fish growth hormone differ from those of the bovine molecule (Wilhelmi, 1955) and that primate growth-hormone preparations have markedly different properties when compared with those from other mammalian species (Table I). These dissimilarities are such that competitive inhibition between monkey and bovine growth hormones could not be demonstrated in the rhesus monkey (Knobil *et al.*, 1958), and, as might be expected, the primate preparations proved to be immuno-

TABLE I

The Physicochemical Characteristics of Growth-Hormone Preparations from Various Species
(From Li, 1958)

Physicochemical Characteristics ^a	Beef	Sheep	Whale	Monkey	Human
$s_{20, w}$	3.19	2.76	2.48	1.88	2.47
$D_{20, w} \times 10^7$	7.23	5.25	6.56	7.20	8.88
V	0.76	0.733	0.737	0.726	0.732
Molecular wt.	45,000	47,800	39,900	25,400	27,100
f/f_0	1.31	1.68	1.45	1.57	1.23
P_I	6.85	6.8	6.2	5.5	4.9
Cystine	4	5	3	4	2
N-terminal residue	Phe,Ala	Phe,Ala	Phe	Phe	Phe
C-terminal residue	Phe	Phe	Phe	Phe	Phe

^a $s_{20, w}$ in S; $D_{20, w}$ in $\text{cm}^2/\text{sec.}$; V in cc./g. ; f/f_0 , dissymmetry constant; P_I , iso-electric point; cystine in residues per mole.

logically distinct from the growth hormones of other species (Hayashida and Li, 1959; Read and Bryan, 1960). Bovine growth hormone, a large molecule compared to that of primates, can be hydrolyzed to an extent of about 25 per cent without loss of biological activity, suggesting that this activity resides in the center or "core" of the molecule (Li, 1957, 1958). Since bovine and primate growth hormones are equally active in the rat, while only the primate preparations are active in primates, Li has suggested that the rat may degrade the non-primate hormones to their "active cores," while primates do not have this ability, the implication being that the primate molecules closely resemble the "active cores" of the non-primate preparations. If this hypothesis is correct, the administration of bovine, porcine, or ovine "active core" to primates would elicit the expected physiological effects. This expectation has not yet been realized by unequivocal experimental evidence. Alternatively, the possibility remains that in the course of evolution, the "effector sites" for the growth-hormone molecule have become more selective, and that a highly specific "lock-and-key" interaction obtains in primates, whereas a less discriminating relationship between the hormone and its receptor are present in the rat, the dog, and the cat. The solution to this problem will provide important insight into the mechanism of action of the growth hormone.

Although the hypophysectomized guinea pig, like the monkey and man, fails to respond to bovine and porcine growth hormone by an acceleration of growth (Mitchell *et al.*, 1954; Knobil and Greep, 1959),

it differs from the latter in exhibiting acute responses to a single injection of non-primate hormone, such as a fall in the concentration of non-protein nitrogen and a rise in the level of non-esterified fatty acids in the plasma (see below). On continued treatment, however, the guinea pig fails to show any evidence of increased growth or nitrogen retention (Hotchkiss and Knobil, 1960). Bovine growth hormone is highly antigenic in the normal and hypophysectomized guinea pig, and a small dose of bovine growth hormone administered to such animals after sensitization by the same preparation results in anaphylactic shock which is lethal in 90 to 100 per cent of the animals (Hotchkiss and Knobil, 1960). It would seem, therefore, that the failure of the guinea pig to respond to daily treatment with bovine growth hormone resides in the inactivation of the injected material by antibodies formed against it, with consequent neutralization and loss of physiological activity. Such a phenomenon would also explain the physiological effectiveness of a single injection of bovine growth hormone to guinea pigs not previously exposed to the hormone. It should be reiterated that an acute response to bovine and porcine growth hormone cannot be observed in a hypophysectomized rhesus monkey that has not previously been exposed to these preparations (Goodman and Knobil, 1960), and that a similar explanation is, in all probability, not applicable to the situation in primates.

On the mode of action of growth hormone

Any consideration of the mode of action of growth hormone must take into account the forbiddingly vast array of physiological and pharmacological effects resulting from its administration. These have been recorded in a massive literature which has been the subject of several comprehensive reviews (Weil, 1955; de Bodo and Altzuler, 1957; Ketterer, Randle, and Young, 1957; Russell and Wilhelmi, 1958). It is not the intent of the present paper to duplicate these efforts. Limitations of time and space will permit a discussion of only a few lines of investigation bearing on the problem, with particular emphasis on our own and related studies.

The effect of growth hormone on some aspects of amino-acid metabolism. It has already been pointed out that growth of the fetus and of the neonatal animal can proceed normally in the absence of pituitary growth hormone; this suggests that the action of the hormone is to sustain the functional integrity of processes which become dependent on it at a critical time in the life of the young individual. Presumably, in the absence of the hormone these processes gradually slow and cease to function, with a resultant arrest of growth. Among the processes most intimately associated with the production of new

protoplasm, or growth, the synthesis of protein occupies a position of primary importance.

As has been mentioned, the treatment of normal and hypophysectomized animals with various preparations of growth hormone leads to an accumulation of protein in the carcass which is greater than that in the untreated, pair-fed controls. As might be expected from these carcass analyses, the administration of growth hormone causes an increase in nitrogen retention. This is illustrated in Figure 2 by an experiment in which an immature, actively growing rhesus monkey was placed on a nitrogen-balance regimen and the daily nitrogen balance was determined during a preoperative control period, then after hypophysectomy, and then during a course of growth-hormone administration. This experiment further demonstrates the physiological ineffectiveness of bovine growth hormone in this species, as discussed above.

The retention of nitrogen occasioned by growth-hormone treatment is accompanied by a decrease in circulating non-protein nitrogen (Li *et al.*, 1949) and free amino acids (Russell, 1953). That these

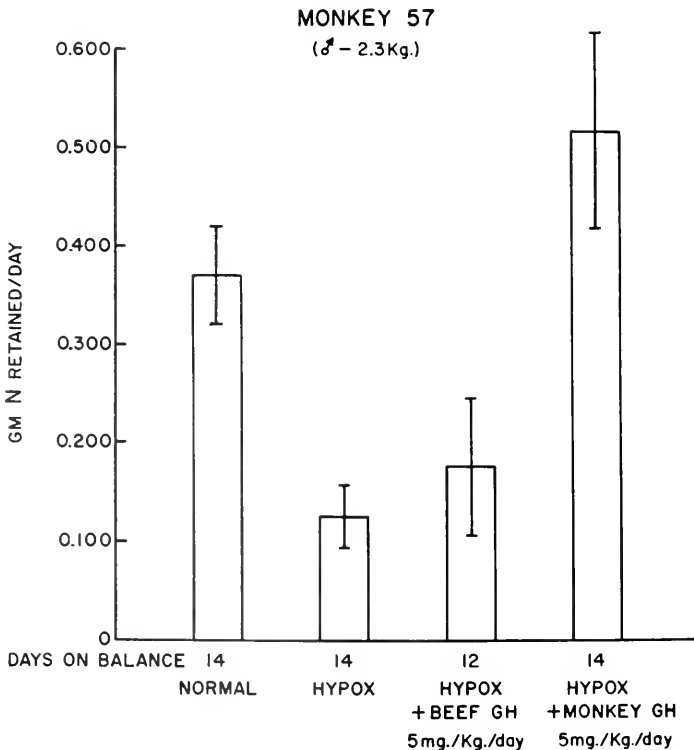

Figure 2. The mean daily nitrogen balance (\pm S.E.) of an immature rhesus monkey before and after hypophysectomy and during growth-hormone treatment. (From Knobil *et al.*, 1957).

changes are not explicable solely in terms of decreased protein and amino-acid catabolism, but rather by an acceleration of amino-acid uptake by the tissues of the body, was demonstrated by the elegant studies of Russell (1953, 1955). All these findings lead to the view that growth hormone, in some manner, stimulates protein synthesis from amino acids.

In an attempt to devise a system which would permit a more direct approach to the study of the role of growth hormone in protein synthesis, the incorporation of C^{14} -labeled leucine by isolated diaphragms removed from normal rats, hypophysectomized rats, and hypophysectomized rats treated with growth hormone was investigated (Kostyo and Knobil, 1959a). It was found that hypophysectomy decreased the *in vitro* incorporation of the amino acid into the protein of diaphragm, and that growth-hormone administration to such animals restored the incorporation of labeled leucine into the diaphragm protein to normal (Figure 3). It remained to determine whether the addition of growth hormone *in vitro* to diaphragms excised from hypophysectomized rats would restore toward normal the reduced capability of such tissues to incorporate labeled amino acids into protein. In a series of preliminary

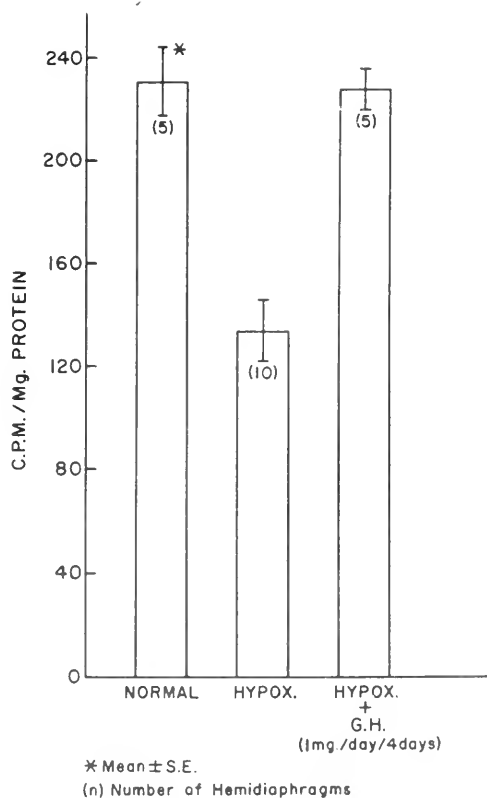

Figure 3. The effect of hypophysectomy and growth-hormone treatment on the incorporation of leucine-2- C^{14} into the protein of isolated rat diaphragm *in vitro*. (From Kostyo and Knobil, 1959a.)

experiments (Kostyo and Knobil, 1959b) in which the hemidiaphragms from hypophysectomized rats were incubated in a suitable medium containing labeled leucine, it was found that the addition of simian growth hormone to one of a pair of hemidiaphragms, the other serving as a control, significantly increased the incorporation of the amino acid into protein. The minimal effective concentration of hormone was ten micrograms per milliliter of medium.

Of considerable interest was the observation that the addition of porcine and bovine growth-hormone preparations to the identical system—preparations which, within the limits of bioassay in the rat, were equipotent with the simian hormone—were relatively ineffective in stimulating the incorporation of labeled leucine into the diaphragm protein. Subsequent experiments designed to clarify this curious phenomenon (Brande and Knobil, 1960) have confirmed the above observations and show further that a similar dichotomy between the effect of bovine and simian growth hormone in this system is demonstrable in the case of phenylalanine incorporation. The incorporation of labeled glycine into the protein of hypophysectomized rat diaphragms on the other hand, is stimulated equally by the addition of simian or bovine growth hormone. The physiological significance of these findings is obscure at present, but they permit the conclusion that highly purified growth-hormone preparations which stimulate the growth of hypophysectomized rats can, when added to an isolated tissue under suitable conditions, stimulate the incorporation of some amino acids into the protein of such tissues. Similar observations have been made independently by Manchester and Young (1959a), who studied the effect of bovine growth hormone, added *in vitro* to diaphragms of hypophysectomized rats, on the incorporation of labeled glycine into protein. It should be noted, however, that growth hormone may not enhance the incorporation of all amino acids into protein, since recent experiments have shown that the addition of either simian or bovine growth hormone to hypophysectomized rat diaphragms in systems identical to the above failed to stimulate glutamic-acid incorporation (Brande and Knobil, 1960).

If, with appropriate reservations and assumptions, it is possible to equate, or at least closely relate, amino-acid incorporation into protein with protein synthesis, the question becomes: does growth hormone act either by accelerating the rate of all or a portion of the various intracellular steps involved in the synthesis of protein from amino acids, or does it facilitate the entrance of amino acids into the intracellular pool, or both?

That growth hormone may exert an influence on amino-acid transport was suggested by the experiments of Noall *et al.* (1957) which showed that a single injection of growth hormone increased the cellu-

lar concentration of a non-utilizable amino acid, α -amino-isobutyric acid (AIB). More recently we have extended these studies to an *in vitro* system employing the isolated "intact" diaphragm preparation of Kipnis and Cori (1957). As illustrated in Figure 4, it was found that hypophysectomy markedly decreases the penetration of labeled AIB into the isolated diaphragm, while the addition of growth hormone to the medium returns the transport of the amino acid to normal (Kostyo,

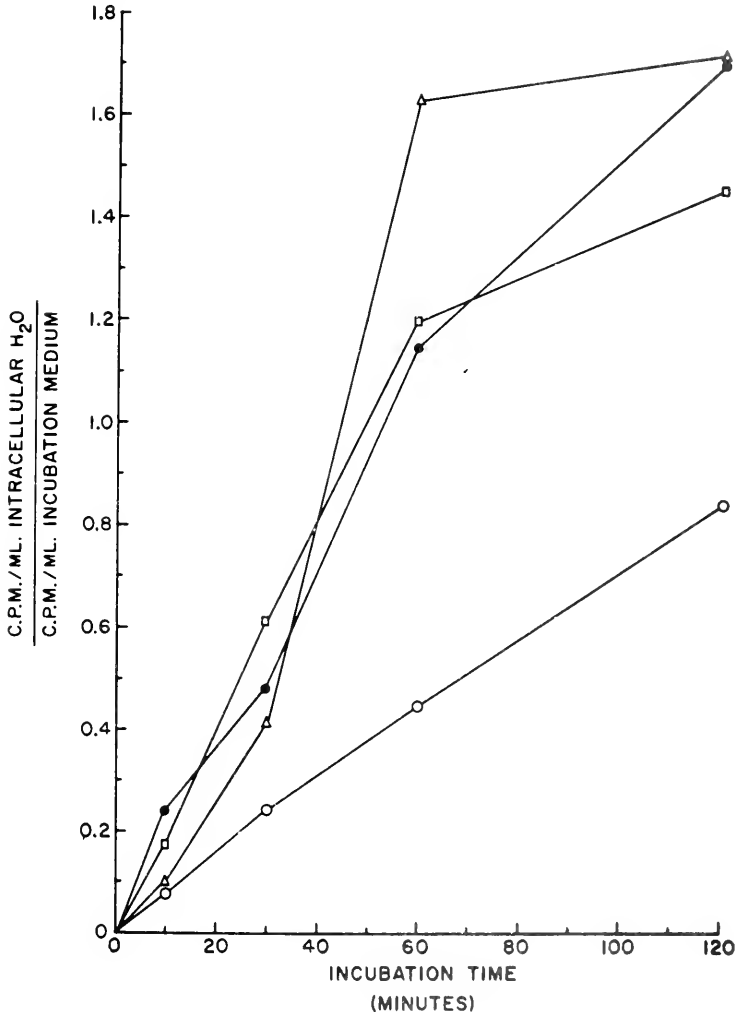

Figure 4. Penetration of AIB-1-C¹¹ into "intact" rat diaphragm preparations. ● normal; ○ hypophysectomized; Δ hypophysectomized + simian growth hormone added to medium (25 μ gm/ml); □ hypophysectomized + bovine growth hormone added to medium (25 μ gm/ml). (From Kostyo, Hotchkiss, and Knobil, 1959.)

Hotchkiss, and Knobil, 1959). The minimal effective concentration of growth hormone has been found to be in the neighborhood of one microgram per milliliter of medium (Kostyo, 1960). Bovine and simian growth hormone were equally effective in this regard. Of interest is the finding (Kostyo, 1960) that the dipping of hypophysectomized rat diaphragms for ten seconds into a growth-hormone solution ($1 \mu\text{gm/ml}$), followed by immediate washing in five changes of buffer, resulted in an elevated transport of labeled AIB; this suggests a form of binding of the hormone resembling that described for insulin (Stadie, 1954).

While it has not yet been demonstrated that growth hormone stimulates the transport of naturally occurring amino acids, the above evidence nevertheless suggests the possibility that the increase in protein synthesis produced by this hormone may be due, at least in part, to an increase in the availability of amino acids to the cell.

An alternative possibility—that a site of action of growth hormone may reside along the protein biosynthetic chain independently of amino-acid transport—is suggested by the elegant study of Korner (1959), in which he found that cell-free preparations of liver obtained from hypophysectomized rats incorporated less labeled amino acid into protein than did those from normal animals when the labeled amino acids were added to the system *in vitro*. This defect was localized at the level of the microsomal particle, and it could be partly corrected by the administration of growth hormone to the donor animal. In a subsequent study, however, in which various liver fractions were obtained after injection of radioactive amino acid in hypophysectomized animals at varying times before sacrifice, the incorporation of the label into the proteins of nuclei, mitochondria, and soluble fractions as well as microsomes was diminished (Korner, 1960a). Once again, these changes could be partly reversed by growth-hormone treatment. Although the complexities of these systems do not yet permit firm conclusions regarding the site of action of growth hormone in protein synthesis, their continued study offers much promise of clarification.

It should be mentioned that growth hormone shares with insulin all of the effects of amino-acid metabolism just discussed. Thus insulin, when added to the isolated rat diaphragm, increases the incorporation of labeled amino acids into protein in the presence or absence of glucose (see Manchester and Young, 1959a, and Wool and Krahl, 1959); insulin increases the transport of AIB when added to rat diaphragm (Kipnis and Noall, 1958); and, when administered to hypophysectomized rats, it stimulates the *in vivo* and *in vitro* incorporation of labeled amino acids into various fractions of cell-free liver preparations (Korner, 1960b). These effects of insulin can be appended to an impressive body of evidence which leads to the generally accepted view

that insulin is a protein-anabolic hormone (Krahl, 1956). These considerations, joined with the numerous observations that the anabolic properties of growth hormone are not demonstrable in the diabetic animal, have led to the suggestion that growth hormone may exert its physiological effects by stimulating the pancreas' secretion of insulin or by otherwise increasing the availability of insulin to the tissues (see Ketterer, Randle, and Young, 1957, and de Bodo and Altzuler, 1958, for review). Clearly, in the systems where growth hormone is added to muscle tissue *in vitro*, the stimulation of amino-acid transport or incorporation into protein cannot be explained in terms of increased pancreatic insulin secretion. It has been argued, however (Ottaway, 1953), that the insulin-like activity of growth hormone *in vitro* could be due to a release of bound insulin from the tissue. To test this hypothesis, Manchester and Young (1959a) prepared an insulin antiserum which completely abolished the ability of insulin to stimulate the incorporation of labeled glycine into the protein of diaphragms from hypophysectomized rats *in vitro*. This antiserum, however, in no way inhibited the action of growth hormone in the same system, which suggests that the effect of growth hormone on amino-acid incorporation is a direct one on the tissue and, though in all probability requiring the presence of insulin in a permissive sense, is not mediated by it (see also Scow and Chernick, 1960).

Of particular interest in this connection is a recent preliminary report by Huggins and Ottaway (1960) that the further fractionation of a highly purified growth-hormone preparation permitted the separation and purification of a peptide with high insulin activity, as assayed *in vitro*. The confirmation of these findings would do much to clarify the significance of the many similarities between the metabolic actions of growth hormone and insulin.

Growth hormone and fatty acid metabolism. The increased deposition of protein (as determined by carcass analysis) that results from growth-hormone administration is accompanied by a concomitant loss of fat. Further, growth-hormone administration leads to a reduction in the respiratory quotient, a mobilization of fat to the liver, and an increased ketogenesis. These widely confirmed observations have led to the generally accepted view that growth hormone has a profound influence on lipid metabolism, and, more specifically, that the hormone accelerates fat mobilization and oxidation (see reviews by Weil, 1955, and de Bodo and Altzuler, 1957).

Renewed interest in the influence of growth hormone in lipid metabolism has been stimulated by the recent appreciation of the metabolic significance of the proportionally small non-esterified or free fatty acid (FFA) fraction of the circulating lipids (see Frederickson and Gordon, 1958). These free fatty acids, by virtue of their rapid

turnover rate, their metabolic lability, and their high rate of utilization by extrahepatic tissues, are considered to represent a principal form in which fat is mobilized, transported, and oxidized.

Raben and Hollenberg (1959) were the first to demonstrate that the administration of small doses of growth hormone to fasting dogs and human subjects was followed by a rapid rise in the plasma FFA concentration. This phenomenon has been confirmed by many laboratories, including our own. In the fasting hypophysectomized rhesus monkey, a rapid rise in circulating FFA can be elicited by a single intramuscular injection of simian growth hormone at a dose of 0.05 milligram per kilogram (Goodman and Knobil, 1959). In the fed animal, however, this response is much reduced. Growth hormone appears to be specific in this regard, as illustrated in Figures 5 and 6. Of all the pituitary preparations examined, regardless of dose, only primate growth hormone is active in increasing the plasma concentration of

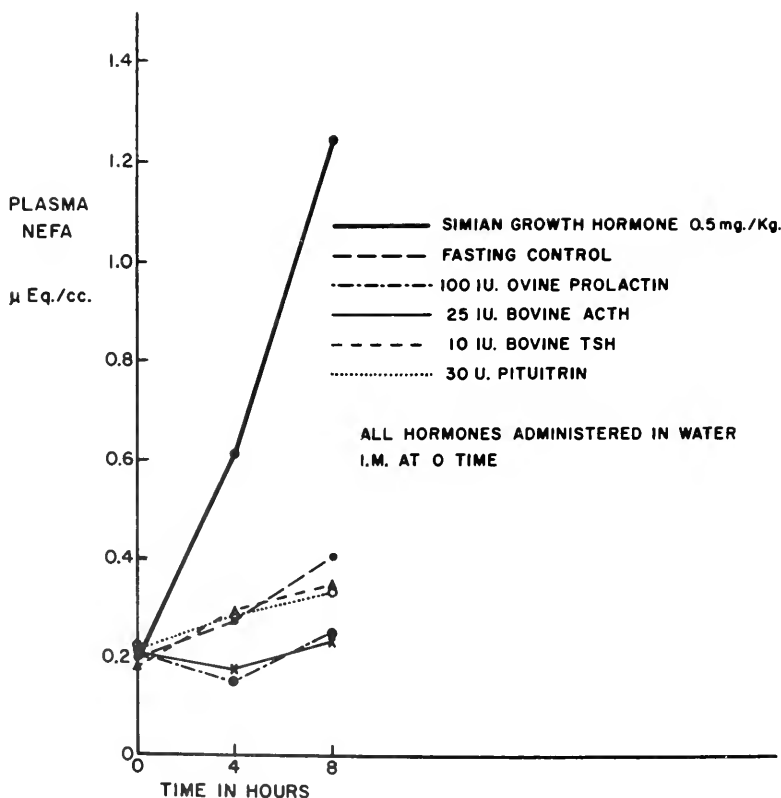

Figure 5. The effect of a primate growth-hormone preparation and of prolactin, ACTH, TSH, and pituitrin on the concentration of non-esterified fatty acids in the plasma of fasting, hypophysectomized rhesus monkeys. (From Goodman and Knobil, 1959).

FFA (Goodman and Knobil, 1959). Similar observations have been made in man (Raben and Hollenberg, 1959). It should be added that this effect of growth hormone is still demonstrable, in the rat at least, in the absence of the thyroid and adrenal glands (Goodman and Knobil, 1960).

Since the plasma concentration of FFA is the resultant of both production and utilization, it became necessary to determine whether the effect of growth hormone is explicable in terms of increased mobilization of FFA from adipose tissue or decreased utilization of fatty acids

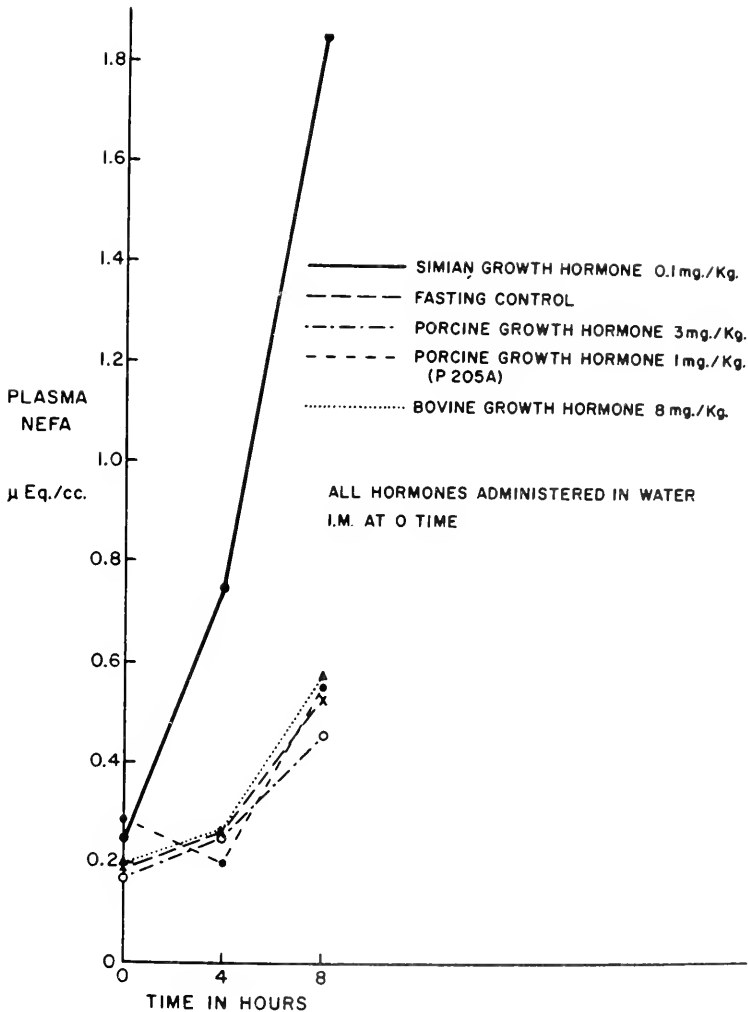

Figure 6. The species specificity of growth hormone with reference to its action on the concentration of non-esterified fatty acids in the plasma of fasting, hypophysectomized monkeys. (From Goodman and Knobil, 1959.)

by peripheral tissues. To this end, the epididymal adipose tissues of normal, hypophysectomized, and hypophysectomized growth-hormone-treated rats were excised, incubated in a suitable medium, and the release of FFA by the tissues into the medium was measured. It was found that hypophysectomy greatly reduced the release of fatty acids from adipose tissue, and that the administration of growth hormone, chronically or acutely, to hypophysectomized animals returned the FFA release toward normal (Table II). These experiments strongly suggest that growth hormone increases the mobilization of fatty acids from adipose tissue and that this increased mobilization in turn leads, at least temporarily, to a rise in circulating FFA (Knobil, 1959), thus confirming the conclusions based on earlier studies employing less direct evidence (see de Bodo and Altzuler, 1957). Whether this effect of growth hormone represents a direct or primary action of the hormone on adipose tissue or whether fatty-acid mobilization from adipose tissue is secondary to its protein anabolic or other metabolic action is still open to question.

When growth hormone is added directly to one of a pair of epididymal adipose tissues exercised from the same animal, an increase in FFA release into the medium is clearly demonstrable (Table III). The minimal effective concentration varies with the growth-hormone preparation used. In the case of bovine growth hormone, a concentration of 50 micrograms per ml. is required for a unequivocal lipolytic effect, whereas one microgram per ml. of a simian growth-hormone preparation is invariably effective. While such low concentrations may at first glance meet the requirements for what is generally acceptable as "physiological," they by no means prove the *in vitro* lipolytic effect

TABLE II
Effect of Hypophysectomy and Growth-Hormone Treatment on
FFA Release by Adipose Tissue
(From Knobil, 1959)

Rats	FFA Release $\mu\text{eq/gm}/\text{hour}$
Normal controls	$5.79 \pm .44^{\circ}$
Hypox + saline	$0.90 \pm .16$
Hypox + G.H. (3 mg./rat 3 hr. before sacrifice)	$2.30 \pm .37$
Hypox + G.H. (3 mg./rat/day for 3 days)	$3.40 \pm .66$

$^{\circ}$ Mean \pm S.E.

TABLE III

Effect of Growth Hormone (*in vitro*) on FFA Release by Adipose Tissue of Normal Male Rats

Concentration ($\mu\text{gm/ml}$)	No. of Tissue Pairs	Increase in FFA Release ($\mu\text{eq/gm/hr}$)	P ^{°°}
Bovine 1	10	$0.38 \pm 0.36^{\circ}$	> .3
Bovine 10	10	0.87 ± 0.29	< .02
Bovine 50	10	3.04 ± 0.29	< .001
Bovine 100	20	3.49 ± 0.23	< .001
Porcine 100	10	1.17 ± 1.54	> .4
Monkey 0.1	20	2.05 ± 0.96	< .05
Monkey 0.5	10	0.22 ± 0.15	> .1
Monkey 1.0	10	5.22 ± 0.85	< .001
Monkey 10.0	10	7.55 ± 1.55	< .001
Human 1	10	1.28 ± 0.54	< .05
Human 10	10	2.65 ± 0.54	< .001
Sheep 1	10	1.23 ± 0.26	< .01

[°] Mean \pm S.E.

^{°°} Method of paired comparisons.

TABLE IV

Effect of Corticotropin (*in vitro*) on FFA Release by Adipose Tissue of Normal Male Rats

Concentration ($\mu\text{gm/ml}$)	No. of Tissue Pairs	Increase in FFA Release ($\mu\text{eq/gm/hr}$)	P ^{°°}
.005	10	$1.97 \pm 0.40^{\circ}$	< .001
.01	10	2.31 ± 0.73	< .02
.05	10	3.49 ± 0.97	< .01
.10	10	4.30 ± 1.37	< .02
.10	10	4.42 ± 0.52	< .001
1.0	10	1.78 ± 0.33	< .001

[°] Mean \pm S.E.

^{°°} Method of paired comparisons.

of growth hormone, for in the same system as little as 0.005 microgram per ml. of corticotropin significantly increases FFA release (Table IV). Similar observations with even lower concentrations of corticotropin have been made by others (Hollenberg, Raben, and Astwood, 1960). It can readily be seen, therefore, that contamination of the growth-hormone preparation with corticotropin to the extent of less than 0.1

per cent would account for its lipolytic effect. Such contamination cannot be excluded with certainty in currently available growth-hormone preparations. In point of fact, these findings rather suggest that the striking FFA-mobilizing effect of growth hormone observed *in vivo* is probably not due to a direct action of the hormone on adipose tissue.

While growth-hormone administration clearly results in enhanced mobilization of fatty acids from adipose tissue, at least in the fasting animal, its influence on fatty-acid utilization or oxidation is somewhat obscure. As has been mentioned, an impressive body of evidence accumulated over the past 20 years has led to the view that the increased protein deposition in response to growth-hormone administration is effected at the expense of fat oxidation (see de Bodo and Altzuler, 1957). The studies of Greenbaum (1953) and Greenbaum and McLean (1953) have been most influential in this regard. Greenbaum (1953) made the important observation that when growth hormone is administered to animals on a restricted food intake, they cease to grow after 50 days of treatment, whereas their controls, fed *ad libitum*, continued to respond. The respiratory quotients of both groups declined after the initiation of growth-hormone therapy. But whereas the R.Q. of the rats fed *ad libitum* remained depressed, that of injected rats on a limited food intake returned to control levels at the time that they became refractory to continued growth-hormone administration. These findings led Greenbaum (1953) to the conclusion that protein deposition in response to growth hormone can take place only as a *result* of an increase in fat catabolism, and that when the body's stores of labile fat are exhausted, growth ceases, the primary action of growth hormone being the direct stimulation of fat breakdown to provide the additional "calories" to drive protein synthesis. Additional evidence, albeit indirect (Greenbaum and McLean, 1953), further suggested that growth hormone stimulates fatty-acid oxidation in the liver as well as in extrahepatic tissues.

The availability of C^{14} -labeled long-chain fatty acids made possible a re-evaluation of this problem, using direct criteria of fatty oxidation in both *in vivo* and *in vitro* systems. Our initial experiments (Franklin and Knobil, 1961) were designed to determine the influence of hypophysectomy and of growth-hormone administration on the conversion of intravenously administered albumin-bound palmitate-1- C^{14} to respiratory $C^{14}O_2$. It was necessary, first of all, to establish that this system would reveal physiological changes in the oxidation of fatty acids such as are occasioned by fasting. Figure 7 clearly shows that the intragastric administration of glucose one hour prior to palmitate injection markedly depresses the recovery of C^{14} as $C^{14}O_2$ when compared to the fasted situation. It would be expected, therefore, that an experimental manipulation which materially altered fatty-acid oxidation

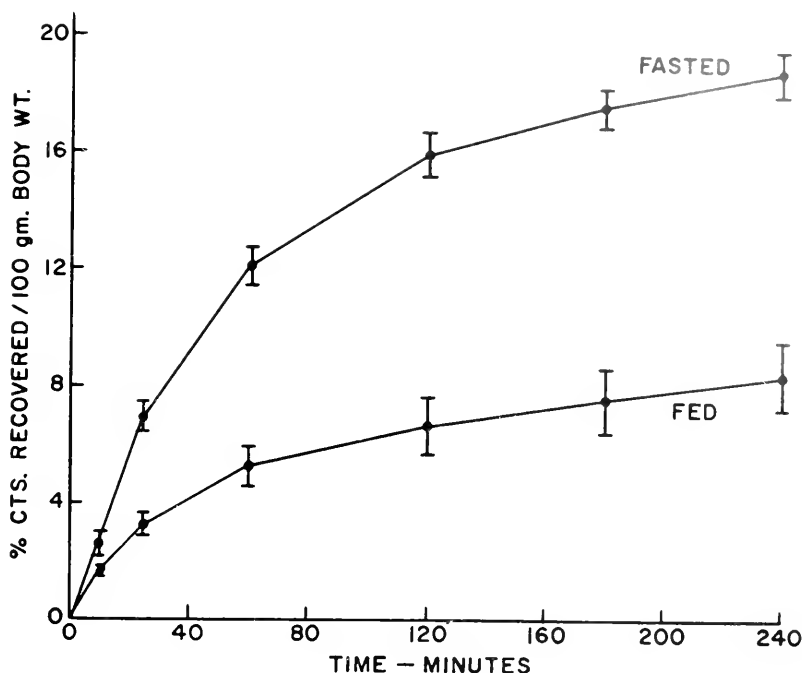

Figure 7. The effect of fasting and glucose feeding on the conversion of palmitate-1- C^{14} injected intravenously, at 0 time, to $C^{14}O_2$ by normal rats. The counts recovered in the expired CO_2 are cumulative. The vertical lines represent standard errors of the means. (Franklin and Knobil, 1961).

could be detected by this system. Removal of the pituitary gland did not influence the pattern of palmitate- C^{14} oxidation to $C^{14}O_2$, whether the hypophysectomized animals were fasted or fed (compare Figure 7 with Figures 8 and 9). Treatment of hypophysectomized animals with growth hormone (three mg. per rat) for four days prior to the experiment similarly did not affect the conversion of administered palmitate to CO_2 (Figure 8). The total CO_2 output and the specific activity of the expired CO_2 of the animals treated with growth hormone did not differ significantly from that observed in the hypophysectomized controls.

The administration of a single dose of growth hormone (three mg. per rat) five hours before the injection of labeled palmitate significantly decreased the recovery of labeled carbon dioxide in the fasted hypophysectomized animals, but it was without effect in the glucose-fed rats (Figure 9). This effect of growth hormone in the fasted group was reflected in a significant reduction in the specific activity of the respired CO_2 , and it could best be accounted for by a dilution of the labeled palmitate by endogenous fatty acids mobilized in response to

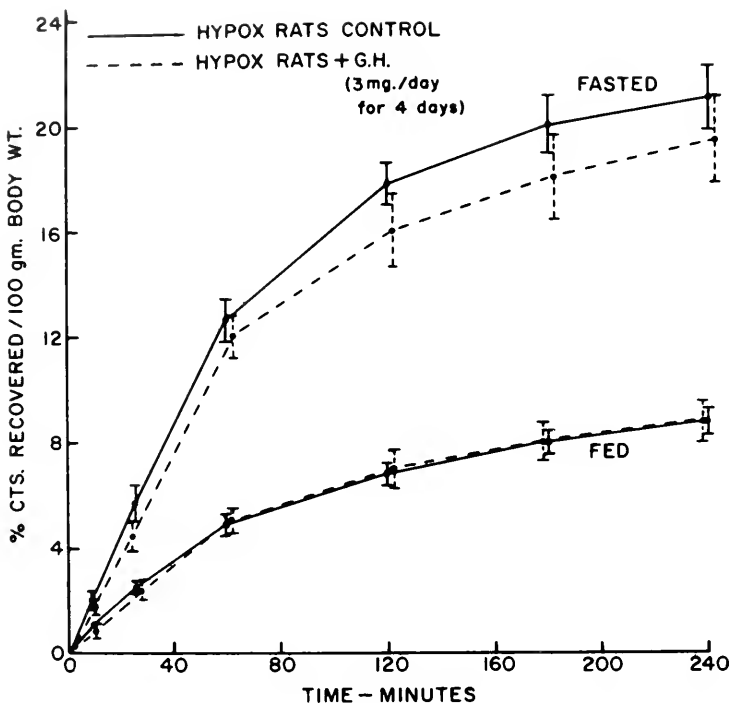

Figure 8. The influence of chronic growth-hormone treatment on the oxidation of palmitate-1-C¹⁴ to C¹⁴O₂ by fed and fasted hypophysectomized rats. (Franklin and Knobil, 1961).

growth-hormone administration, since a significant rise in the concentration of plasma FFA was observed only in this experimental situation.

Our finding that the absence of the pituitary gland does not influence the rate of utilization of labeled palmitate *in vivo*, as evidenced by the respiratory output of labeled carbon dioxide is in accord with earlier studies which similarly failed to demonstrate an inhibitory effect of hypophysectomy on the utilization of octanoate, trilaurin, and tripalmitin (Geyer, Shaw, and Greep, 1950; Matthews *et al.*, 1957). While the above observations also suggest that, under the experimental conditions employed, growth-hormone administration does not appear to stimulate the oxidation of palmitate to CO₂, the complexities of the *in vivo* system make definitive interpretation difficult. The lack of detailed information concerning the effects of growth hormone on the pool size and turnover rates of fatty acids is particularly prohibitive in this regard. In an attempt to obviate some of these difficulties, we turned to a simpler system, designed to study the effect of growth hormone on the

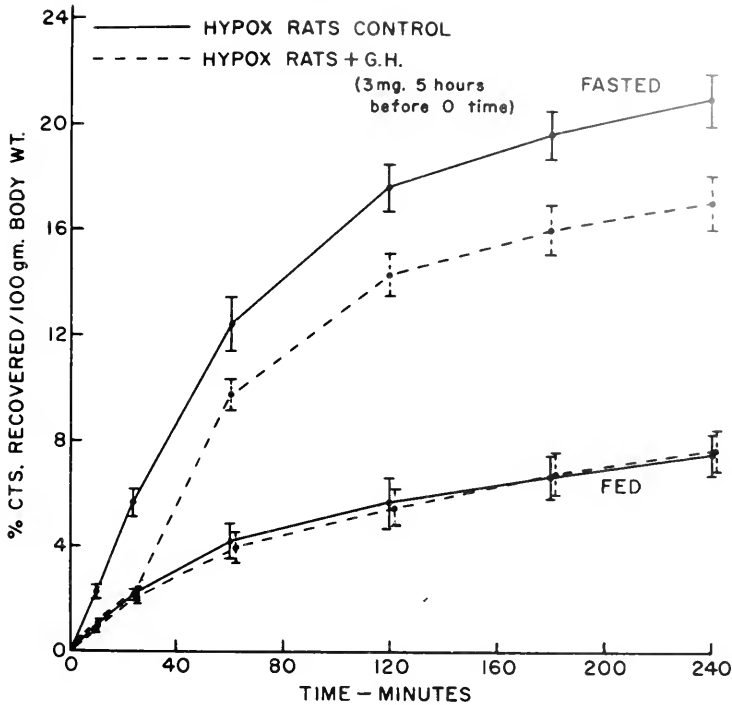

Figure 9. The oxidation of palmitate-1-C¹⁴ to C¹⁴O₂ by fed and fasted hypophysectomized rats in response to acute growth-hormone treatment. (Franklin and Knobil, 1961).

oxidation of labeled albumin-bound palmitate by rat diaphragm tissue incubated *in vitro* (Hotchkiss and Knobil, 1960; Knobil, Franklin, and Hotchkiss, 1960.) In such a system, the fatty-acid content of the tissue could at least be measured as an estimate of pool size.

Diaphragms were excised from normal, hypophysectomized, and hypophysectomized, growth-hormone-treated rats and were incubated in a suitable medium containing labeled palmitate for two and four hours. The CO₂ was collected in base, precipitated as the carbonate, and counted. The results, shown in Table V, permit the conclusion that growth-hormone treatment did not increase the oxidation of palmitate by the isolated muscle. Growth hormone added directly to the medium yielded the same results. Hypophysectomy, if anything, increased the fatty-acid utilization. Identical results were obtained in the presence or absence of glucose in the medium, suggesting that a preferential utilization of substrate was not a factor. That an actual increase in palmitate oxidation may have been effected by growth-hormone treatment but was masked by the diluting effect of endog-

TABLE V
Oxidation of Palmitate-1-C¹⁴ by Rat Diaphragm *in vitro*

	C ¹⁴ O ₂ (C.P.M./100 mg. wet wt.)		Specific Activity (C.P.M./μeq. CO ₂)	
	2 hours	4 hours	2 hours	4 hours
	Normal	1866 ± 255 (9)°	5039 ± 386 (9)	22 ± 5 (4)
Hypophysectomized	2331 ± 92 (11)	5777 ± 342 (10)	38 ± 3 (4)	78 ± 7 (3)
Hypophysectomized + bovine growth hormone (2mg./rat/day for 4 days)	2135 ± 108 (12)	4928 ± 242 (12)	35 ± 4 (4)	72 ± 3 (4)
Incubation medium:	glucose-free low Ca ⁺⁺ Krebs Ringer phosphate containing bovine albumin-bound palmitate-1-C ¹⁴ (0.3 μeg./ml., 16,700 c.p.m./ml.)			

° Means ± S.E.; number of observations in parentheses.

TABLE VI
FFA and Glycogen Content of Diaphragm

	FFA μeq./gm. tissue)	Glycogen (mg. glucose/gm. tissue)
Normal	5.27 ± 0.45 (5)°	1.71 ± 0.30 (6)
Hypophysectomized	5.11 ± 0.18 (10)	1.28 ± 0.17 (6)
Hypophysectomized + bovine growth hormone (2 mg./rat/day for 4 days)	4.54 ± 0.14 (10)	1.47 ± 0.28 (6)

° Mean ± S.E.; number of observations in parentheses.

enous fatty acids is ruled out by the finding that the FFA content of the growth-hormone-treated diaphragms was, if anything, lower than that in the other groups (Table VI). Similarly, under the conditions of these experiments the glycogen content of the diaphragms was the same in all groups.

These findings are in harmony with the prior observations of others that liver slices from hypophysectomized rats oxidize acetate to carbon dioxide at the normal rate (Tompkins, Chaikoff, and Bennett, 1952; Baruch and Chaikoff, 1955), and that growth-hormone treatment

in vivo or *in vitro* does not accelerate the oxidation of palmitate or acetate by rat-liver slices (Allen, Medes, and Weinhaus, 1956; Greenbaum and Glascock, 1957; Bauman *et al.*, 1959). Our findings, as well as those of others who have employed direct criteria of fatty-acid oxidation, are consonant with the view that growth hormone does not enhance the oxidation of fat by peripheral tissues. If this is indeed the case, it is necessary to find a new explanation for the R.Q.-depressing effect of growth hormone, the decrease in carcass fat occasioned by growth-hormone treatment, the ketogenic action of the hormone, and the fate of the fatty acids mobilized after growth-hormone administration.

While a depression of the R.Q. can be brought about by an increase in the proportion of fat in the oxidative substrate, a depression in lipogenesis can yield the same result. That growth hormone can indeed depress the synthesis of fatty acids from a variety of precursors has been repeatedly demonstrated (Welt and Wilhelmi, 1950; Perry and Bowen, 1955, 1957; Greenbaum and Glascock, 1957). An inhibition of lipogenesis could most easily account also for the decreased fat content of growth-hormone-treated animals and the ketogenic action of the hormone (Siperstein, 1959). The disposition of the fatty acids mobilized in response to growth-hormone treatment, however, is more difficult to contend with. Available evidence does not permit a quantitative evaluation of this process, although it does suggest that it is of limited duration. It is most tempting to assume that the fat mobilized after growth-hormone treatment is oxidized, but as we have seen, the experimental evidence does not support this view. One possibility is that the mobilized fatty acids may serve as a source of carbon for the synthesis of amino acids, thus contributing to the protein-anabolic effect of growth hormone in the presence of an adequate nitrogen supply.

That such a process can occur was suggested by the following experiments (Hotchkiss and Knobil, 1960). Hemidiaphragms from young, normal rats were incubated for four hours in the presence of labeled, albumin-bound palmitate. At the end of the incubation period the protein of the diaphragms was purified (Kostyo and Knobil, 1959b) and was exhaustively extracted with a 2:2:1 mixture of ethyl ether, ethyl alcohol, and chloroform. The extractions were continued until no radioactivity was detected in the supernatants. The proteins were then plated and counted. As shown in Table VII, significant quantities of palmitate carbon were recovered in the protein, the higher values being observed when the specific activity of the palmitate was high. More importantly, however, the incorporation of palmitate carbon into protein carbon was significantly increased, as revealed by paired analysis, when the concentration of palmitate was increased but

the specific activity of the medium was kept constant. This observation implies that the more fatty acid presented to the muscle tissue, the more fatty-acid carbon which finds its way into the protein.

Growth hormone, then, as shown by these preliminary experiments, may enhance the conversion of fatty-acid carbon to protein carbon by increasing the fatty-acid concentration in the extracellular fluid. It may, in addition, exert an effect on the tissue, with a resulting stimulation of palmitate-carbon incorporation into protein in the face of a constant palmitate supply. This is suggested by the experiment illustrated in Table VII, which compared the incorporation of the labeled palmitate carbon into the protein of diaphragms from hypophysectomized and from hypophysectomized, growth-hormone-treated rats. While the stimulatory effect of the growth-hormone treatment was not large, it was statistically significant at the 5 per cent level. The possibility remains, however, that these effects are artifacts explicable in terms of dilution by the endogenous fatty-acid pool. Further experiments taking this possibility into account are needed before definitive interpretation is possible.

The idea that the carbon of long-chain fatty acids may be incorporated into protein is given support by the finding of Manchester and Young (1959b) and Manchester and Krahl (1959) that radiocarbon from pyruvate, acetate, propionate, formate, α -ketoglutarate, citrate, succinate, and even bicarbonate was incorporated into the protein of isolated diaphragm and, more specifically, into the individual amino acids of the protein, as revealed by degradation procedures. These workers found in addition that insulin added to rat diaphragm *in vitro*

TABLE VII

Incorporation of C¹⁴ From Palmitate-I-C¹⁴ into Protein of Isolated Rat Diaphragm

	Specific Activity of Medium (c.p.m./ μ eq. palmitate)	Palmitate-I-C ¹⁴ Concentration in Medium (μ eq./ml.)	Counts appearing in protein (c.p.m./mg. protein)
Normal (4)	2.39×10^6	.310	$415.9 \pm 54.3^*$
Normal (6)	3.38×10^4	.305	11.4 ± 1.2
Normal (6)	3.38×10^4	1.016	16.1 ± 2.5
Hypophysectomized (9)	3.95×10^4	.327	12.8 ± 0.7
Hypophysectomized (10) + bovine growth hormone (2 mg./rat/day for 4 days)	3.95×10^4	.327	17.3 ± 1.8

* Mean \pm S.E.; number of observations in parentheses.

stimulated the incorporation of the labeled carbon from these various precursors into protein.

We have recently found (Hotchkiss and Knobil, 1960) that insulin added to diaphragms of hypophysectomized rats also increases the incorporation of carbon from labeled palmitate into protein, but growth hormone added *in vitro* to the same system had no effect (Table VIII). These experiments are preliminary, however, and provide but a starting point for further study.

The foregoing summary of our recent and current studies of the action of growth hormone has omitted consideration of the influences of this hormone on carbohydrate metabolism. These include an inhibition of glucose utilization on the one hand and an insulin-like or hypoglycemic effect on the other, depending on the experimental circumstances involved. There is no doubt that these effects are related to the influence of growth hormone on lipid mobilization and synthesis, but the nature of the relationship remains obscure, and nothing of consequence relevant to these questions can now be added to the extensive discussions that have recently appeared (de Bodo and Altzuler, 1957, 1958; Ketterer, Randle, and Young, 1957; Knobil and Creep, 1959; Wertheimer and Shafrir, 1960).

The underlying metabolic and biochemical bases for the growth-promoting activity of growth hormone remain to be elucidated. Much more information is needed before meaningful working hypotheses can be derived which will permit the synthesis of the great catalogue of often seemingly unrelated facts that has been amassed to date. The possibility that some of the effects ascribed to growth hormone may be

TABLE VIII

Incorporation of C^{14} from Palmitate-1- C^{14} into Protein of Isolated Rat Diaphragm

	Specific Activity of Medium (c.p.m./ μ eq. palmitate)	Palmitate-1- C^{14} Concentration in Medium (μ eq./ml.)	Counts Appearing in Protein (c.p.m./mg. protein)
Hypophysectomized (7)	3.52×10^4	.709	$13.1 \pm 1.0^\circ$
Hypophysectomized (4) + simian growth hormone (50 μ gm./ml.)	3.52×10^4	.709	13.6 ± 1.3
Hypophysectomized (3) + insulin (0.1 unit/ml.)	3.52×10^4	.709	24.3 ± 2.6

$^\circ$ Mean \pm S.E.; number of observations in parentheses.

due to contaminating substances has not been definitely ruled out, and the availability of purer preparations will do much toward this end. Ultimately, however, an understanding of the mechanism of action of growth hormone is dependent upon an understanding of growth and the great complexities that this term implies.

References

- Allen, A., Medes, G., and Weinhouse, S., 1956. "A Study of the Effects of Growth Hormone on Fatty Acid Metabolism *in Vitro*," *J. Biol. Chem.* 221, 333.
- Aschner, B., 1912. "Über die Funktion der Hypophyse," *Pflüger's Arch.* 146, 1.
- Asling, C. W., Walker, D. G., Simpson, M. E., and Evans, H. M., 1950. "Differences in the Skeletal Development Attained by 60 Day Old Female Rats Hypophysectomized at Ages Varying from 6 to 28 Days," *Anat. Rec.* 106, 555.
- Asling, C. W., Walker, D. G., Simpson, M. E., Li, C. H., and Evans, H. M., 1952. "Deaths in Rats Submitted to Hypophysectomy at an extremely Early Age and the Survival Effected by Growth Hormone," *Anat. Rec.* 114, 49.
- Baruch, H., and Chaikoff, I. L., 1955. "Lipogenesis and CO₂ Formation from Acetate in the Liver of the Hypophysectomized Rat," *Endocrinology* 56, 609.
- Bauman, J. W., Hill, R., Nejad, N. S., and Chaikoff, I. L., 1959. "Effect of Bovine Pituitary Growth Hormone on Hepatic Cholesterogenesis of Hypophysectomized Rats," *Endocrinology* 65, 73.
- Brande, P. F., and Knobil, E., 1960. "The Effect of Bovine and Simian Growth Hormone on the Incorporation of Amino Acids into Protein." *Anat. Rec.*, in press.
- de Bodo, R. C., and Altzuler, N., 1957. "The Metabolic Effects of Growth Hormone and Their Physiological Significance," *Vitamins and Hormones* 15, 205.
- de Bodo, R. C., and Altzuler, N., 1958. "Insulin Hypersensitivity and Physiological Insulin Antagonists," *Physiol. Rev.* 38, 389.
- Evans, H. M., 1923-24. "The Function of the Anterior Hypophysis," *Harvey Lectures*, 19, 212.
- Evans, H. M., Meyer, K., and Simpson, M. E., 1943. "Growth and Gonad-Stimulating Hormone of the Anterior Hypophysis," in *Essays in Biology in Honor of Herbert M. Evans* (Berkeley, U. of Calif. Press).
- Evans, H. M., Simpson, M. E., and Li, C. H., 1948. "The Gigantism Produced in Normal Rats by Injection of the Pituitary Growth Hormone," *Growth* 12, 15.
- Franklin, M. J., and Knobil, E., 1961. "The Influence of Hypophysectomy and Growth Hormone on Oxidation of Palmitate-1-C¹⁴ by the Rat," *Endocrinology* 68, 867.
- Frederickson, D. S., and Gordon, R. S., Jr., 1958. "Transport of Fatty Acids," *Physiol. Rev.* 38, 585.
- Geyer, R. P., Shaw, J. H., and Creep, R. O., 1950. "Utilization of Radioactive Lipides by Normal and Hypophysectomized Rats," *Endocrinology* 47, 108.
- Goodman, H. M., and Knobil, E., 1959. "The Effects of Fasting and of Growth Hormone Administration on Plasma Fatty Acid Concentration in Normal and Hypophysectomized Rhesus Monkeys," *Endocrinology* 65, 451.
- Goodman, H. M., and Knobil, E., 1960. Unpublished observations.
- Greenbaum, A. L., 1953. "Changes in Body Composition and Respiratory Quotient of Adult Female Rats Treated with Purified Growth Hormone," *Biochem. J.* 54, 400.

- Greenbaum, A. L., and Glascock, R. F., 1957. "The Synthesis of Lipids in the Livers of Rats Treated with Pituitary Growth Hormone," *Biochem. J.* 67, 360.
- Greenbaum, A. L., and McLean, P., 1953. "The Influence of Pituitary Growth Hormone on the Catabolism of Fat," *Biochem. J.* 54, 413.
- Hayashida, T., and Li, C. H., 1959. "A Comparative Immunological Study of Pituitary Growth Hormone from Various Species," *Endocrinology* 65, 944.
- Hollenberg, C. H., Raben, M. S., and Astwood, E. B., 1960. "The Lipolytic Response to Corticotropin," *Proc. 42nd Meeting Endocrine Soc., Miami*, p. 60.
- Hotchkiss, J., and Knobil, E., 1960. Unpublished observations.
- Huggins, A. K., and Ottaway, J. H., 1960. "Separation of a Peptide with Insulin-Like Properties from Preparations of Ox Growth Hormone," *Biochem. J.* 74, 23P.
- Jost, A., 1953. "Problem of Fetal Endocrinology; the Gonadal and Hypophyseal Hormones," *Rec. Progr. Hormone Res.* 8, 379.
- Ketterer, B., Randle, P. J., and Young, F. G., 1957. "The Pituitary Growth Hormone and Metabolic Processes," *Eigebn. d. Physiol.* 49, 127.
- Kipnis, D. M., and Cori, C. F., 1957. "Studies of Tissue Permeability, III: The Effect of Insulin on Pentose Uptake by the Diaphragm," *J. Biol. Chem.* 224, 681.
- Kipnis, D. M., and Noall, M. W., 1958. "Stimulation of Amino Acid Transport by Insulin in the Isolated Rat Diaphragm," *Biochim. Biophys. Acta* 28, 226.
- Knobil, E., 1959. "Direct Evidence for Fatty Acid Mobilization in Response to Growth Hormone Administration in the Rat," *Proc. Soc. Exptl. Biol. Med.* 101, 288.
- Knobil, E., and Caton, W. L., 1953. "The Effect of Hypophysectomy on Fetal and Placental Growth in the Rat," *Endocrinology* 53, 198.
- Knobil, E., Franklin, M. J., and Hotchkiss, J., 1960. "The Influence of Growth Hormone on Fatty Acid Oxidation," *Acta Endocrinol. Suppl.* 51, 943.
- Knobil, E., and Goodman, H. M., 1959. Unpublished observations.
- Knobil, E., and Greep, R. O., 1959. "The Physiology of Growth Hormone with Particular Reference to its Action in the Rhesus Monkey and the "Species Specificity" Problem," *Rec. Progr. Hormone Res.* 15, 1.
- Knobil, E., Kostyo, J. L., Wolf, R. C., and Greep, R. O., 1958. "Lack of Competitive Inhibition Between Beef and Monkey Growth Hormones in Rhesus Monkeys," *Science* 127, 1394.
- Knobil, E., Wolf, R. C., Greep, R. O., and Wilhelmi, A. E., 1957. "Effect of a Primate Pituitary Growth Hormone Preparation on Nitrogen Metabolism in the Hypophysectomized Rhesus Monkey," *Endocrinology* 60, 166.
- Komer, A., 1959. "The Effect of Hypophysectomy of the Rat and of Treatment with Growth Hormone on the Incorporation of Amino Acids into Liver Proteins in a Cell-Free System," *Biochem. J.* 73, 61.
- Komer, A., 1960a. "The Effect of Hypophysectomy of the Rat and of Treatment with Growth Hormone on the Incorporation *in vivo* of Radioactive Amino Acids into the proteins of Subcellular Fractions of Rat Liver," *Biochem. J.* 74, 462.
- Komer, A., 1960b. "The Effect of the Administration of Insulin to the Hypophysectomized Rat on the Incorporation of Amino Acids into Liver Proteins *in vivo* and in a Cell-Free System," *Biochem. J.* 74, 471.
- Kostyo, J. L., 1960. "In Vitro Effects of Growth Hormone and Corticotropin on Amino Acid Transport in Muscle," *Proc. First Int. Congr. Endocrinology, Periodica, Copenhagen, Denmark.*

- Kostyo, J. L., Hotchkiss, J., and Knobil, E., 1959. "Stimulation of Amino Acid Transport in Isolated Diaphragm by Growth Hormone Added *in Vitro*," *Science* 130, 1653.
- Kostyo, J. L., and Knobil, E., 1959a. "The Effect of Growth Hormone on the *in Vitro* Incorporation of Leucine-2-C¹⁴ into the Protein of Rat Diaphragm," *Endocrinology* 65, 395.
- Kostyo, J. L., and Knobil, E., 1959b. "The Stimulation of Leucine-2-C¹⁴ Incorporation into the Protein of Isolated Rat Diaphragm by Simian Growth Hormone Added *in Vitro*," *Endocrinology* 65, 525.
- Krahl, M. E., 1956. "Functions of Insulin and Other Regulatory Factors in Peptide Formation by Animal Cells," *Rec. Progr. Hormone Res.* 12, 199.
- Li, C. H., 1957. "Properties of and Structural Investigations on Growth Hormones Isolated from Bovine, Monkey and Human Pituitary Glands," *Fed. Proc.* 16, 775.
- Li, C. H., 1958. "Species Variation and Structural Aspects in Some Pituitary Hormones," in Neuberger, A., ed., *Symposium on Protein Structure* (N. Y., Wiley).
- Li, C. H., and Evans, H. M., 1948. "The Biochemistry of Pituitary Growth Hormone," *Rec. Progr. Hormone Res.* 3, 3.
- Li, C. H., Evans, H. M., and Simpson, M. E., 1945. "Isolation and Properties of the Anterior Hypophyseal Growth Hormone." *J. Biol. Chem.* 108, 624.
- Li, C. H., Simpson, M. E., and Evans, H. M., 1949. "The Growth of Hypophysectomized Female Rats following Chronic Treatment with Pure Pituitary Growth Hormone, II." *Growth* 13, 171.
- Manchester, K. L., and Krahl, M. E., 1959. "Effect of Insulin on the Incorporation of C¹⁴ from C¹⁴-Labelled Carboxylic Acids and Bicarbonate into the Protein of Isolated Rat Diaphragm," *J. Biol. Chem.* 234, 2938.
- Manchester, K. L., and Young, F. G., 1959a. "Hormones and Protein Biosynthesis in Isolated Rat Diaphragm," *J. Endocrinol.* 18, 381.
- Manchester, K. L., and Young, F. G., 1959b. "Location of ¹⁴C in Protein from Isolated Rat Diaphragm Incubated *in vitro* with [¹⁴C] Amino Acids and with ¹⁴CO₂," *Biochem. J.* 72, 136.
- Matthews, L. W., Spector, S., Lemm, J. and Olnyk, P., 1957. "Utilization of Exogenous Fat and Turnover Rate of Endogenous Fat in the Normal and Hypophysectomized Rat." *Am. J. Physiol.* 188, 308.
- Mitchell, M. L., Guillemin, R., and Selye, H., 1954. "The Effect of Somatotrophic Hormone on the Growth of Normal and Hypophysectomized Guinea Pigs," *Endocrinology* 54, 111.
- Noall, M. W., Riggs, T. R., Walker, L. M., and Christensen, H. N., 1957. "Endocrine Control of Amino Acid Transfer; Distribution of an Unmetabolizable Amino Acid," *Science* 126, 1002.
- Ottaway, J. H., 1953. "The Insulin-Like Action of Growth Hormone," *Brit. Med. J.* 2, 254.
- Perry, W. F., and Bowen, H. F., 1955. "The Effect of Growth Hormone on Lipogenesis in Intact and Adrenalectomized Rats," *Endocrinology* 56, 579.
- Perry, W. F., and Bowen, H. F., 1957. "The Utilization of Acetate by Liver and Adipose Tissue of Growth Hormone Treated Rats of Different Ages," *Canad. J. Biochem. Physiol.* 35, 759.
- Raben, M. S., 1959. "Human Growth Hormone," *Rec. Progr. Hormone Res.* 15, 71.
- Raben, M. S., and Hollenberg, C. H., 1959. "Effect of Growth Hormone on Plasma Fatty Acids," *J. Clin. Invest.* 65, 433.

- Read, C. H., and Bryan, G. T., 1960. "The Immunological Assay of Human Growth Hormone. *Rec. Progr. Hormone Res.* 16, 187.
- Russell, J. A., 1953. "Effects of Growth Hormone on Metabolism of Nitrogen." in Cole, W. H., ed., *Protein Metabolism, Hormones and Growth* (New Brunswick, N. J., Rutgers U. Press).
- Russell, J. A., 1955. "Effects of Growth Hormone in the Metabolism of Amino Acids," in Smith, R. W., Gaebler, O. H., and Long, C. N. H., eds. *The Hypophyseal Growth Hormone* (N. Y., McGraw-Hill).
- Russell, J. A., and Wilhelmi, A. E., 1958. "Growth (Hormonal Regulation)," *Ann. Rev. Physiol.* 20, 43.
- Scow, R. O., and Cherwick, S. S., 1960. "Hormonal Control of Protein and Fat Metabolism in the Pancreatectomized Rat," *Rec. Progr. Hormone Res.* 16, 497.
- Simpson, M. E., Evans, H. M., and Li, C. H., 1949. "The Growth of Hypophysectomized Female Rats following Chronic Treatment with Pure Pituitary Growth Hormone, I." *Growth* 13, 151.
- Simpson, M. E., Asling, C. W., and Evans, H. M., 1950. "Some Endocrine Influences on Skeletal Growth and Differentiation," *Yale J. Biol. Med.* 23, 1.
- Siperstein, M. D., 1959. "Inter-relationships of Glucose and Lipid Metabolism," *Am. J. Med.* 26, 685.
- Smith, P. E., 1930. "Hypophysectomy and a Replacement Therapy in the Rat," *Am. J. Anat.* 45, 205.
- Smith, P. E., 1954. "Continuation of Pregnancy in Rhesus Monkeys following Hypophysectomy," *Endocrinology* 55, 655.
- Stadie, W. C., 1954. "Current Concepts of the Action of Insulin," *Physiol. Rev.* 34, 52.
- Tompkins, G. M., Chaikoff, I. L., and Bennett, L. L., 1952. "Cholesterol Synthesis by Liver, II: Effect of Hypophysectomy," *J. Biol. Chem.* 199, 543.
- Weil, R., 1955. "Metabolic Function of the Pituitary Growth Hormone." *Arch. Int. Med.* 95, 739.
- Welt, I. D., and Wilhelmi, A. E., 1950. "Effect of Adrenalectomy and of Adrenocorticotrophic and Growth Hormones on the Synthesis of Fatty Acids," *Yale J. Biol. Med.* 23, 99.
- Wertheimer, E., and Shafrir, E., 1960. "Influence of Hormones on Adipose Tissue as a Center of Fat Metabolism," *Rec. Progr. Hormone Res.* 16, 467.
- Wilhelmi, A. E., 1955. "Comparative Biochemistry of Growth Hormone from Ox, Sheep, Pig, Horse and Fish Pituitaries," in Smith, R. W., Gaebler, O. H., and Long, C. N. H., eds., *The Hypophyseal Growth Hormone* (N. Y., McGraw-Hill).
- Wilhelmi, A. E., Fishman, J. B., and Russell, J. A., 1948. "A New Preparation of Crystalline Growth Hormone," *J. Biol. Chem.* 176, 735.
- Wooll, I. G., and Krahl, M. E., 1959. "Incorporation of C¹⁴ Amino Acids into Protein of Isolated Diaphragms: An Effect of Insulin Independent of Glucose Entry. *Am. J. Physiol.* 196, 961.



STEROIDS AND GROWTH

Victor A. Drill

G. D. SEARLE & CO.

Genetic factors, nutrition, and hormones all influence the growth process. As regards nutritional factors, there must be an adequate supply of calories, essential amino acids, vitamins, and minerals; a lack of any one material retards or distorts growth. Although all of these materials are vital, certain deficiencies tend to occur more abruptly and to influence growth more noticeably, so that they are usually discussed among the important growth factors. A similar situation exists with regard to the hormones, and to the extent that any hormone influences biochemical reactions, it can affect growth. Aside from such generalities, it can readily be observed that certain hormones, in addition to what endocrine effects they may have, can, either by deficiency or excess, markedly affect growth.

Growth, in terms of linear change and body weight, is primarily influenced by (1) the pituitary growth hormone, (2) thyroid hormone, (3) androgens, (4) estrogens, and (5) corticosteroids. Inasmuch as the subject of this paper is "steroid hormones," attention will be focused on androgens, estrogens, and corticosteroids; the thyroid gland will not be discussed. Some mention must, however, be made of the growth hormone, particularly as relationships exist with the sex steroids.

There are many aspects of growth to be considered, and any limited presentation of this large subject must of necessity be arbitrary. Inasmuch as the sex hormones are important in the growth process, it is appropriate to present first a brief summary of sex and growth. Secondly, linear growth and steroids will be discussed, and thirdly, data on body weight and steroids. Lastly, steroids can affect the weight of specific organs; namely, the reproductive organs and certain organs unrelated to reproduction, such as the kidney. From

this large area several organs of the reproductive system have been chosen to illustrate the effect of steroids upon organ weight.

Sex and growth

The relationship of sex to growth, either in terms of body length or weight, has been known for a considerable time. It is perhaps seen most clearly in the inbred animal, and Figure 1 shows the effect of sex on the body weight of the Sprague-Dawley rat. It will be noted that growth of the male and the female is quite similar and linear until about the thirtieth day of age. At this time sexual maturity begins, and the male begins to grow in weight (and also length) more rapidly than the female. The male maintains this advantage until growth in either sex ceases.

Similar relationships, although with greater variations, exist in man. In man, growth in general can be divided into four phases.

First, in the immediate period after birth there is a rapid increase in weight and height. In the second phase, the growth continues at a

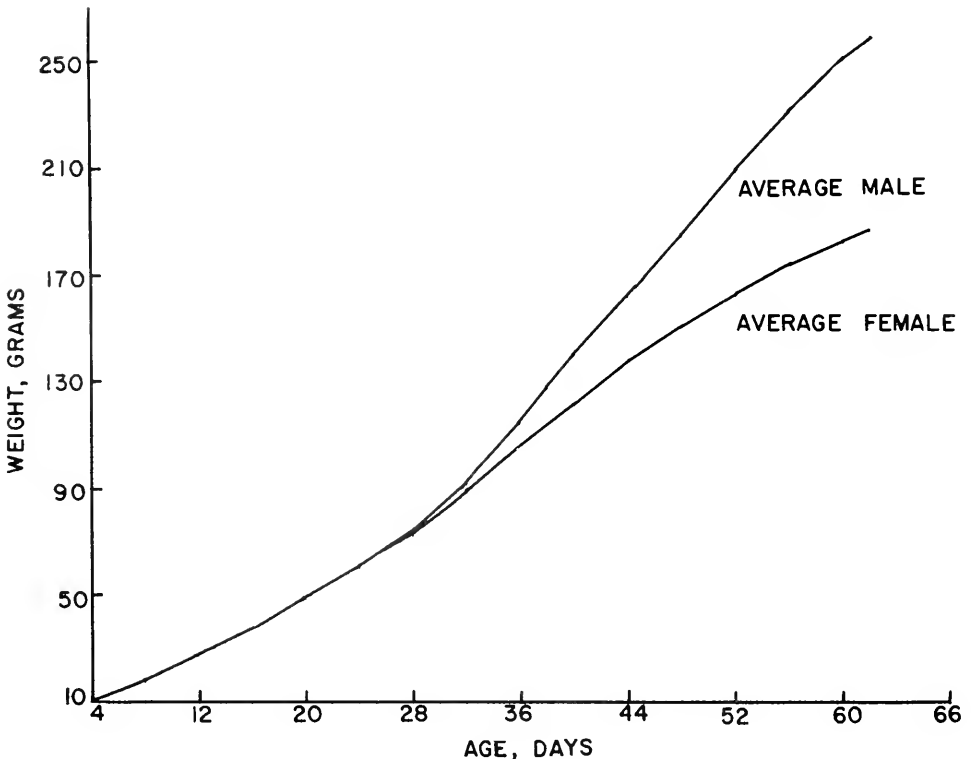

Figure 1. Effect of sex on increase in body weight of Sprague-Dawley rats.

rather constant rate until sexual maturation and puberty occur. In man this second period lasts from the age of two to the tenth or eleventh year. During this time males and females respond similarly, with an average increase in weight of five pounds per year and an annual increment in height of about two inches.

The third phase of growth is characterized by the well-known adolescent acceleration in growth associated with sexual maturity and puberty. In girls there is a slight acceleration in the annual increment in height and a proportionately greater increase in body weight. As sexual development begins earlier in girls, for a span of one or two years they are heavier and taller than boys. As mentioned above, the growth of boys from the ages of five to twelve is relatively slow and constant, averaging about two inches per year; but between the ages of 12 and 15, the growth rate increases to an average of three inches per year (Wetzel, 1941; Jackson and Kelley, 1945), although some boys temporarily may greatly exceed this rate. Body weight increases to an even greater degree, and the body build and musculature characteristics of the male develop.

The fourth phase of development is characterized by a deceleration in the rate of growth which continues until adult size is attained. In general the inhibition of the growth process is apparent in girls by the fifteenth year, and by the seventeenth year in boys. Thus the puberal acceleration of growth occurs earlier and ends sooner in girls than in boys.

It is evident from the above that growth rates are quite independent of sex until sexual puberty begins, at which time the respective hormones of the testes and ovaries are secreted in large amounts. In addition to such general factors as changes in height and body weight, other significant differences related to sex may be noted. For example, centers of ossification appear later in the male than in the female. Further, when specific bones are studied it is noted that the fusion of the epiphyses with the diaphysis, which takes place during puberty, occurs two years later in boys than in girls, on the average.

Linear growth: androgenic steroids

Sources of androgens. Androgens are derived from two sources: the interstitial cells of the testes and the adrenal gland. Testosterone, believed to be the chief androgenic steroid of the testes, has been isolated from the bull (David, *et al.*, 1935) and stallion testis (Tagman, *et al.*, 1946), and it can be recovered from the human testis perfused with radioactive acetate (Savard, *et al.*, 1952). Another source of androgens is the adrenal gland, which produces materials which, though structurally closely related to testosterone, are weaker androgenically.

Androgen production with age. Androgens from the testis and adrenal gland are excreted in part as 17-ketosteroids, and the measurement of urinary 17-ketosteroids serves as an index of androgen production. By determining urinary 17-ketosteroids after orchidectomy or adrenalectomy, the proportion contributed by each organ can be determined. The adult male excretes an average of 14 mg. of ketosteroids per day. Of this amount, about 9 mg. is believed to be derived from the adrenal glands. The adult woman excretes 8 to 10 mg. of ketosteroids per day, presumably all of the end product coming from adrenal androgens (*cf.* Dorfman and Shipley, 1956).

Children under seven years of age excrete little if any 17-ketosteroids (Figure 2). Excretion begins to increase at approximately the eighth or ninth year, the rise continuing through the fifteenth or eighteenth year (Talbot *et al.*, 1943). There is no significant difference in excretion between sexes before puberty. Further, the ketosteroids excreted before puberty are generally thought to be derived from adrenal androgens. The greater increase in 17-ketosteroid excretion that occurs

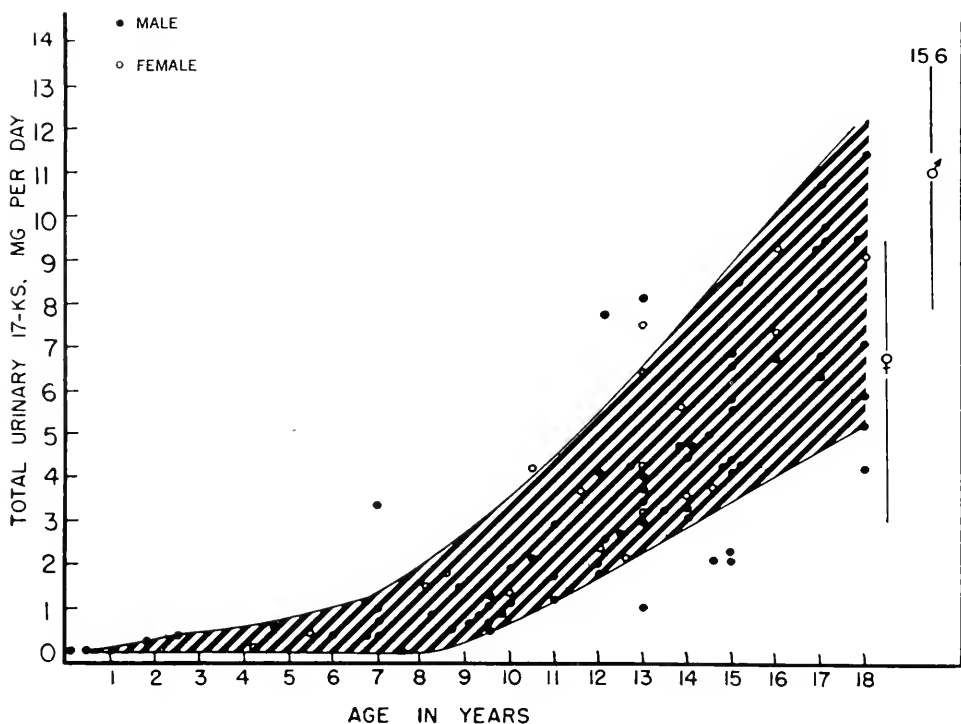

Figure 2. Urinary excretion of 17-ketosteroids in boys and girls of different ages. (○ female; ● male.) Male average is higher than in female, although overlap exists. (Data from Talbot, Butler, *et al.*, 1943.)

in males, as compared to females, after puberty is attributed to added output from the testis. The titer of urinary androgens, measured biologically, has also been determined in relationship to age by a number of investigators (*cf.* Dorfman and Shipley, 1956). Such a bioassay is not simple; it measures the effect of a complex mixture of steroids, consisting of metabolic end products of different androgenic potencies from multiple hormone precursors. However, such excretion data do confirm the general statements made in regard to ketosteroid excretion.

It is evident from the above that the increase in output of androgenic steroids that occurs during adolescence, as shown by increased androgen and 17-ketosteroid excretion, is associated with the increase in growth rate that take place at this time. Further evidence for the role of androgens in the growth process may be noted from the fact that testosterone can stimulate growth even when the pituitary is deficient. It seems quite probable, therefore, that the adolescent spurt in growth is due, at least in males, to androgens. Androgen secretion also increases in the female during adolescence, and probably it accounts for some of the increase in growth. The picture in girls is complicated, as will be seen later, by the increased production of estrogen that also occurs at this time and influences the growth process.

Growth and epiphyseal cartilage. Linear growth finally ceases when the epiphyses fuse to the long bones. Although the exact cause of this fusion is not known, the androgens have been observed to be less effective than estrogens in promoting epiphyseal fusion. It is thought that androgens may influence this process either (a) by direct action on the epiphyseal cartilage or (b) by inhibiting the secretion of growth hormone.

Before reviewing the available data on androgens and epiphyseal cartilage, it is pertinent to review briefly the main effect of hypophysectomy and growth hormone on this process. Hypophysectomy in the rat and other species markedly arrests growth. The injection of purified growth hormone (a protein) into hypophysectomized rats causes resumption of growth, and if treatment is prolonged, the animals will reach giant size (*cf.* Asling *et al.*, 1955). A similar stimulation of growth can be obtained by the administration of this hormone to normal young rats. The reactions of epiphyseal cartilage are important in this growth response. Hypophysectomy arrests chondrogenic and osteogenic processes in the epiphyseal cartilages, producing a typical decrease in the width of the epiphyseal cartilage. The injection of growth hormone stimulates the cartilages so that in width and histological appearance they resemble cartilage of young, normal, growing rats (*cf.* Geschwind and Li, 1955).

Androgens and epiphyseal cartilage. Reports on the effect of testosterone on the epiphyses of the hypophysectomized rat vary consider-

ably, depending on the time after hypophysectomy, the dose of testosterone, the duration of treatment, and the endpoint used (*cf.* Simpson *et al.*, 1944; Reiss *et al.*, 1946). Simpson and associates (1944) found that testosterone, administered in doses of 0.1 or 1.0 mg. per day to rats which had been hypophysectomized for a long period, increased the width of the epiphyseal cartilage. However, when studied under the conditions of the growth-hormone assay, testosterone, in doses of 0.05 or 1 mg., failed to produce a detectable change from the control group. Geschwind and Li (1955), using conditions of a growth-hormone assay, reported that 1 mg. of testosterone per day did not alter control cartilage. They noted, however, that a lower dose of testosterone—0.1 mg. per day—produced a small but significant increase in cartilage width. These studies indicate that under certain experimental conditions testosterone can increase the width of epiphyseal cartilage. This is particularly true of small doses, for large doses of testosterone may fail to produce a response.

Testosterone also affects the response to growth hormone in hypophysectomized rats, the effect produced depending on the dose administered. In the studies of Geschwind and Li (1955) 1.0 mg. of testosterone per day augmented the growth-hormone response (Table I).

TABLE I
Effect of Testosterone Propionate on Response to
Growth Hormone (Geschwind and Li, 1955)

Treatment	Daily Dose, mg.	Tibial Epiphyseal Cartilage Plate Width, Microns	Growth Hormone Equiv. (γ)
Testosterone propionate	1.0	165	0
Growth hormone	0.0075	221 \pm 2.0	28
Combination		237 \pm 1.9	54

However, when the dose of growth hormone was sufficient in itself to produce a maximal response, the same dose of testosterone was without an augmenting effect (Simpson *et al.*, 1944). Conversely, when the dose of growth hormone was low, but still sufficient to produce a significant response, Geschwind and Li (1955) observed that 0.1 mg. of testosterone markedly enhanced the response. The employment of a high dose of testosterone, namely, 4 mg. per day, was reported by Reiss *et al.* (1946) to inhibit the action of growth hormone.

These data, demonstrating an effect of testosterone in the hypophysectomized rat, the potentiating effect of testosterone on growth-hormone response, and the ability of large doses of testosterone to

block growth-hormone effects on the epiphyses, are in general agreement with our understanding of the adolescent growth response. Thus, as androgens are first formed and secreted in significant amounts by the testes and adrenal gland, the growth response is augmented. As the output of androgens reaches a peak during the end of adolescence, epiphyseal fusion occurs. Whether or not the endogenous supply of androgen is sufficient to account for the epiphyseal closure at this time cannot be definitely stated. At least, such a mechanism of action does exist. The androgens may also act to depress the elaboration of growth hormone from the pituitary gland, and this possibility requires investigation.

Panhypogonadism and growth. The term hypogonadism is used to indicate that both the tubules and the interstitial cells of the testes are destroyed or absent as a result of trauma, castration, congenital defects, or other causes. Aside from the absence of normal development of secondary sex characteristics, the fusion of skeletal epiphyses is delayed. Although the adolescent spurt in growth is absent, growth in height continues at an apparently normal and steady rate through the adolescent period. With this continued growth, normal adult stature is usually reached at an approximately normal age. Only a few eunuchoid individuals grow to an exceptionally tall height, even though the delay of skeletal maturation and epiphyseal fusion presumably offers an opportunity for continued growth. Because of the delayed epiphyseal fusion there is, however, a tendency for eunuchs and eunuchoids to develop relatively long extremities (Talbot and Sobel, 1947).

It is apparent from such data that the increased output of androgen from the testes that normally occurs during adolescence is *not* the main factor that finally arrests growth. In the eunuchoid or castrate individual, ketosteroid excretion is below normal (Dorfman and Shipley, 1956) and is derived from adrenal androgen. The adrenal androgen is sufficient to produce some growth of sexual hair but insufficient to allow normal development of other secondary sex characteristics. There is no evidence to implicate adrenal androgens as factors that finally stop growth.

Androgens to stimulate growth. There is ample evidence demonstrating that testosterone and related steroids increase growth rate (height) in children of subnormal stature (Howard *et al.*, 1942; Talbot, Sobel, Burke, *et al.*, 1947; Talbot and Sobel, 1947.) The rate of growth is increased from subnormal to normal or above normal levels. An effect on growth is usually seen within three months and is produced by 5 mg. of methyl testosterone orally per day. Higher doses of 10, 20, or 30 mg. per day apparently do not produce a greater growth response. Further, the androgens will not increase linear growth after fusion of the skeletal epiphyses has occurred. Administration of andro-

gens to children with stunted growth will also accelerate skeletal maturation, which will become evident on X-ray during the treatment period of three months or six to twelve months after treatment. High doses of methyl testosterone, of the order of 30 mg. or more a day, may increase the rate of epiphyseal changes.

Linear growth: estrogenic steroids

Sources of estrogens. Estrogens are produced in large amounts by the ovary and, during pregnancy, by the placenta. Estrogen is also secreted to a lesser degree by the adrenal cortex of both sexes. Estradiol, estrone, and estriol are the main estrogens that have been isolated from human tissues and body fluids, and both estradiol and estrone have been recovered from the ovaries of the sow. Estrone is present in small quantities in male urine.

Estrogen production with age. Boys and girls secrete small constant amounts of estrogen until about the age of seven. Excretion then increases slightly but remains similar in both sexes to the age of ten or eleven (Nathanson, Towne, and Aub, 1941). At this time estrogen production in the female shows a dramatic increase, and cyclic changes in excretion begin to occur (Figure 3). The amount of gonadotropic follicle-stimulating hormone (FSH) secreted by the pituitary gland is also increased at this time, as judged by the increased urinary levels. Only minute amounts of FSH are excreted before puberty. Estrogen excretion also increases during this period in the male, but to a much lesser extent, being derived from the adrenal gland.

The fact that boys and girls secrete equal amounts of estrogen before puberty suggests that in early childhood the hormone is not derived from the ovary. There is sufficient evidence to point to the adrenal gland as the source of the estrogen. However, at puberty the ovary becomes active, and estrogen production is markedly increased. The increase in estrogen production does not occur in a castrated individual or in certain pathological conditions.

What role estrogens play, if any, in normal preadolescent growth is poorly understood. In cases of ovarian agenesis, there occurs retarded growth and osteoporosis. Sexual maturity does not occur; the girls reach a height of only 50 to 58 inches; and there is a moderate delay in epiphyseal fusion (Wilkins and Fleischmann, 1944). However, the syndrome of ovarian agenesis is often associated with congenital defects, and the short stature also is thought to be a genetic defect. Interestingly, the 17-ketosteroid excretion is low, indicating the additional factor of adrenal-cortical depression. In the opposite situation a granulosa cell tumor of the ovary (which secretes large amounts of estrogen) causes acceleration of growth and advanced bone development.

Estrogens and epiphyseal cartilage. The development of the proximal epiphyses of the tibia in normal and hypophysectomized rats has been studied by a number of investigators (Ingalls, 1941; Ingalls and Hayes, 1941; Ray, Evans, and Beeks, 1941; Beeks, Kibrick, Marx, and Evans, 1941). Beeks, Simpson, and Evans (1945, a, b) have paid particular attention to the changes occurring in the normal female rat and the hypophysectomized female rat. These authors demonstrated that a very rapid narrowing of the cartilage plate occurs between the ages of 40 days and 65 days in normal females. This marked decrease in the width of the epiphyseal plate occurs at the beginning of sexual maturity in the strain of animals used and is reflected further by a marked

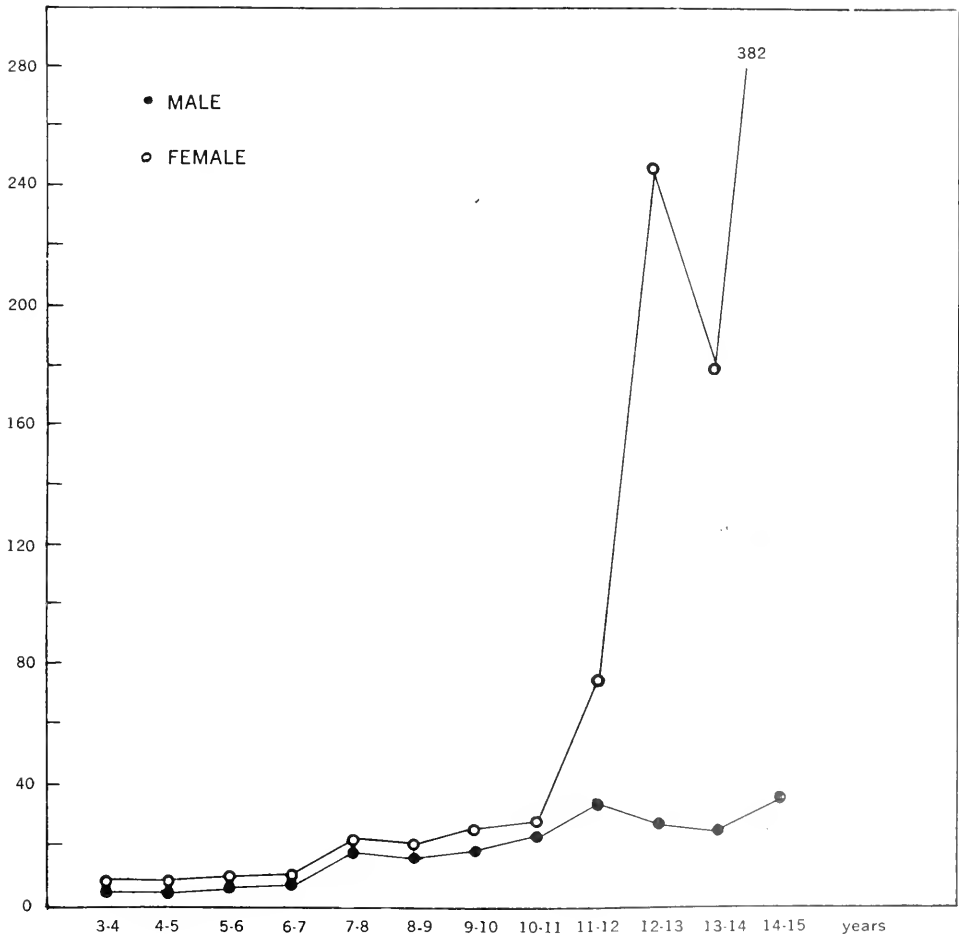

Figure 3. Urinary excretion of total estrogen in international units in boys and girls of different ages. (o female; • male.) (Data from Nathanson, Towne, and Aub, 1941.)

decrease in the rate of tibial growth. The rate of regression of cartilage plate associated with sexual maturity is similar to that observed after hypophysectomy (*cf.* Geschwind and Li, 1955).

It would appear from the above study that estrogen elaborated at the beginning of sexual maturity in the normal animal is able, by some mechanism, to cause the decrease in epiphyseal activity. Exogenous estrogens, as first demonstrated by Gaarenstroom and Levie (1939) and subsequently by others, produce a definite decrease in the width of epiphyseal cartilage.

If the physiological amount of estrogen elaborated from the ovary of the mature rat is sufficient to influence the epiphyseal cartilage, ovariectomy of the animals should alter the response. Such an approach was tried by Geschwind and Li (1955), utilizing animals ovariectomized between the ages of 28 and 35 days. Their data, summarized in Table II, show first the decrease in tibial epiphyseal width

TABLE II
Effect of Ovariectomy on Width of Proximal Epiphyseal
Cartilage of Tibia

Age Days	Tibial Epiphyseal Cartilage Width, Microns	
	Normal Rats	Ovariectomized Rats
30-31	442	
34-40	397	
38		409 (Ov. 8 days)
42	347	
56-62	260	364 (Ov. 21 days)
64-65	230	314 (Ov. 36 days)

° Data adapted from Geschwind and Li, 1955.

in normal rats that occurs with age. Eight days after ovariectomy of a 30-day-old rat the tibial epiphyseal width was not significantly different from that of normal animals, as the 38th day of age is just prior to the beginning of sexual function in the rat. The data for days 56 through 65 demonstrate that approximately one-half of the decline in epiphyseal width that occurs with age in the normal rat can be prevented by ovariectomy. Since ovariectomy does not completely abolish the change occurring in normal rats, other factors also must be operative. The data do, however, demonstrate the importance of ovarian function in inhibiting the epiphyses—an effect probably due to the removal of estrogens.

In contrast to the androgens, the administration of estrogen does not affect the epiphyses of hypophysectomized rats (Kibrick *et al.*, 1942; Geschwind and Li, 1955). Estradiol will, however, significantly depress the response to a standard dose of growth hormone in hypophysectomized rats (Table III). In such studies, large doses of estrogen

TABLE III

Effect of Estradiol Benzoate on Response to Growth Hormone^o

Treatment	Daily Dose, mg.	Tibial Epiphyseal Cartilage Plate Width, Microns	Growth Hormone Equiv. (γ)
Estradiol benzoate	0.5	158	0
Growth hormone	0.015	236	52
Combination		219	26

^o Geschwind and Li, 1955.

are required to inhibit the growth-hormone response. Small doses are without effect. These authors also studied progesterone, finding that 1 mg. per day slightly increased the cartilage width of the control groups but did not affect the response to growth hormones.

Estrogens in growth problems. Estrogens may be employed in the treatment of infantilism arising from primary ovarian deficiency and of pituitary infantilism. Usually stilbestrol is employed in doses of 0.5 to 1.0 mg. per day in attempting to increase the stature. However, depending upon the bone age, epiphyseal closure may be stimulated. In pituitary infantilism, combined estrogen-androgen therapy has been employed. Estrogens have been used in the treatment of pituitary gigantism in the female; although experience in this area is minimal, epiphyseal closure appears to occur in association with such therapy.

Linear growth: steroids of the adrenal cortex

Steroids produced. The adrenal cortex secretes corticosteroids, androgens, and estrogens. The production of the latter two groups of steroids in the prepuberal subject has been discussed above under their respective headings, and the present section will be concerned with a brief discussion of the corticosteroids. The corticoids proper may be divided on the basis of chemical structure and physiologic action into two groups: (a) steroids with an oxygen at position 11, such as cortisone and hydrocortisone, and (b) steroids without an 11 oxygen, such as desoxycorticosterone.

The urinary output of 11, 17-oxycorticosteroids, as measured by

Talbot (1949) in terms of square meters of body surface, shows no significant difference with sex or age. Secretion of these compounds is usually increased in Cushings disease but not in hyperplasia with adrenocortical virilism.

Adrenal cortical function and epiphyseal cartilage. Apparently steroids secreted by the adrenal cortex are necessary for normal bone function. In normal animals the administration of ACTH will produce a marked decrease in the width of epiphyseal cartilage (Becks, Simpson, Lee, and Evans, 1944). However, some secretion from the adrenal gland is probably required for the maintenance of normal disc function, as epiphyseal widths will decrease in adrenalectomized rats maintained on a 1 per cent sodium-chloride solution.

If ACTH is administered to hypophysectomized animals, it will lead to a further narrowing of the epiphyseal cartilage (Marx, Simpson, Li, and Evans, 1943; Marx, Simpson, and Evans, 1944). These authors also demonstrated that when ACTH and growth hormone were both given to hypophysectomized animals, the values were intermediate between those obtained when either hormone was given alone. Further studies have shown that the degree of antagonism between growth hormone and ACTH depends upon the ratio of the two hormones employed.

Geschwind and Li (1955) have recently studied the effect of 17-hydroxy corticosterone (compound F) on epiphyseal cartilage. Various doses, administered to normal 27-day-old rats for four days, markedly decreased the epiphyseal cartilage width. A significant effect was obtained with 100 micrograms of hydrocortisone per day. They also reported that large doses of growth hormone (2.5 mg. per day) only partly counteracted the effect of 0.5 mg. of hydrocortisone. It was observed that whereas 1 mg. of desoxycorticosterone did not alter the response to growth hormone in the hypophysectomized rat, a dose of 10 mg. per day markedly decreased the response.

In summary, it is probable that the adrenal corticoids, secreted in normal amounts, play a permissive role in bone growth in preadolescence and adolescence. They do not account for the adolescent spurt in growth. In disease states, excessive amounts of cortoids are catabolic and produce a negative calcium and, as demonstrated experimentally, can antagonize the growth hormone.

Body weight

It has been known for centuries, from observations of eunuchs castrated before puberty, that the general body build, musculature, and strength of the human male bear a relationship to testicular function. Tumors of the testis have also been observed to produce precocious

growth and musculature, and in 1895 Sacchi described the effects of a tumor of this type in a nine and a half-year-old boy. In addition to precocious arrival of puberty, the boy also had adult genitalia, a full beard, and the musculature of a grown man. Adrenocortical tumors may also put out larger amounts of androgen, producing the so-called infant Hercules syndrome. Similar changes may be noted in the female with bilateral hyperplastic adrenal cortices. The active adrenal tissue in such patients produces an excess of androgenic compounds, resulting in hypertrophy of the clitoris, masculine hirsutism, acne, rapid growth, and heavy musculature.

These observations indicated that testicular functions in general are associated not only with the reproductive function but also with anabolic activity. The term "anabolism" is defined as a constructive metabolism, indicating the building or formation of tissues in general. Thus, the typical androgenic steroids have anabolic as well as androgenic effects. Testosterone propionate, for example, can produce a positive nitrogen balance and retention of phosphorus and potassium. Retention of calcium also may occur, and it has been inferred from this that further formation and/or calcification of bone occurs.

Anabolic effect of testosterone. It was not until 1935 that Kochakian and Murlin first demonstrated that an extract of human male urine not only had androgenic effects but also caused nitrogen retention in castrate dogs fed a constant diet. After this observation, testosterone and testosterone acetate also were observed to produce nitrogen retention in the castrated dog (Kochakian, 1937). Since then these anabolic effects have been amply confirmed in various studies on rats and dogs. With regard to man, Kenyon and co-workers (1938) and others have demonstrated that testosterone propionate will decrease the urinary-nitrogen excretion both in eunuchoidal individuals and in subjects with normally functioning gonads (*cf.* Kochakian, 1946).

The nitrogen-retaining effects of testosterone are reflected in an increased weight gain in both animals and man. Kochakian has studied the growth rate of internal organs and 49 individual muscles of the normal and castrate guinea pig, demonstrating that androgens increase the size of many atrophied muscles (*cf.* Kochakian and Tillotson, 1956). Attempts have been made to utilize the anabolic action of testosterone for underweight patients, in cachectic disease states, in osteoporosis, and in patients with hepatic cirrhosis. The androgenic side-effects of testosterone have usually limited its use, the patients developing hirsutism, deepening of the voice, and other masculinizing changes. Retention of sodium also may occur, particularly in patients with hepatic disease.

Nortestosterone derivatives. Certain steroids have been reported to show a difference in the ratio of anabolic to androgenic effects.

Employing the increase in weight of the rat levator ani muscle as an index of anabolic activity (Eisenberg and Gordon, 1950), Hershberger, Shipley, and Meyer (1953) found that 19-nortestosterone was equal to testosterone in anabolic potency but only one-tenth as androgenic. Of the derivatives of 19-nortestosterones that have been studied, 17-ethyl-19-nortestosterone has been shown to have only 6 per cent of the androgenicity of testosterone, while retaining anabolic effects equal to testosterone (Drill and Saunders, 1956, Saunders and Drill, 1956). The compound is well absorbed orally, producing nitrogen retention in the rat equivalent to that obtained with testosterone or methyltestosterone (Drill and Saunders, 1956; Saunders and Drill, 1958). Nilevar (17-Ethyl-19-nortestosterone) has been shown to produce nitrogen retention in man (Spencer *et al.*, 1956; McSwiney and Prunty, 1956; Weston *et al.*, 1956) and in a variety of clinical conditions (Weston *et al.*, 1956; Pedin *et al.*, 1957; Goldfarb *et al.*, 1958).

Nilevar and weight gain. Following the demonstrations that Nilevar produces nitrogen retention in the normal subject and in debilitating disease conditions, it was studied for effects on body weight. Watson *et al.*, (1959) employed 54 underweight volunteer subjects who desired to gain weight but had tried to do so without success. Their mean results, employing a double blind technique, are shown in Figure 4. The treated subjects showed significant gains in weight, whereas the weight of 18 subjects receiving a placebo remained quite constant. Only eight of the 54 subjects failed to gain weight. When the placebo group was changed to Nilevar, a gain in weight was produced (Figure 5). It is of interest that no androgenic effects of treatment (hirsutism, voice, libido) were produced, showing that a significant degree of separation of androgenicity from anabolic effects can be achieved in a single molecule. After stoppage of treatment, 25 of the patients were observed for a six-month period, and 19 of the group maintained their weight gain or gained additional weight. The effects of Nilevar in increasing body weight in patients with debilitating diseases such as prostatic cancer, mammary cancer, endocrine disorders, or ulcerative colitis, or after gastrectomy, has been studied by a number of investigators (Weston *et al.*, 1956; Epstein *et al.*, 1957; Schaffner, Popper, and Chesrow, 1959; Malejka, 1958). Brendler and Winkler (1959) observed a weight gain in patients with prostatic cancer, and one patient, weighing 100 pounds on admission, gained 46 pounds.

With regard to children, Brown, Libo, and Nussbaum observed a gain in weight in all of 86 patients who ranged in age from seven weeks to 15½ years. Many had complained only of significant anorexia and "weight lag," but others had celiac disease and congenital heart disease. In other studies on premature infants, the administration of Nilevar at 2 mg. per kilogram per day for 33 to 85 days did not significantly affect body weight or length (Meadows *et al.*, 1960).

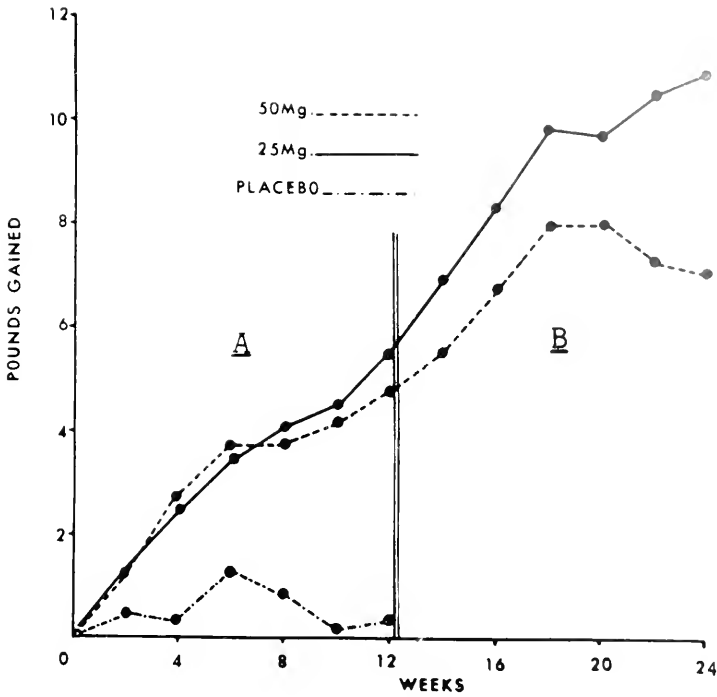

Figure 4. Effect of norethandrolone (Nilevar) on mean weight gain compared with a placebo group. (Data of Watson *et al.*, 1959.)

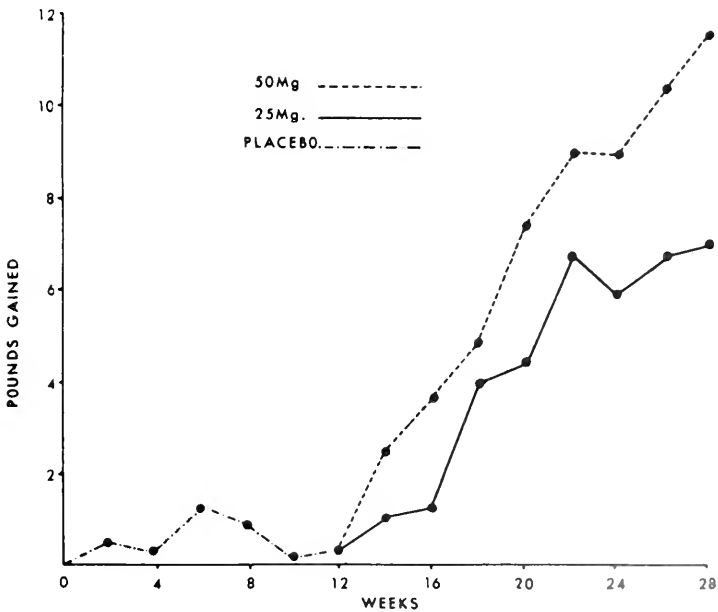

Figure 5. Effect of norethandrolone (Nilevar) on body weight. Subjects received placebo for the initial 12-week period. (Data of Watson *et al.*, 1959.)

A number of newer compounds have been investigated for anabolic effects in animals and man. Burke and Liddle (1959) have recently reported 11β -OH- 17α -methyltestosterone, 2-OH-methyl- 17α -methyl-dihydrotestosterone, and Δ^1 - 17α -methyltestosterone to be active in man. Foss (1960) has noted Δ^1 - 17α -methyltestosterone to increase weight and height in children and hypogonadal patients, and a pyrazole derivative of 17 -methylandrosterone is reported to be anabolic (Howard *et al.*, 1959).

Estrogens and nitrogen retention. High doses of estrogen can cause nitrogen retention in eunuchoid and normal subjects (Knowlton *et al.*, 1942). Thus the increased output of estrogen in the female at adolescence may play some role in increasing body weight at that time.

Individual organ growth

The discussion so far has been concerned with the more general aspects of steroids as related to effects on linear growth and weight growth. The end organs have been, respectively, bone and skeletal muscle. Other tissues significantly influenced by steroids are the secondary sex organs of the male and female. The growth and maintenance of these structures is directly dependent on the production of androgens and estrogens.

When castration is performed in mammals before puberty, the secondary sex organs fail to develop. The organs involved in the male are the penis, scrotum, vas deferens, epididymis, seminal vesicles, prostate, Cowper's gland, and preputial gland. In the female, the uterus, fallopian tubes, vagina, and breasts are particularly affected. Castration in either sex after puberty causes involution and atrophy of these organs. Treatment with the proper steroid can prevent the secondary effects of postpuberal castration, and if given to the prepuberal castrate, it will induce growth of these organs.

Although these statements refer to mammals, analagous changes have been observed in birds (which have been studied extensively), in reptiles, and in amphibians. A discussion of the growth relationships of all of these organs to steroids is beyond the scope of this paper, and references to other sources should be made. The relationships that do exist will be illustrated by brief reference to the effects of steroids on the growth of the cock's comb, the seminal vesicle, and the prostate gland.

Growth of cock's comb. As early as 1849 Berthold demonstrated that the cock's comb underwent atrophy after castration. The atrophy could be prevented by transplantation of the testis into a new site such as the abdominal cavity. It was also noted that the comb of the capon remained atrophic after castration, and that testicular implantation

caused a resumption of growth. These studies were not only the first experimental demonstration of the effects of androgen deprivation but among the first studies of the function of the endocrine gland.

Such experiments were the first of many which demonstrated that the growth of the comb is under the control of the male hormone. Following castration and involution of the cock's comb, the comb maintains a constant size over a long period, and the administration of testosterone or other androgens restores the comb to its normal size. The growth of the comb in the capon or the chick is proportional to the dose of androgen; it serves, therefore, as a means of assay for androgenic potency (*cf.* Dorfman, 1950; Dorfman and Shipley, 1956). The androgens may be applied locally to the comb, injected intramuscularly, or administered orally.

Male White Leghorns are approximately 15 times as sensitive as the Rhode Island Reds and 20 times as sensitive as the Barred Rock to the local application of testosterone propionate (Dorfman, 1948). Similar differences in sensitivity are present in female chicks of the same breeds. Methyltestosterone, a derivative of testosterone which is well absorbed after oral administration, also produces a marked effect on comb growth (Dorfman, 1950). In both of the examples cited, there is a very close relationship between the dose of the hormone and the comb response.

Seminal vesicles. Within two to five days after castration, the seminal vesicles of an adult rat begin to show involution and loss of weight, the changes becoming maximal in about two weeks. During the period of involution, there is a loss of secretion granules, a severe reduction of the Golgi apparatus, and a progressive involution of the secretory epithelium (Moore *et al.*, 1930). Similarly, castration of the immature male rat arrests the further development of the seminal vesicles.

Testosterone and other androgens can reverse the changes induced by castration in the adult rat and can stimulate and seminal vesicles in an animal castrated before puberty or in an immature, intact rat (Carter *et al.*, 1947; Dorfman and Shipley, 1956; Dorfman, 1950). An excellent dose-response relationship exists, and Mathieson and Hays (1945) developed this as an assay method for androgens. The typical stimulating effect of testosterone on seminal-vesicle weight is illustrated in Figure 6. The functioning of the seminal vesicle is affected quite rapidly, and within ten hours after the administration of testosterone, increases in QO_2 , intracellular water, and fructose can be demonstrated (Rudolph and Samuels, 1949).

It will be noted also in Figure 6 that estrogens, such as estrone, produce an increase in the seminal-vesicle weight above the castrate level. With estrogen therapy the seminal vesicle will approximately

double in weight, but the stimulation achieved is far below that obtained with testosterone. The androgens stimulate the epithelium of the seminal vesicles, whereas estrogens produce hypertrophy of the fibro-muscular components.

Prostate. Castration in various species of animals and in men with benign prostrate hypertrophy produces involution of the prostate gland (Dorfman and Shipley, 1956; Huggins and Stevens, 1940). Involutionary changes in the immature rodent are partly prevented by the androgenic steroids secreted by the X-zone of the adrenal gland. The involution can be markedly accelerated by adrenalectomy. Involution of the X-zone occurs with sexual maturity in the rodent, and castration of the mature rat is followed by complete degeneration of the prostate gland.

Administration of androgens can prevent the involution of the prostate that occurs after castration and will also stimulate the atro-

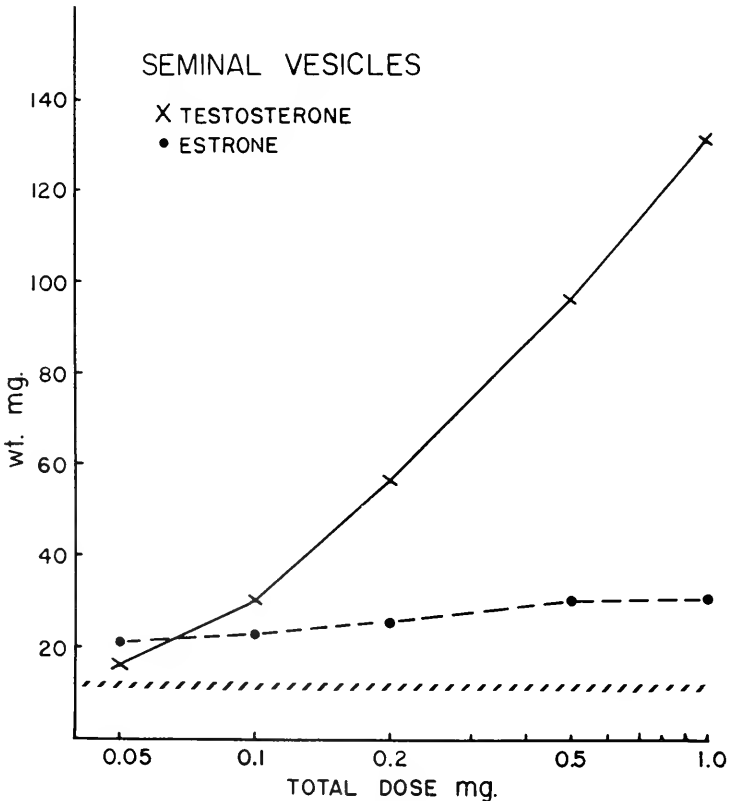

Figure 6. Effect of testosterone and estrone on seminal-vesicle weight of rat. (Data from Saunders, 1958.)

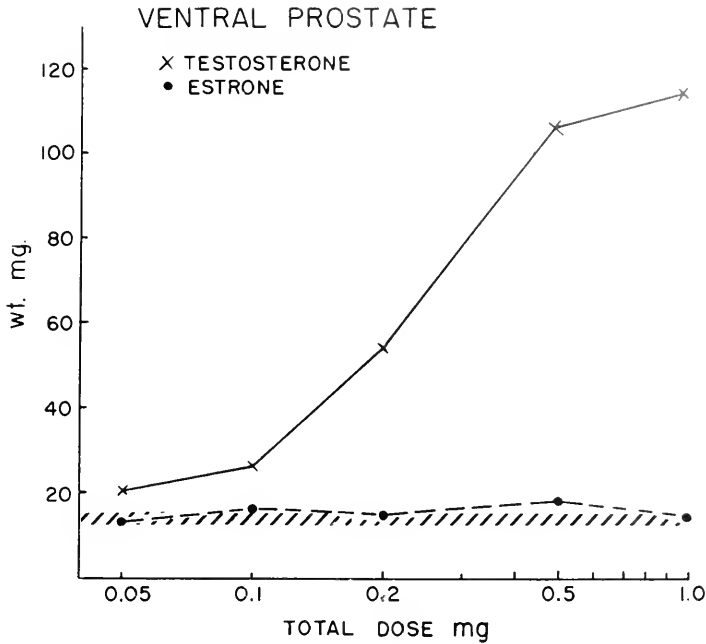

Figure 7. Effect of testosterone and estrone on ventral-prostate weight of rat. (Data from Saunders, 1958.)

phied gland. The response of atrophied prostate to androgens is quite regular and may be used to assay androgenic steroids (Dorfman, 1950; Dorfman and Shipley, 1956). The typical response of the atrophied prostate gland to testosterone is shown in Figure 7. The principle effect of androgens is on the epithelial components of the gland. Estrogens, it will be noted, do not significantly effect prostate weight in the castrated animal.

Glandular function, as well as weight, is affected by steroids. For example, as shown by Huggins and Clark (1940), castration in dogs decreases prostatic secretions, the secretions ceasing within three weeks after operations. Treatment with androgens will reverse this effect of castration. Androgens will also initiate or increase prostate secretions in human hypogonadism (Heckel and Steinmetz, 1941). Prostatic tissue is also rich in the acid phosphatase, and the concentration of this enzyme is increased by androgens and sharply decreased by estrogens (Huggins and Hodges, 1941).

References

Asling, C. W., Simpson, M. E., Moon, H. D., Li, C. H., and Evans, H. M., 1955. "Growth Hormone Induced Bone and Joint Changes in the Adult Rat, in

- Smith, R. W., Gaebler, O. H., and Long C. N. H., eds., *Hypophyseal Growth Hormone, Nature and Actions*, (N. Y., McGraw-Hill).
- Becks, H., Kibrick, E. A., Marx, W., and Evans, H. M., 1941. "The Early Effect of Hypophysectomy and of Immediate Growth Hormone Therapy on Endochondral Bone Formation," *Growth* 5, 449.
- Becks, H., Simpson, M. E., and Evans, H. M., 1945a. "Ossification at the Proximal Tibial Epiphysis in the Rat, I: Changes in Females With Increasing Age," *Anat. Rec.* 92, 109.
- Becks, H., Simpson, M. E., and Evans, H. M., 1945b. "Ossification at the Proximal Tibial Epiphysis in the Rat, II: Changes in Females at Progressively Longer Intervals Following Hypophysectomy," *Anat. Rec.* 92, 121.
- Becks, H., Simpson, M. E., Li, C. H., and Evans, H. M., 1944. "Effects of Adrenocorticotrophic Hormone (ACTH) on the Osseous System in Normal Rats," *Endocrinology* 34, 305.
- Brendler, H., and Winkler, B. S., 1959. "Effect of Norethandrolone on 17-Keto-Steroid Excretion in Prostatic Cancer Patients," *J. Clin. Endocrinol.* 19, 183.
- Brown, S. S., Libo, H. W., and Nussbaum, A. H., 1958. "Norethandrolone in the Successful Management of Anorexia and 'Weight Lag' in Children," Exhibit, Annual Meeting, Am. Acad. of Ped., Chicago.
- Burke, H. A., and Liddle, G. W., 1959. "Studies of Structure-Function Relationships of Steroids: Anabolic Potency of Some Testosterone Analogs," *Abstract*, 41st Meeting Endocrine Society, p. 45.
- Carter, A. C., Cohen, E. J., and Shorr, E., 1947. "The Use of Androgens in Women," *Vitamines and Hormones*, 5, 317.
- David, K., Dingenmanse, E., Freud, J., and Laqueur, E., 1935. "Über kristallinisches männliches Hormon aus Hoden (Testosteron), wirksamer als aus Harn oder aus Cholesterin bereitetes Androsteron," *Z. Physiol. Chemie.*, 233, 281.
- Dorfman, R. I., 1948. "Studies on the Bioassay of Hormones: The Relative Reactivity of the Comb. of Various Breeds of Chicks to Androgens," *Endocrinology* 42, 7.
- Dorfman, R. I., 1950. "Androgens," in Emmens, C. W., ed., *Hormone Assay* (N. Y., Academic Press).
- Dorfman, R. I., and Shipley, R. A., 1956. *Androgens* (N. Y., Wiley).
- Drill, V. A., and Saunders, F. J., 1956. "Androgenic and Anabolic Action of Testosterone Derivatives," in Engle, E. T., and Pincus, G., *Hormones and the Aging Process* (N. Y., Academic Press).
- Edgren, R. A., Calhoun, D. W., and Harris, T. W., 1960. "Studies on the Uterine Growth-Stimulating Effects of Combinations of Testosterone Propionate and Natural Oestrogens," *Acta Endocrinol.* 34, 213.
- Eisenberg, E., and Gordan, G. S., 1950. "The Levator Ani Muscle of the Rat as an Index of Myotropic Activity of Steroidal Hormones," *J. Pharm. Exp. Therap.* 99, 38.
- Epstein, J. A., Vosburgh, L., Reid, G., and Kupperman, H. S., 1957. "Clinical Studies on Norethandrolone: An Anabolic, Progestational Steroid," *Clin. Res. Proc.* 5, 16.
- Foss, G. L., 1960. "Some Experiences With a New Anabolic Steroid (Methandrostenolone)," *Brit. Med. J.* 1, 1300.
- Gaarenstroom, I. H., and Levie, L. H., 1939. "Disturbance of Growth by Diethylstilboestrol and Oestrone," *J. Endocrinol.* 1, 420.
- Geschwind, I. I., and Li, C. H., 1955. "The Tibia Test for Growth Hormone," in Smith, R. W., Gaebler, O. H., and Long, C. N. H., eds., *Hypophyseal Growth Hormone, Nature and Actions* (N. Y., McGraw-Hill).

- Goldfarb, A. F., Napp, E. E., Stone, M. L., Zuckerman, M. B., and Simon, J., 1958. "The Anabolic Effects of Norethandralone, a 19-Nortestosterone Derivative," *Obstet. Gynec. 11*, 454.
- Heckel, N. J., and Steinmetz, C. R., 1941. "The Effect of Testosterone Propionate Upon the Seminal Fluid in Man," *J. Urol. 45*, 118.
- Hershberger, L. G., Shipley, E. G., and Meyer, R. K., 1953. "Myotropic Activity of 19-Nortestosterone and Other Steroids Determined by Modified Levator Ani Muscle Method," *Proc. Soc. Exp. Biol. Med. 83*, 175.
- Howard, J. E., Wilkins, L., and Fleischmann, W., 1942. "The Metabolic and Growth Effects of Various Androgens in Sexually Immature Dwarfs," *Tr. Assn. Am. Physicians 57*, 212.
- Howard, R. P., Norcia, L. N., Peter, J. A., and Furman, R. H., 1959. "Effects of 17 β -Hydroxy-17 α -Methylandrostande (3,2-c) Pyrazole on Metabolic Balance, Serum Lipids and Lipoproteins and Secondary Sex Characteristics," *Abstract, 41st meeting, Endocrine Society*, pg. 86.
- Huggins, C., and Clark, P. J., 1940. "Quantitative Studies of Prostatic Secretion. II: The Effect of Castration and of Estrogen Injection on the Normal and on the Hyperplastic Prostate Gland of Dogs," *J. Exp. Med. 72*, 747.
- Huggins, C., and Hodges, C. V., 1941. "Studies on Prostatic Cancer, I: The Effect of Castration, of Estrogen and of Androgen Injection on Serum Phosphatases in Metastatic Carcinoma of the Prostate," *Cancer Res. 1*, 293.
- Huggins, C., and Stevens, R. E., 1940. "The Effect of Castration on Benign Hypertrophy of the Prostate in Man," *J. Urol. 43*, 705.
- Ingalls, T. H., 1941. "Epiphyseal Growth: Normal Sequence of Events at the Epiphyseal Plate," *Endocrinology 29*, 710.
- Ingalls, T. H., & Hayes, D. R., 1941. "Epiphyseal Growth: The Effect of Removal of the Adrenal and Pituitary Glands on the Epiphyses of Growing Rats." *Endocrinology 29*, 720.
- Jackson, R. L., and Kelley, H. G., 1945. "Growth Charts for Use in Pediatric Practice," *J. Pediat. 27*, 215.
- Kenyon, A. T., Sandiford, I., Bryan, A. H., Knowlton, K., and Koch, F. C., 1938. "The Effect of Testosterone Propionate on Nitrogen, Electrolyte Water and Energy Metabolism in Eunuchoidism," *Endocrinology 23*, 135.
- Kibrick, E. A., Simpson, M. E., Becks, H., and Evans, H. M., 1942. "Effects of Crystalline Estrin Implants on the Tibia of Young Hypophysectomized Female Rats," *Endocrinology 31*, 93.
- Knowlton, K., Kenyon, A. T., Sandiford, I., Lotwin, G., and Fricker, L., 1942. "Comparative Study of Metabolic Effects of Estradiol Benzoate and Testosterone Propionate in Man," *J. Clin. Endocrinol. 2*, 671.
- Kochakian, C. D., 1937. "Testosterone and Testosterone Acetate and the Protein and Energy Metabolism of Castrate Dogs," *Endocrinology 21*, 750.
- Kochakian, C. D., 1946. "The Protein Anabolic of Steroid Hormones," *Vitamins and Hormones 4*, 255.
- Kochakian, C. D., and Murlin, J. R., 1935. "The Effect of Male Hormone on the Protein and Energy Metabolism of Castrate Dogs," *J. Nutr. 10*, 437.
- Kochakian, C. D., and Tillotson, C., 1956. "Hormonal Regulation of Muscle Development," in Engle, E. T., and Pincus, G., eds., *Hormones and the Aging Process* (N. Y., Academic Press).
- Malejka, J. A., 1958. "The Metabolic Response to Surgical Treatment," *J. Int. Coll. Surg. 30*, 294.
- Marx, W., Simpson, M. E., and Evans, H. M., 1944. "Specificity of the Epiphyseal Cartilage Test for the Pituitary Growth Hormone," *Proc. Soc. Exp. Biol. Med. 55*, 250.

- Marx, W., Simpson, M. E., Li, C. H., and Evans H. M., 1943. "Antagonism of Pituitary Andrenocorticotrophic Hormone to Growth Hormone in Hypophysectomized Rats," *Endocrinology* 33, 102.
- Mathieson, D. R., and Hays, H. W., 1945. "The Use of Castrate Male Rats for the Assay of Testosterone Propionate," *Endocrinology* 37, 275.
- McSwiney, R. R., and Prunty, F. T. G., 1957. "Metabolic Effects of Three Testosterone Derivatives Including 17 α -ethyl-19-nortestosterone," *J. Endocrinol.* 16, 28.
- Meadows, R. W., Hughes, W. T., Walker, L. C., and Etteldorf, J. M., 1960. "Effects of Oral 19-nortestosterone Derivative (Nilevar) on Growth of Premature Infants," *Am. J. Dist. Child.* 99, 206.
- Moore, C. R., Hughes, W.; and Gallagher, T. F., 1930. "Rat Seminal Vesicle Cytology as a Testis-Hormone Indicator and the Prevention of Castration Changes by Testis Extract Injection," *Am. J. Anat.* 45, 109.
- Nathanson, I. T., Towne, L. E., and Aub, J. C., 1941. "Normal Excretion of Sex Hormones in Childhood," *Endocrinology* 28, 851.
- Peden, J. C., Maxwell, M. C., and Ohin, A., 1957. "Anabolic Effect of a New Synthetic Steroid on Nitrogen Metabolism After Operation," *A.M.A. Arch. Surg.* 75, 625.
- Ray, R. D., Evans, H. M., and Becks, H., 1941. "Effect of the Pituitary Growth Hormone on the Epiphyseal Disk of the Tibia of the Rat," *Am. J. Path.* 17, 509.
- Reiss, M., Fernandes, J. E., and Golla, Y. M. L., 1946. "The Peripheral Inhibitory Influence of Large Doses of Testosterone on Epiphyseal Cartilaginous Growth," *Endocrinology* 38, 65.
- Rudolph, G. G., and Samuels, L. T., 1949. "Early Effects of Testosterone Propionate on the Seminal Vesicles of Castrate Rats," *Endocrinology* 45, 190.
- Saunders, F. J., 1958. "The Effects of Esterone on the Response to Testosterone Propionate in Castrated Male Rats," *Endocrinology* 63, 498.
- Saunders, F. J., and Drill, V. A., 1958. "Nitrogen Retaining Properties of 17-ethyl-19-nortestosterone," *Metab.* 7, 315.
- Saunders, F. J., and Drill, V. A., 1956. "The Myotropic and Androgenic Effects of 17-Ethyl-19-Nortestosterone and Related Compounds," *Endocrinology* 58, 567.
- Savard, K., Dorfman, R. I., and Pontasse, E., 1952. "Biogenesis of Androgens in the Human Testis," *J. Clin. Endocrinol.* 12, 935.
- Schaffner, F., Popper, H., and Chesrow, E., 1959. "Cholestasis Produced by the Administration of Norethandrolone," *Am. J. Med.* 26, 249.
- Simpson, M. E., Marx, W., Becks, H., and Evans, H. M., 1944. "Effect of Testosterone Propionate on the Body Weight and Skeletal System of Hypophysectomized Rats, Synergism with Pituitary Growth Hormone," *Endocrinology* 35, 309.
- Spencer, H., Berger, E., Charles, M., Gottesman, E. D., and Laszlo, D., 1956. "Effects of 17-Alpha-Ethyl-17-Hydroxy-Nor-Androsterone," *Proc. Am. Assn. Cancer Res.* 2, 149.
- Tagman, E., Prelog, V., and Ruzicka, L., 1946. "Untersuchungen über Organex-trakte Isolierung von Testosteron Aus Testis des Pferdes," *Helv. Chim. Acta* 29, 440.
- Talbot, N. B., 1949. Panel Discussion of The Adrenal Gland in Health and Disease; Physiology of Adrenal Cortex, *Am. Acad. Pediat.* 3, 515.
- Talbot, N. B., Butler, A. M., Berman, R. A., Rodriguez, P. M., and MacLachlan, E. A., 1943. "Excretion of 17-ketosteroids by Normal and by Abnormal Children," *Am. J. Dis. Child.* 65, 364.

- Talbot, N. B., and Sobel, E. H., 1947. "Endocrine and Other Factors Determining the Growth of Children," in Levine, S. Z., *et al.*, eds., *Advances in Pediatrics*, Vol. 2, (N. Y., Interscience).
- Talbot, N. B., Sobel, E. H., Burke, B. S., Lindemann, E., and Kaufman, S. B., 1947. "Dwarfism in Healthy Children: Its Possible Relation to Emotional, Nutritional and Endocrine Disturbances," *New Eng. J. Med.* 236, 783.
- Thorn, G. W., and Engel, L. L., 1938. "The Effect of Sex Hormones on the Renal Excretion of Electrolytes," *J. Exp. Med.* 68, 299.
- Watson, R. N., Bradley, M. H., Callahan, R., Peters, B. J., and Korg, R. C., 1959. "A Six-Month Evaluation of an Anabolic Drug, Norethandrolone, in Underweight Persons," *Am. J. Med.* 26, 238.
- Weston, R. E., Isaacs, M. C., Rosenblum, R., Gibbons, D. M., and Grossman, J., 1956. "Metabolic Effects of an Anabolic Steroid, 17-Alpha-Ethyl-17-Hydroxy-Norandrostenone in Human Subjects," *J. Clin. Invest.* 35, 744.
- Wetzel, N. C., 1941. "Physical Fitness in Terms of Physique, Development and Basal Metabolisms," *J.A.M.A.* 116, 1187.
- Wilkins, L., and W. Fleischmann, 1944. "Ovarian Agenesis, Pathology, Associated Clinical Symptoms and the Bearing on the Theories of Sex Differentiation," *J. Clin. Endocrinol.* 4, 357.

STEROID HORMONES AND AGING IN MAN*

Gregory Pincus

WORCESTER FOUNDATION FOR EXPERIMENTAL BIOLOGY

In previous papers concerned with age-related alterations in steroid excretion and metabolism, we have presented data for men and women of various ages on: (1) the output of corticosteroids, measured as neutral reducing lipid and as 17-hydroxycorticosteroid and also as the cortisol metabolites tetrahydrocortisol (THF), tetrahydrocortisone (THE), allotetrahydrocortisol (ATHF), and β -cortolone (Pincus *et al.*, 1954, 1955; Romanoff *et al.*, 1958, 1959); (2) the output of the total 17-ketosteroid mixture, as well as the individual components thereof (Pincus *et al.*, 1954, 1955; Pincus, 1956, 1960); (3) the estrogen excretion, measured as total biological activity and as the biological activity in urinary fractions concentrating estradiol, estrone, and estriol, respectively (Pincus *et al.*, 1954, 1955; Pincus, 1960).

The data on the outputs of various urinary corticosteroids from the third through the ninth decades of life led to the following findings:

1. The daily total corticosteroid excretion, however measured, tends to be somewhat larger in males but in both sexes declines only slightly with advancing age, and this small decline seems to be related to the total daily activity of the individual studied, since expressing the output as a function of the accompanying creatinine excretion gave no significant change with age.†

2. The daily output of the individual cortisol metabolites is also

* Investigations described in this paper have been aided by grants from the U. S. Public Health Service, the Albert and Mary Lasker Foundation, the American Cancer Society, and the Damon Runyon Fund.

† Also, the marked diurnal rhythm of output seen in younger individuals is, on the average, absent in the later decades.

only slightly reduced in elderly subjects, and when the output is expressed per gram of creatinine, no significant age-related decline can be established.

3. For all ages, the ratio of the reduced α -ketol metabolites of cortisol—THE:THF:ATHF—is on the average 52:29:19, and significant departures from this ratio do not occur in young men and women or in older men and women.

4. Similarly, the proportion of β -cortolone excreted is remarkably constant in all the age groups studied, is equal to approximately 20 per cent of the α -ketol total, and is highly correlated ($r = 0.92$) with the output of THE, its closest α -ketol analogue.

From these findings it was concluded that neither the rate of production nor the rate of metabolism of the major corticosteroid, cortisol, was markedly different in younger and older subjects. This seemed to be borne out by the finding that the excretion patterns of cortisone, cortisol, and their α -ketol metabolites did not differ in younger and elderly subjects either preceding or following ACTH administration (Romanoff *et al.*, 1957). Also, the administration of cortisol to elderly subjects did not lead to any marked alteration in the urinary ratio of 5α (allo) to 5β (normal) metabolites (Pincus *et al.*, 1955).

Consideration of urinary 17-ketosteroid output data led to different findings: (1) the total 17-ketosteroid excretion, somewhat higher in males, declines regularly with advancing age, and is not creatinine-conditioned; (2) this decline is accountable to the marked age-related decrement of 11-deoxy-17-ketosteroids, since the output of 11-oxygenated 17-ketosteroids is only slightly diminished in elderly subjects; (3) the excretion of the biologically active ketonic androgens tends to diminish with advancing age at a rate comparable to that observed for the 11-deoxy-17-ketosteroids, which is to be expected, since androsterone, by far the most active urinary androgen, accounts for approximately 50 per cent of the 11-deoxy-17-ketosteroids in urine; (4) the quantitative yield of the metabolites of testosterone administered to elderly men did not differ from that obtained from younger men, but a tendency for older men to excrete somewhat greater proportions of 5α metabolites was observed.

From these data it was concluded that the major age-related defect in neutral steroid production was that of the urinary 11-deoxy-17-ketosteroid precursor(s). Since similar rates of decrement were seen in both sexes, there are involved adrenocortical precursor(s), presumably produced side-by-side with the corticosteroid precursors not markedly age-conditioned. Recent data suggest that the major adrenocortical precursor of the urinary 17-ketosteroids may be dehydroisoandrosterone (Vander Wiele and Lieberman, 1960). Dehydroisoandrosterone may be synthesized in the adrenal cortex by either of two pathways: di-

rectly from cholesterol by side-chain scission between carbons 17 and 20, or from 17-hydroxy- Δ^5 -pregnenolone by similar scission in this molecule between carbons 17 and 20 (see Figure 1). Another 11-deoxy-17-ketosteroid found in adrenal vein blood is Δ^4 -androstenedione. This may arise from dehydroisoandrosterone by the action of a 3β -ol dehydrogenase or from 17-hydroxyprogesterone by desmolase action between carbons 17 and 20. We have pointed out (Pincus, 1960) that the age-impaired enzyme system activity is probably not the 3β -ol-dehydrogenase since apparently it operates at an undiminished rate in producing corticosteroids from Δ^5 -pregnenolone. Of course there may be a dehydrogenase specific for dehydroisoandrosterone, but none has thus far been demonstrated. The age-conditioned bottleneck would therefore appear to be either the 17-20-desmolase system acting on cholesterol or that acting on 17-hydroxy- Δ^5 -pregnenolone (and probably also on 17-hydroxyprogesterone). The latter, at the moment, seems the most likely, since our efforts to obtain labeled dehydroisoandrosterone

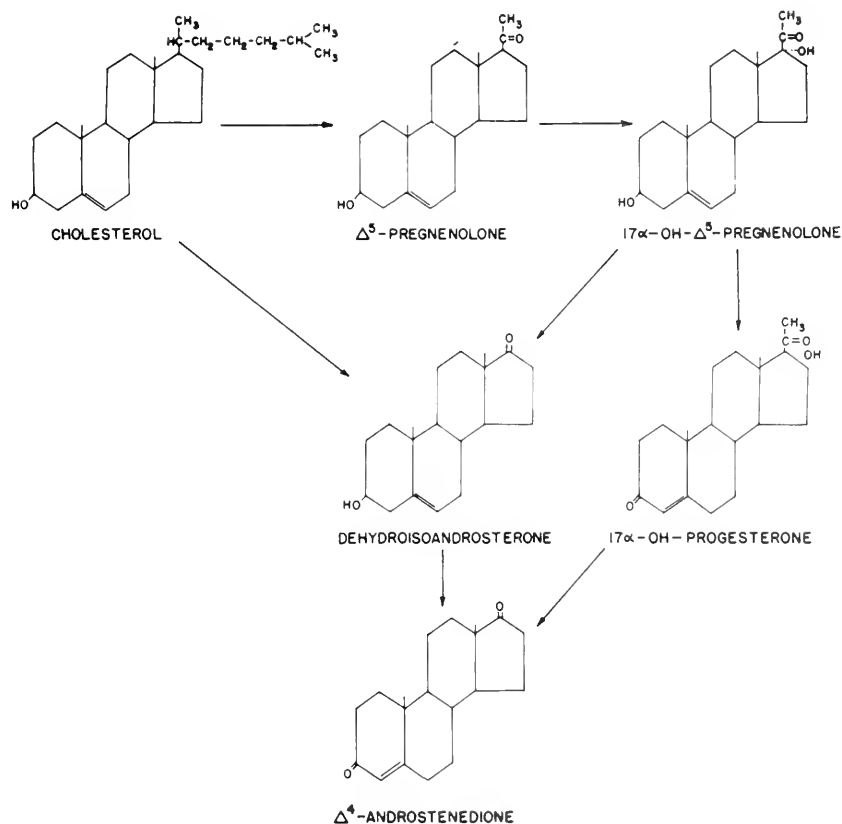

Figure 1. The biosynthesis of adrenal androgens.

TABLE I
 Mean Urinary Outputs of 17-Hydroxycorticosteroids and Classes of 17-Ketosteroids
 in Normal Male Subjects of Various Ages

Age Range (Years)	Median Age (Years)	Number of Subjects	17-OH-Cortico- steroids (Mg. per Day)	Dehydroiso- androsterone (Mg. per Day)	Androsterone + Etiocholanolone (Mg. per Day)	11-O-Androsterone + 11-O-Etiocholanolone (Mg. per Day)
28-39	34	45	6.48	0.41	5.09	2.26
40-44	42	83	6.29	0.41	4.44	2.08
45-49	47	101	6.13	0.46	4.86	2.39
50-59	55.5	56	6.02	0.28	4.25	2.32
60-71	65	23	5.89	0.19	3.55	2.18
Calculated decline from age 30 to age 70			12.6%	65.5%	53.1%	0.0%

directly from labeled cholesterol in adrenal tissue preparations have led to only very small yields (Bloch *et al.*, 1957).

Our studies of estrogen excretion demonstrated: (1) that the total biological activity excreted into the urine appeared to be relatively constant for normal, healthy men throughout the decades studied; (2) that outputs among women declined from a level roughly three times that of men in the third decade to the output level of the men by the sixth decade and a constant excretion rate thereafter; (3) that the biological activity in estradiol and estrone fractions declined with advancing age in both men and women, but in men there was an average tendency for estriol fraction activity to increase, and this was paralleled in the women's data only from the seventh decade on.

From these data on estrogen excretion we concluded, first, that the marked output decline in women to post-menopausal decades indicated a decline in ovarian-estrogen biosynthesis; and, secondly, that in men, testis plus adrenocortical biosynthesis acted to maintain a fairly constant level, but the conversion of the biologically more active estrogens, estradiol and estrone, to the less active estriol tended to be increased with advancing age.

Recently in certain groups of subjects we have re-examined steroid excretion, usually employing somewhat different methods of measurement. I should like to present first of all data on corticosteroid, 17-ketosteroid, and estrogen outputs in urines from a group of men aged 28 to 71 who are being followed for a period of years. In contrast to the acid hydrolysis previously employed, we have used enzyme hydrolysis to liberate the steroids from their conjugated excretion forms. The chromatographic separation of the 17-ketosteroids on paper, and of the estrogens by the method of Bauld (1956), have been practiced.

In Table I are the mean data for the neutral steroids of 308 urine samples from these men. When these data are plotted according to median age, it is possible to calculate the percentage decline in output over the 40-year period from age 30 to age 70. It will be seen that the maximal declines in output occur in the 11-deoxy-17-ketosteroids, and that among these the dehydroepiandrosterone decrement is the largest (about 16 per cent per decade). The total 17-hydroxycorticosteroid output is slightly diminished (about 3 per cent per decade) and the 11-oxy-17-ketosteroid output rate seems to be just about constant.

In Table II are the data for estrogen excretion for the same subjects. The marked average decline in output of the more active estrogens (about 14 per cent per decade) clearly exceeds the decrement in estriol excretion (about 4 per cent per decade). These data agree partially with those obtained previously by bioassay of these fractions differently separated; the previously noted estradiol and estrone decline is seen but is quantitatively greater here, and the previously noted

TABLE II
 Mean Urinary Estrogen Outputs
 in Normal Male Subjects of Various Ages
 (Age Range and Numbers as in Table I)

Median Age (years)	Estradiol + Estrone (μg per day)	Estriol (μg per day)	Total (μg per day)
34	3.48	4.77	8.25
42	3.12	4.78	7.90
47	2.84	4.89	7.73
55.5	2.63	4.46	7.09
65	1.98	4.13	6.11
Calculated decline from age 30 to age 70	54.1%	17.2%	30.7%

TABLE III
 The Output Ratios of Various Urinary Steroids
 in Men of Various Ages
 (Age Range and Numbers as in Table I)

Median Age (years)	Estrone & Estradiol	Androsterone	11-O-Androsterone
	Estriol	Etiocholanolone	11-O-Etiocholanolone
34	0.78	1.00	0.72
42	0.67	0.94	0.72
47	0.59	0.93	0.74
55.5	0.59	0.92	0.78
65	0.51	0.91	0.77
Calculated change from age 30 to age 70	-45.6%	-7.7%	+12.6%

estriol output rise is here a slow decline. Over-all estrogen excretion therefore declines at a rate of about 7.5 per cent per decade.

To ascertain if there are any indications of an age-related alteration in metabolism, we have determined the ratios of metabolically inter-related compounds (Table III). These data suggest: (1) that the metabolism of the estrogens through pathways leading to estriol production is increasingly favored with advancing years; (2) that there is a slight but probably not significant tendency for 11-deoxy-steroids to be metabolized to the 5β isomer; (3) that the proportion of 5α isomers

of the 11-oxygenated 17-ketosteroids tends to preponderate in the later decades. The data on the estrogen ratios confirm those previously obtained with bioassay measurements. It should be noted, too, that we previously found a tendency of older men to convert administered 11-deoxy-17-ketosteroid to 5α metabolites (Pincus *et al.*, 1955).

The foregoing analysis suggests that in addition to quantitative decrements with advancing age, alterations in the degree of metabolic transformation of estrogens and 19-carbon steroids may occur. This has led us to re-examine our somewhat amplified data on corticosteroid excretion. First of all, it should be stated that the slight quantitative decline in output with advancing age seen for the total corticosteroids of the male population (see Table 1) is also seen when the major cortisol metabolites are each separately measured. However, an examination of the relative proportion of THE, THF, and ATHF discloses some significant differences between younger and older subjects. This is illustrated in Table IV, where the percentages of the total α -ketol titers

TABLE IV
Relative Proportions of Tetrahydrocortisone (THE)
in the Urinary α -Ketol Mixture

Subjects	Median Age	Number	THE as % of Total
Men	29	15	52.6 \pm 2.53
Men	74	25	43.8° \pm 1.66
Women	25	15	56.3 \pm 2.70
Women	82	15	48.1† \pm 2.73
Young men and women		30	54.5 \pm 1.85
Older men and women		40	45.4# \pm 1.47

° Significantly different from younger men; $p = 0.01$.

† Significantly different from younger women; $p = 0.05$.

Significantly different from younger subjects; $p = 0.001$.

accountable to THE are presented for young and old subjects. These data indicate that THE is formed at a lesser rate in older persons, *i.e.*, that the degree of conversion of the 11-hydroxy function to an 11-ketone is diminished in the elderly.

If one rank-orders the various subjects according to the proportion of THE excreted, one finds an interesting separation (Table V). As might be expected from the data of Table IV, the upper thirds of the younger subjects do not overlap with the upper thirds of the older subjects, and the lower thirds of the older subjects do not overlap with the lower thirds of the younger subjects. The implication of decreased

TABLE V
Rank Ordering of Subjects
According to Relative Proportion of THE in the α -Ketol Mixture

Subjects	Number	Ranking	% of THE	% of THF	% of ATHF
Young men	5	Upper third	63	28	9
	5	Middle third	54	28	18
	5	Lower third	42	35	23
Older men	8	Upper third	53	28	19
	9	Middle third	44	33	23
	8	Lower third	34	38	28
Young women	5	Upper third	67	20	13
	5	Middle third	57	23	20
	5	Lower third	45	33	22
Older women	5	Upper third	57	28	15
	5	Middle third	51	33	16
	5	Lower third	36	36	28

11-dehydrogenation with advancing age is emphasized. There is some suggestion in these data that the relative amount of 5α reduction increases in older subjects (the mean percentage of ATHF in the 30 young subjects is 17.5 and in the older subjects is 22), a tendency already noted for the 11-oxy-17-ketosteroids (Table III), which are also catabolites of 11-oxygenated corticosteroid precursors.

Let us now recapitulate the present indications concerning age-related biosynthesis and subsequent metabolism of the three major types of steroid hormone thus far studied in man. These are summarized in Table VI.

The degree of sustainment of adrenocortical biosynthesis on into the later decades of life is a notable phenomenon. In this connection I should like to quote Samuels' remarks concerning his studies of 17-hydroxycorticosteroid blood levels in persons of various ages: "One of the striking phenomena brought out by a study of the levels of 17-hydroxycorticosteroids throughout life is the relative constancy from birth to death in the concentrations maintained in the circulating fluids as long as marked pathology does not intervene" (Samuels, 1956). This sustainment of biosynthesis means that the remarkable series of intra-adrenal transformations leading to cortisol production (Figure 2) are age-independent, and that adequate enzymatic machinery for their accomplishment is maintained. Furthermore, neither acute stress nor exogenous ACTH diminishes the capacity for increased cortisol production by this system (Pincus, 1950) in elderly men. We have not conducted any observations in older subjects on the cortisol-secretion response to chronic stress or chronic ACTH administration, although

TABLE VI
Age-Related Changes in Steroid Hormone Metabolism

Type of Hormone	Production	Catabolism
Cortisol	Fairly constant throughout life in both sexes.	11-Dehydrogenation tends to decrease in older men and women; 5α reduction of cortisol catabolites increases in older subjects.
11-Oxy-17-ketosteroid precursor(s) (androgen)	Declines regularly with advancing age in both sexes.	Probably fairly constant, but there may be some tendency for increased 5β reduction in older men.
Estrogen	Declines regularly to postmenopausal ages in women, and also at a lesser rate with advancing age in men.	Rate of conversion to estriol increases with advancing age.

there is some indication that certain chronic diseases may be accompanied by reduced cortisol metabolite excretion.

In contrast to the notable constancy of cortisol biosynthesis are the indications in our latest data of some impairment of cortisol catabolism (see Tables IV and V). The reduced α -ketol metabolites of cortisol

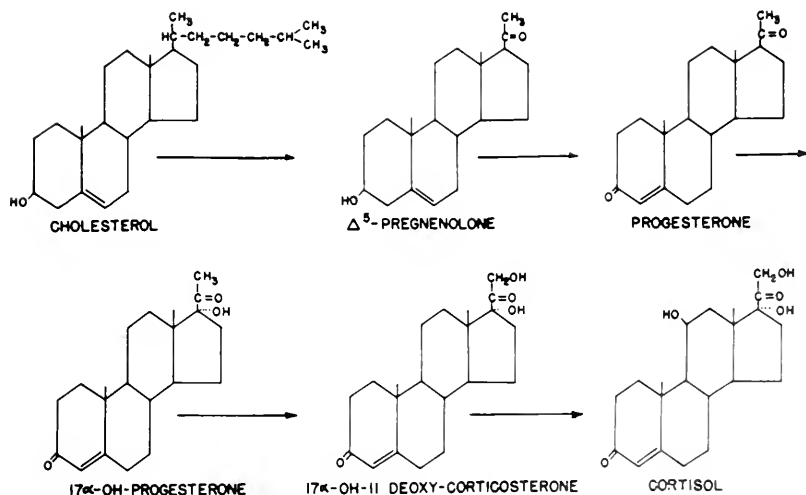

Figure 2. The course of cortisol biosynthesis in the adrenal cortex.

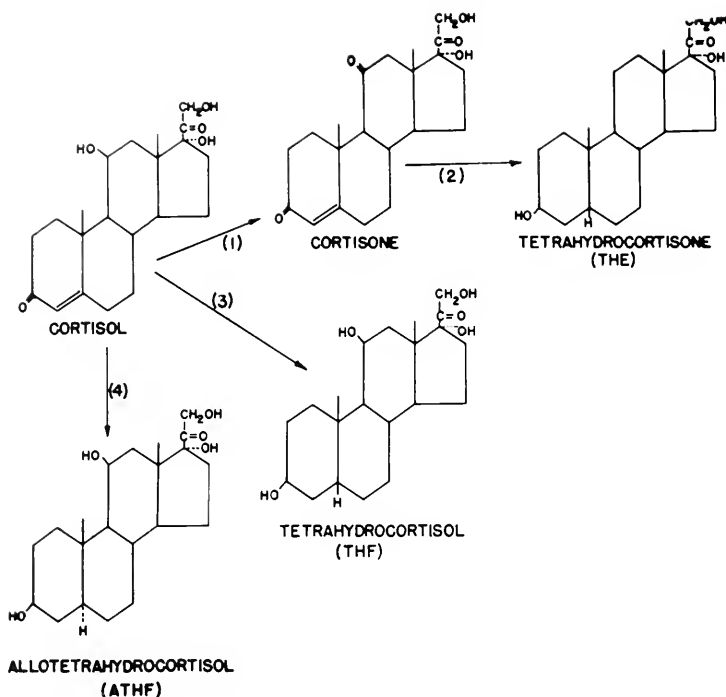

Figure 3. Some extra-adrenal catabolites of cortisol.

appear to be derived by the series of transformations indicated in Figure 3. The 11β -ol-dehydrogenase concerned with step 1 appears to be less active in older people, and the 5α -reductase (step 4) is somewhat more active. With aging, then, either the concentration of these catabolizing enzyme systems is altered or inhibitors (or accelerators) of their activity are increased (or decreased). The essential co-factors for some of these enzyme systems have been determined, but whether they are age-limited or whether specific endogenous inhibitors (or accelerators) exist is not known.

We have already discussed the probable age-limited biosynthetic step in 11-deoxy-17-ketosteroid production. Quantitatively this is perhaps the most striking diminishment of an intra-adrenal enzyme-system activity. Again, aging may accomplish this by decreased enzyme synthesis, by decreased availability of an accelerator or co-factor, or by increased concentration in the steroidogenic tissue of a specific inhibitor. ACTH administration may increase 17-ketosteroid excretion in elderly men (Pincus, 1950), so its production would not appear to be limiting. However, a detailed study of individual metabolic sequences after ACTH administration still needs doing.

As indicated in Table VI, the catabolic transformations leading to

the majority of excreted urinary 11-deoxy-17-ketosteroids do not seem to be markedly age-conditioned. A systematic study of the suggested relative increase in 5β reduction does seem to be called for. Since this implies that etiocholanolone is in relatively larger concentration than androsterone (Figure 4), it is tempting to attribute some of the symptoms of aging to the pyrogenic activity of the former (Kappas *et al.*, 1957) and its lack of androgenicity. However, the clear superiority of testosterone as an androgen as well as an anabolic agent (Dorfman and Shipley, 1956) suggests that its diminishment may be the primary factor in the reduced libido, muscle wastage, and other phenomena observed in elderly subjects. Unfortunately, testosterone as such has not been found in measurable amount in urine or in blood, nor do we have a specific metabolite indicative of its production, unless it prove to be Δ^{16} -androstene-3 α -ol recently found in states characterized by high androgenicity (Burstein and Dorfman, 1960).

A number of recent studies indicate that estrogen biosynthesis proceeds by the pathways indicated in Figure 5. The decline in estrone and estradiol production with advancing age may be due to any of a number of factors. It may be simply conditioned by the reduced production of Δ^4 -androstenedione. This seems not too likely, since the latter is produced in milligram amounts daily, whereas the estrogens are produced in microgram amounts. It is possible that the 19-hydroxylase for androstenedione is the bottleneck in this process and that it is the age-susceptible factor. However, a number of other possibilities clearly exist. Any of the steps, thus far not entirely characterized, be-

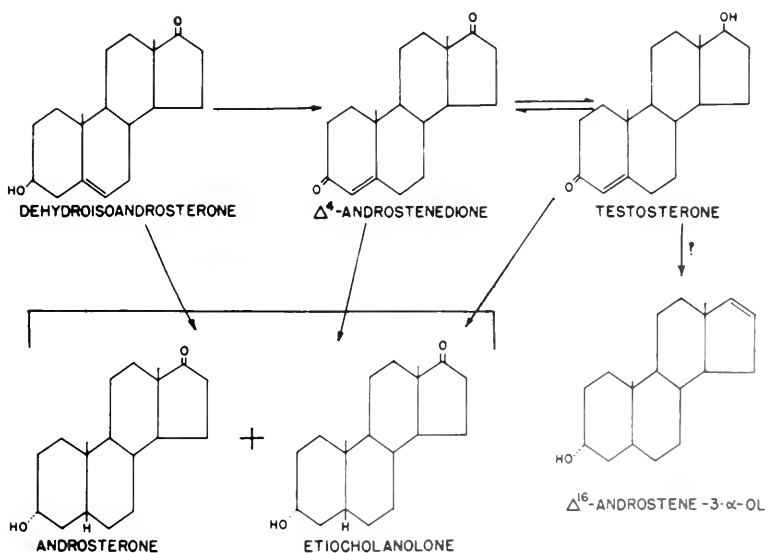

Figure 4. Metabolism of urinary 17-ketosteroid precursors.

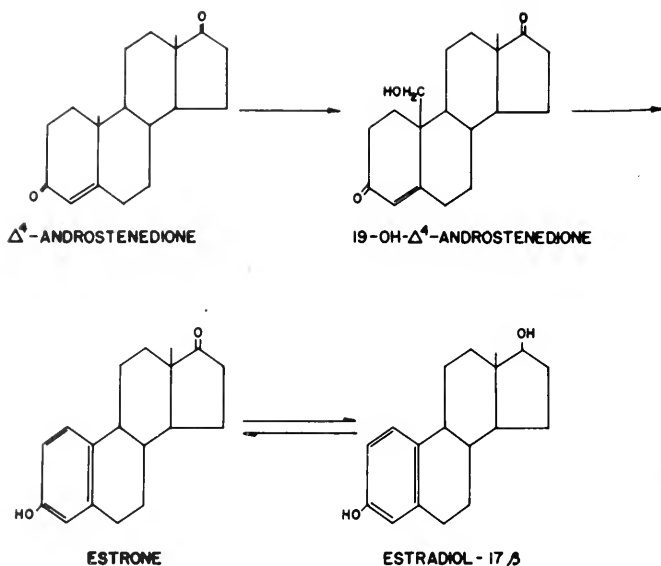

Figure 5. Estrogen biosynthesis.

tween 19-hydroxy- Δ^4 -androstenedione and the estrogens may be limiting; again, inhibitors or accelerators of specific enzymatic steps may be the age-determined factors.

The increased rate of conversion of estrone and/or estradiol to estriol in older subjects is a most interesting phenomenon. Neither where this may take place in the body nor how it may be accomplished biochemically is at all apparent from presently available evidence. It is notable, however, that a decreased output of estrone and estradiol has been found to occur in men with myocardial infarcts, but a sustainment (or slight increase) of estriol excretion occurs. Furthermore, among the Bantu, whose men are characterized by low blood-cholesterol values and an almost complete absence of myocardial infarction, the total estrogen output, and especially the excretion of estrone and estradiol, is higher than among Europeans of the same age (Bersohn and Oelofse, 1958). Finally, it was found that after estradiol-17 β administration men with recent myocardial infarction converted it in excess to estriol (Bauld *et al.*, 1957). Is the relative excess of estriol in older men related to the atherosclerotic process? Does estriol itself have an effect on the process, or is its predominance indicative of some more deep-seated metabolic disturbance?

In reviewing what findings are available on age relationships in steroid biosynthesis and metabolism, we have also exposed large areas of ignorance. Many details of the chemical transformations undergone *in vivo* remain to be established. Furthermore, in many instances

neither the loci of transformations nor the enzymatic systems for which the steroidal products act as substrates are known. Finally, when it comes to possible age-related influences on even known enzyme systems, we are quite in the dark. Do we deal with alterations in the synthesis of these enzymes, or in the synthesis of their co-factors, or in the accumulation of their inhibitors?

For certain important steroidal products we lack any data on their variations in relation to age. With respect to the adrenocortical products perhaps our greatest deficiency is lack of such knowledge concerning the "life-maintaining" hormone, aldosterone. Another significant corticosteroid is corticosterone. Other adrenocortical products may loom large in old age. For example, if the decline in 17-ketosteroid output is limited by the reduced rate of transformation of 17 α -hydroxypregnenolone to dehydroisoandrosterone, then the former may be present in relative excess in the blood of aged individuals. What would be the biological consequences of such an excess? Are there possible effects of such a compound on connective tissue, on ground substance, on fibroblastic phenomena, and so on?

The decline in 11-deoxy-17-ketosteroid precursor with advancing age may not be the sole expression of age-affected metabolism of this class of compound. For instance, the possible non-ketonic metabolites have not been examined in relation to age. Among them may be compounds having significant physiological effects. Similar considerations apply to estrogen metabolites. Actually estrone, estradiol, and estriol are the three thus far most easily measured estrogens in human urine, but seven more metabolites have been identified in recent years (Marrian, 1958; Fishman and Gallagher, 1958). How their production and turnover may be related to aging is unknown. That any of them may play a role in involutionary processes must be examined as a possibility.

In this paper we have considered only the relationships of steroid biosynthesis and metabolism to aging. We cannot in the time available inquire into the physiological actions of these substances in aging target tissues. The pervasive role of the steroid hormones as regulators of a vast complex of bodily processes daily becomes more and more evident. Both the normal and the pathological activities of practically every organ of the body are to a greater or lesser degree affected by endogenous steroid. Many of the most evident symptoms of "normal" aging—such as muscle wastage, connective tissue changes, greater or lesser degrees of osteoporosis, and atherosclerosis—are the result of processes shown to be steroid-affected. Even the well-guarded central nervous system has been found to respond to steroidal hormone action. And when one considers the degenerative diseases, time and again evidence emerges that their course may be altered by steroid action. If a degree of prophecy may be allowed, we would state that in a not-too-distant day comprehension of the production, metabolism, and

age-limited effects of the flux of endogenous steroidal substance will lead to a rational maintenance of youthfulness and a meaningful treatment of senescence.

References

- Bauld, W. S., 1956. "A Method for the Determination of Oestriol, Oestrone, and Oestradiol-17 β in Human Urine by Partition Chromatography and Colorimetric Estimation," *Biochem. J.* 63, 488.
- Bauld, W. S., Givner, M. L., and Milne, I. G., 1957. "Abnormality of Estrogen Metabolism in Human Subjects with Myocardial Infarction," *Canadian J. Biochem. Physiol.* 35, 1277.
- Bersohn, I., and Oelofse, P. J., 1958. "Urinary Oestrogen Levels in Myocardial Infarction," *South Afr. Med. J.* 32, 979.
- Bloch, E., Dorfman, R. I., and Pincus, G., 1957. "The Conversion of Acetate to C₁₉ Steroids by Human Adrenal Gland Slices." *J. Biol. Chem.* 224, 737.
- Burstein, S., and Dorfman, R. I., 1960. "Biosynthesis of Δ^{16} -Androstene-3 α -ol," *Abstract, Program First Internat. Cong. Endocrinol., Copenhagen*. In press.
- Dorfman, R. I., and Shipley, R. A., 1956. *Androgens: Biochemistry, Physiology, and Clinical Significance* (N. Y., Wiley).
- Fishman, J., and Gallagher, T. F., 1958. "2-Methoxyestriol: A New Metabolite of Estradiol in Man." *Arch. Biochem. Biophys.* 77, 511.
- Kappas, A., Hellman, L., Fukushima, D. K., and Gallagher, T. F., 1957. "The Pyrogenic Effect of Etiocholanolone," *J. Clin. Endocrinol. Metab.* 17, 451.
- Marrian, G. F., 1959. "The Biochemistry of the Oestrogenic Hormone," *Proc. Fourth Inter. Cong. Biochem., Vienna, 1958.* 4, 208.
- Pincus, G., 1950. "Measures of Stress Responsivity in Younger and Older Men," *Psychosom. Med.* 12, 225.
- Pincus, G., 1956. "Aging and Urinary Steroid Excretion," in Engle, E. T., and Pincus, eds., *Hormones and the Aging Process* (N. Y., Academic Press).
- Pincus, G., 1960. "Steroid Hormones and Aging in Man," in *Symposium on Aging*, AAAS. In press.
- Pincus, G., Dorfman, R. I., Romanoff, L. P., Rubin, B. L., Bloch, E., Carlo, J., and Freeman H., 1955. "Steroid Metabolism in Aging Men and Women," *Rec. Progr. Hormone Res.* 11, 307.
- Pincus, G., Romanoff, L. P., and Carlo, J., 1954. "The Excretion of Urinary Steroids by Men and Women of Various Ages," *J. Gerontol.* 9, 113.
- Romanoff, L. P., Parent, C., Rodriguez, R. M., and Pincus, G., 1959. "Urinary Excretion of β -Cortolone (3 α , 17 α , 20 β , 21-tetrahydroxy-pregnane-11-one) in Young and Elderly Men and Women," *J. Clin. Endocrinol. Metab.* 19, 819.
- Romanoff, L. P., Rodriguez, R. M., Seelye, J. M., Parent, C., and Pincus, G., 1958. "The Urinary Excretion of Tetrahydrocortisol, 3 α -Allotetrahydrocortisol and Tetrahydrocortisone in Young and Elderly Men and Women," *J. Clin. Endocrinol. Metab.* 18, 1285.
- Romanoff, L. P., Wolf, R., and Pincus, G., 1957. "A Comparison of Urinary Steroid Excretion Patterns in Young and Elderly Subjects Before and After ACTH Administration," *J. Gerontol.* 12, 394.
- Samuels, L. T., 1956. "Effect of Aging on the Steroid Metabolism as Reflected in Plasma Levels," in Engle, E. T., and Pincus, eds., *Hormones and the Aging Process* (N. Y., Academic Press).
- Vander Wiele, R., and Lieberman, S., 1960. "The Metabolism of Dehydroisandrosterone," in Pincus, G., and Vollmer, E., eds., *The Biological Activities of Steroids in Relation to Cancer* (N. Y., Academic Press).

CHANGES WITH AGING*

Ancel Keys

UNIVERSITY OF MINNESOTA

This symposium on Growth began with consideration of the most elementary aspects—the synthesis of nucleic acids and proteins. It is fitting to end, as we do tonight, by discussing aging, or, if you will, the later stages of growth.

Emotionally we distinguish growth and aging as opposites. In value terms, growth is good, aging is not good—or, in positive language, it is “evil.” The relative amount of research activity on the two subjects is possibly explained by this subconscious association. I am reminded of the medieval philosophers who agreed that God and the Devil were complementary and equally complex but who then devoted far more scholarship to God than to the Devil.

I do not propose to be the Devil’s advocate, but perhaps my discussion can be viewed as a consideration of his evil works, as exhibited in the biological changes associated with aging. Mind you, I am not prepared to specify what should actually be called aging, much less to say what causes it.

An easy and not very illuminating definition of aging is that it is the process in which characteristics of an organism change progressively with time. Growth and aging are, in many respects, merely different terms to describe progressive biological changes along the time axis. Degenerative changes, identifiable as some kind of aging, accompany growth from the very beginning. And, similarly, growth, in the sense of the accretion of some substances in the body, is a part of aging.

Figure 1 illustrates the point by the example of the amount of cholesterol and of calcium in the human aorta. From age 10 to age 70

* I am grateful to Mr. Jaakko K. Kihlberg for his help with some of the statistical work reported here.

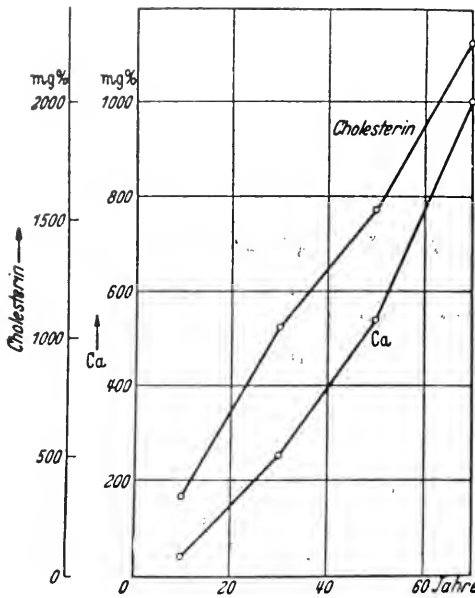

Figure 1. Concentration of cholesterol and of calcium in the human aorta at different ages. (From Bürger, 1939.)

the amount of cholesterol per 100 grams of dry aorta progressively increases some five- or six-fold; the increase in calcium is, even greater. We label these changes "aging" rather than growth primarily because we do not like the result. We say this is an expression of atherosclerosis, but the general trend can scarcely be called a "disease," since it occurs in all people, though the rate of progression varies.

Because age changes do not proceed at the same rate in different individuals, refuge is taken in the concept of "physiological age," which, replacing chronological age, presumably makes all individuals conform to some universal aging curve. But what, then, is the measure of physiological age? Scores or hundreds of measures may be proposed; even if they are normalized to give equal answers for the average person, they will give different answers when individuals are compared. One man may be relatively young in muscular strength, middle-aged in vision and in his arteries, old in his joints, and senile mentally. Or the other way around. Any combination of youthful and aged attributes may be found.

Except as a scientific problem, aging *per se* may not bother us so much. Some loss in physical strength and speed in exchange for a gain in accumulated knowledge and wisdom would not be outrageous. What concerns us more are the real disabilities of illness that too often accompany aging. For this reason, and because we know so little of the basic processes of aging, a discussion of aging generally turns out to be either mere description of age changes, as in the aorta data in Fig-

ure I, or a discussion of age-related diseases. And so it must be in my discussion.

In terms of the number of people affected and the social and economic costs, the great bulk of our health problems in the United States today are strongly age-related: heart disease, vascular disorders of the central nervous system, cancer and other neoplasms, mental disease, arthritis. The United States mortality from various causes is summarized in Table I. All of these major causes of death except "accidents, poisonings, and violence" and "certain diseases of early infancy" are strongly age-related; their incidence and mortality rise sharply with age, especially in the years beyond the forties.

To a considerable extent this age-related mortality may be viewed as an expression of aging—a result of aging if not actually caused by it. What other explanation can be offered at the present time? In the absence of evidence that external or environmental factors are responsible, we are forced to conclude that internal factors, inherent in the tissues or the complex we call the organism, operate spontaneously over time to bring about the end result: for example, death from coronary heart disease. This means that the tendency to develop and die from these diseases is inborn, that each disease appears when the aspect of aging involved progresses far enough to reach some critical level. Individuals may differ in their rates of aging in the various tissues, but the eventual outcome is predetermined.

This, of course, is the fatalistic argument that so long hindered research efforts directed toward the goal of prevention of these non-

TABLE I
Deaths from Various Causes of White Persons
in the United States in 1957
(In thousands)

Cause	Male	Female
Coronary heart disease	266	158
All neoplasms	125	111
Cerebrovascular lesions	79	85
All other heart diseases	72	76
Accidents, poisonings, violence	71	30
Certain diseases of early infancy	30	21
Pneumonia	25	18
General arteriosclerosis	15	16
Diabetes	10	15
Cirrhosis of the liver	12	6
All infectious and parasitic diseases	12	6
All other diseases	106	73

communicable, age-related diseases. Of the list in the table, only cirrhosis of the liver would seem to be a hopeful candidate for improvement, in this view. Perhaps half of the mortality from cirrhosis is associated with alcoholism. Accordingly, control of alcoholism might cut the mortality in half, but the other cirrhosis mortality would be expected to continue as an expression of aging.

Table II shows the age trends among white males in the United States for some of these major causes of death. The age trend is extreme in the three most important causes of death—coronary heart disease, cerebrovascular lesions, and neoplasms.

The special case of accidents requires consideration of the factor of exposure. People are not killed by falling off ladders unless they happen to be up on ladders; to get killed in a speeding car you must be in a speeding car. As people grow older, they tend to avoid the hazardous situations that attract youth. Even though a given accident may be tolerated less well by older people, the net result of less exposure prevents accidental death from having a positive age trend until very old age.

But this matter of exposure may also explain, at least in part, the age trend seen in many diseases. And insofar as this is true, we may attempt to control the result of aging, if not aging itself, by controlling the exposure. This is the hopeful approach that has stimulated so much of the recent tremendous expansion of research in heart disease and neoplasms.

Suppose, for example, that cancer tends to develop in a given tissue partly because of repeated insults or injuries not generated by the tissue itself. The cases of bronchogenic carcinoma and of carcinoma of the female cervix may be in point. The external force in the one case may be noxious principles in the atmosphere or in tobacco smoke. In the other case, physical trauma may be involved.

TABLE II
Death Rates of White Males in the United States, 1957
(deaths per 100,000)

Cause	Age			
	20-24	40-44	60-64	80-84
Coronary heart	1	124	1127	4705
All neoplasms	12	62	564	1611
Cerebrovascular	3	16	208	2316
Accidents, etc.	129	94	144	457
Pneumonia	4	15	61	495
All infectious	3	11	49	96

If we admit the possibility that carcinogenesis may be related to the accumulation of tissue injuries, there are two major possibilities. The probability of carcinogenesis may be a continuous function of the cumulative tissue injuries. Or the relationship may be discontinuous, in that the probability of cancer is suddenly and greatly increased when some critical accumulation of damage is reached. In either case, cancer is not an expression of inherent aging but merely of the summation of events imposed from outside the tissue concerned.

The basic lesion in coronary heart disease is atherosclerosis of the coronary arteries. Figure 2 shows the frequency of finding severe coronary atherosclerosis at different ages in consecutive autopsies on men dying from all causes. At average age 35, about 18 per cent of Minnesota men show a given severe degree of coronary atherosclerosis, and at ages beyond 50 the figure is about 70 per cent. Caucasian men in Hawaii are very similar. So we conclude that by age 50 most of us have very old coronary arteries and it is not surprising if so many of us die from coronary heart disease.

Japanese men on the Island of Kyushu are very different indeed (Kimura, 1956; Keys *et al.*, 1958). At each age the frequency of this

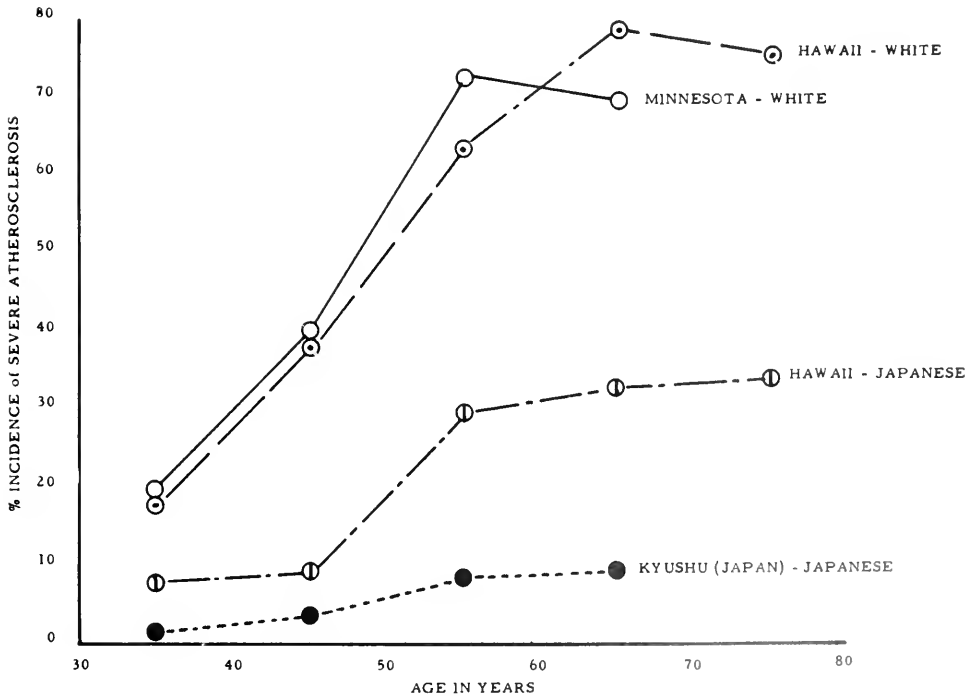

Figure 2. Prevalence of severe atherosclerosis of the coronary arteries in men at different ages. Deaths from all causes.

severe atherosclerosis is only about one-tenth as much. So Japanese coronaries age much less rapidly. Are the Japanese more fortunate in their genes? Then what about the Japanese men, most with ancestry in the same part of Japan, who die in Hawaii? As a matter of fact, the mortality and hospital data for Japanese in California indicate that they are much more like Minnesota men than like men in Japan.

Elsewhere (Keys, 1952, 1953, 1955, 1957) I have given evidence which makes it appear that genetic factors do not explain these differences, and that the mode of life, particularly the diet, is largely responsible.

A central feature in atherosclerosis is the accumulation of lipids, particularly cholesterol, in the intima of the artery. Most, if not all, of this cholesterol is derived from the blood, and there is certainly a highly significant relationship between the concentration of cholesterol in the blood plasma and the development of coronary heart disease. Animal experiments demonstrate that atherosclerosis develops when the blood cholesterol is kept at an elevated level for some time.

But the metabolism of cholesterol differs among species, and the picture of coronary heart disease is peculiar to man. Man is especially susceptible to this kind of aging. The importance of the blood-cholesterol level in man is indicated by many kinds of evidence, including the results of follow-up studies in which cholesterol is measured in the blood of a large number of men and their eventual experience with coronary heart disease is checked.

Table III summarizes the findings in the three major follow-up studies reported so far. In the Cooperative Study (see "Technical Group," etc., 1956) the individual men were classed as above or below the median cholesterol value for the whole group; follow-up studies over a period of two to three years after the examination showed that the men in the above-median class had a rate of development of new coronary heart disease 2.6 times that of the below-median class. The

TABLE III

Follow-up Studies on Frequency of New Coronary Heart Disease Appearing among Men Classified by Serum-Cholesterol Concentration

Study	Cholesterol Cutting Point	Men at Risk		New Coronaries		Relative Risk Above Cut
		< Cut	> Cut	< Cut	> Cut	
Cooperative	Median	1993	1992	16	41	2.6
Framingham	260 mg. per 100 ml.	710	172	30	21	2.9
Albany	275 mg. per 100 ml.	1452	209	33	16	3.4

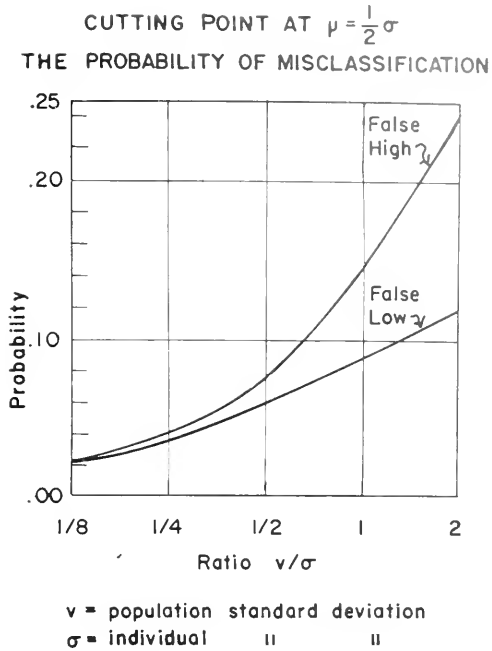

Figure 3. Probability of misclassifying an individual on the basis of a single measurement of cholesterol.

Framingham Study (Dawber, Moore, and Mann, 1957) chose a cutting point at 260 mg. cholesterol per 100 ml., and the follow-up showed that above this cutting point the risk was 2.9 times that below this level. In the Albany Study (Doyle *et al.*, 1957, 1959) the cutting point was 275 mg. per 100 ml., and the risk above that level proved to be 3.4 times that of the men with cholesterol values below 275.

Elsewhere (Keys and Fidanza, 1960; Keys and Kihlberg, to be published) we have shown that these estimates of the relative risks are underestimates of the importance of the relationship between the true mean blood-cholesterol level and the subsequent appearance of the disease. This follows from the fact that in each case the classification of the men was made on the basis of a single measurement. Since there is a considerable degree of variability in an individual's cholesterol level at different times (Keys, Anderson, and Grande, 1959), any classification based on single blood samples will result in some misclassifications in regard to the true mean values of the individuals concerned. Figure 3 shows the probability of misclassification associated with different ratios of inter-individual standard deviations when single cholesterol measurements are used to assign individuals above and below a particular cutting point. In this case the cutting point is the population mean plus half the average inter-individual standard deviation. From available information on the average intra-individual variability of

middle-aged American men, it is possible to recompute the data in terms of expected distributions of true means. Thus, from the Framingham data we now conclude that the risk of future coronary heart disease of men with true mean cholesterol values over 260 would be 4.8 (instead of 2.9) times that of men of the same age with lower serum cholesterol levels, and from the Albany data it appears that the risk at mean levels over 275 would be 5.9 (instead of 3.4) times the risk for men with lower levels.

Atherosclerosis develops silently over the years, and one theory is that it represents an irreversible deposition in the intima of cholesterol from the blood—the resultant of the concentration of cholesterol in the blood acting over time. It is appropriate, then, to compare blood-cholesterol values of men on the Island of Kyushu and of men in Minnesota. These are summarized in Figure 4. The data suggest, of course, that they may hold an important part of the explanation for the differences in atherosclerosis shown in Figure 2.

The data of Figure 2 disclose an interesting feature when they are plotted semi-logarithmically, as in Figure 5. Here the logarithms of

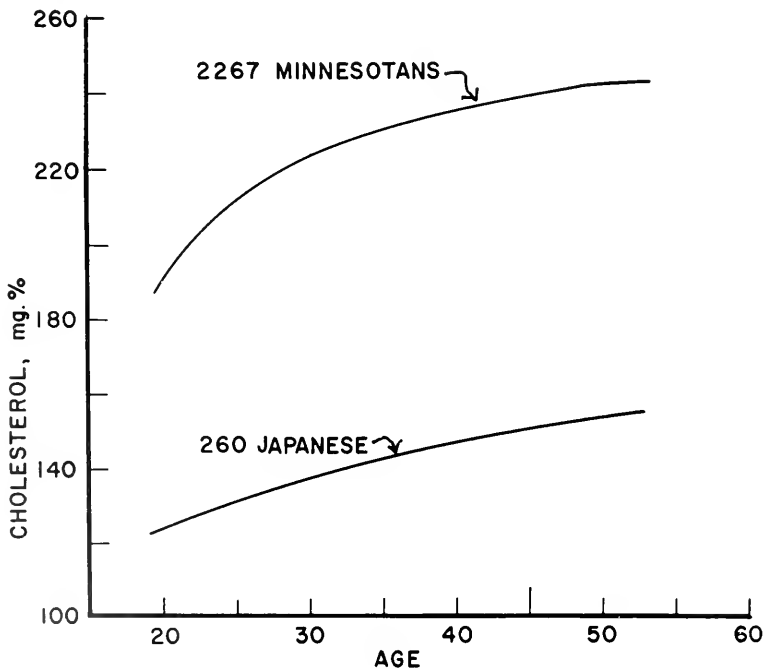

Figure 4. Mean serum-cholesterol concentration in men of different ages in Minnesota and on the Island of Kyushu, Japan. The curves are slightly smoothed. The standard deviations are about 45 for the men in Minnesota and about 40 for those on Kyushu.

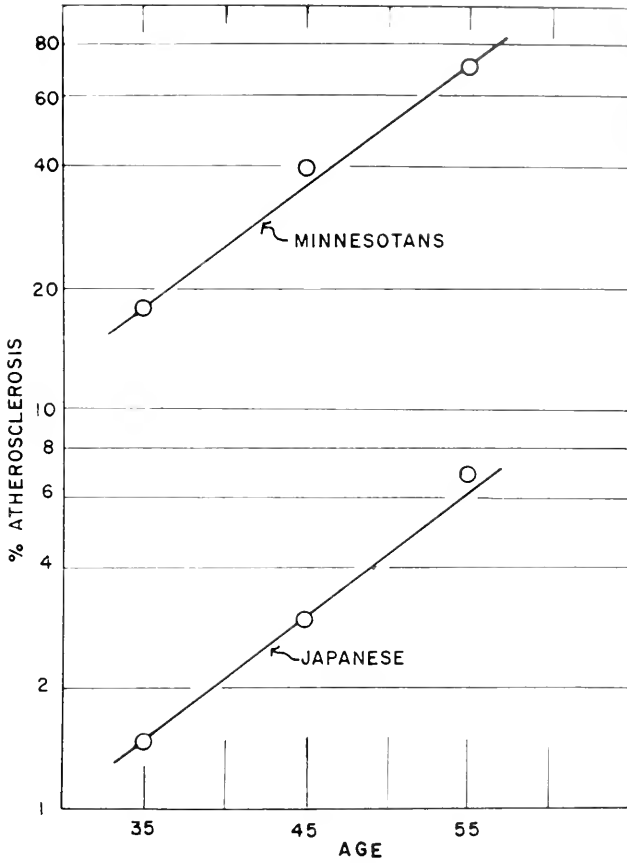

Figure 5. Age and the logarithm of the frequency of severe atherosclerosis. The lines on the graph are parallel, with the slope proportional to the square of the age beyond 15 years.

the average frequency of severe coronary atherosclerosis are plotted against age for the mid-decade ages of 35, 45, and 55. Below the thirties we lack adequate data; above the fifties the effect of losses from the population by death may produce a serious bias. But over this range the points indicate two lines with the same slope. The lines on the graph were drawn with parallel rulers, setting the slope to correspond with the square of the age minus 15 years. In other words, the data indicate that from the end of puberty until the beginning of old age the progression of atherosclerosis is proportional to the square of the duration of exposure.

But what about the great difference between the Japanese and the Minnesotans in the general level of these lines? Is this related to the

serum-cholesterol level? At birth the serum-cholesterol concentration is not zero but something like 70 mg. per 100 ml., and a few days after birth a level of the order of 100 mg. per 100 ml. is the rule. This seems to be true regardless of race or the cholesterol level characteristic of adult life (Bersohn and Wayburne, 1956; Mendez *et al.*, 1959).

In Figure 6 the average serum-cholesterol level minus 100 at a given age is plotted against the logarithm of the frequency of severe atherosclerosis at that age. So for each decade of age there are two points—one for Minnesota, one for Japanese men in Kyushu. Roughly these points suggest three parallel lines.

The findings suggest that the Japanese and Minnesota data on atherosclerosis may form a single system which may be a function of the age beyond 15 and the average serum cholesterol minus 100. Accordingly, regression equations were obtained by the method of least squares in the form:

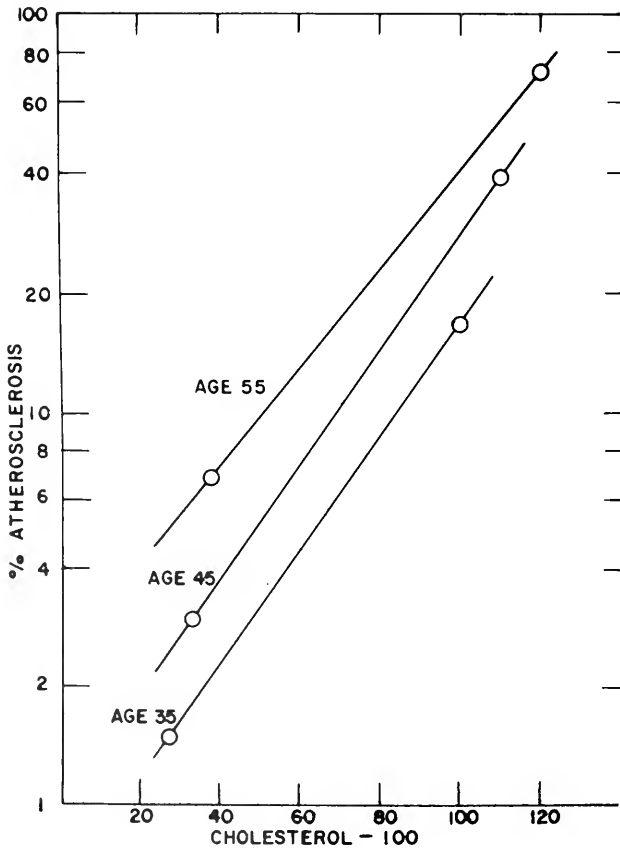

Figure 6. Serum-cholesterol concentration and the logarithm of the frequency of severe atherosclerosis in combined Minnesota and Kyushu data:

(1) $\text{Log } Y = a + b(X-100) + c(Z)$, and

(2) $\text{Log (probit } Y) = e + f(X-100) + g(Z)$,

in which Y is the frequency (%) of severe atherosclerosis and X is the mean cholesterol concentration over the period from decade 1.5 to decade Z.

The solutions to equations 1 and 2 are given in Table IV, together with the observed and estimated values of Y. The correspondence between the observed and the predicted frequencies of severe atherosclerosis is reasonably good with both equations. It seems reasonable to conclude that these two parameters of age and serum-cholesterol concentration are probably the major factors in determining the development of severe atherosclerosis.

TABLE IV

Atherosclerosis vs. Age and Serum Cholesterol

Y = % grades 3 + 4 atherosclerosis

X = Cumulative mean cholesterol, mg. per 100 ml.

Z = Age in decades -1.5

(1) $\text{Log } Y = -0.57 + 0.013 (X-100) + 0.23 Z$

(2) $\text{Log (probit } Y) = 0.30 + 0.0024 (X-100) + 0.042 Z$

Observed Value Y	Estimated from	
	(1)	(2)
1.5	1.7	1.5
3	3	3
7	7	9
18	16	20
40	35	46
72	81	73

The log probit form (equation 2) has the advantage that the predicted values will always stay within the limits of 0 and 100 per cent. It is interesting to see the implications of equation 2 for other ages and mean serum-cholesterol levels. These are summarized in Figure 7. With a mean cholesterol level of 100 mg. per 100 ml. over all the years, even at age 75 the prediction is that only 7 per cent of the men would have severe coronary atherosclerosis. And with a mean cholesterol level of 300 over all the years to age 35, the equation indicates that 99 per cent of such men will have severe atherosclerosis by that age.

This is all very well, but what is the implication, if any, for the problem of aging? The point is that if atherosclerosis is a major phe-

nomenon of aging, then we conclude that the process tends to proceed at a fixed (logarithmic) rate but the general level is determined largely by the cholesterol concentration. So the next step is to ask, what determines the serum-cholesterol concentration?

In part, this too is a function of age, as indicated by the rising curves in Figure 4. But in Japanese men in the fifties the serum-cholesterol level is far below the level of Minnesota men in the twenties. The difference, we believe, is to be found in the diet. Though we may argue about what precisely controls the development of atherosclerosis, there is no longer any doubt about the major importance of the diet in the control of the serum-cholesterol level.

Instead of talking about aging, it would be much easier to discuss the influence of the various constituents of the diet on the serum-cholesterol concentration. Many controlled experiments on man show that the dietary fats are the dominant factor, and that the average serum-cholesterol response of man to given changes in the amount and kind of the fatty acids in the diet is predictable (Keys, Anderson, and Grande, 1959). On a constant diet, however, all men of the same age do not have the same serum-cholesterol level.

Some men are characterized by high levels, some by low, and there is a strong tendency for individuals to maintain their relative places in the distribution of cholesterol level in the population. Figure 8 shows our findings on the typical distribution of serum-cholesterol values among physically healthy, middle-aged men controlled in a closed institution on a rigidly constant diet and a fixed program of rest and exercise. Repeated blood samples were drawn from each man, and the means of the individual were used to compute the distribution, which was then smoothed slightly to fit the normal curve.

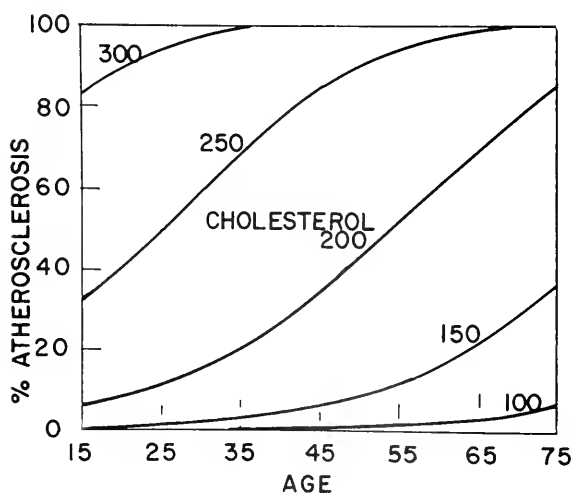

Figure 7. Graph of the Log (probit atherosclerosis) equation (equation 2) for serum-cholesterol values of 100, 150, 200, 250, and 300 mg. per 100 ml.

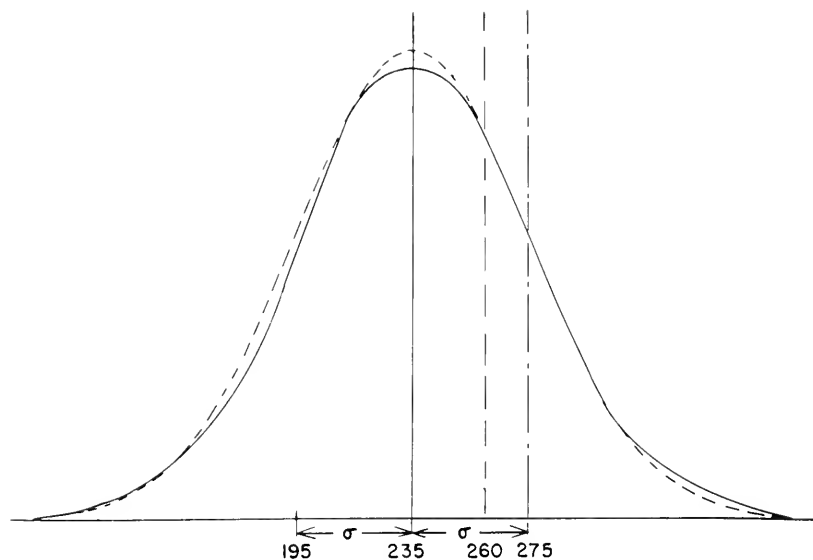

Figure 8. Frequency distribution of serum-cholesterol concentration in middle-aged business men in Minnesota. It is estimated that above the cutting line at 260 the risk of coronary heart disease within the following few years is of the order of four times that for men below that line. Above the cutting point 275, the risk is estimated to be around five times greater than below. The broken curve is perfectly Gaussian.

About 15 per cent of these men characteristically have cholesterol levels of 275 or more. Judging from the follow-up studies previously mentioned, these upper-level men carry a risk of early coronary heart disease some five times greater than the rest of the men in the distribution. It seems reasonable to infer that they have an inherent tendency toward hypercholesterolemia and therefore a built-in factor promoting aging.

At present there is no explanation for these individual differences in cholesterol metabolism. We do know that the serum-cholesterol levels of men who are inherently hypercholesterolemic show unusually large responses to dietary changes, and these changes are quantitatively predictable, within limits.

So it appears that both fatalistic and optimistic views about atherosclerosis and aging of the arteries must be admitted. Each individual has distinguishing characteristics which we can modify but not obliterate. Many of us believe that it is probable we can reduce the excess risk of the man who, on a normal, average diet, has a cholesterol level of 300. We know that we can, by dietary control, reduce the cholesterol level and keep it reduced, though there is no proof as yet that we

thereby will make the inherently hypercholesterolemic man the risk equivalent of his fellows who naturally have lower cholesterol levels. Among other things, he probably has had a lifetime of high cholesterol levels, with all that means in terms of irreversible intimal deposits already accumulated. But I believe we can influence the development of new atherosclerosis.

The beginnings of knowledge in this field go back about 50 years, but quantitative knowledge about man began much more recently. Even the age trend of serum cholesterol, shown in Figure 4 and now so familiar, was unknown until 1949 (Keys, 1949; Keys *et al.*, 1950) and was not widely recognized until the last five or six years. The recognition that the serum-cholesterol level is indeed prognostic of the risk of future coronary heart disease is still more recent. The figures given in the recomputation of the Framingham and Albany risk studies are new in 1960. It is exciting to contemplate what may be the progress from the research of the next decade or two.

After all, it is still true that, for the most part, man is as old as his arteries. If we can modify the progression of atherosclerosis, we shall change a great part of the picture of aging. I firmly believe that research will do just this.

Summary

The relationship between aging and disease is discussed, and differences in the aging rates of different organs and functions are emphasized. It is pointed out that age-related morbidity and mortality may be viewed as, in part, expressions of aging. Since the aging of arteries has such great importance in producing disability and death, the development of atherosclerosis and coronary heart disease is examined with particular reference to differences among populations and individuals. Evidence is presented that individuals must have inherent differences in their rates of developing atherosclerosis and therefore in the tendency of their arteries to age. But external conditions, notably the diet, may modify the tendency, and the differences between some populations in their rate of vascular aging seem to be largely a reflection of the environment, especially the diet.

References

- Bersohn, I., and Wayburne, S., 1956. "Serum Cholesterol Concentration in New-Born African and European Infants and Their Mothers," *Am. J. Clin. Nutrition* 4, 117.
- Bürger, M., 1939. "Die chemischen Altersveränderungen an Gefässen," *Z. Neurol. Psych.* 167, 273.

- Dawber, T. R., Moore, F. E., and Mann, G. V., 1957. "Role of Dietary Fat in Human Nutrition, II: Coronary Heart Disease in the Framingham Study," *Am. J. Pub. Health* 47, 4.
- Doyle, J. T., de Lalla, L. S., Baker, W. H., Heslin, A. S., and Brown, R. K., 1957. "Serum Lipoproteins in Preclinical and in Manifest Ischemic Heart Disease," *J. Chron. Dis.* 6, 33.
- Doyle, J. T., Heslin, A. S., Hilleboe, H. E., and Formel, P. F., 1959. "Early Diagnosis of Ischemic Heart Disease," *New Eng. J. Med.* 261, 1096.
- Keys, A., 1949. "The Physiology of the Individual as an Approach to a More Quantitative Biology of Man," *Fed. Proc.* 8, 523.
- Keys, A., 1952. "The Cholesterol Problem," *Vocding (Amsterdam)* 13, 539.
- Keys, A., 1953. "Atherosclerosis: Problem in Newer Public Health," *J. Mt. Sinai Hosp. (N. Y.)* 20, 118.
- Keys, A., 1957. "Diet and the Epidemiology of Coronary Heart Disease," *J. Am. Med. Assn.* 164, 1912.
- Keys, A., and Anderson, J. T., 1955. "The Relationship of the Diet to the Development of Atherosclerosis in Man," *Nat. Acad. Sci. Publ.* 338, 181.
- Keys, A., Anderson, J. T., and Grande, F., 1959. "Serum Cholesterol in Man: Diet Fat and Intrinsic Responsiveness," *Circulation* 19, 201.
- Keys, A., and Fidanza, F., 1960. *Circulation*, in press.
- Keys, A., and Grande, F., 1957. "Role of Dietary Fat in Human Nutrition, III: Diet and the Epidemiology of Coronary Heart Disease," *Am. J. Pub. Health* 47, 1520.
- Keys, A., and Kihlberg, J. K. 1960. To be published.
- Keys, A., Kimura, N., Kusakawa, A., Bronte-Stewart, B., Larsen, N. P., and Keys, M. H., 1958. "Lessons from Serum Cholesterol Studies in Japan, Hawaii, and Los Angeles," *Ann. Int. Med.* 48, 83.
- Keys, A., Mickelsen, O., Miller, E. v. O., Hayes, E. R., and Todd, R. L., 1950. "The Concentration of Cholesterol in the Blood Serum of Normal Man and its Relation to Age," *J. Clin. Invest.* 29, 1347.
- Kimura, N., 1956. pp. 22-23 in Keys, A., and White, P. D., eds., *World Trends in Cardiology*, Vol. I: *Cardiovascular Epidemiology* (N. Y., Hoeber-Harper).
- Mendez, J., Savitts, B. S., Flores, M., and Scrimshaw, N. S., 1959. "Cholesterol Levels of Maternal and Fetal Blood at Parturition in Upper and Lower Income Groups in Guatemala City," *Am. J. Clin. Nutrition* 7, 595
- Technical Group of the Committee on Lipoproteins and Atherosclerosis, 1956. "Evaluation of Serum Lipoprotein and Cholesterol Measurements as Predictors of Clinical Complications of Atherosclerosis," *Circulation* 14, 691.

PART THREE

*Plant Growth and
Plant Communities*



THE BIOLOGY OF PLANT GROWTH

James Bonner

CALIFORNIA INSTITUTE OF TECHNOLOGY

This discussion will concern plant biology and what we have come to understand about plant growth and development. I wish too to assess some of the problems which it seems to me confront us still. I will discuss these matters in terms of a question: What are the things that determine the ultimate limits of plant productivity on earth? This is an interesting question. The fact of plant growth is of course central to life on earth as we know life today. All flesh is grass, and all atmospheric oxygen is the breath of chloroplasts. The rate at which plants conduct their affairs therefore sets an upper limit on the amount of other life our globe can support. What determines how much plant material is produced per earth per unit time?

In principle, the amount of photosynthesis that takes place over the world each year is ultimately limited by the efficiency with which plants convert the energy of sunlight to energy stored as plant material. This efficiency has been measured in many laboratory and field experiments. In such a field experiment, the increment in plant substance per unit area and over a growing season is determined and its energy content measured (1 gram of plant material releases on combustion approximately 3.5 to 4.5 large calories). The amount of solar energy incident on the unit area during the growing season is also measured. Since only light in the visible region of the spectrum (4,000 to 7,000 Å) is usefully absorbed by chlorophyll, we calculate photosynthetic efficiency on the basis of the amount of solar energy in this wave-length region—approximately 50 per cent of the total. We now calculate efficiency as the energy content of the plant material produced divided by the energy contained in the visible solar flux. This

ratio is 2 to 3 per cent for crop plants grown under optimal or near-optimal conditions (Wassink, 1953, 1959; Brown *et al.*, 1957). The value is the same also for forests (Hellmers and Bonner, 1959), for algae grown in outdoor tanks (Van Oorschot, 1955), and in fact for all plants thus far investigated. The efficiency of plants as converters of solar energy appears, therefore, to be remarkably uniform throughout the plant kingdom.

Why do plants convert and store so little of the incident solar energy? Why is their efficiency 2 per cent instead of some other number? The factors that determine the efficiency of photosynthesis have gradually become clearer during the past ten years, and we can try today to enumerate and assess them.

In the first place, a minimum of approximately ten quanta of energy is required to reduce one molecule of carbon dioxide to the level of plant material. Since ten quanta in the wave lengths absorbed by chlorophyll possess an energy content of roughly 540 large calories per mole, and since only 105 large calories per mole are stored in the reduction of CO_2 to plant material, we must conclude that the photosynthetic act itself possesses an inherent efficiency of approximately 20 per cent (Emerson, 1958). This efficiency may in fact be approximated by higher plants or by algae grown under low light-intensities, where the incident light energy is the limiting factor (Went, 1957; Gaastra, 1958; Van Oorschot, 1955; and others).

In the second place, the photosynthetic rate of leaves becomes saturated at intensities of light well below that of full sunlight. Thus the photosynthetic rate of sugar beet leaves reaches its maximum at an intensity about one-fifth that of full sunlight (Gaastra, 1958). The *absorption* of light by leaves, however, is linear with light-intensity. As the intensity incident on a leaf increases beyond that sufficient to cause light-saturation, light-absorption continues to increase while the photosynthetic rate remains constant. As light-intensity increases, the overall efficiency of the leaf steadily decreases. A leaf photosynthesizing in full sunlight should, on the basis of the above information, exhibit a maximum photosynthetic efficiency of 0.2 (quantum efficiency) \times 0.2 (intensity at saturation as a fraction of full sunlight) = 0.04 , or approximately 4 per cent. This calculated efficiency is not, however, obtainable unless the leaf is provided with CO_2 in a concentration greater than that of air. The photosynthetic rate of leaves, as well as of algal cultures, is normally limited by the range of the CO_2 concentrations in air. The rate of photosynthesis of leaves in air may, in fact, be increased by a factor of roughly two by increasing the CO_2 concentration to a saturating value (Thomas, 1949, and others). So the over-all effectiveness of the leaf in air and in full sunlight is only about 2 per cent, both

by the considerations above and by the elegant measurements of Gaastra (1958).

The efficiency discussed above is of course that to be expected for any area covered with a single layer of leaves. A real plant growing in the field produces several layers of leaves, the lower utilizing the light transmitted by the upper. Since the lower leaves have a smaller intensity of light incident upon them, they are correspondingly more efficient energywise. The fact that average light-intensities are less than that of full sunlight, due to clouds and to the rising and setting of the sun, also acts in the direction of increasing somewhat the efficiency (although not the yield of dry matter) of our plant stands.

Let us, however, pass over these matters and consider instead the central aspect of the problem. It is quite clear that the low efficiency of plants as converters of solar energy is due in the first instance to the fact that the photosynthetic rate becomes light-saturated at intensities lower than that of full sunlight. Why is this? Might we hope to create plants which are more effective at high light-intensities? My own first-approximation analysis of this problem is that plants are inefficient at high light-intensities because they are, so arranged as to be efficient at low intensities.

Photosynthesis is a multi-quantum process. The energy of several quanta must be absorbed, transmitted to, and concentrated in a central spot to bring about the reduction of a single CO_2 molecule. Suppose that we have several chlorophyll molecules wired to this central spot. When each and every one absorbs a quantum within a specified short period, chemistry can be conducted and CO_2 can be reduced. But light is very dilute stuff. Even at an intensity one-tenth that of full sunlight, each individual chlorophyll molecule of the leaf absorbs a quantum, on the average, only about once per second. The time that an enzyme involved in photosynthesis takes to do its work is, however, very much less than this. A chloroplast in which only ten chlorophyll molecules are so arranged as to be able to transfer excitation energy to the enzymatic center will be highly inefficient at low intensities, since only rarely will all ten chlorophyll molecules absorb their needed quanta during the requisite short period of time. The response of such a photosynthetic system to increasing light-intensity will be of higher than first order. The chloroplast, however, is organized in a different manner. As we know from the work of Emerson and Arnold (1932), the chloroplast is arranged so that it contains approximately 2,000 times as many chlorophyll molecules as it does reducing centers in which the chemistry of CO_2 reduction is conducted. The chloroplast contains what are essentially light-collecting panels, in which the energy of photons absorbed by any pigment molecule can be transferred to the

central enzymatic spot. This arrangement makes our plant efficient at low light-intensities but less efficient at high intensities, when more than ten quanta per unit of enzymatic turnover time bombard the photosynthetic unit.

The leaves and chloroplasts of a plant must function over a wide variety of intensities, from null to full sunlight. A leaf may be on the top or on the bottom; the sun comes up and goes down. It is my guess that the size of the photosynthetic unit—the number of chlorophyll molecules per reducing center—has been established during the course of evolution at a figure which maximizes yield over the range of intensities to which plants are subject.

The analysis above is a crude and qualitative one. We know, for example, that CO_2 is not reduced by the chloroplast directly; the function of the absorbed light energy is to generate reducing and phosphorylating agents which then transform the initial product of CO_2 -fixation to carbohydrate. The individual light-powered chemical acts of photosynthesis may very well require fewer than ten quanta. But the principle of the analysis remains unaltered: namely, that the photosynthetic act, as a multi-quantum process, cannot be simultaneously efficient at both low and high intensities and some compromise must be sought—that which maximizes yield. I have tried a little experiment: I have tried to find out, with the aid of modern computerology, how many chlorophyll molecules per photosynthetic unit a chloroplast should contain in order to maximize yield over all light-intensities. I have presented the facts outlined above to a computerologist and asked him to please compute for me the optimum number of chlorophyll molecules per reducing center. The calculation again is crude and to be regarded only as a first approximation, but it agrees with nature in suggesting that the optimum number is of the order of 1,000. And so, in a first sense, the answer to our question, What is the limit on the productivity of plants on earth? is that it is the limit established by the organization of the photosynthetic unit of the chloroplast. And in a more limited sense, productivity is limited by the concentration of CO_2 characteristic of air. There is little that we can do about this latter fact. Plants, by the nature of their dependence on CO_2 concentration, form a negative feedback system controlling the CO_2 concentration of our atmosphere at the level which characterizes it today.

Photosynthetic efficiencies of 2 to 3 per cent are by no means uniformly attained in nature or in agriculture, even for that portion of the year which we know as the growing season. The over-all efficiency of crop plants for the earth as a whole is probably closer to a third of this value (Brown *et al.*, 1957; Wassink, 1959). Why is the gap between the attained and the attainable so great? Undoubtedly the efficiency of plants as converters of solar energy is generally limited also by the

availability of soil moisture, by limitation in one or another essential mineral, and so on. We know, for example, that a brief period of water stress during the middle of the day drastically reduces the photosynthetic rate, and we know, too, that water stress or mineral deficiency slows the rate of growth of plants and increases the length of time required for a crop to effectively cover an area of ground with the numerous layers of leaves needed before full photosynthetic efficiency can be attained. Nevertheless, we know in principle how to conduct our cultivation of plants so as to raise the over-all efficiency during the growing season to the level of 2 to 3 per cent, and this level is in fact now achieved over small portions of the earth, as in Japan, Denmark, and Holland.

Our considerations above have applied to the efficiency of plants during the growing season. In a second sense, the growth of plant life on our planet is determined by climate. The distribution of plants is limited by cold, heat, and drought—extremes of climate which determine the length of time over which our plant can usefully absorb light-energy to be stored in the form of plant material. Because of the paramount importance of temperature in determining the length of the growing season and the total yield of the plant, a vast amount of enterprise has gone into determination of the temperature requirements and tolerances of individual plant species. We know for many kinds of plants the optimal day temperature, the optimal night temperature, and the limits of temperature over which the plant can succeed (Went, 1957). Let us now ask ourselves, however, how does the plant know what the temperature is? What goes wrong with a plant grown in an unfavorable temperature? How does a plant sense and respond to varying temperature? A modest start in the understanding of these matters has been made, and it has turned out that in some cases, at least, the way in which plants sense temperature has a not-overly-complicated chemical basis.

Let us take, for example, the cosmos plant. We know the optimal temperature for this species. We may grow it also at an unfavorably lower temperature—a temperature such that our cosmos plant accumulates dry weight only one-half as rapidly as it does at its optimal temperature. Cosmos plants can, however, be cured, as it were, of sub-optimal temperature by application to them of small amounts of a single chemical substance, thiamine (Bonner, 1943). Such applications cause cosmos plants grown in low temperatures to behave as though grown in a higher temperature. Applications of thiamine to plants grown at their optimal temperature are without effect. In this case it has been possible to show by direct analysis that plants grown at sub-optimal temperature are characterized by a lower concentration of thiamine in their tissues than that characteristic of plants grown at the

optimal temperature. It would appear, then, that we may discuss the effects of low temperature on cosmos growth in chemical terms as follows: While the rates of many of the reactions leading to the production of the cosmos plant must be decreased by low temperature, still the rate of thiamine production appears to be decreased even more than the general average. Cosmos plants grown at suboptimal temperatures suffer from restriction in the amount of thiamine available to them, and their growth rate may be increased by artificial application of this material.

Similar things may be said about the response of plants to unfavorably high temperatures. Thus Langridge and Griffing (1959) have studied three low-temperature-requiring races of *Arabidopsis*—races which are greatly decreased in their growth by temperatures above 30° C. Two of these three races were found to be specifically cured of high-temperature damage by the application of biotin, while the third was found to respond to the application of cytidine. Here the lesion induced by unfavorable climate appears to be inability to synthesize an essential metabolite in sufficient quantity at the high temperature. Similar observations have been made by Davern (1959), who has found that high-temperature damage to certain races of subterranean clover is due to loss of the ability to produce particular amino acids.

It may be noted in passing that the response of higher plants to temperature is similar to that of the so-called temperature mutants of *Neurospora*, which have been studied so extensively. In the temperature mutants of *Neurospora* we have organisms which grow normally at one temperature and fail to grow at a higher or lower temperature. Failure to grow at the higher temperature has been shown to be due to a genetically induced inability to make one or another essential metabolite at that temperature. The higher plants thus far investigated are not mutants, in the sense that they have been made deliberately, but it appears nonetheless that what we call the normal strains of higher plant species behave just as do temperature mutants produced by genetic machinations.

Another and still more complex mode of interaction between plant and temperature has come to light through the work of Went (1957) and of Ketellapper (1960). The essential observation is the fact that certain plants can be cured of low-temperature damage by growing them in a regimen of alternating light and dark in which the daily rhythm is not the 24 hours of our real world but some longer period, such as 30 hours. The same species may similarly be cured of high-temperature damage by growing it under a regimen in which the daily cycle length is less than the 24 hours of our real world; for example, 18 hours. These facts can be summarized by saying that some plants, at least, behave as though they possess a timing mechanism—a clock—

which is measuring diurnal cycles. At 25° C., if this is the optimum temperature for the plant, it is measuring off 24-hour periods. During the diurnal cycle the plant appears to consult its clock to ascertain what portion of the daily ritual comes next. The clock says, "Now photosynthesize," or "Now it is night," or whatever it is that plants have to do on a 24-hour basis. At low temperatures the clock by which the plant programs its operations apparently runs a little too slowly. If the clock is not in synchrony with the outside real-world events, our plant suffers metabolic disturbances. In order to cure the plant of these disorders, what we have to do is to give him his light and dark on a diurnal cycle of a period in synchrony with that of his clock. The clock runs slowly at low temperatures, and we must therefore give him daily cycles of light and dark which are longer than 24 hours in order to make the plant happy at low temperatures. The clock runs too rapidly at high temperatures, and we must therefore give the plant a diurnal cycle shorter than 24 hours at high temperature.

This behavior applies to all species we have so far investigated—which, it is true, is a small number, namely three. The species thus far investigated care not only about the absolute temperature but care in addition about the temperature in relation to the diurnal-cycle length. They all behave as though they have clocks which measure time and which must be in phase with the daily external time signals.

This is a facet of plant behavior about which nothing is known. It is a facet of plant behavior which is basic to our understanding of the relation of plants to temperature. I feel sure that when we find out why the plant has a clock and how this clock works, we will then be able to find materials which we can give to a plant and will say to its clock, "Please run faster, because you are running too slowly," or "Please run slower, because you are running too fast," and that we will in this way be able to do a great deal to foster the mating of plants and temperature.

The act of photosynthesis produces plant material. The partition of this raw material between the varied organs and structures of the plant is controlled in large measure by the plant hormones, which carry out their work as messengers acting under the authority of and in accordance with the instructions contained in the plant's genetic material, and thus, in a third sense, the manifold hormonal systems of plants determine growth and form, vegetation and reproduction in the plant world. We know a great deal about plant hormones. We know, for example, that there are root growth hormones—substances produced in the leaf and transported to the roots, which, though they cannot synthesize these materials, require them in their growth. These root-growth-controlling hormones of the plant are the chemical substances thiamine, niacine, and pyridoxine. We know, similarly, that

there are leaf growth hormones—substances produced in the mature leaves and transported to and required for the growth of the immature leaves. Fruit growth hormones, seed growth hormones, hormones controlling reproduction, and hormones that supervise and regulate cell extension in the stem and other organs—all have been discovered and studied *in extenso*.

In the course of the work on the plant hormones during the past generation a number of unexpected but entirely acceptable applications in the agricultural aspects of biology have come to light. So great, indeed, has the practical import of crop-plant endocrinology become that we sometimes tend to lose sight of the significance this study has for our understanding of the plant. Through the basic work on the plant growth hormones the concept has become available to us that particular substances may be applied to a plant to accomplish particular useful purposes, such as to make leaves drop off, to make fruits stay on, to induce flowering, to inhibit flowering, and even to kill undesired plants. The different chemicals used for the supervision of these varied aspects of plant development are almost without exception substances whose biological effectiveness is based upon structural similarity to one or another of the native plant growth substances. Since a great many substances have been investigated or screened as to ability to evoke this or that plant growth response, we have today what is almost a pharmacology of plants.

But these are mere practical matters. I should like to consider just two kinds of hormones—those that control cell expansion and those that are responsible for the initiation of the reproductive process. The hormones of cell expansion, the auxins, are the longest known of the plant growth substances, and we know a fair amount about them. We know, for example, that from a chemical standpoint indoleacetic acid is the type example of an auxin. We know that indoleacetic acid is produced in the apical bud and travels down the stem to the growing region, in which the rate of cell expansion is determined by the concentration of available hormone. We know that the effectiveness of indoleacetic acid in increasing the rate of cell expansion can be elegantly and quantitatively demonstrated and followed with sections of tissues or with cells excised from a plant and grown *in vitro*. But there is also a great deal we do not know about the auxins. First and most mysterious, perhaps, is why it is that indoleacetic acid is made in some cells (those in the apical bud) and not in others (*e.g.*, normal stem cells). The enzymes that transform tryptophan to indoleacetic acid are present in the bud, absent from the stem (Wildman and Bonner, 1948). Evidently the genetic material of a plant contains information on how to make the enzymes needed for the production of indoleacetic acid. But these

genes pass out their information and cause production of the required enzymes only in a few specific spots within the plant. In all other tissues the genetic information concerning indoleacetic acid synthesis is inert—turned off.

That information about how to produce enzymes suitable for the synthesis of indoleacetic acid is in fact contained within normal stem cells is quite clear from the fact that we know how to cause stem cells to start producing enzymes needed for indoleacetic-acid synthesis. This can be done most elegantly by transformation of normal stem cells into crown-gall tumor cells. In the course of this transformation, stem cells commence production of the enzymes required for indoleacetic-acid synthesis and thus become autonomous with respect to this growth substance (Henderson and Bonner, 1952).

In any case, however, the mystery of why indoleacetic acid is produced only in particular places and not in others is the mystery of differentiations. Students of plant growth substanceology need not be unduly ashamed that they have not solved this matter, since no one else has solved it either. Students of plant growth substanceology may be more concerned with the fact that they do not yet really understand in detail how indoleacetic acid causes plant cells to grow more rapidly. True, the mode of action of indoleacetic acid is slowly being chased to its lair. The growing plant cell consists of living material surrounded by a carbohydrate cell wall. The cell wall is under tension, and the tension is due to the osmotic uptake of water by the cell contents. The factors that immediately control the rate of cell expansion are, then, the osmotically induced load, or tension, to which the wall is subject and the resistance of the wall to deformation under this load (Bonner, 1961). Appropriate mechanical analyses have shown unambiguously that the more rapid elongation of auxin-treated plant material is due to softening of the cell wall—to changes within the wall which cause it to yield more rapidly to a given load (Tagawa and Bonner, 1957). Since indoleacetic acid increases the rate of cell extension by causing increased cell wall deformability, it is evident that the hormone in some way alters cell wall chemistry.

Such alterations have been sought since the beginnings of auxinology. Only in recent years, however, after the advent of appropriate methodology, have they been found. With such methodology it has been shown that the application of indoleacetic acid to an appropriate plant tissue results in increased rate of synthesis of a particular cell wall component—namely, pectic material (Ordin *et al.*, 1955; Alberheim and Bonner, 1959). The new pectic material produced under the influence of indoleacetic acid is of short chain length, in contrast to the long-chain protopectin that characterizes the bulk of cell wall pectic

material. Since pectic material appears to constitute the glue that binds together the cellulose microfibrils and other components of the cell wall, and since short-chain pectin molecules are less effective in this function than long-chain molecules, one can feel intuitively that this biochemical alteration should lead to cell wall softening. Exactly how this is so is yet to be understood. So, too, is the enzymology by which indoleacetic acid influences pectin metabolism. With what enzyme or metabolic process does indoleacetic acid interact in pectin metabolism? Although we are getting closer, we do not know.

The second group of hormones with which I wish briefly to concern myself are those having to do with flowering. A plant grows vegetatively for awhile, its bud producing leaf after leaf, and then suddenly, upon receipt of an appropriate signal, the bud alters its behavior and produces an entirely new structure: a flower and fruit. It becomes a reproductive bud. The initiation of reproduction is elicited by different kinds of signals in different kinds of plants. In the simplest case it may consist merely in notice that an appropriate number of leaves has been produced. This requisite number is promptly followed by production of a flower bud. In other species the reproductive signal may consist in cold treatment of the bud, as in the biennials and winter annuals, or in appropriate day-length treatment of the leaf, as in the photoperiodically sensitive plants. In the photoperiodically sensitive plants, exposure of a leaf or leaves to a long night, if the plant is a long-night plant, or to a long day, if the plant is a long-day plant, results in the sending to the bud of a specific evocator of floral differentiation. The leaf, as the result of treatment with appropriate interplay of light and dark, sends to the bud a hormone whose nature we do not know. This hormone causes the bud to differentiate into a floral bud, and, as a matter of fact, in many species the bud becomes "induced"; that is, it grows as a floral bud forever after, even though the leaves no longer continue to transmit the floriferous signal.

Although we do not yet know the nature of this hormone which travels from leaf to bud to bring about floral development, we do know a little bit about the processes that take place within the bud itself (Salisbury and Bonner, 1960; Bonner and Zeevaart, 1960). We know, for example, that the bud responds to the signal received from the leaf by the production of some specific kind of ribonucleic acid, and that if ribonucleic-acid synthesis in the bud is suspended, the bud cannot perceive or act upon the stimulus sent by the leaf. Here again we have to do with the timing of genic activity. The genetic material of a plant contains all of the information requisite to the formation of the floral structure, yet in the vegetative plant this information is not used. The genes that contain it are inert—turned off. I suppose that when the

bud of our plant receives the floriferous signal from the leaf, what happens is that the signal says to these genes which contain the flowering information, "Please get busy and make the materials concerning which you have information. Make the ribonucleic acid and thence the enzymes which are required for floral differentiation." And in the induced plant these genes, once turned on, stay turned on for evermore. Although we can and should continue to try to find out something about the nature of the signal that travels from leaf to bud, still, the basic problem of floral induction resides again in the mysterious realm that has to do with the control of genic activity itself.

And so we must come to the conclusion that in the fourth and final sense the determining facts concerning plant growth are those written in the nucleus in every plant cell, written in its DNA and in the language of A, T, G, and C. I have said that plant growth is controlled by the efficiency with which plants convert solar energy to plant material, but the very facts of photosynthesis are of course written in the genetic book. That the size of the photosynthetic unit itself is genetically controlled is indicated by work with mutants of barley obtained by Highkin (1959) and of blue-green algae which behave as though possessed of photosynthetic units smaller than the usual. I have spoken of the control of plant growth by climate, by which I mean that some climates are bad for some plants. But here again the climate that is bad for a plant is determined by the genetic information that our plant possesses.

To take a simple instance, the ecotypes of *Arabidopsis* studied by Langridge and Griffing (1959), which are intolerant of high temperature because they cannot make biotin or cytidine at high temperature, all behave as though they differ in one gene from *Arabidopsis* ecotypes tolerant to high temperature. We may suppose, therefore, that intolerance to high temperature resides in some gene which produces an enzyme that is suitable for synthesis of the metabolite in question at ordinary temperatures but is unstable to or unsuitable for operation in high temperature. Or take the biennial plants—for example, *Hyoscyamus*, so favored by my colleague Anton Lang (1956). *Hyoscyamus* will not send up a flower stalk and flower until its bud has been subjected for a suitable time to low-temperature treatment or, alternatively, until an application of the plant growth substance gibberellin is made to the non-cold-treated bud. Applications of gibberellin can, as it were, cure *Hyoscyamus* of the requirement for low-temperature treatment. Low-temperature treatment, we believe, causes the bud to be able to make its own gibberellin. But the biennial strain of *Hyoscyamus* differs by one gene from the annual strain, a strain in which the gene for making gibberellin need not be subjected to low-temperature treat-

ment before it becomes effective. Here again, then, response to climate is written in the genetic language. The very control of form and shape, mediated as it is by the plant hormones, is mediated in accordance with the instructions contained in the plant's genetic material. As another example, take the dwarf mutants of corn, of peas and beans, and of other species. These are dwarfs because they possess genetic information telling them to make less gibberellin and thus be less august in stature than their normal sibs. When we get right down to the nub of the matter, the biology of plant growth and the control of plant growth and development centers in the cell—in fact, the nucleus.

The plant cell, like other cells, contains mitochondria to conduct its respiration and to assure a supply of available metabolic energy; it contains ribosomal particles made of RNA and protein for the synthesis of the manifold species of enzyme molecules required to produce the many different metabolites essential to plant well-being; and, most importantly, it contains a nucleus full of DNA. The genetic material consists of genes, each gene bearing information on how to make a specific kind of enzyme molecule. The genes made of DNA can replicate in the manner about which we have heard so much in recent years. The nucleus, too, and apparently the genetic material of the nucleus, can produce ribonucleic-acid particles which contain bits of the genetic information printed off in RNA form—information on how to make this or that specific species of enzyme molecule. We sum up our knowledge and our guesses by saying that cells behave as though the DNA makes the RNA and the RNA makes the enzymes. Some enzymes make the building blocks for making more enzymes. Other enzymes make building blocks for making more RNA. And still other enzymes make the building blocks that must be present if the DNA is to replicate itself and thus to permit of cell division and growth. In the operation of the cell we glimpse the logic of life.

But as we get our first glimmering of the manner in which cells operate, we are at once confounded with a new and puzzling question. This has to do with the programming of the use of the genetic information. We have seen clearly that not all of the genes of our plant are turned on all of the time. The genes for making flowers, for example, are turned off until our plant receives the signal for flowering. The genes responsible for making some particular hormone are turned off in all cells except those charged with making hormone. The inescapable conclusion is that not all genes make their characteristic RNA, their characteristic ribosomes all of the time. There would appear to be some further part of the cellular system which controls the activity of the gene within the nucleus and which determines whether or not a given gene may produce its characteristic RNA, its characteristic ri-

bosomal particle. What is the nature of this control? Are there genes responsible for the exercise of such control? Are there genes which contain information concerning the programming of the information? We do not know, but now that the question has been posed, we can find out. We can learn, too, to read the message of the DNA, and as we learn to read the message contained within the genetic material, and learn how the reading of the message is programmed by the cell and translated into action, we will come to understand on a truly fundamental level the central features of the biology of plant growth.

References

- Albersheim, P., and Bonner, J., 1959. "Metabolism and Hormonal Control of Pectic Substances," *Biol. Chem.* 234, 3105.
- Bonner, J., 1943. "Effects of Application of Thiamine to Cosmos," *Bot. Gaz.* 104, 475.
- Bonner, J., 1961. "The Mechanical Analysis of Auxin-Induced Growth," in Klein, R., ed., *Plant Growth Regulation* (Iowa City, Iowa, Iowa State Univ. Press).
- Bonner, J., and Zeevaert, J., 1960. Unpublished results.
- Brown, H., Bonner, J., and Weir, J., 1957. *The Next Hundred Years* (N. Y., Viking).
- Davern, C. I., 1959. "Chemotherapy of High Temperature Inhibition of Plant Growth," Doctoral thesis, California Institute of Technology.
- Emerson, R., 1958. "The Quantum Yield of Photosynthesis," *Ann. Rev. Plant Physiol.* 9, 1.
- Emerson, R., and Arnold, W., 1932. "A Separation of the Reactions in Photosynthesis by Means of Intermittent Light," *J. Gen. Physiol.* 15, 391.
- Gaastra, P., 1958. "Light Energy Conversion in Field Crops in Comparison with the Photosynthetic Efficiency under Laboratory Conditions," *Meded. Land. Wagcn.* 54, 1.
- Hellmers, H., and Bonner, J., 1959. "Photosynthetic Limits of Forest Tree Yields," *Proc. Soc. of Am. Foresters*, p. 33.
- Henderson, J., and Bonner, J., 1952. "Auxin Metabolism in Normal and Crown Gall Tissue of Sunflower," *Am. Jour. Bot.* 39, 444.
- Highkin, H. R., 1959. "Studies on the Function of Chlorophyll b in Photosynthesis with a Barley Mutant Lacking Chlorophyll b," in *Biology 1959* (Pasadena, Calif. Inst. of Technology).
- Ketellapper, H. J., 1960. "Interaction of Endogenous and Environmental Periods in Plant Growth," *Plant Physiol.* in press.
- Lang, A., 1956. "Induction of Flower Formation in Biennial *Hyoscyamus* by Treatment with Gibberellin," *Die Naturwissenschaften* 12, 1.
- Langridge, J., and Griffing, B., 1959. "A Study of High Temperature Lesions in *Arabidopsis Thaliana*," *Austr. J. Biol. Sci.* 12, 117.
- Ordin, L., Cleland, R., and Bonner, J., 1955. "Influence of Auxin on Cell Wall Metabolism," *Proc. Nat. Acad. Sci.* 41, 1023.
- Salisbury, F. B., and Bonner, J., 1960. "Inhibition of Photoperiodic Induction by 5-fluorouracil," *Plant Physiol.* 35, 173.
- Tagawa, T., and Bonner, J., 1957. "Mechanical Properties of the *Avena* Coleoptile as Related to Auxin and to Ionic Interaction," *Plant Physiol.* 32, 207.

- Thomas, M. D., and Hill, G. R., 1949. In Franck, J., and Loomis, W. E., eds., *Photosynthesis in Plants* (Ames, Iowa, Iowa State College Press).
- Van Oorschot, J. L. P., 1955. "Conversion of Light Energy in Algal Culture," *Meded. Land. Wagen.* 55, 225.
- Wassink, E. C., 1953. In Burlew, J. S., ed., *Algal Culture from Laboratory to Pilot Plant*, Carnegie Pub. No. 850.
- Wassink, E. C., 1959. "Efficiency of Light Energy Conversion in Plant Growth," *Plant Physiol.* 34, 356.
- Went, F. W., 1957. *Experimental Control of Plant Growth* (N. Y. Ronald Press).
- Wildman, S. G., and Bonner, J., 1948. "Observations on the Chemical Nature and Formation of Auxin in the Avena Coleoptile," *Am. J. Bot.* 35, 740.

**ORGANIZATION AND INTEGRATION:
PLANT CELL GROWTH AND NUTRITION***

F. C. Steward

CORNELL UNIVERSITY

In each period of its development plant physiology has faced special challenges, in large part determined by the physical and chemical techniques of the day and by the current status of knowledge of the living system itself. In an era in which the chemical elements were described as earth, air, fire, and water, there was little incongruity in the Aristotelian idea that the entire substance of plants came from the soil; but from this primitive beginning have come ideas about nutrition, inorganic and organic, which have gone hand-in-hand with advances in chemical knowledge. The recognition of different “gases”—a term attributed to van Helmot—and of the elementary nature of oxygen and its role in combustion needed to be worked out before photosynthesis and respiration as physiological functions could acquire much meaning. Woodward, in 1699, foretold the nutritional role of dissolved materials which were present in Thames River water, in Hyde Park conduit water, and in water to which garden mold was added, as seen by their relative effects upon the growth of mint cuttings (Table I). Nevertheless, the knowledge of the solutes needed in relative bulk for normal growth was not to emerge until the nineteenth century, and the descriptive knowledge of the so-called trace elements is mainly a development of the twentieth. And the idea that plants and cells must absorb their solutes actively from the often very dilute external solu-

* This paper is based on much work which has been supported over the years by various fellowships and research grants awarded to the author or his associates. Special acknowledgment is needed of the grants from the National Cancer Institute. The author is grateful to Mrs. Marion O. Mapes for assistance with the preparation of the figures, and to Dr. H. Y. Mohan Ram for assistance with the preparation of the manuscript for the press.

TABLE I

Woodward's Experiments (1699)
(Phil. Trans., 1699, vol. 21, p. 382.)

Source of water	Weight of plants (in grains)		
	When put in	When taken out	Gain in 77 days (in grains)
Rain water	28¼	45¾	17½
River Thames	28	54	26
Hyde Park conduit	110	249	139
Hyde Park conduit + 1½ ounces garden mould	92	376	284

TABLE II

Sap Composition in Relation to the Medium*
(All sap concentration in milli-equivalents per liter)

Plant		Na	K	Mg	Ca	Cl
Nitella clavata	Sap (max.)	86	59	22	19	107
	Medium	1.2	0.05	3.0	13	1.0
	Acc. ratio	71.6	1180	7.3	15.3	107
Chara ceratophylla	Sap	152	66	26	13	233
	Medium	68	1.4	14	3.8	80
	Acc. ratio	2.2	4.7	1.8	3.4	2.9
Chara ceratophylla	Sap	84	77		13	176
	Medium	0.21	0.04		3.3	0.13
	Acc. ratio	400	1900		4	1350

* Data from Collander, cited by Steward and Sutcliffe (1959).

TABLE III

Accumulation of Ions in the Sap of Marine Plants*
(Mean sap composition in equivalents per liter)

Plant	Na	K	Cl
<i>V. macrophysa</i>	0.113	0.509	0.624
<i>V. ventricosa</i>	0.043	0.591	0.628
Sea Water	0.498	0.012	0.580

* Data from Steward and Martin, cited by Steward and Sutcliffe (1959).

tions in which they may occur (Tables II and III), with the expenditure of metabolic energy in a system which functions dynamically as a working machine, is essentially a contribution of the second quarter of this century.

The interrelations of form and function have been the traditional meeting ground of physiologists and morphologists, and from Haberlandt to J. H. Priestley attempts to interpret the structure of cells, tissues, and organs in relation to their behavior and role inspired the movement which became known as physiological plant anatomy. Prior to this, the general responses of plants to external stimuli, early attributed to a universal property of living material called "irritability," paved the way for the modern work on hormones and growth-regulating substances of all kinds. All this had its basis in the cell doctrine, which led to the development of general and cell physiology as investigators applied their then-available chemical and physical knowledge to problems of cells and of protoplasm and later of their respective inclusions. But enzymology, intermediary metabolism, and the standpoints of "comparative biochemistry" are essentially creations of this century, while the current descriptions of the structure of organelles and of macromolecules at the submicroscopic level could only proceed as the electron microscope and other physical techniques became available. Thus the old problems of form and function are carried down to much lower orders of magnitude.

The triumphs of biochemistry and biophysics, which have helped to describe in ever-greater detail the molecules that build the structures of cells, the metabolites, the enzymes, the co-enzymes that mediate their reactions, and the reversible metabolic cycles which permit the flow of groups, or radicals, of hydrogen or of electrons through the metabolic machine, may now divert attention from what seems to be an important and somewhat neglected topic. This is to know how cells and organisms function as organized systems: *i.e.*, how the various systems that have been described, often at the molecular level, can be put together to make a harmonious, coordinated whole. It is as though in modern cellular biology we have much knowledge of what might be called the "unit operations" but know relatively little about the over-all design of the "factory" in which they occur and still less about its over-all management.

As early as 1905 and in a prescient passage, F. F. Blackman conceived of the cell as a "congeries of enzymes," a "colloidal honeycomb of catalytic agents," etc. Again, General Jan Christian Smuts—soldier, statesman, botanist, and philosopher in the grand tradition of the late nineteenth and early twentieth century—used a plant cell to illustrate his doctrine of "Holism," although he lacked the enormously extended modern knowledge, since he wrote in 1926. According to this doctrine,

the properties of the organized whole are more than the summation of the properties of its parts.

The burden of this paper is therefore as follows: In the current eagerness to know more and more in detail about ever more refined parts of the system, a sense of perspective is needed. This perspective may be obtained through the need to know how all these parts are put together to create a harmonious working machine, in the organism or even in a single cell. Thus the challenge in cell and plant physiology is increasingly concerned with the problems of organization, and it is, therefore, particularly appropriate to dwell upon them now.

In a measure this is the old problem of form and function, seen at new and lower levels of organization. The role of organization is clearly paramount when those physiological functions that increase free energy are in question; this is especially true of processes which are directly concerned with growth. Here order is created out of disorder, and the entropy change is negative. Perhaps in too much of our current plant physiology investigators have attempted to seek systems and experimental approaches in which the complications of growth and active metabolism may be avoided. Laudable as this may be when making the first descriptions of possible reactions, of existing enzymes, of the nature of metabolites and catalysts, etc., it is a poor way to face the problems of organization. One would hardly study the operation of the internal combustion engine as it lies idle in the repair shop, often as this may occur! As modern techniques disclose proteins and amino acids even in fossils (see Barghoorn, 1957), the dead fragments of the metabolic machine may become increasingly evident even in the plants of long ago. But neither the form nor the dead substance of the fossil can convey much of an impression of how it grew or metabolized in life.

There comes a point, therefore, at which the living system can be adequately studied only while it is actively in operation, and increasingly the test of viability is whether the conditions of the investigation would permit the living system to grow. Therefore, to leave the consideration of growth out of our current study of metabolism, and to assume that what appears in the non-growing, fragmented portions of the system will operate *in situ* in the same fashion, is like "leaving the Prince of Denmark out of *Hamlet*." Carried to its logical conclusion, the modern doctrine of molecular biology would have botany a branch of chemistry. But however essential one believes the chemical knowledge to be, it alone is not enough. The problems of organization begin at the point where the knowledge of individual molecules and their unit reactions ends. Therefore, if this "sermon" needed a text, or this new laboratory building a dedicatory superscription, my own suggestion would be, "Consider the lilies of the field, how they grow. . . ."

Against this background, some salient problems of plant physiology will now be examined. The topics to be discussed are drawn from the following areas:

1. Cell physiology in relation to the absorption and movement of solutes.
2. The role of cellular organization in the metabolism of growing and non-growing cells.
3. Cell physiology in relation to morphogenesis.

In each of these areas there is a need to know more about the milieu in which physiological events occur and to understand how relatively simple molecules or stimuli may often influence the behavior of relatively complex systems.

Some problems of ion absorption and movement

This area of cellular and plant physiology furnishes excellent examples of the thesis enunciated above. From the classical period to modern times the problems presented by the composition of the internal aqueous environment of cells and of organisms in relation to the quite different—and usually very much more dilute—solutions with which they are bathed have been apparent. And the movement of solutes—organic and inorganic—over relatively long distances in the plant body has also been a challenging problem. For recent surveys of these great questions, reference may be made to Steward and Sutcliffe (1959), to Swanson (1959), and to Biddulph (1959). From the factual background there outlined, the following ideas emerge.

It may seem a simple thing to expect a plant physiologist to explain how a cell absorbs potassium or chloride ions from the environment. Although their immediate sources may be endogenous, rather than exogenous, the secretion and storage of numerous freely diffusible organic solutes in vacuoles, or aqueous phases, of cells equally requires explanation. It is a familiar fact that when the vital organization is destroyed by killing, or its operations are impaired by anesthetics, poisons, or a variety of restrictions upon metabolism, the principles of diffusion reassert themselves, and solute movements toward true equilibrium occur. In other words, and to quote a familiar aphorism, in living cells and organisms the principles of diffusion do not operate in a free and unrestricted fashion. It is these very restrictions upon diffusion that enable the cells and organisms to retain their integrity in their environment, but it is equally obvious that they are due not to passive properties of a quiescent biological system but to the activity of the cellular system as a dynamic molecular machine.

A most surprising feature of the organization, in a living cell or an

organism, is how little material imposes its effect upon how large an amount of water. Gortner's old description of an undistorted image of a sheet of daily newsprint photographed through a transparent marine organism (such as a jellyfish), which when dried down on the paper produced a barely perceptible and almost unweighable smudge, is graphic enough. Some photographs of growing plant tissue cultures (*e.g.*, of carrot, potato, and banana) are relevant here, for the active cells have a higher water content than their resting counterparts (Figure 1). The relative amounts of water and protein in growing cells are presented in other terms in the numbers of Table IV. In other words, to a surprising degree the problem of organization is to impose the

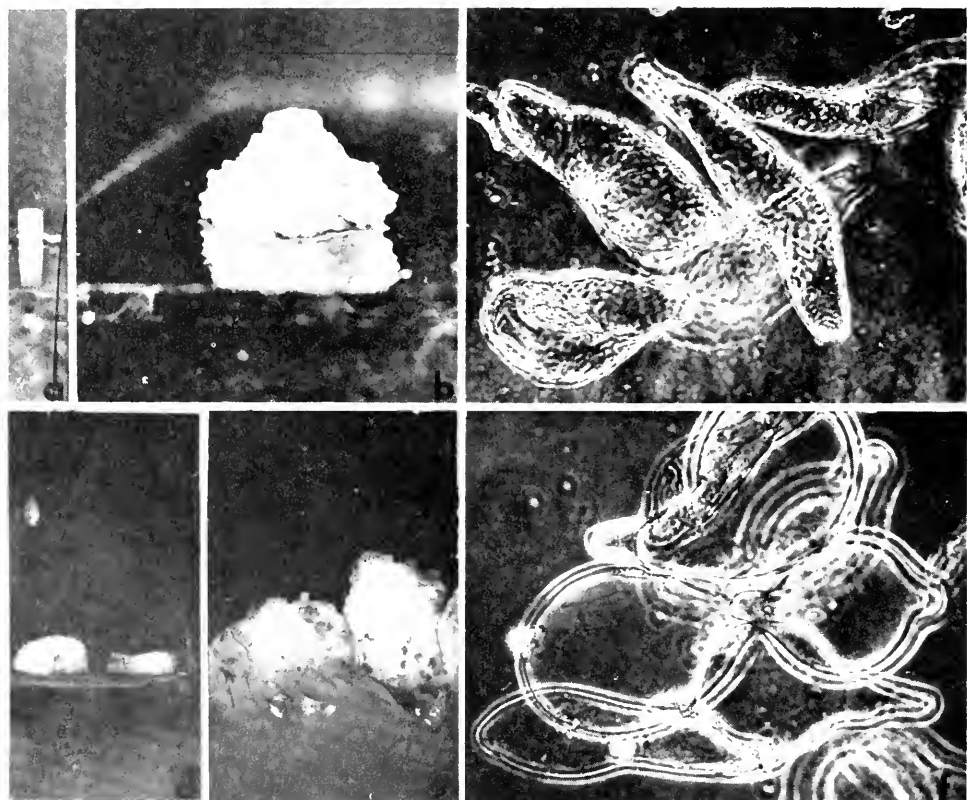

Figure 1. A. Cylindrical explants of carrot-root phloem grown on White's nutrient medium. B. Growth from similar explant on the same medium supplemented by coconut milk. C. Free cells of carrot growing in a liquid medium containing coconut milk. D. A portion of excised banana fruit pulp on an agar medium containing White's basal medium. E. Similar explants of banana tissue on the same medium supplemented by coconut milk and 2,4-D. F. Free cells of the banana fruit in liquid medium containing coconut milk and 2,4-D.

TABLE IV

Relative Abundance of Water and Protein Molecules in Cultured Carrot Cells

% H ₂ O	Micrograms per Cell	No. of H ₂ O Molecules	No. of Protein Molecules ^o	H ₂ O Molecules per Protein Molecules
90%	0.10 to 0.15	Order of 3×10^{15}	Order of 10^9	Order of 10^6

^o The number of protein molecules is estimated on the basis of a molecular weight of 64,000. If their average molecular weight were greater—say 640,000—the number of molecules would be proportionally fewer.

characteristics of the organism upon so much water with so little dry matter!

From the discovery of plasmolysis (by Carl Nageli, 1855) and its recognition as a special case of osmosis (by Wilhelm Hofmeister, 1867), attention became focused upon the relatively brief exchanges between cells and their environment with respect to water. To achieve success in the interpretation of the water relations of vacuolated cells—the simple osmotic view—virtually required that attention should be confined to cells *in being*, in contrast to those originating by division and throughout their growth, and it also required that the exchanges of solutes between cells and their environment be ignored, at least for the duration of the observations. It is therefore not surprising that the period that produced the works of Pfeffer (1877), de Vries (1871), and Graham and M. Traube (1867) saw the first emphasis upon the permeability of cellular membranes as the main control over the passage of solutes into and out of cells. But even so, Overton, the great exponent of permeability theory, sounded a word of warning and stressed that such molecules as sugars, amino acids, and inorganic ions (proverbially slow to move across the boundary surfaces of cells through their “passive” permeability) were nevertheless physiologically necessary, so that their intake into the cells was determined by a sort of secretory activity, for which the term “adenoid activity” was coined. With the passing of time, Collander, one of Overton’s distinguished followers and the outstanding modern student of cellular permeability in plants, has found it difficult to attach much physiological significance to the passive permeability phenomena (Collander, 1959). Indeed, Collander now regards all of the most operative movements of physiologically important solutes as being determined by active transport mechanisms. In such mechanisms the cellular organization must intervene to augment, or to override, the movements that would occur by diffusion alone.

The nature of ion accumulation in cells. This being so, it is surprising how recent are the views concerning active transport of solutes and ions across the boundary surfaces of cells. The early insight of Hoagland, prompted by his first studies upon *Nitella* (1923 to 1929, see Steward and Sutcliffe for references), ushered in an era in which the rigid adherence to simple equilibrium criteria, such as the Donnan equilibrium, was seriously questioned. It became possible to see cells as working machines which converted energy through metabolism to forms which could be directed to the initial accumulation of ions, or solutes, in cells and to their subsequent maintenance there against a concentration gradient which causes them to emerge from the cell when the source of that energy supply is withdrawn or diverted. Indeed, cells appear in true physico-chemical equilibrium with their environment only when they are dead! In this respect life may be seen as the maintenance of essentially non-equilibrium states.

Hoagland saw in the effects of light upon the accumulation of ions in *Nitella* (especially of bromide ion, which was first thought to enter the cells in large part by exchange for chloride—see Figure 2) the evidence that this was the ultimate source of energy for this essentially dynamic process. However, he also maintained that this energy was mediated for the accumulation *per se* through the metabolism of the cell. This truth was indeed self-evident. However, it later became apparent (see Steward and Sutcliffe, 1959, p. 325) that light must also have played a role in determining the growth of some of the cells that

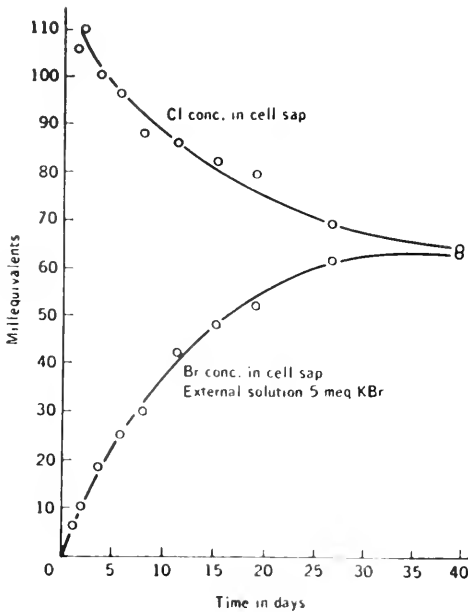

Figure 2. Effect of time on bromide and chloride concentration of *Nitella clavata* sap. (From Hoagland *et al.*, 1926.)

accumulated the ions (bromide). No such system, responsive to the morphogenetic effects of light on growth, can be held to be indifferent, or unaffected, during the course of these relatively long experiments, during which some cells became senescent and no doubt lost their absorbed content (chloride) to the solution. Thus the first experiments on *Nitella* focused attention upon the need of the accumulating cells for an energy source which could be made available through metabolism and applied specifically to the accumulation of ions in the cells. But these experiments could equally well have drawn attention to the fact that the further accumulation so achieved was essentially a function of growing, albeit slowly enlarging, cells. However, the emphasis on the system that could grow, whether by cell division or enlargement, was to come in other ways.

Although the early work of Hoagland and his collaborators ushered in, as it were, a period of intense inquiry and investigation at the end of the first quarter of the twentieth century, one may now see that the second quarter-century did little more than extend our knowledge of the kind of process, or processes, here involved. Different schools of thought made their impact upon the problem in ways affected by, if not limited by, the experimental materials that were favored and the experimental techniques that were adopted. For summaries of the early works on slices cut from storage organs—with their emphasis upon aspects of metabolism affected greatly by oxygen tension, by temperature, and by proximity to the outer surface of the disk, and their emphasis upon cytological events that foreshadowed a later stress on characteristics of cells associated with their ability to grow—reference may be made to the account already cited (Steward and Sutcliffe, 1959).

The use of excised roots in Hoagland's laboratory quickly produced an apparent paradox. The distribution of the accumulated ions along the axis of unbranched and excised roots reflected the activity of the accumulating cells in their own growth and development. Cells near the tip at the peak of their growth acquired high concentration, those away from the tip accumulated less (Prevot and Steward, 1936; Steward, Prevot, and Harrison, 1942). But the parallelism with growth seemed to be evaded by the massive accumulation of ions which could occur in a short time, though it was not maintained later, when the so-called low-salt excised root systems were exposed under appropriate conditions to the salt solutions (Hoagland and Broyer, 1936). The relation to aerobic metabolism, and therefore the process as an active non-equilibrium one, was again apparent from the role of oxygen tension, temperature, etc. But the paradox became clear when it was shown that during the growth of the roots and the plant, supplied only with limiting amounts of nutrients (NO_3 especially), they accumulated

high concentrations of sugar. When salts (KCl or KBr) became available to them, under conditions such that some of the sugar could be metabolized, the cells (as it were) rapidly completed a phase of their arrested growth, turned over much of the stored carbohydrate, and replaced this solute with the inorganic ions (Figure 3). Thus, by these means, two steps in the normal sequence of development were separated; namely, the initial secretion of sugar into the vacuole, and its later metabolism and partial replacement by other solutes such as salts.

One cannot recapitulate here even the essentials of the work on different plant systems, recently summarized by Steward and Sutcliffe (1959). Suffice it to say that work on thin disks of storage tissue, in the author's laboratories, passed through two main phases. It first showed the different variables that affected the over-all respiration and the accumulation of ions concomitantly, and in this phase of investigation the following implications became clear. It is necessary to maintain the processes of aerobic respiration at the required level to maintain a system with the requisite degree of general activity, but once the cells are in this activated state, they carry out many metabolic processes and are enabled, in the outcome, to take the salt accumulation, as it were, "in stride." The oxidative metabolism is therefore necessary to maintain the whole system in its active state—not merely to contribute the relatively minute fraction of the total energy so released that should suffice for the salt accumulation *per se*. Nevertheless, the metabolic pace of the whole system is clearly linked to the ion uptake of which it is capable.

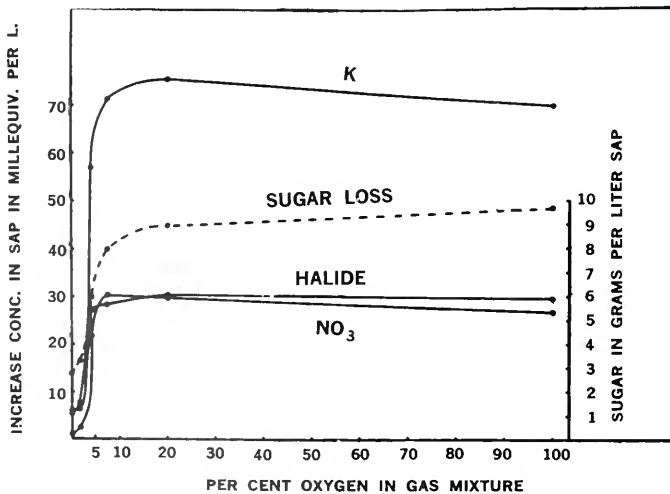

Figure 3. Relation of oxygen tension in flowing gas stream to accumulation of salt by excised barley-root systems. (From Hoagland and Broyer, 1936.)

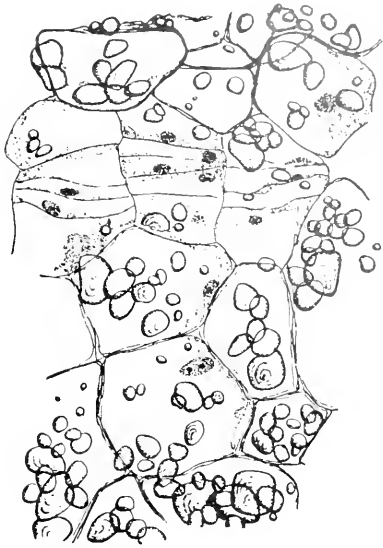

Figure 4. Starch disappearance and cell division in cells near a cut surface of potato-tuber tissue exposed to moist air.

In the second phase of investigation, certain features in the cells, other than the activated respiration, could be identified with the ability to accumulate the salts. These properties could be identified with ability of the surface cells of the disk to grow, as shown by their ability to divide when in moist air (Figure 4). Treatments that inactivated this type of activity (as, for example, storage of potato tubers at 1°C .; Steward *et al.*, 1943) simultaneously inactivated the salt accumulation, although it simultaneously increased the output of carbon dioxide. Thus the property to be causally linked to the accumulation of ions by the tissue was certainly not the carbon dioxide production alone. Unless the accentuated oxygen respiration, which was so characteristic of many accumulating systems, resulted in metabolic energy that could be directed into the constructive processes recognizable as growth, the salt accumulation would not occur or continue. The most significant property of the accumulating cells that are engaged in growth is their ability to synthesize new protein from their store of soluble nitrogenous reserves. In many hitherto unsuspected ways, it was found that the ability to accumulate ions was regulated according as the cells were or were not able to synthesize protein. Thus, paradoxically, one energy-requiring process (salt accumulation) that increased the free energy of the system became linked to another (protein synthesis), probably because both came to a common focus at a point at which metabolic energy was canalized into useful work.

It is not necessary here to follow the course of events through the investigations of other plant systems (such as *Valonia* species) or the

investigations of roots, attached and unattached, by other schools of thought. This has been summarized in the chapter already mentioned (Steward and Sutcliffe, 1959). What does seem to be profitable is to recapitulate in their present form the results of the investigations referred to above.

The essential ideas expressed above largely antedated (1930 to 1940) our present views on phosphate-bond energy and on the now-familiar concept that specific phosphorylated compounds, generated incidentally to carbohydrate breakdown, can apply their energy at specific points to do chemical or physico-chemical work. It is now natural to assume, therefore, that some part of the energy released in over-all respiration—a part which would be related to and a function of the whole—could be specifically directed to the energy-requiring processes of the accumulating cells, *i.e.*, to protein synthesis and/or to ion intake. One still sees, therefore, the energy delivered, as it were, in a similar package for the process of ion accumulation and for the protein synthesis which is its so frequent concomitant. Only if the energy is so linked does the relation between carbon dioxide output and ion intake appear. In fact if, in a number of ways that have been described, the “metabolic clutch” that throws the cellular engine into gear is disconnected, then the energy of respiration runs to waste. In these circumstances, neither renewed protein synthesis nor ion intake ensues; on the contrary, the cells may fail to retain their previously absorbed ions against water. For potato disks this is the condition that obtains after long storage of the intact tubers at low temperature, or if disks from normal tubers are treated at pH 7.0 with relatively high concentrations of carbon dioxide, or if they are exposed to low concentrations of dissolved oxygen. This condition, characterized by inability to accumulate solutes, is one which some cells normally approach in the culminating phases of their development, as, for example, in the cells of certain fruits, especially after the climacteric has passed, or in certain organs of monocotyledons that contain cells which can no longer grow. One now sees, therefore, the salient problem of salt accumulation to be the precise location in the cells of the site at which the metabolic energy is donated by a specific and identifiable energy-rich compound produced by, and a function of, the aerobic respiration of the cells. It would be consistent with the discussion thus far if the site in question could involve simultaneous effects upon ion intake and protein synthesis.

Cells vs. organelles (mitochondria). But how do these views fit into modern ideas about cells and their organization? A popular trend is to see how far the various physiological and biochemical events can be attributed to, or recapitulated in, the particles that can be isolated from cells. For the problems of salt accumulation by cells this would

seem to be a retrograde step, since salt accumulation seems to be indissolubly linked to the whole cellular organization and, in addition, to the ability of the cell to grow. The mitochondrion *in situ* is doubtless the site of production of active phosphorylated compounds, but it seems erroneous to conclude that, for this reason, it should be either an active seat of salt accumulation or necessarily an active site of protein synthesis. Both ideas have been suggested—the former by Robertson *et al.* (1955), the latter by Webster (1955, 1957). Neither of these ideas, insofar as they relate to isolated mitochondria, now seems profitable, especially because they divert attention from what may be the more essential fact. This is that cells are highly compartmentalized. Reactions and stimuli at one point result in actions and responses elsewhere, and the chief challenge of modern plant cell physiology is to determine how this highly discrete system operates in an integrated way. The true role of the mitochondrion would seem to be that, through its activities as a center of oxidation, the high-energy phosphate compounds may be made only to be released to the cytoplasm and thus convey the energy to the point of application.

In this context a recent study (Sutcliffe, Bollard, and Steward, 1960) of particles, obtained under aseptic conditions from cultured carrot cells by the methods used to isolate mitochondria, presents some significant features. The cultured carrot cells, growing on a medium containing the growth-stimulating substances of coconut milk (see Figure 1), not only synthesized protein readily but synthesized a special protein moiety which incorporated C^{14} -proline very avidly (Figure 5) and there converted it progressively into hydroxyproline (Pollard and Steward, 1959). The ratio of C^{14} -proline to C^{14} -hydroxyproline in the hydrolyzed total protein tends to come to a value of about 0.7. Thus one can use this technique as a sensitive and direct measure of protein synthesis in the growing cells. In this way it has been shown that exogenous C^{14} -proline appears appreciably in the protein after as little as 15 minutes, and it increases there linearly with time thereafter. The work of Sutcliffe, Bollard, and Steward (1960) showed quite convincingly that some C^{14} -proline could be incorporated into the protein of the supposed mitochondria as they were isolated from the same type of cells. However, if one measured both the protein synthesis and proline incorporation by the intact cells and by the particles isolated from them, they were not even of the same order of magnitude. Furthermore, there was an important qualitative difference, for the particles which, from their method of preparation, would be called mitochondria never formed hydroxyproline in their protein, although they did incorporate some C^{14} -proline. Again, studies have been made of the absorption of Cs^{137} by the intact cells and by the isolated particles. If the latter (regarded as mitochondria from their

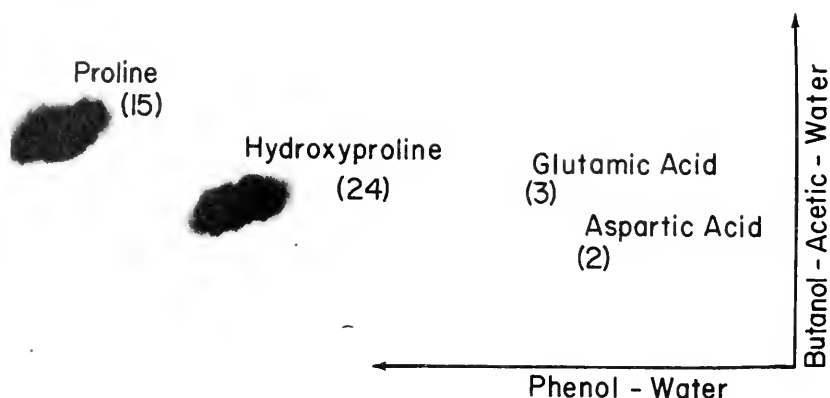

Figure 5. Radioautograph of a chromatogram of the hydrolysate of total protein in growing carrot explants which have incorporated C^{14} -proline. (From Pollard and Steward, 1959.)

method of preparation) are indeed the active organelles of accumulation *in situ*, it would seem that they ought to approach the activity of the whole cells at least within orders of magnitude! However, these discrepancies are such as to inspire no confidence whatsoever in the idea that mitochondria, as conventionally isolated, have any real role as the active organs of salt intake in the cells. Their role as the producers of energy-storing compounds which may be used in processes elsewhere in the cell is, however, another question.

Nucleate vs. enucleate states. The importance of the *complete* cellular organization for the study of vital functions may be assessed in other ways. Some cells (*e.g.*, mammalian red blood cells) become enucleate when mature. From others (amoebae, certain animal eggs, *Acetabularia*) nucleated and enucleated fragments may be compared as to their physiology. In still other systems the changes that occur in metabolism may be traced throughout the ontogeny of the cells as they pass from the state in which they are fully competent to divide to the fully mature state in which they may become incapable of division. Brown and Broadbent (1951) have traced these changes in cells as they occur along the axis of angiosperm roots. Some conclusions can also be drawn from the different metabolism of potato tuber cells as they occur in thin disks, according to the prior treatment of the tubers.

Old ideas of the nucleus as presiding over the metabolism of the cell, and particularly as the center of cellular oxidation and of protein synthesis, have given place to different ideas. These now recognize that the nucleus may exert an influence over the RNA of the cytoplasm.

Indeed, the demonstrably perforate nature of the nuclear membrane (Figure 6) and the possibility of direct communication between nucleus and cytoplasm via the endoplasmatic reticulum suggest an intimate association between the nucleus and the cytoplasm in the determination of cell metabolism and behavior.

When respiratory data are calculated on a "per cell" basis, Brown *et al.* (1951), do not now regard the most actively dividing cells in the apical meristem of the root as the most active in respiration. On the contrary, the respiration and protein nitrogen per cell *both* increase to a maximum at about that point along the axis of the root (5 mm. from



Figure 6. Portions of cells in the pro-meristem region, showing well-defined vacuoles and other cytoplasmic inclusions. Note the endoplasmatic reticulum. (From Whaley *et al.*, 19--.)

the tip for peas) at which the cells are fully extended. Thus the great increase of protein and the greatest respiration are not associated with cells that divide and multiply their self-duplicating structures as much as might have been supposed. If, however, respiration is measured per unit of protein in the cell, the protein present in the youngest cells (0.0 to 0.4 mm.) is found to be more effective in maintaining respiration than that in the older ones. Clearly there is initially a rapid phase of growth in cell volume, accompanied by a rapid increase in both protein nitrogen and respiration, followed by a protracted phase of slower development with respect to all three parameters (volume, respiration per cell, and protein-nitrogen content). It is data such as these that have prompted the view that relatively non-vacuolated, densely cytoplasmic cells, which divide more frequently, are not as active centers of metabolic activity as those cells to which they give rise by the onset of enlargement and the retardation of division.

The case of the potato tuber is instructive, because it can be shown that the ability of cells in thin disks to produce, concomitantly, a recrudescence of growth by cell division, of protein synthesis, and of respiration may be altered by prior storage at 1° C. when, although the respiration may be increased thereby, the effective energy coupling to growth by cell division and to protein synthesis is disturbed. In this respect the temperature treatment resembles the use of 2,4-dinitrophenol, because the energy of the carbohydrate oxidation runs to waste and is equally unavailable for protein synthesis, cell division, and prolonged bromide accumulation (Steward *et al.*, 1943).

The studies of enucleated cells and systems (see Brachet, 1957, pp. 308-351) agree that cellular respiration (oxygen respiration) may continue for relatively long periods in the absence of the nucleus. This agrees with views that assign the oxidative function to other organelles (*e.g.*, mitochondria). However, studies with P^{32} upon nucleated and enucleated portions of amoebae indicate that the nucleated portion maintains its ATP better than the enucleated one. Studies upon protein synthesis and incorporation of labeled amino acids into the protein of nucleated and enucleated amoeba (Brachet, p. 325) show that the activity of the nucleated fragments is maintained, whereas that of the enucleated one is not. In *Acetabularia* the physiological activity of the enucleated portion remains high and relatively unaffected by lack of the nucleus for a relatively long time, with respect to both respiration and photosynthesis. While the fact of independent RNA and protein synthesis in enucleated *Acetabularia* seems definite, it is equally true that eventually the lack of the nucleus causes protein synthesis to be arrested.

In general, then, all the evidence favors the participation of the DNA of the nucleus in the primary formation of the proteins of the

chromosomes and of cytoplasm but also indicates that DNA may affect less directly, the extranuclear synthesis of protein, because it may affect RNA in both the nucleus and the cytoplasm. It is very clear that protein synthesis can occur in enucleated cells; it is equally clear that no enucleated structure has any hope of permanence, and therefore even the behavior of the enucleated cells has its basis in the prior and nucleated organization.

It seems evident, therefore, that the role of the plant growth substances that exert their effects upon cell division (with its concomitant protein synthesis) and/or upon cell enlargement must operate in this area where nuclear-cytoplasmic effects are operating.

Submicroscopic structure of cytoplasm. It is now necessary to re-examine some of the ideas mentioned above in the light of current work on cells. The trend now is to indicate clearly that cells are extremely heterogeneous structurally, and that metabolically they are highly compartmentalized, in such a way that even similar metabolites may do different things in different parts of the same cell (Steward, Bidwell, and Yemm, 1956).

The extreme heterogeneity of the cytoplasm of plant cells is now evident from the examination of critically fixed cytoplasm in cells which admittedly are poor in vacuoles, for their presence so complicates the techniques of electron microscopy that good pictures have not yet been obtained with this type of cell. The cytoplasm of animal cells lends itself well to these studies, and excellent pictures are available in *Frontiers of Cytology*, edited by Palay (1958). At this point, however, one may pardonably assume that the sparse cytoplasm of the vacuolate plant cells should have somewhat similar structure to that which has been examined in the more meristematic cells by Whaley and others (1959). These instructive new techniques shed the following light upon the ion-accumulation problem.

It seems no longer feasible to think only in terms of well-ordered, multi-layered, rather static surface membranes which allow solutes to pass through pores into the more or less liquid and homogeneous cytoplasm and across which the solutes move, by some activated but free diffusion, into the vacuoles at the inner surface. The current picture (see Figure 6) is that the cytoplasm is traversed by a system of canals—the endoplasmatic reticulum—which seems to connect with both the outer (especially at plasmodesmata) and the inner surfaces—especially the nucleus. If these canals are real channels of transport, we may have to look for strictly localized sites of entry into the cell and localized channels of transport through the ground substance of the protoplasm, as well as a much more discrete mechanism of entry into the vacuole, than has previously been conceived. Both mitochondria and Golgi bodies represent vesicular inclusions in the cytoplasm from

which elaborated products may be, and no doubt are, released into the cytoplasm.

Pinocytosis and its possible role in activated transport. It has been a constant source of wonder as to why ions accumulated in vacuoles should ever be withdrawn from the living cell, or even from the vacuoles into the cytoplasm. Isolated cells, as of roots, having absorbed such solutes, hold them so tenaciously that they release them to the outer solution only if they are almost killed. But in the intact plant body, movement from cell to cell and organ to organ is obviously relatively easy. The phenomenon of pinocytosis, studied in *amoebae* by Holter and others (1959), is highly suggestive here. The outer surface of the protoplasm, especially when in contact with the suitable but concentrated solution, throws itself into pseudopodial folds, and these become vesicular, enclosing a minute canal along which injected fluid and C^{14} -labeled solutes may pass into the cytoplasm (Figure 7). Workers on pinocytosis now see the process as of more significance because of the resultant injection of dissolved substances than because of the water which gave the process its name originally (Holter, 1959). Indeed, Holter (p. 537) now sees this newly emphasized mechanism "in relation to the whole great problem of active uptake and transport of substances by cells."

The presence of a cell wall in plants precludes the observation of this phenomena at the outer membrane surface, in contact with the more dilute external solutions. However, the vacuolar surface has long been known to be a seat of movement, and protoplasmic strands, which often traverse the vacuole, may undergo "make and break" (see Figure 8). It is conceivable, therefore, that whereas the entry of solutes into the vacuole may be negotiated along a discrete system of canals (the

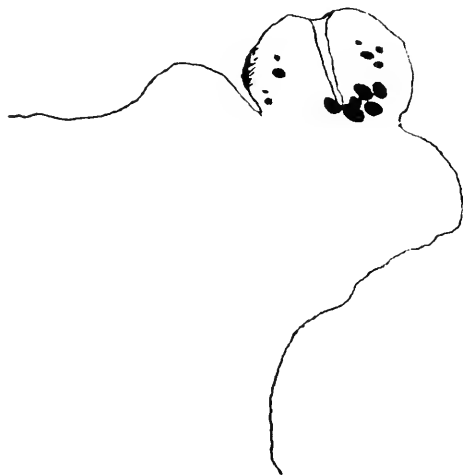

Figure 7. Diagram to show pinocytosis of inorganic salts in amoebae. (From Chapman-Andresen, 1958.)

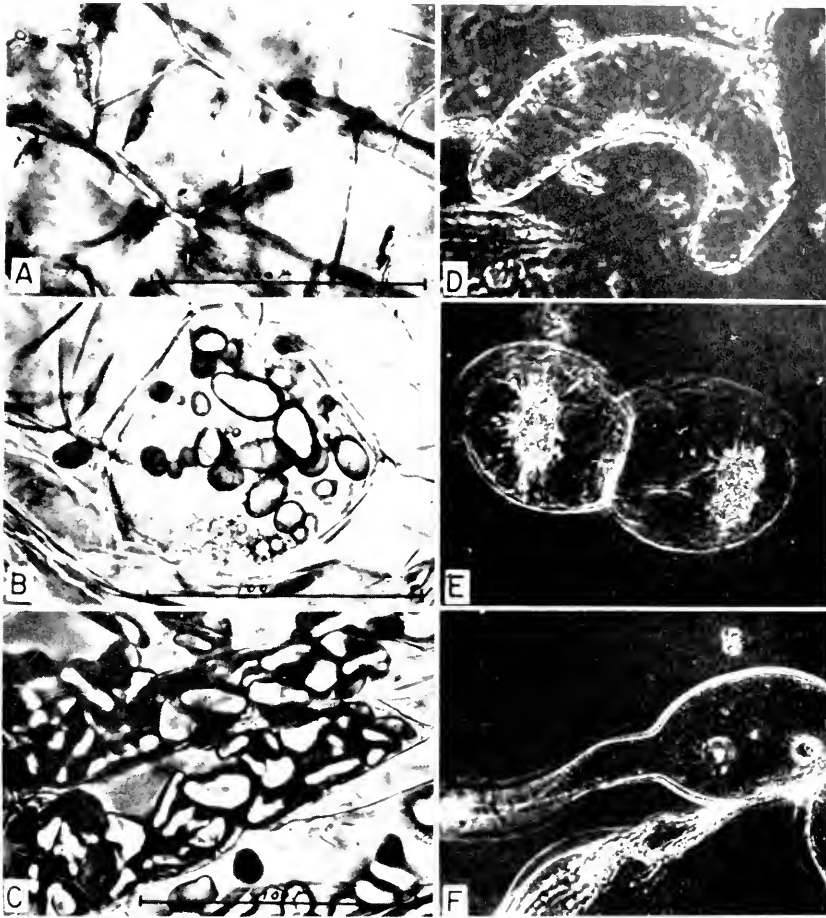

Figure 8. Comparison of cells in their resting and activated states. A: Phloem parenchyma of carrot root. B: Starch-filled cells of potato tuber. C: Cells from pulp of the harvested but unripe banana fruit. D: Same as A, after culturing in a basal liquid medium with coconut milk. E: Cultured cells of potato tuber showing granular inclusions surrounding the nuclei. F: Cultured cell of banana. (Note prominent cytoplasmic strands in D and E. Cells in E and F were grown in a liquid medium containing coconut milk and 2,4-D.)

endoplasmatic reticulum), their later withdrawal into the cytoplasm may be achieved by some phenomenon analogous to pinocytosis.

The cell as a working machine. Thus the great need now, in the interpretation of salt accumulation in cells, is not for more sophisticated schemata based on outmoded concepts of cells but for more direct observational data which will relate cells as integrated working

machines (with their much more intricate cytoplasmic structure than was previously recognized) to the actual events involved in salt accumulation *in vivo*. Merely to compare actively growing and potentially dividing cells with their quiescent, inactive counterparts (see Figure 8) is to contrast a working factory in which every operation is going apace in a coordinated way with the same shop with the fires banked down and the machinery stilled.

The problems of actively metabolizing cells are acutely problems of organization, and the need is to understand how the several parts work together to form a harmonious whole. For example, it seems hardly likely that light will be thrown upon the problem of salt accumulation by applications of enzyme kinetics which are strictly appropriate only to homogeneous systems—especially when this form of analysis is even applied to whole organs such as roots and there is no attempt to locate the postulated sites of ion-absorbing activity in the root. In these circumstances any resemblance between the processes of ion intake *in vivo* and the relations of a substrate and an enzyme seem to be coincidental.

The crucial question seems to be this. In order to grow, cells must absorb; to absorb, they must also grow. The cells that can grow use their energy of metabolism in many ways—to synthesize protein and to maintain the cellular machinery in a variety of ways. Provided the metabolic machinery is “in gear” and canalized toward the constructive use of respiratory energy in growth, some of it gets incorporated into the phosphorylated compounds that can apply the energy at those focal points in the cell at which work is being done.

Cells that cannot synthesize protein may not accumulate ions *de novo*. Cells that grow predominantly by division absorb and accumulate ions by different devices from those that grow predominantly by cell enlargement. Cells which, by virtue of the cell-division factors in their medium, have their activities predominantly directed toward cell division, tend to absorb ions to a relatively low degree of “accumulation,” and this type of absorption is found to be dependent upon stoichiometrical binding at sites that are being multiplied. This absorption in rapidly proliferating cells reaches a fairly stable “accumulation ratio,” and the cells’ concentration of the ion bears a linear relationship to the external concentration. Thus the degree of accumulation of an “indicator ion” (*e.g.*, Cs^{137}) is relatively unaffected by the presence of a large excess (100,000 times) of the carrier cesium ions, which are indistinguishable by the cells from the radiocesium ions (see first section of Table V). These data (extracted from a review by Steward and Millar, 1954) can be interpreted on the basis that the concentration of cesium in these proliferating cells varies as the first power of the external concentration. The situation is very different for carrot cultures

TABLE V

Absorption of Cs¹³⁷ by Proliferating and Non-Proliferating Carrot-Tissue Cells, With and Without the Addition of Non-Radioactive Cesium

Tissue		Days after Inoculation			
		4	7	10	14
Rapidly growing cultures, stimulated by coconut milk, increasing in cell number	With carrier cesium	7.30	9.14	14.1	13.4
	Without carrier cesium	9.43	10.7	12.9	14.5
Cultures <i>not</i> stimulated to grow by coconut milk: cells growing sluggishly and mainly by enlargement*	With carrier cesium	27.2	53.1	77.7	79.5
	Without carrier cesium	375	649	2050	2130

* The entries for the slow-growing cells represent accumulation ratios of Cs¹³⁷, measured by the counts per second per gram of tissue (fresh weight) divided by counts per second per cubic centimeter of the external solution.

in which, because of a lack of the cell-division growth factors, the cells tend to grow by enlargement rather than by cell division (see second section of Table V). In these cells the degree of accumulation (as measured by the accumulation ratio) is greatest from the most dilute solutions; this is a common feature. Consequently the accumulation from a fixed concentration of the radioactive ion is greatly reduced by the presence of the inert carrier cesium.

A striking, but nonetheless curious, example of these contrasting behaviors of cells is illustrated by Figure 9, presenting experiments on tissue from tubers of Jerusalem artichoke (*Helianthus tuberosus*). Unlike the situation in the case of potato tubers, the initially high respiration (CO₂ production) of freshly cut Jerusalem artichoke disks or explants in water declines sharply with time. After some eight days the respiration rate has reached a much lower and somewhat constant level. But in the presence of coconut milk the respiration rate is maintained through this period at a considerably higher level. As in the case of the carrot tissue, the more actively dividing tissue in a coconut milk medium maintains a lower internal concentration of Cs¹³⁷, but absorption proceeds concomitantly with growth to maintain this level. By contrast, the relatively non-proliferating tissue absorbs and stores Cs¹³⁷ in its expanding cells and enlarging vacuoles, and the radiocesium reaches a higher concentration in the tissue. If, after eight days, cell-division

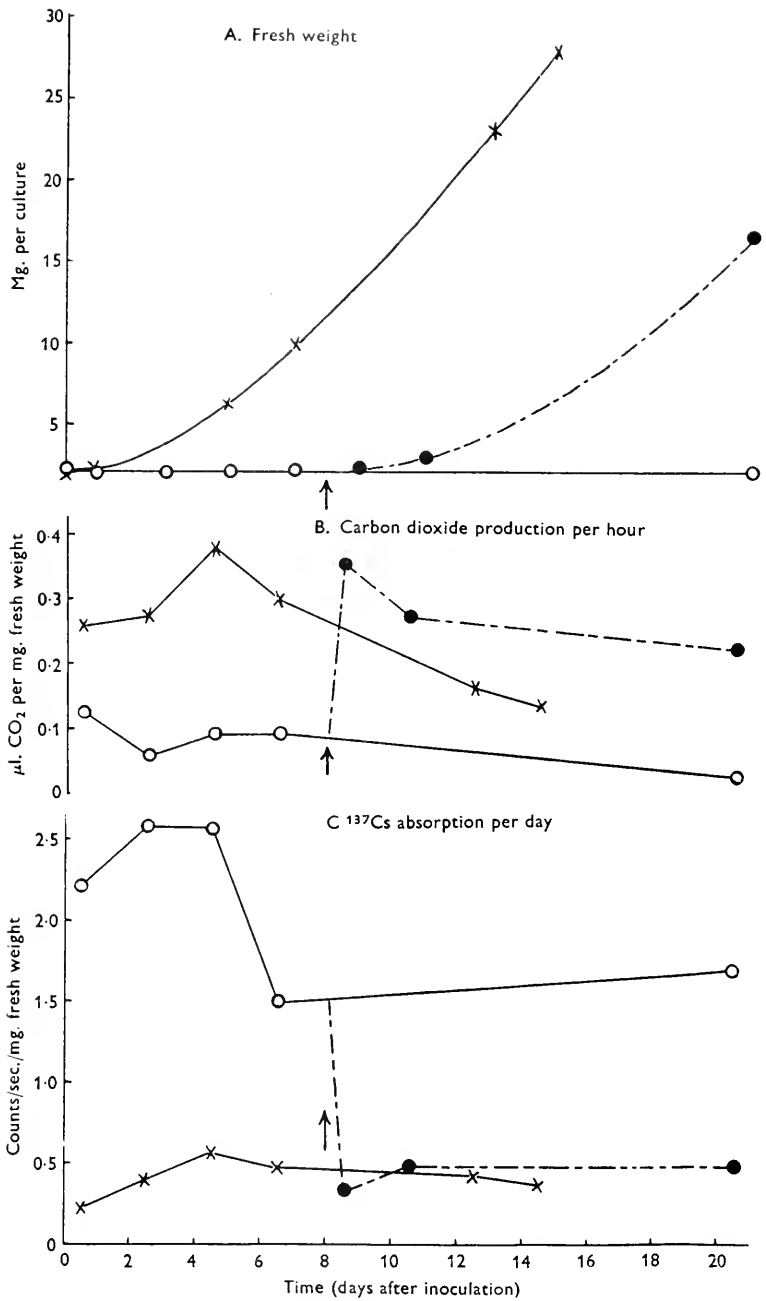

Figure 9. Effects of time and the factors in coconut milk on growth, respiration, and absorption of Cs¹³⁷ by explants of Jerusalem artichoke tuber. (From Steward and Millar, 1954.)

stimuli in the form of coconut milk are added to tissue previously kept in distilled water (or Ca Cl_2), its total respiration is increased as the cells begin to grow and divide; at the same time, the amount of Cs^{137} absorbed per day is such as to reach a lower concentration than in cells which, lacking the coconut milk factors, are not dividing but only extending. These data then show again the sharp contrast between the ways in which dividing cells and enlarging cells absorb ions from a given solution, and the concentration levels attained. In the case of dividing cells, limited "concentrations" are built up by ionic binding on sites which multiply, and the internal concentration is proportional to the first power of the external concentration. In the other case, the growth of the vacuole invokes a mechanism of secretion from the cytoplasm into the vacuole, and in this situation a logarithmic relationship obtains between the internal and external concentrations, so that the degree of accumulation (accumulation ratio) is greater from the more dilute solution.

All these facts have been interpreted to mean that a given cell, in its ontogeny, passes through a first phase in which the ions are bound predominantly on given sites (or surfaces) which are themselves renewed or reduplicated as growth and synthesis proceeds. But as the growth shifts to a condition in which the dividing cells mainly enlarge, and vacuoles form and extend, the ions vacate their previous sites and are secreted into the vacuoles, and so the process may be repeated. (For a general scheme which incorporates these ideas, see Figure 39 of Steward and Sutcliffe, 1959.)

Growing and non-growing cells: Their physiology and metabolism

Sites of action of the growth factors, etc. Some evidence does exist concerning the site of action of the factors that induce or control growth by cell division and by cell enlargement. This evidence flows first from some data upon the effects of radiation. Resting, quiescent tissue, prior to the induction of growth, is very vulnerable to radiation at the point at which cell-division factors, such as those in coconut milk, would otherwise intervene to induce growth by cell division. But although this center of activity is knocked out by radiation, the cells may still enlarge. By contrast, if growth induction by cell division has occurred, the cells become surprisingly resistant to much higher dosages of radiation (Table VI). Similarly, the pre-induction cells are more resistant to cyanide and carbon monoxide than are the post-induction cells, whereas the converse is true of susceptibility to inhibitors that uncouple phosphorylation. This would seem to indicate that carbon monoxide, cyanide, and radiation all affect the cells at a point at which the coconut milk stimulus normally intervenes to unleash the

TABLE VI

Effects of Radiation on Growth of Carrot Cultures by Cell Division and by Cell Enlargement*

A. Effects of irradiation on growth induction by coconut milk				
Growth Period	Not Irradiated		Irradiated (0.10 × 10 ⁶ r)	
	No. of cells per explant (in thousands)	Size of cells (in micrograms per cell)	No. of cells per explant (in thousands)	Size of cells (in micrograms per cell)
24 hrs.	24.0	0.133	16.5	0.196
13 days	571.0	0.103	21.5	0.250

B. Effects of irradiation at eight days on subsequent growth in coconut milk medium				
Further Growth Period	Not Irradiated		Irradiated	
	24 hrs.	117.0	0.137	126.0
13 days	680.0	0.141	508.0	0.110

* The data in this table are taken from hitherto unpublished work with Dr. Z. I. Kertesz of the New York State Geneva Agricultural Experiment Station and Cornell University.

growth by cell division. Simultaneously, the process of *de novo* protein synthesis also is unleashed by the coconut milk stimulus, and Stage 1 of the process of ion intake, as described by Steward and Sutcliffe (1959), gets under way. To the extent that the radiated cells have a residual ability to grow by cell enlargement, they (and no doubt also those treated with carbon monoxide and cyanide) can still absorb some solutes into their vacuoles, but this is strictly limited unless continuous growth by cell division is restored. At this point one can only say that the coconut milk stimulus which causes growth by cell division may also cause some relatively drastic changes in the chromosome complement, especially of free cells. This may be illustrated in a tissue culture of *Haplopappus gracilis*, studied by Dr. J. Mitra, working with the author. In suitable combinations of coconut milk and either 2,4-D or NAA, the stem tissue of this plant will grow, and its two pairs of easily recognizable chromosomes ($2n = 4$) may now undergo easily detectable changes. Thus the chemical stimulus administered by the coconut milk, which induces the growth, is also exerted in the area in which chromosome duplication (DNA) is taking place, and all the

other events—protein synthesis, growth of the cells, ion accumulation—may stem from this fact.

Therefore it is essential to interpret the facts of salt accumulation, recognizing that it is the factors controlling the growth of the cells, first by cell multiplication, later by cell enlargement, that will ultimately control the course of absorption and the final concentrations obtained. This inevitably means that the problem is one of organization and of the specific agents and factors that control the pace and kind of operations it can carry out. But the resting, quiescent cells may differ from active ones in another important respect.

Metabolism and "turnover" in quiescent and growing cells. Cells in their resting state may be expected to exist in a state of nitrogen balance. Any breakdown of protoplasmic protein could be made good by a minimal resynthesis of protein from stored, soluble nitrogenous reserves. But the net effect of this on the carbon balance sheet of the tissue should be negligible. Thus the principal fate of absorbed sugar could well be the conversion of sugar to CO_2 and water by one or another of the standard respiratory routes (glycolysis and Krebs's cycle, etc.).

But when metabolic activity and protein synthesis are stimulated by good aeration and minimal concentration of carbon dioxide, it has seemed necessary to visualize a different possibility. Under these circumstances a principal use for sugar is to furnish carbon for protein synthesis. Moreover, the ready use of the products of glycolysis and the normal operation of Krebs's cycle may be limited for lack of free CO_2 and by fostering decarboxylations. In this way, metabolism gets diverted to the resynthesis of protein from the nitrogen-rich compounds of the tissue, using sugar as the main source of extra carbon; meanwhile the deaminated and deamidated products of the erstwhile storage nitrogen compounds are then respired away in the form of keto acids which can enter Krebs's cycle, as it were, by the "back door" (Steward, Bidwell, and Yemm, 1956, 1958). This view gains credence from the observation that a prime effect of coconut milk, in the stimulation of growth, is not only to promote the net synthesis of protein but also protein turnover. The evidence for "turnover" is that glutamic acid, formed from sugar, becomes labeled in the protein much more rapidly than would be expected from the direct incorporation of the labeled free glutamic acid of the cell. Thus again one should consider the cell, in its growing and non-growing states, not merely as a bag of enzymes that recapitulate their properties as if in homogenous solution but as a highly integrated, coordinated system, capable of doing quite different things in its separate parts and in its separate states. The balance between these various activities—the emphasis given to one or the other—obviously may be controlled and regulated by the

exogenous supply of substances, of the kind present in coconut milk, which induce growth by cell division.

The idea that metabolic patterns may be different in rapidly proliferating and resting cells has been brought out by Braun (1954) with reference to the biochemistry of tumor and gall development. Reference has been made by Braun to the work of Neish and Hibbert (1943), who showed that it is a primary feature of the tumor cell to divert sugar to the formation of protein—a feature which is shared by carrot cultures stimulated to grow by cell division by the effect of coconut milk.

Asymmetric synthesis and molecular architecture of complex substances. The asymmetry and organization of the living system and the factors that control growth also exert an influence over the ways in which complex substances are built up in the cell; this is amply illustrated by the well-documented case of cellulose in the cell wall. The problem here is not only the formation of the chains of anhydro-glucose units linked by 1-4 β (D) gluco-pyranose linkages (this is one of innumerable asymmetric syntheses in the asymmetric environment of cytoplasm), but to explain the formation of the molecular architecture of the cellulose as it exists in the plant cell wall. This architecture must be built up by events determined at a higher level of organization, for its consequences are visible with the electron microscope.

Cellulose newly formed at a naked protoplasmic surface consists of fibrils which are randomly arranged, forming a tangled weft with the minimum of organization. This is well shown by the newly formed cellulose on the surface of a *Valonia* aplanospore—i.e., a spherical droplet of naked protoplasm at the time of its formation (see Figure 10). As the sporeling grows—and it does this best if it is stationary and attached to a surface like marble, which simulates the natural substratum (Steward, 1939)—successive cellulose layers are laid down. The cellulose chains become increasingly oriented, lying parallel to one another as they follow a spiral path around the enlarging vesicle. But the remarkable thing is that, after having first formed cellulose in this way, the direction of the fibrils shifts abruptly—usually so that the fibrils in the new direction cross those of the old at angles about $120^\circ/60^\circ$. This process is repeated, so that in a multilayered wall like that of *Valonia ventricosa* the fibril direction in the first, fourth, seventh, etc. layers tend to be parallel (see Figure 10).

Here we have, then, what seems to be morphologically a very simple system—an expanding, globular vesicle with a central, sap-filled cavity and a thin peripheral sheet of protoplasm which secretes a wall around itself. What kind of message directs the vesicle to abandon the first formed random wall and to produce the first spiral arrangement? And what signal then prompts the periodic shift in direction in the

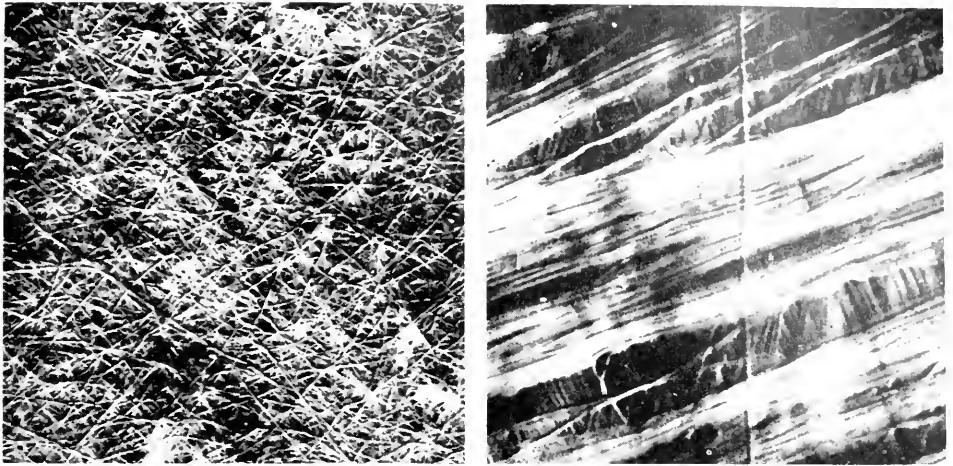

Figure 10. Electron-microscope studies of the cellulose in the wall of *Valonia*. A: Randomly arranged fibrils in the newly formed wall on the surface of a sporeling. B: Strongly oriented, parallel fibrils in the mature wall of an old vesicle. Strands can be seen in three directions in successive lamellae. (From Steward and Muhlethaler, 1953.)

orderly way described? This is an example of the problems that the molecular architecture of complex substances presents, and it is in an understanding of the organization of the living system that a solution should be sought.

In part, the controls over these events may be environmental. If sporelings grow as filaments, away from red light (as in *V. ocellata*, cf. Steward, 1939), their cellulose chains tend to run along the length of the filament. One suspects that if sporelings could be grown in a symmetrical environment, with the geotropic stimulus neutralized and without diurnal variations in light and temperature, much of the structure of the normal cellulose wall would change. Anderson and Kerr (1938) have shown, very beautifully, that the wall of the cotton hair, which forms one new layer each day, becomes much more uniform and homogeneous if the diurnal variations of the normal environment are replaced by constant conditions (Figure 11). Although very little work has yet been done upon them, it is significant that the newly formed walls of free carrot cells, growing in a liquid medium under uniform illumination and aeration, are, like the aplanospores of *Valonia*, formed of cellular fibrils arranged in a relatively random fashion (Figure 12). However, in the course of normal development of more organized structures—such as fibers and vessels—which obviously develop under the influence of asymmetric stimuli within the plant body, the cellulose wall has the strongly oriented structure described by so many workers.

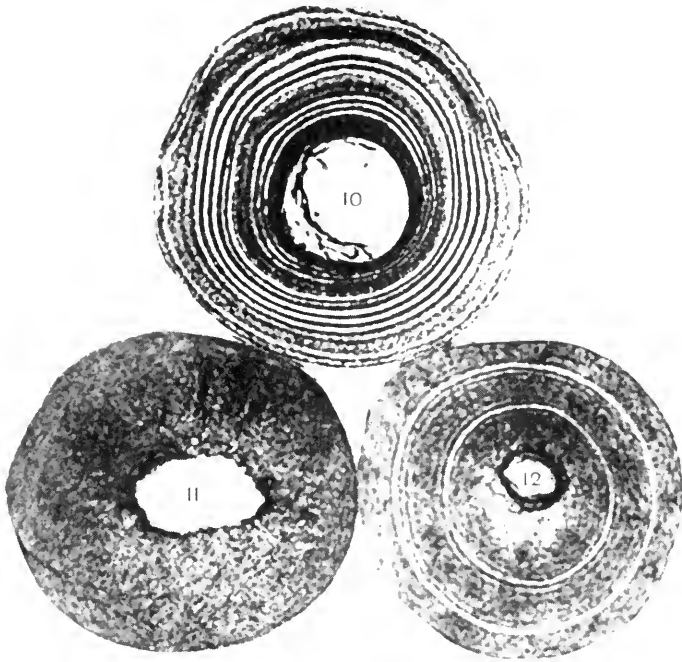

Figure 11. Cross-sections of the cotton hair, showing the hair's strongly lamellated structure (10), which disappears if growth occurs under constant environmental conditions (11) but is restored by experimentally-induced diurnal variations (12). (From Anderson and Kerr, 1938.)

If the living system intervenes in so many ways, through factors operating both from within and without, to determine the architecture of so relatively simple a product as cellulose, built essentially of 1-4 β -glucosidic links, how much more may this apply in the case of such complex substances as protein? The point here is that the controls are neither solely genetic nor inherent in the enzymes that produce the chemical syntheses *per se*, for there must also be obvious controls which operate at the macromolecular level, and these can only be regarded at present as essentially part of that complex which we recognize as organization in the cell and the organism.

Although the above example was drawn from cellulose, a similar argument could be constructed for starch. Phosphorylase may unite glucose-1-phosphate to form the 1,4 α -glucosidic links and this, with the "branching enzymes," may determine whether chemically recognizable amylose or amylopectin is formed, but the morphological structure of the starch grains, which is characteristic even of species of



Figure 12. Appearance under the electron microscope of the wall of cultured carrot cells. (From a photograph by Muhlethaler of material supplied by the author.)

plants, can form only under the influence of the leucoplast as a living inclusion in the cell.

Redistribution of solutes to centers of growth

If salt accumulation in cells follows the lead of growth, it should follow that the redistribution of solutes within the plant body should be related to centers of growth. A powerful "sink" where cells are growing will draw solutes over long distances from a "source" at which cells have completed their development and can only release their solutes. Moreover, the movement would not only be determined in its direction by these growth events; it must inevitably be responsive to the ability to accumulate at the "sink" and to release solutes at the "source." Certain centers of growth and salt accumulation in angiosperms have been recognized, and solutes may be redistributed to these after their initial absorption and accumulation by roots (*cf.* Steward, 1954).

In dicotyledonous shoots (*e.g.*, of *Populus*) the cambial region, when isolated from growing leaves and buds, appears as an active region of salt accumulation, in comparison with the dilute solution in the xylem at that level. But when the cambial region is in direct contact with growing leaves, via vascular traces in which growth is active in the current year, then the growing leaf, or bud, "calls the tune" and accumulates the solute—depleting the cambial region as it does so (Steward, 1954; summary in Steward and Sutcliffe, 1959).

As each leaf comes successively into its "grand period of growth," it enjoys a period of active primary accumulation of solutes. But even so, when new phyllotactic cycles unfold and there are younger leaves above in the same orthostichy, these may require solutes faster than they can be supplied from the roots. Thus the younger leaves may deplete the older ones, which in turn acquire a vicarious ability to reabsorb salts when the supplies from the root again become available (*e.g.*, as at night). A case in point is the entry of bromide, supplied via the roots, into leaves of the first phyllotactic cycle of *Cucurbita pepo* seedlings. Growing leaves compete for the bromide they receive via the stem, and they do so in a way which reflects their own intensity of growth, as reflected by the stage of their development relative to "Sachs' Grand Period of Growth" (Figure 13). But if the plants have access via the roots to nutrients and to bromide, concurrently with the daylight conditions that cause the leaves to grow, then the young leaves grow better than if they have access to nutrients and to salts only in

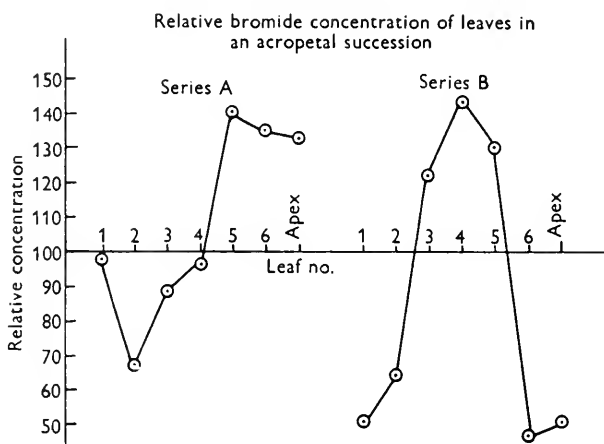

Figure 13. Relative bromide concentration in leaves of *Cucurbita pepo* in an acropetal succession. The relative concentration in each leaf equals the concentration in the leaf divided by the average concentration in the leafy shoot as a whole. (Data from F. C. and A. G. Steward, cited in Steward, 1954.)

the dark. Under these circumstances the youngest leaves and the shoot apex grow, and they receive salts and bromide both from the roots and from the lower leaves with which they may be in direct contact. Thus, as leaf No. 6 (Figure 13) came into its active growth period, it tended to deplete leaf No. 1 of solutes, which in turn could be replaced from the roots when the conditions permitted this. In the 2/5 phyllotaxis of *Cucurbita pepo* (Figure 14), leaf No. 6 connects very directly via a main cauline bundle with leaf No. 1 below.

Thus one sees the internal nutritional economy of the plant body to be responsive to the interplay of the factors in the growing point of the shoot that regulate and coordinate its development. The facts of anatomy and developmental morphology are here neither redundant nor old-fashioned. Indeed, the problems of nutrition become meaningful only as they are interpreted through the metabolism that furnishes the energy and drive for the endergonic processes of growth and also through the morphogenetic responses that are the unfolding expression of the stimuli to growth and organogenesis in the shoot apex. If plants are actively accumulating salts or solutes, it is a sound axiom to look for the places where they are most actively growing, and when movement and redistribution occur, it is also sound to see the driving force that regulates the pace of movement through the use of metabolic energy in the growing, accumulating cells at the "sink." For this reason the leaf in the light, quite apart from its "transpiration pull," exerts its

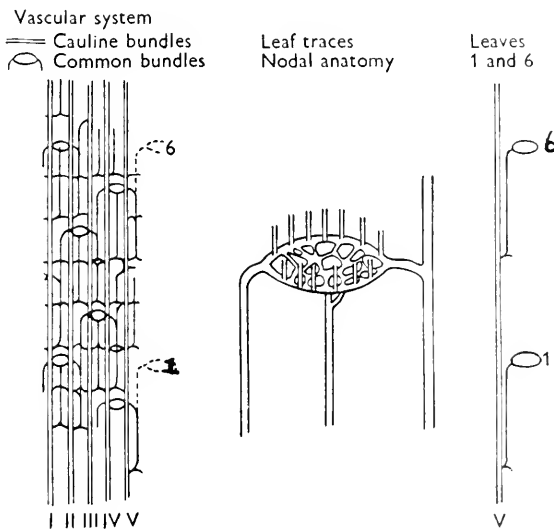

Figure 14. The vascular pattern of *Cucurbita pepo*, showing direct connection of leaves 1 and 6 via cauline bundles. Each leaf receives three leaf traces which fuse into a network at the nodal plate. Of these three traces, one springs directly from a cauline bundle. (From Steward, 1954.)

influence upon the absorbed and redistributed solute, whereas the growing leaf in the dark may not do so (*cf.* work of Millar and Pollock in Figure 64B of Steward and Sutcliffe). Without this pull at the "sink," no active movement along the channels of transport would be of much avail. We are, however, quite at a loss to know what form of signal passes from the accumulating cells at the "sink" to the cells at the source to prompt them to release their previously accumulated solutes.

Two further thoughts are relevant. The role attributed to the cambial region in dicotyledons, which draws off solutes laterally and furnishes them to growing regions above, can be played in monocotyledons by the intercalary meristems in the ensheathing bases of leaves (Steward, 1954). Secondly, the workers on translocation may have been too preoccupied with the characteristics of mature elements of xylem or phloem, regarded as the principal channels of transport over long distances. On the philosophy here outlined, the newly formed cells of the cambial and procambial region—without sharp distinction between xylem and phloem mother cells—have essential prerequisites for a role in rapid transport, and the mature sieve tube would then suggest the "remnant, like a dried-up river bed, suggestive of the place where flow once occurred."

Thus the plea is made here for a return in these problems of plant physiology to their reconsideration in terms of growth and development as the all-important background against which the cellular physiology and biochemistry will become more meaningful.

Cell physiology and morphogenesis

Morphogenesis is the response of the growing system to certain controls, external and internal, and it is natural to see those controls as mediated by chemical growth regulating substances which make their effects apparent upon growth either by cell division or by cell enlargement. This again suggests areas of reponse in which it is important to understand the cells as organized systems capable, by virtue of this organization, of manifold interlocking functions, such as protein synthesis, salt and water intake, etc.

Stimuli to growth. The most important stimulus to growth and morphogenesis is that which follows upon fertilization of the egg. The zygote grows apace, but in angiosperms the product of the other nuclear fusion, which gives rise to endosperm, may often outpace the young embryo. Thus there are laid down, precociously and in advance of the embryo's needs, the nutrients and sources of stimuli that will nourish the zygote. In the present context the point of this observation is that these materials, especially the liquid content of the endosperm,

are now known to contain powerful stimuli to cell division and to all those physiological processes that "follow the lead of growth." These same stimuli—alone or in some cases in conjunction with synergists such as 2,4-D, NAA, certain phenylacetic acids, etc.—will actually restore even mature cells to active growth by division, a characteristic of the embryonic state (Steward and Shantz, 1959; Steward and Mohan Ram, 1960). In these circumstances the resultant growth, with all its consequences for renewed protein synthesis, water absorption, and solute absorption, is released by the exogenous stimuli, which unleash or evoke latent capacities for growth and development that were inherent in the organization of the mature cells. The salient point for this discussion is simply this.

Extrinsic and intrinsic factors. Freed carrot cells, removed from their neighbors *in situ*, display a variety of morphogenetic responses when stimulated by coconut milk (Steward, Mapes, and Smith, 1958). Since the stimulus to grow is in relative excess and comes from without, the cells respond in a variety of ways which suggest that, freed from extrinsic controls, they now give expression to intrinsic capacities for growth. By contrast, when the same cells are part of an organized mass, limitations upon their behavior are imposed by their position in the mass, and they are thus confined to a rigid pattern of growth which is dictated by the milieu. Thus a carrot tissue explant, free of cambium, grows as a proliferated cellus and virtually never organizes, but, in sharp contrast, the cells freed from it produce a great variety of form and responses by cell division, for they also organize readily, forming roots, shoots, and even whole plants (Steward, Mapes, and Mears, 1958). In other words, a single carrot cell from the secondary phloem of the root, even after passage through many transfers in liquid culture, still contains all the coded information necessary to recreate a carrot plant. The nutrients that evoke this growth response, interestingly enough, are just those nutrients that normally nourish immature embryos. Thus a given cell has its *nature* determined by its genetic constitution, but its *nurture* is still a potent factor in its growth and development.

Totipotency of cells. A most striking point is that the freed cells of carrot (*cf.* Figure 8), suspended in a liquid medium which can make them grow (*i.e.*, one containing coconut milk), are now seen to recapitulate in the first sequences of their division many stages that are very reminiscent of the early embryogeny of the carrot plant (Figure 15; *cf.* Steward, 1958). Indeed, there are now good reasons to regard a zygote as but a particular diploid cell which can grow when in an internal medium fully competent to make it grow. If the role of the natural nutrients that normally nourish the embryo is in large part replaced in the culture medium by the use of coconut milk or morpho-

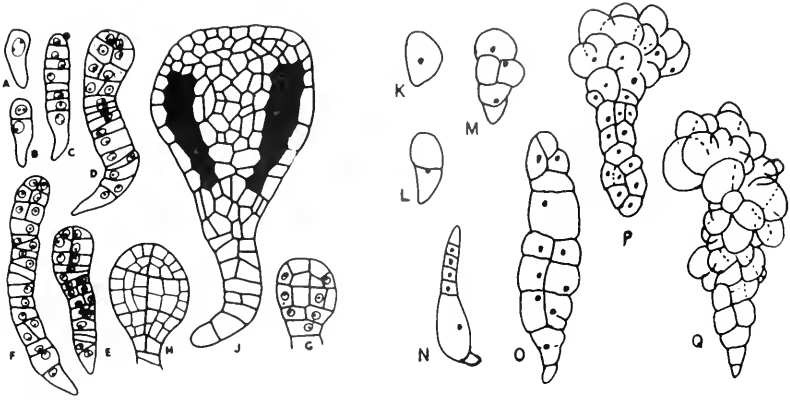

Figure 15. A.-J. Normal embryogeny in the carrot (reproduced from Wardlaw, 1955). K.-Q. Drawings of cells and cell colonies grown from free cells of carrot phloem by the aid of coconut milk.

logically similar materials, the free cells will tend to behave like zygotes. These facts are reminiscent of certain cases of spontaneous apomixis in which a given cell, despite its location in the plant body, begins to grow and behave like the equivalent of a zygote.

Thus the entire, organized, integrated living cell may have inherent but often undisclosed potentialities—*i.e.*, totipotency. The way in which these potentialities are suppressed (as in much normal tissue differentiation) or evoked (as in the responses of the free cells in culture) is presumably determined by the action of growth-regulating mechanisms and compounds. These substances mediate their effect by controlling growth, as it occurs by cell division and by cell enlargement, and thus determine by their interactions the patterns of development that ensue (*cf.* Steward and Mohan Ram, 1960). Since these controls or factors are essentially extra-nuclear, they are equivalent to what Waddington (1957) has termed epigenetic factors or effects—*i.e.*, factors that override the fixed effects of normal genetic constitution. To express these ideas we really need a term which is noncommittal as to the mode of action and is free from the connotations of the existing terms gene, hormone, and vitamin. This term should imply that the substances or mechanisms in question can, within genetically fixed limits, modulate the course or behavior of the cells or organisms, much as the predetermined path of a vessel or a projectile may be modified by suitable controls or instructions issued en route.*

* A Latin word "moderamen" described the arrangements to steer or control, as in a vessel or chariot. So one could call all these controls which are exercised over the living system as "moderaminous" and the substances through which they are mediated as "moderaminants." The scope of such a concept could embrace effects otherwise somewhat arbitrarily assigned to a role as vitamins or hormones,

The argument has thus come full circle. To understand so seemingly specific a problem as the means by which a plant cell acquires its accumulated potassium, one had to invoke the inherent ability of the cell to grow, and it was seen that this process could not be adequately understood without recognizing the role the organized cell may play through both its operation and its self-duplication. The passage of ions from one organ to another involves problems of growth correlation within the plant body. But the lesson to be learned from free cell cultures is that the diploid cell retains far more information in its organization than merely how to accumulate ions or to synthesize proteins or absorb water, for it may retain essentially the full attributes of the whole organism. And when, as in the case of carrot cells, this potentiality is to unfold, two things are important: first, the cells should be freed from restrictions that may be imposed by the proximity of neighboring cells with which they are in organic connection, so that each becomes free to develop in accordance with its own intrinsic properties; and secondly, the free cell should receive exogenously all the known factors that will make it grow. To do this, one may need to recapitulate the nutrients supplied in early embryogenesis by the use of the contents of liquid endosperms.

Thus some of the salient problems of plant physiology extend beyond the much-publicized molecular-biological ones—which would seem to reduce botany to a branch of chemistry. These problems present the equally challenging need to comprehend the ways in which such a variety of chemical controls will regulate or modulate the growth and behavior of the whole cell or organism, but within the broad limits set by its genetic constitution. In plants this path through time—or “creode,” as Waddington terms it—from egg to maturity is only confined within relatively broad limits. These limits comprise such distinctive patterns of development as those of long-day and short-day plants, high- and low-night-temperature plants, and a variety of other morphogenetic responses. The environmental factors that “trigger off” these responses must be mediated by similar “epigenetic” effects exerted upon the cells of the growing regions. These and similar challenging problems are discussed from the standpoint of the substances and factors that control growth by cell division and cell enlargement in a forthcoming review by Steward and Mohan Ram. One may note, however, that again the solution to the problem is concerned not alone with the nature and perception of the stimulus, not alone with the chemical substance through which the stimulus is transmitted to the

for it would recognize that there are a great many different ways, morphogenetic and biochemical, through which the inherent potentialities of the organized, living system are unfolded in a complex but integrated manner.

active site of action, but also with the way that highly active but apparently somewhat simple chemical entities must exercise and mediate control over the operation of such highly integrated systems as single cells or groups of cells. This seems to be the case in the photoperiodic response that turns upon the redistribution of growth in the shoot apex, and in this redistribution a relatively small group of otherwise quiescent cells in the central part of the apex is implicated (Wetmore *et al.*, 1959).

Let us have all the enzymology, descriptive biochemistry, and "molecular biology" we can get, but none of these is of much avail until one has actually shown how the reactions work in, and the causative agents modify, the system that can grow. Thus many problems of plant physiology are now essentially limited by our lack of knowledge at the supramolecular level—*i.e.*, lack of more exact knowledge of what cells are, how they behave, and where and what are the active sites metabolic events occur and morphogenetic responses are determined.

These problems of organization and integration in the living system thus present a major objective for the future. It is no longer enough to study each physiological function separately. Understanding of the living system requires a synthesis of knowledge, for all these attributes of the organism work together and are coordinated to achieve that "built-in goal of growth" which is the complexity and the challenge of every cell and every organism.

References

- Anderson, D. B., and Kerr, T., 1938. "Growth and Structure of Cotton Fiber." *Ind. Eng. Chem.* 30, 48.
- Barghoom, E. S., 1957. "Origin of Life," in *Treatise on Marine Ecology and Paleocology*, Vol. 2. *Geol. Soc. Am. Mem.* 67, 83.
- Biddulph, O., 1959. "Translocation of Inorganic Solutes," in Steward, F. C., ed., *Plant Physiology — A Treatise*, Vol. II (N. Y., Academic Press).
- Blackman, F. F., 1905. "Optima and Limiting Factors," *Ann. Bot.* 19, 281.
- Brachet, J., 1957. *Biochemical Cytology*, (N. Y., Academic Press).
- Braun, A. C., 1954. "The Physiology of Plant Tumors," *Ann. Rev. Plant Physiol.* 5, 133.
- Brown, R., and Broadbent, D., 1951. "The Development of Cells in the Growing Zones of the Root," *J. Exp. Bot.* 1, 249.
- Chapman-Andresen, C., 1958. "Pinocytosis of Inorganic Salts by *Amoeba proteus* (*Chaos diffluens*)," *Compt. Rend. Lab. Carlsberg* 31, 77.
- Collander, R., 1959. "Cell Membranes: Their Resistance to Penetration and Their Capacity for Transport," in Steward, F. C., ed., *Plant Physiology — A Treatise*, Vol. II (N. Y., Academic Press).
- Hoagland, D. R., and Broyer, T. C., 1936. "General Nature of the Process of Salt Accumulation by Roots with Description of Experimental Methods," *Plant Physiol.* 11, 471.
- Holter, H., 1959. "Problems of Pinocytosis with Special Regard to Amoebae," *Ann. N. Y. Acad. Sci.* 78, 524.

- Neish, A. C., and Hibbert, H., 1943. "Studies on plant tumors, III: Nitrogen Metabolism of Normal and Tumor Tissues of the Beet Root," *Arch. Biochem.* 3, 159.
- Palay, S. L., ed., 1958. *Frontiers of Cytology* (New Haven, Conn., Yale U. Press).
- Pollard, J. K., and Steward, F. C., 1959. "The Use of C¹⁴-Proline by Growing Cells: Its Conversion to Protein and to Hydroxyproline," *J. Exp. Bot.* 10, 17.
- Prevot, P., and Steward, F. C., 1936. Salient Features of the Root System Relative to the Problem of Salt Absorption." *Plant Physiol.* 11, 509.
- Robertson, R. N., Wilkins, M. J., and Hope, A. B., 1955. "Plant Mitochondria and Salt Accumulation," *Nature* 175, 640.
- Robertson, R. N., Wilkins, M. J., Hope, A. B., and Nestel, L., 1955. "Studies in the Metabolism of Cells. X: Respiratory Activity and Ionic Relations of Plant Mitochondria," *Aus. J. Biol. Sci.* 8, 164.
- Smuts, J. C., 1926. *Holism and Evolution* (N. Y., Macmillan).
- Steward, F. C., 1939. "The Growth of *Valonia ventricosa* J. Agardh, and *Valonia ocellata* Howe in Culture," in *Papers from Tortugas Laboratory*. XXXII. *Carnegie Inst., Publ. No. 517*.
- Steward, F. C., 1954. "Salt Accumulation in Plants: A Reconsideration of the Role of Growth and Metabolism, B: Salt Accumulation in the Plant Body," *Symp. Soc. Exptl. Biol.* 8, 393.
- Steward, F. C., 1958. Growth and Organized Development of Cultured Cells, III: Interpretations of the Growth from Free Cells to Carrot Plants," *Am. J. Bot.* 45, 709.
- Steward, F. C., Berry, W. E., Preston, C., and Ramamurti, T. K., 1943. The Absorption and Accumulation of Solutes by Living Plant Cells, X: Time and Temperature Effects on Salt Uptake by Potato Discs and the Influence of the Storage Conditions of the Tubers on Metabolism and Other Properties," *Ann. Bot.* 7, 221.
- Steward, F. C., Bidwell, R. G. S., and Yemm, E. W., 1956. "Protein Metabolism, Respiration and Growth. A Synthesis of Results from the Use of C¹⁴-Labeled Substrates and Tissue Culture," *Nature* 178, 734.
- Steward, F. C., Bidwell, R. G. S., and Yemma, E. W., 1958. "Nitrogen Metabolism, Respiration and Growth, III: The Nitrogen Metabolism and Respiration of Carrot Tissue Explants as Revealed by Experiments with C¹⁴-Labeled Substrates," *J. Exp. Bot.* 25, 11.
- Steward, F. C., Mapes, M. O., and Mears, K., 1958. "Growth and Organized Development of Cultured Cells," II: Organization in Cultures Grown from Freely Suspended Cells," *Am. J. Bot.* 45, 705.
- Steward, F. C., Mapes, M. O., and Smith, J., 1958. "Growth and Organized Development of Cultured Cells, I: Growth and Division of Freely Suspended Cells," *Am. J. Bot.* 45, 693.
- Steward, F. C., and Millar, F. K., 1954. "Salt Accumulation in Plants. A Reconsideration of the Role of Growth and Metabolism," *Symp. Soc. Exp. Biol.* 8, 367.
- Steward, F. C., and Mohan Ram, H. Y., 1960. "Determining Factors in Cell growth: Some Implications for Morphogenesis in Plants, in Brachet J., and Abercrombie, M., eds., *Advances in Morphogenesis* (N. Y., Academic Press). In press.
- Steward, F. C., and Muhlethaler, K., 1953. "The Structure and Development of the Cell Wall in the *Valoniaceae* as Revealed by the Electron Microscope," *Ann. Bot.* 17, 296.
- Steward, F. C., Prevot, P., and Harrison, J. A., 1942. "Absorption and Accumulation of Rubidium Bromide by Barley Plants. Localization in the Root of Cation Accumulation and of Transfer to the Shoot," *Plant Physiol.* 17, 411.

- Steward, F. C., and Shantz, E. M., 1959. "The Chemical Regulation of Growth: Some Substances and Extracts Which Induce Growth and Morphogenesis," *Ann. Rev. Plant Physiol.* 10, 379.
- Steward, F. C., and Sutcliffe, J. F., 1959. "Plants in Relation to Inorganic Salts," in Steward, F. C., ed., *Plant Physiology — A Treatise*, Vol. II (N. Y., Academic Press).
- Sutcliffe, J. F., Bollard, E. G., and Steward, F. C., 1960. "The Incorporation of C^{14} into the Protein of Particles Isolated from Plant Cells," *J. Exp. Bot.* 11, 151.
- Swanson, C. A., 1959. "Translocation of Organic Solutes," in Steward, F. C., ed., *Plant Physiology — A Treatise*, Vol. II (N. Y., Academic Press).
- Waddington, C. H., 1957. *The Strategy of the Genes: A Discussion of Some Aspects of Theoretical Biology* (N. Y., Macmillan).
- Wardlaw, C. W., 1955. *Embryogenesis in Plants* (N. Y., Wiley).
- Webster, G. C., 1955. "Incorporation of Radioactive Amino Acids into the Protein of Plant Tissue Homogenates," *Plant Physiol.* 30, 351.
- Webster, G. C., 1957. "Amino Acid Incorporation by Intact and Disrupted Ribonucleoprotein Particles," *J. Biol. Chem.* 229, 535.
- Wetmore, R. H., Gifford, E. M., and Green, M. C., 1959. "Development of vegetative and floral buds," in Withrow, R. B., ed., *Photoperiodism and Related Phenomena in Plants and Animals*, Publication No. 45, American Association for the Advancement of Science (Washington, D. C., A.A.A.S.).
- Whaley, W. G., Mollenhauer, H. H., and Kephart, J. E., 1959. "Endoplasmatic Reticulum and the Golgi Structures in Maize Root Cells," *J. Biophys. Biochem. Cytol.* 5, 501.
- Whaley, W. G., Mollenhauer, H. H., and Leech, J. H., 1960. "The Ultrastructure of the Meristematic Cell," *Am. J. Bot.* 47, 401.

GROWTH AND DEVELOPMENT OF THE INFLORESCENCE AND FLOWER

Claude W. Wardlaw

UNIVERSITY OF MANCHESTER

The angiosperms, estimated at some 250,000 species, are the most highly evolved and numerically the largest and most varied division of the plant kingdom. In particular, the inflorescences and flowers show conspicuous morphological diversity. Notwithstanding the excellent and comprehensive taxonomic investigations of the past 200 years, assisted in more recent times by comparative ontogenetic studies, many important phylogenetic relationships and other phenomena are still inadequately understood: the existence of "phyletic gaps" is just as big a bugbear in the angiosperms as it is in the less highly evolved classes of vascular plants. Also, in view of the materials available, our information on causal aspects of floral morphogenesis is very scanty indeed.

It may well be that the sheer wealth of materials has tended to discourage investigators, making it difficult for them to know which topics to select and how and where to begin. Some drastic simplification of outlook on this great and important group certainly seems to be needed. This may perhaps be achieved by formulating and testing hypotheses relating to major, common factors in floral morphogenesis. The abundant evidence of parallel developments (or homologies of organization), in families and genera not closely related, supports the view that common morphogenetic factors and processes do exist, and that attempts to discover them and to formulate concepts of wide applicability may be fruitful. The aim will be to investigate characteristic, major organogenic developments in inflorescences and flowers, use being made of selected materials and of the ideas and techniques that have proved of value in the study of the vegetative shoot apex. These studies, which we hope will advance knowledge of physiological,

genetic, and other factors in floral development, may also yield new criteria of comparison in phylogenetic investigations.

Needless to say, it remains to be seen whether, from investigations of the extensive and varied mass of angiosperm materials, general laws or principles of a unifying and simplifying character can indeed be discovered. It is at least a reasonable conjecture that if the presence of common, or basic, factors in floral morphogenesis can be substantiated, some of the conspicuous and seemingly important morphological differences may be seen to be not so very different after all: *i.e.*, they may be envisaged as variations on a theme rather than as major or fundamental differences.

Flowers may occur singly or associated together in more or less complex inflorescences, the latter exemplifying characteristic morphological patterns which are often of a remarkable degree of geometrical regularity. Flowers may be hypogynous, perigynous, or epigynous, may be of radial, bilateral, or zygomorphic symmetry, with a relatively large or a relatively small number of parts, and they may have the androecium and gynoecium present in the same flower or separated in different ways. Some species are evidently much more suitable for particular observations or experiments than others; hence, a not inconsiderable but fascinating aspect of new investigations is the search for what Lang (1915) described as "favorable materials."

An actinomorphic, polypetalous, hypogynous, apocarpous flower, with numerous stamens and carpels, may be provisionally accepted as exemplifying the primitive condition in dicotyledons, and for convenience this will be referred to as the prototypic flower.

Theoretical considerations

Floral meristems originate, directly or indirectly, from vegetative-shoot apical meristems or from axillary buds. Accordingly, what has been ascertained or conjectured from causal investigations of the shoot apex, especially during recent years, makes some of the problems of floral morphogenesis considerably more amenable to investigation than seemed possible three or four decades ago. Indeed, our information and ideas on the organization and morphogenetic activity of the shoot apex are essential in any new approach to the problems of floral morphogenesis.

The shoot apical meristem. The following features of the shoot apex are relevant. (1) The organogenically active apex consists of several embryonic regions. (2) The apex functions as a whole and possesses specific organization. (3) All shoot apices (with rare exceptions) produce a characteristic (phyllotactic) pattern of growth centers which typically become leaf primordia. (4) Seemingly different phyllo-

tactic systems may not be so very different fundamentally, and even in the same apex a transition from one system to another can readily take place (Richards, 1951; Cutter and Voeller, 1959; Voeller and Cutter, 1959). (5) The symmetry and orientation of a leaf primordium are determined by the inception of its growth center in the apical meristem and by the rates of growth on its adaxial and abaxial sides; its size and shape are controlled by the genetically and ontogenetically determined apical organization (Wardlaw, 1955). (6) The position of a growth center and the rate of growth of the lateral member formed from it are determined and regulated by the distal region of the apical meristem and the adjacent older primordia (Wardlaw, 1949, 1950). (7) The inception and pattern of vascular tissue are directly related to the active growth of the apical meristem, its growth centers, and the primordia. (8) While the apical meristem may change in characteristic ways during the ontogenetic development of the plant, it usually shows remarkable stability in its histological organization and morphogenetic activity under experimental treatments (Figures 1 and 2).

Growth centers. The concept of growth centers—*i.e.*, discrete cen-

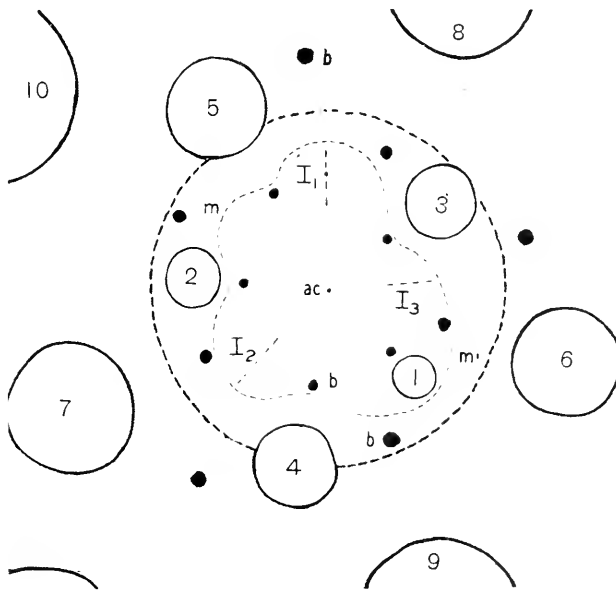

Figure 1. Diagrammatic representation of a fern apex as seen from above, showing the leaf primordia one to ten, the positions of the next primordia to be formed, in the order of their appearance (I_1 to I_3), the apical cell (*ac*), the approximate positions of bud rudiments (*b*), the lower limits of the apical meristems (*m-m'*), and the approximate position of the base of the apical cone (broken circular line). Magnification: $\times 30$. (From *Growth*, Suppl., 1949.)

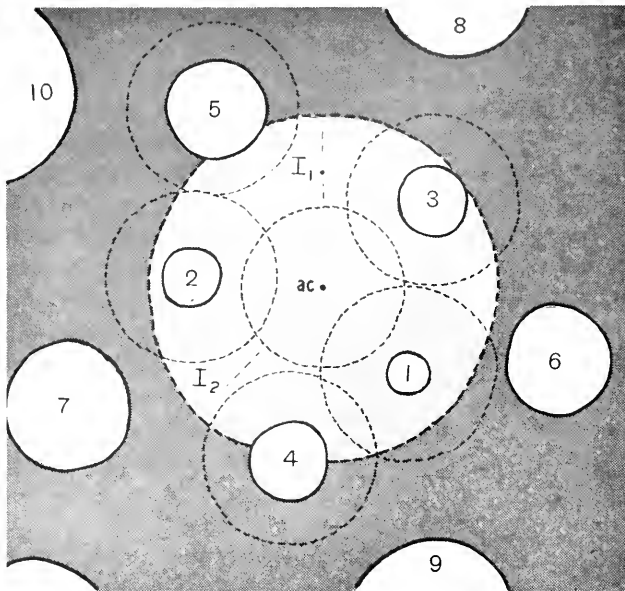

Figure 2. The apex as in Figure 1, with an arbitrary and formalized indication of the physiological fields associated with the shoot and leaf apices. I_1 is the first position which, in the course of growth, will lie outside adjacent inhibitional fields, and I_2 will be the next to do so.

ters of special metabolism in the basicopic margin of the apical meristem—is of special importance. A growth center is a multicellular locus of characteristic size and shape. The leaf primordium into which it develops may remain relatively localized and discrete; it may become more or less extended tangentially round the meristem; or it may soon cease its active growth. The evidence indicates that the growth-center concept has an apt application to floral morphogenesis.

Two further points are specially worthy of mention. Firstly, while all the leaf growth centers of a species are probably closely comparable metabolically, they are not necessarily identical—hence some of the differences in leaf-primordium morphology in species showing heteroblastic development. Moreover, as Foster (1929, 1935) and Schuepp (1929) have shown, for particular species, important differences in the distribution of growth in the developing growth centers can be detected from the outset, these resulting in the conspicuous differences seen, for example, in cataphylls as compared with foliage leaves. Secondly, the writer (Wardlaw, 1949, 1950, 1957a) has shown that the development of growth centers and very young leaf primordia can be modified by surgical and chemical treatments. The latter are of special

interest in the present context. Thus, when various physiologically active substances were applied directly to the apical meristem of *Dryopteris austriaca*, the novel effects included (1) the failure of growth centers to develop into primordia, (2) the inception of double primordia, and (3) the formation of vegetative buds in leaf sites. To summarize: During the vegetative phase, growth centers in the apical meristem usually give rise to leaf primordia, but the activity of a growth center is subject to modification by changes in its metabolic components, and these may have significant effects on the ensuing morphological development.

Lastly, the actual pattern of growth centers at any particular time is determined by the organization of the apical meristem, the stage reached in ontogenesis being important. The genetical constitution is, of course, fundamentally involved. As to the proximate cause, however, a physico-chemical theory along the lines proposed by Turing (1952) seems to be relevant (Wardlaw, 1953, 1955, 1957b). In this theory the apical meristem is regarded as a complex reaction system capable of yielding a patternized distribution of specific metabolic substances (Wardlaw, 1957b), these being accumulated in evenly distributed loci which we describe as growth centers.

The transition apex. With the onset of the reproductive phase, the shoot apical meristem may, in different species, be transformed into a single flower or into an inflorescence. These new morphogenetic activities are usually marked by more or less conspicuous changes in the distribution and kind of growth in the apex. Moreover, as judged by external appearances, the showy, often brightly colored inflorescence or flower seems to bear little relation to the vegetative leafy shoot. Hence some botanists regard the inflorescence and flowers as organs of a completely different category from those formed during the vegetative phase. This, of course, is in marked contrast to the classical concept of the flower as an axis of limited growth with variously modified lateral members which are homologous with leaves. In fact, both in the transition apex and the floral apex we may recognize that we are still dealing with an apical meristem yielding a pattern of growth centers; and while on the one hand certain far-reaching morphogenetic changes do take place in the further development of some of the growth centers, on the other hand certain aspects of apical activity remain singularly unchanged in any fundamental sense. After all, the same genetical constitution underlies all development in both the vegetative and the reproductive phases.

General aspects of organogenesis in a "simple" flower. In a "simple" or prototypic flower (e.g., *Ranunculus* sp.) all the organs can be referred to the development of growth centers, these usually constituting a pattern of considerable regularity. As Tepfer (1953) has so clearly

demonstrated in ontogenetic studies, the floral organs are truly homologous with the leaves formed during the vegetative phase (Figure 3). But in the writer's view this classical concept can probably be applied to all floral development, including even the most evolved gamopetalous and epigynous types, as well as highly condensed and reduced types.

In floral inception and organogenesis, under the impact of a "florigenic" stimulus, important changes take place in the distribution and quality of growth in the apex, both extrinsic and intrinsic factors being involved. If, then, we begin with the prototypic flower, it is not difficult to see that certain characteristic changes in the distribution of growth in the apex—*i.e.*, in the vertical and transverse components—could account for some of the major changes in floral construction: *e.g.*, hypogyny to epigyny, polypetalous to gamopetalous, etc. But within any particular floral or inflorescence category (*e.g.*, exemplifying epigyny, zygomorphy, the umbel or capitulum type of inflorescence, etc.) there is scope for great variation of detail: *i.e.*, much of the evident floral diversity is of a minor rather than a major morphological kind.

In the transition from the vegetative to the floral phase, closely comparable changes in apical growth and morphogenesis occur in

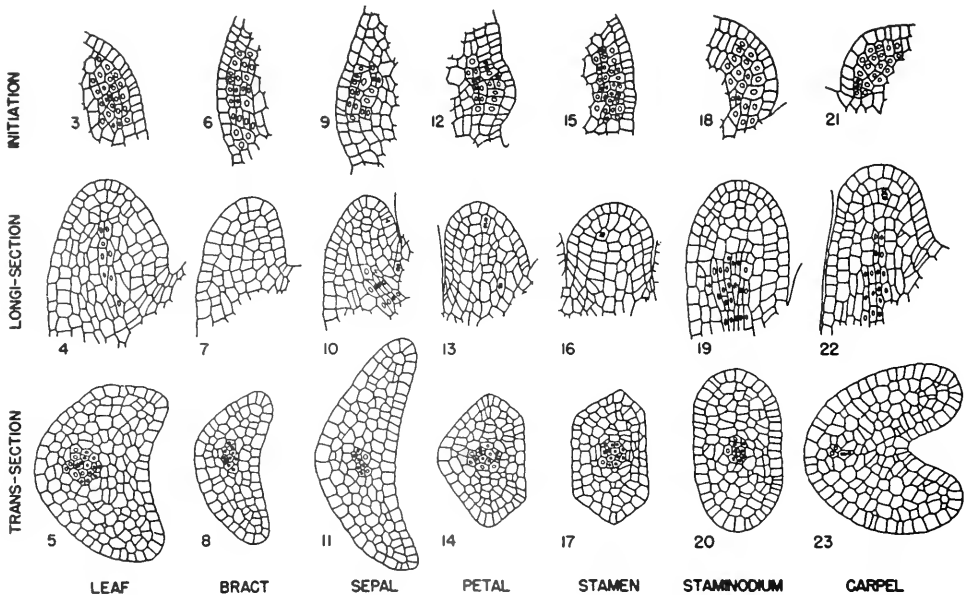

Figure 3. Camera lucida drawings of *Aquilegia formosa* var. *truncata*, showing early stages in the formation of leaves, bracts, and floral organs at the apical meristem. As judged by the usual criteria — *i.e.*, position and mode of inception — all these organs are homologous. (After Tepfer, 1953.)

species from groups not closely related. For example, zygomorphic flowers are usually lateral, the plane of zygomorphy being very commonly that of the axis and the subtending bract (Goebel, 1900, 1913). This suggests that certain genetically determined adaxial/abaxial growth relationships, established at an early stage in floral ontogenesis, are of general occurrence; and similarly for other major features.

The floral meristem as a serial reaction system. The shoot apex, as we have seen, may be regarded as a complex, gene-determined, physico-chemical reaction system, with the property of giving rise to a pattern of growth centers which typically become dorsiventral foliar members, leaves, scales, etc. In the transition meristem, growth centers continue to be formed. The first of these may develop as evident foliar organs, often exhibiting the phenomenon of heteroblastic development. The next group of growth centers gives rise to the perianth members, and centers formed later produce the stamens and carpels (see Figures 4 to 7). Even in highly modified, condensed, epigynous flowers, this conception of the basic nature of floral organogenesis is probably still applicable, attention being paid also to the distribution of growth in the receptacle and to correlative developments, especially during the earliest stages. The ontogenetic approach has, of course, already been effectively used by many workers, mostly in comparative studies, but it is no less essential in causal investigations. What is now required is the investigation of characteristic floral developments in terms of the underlying physiological-genetical factors and others. To this end the writer (Wardlaw, 1957c) has proposed a theory of floral morphogenesis which may now be briefly outlined.

The theory is based on the view that, at the onset of flowering, the shoot apex continues to give rise to a succession of regularly spaced growth centers, the further development of which as primordia, with the distinctive characters of sepals, petals, stamens, and carpels, is the result of the serial evocation and action of particular genes (or groups of genes) together with the other factors at work in the meristem. The existence of metabolic differences between different growth centers, already mentioned, is an important part of the theory. As Engard (1944) noted, there are no real transitions at the morphological level between homologous organs. But, as we now see, there can be important changes and differences in the metabolism of growth centers. The inception of the flower is marked by the entry of new metabolic substance(s), not yet specified or isolated, into the reaction system of the apical meristem, with consequent effects on the metabolism of its growth centers. Other important, usually irreversible, changes also ensue. The allometric growth pattern of the apex is modified to a more or less marked extent, the elongation of the axis being usually conspicuously diminished or arrested. As a result, the growth centers, and the

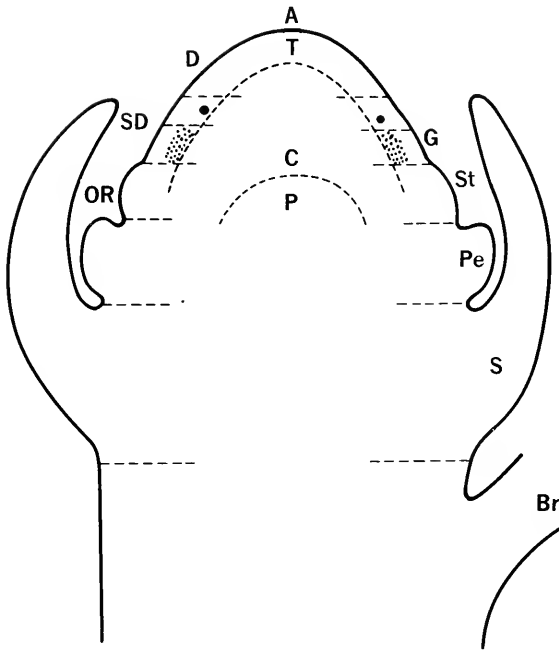

Figure 4. This and the next figure are a diagrammatic illustration of a theory of floral morphogenesis in a prototypic flower. The longitudinal section here shows, in acropetal sequence, a bract (*Br*), young sepals (*S*), young petal primordia (*Pe*), stamen primordia (*St*) at their inception, the positions of the next growth centers to become primordia (*G*), and the beginning of growth centers still closer to the summit of the apex (*A*), tunica (*T*), corpus (*C*), and pith (*P*). The discontinuous transverse lines are intended to indicate a number of zones into which the organized apex is differentiated: the distal zone (*D*); the sub-distal zone(s) (*SD*), in which the reaction system is giving rise to a pattern of growth centers; the organogenic zone (*OR*), in which the active growth centers have given rise to very young primordia. The transverse lines also indicate the successive phases, or stages, through which the apex passes as floral morphogenesis progresses.

lateral organs to which they give rise, are now formed in closely associated groups, either whorls or condensed helices, on an abbreviated axis (see Figure 6 and 7). In normal floral ontogenesis the apical reaction system passes through a sequence of distinctive phases, these being determined and controlled by specific genes and also by physiological correlations and environmental factors (see Figure 4). The fundamental pattern in flower inception, which usually exhibits remarkable stability and constancy, is primarily due to the specific genetical constitution, but during the elaboration of this pattern, extrinsic factors may sometimes exercise important morphogenetic effects. J. and

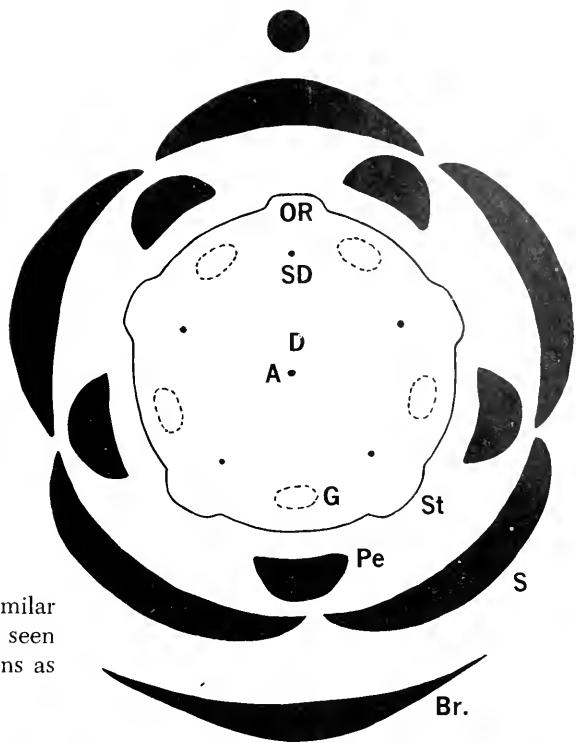

Figure 5. An apex similar to that in Figure 4 as seen from above; indications as before.



Figure 6. Young floral apex of *Aquilegia formosa*, showing, in acropetal sequence, a bract with axillary bud and primordia of sepals and stamens. The tier containing the growth centers (which are not visible) lies closer to the tip of the apical meristem.



Figure 7. An older apex than that shown in Figure 6, with several tiers of primordia (bracts, sepals, petals, and stamens). (After Tepfer, 1953.)

Y. Heslop-Harrison's (1956-59) studies of the morphogenetic effects of temperature, light, and applied auxin on the development of the androecial and gynoecial regions of the floral meristem illustrate this point.

The action of specific genes in flower formation is essentially serial in character. As the florigenic stimulus begins to affect the apical reaction system, the specific action of certain genes, hitherto inert or non-specific in their effects, is induced. The changes thereby effected in the system lead to further specific genic action, and so on in a chain or serial fashion until flower formation terminates with the utilization of all or practically all of the residual distal meristem. It is to the action of particular genes, as components of the reaction system, that the clear delimitation of the several organogenic phases (*i.e.*, the formation of calyx, corolla, androecium, and gynoecium) must be attributed.

The foregoing conceptions afford a basis for explaining some of the main features of floral ontogenesis, such as (1) that the several floral organs are homologous with leaves, (2) that they originate in a characteristic pattern on the meristem, and (3) that the successive groups of growth centers, formed during the course of floral ontogenesis, have distinctive quantitative and qualitative growth properties, and accordingly give rise to groups of organs differing in form and structure. The theory has the merits of treating floral ontogenesis in terms of physiology, genetics, and the dynamic geometry of the embryonic apical region. Moreover, several formerly important and highly controversial hypotheses (for example, relating to homologous and non-homologous floral organs, to organs *sui generis*, to morphological "transition," etc.) are seen in quite a different light as consideration of the relevant phenomena is transferred from the morphological to the physiological plane. Not least, the theory suggests opportunities for new observational and experimental work on floral ontogenesis, in both its general and its specific aspects.

To summarize: A basis for explaining the major features in floral ontogenesis is afforded by the following concepts: (1) the several floral organs are homologous with leaves; (2) they originate from growth centers which have their inception in a characteristic pattern on the floral meristem; (3) in relation to the serial evocation of genes, the successive groups of growth centers have distinctive physiological properties and accordingly give rise to organs differing in form, structure, and function; (4) factors affecting correlative developments and other factors are also important in determining the unified and harmonious floral morphogenesis.

Evidence relating to factors in floral morphogenesis

The theoretical considerations outlined above indicate that the

scope for new observational and experimental investigations of floral morphogenesis is virtually unlimited. As these have their inception in physiological and genetical as well as in morphological concepts, the results should be of interest to both the causal and the taxonomic inquirer. In this section attention will be directed to some recent investigations, and also to some old ones, which illustrate what can be achieved in this field. In this work, too much emphasis cannot be placed on the need for precise observation, in both vegetative and floral meristems, of the apex as a whole and of the manner of development of growth centers (Wardlaw, 1959). For example, some growth centers (normally foliar loci) may give rise to flower buds, as in *Nymphaea* and *Nuphar* spp. (Figure 8); some centers may have a very transitory existence and may soon be lost to view as floral development proceeds, as in the case of bract development in some *Nymphaeaceae* (Cutter, 1957, 1959).

Investigations relating to homology. Goethe's classical view of the prototypic dicotyledon flower as a determinate shoot or axis, bearing the several floral organs, which are homologous with leaves (Arber, 1937; Eames, 1931), is well supported by recent investigations. Tepfer (1953), for example, as we have already mentioned, has produced an elegant histological demonstration that, at their inception in the meristem, the lateral organs, whether of leafy shoot or flower in species of *Ranunculus* and *Aquilegia*, are closely comparable and truly homologous. This view is also supported by the writer's concept of the apical meristem and its property of giving rise to growth centers, and by the J. Heslop-Harrison (1959) physiological studies of floral development. On the other hand, it does not appear that alternative theories of flower formation—*e.g.*, those of Grégoire (1938), McLean Thompson (1937) and others, including that recently advanced by Plantefol (1948), Buvat (1952, 1955), and their adherents—seriously disturb the classical conception as based on contemporary theory and fact, though they have undoubtedly called attention to phenomena which require further investigation. The characteristic heteroblastic developments observed in the transition leaves, bracts, and perianth in many species give realistic support to the classical concept. Obviously the concept of homology should not be pushed too far, for while all the growth centers in a particular species have some properties and activities in common, they may differ in respect of other properties and activities, yielding organs so different morphologically that excessive homologizing becomes absurd. In *Nuphar* and *Nymphaea*, for example, flower buds originate from growth centers which form part of the normal genetic, phyllotactic spiral and are therefore homologous with leaves in this particular respect, but it would be idle to attempt to push the homology further. Some inflorescences present similar difficulties.

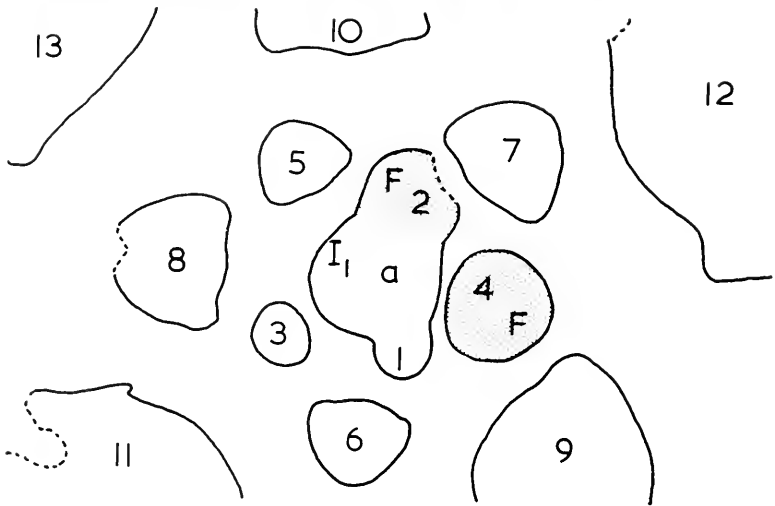
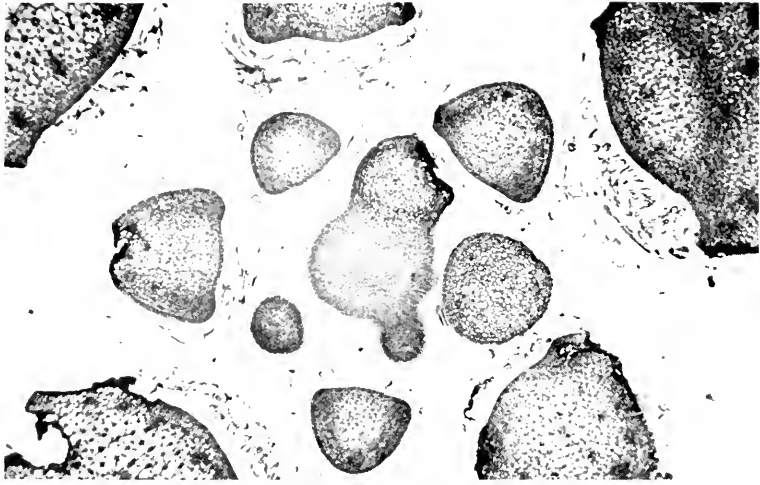

Figure 8. Transverse section (in a photomicrograph at top and diagram below) of the apical meristem of a rhizome of *Nuphar lutca* (L.) Sm., showing the sequence of primordia (1, 2, 3, etc., in the order of increasing age). Flower bud primordia (*F*) originate in leaf sites in the genetic spiral. *a*, center of apical meristem; *I*₁, position of next primordium to appear. (By courtesy of Dr. E. G. Cutter.)

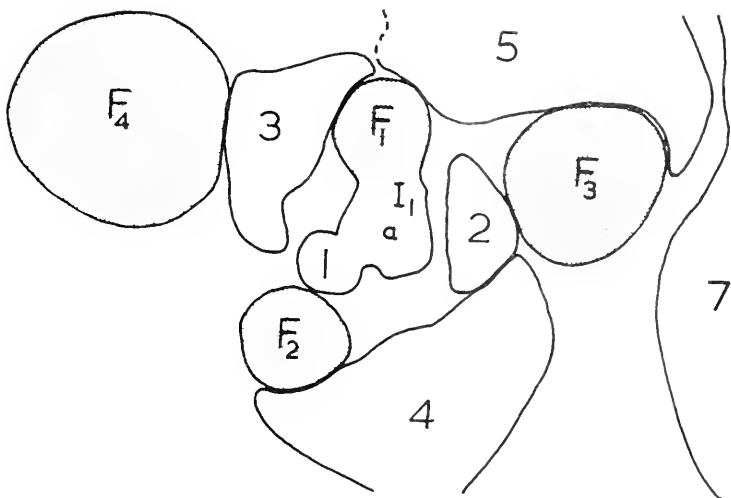
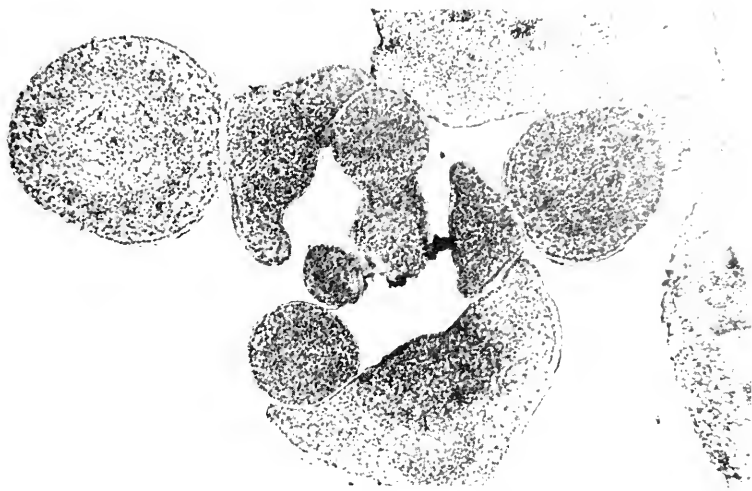

Figure 9. Transverse section (photomicrographic at top and diagrammatic below) of the apical meristem of a rhizome of *Victoria cruziana* d'Orbigny, showing the positions of leaf and flower-bud primordia. The latter, like the former, originate in the apical meristem but occupy interfoliar positions above leaf margins. Indications as in Figure 8. (By courtesy of Dr. E. G. Cutter.)

Investigations of inflorescences. Evident features of many inflorescences are their almost geometrical regularity and harmonious development. The developmental concepts discussed earlier in this paper seem to have an apt application to many aspects of inflorescence construction and suggest scope for new investigations.

Reference may be made to some observations (Wardlaw, 1960) on *Tussilago farfara*, the common coltsfoot (Figure 10). With the onset of the reproductive phase (which begins about September, as Grainger had already noted in 1939), the shoot apical meristem changes considerably in size and form. It now gives rise to a large number of bracts, instead of to a few large foliage leaves. Subsequently the primordia of the ray florets begin to be formed acropetally on the nascent capitulum, the center of which is still bare (see Figure 11). Later, however, floret primordia—destined to become the male disc florets—are also formed in the central, summit region of the capitulum. These are at first approximately the same size as the adjacent ray floret primordia, but they rapidly outgrow them. In this inflorescence the growth pattern thus undergoes important changes during development. Goebel (1913) also illustrated this relationship of ray and disc florets in *Filago*. The compound inflorescence of *Petasites hybridus*, a species usually considered to be nearly related to *Tussilago farfara*, shows an interesting parallel growth phenomenon, in that the terminal capitulum becomes appreciably larger than the lateral ones, although the formative sequence is acropetal.

In *Tussilago farfara* and *Petasites hybridus*, if a number of the still developing, scale-like bracts that enclose the very young capitulum are dissected off and the plant is allowed to continue its growth, the next

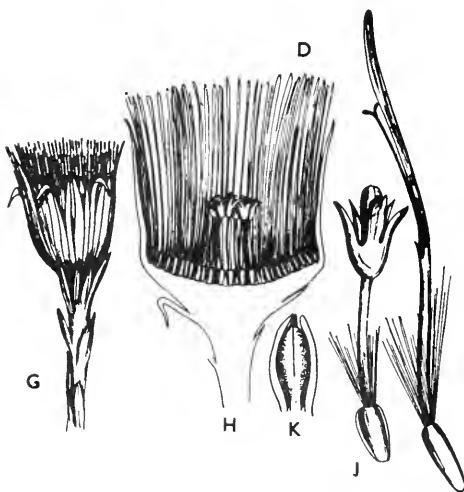

Figure 10. Mature capitulum of *Tussilago farfara* in longitudinal median section (H), showing a group of relatively small disc (male) florets in the center, surrounded by large ray florets, also ray (female) (I) and disc (J) florets dissected out. (After S. G. Jones.) This final stage in development is in marked contrast to the distribution of growth in the young capitulum and young florets, as revealed by morphogenetic investigations and illustrated in Figure 11.

inner bracts form small laminas. This result is not unlike that obtained in some experimental studies of heteroblastic phenomena in vegetative shoots (Figure 12).

Although the time, or season, of the beginning of inflorescence has been the subject of some published investigations, chiefly relating to economic plants such as fruit trees, not enough is known of this important aspect of the biology of flowering plants; but reference can be made to the work of Grainger (1939). Very considerable variation in the time of inception and development of the inflorescence in different species is found: in some perennial species, the floral development is well advanced by autumn; in others it does not take place until the following spring or early summer. The relationships between these developments and factors such as day-length, temperature, etc., require further investigation, while the search for favorable materials for observation and experiment is itself an engaging task. It is also worth noting that the time of inception of the inflorescence in relation to the development of the plant may sometimes have important practical aspects—*e.g.*, in the application of fertilizers and other cultural treatments (Wardlaw, 1959, 1960).

Carr and Carr (1959) have noted some interesting points about the complex inflorescences in species of *Eucalyptus*. For example, some of the characteristic features of the inflorescence pattern are reflections of morphological features peculiar to the shoot system: the outer bracts resemble the adult leaves in their asymmetry about the midrib. Leaf and bract primordia originate decussately at the shoot apex, but in most species the leaves of each pair become separated by the development of a segment of axis (an "intranode") between them. In certain species this development leads to the splitting apart, or "disarticulation," of the unit inflorescence into two subclusters. Some very complex inflorescences thus result from the disarticulation of a simple inflorescence, followed by other developments. The authors conclude that inflorescences with few flowers and with free, persistent bracts, the number of which is related to the flower number in the cluster, are phylogenetically primitive, whereas inflorescences with many flowers and fused bracts, constituting a caducous involucre in which the number of bracts is not related to the number of flowers, are advanced. Though causal in its inception, this investigation has thus enabled important phylogenetic conclusions to be drawn.

The manner of flower formation in species of Nymphaeaceae bears out some of the basic points advanced in this paper (Cutter, 1957-1960). In *Nuphar* and *Nymphaea* spp., as we have seen, flower primordia originate as circular mounds on the surface of the rhizome apical meristem in positions on the genetic spiral which are normally occupied by leaf primordia. The destiny of growth centers must there-

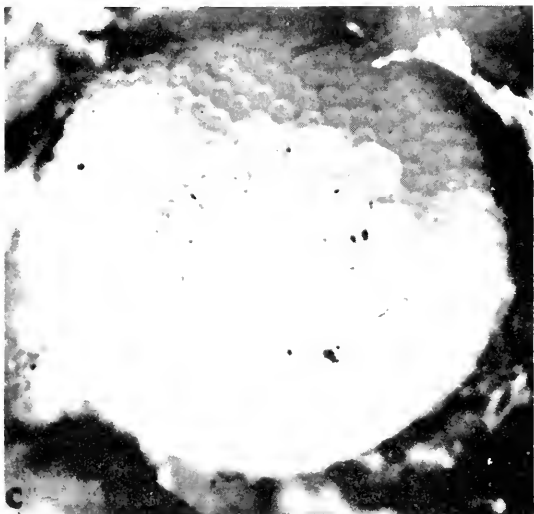
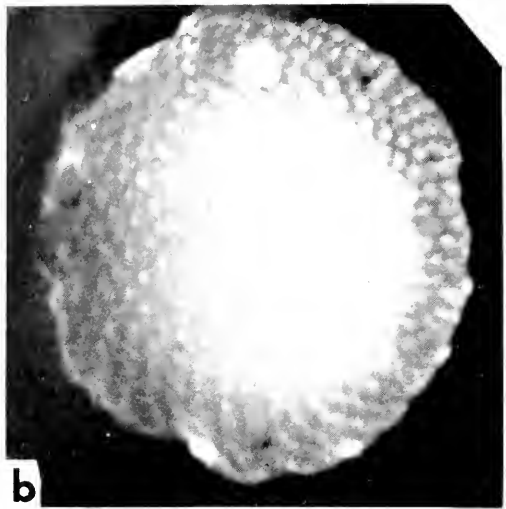
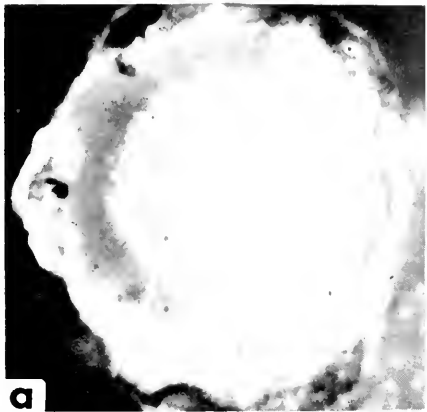

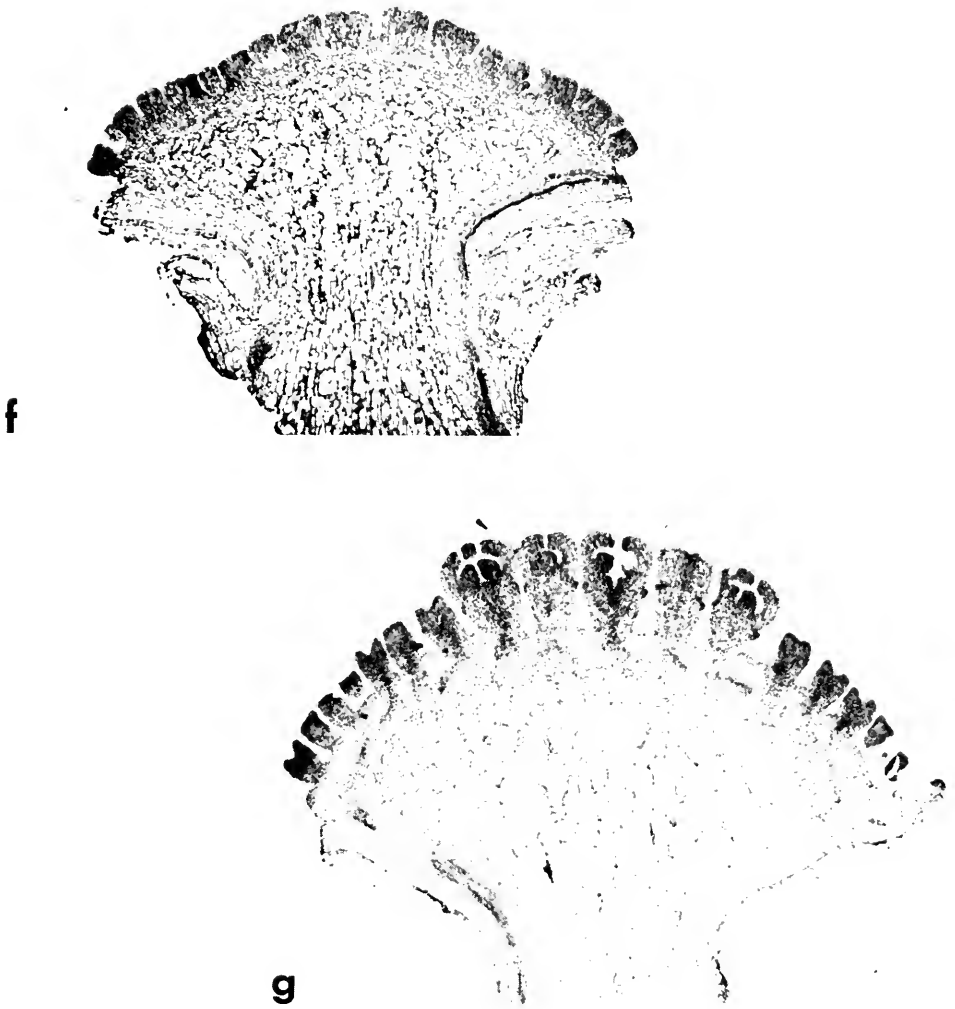

Figure 11. The first three pictures show stages in the development of the capitulum of *Tussilago farfara* L. as seen from above, after the foliage leaves and bracts have been dissected off. Magnification: $\times 30$. (a). The formation of florets is beginning around the base of the capitulum meristem. (b). Florets have now been formed, in acropetal sequence, well up toward the summit, or center, of the capitulum. (c). The last-formed florets — male, disc florets — at the center of the capitulum meristem have now outgrown the surrounding older florets. The next four pictures are longitudinal median sections of capitula at various stages of development. (d). A young capitulum; no florets have yet formed ($\times 112$). (e) Floret formation is beginning around the base of the capitulum, as in (a) ($\times 75$). (f). The terminal, disc, florets have enlarged. (g). They are now conspicuously larger than the earlier-formed ray florets ($\times 50$).

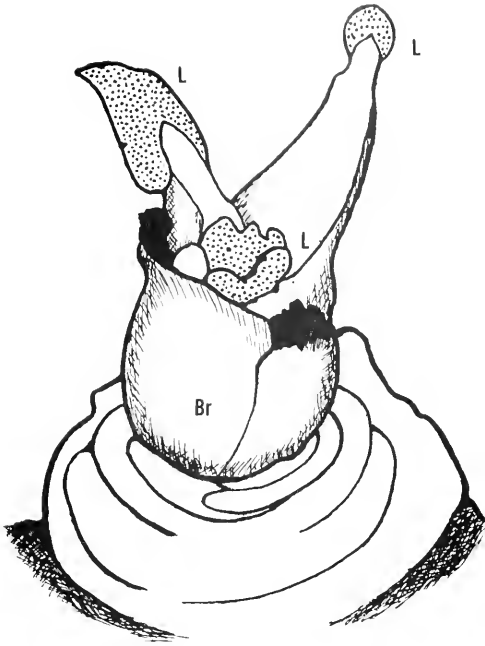

Figure 12. *Petasites hybridus* (L.) Gaertn. May and Sherb. A young inflorescence bud with the vegetative leaves and the outer bracts (*Br*) dissected off. The younger inner bracts, normally non-laminate, have developed laminas (*L*). This is a diagrammatic tracing from a photograph.

fore be determined at a very early stage; *i.e.*, with the onset of flowering some growth centers become loci for the accumulation of the metabolic substances required in flower-primordium formation, as distinct from leaf-primordium formation. This conclusion seems inescapable, but how adjacent growth centers become different metabolically is a problem in developmental physiology for which no adequate explanation has yet been advanced. In *Victoria* sp. (see Figure 9) alternative spirals of leaf and flower primordia can be traced from older regions of the rhizome upwards into the apical meristem (Cutter, 1960). The position of a young flower primordium is not axillary in the usually accepted meaning; it may be described as originating on the apical meristem above the anodic flange of an older tangentially extended leaf primordium, or as being interfoliar. Indeed, it is not unlike the interfoliar loci of bud rudiments in leptosporangiate ferns. In *Victoria*, as in *Nymphaea*, the phenomena of flower disposition and inception must also be sought in the apical meristem—a relatively small mass of embryonic tissue in which these definite but subtly distinctive patternized distributions of metabolites will have to be investigated. (For a full account of inflorescences, see Rickett, 1944.)

Effects of external factors on floral morphogenesis. Some interesting and important results of the effects of external factors in floral morphogenesis are being published at the present time. While there can

be few biologists now who doubt that genic action pervades all morphogenetic development, and that many of the minutiae of floral variation in hybrids and varieties are due to specifiable genes, to small groups of genes, or to polygenes, there is a danger that the effects of extrinsic factors in morphogenesis may not always be sufficiently appreciated.

In studies of the physiology of sexuality, J. Heslop-Harrison (1959) has shown for different species that major changes can be induced in the structure and function of the floral organs by varying external factors such as temperature and light, and by the application of exogenous auxin. Y. Heslop-Harrison and Woods (1959) have shown that when genetically male plants of dioecious *Cannabis sativa* L. are grown under short days and low night temperature, a high proportion of the flowers formed are intersexual, and a considerable amount of meristic variation, fusions, and adnations is found among the male flowers (Figure 13). The intersexuality in male flowers consists in a "transformation of stamens to carpellate or intermediate structures." In some species one or other of the sets of reproductive organs can be more or less completely suppressed in what are normally hermaphrodite flowers (J. Heslop-Harrison, 1960). J. Heslop-Harrison has also shown that

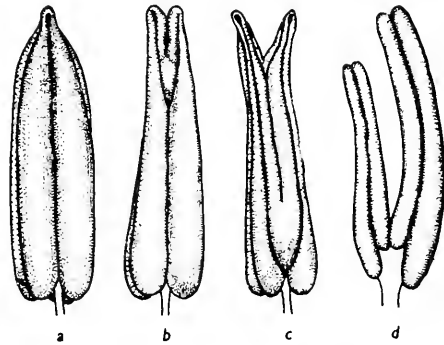
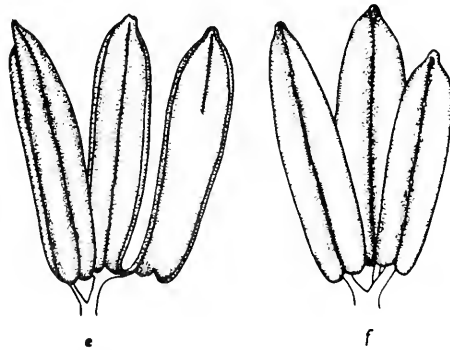

Figure 13. (a), *Cannabis sativa* L. Normal stamen and stamens from flowers of male plants which were exposed to low night temperatures during photoperiodic induction, showing (b to f) various forms of branching and fusion. Magnification: about twelve times. (After Y. Heslop-Harrison and Woods, 1959.)



there are interesting correlative changes in other floral members—*e.g.*, the calyx and corolla.

By applying auxin exogenously to plants at precisely the right stage in their ontogenetic development (*i.e.*, at a sufficiently early stage in floral morphogenesis), he has shown that profound changes in the structure and function of floral members can be induced. In species with hermaphrodite (or monoclinal) flowers, the corolla and androecium may be suppressed to a more or less marked extent, whilst the calyx and gynoecium become relatively enlarged; in monoecious species such as the cucurbits, the appearance of the first female flower may be advanced in time, and the ratio of male to female flowers falls. Again, in a dioecious species such as the hemp plant (*Cannabis sativa*), male plants produce female or intersexual flowers. It is important to emphasize that the auxin in these instances appears to be acting as a regulating rather than as a primary determining factor: *i.e.*, its effects are restricted to changing the balance of growth between floral organs of different kinds. This is in accord with the writer's theory (Wardlaw, 1957c) that the basic properties of the growth centers of any particular whorl or helix on the receptacle (*e.g.*, of calyx, corolla, etc.) are already determined as the result of serial genic evocation.

In short, specific morphogenetic developments can be suppressed but usually not fundamentally modified, though instances of organs of intermediate or dual character are not unknown. As J. Heslop-Harrison has noted: "There is no recorded instance of a primordium of one prospective type being deflected into a foreign developmental path as a result of auxin treatment." In dioecious hemp, however, the auxin-induced intersexuality and sex reversal in genetically male plants "seems to arise from a diversion of the ontogeny of the presumptive stamens from their normal path towards the characteristic of carpels"; that is to say, "auxin may be influencing some determining process in the flower primordium." These effects of applied auxin are, of course, to be linked with the auxin changes now known to occur in plants variously exposed to different environmental factors.

Certain fungal infections are known to cause remarkable changes in floral development: *e.g.*, when *Zea mais* is infected with *Ustilago maydis* or *Melandrium rubrum* with *Ustilago violacea*. In the former, female flowers appear in the normal male inflorescence and J. Heslop-Harrison (1959) notes that this effect is now understandable if the monoecism of maize is related to an auxin gradient, in that the fungus is known to produce IAA in the presence of tryptophane (Wolf, 1952). In *Melandrium rubrum*, the pathogen induces the formation of stamens (see Figure 14) in genetically female plants (Schopfer, 1940; Baker, 1947, a, b). These are only some examples of the effects of extrinsic factors in floral morphogenesis (see the literature in J. Heslop-Harrison, 1959).

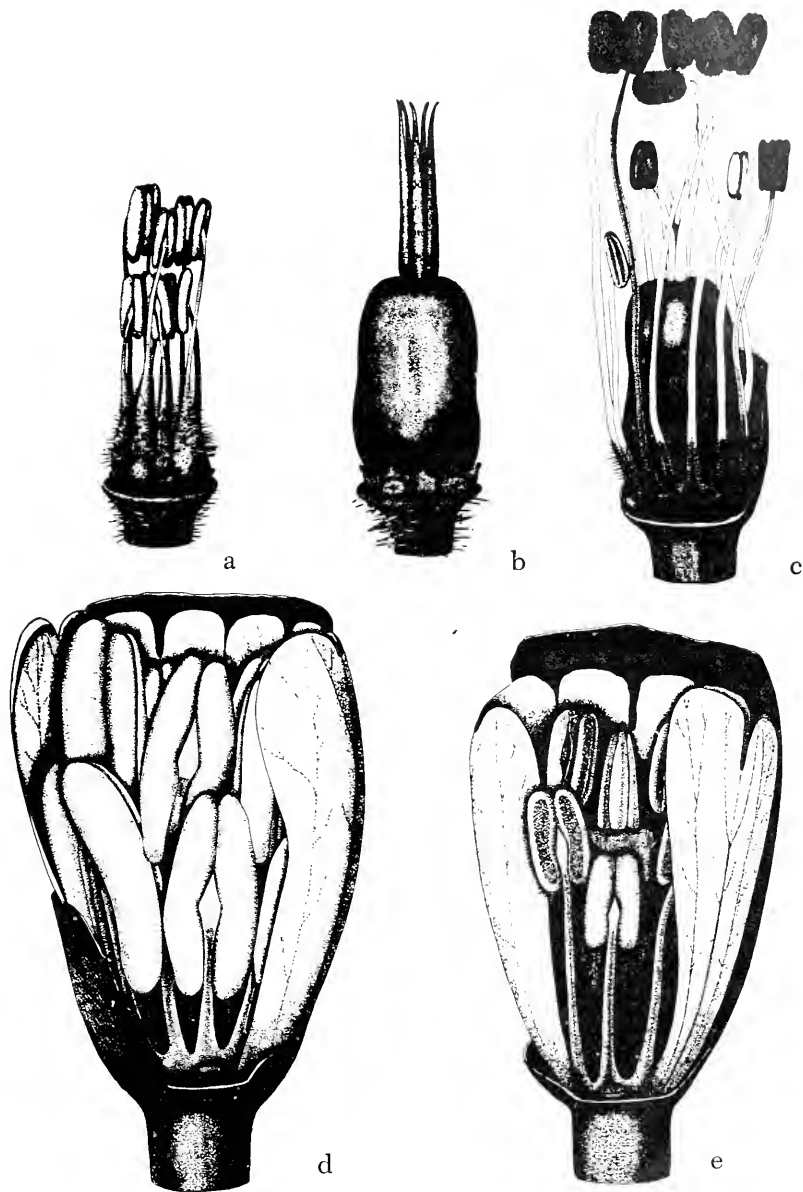

Figure 14. This series illustrates the development of stamens in female flowers of *Melandrium rubrum* (Weig.) Garcke, infected with the fungus *Ustilago violacea*. (a). Androecium of the normal mature male flower. (b). Gynoecium of the normal mature female flower. Note the greatly reduced androecium, consisting of staminodes. (c). An infected female flower, showing the induced stamens, eleven in number, producing dark smut spores in great abundance. (d). Androecium as seen in a dissected male flower bud. (e). Androecium, of somewhat smaller stamens, induced in a smut-infected female flower, as seen in a dissected bud equivalent to that illustrated in (d). (Original drawings, C. W. Wardlaw.)

Biochemical investigations of floral morphogenesis, which will require very delicate techniques (not yet available), will evidently have to be greatly extended before we come to grips with, for example, the factors that determine the quantitative and qualitative differences between a petal and a stamen, or between a stamen and a carpel. Gross analyses are unlikely to prove adequate, though they may sometimes provide useful leads. And similarly, although direct treatments of floral meristems with various metabolic substances, along the lines that have proved feasible in *Dryopteris* (Wardlaw, 1957a) will almost certainly yield some interesting morphogenetic effects, it remains to be seen whether such experimental procedures will increase our understanding of the more fundamental phenomena of floral ontogenesis. In any event, information from such sources, if it is to be of real value, must be brought into relation with the associated genic action.

To summarize: In the chemical approach to floral morphogenesis, the aims are to discover what specific substances, or balance(s) of metabolites, are involved in the inception of the several distinctive floral organs, and to ascertain to what extent the normal pattern of development can be modified at will by specific treatments. That particular substances are closely, and possibly obligatorily, involved in the inception and development of the stamens or of the carpels can scarcely be doubted, but they may be very difficult to detect.

Evidence from surgical treatments. In surgical experiments the principal aims are to obtain new information on the interrelationships of the several regions of the floral meristem and of the incipient and developing organs (Wardlaw, 1957c). By making use of favorable materials—*e.g.*, selected rosette plants, which can survive operational techniques and are suitable for close day-by-day observation at appropriate magnifications—some new possibilities of investigating floral morphogenesis lie before us. In particular, developmental phenomena which are of general occurrence might well be given priority in such investigations.

In surgical experiments on *Primula bulleyana*, Cusick (1956) vertically bisected the meristem at different, known stages in floral ontogenesis—*e.g.*, before perianth inception, and so on. By subsequently observing whether complete or half whorls of the several floral organs were formed, he was able to obtain some validation of the writer's concept of the meristem as a unified reaction system undergoing a sequence of changes in its organogenic activities. For example, floral apices bisected up to the end of the primordial stamen stage continued their development as two growing regions, new organs being formed between them and the incision; bisections made at an earlier stage admitted of the formation of other groups of floral organs between the new flower center and the wound. Surgical experiments along these lines might well be extended with interesting results to

very young capitula, umbels, and the corymb of *Iberis* spp., in which the outer florets or flowers show characteristic zygomorphic developments.

Earlier, in a somewhat different type of surgical experiment, Murneek (1927) had shown that in the spider flower (*Cleome spinosa*), in which a phase of pistil formation is normally followed by a phase of stamen production, the excision of the very young pistils results in the formation of new ones for an abnormally long time.

Zygomorphy. Only the simplest and commonest case of median zygomorphy—*i.e.*, where the plane of dorsiventrality is that of the bract and shoot axis—can be considered here, though the other types also suggest interesting opportunities for new work. Goebel (1900, 1913) has given an excellent survey of this phenomenon, especially from the standpoint of the causal factors that may be involved.

In some species with a racemose inflorescence and median zygomorphy, Goebel noted that if, as a result of some disturbance or injury, a lateral flower primordium develops in a terminal position, it tends to be actinomorphic. Such evidence—from one of “nature’s experiments”—suggests interesting possibilities for the further exploration of the zygomorphic condition by surgical, chemical, and other treatments. These investigations might be of special interest in families such as Orchidaceae and Zingiberaceae, which show somewhat parallel, but not identical, evolutionary trends in their reduced, dorsiventral flowers, Figure 15. In passing, the possibility that an incipient dorsiventrality

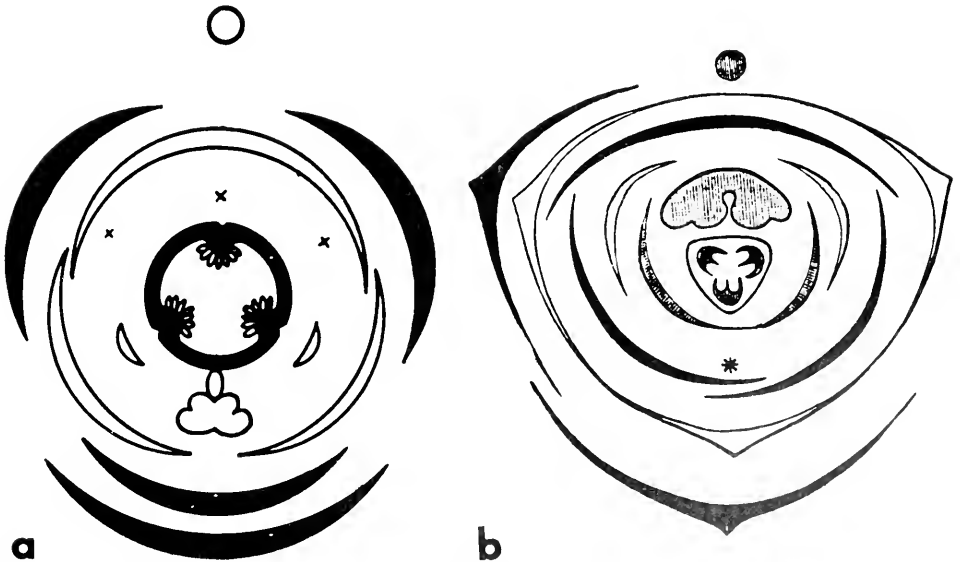

Figure 15. Floral diagrams of Orchidaceae (left) and Zingiberaceae (right), showing parallelism, but not identity, in the marked reduction in the number of stamens. (After Eichler, *Blüthendiagramme*.)

may be present at some stage in the ontogenesis of many flowers may also be noted (see Cutter, 1957). In comparative ontogenetic studies of the flowers in species of *Nymphaea* and *Nuphar*, Cutter observed that the "subtending" bract in the latter, which is the first primordium to originate on the floral meristem, is homologous with the anterior sepal in *Nymphaea*, which has no bract. In both instances the position of the first floral organ suggests that there is some difference in growth between the anterior and posterior sides of the young floral meristem, but on further development, radial symmetry is established. If, however, we suppose that the incipient growth difference between the anterior and the posterior (or abaxial and adaxial) sides of the floral primordium were to be accentuated, then the flower would be zygomorphic. This kind of relationship can perhaps be examined experimentally.

In a species in which the flower is normally actinomorphic, it may be assumed that the growth on the adaxial and on the abaxial faces is approximately equal in amount: *i.e.*, such controlling or regulating effects as may be exercised by the axis, or inflorescence apex, above are equalled by those exercised by the bract below. If, now, the very young floral primordium were to be isolated from the controlling effects from above by a tangential incision, some degree of zygomorphy in the developing flower might be expected to follow. In fact, when a flower locus was isolated from the inflorescence apex in *Primula bulleyana* by a tangential incision, Cusick (1959) found that a flower duly developed, and the present writer notes that it seems to show some zygomorphic development.

Another approach to the phenomenon of zygomorphy is perhaps afforded by the classical case of meristic variation in *Stellaria media*, especially in the androecium, varying from three to eight stamens (Figure 16). Matzke (1932, 1952) has shown that the distribution of missing stamens is not entirely at random but is such as to approximate an incipient dorsiventrality between the axis and the bract. It would be interesting to know whether other instances of seemingly random meristic variation are also of this kind. In the extreme form of androecial meiomery seen in Orchidaceae and Zingiberaceae, it is of interest to note that whereas the residual stamen of the former is in the anterior position, that of the latter is in the posterior position, both flowers showing median zygomorphic symmetry (see Figure 15).

However conspicuous the departures from radial symmetry may be, floral development typically shows evidence of an over-all balance and stability. This is what one would expect on the assumption that the floral meristem is a unified reaction system, producing new organs in a characteristic pattern at intervals in accord with the laws of physical chemistry, and with pervasive reciprocal relationships between the younger and the older organs throughout the floral ontogenesis.

The characteristic disposition of zygomorphic flowers—*i.e.*, lateral and approximately horizontal—has long been associated with insect visitation and the biological advantages of cross-pollination. (See summary of literature in Goebel, 1900). As early as 1819 A. P. de Candolle had noted that the position occupied by a flower has a great

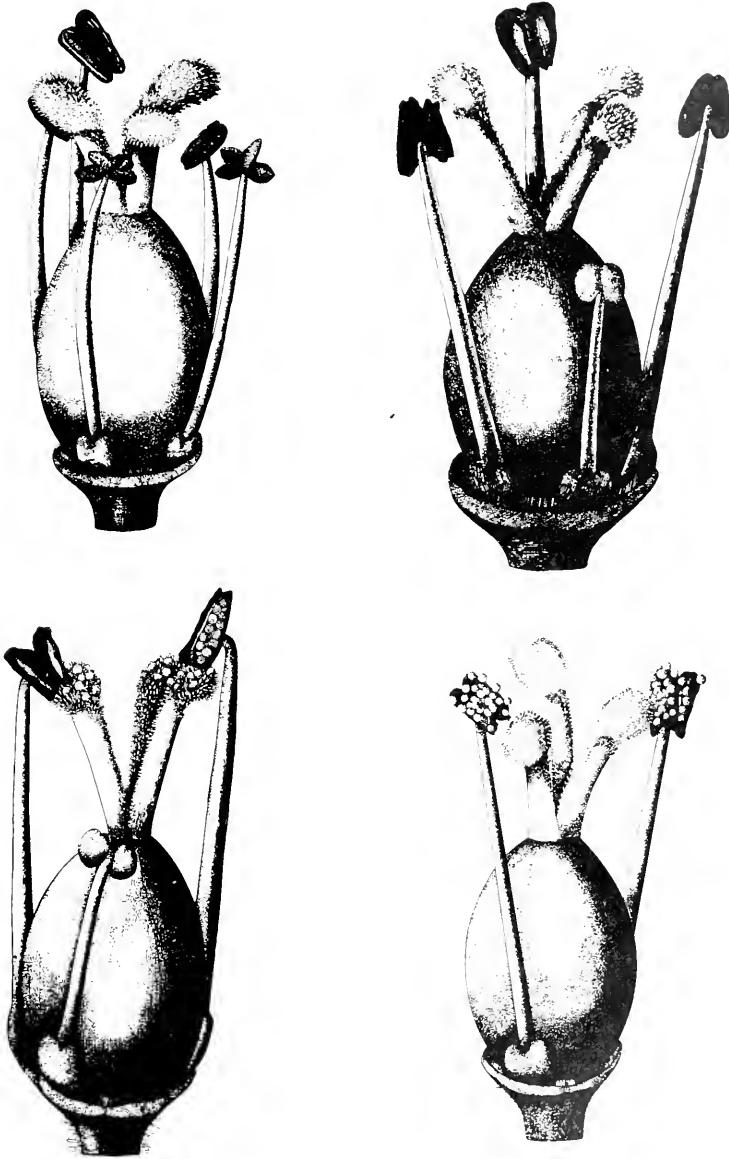

Figure 16. Flowers of *Stellaria media* (L.) Vill., with perianth removed, illustrating various stages of reduction in the number of stamens. (Original drawings, C. W. Wardlaw.)

effect on its symmetry, the solitary, terminal, erect flower being usually of radial symmetry even when it belongs to a family characterized by zygomorphic flowers. Explanations of floral symmetry (Figure 17). have tended to combine elements of both causality and teleology. Space does not admit of an adequate treatment of this fascinating topic. Goebel summarized his views by noting that if zygomorphic flowers were entirely the result of variation in any direction, with selection and survival of the fittest (*i.e.*, those best adapted to insect visitors), it is not evident why many terminal flowers should not also have become zygomorphic; and by noting also that dorsiventrality is found in many anemophilous plants—*e.g.*, many of the grasses. It will certainly be interesting to see to what extent the several views on zygomorphy accord with such results as may be obtained from critical morphogenetic investigations, undertaken without preconceived notions of biological advantage, etc. That certain characteristic morphological features of the adult flower may have an important selective advantage in relation to insect visitation and cross-pollination may be accepted,



Figure 17. Inflorescence of *Digitalis purpurea*; its large, terminal, peloric flower is actinomorphic, while the lateral flowers are zygomorphic. (After Velenovsky.)

but these phenomena have still to be brought into some acceptable relationship with the primary facts of morphogenesis.

Genetical investigations. In the preceding sections, the action of various environmental and physiological factors and developmental relationships, which appear to be of general occurrence in inflorescence and floral morphogenesis, have been noted. These common factors and relationships, which are purely extrinsic, or are not closely and specifically genetical in character, seem likely to be involved in some aspects of parallel development. It is, however, to the genetical constitution of the individual species, and to differences in genetical constitution among species, that the distinctive floral morphology of a particular species, and the great diversity in floral morphology in species at large, must be primarily attributed. So we have to inquire how, and to what extent, homologies of floral organization can be explained genetically. In practice, the respective actions of extrinsic and intrinsic factors can never be completely separated, but there are good reasons why we should try to obtain fuller information on the specific effects of the two categories of factors.

In a genetic approach to the evolutionary differentiation of the families of flowering plants, Stebbins (1950) considered that phenotypic modifications in species are referable to mutations of genes, the genes' time of action, growth substances, allometric growth, and environmental factors, and that the basic questions related to the forces that induce and establish mutations in natural populations. The probable random nature of individual mutations, the accumulation of those that have a relatively slight effect on the phenotype, and the selective advantage conferred on individuals and populations by combinations of different gene-dependent properties, are well-established concepts in contemporary genetics. Yet, as many biologists have recognized, all long-continued evolutionary trends appear to be governed by some guiding force. While natural selection is now generally accepted as an ever-present and effective agent, Stebbins, in common with some other biologists, also considers that there is "some unexplained force which, presumably by causing the more frequent or predominant occurrence of mutations which are genetically unconnected, but have a similar morphological and physiological effect on the phenotype, directs or canalises the course of evolution." Whatever the nature of this "force" may be, it is evidently very important and deserves to be more fully explored.

The details of Stebbins' explanation of the inception of different systematic groups need not be considered here, but some points may be noted. He emphasizes that since the flower is a harmoniously developed and functionally effective organ, any viable change in one of its parts will "immediately change the selective value of modifications in

all the others, as well as the value of such general characteristics as the size, number, and arrangement of the flower produced." Other variables will be introduced into the situation by the economy of the plant as a whole, its habitat, and its mode of life. The eight characters used in taxonomy and held to be primitive in floral morphology—namely, corolla present, polypetaly, actinomorphy, numerous stamens, apocarpous carpels, many ovules, axial placentation, and superior ovary—may each show characteristic evolutionary advances (*e.g.*, actinomorphy to zygomorphy, polypetaly to gamopetaly, etc.). Theoretically, several or all of these morphological advances might be combined, 256 different combinations being possible, but actually only some 34 per cent are realized. About half of these are found in only one or two families (or groups), but certain combinations are present in a large number of groups.

Stebbins considers that the eight characters are not simply combined at random in the different families and genera but are affected by considerations such as constructional feasibility, functional efficiency, and adaptation. Certain combinations occur in only a few groups—*e.g.*, the Leguminosae (*sens. lat.*)—but in them the number of genera is very large. The same is true of the Orchidaceae, Gramineae, Cruciferae, Malvaceae, Scrophulariaceae, Rubiaceae (in part), and Compositae. Some combinations of two or three characters are especially prevalent—*e.g.*, apetaly combined with a reduction in ovule number, floral symmetry, and type of inflorescence (zygomorphy and racemose inflorescence). In other words, the effects of correlative development are abundantly exemplified in floral evolution and may extend to related vegetative and habitat features. Stebbins makes the point that while the relative simplicity of plant structure, as compared with that of animals, restricts the extent of any evolutionary progression, it admits of "an exceptionally large amount of parallel variation, so that morphological similarity is much less indicative of phylogenetic relationship in plants than it is in animals." Critical investigations of some of the interesting ideas he has advanced seem feasible and desirable. The morphogenetic examination of related species which have been closely investigated genetically seems likely to yield valuable information, especially where the action of particular genes is known to be associated with conspicuous morphological developments; for, although the effects of mutant genes are usually very slight, instances are known in which the morphological changes are conspicuous and extensive.

Attention may also be called to the probable value and general biological interest of morphogenetic studies of vegetative and reproductive organs showing special adaptations. Thus we may inquire how and when the special adaptation has its inception and elaboration dur-

ing ontogenesis, and whether the information so obtained accords or is at variance with current explanations of these structures in terms of their evolution and function.

Discussion

The morphological diversity of inflorescences and flowers is impressive, but some simplification of our ideas concerning them begins to seem possible. From the generally accepted prototypic flower, very extensive diversification could come about as a result of genetical changes determining modifications in the distribution of growth in the floral meristem, or receptacle, these modifications being effected by direct gene action and by correlative developments. In the search for general factors in floral morphogenesis, some of the many instances of parallel structural development in different, or seemingly different, phyletic lines should be fully investigated. While each of the developments in which we can perceive homology of organization is ultimately related to, and limited by, the underlying genetical constitution, some of them do not seem to be closely or directly determined by genetical factors. Thus parallelisms in floral construction may be indicative of (1) common ancestry and parallel changes in the genetical constitutions, (2) dissimilar genetical constitutions which nevertheless have comparable morphogenetic manifestations, (3) obscured but latent homology, or (4) the effect of extrinsic factors. Other possibilities also suggest themselves.

In support of the view that certain major developments are apparently not closely and specifically gene-determined, it may be noted that (1) a flower typically consists of an axis and lateral members, develops as a unified structure, and in the growth of its component organs affords evidence of regulation and correlation; (2) the same assemblage of amino acids and other general metabolic substances that is essential for the growth of embryonic tissues has been detected in the apical meristems of taxonomically unrelated species; (3) the "florigenic substance" that determines the onset of the reproductive phase in apical and lateral meristems is probably the same in all flowering plants; and (4) certain environmental factors may determine closely comparable morphogenetic developments, some of critical importance, in unrelated species. On some of these aspects contemporary geneticists have so far had little to say, at least as judged by the contents of standard works.

Although there is great variety in the minor details of floral structure within a species, genus, or family, the main trends in floral evolution can probably be referred to a few major kinds of change, starting from a central prototype. As parallel developments have taken place

in unrelated groups, it may be inferred that the underlying genetical changes were those which had a high probability of taking place and of yielding floral constructions with a high survival value.

In considering the extensive, conspicuous, and often confusing diversification that inflorescences and flowers have undergone during the course of evolution, it now appears, on the evidence and arguments outlined here, that only a comparatively small number of major growth and organogenic changes, in which both genetical and non-genetical factors participate, may have been involved. If this view can be validated by critical investigations along the lines that have been indicated, the hope may well be entertained that this complex mass of biological materials may eventually be understood and described in terms of simplifying and unifying concepts.

Conclusion

Before the word "scientist" was coined and had come into common usage, investigators of natural phenomena, who usually had other scholarly attainments, were described as natural philosophers. It is still important that biological science should have a philosophical content, the central feature of which should surely be an attempt to arrive at a true understanding of living organisms as organisms, in all their diversity, both ontogenetic and phylogenetic. As a working procedure, the attempt to describe the processes in living organisms in terms of mathematics, physics, and chemistry not only has many merits but is indeed essential. But, in the writer's view, it is unlikely to succeed without the elaboration of further concepts—those relating to the specific organization which is passed on from generation to generation and which is characteristic of all living things. The biologist who accepts this view need never fear, as some of our contemporaries do, that biology will pass out of his hands into those of the biophysicist and biochemist. The study of floral morphogenesis, concerned as it is with the most elaborate organs in the most highly evolved and numerically largest group of organisms in the plant kingdom, affords a superabundance of materials to excite man's curiosity and challenge his capacity for investigation and philosophic reflection, leading eventually, we may hope, to the enunciation of simplifying general truths.

Summary

The need for comprehensive morphogenetic investigations of angiosperm inflorescences and flowers has here been emphasized. Such work is likely to advance our knowledge both of causality and phylogeny. The investigations envisaged also hold out the hope that some

simplification and unification of outlook on this great and varied group may in time become possible. Theoretical aspects of the inception and development of the inflorescence and flower, largely based on recent investigations of the shoot apex, have been considered. Examples were given of some of the specific problems in floral morphogenesis that await fuller investigation, and the value and general interest of the information that may be obtained from new observations and experimental investigations of different kinds were discussed.

As work progresses, it seems likely that certain major morphogenetic factors may prove to be of general occurrence. If so, new light may be shed on hitherto obscure phylogenetic relationships, and we may perhaps begin to understand why the same kind of evolutionary change has occurred independently in seemingly unrelated groups.

References

- Arber, A., 1937. "The Interpretation of the Flower: A Study of Some Aspects of Morphological Thought," *Bot. Rev.* 12, 157.
- Baker, H. G., 1947a. "Infection of Species of *Melandrium* by *Ustilago violacea* (Pers.) Fuckel and the Transmission of the Resultant Disease," *Ann. Bot.* 11, 333.
- Baker, H. G., 1947b. "Sex in *Melandrium*," *Nature*, 159, 34.
- Buvat, R., 1952. "Structure, evolution et fonctionnement du méristème apical de quelques dicotylédones," *Ann. Sci. Nat. (Bot.)* 13, 199.
- Buvat, R., 1955. "Le méristème apicale de la tige," *Ann. Biol.* 31, 596.
- Carr, D. J., and Carr, S. G. M., 1959. "Developmental Morphology of the Floral Organs of *Eucalyptus*," *Austr. J. Bot.* 47, 109.
- Cusick, F., 1956. "Studies of Floral Morphogenesis, I: Median Bisections of Flower Primordia in *Primula bulleyana* Forrest," *Trans. Roy. Soc. Edin.* 63, 153.
- Cusick, F., 1959. "Floral Morphogenesis in *Primula bulleyana* Forrest," *J. Linn. Soc. Lond.* 56, 262.
- Cutter, E. G., 1957. "Studies of Morphogenesis in the Nymphaeaceae, II: Floral Developments in *Nuphar* and *Nymphaea*: Bracts and Calyx," *Phytomorph.* 7, 57.
- Cutter, E. G., 1959. "Studies of Morphogenesis in the Nymphaeaceae, IV: Early Floral Development in Species of *Nuphar*," *Phytomorph.* 9, 263.
- Cutter, E. G., 1960. "The Inception and Distribution of Flowers in the Nymphaeaceae," *Proc. Linn. Soc. Lond.* 172, 93.
- Cutter, E. G., and Voeller, B. R., 1959. "Changes in Leaf Arrangement in Individual Fern Apices," *J. Linn. Soc. Lond. (Bot.)* 56, 225.
- Eames, A., 1931. "The Vascular Anatomy of the Flower with Refutation of the Theory of Carpel Polymorphism," *Am. J. Bot.* 18, 147.
- Engard, C. J., 1944. "Organogenesis in *Rubus*," *Res. Publ. Univ. Hawaii*, 21, 1.
- Foster, A. S., 1929. "Investigations on the Morphology and Comparative History of Development of Foliar Organs, I: The Foliage Leaves and Cataphyllary Structures in the Horse-Chestnut (*Aesculus Hippocastanum* L.)," *Am. J. Bot.* 18, 243.
- Foster, A. S., 1935. "A Histogenic Study of Foliar Development in *Carya Buckleyi* var. *Arkansana*," *Am. J. Bot.* 22, 88.

- Goebel, K., 1900. *Organography of Plants* (Oxford, Clarendon Press).
- Goebel, K., 1913. *Organographie der Pflanzen*, 2nd edn., Pt. 1, p. 181 (Jena, Gustav Fischer).
- Grainger, J., 1939. "Studies upon the Time of Flowering of Plants. Anatomical, Floristic and Phenological Aspects of the Problem," *Ann. Appl. Biol.* 26, 684.
- Grégoire, V., 1938. "La morphogénèse et l'autonomie morphologique de l'appareil floral, I: Le carpelle," *Cellule* 47, 285.
- Heslop-Harrison, J., 1956. "Auxin and Sexuality in *Cannabis sativa*," *Physiol. Plant.* 9, 588.
- Heslop-Harrison, J., 1957. "The Experimental Modification of Sex Expression in Flowering Plants," *Biol. Rev.* 32, 38.
- Heslop-Harrison, J., 1959. "Growth Substances and Flower Morphogenesis," *J. Linn. Soc. Lond.* 56, 269.
- Heslop-Harrison, J., 1960. "The Experimental Control of Sexuality and Inflorescence Structure in *Zea mais* L.," *J. Linn. Soc. Lond.* 172, 108.
- Heslop-Harrison, J., and Heslop-Harrison Y., 1957a. "Studies on Flowering-Plant Growth and Morphogenesis, I: Morphogenetic Effects of 2,3,5-Triiodobenzoic Acid on *Cannabis sativa*," *Proc. Roy. Soc. Edin. B*, 66, 409.
- Heslop-Harrison, J., and Heslop-Harrison, Y., 1957b. "Studies on Flowering-Plant Growth and Morphogenesis, II: The Modification of Sex Expression in *Cannabis sativa* by Carbon Monoxide," *Proc. Roy. Soc. Edin. B*, 66, 424.
- Heslop-Harrison, J., and Heslop-Harrison, Y., 1958a. "Photoperiod, Auxin and Sex Balance in a Long-Day Plant," *Nature* 181, 100.
- Heslop-Harrison, J., and Heslop-Harrison, Y., 1958b. "Long-Day and Auxin Induced Male Sterility in *Silene pendula* L.," *Portug. Acta Biol.* 5, 79.
- Heslop-Harrison, Y., and Woods, I., 1959. "Temperature-Induced Meristic and Other Variation in *Cannabis sativa*," *J. Linn. Soc. Lond.* 56, 290.
- Lang, W. H., 1915. "Phyletic and Causal Morphology," Presidential Address (Sect. K) British Association for the Advancement of Science.
- Matzke, E. B., 1932. "Flower Variation and Symmetry Patterns in *Stellaria media*, and Their Underlying Significance," *Am. J. Bot.* 19, 477.
- Murneek, A. F., 1927. "Physiology of Reproduction in Horticultural Plants, II: The Physiological Basis of Intermittent Sterility with Special Reference to the Spider Flower," *Res. Bull. Univ. Mo. Agric. Exp. Sta.* 106, 1.
- Plantefol, L., 1948. "L'ontogénie de la fleur," *Ann. Sci. Nat. Bot.* (Ser. 11) 9, 33.
- Richards, F. J., 1951. "Phyllotaxis: Its Quantitative Expression and Relation to Growth in the Apex," *Phil. Trans. B*, 221, 1.
- Rickett, H. W., 1944. "The Classification of Inflorescences," *Bot. Rev.* 10, 187.
- Schopfer, W. H., 1940. "Recherches sur la phénologie de *Melandrium album* (Miller) Gke. parasité par *Ustilago violacea* (Pers.) Fek.," *C. R. Acad. Sci. Paris*, 210, 703.
- Schüepf, O., 1929. "Untersuchungen zur Beschreibenden und experimentellen Entwicklungsgeschichte von *Acer pseudo-platanus*," *J. B. Wiss. Bot.* 70, 743.
- Stebbins, G. L. Jr., 1950. *Variation and Evolution in Plants*. (N. Y., Columbia U. Press).
- Tepfer, S. S., 1953. "Floral Anatomy and Ontogeny in *Aquilegia formosa* var. *truncata* and *Ranunculus repens*," *Univ. Calif. Publ. Bot.* 25, 513.
- Thompson, J. McL., 1937. "On the Place of Ontogeny in Floral Inquiry," *Publ. Hartley Bot. Labs. Liverpool Univ.* 17, 3.
- Turing, A. M., 1952. "The Chemical Basis of Morphogenesis," *Phil. Trans. B*, 237, 37.

- Voeller, B. R., and Cutter, E. G., 1959. "Experimental and Analytical Studies of Pteridophytes, XXXVIII: Some Observations on Spiral and Bijiugate Phyllotaxis in *Dryopteris aristata* Druce," *Ann. Bot. N.S.* 23, 391.
- Wardlaw, C. W., 1949. "Experiments on Organogenesis in Ferns," *Growth Suppl.* 9th Growth Symp. 13, 93.
- Wardlaw, C. W., 1950. "Experimental and Analytical Studies of Pteridophytes, XVI: The Induction of Leaves and Buds in *Dryopteris aristata* Druce," *Ann. Bot. N.S.* 14, 435.
- Wardlaw, C. W., 1953. "A Commentary on Turing's Diffusion Reaction Theory of Morphogenesis," *New Phytol.* 52, 201.
- Wardlaw, C. W., 1955. "The Chemical Concept of Organization in Plants," *New Phytol.* 54, 302.
- Wardlaw, C. W., 1957a. "Experimental and Analytical Studies of Pteridophytes, XXXV: The Effects of Direct Applications of Various Substances to the Shoot Apex of *Dryopteris austriaca* (*D. aristata*)," *Ann. Bot.* 21, 85.
- Wardlaw, C. W., 1957b. "On the Organization and Reactivity of the Shoot Apex in Vascular Plants," *Am. J. Bot.* 44, 176.
- Wardlaw, C. W., 1957c. "The Floral Meristem as a Reaction System," *Proc. Roy. Soc. Edin. (Biol.)* 66, 394.
- Wardlaw, C. W., 1959. "Methods in Plant Morphogenesis," *J. Linn. Soc. Lond.* 56, 154.
- Wardlaw, C. W., 1960. "Some Preliminary Observations on the inception of the Inflorescence," *Proc. Linn. Soc. Lond.* 172, 90.
- Wolf, F. T., 1952. "The Production of Indoleacetic Acid by *Ustilago zeae*, and Its Possible Significance in Tumor Formation," *Proc. Nat. Acad. Sci.* 38, 106.



**RESPONSES TO ENVIRONMENTAL FACTORS
BY PLANTS IN THE VEGETATIVE PHASE**

Geoffrey E. Blackman

UNIVERSITY OF OXFORD

You will recall that in the courtroom the King of Hearts instructed the White Rabbit to “begin at the beginning, go on to the end; then stop.” I was instructed to begin by discussing the genesis of the concepts of growth analysis, and here history and filial duty dictate that I start with my father. In 1919 V. H. Blackman, stimulated by the first investigation of one of his students, F. G. Gregory, on leaf expansion in the cucumber, pointed out that the growth of an intact plant, as exemplified by the gain in weight, was a continuous process. He drew attention to the fact that the changes in weight with time obeyed the compound-interest law: that is to say, the gain at any time was proportional to the amount of biological capital. On this basis, he criticized the previous proposals put forward by Noll in 1906 that the best measure of the rate of change in plant weight was the ratio that relates the dry weights at two given time intervals (“substanzquotient”). Such a proposal erroneously implied that the relationship between time and weight was linear; a far better measure of the rate of gain was the difference between the logarithms of weight divided by the interval between sampling occasions.

Examining the field data on the growth of *Helianthus annuus* contained in a doctoral thesis of Gressler, one of Noll’s students, Blackman demonstrated that for a considerable part of the growth cycle the calculated rate was relatively constant. Blackman went on to point out that “if the rate of assimilation per unit area of leaf surface and the rate of respiration remain constant, and if the size of the leaf system bears a constant relationship to the dry weight of the whole plant, then the rate of production of new material as measured by the dry

weight will be proportional to the size of the plant." This rate therefore reflected the performance of the plant under a given set of conditions, and Blackman contended that this "efficiency index" could be employed as a critical yardstick for comparisons between either species or habitats.

A year later Brenchley (1920-21) published an account of her investigations on the pattern of change in weight of *Pisum sativum* grown under the conditions of water culture in a greenhouse at different seasons of the year. In each experiment, the efficiency index between consecutive weekly samples was calculated as recommended by Blackman, and an appraisal was made of the influence of temperature and hours of bright sunshine on the variation in the index. At this point it is of some interest to note that the statistical treatment of the data was undertaken by R. A. Fisher, who had recently joined the staff at Rothamsted Experimental Station, and he was the first to calculate multiple regressions linking the index with other factors—namely, in this instance, age, maximal and minimal temperature, and hours of sunshine. Dividing the data into two groups of young (four weeks) and older plants, he showed that for young plants the efficiency index was positively correlated with age and maximum and minimum temperature, whereas for the second phase the correlation for maximum temperature and hours of sunshine was positive and that for age negative.

The next year saw the publication of three papers by Briggs, Kidd, and West (1920-21 a, b, and c) with a varying order of authorship for the individual contributions. Like Blackman, for their basic field data they drew on the extensive records accumulated, but not interpreted, by German botanists in the last quarter of the nineteenth century, particularly the findings of Kreuzler, Prehn, and Becker (1877) on *Zea mays* and of Hornberger (1885) on *Sinapis alba*. From the original data it was possible to calculate on a weekly basis the change in dry weight of both species from the seedling stage to maturity and to compare the seasonal trends with those derived for *H. annuus* from the data of Gressler cited by Blackman. These authors observed that the efficiency index, or the relative growth rate, as they preferred to call it, fluctuated considerably from week to week, and they took Blackman to task for considering that this measurement could be regarded as a physiological criterion of the plant's performance. They were also critical of Blackman and Brenchley for their assumption that growth was a continuous exponential process and that the best method of estimating the rate over a given time interval was obtained by the change in weight on a logarithmic scale. Briggs *et al.* argued that "as we have no exact knowledge of the way in which the relative rate of growth varies over a given period, we have adopted the following purely conventional methods of defining relative growth rate"—*i.e.*, as

the percentage gain in dry weight per week on an arithmetical scale. The rejoinder by Blackman (1920) was that if a single basic assumption had to be made, then the weight of the evidence, particularly for the vegetative phase, was that growth was an accumulatory process, so that any calculation of the mean rate over appreciable time intervals on a linear basis was liable to considerable error. Blackman agreed that when the relative growth rate was calculated over short time intervals, fluctuations in environmental factors would be reflected in variations in the index, but he still held that over longer periods the mean index did give some quantitative indication of the relative performance of different plants. Fisher (1920-21) also pointed out with pungency that if one wanted to find the average change in weight between two sampling times, then the rate was best expressed as:

$$\frac{1}{w} \frac{dw}{dt} \text{ or } \frac{d}{dt} \log_e W.$$

To these strictures Briggs et al. (1920-21c) replied that they had put forward both methods of calculation and that both methods were perfectly proper.

These authors (1920-21b) put into more precise terms the dependency of the relative growth rate on both the level of photosynthesis per unit of leaf surface and the assimilatory area. As the ash content of most plants is small and does not appreciably alter with the stage of development, the net gain in dry matter over each 24 hours is determined by the excess of carbon dioxide fixed during the day over that respired during the night. Hence a measure of the net fixation per unit leaf surface can be obtained if the leaf area is measured simultaneously with the estimation of dry weight. Briggs *et al.* defined "unit leaf rate" as the increase in dry weight per square centimeter of leaf per week, taking as the leaf area the average of the area at the beginning and end of the week. Here, again, in estimating unit leaf rate, the question arose whether changes between sampling occasions should be taken as exponential or not. If an exponential basis is assumed, then the mean rate is best expressed as:

$$\frac{W_2 - W_1}{t_2 - t_1} \times \frac{\log_e A_2 - \log_e A_1}{A_2 - A_1}$$

where W_2 and W_1 and A_2 and A_1 represent the weights and total leaf areas at times t_1 and t_2 . If the relationships are considered to be linear, then the expression becomes:

$$\frac{W_2 - W_1}{t_2 - t_1} \div \frac{A_2 + A_1}{2}$$

In examining Kreusler's data for *Z. mais*, Briggs *et al.* adopted linear measures in their estimates of unit leaf rate. They found that after the eighth week from the early seedling stage the individual figures for the five varieties fluctuated widely, with a downward trend. They decided, therefore, to employ only the results from the first eight weeks, when the rate was rising, in an attempt to correlate variations in the rate with changes in the environmental factors. After eliminating doubtful records, they were left with only 15 to 20 figures from the several years' experiments to correlate with the extensive meteorological data Kreusler had collected. Employing simple correlations, without any attempt to eliminate ontogenetic or time drifts, they correlated the rate per week with the rainfall, the average maximum temperature, and various parameters for light devised by Kreusler. On the basis of these correlations, Briggs *et al.* concluded that above a level of one-fifth of full sunlight light was no longer limiting the unit leaf rate. However, since this correlation was 0.77, while those for total light or hours of sunshine were 0.67 and 0.70, the evidence clearly was not very conclusive.

These authors also calculated the leaf-area ratio—that is to say, the total leaf area divided by the plant weight—and observed that there was a common trend for the ratio and the relative growth rate to rise to a maximum about the fourth week, to fluctuate about this maximum until the eighth week, and then to fall in the flowering and ripening phases. Because of this similarity they came to the conclusion that in maize “the unit leaf rate is roughly constant throughout the main parts of the plant's life cycle.”

Lastly, Briggs *et al.* (1920-21 b, c) made an important contribution to the quantitative analysis of growth. They pointed out that if the changes in plant weight and leaf area are on an exponential basis, it can be shown mathematically that the relative growth is the product of the unit leaf rate and the leaf-area ratio, *i.e.*:

$$\frac{1}{W} \frac{dw}{dt} = \frac{1}{A} \frac{dA}{dt} \times \frac{A}{W}$$

In parenthesis, a quarter of a century elapsed before Williams (1946) emphasized that unless the relationship between area (*A*) and weight (*W*) over the given time interval ($t_2 - t_1$) is known, it is not possible to integrate

$$\frac{1}{t_2 - t_1} \int_{t_1}^{t_2} \frac{1}{A} \frac{dA}{dt} dt$$

If the relationship is linear, then dw/dA will be constant, and the standard formula given on page 527 is derived.

One other general comment can be made at this point: namely, that none of these earlier workers discussed to what extent a complicating factor in the interpretation of seasonal trends was the increasing degree of self-shading as the plants grew taller. For example, reference to the original paper of Kreuzler (1877) shows that two grains of *Z. mais* were sown every 30 centimeters in rows 50 centimeters apart, and at such a density they would shade one another.

In 1921 Gregory published a detailed paper on the growth of the cucumber, particularly the expansion of the leaf surface, when the plants were grown at different times of the year under standard glass-house practice. For the individual leaves the change in area with time was always a sigmoid curve, the shape of which was likened to that of an autocatalytic reaction. On the other hand, the expansion of the total leaf surface was exponential under spring and summer conditions of a high level of light but under December conditions, after following an exponential curve initially, the rate fell away later. When potted plants were grown in a chamber where the illumination was by means of tungsten filament lamps, the "winter" relationship held, and Gregory concluded that this was probably because the temperature (95° F.) was too high. Subsequently (1928) the experiments were repeated over a range of temperatures from 63 to 90.8° F., and at each temperature the relationship between the logarithm of the leaf area against time was linear but at suboptimal temperatures the rate of expansion was independent of temperature. Gregory emphasized that the increase in leaf surface depended on both the size and rate of expansion of the individual leaves and the number of leaf initials laid down by the apical bud; in consequence, internal or external factors might operate differentially on either phase.

It is of some interest that when Milthorpe (1959) re-examined the factors responsible for determining the rate of leaf expansion in the cucumber, he concluded that Gregory's failure to demonstrate a temperature effect in the suboptimal range was due to the low intensity of illumination attainable with the then existing light sources.

In the interval between the two papers on the cucumber, Gregory published a further paper (1926) on the pattern of dry-matter production of barley grown in the open under the conditions of pot culture. By frequent sampling, the courses of dry-matter and leaf production were obtained for five experiments covering four years; in two experiments the level of added nitrogen was high and in three it was low. In the individual experiments the changes in weight with time followed a sigmoid pattern, and Gregory concluded that this change was best fitted by an autocatalytic curve which was "inherent internally and

physiologically." He further postulated that if smoothed curves for the five experiments were fitted on a common basis, then any departures would represent the influence of external environmental factors on the internal physiological processes. Combining all five experiments, Gregory compared the variations in the environment within and between seasons with the departures in relative growth rate, and from the calculated multiple regression he concluded that the rate was primarily dependent on a positive effect of the mean day temperature and a negative effect of the mean night temperature while the term for the light factor, expressed as total solar radiation per day, was very small and negative.

From the data for dry weight and leaf area Gregory also calculated the net assimilation rate (the unit leaf rate of Briggs *et al.*), and over all the experiments he related the variation in rate to the seasonal differences in the environment. In this instance the fitted multiple regression showed a positive effect for solar radiation and day temperature and a negative linkage with night temperature.

In 1928 Briggs criticized Gregory's treatment of his data in arriving at the effect of the environmental factors on the relative growth rate. Briggs held that growth depends on the internal and external complexes of factors and that the problem is to distinguish the influence of the environment at any given time from the drift in the internal processes governing age and any previous effects of the environment. He pointed out that "Gregory's methods attribute differences in rate of growth in the n th period of existence (measured in days or as a fraction of the total existence) solely to the difference in the environment of that period." There was also an unproved assumption in Gregory's statistical treatment of the data: namely, that the effects of the environmental factors—light and temperature—were the same at all stages of development. In his reply Gregory (1928) admitted the validity of Brigg's criticism that no proof had been produced that the magnitude of the influence of individual environmental factors was independent of the age of the plant. Gregory stressed, however, that it was difficult to define the internal factor or tell what its precise role was, and he maintained that the growth rate could be taken as a quantitative measure of the internal factors when it came to determining the influence of the external factors.

Later Williams (1946) commented on the "lumping together" of the results of the experiments receiving either a low or a high nitrogen level, since the nitrogen content would not only contribute to the internal factor but might equally well determine the order of the response to an external factor. Again the statistical treatment of the calculated net assimilation rates carried the assumption that the rate was

relatively independent of the stage of development and nitrogen supply.

At this point it is perhaps worthwhile to look back over the first decade of research and summarize the position. At the end of the period there was little doubt that the gain, either in dry weight or total leaf area, was an accumulative process, and that, at least for the vegetative phase, the change with time followed an exponential or autocatalytic course. It had been established on theoretical grounds that the relative growth rate was the product of the net assimilation rate and the leaf-area ratio, but no experimental work had been undertaken either to compare simultaneously the performance of different species under the same conditions or to eliminate as far as possible ontogenetic drifts in the analysis of the effects of different environments on growth. The concepts then current of the distinct roles of internal and external factors in determining the pattern of development perhaps masked an appreciation of the great variation in the plastic response of species to a change in the environmental conditions and of the fact that the age or physiological status of a plant was the resultant of the interactions between the past external conditions and the internal processes.

The next 15 years saw the further application of these concepts to the study of plant development under either field or glasshouse conditions. Crowther, one of Gregory's students, carried out pioneering investigations on cotton in the Sudan and in Egypt, and by subsampling techniques he obtained comprehensive records of the leaf production and flower and boll formation. In two papers (1934, 1937) he was concerned with the changes in the relative growth rate and net assimilation rate induced by internal and external factors. It was demonstrated that over the ranges of added irrigation water and nitrogen, nitrogen increased the relative growth rate of the leaves and the shoot, but it did not alter the net assimilation rate, while water caused no significant effects. He also concluded that, leaving out of account environmental factors, the net assimilation rate reached a peak value before leaf production was complete and thereafter the rate fell. He ascribed this fall not so much to an internal ontogenetic drift as to the increased self-shading that resulted as the plants grew taller.

It should be pointed out, however, that Crowther did not sample the roots, and this omission might introduce considerable errors in the estimates, since the ratio of shoot to root would vary both with the stage of development and the external conditions. Then again, the values for the net assimilation rate were based on data for leaf weight and not for leaf area, and it will be shown later that the ratio of leaf area to leaf weight is by no means constant.

Between 1936 and 1946 a number of Australian workers, princi-

pally Ballard, Petrie, Tiver, and Williams, examined the effects of such factors as phosphorus, nitrogen, and water supply on the growth of oats, wheat, tobacco, *Linum usitatissimum*, *Sorghum sudanense*, and *Phalaris tuberosa*. These results, together with further information derived from data published by workers outside Australia, were reviewed from the point of view of growth analysis by Williams (1946). One aspect he discussed was the magnitude of the ontogenetic drift in the net assimilation rate and what was the best index of the internal factors governing the photosynthetic efficiency of the leaves. Comparisons of the change in the rate were made when the rate was expressed in terms of leaf weight, leaf area, and leaf protein. The general conclusions reached for an annual plant grown under constant environmental conditions and with a relatively limited nitrogen supply are given in Figure 1. It is seen that the maximum rates were achieved soon after the seedling phase and that subsequently the period of relative constancy was dependent on the parameter selected. For some species, such as *S. sudanense*, the net assimilation rate on a leaf-weight basis might be held constant for a very short period, while for others, such as *P. tuberosa*, the period might be seven or eight weeks. In contrast, if the criterion was leaf protein, the rate remained constant during most of the period of active growth for both these two species and for oats and wheat.

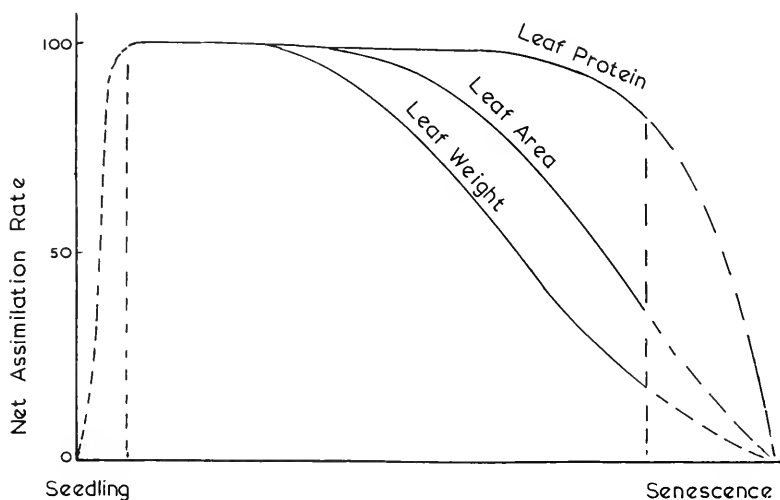

Figure 1. Diagram illustrating the interrelationship between the stage of development and the net assimilation rate, based on the criteria of (a) leaf weight, (b) leaf area, and (c) leaf protein. A constant environment and a limited nitrogen supply are assumed. (Redrawn from data of Williams, 1946.)

To sum up the effects of the nutrient level: Where increases in the nitrogen supply augmented the relative growth rate, this could be attributed to an increase in the leaf-weight ratio rather than to a change in the net assimilation rate on a leaf-weight basis. On the other hand, phosphorus deficiency depressed the relative growth rate by diminishing both the leaf-weight ratio and the net assimilation rate. The findings of more recent investigations on an extended range of species confirm that similar effects are induced by lack of phosphorus and nitrogen, save that when the deficiency of nitrogen is extreme, the net assimilation rate can be depressed (Thurston, 1959).

Further evidence for the relative constancy of the net assimilation rate on an area basis for sugar beet and mangolds is provided by the data of Watson and Baptiste (1938) from the Rothamsted Experimental Station. They sowed both these crops at weekly intervals between April 9 and June 18, and when the net assimilation rates were determined from the end of July onward, no significant effect of the sowing date was recorded. However, since the standard distance between the rows was 56 centimeters and the plants were spaced 23 centimeters apart in the row, a complicating factor was present: the differences in sowing dates would result in differential effects of self-shading within and between the rows.

A notable feature of this investigation was that it was the first occasion on which a detailed growth analysis of the relative performance of two species in the field had been made. Over all the sampling occasions there were no major differences between species in the leaf-area ratio, the net assimilation rate, or the relative growth rate. Between July and November there was a general fall for each of these criteria, but these trends were different from the changes in the size of leaf, the ratio of leaf area to leaf weight, or the rate of leaf production. Here there were significant differences between species. The mangold plants had larger leaves and a greater surface per unit weight of lamina, while the sugar beet possessed a higher rate of leaf production.

These authors failed to establish any significant effects of either the total radiation per day or the mean daily temperature on the mean value of the net assimilation rate, but they were able to demonstrate that the rate of leaf production was temperature-dependent. On general grounds they also reached the conclusion that the changes in the ratio of leaf area to leaf weight were more dependent on external than on internal factors.

From what has been stated so far it is apparent that the diversity of conclusions reached concerning the influence of light and temperature on growth was linked with the difficulty of eliminating age effects. The first attempt to get round this source of error experimentally was made by Goodall (1945) in his study of the growth of the tomato

throughout the year under glasshouse conditions. To do this, he rigorously selected for each experiment a batch of plants each of which had eight leaves, and on 24 occasions during twelve months he measured the changes in root, stem, and leaf weights over a period of 24 hours. It was found that the relative growth rate of the whole plant ranged from a negative value in December to a maximum of 24.7 per cent per day at the height of summer, and that the changes in the net assimilation rate (calculated on a leaf-weight basis) closely followed the variations in relative growth rate, while during the summer months the leaf-weight ratio fluctuated within narrow limits. During daylight the light intensity was measured at 30-minute intervals, and a statistical appraisal was made of the effects of light, the mean day and night temperatures, and the saturation deficit of the air on the diurnal gain in dry weight as a percentage of the initial leaf weight. The multiple regression incorporating all these variables was highly significant, but when further analysis was undertaken to separate the effects of five environmental factors, only the level of light intensity was significant. In passing, it should be noted that during the summer months the glass of the greenhouse was covered with "summer cloud," and that the time from sowing to the eighth leaf stage varied greatly—*i.e.*, from eleven weeks in midwinter to four weeks in midsummer.

The influence of shading on vegetation development

Since seasonal changes in light and temperature are themselves highly correlated, the separation of their effects is rendered difficult. As a first approach, it may be more rewarding to conduct experiments in which only one factor is operating, and the major effects of the light factor can be elucidated by conducting shading experiments in which the design is such that the light quality is not altered and the methods of shading bring about only small differences in the air and soil temperatures. Research along these lines has long been one of my interests, and some of the results I propose to touch on have already been published (Blackman and Rutter, 1947, 1948; Blackman and Wilson, 1951, 1954; Blackman, 1957; Blackman and Black, 1959).

A number of pot experiments have been conducted on the comparative effects of shading during the summer months on the growth in the early vegetative phase of *H. annuus* and *Fagopyrum esculentum*. A representative set of data is given in Figure 2. It is seen that, irrespective of the degree of shading, the relative growth rate of *F. esculentum* is higher than that of *H. annuus*, because the differences in leaf area ratio in favor of *F. esculentum* more than offset the higher net assimilation rates of *H. annuus*. It is equally apparent that the order of depression of the relative growth rate caused by a given reduction in the

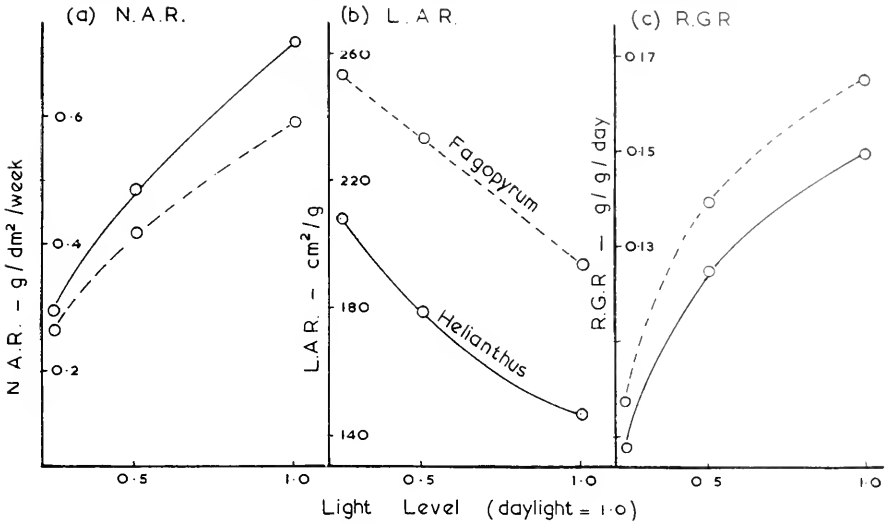

Figure 2. The influence of shading on (a) the net assimilation rate, (b) the leaf-area ratio, and (c) the relative growth rate of *Helianthus annuus* and *Fagopyrum esculentum*.

light level is the resultant of a decrease in the net assimilation rate and an increase in the leaf-area ratio. The further conclusion that can be drawn is that the assimilation rate and the growth rate of unshaded plants were restricted by the radiant energy received during August, though it was high enough to allow daily gains in dry weight of 16.6 and 15 per cent per day.

During the course of these investigations, the response to shading of 22 species has been examined. There are good grounds for concluding that for many of the species the relative growth rate of unshaded plants is restricted by the level of diurnal radiation received during the summer months. This light limitation may also apply to species which are common in woodland habitats. As an example, Figure 3 shows the reactions to shading of *Endymion non-scriptus*, a bulbous perennial, and of *Medicago sativa*, which, it is concluded, has a particularly high light requirement. Since the experimental periods were different (April as against August) only general comparisons can be made. For both species the reduction in the net assimilation rate with increased shading is of the same order, but the rise in the leaf-area ratio for *E. non-scriptus* is much smaller. In this species the leaf primordia are laid down in the previous autumn, and the influence of light cannot operate until the expanding and extending leaves have emerged above ground in the spring; thus this limits their plastic response.

Since for both species the depressions in the assimilation rate are not matched by the gains in the leaf-area ratio, the growth rates are

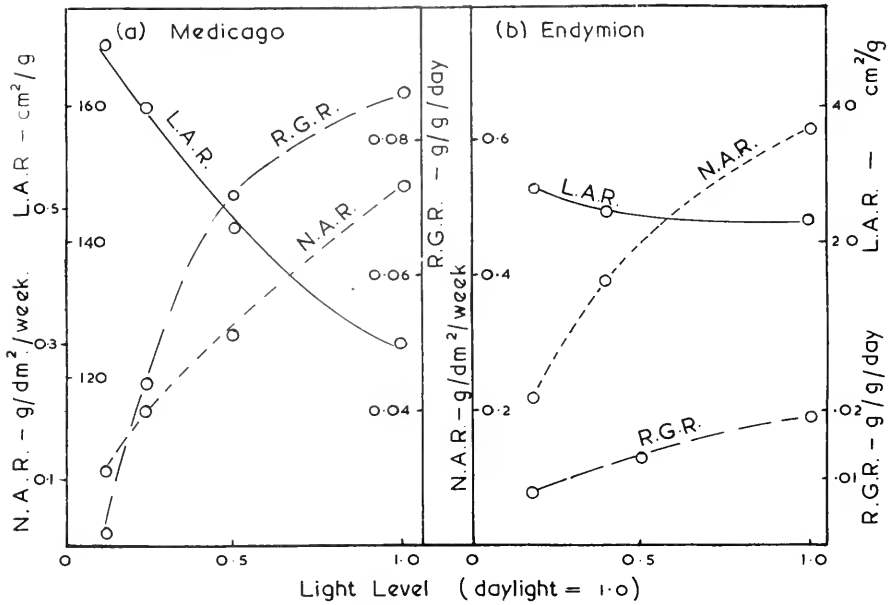

Figure 3. The influence of shading on the net assimilation rate (N.A.R.), the leaf-area ratio (L.A.R.), and the relative growth rate (R.G.R.) of *Medicago sativa* and *Endymion non-scriptus*.

maximal in full daylight. Another point to be noted is the slow growth of *E. non-scriptus* (less than 2 per cent per day in full daylight); it is apparent that the major component responsible is the low leaf-area ratio—23 to 28 cm²/g.

This lack of plasticity in *E. non-scriptus* contrasts with the behavior of *Geum urbanum*, a species associated with shady habitats in Great Britain (see Figure 4). A comparison of Figure 4a with Figures 2 and 3 shows that shading augments the leaf-area ratio of this plant much more than that of the other species, while the depression in the net assimilation rate follows a pattern similar to that of the others. Thus it is the high degree of plasticity in the leaf-area ratio that is largely responsible for the fact that the plant attains its maximal relative growth at about one-half of full daylight.

G. urbanum does not conform to the concept of an obligate shade plant in which the rate of photosynthesis reaches a maximal value at intensities well below those ruling in open habitats. However, Goodall's (1955) studies of the reactions of young plants of cocoa (*Theobroma cacao*) provide an example of a species where shading has little effect on the net assimilation rate (Figure 4b). Thus in this instance it

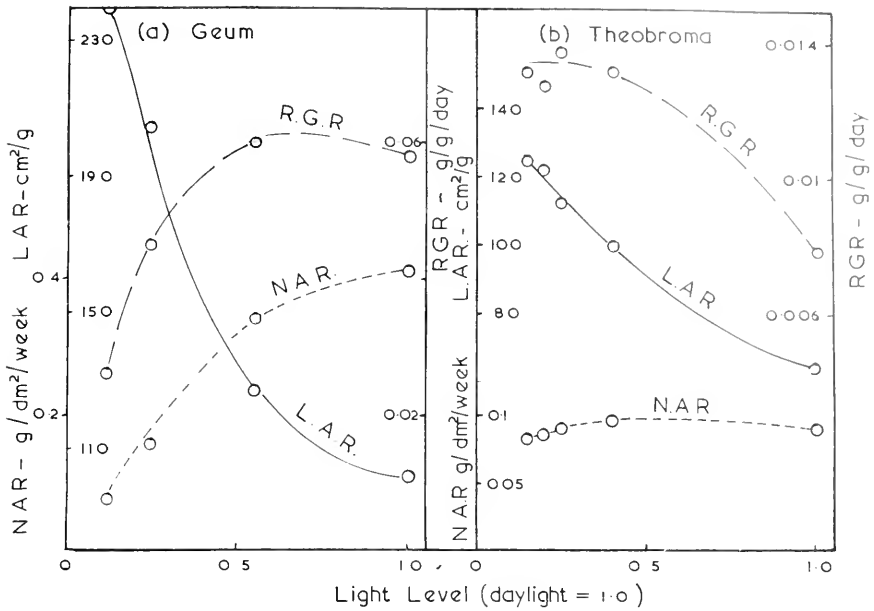

Figure 4. The influence of shading on the net assimilation rate, leaf-area ratio, and relative growth rate of (a) *Geum urbanum* and (b) *Theobroma cacao*. (Data of Goodall, 1955.)

is the increase in the leaf-area ratio that determines that the relative growth rate is greatest below 0.5 daylight.

Shading also brings about differential changes in the growth of the root, shoot, and leaves, and these changes lead to alterations in the ratios of the weights of the root, shoot, and leaves to the total plant weight. The results of an experiment in which *Avena sativa*, *H. annuus*, and *F. esculentum* were compared are shown in Figure 5. The leaf-weight ratio of *H. annuus* and *F. esculentum* is little affected by a reduction to 0.24 daylight, but for *A. sativa* there is a rise. Shading to a small extent increases the stem-weight ratio but depresses the root-weight ratio.

A marked contrast in the reactions of different species is exhibited by the trends for *Lathyrus maritimus*, a littoral species which in North-east Europe inhabits shingle banks, and *G. urbanum* (Figure 6). For *L. maritimus*, down to 0.24 daylight there are no significant changes in any of the ratios and only small rises or falls at 0.055 daylight. On the other hand, the pattern of readjustment for *G. urbanum* involves a sharp reduction in the root-weight ratio and some gains in the ratios for leaf and shoot.

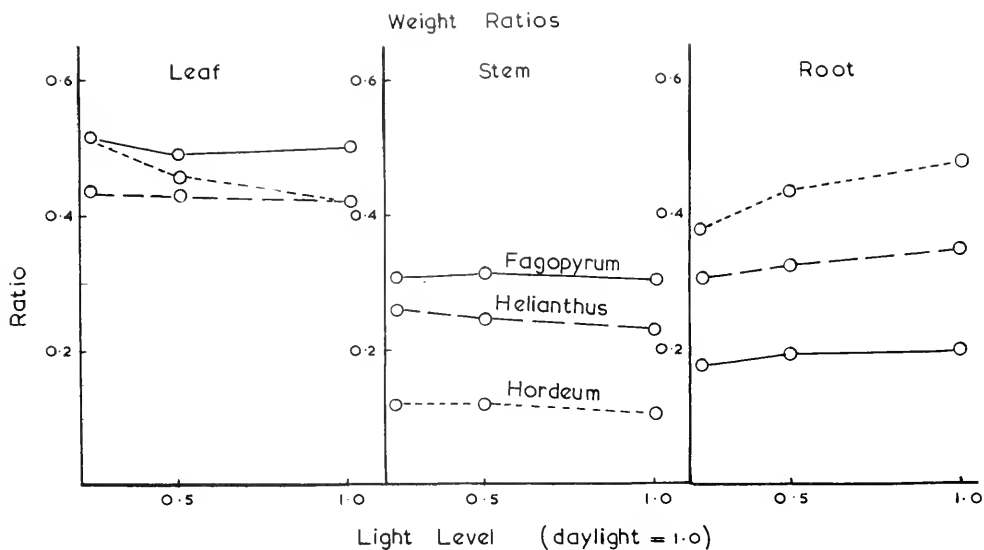

Figure 5. The influence of shading on the leaf-weight ratio, stem-weight ratio, and root-weight ratio of *Fagopyrum esculentum*, *Helianthus annuus*, and *Hordeum vulgare*.

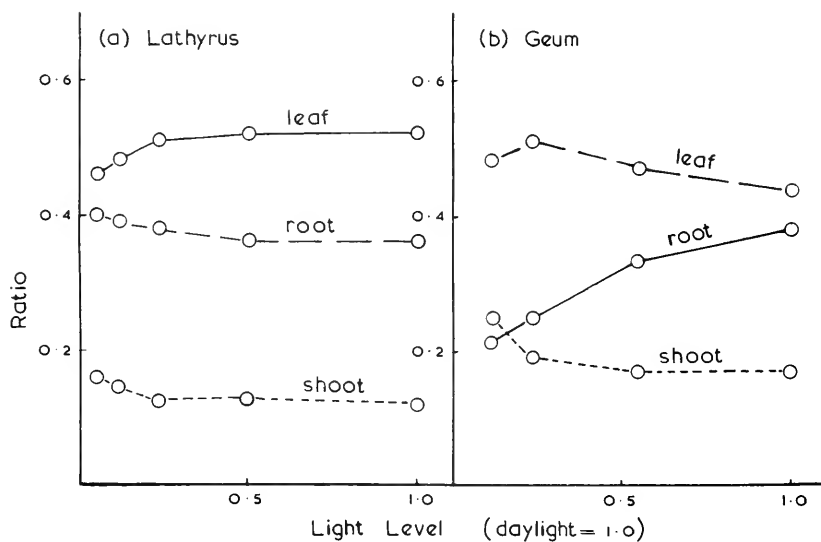

Figure 6. The influence of shading on the leaf-weight ratio, shoot-weight ratio, and root-weight ratio of *Lathyrus maritimus* and *Geum urbanum*.

The changes in leaf-area ratio can be further analyzed, since on consideration it is evident that this ratio is the product of the leaf-weight ratio and the mean of the area-to-weight ratios of the individual leaves. Therefore the observed effects of shading on the leaf-area ratio can be further subdivided into the effects on the two components. Where shading has induced only small changes in the leaf-weight ratio (*e.g.*, in *H. annuus*, *F. esculentum*, and *L. maritimus*), it would be expected that the variation in leaf-area ratio would be closely linked with the changes in the area-to-weight ratio of the lamina. That this proves to be so is apparent in Figure 7. It is also apparent from Figure 5, 6, and 7 that for barley and *G. urbanum* the increase in the leaf-area ratio induced by a diminution in the light level is more dependent on the plasticity of the leaf lamina than on the leaf-weight ratio.

Mention has already been made of the fact that it has not always been appreciated how rapid may be the plastic responses of plants to fluctuations in the environment. The rapidity of the response of the lamina is illustrated in experiments where *H. annuus* is transferred from one light level to another. A full account has already been given by Blackman and Wilson (1954), and only one experiment will be cited here. Plants of *H. annuus* in the early vegetative phase were first subjected to 1.0, 0.5, and 0.24 daylight, and then the pots were redistributed in the nine possible combinations of this range of light levels

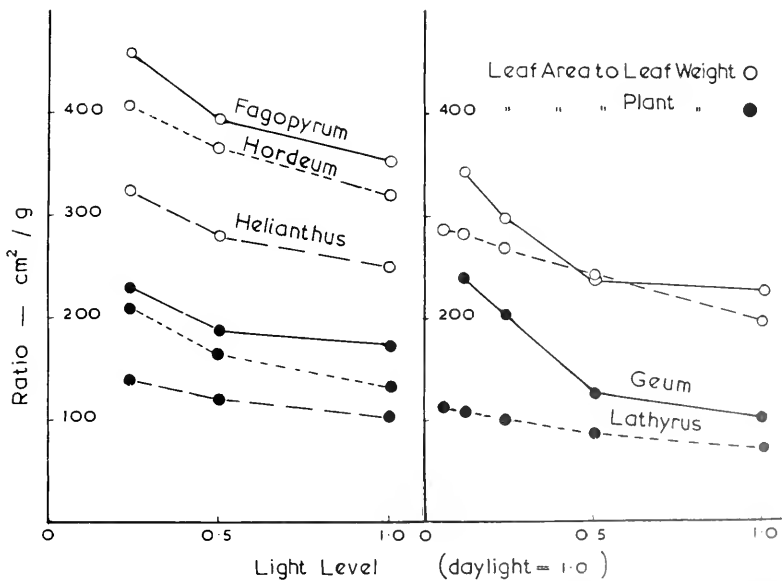

Figure 7. The influence of shading on the ratio of leaf area to leaf weight and the leaf-area ratio of *Fagopyrum esculentum*, *Helianthus annuus*, *Hordeum vulgare*, *Lathyrus maritimus*, and *Geum urbanum*.

before and after transfer. At the time of transfer the area-to-weight ratios of the leaf blades were measured, and these were again determined four days later on comparable leaves of a second sample. The data of Table I demonstrate that even within this short period there have been major adjustments in the ratio: for leaves moved to a lower light intensity the ratio has gone up, while for a move in the opposite direction the ratio has gone down. Thus the adaptation to a "sun" or "shade" type is not confined to the early primordial stage but can take place during the course of leaf expansion.

Interrelationships between light and nutrient supply

The effects of varying light level have been dwelt on in some detail because there is a significant corpus of experimental data to illustrate the extent to which growth analysis can elucidate and classify the nature of the plastic responses of different species to shading. It is self-evident that the light factor cannot be considered in isolation, and it is now proposed to discuss more briefly interactions with the level of nutrient supply and then to go on to review some interactions between light and temperature.

A number of experiments have been carried out with soils of low nutrient status to examine the interrelationships between the light level and the responses of *H. annuus* to additions of nitrogen, phosphorus, and potassium. The results of two selected experiments are given in Figure 8. In both experiments the increase in the relative growth rate due to the addition of nitrogen, phosphorus, and potassium (NPK) is inversely related to the light level, but the trends for the net assimilation rate and the leaf-area ratio are dependent on the experiment. In one, the primary effect of altering the nutrient status is to improve the efficiency of assimilation at the higher light intensities, while in the second, the additional nutrients have augmented both the net assimilation

TABLE I

The Effects of Transfer from One Light Level to Another on the Ratio of Leaf Area to Leaf Weight of *Helianthus annuus*

Light Level before Transfer	Ratio at Time of Transfer (cm ² /g)	Ratio after Transfer to the Indicated Light Levels		
		1.0	0.5	0.24 daylight
1.0 daylight	121	125	160	183
0.5 "	169	145	181	202
0.24 "	196	161	175	208

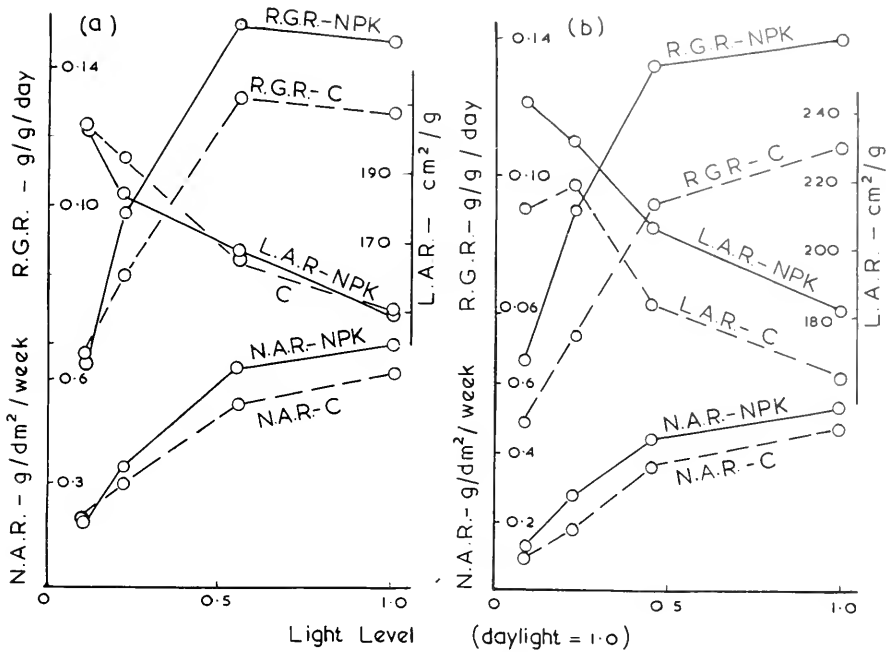

Figure 8. Interacting effects of (a) light intensity and (b) nutrient supply on the net assimilation rate, leaf-area ratio and relative growth rate of *Helianthus annuus*. NPK: nitrogen, phosphorus, and potassium. C: control.

rate and the leaf-area ratio. In other experiments, additions of N, P, and K, alone and in combination, were investigated, but there were no shade treatments. From these results it was concluded that the control plants of Figure 8a were primarily deficient in P and K, while those of Figure 8b were deficient in nitrogen also.

Interrelationships between light and temperature

It has already been emphasized that, in most of the previous attempts to investigate the influence of seasonal changes in light and temperature on growth and development, the experiments were not designed with a view to eliminating ontogenetic drifts, variations in mutual shading, and residual effects of the previous environmental conditions. The approach of Goodall, in selecting plants with standard morphological characteristics for each experiment, would be expected to reduce the error. Further reductions should be accomplished by selecting a stage early in the vegetative phase, when there is little self-shading, and the residual environmental effects are likely to be minimized if the intervening period from sowing is short. Pot experiments

along these lines were first carried out at Oxford with *H. annuus*, where between May and September in two years consecutive experiments at weekly intervals were conducted with plants which at the start of each experiment possessed three pairs of true leaves, the third of which was just visible. At the beginning and end of each experiment the leaf area and the dry weights of the roots, leaves, and stem were measured, and the diurnal variations in light level and air temperature were continuously recorded. Multiple regressions linking the net assimilation rate, the leaf-area ratio, and the relative growth rate with the seasonal variations in light and temperature were then fitted to the data. In the statistical treatment it was found possible to allow for the ontogenetic drift due to variations in the environment in the interval between sowing and the initial sampling (see Blackman, Black, and Kemp, 1955). Subsequently Black (1955) undertook a similar investigation, following the weekly growth of *Trifolium subterraneum* throughout the year under the conditions of Adelaide, Australia. More recently G. L. Hodgson and M. R. Sampford repeated the Oxford experiment on *H. annuus* under the cooler conditions of Scotland, and they added a second species, *Vicia faba*. I am indebted to them for their permission to quote some of their as yet unpublished results.

The main conclusions reached on the basis of statistical analysis are summarized in Table II. Under all conditions there is a positive effect of solar radiation on the net assimilation rate and the relative growth rate and a negative effect on the leaf-area ratio. The influence of temperature is clearly dependent both on the environmental conditions and on the species. Take first *H. annuus*: the net assimilation rate is temperature-dependent at Invergowrie but not at Oxford, while for the leaf-area ratio the position is reversed. The sensitivity of the net assimilation rate to temperature is shared by *V. faba*, but, in contrast to *H. annuus*, its leaf-area ratio is positively linked with temperature. The main climatic differences between the two centers were that at Invergowrie the days were longer and the temperatures lower, and it can be suggested that at Oxford the temperature range was above a threshold value which restricted assimilation at Invergowrie.

Although only the influence of mean daily temperature is cited in Table II, the statistical analysis included an examination of possible effects of the diurnal fluctuations in temperature. In only two instances did these fluctuations prove to be significant. The net assimilation rate of *T. subterraneum* was positively linked with the mean daily range, while the leaf-area ratio of *V. faba* was correlated with both the mean and minimum temperatures.

One of the most striking features of these studies was the high proportion of total variance that could be accounted for in the individual multiple regressions. Thus there were good grounds for concluding

TABLE II

The Effects of Seasonal Changes in the Solar Radiation Per Day and the Mean Daily Temperature on the Net Assimilation Rate, Leaf-Area Ratio, and Relative Growth Rate, as Determined by Regression Analysis

Locality and Species	Net Assim.		Nature of Correlation		Rel. Growth	
	Rate		Leaf-Area		Rate	
	Radiation	Temp.	Radiation	Temp.	Radiation	Temp.
Oxford, England						
<i>Helianthus annuus</i>	+	0	-	+	+	+
Invergowrie, Scotland						
<i>Helianthus annuus</i>	+	+	-	0	+	+
<i>Vicia faba</i>	+	+	-	+	+	+
Adelaide, Australia						
<i>Trifolium sub- terraneum</i>	+	0	-	+	+	0

that, under the experimental conditions, environmental factors other than those investigated could not have played a significant part. From the multiple regressions, and given the mean seasonal changes in diurnal radiation and temperature, it can be shown with clarity how the growth parameters change with the season. As an example, these trends for *H. annuus* under the conditions at Oxford are illustrated in Figure 9. Inspection shows that from May to the end of June the rise in the relative growth rate was closely matched by the gain in the net assimilation rate, but from midsummer onward the net assimilation rate fell faster than the relative growth rate. This failure to keep step after midsummer can be attributed to the variation in the leaf-area ratio which changes but little up to midsummer and then steadily rises. The pattern is imposed by the differences in the seasonal trends for light and temperature. Solar radiation reaches a maximum at the end of June, but temperatures do not until the latter part of July, and as a consequence, for a given level of solar radiation the days are warmer in the autumn than in the spring. Thus, since the leaf-area ratio is temperature-sensitive but the net assimilation rate is not, while the net assimilation rate

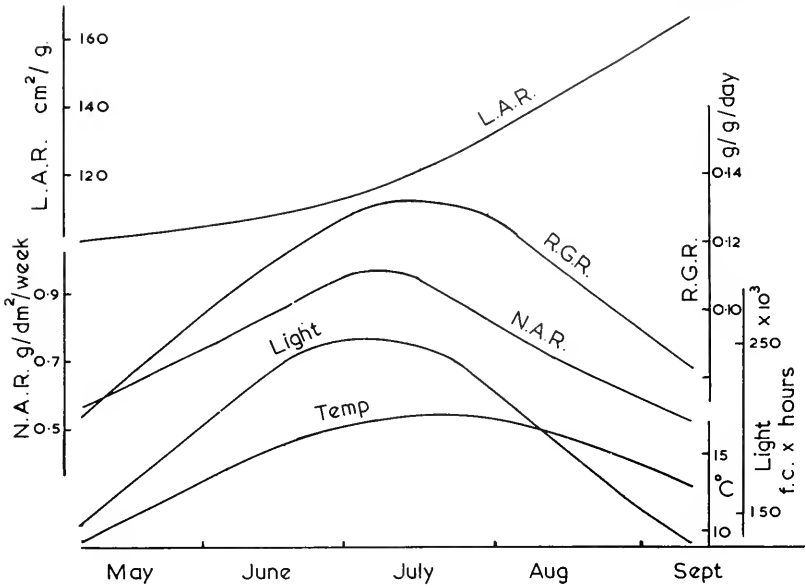

Figure 9. The interrelationships between seasonal changes in the diurnal solar radiation and mean temperature at Oxford and the net assimilation rate, leaf-area ratio, and relative growth rate of *Helianthus annuus* in the early vegetative phase.

may be the same in August as in May the leaf-area ratio will be higher in August, and this in turn will bring about a higher relative growth rate.

For *H. annuus* at Oxford the statistical analysis was extended to determine the effects of light and temperature on the growth of the different parts of the plant (Blackman *et al.*, 1955). The relative growth rate of the stem was positively dependent upon both light and temperature; that of the leaves was positively linked only with light; and the root growth was affected only by temperature. The stem-weight ratio was positively correlated with temperature and negatively with light, while the root-weight ratio was negatively linked with temperature. On the other hand, the leaf-weight ratio was not significantly affected by either factor; the ratio of leaf area to leaf weight, however, was related positively to temperature and inversely to light.

I hope that by this time my illustrations have provided convincing proof of the value of growth analysis in assessing the whole plant's reactions to environmental factors. To me it is not only the relative simplicity of the basic concepts that appeals but also the fact that much can be done with the simplest of laboratory facilities. Indeed, in the laboratory a bare minimum of a drying oven, a balance, blueprint

paper, and a calculating machine will suffice; in the field, admittedly, the equipment required for recording the environment may be both elaborate and costly. Nevertheless, the cost is small compared to the price of a panoply of growth chambers which rarely duplicate the high light intensities found in nature. This acerbity does not carry the implication that growth chambers are not valuable for more detailed analysis, but field studies should come first.

Now I turn to laboratory experiments in which the levels of light and temperature have been controlled.

Twenty-five years ago, at Imperial College, Ashby and Oxley (1935) demonstrated the many advantages possessed by the floating aquatic plant *Lemna minor* for studying the effects of light and temperature on vegetative growth. Clonal material can be readily multiplied in containers placed in a water bath, and the level of light received can be controlled within fine limits, since the plane of growth is horizontal.

The scale of the experiments undertaken by Ashby and Oxley was impressive. The plants were grown under a range of five temperatures (10 to 29° C.); they received continuous light at eight intensities (80 to 1,600 foot-candles); and the changes in the frond weight, frond area, and net assimilation rate were examined under the 40 combinations of light and temperature. It was demonstrated that the weight per frond reached a maximum value under a combination of the lowest temperature (10° C.) and a light range of 500 to 1,600 foot-candles; conversely, a minimum weight was attained when the highest temperature (29° C.) was combined with the lowest light intensities (80 to 150 foot-candles). Irrespective of temperature, the area per frond rose until a level of 500 foot-candles was reached, and thereafter the area remained the same as the intensity was further increased. The areas of fronds grown at 10 and at 18° C. were equal and greater than those of plants subjected to 21° C. Between 21 and 29° C. there was little further effect of temperature.

Over all light levels, raising the temperature from 10 to 18° C. more than doubled the net assimilation rate, but increasing the temperature beyond 18° C. had no further marked effect. Excluding the data for 10° C., over the whole range of light intensities the net assimilation rate rose in a logarithmic manner; that is, the rate was still being restricted by the highest light treatment.

Though we are still wedded at Oxford to *L. minor* for many research purposes, the tropical aquatic fern *Salvinia natans*, which can be cultured in the same manner, has a number of advantages for growth studies. Current research is concerned with the factors that determine the development of its floating leaves. A series of multifactorial experiments is being undertaken by R. C. Achurch on the effects of three

temperatures (20, 25, and 30° C.) and six levels of continuous light provided by daylight fluorescent tubes, the light ranging in intensity from 300 to 1,800 foot-candles (equivalent to 38 to 204 cal/cm²/day). Since a large number of growth parameters has been measured, only some of the results, at times in a condensed form, will be presented.

The general trends for the relative growth rate, net assimilation rate, and leaf-area ratio can be seen in Table III. Taking first the net assimilation rate, it is evident that there is a marked interaction between temperature and light. At the lowest light intensity the temperature effect is small, while at the higher intensities there is a considerable rise in the net assimilation rate as the temperature is increased from 20 to 25° C.; little further increase takes place when the temperature is raised to 30° C. At this juncture it is necessary to point out that the net assimilation rates have been calculated on the assumption that the floating leaves are the only photosynthetic tissues. Such an assumption leads to some degree of overestimation, since the "roots" (actually submerged filiform leaves) contain chlorophyll.

Similarly because of the morphology the leaf-area ratio is somewhat of a misnomer, since it is the ratio of the area of the floating leaves to the combined weight of the floating leaves, internodes, and submerged leaves. Nevertheless, Table III shows that the changes induced fall into line with those observed in the previous field studies; namely, that the ratio is temperature-dependent but negatively cor-

TABLE III
The Effects of Temperature and Light Intensity on the
Net Assimilation Rate, Leaf-Area Ratio, and Relative
Growth Rate of *Salvinia natans*

Temperature (degrees C.)	Light Level (foot-candles)		
	300	900	1500
	Net Assimilation Rate (g/dm ² /week)		
20	0.33	0.61	0.78
25	0.28	0.82	1.06
30	0.29	0.73	1.19
	Leaf-Area Ratio (cm ² /g)		
20	400	219	163
25	607	295	237
30	679	397	273
	Relative Growth Rate (g/g/day)		
20	0.18	0.21	0.19
25	0.27	0.34	0.37
30	0.31	0.43	0.45

related with the light level. For the relative growth rate the interactions between temperature and light are very apparent. At 20° C. the light level has little effect, but at the higher temperatures the rate of growth is accelerated, particularly as the intensity is changed from 300 to 900 foot-candles.

Turning to the development of the leaf, which will be examined in somewhat greater detail, for a range of species it has already been shown that ratio of the leaf area to leaf weight rises as the light level falls, and that for *H. annuus* there is evidence of a positive temperature response. Figure 10 demonstrates very clearly the interacting effects of light and temperature on the ratio: the ratio is greatest when the highest temperature is combined with the lowest intensity; conversely the ratio is least when the plant is subjected to a combination of the lowest temperature and highest intensity. This plastic response can be analyzed further by comparing Figures 11 and 12, which shows the changes induced in the area per leaf and the weight per leaf. Basically the trends are the same up to an intensity of 1,200 foot-candles, since both the weight and the area increase as the level of light rises and the tem-

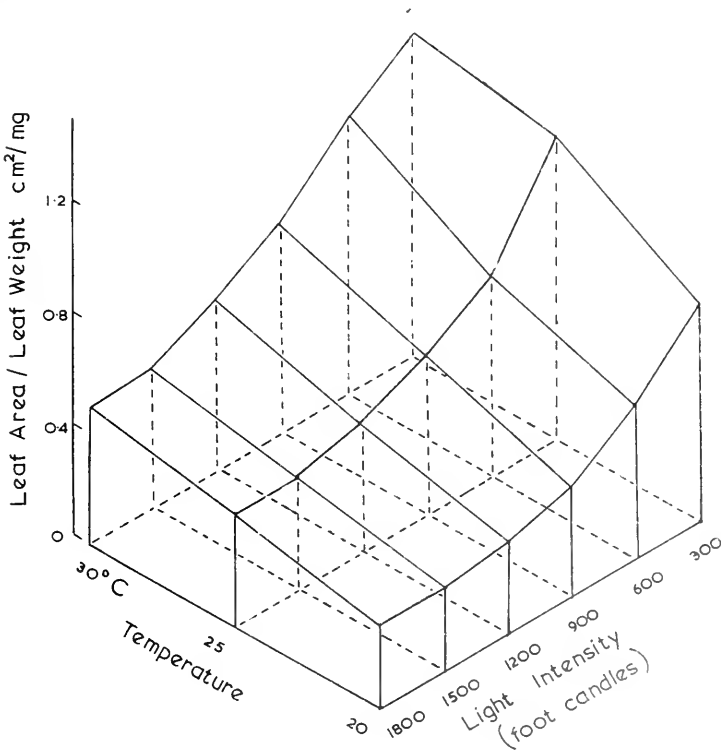

Figure 10. The interacting effects of light and temperature on the ratio of leaf area to leaf weight of *Salvinia natans*.

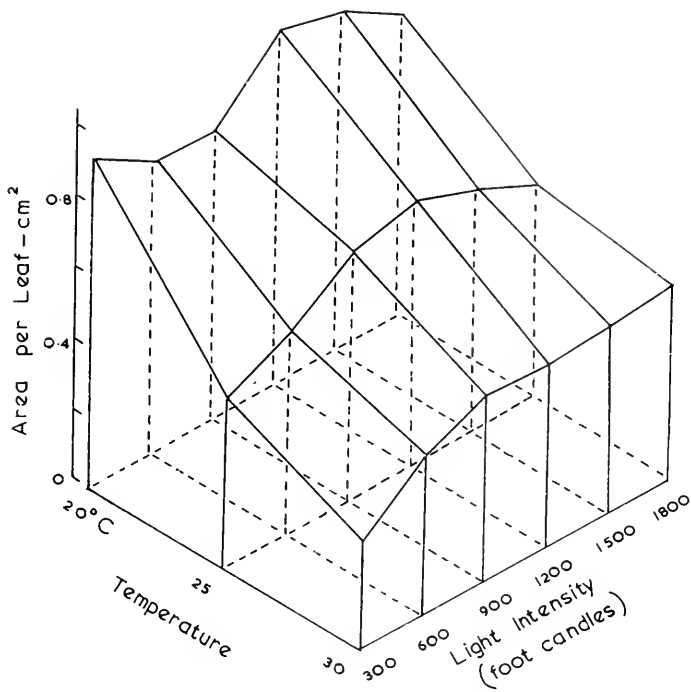

Figure 11. The interacting effects of light and temperature on the area per leaf of *Salvinia natans*.

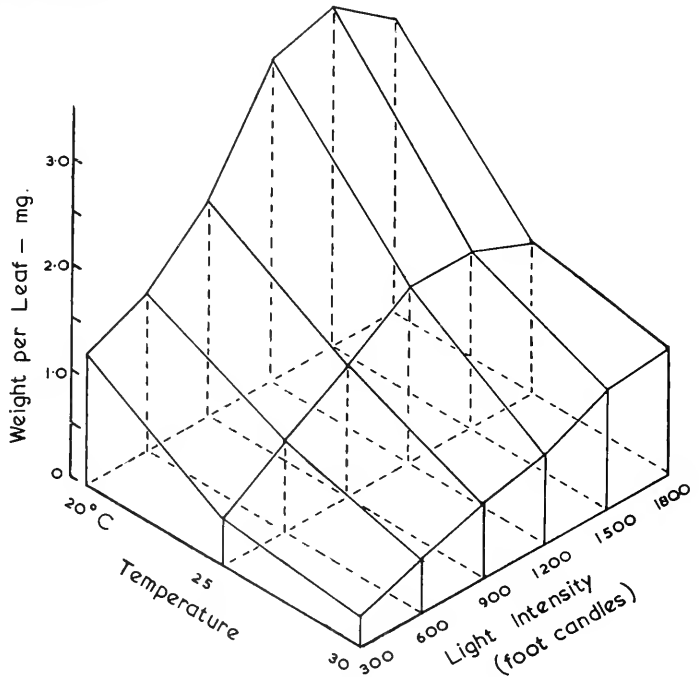

Figure 12. The interacting effects of light and temperature on the dry weight per leaf of *Salvinia natans*.

perature falls. On the other hand, the magnitudes of the effects are different. When the changes induced by the combinations of 30° C. and 300 foot-candles and 20° C. and 1,200 foot-candles are compared, the leaf weight goes up by a factor of 11.4 but the corresponding ratio for area is only 3.2. Between 1,200 and 1,800 foot-candles there is some suggestion that at 20 and 25° C. the highest intensity is superoptimal.

It has been possible to interpret the responses still further, for by the macerating techniques evolved by Brown and Broadbent (1951) the total number of cells per leaf has been counted directly. Thus for the first time, it is believed, it has become possible to express the modifications from a "shade" to a "sun" leaf precisely in terms of cell numbers. From the trends for leaf area and weight, it is not unexpected that the number of cells should be smallest when the highest temperature is coupled with the lowest intensity (Figure 13). There is also a marked interaction between the factors: at 30° C., above 600 foot-candles, the change in cell number is small, but at 20° C., between 600 and 1,200 foot-candles, there is a considerable rise. When the ratio of cell number at 30° C. and 300 foot-candles and 20° C. and 1,200 foot candles is calculated, it is found that this figure (3.1) is nearer the corresponding

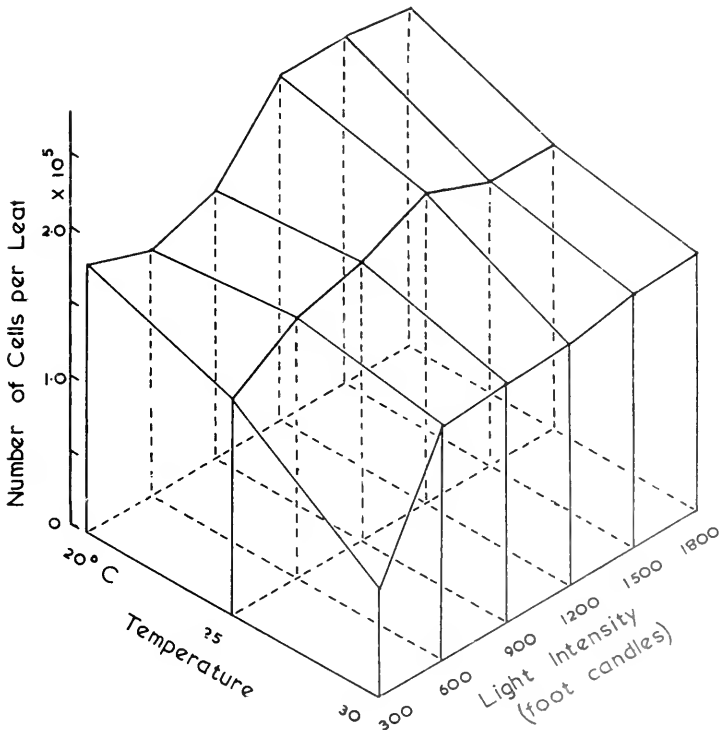

Figure 13. The interacting effects of light and temperature on the total number of cells per leaf of *Salvinia natans*.

ratio for leaf area (3.2) than for leaf weight (11.4). That is, the changes in area are more dependent on the induced variations in cell number than on the changes in leaf weight. It cannot, however, be concluded that the mean weight of the individual cells is unaffected by light and temperature. Figure 14 clearly demonstrates that it is affected by both. At least, up to 1,500 foot-candles there is a progressive rise in weight at each temperature, while over all light intensities there is a negative influence of temperature.

One other aspect of development requires comment, and that is the rate of leaf formation, which in turn is dependent on the production of new buds. It is evident from Figure 15 that the rate is temperature-dependent but the changes induced by light are linked with temperature. At 20° C. light has a negligible effect, while at 30° C. the effect is appreciable. Thus, from a comparison of Figures 13 and 15, it is apparent that the factors that determine the rate of production of new leaf primordia are different from those that control the ultimate number of cells in the expanded leaf. This difference is particularly striking in the case of temperature: the rate of new leaf formation goes up and the number of cells per leaf goes down as the temperature rises. When the trends for cell weight (Figure 14) also are included in the comparison, it is to be observed that at the lowest temperature it is only the cell weight that increases over the range of 600 to 1,800 foot-

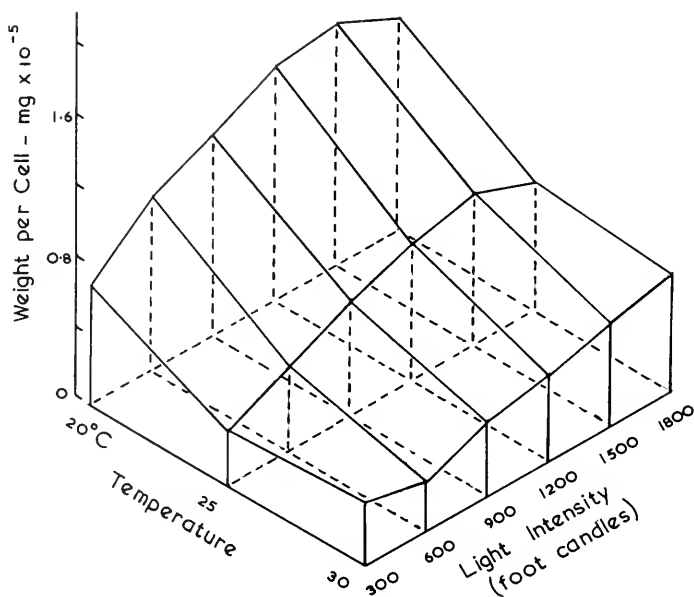

Figure 14. The interacting effects of light and temperature on the mean weight per cell in the leaves of *Salvinia natans*.

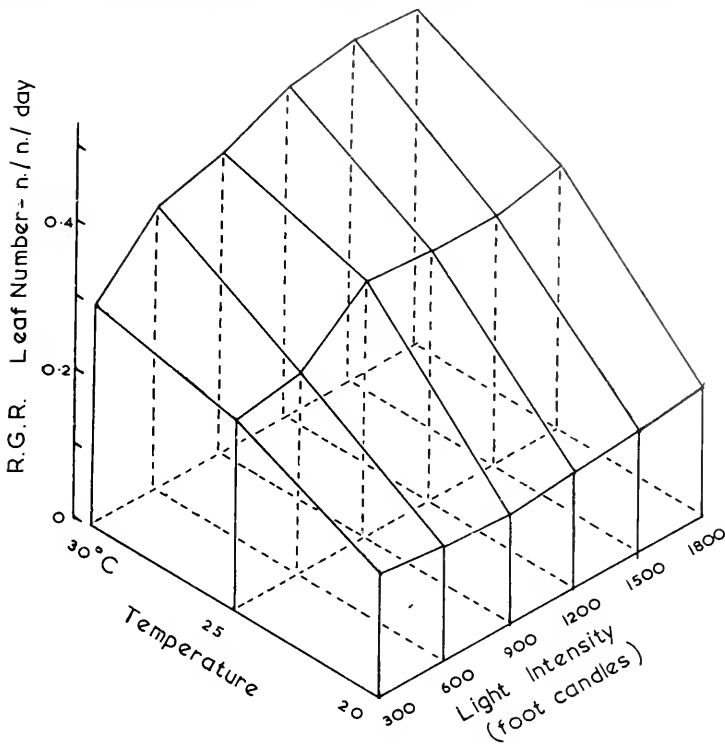

Figure 15. The interacting effects of light and temperature on the rate of leaf production by *Salvinia natans*.

candles, whereas at 30° C. the rate of leaf production, the ultimate number of cells, and the cell weight are all augmented.

The interpretation of this complex pattern raises fundamental problems as to what internal physiological factors determine the rate at which the leaf primordia are laid down and the ultimate size of the leaves. When new meristems are formed, their further development will depend on supplies of substrates transported from other parts of the plant. From the standpoint of carbon substrates, the developing leaves will not be self-supporting until they are capable of active assimilation. It is well established that meristematic activity is highly correlated with temperature; thus temperature and light may operate by varying the amounts of substrate and the competitive power of the different tissues for the substrates. Again, these external factors may influence the relative levels and distribution of auxins and inhibitors that determine whether new meristems are initiated or what their subsequent development is to be. Here I would like to touch on another series of investigations (which are far from complete): studies of the chemical control of leaf expansion in *S. natans*.

Chemical control of leaf expansion

I propose to start with some results from the doctoral thesis of J. K. Templeton, who, during the course of his study of the physiological action of the phytotoxic compound 3-phenyl-1,1-dimethylurea, investigated the possible competitive effects of chemically allied compounds, including 1,3-diphenylurea, which contemporaneously Shantz and Steward (1955) were isolating as an active component of the coconut milk factor. It was found that when the diphenylurea was added to the external solution in which *S. natans* was growing, there was for a time an increase both in the mean leaf area and the length of the internodes (Figure 16).

More recently a number of other compounds have been tested, alone and in combination, and some selected results are given in Figure 17. It is evident that 3-indolylacetic acid and gibberellic acid inhibit rather than promote leaf expansion, while 2,3,5-triiodobenzoic acid causes a small increase in area. In passing, it should be noted that at similar levels of concentration TIBA increases venation in *L. minor* (Sargent and Wangermann, 1959).

As a final example, some effects of kinetin (6-furfurylamino purine) are given in Table IV. The induced changes in leaf area are clearly linked with the stage of development. For the first pair of

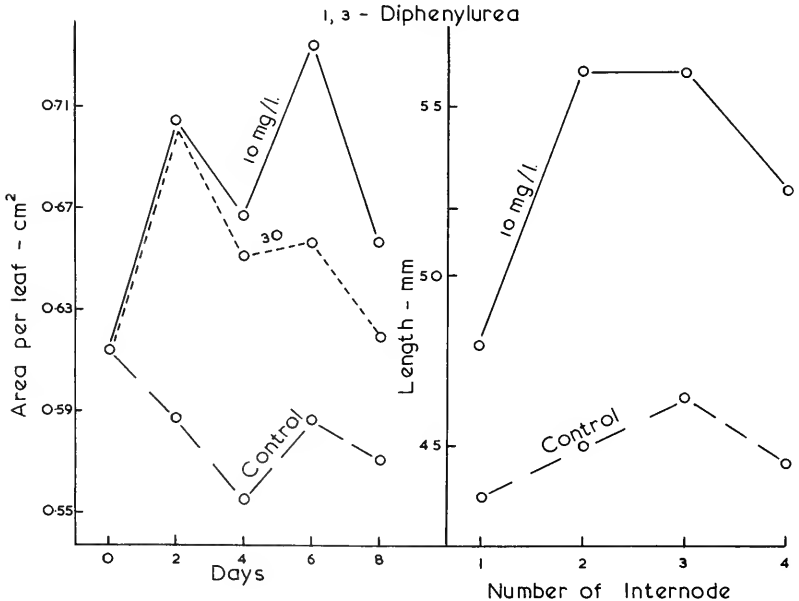

Figure 16. The influence of 1,3-diphenylurea on the area per leaf and the internode length of *Salvinia natans*.

leaves, which were half expanded when the kinetin was added to the solution, there is no change in area, but for the second and younger pair the final area is increased. In contrast, the third and fourth still younger pairs fail to expand. Unlike 1,3-diphenylurea, kinetin causes

TABLE IV

The Effects of Kinetin on Leaf Expansion and Internode Length in *Salvinia natans*

Concentration of Kinetin (mg/l)	Sequence of Leaves			
	1st	2nd	3rd	4th
	Mean Area per Pair of Leaves (cm ²)			
0	1.13	1.18	1.13	0.42
3.0	1.18	1.47	—	—
	Sequence of Internodes			
	1st	2nd	3rd	
	Internode Length (mm)			
0	9.5	9.3	6.3	
3.0	8.1	5.25	—	

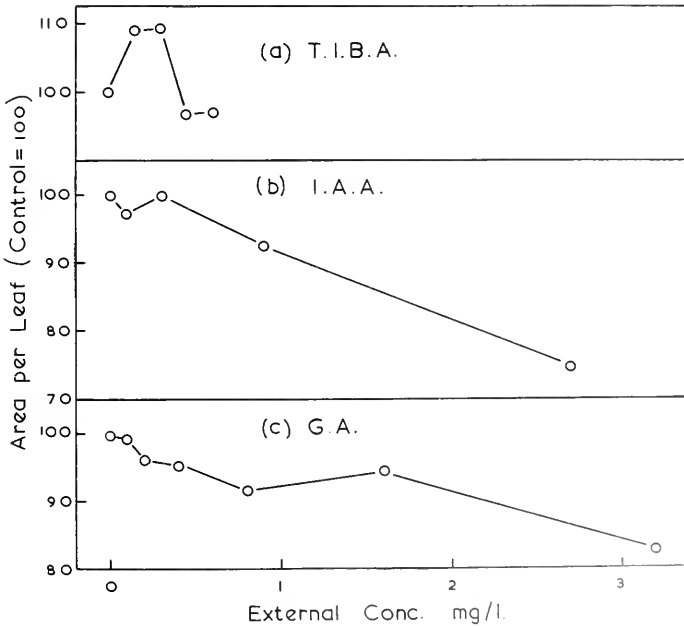

Figure 17. Changes in the area per leaf of *Salvinia natans* induced by (a) 2,3,5-triiodobenzoic acid, (b) 3-indolylacetic acid, and (c) gibberellic acid.

no corresponding increases in internode length; the influence is entirely inhibitory.

These results serve to illustrate that the leaf area and internode length can be modified in a specific manner by different compounds, but it must be stressed that all the investigations were carried out at 25° C. and at light intensities of 300 and 600 foot-candles. It has yet to be demonstrated to what extent the observed responses will vary under other combinations of light and temperature.

Within the compass of my allotted time it is an inevitable consequence that any appraisal of four decades of research must be selective, and I am fully conscious of many omissions. I have now given my evidence and must stop, but I end in a state similar to that of the Mad Hatter after the King said, "Give your evidence and don't be nervous or I'll have you executed on the spot." My anxiety arises from the fact that in this survey of the analytical interpretation of plant responses to environmental factors it seems ungracious that I have made no reference to American workers. This omission is not perverse but is due to my inability to trace a body of papers where the techniques of growth analysis have been fully exploited. This divergence of interest I have discussed on previous visits to the United States, and the opinion has been expressed that the concepts are crude and yield but meager information concerning the basic physiological processes that determine the reactions of plants to the environmental factors. My reply has been that it is essential to match what is learned in the laboratory with an equal and precise knowledge of the reactions of the plant as a whole for a wide range of species and conditions. My hope is that this paper is persuasive enough to support my contention that there is a continuum between research involving the cold room and centrifuge and field experimentation seeking to assess plant performance.

References

- Ashby, E., and Oxley, T. A., 1935. "The Interaction of Factors in the Growth of *Lemna minor*, IV: An Analysis of the Influence of Light and Temperature on the Assimilation Rate and the Rate of Frond Production," *Ann. Bot.* 49, 309.
- Black, J. N., 1955. "The Interaction of Light and Temperature in Determining the Growth Rate of Subterranean Clover (*Trifolium subterraneum*)," *Austr. J. Biol. Sci.* 8, 330.
- Blackman, G. E., 1957. "Influence of Light and Temperature on the Growth of Leaves," in Milthorpe, F. L., ed., *The Growth of Leaves* (London, Butterworth Scientific Publications).
- Blackman, G. E., and Black, J. N., 1959. "Physiological and Ecological Studies in the Analysis of Plant Environment, XI: A Further Assessment of the Influence of Shading on the Growth of Different Species in the Vegetative Phase," *Ann. Bot. N.S.* 23, 51.

- Blackman, G. E., Black, J. N., and Kemp, A. W., 1955. "Physiological and Ecological Studies in the Analysis of Plant Environment, X: An Analysis of the Effects of Seasonal Variation in Daylight and Temperature on the Growth of *Helianthus annuus* in the Vegetative Phase," *Ann. Bot. N.S.* 19, 527.
- Blackman, G. E., and Rutter, A. J., 1947. "Physiological and Ecological Studies in the Analysis of Plant Environment, II: The Interaction between Light Intensity and Mineral Nutrient Supply in the Growth and Development of the Bluebell (*Scilla non-scripta*)," *Ann. Bot. N.S.* 11, 125.
- Blackman, G. E., and Rutter, A. J., 1948. "Physiological and Ecological Studies in the Analysis of Plant Environment, III: The Interaction between Light Intensity and Mineral Nutrient Supply in Leaf Development and in the Net Assimilation Rate of the Bluebell (*Scilla non-scripta*)," *Ann. Bot. N.S.* 12, 1.
- Blackman, G. E., and Wilson, G. L., 1951. "Physiological and Ecological Studies in the Analysis of Plant Environment, VII: An Analysis of the Differential Effects of Light Intensity on the Net Assimilation Rate, Leaf Area Ratio and Relative Growth Rate of Different Species," *Ann. Bot. N.S.* 15, 373.
- Blackman, G. E., and Wilson, G. L., 1954. "Physiological and Ecological Studies in the Analysis of Plant Environment, IX: Adaptive Changes in the Vegetative Growth and Development of *Helianthus annuus* Induced by an Alteration of Light Intensity," *Ann. Bot. N.S.* 18, 71.
- Blackman, V. H., 1919. "The Compound Interest Law and Plant Growth," *Ann. Bot.* 33, 353.
- Blackman, V. H., 1920. "The Significance of the Efficiency Index of Plant Growth," *New Phytol.* 19, 97.
- Brenchley, W. E., 1920-21. "On the Relationship between Growth and the Environmental Conditions of Temperature and Bright Sunshine," *Ann. Appl. Biol.* 6, 211.
- Briggs, G. E., 1928. "A Consideration of Some Attempts to Analyse Growth Curves," *Proc. Roy. Soc. B.* 102, 280.
- Briggs, G. E., Kidd, F., and West, C., 1920-21a. "A Quantitative Analysis of Plant Growth, Part I," *Ann. Appl. Biol.* 7, 103.
- Briggs, G. E., Kidd, F., and West, C., 1920-21b. "A Quantitative Analysis of Plant Growth, Part II," *Ann. Appl. Biol.* 7, 202.
- Briggs, G. E., Kidd, F., and West, C., 1920-21c. "Methods in the Quantitative Analysis of Plant Growth: A Reply to Criticism," *Ann. Appl. Biol.* 7, 403.
- Brown, R., and Broadbent, D., 1951. "The Development of Cells in the Growing Zone of the Root," *J. Exp. Bot.* 1, 247.
- Crowther, F., 1934. "Studies in the Growth Analysis of the Cotton Plant under Irrigation in the Sudan, I: The Effects of Different Combinations of Nitrogen Applications and Water Supply," *Ann. Bot.* 48, 877.
- Crowther, F., 1937. "Experiments in Egypt on the Interaction of Factors in Crop Growth, 7: The Influence of Manuring on the Development of the Cotton Crop," *Roy. Agric. Soc. Egypt. Bull.* 31.
- Fisher, R. A., 1920-21. "Some Remarks on the Methods Formulated in a Recent Article on the Quantitative Analysis of Plant Growth," *Ann. Appl. Biol.* 7, 367.
- Goodall, D. W., 1945. "The Distribution of Weight Change in the Young Tomato Plant," *Ann. Bot. N.S.* 9, 101.
- Goodall, D. W., 1955. "Growth of Cacao Seedlings as Affected by Illumination," in *Report Fourteenth Int. Hort. Cong. Wageningen, Netherlands. Veinman and Zonen.*

- Gregory, F. G., 1921. "Studies in the Energy Relations of Plants, I: The Increase in Area of Leaves and Leaf Surface of *Cucumis sativa*," *Ann. Bot.* 35, 98.
- Gregory, F. G., 1928. "Studies in the Energy Relations of Plants, II: The Effect of Temperature on Increase in Area of Leaf Surface and in Dry Weight of *Cucumis sativa*," *Ann. Bot.* 42, 469.
- Gregory, F. G., 1926. "The Effect of Climatic Conditions on the Growth of Barley," *Ann. Bot.* 40, 1.
- Gregory, F. G., 1928. "The Analysis of Growth Curves: A Reply to Criticism," *Ann. Bot.* 42, 531.
- Hornberger, R., 1885. "Untersuchungen über Gehalt und Zunahmen von *Sinapis alba* an Trockensubstanz und chemischen Bestandtheilen in 7 tätigen Vegetationsperioden," *Landw. Versuch.* 31, 415.
- Kidd, F., West, C., and Briggs, G. E., 1920. "What Is the Significance of the Efficiency Index of Plant Growth?" *New Phytol.* 19, 88.
- Kreusler, U., Prehn, A., and Becker, G., 1877. "Beobachtungen über Wachstum der Maispflanze," *Landw. Jahrb.* 6, 759.
- Milthorpe, F. L., 1959. "Studies in the Expansion of Leaf Surface, I: The Influence of Temperature," *J. Exp. Bot.* 10, 233.
- Sargent, J. A., and Wangermann, E., 1959. "The Effect of Some Growth Regulators on the Vascular System of *Lemna minor*," *New Phytol.* 58, 345.
- Shantz, E. M., and Steward, F. C., 1955. "The Identification of Compound A from Coconut Milk as 1,3-Diphenylurea," *J. Am. Chem. Soc.* 77, 6351.
- Thurston, J. M., 1959. "A Comparative Study of the Growth of Wild Oats (*Avena fatua* and *A. ludoviciana* Dur.) and of Cultivated Cereals with Varied Nitrogen Supply," *Ann. Appl. Biol.* 47, 716.
- Watson, D. J., and Baptiste, E. C. D., 1938. "A Comparative Physiological Study of Sugar-Beet and Mangold with Respect to Growth and Sugar Accumulation, I: Growth Analysis of the Crop in the Field," *Ann. Bot. N.S.* 9, 437.
- Williams, R. F., 1946. "The Physiology of Plant Growth with Special Reference to the Concepts of Net Assimilation Rate," *Ann. Bot. N.S.* 10, 41.

EFFECTS OF LIGHT AND TEMPERATURE ON PLANT GROWTH

Frits W. Went

MISSOURI BOTANICAL GARDEN

An organism's growth is a unique expression of life, utterly different from any properties of the non-living state. Although crystal growth is often compared with the growth of organisms, they have hardly anything in common. In crystal growth, pre-existing molecules arrange themselves in patterns which are pre-determined by laws of molecular attraction, and it always involves association of molecules of the same species, unaltered from those in the mother-liquid. In organisms, the specific constituents that make up the cell that must multiply to produce growth (1) have to be self-duplicating, as far as the basic units are concerned, (2) are dissimilar chemically from the components in the cell medium from which they are assimilated, and, (3) generally have a higher energy content than their components.

About the first point we have heard much during this symposium, but since I have no information of a biological nature which has any bearing on the self-duplicating aspects of plant growth, I am unable to climb on the bandwagon, and therefore I have to skip this aspect of plant growth. The second and third points, however, seem to me to be of such importance that I want to comment on them.

Matter loses entropy, and gains orderliness, as it arranges itself in the growing organism. Both of these facts are opposed to the second law of thermodynamics, which rules reactions and processes in the inanimate world. Now in textbooks and in many discussions, respiration is usually stressed as a basic prerequisite of growth. This statement is correct, but if let stand by itself, it misses the main point of the growth process. Respiration is a dissimilation process which follows all thermodynamic laws, and consequently it can be understood and

explained in classical chemical and physical terms. For respiration follows the second law of thermodynamics: it results in an increase in entropy. But the growth process is not a process of dissimilation; it is one of assimilation. I believe that this is the main reason why the biochemical approach has scored such spectacular successes in advancing our understanding of respiration, whereas it has failed, equally spectacularly, to help us in understanding the growth process, as was so clearly demonstrated in the paper by Dr. Bommer. The preoccupation of so many modern biologists with biochemistry and biophysics, which have shown that partial processes in the organism follow the laws of the inanimate world, has often closed their eyes to the much more basic aspects of biology: namely, those in which the processes do not follow the laws of thermodynamics. This, I submit, is the real content of biology. Similarly, the assimilating aspect of growth, since it is opposed to the second law of thermodynamics, is the more interesting problem, because one does not deal with already established facts and also because it is such a basic problem of life.

We assume that the assimilatory processes of growth are tied in energetically with respiration. When we calculate the over-all energy balance, we find that, on the whole, growth is attended by an increase in entropy. But the major problem in connection with organic synthesis in relationship to growth is that the *direction* of the formation of the organic constituents of the cell is fixed and is contrary to what would be expected theoretically. For thermodynamically we would expect an increase in randomness to result from chemical transformations in the growing and living organism. The lack of randomness, or decrease in entropy, that actually occurs can only be conceived as due to directive forces, in the nature of polarities. It is not sufficiently stressed that basically most of these processes of synthesis and growth are irreversible. And irreversibility is another aspect of polarity. It causes proteins and other substances essential for cell growth to *form* instead of to disappear. This excess of synthesis over disintegration requires directive forces.

We encounter polar phenomena everywhere in living organisms, and in all cases they are equally poorly understood in terms of physical and chemical counterparts. Polarity, for instance, is the process that makes salts accumulate *inside* cells. We know something about the sources of energy for this salt accumulation, and even have models of energy linkage in the process, as discussed this morning, but the reason why the salt molecules all move in one direction—toward the interior of the cell—eludes us. As far as I am concerned, the central problem of evolution, which is the progression toward more and more complex forms, is another expression of polarity. Polarity is the basis for the separation of head and tail. It causes differentiation and is very

generally tied up with synthesis. In all cases polarity is tied up with structure.

This tie-in of structure with growth makes it extremely important to analyze the growth process with agents that will not destroy the structure. An effective analysis of growth can only be carried out if we divide the over-all process into individual processes. In much hormonal research we apply a disruption of the different parts of an organism on a minor scale. In a biochemical approach, we usually are dealing with almost total destruction. Therefore, often in hormonal research, and usually in biochemical research, we have lost the directional or structural aspects of growth.

With light we can probe into the cell with no destruction and at the same time can be highly specific in what we accomplish. This is because a pigment absorbs only certain portions (wave lengths) of the light. Thus the energy absorbed by a given pigment can be transferred to specific processes inside the cell, and it is interesting to note the number of cases in which the absorbed energy is tied up with polarity —*e.g.*, in phototropism. A short review of the different light-absorbing systems in plants shows that:

1. Chlorophyll absorbs both in the red and the blue regions of the spectrum, and the absorbed light can be utilized for synthetic processes in which there is no distinction between the red and the blue rays. That is, the energized chlorophyll molecule arrives at the same condition whether it has absorbed red or blue light.

2. In phototropism the absorbing pigment has absorption characteristics very closely similar to carotene. The phototropic action curve shows in the visible spectrum exactly the same action maxima as the absorption spectrum of carotene. There is a possibility that a pigment with absorption characteristics similar to riboflavin is involved in special cases of phototropism, such as the base response of *Avena* coleoptiles. The light absorbed by the carotene sets up a polarity in the phototropically-sensitive organ, which then is able to transport auxin laterally, and this polarity persists for several hours after the illumination.

3. The photoperiodic pigment, phytochrome, is involved in a remarkably large number of different processes, enumerated by Hendricks. In all cases a pigment with a main absorption peak in the red and only very minor absorption in the blue is involved. In every case studied, the pigment is effective in very low concentrations, so that very low light intensities will saturate this pigment. In this respect it agrees with the phototropic pigment. The photoperiodic pigment is tied in more or less directly with the growth process, whereas the phototropic pigment is tied in with polarity, causing a redistribution of auxins. This makes it possible to understand the discrepancy that red light speci-

cally influences growth in length, whereas blue light causes phototropism in the same organ. Although phototropism is also a manifestation of growth, as pointed out by Blaauw, there is no over-all change in growth in the typical phototropic curvature.

4. There are some cases in which reactions in plants are brought about by a cytochrome absorption. In this case also, very low light intensities are effective and the process is soon saturated.

5. Plants can be grown in light of very limited spectral composition. For instance, when tomato plants are grown in red light only, they develop into long spindly plants which seem more or less etiolated. Leaf growth is decreased, whereas stem growth is greater than in white light. To obtain sufficient growth, high intensities of red light are required. Evidently the plant has a rather high concentration of red-absorbing pigment. If plants are grown in blue light, the stem growth is less than in white light, but the leaf development is normal. Again, high intensities are required to produce this effect. Since the effects of red and blue light are entirely different, it is impossible to attribute these effects to chlorophyll absorption. We must be dealing with two different light-absorbing systems—one absorbing in the blue and the other absorbing in the red. The normal growth obtained when plants are grown in white light must, therefore, be due to the combined effect of the red and the blue pigment.

6. There is an indication that green light, applied at very high intensities, is inhibitory to growth. Of the wave lengths in visible light, green rays are the least absorbed by chlorophyll; consequently green light, per number of quanta falling on the plant, produces less photosynthesis than does red or blue. This has been shown repeatedly.

When a plant is grown in green light, it is much lighter in weight than plants grown in equal intensities of red, blue, or white light (expressed in quanta or in ergs supplied), and its growth is retarded, even when high intensities are provided (see, *e.g.*, Went, 1957, Figure 65). Since in this same graph it appeared that plants grown in a combination of red and blue light grew larger and heavier than those grown in white light, the conclusion was drawn that green light was inhibitory to growth.

A few experiments were carried out to test this conclusion. In a greenhouse, kept at 26° C. during the day and 20° C. during the night, frames covered with colored plastic sheets were placed in a horizontal position over benches, and tomato plants were kept under them in such a way that ventilation was not impaired but that most of the light reaching the plants passed through the filters. (The filters used were all obtained from the Bates Lighting Company and Scenic Study. Each filter is designated by a number: No. 112, flesh pink, absorbs mainly in the region from 4,800 to 5,300 Angstroms; No. 18, deep flesh pink—

called "purple" hereafter—has its main absorption in the range 4,800 to 5,650A.; No. 81, flame tint—light gray—and No. 80, neutral gray, absorb all wave lengths equally.)

In Figure 1 the growth rates of plants under different filters are plotted as a function of time. It shows the comparative growth under a pink and under a light gray filter, each passing about 70 per cent of the total sunlight, and under a purple and a neutral gray filter each transmitting about 40 per cent of the sunlight. It is obvious that growth became progressively better when the green part of the spectrum was filtered out of sunlight. This was reflected not only in the growth rates but also in wet weight and in leaf size.

For another experiment, carried out in the same way, the total growth and wet weight were plotted as a function of the light intensity (Figure 2). Again the results were the same: removal of the green rays speeded up growth and the wet-weight production.

These results may explain the inhibitory effect of the high-pressure

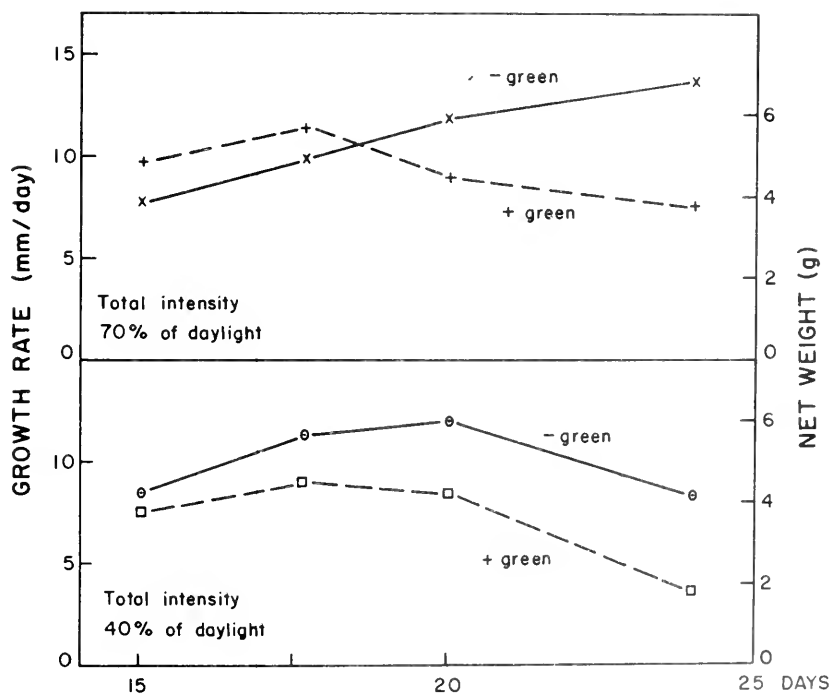

Figure 1. The growth rates and final wet weights of tomato plants growing under gray filters, which let green light pass (+ green), and under pink or purple filters, which screen out green light (- green). The plants were grown in sunlight, reduced by the filters to 70 per cent and to 40 per cent of its normal intensity, and at a day temperature of 26° C. and night temperature of 20° C.

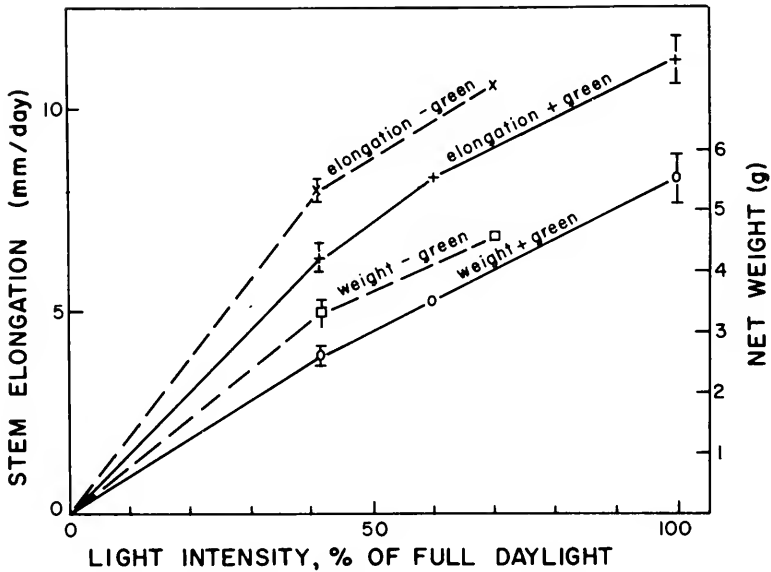

Figure 2. The growth rates and final wet weights of tomato plants grown under the same conditions as in Figure 1. Standard error indicated. Abscissa: the percentage of daylight passing through the filters.

mercury-vapor lamp on plant growth. Both tomato and pea plants were grown either in a greenhouse (average light intensity: 4,000 foot-candles), or under warm-white fluorescent lamps (intensity: 1,500 foot-candles), or under high-pressure mercury-vapor lamps (H400-R₁ General Electric) at different intensities, with or without a glass plate to screen out excessive ultraviolet light. For both plants the responses were the same: they showed essentially equal growth in daylight and in fluorescent light, in spite of the big difference in intensity. This shows that at 1,500 foot-candles these young plants are almost saturated with light, and that the mercury-vapor lamp causes a strong inhibition of growth. This inhibition is *not* due to the high intensity as such, as the growth in daylight proves; nor is it a result of too much ultraviolet, since interposition of the glass pane did not produce more growth. Therefore the conclusion seems justified that the high intensity of the green rays emitted by this lamp is responsible for the poor growth.

An experiment was performed to test this conclusion. Instead of the H400 high-pressure mercury lamp, one with the same light element but with a fluorescent coating (H400-RC₁) was used. This lamp provides a better distribution of light over the visible light range, although it still emits proportionately much more green light than warm-white fluorescent lamps or sunlight. Under two of these lamps, frames with

pink or purple plastic sheets were mounted, and different intensities were obtained by placing the plants at varying distances from the light source. At low intensities (about 1,000 foot-candles) the unscrined light gave most growth, but at high intensities (2,000 foot-candles) both peas and tomatoes grew significantly more under the purple filter than in the unfiltered light. The plants under the pink screen grew poorest (at 14° C. tomatoes grew 4.2 mm/day under the pink filter, 4.4 mm. under no filter, and 5.0 mm. under the purple filter; in the same conditions peas grew 4.8, 5.6, and 5.8 mm., respectively).

Therefore we can conclude that the pink filter did not remove the proper wave length but the purple filter did, and that the inhibitory effect of green light is observable only at high intensities of green light.

The latter conclusion was confirmed by experiments carried out by Dr. U. Brodführer (unpublished), who found no inhibition of growth or dry-weight production when light from a green fluorescent (*i.e.*, low-intensity) lamp was added to a mixture of red and blue light. The intensity of the added green light (wave lengths between 5,000 and 6,000 Å.) did not exceed one quarter of the intensity of the red and blue (4,000 to 5,000 and 6,000 to 7,000 Å.).

There is no information in the literature that green light inhibits photosynthesis. The experiments of Dr. Dunn in the Earhart Laboratory (see Went, 1957) also indicate that photosynthesis in tomato plants, when measured as dry-weight production, is low, because of low absorption, but is not inhibited. The results I have cited, therefore, must be interpreted in terms of the effects of green light on growth. This effect can lead secondarily to inhibition of photosynthesis, as demonstrated for tomatoes (Went, 1957).

If growth is inhibited by high-intensity green light, then one may expect to find this effect in nature, where the intensity of the green portion of the sun's rays is high. This may account for the inhibition of stem growth during the day that has been observed by so many investigators since Sachs described it for the first time. This leads to two suggestions:

1. Installation of purple filters or purple glass in greenhouses might increase the growth of plants by removing the inhibiting green rays. In several instances this is being done by practical growers, apparently with good success.

2. In nature we often find red or purple anthocyanin in the epidermal cells of growing shoots, especially of plants growing in full sunlight (*Vaccinium*, *Acer*, *Quercus*, *Sassafras*) or in the tropics. The explanation given for this phenomenon has usually been that the pigment serves to screen young tissues against too intense radiation or to prevent overheating. We may now suggest that it acts as a screen not

against radiation in general but against green light, which is specifically absorbed by anthocyanins.

When we take all the effects of light into consideration, we can say that the higher plants contain a remarkable number of different pigments and light-absorbing systems, each tied in with a special reacting system. Therefore it is possible to influence the growth of plants in many different ways by applying monochromatic light of different spectral regions.

Whereas in the case of light it is possible to add very specific amounts of energy to very specific molecules, in the case of temperature effects the activation is far less specific, since individual wave lengths are not involved. There are several ways in which temperature can affect reactions and processes. In the first place, there are the processes in which all the molecules of a species are equally involved, such as diffusion. In this case the temperature effect is relatively minor and amounts to a Q_{10} of approximately 1.2. It is also possible that we are dealing with reactions in which only thermally-activated molecules are involved. This is the usual case in chemical reactions in living substances. In such cases the Q_{10} is very much higher and is usually more than 2. The actual value of the Q_{10} can give us a further idea about the type of reaction involved, since the higher the activation energy needed, the greater the Q_{10} .

Most of the individual growth processes, such as the growth of isolated roots or of tissue cultures, have Q_{10} 's between 2 and 3 and are stimulated by heat up to temperatures near the thermal deathpoint of protoplasm. For intact plants, the optimal temperatures are practically always very much lower. These optimal temperatures may range from 10° C. or even lower to 20° C. or slightly higher. Therefore the integrating mechanism that makes a complete plant out of a number of separate organs has a very different temperature characteristic from the individual organs themselves. Thus far there is no indication that this temperature response is due to the hormonal mechanism, but every-thing points to the involvement of the plant's translocating system.

At the optimal growing temperatures we often find in intact plants a rather wide range over which growth is hardly affected by changing temperature. I would like to interpret this by assuming that a diffusion process is the limiting growth factor in the plant over such a temperature range. There are several other reasons why we have to accept the fact that physical rather than chemical processes are limiting when the plant is growing at an optimal rate.

Finally, during the last few years it has been shown that the circadian cycle, which is so generally operative in the normal growth of plants, has a Q_{10} of 1.2 to 1.3, and it can also be shown that part of the temperature adaptation of plants is due to the effect of temperature



Figure 3. This photograph and the one below (Figure 4) show the effects of temperature on the daily cycle of tomato plants. Here, at a temperature of 15° C. (59° F.), the plant's internal rhythm is slowed so that it makes its greatest growth with an external "day" of 27 hours.



Figure 4. At a temperature of 30° C. (86° F.) the same variety of plants achieves its greatest growth with a shortened "day" of 18 to 20 hours.

on the length of the circadian cycle. Thus a tropical plant cannot grow in a cool climate because the internal rhythm is slowed down to a much longer span than 24 hours, so that the rhythm no longer coincides with the 24-hour cycle of the day. Conversely, a temperate-region plant will not grow at high temperature unless the external "day" is reduced to well below 24 hours.

In all these cases of low Q_{10} (in the neighborhood of 1.2) control of growth is exerted by a diffusion-like process in which all the molecules involved are equally energized by temperature—which would lead to a Q_{10} of 1.18 at room temperature. Since diffusion in an open system cannot be influenced by factors other than temperature, there is little chance that processes with low Q_{10} 's can be stimulated beyond their normal rate. Differences in concentration, for instance, have little effect on the diffusion rate. Therefore there seems to be little chance of increasing the growth rates of plant organs in the temperature range over which they show a Q_{10} of 1.2, which means in their optimal growing range.

In the lower temperature range, and for most individual plant physiological processes, Q_{10} 's of 2 or more are found, and in such cases we can conclude that the growth process is controlled by a chemical reaction. It is exactly in that range that the application of plant growth hormones produced positive effects, which fits in nicely with the theoretical considerations just given above.

Our analysis has tended to emphasize the importance of polarity and diffusion processes in the growth of plants, and the relatively subordinate importance of chemical control of these processes. This does not dispute the role of chemical processes in life in general, but it emphasizes some aspects which have been relatively neglected, to the detriment of a well-balanced view of growth and life in general. We have to admit that our knowledge of biochemistry completely affirms the validity of the laws of thermodynamics in most partial processes in the living system. It has been shown that as far as growth and assimilatory or synthetic processes in general are concerned, the second law of thermodynamics loses its applicability, and therefore we should try to understand the processes that oppose this law in the living organism. We can have a better chance of arriving at an understanding of life by focusing on those processes than by affirming the processes that agree with the second law.

Reference

- Went, F. W., 1957. *The Experimental Control of Plant Growth* (N. Y., Ronald Press).

THE ORIGIN AND GROWTH OF PLANT COMMUNITIES

Pierre Dansereau

UNIVERSITY OF MONTREAL

The spatial arrangement of plants in the oceans, rivers, lakes, and streams and on the land forms a mosaic in which many observers have recognized the repeated occurrence of a number of pieces. At a certain order of magnitude, the controlling power of climate is clearly responsible for the outstanding features of distribution. From the equatorial rain forest to the arctic tundra, a number of transitions (gradual or abrupt) induce considerable changes in the physiognomy of regional vegetation. Within each geographic region, however, the general homogeneity gives way to an often complex variety of communities which at first sight appear to be segregated according to site factors (topography, drainage, soil) but which turn out also to be influenced by history.

The plant cover of almost any landscape comprises a number of distinct plant communities. Their discontinuity is very often the result of abrupt changes in the site conditions (edge of the water, rise of the slope, replacement of clay by sand, increase in the organic content of the soil, improvements of drainage, etc.) or of actual interference, usually recent (by grazing, fire, plowing, etc.).

Whereas there is no denying the objective existence of an individual plant community as a stand in a given place (a cattail marsh at Ile Perrot, Quebec; a white pine forest at Grayling, Michigan; a palm forest at El Yunque, Puerto Rico; a kauri forest at Trounson Woods, New Zealand; a live-oak forest at Montserrat, Spain, etc.), some doubt has been cast on the objectivity of the plant "associations" that have been described and defined by phytosociologists.

The sampling of stands that leads to these definitions is generally

made on one of the following bases: (1) the boundaries of a regional climate; (2) a near identity of terrain with respect to the exposure and slope, drainage, and soil texture (at least at the surface); or (3) some outstanding feature of the vegetation itself (floristic only or floristic and structural). It seems reasonably clear that a single association does in fact describe such communities as cattail in southern Michigan (Segadas-Vianna, 1951), aspen groves in Idaho (Lynch, 1955), a red fir forest in the Sierra Nevada (Oosting and Billings, 1943), a live-oak forest in southern France (Braun-Blanquet, 1936), a spurge forest in the Congo (Lebrun, 1947), an *Ocotea catharinensis* rain forest in Southern Brazil (Veloso and Klein, 1959). The data collected show a great deal of repetition of the same floristic and ecological features—in fact, a combination thereof which is unique. Because of the existence of such assemblages, many investigators of vegetation have been led to define plant associations largely on the basis of floristic coherence (Braun-Blanquet, 1928, 1932, 1951; Guinochet, 1955) and irrespective of the general structure or spatial assemblage within the individual stands. Others have laid a great deal more stress on structure and have been unwilling to give ultimate pre-eminence to the floristic criterion (Dansereau, 1951, 1958b, 1959).

A number of workers in the field believe that it is indeed possible to define an association regionally by sampling a number of stands. They think that the interaction of floristic history, geological and pedological processes, and the repeated occupancy of contiguous landscapes by wave upon wave of vegetation in the past have left a residue of species very unevenly fitted to fill the available ecological niches, which are themselves, as often as not, sharply discontinuous. In no other way can the phenomenon of dominance have arisen.

On the other hand, the view stated above is not mathematically proved, and it has seemed more economical to many ecologists to remain within Gleason's (1926) reserve and to consider each stand as unique and therefore each concrete community as an entity not referable, together with other stands, to an association. Others, such as Curtis and his collaborators (1959), take in a broader piece of vegetation than the individual stands and ordinate them in a continuum. I am not sure that the measurements of the continuum produced so far provide proof of the nonexistence of the association. The sample units, after all, are not contiguous, and the statistical treatment to which they have been subjected results in just as "abstract" a construction as the association. Moreover, some of the criteria are applied as a result of general views of the areas surveyed.

All students of vegetation probably agree that both continuity and discontinuity exist, and that their interplay is responsible for the emerg-

ing pattern. At all events, increasingly sharp tools are being used for the measurement of plant communities. The work of Evans (1952), Cain (1943), Goodall (1954), Gounot (1957), and many others promises a more precise means of defining the ways of vegetation and the scope of its units.

In the present contribution, however, I do not pretend to assess the "objective reality" of the association and even less to present a new synthesis of the problem. I am frankly taking the view that the plant association does indeed exist. I have myself made studies of a certain number of them in the field in many different areas, and I can at least point out the significant elements that are worth considering as valid criteria and mechanisms. In so doing I propose to review the anatomy and physiology of the plant community and to provide a tentative explanation of how some associations are defined sharply, others very loosely—and why.

The space and time allowed hardly permit a redefinition of all the terms employed in this contribution, even less a justification of all the assumptions, although I hope that the latter are mutually consistent. It is also impossible to elaborate upon the various criteria to be used in the analysis of communities, and I shall all too often have to refer to previous papers (especially 1951, 1952a, 1956a, 1956b, 1957a, 1958b).

The parts that make up a plant community are populations of one or more species. In a given stand, each species has its own (complete or incomplete) cycle, its growth form, its minimum and maximum height and breadth, and is represented by a more or less variable number of individuals. Each specific population is arranged according to a pattern which reflects its relative fitness to exploit the total resources of the environment. The biomass as a whole also shows a greater or lesser stability.

In order to understand such a dynamic equilibrium, it is necessary to examine the relative ecosystematic fitness of the species populations. This can only be done by taking the pieces apart to study their nature and structure and also to observe the behavior of the parts and of the whole. Thus an analysis of floristic composition and of structure will reveal the "anatomy" of the plant community, and a study of its periodic fluctuations, methods of tapping resources, and tendencies to floristic and structural change will reveal its "physiology."

Such an analysis will serve to define, one by one, the units of the plant cover. It has been well established, in a large number of cases, that such units are to be found in essential integrity throughout a fairly large geographical area. If we dare to pose the problem of their origin at all, we must therefore look to past vegetational and climatic history in order to account for the present—and perhaps temporary, although

TABLE I

Number of Species in a Stand vs. Number of Species in All Sampled Stands of a Given Association

Association	Location	Author	Number of Stands	Total number of Species	Numbers in One Stand		
					Max.	Mean	Min.
<i>Quercetum ilicis galloprovincialis</i> Live-oak forest	Mediterranean zone of Southern France	J. Braun-Blanquet, 1936	34	151	51	34.6	25
<i>Abietetum magnificae</i> Red fir forest	Sierra Nevada of California	Oosting and Billings, 1943	16	97	41	30.4	17
Alpine-fell field	Wyoming	Cain, 1943	5	57	41	35.6	25
<i>Spiraeetum tomentosae</i> Steeple-bush field	Southern Quebec	Dansereau and Gille, 1949	10	87	43	36.4	23
<i>Vallisnerietum americanae</i> Eel-grass prairie	Southern Quebec	Dansereau, 1945	57	41	9	3.4	1

stable—floristic assemblage and spatial distribution. Thus we may arrive at an ordination of plant communities within a given region, by applying a shifting scale of population-community adjustments.

I shall attempt to implement this approach to plant communities, at least in part. My demonstration will be centered upon a sampling of vegetation in the Saint Lawrence Valley. However, because I believe that the same criteria and principles apply very widely, I shall also draw from evidence in other areas where I have had field experience and have gathered data exactly in the same way as I have in Quebec. If this does not guarantee objectivity, it probably affords consistency through uniform application of an identical subjectivity. The criteria I propose to use will be applied primarily to 14 stands of vegetation upon which I have made a previous report (1957a, Appendix). The report contains complete species lists taken in the spring and in the summer and a number of specific coefficients, some of them relative to the species wherever it is found, others applicable only to a particular stand. My tables therefore show a rather extensive grading by species, emphasizing the diverse modalities of their place in the community. Each community, in turn, can be evaluated in terms of the relative weight of each of these characters.

Anatomy of the plant community

A stand of vegetation can be taken apart in two different ways: by considering its species and the various qualities of each one, or by analyzing the mass as a whole and distinguishing its parts without primarily referring to composition. In my opinion, no interpretation of the community is possible without the application of both of these tests. In fact, no description is complete if both criteria are not used.

Floristic composition. There are three principal considerations concerning flora: its relative richness, the geographic affinities it shows, and the indicator-value of all or some of its members. The first is a quantitative assessment, whereas the latter two require qualitative discrimination. Both are strongly affected by historical circumstances, although immediately governed by present conditions.

1. *Richness.* Some stands harbor a large number of species, others very few (Table I). In the comparable data of our 14 Laurentian tables, the mature undisturbed forests have the highest numbers of species, whereas most of the secondary associations have very few (see Table II).

This is generally considered a significant aspect of community anatomy. It can be envisaged in a number of ways. One can seek a series of floristic ratios between (a) stand and area, (b) association and stand, and (c) region and association.

a. *Species-area curve.* A standard procedure in phytosociology

TABLE II

Some Characteristics of 14 Stands of Vegetation Typical of the St. Lawrence Valley

Association	Common Name	No. of Species	Formation Type	Site	Dynamic Stage	Ecosystematic Control
<i>Aceretum saccharophori laurentianum</i>	sugar maple forest	35	forest	well-drained upland	climax	tropophytia
<i>Aceretum saccharophori tsugosum</i>	hardwood-hemlock forest	30	forest	moist-cool upland	quasiclimax	tropo-oxyphytia
<i>Aceretum saccharophori ulmosum</i>	sugar maple-elm forest	30	forest	moist-warm upland	quasiclimax	tropophytia
<i>Aceretum saccharophori dennstaedtii</i>	fern forest	34	forest	humpered and grazed upland	disclimax	tropophytia
<i>Aceretum saccharophori acerosum</i>	maple-seedling forest	20	forest	abundantly thinned and grazed forest	disclimax	tropophytia
<i>Betuletum populifoliae</i>	wire-birch forest	23	forest	variable, often moist	subclimax	tropophytia
<i>Alnetum rugosae</i>	alder thicket	20	scrub	very wet organic soil	hydroseral consolidation	helophytia
<i>Solidagineetum canadensis</i>	goldenrod field	18	prairie	old field	xeroseral consolidation	mesoxerophytia
<i>Poaetum pratensis</i>	bluegrass meadow	16	meadow	agricultural plot	xeroseral consolidation	paranthropophytia
<i>Thujetum occidentalis</i>	cedar swamp	14	forest	wet organic ground	hydroseral subclimax	helophytia
<i>Acereto-ulmetum laurentianum</i>	elm-silver maple forest	27	forest	floodplain	serclimax	tropo-helophytia
<i>Populetum deltoidis</i>	cottonwood belt	24(23)	forest	sandy shore	hydroseral consolidation	tropo-subxerophytia
<i>Spiraeetum tomentosae</i>	steplebush fen	32	steppe	fluctuating drainage	hydroseral consolidation	helophytia
<i>Lythretrum salicariae</i>	loosestrife marsh	18	prairie	flooded shores	hydroseral pioneer	helophytia

* Complete phytosociological and other data will be found in Dansereau, 1957a, pp. 295-315.

consists in determining the "minimal area"—*i.e.*, the smallest areal unit likely to contain most of the characteristic species of a given association. This is done by cumulative sampling of quadrats which are doubled a number of times—for instance, 10 cm.², 20 cm.², 40 cm.², etc. It may be immediately apparent that plant communities that include the larger life forms (such as trees) will of necessity have a greater areal requirement. But it does not follow that the latter is necessarily proportionate to mass-development. Cain and Castro (1959) have very recently reviewed the manifold aspects of this question and abundantly documented its methodology.

b. Stand and association. The constancy of a given species is deduced from the percentage of its occurrence in the total number of stands sampled, whereas its frequency is its percentage of occurrence in the quadrats of a single stand. (See Braun-Blanquet, 1932, 1951, for original definitions; see Dansereau, 1957a, for applications.) These notions, which first come to mind, will be considered below, although it must be remembered that they cannot well be dissociated from the various calculations meant to show relative richness. In all the published phytosociological charts, considerable variation occurs in the percentage of species that recur in any given stand. The charts themselves are designed, in the first place, on the basis of this recurrence (constancy) and on the basis also of other criteria (such as fidelity.) Table I shows some of the extremes and ratios obtained with respect to the stand/association relationship.

c. Association and regional flora. The richer the regional flora, the greater the availability of building blocks for any given community. But it does not follow that the association will be richer, for a number of factors will counter this probability. For instance, some of the riparian associations along the Amazon are very poor in species, whereas the regional flora is the richest in the world. On the other hand, it has long been recognized that the upland rain forest comprises some of the richest stands of vegetation ever recorded (Schimper, 1903; Warming, 1909). It has often been said that this richness is such as to preclude any proper delimitation of associations on a floristic basis, detectable by the means commonly employed by phytosociologists. More careful study has shown that dominance does indeed occur in some cases (Beard, 1944; Veloso, 1945), although it may be more shifting than elsewhere (Aubréville, 1949). Recent studies (Schnell, 1952; Cain, Castro, Pires, and da Silva, 1956; Veloso and Klein, 1959) all tend to show that it is quite possible to apply current phytosociological concepts and methods to this richest of all vegetations.

In cooler and drier regions the relationship of regional flora to association flora assumes more manageable proportions. The real question is: How many of the available species are incorporated (however

loosely) into a given stand (or association)? The preliminary condition is that they be within dispersal range thereof, which is not necessarily so of all members of the regional flora.

The figures that can be obtained for a stand or an association will therefore indicate in each case what percentage of the regional species is able to take at least some advantage of this particular ecosystematic complex. It gives no clue whatsoever to the relative number of dominants (concomitant or alternative) nor indeed of any exclusivity. In this respect the flora-vegetation ratio may be quite characteristic of an area. For instance, in Central Baffin the striking ecological amplitude of very many species makes for a high percentage of regional flora in several communities. This also coincides with poorly defined boundaries between communities. In Central California, where the vegetation mosaic is quite complex, it is rather remarkable how short the species lists in many stands can be.

3. *Indicators.* The very presence of a certain species, especially if it is somewhat abundant, is the traditional starting point of all plant sociology. Therefore, quite apart from the sheer numbers of identifiable species, some individual characterization is due each and every one that occurs at least once in a quadrat, in a stand, or in the association as a whole. Three principal qualities can be sought in this respect: the floristic groups into which the species fall, as suggested by their general geographical distribution; the indicator groups which their ecological amplitude casts them into; and finally their frequency and/or constancy in the particular unit considered.

a. *Floristic elements.* There are not too many plant communities whose component species all belong to the same floristic element. An "element" can be defined as a group of species (usually taxonomically unrelated) which have a fairly long common history. It is in that sense that phytogeographers have spoken of "boreal," "amphi-Atlantic," "Appalachian," "Mediterranean," and other elements. Such designations are usually not based on actual knowledge of past migration from fossil evidence but more generally on the present general distribution and form of area, on the one hand, and on the geographic location of the closest of kin, on the other. Since the days of Humboldt, Asa Gray, and Engler, such gradings have been widely applied: Wulff (1943), Cain (1944), and Good (1953) have abundantly discussed the justification and consequences of these recognized floristic affinities. No doubt the Scandinavians have used it more thoroughly than others, especially Hultén (1950), whose theory of equiformal areas (1937) deserves to be tested in other parts of the world.

It must be emphasized that the total geographic area of a species is a bioclimatic unit of a certain magnitude, usually exceeding that of one or more communities to which it belongs and almost always ex-

ceeding a single climax area (see example of sugar maples in Dansereau, 1957a, Figures 2-6A, 2-6B).

The data in Table III show how diverse the associations of the Montreal region are in this respect. Thus the Atlantic coastal plain element is absent from all communities except two. The deciduous forest element, so strongly predominant in the climax and in the warmer phase of the quasiclimax, is cut by two-thirds in the cooler, moister phase of the maple forest, and it is notably lower in all non-forest communities. Six units are entirely lacking in non-indigenous species, whereas the bluegrass meadow has 87.4 per cent, the loosestrife marsh 50 per cent, the goldenrod prairie 44.3 per cent.

It will be noted, as it must be repeatedly with reference to other criteria discussed below, that such gradings of floristic lists provide an estimate of the qualities of the flora and only indirectly of the vegetation. Many writers have been at great pains to emphasize this point, especially in connection with life forms (see Dansereau, 1945; Dansereau and Gille, 1949; Dansereau, 1957a; Cain and Castro, 1959). Therefore, if one uses a quantitative coefficient, such as coverage, frequency, constancy, etc., some of the values will rise and others will fall.

b. Valence. A species is considered a good indicator when it shows a certain narrowness in its ecological adjustment. Thus truly aquatic plants, such as the Nymphaeaceae, are never found on dry land because they cannot withstand even brief exposure; extremely salt-tolerant species, such as most *Atriplex* species, reveal the nature of the soil on which they grow; extremely air-moisture-loving plants, such as most *Hymenophyllum* species indicate that the atmosphere where they grow is nearly saturated most of the time.

There are therefore indicators of this or that condition. It would be difficult to blueprint ecological valence in a table that would show all possible kinds of indicators, but a few general statements can be made and a few examples can be pointed to.

Those species that are restricted to a narrow band in the ecological spectrum (for humidity or acidity of soil, for light intensity, etc.) and are therefore unable to tolerate a slight increase or decrease, give a sure sign by their mere presence that the habitat is indeed limited to those precise conditions. *Stenovalent species therefore are the best indicators.* But they may reveal only one of the many conditions present in the habitat (reduced light, neutral soil, or constant humidity), and each stand may contain species reunited in a common association primarily because of their requirement of one of these (*e.g.*, the conditions of light but not of soil nor humidity). Others, however, are not indicators of one but of a combination of factors associated in a rather unique fashion.

As an extreme of this kind of limitation to the ecological ampli-

TABLE III

The Distribution (in Percentages) of Floristic Elements in 14 Stands of Typical Montreal Plain Associations.* The symbols have the following meanings: D, ranging widely through the extent of the Deciduous Forest formation of Eastern North America; G, Great Lakes — St. Lawrence; B, Boreal; A, Appalachian; H, Arctic-Alpine; M, Midwestern; C, Atlantic Coastal Plain; P, Prairie; S, Subcosmopolitan; N, Naturalized.

Association	No. of Species	Floristic Elements												
		D	G	GB	A	DB	B	BH	DM	CD	C	P	S	N
<i>Aceretum saccharophori laurentianum</i>	35	57.1	17.1	2.9	14.3	5.7								2.9
<i>Aceretum saccharophori tsugosum</i>	30	23.4	36.6	6.7	20.0	6.7	3.3							3.3
<i>Aceretum saccharophori ulmosum</i>	30	66.7	10.0		13.3	6.7								3.3
<i>Aceretum saccharophori dennstaed- tiosum</i>	34	20.7	20.7	2.9	23.5	11.7	2.9							2.9
<i>Aceretum saccharophori acerorum</i>	20	55.0	10.0		5.0	15.0								15.0
<i>Betuletum populifoliae</i>	23	17.5	8.7	4.3	4.3	21.8	13.0	4.3				4.3		17.5
<i>Alnetum rugosae</i>	20	30.0	10.0	10.0		20.0	20.0							10.0
<i>Solidaginetum canadensis</i>	18	11.1	5.6		5.6	22.2	5.6					5.6		44.3
<i>Poaetum pratensis</i>	16	6.3				6.3								87.4
<i>Thujetum occidentalis</i>	14	35.7	28.6	7.1		14.4	7.1							7.1
<i>Acereto-ulmetum laurentianum</i>	27	48.2	7.4		3.7	18.5	3.7							18.5
<i>Populetum deltoidis</i>	24(23)	21.8				17.3	13.0					17.4	8.8	17.4
<i>Spiraeetum tomentosae</i>	32	25.0	3.1		3.1	18.8	6.3							9.4
<i>Lythretum salicariae</i>	18	16.6				16.7	11.1						5.6	50.0

* From Dansereau, 1957a, Table A-3.

tude of a species, the phytosociologists have proposed the notion of "fidelity" (Braun-Blanquet, 1932, 1951). A perfectly faithful species is virtually not found outside the stands of a certain association. Elsewhere (1952a, 1957a) I have shown some examples of this situation in various regions.* Thus in the St. Lawrence Valley *Symplocarpus foetidus* and *Acer saccharinum* are strictly confined to the elm-silver maple flood plain community.

c. *Frequency and constancy.* Tests by quadratting or line-transects, or point-quadrats will produce a statistical count of the number of times a certain species occurs within a stand (frequency) or among all the known stands of the association (constancy).

Although abundance favors high coverage and the latter favors frequency and frequency favors constancy, it is well established that these notions can (indeed must!) be applied separately and cannot be deduced from one another. (Many examples in Dansereau, 1952a, 1957a.)

Structure. The arrangement in space of the different parts of a stand of vegetation can be outlined without reference to its composition: the amount, texture, ramification of hard and soft parts, of light and heavy pieces, of flat and cylindrical organs, of green and other-colored appendices, can all be plotted as part of a mechanical device. The differences between two stands of vegetation can then be evaluated in purely structural terms.

Whereas no biologist would think of limiting his description of vegetation by the exclusive application of this method, it is unfortunate that so very few phytosociologists have not complemented their floristic inventories with some kind of structure design. This can be done by considering a minimum of three sets of criteria relating to life form, layering, and spacing. I have written a good deal on this subject (see especially 1951, 1958b, 1960), and I will not attempt here a full discussion of the issues and categories involved but will dwell more in detail on some applications to material already analyzed from the floristic point of view.

1. *Epharmonic types.* In his monograph (1931) Du Rietz quite thoroughly reviewed the question of life forms and growth forms, and he proposed an elaborate new system which was based on a number of factors. It is rather odd that this remarkable work did not immediately stimulate further endeavors along these lines. It may have come at a time when epharmonic responses did not seem a proper object of study, for at that time natural selection itself was little spoken of. In recent years, however, a renewed interest has been shown (Cain, 1950; Cain

* Brito da Cunha and Dobzhansky (1954) and Brito da Cunha, Dobzhansky, Pavlovsky, and Spassky (1959) have applied this ecological frame to *Drosophila* populations in Brazil.

TABLE IV

The Distribution (in Percentages) of Life Forms in 14 Associations of the Montreal Plain.* The meaning of the symbols is the following: Pg, megaphanerophytes (more than 25 m.); Pm, mesophanerophytes (10 to 25 m.); Pp, microphanerophytes (2 to 10 m.); Ph, nanophanerophytes (0.5 to 2 m.); Ps, climbing phanerophytes; Ch, chamaephytes; H, hemicryptophytes; C, geophytes; Th, therophytes (annuals).

Association	No. of Species	Pg	Pm	Pp	Ph	Ps	Ch	H	C	Th
Aceretum saccharophori laurentianum	35	11.4	5.7	5.7			5.7	37.2	34.3	
Aceretum saccharophori tsugosum	30	20.0	6.7	3.3			10.0	26.7	33.3	
Aceretum saccharophori ulmosum	30	16.7	3.3	6.7			10.0	23.3	40.0	
Aceretum saccharophori dennstaedtiotium	34	11.9	5.9	5.9	3.0		8.3	38.3	26.7	
Aceretum saccharophori acerotum	20	15.0	10.0				10.0	45.0	15.0	5.0
Betuletum populifoliae	23	4.3	8.7	8.7	8.7		17.4	34.8	17.4	
Alnetum rugosae	20	5.0		25.0	5.0		15.0	30.0	20.0	
Solidaginietum canadensis	18		5.5				5.5	77.9	11.1	
Poaetum pratensis	16						18.7	75.0	6.3	
Thujetum occidentalis	14	14.3	7.1	14.3			14.3	35.7	14.3	
Acereto-ulnetum laurentianum	27	14.9	3.7	11.1			3.7	37.0	25.9	3.7
Populeetum deltoidis	24 (23)	13.0		17.4		8.7	13.0	21.8	26.1	
Spiraeetum tomentosae	32	3.1	3.1		3.1		18.8	62.5	3.1	6.3
Lythretum salicariae	18			5.4	5.6			66.6		22.2

* From Dansereau, 1957a, Table A-1.

and Castro, 1959). New methods have also been proposed (Schmid, 1956; Lems, 1957).

Any discussion of epharmony poses the question of the relative correspondence of form and function. Any system of life-form classes or categories therefore is based on the premise of an underlying physiological likeness. Life-form classes, however, are defined in morphological terms, and it will always remain to demonstrate whether or not any particular form in general or that particular form in a certain species or individual does indeed serve as an outward sign of a function actually fulfilled.

Epharmonic schemes therefore have rested on *form* (habit, type of leaf) and often on *function* (nutrition, vegetative response, propagation, periodicity, regeneration). Raunkiaer's (1907, 1934) well-known classification is universally employed and has been used to grade floras and associations. The fourteen stands of Laurentian vegetation recorded in Table IV show some very important divergences in this respect. Thus the forest associations (which all have a heavy tree canopy) vary from 13 per cent (*Betuletum populifoliae*) to 26.7 per cent of trees (Pg and Pm), whereas the others have 6.2 per cent or less. The geophytes are also highest in the forest. Cain (1950), Dansereau (1957a), and Cain and Castro (1959) list many more life-form spectra and discuss their meaning at some length.

Other gradings have been applied besides Raunkiaer's life forms (see Du Rietz, 1931), some of them much simpler and making fewer assumptions. The types I proposed in 1951 and later modified (1958b) make no functional assumptions whatsoever except those concerning sheer spatial occupancy. Thus erect woody plants are distinguished from climbing or decumbent woody plants, and these in turn from herbs, epiphytes and crusts, and moss-like plants, or bryoids, and they are situated in a vertical scale of seven divisions. Table V shows the distribution of these structure forms among the 14 Laurentian associations. The lianas and epiphytes are absent from these particular stands. The bryoids play an important role in two communities: the *Betuletum populifoliae* and the *Acereto-ulmetum laurentianum*. The W/H ratio is lowest in the *Poaetum* and highest in the *Populetum*.

The consistency of the stand also has been the object of analysis, over and above the distinctions just made. Raunkiaer (1934), for instance, has proposed a grading of leaf-surface units (see Dansereau, 1957a; Cain and Castro, 1959, pp. 275-285). Not only do vegetation types of different climatic regions differ, but contiguous communities belonging to contrasting ecosystems do as well: witness a broadleaf deciduous forest (*Aceretum saccharophori*) and a neighboring leather-leaf bog (*Chamaedaphnetum calyculatae*).

Other similar gradings involve something more than size—for in-

TABLE V

A Simplified Life-Form System.* W = erect woody plants; L = climbing or decumbent woody plants; E = epiphytes and crusts; H = herbs; M = bryoids.

Association	No. of Species	W	L	H	E	M
Aceretum saccharophori laurentianum	35	22.90	—	77.10	—	—
Aceretum saccharophori tsugosum	30	33.33	—	66.67	—	—
Aceretum saccharophori ulmosum	30	26.60	—	73.40	—	—
Aceretum saccharophori dennstaed- tiosum	34	29.40	—	70.60	—	—
Aceretum saccharophori acerosum	20	25.00	—	75.00	—	—
Betuletum populifoliae	23	30.40	—	60.90	—	8.70
Alnetum rugosae	20	30.00	—	70.00	—	—
Solidaginetum canadensis	18	5.55	—	94.45	—	—
Poaetum pratensis	16	—	—	100.00	—	—
Thujetum occidentalis	14	35.80	—	64.20	—	—
Acereto-ulmetum laurentianum	27	29.60	—	66.70	—	3.70
Populetum deltoidis	24(23)	45.75	—	54.25	—	—
Spiraeetum tomentosae	32	9.50	—	90.50	—	—
Lythretum salicariae	18	11.00	—	89.00	—	—

* From Dansereau, 1951, 1958b.

stance, general shape and texture. My 1951 and 1958b system allows such a grading, which is applied in Table VI and VII and which shows very sharp differences between the communities. For instance, the graminoids are most prominent in the Lythretum, the Spiraeetum, the Solidaginetum, the Poaetum; the broadleaved are overwhelmingly more important in the Aceretum saccharophori laurentianum and in the Aceretum saccharophori tsugosum than elsewhere; very small leaves, needle or subulate, are quite absent from five communities, whereas they are 10 per cent or more in four others. These differences are much more pronounced if a coverage coefficient is used (column B in Table VI). For instance, the spatial importance of the needle type in the Thujetum association rises from 7.15 per cent to 55.5 per cent.

Leaf texture likewise shows a very uneven distribution. The meadow (Poaetum pratensis) has an almost all-membranous leaf type, whereas six communities have 10 per cent or more hard-leaf type. The filmy-leaf type is very poorly represented—in only three communities. And here again the use of a coverage coefficient strongly emphasizes the differences: the succulent or fungoid type, although represented by many species, has little spatial value; the sclerophyll type is extremely important in the cedar wood and the hardwood-hemlock forest.

TABLE VI

A Distribution of Leaf Shape and Size in 14 Stands of Laurentian Vegetation. The symbols^o have the following meaning:
 n: needle, spine, scale or subulate; g: graminoid; a: medium or small; h: broad; v: compound. The percentages refer:
 A, to the total flora of the stand; B, to an index value calculated from the cumulation of all the coverage figures.

Association	No. of Species	n		g		a		h		v	
		A	B	A	B	A	B	A	B	A	B
<i>Aceretum saccharophori laurentianum</i>	35	—	—	5.70	4.35	20.00	13.05	45.70	60.89	28.60	21.71
<i>Aceretum saccharophori tsugosum</i>	30	10.00	20.30	—	—	40.00	26.10	36.70	43.50	13.30	10.10
<i>Aceretum saccharophori ulmosum</i>	30	—	—	6.64	4.24	40.00	27.66	23.36	46.80	30.00	21.30
<i>Aceretum saccharophori dennstaedtiolum</i>	34	2.90	1.54	11.75	6.15	38.20	18.46	17.65	24.62	29.50	49.23
<i>Aceretum saccharophori acerolum</i>	20	—	—	10.00	6.60	35.00	19.70	25.00	53.10	30.00	21.20
<i>Betuletum populifoliae</i>	23	13.05	17.20	17.40	14.30	47.80	45.70	8.70	8.50	13.05	14.30
<i>Abnetum rugosae</i>	20	5.00	1.89	10.00	7.51	45.00	58.50	20.00	13.20	20.00	18.90
<i>Solidagineetum canadensis</i>	18	5.55	12.75	27.80	27.70	38.90	46.80	11.10	4.25	16.65	8.50
<i>Poaetum pratensis</i>	16	—	—	18.75	40.00	56.25	36.00	6.25	6.00	18.75	18.00
<i>Thujectum occidentalis</i>	14	7.15	55.50	14.25	5.55	35.80	18.10	21.40	13.86	21.40	6.99
<i>Acereto-ulmnetum laurentianum</i>	27	11.10	9.54	3.70	2.38	33.35	29.75	18.50	33.33	33.35	25.00
<i>Populetum deltoidis</i>	24(23)	4.16	3.28	8.30	9.84	37.50	47.54	20.80	18.00	29.24	21.34
<i>Spiracnetum tomentosae</i>	32	12.95	10.93	32.20	28.75	29.00	34.30	3.25	1.37	22.60	24.65
<i>Lythretrum salicariae</i>	18	—	—	39.00	35.23	33.20	46.25	5.60	7.42	22.20	11.10

^o From Dansereau, 1951, 1958.

TABLE VII

Percentages of Leaf Texture in 14 Stands of Laurentian Vegetation. A and B as in Table VI. Symbols have the following meaning: f: filmy; z: membranous; x: sclerophyll; k: succulent or fungoid.

Association	No. of Species	f		z		x		k	
		A	B	A	B	A	B	A	B
		<i>Aceretum saccharophori laurentianum</i>	35	2.16	2.16	85.70	93.50	2.86	2.17
<i>Aceretum saccharophori tsugosum</i>	30	—	—	73.40	75.40	13.30	21.70	13.30	2.90
<i>Aceretum saccharophori ulmosum</i>	30	3.30	4.24	76.70	86.20	3.30	4.24	16.70	5.32
<i>Aceretum saccharophori dennstaedtiolum</i>	34	—	—	82.40	93.84	5.85	4.62	11.75	1.59
<i>Aceretum saccharophori acerolum</i>	20	—	—	85.00	96.70	—	—	15.00	3.30
<i>Betuletum populifoliae</i>	23	4.35	2.90	78.25	82.80	8.70	14.30	8.70	0.00
<i>Alnetum rugosae</i>	20	—	—	85.00	90.60	10.00	5.65	5.00	3.75
<i>Solidaginetum canadensis</i>	18	—	—	88.90	91.50	11.10	8.50	—	—
<i>Poaetum pratensis</i>	16	—	—	93.75	96.00	6.25	4.00	—	—
<i>Thujetum occidentalis</i>	14	—	—	85.75	43.10	14.25	56.90	—	—
<i>Acereto-ulmetum laurentianum</i>	27	—	—	81.50	83.34	3.70	7.14	14.80	9.52
<i>Populetum deltoidis</i>	24(23)	—	—	79.20	85.25	8.30	6.55	12.50	8.20
<i>Spiraeetum tomentosae</i>	32	—	—	87.10	91.75	12.90	8.25	—	—
<i>Lythretum salicariae</i>	18	—	—	83.40	85.20	11.10	11.10	5.50	3.70

Such categories are certainly useful, inasmuch as they take notice of certain outstanding qualities of the parts (species populations) that make up a stand of vegetation. The biological spectra constructed from these data reveal how many or what percentage of the taxonomic units contribute to a given form. However, in order to project the spatial importance of each category (now divorced from its taxonomic appurtenance), a quantitative coefficient is required. On the scale of plant communities, a very striking difference can be shown between the percentage of life forms specieswise and masswise, as Table VI and VII have indicated. Another instance can be quoted: in three aquatic communities (Dansereau, 1945) the rush-like life form was represented by four or five species, which ran to percentages of total flora of 18.5, 17.9, and 20.0. The use of a quantitative coefficient, however, raised the value by ten times for one of the three communities. A similar discrepancy was noted in two field communities (Dansereau and Gille, 1949), where percentagewise the therophytes rated 17.54 and 9.53 per cent, whereas masswise they were respectively reduced to 8 per cent and 3 per cent!

2. *Layering*. Once the elementary pieces have been detected, species by species, and lumped according to the category they belong to, it remains to assemble them vertically (layering) and horizontally (coverage). Although it may seem artificial to separate stratification from coverage (see Cain and Castro, 1959, pp. 223-233) it has seemed useful to me to employ independent scales so that any number of actual combinations can be represented.

I have reviewed elsewhere (1960) the different approaches to the methodology of measuring layering. I shall be concerned here only with the system I have myself applied in various publications and in the tables of the present contribution.

Layering is an adjustment not only to the qualities of the site but also to the interactions among the species and even the life forms. The ceiling imposed upon an individual is a function of its morphogenesis, but the time and rate at which this maximum vertical extension can be attained are controlled by complex immediate conditions, involving root competition as well as light, crowding, nutrients, etc. The more the reason to measure layering independently.

The scale already used (Dansereau, 1958b) provides for seven layers. This rigid frame, although it does not reflect the complex reality of some stands, is very useful for comparison purposes. If a necessary distinction is made between layer and synusia (see Dansereau and Arros, 1961), the dynamics of layering immediately become apparent. However, dynamics are not primarily involved: it is the *spatial distribution at a certain time and place* that is of major interest and that this graphic method purports to illustrate.

3. *Spacing and coverage.* Stratification is not all, of course, and is scarcely separable from coverage. The components of coverage are the size and spread of individual components (whether considered *sub aspectu speciei* or *sub aspectu formae biologicae*), their spacing, and the availability of light, moisture, etc. However, none of these considerations is necessary to a plotting of the space occupied, and they are undesirable if the correlation with site or site factors is indeed *q.e.d.*

The mobile scale I have used (1951, 1958b) would seem to allow an indefinite number of stratification-coverage combinations. I have argued that this is not the case and that most formation types fall into one of the following ten (which I have defined and illustrated): forest, woodland, savanna, scrub, prairie, meadow, steppe, desert, tundra, and crust. Some of these terms (used in order to avoid the coining of new words) are employed in a narrower or broader sense than is generally accepted. At all events, it is worth pointing out that they have no obligate geographical connotation!

The 14 stands of vegetation have been labeled in this way in Table II. It may or may not appear that identical formation types have different inner dynamics, and this, precisely, is the subject of physiological rather than anatomical investigation.

It might remain, in terms of structure, to define further some biotopic peculiarities, such as various niches within the general matrix. The system already used provides for epiphytes and crusts to be shown. To this could possibly be added microrelief features of the kind illustrated in Jovet (1949) and Dansereau (1957a, Figures A-4 and A-6).

Physiology of the plant community

The plant community is a part of the ecosystem: its living vegetable matrix rests upon and penetrates the inorganic and the dead organic material. Roots, stems, leaves, and fructifying parts carry on a latent or variously active exchange with the gases, liquids, and solids that surround them. The functions of the unit as a whole are governed by the aptitudes of the component species, many of which are bound to have nearly identical requirements and/or responses at the same time. Such *functions* must therefore be analyzed, much in the same way as the *forms* mentioned above, in order to establish their relative importance in the community and to draw comparisons with other communities. Here again, each one must be assessed independently of all others.

Periodicity and dispersal. Most plant communities are adjusted to seasonal variation. This has been detected even in wet tropical areas (Velooso, 1945). In the so-called temperate zone, periodicity is overwhelmingly in evidence. Temperate forests and tropical savannas, in

cold or dry seasons, lose so much of their vegetative parts that the total weight carried, the total space occupied, the total water utilized, the total nutrient use and storage, and the total light and heat intercepted vary by huge amounts.

1. *Vegetative periodicity.* The response of unfolding, spreading, and shedding of vegetative parts is therefore structurally as well as physiologically important. The number of evergreen species, and above all their total bulk, in any community is therefore of great significance. A New Zealand beech forest contains practically no deciduous species, whereas a New England beech forest contains almost no evergreens. In the group of 14 stands of the St. Lawrence Valley, only one, the *Thuja occidentalis*, is predominantly evergreen, although the *Aceretum saccharophori tsugosum* presents a secondary character of evergreenness. Table VIII shows the exact distribution of evergreenness. The disturbed maple forest and the bluegrass meadow have no evergreens at all; the beech-maple-hemlock stand, the cedar forest, the steeple-bush steppe, and the wire-birch forest have quite high percentages. And here again (see column B) the use of a coverage coefficient conveys a more accurate picture.

2. *Reproductive cycle.* Likewise, the reproductive and dispersive processes will give us valuable clues to the inner mechanics of the stand. For instance, if reliable data were available, it would be interesting to determine the incidence, among the species present in a stand, of the following: (a) predominance of vegetative over sexual propagation; (b) the systems of reproduction—sexual, vegetative (obligate), viviparous, or agamospermous (through adventitious embryony, agospory, diplospory). A tentative analysis of nine stands of North American vegetation gave some indication of the results to be sought in this respect. These are shown in Table IX. It appears that the open communities show a much higher percentage of maintenance by seeding. However, although about half the species of the forests owe their present position mostly to vegetative propagation, very few of them are either apomictic or obligately vegetative.

3. *Dispersal.* It is agreed that morphological devices do not necessarily indicate the means of dispersal. The latter must be actually observed *in situ* in order to be reliably recorded as efficient. Nevertheless, a number of morphological structures (winged appendices, plumose or hooked fruits) are such highly differentiated elaborations, as compared to the widespread seed diaspores of medium size and weight, that it is difficult to deny their significance if they show a degree of incidence in a community. A grading devised by Dansereau and Lems (1957) has been applied to the 14 Laurentian stands, and the resulting unevenness of distribution is quite characteristic (Table X). Thus, the auxochores are really high only in the forest stands, and so are the pterochores.

TABLE VIII

The Periodicity of Species and of the Stands' Vegetation as a whole. Symbols* as follows: d, deciduous; s, semideciduous; e, evergreen; j, evergreen-succulent or evergreen-leafless. A and B as in Table VI.

Association	No. of Species	d		s		e		j	
		A	B	A	B	A	B	A	B
		<i>Aceretum saccharophori laurentianum</i>	35	91.50	93.50	5.70	4.33	2.80	2.17
<i>Aceretum saccharophori tsugosum</i>	30	80.00	71.00	3.30	1.45	16.70	27.53	—	—
<i>Aceretum saccharophori ulmosum</i>	30	93.36	93.60	—	—	6.64	6.40	—	—
<i>Aceretum saccharophori dennstaedtioides</i>	34	91.16	95.39	2.95	1.54	5.89	3.07	—	—
<i>Aceretum saccharophori acerosum</i>	20	100.00	100.00	—	—	—	—	—	—
<i>Betuletum populifoliae</i>	23	87.00	82.80	—	—	13.00	17.20	—	—
<i>Alnetum rugosae</i>	20	90.00	94.34	—	—	10.00	5.66	—	—
<i>Solidaginetum canadensis</i>	18	94.45	95.70	—	—	5.55	4.30	—	—
<i>Poaetum pratensis</i>	16	100.00	100.00	—	—	—	—	—	—
<i>Thujetum occidentalis</i>	14	85.75	43.10	—	—	14.24	56.90	—	—
<i>Acereto-ulmetum laurentianum</i>	27	96.30	92.86	—	—	3.70	7.14	—	—
<i>Populetum deltoideis</i>	24(23)	100.00	100.00	—	—	—	—	—	—
<i>Spiraeetum tomentosae</i>	32	87.10	89.05	—	—	12.90	10.95	—	—
<i>Lythretum salicariae</i>	18	100.00	100.00	—	—	—	—	—	—

* From Dansereau, 1951, 1958.

TABLE IX

A Grading of Nine Stands According to the Means of Propagation of Their Species, Showing How They Maintain Their Numbers and What Means of Reproduction They Have. Mosses and lichens do not appear in this table.

	Number of Species	Maintenance Sexual	Vegetat.	Reproduction Sexual	Non-sex.
1. Larreetum divaricatae Creosote bush flat Southwest Texas	7	5	2	5	2
2. Yuccetum riograndense Yucca scrub Southwest Texas	16	12	4	12	4
3. Kobresietum myosuroidis Sedge barren Central Baffin	13	8	5	12	1
4. Artemisietum gaspense Artemisia barren Gaspé	12	9	3	10	2
5. Agrostetum canadense Redtop-quackgrass meadow Central Quebec	9	5	4	6	3
6. Calamagrostetum canadensis Bluejoint wet prairie Northern Quebec	5	0	5	3	2
7. Piceetum rubentis Red spruce forest Catskills	20	11	9	18	2
8. Aceretum saccharophori quercosum Beech-maple forest Central Quebec	29	15	14	28	1
9. Aceretum saccharophori denstaedtiosum Maple forest (disturbed) Central Quebec	42	23	19	37	5

TABLE X

The Dispersal Types of Species in the 14 Laurentian Stands. The Figures 1 to 10 Refer to the Kind of Diaspore, as Described by Dansereau and Lems (1957). 1, Auxochore; 2, Cyclochore; 3, Pterochore; 4, Pogonochore; 5, Desmochoire; 6, Sarcochore; 7, Sporochoire; 8, Sclerochoire; 9, Barochore; 10, Ballochoire.

Association	No. of										
	Species	1	2	3	4	5	6	7	8	9	10
<i>Aceretum saccharophori laurentianum</i>	35	20.0		11.4	5.7	5.7	25.7	8.6	22.9		
<i>Aceretum saccharophori tsugosum</i>	30	13.3		23.4	3.3		33.3	10.0	16.7		
<i>Aceretum saccharophori ulmosum</i>	30	16.7		10.0		3.3	30.0	13.3	23.4	3.3	
<i>Aceretum saccharophori demstaedtiosum</i>	34	7.4		17.6	5.9	2.9	33.8	11.8	20.6		
<i>Aceretum saccharophori acerorum</i>	20	17.5		15.0	10.0	10.0	17.5		25.0		5.0
<i>Betuletum populifoliae</i>	23	10.9		13.0	21.8	4.3	6.5	17.4	26.1		
<i>Alnetum rugosae</i>	20			15.0		5.0	35.0	15.0	30.0		
<i>Solidaginetum canadensis</i>	18	2.8		5.5	38.9	11.1	2.8	11.1	27.8		
<i>Poaetum pratensis</i>	16	3.1		6.3	18.7	6.3	3.1		62.5		
<i>Thujetum occidentalis</i>	14	3.6		28.6		7.1	17.9	7.1	35.7		
<i>Acereto-ulmetum laurentianum</i>	27	1.9		22.2		11.1	20.4	14.8	25.9		3.7
<i>Populetum deltoidis</i>	24(23)			13.0	26.1	4.3	21.8	8.7	21.8		4.3
<i>Spiraeetum tomentosae</i>	32	1.5		9.4	15.6	9.4	4.7	18.8	40.6		
<i>Lythretum salicariae</i>	18			11.1	16.7	11.1			61.1		

Concerning the latter, it is interesting to note that they are mostly concentrated in the tree layer. (Farther south and west, in the oak-hickory region, the barochores replace them!) The pogonochores, on the other hand, rank highest in open fields.

Ecosystematic control. Many of the phytosociological investigations that concern themselves primarily with the items listed above under "floristic composition" (and to a lesser degree under "structure") also offer some indication on site conditions, such as exposure, slope, drainage, and, even more frequently, soil. The latter is sometimes analyzed in considerable physical and chemical detail. In any given stand where it is intended to make a truly exhaustive study, such painstaking analyses are indeed a most vital part of the record. However, the phytosociologist whose main interest is in the composition (and structure?) of the association, and who must lay down a large number of quadrats in order to sample a good number of stands, cannot always resort to such minute observation of site qualities. (May I note in passing that the taxonomist, the biosystematist, and the geneticist usually stop even shorter of this mark?) The most commonly used allusive descriptions refer to soil moisture and to shade. Thus the "habitat" is described as "xerophytic," "mesophytic," "hygrophytic," or as "rich woods," "open fields," "sandy plain," etc.

Again, the best description of an individual site is a record of the physical conditions actually observed there, as in the case of structure. An actual representation of the existing layering is "truer" than a diagram which forcibly fits the actual stratification into pre-established height classes. Nevertheless, in both cases, for purposes of comparison a standard is useful. Such a standard must always be based, and as narrowly as possible, on criteria known to be significant. Some years ago I convinced myself that Huguet del Villar (1929) had provided the most acceptable framework for a recognition of the main habitats. In 1952 I translated his scheme from the Spanish and only slightly modified it and have applied it in many later contributions (see especially 1952a, 1956a, 1957a).

Although it is recognized that single factors do not control the site in an absolute way, del Villar's prime assumption is that deficient or excessive elements exert a major influence. He has therefore aligned the factors actually known to induce some kind of limitation upon plant species in a hierarchic order. The limitations thus undergone go from exclusion through various forms of suboptimal reaction (*e.g.*, lack of flowering) to complete fitness. The latter, in each of the cases defined, is nothing less than a physiological regimen. The demands made upon a plant living in excessively acid or warm and dry or rocky substrata are such as to elicit responses of a peculiar kind (which the morphology of the plant may or may not betray). Therefore, when del Villar

writes of oxyphytia, hyperxerophytia, or lithophytia, he refers to the whole metabolism and to the chain of cyclic responses of a certain group of plants which show various degrees of well-being under these more or less stressful conditions. This scheme, which comprises 25 alternatives plus a number of combinations thereof (see del Villar, 1929; Cuatrecasas, 1934), is non-geographic and therefore lends itself to a completely independent application.

Del Villar himself plotted it on a small-scale map of Europe (1929, p. 208). But it can just as well be used on a larger scale, as Cuatrecasas (1934) has done in grading the mountain zones of Colombia and as I have done for the St. Lawrence Lowlands (Dansereau, 1960). Table II shows an application to the 14 stands already graded for other features.

Again the mere label "tropophytia" or "oxyphytia" is nothing more than a key to the prevalent influence in a stand, an association, or a region. It remains to demonstrate, by evaluating the ecological amplitude of all component species, how strongly tropophytic or oxyphytic the area is, and this mostly by comparison with other comparable areas.

Here a quantitative plotting of index values will provide the kind of evidence needed. For instance, the prevalent reaction to light and moisture in the Laurentian maple forest species (Dansereau, 1943, 1946) or in Quebec pasture associations (Dansereau and Gille, 1949) or in Wisconsin forests (Curtis, 1959) allows the elaboration of cumulative indices which fairly characterize different kinds of vegetation and place them in some linear or multidimensional order reflecting their ecological affinities.

Exploitation and turnover. Much attention has been given in recent years to the yield of communities, and various experiments have been performed to implement Lindeman's (1942) concept of the "trophic-dynamic" nature of the plant community. Biogeochemical studies are increasingly numerous and have cast a great deal of new light on the metabolism of ecosystems. H. T. Odum (1956, 1957, 1960) has advanced considerably along these lines by either estimating or actually measuring energy flow. I can only agree that what we are seeking is a *bioenergetic law*, but I am rather uncertain that our understanding of ecosystematic anatomy and physiology is such as to allow us, at this time, to measure the right things. I have argued elsewhere (1958a) that we should have in mind: (1) the total amount of resources of each kind and their microdistribution; (2) the percentage of bound and free resources; (3) the degree of utilization of all resources by the living members of the ecosystem; (4) the relative capacity of plants (of different physiological kinds) to liberate resources, to transform them, and to feed them back into the ecosystem.

The major taxonomic groups, of course, provide us with some obvious differences in the tapping mechanism of plants: algae, lichens,

fungi, mosses, vascular plants have different modes of uptake, transformation, storage, and decomposition. But we need to make much finer distinctions if we are truly to understand the turnover within the ecosystem.

Replacement and encroachment. So much has been written about plant succession that only the barest allusion to some of the review papers can be made—for instance, Clements (1936), Cain (1939), Watt (1947), Whittaker (1953), Dansereau (1956a). The matter of the cyclic behavior of species, and indeed of entire communities, is very much emphasized by Watt (1947), and I feel sure that it occurs at various levels in the dynamic pattern, sometimes involving only a group of pioneer stages, sometimes extending to the very climax (Dansereau, 1956a, Figures 4, 5, 6, 7). The occurrence of cycle within cycle, or rather of small cycles operating on the axis of a generally ascending potential, has been demonstrated by Scurfield (1956). Detailed monographs such as Jovet's (1949) and Dall's (1956) provide the best possible test of these interpretations. They are unfortunately very scarce.

The phytosociologists of the Zürich-Montpellier school, on the other hand, have long recognized initial, optimal, and terminal phases (Braun-Blanquet, 1932, p. 231). Because of the prevalence of the phenomenon of succession, they have been led to recognize, in each association, species which are constructive, conserving, consolidating, neutral, or destructive. The presence of a number of species (even more, of a number of individuals) considered characteristic of another association can therefore be regarded either as showing a lag in the full development of the association (*Clintonia borealis* and *Streptopus roseus* in the *Aceretum saccharophori laurentianum*) or else the beginnings of an invasion from another association (*Betula populifolia* in the *Solidaginetum laurentianum*).

Ordination of plant communities

A full application of the criteria defined above to any single stand of vegetation (or to the synthetic tabulation of data from many stands which defines the association), conveys a picture of what it *is* and of how it functions. Should the communities be compared among themselves in the manner of organisms (whether or not one accepts the idea of their being superorganisms), any classification will place some of the characteristics listed herewith either above or below some of the others, since all classification proceeds by subordination in that it singles out some feature (morphological or functional or both) as having more significance than the others. The various taxonomies to which the plant world has been subjected demonstrate the many possible shifts in criteria. In the field of taxonomy, precisely, functional

criteria (mostly genetic) have gained much ground over descriptive ones.

If such a trend is to be followed in placing the plant communities of a region in some kind of relative order, then their genetic features should be of the utmost significance. But what can be properly considered a genetic feature in a plant community? Is it too tenuous an analogy to make the following equation?

$$\frac{\text{species-population}}{\text{community}} = \frac{\text{gene}}{\text{species}}$$

One might not be prepared to go so far as to add:

$$\frac{\text{species}}{\text{association}} = \frac{\text{species-population}}{\text{community}}$$

The considerations offered above concerning the anatomy and the physiology of the plant community, if applied with a certain rigor and uniformity, will indeed characterize them individually so well that they can be readily distinguished from one another. It is only another step to attempt to lump together all the communities that are located in the same range of variation for each of these criteria. I have made an experiment in this direction. In 1946 I had designed a pattern of 30 plant communities in the Montreal area which showed their points of contact and their probable mutual (successional) relationships. This pattern of associations can now be analyzed by superimposing upon it any of the criteria deemed significant. Thus I have recently (1960) drawn upon the same pattern the distribution of layering and coverage, of periodicity, of ecosystematic control, and of successional status, all of which follow non-coincident lines. For instance, evergreenness impinges upon forest and scrub formation types, upon consolidation, subclimax, and quasiclimax stages, etc.

This would tend to show that synecological units can be regrouped in a number of ways—in as many ways as there are criteria. Table XI gives a tentative alignment of values of each of the criteria that have been considered in the sections above. It is suggested that a community which has attained a high degree of sociological differentiation and is the climax of a regional complex generally has the qualities listed on the right. Its floristic composition reveals a great richness, some uniformity of geographical range, a degree of ecological specialization, and few species “out of place.” Its structure shows dense coverage, with a somewhat complex layering, consisting of a fair representation of many life forms and leaf types. Physiologically, its periodicity is

TABLE XI

Range of Values for Criteria Applied to the Anatomy and Physiology of the Plant Community. The Value Given at the Right-Hand Side of the Table is Considered Usual in a Climax Community.

Criteria	Range		
	1 low	2 intermediate	3 high
Anatomy			
Floristic composition			
a. Number of species	few		many
b. Origin of elements	varied		uniform
c. Ecological valence	wide		narrow
d. Indicator groups	many		few
Structure			
e. Coverage	sparse		dense
f. Layering	simple		complex
g. Life-forms	few		many
h. Leaf-types	one		many
Physiology			
i. Periodicity	seasonal		none
j. Dispersal	few types		many types
k. Ecosystematic control	fluctuating		constant
l. Exploitation	partial		full
m. Succession	active		reduced

relatively reduced; several dispersal types are well represented; its ecological determinants are not extreme but moderate; and it exploits the resources of the ecosystem to the full, whereas it betrays little evidence of succession.

Table XII grades the 14 stands previously considered according to the scale proposed in Table XI. It will be seen that the first three stands, as well as the *Acereto-ulmetum laurentianum* and the *Alnetum rugosae*, have a high cumulative index, mostly due to a high percentage of 3's and only an exceptional 1, whereas the *Solidaginetum*, the *Poaetum*, the *Spiraeetum*, and the *Lythretum* have practically no 3's and a good number of 1's.

Ecosystematic fitness of populations. The individuals belonging to a single interfertile population have been characterized above in several respects: floristic element, valence, fidelity, frequency, constancy, life form, layering, spacing, coverage, periodicity. In a previous essay on "the varieties of evolutionary opportunity" (1952a) I argued that the

TABLE XII

Values (1, 2, 3) of Criteria (a to m), as Listed in Table XI, for the 14 Laurentian Stands

Association	a	b	c	d	e	f	g	h	i	j	k	l	m	Cumulative Index
<i>Aceretum saccharophori laurentianum</i>	3	3	3	3	3	3	3	3	3	1	3	3	3	37
<i>Aceretum saccharophori tsugosum</i>	3	2	2	2	3	3	3	2	2	3	2	2	3	32
<i>Aceretum saccharophori ulmosum</i>	3	2	2	3	3	3	3	3	1	3	3	2	3	34
<i>Aceretum saccharophori dennstaedtioides</i>	3	2	1	1	3	3	3	2	1	3	2	2	2	28
<i>Aceretum saccharophori acerosum</i>	2	2	1	1	3	2	3	2	1	3	2	2	1	25
<i>Betuletum populifoliae</i>	2	1	1	2	3	3	3	2	1	2	3	2	2	27
<i>Alnetum rugosae</i>	2	3	2	3	3	2	2	2	1	2	3	2	3	30
<i>Solidagineetum canadensis</i>	1	1	1	2	3	2	1	2	1	2	1	2	1	20
<i>Poaetum pratensis</i>	1	1	1	2	2	1	1	2	1	2	3	2	1	20
<i>Thujetum occidentalis</i>	1	3	2	3	3	2	1	2	2	3	3	2	2	29
<i>Acereto-ulmetum laurentianum</i>	2	2	3	3	3	3	3	3	1	3	3	2	3	34
<i>Populeetum deltoidis</i>	2	1	3	3	2	2	3	2	1	2	1	2	2	26
<i>Spiraeetum tomentosae</i>	3	1	1	1	2	2	2	2	1	3	1	2	1	22
<i>Lythretum salicariae</i>	1	1	1	1	2	2	1	2	1	2	1	2	1	18

ecological strategy of a species could well be defined in terms of its phytosociological responses. On a later occasion, in a symposium on "the impact of population studies on ecology" (A.I.B.S. meeting, Bloomington, Indiana, August, 1958), I attempted to show different degrees of ecosystematic fitness by using synecological units as a measure thereof. The present purpose calls for a restatement of these issues.

Population-community adjustments are of several kinds and of many degrees. I have suggested (1956b) that there are four principal thresholds to be recognized: (1) survival; (2) local abundance; (3) euryvalence; (4) dominance. The fourth step does not necessarily require the third; indeed, there are many examples to the contrary.

For instance, considering the species of the *Aceretum saccharophori laurentianum*, the following gradation can be recognized:

A. Dominant species are those that have achieved, in their layer, an absolute or relative monopoly of space: *Acer saccharophorum* (two upper layers); *Erythronium americanum*, *Claytonia caroliniana* (lowermost layer in the spring); *Osmorhiza claytoni* (second layer in the summer); *Viola pennsylvanica*, *Solidago flexicaulis* (lowermost layer in the summer). A dominant has achieved the maximum ecological success.

B. Subdominant species are those that occupy less space than the dominants and yet a good deal more than any of the remaining species: *Fagus grandifolia* (in the uppermost layer); *Dicentra cucullaria* (in the lowermost, in the spring). A subdominant is held in check by the dominant.

C. Constant species are those which, however small their population, are usually present: *Tilia americana*, *Cornus alternifolia*, *Sambucus pubens*, *Viburnum lantanoides*, *Desmodium glutinosum*, *Smilacina racemosa*, *Botrychium virginianum*, *Carex plantaginea*, *Carex arctata*, *Sanguinaria canadensis*. A constant seems assured of widespread persistence.

D. Companion species are not out of place, in that their usual ("normal"?) habitat does not differ too markedly from the *Aceretum saccharophori laurentianum*, but they are not constant, although they can occasionally be very abundant: *Eupatorium rugosum*, *Laportea canadensis*, *Actaea pachypoda*, *Tiarella cordifolia*, *Dryopteris spinulosa*, *Trillium erectum*, *Streptopus roseus*, *Dentaria diphylla*, *Uvularia grandiflora*. A companion is almost always euryvalent and therefore not disturbed by shifting features in the environment.

E. Accidental species are present only because of chance dispersal, local disturbance, or microtopic variation; they do not "belong," in fact are usually characteristic of some other association or at least indicators of some other ecological condition (e.g., more

light, more moisture, etc.). In this particular list there is no accidental species. In other stands of the same association some of the following are sometimes found: *Impatiens capensis*, *Galeopsis tetrahit*. An accidental owes its presence to temporary conditions.

The ecological strategy involved is fairly uniform within each one of these groups in this particular association (the *Aceretum saccharophori laurentianum*). The above A-B-C-D-E scale roughly shows five degrees of population-community adjustment. If it is applied to a number of spatially contiguous communities, the inner structure of each one will turn out to be quite different. It is easily seen that the companions and even the accidentals are relicts, heralds of change, or mere indicators of a passing disturbance.

Cohesion of communities. The degree to which two or more species are obligate associates (fidelity) or statistically frequent associates (constancy) can be measured with some degree of objectivity (especially if the fundamental difference between fidelity and constancy is kept in sight), and this can be used as a proof of the relative cohesion of the community. However, it is in a sense unreal to exclude dominance for this test, inasmuch as the spatially prevalent populations exert major control by their action as the principal agents of the resource turnover.

It would seem, therefore, that open *vs.* closed communities, mono-dominated *vs.* pluri-dominated communities, floristically pure *vs.* mixed communities will present various degrees of looseness and tightness. The latter will be due essentially to a fairly full utilization of resources which results from a certain variety of tapping mechanisms in a mutually well-adjusted species population. Such would seem to be not only the climax *Aceretum saccharophori laurentianum*, but also some of the more stable seral stages, such as the *Chamaedaphnetum calyculatae*, the *Alnetum rugosae*, the *Calamagrostetum canadensis*. The *Betuletum populifoliae* and the *Solidaginetum laurentianum* are not in this category. A most important feature of these two is their high number of accidental species and the occasionally high development of their populations, in contrast to the power of the other associations to virtually exclude accidental populations.

Origin and senescence of communities. How, then, are communities formed in the first place? What can we know of their origin and early stages of growth? Having taken them apart in the preceding sections, what key features can we rely upon to trace them to their beginnings? The juxtaposition and the eventually harmonious partaking of common resources by species populations of different elementary floristic groups suggests two possibilities.

The first hypothesis is the unprecedented coming together of

species without much common bioclimatic history. Thus the Laurentian goldenrod association (*Solidaginetum laurentianum*), now a fairly harmonious (although admittedly heterogeneous) community, consists of North American natives and recently introduced European elements. Likewise the wire-birch forest has as its dominant tree an Atlantic Coastal Plain species now associated with many boreal species!

The second hypothesis is the more or less local persistence of a very ancient association which more or less recent climatic change has otherwise forced to disintegrate into several parts. Such may be the *Thuja occidentalis* association, a species-poor community probably cornered out of a rich, temperate rain forest of the *Tsuga-Thuja* type now prevailing on the North Pacific Coast of North America.

Fossil remains of Tertiary and Pleistocene communities provide evidence of the composition and structure of earlier states of modern communities. Cain (1944) thinks that constancy is a better indication of dominance than local abundance. He makes many useful comparisons between fossil vegetations and their modern counterparts. Sharply defined modern associations in areas marked by seasonal climates may well have emerged out of relatively "undifferentiated" communities of modern climates. Lucy Braun (1935, 1938, 1941, 1950) was the first to suggest the development of "association-segregates," apropos of the deciduous forest of Eastern North America. In the mountains of Brazil I was struck with the wide applicability of this hypothesis (1947). Later (1952b, 1957b) I ventured to consider the origin of the deciduous forest complex itself and suggested that it had emerged through association-segregation from temperate rain forest.

In fact, the remnants of temperate rain forest at the mid-latitudes, if compared among themselves and with Mid- and Late-Tertiary deposits, allow of such an interpretation. The Canary Islands, Madeira, and the Azores still harbor almost intact and certainly very pure and cohesive stands of laurel-type forest. These are, however, lacking in many elements present in the Pliocene of Europe, especially the pre-Dicotyledon elements, such as *Sequoia* and *Ginkgo*. On the other hand, the Mexican cloud forest harbors a number of deciduous-forest elements (*Liquidambar*, *Acer*, *Fagus*, which are not as fully deciduous as in Eastern North America), together with *Podocarpus*, *Clethra*, *Rapanea*, and other exclusively temperate rain forest elements.

Is this a "before" or "after" phenomenon? Is this one step back from the "mixed mesophytic"? Can the following equation be accepted?

$$\frac{\text{Mexican cloud forest}}{\text{Mixed mesophytic}} = \frac{\text{Mixed mesophytic}}{\text{Beech-maple, etc.}}$$

In fact, there is good reason to suppose that many of our modern

vegetations are highly differentiated, many of them through impoverishment. The contemporary Canary laurel forest is floristically poor (Ceballos y Ortuño, 1951) in comparison with French Pliocene forests (Depape, 1922); the temperate rain forests of the Antilles have none of the deciduous-forest elements (and may have diverged before their emergence). The contemporary stands of evergreen cherry, *Rhododendron*, *Laurus*, *Myrica faya* in Southwestern Europe, are badly cut up and invaded by "stronger" associations, when their component species are not quite absorbed into the matrix of the moister oak (or even beech) forests. This is the usual fate of such species as *Viburnum tinus*, *Ilex aquifolium*, *Ruscus aculeatus*, *Prunus lusitanica*, *Laurus nobilis*, *Rhododendron ponticum*. These species, especially the first three, can be considered bona fide members of modern associations.

On the other hand, in some of the areas of high moisture (such as parts of the Maritime Provinces of Canada), we may be witnessing the persistence of an early Northern Mixed Mesophytic forest, where *Picea*, *Abies*, *Tsuga*, *Thuja*, *Acer*, *Fagus*, *Tilia*, *Fraxinus* all occur together in fluctuating numbers. I am aware that this has often been interpreted as a postglacial merger of Boreal, Great-Lakes, and Deciduous-Forest elements, and there is no denying that the descent of the glacial sheet did repeatedly press together narrowing bands of these three zones, and that a persistent cool-moist period may well have blurred for some time the barriers between spruce-fir forest, hemlock-hardwood forest and deciduous forest!

I have attempted elsewhere (1953, 1956 a, b) to show how climatic and ecological gradients, alternately narrowing and broadening, may cause a phenomenon which I have called "cornering" and which consists in reducing the area where the critical physiological requirements of a species can be met to such an extent as to send it sliding down the scale of the four thresholds defined above. In this event, for instance, a broad zone of *Tsuga-Thuja* forest, extending in North America from the Pacific to the Atlantic between a *Picea-Abies* zone to the north and a *Sequoia* zone to the south, is gradually squeezed out as continentalization of the climate proceeds. Some of its species (such as *Ilex aquifolium*, *Viburnum tinus*, etc., in Europe) remain as members of a new climax *Acer-Fagus-Tsuga*; others slip down to seral stages (*Thuja*).

On the ecological scale, at a more immediately observable level, there are a number of species which are regionally located within a certain climax area (*Quercus rubra*, *Pinus resinosa*) but which *at this time* nowhere find a climatic-edaphic compensation system that will allow them optimal development. This will keep them down as sub-dominants or companions in a community. Rey (1960) has developed a very ingenious system for calculating these equivalences, and his

demonstration would tend to show that *Quercus rubra* is a physiological relict, inasmuch as its theoretical optimum simply does not occur in North America at the present time. I had already (1953) argued something of the sort to explain the observed ecological strategy of the three northern pines in Eastern North America (*Pinus strobus*, *P. resinosa*, *P. banksiana*) in the face of palynological evidence of their regional dominance in the early postglacial period.

A preliminary inventory of Laurentian plant associations (Dangereau, 1959) shows that only a small number are dominants (in the sense used above). Most species, on the other hand, are not only not dominants or constants but are more often companions, and as likely as not these are cornered species, which is most manifest in their position on the margins between two communities. Such are *Hystrix patula* on the edge of deciduous forest and field, *Cornus stolonifera* on the edge of alder thickets and grassy marshes, etc.

Conclusions

The present essay poses many questions and answers very few. In fact, the convergence of criteria that is called for here is relatively new, and the complete data that would allow its application are not available from many parts of the world. The very idea of a functional analysis of vegetation has not been the object of much investigation so far.

I think I have been bold enough in outlining some generalities, which I shall attempt to restate tentatively.

1. A multidimensional description and grading of the anatomy of plant communities can be attempted if measures are made which respond to the following criteria: the richness and indicator value of the floristic composition; the distribution of structural elements, showing life form, layering, and spacing.

2. An understanding of the physiology of the plant community will result from recording of periodicity, ecosystematic control, means of exploitation, and degree of stability.

3. An ordination of plant communities becomes possible through the application of the above. It will turn out that the ecosystematic fitness of the species populations assembled will vary so much as to allow very different degrees of cohesion.

4. The origin and senescence of plant communities is a function of a shifting climatic-edaphic compensation system, which eliminates some elements (species) altogether and allows others to alter their ecological strategy very significantly. By this process, species that overlap only slightly, either as floristic elements or as members of a valence

group, can form new associations, or else be relegated as relicts within one association or even on the contact zone between two of them.

References

- Aubréville, A., 1949. *Climats, forêts et désertification de l'Afrique tropicale*. (Paris, Soc. Edit. Géogr., Maritimes et Coloniales).
- Beard, J. S., 1944. "Climax Vegetation in Tropical America," *Ecology* 25, 127.
- Braun, E. L., 1935. "The Undifferentiated Deciduous Forest Climax and the Association-Segregate," *Ecology* 16, 514.
- Braun, E. L., 1938. "Deciduous Forest Climaxes," *Ecology* 19, 515.
- Braun, E. L., 1941. "The Differentiation of the Deciduous Forest of the Eastern United States," *Ohio J. Sci.* 41, 235.
- Braun, E. L., 1950. *Deciduous Forests of Eastern North America* (Phila., Blakiston).
- Braun-Blanquet, J., 1928. *Pflanzensoziologie. Grundzüge der Vegetationskunde*. (Berlin, Springer).
- Braun-Blanquet, J., 1932. *Plant Sociology*, trans. by H. S. Conard and G. D. Fuller (N. Y., McGraw-Hill).
- Braun-Blanquet, J., 1936. "La chênaie d'yeuse méditerranéenne (*Quercion ilicis*)," Monographie phytosociologique. *Comm. Sta. Inter. Géobot. Médit. Alpine* 45, 1.
- Braun-Blanquet, J., 1951. *Pflanzensoziologie* (Wien, Springer-Verlag).
- Brito da Cunha, A., and Dobzhansky, T., 1954. "A Further Study of Chromosomal Polymorphism in *Drosophila willistoni* in Its Relation to the Environment," *Evolution* 8, 119.
- Brito da Cunha, A., Dobzhansky, T., Pavlovsky, O., and Spassky, B., 1959. "Genetics of Natural Populations, XXVIII: Supplementary Data on the Chromosomal Polymorphism in *Drosophila willistoni* in Its Relation to the Environment," *Evolution* 13, 389.
- Cain, S. A., 1939. "The Climax and Its Complexities," *Am. Mid. Nat.* 21, 146.
- Cain, S. A., 1943. "Sample-Plot Technique Applied to Alpine Vegetation in Wyoming," *Am. J. Bot.* 30, 240.
- Cain, S. A., 1944. *Foundations of Plant Geography* (N. Y., Harper).
- Cain, S. A., 1950. "Life-Forms and Phytoclimate," *Bot. Rev.* 16, 1.
- Cain, S. A., Castro, G. M. de Oliveira, Pires, J. M., and da Silva, N. T., 1956. "Application of Some Phytosociological Techniques to Brazilian Rain Forest," *Am. J. Bot.* 43, 911.
- Cain, S. A., and Castro, G. M. de Oliveira, 1959. *Manual of Vegetation Analysis* (N. Y., Harper).
- Ceballos, L. y Ortuño, F., 1951. *Vegetación y Flora Forestal de las Canarias Occidentales* (Madrid, Inst. For. Investig. Exper).
- Clements, F. E., 1936. "Nature and Structure of the Climax," *J. Ecol.* 24, 253.
- Cuatrecasas, J., 1934. *Observaciones geobotánicas en Colombia* (Madrid, Trabajos del Museo Nacional de Ciencias Naturales, Ser. Botánica, 27).
- Curtis, J. T., 1959. *The Vegetation of Wisconsin: An Ordination of Plant Communities* (Madison, U. of Wisconsin Press).
- Dahl, E., 1956. *Rondane: Mountain Vegetation in South Norway and Its Relation to the Environment* (Oslo, Norske Videnskaps-Akademi), I. Mat.-Naturv. Klasse, 1956, No. 3.

- Dansereau, P., 1943. "L'erablière laurentienne, I: Valeur d'indice des espèces," *Canad. J. Res. C* 21, 66; also *Contrib. Inst. Bot. Univ. Montréal* 45, 66.
- Dansereau, P., 1945. "Essai de corrélation sociologique entre les plantes supérieures et les poissons de la beine du Lac St-Louis," *Rev. Canad. Biol.* 4, 369; also *Contrib. Inst. Biol. Univ. Montréal* 16, 369.
- Dansereau, P., 1946. "L'erablière laurentienne, II: Les successions et leurs indicateurs," *Canad. J. Res. C* 24, 235; also *Contrib. Inst. Bot. Univ. Montréal* 60, 235.
- Dansereau, P., 1947. "Notas sobre a biogeografia de uma parte de Serra do Mar," *Rev. Bras. Geog.* 9, 497.
- Dansereau, P., 1951. "Description and Recording of Vegetation upon a Structural Basis," *Ecology* 32, 172; also *Bull. Serv. Biogéog.* 8, 172 (1953).
- Dansereau, P., 1952a. "The Varieties of Evolutionary Opportunity," *Rev. Canad. Biol.* 11, 305.
- Dansereau, P., 1952b. Review of *Deciduous Forests of Eastern North America*, by E. L. Braun (1950). *Bull. Torr. Bot. Club*, 79, 330.
- Dansereau, P., 1953. "The Postglacial Pine Period," *Trans. Roy. Soc. Can.* 47, 23.
- Dansereau, P., 1956a. "Le régime climatique régional de la végétation et les contrôles édaphiques," *Rev. Canad. Biol.* 15, 1.
- Dansereau, P., 1956b. "Le coïncement, un processus écologique," *Acta Bioth.* 11, 157.
- Dansereau, P., 1957a. *Biogeography: An Ecological Perspective* (N. Y., Ronald Press).
- Dansereau, P., 1957b. "A Preliminary Note on the Structure Variations of Temperate Rainforest," in *Proc. of the Eighth Pac. Sci. Congress*, Vol IV (Botany), 407.
- Dansereau, P., 1958a. "Vegetation as an Indicator of Environmental Potential," in *Proc. of the Ninth Pac. Sci. Congr.* 1957, 20, 57.
- Dansereau, P., 1958b. "A Universal System for Recording Vegetation," *Contrib. Inst. Bot. Univ. Montréal* 72, 1.
- Dansereau, P., 1959. "Phytogeographia Laurentiana, II: The Principal Plant Associations of the Saint Lawrence Valley," *Contrib. Inst. Bot. Univ. Montreal* 75, 1.
- Dansereau, P., 1960. "Essais de représentation cartographique des éléments structuraux de la végétation," Symposium. Toulouse. In press.
- Dansereau, P., and Arros, J., 1961. "Essais d'application de la dimension structurale en phytosociologie, II: La distinction entre la strate et la synusie," in press.
- Dansereau, P., and Gille, A., 1949. "Ecologie des principaux types de pâturages des environs de Granby," *Bull. Serv. Biogéog.* 4, 1.
- Dansereau, P., and Lems, K., 1957. "The Grading of Dispersal Types in Plant Communities and Their Ecological Significance," *Contrib. Inst. Bot. Univ. Montréal* 71, 1.
- Depape, G., 1922. "Recherches sur la flore pliocène de la Vallée du Rhône. Flores de St-Marcel (Ardeche) et de Théziers (Gard)," *Ann. Sc. Nat. Bot.* 4, 73.
- Du Rietz, G. E., 1931. "Life-Forms of Terrestrial Flowering Plants," *Acta Phytogeog. Suecica* 3, 1.
- Evans, F. C., 1952. "The Influence of Size of Quadrat on the Distributional Patterns of Plant Populations," *Contrib. Lab. Vert. Biol. Univ. Mich.* 54, 1.
- Gleason, H. A., 1926. "The Individualistic Concept of the Plant Association," *Bull. Torr. Bot. Club* 53, 7.
- Good, R., 1953. *The Geography of the Flowering Plants* (N. Y., Longmans, Green).

- Goodall, D. W., 1954. "Vegetation Classification and Vegetational Continua," *Angew. Pflanz. Festsch. Aich. I*, 168.
- Gounot, M., 1957. "Utilisation des fiches perforées pour la comparaison des relevés," *Bull. Serv. Carte Phytogéog. Sér. B.*, Tome II, Fasc. 2, 37.
- Guinochet, M., 1955. "Logique et dynamique du peuplement végétal," *Coll. Evolution des Sciences* 7, 1.
- Hultén, E., 1937. *Outline of the History of Arctic and Boreal Biota during the Quaternary Period* (Stockholm, Bokförlags Aktiebolaget Thule).
- Hultén, E., 1950. *Atlas över växternas utbredning i Norden* (Stockholm, Generalstabens Litografiska Anstalts Förlag).
- Jovet, P., 1949. *Le Valois. Phytosociologie et Phytogéographie*. (Paris, Soc. Edit. Enseign. Supér.).
- Lebrun, J., 1947. "La végétation de la plaine alluviale au sud du Lac Édouard," in *Exploration du Parc National Albert*, Fasc. I (Mission J. Lebrun, 1937-38), 4^e Partie, pp. 471-800.
- Lems, K., 1957. "Phytogeographic Study of the Canary Islands," Doctoral Thesis, University of Michigan, Ann Arbor.
- Lindeman, R. L., 1942. "The Trophic-Dynamic Aspect of Ecology," *Ecology* 23, 399.
- Lynch, Brother D., 1955. "Ecology of the Aspen Groveland in Glacier County, Montana," *Ecol. Monog.* 25, 321.
- Odum, H. T., 1956. "Primary Production in Flowing Waters," *Limnol. Oceanog.*, 1, 102.
- Odum, H. T., 1957. "Trophic Structure and Productivity of Silver Springs, Florida," *Ecol. Monog.* 27, 55.
- Odum, H. T., 1960. "Ecological Potential and Analogue Circuits for the Ecosystem," *Am. Sci.* 48, 1.
- Oosting, H. J., and Billings, W. D., 1943. "The Red Fir Forest of the Sierra Nevada," *Ecol. Monog.* 13, 261.
- Raunkiaer, C., 1907. *Planterigets Livsformer og deres Betydning for Geografien*. København.
- Raunkiaer, C., 1934. *The Life Forms of Plants and Statistical Plant Geography* (Oxford, Clarendon Press).
- Rey, P., 1960. *Essai de Phytocinétique Biogéographique*. Thèse, Faculté des Sciences de l'Université de Toulouse, Impr. Louis-Jean, Cap.
- Schimper, A. F. W., 1903. *Plant Geography upon a Physiological Basis*, trans. by W. R. Fisher. (Oxford, Clarendon Press).
- Schmid, E., 1956. *Die Wuchsformen der Dikotyledonen*, Ber. ii. d. Geobot. Inst. Rübel, f.d.j., 1955, pp. 38-50.
- Schnell, R., 1952. *Végétation et flore de la région montagneuse du Nimba*. Mém. Inst. Français Afrique Noire, No. 22.
- Scurfield, G., 1956. "Note on Experimental Ecology and the Uses of a Biological Flora," *Vegetatio* 7, 3.
- Segadas-Vianna, F., 1951. "A Phytosociological and Ecological Study of Cattail Stands in Oakland County, Michigan," *J. Ecol.* 39, 316.
- Veloso, H. P., 1945. "As Comunidades e as Estações Botânicas de Teresópolis, Estado do Rio de Janeiro," *Bol. Museu Nacional*, Rio de Janeiro, n.s. N^o 3 (Botânica), 1.
- Veloso, H. P., and Klein, R. M., 1959. "As Comunidades e Associações Vegetais da Mata Pluvial do Sul do Brasil, II: Dinamismo e Fidelidade das Espécies em Associações do Município de Brusque, Estado de Santa Catarina," *Sellowia* 10, 9.

- Villar, H. del, 1929. *Geobotánica* (Barcelona-Buenos Aires, Editorial Labor).
- Warming, E., 1909. *Oecology of Plants: An Introduction to the Study of Plant Communities* (London, Oxford U. Press).
- Watt, A. S., 1947. "Pattern and Process in the Plant Community," *J. Ecol.* 35, 1.
- Whittaker, R. H., 1953. "A Consideration of Climax Theory: The Climax as a Population and Pattern," *Ecol. Monog.* 23, 41.
- Wulff, E. V., 1943. *An Introduction to Historical Plant Geography*, Chronica Botanica Series (N. Y., Ronald Press).

THE ORIGIN OF THE PLANT TUMOR CELL*

Armin C. Braun

THE ROCKEFELLER INSTITUTE

One of the most striking characteristics of higher animals and plants is the extraordinary way in which all of their functional parts fall into a coherent, flexible, but definitely limited pattern. This harmony of structure and function is a reflection of organized and self-regulated growth and development. Sometimes, however, a relaxation of the orderly control of cellular growth occurs. This is never more dramatically illustrated than in the so-called cancerous diseases, for here the characteristic feature of the disease is the breakdown of the restraining influences that govern so precisely the growth of all normal cells within an organism. The question of what governs the growth of normal cells and what is entailed in overcoming those restraints under conditions of neoplasia is fundamental and constitutes the ultimate basis of the tumor problem. It is with that problem that we should like to concern ourselves at this time.

A century of experience has demonstrated that a tumor cell is an altered, more or less randomly proliferating cell which reproduces true to type and against the growth of which there is no adequate control mechanism in a host. This cell type has acquired, as a result of its alteration, a capacity to direct its own activities largely irrespective of the laws that govern so precisely the growth of all normal cells within an organism. Since the tumor cell is an altered cell, it might be appropriate to inquire briefly into the nature of the agencies responsible for the cellular change. In considering this aspect of the tumor problem, one is forcefully struck by the multiplicity of diverse agencies that have

* *This investigation was supported in part by a research grant (PHS C-2944 M&G) from the National Cancer Institute.*

been shown to be effective in this respect. Radiant energy, irritation, many structurally very different chemical substances, as well as microorganisms and viruses, have been found to be tumorigenic. The effectiveness of these agencies in eliciting tumors appears, moreover, to be a function of the hereditary constitution of the host to which they are applied.

A major point at issue in the tumor problem today is whether tumors in general result from an intrinsic cellular change involving a somatic mutation (at the chromosomal, genic, or cytoplasmic level) or from an extrinsic factor such as a virus. In either case, the end result can be looked upon as involving a change in cellular heredity, since in the case of the virus-induced tumors the infected host cell has acquired new genetic information as a result of the presence of the virus. If, nevertheless, it could be established experimentally that the generality of tumors is caused by viruses, or that most are the result of somatic mutations, it would still not explain enough. The question would remain as to how either a virus or a somatic change induces the tumorous state in a cell. I should like now to examine this question by analyzing three non-self-limiting tumorous diseases of plants, each of which has a different and quite distinct proximate cause, to learn whether some common underlying mechanism can be characterized that will permit us to gain insight into the nature of autonomous growth in representative plant-tumor cell types.

The first of these non-self-limiting neoplastic diseases is known as Black's wound-tumor disease (Black, 1949). This disease is caused by a typical virus, which has been isolated and pictured with the aid of the electron microscope. The virus particle has been found to be a polyhedron having a diameter of approximately 80 millimicrons (Brakke *et al.*, 1954). Although this disease is caused by a virus, its expression in a host is limited to areas of irritation such as those caused by wounds. In addition to the virus and an area of irritation, the genetic constitution of the host plays an important role in the expression of this disease (Black, 1951). The genetic constitution may determine susceptibility of the host to the virus or it may determine the response of the cells to the presence of the virus. Thus the virus (1) may fail to multiply in a particular host species, (2) may multiply but fail to elicit tumors, or (3) may multiply and produce tumors. In the third category, and within the same plant species, various clones may show striking differences with respect to the frequency, distribution, size, and shape of the resulting tumor. It is significant that the inbred B21 clone of sweet clover, which responds readily to virus infection with tumor formation, also occasionally gives rise to tumors spontaneously in the non-infective state (Littau and Black, 1952). This situation is comparable to that observed in strain C₃Hb mice which have lost the

mammary carcinoma virus and yet show an inherent tendency to develop mammary tumors.

The second non-self-limiting tumorous disease of plants is one in which the genetic constitution of the host, and more particularly the genetics of all of the cells comprising the host, plays a primary role (Kehr, 1951). No external agent, such as, for example, a virus, is involved in the tumor inception or development. This condition, known as the Kostoff genetic tumors, results regularly in certain interspecific hybrids within the genus *Nicotiana*. When, for example, two plant species such as *N. glauca* and *N. langsdorffii* are crossed and the seed of the hybrid is sown, the resulting plants commonly grow normally during the period of their active growth and in the absence of irritation. Once the plants reach maturity and terminal growth ceases, a profusion of tumors invariably breaks out on all parts of the plant. These tumors commonly arise at points of natural wounds. Irradiating such hybrid plants hastens the onset of tumor formation and increases significantly the number of tumors that develop (Sparrow and Gunckel, 1956; Sparrow *et al.*, 1956). Recently evidence has been provided to indicate that in these hybrids neither spontaneous tumor formation nor radiation-induced tumor formation involves a process of somatic mutation at the nuclear gene level (Smith, 1958).

It has been found, further, that the parents of the tumorous hybrids can be divided into two groups, which have arbitrarily been designated as "plus" and "minus" (Näf, 1958). If an intragroup cross is made between two "plus" species or between two "minus" species, the resulting offspring will not develop tumors. On the other hand, crosses between a "plus" and a "minus" species produce tumor-bearing offspring. Of a total of more than 50 such crosses studied, very few exceptions to this rule have been found. From these studies it was concluded that the critical contributions of the "plus" parents differ from those of the "minus" parents. These contributions, although primarily genetic in nature, should also be reflected in parental metabolism, and attempts are being made by Näf to characterize these at a physiological level. These tumor-bearing hybrid plants appear to be comparable to the situation described in animals by Gordon (1958) in platyfish-swordtail hybrids.

The third non-self-limiting tumor disease of plants, and one that I should like to discuss in some detail, is the so-called crown-gall disease. This disease is initiated by a specific bacterium known as *Agrobacterium tumefaciens*. The crown-gall bacterium possesses the remarkable ability to transform normal plant cells into tumor cells irreversibly in short periods of time. Once this cellular transformation has been accomplished, the continued abnormal proliferation of the tumor cells becomes an automatic process which is completely inde-

pendent of the inciting bacteria. This leads to the development of massive tumorous growths, which in extreme instances may weigh as much as 100 pounds. Such tumors are potentially malignant, in that they seriously damage or kill the plants in which they develop. In certain hosts, such as the sunflower (Braun, 1941) and Paris daisy (Smith *et al.*, 1912), there may be produced, in addition to primary tumors, secondary tumors which arise at points distant from the seat of the primary growth. These secondary tumors are interesting because they are frequently free of the bacteria that initiate the primary tumor (Braun, 1941; Smith *et al.*, 1912).

The finding that many of the secondary tumors are bacteria-free permitted the unequivocal demonstration of the truly autonomous nature of the crown-gall tumor cell (Braun and White, 1943; White and Braun, 1942). Sterile tissue isolated from secondary tumors grows profusely and indefinitely on a defined culture medium which does not support the continued growth of normal cells of the type from which the tumor cells were derived. This indicates that a profound and heritable change has occurred in the plant cells as a result of the localized presence of the inciting bacteria in susceptible host tissues. Small fragments of such tumor tissue, implanted into a healthy host, develop again into tumors comparable to those initiated by the bacteria in every respect except that the implants are sterile. Since such sterile tumor cells, isolated not only from secondary tumors but subsequently also from primary tumors of many different plant species (de Ropp, 1947; Gautheret, 1947; Hildebrandt and Riker, 1949; Morel, 1948; White, 1945), have not in the more than ten years that they have been kept in culture shown the slightest tendency to become less autonomous, they have generally been regarded as being permanently altered cells which reproduce true to type and against the growth of which there is no control mechanism in the host. These are the characteristics by which the malignant animal cells are distinguished from healthy or merely inflammatory cells.

After it had been definitely established that normal cells were changed to tumor cells under the influence of the bacteria, the next problem that engaged our efforts was concerned with the period necessary for the bacteria to accomplish the cellular transformation (Braun, 1943, 1947, 1951a).

In order to study this question, an experimental method was devised which permitted the selective killing by thermal treatment of the inciting bacteria at any desired time following their introduction into the heat-resistant host, *Vinca rosea*, without affecting the capacity of the host cells to respond with tumor formation to any alteration that had occurred prior to the killing of the inciting organisms. With the use of this method, it was possible to demonstrate that tumors are not

initiated in 24 hours, but small, slowly growing, benign tumors are produced in 34 hours. A 50-hour exposure of plant cells to the action of the bacteria results in tumors which grow at a moderately fast rate, while tumors initiated in 72 to 96 hours grow very rapidly and are of a potentially malignant type.

Sterile tissues isolated from the three types of tumors and planted on a simple inorganic salts-sucrose-containing culture medium retain indefinitely their characteristic growth patterns. Normal cells of the type from which the tumor cells were derived do not grow on the basic culture medium. These results indicate that the transformation of normal cells to tumor cells takes place gradually and progressively, leading in a period of three to four days to a completely autonomous, rapidly growing tumor-cell type. Cells altered in shorter periods represent a lower grade of tumor-cell change. This, then, appears to be an excellent example of tumor progression in which various degrees of neoplastic change can be obtained and such cells cultured at will. In all instances the bacteria were killed before there was the slightest evidence of tumefaction at the points of inoculation, and yet large, rapidly growing tumors were produced if the bacteria were allowed to act for 72 or more hours. The above study, in addition to defining the inception period, also shows us that a factor of considerable biological interest passes from the bacteria to the host cells and brings about a profound and heritable change in the subsequent behavior of the affected cells. We have called this factor the tumor-inducing principle.

In any analysis of a complex series of events such as occurs during tumor formation, it is often convenient to subdivide the total event, insofar as is possible, into a series of contributing events, each of which is essential for the consummation of the completed process. In studying part events in the crown-gall disease, use was made of the fact that isolates within different strains of the inciting bacteria may show different degrees of virulence. Some isolates are regularly capable of initiating large, rapidly growing tumors, whereas certain sister-cell cultures may produce only small, benign growths. It was found that when the small growths initiated by the attenuated culture were supplemented at a distance with growth substances of the auxin type, they expanded rapidly and were comparable in size and rate of development to tumors initiated by the highly virulent strain (Braun and Laskaris, 1942; Thomas and Riker, 1948). These artificially stimulated tumors expanded rapidly only as long as the source of auxin was present; when the hormone was removed, growth promptly slowed down. They were, therefore, hormone-dependent tumors. These studies suggested that plant cells transformed to tumor cells by the virulent strain of bacteria were themselves capable of synthesizing optimal amounts of growth substances of the auxin type, while those altered by the attenuated

strain had their requirements in terms of rapid growth only partly satisfied for substances of that type.

It was also concluded from these studies that tumor formation takes place in essentially two distinct phases (Braun and Laskaris, 1942). In the first phase, normal cells are changed to tumor cells which do not as yet develop into a neoplastic growth. The second phase, according to this concept, is concerned with the continued abnormal proliferation of the tumor cells after the cellular alteration has been accomplished. The virulent bacteria obviously can accomplish both phases; the attenuated culture, essentially only the first. This study emphasized, then, the need for recognizing a distinction between those factors that render the cells neoplastic and those that affect their subsequent behavior.

Two known requirements must be satisfied to complete the first, or inception, phase. These have been termed "conditioning" and "induction." By conditioning is meant that only those plant cells that have been rendered susceptible to transformation as a result of irritation accompanying a wound can be altered to tumor cells (Braun, 1952). An analysis of the conditioning process has revealed that an interesting relationship exists between the period in the normal wound-healing cycle in which the cellular alteration is accomplished and the rate of growth of the resulting tumors (Braun, 1952; Braun and Mandle, 1948). It has been found that the host cells gradually become vulnerable to the action of the tumor-inducing principle, reaching a maximum susceptibility about 60 hours after a wound is made. Thereafter the cells gradually become more resistant to transformation as wound healing progresses toward completion. If the cells are not adequately conditioned, as appears to be the case in the very early and late stages of the wound-healing cycle, the transformation of normal cells to tumor cells is not accomplished, despite the presence of many virulent bacteria in intimate contact with the host cells. When these findings are compared with histological events in the region of the wound, we find that it is just before or during the earliest stages of active wound healing that normal cells are transformed to tumor cells of the most rapidly growing type (Braun and Mandle, 1948). It is at this period in the wound-healing cycle that the plant cells show the highest rate of metabolic activity.

Induction refers to the actual conversion of conditioned host cells into tumor cells by a tumor-inducing principle elaborated by the bacteria. Induction, as far as we now know, completes the first phase of tumor formation.

The second phase of tumor formation, according to this concept, is concerned with the continued unregulated and autonomous growth of the tumor cell once the cellular alteration has been accomplished. This

aspect of the tumor problem is concerned with growth, and in order to gain insight into the nature of autonomous growth it is necessary to understand something of the processes involved in normal cell growth and division.

Growth in all higher organisms results either from an enlargement of the cells or from the combined processes of cell enlargement and cell division. In plant cells the development of these fundamental growth processes appears to be dependent upon specific substances that may be synthesized by the cells. It is now possible, moreover, to delimit, under fully controlled experimental conditions and with the use as a test object of certain specialized plant cell types, these two fundamental growth processes (Jablonski and Skoog, 1954; Steward and Caplin, 1951). When, for example, tobacco-pith parenchyma cells are isolated from a plant and treated with growth substances of the auxin type, they enlarge greatly in size but do not divide (Jablonski and Skoog, 1954.) It is only when a second growth factor, such as 6-furfurylaminopurine or a naturally occurring equivalent of that substance, is supplied to the pith cells in addition to an auxin that a profuse growth accompanied by cell division results. Application of 6-furfurylaminopurine alone is ineffective in encouraging either enlargement or division of the pith parenchyma cells. These findings demonstrate that two growth substances, one concerned with cell enlargement and the other with cell division, act synergistically to promote growth and cell division in tobacco-pith parenchyma cells. Normal tobacco-pith cells do not and cannot synthesize these substances, for if they did, the cells would respond in the characteristic manner described above.

Since the cellular systems responsible for the synthesis of these two growth substances appear to be solidly blocked in normal tobacco-pith cells, it was of interest to learn how such cells would respond when transformed to crown-gall tumor cells. If, for example, only the system synthesizing the cell-enlargement factor is activated as a result of the transformation of normal cells to tumor cells, then the altered pith cells should enlarge greatly, without, however, dividing. If, on the other hand, the system producing the cell-division factor is activated without a corresponding activation of the auxin system, then neoplastic growth should not result, because, as we have seen, the cell-division factor without auxin is ineffective in initiating growth accompanied by cell division in tobacco-pith tissue. Only if both of the growth-substance-synthesizing systems are activated simultaneously, following the transformation of normal cells to tumor cells, will a tumor develop in this test system. The result of studies bearing on this question indicates that when healing pith parenchyma cells are inoculated with crown-gall bacteria, a typical crown-gall tumor develops (Braun, 1956). What does this simple experiment show us? It demonstrates that, although

the normal tobacco-pith cells could not actively synthesize either a cell-enlargement factor or a factor limiting for cell division, following their transformation to tumor cells, both of these substances were produced in greater than regulatory amounts. If this were not true, continued growth accompanied by cell division and hence tumor formation would not have resulted in the test system used in this work.

That these two growth substances are actively synthesized by growing tumor tissue can be further demonstrated by grafting a fragment of sterile tobacco-tumor tissue on a fragment of normal tobacco-pith tissue. The tumor tissue stimulates the pith to divide to such an extent that stimulated pith cells may raise the tumor tissue a considerable distance above the graft surface (Braun, 1956). This is reminiscent of the desmoplasias of animal pathology, where the tumor stimulates the normal cells of its stroma to very active division.

Finally, it is possible to demonstrate the presence of a cell-enlargement factor and a factor limiting for cell division in the tumor tissue by isolation and diffusion techniques.

All of these studies indicate that the tumor tissue synthesizes greater than regulatory amounts of a cell-enlargement factor and a factor normally limiting for cell division. The permanent activation of these two growth-substance-synthesizing systems, with the resulting production of greater than regulatory amounts of the cell-enlargement and cell-division factors, would appear in itself sufficient to account for the continued abnormal proliferation of the crown-gall tumor cell. More recent work has shown that this is not the entire explanation (Braun, 1958).

It was indicated earlier in this discussion that the alteration of normal cells to tumor cells is a gradual and progressive process, leading in a 3- to 4-day period to a completely autonomous, rapidly growing tumor cell. Cells altered in a 34-hour period grow very slowly in a host as well as in culture, while those transformed in a 50-hour period proliferate at a moderately fast rate. Normal cells of the type from which the tumor cells were derived do not grow on the basic medium. Thus, although the difference between the three types of tumor cells is quantitative, since all can grow indefinitely although at different rates on the basic medium, the difference between the tumor cells and normal cells is qualitative. Since the three types of tumor cells were derived from the same plant species, they were admirably suited and were used for a study of the factors required for rapid autonomous growth. In these studies the fully altered, rapidly growing type of tumor cell was used as the standard. This cell type can synthesize, in optimal or near-optimal amounts, all of the growth factors needed for its continued rapid proliferation from the mineral salts and sucrose present in the basic medium. The moderately fast-growing tumor cells

altered in a 50-hour period required that the basic medium be supplemented with an auxin, glutamine, and meso inositol to achieve a growth rate equal to that of the rapidly growing, fully transformed tumor-cell type. These represented the minimum requirements necessary for optimal growth. In addition to these three compounds, the very slowly growing benign tumor cells transformed in a 34-hour period required cytidylic acid for rapid growth in culture.

These results clearly demonstrate, then, that as the crown-gall tumor cell becomes more autonomous, its requirements in terms of externally supplied growth factors become less exacting. They demonstrate further that a series of well-defined but quite distinct growth-substance-synthesizing systems gradually become activated, and the degree of activation of these biosynthetic systems determines the rate of growth of the tumor cell.

Normal cells of the type from which the tumor cells were derived do not grow on the basic medium. Thus, although, as indicated, the difference between the three types of tumor cells is quantitative, the difference between the tumor cell and the normal cell is qualitative. One qualitative difference found to exist was the absolute requirement of the normal cells for a factor normally limiting for cell division in such cells. This requirement was satisfied by 6-furfurylaminopurine or a naturally occurring equivalent of that substance. The normal cells, unlike the tumor cells, also possessed an absolute requirement for an external source of an auxin for their continued growth in culture. It thus appears that, as a result of the transition from a normal cell to a fully altered, rapidly growing crown-gall tumor cell, a series of quite distinct but well-defined growth-substance-synthesizing systems become progressively activated. This leads to the production by the affected cells of greater than regulatory amounts of these growth-promoting substances. The continued production of these substances in greater than regulatory amounts by the tumor cell could and most probably does account for the continued unregulated and autonomous growth of those cells. Thus autonomy, in this instance, finds its explanation in terms of cellular nutrition. Precisely how the diverse biosynthetic systems become permanently activated, as a result of the action of the tumor-inducing principle associated with this disease, remains unanswered.

The concept of growth autonomy presented above finds additional support in other directions. It has been possible to reproduce, under precisely defined experimental conditions and with the use of certain normal cell types as the test object, not only the morphological growth pattern but also the histological (hypertrophy, hyperplasia, leading to disorganization and loss of function) as well as cytological (aberrant nuclear behavior—multinuclear giant cells, etc.) events that character-

ize the tumorous state in crown gall. This was accomplished by varying the concentration of cell-enlargement and cell-division factors in an otherwise suitable culture medium on which the normal cells were planted. These artificially stimulated normal cells, in contrast to the tumor cells, are self-limiting growths, and when the externally supplied stimuli are removed, their growth promptly stops. The fact that such artificially stimulated normal cells commonly show histological and cytological characteristics of tumor cells but are themselves self-limiting growths indicates that the observed cellular abnormalities are the result, rather than the cause, of the tumorous state.

The results of all of these studies demonstrate, then, that it is possible for a cell to acquire a capacity for autonomous growth as a result of the permanent activation of a series of growth-substance-synthesizing systems, the products of which are concerned specifically with growth accompanied by cell division. These systems are precisely regulated in all normal plant cells.

If we now return again very briefly to the other two non-self-limiting tumorous diseases of plants, we find that in the case of Black's wound-tumor disease, as in crown gall, the tumor tissue grows profusely on White's basic medium supplemented with phosphate and thiamin, whereas normal tissue of the type from which the tumor tissue was derived does not grow on that medium. These findings indicate that the virus confers upon the cell the capacity to synthesize greater than regulatory amounts of growth substances essential for growth accompanied by cell division. Similarly, tumors that develop on certain F_1 hybrids can and do grow indefinitely on the basic culture medium, while normal tissue isolated from either parent cannot grow on that medium. The implication of this finding is clear, in view of the preceding discussion. Thus we see that, although three different and quite distinct agencies can initiate the tumorous state in plants, the physiological basis for the autonomous growth of the tumor cell appears to be similar in all three instances.

The finding that the alteration of a normal plant cell to a tumor cell represents a change from a fastidious, nutritionally exacting cell to a variant type which is essentially non-exacting in its requirements indicates that the transformation process redirects cellular metabolism from the normal, precisely regulated course to primitive pathways which permit the synthesis from mineral salts and sucrose of all metabolites required for growth and division—a characteristic metabolism of many unicellular forms. It might be postulated, therefore, that as a result of the transformation process the trend of evolution has been reversed. A primitive area of metabolism, which is characteristic of free-living unicellular organisms and on which has been superimposed during the course of evolution the specialized and precisely regulated

metabolism characteristic of differentiated cells of higher organisms, again predominates as a result of the cellular transformation.

The question as to whether this new pattern of synthesis found in the tumor cell results in an irreversible loss of the previous pattern concerned with differentiated function, or whether it simply overwhelms the latter, has been investigated in the crown-gall disease (Braun, 1951b, 1959). There are produced in plants, in addition to the permanently altered tumor cells of the unorganized type, complex tumors, or teratomata, composed of a chaotic assembly of tissues and organs which show varying degrees of morphological development. Teratomata arise when pluripotent cells, which possess highly developed regenerative capacities at the time of their alteration, are transformed to tumor cells. The use of clones of teratoma tissue of single-cell origin has permitted the unequivocal demonstration that the complex tumors

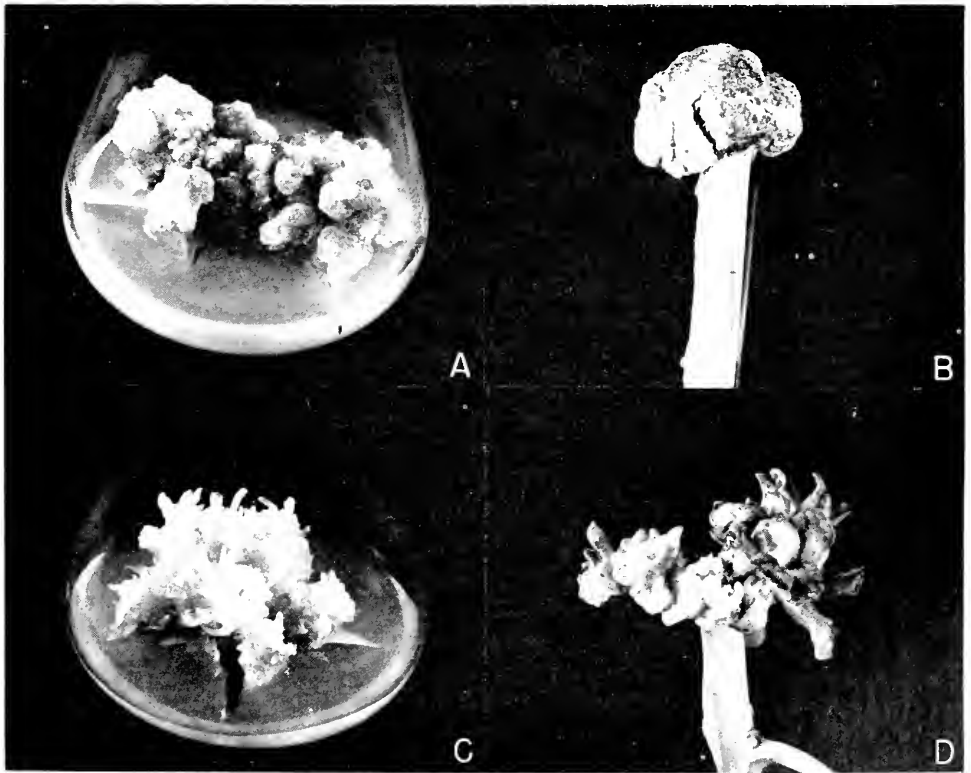

Figure 1. A. Culture of crown-gall tobacco tumor tissue of the unorganized type. B. Result obtained when a fragment of sterile tumor tissue of the type shown in A was grafted to the cut stem end of a tobacco plant. C. Culture of crown-gall tobacco teratoma tissue. D. Result obtained when a fragment of sterile teratoma tissue was grafted to the cut stem end of a tobacco plant.

are not a mixture of normal and tumor cells but are composed entirely of tumor cells which retain, despite their alteration, highly developed capacities to organize morphologically abnormal leaves and buds. The cells of these complex tumors, like those of the unorganized type, grow profusely and indefinitely on a basic culture medium which does not support the continued growth of normal cells.

An attempt was made to distinguish between somatic mutation at the nuclear gene level and the presence in the tumor cell of cytoplasmic changes which had assumed control of the cells and were responsible for the continued abnormal proliferation of the affected cells. It is well known in biology that certain self-replicating cytoplasmic entities can be eliminated from cells under conditions that favor the increased multiplication of those cells in relation to the multiplication of the self-duplicating factor.

The primary growth of higher plants is the result of the very rapid division and subsequent elongation of meristematic cells found at the extreme apex of a shoot or root. Since normal meristematic cells at the apex of a rapidly growing root or shoot divide at a far faster rate than do most crown-gall tumor cells, it was hypothesized that if the abnormal tumor buds found to develop from teratomata could be forced into very rapid growth, recovery of the tumor cells might be accomplished, provided that the factor responsible for the continued abnormal growth of the tumor cell was subject to the effects of dilution in very rapidly dividing cells. The results of this study demonstrated that when tumor shoots derived from tumor buds were forced into very rapid growth as a result of a series of graftings to healthy plants, they gradually recovered and ultimately became normal in every respect.

These findings indicate that the crown-gall tumor cell contains, potentially at least, all of the factors, both genetic and non-genetic, that are present in the normal cell. In this instance nothing has been permanently lost as a result of the cellular alteration. These results make somatic mutation at the nuclear gene level appear highly unlikely as a possible explanation of the cellular alteration in crown gall. They suggest, instead, that cytoplasmic changes, which may, however, be more or less under control of the nuclear genes, are responsible for the continuity of the tumorous properties from one cell generation to the next.

These results may be interpreted in terms of steady-state chemistry: that is, that alternative areas of metabolism compete with one another, leading to biosynthetic states which commonly show very high degrees of stability but which under certain special conditions may be reversible. If this is true of the generality of tumors, it could have interesting implications, for it would mean that the malignant tumor cell is not, as is now commonly believed, an irreversibly altered cell. A

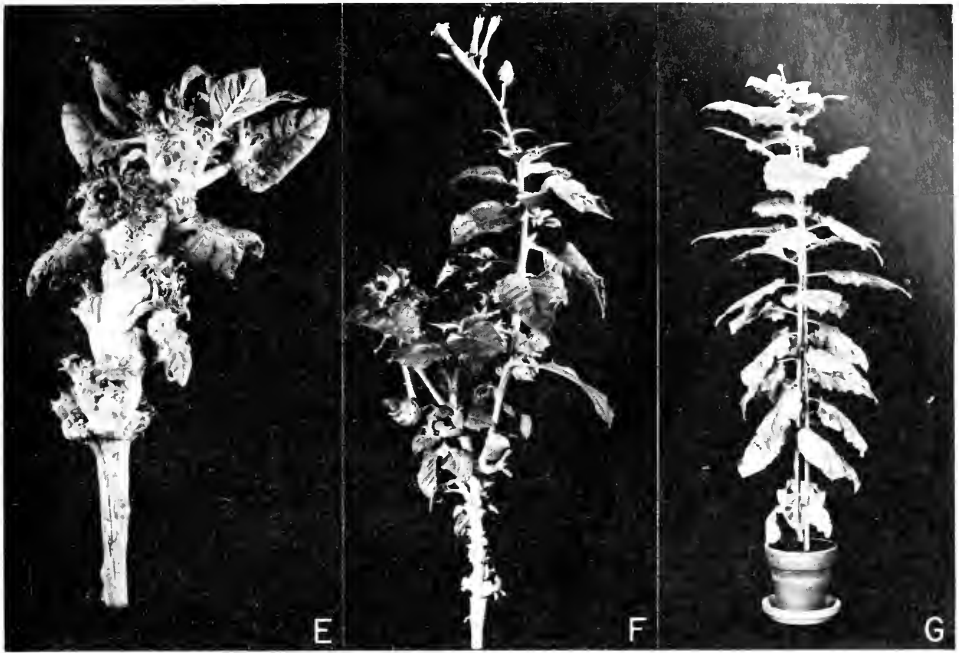

Figure 2. Three stages in the recovery of a crown-gall teratoma. E. A tumor bud, such as is shown at the top of the teratoma pictured in Figure 1, D, was grafted to the cut stem tip of a normal tobacco plant. Note the abnormal character of the resulting growth. F. A tumor shoot of the type shown at the apex of E was grafted to the cut stem end of a healthy tobacco plant. Note that the resulting growth appeared more normal than that shown in E. Although the lower portion of the scion showed evidence of abnormal growth behavior, the upper portion appeared normal, flowered, and set seed. G. Seed from a recovered scion, such as that found in F, was planted and upon germination gave rise to normal tobacco plants of the type shown. Since the normal tobacco plant shown in G was derived from teratoma tissue of single-cell origin (Figure 1, C), the results demonstrated unequivocally that the progeny of a single somatic cell of tobacco may possess all of the potentialities necessary to reconstitute an entire tobacco plant.

return to normality of such cells could be achieved if conditions could be defined that would permit the controlled manipulation of these alternative areas of cellular metabolism.

References

- Black, L. M., 1949. "Virus Tumors," *Surv. of Biol. Prog.* 1, 155.
 Black, L. M., 1951. "Hereditary Variation in the Reaction of Sweet Clover to the Wound-Tumor Virus," *Am. J. Bot.* 38, 256.
 Brakke, M. K., Vatter, A. E., and Black, L. M., 1954. "Size and Shape of Wound-Tumor Virus," in *Abnormal and Pathological Plant Growth*, Brook-

- haven Symposia in Biology, No. 6 (Upton, N. Y., Brookhaven National Laboratory).
- Braun, A. C., 1941. "Development of Secondary Tumors and Tumor Strands in the Crown Gall of Sunflowers," *Phytopath.* 31, 135.
- Braun, A. C., 1943. "Studies on Tumor Inception in the Crown-Gall Disease," *Am. J. Bot.* 30, 674.
- Braun, A. C., 1947. "Thermal Studies on the Factors Responsible for Tumor Initiation in Crown Gall," *Am. J. Bot.* 34, 234.
- Braun, A. C., 1951a. "Cellular Autonomy in Crown Gall," *Phytopath.* 41, 963.
- Braun, A. C., 1951b. "Recovery of Crown-Gall Tumor Cells," *Cancer Res.* 11, 839.
- Braun, A. C., 1952. "Conditioning of the Host Cell as a Factor in the Transformation Process in Crown Gall," *Growth* 16, 65.
- Braun, A. C., 1956. "The Activation of Two Growth-Substance Systems Accompanying the Conversion of Normal to Tumor Cells in Crown Gall," *Cancer Res.* 16, 53.
- Braun, A. C., 1958. "A Physiological Basis for Autonomous Growth of the Crown-Gall Tumor Cell," *Proc. Nat. Acad. Sci.* 44, 344.
- Braun, A. C., 1959. "A Demonstration of the Recovery of the Crown-Gall Tumor Cell with the Use of Complex Tumors of Single-Cell Origin," *Proc. Nat. Acad. Sci.* 45, 932.
- Braun, A. C., and Laskaris, T., 1942. "Tumor Formation by Attenuated Crown-Gall Bacteria in the Presence of Growth-Promoting Substances," *Proc. Nat. Acad. Sci.* 28, 468.
- Braun, A. C., and Mandle, R. J., 1948. "Studies on the Inactivation of the Tumor-Inducing Principle in Crown Gall," *Growth* 12, 255.
- Braun, A. C., and White, P. R., 1943. "Bacteriological Sterility of Tissues Derived from Secondary Crown-Gall Tumors," *Phytopath.* 33, 85.
- deRopp, R. S., 1947. "The Isolation and Behavior of Bacteria-Free Crown-Gall Tissue from Primary Galls of *Helianthus Annuus*," *Phytopath.* 37, 201.
- Gautheret, R., 1947. "Action de l'acide indole-acétique sur le développement des tissus normaux et des tissus de crown-gall de topinambour cultivé *in vitro*," *Compt. Rend. Acad. Sci.* 224, 1728.
- Gordon, M., 1958. "A Genetic Concept for the Origin of Melanomas," *Ann. N. Y. Acad. Sci.* 71, 1213.
- Hildebrandt, A. C., and Riker, A. J., 1949. "The Influence of Various Carbon Compounds on the Growth of Marigold, Paris-Daisy, Periwinkle, Sunflower and Tobacco Tissue *in Vitro*," *Am. J. Bot.* 36, 74.
- Jablonski, J. R., and Skoog, F., 1954. "Cell Enlargement and Cell Division in Exeised Tobacco Pith Tissue," *Physiol. Plantarum* 7, 16.
- Kehr, A. E., 1951. "Genetic Tumors in *Nicotiana*," *Am. Nat.* 85, 51.
- Littau, V. C., and Black, L. M., 1952. "Spontaneous Tumors in Sweet Clover," *Am. J. Bot.* 39, 191.
- Morel, G., 1948. "Recherches sur la culture associée de parasites obligatoires et de tissus végétaux," *Ann. Epiphyt., N.S.* 14, 123.
- Näf, U., 1958. "Studies on Tumor Formation in *Nicotiana* Hybrids, I: The Classification of the Parents into Two Etiologically Significant Groups," *Growth* 22, 167.
- Smith, E. F., Brown, N. A., and McCulloch, L., 1912. *The Structure and Development of Crown Gall: A Plant Cancer*. U. S. Dep't. of Agriculture, Bureau of Plant Industry, Bulletin 255.
- Smith, H. H., 1958. "Genetic Plant Tumors in *Nicotiana*," *Ann. N. Y. Acad. Sci.* 71, 1163.

- Sparrow, A. H., and Gunckel, J. E., 1956. "Induction of Tumours by Ionising Radiation on Stems, Leaves and Roots of an Interspecific *Nicotiana* Hybrid," in Mitchell, J. S., ed., *Progress in Radiobiology* (Springfield, Ill., C. C. Thomas).
- Sparrow, A. H., Gunckel, J. E. Schairer, L. A., and Hagen, G. L., 1956. "Tumor Formation and Other Morphogenetic Responses in an Amphidiploid Tobacco Hybrid Exposed to Chronic Gamma Irradiation," *Am. J. Bot.* 43, 377.
- Steward, F. C., and Caplin, S. M., 1951. "A Tissue Culture from Potato Tuber: The Synergistic Action of 2,4-D and of Coconut Milk," *Science* 113, 518.
- Thomas, J. E., and Riker, A. J., 1948. "The Effects of Representative Plant Growth Substances upon Attenuated Bacterial Crown Galls," (abstract), *Phytopath.* 38, 26.
- White, P. R., 1945. "Metastatic (Graft) Tumors of Bacteria-Free Crown Galls on *Vinca rosea*," *Am. J. Bot.* 32, 237.
- White, P. R., and Braun, A. C., 1942. "A Cancerous Neoplasm of Plants: Autonomous Bacteria-Free Crown-Gall Tissue," *Cancer Res.* 2, 597.

GROWTH ASPECTS OF PLANT VIRUS INFECTIONS

Glenn S. Pound

UNIVERSITY OF WISCONSIN

The self-replication of plant viruses is one of the least understood and most intriguing phenomena of biological growth. Plant viruses are reproduced only in living cells and apparently by the living cells. Their synthesis results from an aberration of nucleoprotein metabolism, the alteration being initiated by the presence of the virus, the nucleic acid of which presumably serves as a template for virus duplication. Therefore, the growth aspects of virus infections, embracing both the host and the pathogen, are those of the physiology of the infected plants. One short paper cannot give consideration to all aspects of such growth. This paper will deal only with anatomical and physiological aspects of virus-infected plants and with the relation of certain environmental factors to host growth and virus synthesis. It does not purport to consider every aspect of these areas of growth but only the more common phenomena.

Virus effects on host anatomy

When one looks at the anatomy of virus-infected plants, he sees the same basic pathological effects characteristic of other plant diseases: namely, hypoplasia (underdevelopment), hypertrophy (overgrowth due to excessive cell size), hyperplasia (overgrowth due to excessive cell division), and necrosis (death of tissue). These are not always evident as single effects but in most cases occur in combinations.

Viruses causing "mosaic" diseases are generally found in all tissues of the host, but their anatomical effects are primarily related to parenchyma tissue. They characteristically cause a reduction in the number

and size of chloroplasts, particularly in the mesophyll tissue (Esau, 1944; Porter, 1954; Esau, 1956). Porter has shown that the yellow areas of cucumber leaves affected with cucumber mosaic virus are hypoplastic, whereas the dark-green raised islands are hyperplastic and contain abnormally long palisade cells. In some mosaic diseases, differentiation into palisade and spongy parenchyma is suppressed (Esau, 1944), while in others, normal differentiation occurs (Porter, 1954). Suppression of normal morphologic differentiation may be so acute as to cause extreme leaf deformation, a good example of which is the "shoestring" disease of tomato (Figure 1).

Many viruses do not produce a mosaic pattern on the leaves but a syndrome of dwarfing, leaf curling, adventitious roots or shoots, or yellowing. These are characteristic symptoms of the so-called yellows diseases (Figure 2). Many of the obvious effects of these viruses are due to deranged tissues, especially conductive tissues. The viruses of barley yellow dwarf, potato leafroll, beet yellows, beet curlytop, and aster yellows all incite a degeneration of phloem tissue as a primary effect (Bennett and Esau, 1936; Girolami, 1955; Esau, 1957). The potato leafroll virus and the barley yellow-dwarf virus characteristically incite a necrosis of the sieve tubes (Figure 3). The beet curlytop virus



Figure 1. Extreme leaf deformation ("shoestringing") in tomato caused by the tobacco-mosaic virus.

and the aster yellows virus, which are limited to the phloem, cause hypertrophy and hyperplasia of the phloem and pericycle, resulting in numerous short sieve elements. Derangements in phloem and pericyclic tissues undoubtedly account in part for certain teratological ef-



Figure 2. Adventitious root and shoot development in the carrot (left) as a result of infection by the aster-yellows virus. A healthy plant is at the right. (Photo courtesy of R. H. Larson.)



Figure 3. Potato tuber, showing phloem net necrosis as a primary effect of leafroll infection. (Photo courtesy of R. H. Larson.)

fects of viruses, such as aerial tubers on potato plants, phyllody in flowers, big buds, adventitious roots and shoots, etc.

The vein-clearing symptom so common to virus diseases has been shown in the case of beet yellows (Lackey, 1954) and beet curly top (Esau, 1956) to be due to hypertrophy of cells adjacent to the veins. These cells obliterate intercellular spaces and, since they contain little chlorophyll, appear more translucent than normal tissue.

Some viruses appear to be located in or restricted to xylem tissue. Houston *et al.* (1947) showed that vectors of the Pierce's disease virus could effect transmission, that the virus could multiply only when the vectors fed on xylem tissue, and that the virus was probably transported upward in the tracheary elements of the stem. Anatomical effects of this disease are also related to the xylem (Esau, 1948b). Deposits of gums occur in vessels and other xylem cells, and an excessive development of tyloses occurs in the wood. Vessel occlusions occur before the appearance of external symptoms and first in the inoculated leaf. The phony virus of peach shows a similar pathologic effect.

Virus-induced overgrowths in plants are perhaps best illustrated by the galls of the Fiji disease of sugar cane, the tumors of the wound-tumor disease of clover, the swollen stems of cacao infected with the swollen-shoot virus, and enations produced by certain viruses. The galls of the Fiji disease of sugar cane consist of elongated swellings on the undersurface of leaves. Their restriction to the undersurface of leaves is due to the fact that they are of phloem origin and the phloem side of the vascular bundle is to the outside (Kunkel, 1924). The virus stimulates phloem cells to proliferate and enlarge to produce the gall. In late development, cells in the outer layer of the gall become highly lignified and produce a distinct woody covering.

The wound-tumor disease is a striking example of overgrowths due to hypertrophy and hyperplasia (Black, 1945; Kelley and Black, 1949; Lee, 1955). The wound-tumor virus affects a number of host species, causing various types of overgrowths, such as leaf enations and root and stem tumors (Figure 4). The tumors originate in the primary phloem fibers of stems or from the pericycle of roots. Both hyperplasia and hypertrophy are a part of tumor development, the former being more important in the later stages of development. Many microscopic tumor initials occur in stems of infected clover that do not develop into macroscopic overgrowths (Lee, 1955). Black and Lee (1957) showed that tumor development from such initials could be induced by use of growth-promoting substances such as alpha-naphthalene acetic acid.

The swollen-shoot virus induces conspicuous areas of enlargement of the stem and root of the cacao plant. This effect results primarily from hyperplasia and hypertrophy of both phloem and xylem, the

same proportion of the two tissues being maintained as in normal secondary thickening (Knight and Tinsley, 1958).

Enations and veinal enlargements do not occur with all virus diseases, but they are not uncommon (Figure 5). Irregular enlargement of veinal tissue is a diagnostic symptom produced by the beet curlytop virus and the wound-tumor virus. Enations generally occur as leafy outgrowths from leaf surfaces. On certain hosts, the tobacco-mosaic virus causes the production of distinct phylloid structures which have the same cellular anatomy as the leaves from which they arise.

Necrosis is a very common effect of viruses and may occur in a number of tissues. Viruses causing a derangement in phloem tissue often cause "phloem necrosis" (see Figure 3), and necrotic streaking along vascular tissue characterizes many mosaic viruses. Necrosis often occurs in meristematic tissue and not in other tissue. In many infections, virus invasion of the host is restricted to a few cells around the



Figure 4. Tumors on crown and roots of *Rumex acetosa* L. as a result of infection by the wound-tumor virus. (Photo courtesy of L. M. Black.)



Figure 5. Leaf enations produced on leaves of cabbage by the cauliflower-mosaic virus.

point of entry, and most "local lesion" necrotic reactions are due to restriction in parenchyma cells which quickly become necrotic. Resistant hosts not ordinarily infected by a given virus may sometimes be infected by altering the environment so as to increase susceptibility, or by virus transmission through a graft union. When this occurs, necrosis is often the symptom produced. In many cases necrosis of the cell undoubtedly results from direct invasion by the virus; in others it is probably a secondary effect. The amount of virus synthesized in a cell that becomes necrotic is often less than that in cells that do not die.

One anatomical phenomenon associated with many virus diseases, particularly mosaic diseases, is the presence of intracellular inclusion bodies. These bodies are specific to virus-infected tissue but do not occur in all host-virus complexes. All strains of the tobacco-mosaic virus produce inclusion bodies in a number of hosts, whereas no such bodies are produced in the same hosts by the cucumber-mosaic virus. The inclusion bodies are somewhat ephemeral in nature, in that they can be found for only a part of the time the plants show symptoms. The presence of inclusion bodies in some host-virus combinations but not in others is a moot question. It was early thought that their occurrence was related to virus concentration in the cell. This may well

be true, but inclusion bodies occur with some viruses which are not considered to occur in high concentration.

Inclusion bodies vary considerably in size, shape, and in the tissues in which they occur (Esau, 1960). Those of the tobacco-mosaic virus are of two distinct types. One type is a striate body which may be flat and plate-like or long and needle-like. It varies in size and shape, some bodies being irregular in outline and others perfect hexagonals. As they turn over in the protoplasmic stream they show different facets and are regarded as true crystals. They are generally in the cytoplasm but may be intranuclear. The other type consists of amorphous, amoeboid bodies called "X-bodies." These also vary in size and shape, some being as great as 30 microns and some as little as five microns in diameter. They are generally rounded to oval and have the appearance of dense cytoplasm. They have been shown to change their shape as they are carried about in the protoplasmic stream of the cell.

It is now generally thought that the crystalline bodies of the tobacco-mosaic virus represent almost pure virus (Steele and Williams, 1953; Wehrmeyer, 1957). The X-bodies are less accurately identified but are probably an insoluble complex of virus and cellular constituents of the host. They sometimes contain crystalline bodies, which seem to be identical to the crystalline bodies found in the cytoplasm. The X-bodies are highly infectious and contain too much virus to be explained as of non-viral origin.

Virus synthesis and its effects on host physiology

The pronounced morphological and histological abnormalities associated with virus diseases are undoubtedly traceable to disturbed growth processes of the host. One would think that the causes and nature of such profound changes would be easily detectable, but this is not so. In fact, the changes in host metabolism due to virus infections have not been easily established.

In the infection process the virus nucleic acid enters the cell and there presumably serves as a template for its own reproduction and simultaneously alters the host metabolism so that virus protein is produced for incorporation along with the nucleic acid into virus nucleoprotein. The fact that nucleic acid alone is infectious, and that infective nucleoprotein can be reconstituted from the nucleic acid and protein components, would indicate that the protein moiety may not enter the host, and that the combination of the two in the cell to complete the formation of new virus is simply an assembly process.

Proteins. Since viruses are nucleoproteins, the fact that their synthesis markedly affects the normal protein and nitrogen concentration

in cells is not surprising, but the literature shows disagreement as to the nature and extent of such effects. Stanley (1937) reported that some viruses increased the total nitrogen of leaves and the concentration of protein in saps, whereas other viruses decreased them. Some reports (Martin *et al.*, 1938; Holden and Tracy, 1948) indicate that tobacco-mosaic virus increases the soluble protein concentration but does not affect the total nitrogen concentration of plant saps, whereas others (Wildman *et al.*, 1949) report no increase in protein but rather a decrease in normal nucleoproteins proportionate to the increase of virus. Bawden and Kleczkowski (1957) demonstrated differential virus effects on the soluble-protein content of infected tobacco tissue and wide fluctuations in the soluble-protein content of infected tissue in relation to healthy tissue—fluctuations which were affected by host environment, tissue sampled, etc. Thus the conditions under which plants were grown and sampled may account for some of the discrepancies in the literature.

From what is virus produced in the cell? From elaborated host protein? From the same pool of building blocks from which host protein is produced? These questions are only partly answerable. Wildman *et al.* (1949) and Wildman (1959) concluded that virus synthesis occurred at the direct expense of elaborated host proteins, on the basis of their findings that as virus nucleoprotein increased in inoculated leaves, a corresponding decrease occurred in soluble host proteins. This idea has not been generally accepted, and there is considerable evidence that virus synthesis does not result from hydrolysis of host protein. Meneghini and Delwiche (1951), using labeled nitrogen ($N^{15}H_4Cl$), concluded that tobacco-mosaic virus is formed in tobacco from nitrogenous compounds, such as amino acids or polypeptides, which have a more rapid exchange of nitrogen with ammonium ion than does the cytoplasmic extractable protein of the cell. Labeled nitrogen appeared in virus fractions at a rate two to three times as great as in cellular proteins. These authors believed that the process of virus synthesis is irreversible, and that the virus behaves as a foreign protein which is not in dynamic equilibrium with the rest of the cell constituents. Commoner and Dietz (1952) reached a similar conclusion. They showed that the largest difference between infected and healthy tissue was in the ammonia content. Virus synthesis was correlated with a drain of nitrogen from the soluble nitrogen pool. They concluded that most of the nitrogen of the virus protein came from the leaf's pool of soluble nitrogen (ammonia, amino acids, and amides), and that virus is formed from ammonia nitrogen and non-nitrogenous carbon sources. This is further indicated by the fact that during the period of rapid virus synthesis there is a deficiency of a number of amino acids that occur in the virus molecule (Commoner and Nehari, 1953). Commoner

et al. (1953a) showed that virus synthesis was associated with a net increase in protein content. This was due to the presence of virus nucleoprotein as well as to excesses of both insoluble protein and the soluble non-virus protein that occurs only during virus synthesis. It was suggested that the appearance of virus was preceded by the synthesis of an insoluble precursor which is converted into virus or some soluble intermediate protein, and that virus formation is due to a diversion of some part of the host's protein-synthesis mechanism and not to protein degradation.

Virus synthesis results in the occurrence in infected plants of a multiplicity of proteins which are not found in healthy plants. These have been reported for both rod-shaped and spherical viruses (Bawden and Pirie, 1945; Markham and Smith, 1949; Rice *et al.*, 1955; Sinclair *et al.*, 1957). Several anomalous or accessory non-infectious proteins accompanying synthesis of tobacco-mosaic virus have been isolated, and considerable speculation has been placed on their role in virus synthesis. Takahashi and Ishii (1952a) isolated a protein which appeared as roundish aggregates and which they termed "protein X." They later (1952b) showed that this protein would polymerize to form rigid rods which were quite identical in gross morphology with the virus particles. Commoner *et al.* (1952) described a similar component, "protein B," and suggested that it might be a precursor of tobacco-mosaic virus protein. In a later paper (Commoner *et al.*, 1953b) three such accessory proteins, all of which were devoid of nucleic acid, were described. All were made to polymerize into virus-like rods, and all were serologically related to one another and to tobacco-mosaic virus.

Studies made with radioactive isotopes quite clearly indicate that the anomalous proteins are not degradation products of the virus. Jeener (1954) studied the incorporation of C^{14} into the nucleoprotein and the nucleic acid-free antigen of the turnip yellow-mosaic virus and found that the nucleic acid-free protein always incorporated the labeled carbon faster than did the nucleoprotein. He reasoned that the former was not a degradation product of the nucleoprotein: that the protein and nucleic acid were synthesized independently and subsequently united into nucleoprotein. It was suggested that the nucleic acid-free protein was the protein portion of the uncompleted virus. Similar results were obtained with C^{14} and tobacco-mosaic virus and similar conclusions reached by Van Rysselberge and Jeener (1957). Matthews (1958) questioned that the nucleic acid-free protein accompanying the turnip yellow-mosaic virus was the immediate precursor of the virus protein, because of his finding that the ratio of virus nucleoprotein to acid-free proteins was approximately two to one and was maintained as such over a long period and over a wide range of conditions.

Somewhat different results were obtained with tobacco-mosaic virus by Commoner and Rodenberg (1955), and by Delwiche *et al.* (1955), using N^{15} . In both cases the nucleic acid-free protein and nucleoprotein had similar contents of isotopic ammonium. Commoner and Rodenberg suggested that the nucleic acid-free protein and virus protein are synthesized at the same time and from the same nitrogenous (non-protein) source. While Delwiche *et al.* related the non-virus protein to virus synthesis, they did not consider it to be a direct precursor of virus.

Electron microscopy and chemical studies have further related the anomalous proteins to virus synthesis (Markham, 1951; Consentino *et al.*, 1956; Fraser and Consentino, 1957; Newmark and Fraser, 1956). The "top" component of turnip yellow-mosaic virus has the same gross morphology and exactly the same amino-acid composition as the protein shell of the virus particle. The amino-acid compositions of the anomalous protein and of the nucleoprotein of tobacco-mosaic virus have also been shown to be identical. The non-infectious protein of tobacco-mosaic virus can be combined with infectious nucleic acid to produce an infectious nucleoprotein (Takahashi, 1959a). The closeness, in many respects, of the anomalous proteins and virus proteins would indicate that they are all part of virus synthesis. Takahashi (1959b) believes that the protein accompanying tobacco-mosaic-virus synthesis is indeed the protein used in the production of virus nucleoprotein; that protein and nucleic acid are synthesized separately and the final step in virus production is an assembly of the two components.

Nucleic acid. Fewer comparative studies have been made of healthy and virus-infected tissue in regard to nucleic-acid composition. Prior to the detection of tobacco-mosaic virus in inoculated plants, the nucleic acid in infected tissue exceeds that in healthy tissue by an amount slightly in excess of the nucleic acid incorporated into the virus produced (Basler and Commoner, 1956). In other words, there is an accumulation of nucleic acid slightly in excess of that which will go into virus particles. As virus appears, this excess rapidly diminishes, and an actual deficiency develops. When the excess is analyzed in terms of uracil, cytosine, and adenine, the concentrations of these almost equal the respective amounts going into virus. Therefore Basler and Commoner reasoned that the excess nucleic acid prior to virus appearance represents a nucleic-acid precursor to the virus nucleic acid.

Carbohydrates. Much attention has been given to the effects of virus infection on carbohydrate and nitrogen metabolism and to the C/N ratio in plants. Dunlap (1930), after studying the literature and experimenting with mosaic and yellows diseases of a number of plants, suggested that virus diseases might be grouped according to their effect on the C/N ratio. Mosaic diseases were found to be accompanied

by an increase in total N and a decrease in total carbohydrates of infected leaves. There seems to be no question but that a reduced carbohydrate content is characteristic of many mosaic diseases. In many cases this is accompanied by an increase in total N, thus resulting in a marked decrease in the C/N ratio. In other cases the C/N ratio is decreased by a reduction in leaf carbohydrates without a significant change in nitrogen content. Yellows diseases were found by Dunlap to effect a reduction in total nitrogen and often an increase in carbohydrates. The literature has shown this to occur in a number of cases. Although these different effects occur, the number of cases examined is too low for this to be of use in virus classification, as has been suggested.

Starch accumulation in leaves is quite marked in some virus diseases (*e.g.*, potato leafroll) and much thought has been given to explain it. It was early postulated that starch accumulation in potatoes affected with leafroll was due to deranged phloem. However, starch accumulation begins before phloem necrosis is evident (Thung, 1928). Data do not indicate that enzymatic disturbances are the answer, although this has not been adequately investigated. As Wynd (1943) suggests, some change may occur in the permeability of cell membranes, so that starch becomes locked in the cells. It has been generally thought that the yellows viruses effect an increase in carbohydrates, due to the fact that they commonly cause conductive-tissue derangements which impede the movement of carbohydrates. The mosaic viruses are commonly parenchyma invaders and do not cause marked derangements of conductive tissues. However, mosaic viruses also reduce the movement of starch from leaves, as can be shown by the Holmes (1931) starch retention test. As Bawden and Pirie (1952) have suggested, the answer to the different effects on the C/N ratio may lie in differential virus effects on photosynthesis rather than on synthesis or translocation of carbohydrates.

Respiration. It was Bunzel (1913) who perhaps made the first suggestion of increased respiration of virus-infected tissue and referred to the phenomenon as a "fever," and Thung (1928) who performed the first really significant experiments on the effect of virus infection on respiration. Thung showed that potato tissue infected with leafroll virus eliminated over twice as much carbon dioxide per gram of dry weight as did healthy tissue. Subsequent reports have created much confusion as to virus effects on respiration. Whitehead (1934) reported an increase in respiration due to virus infection, but Lemmon (1935) reported that mosaic-infected tobacco tissue had a lower respiratory rate than healthy tissue. Takahashi (1947), in carefully controlled experiments, showed that in discs of tobacco leaves infected with tobacco-mosaic virus the respiratory rate in both darkness and light

tended to be lower than in healthy tissue, and that the respiratory quotients did not differ significantly. Although evidence indicates that in many instances plant viruses cause an increased respiration, it is not evident that increased respiration always accompanies viral infection, and where it does accompany infection it does not necessarily mean a stimulated rate of respiration. It may be due, as Whitehead (1934) suggested, to an increase in the available substrate.

Owen, in a series of papers (1955, 1956), has shown where some of the confusion lies. Respiration rates of tobacco-mosaic leaves (as measured by CO₂ liberation) may be higher, lower, or identical with those of healthy leaves, depending upon the time that has elapsed since inoculation, the physiological condition of the plants, the environmental conditions of host growth, and how the results are expressed. In carefully controlled measurements over a 20-hour period, Owen showed that the rate of CO₂ production per gram of dry matter in young leaves was 10 per cent less in diseased than in healthy leaves but that in older leaves there was no difference. Older leaves of infected plants had an initial water content less than that of healthy leaves, and both older and younger infected leaves absorbed less water over the 20-hour period than did healthy leaves. This difference in initial water content was great enough to conceal a decrease in respiration due to infection, and differences in the water uptake of detached leaves were sufficient to reverse such an effect when respiration was expressed in terms of wet weights. Thus the only safe way to express results is on the basis of dry weights. Owen also showed that whether results were obtained in winter or summer made a difference, respiration being increased in detached infected leaves in winter but not in summer. In winter, increasing light intensity prior to inoculation decreased respiration rates after infection. Photoperiod had no effect. Respiration rates were changed within one hour after inoculation, which suggested that such change was unlikely to be associated with the formation of new virus, since there is no evidence for the formation of infective virus prior to six to eight hours (Kassanis, 1959). Within the first hour the introduced virus is likely to be still confined to epidermal cells, and in relatively few of them. Thus it appears that this almost immediate effect on respiration is due to entry of the virus in the cell and is the product of abnormal metabolism. In contrast with the effect on *Nicotiana tabacum*, this virus does not effect an increased respiration of *N. glutinosa* until symptoms appear (Owen, 1958). The tobacco-etch virus shows a similar picture, in that it does not cause an increase in respiration rates in tobacco until leaves show external symptoms, when increases as high as 40 per cent may be obtained (Owen, 1957a). Also, the increased respiration is maintained for long periods, and the decline that has been reported for tobacco-mosaic virus was not detected. Lo-

benstein (1959) showed that sweet-potato plants infected with the vein-clearing virus showed a much higher rate of respiration than healthy plants, and that this elevated rate of respiration was maintained for as long as 70 days without decline. As with tobacco-mosaic virus, the absolute values of respiration are greatly dependent on environment, leaf age, etc.

Photosynthesis. It is to be expected that plant viruses should affect photosynthesis, in view of the derangement they cause in chlorophyllous tissue. Little quantitative work has been done, however, to establish these effects. Owen (1957, a, b; 1958) has shown that the rate of photosynthesis in tobacco plants infected with tobacco-mosaic virus, tobacco-etch virus, or potato X virus is lower than in healthy plants. In the case of tobacco-mosaic virus, the reduction is measurable within one hour after inoculation. Since epidermal cells are not active photosynthetically, this would indicate that the virus either moves into chlorophyllous tissue much more rapidly than has been thought, or that its presence in epidermal cells can markedly affect the photosynthetic rate of uninfected cells. In the case of tobacco leaves infected with the potato X virus or with tobacco-etch virus, respiration and photosynthesis remained unchanged until symptoms appeared, at which time the respiration rate rose and the photosynthesis rate declined (Owen, 1957a, 1958). Thus two different viruses may show a fundamental difference in regard to both respiration and photosynthesis in the same host. It is obvious that generalizations cannot be made in regard to virus effects on these important growth processes.

Growth substances. Certain symptoms produced by viruses resemble effects produced by toxic levels of growth-promoting chemical substances. Because of this and known effects of viruses on plant growth, some interest has been shown in relating the virus effects to the activity of these substances in the host. Thung (1951) suggested that the presence of virus in plants more or less neutralized the influence of growth substances on host development. The few quantitative studies of the effects of virus infection on auxin content that have been made indicate that infection results in reduced auxin activity (Grieve, 1943; Pavillard, 1952, 1954; Hirata, 1954). These results would indicate that the general stunting caused by viruses is perhaps the result of reduced or inhibited auxin activity. It should be pointed out, however, that too few critical studies have been made for this to be accepted categorically. Recent studies (Maramorosch, 1957; Chessin, 1958) have shown that stunting produced by viruses may be counteracted with gibberellic acid. Quantitative effects on virus multiplication have not been made, but the fact that conspicuous leaf symptoms remain on the gibberellin-treated plants would suggest that the reversal of the stunting effect does not necessarily reduce virus synthesis. Virus effects on

growth may also be related to scopoletin. This compound, which is a constituent of healthy plant tissue, increases in amount in tomato plants and tobacco plants as a result of virus infections (Pavillard and Beauchamp, 1957). It is inhibitory to growth, and it has been suggested that its increase in tobacco, as a result of virus infection, occurs at the expense of indoleacetic acid (Pavillard and Beauchamp, 1957).

Enzymes. A. F. Woods (1902) noted that mosaic-infected tobacco contained a higher content of oxidizing enzymes than did healthy tissue. This led him to postulate an enzyme theory of virus origin. We know that Woods' enzyme theory of the nature of virus was wrong, but his observation about diseased tissue having higher levels of oxidases was right. There are many observations recorded in the literature which indicate that viruses effect an increase in oxidase and peroxidase systems of the host.

Reports have been made on virus effects on other enzyme systems, including, among others, chlorophyllase (Peterson and McKimney, 1938), dehydrogenase (Gerola and Testa, 1957), catalase (Wynd, 1942), and amylase (Balls and Martin, 1938), and these generally indicate a stimulated enzyme activity in infected tissue. It should be pointed out, however, that the literature is not in agreement at all points, and that this area of research has received disproportionately little attention in recent years.

Host environment in relation to growth and virus synthesis

The manner and extent of plant growth are greatly dependent upon environment, particularly on mineral nutrition, temperature, and light. Cellular growth, as enlargement or division, cannot occur without a source of carbohydrate and nitrogenous foods, and it requires that new proteins and cell-wall materials be produced and readily available. These materials are synthesized in green cells when the cells are provided the proper environment. Amino-acid synthesis is dependent upon carbohydrate metabolism for energy and building materials, and the production of these in turn depends upon the mineral nutrition of the plant. The major chemical elements of most critical importance in host growth are nitrogen, phosphorus, and potassium—the elements with which commercial fertilizers are formulated. Each of these elements increases plant growth up to a point where the concentration of the element becomes toxic and growth is reduced (Figure 6). Nitrogen constitutes a considerable portion of the mass of plant viruses, and phosphorus is an important constituent of nucleotides, which have a central role in nucleic-acid metabolism and in energy transfers in metabolic reactions (Arnon, 1953). It is reasonable to assume, therefore, that

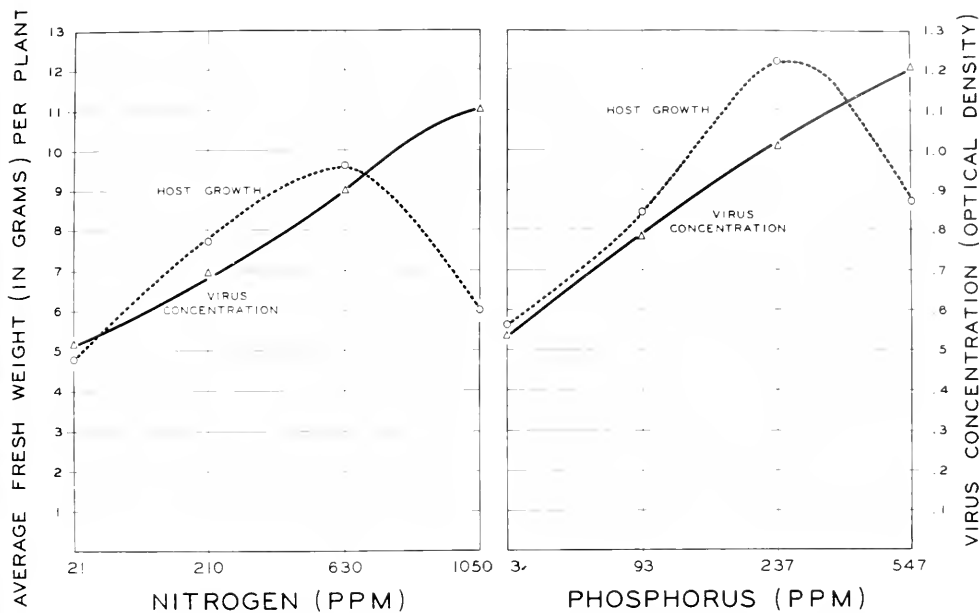

Figure 6. The relation of nitrogen and phosphorus nutrition of tobacco to host growth and concentration of tobacco-mosaic virus. Plants were grown in a sand medium and harvested 21 days after inoculation.

nitrogen and phosphorus deficiencies can affect virus synthesis directly by limiting the supply of necessary building materials, and indirectly by upsetting vital functions of the cell related to protein and nucleic-acid synthesis.

The mineral trace elements, as will be shown below, also affect virus synthesis, probably indirectly through their effects on cellular metabolism.

Growth processes of plants are also functions of temperature and light. The most rapid respiration occurs at the points of rapid growth (*e.g.*, terminal growing points and other embryonic tissues). Respiratory substrates in the form of readily oxidizable carbohydrates must be in plentiful supply. This is provided by translocation, a process proceeding most efficiently in darkness. Kinetic activity and, therefore, diffusion rates increase with increase in temperature. Within limits, enzyme reactions such as respiration are increased by increases in temperature, and strictly chemical reactions generally have a Q_{10} value of 2 to 3 (Went, 1953). Over a range of 10° C. to 25° C., and under a suitable light intensity and concentration of CO_2 , the Q_{10} value of photosynthesis is approximately 2. In general, increased light intensity will, up to a certain point, increase photosynthetic activity unless some

other factor is limiting. Certain complicating situations may make this untrue. For example, under very low light intensities, stomata may be closed and the CO₂ uptake reduced to the point of retarding photosynthesis. Also, under very high light intensities, transpiration may be increased to a point where photosynthesis will be reduced because of limited water content of the cells (Meyer and Anderson, 1952). Sub-optimal light intensity will reduce the photosynthetic rate by inhibiting the photochemical reaction of photosynthesis. Since the temperature coefficient of the photochemical reaction in photosynthesis is approximately 1, temperature would not affect photosynthesis under low light intensities. Under high light intensities, however, and in a suitable atmosphere of CO₂, temperature does markedly affect the photosynthetic rate by affecting the enzymatic reaction of this process (Meyer and Anderson, 1952). Thus, if virus synthesis is directly correlated with host growth, the rate of synthesis should be expected to increase, within limits, as the temperature of the host environment increases, and it should directly parallel the effects of light and light-temperature interactions on growth. As we shall point out below, such direct relationships do not always exist.

Mineral nutrition. Spencer (1939) reported that the concentration of tobacco-mosaic virus in tobacco plants was directly correlated with the amount of nitrogen supplied to the host. He detected no correlation between the amount of host growth and virus concentration. Bawden and Kassanis (1949) were unable to confirm Spencer's work and concluded that nitrogen effects on virus concentration were correlated with the effects on host growth. It should be pointed out that Bawden and Kassanis were, for the most part, using plants grown in soil, and therefore did not have adequate control of the mineral nutrition.

Other workers have shown that the nitrogen effects on virus concentration in expressed sap extracts, in some host-virus combinations, are directly related to the amount of nitrogen supplied the host, as Spencer reported (Weathers and Pound, 1954; Helms and Pound, 1955b). The concentration of tobacco-mosaic virus in tobacco increases as available nitrogen increases, and at 1,050 ppm. of nitrogen it is higher than that at 630 p.p.m., even though, at the highest nitrogen level, growth (wet weight) is markedly reduced in comparison with that at 630 p.p.m. (see Figure 6). Also, the concentration of potato X virus in *Nicotiana glutinosa* and of tobacco-ringspot virus in cucumber increase with a rise in nitrogen, even though marked suppression of host growth occurs at the highest nitrogen levels (Helms and Pound, 1955a). In other cases, direct correlations do not occur between the nitrogen effects on host growth and virus concentration (Cheo *et al.*, 1952; Pound and Weathers, 1953). With the cucumber-mosaic virus in

spinach and the turnip-mosaic virus in *Nicotiana* species, the virus concentration closely parallels the host growth (Figure 7). In cases where the same virus has been studied in more than one host, identical patterns of nitrogen effects have been found.

Generally, increasing the phosphorus level increases the virus concentration in plants (see Figure 6), even though host growth is markedly reduced at the higher phosphorus levels (Cheo *et al.*, 1952; Pound and Weathers, 1953b; Weathers and Pound, 1954; Helms and Pound, 1955b). In occasional assays of the potato X virus and the tobaccoring-spot virus Helms and Pound (1955a) found that the highest virus concentration was obtained at the phosphorus level giving the greatest host growth. In these cases, however, phosphorus had much less

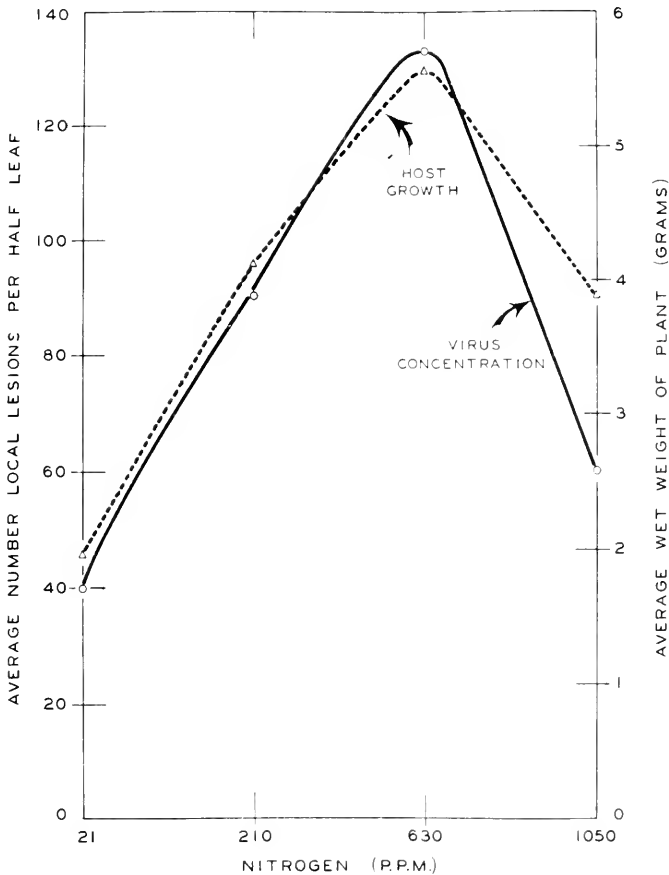

Figure 7. Nitrogen effects on host growth and virus concentration in plants of *Nicotiana glutinosa* L. infected with turnip-mosaic virus. Plants were grown in a sand medium and harvested 21 days after inoculation.

marked effects on host growth than did nitrogen, and host growth differences at the higher phosphorus levels were not great.

Potassium effects on host growth are much less marked than the effects of nitrogen and phosphorus. Correspondingly, it has less effect on virus synthesis. Increases in plant growth, however, are generally accompanied by increases in virus concentration and *vice versa* (Cheo *et al.*, 1952; Pound and Weathers, 1953b; Weathers and Pound, 1954). It is thus indicated that potassium is not directly involved in virus synthesis.

Varying the osmotic concentration of balanced nutrient solutions also results in varying growth patterns. Such variations in the solution concentration also result in variations in virus concentration, and in all cases a positive correlation in host growth and virus concentration occurs (Cheo *et al.*, 1952; Pound and Weathers, 1953b; Weathers and Pound, 1954).

The minor element nutrition of tobacco in relation to the synthesis of tobacco-mosaic virus has been studied in some detail. In the case of zinc, the virus concentration in growing tobacco plants or excised leaf discs increases with increased zinc up to a level toxic for growth, and thereafter the virus concentration decreases (Helms and Pound, 1955b). As the virus multiplies in zinc-deficient plants, symptoms of zinc deficiency are markedly and rapidly increased. No direct relationship between virus multiplication and host utilization of zinc has been demonstrated, and it is probable that the primary effect of zinc on virus synthesis has to do with the host's growth. How zinc indirectly affects virus synthesis can only be surmised. It is known that zinc deficiency in some plants results in auxin deficiency (Skoog, 1940). It has also been suggested (see page 633) that virus synthesis in plants results in a reduction of auxin in the host, and it may be that virus synthesis is associated with utilization or destruction of auxin. However, Helms and Pound showed that the virus content of zinc-deficient plants and of plants growing at optimal levels of zinc was not only not increased but was actually decreased when indole-3-acetic acid was supplied through the roots to plants growing in nutrient solutions. Furthermore, the addition of zinc to deficient plants did not immediately result in increased virus concentration, even though it probably increased the auxin content of the plants. It is known that zinc deficiency produces marked changes in the concentration of certain plant enzymes and affects mineral uptake in plants (Brown and Steinberg, 1953; Nason *et al.*, 1952). Thus it is also plausible that the zinc effects on virus synthesis are due to association with enzymes involved in protein metabolism.

Manganese is very important in plant nutrition, being essential for a number of metabolic processes that affect growth. It functions as a co-factor in enzymatic reactions, especially in the activation of the

enzyme systems of the citric-acid cycle, and it can activate most of the enzymes of the glycolytic cycle (McElroy and Nason, 1954). Photosynthesis is believed to be inhibited in the absence of manganese. One would expect, therefore, to find positive correlations between manganese effects on host growth and virus synthesis. However, this is not the case with tobacco-mosaic virus in tobacco. Welkie and Pound (1958) showed that, regardless of the assay method used, virus concentration was greatest in manganese-deficient plants. This suggests either that manganese triggers some mechanism inhibitory to virus synthesis or that virus synthesis occurs independently of physiological processes which are related to growth and controlled by manganese. If virus synthesis is independent of some of these manganese-controlled metabolic reactions of the host, multiplication might continue when host growth would be suppressed by the absence of manganese. Further studies in this area are needed to determine whether manganese affects the synthesis of other viruses as it does tobacco mosaic virus.

Iron is another element of major importance in host growth. Its total role in host metabolism is not certain, but the major metabolic processes are influenced by its presence or absence. Both respiration and photosynthesis have been correlated with the degree of chlorosis or amount of chlorophyll present in plants supplied with low levels of iron. Perhaps the most important function of iron is its catalytic action when it occurs as an iron-porphyrin enzyme. These are constituents of cytochromes which function as an electron-transport system of the cell. Moderate iron deficiency of tobacco does not influence the synthesis of tobacco-mosaic virus in either growing plants or floating leaf discs (Pound and Welkie, 1958). Extreme iron deficiency does, however, reduce virus concentration. Only at a critically low level does iron deficiency exert a greater limitation on virus multiplication than it does on host growth. Iron has been shown (Loring and Waritz, 1957) to be tightly bound to highly purified preparations of tobacco-mosaic virus. Whether it is an integral part of the virus protein is not certain, but in any event, the amount is so small that it does not seem likely that the level of deficiency studied would limit the availability of iron for direct incorporation into virus.

The effect of boron on virus synthesis is also apparently an indirect effect (Shepherd and Pound, 1960a), but virus concentrations do not directly parallel host growth. In boron-deficient tobacco plants the concentration of tobacco-mosaic virus in expressed saps or from dried tissue is reduced during the first 7 to 14 days following inoculation, but in later assays the concentration equals that in normal plants. In inoculated leaves of deficient plants the virus increases at a rate equal to that of normal plants and after a few days even exceeds the concentration of the latter. How does boron affect virus synthesis? It has been shown

that boron functions in sugar translocation (Sisler *et al.*, 1956). Sugar-borate complexes are believed to pass through cell membranes more readily than non-borated sugars. It has also been suggested that boron may be a constituent of cell membranes, where temporary union is formed with sugar molecules, thereby enhancing passage through membranes. As Shepherd and Pound have pointed out, the initial lag in virus concentration in deficient plants and the increased concentration in the inoculated leaves of deficient plants may well be explained on the basis of reduced virus movement and spread in the plants. If tobacco-mosaic virus is spread in the plant in conjunction with sugars, then translocation would be inhibited in deficient plants. It is well known that spread of some plant viruses in the host is related to the translocation of the products of photosynthesis.

Magnesium has only minor effects on tobacco-mosaic virus synthesis in tobacco (Shepherd and Pound, 1960b). Differences in virus concentration of deficient and non-deficient plants are small, but virus yields are consistently less from severely deficient plants. Magnesium is a constituent of chlorophyll and also activates a number of enzymes, several of which are active in protein and carbohydrate metabolism (McElroy and Nason, 1954). Undoubtedly, one of the major functions of magnesium in enzyme systems is in the adenosine triphosphate-catalyzed reactions that control many biosynthetic processes. It is surprising that the effect of magnesium on virus synthesis is as small as it is, since the energy-providing mechanisms of the plant upon which host growth and virus synthesis depend are undoubtedly impaired by magnesium deficiency. Since host growth is affected by deficiency to a greater degree than virus synthesis is, the virus-synthesis mechanism must compete successfully for the components and energy necessary for synthesis.

Temperature. Two types of temperature effects on virus synthesis occur in systemically-infected plants. In one, represented by turnip-mosaic virus, the virus concentration in plants over a range of temperatures shows a gradient pattern, and the concentration at one temperature remains relatively constant in relation to other temperatures. For example, the cabbage A and cabbage black-ring strains of turnip-mosaic virus always are in greater concentration in systemically-infected cabbage plants growing at 28° C. than in cabbage plants growing at 16° C. Concentrations progressively decrease from 28° to 16° (Pound, 1952). These reactions are reversible, in that if infected plants growing at 28°, 24°, 20°, 16° are transferred to 16°, 20°, 24°, 28°, respectively, a corresponding reversal in the virus concentration gradient follows. In horseradish (also in the cruciferae), however, all strains of this virus tested show a virus-concentration pattern in response to temperature the reverse of that in cabbage (Pound, 1949). If the same viruses are

allowed to multiply in *Nicotiana glutinosa* L. (Figure 8), a concentration gradient identical with that in horseradish and the reverse of that in cabbage occurs (Pound and Weathers, 1953b). In *N. multivalvis* (also in the solanaceae) air temperature has little effect on concentration of these viruses in systemically-infected plants. In all of these hosts (horseradish not tested) virus synthesis in inoculated leaves is a direct function of temperature, increasing as temperature increases. This indicates that virus synthesis is actually enhanced by the 28° temperature but movement of the virus out of inoculated leaves of some hosts into other portions of the plants is impeded at this temperature. The growth of cabbage increases with increase in temperature up to 24° C., above which it levels off or drops, depending upon the variety. The growth

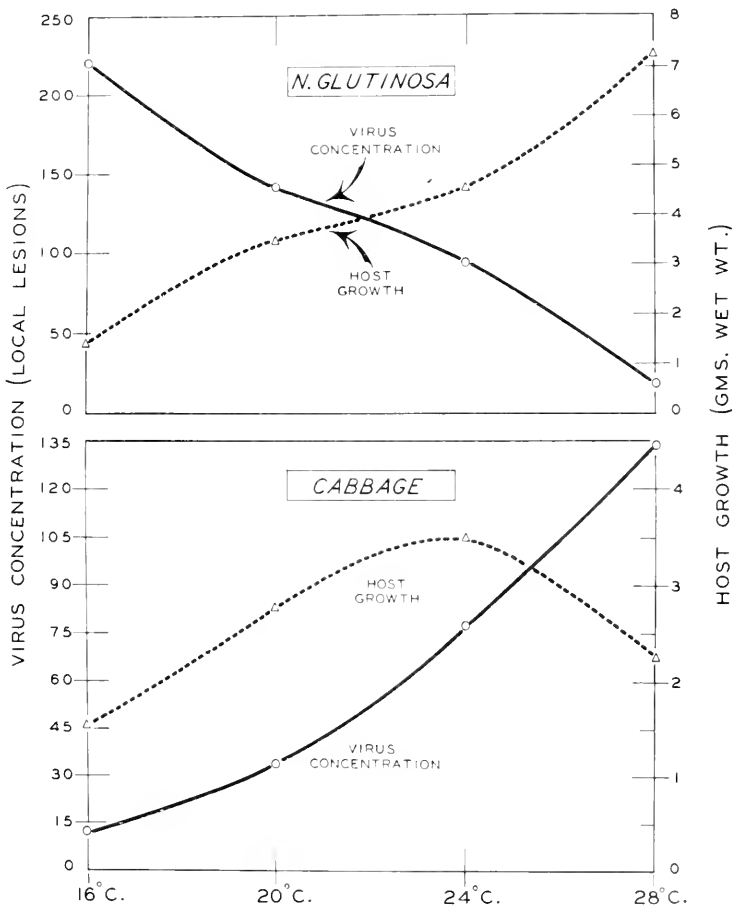

Figure 8. The relation of air temperature to host growth and concentration of turnip mosaic virus in systemically-infected plants of *Nicotiana glutinosa* L. and cabbage at two weeks after inoculation.

rate of *N. glutinosa* at these temperatures is similar to that of cabbage, except that growth does not fall off at 28°. At this temperature, growth is greater than that at 24°. Thus the effect of temperature on virus synthesis in inoculated leaves closely parallels the temperature effects on host growth. One might suspect that some metabolite accompanying virus synthesis in inoculated leaves was inhibitory to virus movement or to virus synthesis in systemically-infected leaves. Systemically-infected leaves of *N. glutinosa* growing at 28° and containing low concentrations of virus (as determined by samples of excised discs) support marked increases of virus synthesis when reinoculated. This would seem to rule out the production of a toxic metabolite inhibiting synthesis. Obviously the relation of temperature to virus concentration in systemically-infected leaves of *N. glutinosa* must be affected by virus movement. The effect of high temperature on virus accumulation in plants of *N. glutinosa* would seem to be one of restricted invasion of cells rather than restricted synthesis.

A second type of temperature reaction is represented by tobacco-mosaic virus and has been studied in detail by Bancroft and Pound (1956). With this host-virus combination, no single temperature consistently promotes maximal virus concentrations over a given period. In inoculated leaves harvested four days after inoculation, and in systemically-infected leaves harvested seven days after inoculation, the virus concentration increases with increase in temperature, showing that initially the rate of virus synthesis is a direct function of temperature. Host growth also increases with increase in temperature to an optimum of about 24°. At 28° growth is slightly less than at 24°. Thus the initial effects of temperature on virus synthesis closely parallel the temperature effects of growth.

Subsequent assays from systemically-infected tissue show an orderly shift of virus concentrations among the different temperatures. The maximum virus concentration obtained depends not only upon temperature but also upon the time of sampling. At each temperature, virus concentration reaches a maximum and then drops in relation to host growth. When cumulative virus concentrations are plotted against cumulative growth curves, it is evident that temperature determines directly, or indirectly through host growth, the rate and magnitude of virus accumulation in plants as well as the rate and magnitude of concentration decline after the maximum is reached (Bancroft and Pound, 1956). After the maximum virus concentration is reached, a correlation between the amount of host growth and virus concentration exists: as host growth increases, virus concentration decreases. The virus apparently does not continue to multiply as rapidly as it does initially in relation to host growth, and when assays are made on a host weight basis the host acts as a diluent, resulting in an observed drop in virus

concentration. That host growth does create a dilution effect was indicated by the fact that no decline in virus concentration over a 14-day period could be detected in mature tobacco leaves in which growth was negligible.

At low temperatures virus synthesis parallels host growth for a longer period, and maximum virus concentrations are reached much later than at high temperatures. Since host growth is less rapid at low temperatures, less of a dilution effect occurs, and less of a drop in virus concentration follows.

The concentrations of cucumber-mosaic virus and tobacco-mosaic virus in tip leaves of tobacco show a cyclic pattern, in that maximal concentrations occur at any given temperature at different time intervals (Cheo and Pound, 1952; Bancroft and Pound, 1956). At any temperature, the virus concentration follows a low-high-low-high pattern. The frequency of the cycle depends upon temperature, and since these reversals occur while growth is steadily increasing, some factor other than the temperature effect on host growth must control this pattern. Two possible suggestions occur to explain this phenomenon: (1) The virus, while using the products of the host's enzymes for its own synthesis, competes with these host enzymes for constituents necessary for the synthesis of both. This successful competition by the virus allows an initially rapid virus build-up. When certain of these host enzymes become depleted, virus synthesis is retarded until the host replenishes its enzymatic machinery, after which the products again allow a new burst of virus synthesis. (2) Some by-product of virus synthesis acts as an inhibitor of certain host enzymes by a feedback mechanism, such that the virus periodically checks its own synthesis while allowing the host to recover.

These experiments dealt only with virus concentrations in tissue samples at stated intervals of time and gave no consideration to the possibility of a dynamic equilibrium between the synthesis and inactivation of virus. There is evidence against proteolysis of virus in established systemic infections (Meneghini and Delwiche, 1951), but some recent studies indicate that in some host-virus combinations, virus synthesis and virus inactivation may occur simultaneously in the plant, and that the measurable virus concentration at any one time may reflect the relative intensity of these opposing reactions. Harrison (1956), working with tobacco-necrosis virus in the French bean, found that inactivation greatly exceeded synthesis in plants growing at 30° C., and he obtained some evidence that these two processes may occur simultaneously at lower temperatures as well. Kassanis (1957) reported that tobacco-mosaic virus did not accumulate in tobacco plants kept at 36°, and that virus produced in plants at lower temperatures actually disappeared from systemically-infected leaves when plants were shifted

to 36°. Observations with such limited numbers of host-virus combinations and without measurements of absolute virus contents would not warrant general conclusions that these opposing processes are the general pattern. These experiments of holding plants at high temperature (30° to 36° C.) do indicate that host metabolism can be upset to a point where virus synthesis is no longer supported but where host growth continues.

Temperature not only affects the quantity of virus synthesized but also the quality. A legume strain of tobacco-mosaic virus has a different amino-acid composition if produced in tobacco plants held at 30° C. than if produced at 20° C. (Bawden, 1958). Another indication that temperature effects are qualitative in nature is that some strains of a virus (*e.g.*, cucumber-mosaic virus) will multiply in a host at a temperature which will not permit synthesis of other strains (Hitchborn, 1956, 1957).

The relatively little work that has been done on soil temperature indicates that soil-temperature effects usually parallel those of air temperature in direction but not in magnitude. Soil-temperature effects on virus synthesis are less marked than those of air temperature (Cheo and Pound, 1952; Pound and Weathers, 1953a; Pound and Helms, 1955; Bancroft and Pound, 1956).

Light. Little experimentation has been done to determine the qualitative and quantitative effects of light on virus synthesis. It is a general observation that keeping plants in reduced light for short periods prior to inoculation increases their susceptibility to virus infection. The reason for this is unknown, but it is possibly related to carbohydrate metabolism. Sufficient data are at hand to indicate some relationships between the effects of light on host growth and on virus synthesis. With cucumber-mosaic virus (Cheo and Pound, 1952), tobacco-mosaic virus (Pound and Bancroft, 1956), and squash-mosaic virus (Bancroft, 1958), long photoperiods and high light intensities generally favor virus synthesis during the early days of infection. Thus in inoculated leaves the effects of light on the initial virus increase parallel the effects on host growth. In systemically-infected plants, however, this parallelism does not hold. In systemically-infected plants, tobacco-mosaic virus synthesis in tobacco under different treatments of photoperiod or light intensity is not along a straight-line gradient, as growth is, and a given group of plants may show exactly opposite virus-concentration patterns in relatively short periods. A reversal of virus-concentration gradients while the growth gradient remains the same indicates that virus synthesis, at least virus accumulation, is not necessarily related to growth. Similar negative correlations between host growth and virus concentration were reported by Bancroft (1958) for squash mosaic.

A direct correlation does exist between host growth and virus con-

centration in the case of turnip-mosaic virus in rape under different photoperiods (Pound and Garces, 1959). When rape plants are grown under 4-, 8-, 12-, and 16-hour photoperiods, both virus concentration and host growth increase with increased photoperiod, regardless of the time interval after inoculation (Figure 9). Shortly after inoculation, virus synthesis is more affected by photoperiod than is host growth, but in later assays the two are closely parallel. Since there are no reversals in concentration patterns, it is suggested that in this host-virus combination, virus synthesis and host growth are in a balance which is not upset by photoperiod or by temperature.

Summary and general conclusions

Virus synthesis in plants obviously results from an aberration of the cellular metabolism of the host, since viruses do not have the necessary enzymes for their own self-duplication. The virus nucleic acid

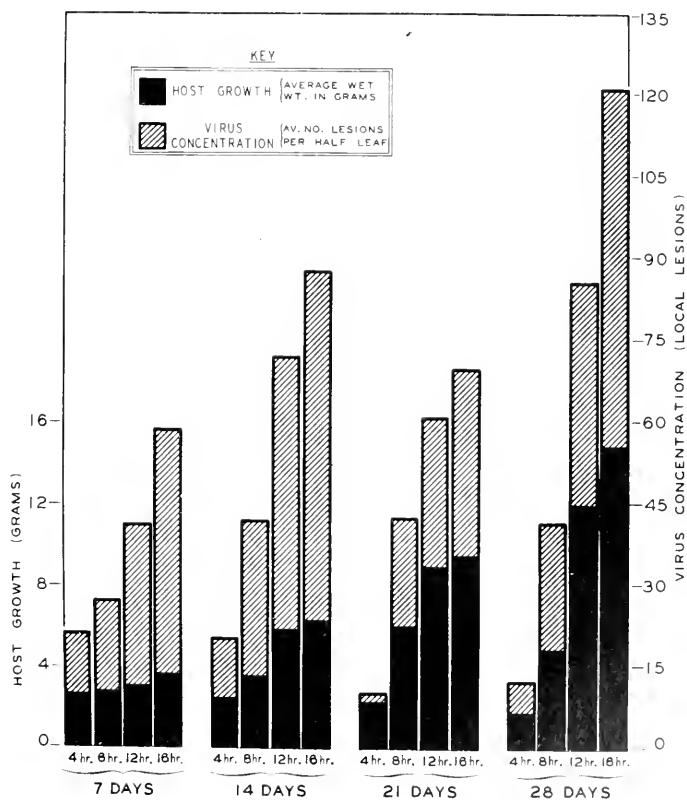

Figure 9. Effect of photoperiod on host growth and concentration of turnip mosaic virus in rape. (After Pound and Carlos Garces-Orejuela.)

diverts the metabolic machinery of the cell from the synthesis of normal cellular constituents to that of virus nucleic acid and virus protein, which are subsequently assembled into the virus nucleoprotein. This invariably results in growth abnormalities of the host, which are expressed as anatomical or physiological changes.

Virus effects on host anatomy include suppressed or stimulated cell division and differentiation, necroses, vascular occlusions, plastid degeneration, and intracellular inclusion bodies. Teratological effects, such as tumorous overgrowths, giant flower buds, adventitious roots and shoots, and alamate leaves, are not common to all virus diseases but are conspicuous in some.

Physiological effects are numerous but still poorly defined. Carbohydrate, protein, and nucleic-acid metabolism are all affected. Respiration is often increased and photosynthesis decreased by virus infection. Reactions are not the same for all host-virus combinations, and it is not possible to draw general conclusions which would encompass all virus infections. Many conclusions that have been drawn have been based upon experiments dealing with sap extracts of plants, excised leaf discs, or otherwise altered living systems; these experiments, at the most, may be only indicative of what happens within the cell.

Studies of host environment have revealed definite relationships between host growth and virus synthesis. In many instances the conditions of environment that promote the best host growth (increase in weight) are also the best conditions for virus synthesis. Notable exceptions occur, however. In some cases, virus synthesis is directly related to the amount of nitrogen supplied the host, even though the nitrogen concentration may be great enough to cause marked stunting. In other cases, the effect of nitrogen on virus synthesis directly parallels its effect on host growth. Similar results have been obtained with phosphorus. These elements are major constituents of the virus nucleoprotein, and it is reasonable to assume that deficiencies of them limit virus synthesis directly by limiting the necessary materials for synthesis and indirectly by upsetting the growth processes of the plant. Other elements which are not constituents of the virus particles probably affect virus synthesis indirectly through their effects on host metabolism, and in such instances virus synthesis generally parallels host growth. However, the synthesis of tobacco-mosaic virus is greater in manganese-deficient tobacco than in plants receiving adequate manganese. While growth differences in tobacco due to iron nutrition are easily established, only under extreme deficiency is synthesis of tobacco-mosaic virus affected. Boron also has only limited effects on virus synthesis, while host growth effects are very marked.

The effects of temperature and light on virus synthesis are very complex. In inoculated leaves, virus synthesis is generally a direct func-

tion of temperature and closely parallels host growth. However, in systemically-infected leaves, where movement and transport are involved, the rate of virus accumulation is often inversely related to host growth. In some host-virus combinations a cyclic pattern of virus concentration accompanies a straight-line pattern of growth. Initial virus synthesis is also generally favored by long days and relatively high light intensities—conditions which also favor host growth. In some cases this relationship between virus synthesis and host growth continues with time, while in others no such correlation occurs.

Thus there is considerable evidence that virus synthesis is closely and directly related to the host growth processes. But virus accumulation in plants, which depends upon movement of virus out of cells, transport to other portions of the plant, and entry into cells, is a different story. It is probably here that explanations of the anomalous situations described are to be found.

References

- Amon, D. I., 1953. "The Physiology and Biochemistry of Phosphorus in Green Plants," in Norman, A. G., ed., *Agronomy Monographs*, Vol. 4 (N. Y., Academic Press).
- Balls, A. K., and Martin, L. F., 1938. "Amylase Activity of Mosaic Tobacco," *Enzymologia* 5, 233.
- Bancroft, J. B., and Pound, G. S., 1956. "Cumulative Concentrations of Tobacco Mosaic Virus in Tobacco and Tomato at Different Temperatures," *Virology* 2, 29.
- Bancroft, J. B., 1958. "Temperature and Temperature Light Effects on the Concentration of Squash Mosaic Virus in Leaves of Growing Cucurbits," *Phytopath.* 48, 98.
- Basler, E., and Commoner, B., 1956. "The Effect of Tobacco Mosaic Virus Biosynthesis on the Nucleic Acid Content of Tobacco Leaf," *Virology* 2, 13.
- Bawden, F. C., 1958. "Reversible Changes in Strains of Tobacco Mosaic Virus from Leguminous Plants," *J. Gen. Microbiol.* 18, 751.
- Bawden, F. C., 1959. "Physiology of Virus Diseases," *Ann. Rev. Plant Physiol.* 10, 239.
- Bawden, F. C., and Kassanis, B., 1949. "Some Effects of Host-Plant Nutrition on the Multiplication of Viruses," *Ann. Appl. Biol.* 37, 215.
- Bawden, F. C., and Kleczkowski, A., 1957. "An Electrophoretic Study of Sap from Uninfected and Virus-Infected Tobacco Plants," *Virology* 4, 26.
- Bawden, F. C., and Pirie, N. W., 1945. "The Separation and Properties of Tobacco Mosaic Virus in Different Stages of Aggregation," *Brit. J. Exp. Path.* 26, 294.
- Bawden, F. C., and Pirie, N. W., 1952. "Physiology of Virus Diseases," *Ann. Rev. Plant Physiol.* 3, 171.
- Bennett, C. W., and Esau, K., 1936. "Further Studies on the Relation of the Curly Top Virus to Plant Tissues," *J. Agr. Res.* 53, 595.
- Beauchamp, C., 1959. "La Constitution Auxinique des tabacs, sains ou viroses," *Rev. Gen. Bot.* 65, 477.
- Black, L. M., 1945. "A Virus Tumor Disease of Plants," *Am. J. Bot.* 32, 408.

- Black, L. M., and Lee, C. L., 1957. "Interaction of Growth-Regulating Chemicals and Tumefacient Virus on Plant Cells," *Virology* 3, 146.
- Brown, J. C., and Steinberg, R. A., 1953. "Iron and Copper Enzymes in Leaf Lamina of Tobacco when Deficient in Micronutrients or Grown in Calcareous and Organic Soils," *Plant Physiol.* 28, 488.
- Bunzell, H. H., 1913. *A Biochemical Study of the Curly Top of Sugar Beets*. U. S. Department of Agriculture, Bureau of Plant Industry, Bulletin 277.
- Cheo, P. C., and Pound, G. S., 1952. "Relation of Air Temperature, Soil Temperature, Photoperiod, and Light Intensity to the Concentration of Cucumber Virus I in Spinach," *Phytopath.* 42, 306.
- Cheo, P. C., Pound, G. S., and Weathers, L. G., 1952. "The Relation of Host Nutrition to the Concentration of Cucumber Virus I in Spinach," *Phytopath.* 42, 377.
- Chessin, M., 1958. "Growth Substances and Stunting in Virus Infected Plants," *Proc. Third Inter. Conf. Potato Virus Diseases*, p. 80.
- Commoner, B., and Dietz, P. M., 1952. "Changes in Non-Protein Nitrogen Metabolism during Tobacco Mosaic Virus Biosynthesis," *J. Gen. Physiol.* 35, 847.
- Commoner, B., and Nehari, V., 1953. "The Effects of Tobacco Mosaic Virus Synthesis on the Free Amino Acid and Amide Composition of the Host," *J. Gen. Physiol.* 36, 791.
- Commoner, B., Newmark, P., and Rodenberg, S. D., 1952. "An Electrophoretic Analysis of Tobacco Mosaic Virus Biosynthesis," *Arch. Biochem. Biophys.* 37, 15.
- Commoner, B., and Rodenberg, S. D., 1955. "Relationships between Tobacco Mosaic Virus and the Non-Virus Proteins," *J. Gen. Physiol.* 38, 475.
- Commoner, B., Schieber, D. L., and Dietz, P. M., 1953a. "Relationships between Tobacco Mosaic Virus Biosynthesis and the Nitrogen Metabolism of the Host," *J. Gen. Physiol.* 36, 807.
- Commoner, B., and Yamada, M., 1955. "The Non-Virus Proteins Associated with Tobacco Mosaic Virus," *J. Gen. Physiol.* 38, 459.
- Commoner, B., Yamada, M., Rodenberg, S. D., Wang, T. Y., and Basler, E., 1953b. "The Proteins Synthesized in Tissue Infected with Tobacco Mosaic Virus," *Science* 118, 529.
- Consentino, V., Paigen, K., and Steere, R. L., 1956. "Electron Microscopy of Turnip Yellow Mosaic Virus and the Associated Abnormal Protein," *Virology* 2, 139.
- Delwiche, C. C., Newmark, P., Takahashi, W. N., and Ng, M., 1955. "The Relationship between Tobacco Mosaic Virus and an Accompanying Abnormal Protein," *Biochim. Biophys. Acta* 16, 127.
- Dunlap, A. A., 1930. "The Total Nitrogen and Carbohydrates, and the Relative Rates of Respiration in Virus-Infected Plants," *Am. J. Bot.* 17, 348.
- Esau, K., 1935. "Ontogeny of the Phloem in Sugar Beets Affected by the Curly-Top Disease," *Am. J. Bot.* 22, 149.
- Esau, K., 1944. "Anatomical and Cytological Studies on Beet Mosaic," *J. Agri. Res.* 69, 95.
- Esau, K., 1948a. "Some Anatomical Aspects of Plant Virus Disease Problems, II," *Bot. Rev.* 14, 413.
- Esau, K., 1948b. "Anatomic Effects of the Viruses of Pierce's Disease and Phony Peach," *Hilgardia* 18, 423.
- Esau, K., 1956. "An Anatomist's View of Virus Diseases," *Am. J. Bot.* 43, 739.
- Esau, K., 1957. "Phloem Degeneration in Gramineae Affected by the Barley Yellow-Dwarf Virus," *Am. J. Bot.* 44, 245.

- Esau, K., 1960. "Cytologic and Histologic Symptoms of Beet Yellows," *Virology* 10, 73.
- Fraser, D., and Consentino, V., 1957. "The Amino Acid Composition of Turnip Yellow Mosaic Virus and the Associated Abnormal Protein," *Virology* 4, 126.
- Gerola, F. M., and Testa, G., 1957. "Ricerche sulla fisiologia delle piante virosate, II: Attività deidrogenasica in tuberi di patata di individui sani e virosati," *Nuovo G. Bot. Ital. N.S.* 64, 185.
- Girolami, G., 1955. "Comparative Anatomical Effects of the Curly-Top and Aster-Yellows Viruses on the Flax Plant," *Bot. Gaz.* 116, 305.
- Grieve, B. J., 1943. "Studies in the Physiology of Host-Parasite Relations, IV: Some Effects of Tomato Spotted Wilt on Growth," *Austr. J. Exp. Biol. Med. Sci.* 21, 89.
- Harrison, B. D., 1956. "Studies on the Effect of Temperature on Virus Multiplication in Inoculated Leaves," *Ann. Appl. Biol.* 44, 215.
- Helms, K., and Pound, G. S., 1955a. "Host Nutrition in Relation to Concentration of Potato Virus X and Tobacco Ringspot Virus," *Phytopath.* 45, 567.
- Helms, K., and Pound, G. S., 1955b. "Zinc Nutrition of *Nicotiana tabacum* L. in Relation to Multiplication of Tobacco Mosaic Virus," *Virology* 1, 408.
- Hills, C. H., and McKinney, H. H., 1942. "The Effect of Mosaic Virus Infection on the Protein Content of Susceptible and Resistant Strains of Tobacco," *Phytopath.* 32, 857.
- Hirata, S., 1954. "Studies on the Phytohormone in the Malformed Portion of the Diseased Plants, I: The Relation between the Growth Rate and the Amount of Free Auxin in the Fungous Galls and Virus-Infected Plants," *Ann. Phytopath. Soc. (Japan)* 19, 33.
- Hitchborn, J. H., 1956. "The Effect of Temperature on Infection with Strains of Cucumber Mosaic Virus," *Ann. Appl. Biol.* 44, 590.
- Hitchborn, J. H., 1957. "The Effect of High Temperature on the Multiplication of Two Strains of Tobacco Ring Spot Virus," *Virology* 3, 243.
- Holden, M., and Tracey, M. V., 1948. "The Effect of Infection with Tobacco Mosaic Virus on the Levels of Nitrogen, Phosphorus, Protease, and Pectase in Tobacco Leaves and on their Response to Fertilizers," *Biochem. J.* 43, 151.
- Holmes, F. O., 1931. "Local Lesions of Mosaic in *Nicotiana tabacum* L.," *Contrib. Boyce Thompson Institute* 3, 163.
- Houston, B. R., Esau, K., and Hewitt, W. B., 1947. "The Mode of Vector Feeding and the Tissues Involved in the Transmission of Pierce's Disease Virus in Grape and Alfalfa," *Phytopath.* 37, 247.
- Jeener, R., 1954. "A Preliminary Study of the Incorporation in Growing Turnip Yellow Mosaic Virus and Its Related Non-Infective Antigen of Labelled Amino Acids," *Biochim. Biophys. Acta* 13, 307.
- Kassanis, B., 1957. "Some Effects of Varying Temperature on the Quality and Quantity of Tobacco Mosaic Virus in Infected Plants," *Virology* 4, 187.
- Kassanis, B., 1959. "Comparison of the Early Stages of Infection by Tobacco Mosaic Virus and its Nucleic Acid," *J. Gen. Microbiol.* 20, 704.
- Kelly, S. M., and Black, L. M., 1949. "The Origin, Development and Cell Structure of a Virus Tumor in Plants," *Am. J. Bot.* 36, 65.
- Knight, R., and Tinsley, T. W., 1958. "Some Histological Observations on Virus-Infected *Theobroma cacao* L.," *Ann. Appl. Biol.* 46, 7.
- Kunkel, L. O., 1924. "Histological and Cytological Studies on the Fiji Disease of Sugar Cane," *Bull. Exp. Sta. Hawaiian Sugar Planters' Assn.* 3, 99.
- Lackey, C. F., 1954. "Histological Changes Produced by Virus Yellows in Sugar Beet Leaves," *Proc. Am. Soc. Sugar Beet Tech.* 8, 225.

- Lee, C. L., 1955. "Anatomical Changes in Sweet Clover Shoots Infected with Wound-Tumor Virus," *Am. J. Bot.* 42, 693.
- Lemmon, P., 1935. "Comparative Studies on Metabolism of Healthy and Mosaic-Infected Tobacco Leaves: Respiration Studies," *Am. J. Bot.* 22, 912.
- Loebenstein, G., 1959. "Effect of a Virus Infection in Sweet Potatoes upon the Host Plant Respiration," *Virology* 9, 62.
- Loring, H. S., and Waritz, R. S., 1957. "Occurrence of Iron, Copper, Calcium, and Magnesium in Tobacco Mosaic Virus," *Science* 125, 646.
- McElroy, W. D., and Nason, A., 1954. "Mechanism of Actions of Micronutrient Elements in Enzyme Systems," *Ann. Rev. Plant Physiol.* 5, 1.
- Maramorosch, K., 1957. "Reversal of Virus-Caused Stunting in Plants by Gibberellic Acid," *Science* 126, 651.
- Markham, R., 1951. "Physicochemical Studies of the Turnip Yellow Mosaic Virus," *Dis. Faraday Soc.* 11, 221.
- Markham, R. and Smith, K. M., 1949. "Studies on the Virus of Turnip Yellow Mosaic," *Parasitology* 39, 330.
- Martin, L. F., Balls, A. K., and McKimney, H. H., 1938. "The Protein Content of Mosaic Tobacco," *Science* 87, 329.
- Matthews, R. E. F., 1958. "Studies on the Relation between Protein and Nucleoprotein Particles in Turnip Yellow Mosaic Virus Infections," *Virology* 5, 192.
- Meneghini, M., and Delwiche, C. C., 1951. "The Multiplication of Tobacco Mosaic Virus in the Host Tobacco Plant," *J. Biol. Chem.* 189, 177.
- Meyer, B. S., and Anderson, D. B., 1952. *Plant Physiology*, second ed. (N. Y., Van Nostrand).
- Nason, A., Oldewurtel, H. A., and Propst, L. M., 1952. "Role of Micronutrient Elements in Metabolism of Higher Plants, I: Changes in Oxidative Enzyme Constitution of Tomato Leaves Deficient in Micronutrient Elements," *Arch. Biochem. Biophys.* 38, 1.
- Newmark, P., and Fraser, D., 1956. "Composition of an Abnormal Protein Present in Tobacco Plants Infected with Tobacco Mosaic Virus," *J. Am. Chem. Soc.* 78, 1588.
- Owen, P. C., 1955a. "The Respiration of Tobacco Leaves in the 20-Hour Period Following Inoculation with Tobacco Mosaic Virus," *Ann. Appl. Biol.* 43, 114.
- Owen, P. C., 1955b. "The Respiration of Tobacco Leaves after Systemic Infection with Tobacco Mosaic Virus," *Ann. Appl. Biol.* 43, 265.
- Owen, P. C., 1956. "The Effect of Infection with Tobacco Mosaic Virus on the Rates of Respiration and Photosynthesis of Tobacco Leaves," *Ann. Appl. Biol.* 45, 327.
- Owen, P. C., 1957a. "The Effect of Infection with Tobacco Etch Virus on the Respiration of Tobacco Leaves of Varying Ages in the Period between Inoculation and Systemic Infection," *Ann. Appl. Biol.* 44, 227.
- Owen, P. C., 1957b. "The Effects of Infection with Tobacco Mosaic Virus on the Photosynthesis of Tobacco Leaves," *Ann. Appl. Biol.* 45, 456.
- Owen, P. C., 1958. "Photosynthesis and Respiration Rates of Leaves of *Nicotiana glutinosa* Infected with Tobacco Mosaic Virus and of *N. tabacum* Infected with Potato Virus X," *Ann. Appl. Biol.* 46, 198.
- Pavillard, J., 1952. "Recherches sur la croissance des plantes virosées: virus et auxines," *Compt. Rend. Acad. Sci.* 235, 87.
- Pavillard, J., 1954. "La teneur en auxine des pommes de terre virosées," *Proc. Second Inter. Conf. Potato Virus Diseases*, p. 178.
- Pavillard, J., and Beauchamp, C., 1957. "La constitution auxinique de tabacs sains ou atteints de maladies à virus: présence et rôle de la scopoletine," *Compt. Rend. Acad. Sci.* 244, 1240.

- Peterson, P. D., and McKinney, H. H., 1938. "The Influence of Four Mosaic Diseases on the Plastid Pigments and Chlorophyllase in Tobacco Leaves," *Phytopath.* 28, 329.
- Porter, C. A., 1954. "Histological and Cytological Changes Induced in Plants by Cucumber Mosaic Virus (*Marmor cucumeris* H.)," *Contrib. Boyce Thompson Inst.* 17, 453.
- Pound, G. S., 1949. "The Effect of Air Temperature on Virus Concentration and Leaf Morphology of Mosaic-Infected Horseradish," *J. Agr. Res.* 78, 161.
- Pound, G. S., 1952. "Relation of Air Temperature and Virus Concentration to Mosaic Resistance in Cabbage," *Phytopath.* 42, 83.
- Pound, G. S., and Bancroft, J. B., 1956. "Cumulative Concentrations of Tobacco Mosaic Virus in Tobacco at Different Photoperiods and Light Intensities," *Virology* 2, 44.
- Pound, G. S., and Garces-Orejuela, C., 1959. "Effect of Photoperiod on the Multiplication of Turnip Mosaic Virus in Rape," *Phytopath.* 49, 16.
- Pound, G. S., and Weathers, L. G., 1953a. "The Effects of Air and Soil Temperatures on the Multiplication of Turnip Virus 1 in Certain *Nicotiana* Species," *Phytopath.* 43, 550.
- Pound, G. S., and Weathers, L. G., 1953b. "The Relation of Host Nutrition to Multiplication of Turnip Virus 1 in *Nicotiana glutinosa* and *N. multivalvis*," *Phytopath.* 43, 669.
- Pound, G. S., and Welkie, G. W., 1958. "Iron Nutrition of *Nicotiana tabacum* L. in Relation to Multiplication of Tobacco Mosaic Virus," *Virology* 5, 371.
- Rice, R. V., Lindberg, G. D., Kaesberg, P., Walker, J. C., and Stahmann, M. A., 1955. "The Three Components of Squash Mosaic Virus," *Phytopath.* 45, 145.
- Shepherd, R. J., and Pound, G. S., 1960a. "Influence of Boron Nutrition of *Nicotiana tabacum* on the Multiplication of Tobacco Mosaic Virus," *Phytopath.* 50, 26.
- Shepherd, R. J., and Pound, G. S., 1960b. "Magnesium Nutrition of *Nicotiana tabacum* in Relation to Multiplication of Tobacco Mosaic Virus," *Phytopath.* 50, 195.
- Sinclair, J. B., Geil, P. H., and Kaesberg, P., 1957. "Biophysical Studies of Wild Cucumber Mosaic Virus," *Phytopath.* 47, 372.
- Sisler, E. C., Duggar, W. M. Jr., and Gauch, H. G., 1956. "The Role of Boron in the Translocation of Organic Compounds in Plants," *Plant Physiol.* 31, 11.
- Skoog, F., 1940. "Relationships between Zinc and Auxin in the Growth of Higher Plants," *Am. J. Bot.* 27, 939.
- Spencer, E. L., 1941. "Influence of Nitrogen Supply on the Rate of Multiplication of Tobacco Mosaic Virus," *Plant Physiol.* 16, 663.
- Stanley, W. M., 1937. "A Comparative Study of Some Effects of Several Different Viruses on Turkish Tobacco Plants," *Phytopath.* 27, 1152.
- Steere, R. L., and Williams, R. C., 1953. "Identification of Crystalline Inclusion Bodies Extracted Intact from Plant Cells Infected with Tobacco Mosaic Virus," *Am. J. Bot.* 40, 81.
- Takahashi, W. N., 1947. "Respiration of Virus-Infected Plant Tissue and Effect of Light on Virus Multiplication," *Am. J. Bot.* 34, 496.
- Takahashi, W. N., 1955. "Anomalous Proteins Associated with Three Strains of Tobacco Mosaic Virus," *Virology* 1, 393.
- Takahashi, W. N., 1959a. "The Role and Occurrence of Noninfectious Proteins in Virus Synthesis," in Holton, C. S., ed., *Plant Pathology, Problems and Progress, 1908-1958* (Madison, Wisc., U. of Wisconsin Press).
- Takahashi, W. N., 1959b. "The Role of an Anomalous Noninfectious Protein in Virus Synthesis," *Virology* 9, 437.

- Takahashi, W. N., and Ishii, M., 1952a. "An Abnormal Protein Associated with Tobacco Mosaic Virus Infection," *Nature* 169, 419.
- Takahashi, W. N., and Ishii, M., 1952b. "The Formation of Rod-Shaped Particles Resembling Tobacco Mosaic Virus by Polymerization of a Protein from Mosaic-Diseased Tobacco Leaves," *Phytopath.* 42, 690.
- Takahashi, W. N., and Ishii, M., 1953. "A Macromolecular Protein Associated with Tobacco Mosaic Virus Infection: Its Isolation and Properties," *Am. J. Bot.* 40, 85.
- Thung, T. H., 1928. "Physiologisch onderzoek met betrekking tot het virus der bladrolziekte van de aardappelplant, *Solanum tuberosum* L.," *Tijdschrift. over Plantenziekten.* 34, 1.
- Thung, T. H., and Hadiwidjaja, T., 1951. "Groeistof in verband met virusziekte, in het bijzonder bij *Arachis hypogaea*," *Tijdschrift. over Plantenziekten* 57, 95.
- Van Rysselberge, C., and Jeener, R., 1957. "Plant Virus Synthesis and the Abnormal Protein Constituents of Infected Leaves," *Biochim. Biophys. Acta* 23, 18.
- Weathers, L. G., and Pound, G. S., 1954. "Host Nutrition in Relation to Multiplication of Tobacco Mosaic Virus in Tobacco," *Phytopath.* 44, 74.
- Wehrmeyer, W., 1957. "Darstellung und strukturordnung eines tabakmosaik-virus —einschlusskorpers in der zelle," *Naturwiss.* 43, 519.
- Welkie, G. W., and Pound, G. S., 1958. "Manganese Nutrition of *Nicotiana tabacum* L. in Relation to Multiplication of Tobacco Mosaic Virus," *Virology* 5, 92.
- Went, F. C., 1953. "The Effect of Temperature on Plant Growth. *Ann. Rev. Plant Physiol.* 4, 347.
- Whitehead, T., 1934. "The Physiology of Potato Leaf-Roll, I: On the Respiration of Healthy and Leaf-Roll Infected Potatoes," *Ann. Appl. Biol.* 21, 48.
- Wildman, S. G., 1959. "The Process of Infection and Virus Synthesis with Tobacco Mosaic Virus and Other Plant Viruses," in Burnet, F. M. and Stanley, W. M., eds., *The Viruses*, Vol. II (N. Y., Academic Press).
- Wildman, S. G., Cheo, C. C., and Bonner, J., 1949. "The Proteins of Green Leaves, III: Evidence of the Formation of Tobacco Mosaic Virus Protein at the Expense of a Main Protein Component in Tobacco Leaf Cytoplasm," *J. Biol. Chem.* 180, 985.
- Woods, A. F., 1902. "Observations on the Mosaic Disease of Tobacco," U. S. Department of Agriculture, Bureau of Plant Industry, Bull. 18, 1.
- Wynd, F. L., 1942. "Certain Enzymatic Activities of Normal and Mosaic Infected Tobacco Plants," *J. Gen. Physiol.* 25, 649.
- Wynd, F. L., 1943. "Metabolic Phenomena Associated with Virus Infection in Plants," *Bot. Rev.* 9, 395.

THE BIOLOGICAL ENVIRONMENT OF ROOTS

A. G. Norman

UNIVERSITY OF MICHIGAN

Soil-plant relationships are properly recognized to be highly complex. Because of interactions between factors, the investigator can rarely design rigorous experiments in the classical manner, in which all factors but one are maintained constant, while the one under study is varied. Moreover, problems of soil-plant relationships are usually approached on a disciplinary basis, which may mean that the investigator myopically concentrates on the group of factors closest to his own interests, ignoring all others. Each discipline may bring to bear on the problem all the resources available to it, which is good, but because some of the variables are not independent variables, there is a risk of oversimplification. Furthermore, all the factors to be considered in soil-plant relationships are not of equal weight when evaluated in terms of total plant growth, or yield of a particular plant part, as is customary.

Some components of the soil system, though readily recognizable as being variables in soils, may be relatively unimportant in causing demonstrable effects on plant yield or plant welfare. Much of soil biology, superficially at least, would appear to fall into this category. Certainly the weight to be given to some of the biological variables in the soil is not a matter of general agreement. The soil physicist has no difficulty in demonstrating a direct relationship between the supply of water or oxygen and plant growth. The physiologist can show direct relationships between the supply of available major nutrients and plant growth. Because the soil biologist cannot set up similar experiments with soil organisms as factors affecting the soil as a medium for plant growth, the significance of the presence of organisms is ques-

tioned. It is usual to recognize the role of soil organisms in organic-matter transformations but to ignore their presence when considering the physico-chemical events taking place on root surfaces.

Soil ecology

The world of the soil is a biological community of which the higher plant, supported by the soil, is a most important member, contributing as it does to the energy supply for the vast mass of the soil population. The microorganisms within the soil are, in truth, largely dependent on the higher plants, though at times one senses a desire on the part of microbiologists to prove that the higher plants are dependent on the soil microorganisms. It is only incidental that the activities of some organisms contribute to the nutritional support of higher plants.

There is a growing field of soil ecology in which consideration is given to the whole community of the soil. The microbiologist has isolated from soils an enormous array of organisms—bacteria, actinomycetes, fungi, algae, protozoa, etc.—with physiological capabilities of bewildering diversity, which in the great majority of cases cannot be related directly to the welfare of the higher plant. More is heard about disadvantageous organisms—the pathogens, parasites, cutworms, and nematodes that cause root injury to seedlings or established plants—than about the great company of unclassified soil inhabitants. Much of the time there is hardly a whisper about the soil fauna, which may account for a considerable part of the total living mass in the soil.

Garrett (1956) pointed out astutely that soil ecology is analogous to the better-known field of plant ecology, but in reverse. In the sequence of events leading to the climax situation, the successful organisms prepare the way for their replacement through the autogenic changes they produce in the habitat. "But whereas an autogenic succession of higher plants tends to improve the capacity of the habitat to support growth of the more specialized types . . . a succession of heterotrophic micro-organisms progressively depletes its substrate because this is finite and exhaustible, and so the end-point of the microbial succession is not a climax association but zero."

It is immaterial that plants can be grown satisfactorily in an environment that excludes all other organisms—as can animals. This is merely an experimental trick, in view of the unchallengeable fact that the normal environment is one in which organisms are numerous. Plant roots not covered by the rhizosphere mantle of microorganisms would be abnormal, but there is no clear evidence that this is either good or bad; it is only inevitable.

The soil environment

The study of the microbiology of soils presents some special difficulties, not sufficiently recognized, which are basic to the discussion of ecological relationships in soil. These difficulties arise because of the peculiar nature of soil as an environment. The science of bacteriology rests solidly on the classical, pure-cultural methods of the pioneers, just as the technology of the fermentation industries similarly depends on the exclusion of all but the selected organism. Whenever the bacteriologist has been confronted with situations involving mixed populations, he has been less successful in distinguishing the organisms that are of major significance from the hangers-on whose presence is inessential. Consider, for example, the state of our knowledge of the microbiology and ecology of the rumen flora, or that of ocean waters. As an environment, soil possesses the peculiarity that, except when waterlogged, it lacks continuity, and even more importantly, largely lacks substrate uniformity. The micro-environment of most soil organisms is a water film. Fungal mycelia may not be so limited, if in a zone of high humidity. Calculation of the internal surface of soils makes it evident at once that at field capacity or lower moisture content, the water film cannot be of sufficient volume to accommodate clumps, clusters, or colonies of bacteria, except in micro-pools or contact rings between soil particles. The effective discontinuity of the water film means also that there is no substrate uniformity. Not all soil water in a particular horizon contains the same nutrients, though there may be a measure of physico-chemical uniformity by reason of the equilibrium condition arising from the presence of the same array of clay minerals. Even this, however, might be only an average condition of innumerable micro-habitats—similar but not identical.

In surface soils there is little continuity or uniformity in the distribution of the primary energy sources of vegetative origin, but as decomposition proceeds, and synthesized microbial tissue is substituted for plant residues, the nutritional dissimilarities between micro-habitats are reduced. A common type of energy material may be progressively substituted for more dissimilar materials. In lower horizons or illuvial zones also, there may be a greater measure of substrate uniformity, though at the same time the microbial diet is leaner.

Fluctuations in the moisture level, by changing greatly the volume available for colonization by microorganisms, have disproportionate effects on the microbial world of the soil. This is probably the most potent single factor influencing soil-microbial activities, because in addition to these spatial considerations, moisture changes are accompanied by changes in the concentration of inorganic ions and of soluble

organic products. Although plant residues form the primary source of support for the soil population, the accumulating evidence suggests that soluble products, such as organic acids, may remain at detectable levels in soils even under aerobic conditions (Schwartz *et al.*, 1954), possibly as a resultant of adsorption phenomena with inorganic colloids. In general, however, the energy material supporting the soil microflora is largely insoluble, so that utilization depends on production of extracellular enzymes. The organisms supported are to be found in clumps and aggregations in the immediate vicinity of the fragment—not in dense colonial form, as on the surface of agar media, but nevertheless in communities linked together by common nutritional capabilities. These constitute the micro-habitats of the soil about which conventional bacteriological procedures supply no revealing information. Only if there is a high degree of nutritional uniformity can it be assured that there are many similar micro-habitats.

One of the great dilemmas of soil microbiology is the question of what constitutes an adequate and representative sample microbiologically. Should the sample be taken from a large composite, or would this tend to obscure differences of importance? Alternatively, should several very small samples be examined independently? If so, what weight is to be placed on differences between replicates? The very taking of a sample changes it to a degree. A sample, once taken, is destroyed and cannot be re-used.

About two decades ago much attention was given to apparent short-term or even rhythmic fluctuations of numbers of microorganisms in soil, and although within the context of the experiments these fluctuations seemed to be supported by the statistical analysis of the data, nevertheless their significance in terms of a discontinuous system of micro-habitats presented difficult problems of interpretation (Gray, 1938; James and Sutherland, 1940). Respirometric studies on a number of replicate soil samples do not suggest rhythmic changes or great eccentricities in behavior, nor, under constant environmental conditions, are there unexplainable peaks or troughs in oxygen uptake or carbon-dioxide evolution. Instead, after an early peak there is attained a steady state, trending only slowly downward. Any sort of physical disturbance of a soil is followed by a brief rise in microbial activity. The initial respiratory behavior of freshly taken soil samples is to be discounted because of this phenomenon. No doubt this arises because of the rupture and redistribution of microbial communities and the establishment of new micro-habitats.

The biochemical events in uncropped soil are reasonably well understood as a whole. Because of the versatility of many soil organisms, dissimilatory processes may lead to the same end-result, even though there may have been different sequences. Some biochemists consider

that the soil is analogous to a tissue, in which energy sources are metabolized and in which the over-all transformations can be ascertained without specific knowledge of the pathways, the enzymes, or (in the case of the soil) the organisms bringing them about. Some of the end-products, particularly nitrate, are directly available to plants, but, of course, they are removed only if and when roots penetrate into the soil mass and, as it were, tap the accumulated reserve.

This concept of soil microbiology, however, is not adequate, because there is now ample evidence to support the view that the microbiologies of cropped and uncropped soils are not identical. In other words, the invasion of previously root-free soil by an expanding root system is followed by great changes in the microbiology and biochemistry of the invaded soil. The microbiological environment of the roots is changed in response to the presence of the roots themselves. To a degree, therefore, roots determine their own immediate microbiological environment and microbial associates. One might say that in soil which supports vegetation there are two co-existing microbiological communities or systems: one in the immediate vicinity of roots, and the other in the zone not yet invaded by roots and at some distance from them. Just how far this distance may be is the subject of some controversy. The question, in effect, is: How far from a root does its significant influence extend? Certainly not far in millimeters, or perhaps in fractions of a millimeter; but the distance is not to be underestimated in the aggregate, because of the enormous total length and surface area of the root system of most plants (Dittmer, 1937; Pavlychenko, 1937).

It is unnecessary to recapitulate the evidence establishing the presence of a different soil flora in the immediate vicinity of roots. The descriptive microbiology of the rhizosphere has been well explored by cultural procedures and microscopic techniques (see Katznelson *et al.*, 1948; Clark, 1949). Healthy roots are virtually encompassed by a microbial mantle which is predominantly, but not exclusively, bacterial. The density is generally much greater than in uncropped soil, and many of the active forms seem characteristically to be somewhat less versatile nutritionally, to have lower synthetic capabilities, and to be more dependent on an external supply of growth substances and organic nitrogen compounds. Much of the information on the nutrition of rhizosphere organisms comes from Canadian workers directed or inspired by A. G. Lochhead. Their findings attest not merely to the richness and density of the rhizosphere flora but also to differences among the array of organisms present on the roots of different species in the same soil—an observation foreshadowed by R. L. Starkey many years earlier.

Now this is a circumstance of great significance, because it points to the underlying nutritional basis for the very existence of the rhizo-

sphere microflora. Clearly, in conventional bacteriological terminology, this is an "enrichment" phenomenon in response to an abrupt change in the nutritional state. Invasion by plant roots is hardly likely to be accompanied by the introduction of new organisms, though one has to be cautious about generalizations of this sort because one remembers that seed inoculation with rhizobia does result in the development of nodules on the roots in soils in which this organism is absent. However, the normal surface flora of seed and the rhizosphere population of the roots of seedlings grown therefrom do not seem to have much in common (Peterson, 1959; Rouatt, 1959). The rhizosphere population arises in response to, and is supported by, solutes leaking or exuding from the roots. This leakage is apparently a normal phenomenon, though poorly understood. The physiological aspects of this characteristic of plants have not been adequately investigated.

It is not known whether leakage occurs at a constant rate or is influenced by the nutritional status of the plant, its stage of maturity, or the condition of the root. It may well be an inevitable consequence of the existence, within roots, of apparent "free space" or "outer space," which is that part of the root volume readily accessible by diffusion to external ions in solution and from which active ion accumulation may take place. The free space may normally contain organic solutes originating in the cytoplasm of adjacent cells, these solutes in turn being lost by diffusion from the roots. From media containing sterile root systems, numerous amino acids and sugars have been identified (Rovira, 1956). Though there is no information on this point, a reasonable assumption might be that those regions of the root that are most active in water and ion uptake are also those from which the greatest amount of solute loss occurs.

On root surfaces and in the immediate vicinity of roots the distribution of organisms is less clearly colonial than in the soil remote from roots, because the leaking solutes or exudates presumably form a more or less continuous system in the water film between the roots and contiguous colloidal particles (Starkey, 1938; Rovira, 1956). Another consequence of the extension of roots into soil is that water is withdrawn in amounts controlled by the plant demand in relation to the soil water tension. It has already been pointed out that soil moisture changes may have disproportionate effects on the space available for growth of bacterial colonies. This must apply also to the rhizosphere, though as yet little attention has been given to the significance of moisture changes in the immediate vicinity of roots.

Recapitulating, then, the extension of roots into soil is accompanied by the introduction of soluble energy material and the withdrawal of water—both events which may be expected to cause major microbial responses. Nutritionally the rhizosphere has a considerable degree of

substrate uniformity and continuity, in contrast to the discontinuity of the micro-habitats in the zone not invaded by roots. These are two different microbiological worlds—different in physical arrangement and in nutritional status. One must not overemphasize this point, however, because although the extension of a root into soil may result in the introduction of new and more readily available energy sources, it cannot remove what was already present. The rhizosphere flora is, therefore, a superimposed population, arising in response to this new circumstance. One can suggest, as an analogy, the many changes that result in human populations when a large industrial plant is established in an area previously wholly rural. Perhaps there is a further lesson in this analogy, because a sociologist, charged with the responsibility of studying human factors in relation to the industrial operations, would surely not concentrate on the number and occupations of the rural inhabitants prior to this erection of the new plant.

The rhizosphere population and the population at some distance from the roots are both in contact with the same array of clay minerals—a circumstance which may impose some overriding physico-chemical similarities. Further, it would be misleading to paint too static a picture of the differences between these two zones. Roots, rootlets, and root hairs are constantly being produced as the root system enlarges and ramifies. At the same time, older roots become senescent, die, and are decomposed, particularly if the plant has a spreading adventitious root system.

Microbial antagonisms

Up to this point emphasis has been placed primarily on the influence of the nature of the substrate in determining those organisms that are currently active in micro-habitats or the rhizosphere zone. When the initial substrate is insoluble, there may be a sequence of active forms with physiological capabilities which fit together efficiently. In the rhizosphere such dependent sequences may be much less important, but in both situations antagonistic or antibiotic effects between organisms may be a potent factor in modifying the population. A great deal of attention has been given by pathologists to the study of pathogenic fungi in the root zone, particularly those that can live a normal saprophytic existence but are given a competitive advantage by their ability to invade roots. This is pictured as being an evolutionary escape from the competitive vigor of saprophytic life (Garrett, 1950). Implied in this theory also is the opinion that root-invading fungi may not be as vigorously competitive as saprophytes, and therefore may tend to be displaced and to disappear if over a period of time the opportunity of invading roots is not presented. The competition involved here

would seem to rest primarily on their relative abilities to deal with the prevailing substrate.

The adoption of management practices involving incorporation of crop residues has been reasonably successful in the control or suppression of certain troublesome root pathogens, which presumably have not been favored as saprophytes by the organic matter supplied. However, in any discussion of antagonism or competition between organisms the question of the production of microbial products that may have antibiotic effects must arise. If an organism indeed produces an antibiotic which can inhibit the growth of other soil forms, it may have a substantial competitive advantage and may become dominant over others equally well or better able to utilize the available substrate. The property of antibiotic production may therefore be a vital aid to survival in the intensely competitive microbiological world of the soil (Brian, 1957b).

This is not the place to review the controversy as to whether antibiotics are or are not produced in soil. Direct experimental proof of antibiotic production in normal soil is difficult but has been accomplished (Brian, 1957b). Some of the approaches made in this connection have been unrealistic, because they have failed to take into account the generally colonial habit and discontinuous distribution of soil organisms. It is hardly to be expected that the whole soil mass would be permeated by antibiotics that could be extracted and identified. Moreover, the antibiotic effects are revealed only by organisms inhibited by the particular product in question. To unresponsive organisms the antibiotic is merely a potential energy source which can be metabolized. Some have maintained that if antibiotics are produced in soil, they are of no consequence, because they will be immediately utilized by species to which they are not inhibitory. But this presupposes that at every point in the soil there is a wide array of viable forms capable of developing rapidly if an appropriate substrate appears. This is contrary to the concept of discontinuity, of colonial development in micro-habitats, and of varied persistence when the substrate is depleted.

It is well established that a substantial percentage of the microorganisms isolated from soil—bacteria, fungi, and actinomycetes—are antibiotic producers when cultured on laboratory media (Brian, 1951; Benedict, 1953). In a few cases the experiments have been extended to show production when inoculated into sterile soil supplemented with an energy source (see Brian, 1957b). Antibiotics have been detected and identified in fragments of plant material recovered from unsterilized soil (Wright, 1956a) and, perhaps significantly, from the decomposing seed coat after germination in soil (Wright, 1956b). The weight of the evidence, admittedly mostly indirect, is that microbial antago-

nisms in soil, which may greatly modify or limit the forms that develop, arise because of the production of microbial products with antibiotic properties. The affected zone may be very restricted; the effect of the antibiotic may well be only transitory; but at a particular locus the ecological result may be substantial.

It is necessary next to think out the implications this may have in the rhizosphere. Here the plant provides the energy sources in the form of solutes leaking from its roots. As a root elongates, a heavy population is rather quickly established on its surface, though the root tip itself seems to remain relatively free from microorganisms. Because solutes continue to leak from roots, any organisms on the surface or in the moisture film encompassing the root will have a continuing nutrient supply—a circumstance which is likely to provide some stability. If, in addition, microbial products with antibiotic properties are formed, it is unlikely that there will be the sequence of active forms that is characteristic of the decomposition of plant residues in soil. Furthermore, the rhizosphere population is to a degree protected against desiccation in periods of low soil moisture. Roots will even elongate into dry soil in which microbial activity, as measured by respirometry, is low. Either in moist or dry soils, therefore, the microflora in the immediate vicinity of the root surface is likely to persist as long as the root remains functional and solute leakage occurs. The germination of spores of pathogenic fungi in the vicinity may be repressed if fungistatic products are present (Jackson, 1957), or it may take place normally if, as saprophytes, these fungi are compatible with their neighbors. Some pathogens have an ectotrophic growth habit, ramifying extensively over the outside of the moist root but invading only infrequently by branch hyphae. Some of the troublesome damping-off pathogens seem relatively non-specific but not vigorously invasive.

The activities of the soil population, whether in the rhizosphere or in the soil at large, have long been regarded as primarily affecting the level and supply of nutrient ions, major and minor. In any discussion of interactions between soil organisms and higher plants, this effect, though indirect, is of prime significance. But the observation that microbial products may directly bring about changes in the roots introduces another consideration deserving more attention.

Some soluble microbial products may affect root-growth development and function if absorbed and translocated (Brian, 1957a; Norman, 1959). Less mobile products, similarly inhibitory, may influence root-hair proliferation locally and therefore adversely affect the welfare of the plant. A number of polypeptide antibiotics, including polymyxin, duramycin, circulin, novobiocin, and bacitracin, cause direct injury to root tissues at low concentrations. The polypeptide becomes quickly bound to absorption sites on root surfaces and in the accessible free

space, and it brings about at once some change in permeability, so that solutes, both inorganic and organic, leak from the tissue (Norman, 1955, 1960). Such injury is irreversible or irreparable, but in some cases it may be mitigated by simultaneous presentation of divalent cations. The induced leakage presumably resembles that which occurs normally and which supports the rhizosphere population, but it can be vastly greater in amount. Affected areas, perhaps occurring initially only at point loci, would probably enlarge, because the solutes released would support additional microbial growth and polypeptide production. These injured areas could constitute ready portals of entry for weakly invasive pathogens, particularly those of ectotrophic habit, if they themselves are not antagonized by the antibiotic. The apparent abrupt collapse in resistance to damping-off organisms exhibited by certain seedlings may have its origin in this phenomenon, which has not hitherto been considered in discussions of root invasion by weakly pathogenic fungi.

Epilogue

In summation, the picture of the microbiological world of the soil presented in this review is one of complex communities fiercely competitive for food, at times greatly modified or limited by antibiotic effects. This population is seen in its simplest form in subsurface horizons of fallow or uncropped soil. When higher plants are present, either in the natural vegetation or through cropping, the economy is changed, and new and quite different communities develop in the immediate vicinity of root surfaces. The plant itself is the major member of these communities, which arise as a result of its presence. The intimate ecology and biochemistry of the rhizosphere zone is much more involved than that of soil at a distance from roots, because of the phenomena of root leakage and antibiotic production. There are interactions among the dominant saprophytic forms. There are interactions between saprophytes and root pathogens which may determine whether or not the roots are invaded. There are interactions between the saprophytes and the higher plants, in that products of the former may adversely affect the growth and possibly the functioning of roots, or, if adsorbed, may cause tissue damage which can increase the probability of invasion by pathogens.

Some soil chemists and plant physiologists tacitly limit themselves to the study of a system in which the plant is the only living member. They deal either with the 3-phase system of root, water, and clay minerals, or the even simpler 2-phase system of root and water with ions in solution. It may be appropriate to conclude with a plea that the presence of microorganisms in the root zone not be overlooked, either

in physico-chemical studies or in nutritional studies. Microbial surfaces contain active exchange sites. The effective exchange capacity in the vicinity of roots is likely to be much higher than that of the inorganic soil colloids alone, and it must surely affect the concentration and array of ions that can enter the free space of the roots. Microbial products may indirectly or directly affect the solubility of nutrient ions. Some cycling of nutrients, particularly nitrogen, may take place in the rhizosphere zone. Root exudates are reported to have a relatively narrow carbon/nitrogen ratio and to contain amino acids which would be quickly deaminated. This nitrogen would either be temporarily immobilized as microbial protein or be re-absorbed by the plant.

References

- Benedict, R. B., 1953. "Antibiotics Produced by Actinomycetes," *Bot. Rev.* 19, 229.
- Brian, P. W., 1951. "Antibiotics Produced by Fungi," *Bot. Rev.* 17, 357.
- Brian, P. W., 1957a. "The Effects of Some Microbial Metabolic Products on Plant Growth," *Symp. Soc. Exp. Biol.* 11, 166.
- Brian, P. W., 1957b. "The Ecological Significance of Antibiotic Production," in Williams, R. E. D., and Spicer C. C., eds., *Microbial Ecology* (N. Y., Cambridge U. Press).
- Clark, F. E., 1949. "Soil Micro-Organisms and Plant Roots," *Adv. Agron.* 1, 241.
- Dittmer, H. J., 1937. "A Qualitative Study of the Roots and Root Hairs of a Winter Rye Plant," *Am. J. Bot.* 24, 417.
- Garrett, S. D., 1950. "Ecology of the Root-Inhabiting Fungi," *Biol. Rev.* 25, 254.
- Garrett, S. D., 1956. *Biology of Root-Infecting Fungi* (N. Y., Cambridge U. Press).
- Gray, P. H. H., 1938. "Microbiological Studies of Appalachian Podzol Soils, III: Synchronous Changes in Bacterial Numbers in Two Field Soils," *Canad. J. Res. C.* 16, 145.
- Jackson, R. M., 1957. "Fungistasis as a Factor in the Rhizosphere Phenomenon," *Nature* 180, 96.
- James, N., and Sutherland, M. L., 1940. "Fluctuations in Numbers of Bacteria in soil," *Canad. J. Res. C.* 18, 435.
- Katznelson, H., Lochhead, A. G., and Timonin, M. I., 1948. "Soil microorganisms and the Rhizosphere," *Bot. Rev.* 14, 543.
- Norman, A. G., 1955. "The Effects of Polymyxin on Plant Roots," *Arch. Biochem. Biophys.* 58, 461.
- Norman, A. G., 1959. "Inhibition of Root Growth and Cation Uptake by Antibiotics," *Soil Sci. Soc. Am. Proc.* 23, 368.
- Norman, A. G., 1960. "The Action of Duramycin on Plant Roots," *Soil Sci. Soc. Am. Proc.* 24, 109.
- Pavlychenko, T. K., 1937. "Quantitative Study of the Entire Root Systems of Weed and Crop Plants under Field Conditions," *Ecology* 18, 62.
- Peterson, E. A., 1959. "Seed-Borne Fungi in Relation to Colonization of Roots," *Canad. J. Microbiol.* 5, 579.
- Rouatt, J. W., 1959. "Initiation of the Rhizosphere Effect," *Canad. J. Microbiol.* 5, 67.

- Rovira, A. D., 1956. "Plant Root Excretions in Relation to the Rhizosphere Effect," *Plant and Soil* 7, 178.
- Schwartz, S. M., Varner, J. E. and Martin, W. P., 1954. "Separation of Organic Acids from Several Dormant and Incubated Ohio Soils," *Soil Sci. Soc. Am. Proc.* 18, 174.
- Starkey, R. L., 1938. "Some Influence of the Development of Higher Plants upon the Micro-Organisms in the Soil, VI: Microscopic Examination of the Rhizosphere," *Soil Sci.* 45, 207.
- Wright, J. M., 1956a. "The Production of Antibiotics in Soil, III: Production of Gliotoxin in Wheatstraw Buried in Soil," *Ann. Appl. Biol.* 44, 461.
- Wright, J. M., 1956b. "The Production of Antibiotics in Soil, IV: Production of Antibiotics in Coats of Seeds Sown in Soil," *Ann. Appl. Biol.* 44, 561.

PLANT ROOT-SOIL INTERACTIONS*

Hans Jenny

UNIVERSITY OF CALIFORNIA, BERKELEY

The boundary phenomena of root and soil include observations of long standing. Designating a root as , the opposing processes in the boundary region may be represented schematically as follows:

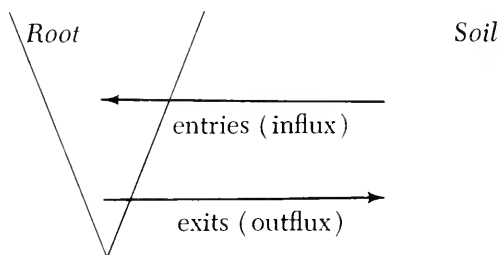

Non-living matter that *enters* the root may in part be arranged as follows: (1) Water-flow from the soil into the root as a consequence of transpiration pull and diffusion gradients (Bonner, 1959; Bernstein *et al.*, 1959). (2) Entry of dissolved substances with the transpiration stream (Hylmo, 1958) and by diffusion (Hope and Stevens, 1952; Robertson, 1956, 1958). These may be subdivided as (a) gases, especially oxygen and carbon dioxide; (b) mineral nutrients, mainly as inorganic ions; and (c) organic molecules (and ions) of low and high molecular weight—as high as 63,000, represented by hemoglobin (Jensen and McLaren, 1960). It is well established that the mineral influx is to some

* This work was in part supported by Atomic Energy Commission Contract AT(11-1)-34.

extent selective and not directly proportional to the concentration of the soil solution. Some ions, especially potassium, are taken up preferentially; others, such as calcium, are partly excluded.

Matter that *leaves* the root may be grouped as follows: (1) Water, which may be lost from roots in dry soil (Breazeale, 1930; Stone, 1957). (2) Carbon dioxide, produced by root respiration. (3) Nutrient ions, as leakage when the salt concentration in the root is high (Helder, 1956), or, when it is low, in the presence of clay (Jenny and Overstreet, 1939). (4) Protons diffusing out from the organic-acid pool (Overstreet *et al.*, 1942), possibly not related to respiratory CO₂. (5) A flow of electrons, as postulated by Lundegårdh (1958). (6) Organic substances, *e.g.*, organic acids. Information is meager and conflicting, and it is difficult to separate active excretion from mere autolysis—*viz.*, the release of material from injured and dying cells (Fuss, 1956; Helder, 1956; Starkey, 1958).

The fluxes take place in the liquid phase, but such a statement is too broad to be meaningful. Although growth media consisting of quartz sand and nutrient solution conform to the common idea of liquid phase and solid phase, in fine-textured soils, in which colloidal particles abound, the sharp distinction between solid and liquid becomes blurred, and boundary and surface phenomena become increasingly important.

Model of root-soil boundary region

The patterns of influx and outflux are bound to be influenced by the submicroscopic architecture of the root surface. An attempt is made in Figure 1 to portray the boundary zone as it might be envisaged

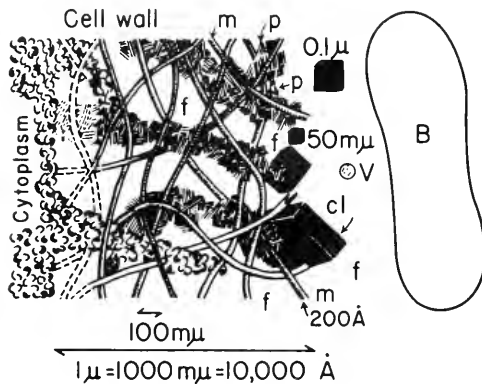

Figure 1. Model of root-soil boundary region, based on the work of Frey-Wyssling and of Scott *et al.* The cell wall consists of cellulose microfibrils (*m*), pectic substances (*p*), and free space (*f*), the pore diameter of which is exaggerated. The thin plasma membrane, 30-50 Angstrom in diameter, at the boundary of cytoplasm and cell wall is shown, but sketchily. The black bodies are clay particles (*cl*); *B* is a small bacterium; *v* is a virus particle.

from the work of Frey-Wyssling (1954) and of Scott *et al.* (1956). The diagram emphasizes the following prominent structural features of the root: (1) The frame structure of the cell wall (one micron thick), composed of relatively inert cellulose fibrils (m), about 200 Angstrom units in diameter. (2) The pore spaces, or free spaces (f), of ultramicroscopic proportions, filled with water, solute, and gases. (3) Interfibrillar material (p), composed of pectic substances, hemicelluloses, etc., which possess reactive carboxyl, alcoholic hydroxyl, and possibly other groups. The irregular cross-hatching denotes localized areas of oriented thread molecules. (4) Cytoplasm, with strands into the cell wall. Outside the root (right-hand side of drawing) is a portion of the soil phase. The black parallelepipeds denote colloidal clay particles of various sizes, or iron-oxide grains and rods; the round and oval areas represent a virus (V) and a small bacterium (B). Ordinary molecules and ions are too small to be shown. In the water-saturated state the blank areas represent the solution phase—pore solution in the cell wall and soil solution on the outside. The two intercommunicate freely.

In the solution phase, entry of ions and molecules into the root is considered akin to conditions that exist in a culture solution. For these the investigations accomplished are legion. They will not be examined here, as excellent surveys have recently been published (Robertson, 1956, 1958). Rather, we shall focus attention upon the interaction of the gel frame structures, represented by close-packed stacks and arrays of clay particles, and by the aggregates of intermicellar material in the cell wall.

Ion-exchange properties of soils and roots

The knowledge that soils, specifically clays, possess ion-exchange properties is over a century old (Deuel and Hostettler, 1950). During eleven decades and on tortuous paths, countless soil chemists have explored and clarified the base-exchange process experimentally. They have developed theoretical models on thermodynamic and kinetic grounds and on the basis of Donnan equilibria. With the onset of the resin industry, ion exchange has become a scientific and technical commonplace. In recent years it has been applied to roots.

Briefly, ion exchange with clays is stoichiometric and is represented by equations such as the following:



At times it is advantageous to stress the colloidal nature of the clay

particles, and the reactions are then written, for example, as follows, the rectangles denoting clay:

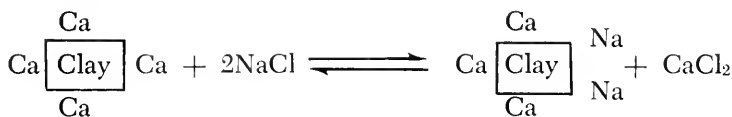

The extent of exchange depends on many factors, such as the nature of the clay mineral, the salt concentration, the nature of the anion, and particularly the sizes and the charges of the participating cations (lyotropic series, valency series).

From the standpoint of plant nutrition and root-clay interactions, the following exchanges deserve special consideration:

hydrolysis:

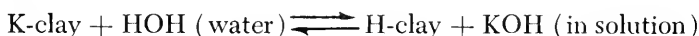

carbonic acid exchange:

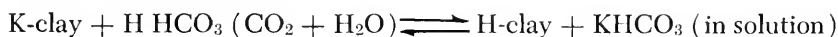

The carbon-dioxide reaction assumes importance in the vicinity of the root surface, where a high CO_2 gradient is assumed to exist.

Excepting the early (1916) work of Devaux (Mehlich and Drake, 1955), McGeorge was one of the first to demonstrate exchange properties of roots (Mehlich and Drake, 1955). Soon afterward workers in California (Jenny and Overstreet, 1939; Williams and Coleman, 1950) and in Sweden (Wiklander, 1957) became active in this field, and in recent years, partly due to the stimulation by Drake (Drake *et al.*, 1951), the ion-exchange capacities of roots have been studied in many parts of the world (Blanc, 1958; Helmy and Elgabaly, 1958). Keller and Deuel (1957) demonstrated that the majority of exchange sites in roots are attributable to carboxyl groups.

Pertinent are the experiments of Williams and Coleman (1950) on the exchange isotherms of the outer portions of the living root. The reactions were confined to surface regions by restricting the exchange process to a duration of only ten seconds. These investigators prepared living H-roots by immersing roots of intact plants in distilled water saturated with carbon dioxide. The roots were then rinsed repeatedly in distilled water to remove occluded CO_2 . The washed roots were dipped for ten seconds into dilute, neutral K_2SO_4 solution. Immediately the salt solution turned acid. Titration curves revealed the presence of H_2SO_4 , not H_2CO_3 or malic acid. The reaction may thus be depicted as H-ion exchange:

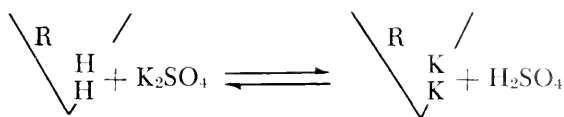

or, more specifically:

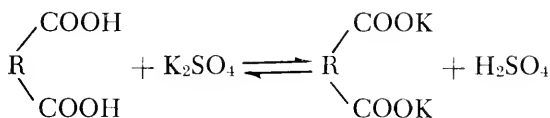

This reaction—also repeated with the organic cation methylene blue (M.B.) as exchangeable ion on the root—disclosed strong lyotropic and valency series. M.B. was displaced most effectively by HCl, least by LiCl. The series, typical of colloidal systems, reads:



Significant is the excess uptake of Ca over K, as high as 6:1. Deuel and others (1953) report high Ca adsorption by pectin resins.

The intensity of exchange per 100 grams of fresh roots was about the same whether the reaction occurred at 25° C. or at 0° C. or whether the roots were dead or alive.

Clearly these reactions are *non-metabolic exchange reactions*. That this is so is confirmed by the reverse behavior of these ions in metabolic uptake. Potassium is accumulated by roots in much larger quantities than calcium. For radish seedlings Hassan and Overstreet (1952) found a K:Ca ratio of 2.8. Their ionic series for metabolic uptake reads as follows:

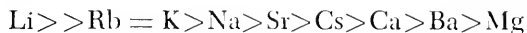

In contrast to non-metabolic exchange, the divalent ions are at the end of the series.

Epstein and Leggett (1954), using radioactive strontium, extended the work on differentiation between non-metabolic exchange adsorption and metabolic accumulation. In particular they showed that exchangeable strontium in the root slowly becomes non-exchangeable—that is, metabolically utilized.

Generally speaking, ion-exchange phenomena and colloidal behavior are customarily approached from two entirely different viewpoints. The first is the electric double-layer concept of Helmholtz and Gouy, and its recent developments (Booth, 1953), according to which the exchangeable ions form an ion swarm or ion cloud around the

colloidal particle. It governs exchange, and determines electrokinetic behavior. The second is the Donnan membrane equilibrium, which stresses the electrolyte nature of colloidal systems. It has been productive in describing the bio-ionic potentials of ion-exchange membranes (Helfferich, 1956; Robertson, 1956).

Flow and counter-flow of ions between root and soil

In one of the earliest quantitative experiments (Jenny and Cowan, 1933) on two-way migrations of ions in root-soil systems, soybean seedlings were grown for 35 days in a pure Ca-clay suspension which had an initial pH of 6.3. The plants removed from the clay 1.02 milliequivalent (m. eq.) of calcium, whereas the clay gained simultaneously 0.95 m. eq. of exchangeable hydrogen—a nearly equivalent exchange.

In standard Hoagland solution, barley plants accumulate large quantities of nutrients. They develop "high-salt roots." Transferred to distilled water, these roots will leak appreciable amounts of potassium. But plants raised in dilute Hoagland solution develop "low-salt roots." Tenaciously they hold on to their nutrients, and the release of potassium to distilled water is nil or negligible. Four grams (dry-weight basis) of excised, low-salt barley roots were leached continuously for ten hours with 380 liters of distilled water (Jenny and Overstreet, 1939). The potassium content was but slightly lowered: 2.1 per cent, from 43.1 to 42.2 m. eq., which is within experimental error and root variability.

Clay suspensions, on the other hand, drastically deplete low-salt roots by a two-way flow of ions. As the results have been reported previously (Jenny and Overstreet, 1939; Jenny *et al.*, 1939), they will be merely sketched here.

1. Excised, low-salt roots were immersed in dilute K-H-clay suspension. The roots absorbed potassium ions and increased their potassium content by 28.5 per cent; at the same time they lost calcium ions to the clay, to the extent of 22.2 per cent of their supply.

2. When placed in Ca-H-bentonite sols, corresponding roots took up calcium ions (6.4 per cent of their initial content) but experienced a loss of potassium of 19.4 per cent.

3. Roots (4.51 grams, oven-dry basis) of intact barley plants containing radioactive potassium were placed in K-Ca-bentonite suspensions (0.35 per cent). After five hours the roots had given off 0.114 m. eq. of their potassium to the suspension, as detected by radioactivity of the clay. At the same time the roots accumulated 1.155 m. eq. of potassium from the clay suspension. Potassium ions must have moved simultaneously in both directions—from root to clay and from clay to

root. Similar relationships existed for sodium systems. Ion uptakes, as usually measured, are net-influxes.

Ratner (Jenny, 1952) also has observed extensive desorption by clay of potassium from roots, and even from stems and leaves. It is important to record that in all trials the roots and plants always appeared healthy and revealed no physiological signs of root injury.

An interesting valence effect of ion uptake from colloidal systems, advanced by Mattson (Mattson, 1948; Wiklander, 1955), states that in any colloidal system—root or soil—the adsorption of bivalent ions in relation to univalent ions is favored by high exchange capacities. Since legume roots often have considerably higher exchange capacities than grass roots do, the former should have, and do have, higher Ca/Na ratios than the latter, when grown in the same nutrient medium. Conversely, for a given plant species, its Ca/Na ratio should decrease as the soil's exchange capacity increases. Elgabaly and Wiklander (Wiklander, 1955, 1957) noted that the Ca/Na ratio of barley roots was 0.72 when grown in kaolinite suspension (low exchange capacity), and only 0.45 when grown in bentonite suspension (high exchange capacity). It is somewhat surprising that this theorem operates with living roots, since the uptake of ions is strongly controlled metabolically whereas the valence effect operates non-metabolically.

Though significant from the point of view of growth, these observations on plant-soil interactions provide no clue to the mechanisms involved in the counter flow of ions. The aforementioned hydrolysis of exchangeable ions may play a part, also the exchange with H_2CO_3 produced by respiration.

Jenny and Overstreet (1939) suggested an additional mechanism of interaction—the *contact* model, or *contact-exchange* theory. Briefly, if root surfaces and clay particles are brought together so closely that their electric double layers (cation swarms) intermingle, a mutual transfer of ions is facilitated. In other words, the exchangeable ions of root and soil are credited with reactivity in the root-soil contact zone, independently of the soil-solution processes.

Two-phase experiments

In a strict sense the contact model can neither be proved nor disproved. But certain consequences of surface interaction may be examined by separating the participating phases in one way or another. For instance, plants may be grown in a clay suspension and in a solution which is in equilibrium with it, the two resembling the two phases of a classical Donnan system. In fact, two-phase experiments have become the key criterion for assessing the direct contribution of exchangeable ions in plant nutrition and the plausibility and range of applica-

tion of the contact theory, provided that rival mechanisms can be ruled out. Under ideal conditions two requirements must be met: (1) at the start of the experiment the separate phases must be in equilibrium with one another; (2) during the experiment the composition of the phases should not change.

In the presence of plants the second condition cannot be fully met. It is approached by making the phases large enough so that additions and withdrawals of ions will not significantly change the composition of the phases. If the deviations from ideal conditions are marked, the interpretation of the results becomes correspondingly uncertain.

Two-phase experiments are performed in various ways. In one set of tests Jenny, Overstreet, and Ayers (1939) separated the suspension and solution phases by a cellulose membrane which permitted ready passage of potassium ions but not of clay particles. This barrier reduced the diffusion rates of cations by only 10 per cent. Batches of excised barley roots which had accumulated radioactive potassium were permitted to interact for twelve hours with the K-clay suspension directly, in the absence of the membrane, and indirectly, with the membrane present. Release of root potassium was determined by counting the gain in radioactivity of the liquid. The following values were obtained: with no membrane between the root and clay, 76.4 ± 5.8 counts per minute; with membrane between the root and clay, 6.8 ± 1.8 c.p.m.

Inserting the membrane brought depletion of the potassium of the root nearly to a standstill. Petersburgski (1959) also used membranes to investigate a solid-phase influence on growth.

A similar type of two-phase experiment (Lopez-Gonzales and Jenny, 1958) is illustrated in Figure 2. At the outset the large vessel held 700 ml. of water, containing 122 m. eq. of tagged $\text{Sr}(\text{OH})_2$. Beads of H-resin (34.26 g.) were added. Weeks later the bulk of the $\text{Sr}(\text{OH})_2$ had been consumed by the resin, and the solution—now also



Figure 2. Two-phase experiment. Roots are shown in a Sr-resin slurry and in equilibrated solution phase.

in equilibrium with air—contained only 2.2μ eq. of strontium. Without discarding any part of the solution or solid, the strontium resin was scooped into a short, vertical lucite tube, the bottom end of which is open and covered with nylon gauze. If final equilibrium had not been achieved (which could not be determined precisely) the error was in favor of the solution phase.

Roots of alfalfa seedlings were immersed for 18 hours in the equilibrium solution and in the resin slurry. The solution plants acquired 2.8μ eq. of strontium, and in doing so reduced the strontium content of the solution by only 12 per cent. The slurry-plants accumulated 17.8μ eq. of strontium—a five-fold increase.

In a second type of two-phase experiment, a large volume of clay suspension is centrifuged or passed through an ultrafilter to obtain a large quantity of supernatant liquid or dialysate. Plants are then grown in the original suspension and in the separated phase (Scheuring and Overstreet, 1961). Or, if only a small amount of ultrafiltrate is obtained, a large volume of artificial analogue solution is used as the phase partner (Jenny, 1952). As a modification, carbon dioxide is passed through the clay sol, and an ultrafiltrate is obtained which supposedly simulates conditions near the root surface (Overstreet and Jenny, 1939).

A third type of two-phase experiment employs the double-column or two-pot technique. Soil is in one vessel, inert sand in the other, and both are shunted, either in parallel or in series (see Figure 6). A common nutrient solution continually circulates through both vessels, by pump lifting and gravity flow. A detailed illustration is presented in the ensuing sections.

Ion transfer: a rate problem

Amberplex-C-1 membranes, manufactured by Rohm and Haas Co., consist of a frame structure of thread molecules carrying negative charges, mainly as sulfonic-acid groups. They may be neutralized by cations, which are then exchangeable.

In a wet, swollen condition, H-amberplex is 0.80 mm. thick. A slab one square centimeter in cross-section contains 0.127 m. eq. of H^+ , or 2.57 m. eq. per gram of oven-dry membrane. In the wet membrane the mean distance between two exchange sites is 10 Angstrom units. If the exchangeable cations are considered dissolved in the total water content of the membrane, their concentration corresponds to 4.7 normal. According to H. El Hamawi, the H-membranes have a pore space, or "free space," of 9.70 per cent, as determined by HCl uptake (Hope and Stevens, 1952). For calcium membranes the free space is 7.90 per cent.

TABLE I

Transfer of Strontium from Strontium Membrane (195 μ eq. Sr) to H-Membrane via Solution and by Contact

Time (hours)	Transfer of Sr to H-membrane		Ratio, Contact to Solution
	Via Solution μ eq/disc	By Contact μ eq/disc	
24	—	50	—
48	—	82	—
172	0.022	90	4091
560	0.072	—	—
1011	0.102	—	—
2090	0.104	—	—
∞ (equilibrium)	97.5	97.5	1.0

A strontium membrane was prepared by adding 195 μ eq. of $\text{Sr}(\text{OH})_2$, tagged with Sr^{85} , to an H-membrane disc (diameter of 2.08 cm.) which was floating in 150 ml. of water. After a reaction time of weeks the solution contained less than 0.54 μ eq. of strontium. Now a second, equivalent, H-membrane was introduced into the same beaker, such that it never touched the strontium partner. As anticipated, the H-membrane sorbed the strontium in solution; new strontium moved out of the strontium membrane and reacted with the second disc. Vigorous agitation of the solution phase insured that diffusion of strontium from one membrane to another through the centimeter-wide water gap was not a rate-limiting step. According to Table I (Lopez-Gonzales, 1959), transfer via the solution phase was exceedingly slow. It would take many years to distribute strontium in equal amounts

TABLE II

Uptake of Sr by Plants Tied to a Sr-H-Membrane
($\mu\text{g.}$ of Sr per gram of oven-dry material)

	Plants in Solution	Plants in Contact with Sr-membrane	Ratio, Contact to Solution
Leaves	0.005	0.023	4.6
Roots	0.298	0.641	2.2

between the two membranes (equilibrium state). But the table shows that when identical strontium and H-membranes were brought into direct contact under a pressure of five kilograms (see Figure 3), transfer of strontium was very rapid. Over 80 per cent of the equilibrium distribution was reached within 48 hours. Contact transfer was vastly superior to solution transfer. Either process, however, should lead to the same equilibrium state.

If the H-membrane is replaced by live roots, made to touch the strontium membrane by tying them to it with a string (Figure 4), the transfers, expressed as micrograms of strontium per gram of oven-dry material (Table II), are in favor of contact (Lopez-Gonzales and Jenny, 1958).

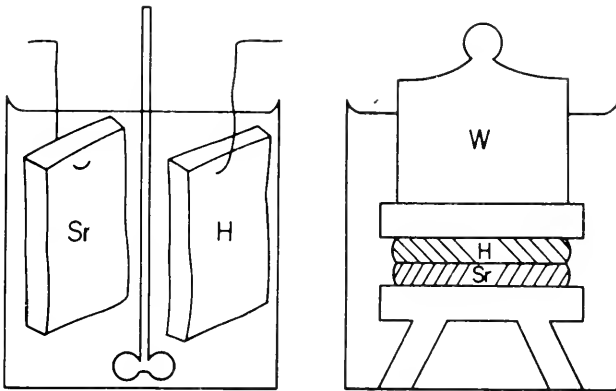

Figure 3. Rate experiment of solution transfer and contact transfer of strontium from a Sr-membrane to a H-membrane.

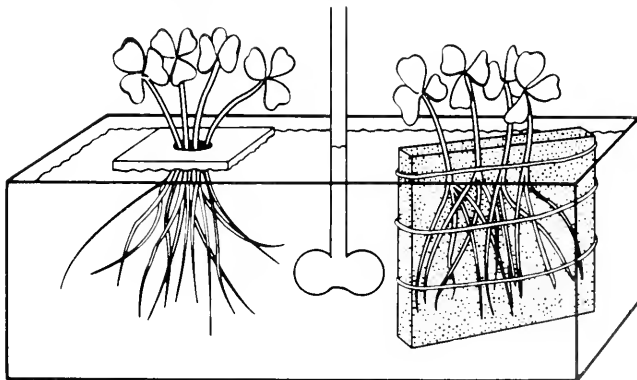

Figure 4. Roots tied to a Sr-H-membrane slab accumulate more strontium than roots in an equilibrium solution.

The slow transfer of strontium in the absence of contact may in part be attributed to a diffusion barrier (*e.g.*, Nernst water film) at the membrane-water and root-water boundaries. Boyd's and Helfferich's "film" diffusion (Boyd *et al.* 1947; Helfferich, 1956; Krishnamoorthy and Desai, 1953) will then be a rate-limiting step. Upon mechanical contact, the water films of the two membranes, or root and membranes, are bridged by the intermingling ion swarms, and direct particle-particle diffusion is initiated.

Mattson (1948) is of course correct when he states: "Whether the uptake of the ions by the roots takes place through direct contact of soil and roots or through the soil solution, the ultimate result should be the same where the three phases are in equilibrium." However, plant growth is a rate process far removed from equilibrium, and for a plant to grow rapidly, nutrients must be delivered to the root surface at a corresponding rate. As will be shown later, contact may become a matter of life and death to the plant.

Criticisms examined

Though widely accepted (Bartlett and McLean, 1959; Cerana and Bielsa, 1959; Deuel *et al.*, 1953; Ratner, 1954; Schweigart, 1956; Williams and Coleman, 1950; Wynd, 1951), the contact theory and its manifestations have been criticized on theoretical as well as on experimental grounds. In some instances a two-phase effect could not be observed (Lagerwerff, 1958; Vlamis, 1953); in others it could but was not explicitly recognized as such (Bernstein and Pearson, 1956). In a third group the effect was again present but was explained (Peterburgski, 1959) as an H_2CO_3 carrier problem—a viewpoint previously advanced (Overstreet *et al.*, 1942). We shall examine the most crucial cases.

Schuffelen (1954) asserted that plants growing in a clay suspension should be compared not with plants in its equilibrated, supernatant liquid or dialysate but with plants in an artificial salt solution which has the same cation activity as the clay suspension. In his experiments with equal cation activities, the clay suspension and the salt solution were equally effective.

Bartlett and McLean (1959), who reason like Schuffelen but used Marshall's technique of measuring cation activities in clay suspensions, observed a marked "contact effect"—a superiority of the clay sol over the equal-activity salt solution.

The activity approach presents an interesting and valuable attempt to assess the total ionic environment of the root. While it does not distinguish between two phases and does not recognize soil solution or ultrafiltrate, it explicitly takes for granted that adsorbed, exchangeable

ions, insofar as they contribute to activity, will react directly with the root.

Lagerwerff's (1956) experiments with Rb-clay suspensions containing RbCl led him to conclude that the two-phase effect is nil, that it has no plant physiological significance, and that the soil solution (ultrafiltrate) completely characterizes the ionic environment of the root.

Lagerwerff's technique differed from that of Jenny and Overstreet in the addition of RbCl to a Rb-clay suspension. Since salts rapidly diffuse into the free space of the root, whereas clay particles can interact only at the outer surface, solution ions are in a preferred condition for metabolic absorption, and they may overshadow contact exchange at relatively low concentrations.

Scheuring and Overstreet (1961) have re-investigated the competition for entry of solution ions and adsorbed ions. They mixed a 1 per cent Na-clay suspension with variable amounts of NaCl, up to ten m. eq./L, and after long standing obtained a large amount of ultrafiltrate for comparison with the unfiltered suspension. According to Figure 5, a two-phase effect exists at low salt concentrations but disappears at high ones.

Vlamiš (1953) examined by double-column technique a strongly acid soil to which he added fertilizer. He could not observe a two-

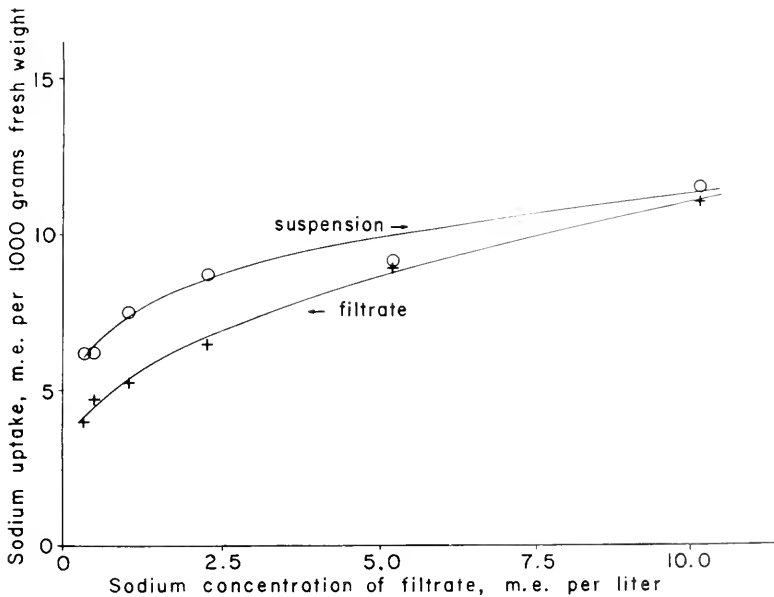

Figure 5. Experiment of Scheuring and Overstreet on the effectiveness of sodium-ion uptake by roots from mixtures of Na-clay + NaCl and from their ultrafiltrates.

phase effect. Lagerwerff (1958) carried out an elaborate double-pot experiment in which he added sand to one pot and a mixture of sand and resin grains (0.4 to 0.7 mm. in diameter) to the other. Nutrient solution circulated through both pots. Growth and nutrient uptake were alike in both pots; that is, no phase effect appeared. On the other hand, Lopez-Gonzales and Jenny (1958), using a very similar double-column technique with coarse Sr-resin particles, observed a 16.4-fold superiority of the resin column over the sand column.

These experimental discrepancies appear to be related to the very word "contact." To ascertain the existence of an exchangeable ion effect, it is imperative to provide a relatively large number of contact points between the root and the milieu, and a small quantity of ions in solution. To "disprove" particle influences, one simply chooses a medium with few contact sites but relatively high solution concentrations. For roots with low metabolic activity, either mechanism might supply sufficient nutrients to the root surface.

Quantitative experiment on density of contact sites

An experiment was designed to measure quantitatively the growth of alfalfa as conditioned by the number of contact sites between root surfaces and iron-oxide particles (Clauser and Jenny, 1960a).

In a double-column system, as shown in Figure 6, two tubes 17 centimeters long and two centimeters in diameter were arranged in series. The lower column was filled with purified quartz sand with grain sizes of 0.5 to 1.0 mm. diameter. The upper column was likewise charged with sand grains, but some of them had a thin coat of iron oxide. The coat had been prepared by dipping the quartzite grains into a sol of $\text{Fe}(\text{OH})_3$; drying at 105°C . produced stable brown coats of iron hydroxide in various degrees of dehydration. For brevity's sake, the expression Fe-sand will be used for these particles. The white and brown sand grains could be mixed in any desired proportion. CaCO_3 (0.5 per cent) was added to each column, and, with the aid of a pump, 0.1-strength, complete Hoagland solution was circulated every 15 minutes. Its pH was maintained daily between 7.5 and 8.5. At such high alkalinity iron is exceedingly insoluble.

Six alfalfa seedlings (*Medicago sativa*), eight days old, were planted in the columns. For analytical purposes each sextet of plants constituted one sample.

The experiment poses a number of questions which touch upon a broad spectrum of root-soil interactions: Fe-solubility, CO_2 influence, excretion of chelating substances, and contact *per se*. To answer them, pertinent treatments were included.

As a check, a double column was first charged only with white

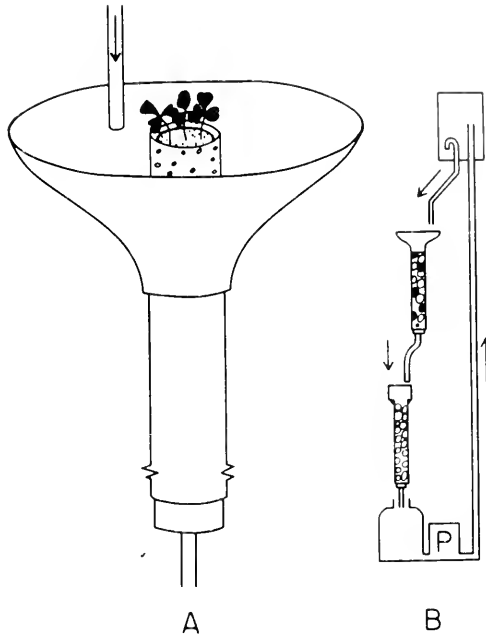

Figure 6. Diagram of a two-phase experiment by the double-column technique, with columns arranged in series (B). The upper column contains Fe_2O_3 -coated sand grains; the lower column (solution phase) contains sand grains only. A shows the arrangement for pouring solution in the upper column to prevent flooding of delicate seedlings.

sand; this is designated as Treatment I in Table III. In this case any uptake of iron by the plants had to come from contaminating iron in the circulating solution or from the white sand grains themselves. Therefore the upper and lower columns had to behave alike.

In the experiments employing Fe-sand, the excess of iron uptake over that in the check must come from the iron-coated sand grains in the upper column. If *solubility* of the Fe_2O_3 is crucial, the plants in the lower white-sand column should also benefit from it. To rule out the remote possibility that roots in the upper column might deplete it of all the dissolved iron and thus deprive the lower-column partner of its share, in one treatment (Treatment V) the upper column had Fe-sand but no plants; the lower column had white sands plus plants.

Roots are known to contain iron-chelating organic acids, and these have been linked to iron nutrition. Hutner *et al.* (1950) state: "It is difficult to understand, however, how plants could exist on a neutral or alkaline soil low in organic matter unless the root hairs excreted a metal-solubilizing substance such as citric and malic acid." Presumably the excreted organic acid would diffuse to the Fe-grains, chelate the iron, and diffuse back to the root as Fe-chelate. Since the percolating solution would carry a portion of the diffusing Fe-chelate to the lower column, its plants should exhibit partial growth at least.

TABLE III
Quantitative Contact Experiment

Treatment No.	Composition of Column	Plants Number	Color ^o	Dry weight (milligrams)	Iron content ^{o o} (micrograms)
I <i>u</i>	sand	6	y-w	87	3.6
I <i>l</i>	sand	6	y-w	75	3.9
II <i>u</i>	4% Fe-sand	6	g-y	183	8.3
II <i>l</i>	sand	6	y-w	78	3.8
III <i>u</i>	10% Fe-sand	6	y-g	308	14.4
III <i>l</i>	sand	6	y-w	81	3.4
IV <i>u</i>	20% Fe-sand	6	g	663	37.0
IV <i>l</i>	sand	6	y-w	66	3.7
V <i>u</i>	20% Fe-sand	—	—	—	—
V <i>l</i>	sand	6	y-w	69	3.6
VI <i>u</i>	20% Fe-sand (CO ₂)	—	—	—	—
VI <i>l</i>	sand	6	o-b	65	4.4

^o y = yellow; w = white; g = green; o-b = olive brown.

^{o o} The iron content of the plants is the means of four replicate sextets. Individual sextets are plotted in Figure 8.

The influence of carbon dioxide excretion is more difficult to evaluate. Average soil air contains 0.30 volume per cent of CO₂, and at that partial pressure the pH of a CaCO₃ solution is 7.8, still too high for solubilizing iron. Inside the root, carbon-dioxide pressures are high (Lundegardh and Burstrom, 1933), and conceivably at the root surface there might be pockets and cavities where the liquid phase is completely saturated with carbon dioxide. Under such conditions, and in the presence of solid CaCO₃, a pH of 6.3 obtains, and iron solubility would be in the realm of practical significance, as suggested by Chapman (1939) and Milad (1939). To assess the role of CO₂, Treatment VI (see Table III) was included. The upper column contained Fe-sand but no plants. Instead, CO₂ gas was continuously bubbled into it through a glass tube reaching to the bottom of the Fe-sand layer. The lower column was filled with white sand and was given to plants. The percolating solution was maintained at pH 6.3.

Three treatments measured contact effects proper. The upper column in Treatment II contained 4 per cent iron sand, in Treatment III, 10 per cent, and in Treatment IV, 20 per cent. There were six plants in each vessel. All the lower columns carried white sand with plants.

Each treatment was replicated four times, and the entire set—with

slight modifications—was repeated during various seasons, always producing the same pattern of results.

Growth and iron accumulation. As seen from Table III and Figure 7, the plants from the sand check (I) were yellow-white, tiny dwarfs, and so were all other plants in the lower columns. Moreover, all plant sextets had the same iron content, as determined by the bathophenanthroline method (Smith *et al.*, 1952). Evidently the specimen in the lower columns (except IV) did not receive iron from the Fe-grains above. This want casts serious doubt on the efficacy of iron solubility and of chelate excretion, as it operated in this experiment. In confirmation, whenever iron chelate Fe-EDTA was added to the yellow-white dwarfs they turned green and developed into healthy plants.

In the CO₂-set the plants were higher in iron—68 against 48 p.p.m.—but this gain was nullified by the poor growth in the CO₂-enriched percolating solution.

The plants in the upper columns improved in growth and color as the proportion of iron sand increased. As seen in Figure 8, the relationship between the mean iron contents of the entire plants (*Fe*)—as sextets—and the percentage of Fe-sand (*i*) is exponential

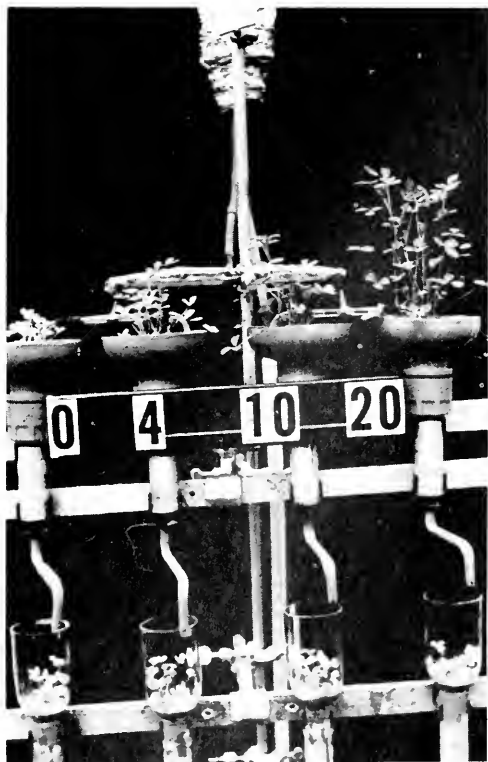

Figure 7. Double-column experiment showing the growth of alfalfa plants as influenced by the number of contact sites on the roots (in 0, 4, 10, and 20 per cent Fe₂O₃-sand).

$$\log \text{Fe} = 0.0480i + 0.634 \quad (r = 0.960)$$

or
$$\text{Fe} = 4.31 \cdot e^{0.110i}$$

Surface density of contact sites. Since the plant roots could not have grown unless they pushed the sand grains apart, the contact between the root surface and particles must have been intimate. It is appropriate to express the root-soil boundary as areas.

The minimal surface area of alfalfa roots was obtained by cutting individual roots into uniform segments, one to ten centimeters in length, measuring the diameter, and computing the surface as πld . The mean area of fresh roots of 12 entire root systems was 1.56 ± 0.042 square centimeters for one milligram of dry root, regardless of the size, age, or weight of the plants, as determined in separate trials.

Figure 9 shows that the iron content in the total plant is directly proportional to the minimal root surface area.

Experimentally, the mean number of Fe-sand grains per square centimeter of cross-section of the sand medium was found to be $1.98i - 0.20$ ($r = 0.969$). Within experimental error, this mean number (designated as ρ) is twice the Fe-sand percentage concentration.

Since six transplants had an average dry weight of roots of 3.6 milligrams, their fresh minimal surface area was 5.62 cm^2 . Immersed in sand, this root area was contacted by:

43 Fe-sand grains in Treatment II (4 per cent Fe-sand)

110 Fe-sand grains in Treatment III (10 per cent Fe-sand)

222 Fe-sand grains in Treatment IV (20 per cent Fe-sand)

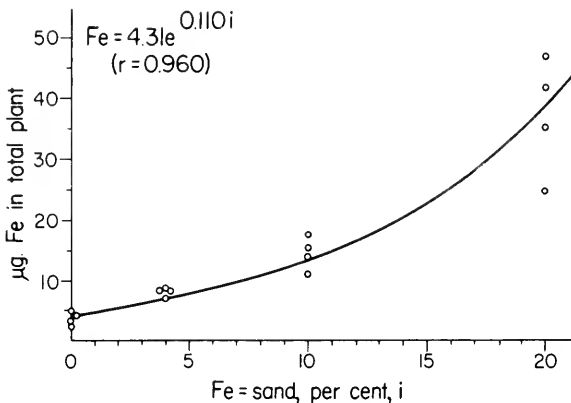

Figure 8. The uptake of iron by alfalfa plants, as related to the number of iron-oxide-coated sand grains (Fe-sand) in the growth medium.

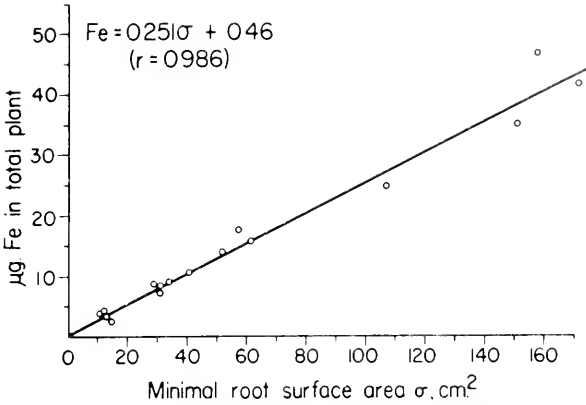

Figure 9. The uptake of iron by plants in relation to the minimal root-surface area.

These variations in the surface densities of contact sites set in motion the profound differentiation in growth rates shown in Figure 8.

Generalizing this conclusion for the entire experiment, by stating that *the rate of iron uptake is proportional to the number of contact sites on the root surface*, we formulate:

$$\frac{dFe}{dt} = k_1 \rho \sigma$$

where ρ is the density of Fe-sand grains per cm², σ the minimal surface area of the root, and k_1 a proportionality factor.

Neglecting in Figure 8 the minute intersect on the y-axis, the iron content of the plant is directly proportional to root area:

$$Fe = k_2 \sigma$$

$$\frac{dFe}{dt} = \frac{k_1}{k_2} \rho Fe,$$

$$\text{or } Fe = (Fe)_0 e^{\frac{k_1}{k_2} t \rho}$$

For a given age of the plant, and since $\rho \cong 2i$,

$$Fe = (Fe)_0 e^{ki}$$

which is the equation found empirically. It is not known how far beyond 20 per cent Fe-sand the equation retains its validity.

Contact decomposition of Fe_2O_3 and Fe-diffusion

The clear-cut relationship between iron uptake and the number of action sites on the root surface indicates acquisition of iron in a contact-microregion. Two questions immediately present themselves: By what chemical mechanism does the root surface acquire iron? How is the iron subsequently transported to the inner regions of the root?

Although chelate excretion and round-trip diffusion of chelate compounds is not a plausible cause in the present study, chelating molecules might reside on the root surface, as postulated for algae by Hutner (1947-48) and for yeast by Rothstein and Hayes (1956). After acquisition of iron by contact with Fe-sand, the chelate molecule could move inward as a mobile constituent of the cytoplasm, but in that case the cytoplasm would have to penetrate the cell wall, reach the root surface, and touch the Fe-sand, which is rather improbable. As an alternative, the chelating compound at the root surface might be firmly anchored in the non-living matrix of cellulose fibrils and pectic substances. If so, a specific reaction, presumably enzymatic, would have to break the bond between lodged chelate and Fe, releasing the iron ion into pore-space solution, from where it would have to reach the cytoplasm without being reprecipitated.

The CO_2 mechanism, though ruled out for niobium (Vlams and Pearson, 1950), remains a possibility for iron solubility at localized spots in the microregion of contact.

A third alternative, and a very effective one, is provided by the carboxyl groups of the interfibrillar pectic matrix that decompose Fe_2O_3 by contact. Grunes (Grunes and Jenny, 1960) has made a thorough study of this decomposition process, using iron oxide and amberlites, and Charley (Charley and Jenny, 1960) has tested it with H-roots. The acquired iron may migrate to the cytoplasm by exchange diffusion (Lopez-Gonzales and Jenny, 1959).

The two processes—decomposition of Fe_2O_3 and gel diffusion of Fe—may be examined simultaneously.

Plugs of H-roots. Twenty grams of fresh alfalfa roots were killed with ether, leached with dilute HCl, and washed thoroughly with distilled water. In this process they lost, on a dry-weight basis ($60^\circ C.$), 0.545 gram of material, including 0.0159 g. of nitrogen. The remaining H-root material (oven dried) weighed 0.747 g. and contained 3.84 per cent nitrogen. Its exchange capacity, as determined by the Ca-acetate method (Keller and Deuel, 1957), was 66.8 m. eq. per 100 g., oven dried. In a hydraulic press at 42 kg/cm^2 , the dry roots (2.5 g.) were compacted into a dense plug or disc, having a diameter of 1.91 cm. and a height of 0.90 cm. A lucite cell was constructed (Figure 10) which permitted study of iron transfer to roots from radioactive iron

oxide (dried, colloidal $\text{Fe}(\text{OH})_3$) in the presence and in the absence of contact, and in a CO_2 -saturated environment.

In *contact experiments* the lucite tube was filled with CO_2 -saturated water. The dry root plug was inserted and, after swelling had ceased, was evacuated to remove trapped air. An "iron-oxide lid" was then placed on top of the wet plug. It consisted of a lucite disc with five holes in it, the bottom side of which had partly fused-in particles of highly radioactive (Fe^{59}) iron-oxide grains, mixed with solid CaCO_3 . On top of the lucite disc was laid a cellulose membrane (Visking), and over it was sprinkled a layer of CaCO_3 powder. The total amount of carbonate was equal to the exchangeable H in the root plug. The lid was pressed upon the root plug (to which a few drops of toluene had been added) by a weight of 2.27 kg. In that condition the height of the wet root plug was 1.50 cm. The hollow space inside the pressing tube was filled with 15 ml. of water—designated as supernatant liquid—and CO_2 gas was continually bubbled into it.

In *solution experiments*, conducted identically except as stated, the iron oxide-lucite disc was suspended in the CO_2 -saturated, supernatant liquid. The root plug was held together, and pressed upon, by a lucite lid with 16 holes. It was also covered with a cellulose membrane sprinkled with CaCO_3 powder. To reach the roots, iron dissolved from the oxide grains in the presence of CaCO_3 , saturated with CO_2 (pH 6.3), had to diffuse through the Visking membrane and the pores of the disc resting on the surface of the root plug.

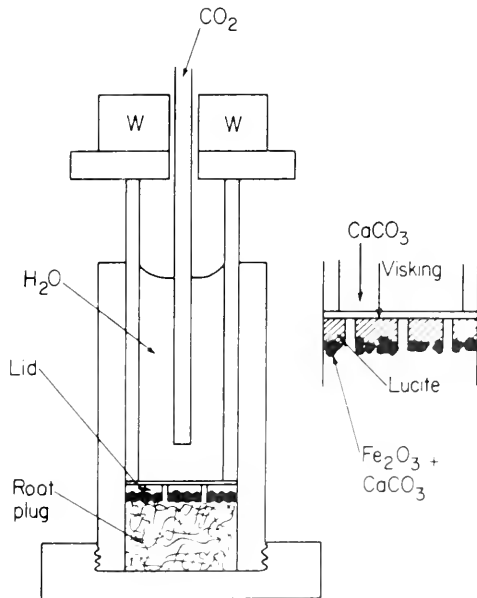

Figure 10. Diagram of a lucite cell for measuring the decomposition of iron oxide and the diffusion of iron in root piles. At the right is an enlargement of the lid, showing the Visking membrane and the perforated lucite disc.

The extent of this mechanical diffusion barrier was determined experimentally by inserting it into an agar column and measuring the diffusion retardation of KCl. As is well known, in dilute agar gels the diffusion coefficient of KCl is identical with that in water (Moreno, 1957). The ratio of KCl's diffusion in agar in the absence of barrier to its diffusion in the presence of barrier was 2.56. To correct for the barrier effect, which in essence corresponded to a reduction of the cross-section of the boundary to 39 per cent, the quantity of iron diffused into the root plug was multiplied by 2.56. Probably this was too severe a correction.

The columns were dismantled after two days in one experiment, after five days in another, and after ten days in a third. The plugs were sliced with a razor blade into discs of approximately 1.5 mm. thickness. The root-plug portion near the contact zone was embedded in wax and sliced into 0.1 mm. segments with the aid of a microtome.

Diffusion curves. The results of the two-day runs, expressed as parts per million of iron diffused into the root plug, are plotted in Figure 11. The experimental values (circles) are well described by the ideal diffusion equation (Crank, 1956):

$$Fe = (Fe)_0 \operatorname{erfc} \frac{x}{2\sqrt{Dt}}$$

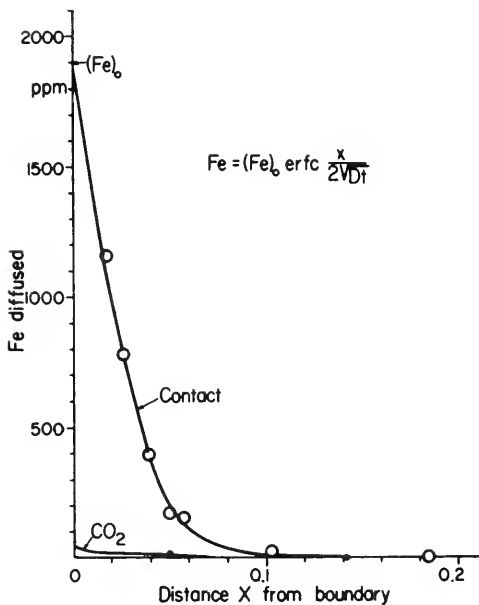

Figure 11. The relative diffusion of iron into root piles resulting from contact decomposition and from solubility of Fe_2O_3 in a CO_2 -saturated solution.

TABLE IV
Fe-Diffusion Parameters for Root Plugs

	Contact Piles			Solution Piles		
	2 days	5 days	10 days	2 days	5 days	10 days
$(Fe)_0^\circ$ (p.p.m.)	1,900	1,800	3,000	38	12	26
$D \cdot 10^9$ (cm ² /sec)	2.8	1.8	0.9	7.8	7.3	7.6

^o Obtained by extrapolating the diffusion curve to $x = 0$, and in the case of solution piles by multiplying the extrapolated value by 2.56 to correct for the diffusion barrier of disc + cellulose membrane.

$(Fe)_0$ is the concentration of iron in p.p.m. in the root at the iron oxide-root boundary, which may be considered as invariant; x is the distance from the boundary in centimeters; D is the diffusion coefficient; t is the time in seconds, and $erfc$ is the error function complement. For the contact and solution pairs and for the three time periods—six root piles in all—the crucial parameters are listed in Table IV.

The most striking observation is the inefficiency of the CO₂-mechanism, as seen from the curves in Figure 11 and from the $(Fe)_0$ concentrations at the plug boundary. Whereas the contact-decomposition of Fe₂O₃ furnished a large, steady supply of iron—1,800, 1,900, and even 3,000 p.p.m. at the root boundary—the CO₂-saturated solution charged the root plane with only 12 to 38 p.p.m. of iron. Since, in the growth-contact trials with Fe-sand, the roots containing 110 to 125 p.p.m. of iron still carried strongly chlorotic tops, the CO₂-mechanism, in the light of the root-plug test, appears incapable of delivering sufficient iron to the root. But contact transfer of iron is highly efficient. Near the contact zone the iron concentration in the root reaches over 1,500 p.p.m.

Judging from the diffusion coefficients in the solution piles (Table IV), the dissolved Fe ions, presumably as Fe⁺⁺ or Fe⁺⁺⁺ bicarbonates, appear to diffuse somewhat faster than the adsorbed Fe ions. Since the dissolved Fe ions are accompanied by high concentrations of CO₂, they are expected to react but mildly with the COOH groups and therefore to diffuse to a considerable extent in the larger pores. The contact experiments, on the other hand, are at a disadvantage as far as CO₂-supply is concerned, for no correction could be made for the CO₂-diffusion barrier consisting of the Visking membrane and the lucite disc with only five holes. Nevertheless, contact proves a hundredfold superior in acquisition of iron.

Mechanism of transfer. In the contact zone, the carboxyl groups may react with iron oxide as follows:

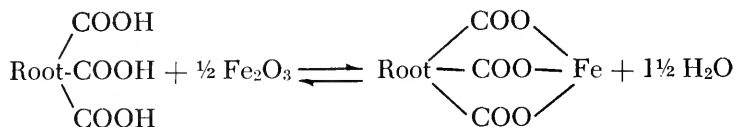

The H-root surface becomes an Fe-root surface, either as Fe^{+++} or Fe^{++} or as a complex Fe-OH cation. The Fe ions migrate into the interior of the root via exchange diffusion with H ions, which move from the interior toward the outer boundary. Should Fe diffuse mainly as ferrous ions, a current of reducing electrons would have to migrate from the interior to the surface.

The influx of iron must have been accompanied by an influx of calcium ions, according to the reaction:

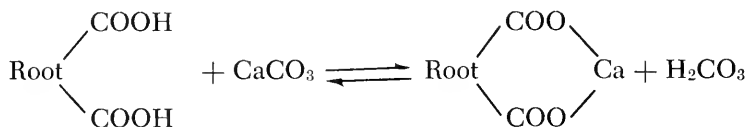

The two equations gain support from Grunes's observation (Grunes and Jenny, 1960) that only hydrogen surfaces will decompose haematite particles; sodium and magnesium surfaces are ineffective. The existence of counter-flow may be demonstrated analytically by pressing a Ca-amberplex membrane to one of hydrogen. Analysis of exchangeable calcium and hydrogen in both membranes discloses equivalent transfer in opposite directions (Glauer and Jenny, 1960b). For root and milieu the counter-flows of ions may be as follows:

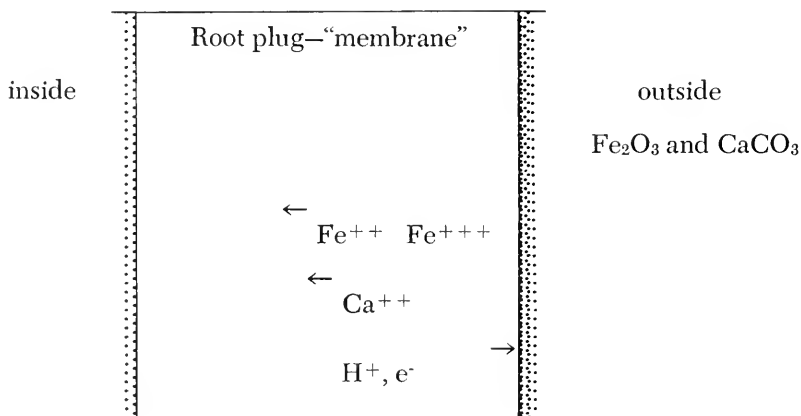

Calcium and iron migrate— Fe^{+++} perhaps slower than Fe^{++} because of stronger adsorption—by exchange diffusion, hopping, so to speak, from carboxyl group to carboxyl group against a current of hydrogen ions. In the moist root plug the mean distance between two exchange sites is 16.5 Angstrom units.

Although the acquisition and diffusion of iron were accomplished in a non-living root pile, in single roots metabolic activity appears essential to transporting iron continuously from the surface through the cell wall to the cytoplasm, because a gradient of exchangeable hydrogen ions, and possibly an outward electron flow, must be maintained. The hydrogen ion might originate in the organic-acid pool, as suggested by Overstreet *et al.* (1942), rather than from calcium dioxide diffusing out.

A picture of the root surface, based on the experiments

It appears expedient to distinguish at least two portals for entry of substances into a root: large, *size*-discriminating pores, and small, *charge*-discriminating pores, the latter acting as ion sieves (Figure 12).

The walls of the *large pores*, with diameters of 50 or 100 Angstrom units and maybe larger, have charge densities which vary according to the abundance of carboxyl groups. Organic molecules and ion pairs (e.g., KCl) readily diffuse through the large channels or are carried through it by the transpiration stream. (In the aforementioned root piles the diffusion coefficient for the chloride ion is 3.4×10^{-7} cm.² per second.) The size limitation is primarily physical. During their passage, the cations of ion pairs (KCl) may interchange with the counterions of the electric double layer along the wall, and thus affect per-

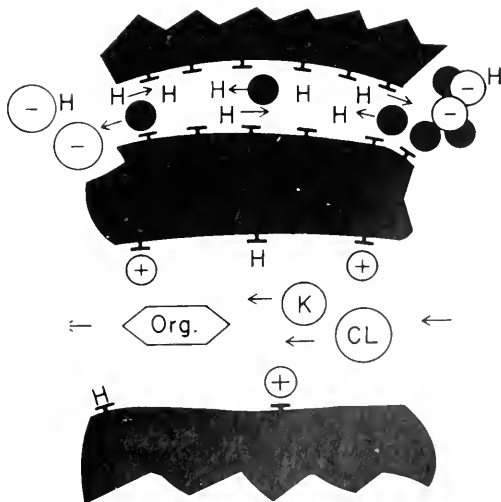

Figure 12. Hypothetical diagram of channels in the cell wall for entry of substances into a root. The narrow channel admits cations, largely unaccompanied by dissolved anions (the black circles are Fe^{+++} cations). The wide channel allows migration of ion pairs (e.g., KCl) and organic molecules by solute diffusion and in the transpiration stream.

meability. The transpiration stream imposes an electrical potential difference upon the pore capillaries—the well-known streaming potential.

In the *small pores* the counter-ions intermingle with one another, and they may do it so completely that they form a “cation solution.” Cation diffusion—essentially an exchange diffusion (Lopez-Gonzales and Jenny, 1958)—readily proceeds in either direction: into the root or out of it, according to the concentration gradients. The pores act as ionic sieves, keeping out anions because of repulsion forces. Iron ions acquired at the root surface may readily diffuse into the interior without being precipitated, as there are few soluble anions present. This portion of the cell wall acts as an ionic membrane.

Whenever the electric double layer of one surface impinges upon that of another—as when a root surface presses against a clay surface—the intermingling of the positive ion swarms produces a localized increase in ion concentration, in osmotic pressure, and in associated energy changes. The inner layers—*viz.*, the negative charges—of the double layers of root and clay may become disarranged, resulting in momentary changes in permeability, in influx, and in outflux. The marked effect of resin particles upon releasing non-exchangeable potassium from soil minerals (Arnold, 1958; Jenny, 1952) might perhaps be viewed in this light, the ion swarms of the resin prying open or disrupting the layer lattice of micaceous plates and initiating ion exchange diffusion.

No account has been taken of pinocytosis (Buvat, 1958; Holter, 1959), the gulping type of uptake of material by way of invaginations of the surface. If it occurs in roots, as has been suggested (Jensen and McLaren, 1960), it would be expected to operate at the cytoplasm boundary rather than at the outer fringes of the cell wall.

Summary

Between root and soil a two-way flow of substances, into the root and out of the root, continually takes place.

The significance of the interactions involving exchangeable cations between the root surface and the soil surface has been analyzed and reviewed on the basis of two-phase experiments with roots, clays, resin particles, and ion-exchange membranes. Ion transfer is a rate problem.

In controlled experiments on the availability of iron in calcareous media (high pH), it was found that the rate of uptake of iron by alfalfa plants is directly proportional to the number of contact sites between individual iron-oxide particles and the root surface.

H-roots are able to decompose iron-oxide (Fe_2O_3) particles, even in the presence of CaCO_3 . Iron thus acquired by the root surface rap-

idly migrates into the root interior by exchange diffusion along the network of carboxyl groups.

References

- Arnold, P. W., 1958. "Potassium Uptake by Cation Exchange Resins from Soils and Minerals," *Nature* 182, 1594.
- Bartlett, R. J., and McLean, E. O., 1959. "Effect of Potassium and Calcium Activities in Clay Suspensions and Solutions on Plant Uptake," *Soil Sci. Soc. Am. Proc.* 23, 285.
- Bernstein, L., and Pearson, G. A., 1956. "Influence of Exchangeable Sodium on the Yield and Chemical Composition of Plants, I: Green Beans, Garden Beets, Clover and Alfalfa," *Soil Sci.* 82, 247.
- Bernstein, L., Gardner, W. R., and Richards, L. A., 1959. "Is There a Vapor Gap around Plant Roots?" *Science* 129, 1750.
- Blanc, D., 1958. "Influence de la nutrition azotée sur les propriétés d'échange des racines," *C. R. Acad. Sci. Paris* 246, 2035.
- Bonner, J., 1959. "Water Transport," *Science* 129, 447.
- Booth, F., 1953. "Recent Work on the Application of the Theory of the Ionic Double Layer to Colloidal Systems," *Prog. in Biophys.* 3, 131.
- Boyd, G. E., Adamson, A. W., Myers, L. S., 1947. "The Exchange Adsorption of Ions from Aqueous Solutions by Organic Zeolites, II: Kinetics," *J. Am. Chem. Soc.* 69, 2836.
- Breazeale, J. F., 1930. *Maintenance of Moisture-Equilibrium and Nutrition of Plants at and below the Wilting Percentage*, University of Arizona Agricultural Experiment Station, Tech. Bull. 29.
- Buvat, R., 1958. "Recherches sur les infrastructures du cytoplasme, dans les cellules du méristème apical, des ébauches foliaires et des feuilles développées d'*Elodea canadensis*," *Ann. Sci. Nat. Bot. Biol. Veg.* 19, 121.
- Cerana, L. A., and Bielsa, de L. B., 1959. "Intercambio por contacto," *Rev. Fac. Ing. Quém.*, Santa Fe, Arg. 28.
- Chapman, H. D., 1939. "Absorption of Iron from Finely Ground Magnetite by Citrus Seedlings," *Soil Sci.* 48, 309.
- Charley, J. L., and Jenny, H., 1961. "Two-Phase Experiments on Availability of Iron in Calcareous Soils, IV: Decomposition of Fe_2O_3 by Roots and Fe Diffusion in Roots," *Agrochimica* 5, 99.
- Crank, J., 1956. *The Mathematics of Diffusion* (N. Y., Oxford U. Press).
- Deuel, H., and Hostettler, F., 1950. "Hundert Jahre Ionenaustausch," *Experientia* 6, 445.
- Deuel, H., Hutschmecker, K., and Solms, J., 1953. "Selektives Verhalten von Ionenaustauschern," *Z. Elektroch.* 57, 172.
- Drake, M., Vengris, J., and Colby, W. G., 1951. "Cation Exchange Capacity of Plant Roots," *Soil Sci.* 72, 139.
- Epstein, E., and Leggett, J. E., 1954. "The Absorption of Alkaline Earth Cations by Barley Roots: Kinetics and Mechanism," *Am. J. Bot.* 41, 785.
- Frey-Wyssling, A., 1954. "The Fine Structure of Cellulose Microfibrils," *Science* 119, 80.
- Fuss, K., 1956. "Die Ansäuerung der Nahrösung durch *Lupinus luteus* und ihre papierchromatographische Untersuchung auf saure Wurzelauausscheidungen," *Flora (Jena)* 144, 1.
- Glauser, R., and Jenny, H., 1960a. "Two-Phase Experiments on Availability of Iron in Calcareous Soils, I: Growth of Alfalfa Plants," *Agrochimica* 4, 263.

- Glauer, R., and Jenny, H., 1960b. Two-Phase Experiments on Availability of Iron in Calcareous Soils, III: Contact and Exchange Diffusion in Ionic Membranes," *Agrochimica* 5, 1.
- Grunes, D. L., and Jenny, H., 1960. Two-Phase Experiments on Availability of Iron in Calcareous Soils, II: Decomposition of Colloidal Iron Hydroxide by Ion Exchangers," *Agrochimica* 4, 279.
- Hassan, M. N., and Overstreet, R., 1952. "Elongation of Seedlings as a Biological Test of Alkali Soils, I: Effects of Ions on Elongation," *Soil Sci.* 73, 315.
- Helder, R. J., 1956. "The Loss of Substances by Cells and Tissues (Salt Glands)," in Ruhland, W., ed., *Encyclopedia of Plant Physiology*, Vol. II (N. Y., Springer).
- Helmy, A. K., and Elgabaly, M. M., 1958. "Exchange Capacity of Plant Roots," *Plant and Soil* 10, 78.
- Helfferich, F., 1956. "Bio-ionic Potentials," in "Membrane Phenomena," *Disc. Faraday Soc.* 21, 83.
- Holter, H., 1959. "Pinocytosis," *Inter. Rev. Cytol.* 8, 481.
- Hope, A. B., and Stevens, P. G., 1952. "Electrical Potential Differences in Bean Roots and Their Relation to Salt Uptake," *Physiol. Plantarum* 5, 335.
- Hutner, S. H., 1947-48. "Essentiality of Constituents of Sea Water for Growth of a Marine Diatom," *Trans. N. Y. Acad. Sci., Ser. II*, 10, 136.
- Hutner, S. H., Provasoli, L., Schatz, A., and Haskins, C. P., 1950. "Some Approaches to the Study of the Role of Metals in the Metabolism of Microorganisms," *Proc. Am. Phil. Soc.* 94, 152.
- Hylmö, B., 1958. "Passive Components in the Ion Absorption of the Plant, II: The Zonal Water Flow, Ion Passage, and Pore Size in Roots of *Vicia Faba*," *Physiol. Plantarum* 11, 382.
- Jenny, H., and Cowan, E. W., 1933. "The Utilization of Adsorbed Ions by Plants," *Science* 77, 394.
- Jenny, H., and Overstreet, R., 1939. "Cation Interchange between Plant Roots and Soil Colloids," *Soil Sci.* 47, 257.
- Jenny, H., Overstreet, R., and Ayers, D. A., 1939. "Contact Depletion of Barley Roots as Revealed by Radioactive Indicators," *Soil Sci.* 48, 9.
- Jenny, H., 1952. "Contact Phenomena between Adsorbents and Their Significance in Plant Nutrition," in Truog, E., ed., *Mineral Nutrition of Plants* (Madison, Wisc., U. of Wisconsin Press).
- Jensen, W. A., and McLaren, A. D., 1960. "Uptake of Proteins by Plant Cells—the Possible Occurrence of Pinocytosis in Plants," *J. Exp. Cell Res.* 19, 414.
- Keller, P., and Deuel, H., 1957. "Kationenaustauschkapazität und Pektinengehalt von Pflanzenwurzeln," *Z. Pfl. Düng. Bod.* 79 (124), 119.
- Krishnamoorthy, C., and Desai, A. D., 1953. "Kinetics of Ion Exchange between Two Adsorbents, I: Monovalent Ion Systems," *Soil Sci.* 76, 307.
- Lagerwerff, J. V., 1956. "The Uptake of Ions by Excised Barley Roots from Soil-Water Systems," Doctoral thesis, Cornell University, Ithaca, N. Y.
- Lagerwerff, J. V., 1958. "Comparable Effects of Adsorbed and Dissolved Cations on Plant Growth," *Soil Sci.* 86, 63.
- Lopez-Gonzales, J. de, and Jenny, H., 1958. "Modes of Entry of Strontium into Plant Roots," *Science* 128, 90.
- Lopez-Gonzales, J. de, and Jenny, H., 1959. "Diffusion of Strontium in Ion-Exchange Membranes," *J. Coll. Sci.* 14, 533.
- Lundegårdh, H., and Burström, H., 1933. "Atmung und Ionenaufnahme," *Planta* 18, 683.

- Lundegårdh, H., 1958. "Investigations on the Mechanism of Absorption and Accumulation of Salts, I: Initial Absorption and Continued Accumulation of Potassium Chloride by Wheat Roots," *Physiol. Plantarum* 11, 332.
- Mattson, S., 1948. "Laws of Ionic Exchange, III: Donnan Equilibria in Plant Nutrition," *Ann. Royal Agr. Coll. Sweden* 15, 308.
- Mehlich, A., and Drake, M., 1955. "Soil Chemistry and Plant Nutrition," in Bear, F. E., ed., *Chemistry of the Soil* (N. Y., Reinhold).
- Milad, Y., 1939. *Physiological Studies in Lime-induced Chlorosis*, Horticultural Section, Technical and Scientific Service, Ministry of Agriculture, Egypt, Bulletin 211.
- Moreno, E. C., 1957. "Diffusion Rates of Soil Phosphorus from the Solid to the Liquid Phase," Doctoral thesis, University of California, Berkeley.
- Overstreet, R., and Jenny, H., 1939. "Studies Pertaining to the Cation Absorption Mechanism of Plants in Soil," *Soil Sci. Soc. Am. Proc.* 4, 125.
- Overstreet, R., Broyer, T. C., Isaacs, T. L., and Delwiche, C. C., 1942. "Additional Studies regarding the Cation Absorption Mechanism of Plants in Soils," *Am. J. Bot.* 29, 227.
- Peterburgski, A. W., 1959. "Adsorptions progrese im Boden und die Wurzelernährung der Pflanzen," *Plant and Soil* 11, 157.
- Ratner, E. I., 1954. "The Ways in which Absorbed Soil Potassium Is Utilized by Plants," *Soils and Fert.* 17, 155.
- Robertson, R. N., 1956. "The Mechanism of Absorption," in Ruhland, W., ed., *Encyclopedia of Plant Physiology*, Vol. II (N. Y., Springer).
- Robertson, R. N., 1958. "The Uptake of Minerals," in Ruhland, W., ed., *Encyclopedia of Plant Physiology*, Vol. IV (N. Y., Springer).
- Rothstein, A., and Hayes, A. D., 1956. "The Relationship of Cell Surface to Metabolism, XIII: The Cation-Binding Properties of Yeast Cell Surface," *Arch. Biochem. Biophys.* 63, 87.
- Scheuring, D. G., and Overstreet, R., 1961. "Sodium Uptake by Excised Barley Roots from Sodium Bentonite Suspensions and from Their Equilibrium Filtrates. In press.
- Schuffelen, A. C., 1954. "The Absorption of Potassium by the Plant," in *Potassium Symp.*, International Potash Inst., Bern, Switz., 169.
- Schweigart, H. A., 1956. "A Discussion on the Mechanism of the Reaction of Trace Elements, IV: Transference to the Roots by Contact. *Potash Rev. Sub.* 25, 11th suite.
- Scott, F. M., Hamner, K. C., Baker, E., and Bowler, E., 1956. "Electron Microscope Studies of Cell Wall Growth in the Onion Root," *Am. J. Bot.* 43, 313.
- Smith, G. F., McCurdy, W. H., and Diehl, H., 1952. "The Colorometric Determination of Iron in Raw and Treated Municipal Water Supplies by Use of 4:7-Diphenyl-1:10 Phenanthroline," *Analyst* 77, 418.
- Spiegler, K. S., 1956. General Discussion on Membrane Phenomena, *Disc. Faraday Soc.* 21, 213.
- Starkey, R. L., 1958. "Interrelations between Microorganisms and Plant Roots in the Rhizosphere," *Bact. Rev.* 22, 154.
- Stone, E. C., 1957. "Dew as an Ecological Factor, I: A Review of the Literature," *Ecology* 38, 407.
- Vlamiš, J., and Pearson, G. A., 1950. "Absorption of Radioactive Zirconium and Niobium by Plant Roots from Soils and Its Theoretical Significance," *Science* 111, 112.

- Vlams, J., 1953. "Acid Soil Infertility as Related to Soil-Solution and Solid-Phase Effects," *Soil Sci.* 75, 383.
- Wiklander, L., 1955. "Cation and Anion Exchange Phenomena," in Bear, F. E., ed., *Chemistry of the Soil* (N. Y., Reinhold).
- Wiklander, L., 1957. "Plant Physiology," in Calmon, C., and Kressman, T. R. E., eds., *Ion Exchangers in Organic and Biochemistry* (N. Y., Interscience).
- Williams, D. E., and Coleman, N. T., 1950. "Cation Exchange Properties of Plant Root Surfaces," *Plant. and Soil* 2, 243.
- Wynd, F. L., 1951. "Availability to Wheat Plants of Iron in Very Insoluble Glass Frits," *Lloydia* 14, 1.

TRANSPORT PROCESSES IN THE SOIL-PLANT SYSTEM

Morell B. Russell and Joseph T. Woolley

UNIVERSITY OF ILLINOIS

Growth is a dynamic process in which energy and a variety of materials are transported within the organism and between it and the environment. The transport conforms to certain basic physical laws and, in principle at least, is susceptible to quantitative definition and measurement. It is the purpose of this paper to examine the General Transport Law in both its simple and its more complex forms and to discuss its application to several of the flow phenomena that occur in the soil-plant system.

The analytic description of flow involves three major parameters. These are the *flux*, which expresses the quantity of the substance being transported through a unit area in unit time; the *driving force*, represented by the gradient (*i.e.*, space rate of change) of an appropriate potential; and the *transmission coefficient*, which is the ratio of the flux to the driving force and reflects the properties of the quantity flowing and of the medium through which the flow occurs. Transport phenomena may be formally described by the following General Transport Law:

$$F = k \nabla P$$

where F is the flux, k is the transmission coefficient, and ∇P is the gradient of the potential.

Under the broad coverage of the General Transport Law, several subgroups of flow phenomena may be identified. The non-turbulent steady-state flow of an incompressible fluid through a completely filled geometrically simple tube can be accurately described in terms of the velocity of flow, the dimensions of the tube, the distribution of pres-

tures, and the intrinsic properties of the fluid and of the material comprising the tube. Such analytical description becomes more difficult if the flow is turbulent, if the flux is time-dependent, or if the medium through which the flow occurs is geometrically complex or only partly filled by the flowing fluid. Complexity of the flow equation thus may arise because of the nature of the function needed to describe either the F , the k , or the P in the General Transport Law. In arriving at an adequate analytical expression for many of the flow phenomena encountered in the soil-plant system, complex functions are frequently encountered for each of the three terms of the General Transport Law. As a consequence, only elementary progress has been made to date in the quantitative study of such phenomena.

In addition to the three parameters appearing in the General Transport Law, the analysis of flow also involves some expression for the volume-concentration of the material being transported. In the case of water flow in soil this parameter is the volume-fraction of water, designated herein as C . For non-steady-state flow through unsaturated porous media such as soil, C may change with time at various points along the flow path; *i.e.*, the porous medium may be acting as a source or a sink for the fluid being transmitted. In such cases the dependence of C on location and time as well as on the potential must be specified. Inasmuch as k , P , and C are interdependent, it is useful to examine the functional relations that may exist among them. In the study of soil-moisture behavior, the system can be most usefully described in terms of the $C = f(P)$ and the $k = f(P)$ relationships. A derived parameter, $S = dc/dp$, is called the specific yield. The $S = f(P)$ function is a third useful relation for describing soil-moisture behavior. The flow equation may be written with the potential gradient replaced by a concentration gradient. In this form the transmission constant, k , is replaced by the diffusivity, D , which is defined as $D = \rho k / \rho_s S$, where ρ and ρ_s are the density of the fluid and the bulk density of the porous medium, respectively. The selection of the concentration-dependent or the potential-dependent form of the flow equation is largely determined by the type of data available.

Considerable progress in the study of flow phenomena has been made by investigators studying the flow of fluids in saturated porous media. In porous media such as soil or oil-bearing rocks it is necessary to determine k experimentally because of the geometric complexity of the voids. The classic work of Darcy, conducted 100 years ago, was the straightforward application of the General Transport Law to the flow of water through a saturated porous medium. Darcy's Law continues to serve as the basic principle for the study of steady-state laminar flow through saturated porous media. Numerous attempts to determine the transmission coefficient analytically from such media parameters as

grain size, specific surface, and pore-size distribution have met with only limited success. It is usually necessary to determine k experimentally, either in the laboratory on suitably taken samples or *in situ*, because of the heterogeneity commonly encountered in the field. For the flow of incompressible fluids such as water through saturated porous media, the specific yield is zero, and the transmission coefficient k is independent of B , the potential, if the flow remains non-turbulent. The fact that C , S , and k are not dependent on the potential greatly simplifies the mathematical forms of the flow equations used to describe steady-state flow in fully saturated porous media. The analysis of the flow of water or oil to a well through a saturated aquifer or oil-bearing strata and the movement of water into tile drains are examples of the successful use of the General Transport Law for the complete analytical description of flow phenomena.

The flow of water in unsaturated soil is a phenomenon of great agricultural importance. It also obeys the General Transport Law. Although basically similar to the flow through a saturated soil, flow in unsaturated soil differs from the former in that C (and hence S) and k are both highly dependent on the potential. Typical curves of the $C = f(P)$, $k = f(P)$, and $S = f(P)$ relations for soils having different textures are shown in Figures 1, 2, and 3. The potential is negative for unsaturated soils. The reference state, which is taken as a free, flat-water surface at the same temperature, is given a potential of zero.

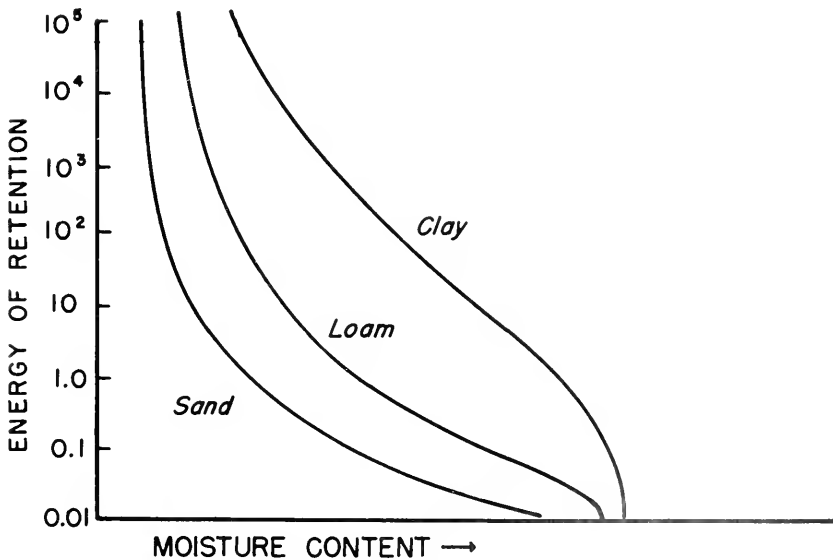

Figure 1. Idealized moisture-retention curves for three soils.

The potential may be expressed as specific free energy, as aqueous vapor pressure, as the pressure or suction in the liquid phase, or as the DPD (diffusion-pressure deficit) of the liquid phase in plant tissues. The curves in Figure 1 show that the volume-fraction of water is highly dependent on the potential, and that the texture of the porous material strongly affects the relationship. The latter effect results because of the effect of grain size on the size distribution of the voids that occur between the particles. The relationships shown in Figure 2 arise because the water flow occurs only through the water-filled voids; hence it follows that the transmission coefficient of unsaturated soils also will be highly dependent on the volume-fraction and on the potential of the water. The capacity of an unsaturated soil to serve as a source or as a sink for moisture is summarized in Figure 3. The curves show that the capacity to absorb or yield water in response to a unit change in potential is highly dependent upon both the texture and the potential.

The fact that C , k , and S is each markedly influenced by changes in the potential of the fluid being transmitted greatly increases the complexity of the flow equations needed to analytically describe fluid flow in unsaturated porous media. The problem is made even more difficult if the defining equations are also time- or space-dependent, as is the case for transient flow or flow through anisotropic media. A further complication is introduced by the fact that the relations shown in Figures 1, 2, and 3 all exhibit hysteresis; consequently, different equilibrium values of the dependent variables C , k , or S are obtained

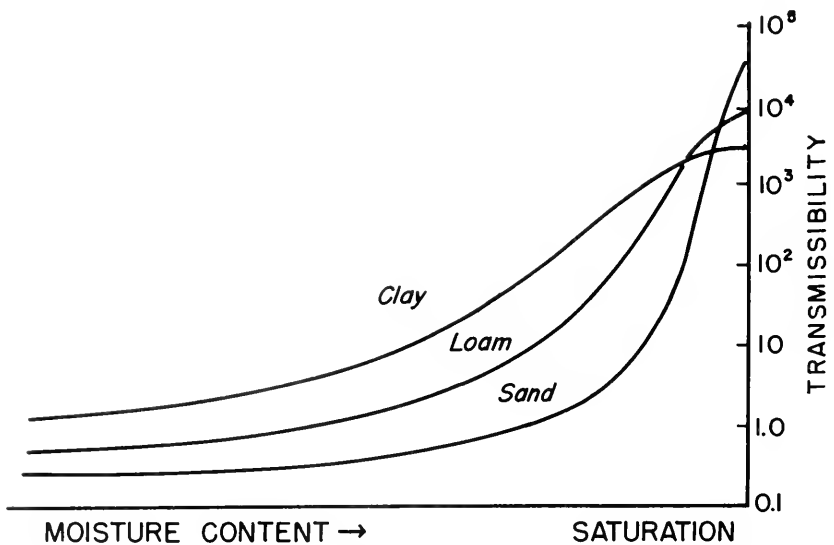

Figure 2. Idealized curves showing the effects of texture and moisture content on the transmission coefficient.

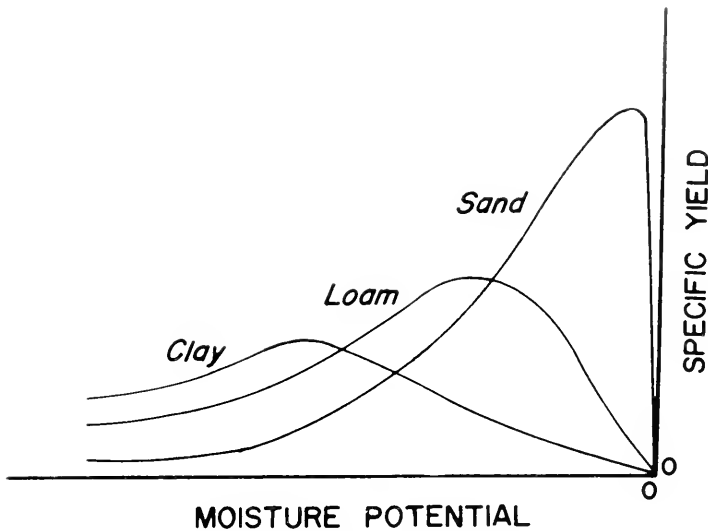

Figure 3. Idealized curves of the effects of texture and moisture potential on the specific yield.

for the same values of the potential, depending on the direction from which the equilibrium is approached. Little progress has been made in handling this perplexing problem, and most investigators have avoided the issue by restricting their analyses to systems that undergo either continuously increasing or continuously decreasing changes of potential. Water flow in such a dynamic system as the soil-plant-atmosphere continuum exhibits diurnal cycles of desorption and rehydration at several points along the flow path. At present no satisfactory mathematical technique has been developed to handle adequately the type of complexity introduced into such problems by hysteresis.

Flow of water in the soil-plant system

The movement of water through the soil, into and through the living plant, and into the atmosphere involves a series of interdependent flow phenomena. Despite the serious limitations mentioned in the preceding section, the entire system, as well as each of its component parts, may be analyzed, at least formally, in terms of the General Transport Law (Honert, 1948; Philip, 1957). Figure 4 serves to illustrate some of the important characteristics of the flow of water through the soil-plant-atmosphere system.

Water flows in series through each part of the system, and because the amount of water transpired daily greatly exceeds any diurnal

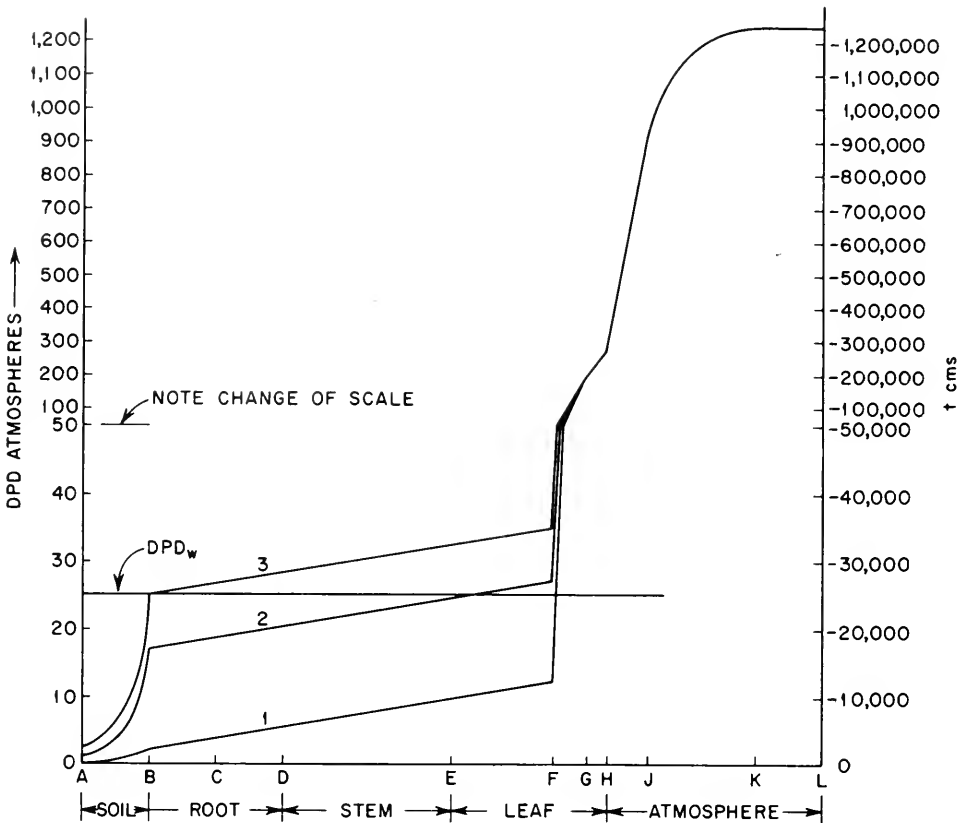

Figure 4. Schematic curves showing the distribution of potential in a soil-plant system during three flow conditions. (From Philip, 1957.)

changes in the moisture content of the plant, it follows as a first approximation that the total flux is constant through each section. Therefore the transmission characteristics of the several sections must differ to account for the wide differences observed in the potential gradients throughout the system. The resistance to flow (*i.e.*, small value of k) is greatest at the leaf-atmosphere interface and at the soil-root interface. Figure 4, although only qualitatively correct, serves to emphasize that the water economy of plants is controlled in large measure by the conditions for water transport at the points of entry and exit.

Flow to the root surface

The roots of most plants require an external supply of free oxygen for normal growth and activity. Consequently, active roots are found

in soils having a portion of their pores filled with air. In such unsaturated soils the movement of water to the root surface occurs through the water-filled voids; hence the transmission characteristics of such media are highly dependent upon their degree of saturation, and the potential gradient needed to cause a given rate of water flow to the root surface will be dependent upon the moisture content of the soil surrounding the absorbing root. During steady-state water flow to the root, the equipotential surfaces may be represented as concentric circles around the root and the flow lines as radii which converge as they approach the root surface. As the root surface is approached, the flow velocity per unit transmitting area increases sharply and is accompanied by a corresponding increase in the potential gradient. This fact accounts for the shape of the moisture-potential function in the soil section of Figure 4. If the flow into the root from the cylindrical layer of soil adjacent to the root exceeds the rate at which water moves into that layer from the surrounding soil, a reduction in moisture content and in the moisture potential will occur in accordance with the $C = f(P)$ relationship shown in Figure 1. The reduction of the moisture potential in the adjacent soil will reduce the gradient between the root and the soil but will increase the gradient between that region and the surrounding soil. The lower limit of potential in the soil adjacent to the root is thus set as being the minimum potential that can be created in the absorbing root. The reduction in moisture potential is accompanied, however, by a marked increase in the resistance to water flow, as illustrated by the great reduction in k depicted in Figure 2. The pattern of water extraction from the soil adjacent to an absorbing plant root therefore is dependent on the moisture-yield characteristics of the soil as expressed in the $S = f(P)$ relationship, on the velocity of flow per unit absorbing area of the root, on the initial moisture content of the soil, and on the geometry of the absorbing surface (Ogata, Richards, and Gardner, 1960).

The rate of water flow through the soil-plant-atmosphere system varies with time. Diurnal fluctuations, largely controlled by the variation in the amount of energy available at the leaf surface for the vaporization of water from the substomatal cellular surfaces, are superimposed on longer-term changes, which are influenced not only by the energy supply but also by the changing morphology of the plant, particularly the ratio of active absorbing root surface to active transpiring leaf surface. Short periods of high transpiration may result in some depletion of moisture content of the plant tissues, as well as that of the soil immediately adjacent to the absorbing root. Following periods of high water demand, readjustments of moisture occur, both in the plant and in the soil immediately adjacent to the absorbing roots. Consequently, both the plant and the soil adjacent to the active roots undergo

cyclic changes in moisture content. The amplitude of such diurnal variations is determined by the intensity and duration of the periods of high transpiration and by the nature of the $S = f(P)$ function for both the soil and the plant tissues. Moisture readjustments in soils are known to occur rather slowly, particularly at higher values of P , as a consequence of the well-established hysteresis effect that exists in the $C = f(P)$ relationship. Less quantitative information is available concerning hysteresis in the $C = f(P)$ function for plant tissues, but data obtained by Slatyer (1957) and reproduced in Figure 5 indicate that the phenomenon occurs in plants. If complete moisture recovery does not take place during the readjustment period of the diurnal cycle, progressive moisture depletion occurs in the region adjacent to the root, to the point where the liquid flow approaches zero.

From the preceding discussion it is clear that the ability of a soil to supply water to a living plant is not determined solely by its moisture content (Gingrich and Russell, 1957). It is not to be expected, therefore, that any single-valued relationship should exist between soil-moisture content and plant response to moisture. Rather, the relation between water uptake and soil-moisture conditions will be rate-dependent as well as potential-dependent, and will be strongly affected by the dynamic characteristics of the soil-plant-water system.

In a recent quantitative assessment of the role of water movement on its availability to plants, Gardner (1960) has calculated the distribution of potentials as a function of time and the radial distance away from a cylindrical absorbing root of unit length. A single root of unit length was analyzed in an infinite, two-dimensional, isotropic medium. Assuming cylindrical symmetry, the flow equation may be written as:

$$\frac{\delta C}{\delta t} = \frac{1}{r} \frac{\delta}{\delta r} \left(rD \frac{\delta C}{\delta r} \right)$$

where C , D , r , and t represent the volumetric moisture content, diffusivity, radial distance, and time, respectively. The curves shown in Figure 6 are for $t = 1$ day and for a flux of 0.1 ml. per cm. per day in a Pachappa sandy loam having initial moisture potentials of -5 bars and -15 bars. The relations shown in Figure 6 were from the following solution of the preceding equation:

$$-\Delta P = \frac{F}{4\pi k} \left(\ln \frac{4Dt}{r^2} - .577 \right)$$

where P , F , k , D , r , and t have the previously assigned meanings and t was taken as one day. Gardner also calculated the difference in poten-

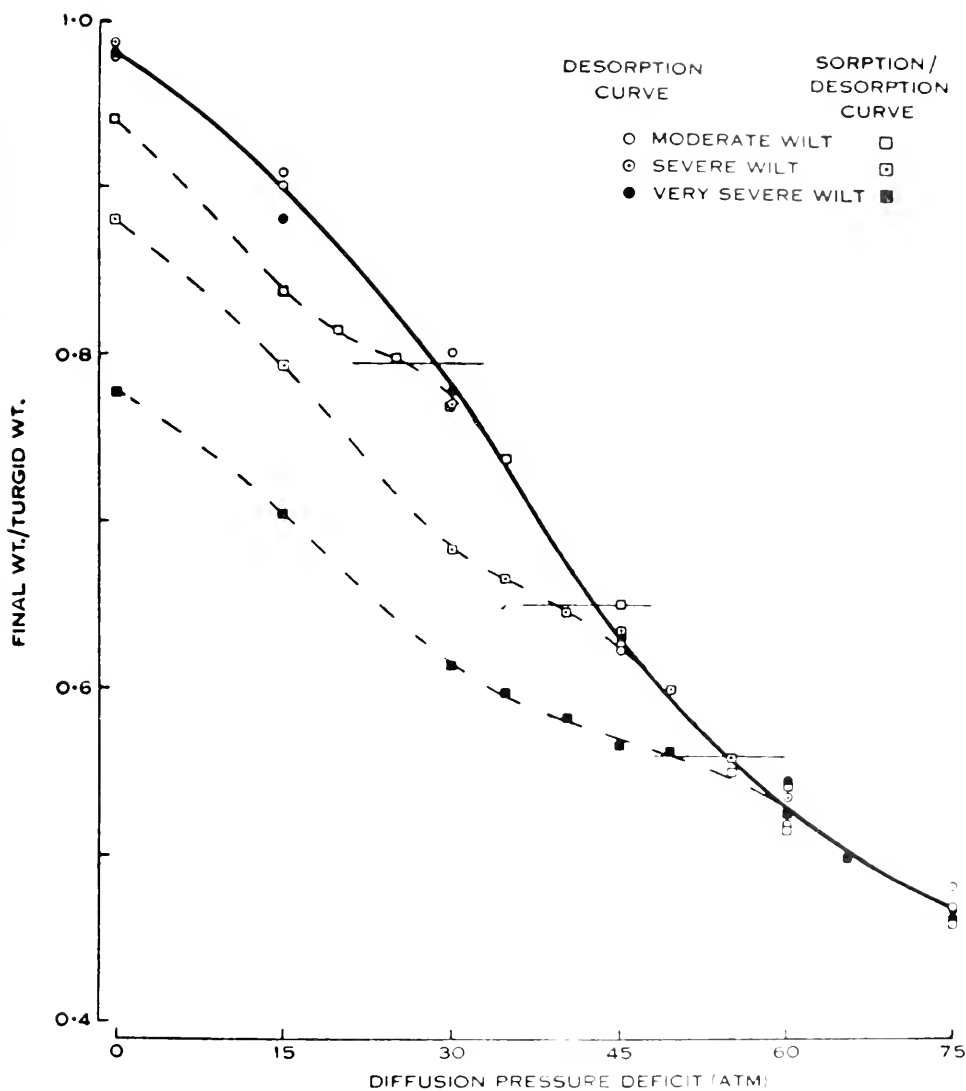

Figure 5. Relative turgidity as a function of DPD, showing hysteresis effects (Slatyer, 1957).

tial between the root and the surrounding soil as a function of time, assuming a D/a^2 value of 200, where D is the diffusivity and a is the radius of the root. Curve a in Figure 7 represents the values obtained if the flow is assumed to be constant for a 24-hour period. Curve b is for a flux double that for curve a for the first 12 hours, with no flow for the last 12 hours. For curve c the total flux for the 24 hours is the same as

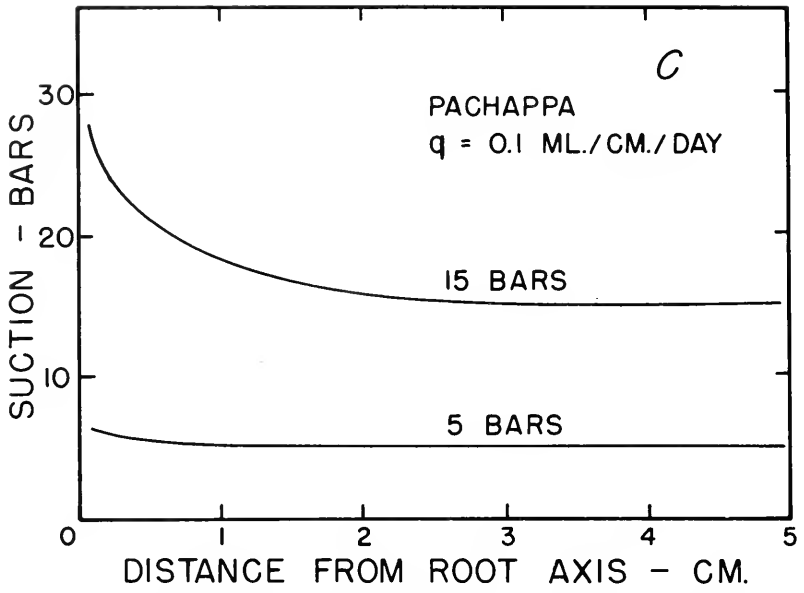

Figure 6. Distribution of moisture potential at different distances from an absorbing root. (From Gardner, 1960.)

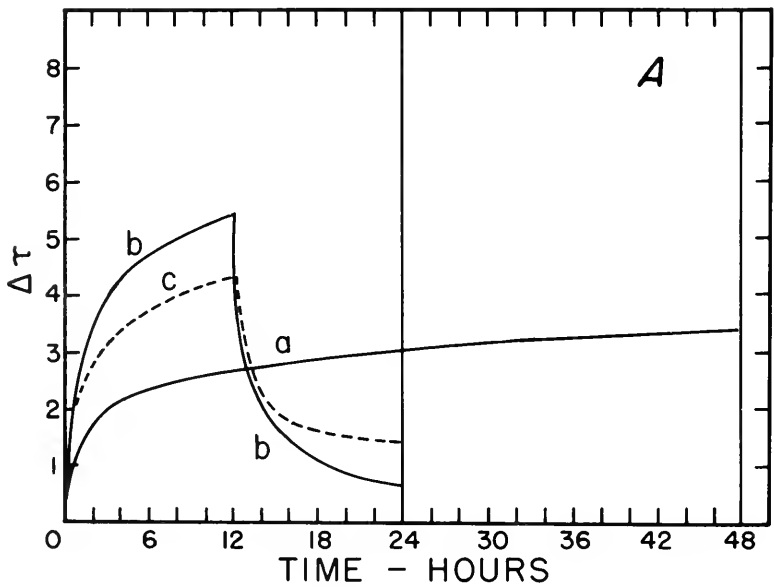

Figure 7. Pressure difference between a root and the surrounding soil as a function of time. (From Gardner.)

TABLE I

D cm ² /day	Root Radius		
	.01 cm.	.03 cm.	0.1 cm.
1	0.48	0.54	0.62
10	1.35	1.53	1.73
100	3.70	4.20	4.85
1000	10.0	11.5	13.5

that for curves *a* and *b*, but the rate for the first 12 hours is five times that of the last 12 hours.

The range of influence, defined as the radial distance from the center of the root at which 90 per cent of the total potential drop occurs, has been calculated by A. Klute (1960) as a function of the root radius and the soil diffusivity for a flow period of one day. The data are summarized in Table I.

The analysis summarized in Figure 8 shows that the ΔP necessary to maintain a given flow to the root surface is primarily dependent on the transmission constant *k* and the flow rate *F*. If a maximum DPD of

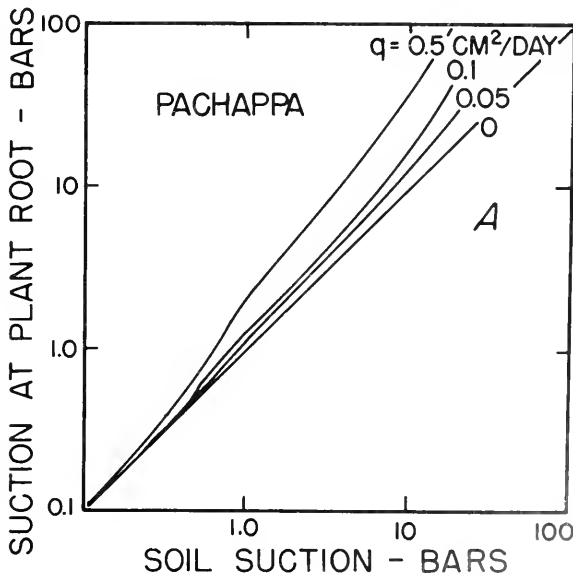

Figure 8. Pressure at plant root for different rates of water uptake as a function of the average moisture potential in the surrounding soil. (From Gardner.)

20 atmospheres is assumed at a root surface, Figure 9 shows the value of the moisture potential in the surrounding soil necessary to maintain a given flow rate from the soil to the root surface.

The effect of potential in the soil moisture on transpiration rate also has been analyzed by Gardner for plants having leaves with DPD values of 25, 50, 100, and 200 atmospheres. An initial flux of 0.1 ml. per cm. per day to the root is assumed; this, together with the assigned DPD values in the leaves, also defines the integrated permeability of the flow path through the plant. Figure 10 summarizes the calculated effects, which are in good agreement with the experimental results obtained by Slatyer (1957), as shown in Figure 11.

Flow of water through the plant

Water entering the root must pass through the epidermis, cortex, endodermis, and sometimes other tissues before entering the pipe-like conducting elements of xylem. The water then passes up the xylem along the root and stem into the leaf. Within the leaf, the water must again pass through a series of living, vacuolated mesophyll cells before reaching the air-filled intercellular spaces into which it moves as water vapor. The water vapor then passes through intercellular spaces into the substomatal cavity and finally out between the guard cells of the stomate. Three possible pathways available for the movement of

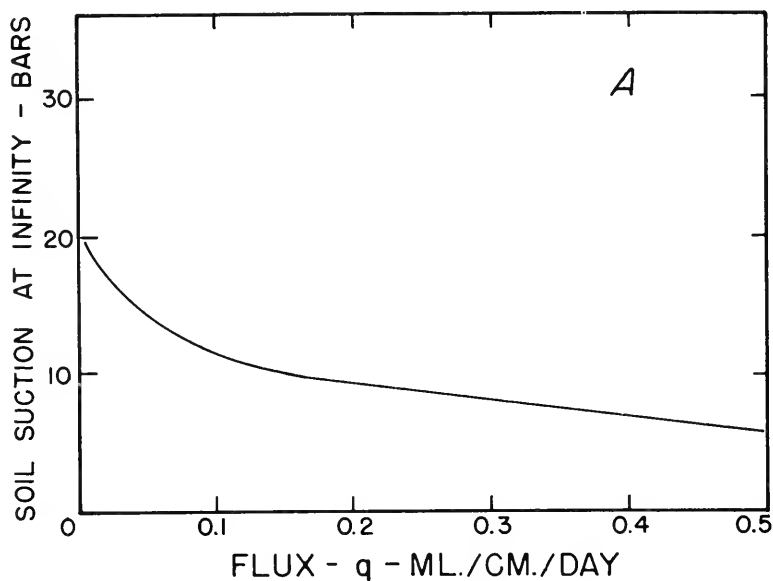

Figure 9. Pressure in the surrounding soil necessary to maintain a given rate of flow to a root having a DPD of 20 bars. (From Gardner.)

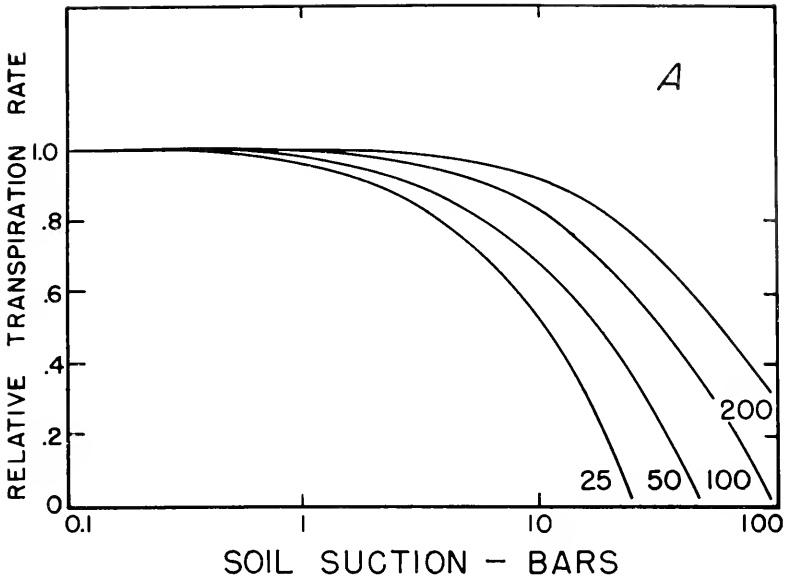

Figure 10. Relative rate of transpiration for leaves having different DPD, as affected by the moisture potential of the soil around the roots. (From Gardner.)

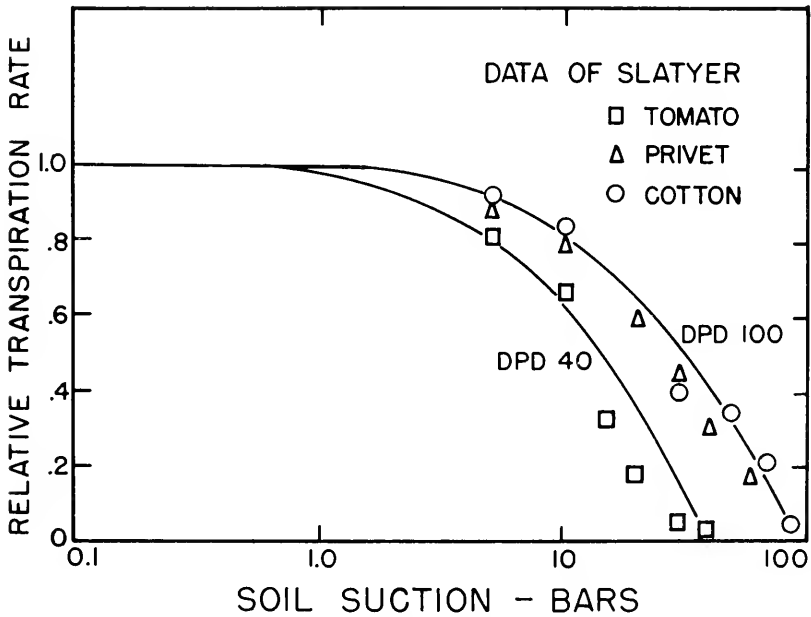

Figure 11. Relative transpiration for tomato, privet, and cotton as a function of moisture potential. Smooth curves represent calculated values for leaf DPD values of 40 and 100 bars. (From Gardner.)

water through the cortex of an absorbing root are illustrated in Figure 12.

A. The most obvious path, and indeed the only path usually considered in a cursory examination of the problem, is that directly through the cell walls, cytoplasm, and vacuoles of the cells.

B. The cell walls themselves offer an attractive possibility.

C. The third path, involving cytoplasm and cell walls, but not involving the vacuoles, must be considered, especially in view of recent evidence that the cytoplasm itself may be relatively permeable (Kylin, 1960).

Additional paths involving intercellular spaces may be available, but they will not be considered here because such spaces are thought usually to be air-filled and therefore unavailable for liquid-water transport. If these spaces should be water-filled, however, their maximum effect would be to approximately double the permeability of any path involving the cell walls. Examination of the longitudinal and cross-sections of a root reveals no continuous radial path available through intercellular spaces alone.

To decide which of the available paths might be taken by the water, it is helpful to make estimates of the water permeabilities of the various materials involved.

Cell walls are composed of a framework of cellulose associated with a variety of pectic and other substances; the latter sometimes ac-

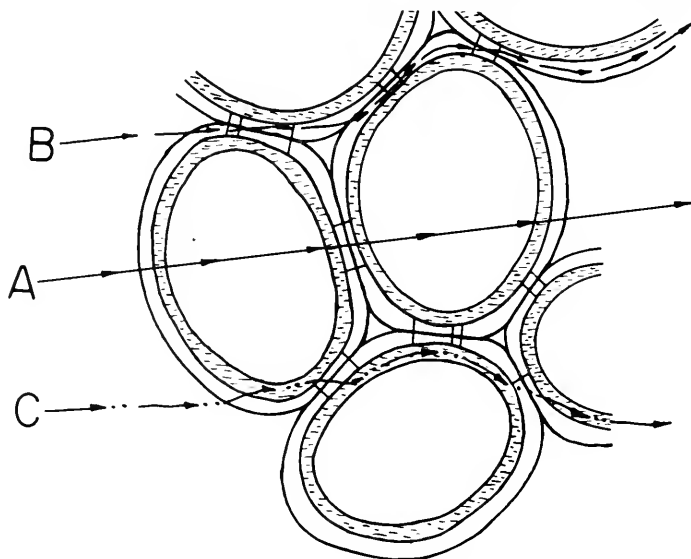

Figure 12. Schematic diagram of three possible flow paths through plant tissue.

counts for as much as half of the dry weight of the cell wall (Jensen and Ashton, 1960). Direct measurement of the permeability of the cell wall is made difficult by the cytoplasm, which is closely associated with the wall, but the permeability of artificial cellulose membranes may be taken as an approximation. Measurements of the permeabilities of such membranes vary greatly, but a value of 0.001 cm^2 per hour per atmosphere of pressure is reasonable as the maximum permeability that might be shown by cellulose similar to that of the root cell walls.

The best available measurements of the water permeability of plant cytoplasm are those made by plasmolysis and deplasmolysis of onion-scale protoplasts (Levitt, Scarth, and Gibbs, 1936). The measurements involve the movement of water not only into and through the cytoplasm but also through the entire path from the outside of the cytoplasm to the vacuole; hence it is not clear whether the major resistance to flow lies in the external membrane, the cytoplasm itself, or the vacuolar membrane. The linear rate of flow of water into such isolated protoplasts is about two thousandths of a centimeter per hour per atmosphere.

To evaluate the importance of the various available pathways, the cross-sectional areas presented by each of the components of the root must also be considered. In the cortex of small absorbing corn roots the relative volumes (and therefore relative areas presented) are approximately as follows: intercellular space, 10 per cent; cell wall, 4 per cent; cytoplasm, 4 per cent; and vacuole, 82 per cent. From the preceding data it is possible to estimate the resistance to flow of the three alternative paths through the root.

Path A: Assuming a path length six cells thick from epidermis to cortex, involving twelve layers of cytoplasm, the total cytoplasmic rate of water flow would be 2×10^{-3} cm. per atmosphere per hour divided by twelve, or 1.7×10^{-4} cm. per atmosphere per hour. The permeability of the cell walls in series with the cytoplasm can be calculated by dividing the specific permeability of cellulose by the total cell-wall path length of 8×10^{-4} cm. The resulting figure of 1.25 cm. per atmosphere per hour indicates that the resistance of the cell wall in path A is so much smaller than that of the cytoplasm that it can be neglected, and the value of 1.7×10^{-4} cm/atmos/hr, multiplied by the relative area of 82 per cent, gives 1.4×10^{-4} cm/atmos/hr as the over-all path-A permeability of one square centimeter of root surface.

Path B: Assuming that the cell-wall path through the six-cell layer from the epidermis to the endodermis is 0.15 mm. long, a linear rate of water flow in path B of 1×10^{-3} cm²/atmos/hr, divided by 1.5×10^{-2} cm., gives 7×10 cm/atmos/hr, which, multiplied by the relative area of path B of 4 per cent, gives 2.8×10^{-3} cm/atmos/hr.

Path C: No figures for the permeability of cytoplasm itself were

found for use in evaluating path C. If the resistance to flow is the same throughout the cytoplasm, or if the resistance of the external membrane is the same as that of the vacuolar membrane, very little flow might be expected in path C, due to its limited cross-sectional area. However, if the major cytoplasmic resistance to flow is in the vacuolar membrane, it may well be that substantial flow occurs in path C. For the moment, flow in this path will be neglected. Based on the rough calculations of the transmission characteristic of paths A and B, it is concluded that, in spite of the relatively small area presented by the cell walls, the major portion of the water flow may occur in them rather than through the cells themselves. It may also be concluded that the root cortex presents two parallel paths for water flow, one path being independent of the cytoplasm and one being through the cytoplasm. Therefore any changes in the permeability of the cytoplasm might be expected to change the total root permeability to a slight extent, but the water flow through the root is probably not completely controlled by the cytoplasmic permeability.

The endodermis is an enigmatic tissue, but it seems usually to be interpreted by plant physiologists as a structure in which all transport must necessarily take place via the cytoplasm and vacuole. If this is true, the endodermis may be the site at which all material entering or leaving the root becomes subject to the restrictions imposed by living, differentially-permeable membranes. It seems likely, therefore, that the endodermis is a salt barrier rather than a water barrier, and it will be treated as such in this paper.

Recent work has tended to indicate that the vacuolar membrane, rather than the external membrane or the cytoplasm of a cell, might be the cell's salt barrier. If this is true, one might reasonably assume that the greatest resistance to water flow also resides in the vacuolar membrane, and that the cytoplasm itself is relatively permeable to water. In this connection it should be pointed out that the figures used in the calculation of the cell-wall permeability are for rather permeable cellulose, but that normal cell walls contain considerable pectic material, which might decrease the wall permeability. Therefore, if only moderate potential drops exist across the cortex, it might be reasonable to assume that most of the water is flowing through path C. Insufficient information is available at present to justify a definite statement as to whether path B or path C is the principal water path. However, there is some evidence that the permeability of roots to water can change rapidly, in a direction opposite to that which might be expected from purely physical considerations, and that therefore a significant part of the water flow must be through cytoplasm. Rufelt (1959) found that when the roots of transpiring plants were moved from a warm to a cold solution, there was an initial increase in transpiration, followed by a

gradual decrease. When the roots were transferred from a cold to a warm environment, there was an initial decrease in transpiration, followed by a gradual increase. Such initial responses could be interpreted as evidence that the permeability of the cytoplasm had temporarily changed, causing a change in the rate of transport of the portion of the water that was flowing through the cytoplasm. Experiments of this type must be interpreted with care, however, because the plant itself can act as a source or sink for water. Only about 5 per cent of the water contained in the corn plant of our calculation, for instance, would be required to increase the rather high transpiration rate by a factor of 10 per cent for an hour. A temporary change in transpiration rate might actually indicate a permanent change in permeability or merely in hydration of the tissue, with the plant finally reaching a new stress equilibrium at practically the same transpiration rate as was originally observed.

The functional xylem consists essentially of cells interconnected so as to form long tubes with no protoplasmic barriers to flow. Therefore a rough approximation of the flow resistance can be obtained by the use of the Poiseuille equation, if the dimensions of the tubes and the rate of flow are known. The xylem path extends from the stele of the roots through the stem and into all parts of the leaves. The nodes of the stem of the corn plant have sometimes been regarded as barriers to movement, because certain substances apparently collect at these points in some diseased plants. In actuality, however, the nodes are locations in which a great amount of interconnection of conducting tissue takes place, so that there may be less resistance to flow at the nodes than in the internodes. Probably the reason for the apparent collection of substances at the nodes of corn plants is that at these places one can obtain a less diluted sample of the contents of the xylem than can be obtained at the internode.

The smallest veins of a corn leaf are about 0.016 cm. apart, and rows of stomata alternate with veins across the corn leaf, stomata being about the same distance apart in the rows. Thus the average molecule of water has to pass through about 0.08 mm. of mesophyll tissue on its journey from the vein to the surface of the mesophyll cell where it will evaporate. The resistance of the mesophyll tissue is probably about the same as that of the root cortex, but in the mesophyll intercellular spaces offer alternate pathways in which water can move as vapor. The resistance of an air pathway to the transport of water (as vapor) is about 40 times that of a cellulose pathway of the same dimensions. Because the cross-sectional area of the air path in the mesophyll may often be many times as great as the area of the cellulose path, a significant fraction of the water movement in the leaf mesophyll may take place as vapor movement in intercellular spaces.

Any vapor movement is limited not only by the characteristics of the transmission path but also by the availability of the energy required to evaporate the water at its vaporization site. Thus the existence of vapor transport in a given path is dependent upon the exact locations at which the leaf absorbs radiant or sensible energy and upon the thermal-conductivity characteristics of the leaf tissue.

The transmission characteristics of the vapor path from the mesophyll surface through the substomatal chamber, the stomata, the micro vapor cap, and the layer of still air over the leaf surface can be approximated for corn, as has been done by Bange (1953) for *Zebrina* leaves, although the calculations for corn will be less accurate than those for *Zebrina*, due to the greater eccentricity of the elliptical stomatal pore of corn. The resistances of the various parts of the vapor path are shown in Figure 13 as a function of the stomatal aperture. Under normal conditions, the greatest potential drop of the soil-plant-atmosphere system occurs in this vapor path, the difference in potential between the nearly saturated air at the mesophyll surface and an outer atmosphere at 50 per cent relative humidity being about 700 atmospheres. When the stomata are fully open in still air, about 80 per cent of the total path resistance comes not inside the leaf but in the air layers over the

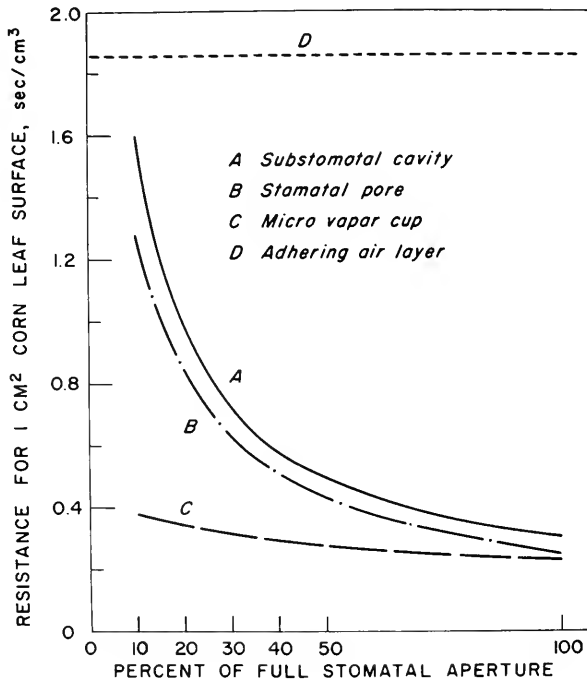

Figure 13. Calculated resistance to water-vapor flow from a transpiring leaf as a function of stomatal aperture.

leaf surface. It may be that the function of epidermal hairs is to decrease the rate of air movement across the leaf surface and thus increase the resistance of the flow path, but it is also possible that corn epidermal hairs, being rather far apart, serve instead to create turbulence in the air at low wind speeds and thereby promote gas exchange. The increase in transpiration that results from wind movement (Figure 14) is attributed to the removal of laminar air layers at the leaf surface.

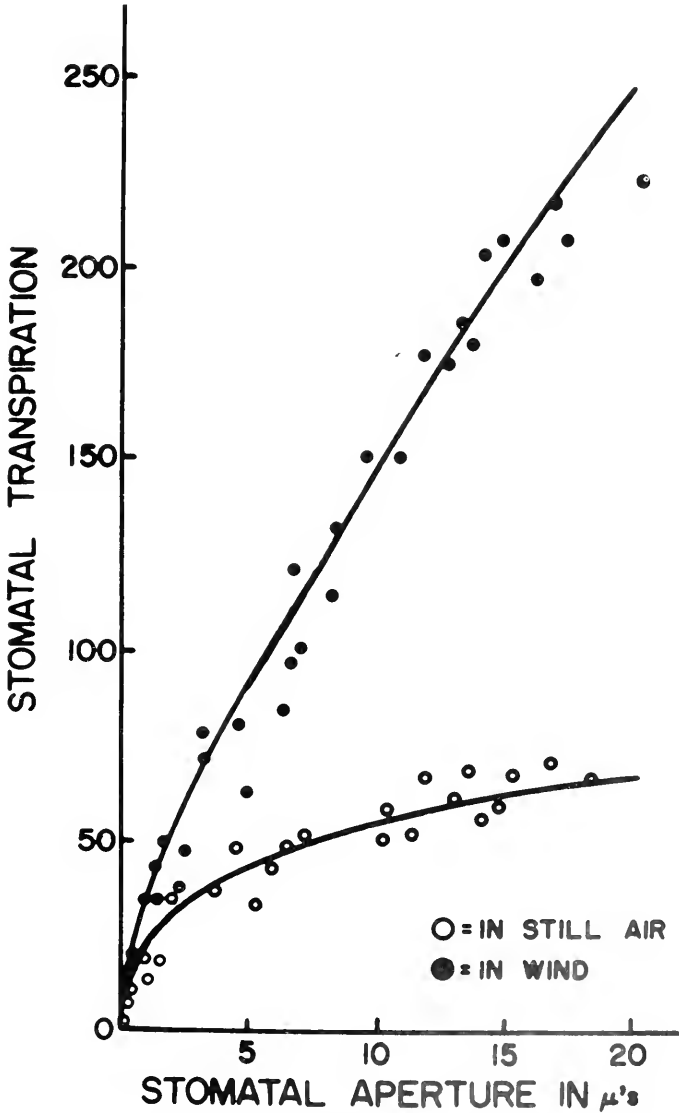

Figure 14. The effects of stomatal aperture and wind on transpiration. (From Bange, 1953.)

By making certain approximations, the resistance of the various tissues to the passage of water may be calculated for various transpiration rates. For such a calculation the mature corn plant is assumed to have the following (not unreasonable) characteristics:

Leaf area (both sides): 2 m^2 .

Area of leaf mesophyll exposed to intercellular space: 2 m^2 .

Root area (excluding root hairs): 3 m^2 .

Root area effective in water uptake (excluding root hairs): 2 m^2 .

Diameter of stem at internode: 3 cm.

Root weight: 500 gm.; above-ground weight: 1,500 gm.

Diameter of xylem lacunae: 0.012 cm.

Total cross-sectional area of vessels in 3-cm.-diameter stem: 0.20 cm^2 .

Rate of transpiration: 200 gm. per hour.

Using these values, the following quantities may be calculated:

Velocity of transpirational stream: 1,000 cm. per hour.

Average velocity on a total stem-area basis: 30 cm. per hour.

Hydraulic head loss in distance of four meters (root tip to leaf end): 3.2 atmospheres.

Velocity of transpiration stream into roots: 0.01 cm. per hour.

Pressure drop from epidermis to endodermis: 3.5 atmospheres.

Pressure drop from leaf xylem to surface of mesophyll: 1.7 atmospheres.

For the sake of simplicity, the root hairs have been ignored in this discussion even though under certain circumstances the inclusion of the root hairs may significantly change the calculations. Root hairs may, for example, increase the surface area within the root-hair zone ten-fold, and the length of the path traversed by water from the epidermal surface to the endodermis may be increased several-fold if the water enters the distal portion of a root hair. These two factors would, of course, tend to cancel each other out in calculations of potential drop, but they might be quite significant in other ways. Probably the principal effect of root hairs is to increase the volume of soil from which a given root can draw water, and therefore greatly increase the effective radius of the root in terms of water uptake. The advantage given to the plant by the root hairs lies in the fact that, in fairly dry soil, transfer of water to the root through the root hair is easier than transfer of the water through the soil, and it seems to be under just such conditions that root hairs reach their maximum development.

Several investigators have pointed out the similarity between the flow of water in porous media and other transport phenomena, such as the flow of heat, the diffusion of gases, and the transport of ions. In each case the flow obeys the General Transport Law, and the flux is

proportional to the appropriately defined transmission coefficient and potential gradient. The preceding sections of this paper have considered in some detail the application of the General Transport Law to the flow of water in the soil-plant system. Attention is now given to a more abridged discussion of other important transport phenomena occurring in soils and plants—phenomena which are fundamentally similar to the flow of water.

Heat flow

Thermal energy is transported primarily by the process of conduction in soils and plant tissues in response to temperature gradients. Transport also occurs, particularly between the plant and soil surfaces and the atmosphere, by radiation and convection. The thermal conductivity of the solid, liquid, and gaseous components of the soil have relative values of 1.0, 1.7, and 0.07. Transport through soil in response to a given temperature gradient is highly dependent on the volume-fractions of the solid, liquid, and gaseous phases. The specific heat of the soil components also is quite different when expressed on a volume basis. Therefore the temperature responses that occur as the result of heat flux into or from a unit volume of soil also are highly dependent on the volume-fractions of the solids, liquids, and gases that comprise the soil. The thermal properties of plant tissues are dominated by their high moisture content, and the thermal conductivity and heat capacity of living plants may be considered to be equal to those of an equal volume of water held in the same geometric configuration.

The flow of heat in the soil-plant system is in many respects similar to the flow of water, in that it is a highly dynamic phenomenon which shows characteristic diurnal and seasonal variations and is affected, although not as greatly as is water flow, by the bulk density and moisture content of the material through which the flow occurs. Heat-flow problems are simplified by the fact that both the specific heat and the thermal conductivity are largely independent of the temperature and are free of hysteresis effects. In analyzing heat-flow problems in soils and plants, it is necessary to account for the heat sinks and sources found within the system and for the transfer of heat by the movement of water and water vapor in the system.

Heat-flow problems, because of their greater inherent simplicity, have been analyzed more extensively than problems involving fluid flow in unsaturated porous media, and as a consequence they have been widely used as models for the mathematical analysis of the more complex problems of water flow (Carslaw and Jaeger, 1947; Philip, 1957). To analyze fully the highly dynamic behavior of water in the soil-plant atmosphere system, it is necessary to incorporate into the

analysis the appropriate heat-flow processes. The flow of water is controlled in large measure by the potential differences created by evaporation at the surface of the soil or at the surface of the mesophyll cells in the leaf. The 580 calories per gram required for this change of state must move to the site of evaporation at a sufficient rate to maintain the process; hence the flows of heat and of water in the soil-plant atmosphere are inextricably intertwined.

Flow of gases in soil

The exchange of oxygen and carbon dioxide between the air-filled voids in the soil and the atmosphere takes place primarily by the process of molecular diffusion in response to the gradients of the partial pressures of the individual gases. Except at very low values of air-filled pores, the diffusion coefficient is proportional to the volume-fraction of gas-filled pores. The diffusion of oxygen through water is only about 1×10^{-5} as rapid as through air at atmospheric pressure. Therefore the movement of oxygen through the soil to the site of its utilization in aerobic respiration in the root is largely determined by the thickness of the water films through which it must diffuse. Gaseous diffusion in both soils and plants is complicated by the solubility of the gases in the liquid phase and by the effects of temperature on such solubilities.

The diffusion of oxygen to the respiring root may be analyzed by applying Fick's law to the radial diffusion to a unit length of a root. The concentration of oxygen (C_r) at the root surface is given by the following equation:

$$C_r = C_p + \frac{qR^2}{2D_e} \ln \frac{R}{r_e}$$

where C_p is the concentration of oxygen in the surrounding soil solution, q is the oxygen consumed per unit volume of respiring tissue, D_e is the diffusion coefficient of oxygen through the water films, and R and r_e are the radii of the root and of the root plus the water films, respectively. From measurements of oxygen-diffusion rates to a platinum microelectrode (Lemon and Erickson, 1952) having a radius of 0.05 cm. in a clay soil with a moisture potential of -0.2 atmosphere, Wiegand (1956) calculated an effective diffusion path length of .23 cm. when the air-filled pores in the soil contained 19.8 per cent oxygen by volume. Wiegand also has calculated the critical oxygen concentration of 4.45×10^{-6} gm. per c.c. at the root surface for a root having a radius of .037 cm. and consuming oxygen at the rate of 1.12×10^{-7} gm. per c.c. per sec. This value of C_r is equal to the oxygen concentration of

water in equilibrium with 12 per cent oxygen. The equation indicates that the oxygen concentration at the root surface will depend on both the oxygen consumption rate and the diffusion characteristics of the surrounding flow path. Hence the phenomena of root aeration and water movement to an absorbing root are similar, in that both are rate-dependent and also are strongly affected by the transmission characteristics of the adjacent soil.

Gas transport in plant tissue

The two gases with which the plant is concerned—carbon dioxide and oxygen—are intimately related quantitatively, because the chemical process of the plant usually involves both gases in equal amounts. But the solubilities of the two gases, and their normal concentrations in the atmosphere, are so different that each gas presents a unique transport problem.

Because of the limited solubility of oxygen in aqueous media, the supply of respiratory oxygen to the center of the root is limited. It is doubtful that diffusion could provide sufficient transport of oxygen from the outside of a root larger than 2 mm. in diameter, regardless of which of the three transport paths were taken. But movement in tissues is not all by diffusion. Protoplasmic streaming could account for considerable oxygen movement, and, indeed, transport of oxygen may be the principal function of such streaming. It is true that there are numerous longitudinal intercellular spaces in roots, and that these spaces may be interconnected to form long tubes, so that some root aeration could be by diffusion of oxygen through these tubes. Certain aquatic plants have specialized conducting tubes which allow respiration of submerged roots, but calculations show that the possible oxygen supply through intercellular spaces to an ordinary root in soil would be rather limited. If 10 per cent of the root cross-sectional area were taken up by the intercellular spaces, and if the root were respiring at the rate of 0.5 ml. of oxygen per c.c. per hour, oxygen diffusion from free air at one end of the root would be sufficient for a root about 5 cm. long.

Oxygen itself need not necessarily all be transported in plant tissue. It may be that some electron carrier is transported, and that the final biochemical utilization of oxygen takes place only near the surfaces of plant tissues.

The solubility of carbon dioxide in aqueous media is about 25 times as great as the solubility of oxygen, and some carbon dioxide may be transported as the bicarbonate ion, so the transport of CO_2 as a respiratory product is no great problem. That is, if oxygen can get into a tissue, carbon dioxide can get out. But, because of its low concentration in the atmosphere, the movement of carbon dioxide into the leaf

may sometimes be the limiting factor in photosynthesis. The corn leaves considered in this paper, losing 0.01 gm. of water per sq. cm. per hour in an external relative humidity of 50 per cent might be expected to allow the passage of about 1.3×10^{-4} gm. of carbon dioxide from an external CO_2 concentration of 0.03 per cent and an internal CO_2 concentration of zero. This would be about the same as the rate of CO_2 uptake by corn observed by Moss, Musgrave, and Lemon (1960) at a light-intensity of 6,000 foot-candles. Moss and Musgrave found that under these conditions increases in the amount of CO_2 in the air caused an increase in the photosynthetic rate, so it appears that the transfer of CO_2 was limiting. Unfortunately, the plant has no mechanism by which it can decrease the diffusion-path resistance to carbon dioxide without reducing the resistance of the same path to water vapor, although any temperature difference between the leaf and the air could be expected to work in opposite directions on the two processes.

Flow of ions

In spite of the difficulties in measuring and interpreting salt movement in plants, all such movement must conform to the General Transport Law. Because of the obscurity of the mechanisms involved, application of this law to such movement has not been as useful as the application to water movement. Adsorption of ions to plant materials and movements by protoplasmic streaming further complicate the picture. Ions have the same three root paths available to them as were discussed for water, but the transport characteristics of the paths may be much different for ions than for water, and the relative importance of the three paths is currently the subject of active investigation and debate.

Path A, directly through the cytoplasm and vacuoles of the cells, is undoubtedly the path taken by some of the ions. It is known that the cells can store salts in solution in their vacuoles in concentrations far greater than the concentration in the external medium. In terms of the General Transport Law, this means that the potential barrier at the vacuolar membrane (or somewhere in the cytoplasm) must be high enough to prevent the outward flow of these ions. It is also known that the plant can drastically deplete the nutrient solution of its salts, so some region in the cytoplasm or vacuolar membrane must act as a sink, or place at which the potential of the ions is lowered. Thus there must exist a polarity within the cell; further, there must be a source of energy to establish such a concentration gradient. Both of these conditions can be fulfilled by some sort of ion-carrier system with appropriate concentration gradients in combined and uncombined carriers maintained by metabolic energy. The amount of energy required per ion depends

upon the potential difference between the external medium and the cell vacuole, which is difficult to measure over the course of an experiment. Many investigators have assumed, however, that a carrier system or "ion pump" may be functioning, using respiratory energy, regardless of whether the ions are being pumped "uphill" or "downhill." Although subject to numerous technical difficulties (measurement and respiratory quotients), studies of the relation of nutrient accumulation to respiration have yielded the information that the four theoretical monovalent ions can seemingly be accumulated for each oxygen molecule used in respiration.

Because ions accumulate in the vacuoles, and because respiratory energy is needed for this transfer, regardless of the actual potential gradient, it may be that path A would require too much energy for the transfer of ions across the cortex. Thus one oxygen atom might be needed for the transfer of one monovalent ion for each passage from vacuole to cytoplasm or cytoplasm to vacuole. In this case the efficiency of the process would be prohibitively low for a path several cells long, unless there was some mechanism by which the energy released by an ion moving "downhill" would become available to move another ion "uphill."

Cellulose is permeable to salts, so there is a possibility that some of the ions taken into the plant flow passively with the transpiration stream through the cell walls (path B). The same may be said for the flow through the cytoplasm (path C) if the cytoplasm is indeed permeable to ions. The permeability of the cytoplasm is now being investigated at several laboratories, with some investigators reaching one conclusion while other investigators reach the opposite conclusion (Haapala, 1960; Kylin, 1960).

For the present, the following picture may suffice to explain the movement of ions in the cortex. Water flows through the cell walls, and possibly the cytoplasm, drawn by the evaporation at the leaf. This water carries ions with it. The cortical cells act as ion sinks and sources, and they lie adjacent to the path of transport, withdrawing ions from the transpiration stream or secreting ions into the stream in response to metabolic regulatory mechanisms.

At the endodermis, as was mentioned before, the ions become subject to the influence of a differentially permeable membrane, and it may well be that an osmotic potential at this membrane is responsible for the well-known root pressure of plants at low transpiration rates. The endodermis need not be completely impermeable to salts to cause root pressure, as the root could be acting as a "leaky osmometer" (Philip, 1958), with merely a greater resistance to ions than to water in the endodermis. From the inside of the endodermis upward through the

xylem, the ions are carried passively with the transpiration stream to the leaves, with all the cells adjacent to the xylem acting as ion sources or sinks.

The possibility has not been excluded, however, that the ion carrier may be at the surface of the epidermis rather than in the endodermis, and that all ion movement in the cortex is metabolic and independent of water movement in that tissue. Either of these two hypotheses could account for the known facts. Ion uptake by the plant can be either independent of transpiration or proportional to transpiration, regardless of which model is selected, because of the complexity of the anatomy of the plant and of the processes involved, because the original approach of the ion to the root must be through solution, and because the transport of ions up the xylem is largely by movement of ions along with water.

Summary

The soil-plant system is highly dynamic. Water, gases, ions, and energy flow through the system in response to potential differences and in accordance with the General Transport Law. Steady-state flow is the exception rather than the rule in the soil-plant system, and the geometric complexity of the flow path makes necessary experimental determinations of the relevant transmission coefficients. The media through which flow occurs at times serve as either a source or a sink for the material being transported. For water flow, both the amount retained by the porous media and the transmission characteristics are highly dependent on the moisture potential and exhibit hysteresis, which greatly complicates the mathematical analysis of flow in such media. To date no analysis has included the effects of root elongation into new areas of absorption.

Despite the rather formidable difficulties, considerable progress has been made in the mathematical analysis of flow in the soil-plant system. To apply the General Transport Law, it is necessary to obtain experimental data on the concentration as a function of potential, position, and time, and of the transmission coefficient as a function of the same three independent variables. Limited data of this kind are available for a few soils, but practically none is available for plants or for an entire soil-plant system. Future progress in the study of the highly dynamic system is dependent upon the development of more adequate techniques of measurements and of computational techniques for solving the complex mathematical expressions needed to more adequately describe transient flow in anisotropic systems which also exhibit hysteresis effects.

References

- Bange, G. G. J., 1953. "On the Quantitative Explanation of Stomatal Transpiration," *Acta Bot. Neerlandica* 2, 255.
- Carslaw, H. S., and Jaeger, J. C., 1947. *Conduction of Heat in Solids* (N. Y., Oxford U. Press).
- Gardner, W. R., 1960. "Dynamic Aspects of Water Availability to Plants," *Soil Sci.* 89, 63.
- Gingrich, J. R., and Russell, M. B., 1957. "A Comparison of Effects of Soil Moisture Tension and Osmotic Stress on Root Growth," *Soil Sci.* 84, 185.
- Haapala, E., 1960. "Permeability of the Plasmalemma as Compared with That of the Tonoplast," *Physiol. Plantarum* 13, 358.
- Honert, Van den, T. H., 1948. "Water Transport in Plants as a Catenary Process," *Disc. Faraday Soc.* 3, 146.
- Jensen, W. A., and Ashton, M., 1960. "Composition of Developing Primary Wall in Onion Root Tip Cells, I: Quantitative Analyses," *Plant Physiol.* 35, 313.
- Klute, A., 1960. Personal communication.
- Kylin, A., 1960. "The Apparent Free Space of Green Tissues," *Physiol. Plantarum* 13, 385.
- Lemon, E. R., and Erickson, A. E., 1952. "The Measurement of Oxygen Diffusion in the Soil with a Platinum Microelectrode," *Soil Sci. Soc. Am. Proc.* 16, 160.
- Levitt, J., Scarth, G. W., and Gibbs, R. D., 1936. "Water Permeability of Isolated Protoplasts in Relation to Volume Change," *Protoplasma* 26, 237.
- Moss, D. N., Musgrave, R. B., and Lemon, E. R., 1960. "Photosynthesis under Field Conditions, III: Some Effects of Light, Carbon Dioxide, Temperature, and Soil Moisture on Photosynthesis, Respiration, and Transpiration of Corn." *Agron. J.*, in press.
- Ogata, G., Richards, L. A., and Gardner, W. R., 1960. "Transpiration of Alfalfa Determined from Soil Water Content Changes," *Soil Sci.* 89, 179.
- Philip, J. R., 1958. "The Osmotic Cell, Solute Diffusibility, and the Plant Water Economy," *Plant Physiol.* 33, 264.
- Philip, J. R., 1957. "The Physical Principles of Soil Water Movement during the Irrigation Cycle," Third Congress of International Commission on Irrigation and Drainage, *Quest.* 8:8.125.
- Rufelt, H., 1959. "Changes in Transpiration of Wheat Leaves Caused by Changes in the Properties of the Root Medium." *Physiol. Plantarum* 12, 390.
- Slatyer, R. D., 1957. "The Influence of Progressive Increases in Total Soil Moisture Stress on Transpiration, Growth, and Internal Water Relationships of Plants," *Aust. J. Biol. Sci.* 10, 320.
- Wiegand, Craig L., 1956. "A Field Study of Some Plant-Soil Relations in Aeration," Master's thesis, Texas A. and M. College.

COLLOID CHEMISTRY OF THE SOIL IN RELATION TO PLANT NUTRITION*

C. Edmund Marshall

UNIVERSITY OF MISSOURI

Eleven years ago, at a symposium on the mineral nutrition of plants, the author reviewed and correlated the differing concepts of the soil solution and then proceeded to develop the idea of the complete ionic environment of plant roots (Marshall, 1951). This includes contributions from dissociating soil colloids as well as from soluble salts. Cationic activity measurements, made by the use of membrane electrodes, furnished the experimental basis for this treatment. Illustrations were given of the differing properties of clay minerals as dissociating colloidal systems, of the relationships of monovalent and divalent cations, and of the consequences of polyfunctional characteristics in the clays. In later publications (Barber and Marshall, 1951, 1952) further details on clay systems were given, especially of the mutual effects of cations, and the humic colloids of soils were characterized by similar experimental methods (Marshall and Patniak, 1953).

Much has occurred since the Wisconsin symposium which bears on these matters. After a period of considerable confusion in the early 1950's, a large measure of clarification has been achieved. This contribution seeks to present a balanced view of the position today.

The definition of chemical environment

Since the soil is inherently a highly complex system with many solid phases, it will be necessary to simplify the problem by use of a reasonable model. The main properties of soils with regard to exchange

* Contribution from the Missouri Agricultural Experiment Station. Approved by the Director.

cations and water can be simulated by systems comprised of (1) an inert skeleton of sand and silt grains, (2) a colloidal cation exchanger such as a clay, (3) electrolytes in true solution, (4) water. We shall simplify this further for the moment by ignoring the skeleton, by taking a homionic clay, and by considering the chloride of the exchangeable cation to be the sole salt in true solution: for example, potassium clay, potassium chloride, and water.

Taking the last first, the chemical potential of the water is affected by both the salt and the clay, and it is accurately defined in terms of its vapor pressure at a given temperature and external pressure. The chemical potential of the potassium chloride can be thermodynamically defined through the electrical potential of a cell, one electrode of which is reversible to the chloride ion and the other to the potassium ion. It is affected by the chemical potential of the clay and that of the water. The chemical potential of the clay cannot so easily be defined. To treat it as a conventional solid phase in thermodynamic terms—that is, to say that it is in its standard state with chemical potential zero—solves no problems and affords no insights. Ionic exchangers bear little resemblance to sparingly soluble salts such as barium sulphate. The equilibrium with an external true solution is only partial and operates through diffuse ionic atmospheres and Donnan effects. The solution is at no point congruent in composition with the solid phase.

Yet exchangers can exert very strong effects on the chemical potential of molecular species in solution. If potassium clay is added to a dilute solution of potassium chloride, then the chemical potential and activity of the salt can be greatly changed, as indicated in Table I. It is almost as though another salt were added, and indeed it is easy to calculate how much potassium nitrate would produce the same change. Would it not be possible therefore to treat the exchanger as homogeneously distributed in solution? The molecule would then be the amount of exchanger associated with one monovalent exchange site. The difficulty with this approach is that there is no unique relationship

TABLE I
Effect of Potassium Bentonite Clay on the Activity of
Potassium Chloride in Dilute Solutions

Clay Conc. %	Exch. K meg/100 gm.	Total K Concentration	KCl Activity
0	0	6.5×10^{-5}	0.65×10^{-4}
0.387	0.66	2.62×10^{-3}	2.6×10^{-4}
0	0	1.30×10^{-4}	1.30×10^{-4}
0.387	0.66	2.68×10^{-3}	2.7×10^{-4}

between this idealized molecular unit and the actual kinetic units present. If the latter are treated as immobile, then we are back at the simple Donnan situation in which the soluble colloidal system forms the internal phase and a dilute true solution containing no colloid provides the external phase in equilibrium with it. The effect of the colloid on the chemical potentials of the water and of a salt can be measured, but the converse problem of assessing the effects of the water and of the salt on the chemical potential of the colloidal phase remains intractable.

If no complete thermodynamic solution of this problem is available, can our progress be advanced by partial solutions? At what points can extra-thermodynamic concepts and procedures usefully be introduced? Fortunately, if the exchangeable cations are treated as independent species, several approaches are possible. Their consistency one with another and with the thermodynamic results on complete molecules can be experimentally tested.

This is not the place to go into details of the involved controversies that raged a few years ago regarding the significance of different types of measurement (Coleman *et al.*, 1951; Peech *et al.*, 1953). The problem has now been solved for dilute bentonite and exchange-resin systems by careful comparison of three electrometric methods: (1) determination of salt activities as outlined above, (2) conventional potentiometric measurements with potassium chloride liquid junctions, and (3) conductivity determinations, including variation with frequency and cataphoresis of colloidal particles (Deshpande and Marshall, 1959). It is clear that the older classical interpretation of the second method as affording a valid measure of ionic chemical potential still stands. This is of particular importance in considering the soil as a source of cationic nutrients for plants. It means that we can obtain a solution as regards that part of the problem which most concerns us, since plants do not take up soil colloids congruently in solution.

Ionic bonding and its effects

As the author has shown, the situation of a given cation in relation to the colloidal exchanger can usefully be expressed in free-energy terms (Barber and Marshall, 1951, 1952; Marshall, 1951), since soil colloids are commonly only partly dissociated. They can thus be considered as exerting a bonding energy toward the cation. Numerically this is the difference in free-energy status between the cation as it exists in the soil or suspension and the corresponding value for a completely dissociated ion. If c is the total concentration of exchangeable cation and a is the activity, then the mean free bonding energy is $RT \ln c/a$. This quantity is a variable property of the colloidal system as a whole. It reflects changes in concentration, in the degree of saturation with a

particular cation, in the nature of the complementary ions and in the nature of colloidal particles (Barber and Marshall, 1951, 1952; Marshall and Patniak, 1958; Marshall and Upchurch, 1953). In terms of plant nutrition, we can get an idea of its usefulness by reference to Arnon's and Grossenbacher's observation (1947) that plants grown upon the calcium form of the sulphonic acid exchanger Amberlite IR 100 suffered from calcium deficiency. Much exchangeable calcium was present, but apparently the plants could not successfully compete for it.

However, this type of experiment needs very careful examination before the bonding of a single ion can be isolated as the main factor in plant response. Actually, Arnon and Grossenbacher used a mixed resin system which contained all the nutrient cations and anions in exchangeable form. Was the observed calcium deficiency due to an unfavorable potassium-calcium ratio in the equilibrium solution, or was the absolute level of calcium activity in the whole resin system responsible? If both factors need to be considered, how would it be possible to distinguish them experimentally? Before examining the situation in greater detail, certain experiments in solution cultures must now be considered.

Absolute activity levels

First we must see at what point in the cationic concentration or activity scale definite signs of deficiency appear. This varies, of course, for different elements, but in all cases it is low. To fix it definitely is not simple. The rate of growth and the relationship to other nutrients both need consideration. Furthermore, since cations can readily pass from root to substrate, very good conditions for renewal of the nutrient media must be maintained.

In this laboratory we have, on three occasions, carried out such experiments on soybeans. In the first series (McLean, 1948) relatively simple comparisons of bicarbonate solutions with Wyoming bentonite suspensions were made. In one set of comparisons, only calcium was offered in the substrate. In four other comparisons, varying proportions of calcium and potassium were employed; at each level the respective calcium and potassium activities of the bicarbonate and bentonite systems were equal. In no case was there evidence of calcium or potassium deficiency. The lowest calcium activity—namely, 0.7×10^{-4} mols/L—was evidently ample, since four times this amount caused no significant increase in uptake. The lowest potassium activity was 1.6×10^{-4} mols/L, and this also gave close to the maximum uptake.

In the second series (Upchurch, 1953) chlorides, bicarbonates, Wyoming bentonite, Putnam clay, and Amberlite IR 120 were used as substrates. In the mixed cationic systems (chloride, bicarbonate, and

Amberlite only) the potassium activity was 1.1×10^{-4} molar, and the lowest calcium activity was 4.7×10^{-5} molar. Again there was no injury, but evidence of deficiency was shown in a steep rise of calcium uptake with increasing activity. In these experiments, as discussed below, the importance of the bonding-energy relationships of cations was demonstrated (Marshall and Upchurch, 1953).

In the third series (Higdon, 1958) a number of low cationic activities were included, and definite evidence of deficiencies, both direct and indirect, was obtained. The sprouting procedure used, combined with the low calcium content of the seed, gave seedlings which were beginning to suffer from calcium deficiency. The study was thus concerned with recovery from or enhancement of this deficiency.

Where calcium was the only cation of the substrates, the calcium chloride solution at 5.3×10^{-5} molar did not arrest losses of calcium, whereas the calcium bicarbonate at the same concentration just did so. In calcium-potassium systems, plants grown on the chlorides at 6.8×10^{-5} molar calcium lost this element when the K/\sqrt{Ca} ratio was 0.078, but they just maintained constancy at $K/\sqrt{Ca} = 0.021$. Thus the steep part of the curve for uptake of calcium was around 7×10^{-5} .

In the presence of large amounts of calcium (4×10^{-3}), the chloride system grown at a potassium activity of 3.5×10^{-4} showed much greater uptake than that at 1.0×10^{-4} . In the presence of small amounts of calcium (6×10^{-5}), the chloride system grown at $a_K = 6.4 \times 10^{-4}$ gave slightly greater uptake than that at $a_K = 1.7 \times 10^{-5}$. Thus the steep part of the curve for uptake of potassium in relation to activity lies in the range 1 to 5×10^{-4} molar.

Where uptake lay on the steep parts of the respective curves, the absolute activity of the cation was found to be of greater importance than the K/\sqrt{Ca} ratio, although this also had its effects.

Weak electrolyte effects

There is a considerable body of evidence to show that plant roots take up larger quantities of nutrient cations from the salts of weak acids than from corresponding salts of strong acids. In highly dilute systems, bicarbonates have been shown to be superior to chlorides (Higdon and Marshall, 1959). In our most recent comparisons (Table II), the absolute activities of the cations are similar, whilst their ratios to one another vary only slightly. The factor that influences uptake is the relationship of the hydrogen ion to the anion in solution. Formation of a weakly dissociated acid favors uptake of nutrient cations.

This has been formulated in terms of a cation exchange reaction between the plant root and nutrient salt, by which the root takes up the metallic cation and loses hydrogen ions. Obviously any bonding be-

TABLE II

Uptake of K and Ca by Young Soybeans from Chlorides and Bicarbonates

Substrate	pH	a_K $\times 10^{-5}$	a_{Ca} $\times 10^{-5}$	K/\sqrt{Ca}	Uptake K	Uptake Ca (mols $\times 10^{-5}$)
Ca Chloride	6.22	—	5.3		—	1.02
Ca Bicarbonate	6.45		5.4		—	2.43
K-Ca Chloride	6.05	64.3	6.8	.078	43.8	1.28
K-Ca Bicarbonate	6.85	52.5	8.4	.057	70.3	3.45
K-Ca Chloride	5.98	16.9	6.2	0.21	35.3	2.33
K-Ca Bicarbonate	6.58	12.0	8.2	.013	36.8	4.70
K-Ca Chloride	6.00	12.10	82.0	.0042	68.2	14.6
K-Ca Bicarbonate	6.58	16.8	66.1	.0005	81.1	24.0

tween the hydrogen ion and a soluble anion will shift the equilibrium so as to favor uptake. Equally, one would expect that bonding of the nutrient cation by any anion (colloidal or other) in the nutrient substrate would decrease uptake.

But here one must examine certain limitations in the application of this conclusion. If a chloride and a bicarbonate system offer sufficiently high concentrations of, say, potassium, then the initial uptake will lie on the part of the total curve that is insensitive. Similarly, when comparison is made between a highly bonded and a loosely bonded metallic cation, if both systems offer equal and sufficiently high ionic activities, differences in initial uptake might well be small. Thus, in general, bonding effects, like absolute activity levels, will show themselves markedly only at quite low concentrations, the ranges of sensitivity being different for different elements.

It will be noted that "initial" uptake is referred to above. This might be defined as that part of the total uptake which operates without significant change in the external medium. For such effects to be unequivocally shown, stringent conditions must govern the renewal of nutrient solution in relation to the accumulation products from the roots.

In the experiments reported by Marshall and Upchurch (1953), calculation of the bonding energy balance, as between the hydrogen ion and a metallic cation on a given exchanger, revealed several cases in which this was a critical factor. It was apparent that differences upwards of 1,000 calories per mole were necessary in order to show such effects clearly. (In comparing these with other factors it

must be remembered that 1,364 calories per mole represents the free-energy difference for a ten-fold change in the activity of a given ion.)

Relationships involving ionic ratios

From the fundamental condition that in an equilibrium system the chemical potential of mobile molecular species must everywhere be the same, the following relationships involving ratios of ionic activities in a true solution (S) and in colloidal systems (I and II) in equilibrium with the solution can be deduced. These relationships hold independently of the geometrical relationship of the cations to the colloidal phases.

For homoivalent pairs of ions such as Na and K, Ca and Mg:

$$\left[\frac{a_{\text{Na}}}{a_{\text{K}}} \right] \text{Colloid I} = \left[\frac{a_{\text{Na}}}{a_{\text{K}}} \right] \text{Solution} = \left[\frac{a_{\text{Na}}}{a_{\text{K}}} \right] \text{Colloid II.}$$

$$\left[\frac{a_{\text{Ca}}}{a_{\text{Mg}}} \right] \text{Colloid I} = \left[\frac{a_{\text{Ca}}}{a_{\text{Mg}}} \right] \text{Solution} = \left[\frac{a_{\text{Ca}}}{a_{\text{Mg}}} \right] \text{Colloid II.}$$

For monovalent-divalent pairs such as K and Ca:

$$\left[\frac{a_{\text{K}}}{\sqrt{a_{\text{Ca}}}} \right] \text{Colloid I} = \left[\frac{a_{\text{K}}}{\sqrt{a_{\text{Ca}}}} \right] \text{Solution} = \left[\frac{a_{\text{K}}}{\sqrt{a_{\text{Ca}}}} \right] \text{Colloid II.}$$

These are general equilibrium relationships; two colloids initially not in equilibrium with the same solution will undergo adjustment of the ionic proportions until the above conditions are fulfilled.

Thus, if roots may be treated purely as non-metabolizing exchangers at equilibrium in a colloidal substrate, and if the equilibrium solution is sufficiently dilute, then the activity ratios for the two dissociating colloids are the same, although the absolute activity will, in general, be different. The appropriate ratios are easily determined by analysis of the dilute solutions. If the absolute cation activity for one cation on one colloidal phase is determined, then all others can be calculated by use of the above ratios. This method was first used by Schüffelen and Loosjes in characterizing colloidal substrates for plant growth.

Some workers have preferred to avoid this last step and have used small dilute exchanges against neutral salts, in order to determine the above ratios (Schofield, 1955) and through them to calculate a potential or free-energy characteristic of the soil-water system (Woodruff, 1955a). For satisfactory validity, the composition of the exchange complex must not be appreciably changed by the exchange reaction, and

the salt concentration in the external solution must be so low that for all practical purposes the ionic atmospheres of the colloidal phase are free from salt.

This type of characterization gives such quantities as the "lime potential" of Schofield, namely, $\text{pH} - \frac{1}{2}\text{pCa}$; and the energy of exchange of Woodruff, for example, $RT \ln \frac{^aK}{\sqrt{^A\text{Ca}}}$ or $1,364 (\text{pK} - \frac{1}{2}\text{pCa})$.

These, of course, are intensity ratios, and their relation to the gross cationic composition of the exchange complex has to be determined by complete exchange. This last has always been regarded as an important determination by soil scientists, since it expresses quantitatively the absolute level of each of the readily available cationic reserves. From the individual analytical results appropriate ratios are easily calculated.

An important characteristic of the exchange complex can be derived by dividing a particular activity ratio by the corresponding ratio of total exchangeable quantities. Under the conditions specified (very dilute external solution), the result is the ratio of the activity coefficient of the two cations of the colloid where these have the same valency (Wiklander, 1946). This quantity is often described as the equilibrium constant for the exchange reaction (k_s), but for many exchangers it varies greatly with the proportions of the two cations on the exchanger. In fact, the modern trend is to treat it as a variable, to call it the "selectivity number" or "selectivity coefficient," and to characterize a given exchanger in relation to any pair of cations by the curve connecting k_s with exchange composition. A soil in its natural condition corresponds to one point on such a curve for each pair of cations. These curves can be derived also from individual cation activity measurements whenever they are available for bionic systems. No doubt in the future we shall see increasing use of this method of characterizing the exchange properties of soils and soil colloids.

Can the same be done for plant roots under low rates of metabolism? With roots it is extremely difficult to effect a small exchange even at low temperatures. There is, apparently, fairly rapid passage from the interior of the root through the surface exchanger to the outer solution. Higdon (1957) found that upon exchange against salt solutions of 10^{-4} molar, the amounts found in solution were often a quarter of the exchange capacity of the root. Therefore, to make such determinations without changing the composition of the exchanger, dilute salt mixtures of the correct proportions should be used. If this type of determination can be made in sufficient detail, evidence on the possible variations in cationic bonding by different sites on plant roots should emerge. This would throw light on the basic assumptions used by Epstein and Hagan (1952) in their interpretation of the kinetics of uptake.

Dynamic factors

So far we have considered chiefly the static factors in the passage of nutrient cations from soil to plant root. What are the dynamic factors on the soil side and how can they be assessed?

It is clear that ions can move in the soil by two chief mechanisms: by mass movement of solvent and by ionic diffusion. It appears that plants do not normally depend on mass movement of water for their cationic nutrition, although they probably obtain considerable amounts by this route. Growth in a saturated atmosphere appears to be entirely similar to that in an unsaturated one, although highly critical experiments on such effects are very difficult to carry out. Nevertheless it is important to consider the general situation as regards plants and this aqueous environment.

The existence of a fairly well-defined wilting point sets a limit to the chemical potential of water utilizable by plants. Approximately, for many species, the wilting point lies near pF 4.2, which corresponds to a suction or osmotic-pressure difference of about 15 atmospheres. Beyond this point, the mass movement of water over solid surfaces is extremely slow, and redistribution is effected mainly through the vapor phase.

With intermittent rainfall, plants take most of their water under tensions between about one-third of one atmosphere (which corresponds roughly to field capacity) and 15 atmospheres. Even at one-fifth atmosphere, mass movement of water is very slow. Richards (quoted by Bayer, 1956) found that at this tension, capillary conductivity varied from 0.002 per cent (in a sand) to 0.16 per cent (in a silty clay) of the respective values at saturation.

The existence and properties of root potentials first described by Lundegardh (1943) indicate that a general resemblance between negatively charged colloidal membranes and roots can be established, but it does not afford a detailed view of the mechanism of uptake of any particular ion. If this were all that was involved, cations would be more freely admitted than anions. Special mechanisms superimposed upon the simple membrane picture are invoked to explain uptakes of anions. But if this can be demonstrated for anions is it not possible that particular mechanisms may control the uptake of individual cations? This is, in effect, the basis of the Epstein and Hagan formulation, suggesting that a small proportion of the total exchange sites on the root surface are responsible for most of the uptake, through their higher bonding energy for particular cations.

Such considerations would not in any way upset the validity of the Donnan relationships involving activity ratios of pairs of cations, pro-

vided that two conditions were fulfilled: (1) the complexing of cations by roots should not involve the formation of diffusible molecules that could pass into the external medium, and (2) the rate processes operating should be so slow that simple diffusion could maintain an approximate equilibrium state.

In the case of rapidly growing plants, it would seem that this simple Donnan equilibrium model would be unrealistic and that some consideration should be given to diffusion processes in the medium surrounding the roots.

Picture a linear root as occupying the center of a long cylindrical space in a colloidal medium. The first question that arises is whether the root surfaces are actually in contact with the colloidal system or whether a film of water, free from colloid, separates the two. On a micro scale the existence of such a film would not be unreasonable; indeed, in a soil system under a given moisture tension, it might be assumed to have roughly the same thickness as the water films between soil grains. Under a tension of one-third atmosphere, such a film might be about five microns thick. At 15 atmospheres the value would be 0.1 micron if under that pressure the surface tension of water has its normal value, which is doubtful. Thus the final step in the diffusion path of cations to the root surface would be through this attenuated water film. Under equilibrium conditions the root could be thought of as bathed by a true solution, which would be the external phase common to two Donnan systems—the soil colloids on the one side and the root surfaces as a colloidal system on the other. All the cationic relationships discussed above would hold. The ionic composition of the exchange sites concerned directly in uptake would be governed by the ionic activity ratios. If there are several kinds of such sites, endowed with greater or less specificity for given cations, these general activity relationships would still hold, but the ionic compositions on the different groups of sites would be different.

Thus under true equilibrium conditions such ratios as a_H/a_K , $a_H/\sqrt{a_{Ca}}$, $a_K/\sqrt{a_{Ca}}$, etc., will govern the relationships between variations in the soil system and variations in the composition of exchange sites of all kinds on the root.

Now consider the root as a more active participant in such a system. For the moment, assume that some unspecified reaction within the root produces hydrogen ions, which immediately change the ionic composition of all exchange sites on its surface. Hydrogen ions then exchange between the root sites and the solution immediately adjacent. The accession of fresh metallic cations to the root surface will be determined now by their speed of diffusion across this layer of changed composition. As long as the layer of changed composition remains

within the cylindrical water envelope, processes of diffusion in true solution will operate, the constant source of metallic cations being the Donnan external phase. A quasi-steady state will be reached when the rate of radical movement of the boundary between the layers is inversely proportional to the distance from the center of the root to the boundary.

But since the water layer itself is relatively thin, the layer of changed composition will soon move outward into the colloidal phase. The governing parameters now change drastically. We deal with exchange of ions in the colloidal phase and with ionic movements in the overlapping atmospheres of individual particles.

Thus, although the colloidal phase may not provide the immediate environment of the root surfaces in natural soils, ionic processes within the colloidal system soon become governing as regards the release and movement of nutrient ions. What properties will then be of greatest significance in the operation of the quasi-steady state here envisaged? One is the self-diffusion of cations in colloidal systems. There is evidence from the work of Bloksma (1957) that this type of diffusion is less rapid than the corresponding diffusion in the equilibrium dialysate. Thus at 25° C. the coefficient of self-diffusion of the sodium ion in a 6.2 per cent bentonite paste was 0.56×10^{-5} , as compared with values of around 2×10^{-5} for low concentrations of salt in water. Part of this reduction was ascribed to a tortuosity factor and part to the limited dissociation of the sodium ion from sodium clay. The mean diffusion coefficient of the molecule NaI in the clay paste was 1.08×10^{-5} , as compared with about 2×10^{-5} in water alone. Thus the self-diffusion of cations and of salts is considerably reduced by the presence of clay.

Furthermore, in capillary systems such as natural soils a decrease in moisture content greatly decreases the rate of self-diffusion of ions, whether they are in true solution as salts (Klute and Letey, 1959) or in the overlapping ionic atmospheres of colloidal particles (Kemper, 1960). Thus the relationship between moisture stress and cation uptake is likely to impose limitations as regards plant nutrition. But very little is known about this directly. The recent work of Danielson and Russell (1957) indicates a roughly logarithmic decrease of Rb^{86} uptake with increasing moisture tension.

Another major factor influencing the quantity of a nutrient ion moving toward the root in unit time is obviously the exchange reaction between the outwardly diffusing hydrogen ion and the soil colloid. The position of equilibrium temporarily attained at each distance from the root will be determined by the respective activities and bonding energies of the hydrogen ion and the nutrient cation. In clay and soil sys-

tems there is usually no variant equilibrium constant; the latter changes very significantly with the ionic composition of the exchange complex, as we have shown above.

Evaluation of soils as nutrient media

Certain basic determinations have long been used by soil scientists to evaluate soils, and these still retain their importance, although we should now amplify the information they provide. We can list four criteria, the first two of which are traditional.

1. Determination of the organic matter in the soil. Rapid wet-combustion methods are widely used to give an approximate value. This then affords a relative measure of the annual release of nitrogen, phosphorus, etc., under stated climatic conditions and agricultural practices. It also defines roughly the share of the total exchange capacity that can be attributed to the organic matter. The exchange capacity of soil organic matter is high compared with that of clay. Cations are more extensively dissociated from soil organic matter than from clays (Marshall and Patniak, 1953). There are measurable differences in different organic-matter fractions and in soil organic matter derived under different climatic and vegetative environments, but the over-all situation can be judged fairly well from the simple wet combustion.

2. Determination of exchange capacity and of individual exchangeable cations, including hydrogen and aluminum. These results determine reserves and are of great relative value where soils of similar exchange complexes are to be compared.

3. Cationic activities and bonding energies. As we have seen, absolute activities are sometimes controlling. In passing from one type of exchange complex to another, the bonding of individual cations becomes extremely important. This can throw important light on soil-forming processes, as well as on general agricultural characteristics. (Brydon and Marshall, 1958). Combining 2 and 3, we obtain measures of the total immediately available reserves and of their ease of release.

4. Recent determinations of ionic ratios by the use of dilute salt exchange. These values are essentially potentials—that is, intensity factors. They are likely to come into increasing use as a means of characterizing soil-root systems under conditions of zero uptake. They are likely to prove important in the comparison of different types of exchange complexes as initial media for plant growth. Their significance probably will decrease as metabolism rates increase, with consequent large-scale changes in the proportions of exchange cations near active roots. It remains to be determined by field experimentation under widely different cationic ratios how far one can go in using this char-

acterization of the exchange complex. At what ratios do deficiency symptoms appear, and what variability is there under the conditions of agricutural practice? The answers to these questions are already being sought in many laboratories.

References

- Arnon D. I., and Grossenbacher, K. A., 1947. "Nutrient Culture of Crops with the Use of Synthetic Ion Exchange Material," *Soil Sci.* 63, 159.
- Barber, S. A., and Marshall, C. E., 1951. "Ionization of Soils and Soil Colloids, II: Potassium-Calcium Relationships in Montmorillonite Group Clays in Attapulgitic," *Soil Sci.* 72, 373.
- Barber, S. A., and Marshall, C. E., 1952. "Ionization of Soils and Soil Colloids, III: Potassium-Calcium Relationships in Illite, Kaolinite and Halloysite," *Soil Sci.* 73, 403.
- Bartlett R. J., and McLean E. O., 1959. "Effect of Potassium and Calcium Activities in Clay Suspensions and Solutions on Plant Uptake," *Soil Sci. Soc. Am. Proc.* 23, 285.
- Bloksma, A. H., 1957. "The Diffusion of Sodium and Iodide Ions and of Urea in Clay Pastes," *J. Coll. Sci.* 14, 40.
- Brydon, J. E., and Marshall C. E., 1958. *Mineralogy and Chemistry of the Hagerstown Soil in Missouri*, Missouri Agricultural Experimental Station, Research Bulletin 655.
- Coleman, N. T., *et al.*, 1951. "On the Validity of Interpretations of Potentiometrically measured Soil pH," *Soil Soc. Sci. Am. Proc.* 15, 106.
- Danielson, R. E., and Russell, M. B., 1957. "Ion Absorption by Corn Roots as Influenced by Moisture and Aeration," *Soil Sci. Soc. Am. Proc.* 21, 3.
- Deshpande, K. B., and Marshall C. E., 1959. "An Interpretation of Electrochemical Measurements on a Montmorillonite Clay," *J. Phys. Chem.* 63, 1659.
- Epstein, E., and Hagan, C. E., 1952. "Kinetic Study of the Absorption of Alkali Cations by Barley Roots," *Plant Physiol.* 27, 457.
- Higdon, W. T., 1957. "An Experimental Study of Three Chemical Theories of Cation Uptake by Plants," Doctoral thesis, University of Missouri.
- Higdon, W. T., and Marshall, C. E., 1959. "The Uptake of Ca and K by Young Soybean Plants," Missouri Agricultural Experimental Station Research Bulletin 716.
- Kemper, W. D., 1960. "Water and Ion Movement in Thin Film as Influenced by the Electrostatic Charge and Diffuse Layer of Cations Associated with Clay Mineral Surfaces," *Soil Sci. Soc. Am. Proc.* 24, 10.
- Klute, A., and Letey, J., 1959. "The Dependence of Ionic Diffusion on the Moisture Content of Nonadsorbing Porous Media," *Soil Sci. Soc. Am. Proc.* 23, 213.
- Lundegardh, H., 1943. "Electrochemical Relations Between Root Systems and Soil," *Soil Sci.* 54, 177.
- McLean, E. O., 1948. "The Measurement of Potassium and Calcium Activities by Means of Clay Membrane Electrodes in Homionic and Polyionic Systems including Plant Cultures," Doctoral thesis, University of Missouri.
- Marshall, C. E., 1951. "The Activities of Cations Held by Soil Colloids and the Chemical Environment of Plant Roots," in Truog, E., ed., *Mineral Nutrition of Plants* (Madison, Wisc., U. of Wisconsin in press).
- Marshall, C. E., and Patniak, N., 1958. "Ionization of Soils and Soil Colloids, IV: Humic and Hymatomelanolic Acids and Their Salts," *Soil Sci.* 75, 153.

- Marshall, C. E., and Upchurch, W. J., 1953. "Free Energy in Cation Interchange as Illustrated by Plant Root-Substrate Relationships," *J. Phys. Chem.* 57, 618.
- Marshall, C. E., and Upchurch, W. J., 1953. "Chemical Factors in Cation Exchange Between Root Surfaces and Nutrient Media," *Soil Sci. Soc. Am. Proc.* 17, 222.
- Peech, M., *et. al.*, 1953. "Significance of Potentiometric Measurements Involving Liquid Junctions in Clay and Soil Suspensions," *Soil Sci. Soc. Am. Proc.* 17, 214.
- Schofield, R. K., and Taylor N. W., 1955. "The Measurement of Soil pH," *Soil Sci. Soc. Am. Proc.* 19, 164.
- Schuffelen, A. C., and Loosjes, R., 1942. "The Importance of the Growth Medium for the Absorption of Cations by Plants," *Nederl. Akad. van Wetenschappern* 45, 3.
- Upchurch, W. J., 1953. "An Experimental Study of the Chemical Factors in Cation Exchange Between Root Surfaces and Nutrient Media," Doctoral thesis, University of Missouri.
- Wiklander, L., 1946. "Studies on Ionic Exchange with Special Reference to the Conditions in Soils," *Ann. Roy. Agr. Coll., Sweden* 14, 1.
- Woodruff, C. M., 1955a. "Cation Activities in the Soil Solution and Energies of Cationic Exchange," *Soil Sci. Soc. Am. Proc.* 19, 98.
- Woodruff, C. M., 1955b. "Ionic Equilibria Between Clay and Dilute Salt Solution," *Soil Sci. Soc. Am. Proc.* 19, 36.
- Woodruff, C. M., 1955c. "The Energies of Replacement of Calcium by Potassium in Soils," *Soil Sci. Soc. Am. Proc.* 19, 167.

GLOSSARY

A adenosine.

Acetabularia a large unicellular marine alga which is differentiated into a rhizoid, a stem, and a cap.

ACTH a hormone from the anterior pituitary gland which stimulates the adrenal cortex.

actinomorphic regular-shaped flowers with radial symmetry.

activity the ideal or thermodynamic concentration of a substance, the substitution of which for the true concentration permits the application of the law of mass action.

alleles the alternative forms of hereditary material that may exist at the same locus.

analogue a chemical that resembles another in structure or function.

androecium the stamens of a flower.

aneuploid an organism with a chromosome number which is not an exact multiple of the haploid number. Types such as $2N + 1$ or $2N - 2$ are aneuploid.

angiosperm plants with true flowers which produce seeds enclosed within an ovary.

Ångstrom unit 10^{-10} centimeter.

anisotropic exhibiting different properties in different directions.

antimetabolite a compound which interferes with utilization of a normal metabolic intermediate.

Arabidopsis a plant.

archaeopteryx an extinct bird which possessed teeth.

archencephalon primitive brain anterior to the end of the notochord.

ascospore a spore developing in an ascus, or sac.

assimilatory capable of being incorporated into the complex of living material.

atherosclerosis fatty degeneration of the connective tissue of the arterial walls.

ATHF allotetrahydrocortisol, a cortisol metabolite.

atropine an alkaloid drug which inhibits structures innervated by post-ganglionic cholinergic nerves.

autogenic succession due to biotic reaction; contrasts with allogenic succession.

- auxin** a plant growth substance, such as indoleacetic acid and related compounds.
- axolotl** a form of salamander which retains some larval characteristics throughout life.
- β -galactosidase** an enzyme that hydrolyzes β -galactosides, such as lactose.
- blastema** a group of cells which will give rise to an organ or structure either during regeneration or in normal embryogenesis.
- blastocoele** the cavity of the blastula.
- blastocyst** the blastula of mammals.
- blastula** a stage in the early development of the embryo, consisting of a hollow sphere of cells.
- bronchogenic** originating in a bronchus (branch of the trachea).
- C** cytosine.
- Cannon bone** either metacarpal or metatarsal bone of the horse.
- carpel** a flower organ which constitutes all or part of a pistil and in which seeds are produced.
- cataphoresis** the migration of suspended particles under the influence of an electric field.
- cauline** pertaining to the stem or of stem derivation.
- centriole** a cell organ usually present as two small chromatic granules in the cytoplasm closely opposed to the nuclear wall. Plays a role in cellular division.
- chelate** a compound in which the same molecule is attached to a central atom at two different points, forming a ring structure, at least one such attachment being a coordinate linkage.
- chelating agent** a compound which can bind cations by forming stable complexes.
- chemostat** an instrument for maintaining growing microorganisms at a constant concentration.
- chondrogenesis** formation of cartilage.
- chorioallantois** an extra embryonic sac formed by fusion of the chorion and the allantois.
- Circadian cycle** the inherent diurnal rhythm shown by various physiological processes and behavior patterns.
- cis-trans test** a genetic test to determine whether two characteristics are in the same functional unit (cistron).
- clone** all the descendants of a single individual.
- contact exchange theory** exchange of ions between soil surface and root surface.
- corpora allata** paired glands present in insects; they secrete the juvenile hormone.
- cotyledons** food-storage organs of a plant embryo; they may or may not persist in the seedling as photosynthetic organs.
- c.p.m.** counts per minute (emissions from a radioactive source).
- cytokinesis** the changes that occur in the cytoplasm of the cell during division and fertilization.

- Dauermodifikation** an experimentally produced modification of the phenotype in which the effect is attenuated with successive generations until it disappears.
- dCMP** deoxycytidine monophosphate.
- dCTP** deoxycytidine triphosphate.
- dCTPase** an enzyme which degrades dCTP.
- DEAE cellulose** diethylaminoethyl cellulose.
- dedifferentiation** reversal of a tissue to a more primitive state; loss of differentiation.
- dHMP** deoxyhydroxymethylcytidine monophosphate.
- dHTP** deoxyhydroxymethylcytidine triphosphate.
- diaphysis** shaft of long bone.
- differentiation** the process of acquiring individual characteristics, such as occurs in the development of the embryo.
- diffusion pressure deficit** the pressure difference between two points on a diffusion gradient.
- DNA** deoxyribonucleic acid.
- DPA** dipicolinic acid.
- Donnan membrane equilibrium** equilibrium between the ions of a salt solution and the colloidal particles and associated ions of a colloidal electrolyte separated by a membrane.
- dTMP** thymidine monophosphate.
- dUMP** deoxyuridine monophosphate.
- 2,4-D** 2,4-dichlorophenoxyacetic acid.
- ectoblast** an embryonic cell layer.
- ectoderm** the outermost of the three primary germ layers of the embryo; gives rise to skin, hair, nervous system, etc.
- efficiency index** rate of production of new plant material in relation to the dry weight of the plant.
- EMB lactose medium** a medium containing eosin, methylene blue, and lactose.
- entropy** the theoretical final state of energy equilibrium.
- epharmonic** differing from the normal or usual because of influences of the environment.
- epigenesis** a theory of embryogenesis which states that development consists in the successive formation of new parts which do not preexist in the fertilized embryo.
- epigynous** flowers with sepals, petals, and stamens appearing to arise above the ovary.
- epiphysis** the head of a long bone; the part of a long bone separated by cartilage.
- euploid** an organism whose chromosome number is a whole number multiple of the basic or haploid number.
- fibroblast** the connective tissue cells.
- field capacity** the moisture content of a well-drained soil after excess has drained away and the rate of downward movement has materially decreased.

- flux** the rate of flow or transfer of ions, water, energy, etc., the term being used to denote the quantity that crosses a unit area of a given surface in a unit of time.
- G** guanidine.
- gastrula** an early stage in embryonic development; it follows the blastula stage.
- Gaussian** a type of statistical distribution expressed by a "normal," bell-shaped curve.
- genome** the complete complement of genetic material for an organism.
- gibberellic acid** an acid, originally extracted from *Gibberella*, which has morphogenetic effects on plants.
- GTP** guanosine triphosphate.
- gynoecium** the pistils of a flower.
- HeLa cell** a line of cultured cells originally derived from a human cervical carcinoma.
- heterotrophic** an organism which is unable to use simple inorganic substances for food.
- heterozygote** an individual with different alleles at the same locus on homologous chromosomes.
- hinny** a cross between a stallion and a jennet (female jackass).
- histolysis** lysis of a tissue.
- HMC** hydroxymethylcytosine.
- Holism** the doctrine of J. C. Smuts that the properties of the organized whole are more than the summation of its parts.
- homionic** refers to clays or exchange materials saturated with only one kind of exchangeable cation.
- homologous** similar by virtue of a phylogenetic relationship.
- hyperploid** an organism whose chromosome number is greater than a whole number multiple of the haploid number, e.g., $2N + 1$ or $2N + 2$.
- hypogynous** flowers with the sepals, petals, and stamens attached to the receptacle at the base of the ovary.
- hypophysectomy** surgical removal of the pituitary gland.
- hysteresis** a lagging or retardation of the effect when the forces or direction of forces acting upon a system are changed.
- IAA** indoleacetic acid.
- instar** the larval stage of an insect between molts.
- intercalary** between primary vascular bundles.
- ion-exchange capacity** the capacity (in milliequivalents) of a clay (or root) to bind cations reversibly, due to its possession of negatively charged groups.
- isotropic** having the same properties in all directions.
- karyogamy** cell conjugation with union of nuclei.
- karyotype** the chromosomes of an organism as they appear at metaphase of a somatic division.
- kinase** an enzyme transferring a phosphate group from adenosine triphosphate to an acceptor compound.

kinetin 6-furfurylaminopurine.

leaf-area ratio total leaf area/plant weight.

lithophytia a class of ecosystem predominantly controlled by the rocky substrate.

lobopodium the clear cytoplasmic area in certain types of zoospores which is capable of ameboid change of shape.

M molar.

meristem a localized group of embryonic cells which persists throughout the life of a plant and produces additional adult tissue.

mesenchyme embryonic connective tissue which gives rise to the connective tissues of the body and the blood vessels.

mesonephros the excretory organ (or kidney) of the embryo; it is behind the pronephros, toward the tail end.

metamorphosis a change in shape or structure involving a transition from one developmental form to another, as in the insect and frog.

monocotyledon a group of plants characterized by the presence of one cotyledon (seed leaf) in the embryo.

monoecium individual plants which produce both staminate and pistillate flowers.

mutagenesis the process of mutation.

mycelium system of fungal hyphae.

myxamoebae motile cells of cellular slime molds.

NAA naphthaleneacetic acid.

net assimilation rate (unit leaf rate) the increase in dry weight per square centimeter of leaf per week.

neurula a stage in the development of the embryo that follows the gastrula. The neural tube appears during this stage.

nucleoside a compound composed of a nitrogenous base and a sugar.

nucleotide a compound composed of a nitrogenous base, a sugar, and a phosphate.

nutrilite a nutritional element.

ONPG orthonitrophenolgalactoside.

orchidectomy surgical removal of the testes.

osteogenesis formation of bone.

ovine pertaining to sheep.

oxyphytia a class of ecosystem predominantly controlled by acid substrate.

$\Phi \times 174$ a bacteriophage.

perigynous flowers with the sepals, petals, and stamens attached to a raised portion of the receptacle so that these parts appear to arise in a ring around a partly enclosed ovary.

phagocytes cells of the body that ingest microorganisms, other cells, and foreign particles.

photoperiod a series of relative lengths of day and night which induce flowering and other developmental effects.

phototropism the response of plant organs to unilateral light.

phyllotaxis the arrangement of leaves on a stem.

- phytochrome** a proteinaceous pigment isolated from plants which controls a variety of responses to red and far-red light.
- pinoocytosis** the absorption of liquids by cells.
- pituitary** an endocrine gland located on the floor of the brain in the sella turcica. The pituitary secretes at least nine different hormones, some of which stimulate other endocrine glands such as the thyroid, gonads, etc.
- plasmodesmata** minute cytoplasmic connections between cells.
- polymer** a large molecule made up of repeating smaller units.
- polymerase** an enzyme bringing about union of units into a polymer.
- procambium** embryonic plant tissue which will mature into vascular tissue.
- prothoracic gland** an endocrine gland of the insect which secretes ecdysone, the growth and differentiation hormone.
- protista** a group of the lowest unicellular forms of plants and animals.
- protochordate** a simple animal which lacks a cranium and brain such as the tunicates and shows similarities to the ancestors of the chordates.
- pseudopodia** small protrusions of protoplasm from the main body of the cell.
- pupa** the stage between the larva and imago in the development of an insect.
- Q₁₀** Every temperature increase of 10° C. approximately doubles to triples the speed of chemical and biological reactions. A temperature coefficient of a reaction may be expressed as the Q₁₀.
- rad** a unit of absorbed radiation dose: *i.e.*, 100 ergs/gram.
- rhizosphere** the soil region in the immediate vicinity of the plant roots in which the abundance or composition of the microbial population is affected by the presence of the roots.
- RNA** ribonucleic acid.
- R.Q.** respiratory quotient.
- Schlieren peak** the high point of a curve obtained with a special technique of optical measurement.
- SH-group** sulfhydryl group.
- soma** pertaining to the body; vegetative or non-reproductive portions.
- SS-group** a linkage formed between two compounds with -SH groups by removal of hydrogen.
- stamen** the flower organ that produces pollen.
- stele** the central cylinder in the stems and roots of vascular plants.
- syngamy** fusion of identical gametes.
- S_{20,w}** the sedimentation constant corrected to conditions which would be obtained in water at 20° C.
- T** thymidine.
- TCA-cycle** tricarboxylic acid (Krebs or citric acid) cycle.
- T-even phages** the bacteriophages named T2, T4, T6.
- teratoma** a tumor resulting from faulty embryonic differentiation and organization.
- THE** tetrahydrocortisone, a cortisol metabolite.
- therophytes** annual plants in the life-form classification of Raunkaier.
- THF** Tetrahydrocortisol, a cortisol metabolite.

T-phages T1, T2, T3, T4, T5, T6, T7.

transduction the transfer of genetic material from one cell to another when mediated by a bacteriophage.

trophoblast the enveloping layer of cells of the early embryo which will attach the ovum to the uterine wall and supply nutrition to the embryo.

tropophytia a class of ecosystem having environmental controls well balanced in effectiveness but alternating in time.

μ micron (10^{-6} meter).

μc microcurie.

UDPG uridinediphosphoglucose.

$\mu\text{eq.}$ micro equivalent.

μmole micromole.

versene ethylenediaminetetraacetic acid.

wether a ram castrated prepubertally.

xerophytia a class of ecosystem predominantly controlled by scarcity of water.

zygomorphic irregularly shaped flowers with bilateral symmetry.

zygote the cell resulting from the union of the male and female gametes.

INDEX

A

- Abercrombie, M., 209
Acetabularia mediterranea, 262, 264,
265-266, 270, 468
Achurch, R. C., 545
Adams, C. E., 322
Adams, M. H., 33
Adelberg, E. A., 80
Adova, A. N., 283
adrenal cortex, 393-394
Aerobacter acrogenes, 86, 222
aging, changes with, 421-435
 and steroids, 407-420
Agrobacterium tumefaciens, 607
Albersheim, P., 447
Alfert, M., 169, 175, 177
Allen, A., 375
Allendy, R., 22
alpha-globulin, 192
alpha-helix, 6
Altzuler, N., 359, 365, 368, 370, 377
Amblystoma punctatum, 280, 281
Ames, B. N., 26, 82
amino acid metabolism, 359-365
amino acid sequence, 4, 6, 7, 34
amino acids, 10, 11-14, 88-89, 346-348,
634
Amoeba, 174, 470
amphibian eggs, RNA in, 245-258
Amprino, R., 280
Andersen, D. B., 480, 636
Anderson, J. T., 427, 432
Anderson, M., 222
Anderson, T. F., 18
Andreasen, E., 296, 301
Andres, C., 216
Andrew, N. V., 296
Andrew, W., 296
Andrews, J. S., 283, 288
androgens, 385-390, 399-401
aneuploidy, 186
angiosperms, 491-492
antibiotics, and growth, 348-349
apical cap, 280-281, 284, 285
apical meristem, 492-496
Aquilegia formosa, 496, 501
Arabidopsis, 444, 449
Arber, A., 501
Arnold, P. W., 690
Arnold, W., 441
Arnon, D. I., 338, 634, 726
Arros, J., 583
Aschner, B., 354, 355
ascorbic acid, 344-345
Ashby, E., 545
Ashbya gossypii, 340
Ashton, D. M., 86
Asling, C. W., 355, 356, 387
Aspergillus nidulans, 42, 44, 45, 49, 54,
70, 71, 72
Astrachan, L., 19, 20
Astwood, E. B., 369
atherosclerosis, 425-426, 428-434
Aub, J. C., 390, 391
Aubréville, A., 573
Auerbach, R., 216
Avena sativa, 537
Avery, O. T., 58
Axolotl, 243, 280, 281, 295, 302
Ayers, D. A., 672

B

- Babcock, C., 304
Bacillus cereus, 108, 109, 113, 114, 116,
119, 120, 122, 123, 124, 125, 128
Bacillus megaterium, 109, 112
Bacillus stearothermophilus, 108
bacteria, and enzyme formation, 93-106
 and spore formation, 107-132
Baker, H. G., 510
Balinsky, B. I., 281
Balls, A. K., 634
Bancroft, J. B., 642, 643, 644

- Bange, G. G. J., 712, 713
 Baptiste, E. C. D., 533
 Barber, S. A., 723, 725, 726
 Barfurth, C., 285
 Barghoorn, E. S., 456
 Barka, T., 174
 Barker, H. A., 344
 Bamer, H. D., 28, 29
 Barth, L. G., 217
 Barth, L. J., 217, 262
 Bartlett, R. J., 676
 Baruch, H., 374
 Basler, E., 630
 Bauld, W. S., 411, 418
 Bauman, J. W., 375
 Bautzmann, H., 242
 Baver, 731
 Bawden, F. C., 628, 629, 631, 636, 644
 Beadle, G. W., 44
 Beard, J. S., 573
 Beatty, R. A., 262
 Beauchamp, C., 634
 Becker, G., 526
 Becks, H., 391, 394
 Bell, E., 280
 Bender, M. A., 188
 Benedict, R. B., 660
 Benitez, H., 217
 Bennett, C. W., 622
 Bennett, L. L., 374
 Benzer, S., 44, 47, 49, 52
 Bernhard, W., 163, 167
 Bernstein, L., 665, 676
 Bersohn, I., 418, 430
 Bessman, M. J., 31, 32
 Bibring, T., 164, 165, 167, 168
 Biddulph, O., 457
 Bidwell, R. G. S., 469, 477
 Bieber, S., 248
 Bielsa, L. B. de, 676
 Billingham, R., 216, 297
 Billings, W. D., 568
 biosynthesis, age-related, 414-420
 Bishop, J., 13
 Black, J. N., 534, 542, 544
 Black, L. M., 606, 624, 625
 Blackman, G. E., 534, 539, 542, 544
 Blackman, V. H., 525-526, 527
 Blanc, D., 668
 blastema, 278, 279, 281, 282, 283, 284,
 285, 296, 301, 304, 305
 and epidermis, 288-292
 Bloch, E., 411
 Bloksma, A. H., 733
 Blount, R. W., 246
 Bodemer, C. W., 285, 293, 297
 Bodo, R. C. de, 359, 365, 368, 370, 377
 body proportions, of farm animals, 328-
 333
 body weight, 394-398
 Bollard, E. G., 465
 Bonner, J., 440, 443, 446, 447, 448, 558,
 665
 Bonner, J. T., 221, 235
 Booth, F., 669
 Bostroem, E., 296
 Bounhiol, J. J., 315
 Boveri, T., 163
 Bowen, H. F., 375
 Boyd, G. E., 676
 Brachet, J., 160, 207, 241, 242, 245,
 246, 247, 248, 249, 250, 251, 252,
 253, 254, 255, 256, 257, 258, 259,
 260, 261, 262, 263, 264, 265, 269,
 468
 Braithwaite, G. D., 337
 Brakke, M. K., 606
 Brande, P. F., 362
 Braun, A. C., 478, 608, 609, 610, 611,
 612, 615
 Braun, E. L., 597
 Braun-Blanquet, J., 568, 573, 577, 591
 Breazeale, J. F., 666
 Brenchley, W. E., 526
 Brendler, H., 396
 Brian, P. W., 660, 661
 Bridges, J. B., 217
 Briggs, G. E., 526, 527, 528, 530
 Brito da Cunha, A., 577n
 Broadbent, D., 466, 549
 Brodführer, U., 563
 Bromley, N. W., 283, 295, 304
 Brooke, M. S., 86
 Brown, B., 93
 Brown, G. M., 340, 343, 345
 Brown, H., 440, 442
 Brown, J. C., 638
 Brown, R., 466, 467, 549
 Brown, S. S., 396
 Brown, W. L., 109
 Broyer, T. C., 461, 462
 Bruez, 187
 Brunst, V. V., 301
 Bryan, G. T., 358
 Brydon, J. E., 734
 Bucher, N. L. R., 168
 Bullough, W. S., 173
 Bunzel, H. H., 631
 Bürger, M., 422
 Burk, D., 347
 Burke, H. A., 389, 398
 Burnet, F. M., 217
 Burstein, S., 417
 Burstrom, H., 680
 Burton, K., 18, 19

- Butenandt, A., 314
 Butler, A. M., 386
 Butler, E. G., 301
 Buvat, R., 501, 690
- C
- Cagiannt, B., 249
 Cain, S. A., 569, 573, 574, 575, 577, 579, 583, 591
 Cairns, J. M., 280
 calcium, in aorta, 421-422
 Calef, E., 45, 71
 Camiener, G. W., 340
 Camosso, M., 280
 cancer therapy, 189
 Candolle, A. P. de, 515
Cannabis sativa, 509, 510
 Caplin, S. M., 611
 carbohydrates, and virus infection, 630-631
 carcinogenesis, 425
 Carr, D. J., 505
 Carr, S. G. M., 505
 Carslaw, H. S., 715
 Carter, A. C., 399
 Case, M. E., 55
 Castle, W. E., 322
 castration, 398-401
 Castro, G. M. de O., 573, 575, 579, 583
 Cate, G. ten, 262
 Caton, W. L., 355
 Ceballos, L. y Ortuno, 598
Cecropia silkworm, 315-316
 cell aggregation, 198-205
 heterologous, 214-218
 heterotypic, 212-214
 histogenesis in, 209-212
 and molecular requirements, 207-209
 and temperature, 206-207
 cell division; *see* cellular reproduction
 cell growth, mammalian, 181-196
 plant, 453-490
 cell organization; *see* synchronous cell systems; tissue reconstruction
 cellular differentiation, in slime mold, 221-239
 cellular reproduction, 159-179
 centrioles, reproduction of, 162-168
 Cerana, L. A., 676
 Chaikoff, I. L., 374
 Chalkley, D. T., 282, 292
 Chantrenne, H., 10, 153
 Chapman, H. D., 680
 Chapman-Andresen, C., 470
 Charley, J. L., 684
 Chase, M., 49, 52, 53
 chemostat, 95, 96-100
 Cheo, P. C., 636, 637, 638, 643
 Chernick, S. S., 365
 Chesrow, E., 396
 Chessin, M., 633
 Child, C. M., 247
 chloroplast, 441-442
 cholesterol level, 421-422, 426-434
 Christensson, E., 142
 chromosomes, 40-73
 reproduction of, 169-170
 see also cell growth
 Chu, E. H. Y., 188
 Church, B. D., 111, 128
 Cieciora, S. J., 183, 184, 192, 193
 cirrhosis, 424
cis-trans test, 49-51
 Clark, F. E., 657
 Clark, P. J., 401
 Clements, F. E., 591
Cleome spinosa, 513
 Cleveland, L. R., 163, 167
Clostridium roseum, 113, 114
 coenzymes, 346-347
 Cohen, A. L., 227
 Cohen, G., 79, 90, 100
 Cohen, S. S., 18, 19, 20, 21, 22, 23, 26n, 28, 29n, 32
 Cohen-Bazire, G., 82, 102
 Cohn, M., 79, 80, 94, 102
 Coleman, N. T., 668, 676, 725
 Collander, R., 459
 Collier, R., 107n, 113
 colloid chemistry, and plant nutrition, 723-736
 Comly, L. T., 13
 Commoner, B., 628, 629, 630
 Conklin, E. G., 198
 Consentino, V., 630
 copying process, 4-5
 Cori, C. F., 363
corpora allata, 315-316
 corticosteroids, 393-394, 407-408, 419
 cortisol-secretion, 414-416
 cosmos plant, 443-444
 Cowan, E. W., 670
 Crank, J., 686
 Crawford, L. V., 28
 Cresp, J., 282
 Crick, F. H. C., 5, 6, 10, 12, 40, 174
 crossing-over; *see* recombination analysis
 Crowther, F., 531
 Cuatrecasas, J., 590
Cucurbita pepo, 482-483
 Curtis, A. S. G., 207, 260-261
 Curtis, J. T., 568, 590
 Cusick, F., 512, 514

Cutter, E. G., 493, 501, 502, 503, 505,
508, 514
cytoplasm, 469-470

D

Dahl, E., 591
Dalby, A., 102
Dalcq, A., 248, 259, 260
Dalglish, C. E., 338
Dalton, A. J., 260
Danielli, J. F., 161, 208
Danielson, R. E., 733
Danini, E. S., 295
Dansereau, P., 568, 573, 575, 577, 578,
579, 580, 581, 583, 584, 585, 586,
588, 590, 591, 599
Darcy's Law, 696
Darlington, C. D., 40
Das, N., 175, 177
Davern, C. I., 444
David, K., 385
Davis, B. D., 80
Davis, M. H., 285, 297
Dawber, T. R., 427
Deck, J. D., 279
De Duve, C., 318
de Harven, E., 163, 167
dehydroisoandrosterone, 408-409
Delange-Cornil, M., 262, 263, 264
Delbruck, M., 230
Delihias, N., 27
Delwiche, C. C., 628, 630, 643
Dent, J. N., 250
Depape, G., 598
De Pinto, J., 107n
Desai, A. D., 676
Deshpande, K. B., 725
Deuchar, E. M., 262
Deuel, H., 667, 668, 676, 684
Dewey, V. C., 154
Dictyostelium discoideum, 221, 222,
227, 228-229, 233
Dictyostelium mucoroides, 233
Dietz, P. M., 628
Diptera, 317
Dirksen, E., 171
*Discourses Concerning Two New Sci-
ences* (Galileo), 9
dithiodiglycol, 264-269
Dittmer, H. J., 657
DNA, 4, 6, 7, 9, 10, 11, 17-38, 40, 41,
42, 43, 54, 58-73, 94, 160, 161,
162, 168, 169, 170, 173, 174, 175,
176, 181, 182, 183, 184, 190, 191,
450, 451
Dobzhansky, T., 577n

Doctor, B. P., 13
Doermann, A. H., 49, 52, 53
Donnan effects, 724, 725, 732, 733
Dorfman, R. I., 386, 387, 389, 399, 400,
401, 417
Doyle, J. T., 427
Drake, M., 668
Drew, R. M., 183, 190, 191
Dreyer, W. I., 33
Drill, V. A., 396
Drosophila, 45, 49, 73
Dryopteris austriaca, 495, 512
Dubin, D. T., 26
Dubinin, N. P., 45
Dukes, P. P., 33
Dunlap, A. A., 630, 631
Du Ritz, G. E., 577, 579

E

Eagle, H., 192, 345
Eakin, R. M., 247
Eames, A., 501
Ebert, J. D., 217, 259
ecdysion, 314-315, 316, 318
ecosystematic control, 589-590
ecosystematic fitness, 593-596
Edds, M. V., 207
Eisenberg, E., 396
Elgabaly, M. M., 668, 671
Elkind, M. M., 189, 190
Emerson, R., 440, 441
Endymion non-scriptus, 535, 536
Engard, C. J., 497
Engelberg, 188
Engländer, J., 242
Engle, F., 107n
Ennis, H. L., 222, 225, 227, 228
enucleate states, 466-469
environmental factors, and plant growth,
525-556
enzyme formation, and bacteria, 93-106
enzyme induction, 78-80
enzyme regulation, role of, in metab-
olism, 77-92
enzyme synthesis, repression of, 80-83
enzymes, 4, 7, 446-448, 450
and spores, 110-113
and virus, 22-35, 634
epharmonic types, 577-583
Ephrussi-Taylor, H., 42, 59, 60
epidermis, role of, in regeneration, 277-
306
epiphyseal cartilage, 387-389, 391-393,
394
epithelium, and regeneration, 277-311
Epstein, E., 669, 730, 731

- Epstein, J. A., 396
Eremothecium ashbyii, 340
 Erickson, A. E., 716
 Esau, K., 622, 624, 627
Escherichia coli, 17, 21, 28, 29n, 31, 34, 78, 80, 81, 82, 83, 85, 86, 90, 95, 99, 101, 222, 235, 339, 341, 342, 343, 346, 350, 351
 estradiol, 418, 419
 estriol, 418, 419
 estrogen excretion, 411-412
 estrogens, 390-393, 398, 407-420
 estrone, 418, 419
Eucalyptus, 505
 Evans, A. H., 59
 Evans, F. C., 569
 Evans, H. M., 355, 356, 391, 394
- F
- Faber, J., 280, 284
Fagopyrum esculentum, 534, 535, 537, 538, 539
 farm animals, growth in, 321-334
 fatty acid metabolism, 365-378
 Faworina, W. N., 279, 283, 295, 304
 feedback inhibition, 83-88
 Feldman, A., 188
 Feldt, A. M., 283
 Fell, H. B., 217
 Fennell, D., 221
 Fessenden, L. M., 280
 fetuin, 192, 208
 FFA (free fatty acid), 365-370, 372
 Ficq, A., 250
 Fidanza, F., 427
Filago, 504
 Fincham, J. R. S., 51
 Fischer, F. G., 247
 Fisher, H. W., 183, 184, 192, 193, 208
 Fisher, R. A., 526, 527
 Fishman, J., 419
 fission process, 160, 161
 Flaks, J. G., 22, 23, 25, 26, 27, 28
 Flavin, M., 154
 Fleischmann, W., 390
 Flickinger, R. A., 217, 246, 247, 260
 Flinker, D., 297
 flower, growth and development of, 491-523
 folic acid, 342-343
 Ford, C. E., 184, 186, 216
 Forrest, H. S., 340
 Foss, G. L., 398
 Foster, A. S., 494
 Foster, J. W., 109, 112, 113, 127
 Fowler, C. B., 18, 26n
 Fox, J. J., 28, 249
 Fraisse, P., 285, 296, 297
 Frankel, J., 156
 Franklin, A. L., 350
 Franklin, M. J., 370, 372, 373
 Fraser, D., 630
 Frederickson, L., 326, 331
 Frederickson, D. S., 365
 Freese, E., 58
 Freudenthal, W., 296
 Frey-Wyssling, A., 667
 Friedkin, M., 21, 22
 Friedman, 90
Frontiers of Cytology (Palay), 469
 Fukuda, S., 315
 Fuss, K., 666
- G
- Gaarenstroom, I. H., 392
 Gaastra, P., 440, 441
 galactosidase (β), 95-96, 98-105
 Gallagher, T. F., 419
 Gállera, J., 248
 Garcés-Orejuela, C., 645
 Gardner, W. R., 701, 702, 704, 705, 706, 707
 Garen, A., 95, 99
 Garrett, S. D., 654, 659
 Garry, B., 82
 gas flow, in plant, 717-718
 in soil, 716-717
 Gasseling, M. T., 280
 Cautheret, R., 608
 Gautier, M., 186
 Gelfant, S., 173
 gene, fine structure of, 45-47
 gene conversion, 55; *see also* mutation
 General Transport Law; *see* soil-plant system
 generative process, 160-161
 genetic investigations, of floral organization, 517-519
 genetic pairing, theory of, 53-54
 Gerhart, J. C., 86
 germination; *see* spores
 Gerola, F. M., 634
 Geschwind, I. I., 387, 388, 392, 393, 394
Geum urbanum, 536, 537, 538
 Ceyer, R. P., 372
 Gfeller, M. D., 280
 gibberellin, 449-450
 Gibbs, R. D., 709
 Gidge, N. M., 279
 Giese, A. C., 142
 Giles, N. H., 51, 55

- Gille, A., 575, 583, 590
 Gingrich, J. R., 702
 Girolami, G., 622
 Glascock, R. F., 375
 Clauser, R., 678, 688
 Gleason, H. A., 568
 Godlewski, E., 278, 279, 281, 283
 Goebel, K., 497, 504, 513, 515, 516
 Goldberg, I., 107n
 Goldfarb, A. F., 396
 Collakota, K., 107n, 109, 118
 Gollub, E. C., 90
 Good, R., 574
 Goodall, D. W., 533, 536, 537, 541, 569
 Goodgal, S. H., 59
 Goodman, H. M., 357, 359, 366, 367
 Goodman, I., 249
 Goodwin, T. W., 337
 Gordon, G. S., 369
 Gordon, M., 346, 607
 Gordon, R. S., Jr., 365
 Gorini, L., 81, 82, 84
 Goss, R. J., 279, 283, 284, 305
 Gots, J. S., 86, 90
 Gounot, M., 569
 Graff, S., 154
 Grainger, J., 504, 505
 Grande, F., 427, 432
 Gray, P. H. H., 656
 Green, M., 21
 Greenbaum, A. L., 370, 375
 Creep, R. O., 357, 358, 372, 377
 Gregg, J. H., 222
 Grégoire, V., 501
 Gregory, F. H., 525, 529-530
 Gregory, P. W., 322
 Grelet, N., 113
 Grieve, B. J., 633
 Griffing, B., 444, 449
 Grobstein, C., 207, 213, 216, 217, 260
 Gros, F., 10, 12, 88
 Grossenbacher, K. A., 726
 growth, and antibiotics, 348-349
 in farm animals, 321-334
 and flower, 491-523
 plant, 439-452, 557-566
 plant cell, 453-490
 of plant communities, 567-603
 and steroids, 383-405
 and vitamins, 335-348
 see also pituitary growth hormone;
 plant virus infections
 growth autonomy, concept of, 613-614
 growth centers, of leaf, 493-495, 497
 growth rate analysis, of plants, 525-554
 Grunes, D. L., 684, 688
 Guinochet, M., 568
 Gunkel, J. E., 607
 Guttman, B., 101
- H
- Haapala, E., 719
 Hagan, C. E., 730, 731
 Haguenuau, F., 288
 Hall, T. S., 250
 Halvorson, H. O., 107, 109, 110, 111,
 112, 118, 128
 Ham, A. W., 288
 Ham, R. G., 192, 193
 Hamburger, K., 142, 147, 151, 152
 Hammerton, J. E., 184
 Hammond, J., 322, 324, 329, 331, 332
 Handschumacher, R. E., 90
Haplopappus gracilis, 476
 Hardwick, A., 113
 Harris, D. L., 340
 Harris, P. J., 164, 167, 168
 Harrison, B. D., 643
 Harrison, J. A., 461
 Hartwig, H., 247
 Hasegawa, H., 254
 Hassan, M. N., 669
 Hay, E. D., 281, 282
 Hayashi, Y., 242, 244
 Hayashida, T., 358
 Hayes, A. D., 684
 Hayes, D. R., 391
 Hayes, W. H., 58
 Hays, H. W., 399
 heat flow, in soil-plant system, 715-717
 Heath, H. D., 282
 Heckel, N. J., 401
 Hegner, B., 135n
 Heidenhain, M., 167
 Helder, R. J., 666
 Helfferich, F., 670, 676
Helianthus annuus, 525, 526, 534, 535,
 537, 538, 539, 540-542, 543, 544,
 547
Helianthus tuberosus, 473-474
 Hellmers, H., 440
 Hellmich, W., 282
 Helms, K., 636, 637, 638, 644
 Helmy, A. K., 668
 Henderson, J., 447
 Hershberger, L. G., 396
 Hershey, A. D., 18, 19, 20, 26, 33, 42
 Heslop-Harrison, J., 500, 501, 509, 510
 Heslop-Harrison, Y., 500, 509
 Hewitt, H. B., 188
 Hibbert, 478
 Higdon, W. T., 727, 730
 Highkin, H. R., 449
 Hildebrandt, A. C., 608
 Hills, G. M., 107, 108, 110, 111

Hirata, S., 633
 Hisaoka, K. K., 249
 histogenesis, in cell aggregates, 209-212
 Hitchborn, J. H., 644
 Hitchings, C. H., 248
 HMC, significance of, 20-33
 Hoagland, D. R., 460, 461, 462
 Hoagland, M. B., 10, 12, 13
 Hodges, C. V., 401
 Hodgson, G. L., 542
 Holden, M., 628
 Hollenberg, C. H., 366, 367, 369
 Holley, R. W., 13
 Holmes, F. O., 631
 Holter, H., 470, 690
 Holtfreter, J., 242, 254, 260
 Holtzer, H., 199, 284
 Holz, C. G., 142, 147, 153
 Honert, T. H. van den, 699
 Hood, S., 189
 Hope, A. B., 665, 673
 Hopper, A. F., 249
Hordeum vulgare, 538, 539
 Horibata, K., 102
 Horiuchi, T., 82, 95, 104
 hormone, juvenile, 315-319
 pituitary, 353-381
 plant, 446-451
 hormones, and nutrition, 331-333
 Hornberger, R., 526
 Hostettler, F., 667
 Hotchkiss, J., 359, 363, 364, 373, 375,
 377
 Hotchkiss, R. D., 59, 60, 69
 Houston, B. R., 624
 Howard, R. P., 389, 398
 Howatson, A. F., 288
 Huggins, A. K., 365
 Huggins, C., 400, 401
 Hughes, W. L., 40, 183
 Hugon, de Scoeux F., 260
 Hultén, E., 574
 Hunter, C. L., 324, 325, 326
 Hutner, S. H., 679, 684
 Hylmo, B., 665
Hymenoptera, 317
Hyoscyamus, 449
 hypogonadism, 389

I

I-cells, 222-238
Iberis, 513
 Ide-Rozas, A., 283, 284, 292, 293, 296,
 297, 298, 300, 302
 indoleacetic acid, 446-448
 inflorescence, growth and development
 of, 491-523

Ingalls, T. H., 391
 Inoue, S., 284, 306
 insect metamorphosis, 313-320
 ion absorption, 457-475
 ion flow, 670-671, 718-720
 ion transfer, 673-676
 ionic bonding, 725-726
 ionic ratios, 729-730
 iron accumulation, 681-689
 Ishii, M., 629
 Ishikawa, S., 297
 Iverson, R. M., 142

J

Jablonski, J. R., 611
 Jackson, R. L., 385
 Jackson, R. M., 661
 Jacob, F., 82, 93, 100, 103, 105
 Jacobs, P. A., 186
 Jaeger, J. C., 715
 Jaenicke, L., 343
 Jabn, T. L., 142
 James, N., 656
 James, R., 217
 Jeener, R., 629
 Jefimoff, M. I., 278, 279, 283, 304
 Jenny, H., 666, 668, 670, 671, 672, 673,
 675, 677, 678, 684, 688, 690
 Jensen, W. A., 665, 690
 Jesaitis, M. A., 20
 Johnen, A. G., 242
 Jolit, M., 82
 Jones, S. G., 504
 Jost, A., 355
 Joubert, D. M., 324, 325, 326, 327
 Jovet, P., 584, 591

K

Käfer, E., 43
 Kaighn, M. E., 280
 Kamrin, A. A., 293, 300, 301, 303
 Kappas, A., 417
 Karasaki, S., 248
 Karlson, P., 314
 Kassanis, B., 632, 636, 643
 Katznelson, H., 657
 Keck, K., 22
 Kehr, A. E., 607
 Kellenberger, E., 33
 Keller, P., 668, 684
 Kelley, H. G., 385
 Kelley, S. M., 624
 Kemp, A. W., 542, 544
 Kemper, W. D., 733
 Kendrew, J. C., 6
 Kenyon, A. T., 395

- Kerr, T., 480
 Kertesz, Z. I., 476
 Ketellapper, H. J., 444
 ketosteroids, 386-387, 408, 416, 419
 Ketterer, B., 356, 359, 365, 377
 Keys, A., 425, 426, 427, 432, 434
 Kibrick, E. A., 391, 393
 Kidd, F., 526, 527, 528, 530
 Kidder, G. W., 154
 Kihlberg, J. K., 421ⁿ, 427
 Kimball, R. F., 174
 Kimura, N., 425
 Kipnis, D. M., 363, 364
 Klaatsch, H., 282
 Kleckowski, A., 628
 Klein, R. M., 568, 573
 Klute, A., 705, 733
 Knight, R., 625
 Knobil, E., 355, 357, 358, 359, 360, 361,
 362, 363, 364, 366, 367, 368, 370,
 372, 373, 375, 377
 Koch, G., 33
 Kochakian, C. D., 395
 Koerner, J. F., 31, 32
 Komala, Z., 279, 284
 Kornberg, A., 21, 22, 23, 31, 32
 Korner, A., 364
 Kostoff genetic tumors, 607
 Kostyo, J. L., 361, 362, 363, 364, 375
 Kozloff, L. M., 18ⁿ, 20, 33
 Krahl, M. E., 364, 365, 376
 Krauss, F., 282
 Krebs's cycle, 477
 Kreuzler, U., 526, 528, 529
 Krishnamoorthy, C., 676
 Kriszat, G., 262
 Krivanek, J. O., 221
 Krivanek, R. C., 221
 Kunkee, R. E., 18ⁿ
 Kunkel, L. O., 624
 Kuusi, T., 242
 Kylin, A., 708, 719
- L
- Lackey, C. F., 624
 Lacks, S., 12, 60, 69
 LaCour, L. F., 170
 Lagerwerff, J. V., 676, 677, 678
 Lallier, R., 250, 262
 Lamfrom, H., 13
 Lang, A., 449
 Lang, W. H., 492
 Langridge, J., 444, 449
 Larson, R. H., 623
 Lash, J. W., 306
 Laskaris, T., 609, 610
Lathyrus maritimus, 537, 538, 539
 Lavarack, J. O., 246
 Lawrence, A. S. C., 261
 Lawrence, N. L., 107, 111
 Lazarenko, T. M., 295
 leaf expansion, chemical control of, 552-
 554
 Lebrun, J., 568
 Lederberg, E., 58
 Lederberg, J., 58, 101
 Ledoux, L., 256, 257, 261
 Lee, C. L., 624
 Lee, H. H., 18
 Leggett, J. E., 669
 Lehmann, F. E., 250
 Lejeune, J., 186
 Lemmon, P., 631
Lemna minor, 545, 552
 Lemon, E. R., 716
 Lems, K., 579, 585, 588
 Letey, J., 733
Leuconostoc citrovorum, 350
 Levan, A., 184
 Levander, G., 296
 Levie, L. H., 392
 Levine, L., 26, 32
 Levinson, H. S., 111
 Levinthal, C., 40, 95
 Levitt, J., 709
 Lewis, E. B., 49
 Li, C. H., 356, 358, 360, 387, 388, 392,
 393, 394
 Libo, H. W., 396
 Liddle, G. W., 398
 Lieberman, I., 208
 Lieberman, S., 408
 Liedke, K. B., 248
 light, and nutrient supply, 540-541
 and temperature, 541-551, 557-566
 and virus infection, 644-645
 Lindeman, R. L., 590
 linked genes, 41-42
Linum usitatissimum, 532
 Lipman, F., 151
 lithium ions, 250
 Littau, V. C., 606
 Lobenstein, G., 632-633
 Loosjes, R., 729
 Lopez-Gonzales, J. de, 672, 674, 675,
 678, 684, 690
 Lorincz, A. L., 297
 Loring, H. S., 639
 Louderbach, A. L., 142
 Lund, A., 112
 Lundegårdh, H., 66, 680, 731
 Luria, S. E., 230
 Luther, W., 279, 282

Lwoff, A., 163
 Lynch, D., 568
 Lynen, F., 347

M

- Maas, W. K., 81, 341
 McCance, R. A., 327
 McCarty, 58
 McCay, C. M., 327
 McCullock, E. A., 188
 MacDowell, E. C., 326
 McElroy, W. D., 639, 640
 McKinney, H. H., 634
 McLaren, A. D., 665, 690
 McLean, E. D., 676, 726
 McLean, P., 370
 MacLeod, C. M., 58
 McNutt, W. S., 340
 McSwiney, R. R., 396
 macromolecules, and natural selection, 3-8
 Magasanik, B., 79, 86
 Mager, J., 151
 Malejka, J. A., 396
 Maley, F., 31
 Manchester, K. L., 362, 364, 365, 376
 Mandel, H. G., 153
 Mandle, R. J., 610
 Mann, G. V., 427
 Manner, H. D., 282
 Mapes, M. O., 453n, 485
 Mapson, L. W., 345
 Maramorosch, K., 633
 Marcus, P. I., 170, 188
 Markham, R., 153, 629, 630
 Marmur, J., 59
 Marrian, G. F., 419
 Marshall, C. E., 723, 725, 726, 727, 728, 734
 Martin, H. H., 127
 Martin, L. F., 628, 634
 Marx, W., 391, 394
 Mathieson, D. R., 399
 Matsumoto, S., 297
 Matthews, L. W., 372
 Matthews, R. E. F., 629
 Mattson, S., 671, 676
 Matzke, E. B., 514
 Maurer, F., 282
 Mazia, D., 162, 163, 164, 167, 168, 170, 173, 262
 Meadows, R. W., 396
 Medawar, P. B., 297
 Medes, G., 375
Medicago sativa, 535, 536, 678
 Mehlich, A., 668
Melandrium rubrum, 510, 511
 Melechen, N. E., 19
 Mendez, J., 430
 Meneghini, M., 628, 643
 mercaptoethanol, 264-269
 Meselson, M., 40
 metabolic function, virus-induced acquisition of, 17-38
 metabolism, amino acid, 359-365
 fatty acids, 365-378
 in plant cells, 476-478
 role of enzyme regulation in, 77-92
 metamorphosis, of insects, 313-320
 Mettetal, C., 285
 Meyer, B. S., 636
 Meyer, R. K., 396
 microbial antagonisms, 659-662
 microbial systems, 39-75
 microsomes, in induction, 259-261
 Milad, Y., 680
 Millar, F. K., 472, 474, 484
 Milthorpe, F. C., 529
 mineral nutrition, and virus infection, 636-640
 Mitchell, M. B., 55
 Mitchell, M. L., 357, 358
 Mitchison, J. M., 159n, 174, 175, 177
 mitochondria, 464-466
 mitosis, 162-178, 190-191
 Mitra, J., 476
 Mizuna, D., 95
 Mohan Ram, H. Y., 453n, 485, 486, 487
 Mole, R. H., 187
 molecular theory, 39-40
 Monod, J., 18, 79, 80, 82, 93, 100, 102, 103, 105
 monomers, 5-6
 Moore, A., 184
 Moore, C. R., 399
 Moore, F. E., 427
 Morel, G., 608
 Moreno, E. C., 686
 Morgan unit, 42, 43, 44
 Morkovin, D., 188, 189
 Morosow, I. I., 279
 morphogenesis, and cell physiology, 484-488
 floral, 497-521
 role of RNA and sulfhydryl groups in, 241-275
 Moscona, A. A., 198, 199, 203, 204, 207, 209, 212, 213, 214, 216, 217
 Moscona, H., 199
 Moss, M. I., 207
 Moyed, H. S., 90
 Muhlethaler, K., 479, 481
 Murakami, W. T., 32, 33

Murlin, J. R., 395
 Murneek, A. F., 513
 Murray, M. R., 217
 Murrell, W. G., 113
 Murty, C. G. K., 109, 112
 mutation, 40-73

N

Nachmansohn, I., 347
 Näf, U., 607
 Nakata, H., 107, 111, 113, 114, 116
 Narasimhan, L., 107n
 Nason, A., 638, 639, 640
 Nathanson, I. T., 390, 391
 natural selection, and macromolecules,
 3-8
 Naville, A., 280, 285, 292, 296
 Needham, J., 259
 negative interference phenomenon, 51
 Nehari, V., 628
 Neish, A. C., 478
 Nelson, M. M., 349
 Nelson, N. J., 51
Neurospora crassa, 44, 45, 56, 72, 235,
 337
 Newmark, P., 630
 Nicholas, J. S., 278
Nicotiana, 607, 632, 636, 641-642
 nicotinic acid, 338-339
 Nilevar, 396-397
Nitella, 460-461
 Niu, M. C., 207, 243-244
 Noall, M. W., 362, 364
 Noel, E., 225
 Norman, A. G., 661, 662
 nortestosterone, 395-396
 Novick, A., 85, 88, 93, 95, 96, 103, 194
 nucleate states, 466-469
 nucleic acids, 3, 4, 5-7, 88
 and virus infections, 630
see also DNA, RNA
Nuphar lutea, 501, 502, 505, 514
 Nussbaum, A. H., 396
 nutrition, of farm animals, 321-334
 of plant cells, 453-490
Nymphaea, 501, 505, 508, 514

O

Ochoa, S., 31
 Odland, G. F., 286, 290
 Odum, H. T., 590
 Oelofse, P. J., 418
 Ogata, G., 701
 Oorschot, J. L. P. van, 440
 Oosting, H. J., 568
 Oprecht, O., 248

Orchidaceae, 513
 Ordal, Z. J., 108, 110
 Ordin, L., 447
 Orchowitsch, W. N., 283, 295, 304
 organ growth, 398-401
 organogenesis, general aspects of, 495-
 497
 Ottaway, J. H., 365
 Ottoson, D., 290
 Overstreet, R., 666, 668, 669, 670, 671,
 672, 673, 676, 677, 689
 Overton, J., 295, 306
 Owen, P. C., 632, 633
 Oxley, T. A., 545

P

Painter, R. B., 183, 190, 191
 Palade, G. E., 288
 Palay, S. L., 469
 Pålsson, H., 326, 328, 330, 331, 332
 pantothenic acid, 341-342
Paramecium, 174
 Pardee, A. B., 18n, 20, 78, 80, 81, 82,
 83, 84, 85, 86, 88, 90, 93, 100n
 Park, B. H., 33
 Parks, R. E., 153
 Partridge, C. W. H., 51
 Pasteels, J., 248, 250, 252, 260
 Pateman, J. A., 51
 Patniak, N., 723, 726, 734
 Pavillard, J., 633, 634
 Pavlovsky, O., 577n
 Pavlychenko, T. K., 657
 Pearson, G. A., 676, 684
 Pedin, J. C., 396
 Peech, M., 725
 Pelc, S. R., 170
 periodicity, vegetative, 585
 permeases, 79
 Perrin, D., 100, 103, 105
 Perry, J., 113
 Perry, W. F., 375
Petasites hybridus, 504, 508
 Petersburgski, A. W., 672, 676
 Peterson, E. A., 658
 Peterson, P. D., 634
 phagocytosis, and epithelial movements,
 292-300
Phalaris tuberosa, 532
 Philip, J. R., 699, 700, 715, 719
 photosynthesis, 439-446, 563
 and virus infection, 633
 phototropism, 559-560
 Piepho, H., 247
 Pietrzyk-Walknowska, J., 279
 Pincus, G., 407, 408, 413, 416
 Pinkus, H., 296

pinocytosis, 470-471
 Pires, J. M., 573
 Pirie, N. W., 629, 631
Pisum sativum, 526
 pituitary growth hormone, 353-381, 387
 Pizer, L. I., 22, 26*n*
 plant cell growth, 453-490
 plant communities, origin and growth of, 567-603
 plant growth, biology of, 439-452
 plant growth hormones, 446-451
 plant nutrition, and colloid chemistry, 723-736
 plant tumor cell, origin of, 605-619
 plant virus infection, growth aspects of, 621-652
 Plantefol, L., 501
 Plaut, G. W. E., 340, 341
 Plaut, W., 170
 Plesner, P. E., 142, 150, 153
Pleurodeles, 264
Pneumococcus, 60
 polarity, 558-559
 Polezaiev, L. W., 279, 283, 295, 304
 Pollard, J. K., 466
 Pollock, M. R., 78, 80, 82
 polymer synthesis, 18-20
 polypeptide chain, 35-40
 polypeptides, synthetic, 6
Polyphemus silkworm, 316
 Pomerat, C. M., 187
 Pomeroy, R. W., 329
 Pontecorvo, G., 43, 44, 47, 49, 53
 Popper, H., 396
 Porter, C. A., 622
 Porter, K. R., 286, 288
 Pound, G. S., 636, 637, 638, 639, 640, 641, 642, 643, 644, 645
 Powell, J. F., 107, 108, 111, 112
 Prehn, A., 526
 Prescott, D. M., 174, 175, 177
 Pressman, D., 194
 Prestidge, L. S., 20, 85, 88, 90
 Prevot, P., 461
Primula bulleyana, 512, 514
 Pritchard, J. J., 217
 Pritchard, R. H., 42, 51, 53, 54
 protein synthesis, 7, 9-15, 18-19, 27, 31-33, 88, 175, 241, 362-364, 463
 proteins, 3, 4, 5-7
 and virus infection, 627-630
 Prunty, F. T. G., 396
 Puck, T. T., 18, 170, 183, 184, 185, 186, 188, 189, 190, 191, 192, 193

Q

Quastler, H., 281, 282

R

R-cells, 222-238
 Raben, M. S., 357, 366, 367, 369
 Racker, E., 98
 radiobiology, 187
 radiosensitivity, 187-189
Rana, 260
 Randle, P. J., 356, 359, 365, 377
 Ranzi, S., 261
 Raper, K. B., 221, 227
 Rapkine, L., 261, 262
 Rasmussen, L., 135*n*
 Ratner, E. I., 671, 676
 Raunkjaer, C., 579
 Raven, C. P., 259
 Ravin, A. W., 59
 Ray, E. K., 297
 Ray, R. D., 391
 Read, C. H., 358
 recombination analysis, in microbial systems, 39-75
 recombination theory, classical, 41-45
 Redfield, H., 43
 regeneration, in vertebrates, 277-311
 Reiss, M., 388
 reproduction; see cellular reproduction
 respiration, 557-558
 and virus infection, 631-633
 Retterer, E., 282
 Rey, P., 598
 riboflavin, 340-341
 ribonucleic acid; see RNA
 ribonucleoproteins, 242-244, 270
 ribosomes, 10-14, 175
 Rice, R. V., 629
 Rich, A., 6
 Richards, F. J., 493
 Richards, L. A., 701
 Rickenbacher, J., 249
 Rickett, H. W., 508
 Riddiford, 300
 Riemann, H., 110
 Riker, A. J., 608, 609
 RNA, 6, 7, 10, 11-14, 19-20, 34, 40, 171, 174, 175, 181, 182, 207, 319, 450
 role of, in morphogenesis, 241-261, 270
 Roberts, R. B., 88
 Robertson, R. N., 465, 665, 667, 670
 Robinson, A., 183, 185, 186
 Robinson, T. J., 322
 Rodenberg, S. D., 630
 Rogers, S., 33
 Roguski, H., 293, 297
 Roman, H., 55
 Romanoff, L. P., 407, 408

- root-soil interactions, 665-694
 roots, biological environment of, 653-664
 Roper, J. A., 47, 49
 Ropp, R. S. de, 608
 Rose, S. M., 281, 282, 289, 291, 292, 293
 Ross, I. K., 224, 230, 233
 Rothfels, K. H., 53, 58
 Rothman, S., 302, 304
 Rothstein, A., 684
 Rotman, R., 42
 Rouatt, J. W., 658
 Rounds, D. E., 260
 Rovira, A. D., 658
 Rowson, L. E., 322
 Ruben, L. N., 281
 Rudolph, G. G., 399
 Rufelt, H., 710
 Runnström, J., 262
 Russell, J. A., 359, 360, 361
 Russell, L. B., 188
 Russell, M. B., 702, 733
 Russell, W. L., 188
 Rutter, A. J., 534
 Ryan, F. J., 160
- S
- Saccharomyces*, 72
 Saguchi, S., 282
 Salisbury, F. B., 448
 Salpeter, M. M., 288, 289, 290
 salt accumulation, 462-463, 558
Salvinia natans, 545, 546, 547, 548, 549, 550, 551, 552, 553
 Sampford, M. R., 542
 Samuels, L. T., 399, 414
 Sanchez, C., 100, 103, 105
 Sanders, H. G., 333
 Sargent, J. A., 552
 Sato, G., 183, 184
 Saunders, F. J., 396, 400, 401
 Saunders, J. W., 280, 281
 Savard, K., 385
 Scarth, G. W., 709
 Schaeffer, P., 60
 Schaffer, J., 282, 301
 Schaffner, F., 396
 Schaxel, J., 279, 283
 Scherbaum, O., 135, 136, 142, 143, 146, 147, 154, 173
 Scheuing, M. R., 285, 293, 297, 298
 Scheuring, D. G., 673, 677
 Schimper, A. F. W., 573
Schizosaccharomyces pombe, 174
 Schmid, E., 579
 Schmidt, A. J., 293, 304
 Schnell, R., 573
 Schofield, R. K., 729, 730
 Schopfer, W. H., 510
 Schotté, O. E., 301
 Schuberg, A., 282
 Schuepp, O., 494
 Schuffelen, A. C., 676, 729
 Schultz, J., 43
 Schwartz, S. M., 656
 Schweigart, H. A., 676
 Scott, F. M., 216, 667
 Scott, J. F., 10
 Scott, O. C. A., 189, 190
 Scow, R. O., 365
 Scurfield, G., 591
 Seamann, G. R., 151
 Segadas-Vianna, F., 568
 Seilem-Aspang, F., 262
 Selby, C. C., 286, 290
 Selye, H., 217
 Serebrovsky, A. S., 45
 sex, relationship of, to growth, 384-385
 shading, influence of, 534-540
 Shaffer, B. M., 235
 Shafrir, E., 377
 Shantz, E. M., 485, 552
 Shaver, J., 259
 Shaw, J. H., 372
 Shepherd, R. J., 639, 640
 Shepherdson, M., 81, 82
 Sheppard, G. W., 250
 Shimomura, S., 297
 Shipley, E. G., 396
 Shipley, R. A., 386, 387, 389, 399, 400, 401, 417
 shoot apex, 492-493, 497
 Sidman, R. L., 297, 305
 Siekevitch, P., 288
 Silva, N. T. da, 573
 Simpson, M. E., 356, 388, 394
 Simpson, S., 326
Sinapis alba, 526
 Sinclair, J. B., 629
 Singer, M., 278, 281, 283, 285, 288, 289, 290, 293, 297, 298, 300, 301, 303, 304, 305, 306
 Sinsheimer, R., 20
 Siperstein, M. D., 375
 Sisler, E. C., 640
 Skaar, P. D., 99
 Skoog, F., 611, 638
 Skupiński, F. X., 233
 Slatyer, R. D., 702, 703
 slime mold, cellular differentiation in, 221-239
 Smith, E. F., 608
 Smith, G. F., 681
 Smith, H. H., 607

- Smith, J., 485
 Smith, K. M., 629
 Smith, M. J., 184
 Smith, P. E., 326, 354, 355
 Snodgrass, R. E., 313
 Sobel, E. H., 389
 soil ecology, 654
 soil environment, 655-659
 soil-plant system, transport processes in, 695-721
 soil-root interactions, 655-694
 solar energy, 439-446
 Somerville, R., 22, 31
 Sonneborn, T. M., 194, 222
Sorghum sudanense, 532
 Sparrow, A. H., 607
 Spassky, B., 577n
 Spencer, E. L., 636
 Spencer, H., 396
 spores, formation of, 107-132
 sporulation; *see* spores
 Spratt, N. T., 248
 Stadie, W. C., 364
 Stadler, D. R., 56, 57
 Stadler, L. J., 45
 Stadtman, E. R., 342
 Stahl, F., 40
 Stanier, R. Y., 80
 Stanley, W. M., 628
 Starkey, R. L., 658, 666
 Stebbins, G. L., Jr., 517, 518
 Steere, R. L., 627
 Steffenson, D., 169
 Steinberg, M. S., 206
 Steinberg, R. A., 638
 Steinert, M., 246, 249, 254
 Steinmetz, C. R., 401
Stellaria media, 514, 515
 steroids, and aging, 407-420
 and growth, 383-405
 Stevens, P. C., 665, 673
 Stevens, R. E., 400
 Steward, F. C., 457, 460, 461, 462, 463, 464, 465, 466, 468, 469, 472, 474, 475, 476, 477, 479, 481, 482, 483, 484, 485, 486, 487, 552, 611
 Stewart, B. T., 107, 109, 110
 Stone, E. C., 666
 Stone, J. M. van, 305
 stratification-coverage, 584
 Strong, J. A., 186
 Stroud, 187
 sulfhydryl groups, role of, in morphogenesis, 261-275
 Sunakawa, S., 18
 Sussman, M., 222, 225, 227, 228, 229, 231, 233, 234, 235
 Sussman, R., 222
 Sutcliffe, J. F., 457, 460, 461, 462, 464, 465, 475, 476, 482, 484
 Sutherland, M. L., 656
 Sutton, H., 189
 Swann, M. M., 171
 Swanson, C. A., 457
 synchronous cell systems, 135-156
 Sze, L. C., 247
 Szilard, L., 85, 88, 93, 95, 96
 Szybalski, W., 184
- T
- T-even phages, 17-35
 Taban, C., 280, 283, 285, 286, 292, 293, 300, 305
 Taft, E. B., 10
 Tagawa, T., 447
 Tagman, E., 385
 Takahashi, W. N., 629, 630, 631
 Takata, T., 242, 243, 246
 Talbot, N. B., 386, 389, 394
 Tandler, C. J., 175
Tarícha, 260
 Tatum, E. L., 44, 58
 Taube, E., 279, 283, 285
 Taylor, E. W., 171
 Taylor, J. H., 40, 58, 170
 temperature, and light, 541-551, 557-566
 plant reaction to, 444-445
 and virus infection, 640-644
 temperature shock; *see* synchronous cell systems
 Templeton, J. K., 552
 Tepfer, S. S., 495, 496, 499, 501
 Testa, G., 634
 testosterone, 385, 387-388, 389, 395, 399, 417
Tetrahymena pyriformis, synchronized growth in, 135-156, 173, 174
 THE (tetrahydrocortisone), 413-414
Theobroma cacao, 536, 537
 thermodynamics, laws of, 557-558, 566
 thiamine, 339-340
 Thom, C., 227
 Thomas, C. A., 45
 Thomas, J. E., 609
 Thomas, M. D., 440
 Thomason, D., 250
 Thompson, J. McL., 501
 Thormar, H., 143, 144, 145, 146, 147, 155
 Thornton, C. S., 280, 281, 283, 284, 305
 Thung, T. H., 631, 633
 Thurston, J. M., 533
 Tiedemann, D., 243
 Tiedemann, H., 243

Till, J. E., 188
 Tillotson, C., 395
 Tinsley, T. W., 625
 tissue reconstruction, 197-220
 Tjio, J. H., 183, 184, 185, 186
 Tomizawa, J., 18, 99, 103, 104
 Tompkins, C. M., 374
 Töndury, G., 249
 Tornier, G., 278, 283, 285
 Torriani, A., 82, 83, 95
 Towne, L. E., 390, 391
 Tracy, M. V., 628
 Trampusch, H. A. L., 279, 280, 282, 284
 transition apex, 495
 transport processes, in soil-plant system,
 695-721
Trifolium subterraneum, 542, 543
 Trinkaus, 213
Triturus rivularis, 243
Triturus torosus, 243
 Trudinger, P. A., 90
 tryptophan, 338-339
 Tschumi, P. A., 281
 tumor cell; *see* plant tumor cell
 Turing, A. M., 495
 Turpin, R., 186
Tussilago farfara, 504, 507

U

Umbarger, H. E., 80, 84, 93
 unit leaf rate, 527-528, 530
 Upchurch, W. J., 726, 727, 728
Ustilago maydis, 510
Ustilago violacea, 510, 511

V

Valonia ocellata, 479
Valonia ventricosa, 478
 Van Bibber, M. J., 32
 Van Rysselberge, C., 629
 vegetation stand; *see* plant communities
 Veloso, H. P., 568, 573, 584
 Verges, J. B., 326, 330, 331, 332
 vertebrates, regeneration in, 277-311
Vicia faba, 542, 543
Victoria cruziana, 503, 508
 Vidaver, G., 20
 Villar, H. del, 589-590
 Vilter, V., 297, 298
Vinca rosca, 608
 virus infections, of plants, 621-652
 Vitamin A, 337-338
 vitamin antagonists, 349-351
 Vitamin B₁₂, 343-344
 vitamins, and growth, 335-348
 Vlamis, J., 676, 677, 684

Voeller, B. R., 493
 Vogel, H. J., 80
 Volkin, E., 19, 20
 Voll, M. J., 59

W

Waddington, C. H., 249, 486, 487
 Waldschmidt, M., 342
 Walker, P., 175
 Wallace, L. R., 323
 Walton, A., 324
 Wangermann, E., 552
 Wardlaw, C. W., 493, 494, 495, 497,
 501, 504, 505, 510, 511, 512, 515
 Waritz, R. S., 639
 Warming, E., 573
 Wassink, E. C., 440, 442
 Watanabe, I., 18
 water flow, in soil-plant system, 699-715
 Watson, D. J., 533
 Watson, J. D., 40
 Watson, R. N., 396, 397
 Watt, A. S., 591
 Way, J. L., 153
 Wayburne, S., 430
 Weathers, L. G., 636, 637, 638, 641,
 644
 Weber, W., 285
 Webster, C. C., 465
 Weed, L. L., 20, 21
 Wehmeier, E., 242
 Wehrmeyer, W., 627
 Weil, R., 359, 365
 Weinberg, A., 297
 Weiner, M., 95, 96, 100n, 103
 Weinhaus, S., 375
 Weis, T., 204
 Weiss, L., 207
 Weiss, P., 207, 209, 216, 217, 301, 303
 Welkie, G. W., 639
 Wells, G. C., 304
 Welt, I. D., 375
 Wendelstadt, H., 292
 Went, F. C., 635
 Went, F. W., 440, 443, 444, 560, 563
 Went, H., 171
 Wertheimer, E., 377
 West, C., 526, 527, 528, 530
 Weston, R. E., 396
 Wetmore, R. H., 488
 Wetzell, N. C., 385
 Weygand, F., 342
 Whaley, W. G., 467, 469
 White, P. R., 608
 Whitehead, T., 631, 632
 Whitfield, J. F., 189
 Whitmore, G. F., 175

- Whittaker, R. H., 591
 Widdowson, E. M., 327
 Wiegand, C. L., 716
 Wiele, V. R., 408
 Wigglesworth, V. B., 315, 317
 Wijesundara, S., 80
 Wiklander, L., 668, 671, 730
 Wilde, C. E., 217
 Wildman, S. G., 446, 628
 Wilhelmi, A. E., 356, 357, 359, 375
 Wilkins, L., 390
 Williams, C. M., 315, 316
 Williams, D. E., 668, 676
 Williams, I., 18*n*
 Williams, N., 147
 Williams, R. C., 627
 Williams, R. F., 528, 530, 532
 Willis, J., 316, 317
 Willmer, E. N., 208
 Wilson, A. C., 89
 Wilson, C. M., 233
 Wilson, C. W., 188
 Wilson, G. C., 534, 539
 Winkler, B. S., 396
 Winzler, R. J., 347
 Wolff, E., 214
 Wolff, S., 188
 Wollman, E., 18
 Woodruff, C. M., 729, 730
 Woods, A. F., 634
 Woods, D. D., 80
 Woods, I., 509
 Woods, P. S., 40
 Woodward, D. O., 51
 Wool, I. G., 364
 wound epithelium, role of, in regeneration, 277-311
 Wright, B., 222
 Wright, J. M., 660
 Wulff, E. V., 574
 Wyatt, G. R., 18, 20, 29*n*
 Wynd, F. C., 631, 634, 676
 Wyngaarden, J. B., 86
 Wynne, E. S., 109
- X
- X-irradiation, 188-190
Xenopus, 264
- Y
- Yamada, D., 191, 242, 243, 244, 259
 Yates, R. A., 80, 81, 84, 86, 88, 93
 Yemm, E. W., 469, 477
 Yoshikawa, S., 14
 Young, F. G., 356, 359, 362, 364, 365, 376, 377
- Z
- Zamecnik, P. C., 10, 12, 13
 Zawarzin, A., 295
Zea mais, 510, 526, 528, 529
Zebrina, 712
 Zeevaart, J., 448
 Zeuthen, E., 135, 136, 137, 142, 143, 147, 151, 152, 154, 155, 156, 159*n*, 171, 173, 174, 177
 Zinder, N. D., 58
Zingiberaccae, 513
 Zwilling, E., 213, 280
 zygomorphy, 513-517



