

GREEK ARCHAEOLOGY





LIBRARY OF
GLADYS R. DAVIDSON

G. R. Davidson

38

w

GREEK SERIES FOR COLLEGES AND SCHOOLS

EDITED

UNDER THE SUPERVISION OF

HERBERT WEIR SMYTH, PH.D.

ELIOT PROFESSOR OF GREEK LITERATURE IN HARVARD UNIVERSITY

VOLUMES OF THE SERIES

- GREEK GRAMMAR FOR SCHOOLS AND COLLEGES. By the Editor, Prof. Herbert Weir Smyth.
- GREEK GRAMMAR FOR COLLEGES. By the Editor, Prof. Herbert Weir Smyth.
- BEGINNER'S GREEK BOOK. Prof. Allen R. Benner, Phillips Academy, Andover; and the Editor.
- BRIEF GREEK SYNTAX. Prof. Louis Bevier, Jr., Rutgers College.
- GREEK PROSE COMPOSITION FOR SCHOOLS. Clarence W. Gleason, Volkmann School, Boston.
- GREEK PROSE COMPOSITION FOR COLLEGES. Prof. Edward H. Spieker, Johns Hopkins University.
- AESCHYLUS. PROMETHEUS. Prof. J. E. Harry, University of Cincinnati.
- ARISTOPHANES. CLOUDS. Dr. L. L. Forman, Cornell University.
- DEMOSTHENES. ON THE CROWN. Prof. Milton W. Humphreys, University of Virginia.
- EURIPIDES. IPHIGENIA IN TAURIS. Prof. William N. Bates, University of Pennsylvania.
- EURIPIDES. MEDEA. Prof. Mortimer Lamson Earle, Columbia University.
- HERODOTUS. BOOKS VII.-VIII. Prof. Charles Forster Smith and Prof. Arthur Gordon Laird, University of Wisconsin.
- HOMER. ILIAD. Prof. J. R. S. Sterrett, Cornell University.
BOOKS I.-III. BOOKS I.-III. AND SELECTIONS.
- LYSIAS. Prof. Charles D. Adams, Dartmouth College.
- PLATO. APOLOGY AND CRITO. Prof. Isaac Flagg, University of California.
- PLATO. EUTHYPHRO. Prof. William A. Heidel, Wesleyan University.
- THUCYDIDES. BOOKS II.-III. Prof. W. A. Lamberton, University of Pennsylvania.
- XENOPHON. ANABASIS. BOOKS I.-IV. Dr. M. W. Mather, Instructor in Harvard University, and Prof. J. W. Hewitt, Wesleyan University.
- XENOPHON. HELLENICA (Selections). Prof. Carleton L. Brownson, College of the City of New York.
- GREEK ARCHAEOLOGY. Prof. Harold N. Fowler, Western Reserve University, and Prof. James R. Wheeler, Columbia University.
- GREEK LITERATURE. Dr. Wilmer Cave Wright, Bryn Mawr College.
- GREEK RELIGION. Arthur Fairbanks, Ph.D., Litt.D., Director of the Boston Museum of Fine Arts.
- GREEK SCULPTURE. Prof. Rufus B. Richardson, formerly Director of the American School of Classical Studies, Athens.

A HANDBOOK
OF
GREEK ARCHAEOLOGY

BY
HAROLD NORTH FOWLER
WESTERN RESERVE UNIVERSITY
AND
JAMES RIGNALL WHEELER
COLUMBIA UNIVERSITY

WITH THE COLLABORATION OF
GORHAM PHILLIPS STEVENS



NEW YORK ·· CINCINNATI ·· CHICAGO
AMERICAN BOOK COMPANY

COPYRIGHT, 1909, BY
AMERICAN BOOK COMPANY.

ENTERED AT STATIONERS' HALL, LONDON.

FOWLER AND WHEELER. GREEK ARCHAEOLOGY.

W. P. 7

Το

WILLIAM WATSON GOODWIN

ὅς ποτ' ἐς Ἑλλάδα γῆν νεαρὸς ἡμᾶς ἐκάλεσσας
 κεῖς Μουσῶν κήπους, Παλλάδι πειθόμενος ·
νῦν δ' ἀγαθῶν πολλῶν βαιὴν δέξαι τιν' ἀμοιβήν,
 μνήμά τε γῆς ἐρατῆς, σοί τε χάριν φίλιων.

PREFACE

THIS manual is intended primarily for the use of students who expect to pursue the study of Greek Archaeology seriously, but it may also be of use to those who desire only a general knowledge of the subject. Neither the serious student at the beginning of his course of study nor the general reader should be disturbed by a discussion of conflicting theories. Matters concerning which some degree of certainty has not been attained have, therefore, been in great measure omitted. The attempt has been made to avoid a very detailed treatment of the subject-matter, though in the discussion of technical processes, especially those of architecture, it was necessary to include a good many details, chiefly because a knowledge of them is needful to the student and is not easily accessible. Few entire categories of works of art have (like the carvings in ivory) been completely omitted, though some (*e.g.* terracotta reliefs) have been treated very briefly, since the size of the book was limited. In the chapter on Vases, footnotes have been used more freely than elsewhere, owing to the fact that the material for illustration and detailed study is scattered and not always easily found.

The chapter on Architecture is the work of Mr. Gorham Phillips Stevens, formerly for two years Fellow in Architecture at the American School of Classical Studies at Athens, on the grant of the Carnegie Institution. Its historical and descriptive parts are based largely on portions of Borrmann's *Die Baukunst des Altertums und des Islam im Mittelalter*, and the chapter has been revised by Mr. Fowler. The chapters on Vases and Painting are by Mr. Wheeler, and he has supervised the preparation of the illustrations. The other chapters are by Mr. Fowler, but both authors have read the whole book carefully and accept

responsibility for the statements contained in it. The chapter on Gems is little more than a brief summary of the late Professor Furtwängler's *Antike Gemmen*.

The authors desire to express their thanks to all who have aided them in their work, whether by advice and counsel or in other ways. Thanks are due especially to Professor R. Borrmann, and the publisher, E. A. Seemann, for permission to make use of *Die Baukunst des Altertums und des Islam im Mittelalter*; to the late Professor Furtwängler and the firms of F. Bruckmann and Giesecke and Devrient for permission to reproduce illustrations from Furtwängler and Reichhold's *Griechische Vasenmalerei* and Furtwängler's *Antike Gemmen*; to the authorities of the British Museum, and more particularly to Mr. H. A. Grueber, for permission to reproduce illustrations from *Coins of the Ancients*; to Dr. Edward Robinson of the Metropolitan Museum, New York, for permission to publish Greek gold work in the Museum; and to the authorities of the Museum of Fine Arts, Boston, particularly to Dr. Edward Robinson, Mr. J. Randolph Coolidge, Jr., Dr. Arthur Fairbanks, Mr. B. H. Hill, and Mr. Sidney N. Deane, for allowing the publication of monuments in the Museum and for furnishing photographs of them.

HAROLD N. FOWLER.
JAMES R. WHEELER.

TABLE OF CONTENTS

	PAGE
INTRODUCTION	
THE STUDY AND PROGRESS OF ARCHAEOLOGY IN MODERN TIMES	11
CHAPTER I	
PREHELLENIC GREECE	38
CHAPTER II	
ARCHITECTURE	96
CHAPTER III	
SCULPTURE	193
CHAPTER IV	
TERRACOTTAS	293
CHAPTER V	
METAL WORK (BRONZES, SILVERWARE, JEWELRY)	322
CHAPTER VI	
COINS	353
CHAPTER VII	
ENGRAVED GEMS	381
CHAPTER VIII	
VASES	412
CHAPTER IX	
PAINTING AND MOSAIC	526
BIBLIOGRAPHY	542
INDEX	551

INTRODUCTION

THE STUDY AND PROGRESS OF ARCHAEOLOGY IN MODERN TIMES

GREEK archaeology may be defined as the scientific study of the arts of construction and design as they were developed by the Greeks ; but since much important information concerning art is derived from inscriptions, and the identification of works of art, especially of architecture, is often affected by topographical considerations, epigraphy and topography are frequently included in the definition of archaeology.¹ Since, however, epigraphy and topography are not within the scope of this book, their progress will not be sketched in this chapter, and for the same reason Assyriology, Egyptology, and various other branches of archaeology will be passed over in silence, in spite of the fact that their progress has been, and is, an important factor in that of Greek archaeology.

For the most part Greek archaeology is a product of the nineteenth century, though its beginnings are to be sought in the period of the Renaissance in Italy, when Petrarch (1304–
1374) collected and interpreted Roman coins, Cyriacus of Ancona (b. 1391, d. before 1457) travelled in southern Italy, Illyria, and Greece, collecting and copying inscriptions and making drawings of buildings and other monuments, Pliny, Pausanias, Vitruvius, and other ancient writers were studied for the sake of the information they convey concerning ancient art, and the beginnings of the great Italian museums were made.

¹ The term "archaeology" is sometimes used in a broader sense to include the study of Greek antiquities as a whole, especially as known to us through other than literary sources.

At the same time artists appreciated and studied the remains of ancient art. The influence of Roman architecture and of the study of Vitruvius upon the architecture of the Renaissance is too well known to require mention. Mantegna (1431-1504) declared that good antiques were more beautiful than living figures, and his paintings bear witness to the honesty of his declaration.

The study of ancient art was at this time, and almost until the beginning of the nineteenth century, virtually confined to monuments that existed in Italy (chiefly in Rome), and these were, with few exceptions, such as the Dying Gaul, the Gaul Killing Himself, the Farnese Bull, and the Laocoön, either strictly Roman works or Roman copies of Greek originals. The interest of those who studied the monuments was also, at least until the middle of the eighteenth century, chiefly in Roman, rather than Greek history and art, and their studies were carried on from a Roman point of view. Nevertheless, they made useful collections of material and read the ancient authors with great diligence.

In the sixteenth and seventeenth centuries the Roman museums increased in number and in the importance of their contents, and at the same time collections of ancient marbles were formed in other places in Italy, and even in other countries. These collections still consisted of objects found in Italy, chiefly in and near Rome, though some collections, especially in England, like that formed in the early part of the seventeenth century by Thomas Howard, fourth Earl of Arundel, contained also objects brought from Greece and the Greek islands. The works of sculpture discovered in Italy, since they are, with few exceptions, either specifically Roman or Roman copies of Greek originals, possess a certain similarity in technique, and even in general appearance, which makes it difficult to trace in them the progress of art. It is therefore only natural that the scientific historical method of archaeological investigation was of slow growth. Even as late as the Napoleonic period, when the most famous works of art from all parts of Europe were gathered together in Paris, the great authority of the time, Ennio Quirino

The sixteenth and seventeenth centuries

Visconti, maintained that Greek art reached its height in the time of Phidias and remained without important changes at the same level until the reign of Hadrian, and this doctrine met with no little favor, in spite of the fact that Winckelmann had promulgated a truer theory half a century before.

In the early part of the eighteenth century the discovery of Herculaneum and, almost at the same time, of great numbers of painted vases in Etruria and southern Italy, followed in 1748 by the discovery of Pompeii, furnished new material for study and new points of comparison with what was already known. Especially important were the bronze statues found at Herculaneum in 1753, for the Greek origin of the painted vases was not clearly recognized until much later.

**Hercula-
neum, Etru-
ria, and
Pompeii**

Such was the material available, chiefly Roman, when Johann Joachim Winckelmann (1717-1768) published, in 1763, his *History of Ancient Art*. Winckelmann is justly regarded as the founder of the science of archaeology, for he was the first to study ancient art from the historical — which is in this instance the scientific — point of view. His *History*, afterwards supplemented by the *Monumenti Inediti*, was recognized as the work of a master, and its influence endures even to the present day, in spite of the fact that the discoveries made since his time have proved many of his views to be erroneous. His errors were due chiefly to the lack of original Greek (as well as Egyptian and oriental) works of art. He recognized that the history of art is a continual progress, and divided Greek art into four periods: the old style, from the beginning to the fifth century; the high style, from the time of Phidias to that of Alexander; the style of imitators and the fall of art through imitation; and Greek art under the Romans. These main divisions may still, though with some modifications, be accepted.

**Winckel-
mann**

Many scholars of the eighteenth century wrote on archaeological themes. They had little or no knowledge of original Greek works of art, but their books are, nevertheless, even now valu-

able as collections of material, or examples of method, or both. Among these are Bernard de Montfaucon (1655-1741), whose work, *L'Antiquité expliquée et représentée en figures*, is an immense collection of material, but without distinction of epochs or of Roman copies from Greek originals; Gotthold Ephraim Lessing (1729-1781), whose *Laokoon*, an essay on the boundaries of literature and art, is a masterpiece of criticism; Christian Gottlob Heyne (1729-1812), a learned philologist, who lectured on archaeology and inserted valuable archaeological matter in his commentaries on ancient authors; and Joseph Hilarius von Eckhel (1737-1798), whose great work on ancient coins, *Doctrina Numorum Veterum* (1792-1798), cannot even yet be entirely neglected by numismatists. Other scholars also, such as Carlo Fea and Georg Zoega, although their published works are concerned with Roman (and, in the case of Zoega, with Egyptian) archaeology, exercised great influence upon the study of all remains of antiquity. Especially important are the great publications of the collections formed at Naples by Sir William Hamilton, which appeared in 1766-1767 and 1791-1795, for they made the Greek vases of Lower Italy not only known but popular. Hamilton was not the only Englishman who collected works of ancient art at this time, and several such collections, among them that of Richard Payne Knight and the greater part of Hamilton's own, are now among the rich possessions of the British Museum, which was first opened in 1759.

Even before Winckelmann wrote his *History of Ancient Art*, the exploration of Greece had begun. In 1674 the Marquis de Nointel was in Athens, and with him was an artist who made drawings of the Parthenon and its sculptures. Who the artist was is uncertain, but he was not, as has been supposed for many years, Jacques Carrey, a pupil of Lebrun. The drawings, especially those of the pediments, are of great importance, because they were made before the explosion which shattered the building in 1687. In 1675-1676 Jacques Spon and George Wheler visited Greece, Dalmatia, the Greek islands, and parts of Asia Minor, and

published, in 1676 and 1678, an account of their journey, with descriptions and discussions of ancient monuments at Athens and elsewhere, a work which is still of some importance because it describes the monuments of Athens as they were before the bombardment of the Acropolis in 1687 by the Venetians.

But it was not until the middle of the eighteenth century that the ruins of Athens were carefully measured and adequately published. This was the joint work of the painter, James Stuart, and the architect, Nicholas Revett, who were in Greece and the neighboring regions nearly four years (1751-1754), spending half of that time in the careful study and delineation of the monuments of Athens. In 1761-1762 appeared the first volume of the *Antiquities of Athens*, a work which was in another way as important as Winckelmann's *History of Ancient Art*, and which was not surpassed by any archaeological publication for more than a century. The *Antiquities of Athens* The second volume appeared in 1787-1788, after Stuart's death, the third in 1794, and the fourth, which treats of the monuments of Salonichi, Pola, and Corinth, and contains also Pars' drawings of the frieze of the Parthenon, not until 1816. A later edition, published in 1825-1827, contains additional notes by various authors. As a supplement to the *Antiquities of Athens*, Sir William Gell published in 1817 the *Unedited Antiquities of Attica*, treating of the ruins of Eleusis, Rhamnus, Sunium, and Thoricus, and a further supplement, published in 1830, by Cockerell, Kinnaird, and Donaldson, was devoted to the temple of Zeus at Girgenti, the early temple of Cadacchio on the island of Corfu, the temple at Phigaleia, and the "Treasury of Atreus." So far reaching and long continued was the immediate effect of the work of Stuart and Revett.

A natural consequence of the interest aroused in England by the first volume of the *Antiquities of Athens* was the sending, by the Society of Dilettanti, founded in 1733, of an expedition to explore, measure, and draw the monuments of Asia Minor and Greece. The leader of the expedition was Dr. Richard Chandler,

and with him were Revett and the artist Pars. Their report, the *Antiquities of Ionia*, appeared in 1769 and 1797, and was for many years the chief source of information concerning the ruins of Ephesus, Priene, Miletus, Mylasa, Sardis, Olympia, and other less important places.

Winckelmann laid the foundation for the historical study of Greek art, and Stuart and Revett, with those who continued and supplemented their work, added, as important material for such study, careful descriptions and drawings of monuments of Greek architecture and sculpture. But as yet original works of Greek art, with the exception of vases, small bronzes, coins, and gems, were almost unknown to all who had not themselves travelled in Greece. About 1787 one metope and one slab of the frieze of the Parthenon were brought to France through Choisseul Gouffier, at that time French ambassador at Constantinople, but they attracted little attention. It was Thomas Bruce, Lord Elgin, **The Elgin Marbles** who first made Greek art really known in modern times. In 1799 he was appointed ambassador to the Sublime Porte. He gathered together a number of artists, who reached Athens in 1800, where they were at first allowed only to make drawings; but the victories of the British forces over the French in Egypt gave the ambassador greater influence at the Porte, and he obtained permission to make casts and to remove stones on which were inscriptions or figures. After Lord Elgin's recall, in 1803, two hundred cases filled with sculptures from the Parthenon, the Erechtheum, and the temple of Athena Nike, with various other works found in Athens, besides many casts, were shipped for England. Eighty cases were left behind and did not reach England until 1812. Lord Elgin himself was taken prisoner by the French and not released until 1806. When he arrived in England he gathered his treasures together from the various ports where they had been landed and exhibited them in London. Although they were enthusiastically admired by some artists, the influential Society of Dilettanti, led by Payne Knight, failed to recognize their value, and it was not until Visconti, then the leading archaeologist,

and Canova, the most famous sculptor of Europe, and other distinguished foreigners had expressed unbounded admiration for them that they were finally purchased by act of Parliament for the British Museum. The price paid did not reimburse Lord Elgin for his expenditures, but his name is indissolubly connected with the "Elgin Marbles," the possession of which makes the British Museum more important than any other collection of works of Greek sculpture.

While the Elgin Marbles were awaiting their final disposition, two other important series of Greek sculptures were added to European museums. In 1811 two Germans, Haller von Hallerstein and Linckh, and two Englishmen, Cockerell and Foster, **Bassae and Aegina** while investigating the ruins of the temple of Aphaia (then supposed to be that of Zeus Panhellenius and afterwards that of Athena), on the island of Aegina, discovered the remains of the pediment groups. These were bought in 1812 by the Crown Prince Ludwig of Bavaria, who had them restored by Thorwaldsen and placed, as its most precious possession, in the newly established Glyptothek in Munich.¹ The same group of travellers discovered in 1811 the frieze of the temple of Apollo Epicurius at Bassae (Phigaleia), which was bought in 1814 for the British Museum. The excavations at these two sites not only led to the discovery of important works of sculpture, but at the same time added to what was known of Greek architecture.

These discoveries in Greece proper were supplemented by equally important, and more extensive, investigations of the monuments of Greek art in Lower Italy and Sicily. In 1807 William Wilkins published his *Antiquities of Magna Graecia*, in 1812 Cockerell investigated the temple of Zeus at Girgenti, and **Magna Graecia and Sicily** in 1822-1823 Samuel Angell and William Harris excavated at Selinus. Here temples of various ground plans and various ages, though all early, were discovered, and the metopes of one temple (temple C) differed as widely from the

¹ Further excavations were carried on under Professor A. Furtwängler, in 1901-1902, with interesting and important results.

works of Greek sculpture previously known as did the ground plans of the temples from those of the "Theseum" and the Parthenon. Traces of color on the metopes led to much discussion of the use of color in Greek sculpture and architecture, which was carried on later by Hittorff, Semper, and others. Later discoveries have disproved some of the early theories, but have established without the possibility of a doubt that the Greek architects and sculptors made free and constant use of color. Further excavations and investigations at Selinus, carried on, with intermissions, almost to the end of the century by the Duke of Serradifalco, Saverio Cavallari, and others, led to the uncovering of further temples and sculptures, with other remains of the ancient city.

In Greece itself the war for independence (1821-1828) interfered with archaeological discovery, but shortly before the war broke out, chance brought to light (1820) the Aphrodite of Melos, one of the most popular and, in some respects, most enigmatical extant works of ancient art. In 1828 a French army, accompanied by artists and scientists, landed in Peloponnesus, and in 1829 Blouet and Dubois excavated for a short time at Olympia, where they secured for the Louvre one metope of the temple of Zeus and some fragments. In 1832 Otto of Bavaria became king of Greece, and made Ludwig Ross Conservator of Antiquities. Under Ross (1832-1836), most of the mediaeval and Turkish buildings were removed from the Acropolis at Athens, various works of sculpture were discovered, and (1835) Schaubert and Hansen restored the temple of Athena Nike, which had been built into the Turkish fortifications. In the following years the Erechtheum was partially restored; Penrose made carefully measured drawings of the Parthenon and the Propylaea (1846-1847) and determined minutely the horizontal curvatures of the Parthenon; the Greek Archaeological Society was organized (1837); and the French School at Athens was founded (1846). The most important single discovery at this time was the Apollo of Tenea (1846), which is now in the Glyptothek at Munich. The travels of Ludwig Ross (especially among the islands) and

H. N. Ulrichs furnished hardly less important topographical, historical, and archaeological material than had been furnished in the early years of the century by the travels of Dodwell, Gell, and Leake.

After the publication of the *Antiquities of Ionia*, there was for a time little archaeological investigation in Asia Minor. In 1833–1837 Charles Texier made drawings and plans of many ancient cities and buildings, among them the Doric temple at Assos, a site which was afterwards (1881–1883) completely excavated by the Archaeological Institute of America. Most of the very archaic reliefs from this temple are now in the Louvre, the rest in Boston and Constantinople. A second French expedition under Philippe Lebas, in 1843–1844, produced no striking results. In 1838 Charles Fellows travelled in Asia Minor, and again in 1839 and 1840, this time accompanied by the draughtsman Scharf. The drawings and descriptions published by Fellows in two books, *Asia Minor* and *Lycia*, aroused so much interest that in 1842 an expedition was sent out which brought the reliefs of the “Harpy Tomb” and the “Nereid Monument” to England. Another expedition followed in 1843–1844, and now the Lycian Room of the British Museum was inferior in interest only to the Elgin Room.

But the British Museum was soon enriched by even more important treasures from Asia Minor. In 1846, through Sir Stratford Canning, then ambassador at Constantinople, twelve slabs of the Amazon frieze of the Mausoleum, which had been built into the walls of the fortress at Budrum, were brought to England.¹ Charles Thomas (afterwards Sir Charles) Newton conceived the plan of excavating on the site of the Mausoleum, and in 1857 he had the satisfaction of carrying out his plan and transferring to London all the existing sculptured remains of the building. The next year Newton excavated the ancient city of Cnidus and brought to the British Museum the

¹ A few fragments found somewhat later in Rhodes and Constantinople and a slab which had been in private possession in Genoa were afterwards acquired by the Museum.

Demeter of Cnidus, a colossal lion from the monument erected in commemoration of the victory gained by Conon in 394 B.C., and the series of seated statues from the sacred way that led from the harbor to the temple of Apollo near Miletus. Not many years later, the architect Pullan, while investigating various temples in Asia Minor, discovered a series of late reliefs from an altar at Priene, which were added to the British Museum, and in 1874 another architect, J. T. Wood, after years of toil, brought to the Museum the sculptured drums and various other remains of the temple of Artemis at Ephesus.

Among other discoveries of about the same period should be mentioned the archaic reliefs of the gravestone of Philis and an altar to Apollo and the Nymphs at Thasos, discovered by the French investigator, E. Miller, and now in the Louvre. The Macedonian expedition under Léon Heuzey also led to some interesting results.

The discoveries thus far mentioned have to do chiefly with architecture and sculpture. Of Greek painting and its development little was known. To be sure, paintings had been found at Herculaneum and Pompeii,¹ but they were regarded as Roman works, as indeed they are, so far as their actual execution is concerned, and the Greek origin of their designs was not recognized. Greek vases, too, had been known since the early part of the eighteenth century, but they were studied chiefly with a **Greek vases** view to mystical interpretations of their designs. The **and painting** discovery, in 1827, first at Corneto, then at Chiusi, Veii, Cervetri, and Orvieto, of Etruscan tombs with painted walls, was speedily followed by general recognition of the fact that these paintings were Etruscan imitations of Greek originals, and that

¹ The excavations at Herculaneum were continued only a short time after the discovery of the site. At Pompeii they were carried on in more or less desultory fashion, with intermissions, until the close of the eighteenth century, and with more energy under the short-lived Republic of Parthenope, and in the reigns of Joseph Bonaparte and of Murat, whose wife, Queen Caroline, was especially interested in them.

in them the progress of Greek painting could be traced. The discovery at Vulci, in 1828, of graves containing painted vases, led to further discoveries of the same kind, and the importance of the vases was clearly set forth in 1831 by Eduard Gerhard, who had already made Etruscan ash-urns and mirrors the objects of careful study. Gerhard was one of the founders¹ of the *Istituto di corrispondenza archeologica*, which was for many years, under the direction of Gerhard, Emil Braun, and Heinrich Brunn, the chief centre of archaeological studies, and has been, since 1885, the Roman division of the Imperial German Archaeological Institute. Gerhard called attention to the workmanship of the vases, which shows the excellence of Greek handicraft, to the importance of the representations on them, which portray myths that literature has either not recorded at all or has recorded in different versions, and to the chronological development of the style of decoration. He recognized an earliest "orientalizing" class, a class with black figures on a red ground, a class with red figures on a black ground, and (in Lower Italy) a class with picturesque polychrome paintings, which is a development from the class with red figures. This classification still holds, though earlier classes than "orientalizing" vases are now known, and Gerhard's views have been modified in important details. The Greek origin of Gerhard's first three classes was proved in 1837, by Gustav Kramer, who ascribed most of the "orientalizing" vases to the Corinthians and the others to Athens. In 1854 Otto Jahn ascribed the picturesque polychrome vases to Lower Italy and determined the chronology of the classes as well as was possible at that time.

Vase paintings are small works of industrial art, and in them the progress of painting can be traced, to be sure, but the appearance of real paintings can be imagined with their aid only as that

¹ The others were Bunsen, Kestner, Carlo Fea, and Thorwaldsen. The Institute was founded under the protectorate of Prince Friedrich Wilhelm of Prussia, on Winckelmann's birthday, December 9, 1828, and held its first open meeting on the traditional anniversary of the founding of Rome, April 21, 1829.

of modern paintings might be imagined without other aid than that of woodcuts. The discovery, in 1831, in the *casa del fauno* at Pompeii, of the superb mosaic that represents the victory of Alexander over Darius, made a great Greek historical painting known in a completely colored and carefully executed ancient reproduction. This mosaic supplemented in a most welcome manner the paintings on the walls of Etruscan tombs, the designs on vases, and the pictures that adorned the houses of Herculaneum and Pompeii. The knowledge of Greek painting was further increased in 1844, when Alessandro François discovered the famous "François vase" in a grave near Chiusi; in 1848, when pictures representing the adventures of Odysseus were discovered in a house on the Esquiline in Rome; and in 1857, when François and Noël des Vergers discovered at Vulci the *grotta François*, the walls of which are decorated with parallel scenes of Greek and Etruscan legend.

Pompeii, and more especially Herculaneum, had made known the excellence of late Greek handicraft in the manufacture of household utensils and the like, especially of bronze pieces; the Etruscan graves had delivered up countless specimens of the Greek potters' handicraft; and in 1836, in a tomb near Cervetri, called the Regulini-Galassi tomb, from the names of its discoverers, a rich treasure of early metal work in bronze, silver, and gold was brought to light, which was for a long time the chief source of knowledge concerning early work of that kind and was generally believed to exemplify the art of the Homeric period, until Schliemann's discoveries brought new knowledge and new theories.

In southern Russia, especially the Crimea, great quantities of gold ornaments were found in graves of native rulers. The first discovery was made in 1830 at Kul Oba, the richest in 1862-1863 at Nicopolis. The numerous Attic vases found in the Crimea show active trade relations with Athens, and it becomes virtually certain that many of the objects of gold are Attic work. They are now the chief pride of the Department of Antiquities in the Museum of the Hermitage at St. Petersburg.

The condition of Greek Archaeology about the year 1870 was, then, as follows: The chief temples of Greece, southern Italy, and Sicily, and some of those of Asia Minor, had been studied with greater or less care, and measured drawings of them had been published. Archaic Greek sculpture was known through the Apollo of Tenea, the statues from near Miletus, the metopes from Selinus, the pediment groups from Aegina, and a few other works; the great period of the fifth century was represented by the Elgin Marbles, the frieze from Bassae, and the Lycian Marbles in the British Museum; and the sculptures of the Mausoleum and the temple of Artemis at Ephesus were the chief original works of the fourth century known. Moreover, through the descriptions by ancient writers, and by comparison with the known and accessible original works, many Roman copies of Greek statues had been identified, among them the Discobolus and the Marsyas of Myron, the Doryphorus and the Diadumenus (in 1871) of Polyclitus, the Apoxyomenus of Lysippus (but see page 269 f.), and the group of Harmodius and Aristogiton by Critius and Nesiotes. The use of color in Greek architecture and sculpture was more or less generally acknowledged. The importance of Greek vases and vase paintings was clearly recognized, and their chronology was in part already determined. Something was known, through vase paintings, the paintings of Etruscan tombs, the decorations of houses at Pompeii and Herculaneum, and the great mosaic from Pompeii, of Greek painting and its development. The study of coins and gems had never entirely ceased since the time of the Renaissance, though there had been additions of material rather than any notable advance of knowledge in recent years. Much progress had been made in the interpretation of the meaning of ancient works of art, especially of vase paintings. Important discoveries in the interior of Asia Minor, in Assyria, Babylonia, Egypt, and other regions had brought forward and, in a few cases perhaps, answered questions concerning the relations of Greek art to the art of other countries. The *Istituto di corrispondenza archeologica*, which had been founded

as an international undertaking, was now almost entirely German, though scholars of other nations, especially Italians, took part in its meetings. In the publications of the Istituto, *Annali*, *Bullettino*, and *Monumenti*, many monuments of ancient art were published and discussed. The study of archaeology was encouraged and supported by the *École française* at Athens by the French *Académie des Inscriptions* in Paris, the Academies of Sciences in the various states of Germany, the Society of Dilettanti in England, and other less distinguished literary and scientific bodies. The great museums, such as the British Museum, the Louvre, the Hermitage, the museums at Berlin, Vienna, and Dresden, not to speak of the old Italian collections, made the study of ancient art possible and more or less convenient, while their curators and other officers had exceptional opportunities for productive study. Good catalogues of many collections had already been made. In Germany systematic instruction in archaeology was given in most, if not all, universities, usually supplemented by collections of casts, vases, and other illustrative material. Except in Germany systematic instruction was hardly to be found, and even there, archaeology was regarded as a handmaid of philology.

In the last three decades of the nineteenth century great changes took place. Before 1870, many excavations had been carried on, but as yet almost always with the purpose of studying some particular building or of obtaining portable objects for some museum. Hardly anywhere except at Pompeii, and there only imperfectly, had the attempt been made to bring to light systematically an ancient city or a large group of related buildings. Since 1870 many excavations have been undertaken with a view to laying bare whole sites—great sanctuaries, such as Olympia and Delphi, or cities, such as Ephesus and Miletus—though smaller excavations have been both numerous and productive. In 1870 virtually nothing was known of the great and brilliant civilization which existed in Greece and the neighboring regions before the “Dorian Invasion,” but since 1871 the knowledge of that Prehellenic civilization has increased almost

daily. In 1870 Greek art and Greek life between the time of Alexander the Great and that of Augustus were little known (though in that very year Brunn recognized the copies of figures from the gift of Attalus to Athens), and this period also has since that time been made familiar by the work of the excavator. Moreover, such works of sculpture as the pediment figures and the Hermes of Olympia, the bronze charioteer of Delphi, and the archaic reliefs and figures found on the Acropolis at Athens, to mention only a few, and such buildings as the Heraeum at Olympia and the Tholos at Epidaurus have given a new precision and a new breadth to the study of classical Greek sculpture and architecture, while the chronology of Greek vases, and with them that of Greek painting, has been revolutionized. The study of Greek terracotta figurines begins with the first discoveries at Tanagra in 1870.

The great undertakings of the last few decades have been aided by political events, by the general increase in wealth, and the greater ease and rapidity of travel, but also by changes and progress in the organization of archaeological work. The *Istituto di corrispondenza archeologica*, after having been since 1871 a Prussian institution, became in 1874 the *Kaiserlich deutsches archäologisches Institut*, when the German Institute at Athens was founded. Since its reorganization in 1885, the *Institut* is managed by a central board in Berlin, while the branches at Athens and Rome are directed each by its own Secretary. The Archaeological Institute of America was founded in 1879, the American School of Classical Studies at Athens, founded under the auspices of the Institute, began its work in 1882, and the American School of Classical Studies in Rome was founded in 1895. In England the Society for the Promotion of Hellenic Studies was founded in 1879, and the British Schools at Athens and at Rome were opened in 1885 and 1900 respectively. France had a school at Athens (1846) and founded one at Rome in 1874. The Austrian Archaeological Institute, created in 1898, with headquarters in Vienna, established

Organization
of archaeo-
logical work

an Athenian branch, similar in some respects to that of the German Institute. In Italy the *Accademia dei Lincei* encourages and supports archaeological investigations, and in France the publication of works of ancient art is aided by the *Fondation Piot*. In France, England, and the United States systematic instruction in archaeology is now given at the great universities. Everywhere old museums have been reorganized and enlarged and new ones founded. Among the new foundations the museums at Athens, Olympia, and Delphi, the Metropolitan Museum in New York, the Museum of Fine Arts in Boston, the Imperial Ottoman Museum at Constantinople, and the Glyptothek Ny-Carlsberg at Copenhagen are most important.

Perhaps no single agency has done more to facilitate archaeological work in the field, the publication of new discoveries, the intensive study of monuments already known, and the giving of systematic instruction than the development of photography and the allied methods of accurate and inexpensive reproduction. By the aid of photography the archaeologist of to-day commands a more accurate acquaintance with the entire field than was attainable without its aid when the entire field was vastly less extensive than it now is.

So numerous and so great have been the excavations, so rapid the advance of knowledge, so many the new problems (some of them still unsolved) which have changed, enriched, and invigorated Greek archaeology since 1870, that anything more than a brief statement of the leading facts would be impossible within the limits of this chapter.

The first excavation of an entire series of buildings was in 1873 and 1875, when two Austrian expeditions under the direction of Alexander Conze excavated the sanctuary of the **Samothrace** Cabiri at Samothrace. The forms and arrangement of the edifices here brought to light disclosed characteristic features of Hellenistic architectural design, which had previously been known only through Pompeian paintings. An incidental gain was the discovery of the base of the great statue of Nike (which

had been in the Louvre since 1863), with the result that Bendorff was led to recognize on coins of Demetrius Poliorcetes a reproduction of the statue and thereby to determine its date. The results of these excavations were published in the first great archaeological work in which photographs are included.

Twenty years passed before a second great excavation of a Greek site was conducted under Austrian leadership, though Austrian archaeologists were active in other fields, and in 1882 an expedition to Lycia and Caria under Bendorff, Niemann, and Petersen secured for the Imperial Museum at Vienna the reliefs of Gjölbасhi (Trysa), which exhibit so clearly the spread of Attic art and the influence of painting upon decorative sculpture. In 1895 the Austrian excavations at Ephesus began, to be continued for ten years. The remains of the great Hellenistic and Roman city were laid bare, the general topography and history of the place were carefully studied, and many interesting discoveries were made, among them that of a beautiful bronze statue. The inscriptions found here are of great historical interest, and various previously unknown facts concerning architecture and the arrangement of buildings in Hellenistic and Roman times were established.

Ephesus

Far more ambitious than the work at Samothrace was the excavation of Olympia by the German Empire in 1875-1880. The moving spirit of this great undertaking was Ernst Curtius, but in the work itself and in its publication many others took part, among them Adler, Dörpfeld, Furtwängler, Hirschfeld, and Treu. The entire Altis or sacred precinct and the adjacent buildings were laid bare, and the immediate surroundings were carefully investigated. In the small bronzes, terracottas, vases, sculptures, and buildings, the art of all periods from the "Dorian Invasion" to Byzantine times can be traced. The Heraeum threw unexpected light upon the early stages of the Doric style, the sculptures of the temple of Zeus and the Nike of Paeonius offered new information and new problems concerning the sculpture of the fifth century, and in the Hermes

Olympia

of Praxiteles an original work of one of the greatest of Greek sculptors was restored to the world. These are only some of the most striking results of the first systematic excavation of a really extensive and important centre of Greek life.

In 1878, while the work at Olympia was in progress, excavations were begun by the Berlin Museum at Pergamon, where Karl Hermann had discovered traces of the great altar. The **Pergamon** object of the work was primarily to enrich the Museum, an object which was completely accomplished by the transportation to Berlin of the sculptures of the great altar and many other works; but in the course of the excavations, — from 1878 to 1886, — the entire citadel and some adjacent parts of the city were laid bare. In 1900 the excavations were resumed and are still unfinished, their present object being to gain as much knowledge as possible of the great and splendid city. Besides the great altar, the temples, and other buildings on the acropolis, porticoes, gateways, gymnasium, a theatre, an amphitheatre, houses, tombs, and waterworks have been excavated and investigated. Many works of sculpture have been found, and here, as at nearly all the extensive sites excavated in recent years, great numbers of inscriptions have come to light. No other single site has added so much to our knowledge of Hellenistic civilization.

Several other great excavations have been carried on by Germans, in addition to many lesser works. In 1887 and 1888, at the **Other German excavations** sanctuary of the Cabiri, in Boeotia, an entirely new variety of painted vases was found, and new light was thrown upon a little known cult. In 1890 Hiller von Gaertringen excavated in the theatre at Magnesia on the Meander, and this led (1891–1893) to extensive and systematic excavation of the city by the Berlin Museum. The city of Priene was also excavated by the Berlin Museum (1895–1899), with the result that the plan and architecture of a Hellenistic city were more completely brought to light than ever before. In 1899 the Museum undertook the even greater task of excavating the remains of the great city of Miletus, a task which is not yet (1909) completed.

Here, as at Ephesus, Magnesia, Priene, and Pergamon, the excavations have revealed chiefly the city of late periods, with but few remains of early Ionic art. Other important German excavations are those at Thera (1896-1901), carried on at his own expense by Hiller von Gaertringen, which furnished new and valuable information concerning nearly all periods of Greek civilization, and those at the sanctuary of Asclepius at Cos, under the leadership of R. Herzog. The important excavations carried on at Athens near the northwest foot of the Acropolis, which laid bare an interesting quarter of the ancient city and made clear the Athenian system of water supply, were conducted by W. Dörpfeld, head of the German Institute at Athens, and many less extensive excavations in and near Athens are also the work of the German Institute. The Bavarian excavations carried on by A. Furtwängler at Aegina have led to a more complete understanding of the famous sculptures of the temple, as well as to new views of the development of pedimental composition.

The first excavations undertaken with the intention of laying bare and studying an entire ancient city were those of the Archaeological Institute of America at Assos (1881-1883). **American excavations.** The archaic temple on the acropolis was for the first **Assos** time accurately measured, the much later city walls, market buildings, baths, and other structures were excavated, photographed, and drawn. Unfortunately an adequate publication has been long delayed, and is only now in process of completion by F. H. Bacon.

In 1892 and 1893 the American School of Classical Studies at Athens, aided by the Archaeological Institute of America, excavated at the Argive Heraeum. **The Argive Heraeum.** The continuous occu- **Corinth** pation of this site from the earliest prehistoric epoch to Byzantine times makes it peculiarly interesting. The scanty vestiges of the early temple, the more satisfactory, though still incomplete, remains of the temple of the fifth century, with important fragments of its sculptures, and the foundations and other existing portions of several buildings per-

taining to the famous sanctuary were uncovered and carefully studied. Many more or less primitive bronze fibulae, pins, and the like, fragments of pottery, and primitive terracottas added new material for the study of early ages in Greece. The second extensive work of excavation undertaken by the American School at Athens is at Corinth, where active work has been carried on nearly every spring and summer since 1896. Important results have been achieved in determining topographical points and the levels of different strata of occupation; the peculiarly interesting ancient system of water supply has been in part made clear, and some interesting architectural novelties have come to light. Smaller excavations have been carried on by the School at Plataea, Icaria, Thoricus, Sicyon, Eretria, Sparta, Oeniadae, and the Cave of Vari, all with results of more or less importance.

At Delos, the sacred birthplace of Apollo and Artemis, the centre of the Delian Confederacy, and at one time the chief commercial port of the Aegean, excavations were begun
Delos in 1877 by the French School at Athens and continued at intervals until 1894. Since 1902 they are again in progress, and are now more systematically conducted. Already the temple of Apollo and many other buildings, including warehouses, temples, places of meeting, and many houses of Hellenistic and Roman times, have been excavated, and many important works of art have been found. Among these are the primitive statue dedicated by Nicandra, the Nike of Archermus(?), several draped figures of the Chian school, an admirable copy of the Diadumenus of Polyclitus, several mosaics, and numerous coins.

At Delphi, as at Olympia, the excavators were guided in their work and aided in the interpretation of their discoveries
Delphi by the detailed description of Pausanias. Between 1893 and 1901 the French excavators cleared the entire sacred precinct of the Pythian Apollo, as well as some neighboring territory. They made known the bronze charioteer, the Agias of Lysippus, the treasuries or communal houses of

the Athenians, Cnidians, and Siphnians, with their important sculptures, and many other buildings and monuments that were grouped about the temple; and the temple itself is now known to have been rebuilt in the fourth century B.C. Lesser French excavations were carried on in 1885 and 1886 at the temple of Apollo Ptoïos, in Boeotia, where a series of archaic nude male figures came to light; in 1887 and 1888 at Mantinea, where reliefs attributed to Praxiteles were found; and twice at Tegea, where in 1888 and 1889 the agora and other parts of the town were located, and in 1900 and 1901 fragments of the sculptures of the temple of Athena Alea were added to those discovered by a peasant in 1880.

The Greek Archaeological Society, which in its earlier years had almost entirely refrained from general activity in the field, was remarkably active in the last quarter of the nineteenth century. In 1876 the sanctuary of Asclepius at Athens was excavated, and in 1881 the excavation of the great sanctuary of the same god at Epidaurus was begun. The work has not been continuous, and is not yet entirely completed, but important results have been attained. One of the greatest Greek sanctuaries of the fourth century B.C. and the succeeding periods—a sanctuary which was at the same time a fashionable health resort—has been made known, many important works of sculpture have been found, and interesting architectural features have helped to make Epidaurus one of the most important sites in Greece. At Eleusis excavations carried on from 1882 to 1890 laid bare the famous sanctuary with its enigmatical Hall of the Mysteries, its temples, and its propylaea; at the far less famous, though still important, sanctuary of Amphiaraus, near Oropus, excavations were carried on in 1884, 1886, 1887, and 1906; the excavation of the temple of Despoena, at Lycosoura, where fragments of the statues by Damophon were found, took place in 1889, and for three years (1897–1899) work was carried on at Thermus, in Aetolia, where an ancient temple, which once had painted metopes

**The Greek
Archaeologi-
cal Society.
Epidaurus,
Eleusis,
Athens, etc.**

and was divided by a single row of columns in the interior, was discovered. The Society has also carried on many smaller excavations, and cares for the preservation of ancient monuments. But its most important achievement was the complete excavation of the Acropolis at Athens (1885-1891). This resulted in the discovery of the ancient temple beside the Erechtheum, of remains of a prehistoric palace, of the hidden approaches to the citadel, of remains of several temples, and of many works of sculpture, which made Greek art, especially Attic art, of the sixth century known for the first time. Moreover, the numerous fragments of pottery found in the débris which was used as filling material after the departure of the Persians in 479 B.C., are manifestly earlier than the Persian invasion, and since among these are many fragments of red-figured ware, the date of such ware, and consequently of the black-figured vases which preceded it, was seen to be much earlier than had previously been supposed. The history of Greek vase painting, and therefore of Greek painting in general, was thus put on a new chronological basis.

The excavations at Megalopolis (1890-1891) and at Sparta (begun in 1906), by the British School at Athens, and the Danish **Megalopolis**, excavations at Lindus, in Rhodes (1902-1904), should **Lindus** also be mentioned among the important works of large scope which have contributed to make not only the art, but the life of the ancient Greeks familiar and comprehensible as never before since the end of the ancient civilization.

It would be impossible within the limits of this chapter to enumerate all the monuments of Greek sculpture which have been discovered since 1870. Some have already been mentioned in connection with various excavations, but two detached discoveries should at any rate not be omitted, even in a rapid summary: the **Sidon, Ceri-** superb sarcophagi found at Sidon in 1887 (see page **gotto** 274) and the remains of the cargo of a ship which was sunk in ancient times off Cerigotto (Anticythera), not far from Cythera. The ship contained numerous works of sculpture, some of which were found in 1900. All were much injured by long

continued action of salt water, but a fine bronze statue (page 267) has been successfully restored.

The discoveries mentioned up to this point have made the arrangement of Greek cities, especially in Hellenistic times, and of Greek sanctuaries known; they have at the same time added greatly to our knowledge of Greek architecture, not only in the classical period, but also before and after that time, thus making a history of its development possible. The numerous works of sculpture unearthed have greatly increased the material available for study, not only by the addition of virtually new classes, such as the works of the sixth century and of the Pergamene school, but also by the increase in the number of works of all periods. It has thus become possible to distinguish with some degree of accuracy the individuality of certain sculptors, such as Phidias, Polyclitus, Scopas, Praxiteles, and Lysippus, and even to trace their development. History and topography have gained greatly, especially by reason of the inscriptions discovered, and vast numbers of lesser objects, such as bronzes, terracottas, and pottery, have helped to complete the record of Greek civilization. So far as architecture and sculpture are concerned, the chief elements of the progress made since 1870 have been mentioned.

In the same period the knowledge of Greek painting has also advanced. In 1870 Conze, who had published the first examples of "Melian" vases in 1862, added the geometric style to the classes of vases previously established, and the discovery of the Dipylon vases in 1871 made the most striking features of a style that preceded that of the Corinthian vases familiar. In 1879, by the publication of Klein's *Euphronios*, the first important and systematic attempt to differentiate from his fellow-workers one of the most gifted of Attic vase painters and to establish his position in the history of painting, the study of vase painting entered upon a new stage. In 1882 Robert recognized in an important class of vase paintings the influence of Polygnotus, thereby making the close connection between the

humble art of the vase painter and the great art of the fifth century clear beyond question. The discovery of the Clazomenian sarcophagi in 1883, followed by that of interesting and evidently non-Attic vases at Naukratis (1884-1886) and Daphnae (1888) in Egypt, made the influence of Ionic art upon that of all Greece evident and led to new views concerning the development of design and the use of colors in early times. Boehlau's investigations (1894) in the cemeteries of Samos added precision to the knowledge of Ionic art and designated Miletus as the centre of manufacture of vases previously regarded as Rhodian or assigned to other places. The excavation of the Acropolis at Athens (1885-1891) fixed the chronology of Attic vases. Thus the foundation has been laid for accurate knowledge of the development of vase painting — and with it of monumental painting — in the sixth and fifth centuries B.C., and painted stelae, especially those found in 1907 at Pagasae, reflect the great art of the third and second centuries. The late paintings, at Pompeii and elsewhere, have also been assigned to their proper historical place since Helbig, in 1873, proved that their origin is Hellenistic. In 1878 the discovery of a villa in the Farnesina, at Rome, the walls of which were adorned with a great number of frescoes, added a most valuable series to the works of this class previously known. In spite of the fact that the works of the great Greek painters are all lost, the history of Greek painting can now be sketched from the sixth century to Roman times.

Although Greek terracottas of various kinds have long been known, they awakened little interest until 1870, when the first discoveries of exquisite figurines were made at Tanagra. **Terracottas** More or less systematic excavations carried on there, especially from 1870 to 1874, brought to light great numbers of statuettes, chiefly delightful little works of the fourth century, though earlier figurines were fairly numerous. At about the same time figurines from Asia Minor began to appear, and in the necropolis of Myrina (1880-1881) E. Pottier and S. Reinach brought them to light in great numbers. Great general similarity

and at the same time marked differences between the figurines from Myrina and those from Tanagra were at once observed. Terracottas from many sites, especially Cyprus, Rhodes, the Cyrenaica, Sicily, and southern Russia, were already known, and their number was increased by discoveries at many places, among them Athens, Eretria, and Priene. The German Archaeological Institute planned a great publication of this material, under the direction of R. Kekule v. Stradonitz. In 1880 and 1884 terracottas from Sicily and Pompeii were published by Kekule and Von Rohden respectively, and in 1903 appeared, in two folio volumes, a catalogue of types (*Typenkatalog*) by F. Winter, in which several thousand illustrations exhibit the endless variety of Greek terracotta figurines, their local differences, and their historical development.

Prehellenic Greece was first made known to the modern world by Heinrich Schliemann, a remarkable man, who, though without systematic training or scientific aptitudes, became, through his boundless enthusiasm, persistent energy, and marvellous intuition, the founder of a new branch of science. His first great undertaking was the excavation of the Homeric Troy, at Hissarlik, begun in 1870, and resumed at various times, the last time with the assistance of W. Dörpfeld, in 1890. After Schliemann's death, in 1890, Dörpfeld excavated at Hissarlik in 1893 and 1894. The results of the work at this site are published in *Troja und Ilion* (Athens, 1902), by W. Dörpfeld. In 1880 Schliemann excavated the beehive tomb at Orchomenus, in Boeotia, and in 1884 came his excavations at Mycenae and Tiryns. At both of these sites his work was afterwards supplemented by that of others. Of his less important excavations it is needless to speak. Schliemann made his discoveries known by prompt, but unscientific publications, the chief contents of which were collected (in 1890) in one volume, *Schliemann's Excavations*, by Carl Schuchhardt (translated by Eugénie Sellers).

In 1877 and 1880 Prehellenic tombs were discovered at Spata and Menidi, in Attica; in 1888 the tomb at Vaphio, in Laconia,

Heinrich
Schliemann.
Prehellenic
Greece

yielded the famous gold cups ; in 1884 Italian scholars investigated the grotto of Zeus on Mt. Ida, in Crete ; since 1900 Dr. Arthur Evans has been carrying on his excavation of the vast palace and its dependencies, including tombs, at Cnossus, while Italian excavations at Phaestus, the excavations of the British School at Palaikastro, those of Miss Boyd (Mrs. Hawes) at Gourniá and its neighborhood, and of Mr. Seager at Pseira and Mochlos, with other investigations of lesser scope, have contributed to make it evident that Crete was for centuries the chief seat of a brilliant Prehellenic civilization. Meanwhile the excavations carried on (1896-1899) at Phylakopi, in Melos, by the British School at Athens, the investigations of Tsountas and others in other islands of the Aegean, and the discovery of tombs and other remains not only in the Argolid, but in Thessaly, Boeotia, and elsewhere, have made it possible to trace the development of civilization in Greek lands from the neolithic period to the so-called Dorian Invasion. The results of these discoveries are summarily treated in the chapter on Prehellenic Greece.

The work of excavation and discovery has been accompanied and supplemented by that of publication, classification, and discussion. Each great excavation has been, or is to be, followed by an exhaustive special publication, and the relations of newly discovered monuments to those previously known are discussed in many books, monographs, and articles in periodicals. The museums publish catalogues, often illustrated, which are monuments of learning as well as of industry. Under the auspices of the German Institute and other organizations, great collections of special classes of monuments have been published or are in preparation, such as the *Attische Grabreliefs* (Conze) and the *Römische Sarkophagreliefs* (Robert). S. Reinach has brought together in handy volumes the contents of earlier expensive publications, with additions from various sources, in his *Répertoire de la statuaire grecque et romaine* and his *Répertoire des vases peints grecs et étrusques*. The *Denkmäler griechischer und römischer Sculptur*, published by the F. Bruckmann Company, in Munich, and other

great collections of photographic prints make the study of ancient monuments possible even to those who have not constant access to great museums. Thus the material at the command of the archaeologist is multiplied. The *Histoire de l'art dans l'antiquité*, by Perrot and Chipiez is a work of great learning, industry, and insight, in which the attempt is made to bring together and discuss virtually all the important material known. In the earlier volumes the art of Egypt, Chaldaea, Assyria, Phoenicia, Cyprus, Palestine, Sardinia, and the various parts of Asia Minor are treated, and Volumes VI, VII, and VIII are devoted to Greek art before its great development in the fifth century.

With such means at its disposal — original monuments, collections of photographs, general and special publications — Greek archaeology has become an organized science, taking its place beside philology and the study of Greek literature as an equally important element in the reconstruction of Greek antiquity, and beside the study of the art of the Renaissance as an equally important division of the study of the history of art.

In its main lines the development of Greek art is now known. It remains to determine more exactly the relations between the art of different centres, the personal qualities of individual artists, their influence upon their contemporaries and successors, and the successive stages in the development of each master. Some work in this direction has already been attempted, notably by Furtwängler, in his *Masterpieces of Greek Sculpture*, but as yet only a beginning has been made, and many corrections and additions are needed. There is still important work to be done, in spite of the vast and rapid progress of the last few decades.

CHAPTER I

PREHELLENIC GREECE

GREEK art begins its rapid and wonderful development hardly earlier than 700 B.C. From about that time continuous and, on the whole, steady progress may be traced, and the rude works of the seventh century already show something of the qualities which distinguish Greek art from that of other peoples.

But the art which can thus be traced from the seventh century onward is not the earliest art known on Greek soil. For many centuries before the so-called Dorian Invasion continental Greece and the Greek islands were inhabited, and many monuments of the early inhabitants remain. Whether the Prehellenic inhabitants of Greece, the islands, and the coasts of Asia Minor were

at any time all of one race or related races, we do not know; but that at one time there was an important civilization which extended over nearly the whole of this region is certain. When fresh and vigorous tribes came in to take possession of the soil, the previous inhabitants cannot have been utterly exterminated, neither can they all have emigrated. Most of them doubtless remained in their old homes as slaves, subjects, fellow-citizens, or allies of the conquerors. As in most other cases, so probably in the case of Greece, the conquering tribes were less numerous than the conquered people. Thus the Prehellenic inhabitants of Greece became in great measure the ancestors of the Hellenes, whether they were originally of kindred race with the invaders or not. The remains of their art are therefore of interest to the student of Greek archaeology. But their art throughout its long and varied development is different from Greek art, and there is a period of several centuries between

the overthrow of the latest Prehellenic civilization and the earliest recognizable works of Greek art; the Prehellenic period, or periods, must therefore be treated briefly in a book on Greek archaeology.

No remains of the palaeolithic age — the period when men had not yet learned to grind or polish their stone implements — have as yet been found on Greek soil. Of the neolithic period, however, some monuments are known, and further discoveries will doubtless bring others to light. This is the period when the use of metals was as yet unknown, but when stone implements were ground and polished, not merely chipped. Of course some kinds of stone, notably obsidian, are never ground, because they acquire a sharper edge by being chipped or broken.

The stone age in Greece was shorter than in northern and western Europe, perhaps because Greece was so near the early civilization of Babylonia and Egypt. The lowest stratum at Troy probably belongs to the neolithic age; at Dimini, Sesklo, and other places in Thessaly, were important neolithic settlements; at Cnossus and other sites in Crete neolithic remains are extensive, and at various other places minor discoveries of neolithic objects have been made. In general the neolithic remains consist of stone and bone implements and rude pottery. This last is made of imperfectly worked clay, is shaped by hand without the use of the potter's wheel, is decorated, if at all, with lines incised in the soft clay, and is fired in an open fire, not in a potter's oven. At Cnossus and in Thessaly the use of color for the decoration appears before the use of metal tools. Undoubtedly the stone age lasted longer in some places than in others, and the use of metal tools does not always mark exactly the same stage of civilization.

Various terms are used by different writers to designate the various civilizations which existed in the centuries between the neolithic age and the beginnings of Hellenic culture. By some everything in Greece and the Greek islands earlier than the Dorian Invasion has been called "Mycenaean"; but this ex-

tended use of the word is now becoming rare. The term "Aegean" is sometimes used as the equivalent of "Mycenaean" in this sense. At present the term "Mycenaean" is applied especially to the comparatively late period when Mycenae was at the height of her power and the greatness of Cnossus was already old. Everything before this time is often called "Premycenaean," but here also various divisions are made, corresponding with differences in culture. The term "Proto-
Nomenclature mycenaean" is applied to pottery and other objects, the decoration of which leads up directly to that of objects classed as "Mycenaean," and the term "Early Mycenaean" is used in a similar sense. "Cycladic" is a term applied to a limited series of rather primitive objects found in the Cyclades, and to the civilization that produced them. The word "Amorgian" was formerly used, because Amorgos furnished many of these objects, but "Cycladic" is preferable. The island of Crete was evidently for centuries the seat of a powerful civilization which is connected by tradition with the name of King Minos. Hence the word "Minoan" is used to designate the civilization of Crete before and during the "Mycenaean" epoch; it should not be employed where no reference to Crete is intended. Even more limited is the term "Kamáres" (Kamárais), applied primarily to a kind of Premycenaean pottery first found in a cave on Mt. Ida in Crete, and secondarily to the civilization of the people by whom the pottery was produced. Objects produced in the period immediately after the Mycenaean age, and showing qualities of Mycenaean art, are sometimes called "Submycenaean," and the term "Predorian" is sometimes used to designate all that precedes the "Dorian Invasion." This last term may properly be used only in reference to those regions which were afterwards occupied by the Dorians. Of the terms here defined, only "Aegean" and "Mycenaean," with "Premycenaean," "Protomycenaean," and "Submycenaean," can properly be applied to all parts of the Greek world. The application of the other terms is limited in space as well as time.

The different phases and degrees, as well as the different dates of civilization in Prehellenic Greece, may be distinguished and studied in various kinds or classes of existing remains : Existing
city walls, house walls, and foundations ; tombs, weap- remains
ons, utensils and ornaments of stone, metal, ivory, bone, and glass ; sculptures, frescoes, and pottery ; but the most important of all is the pottery. This is found in all cemeteries and inhabited sites, and occurs in such numerous specimens that it serves as a fairly sure indication of the degree of civilization of the people who made it, especially when it is considered in connection with the tombs, walls, and other remains among which it is found. It is therefore chiefly by differences in their pottery that the different periods of early civilization are most clearly marked.

The most primitive pottery of the Troad is handmade and black. The shapes are usually round and full, sometimes nearly spherical. Often the human face or form is rudely imitated, and imitations of animals also occur. The decoration is usually in- Primitive
cised, often added in relief. Pottery resembling that pottery
of the Troad is found also in Cyprus. Painted pottery does not seem to have been produced at Troy until a comparatively late period, and then only in imitation of imported Mycenaean ware.

At various places in continental Greece, as at Athens, Tiryns, and Orchomenus, primitive handmade pottery has been found, which evidently belongs to a very early period. Ware similar to this occurs in the Cyclades, from Thera at the south to Tenos at the north, and in these islands the pottery is found in graves and among the ruins of settlements. These remains evidently belong to different periods, and the pottery develops from primitive rudeness to a high degree of excellence before the native manufacture of the islanders yields to imported Mycenaean ware. At no single place can this development be more easily traced than at Phylakopi, the site of an ancient town on the island Phylakopi
of Melos, excavated by the British School at Athens in 1896 and the following years. The site was evidently occupied by several successive settlements, and the occurrence of

pottery in the different strata formed by the remains of these settlements makes it possible to study the changes in the vases and their decoration and to connect each kind of pottery with the proper stage of culture as exhibited by the other remains. At Phylakopi the earliest stratum shows fragments of primitive, unpainted, handmade ware, decorated, if at all, with incised straight lines, but it shows no traces of walls. The people of this earliest period lived, then, in huts which have left no trace. Above these slight remains was built the first of three successive cities. This first city has left remains of straight-walled houses, containing one, two, and more rooms. The walls of the houses were of stone, plastered inside. A manufactory of obsidian implements was found in connection with the remains of this city. The pottery is still handmade, and its decoration is often incised, but the patterns are more advanced, and painted decoration is introduced. The color is sometimes dull (*mattmalerei*) and sometimes glazed (*firnis-malerei*). Neither stone implements nor metal tools were found in this stratum. The first city was unfortified. In the second city the house walls were of stone, like those of the first city, but better built, and the inner walls were sometimes decorated with paintings. Lead and bronze were in use by the inhabitants of the second city. The pottery is no longer exclusively handmade; curvilinear decoration, already introduced in the first city, almost drives out the decoration with straight lines; incised decoration disappears, and naturalistic painted designs are introduced. This city was surrounded with a strong fortification. The third city continued for a time to produce pottery like that found in the second, but much pottery of Mycenaean style began to be imported. The importance of the place was evidently declining, perhaps with the decline of the demand for obsidian implements, the only important objects of export which Melos could produce. Phylakopi shows a development from the rudest handmade pottery with rectilinear incised decoration through successive stages to carefully made vases turned on the wheel and decorated with naturalistic painted designs.

Various stages of this development are represented, with local differences, by objects found at Amorgos, Paros, Antiparos, Syra, and other places in the Cyclades. A few specimens will serve to illustrate the progress of art from the earliest to the latest times of Premycenaean Cycladic civilization. At various places cemeteries have been found which correspond, more or less closely, with the earliest remains and the first city at Phylakopi. The tombs are small cists, made of slabs and small stones, in which the dead were buried in a bent posture. Some of the earliest of these graves were found at Amorgos and Melos, some of the latest at Syra. In them were clay vessels, marble vases and idols, obsidian implements, and, in a few instances, objects of bronze. The marble idols range from two or three centimetres to a metre and a half in height, but are usually less than twenty centimetres high. Many of them represent a nude female, though some represent a male, and in others the sex is indeterminate (Fig. 1). There are two main types, each with many variations. One type shows the nude person, with the head and limbs clearly outlined, the arms laid across the breast. The other type resembles a violin. The head is represented only by a long projection like a neck, while the arms appear as mere swellings, and a similar swelling probably indicates the drapery about the legs. The two types existed side by side, and it is difficult to see how one could have arisen from the other. Apparently these idols were connected with the religious cult of the people who produced them, and although the form of the nude female idols may possibly be influenced by that of the Babylonian Ishtar, it is at least as probable that no such influence was exerted. Such idols have been found also in Crete and in continental Greece, but



FIG. 1.—Idols from the Cyclades, Athens. (Photograph.)

The other type resembles a violin. The head is represented only by a long projection like a neck, while the arms appear as mere swellings, and a similar swelling probably indicates the drapery about the legs. The two types existed side by side, and it is difficult to see how one could have arisen from the other. Apparently these idols were connected with the religious cult of the people who produced them, and although the form of the nude female idols may possibly be influenced by that of the Babylonian Ishtar, it is at least as probable that no such influence was exerted. Such idols have been found also in Crete and in continental Greece, but

not as yet in such numbers as in the Cyclades. The pottery found in these tombs is for the most part rude, and adorned only with incised straight lines. The clay is of various kinds and colors, apparently the local clay of each place. The surface, usually black, is polished by rubbing. Patterns of curved lines, spirals, and circles joined by straight lines are common, but not in the ear-



FIG. 2. — Flat vessel from Syra. Athens. (Photograph.)

liest graves. A well-developed form of this kind of ornament is found on some curious flat vessels from Syra (Fig. 2). The incised lines are often filled with a white substance. Most of these early vessels are nearly spherical in shape, often with a base and a neck, or are flat dishes or cups. Often they have projections at the sides, perforated either horizontally or vertically, doubtless that the vessel might be hung up by a string. The marble vessels are not for use, but are imitations of clay vessels. This is evident from the fact that they

are only partially hollow. These marble vessels show no traces of painting, though painted geometrical decoration is found on some ware of the period to which they belong. Pottery similar to this early ware from the Cyclades, but differing from it in some respects, has been found in Crete, and the early pottery of Cyprus shows a parallel development. Ware found in the second settlement at Troy and in Sicily shows that the early civilization of a great part of the coast region of the eastern Mediterranean possessed the same general character.

Even in the early stages of civilization which produced the objects just described, different places show more or less independent development. In the following period the local differences are greater and more important. At this time cities were fortified with walls, rough and poorly built at first,

Local differ-
ences

but more carefully constructed of hewn stone as time went on. Whether the stones were polygonal or rectangular depended in great measure upon their hardness and natural cleavage. At this time, and throughout the Prehellenic ages, the stones were laid in clay mortar, or mud, and in the early part of the period, at least, small stones were stuck into the interstices between the large blocks (Fig. 16). At Cnossus, in Crete, there was little or no fortification, for even at this time the inhabitants seem to have believed themselves safe from attack on account of their naval supremacy. Crete was, for a period of several centuries, which includes part of the Mycenaean Age, the chief centre of civilization in the Aegean region.



FIG. 3.—Stucco relief from Cnossus. Candia. (*B.S.A.*, Vol. VII, p. 17.)

At Cnossus important settlements existed from the neolithic period, and in later times Cnossus and Phaestus were the sites of great palaces, which reached the height of their splendor in the times of the second and third cities at

Cnossus

Phylakopi. The walls of these vast structures were decorated with paintings and stucco reliefs, many fragments of which have



FIG. 4. — Painting from Cnossus. Candia. (*B.S.A.*, Vol. VII, p. 57.)

been found, especially at Cnossus. The subjects represented cannot in all cases be determined, but among them are processions, groups of men and women, and combats of men, and also of women, with bulls.

The style is naturalistic and the execution admirable. The fragment of a stucco relief reproduced in Figure 3 represents the arm and part of the body of a man, and may serve to give some idea of Cretan decorative art.

In date this and some of the other works of art mentioned above may not be earlier than some of those to be described hereafter as products of Mycenaean art, but it is now evident that Mycenaean art was in great measure derived from Crete, where art developed earlier than on the Greek mainland. Perhaps even later than the stucco relief is the painting of a girl (Fig. 4). Some of the Cretan clay figurines are also interesting and instructive. An early type is seen in Figure 5 (from Petsofa), while the figure of a snake-goddess, in faïence or glazed



FIG. 5. — Painted terracotta from Petsofa. Candia. (*B.S.A.*, Vol. IX, Pl. 8.)



FIG. 6. — Snake-goddess from Cnossus. Candia. (*B.S.A.*, Vol. IX, p. 75.)

terracotta, from Cnossus (Fig. 6) belongs to a time nearer that of the stucco relief, and the faïence plaque representing a goat suckling her young (Fig. 7) may be even a little later. All these clay figurines were colored.



FIG. 7. — Terracotta relief from Cnossus. Candia. (*B.S.A.*, Vol. IX, Pl. 3.)

A peculiar product of Crete, contemporary, roughly speaking, with the second city at Phylakopi, is the so-called Kamáres (Kamárais) ware. This is sometimes coarse, some- **Kamáres**
times very fine, but is distinguished from other ware **ware** by its use of red and dull white paint, with some orange and yellow, upon a ground of black (sometimes reddish or purplish) varnish or glaze. The ornament is most often geometrical, but sometimes imitates plants. Many vases are adorned with rings, wavy lines, and knobs in relief, and some are partially covered with irregular lines which look as if made with the finger tips. These vessels are all made on the potter's wheel, except some large, coarse specimens, which are handmade. Some of the usual shapes are small cups, with or without handles; others are higher vases with spouts or beaks (so-called Schnabelkannen) (Figs. 8, 9). Many of these

vessels are evident imitations of metal work. So one common kind of cup closely resembles such cups as those found at Vaphio (Fig. 40), even having knobs to represent the rivets that fasten on the handles.



FIG. 8. — Kamáres vase (Schnabelkanne) from Cnossus. Candia. (*J.H.S.*, Vol. XXI, Pl. 6.)



FIG. 9. — Kamáres vase (Schnabelkanne) from Cnossus. Candia. (*J.H.S.*, Vol. XXI, Pl. 6.)

Almost as soon as vases began to be painted at all in Crete, two systems, that of painting the designs in white or light color on a dark ground, and that of using black or dark colors on a light ground, existed side by side. The Kamáres ware is a development of the system of painting light on dark. It is decorated in white and colors upon a ground of black. Other Cretan vases show white decoration on a black ground, as, for instance, the vase reproduced in Figure 10, which was found at Cnossus, and belongs to the time when Kamáres ware was becoming less popular. The white lilies on this vase are naturalistic, with hardly a trace of conventionalism in design. After this the fashion prevailed of painting the design in lustrous black upon the buff or reddish clay of the vase as a ground color. Some Cretan vases of this kind are very fine. At Cnossus they are found in the ruins of the greatest period of the palace, and their style has been called by Dr. Evans the "Palace Style." Figure 11 represents a vase of this style found



FIG. II. — Vase of palace style from Mycenae.
(*J.H.S.*, Vol. XXIV, Pl. 13.)



FIG. 10. — Vase from Knossos, Candia.
(*B.S.A.*, Vol. X, p. 7.)

not at Cnossus, but at Mycenae. As time went on the pottery of Crete and that of Mycenae and other places on the mainland became practically identical in decoration, though local varieties may still be traced.

Kamáres ware was apparently made in Crete from a time considerably before 2000 B.C. until 1600 B.C. or a little later. Vases imported from Crete were found in the second city at Phylakopi.

Both in Crete and in Melos this was a period of prosperity and culture. The palaces at Cnossus and Phaestus were great and splendid, and the second city at Phyla-



FIG. 12. — Fisherman vase or lamp-stand from Phylakopi. Athens.
(*Phylakopi*, Pl. XXII.)

kopi apparently attained a degree of prosperity higher than any city of Melos ever reached in later times. The Melian pottery of this period is often very beautiful and adorned with striking representations of plants, animals, and even men, as well as with geometrical patterns. A remarkable fragment shows a number of men walking, each holding a fish in his hand (Fig. 12). Still more remarkable is a wall fresco representing flying fish, painted

in blue, yellow, and black, or dark brown, on a creamy white ground. The drawing is naturalistic and the decorative effect good. This fresco is very similar to some of the paintings at Cnossus, and may be the work of a Cretan artist (Fig. 13).



FIG. 13.—Fresco from Phylakopi. Athens. (*Phylakopi*, Pl. III.)

The pottery from the island of Thera is especially interesting. The clay is carefully prepared, and has a grayish yellow surface. The decoration is applied in dull color, usually dark brown. Straight lines, circles, and spiral curves are most usual, but representations of plant forms are frequent, and birds and animals also occur. The shapes of the vases are more elegant than those of the primitive vases from graves in the Cyclades, sometimes as fine as those of the later period. They include cups, pitchers or jugs, and funnel-shaped vessels with a hole in the bottom, which must have been used either as funnels for pouring liquids into narrow-necked receptacles or as drinking cups. In the latter case, the drinker must have stopped the hole in the bottom with his finger or thumb, by removing which he



FIG. 14. — Vases from Thera. Athens. (Rayet and Collignon, *Hist. de la Céramique Grecque*, pp. 9, 10, 11.)

could let the liquid run into his mouth. As the vessel could not be set down unless empty, it was necessarily emptied at a draught (Fig. 14).

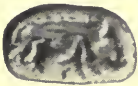

FIG. 15. — Primitive gems. (Furtwängler, *Antike Gemmen*, Pl. IV, 25, 26, 28.)

At various places in what were afterwards Hellenic lands, especially in Crete, engraved seals or gems have been found which belong to the period under discussion. They

Gems

have usually three sides, all engraved with the same device. Sometimes the shape is conical. The stone used is soft, chiefly steatite, and in this the devices are rudely cut and bored by hand. The devices consist of men, beasts, vases, ornaments (often spirals), and various signs, some of which seem to be a kind of writing. Some of the ornaments show close connection with Egyptian art of the Twelfth Dynasty, about 2000 B.C. (Fig. 15). The seals themselves are probably of not much later date. At a later time, in the

“Mycenaean” period, the use of engraved seals, or gems, was widespread, and the engraving is often very fine.

At Cnossus and Phaestus, the two great centres of early civilization in Crete, the period marked by the production of Kamáres ware came to a violent close. The great palaces were destroyed, and new rulers, possibly foreigners, entered into possession. After this the palaces were rebuilt, but the art now displayed is not a mere development from what preceded, but something new and different. The old art survived in some places alongside of the new, and many old elements were accepted by the new artists, but in general a marked change took place. The new art of Cnossus, Phaestus, and other places in Crete is identical with the art previously known from discoveries in many places, among which Mycenae was the first discovered and the most important, and it is called for that reason “Mycenaean Art,” **Mycenaean Art** though its chief seat seems, in the light of recent discoveries, to have been Crete. Mycenae and Tiryns were, however, important centres; less important settlements were other places in the Argolid, in Laconia, Attica, Megara, Boeotia, Thessaly, and many of the Greek islands, including Cephalonia, Ithaca, and Leucas off the western coast of Greece.¹ The pottery and other objects produced by the artisans and artists belonging to this civilization are found from Egypt to Sicily. The connection with Egypt was evidently especially close in Crete, which is a natural result of the geographical position of the island, but it extended to all Greek islands and the mainland. Egyptian influence is plainly seen in many products of Mycenaean art, but that art is clearly different from Egyptian art, as the Mycenaean civilization was different from Egyptian civilization.

In the great Cretan centres of Mycenaean civilization, Cnossus and Phaestus, massive fortifications did not exist, but the walls of

¹ It may be that the civilization spread from Crete to the mainland, and that then the inhabitants of the mainland (Achaean) crossed over to Crete and conquered the great Cretan cities. This theory would account for some of the changes that evidently took place in Crete.

Tiryns and Mycenae testify strongly to the skill of their builders. The earlier parts of the walls at Tiryns are built of large stones, left nearly in their natural shapes, but with the outer face roughly hammered to something like a plane surface. The interstices were filled with small stones and clay mortar, which has now been almost entirely washed out by the rains of centuries (Fig. 16). Other and later parts of the walls are built of square blocks, laid in somewhat irregular horizontal courses. A remarkable feature of the walls at Tiryns is a series of rooms leading from a gallery constructed in the thickness of



FIG. 16.—Wall of the citadel of Tiryns. (Photograph.)

the walls. The roof of the gallery and the doorways leading into the rooms have nearly the form of a Gothic arch, but the principle of the keystone arch is not applied. The great blocks of stone project from the side walls, and the space between the top of these projecting blocks is filled with a stone resting on and between those immediately below it (Fig. 17) Such galleries are

exceptional, though something like them existed at Mycenae, but the system of the corbelled arch, formed by courses of stones, each projecting over the one immediately below, is employed in highly perfected form in the dome (beehive) tombs of Mycenae and Orchomenus. A fine example of Mycenaean wall-building, of a date later than that of the walls at Tiryns, is seen at the Lions'



FIG. 17. — Gallery at Tiryns. (Perrot and Chipiez, *Hist. de l'art dans l'antiquité*, Vol. VI, p. 276.)

Gate at Mycenae (Fig. 18). Here the stones are cut into rectangular blocks and laid in horizontal courses. The gateway, slightly narrower at the top than at the bottom, is framed by massive stone jambs and covered by a great stone lintel, above which is a triangular space, left empty save for the comparatively thin slab on which the lions are carved. This space was not filled with heavy blocks for fear that their weight would break the lintel. The main entrance to the citadel at Tiryns resembles, so far as it is preserved, the Lions' Gate. Both at Mycenae and Tiryns a smaller postern gate exists, less elaborate than the main entrance, but constructed in the same way, except that on account of the narrowness of the gateway it was not necessary to relieve the

lintel of the weight of the wall above. A third fine example of Mycenaean fortification is found at Gla, once in Lake Copais, and remains of Mycenaean city walls exist in some other places.



FIG. 18. — The Lions' Gate at Mycenae. (Perrot and Chipiez, *Hist. de l'art dans l'antiquité*, Vol. VI, p. 317.)

The most important remains of dwellings of the Mycenaean times are those of the palaces at Cnossus, Phaestus, Tiryns, and Mycenae. Of these, the palace at Cnossus was by far the largest, and is, in some respects, the best preserved. The palaces at Phaestus (Phaestus proper and Hagia Triada) were also magnificent residences, and are in parts well preserved. The palaces at Tiryns and Mycenae were less large than the great Cretan palaces, but they have been known longer, and their clearness and simplicity of plan makes them easier to understand. These palaces are all built on hills, and in each case the hill has been prepared to receive the building, but not so that the foundations for the entire palace are on one level. On the contrary, the palaces are built on two or more terraces, so that the floors were at different heights, and different parts of the

buildings were approached by stairs. The division into terraces is especially noticeable in the great Cretan palaces. It is, however, certain that each of these was built at several different times, and it is as yet not quite clear how great a part of any of them

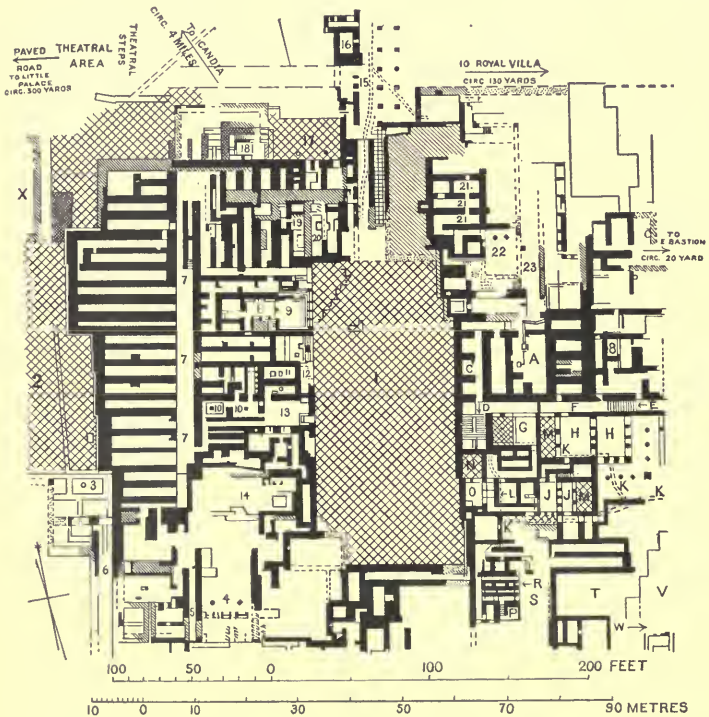

FIG. 19. — Plan of the palace at Cnossus. (Burrows, *The Discoveries in Crete*, Pl. 4.)

was in use at one time. All the palaces, whether in Crete or in continental Greece, are alike in having their foundations and the lower parts of their main walls built of well-squared blocks of stone. In Crete the upper parts of the walls were of rubble, held together with clay mortar and wooden beams. In Greece proper

the upper parts of the wall seem to have been rather of sun-dried brick. The surfaces of walls were covered, at least within the palaces, where they would be seen by inmates and visitors, with plaster, which was decorated with paintings. At Cnossus and Phaestus, the lower parts of walls were often cased with slabs of gypsum. The plan of the Cretan palaces is elaborate and complicated, as is natural in such great structures. The palace at Cnossus was in parts, at least, two or three stories high and contained several courts, one or two chapels or sanctuaries, rooms for audiences and receptions, magazines, storerooms, sleeping rooms, workshops of various kinds, bathrooms, — in short, all the apartments of a great establishment, where wealth and luxury abounded (Fig. 19).

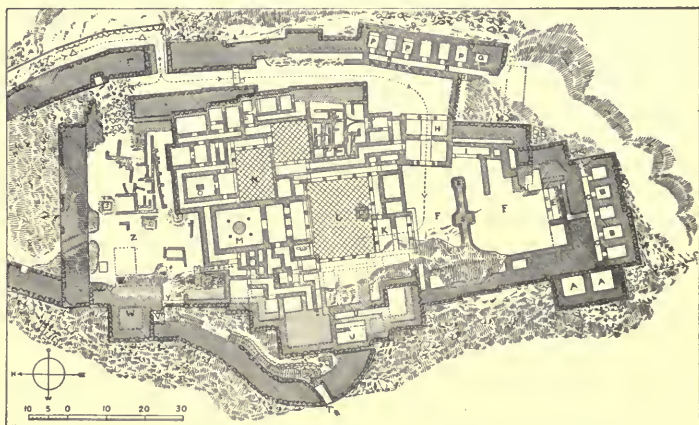

FIG. 20.—The palace at Tiryns. (Schuchhardt, *Schliemann's Ausgrabungen*, Pi. 4)

The palace at Tiryns, though far less extensive than the palace at Cnossus or those at Phaestus, was still a large edifice or group of edifices (Fig 20). It had a pillared gateway or propylaeum, a large open court, a megaron or hall for men, a similar, somewhat smaller hall for the women, a bathroom, and many other apartments. The megaron, with its porch (*aitousa*) and vestibule (*pro-*

domos), was the chief part of the palace, about which the other apartments were grouped. The arrangement agrees in general with the Homeric description of the house of Odysseus. The hall itself was nearly square. In the middle was the hearth, about which stood four columns to support the roof. The flat bases of these columns are still in place. The side walls of the hall are continued toward the front, forming the outer walls of the vestibule and the porch. Where these walls end, at the front of the building, are stone bases, upon which once stood wooden planks, as a protection for the crude brick walls against the weather. Between the ends of the walls are two stone foundations for columns which once supported the architrave or beam that extended from one wall (or *anta*) to the other. The front of the building was therefore very similar to the front of a Greek temple *in antis*. The roof of the Mycenaean house was probably flat and covered with earth or clay. This is *a priori* probable, since tiles were as yet unknown in Greece, and thatch is for various reasons not likely to have been in general use, and it is conclusively proved by a fragment of a silver vessel found at Mycenae (see Fig. 41, p. 81), on which houses with flat roofs are represented. Over the architrave the ends of beams would naturally have been visible; on these were laid the boards, or, more probably, poles, upon which the earth was spread. This would be the simplest form of such a roof, the projecting eaves of which would have the appearance of a rude cornice immediately above the architrave. If large beams were laid at intervals from the architrave to the wall of the porch, the roof would be strengthened, and the layer of earth or clay could be made thicker and therefore more perfectly waterproof. Above the architrave would then appear at regular intervals the ends of the large beams, and between these would be vacant spaces. If, as is probable, the beams were of oblong rectangular section and somewhat thicker in their vertical than in their horizontal dimension, the effect would resemble that of the Doric frieze of triglyphs between metopes. It is, in fact, probable that the Doric temple was de-

Roofs

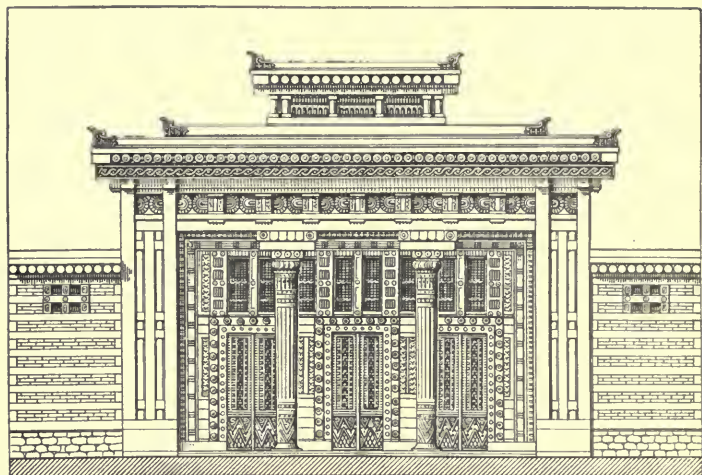

FIG. 21.—Mycenaean palace. Reconstruction by Charles Chipiez. (Perrot and Chipiez, Vol. VI, Pl. II.)

veloped from the Mycenaean palace, though some of the details of its development are not as yet clear (Fig. 21).

The column in Mycenaean architecture had no base, such as the Ionic column of later times possessed, but its shaft rose directly from the flat stone that formed its foundation. The shaft¹ was surmounted by a capital which has some resemblance to the

Columns

Doric capital, but is more rounding in form. Such columns are represented in several monuments of Mycenaean times, *e.g.* a wall painting from Cnossus and the relief over the Lions' Gate at Mycenae (see Fig. 18), while the semi-columns that once stood beside the entrance of the so-called Treasury or Tomb of Atreus at Mycenae are still so far preserved that

¹On some gems and paintings columns are represented, the shafts of which are smaller at the bottom than at the top. It is, however, doubtful whether this was usual. See J. Durm, *Jahreshefte d. Oesterr. Arch. Inst.* X, 1907, pp. 41 ff. The restoration of the semi-columns of the so-called Treasury of Atreus, (Fig. 22) and Fig. 21 should perhaps be corrected in this particular.

they can be completely restored (see Fig. 22). These are, however, the only stone columns of which any remains or traces exist. As a rule the columns in Mycenaean buildings were of wood, probably often protected at the bottom and adorned at the top with a sheathing of bronze.

Among the most remarkable remains of Mycenaean times are the chamber tombs. These are generally excavated in the earth or rock of a hill, and approached by a sloping passage (*dromos*). They are ordinarily of such moderate size that the hard earth or rock keeps its place without artificial support. Such tombs are merely excavated, not built. But in many

instances, either on account of the character of the soil or because a more magnificent tomb was desired, the subterranean chamber is entirely walled with stone. Such tombs are circular, and their walls converge in a curve to a point at the top. They are therefore called dome tombs, or beehive tombs. The courses of stone are not laid so as to converge toward a centre in the inside of the hollow space, but are horizontal, and the individual stones have horizontal upper and lower surfaces. The principle employed is that of the corbel arch, not of the key-stone arch, and the stones are

held in place by the pressure of earth heaped upon the outside. Some of these tombs, as that at Menidi, near Athens, and those at Dimini, in Thessaly, are built of small, rough, and irregular stones, while others are beautifully constructed of stones carefully cut and

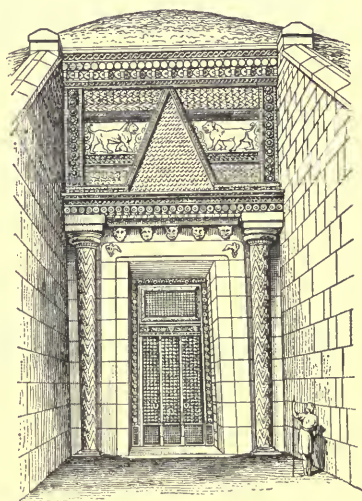

FIG. 22. — Entrance of the "Tomb of Atreus." Reconstruction by Charles Chipiez. (Perrot and Chipiez, Vol. VI, Pl. 6.)

Chamber
tombs

fitted together. The most perfect example is the so-called Treasury of Atreus, at Mycenae (Fig. 23), though the tomb beside it, excavated by Mrs. Schliemann, and the tomb at Orchomenus, in Boeotia, were originally hardly less magnificent. The entrance passage, or dromos, of the "Treasury of Atreus" is 6 metres wide and 35 metres long, walled on each side with well-laid masonry of

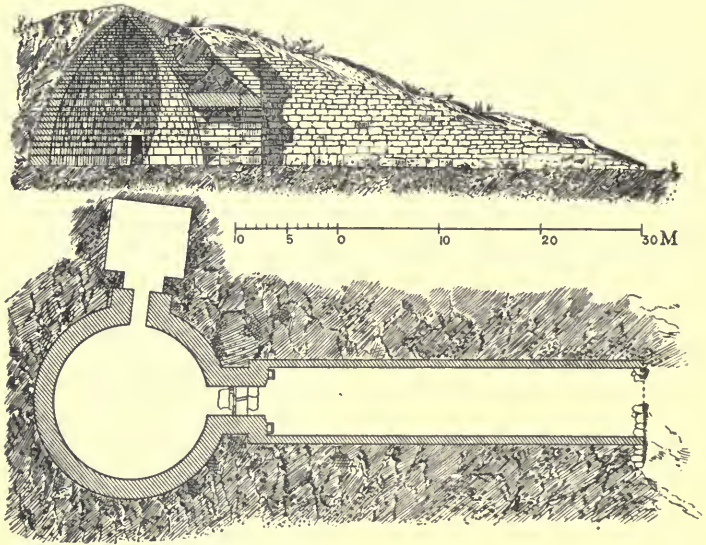

FIG. 23. — Section and plan of the "Tomb of Atreus." (Perrot and Chipiez, Vol. VI, Pl. 3.)

rectangular cut stones. The door is 5.40 metres high, 2.66 metres wide at the bottom, and 2.46 metres at the top. Above the door is an immense lintel, formed of two stones, the inner of which is 9 metres long, 5 metres wide, and 1 metre thick, and must weigh not far from 120 tons. The circular room measures about 15 metres in diameter at the bottom, and its height is about the same. Many small holes and remains of bronze nails show where ornaments, probably bronze rosettes and the like, were once attached to the

walls. To the right a small doorway leads into a rectangular chamber cut in the rock. The sides and top of this chamber are now rough and unadorned, but in the similar chamber of the tomb at Orchomenus the ceiling was formed of a great slab of slate completely covered with an elaborate carved pattern, and there are indications that the rough walls and top of the rectangular chamber of the "Treasury of Atreus" were once hidden by slabs of stone, probably adorned with carvings or paintings. In this chamber was, apparently, the real burial place, the large circular room being used for funeral and commemorative ceremonies. The entrance from the dromos to the great chamber was elaborate and magnificent. At each side stood a richly carved column, and the relieving triangle above the lintel was certainly filled with a carved slab of stone (cp. the Lions' Gate). There are sufficient traces of other ornamentation to make the reconstruction by M. Chipiez (Fig. 22) substantially certain in all essential points, though some details may be incorrect. Such a doorway cannot have been covered up immediately after the burial. On the contrary, the tomb must have continued to be visible and accessible. Undoubtedly, ceremonies in honor of the deceased were performed here by his, or their, descendants. In fact, this great tomb and others of the same kind were, without doubt, family tombs, which continued in use for years, probably for several generations. Most dome tombs are much smaller and less elaborate than this. They have no side chamber, but the dead were buried in the floor of the circular room or, in some cases, especially in Crete, were placed in terracotta sarcophagi. The entrances are unadorned and the masonry comparatively rude. All show, however, the same general qualities which are seen in their highest development in the "Treasury of Atreus."

The carving of the columns beside the entrance of the "Treasury of Atreus" suffices to prove that the processes of sculpture were not unknown to the Mycenaean workmen. There are, however, comparatively few extant examples of Mycenaean sculpture. Among the most widely known of these

are four stelae found by Dr. Schliemann above the shaft graves in the acropolis at Mycenae (see p. 70). These are all ornamented with patterns of curved lines, and three of them bear, in addition, scenes of battle or the chase. On the stele reproduced in Fig. 24, a warrior with a great sword at his side is driving his chariot toward an enemy, who holds his sword high in the air, but seems to be turned away from his assailant, perhaps intending to flee. Of the chariot only one wheel is represented, and there appears



FIG. 24.—Stele from Mycenae.
(Schuchhardt, *Schliemann's*,
Ausgrabungen, Fig. 146.)

to be only one horse, though there can be no doubt that the chariots were drawn by two horses. The second wheel, like the second horse, is supposed to be entirely hidden. Whether the broad, straight object extending from the charioteer's hand to the horse's head is a spear, or represents the reins, is uncertain. Apart from the clumsiness of the drawing, the most striking quality in the execution of this relief is its flatness. The figures are throughout of uniform thickness, as if they had been cut out of a thin sheet of stone and pasted upon the background. The date of

this stele cannot be much, if at all, earlier than that of the stucco reliefs from Cnossus (see p. 45), to which it is immeasurably inferior. Perhaps, however, some of the awkwardness of the design was originally modified by a thin coat of plaster, and there is no doubt that the relief was painted, even if no plaster was added before the paint was applied.

A later, and more famous, specimen of Mycenaean sculpture adorns the slab that fills the relieving triangle over the Lions' Gate. Here two lions (or lionesses, for the sex is not indicated) are seen standing one at each side of a column, which rests upon a high base of peculiar form, and upon this base the lions have placed

their fore feet. The heads of the lions are now wanting. They were made of separate pieces and fastened to the slab, no doubt in such a way that they faced those who approached the gateway. The column has a capital similar to the capitals of the columns beside the doorway of the "Treasury of Atreus," and above this are two flat horizontal projections, between which are four small circular disks. As the column must represent a real column, it is evident that the projections above represent an architrave, the ends of round beams above the architrave, and a second transverse beam above these. In Mycenaean worship columns served as symbols of deity, and in some cases such columns have beams over them, the deity being, perhaps, regarded as the "pillar of the house." It is natural, therefore, to regard the base of the column above the Lions' Gate as an altar, and the column itself as the sacred object of worship. Lions also seem to have been symbolic of deity. The relief is, then, a monument to the religious sentiments of those who set it up above the entrance to their citadel. In style and execution this relief is greatly superior to those on the gravestones found within the acropolis, and hardly, if at all, inferior to the best stucco reliefs of Cnossus. Part of its superiority to the gravestones may be due to the fact that it is made of much finer and better stone, and that it was not intended to be covered with a coat of plaster, but it is evidently the work of a more advanced artist. Its place above the gateway, in a relatively late wall, shows that it belongs to a comparatively late time in the history of Prehellenic Mycenae, certainly much later than the time of the stelae from within the acropolis.

Small examples of Mycenaean sculpture are comparatively numerous. Some of the clay figurines from Crete, which may be regarded as precursors of Mycenaean sculpture, have already



FIG. 25.—Bronze statuette. Berlin. (Perrot and Chipiez, Vol. VI, p. 754.)

been mentioned. A bronze statuette (Fig. 25), said to have been found in the Troad and now in Berlin, resembles the Cretan figurines in some respects, and may perhaps be actually a product of Cretan art, since it was probably not made in the Troad, but at any rate it is Mycenaean in its character, and



FIG. 26.—Ivory figure from Cnossus. Candia.
(*B.S.A.*, Vol. VIII, Pl. 3.)

belongs to the time of the Mycenaean civilization. The flounced skirt seen in this figure is a characteristic part of the Mycenaean woman's costume. The closely fitting bodice is also to be observed. Possibly the noticeably slender waist of this figure (a peculiarity even more pronounced in some other Mycenaean works) may be in some degree a natural characteristic of the race, for even the men represented in Mycenaean sculpture and painting have remarkably slender waists, but the lady of our statuette, as well as those represented by the Cretan figurines, must certainly have worn something like modern corsets. Evidently the costume of women in those days was elaborate and artificial. The male costume, on the other hand, was extremely simple, consisting for the most part of a mere loin cloth. This is seen on many monuments, among them a leaden figurine from Kampos, in Messenia. The workmanship of this statuette is by no means so good as that of

belongs to the time of the Mycenaean civilization. The flounced skirt seen in this figure is a characteristic part of the Mycenaean woman's costume. The closely fitting bodice is also to be observed. Possibly the noticeably slender waist of this figure (a peculiarity even more pronounced in some other Mycenaean works) may be in some degree a natural characteristic of the race, for even the men represented in Mycenaean sculpture and painting have remarkably slender

the bronze statuette of a woman, but even here there is life and action, in spite of some rudeness of execution. An ivory figure from Cnossus shows still greater liveliness, joined with exquisite workmanship. This figure (Fig. 26) was found in the palace at Cnossus with other objects that belong to the time before that in which Mycenaean vases prevail there, and it may therefore be regarded, perhaps, as a specimen of the art from which the Mycenaean artists learned their lessons rather than as an example of Mycenaean art itself. The ivory has suffered much from the ravages of time, but parts of it, especially the face, are so well preserved that the delicacy of the work is evident. The youth represented is clearly enough engaged in some athletic or acrobatic exercise, probably in a bull fight, since that seems to have been a favorite sport at Cnossus. Fragments of ivory adorned with reliefs have been found in tombs at Mycenae, Spata (in Attica), and elsewhere. The one reproduced in Figure 27 represents the head of a man wearing an elaborate helmet with a broad chin-strap. The hair above the forehead appears in the form of conventional curls, and at the back of the head, below the helmet, it seems to be straight and fastened with a band. All details are wrought with the greatest care. Other ivory reliefs represent animals, birds, and human beings.



FIG. 27. — Ivory head from Mycenae. Athens. (Perrot and Chipiez, Vol. VI, p. 811.)

In Crete not a few small reliefs carved in steatite have been found, several of which are interesting on account of their representations as well as their style, but the most interesting is a fragment of a black steatite vase, found at Hagia Triada. It was probably once plated with gold. Unfortunately the lower part of the vase has not been found, but the missing portion is certainly of less importance than that which is preserved to us, since what we have includes the heads and bodies of the persons represented (Fig. 28). The part of the relief

The Harvesters Vase

preserved is only about 6 centimetres ($2\frac{1}{2}$ inches) high, but the small scale of the work has not interfered with its admirable execution. The details of the costume, the headdresses, the loin cloths, the curious covering or cape worn by the long-haired person who seems to be the leader of the procession, the shield-like objects carried by three of the company, and the long, three-pronged forks



FIG. 28. — Steatite vase from Hagia Triada. (*Monumenti Antichi*, Vol. XIII, Pls. I and 3.)

carried by nearly all the others, are represented with the utmost conscientiousness and clearness. The doubts that have existed concerning the interpretation of the relief have been due, not to any ambiguity in the artist's expression, but to the fact that ancient utensils are not readily recognized by modern eyes. The long, three-pronged objects are not tridents intended to be used as weapons, but rather pitchforks, and the objects carried like shields, which are in form unlike any shields known in the Mycenaean period or

before it, are winnowing sieves or pans. The men are not warriors, but harvesters, and their mouths are opened, not to shout defiance or to raise the hymn of victory, but to sing the harvest song. The glad autumn festival of thanksgiving is represented, and the artist has been able to indicate something of the joyousness of the occasion by the attitudes and expressions of some, at least, of the participants. The religious character of the festival, and at the same time the influence of Egypt upon Crete, is shown by the sistrum held up by one of the men, perhaps a priest. This remarkable work, carved in Cretan steatite and found in Crete, is one of the finest known products of the Cretan art in the Mycenaean age.

Of all the monuments of the Mycenaean age, none are more remarkable than the objects of gold and silver, especially those of gold. At Troy, Dr. Schliemann discovered a deposit of gold **Gold and silver work** ornaments, the style of which indicates a date some centuries earlier than that of the similar objects found at Mycenae. These were probably not made at Troy, but imported, perhaps from Crete. At Mochlos, off the Cretan coast, Mr. Seager has found remarkably fine examples of early work in gold; but these must be passed over with merely brief mention in a rapid survey of the most important remains of the art of Prehellenic Greece. At Mycenae itself great deposits of goldsmith's work were found in six graves within the fortifications of the acropolis.

Only a few steps inside of the Lions' Gate is a large, nearly level circle surrounded by an enclosing wall, which consists of two concentric rings of upright slabs about one metre apart. The space between the rings, which is now for the most part empty, was originally filled with earth and small stones, over which horizontal slabs, supported on the mass below and also on beams, formed a flat covering. Some of these slabs are still in place. The two concentric rings, with the filling of earth and the covering of slabs, formed, then, a solid encircling wall about a metre thick and a metre to a metre and a half high. The entrance to the circular

space was from the direction of the Lions' Gate and was about two metres wide. The space itself is about 26.50 m. in diameter. The ground was evidently artificially levelled, for the eastern part of the encircling wall rests directly on the rock, while the western part is supported by a wall of "Cyclopean" masonry about 4 m. high. The purpose of this circular enclosure is not clear, but it had probably some religious significance, perhaps connected with the graves below. Some 8 ft. under the surface of the circle Dr. Schliemann came upon a round structure which he regarded with great probability as an altar, and at a further depth of 3 ft. reached the top of a grave, which was itself about 10 ft. deep.

Shaft graves at Mycenae Five other graves were found later, the last by Stamatakis, after Schliemann's excavations were finished. The graves vary in depth from 3 to 5 m. They are rectangular, the largest 6.75 by 5 m., the smallest 3 by 2.75 m. in size. All have vertical walls of small stones and clay, and originally they were covered with slabs of slate supported on beams that were laid across the open graves. The ends of some at least of these beams were protected by a covering of copper. The corpses, with their rich gold ornaments and other accessories, rested on a layer of small pebbles at the bottom of the graves. Above these graves stood the stelae already mentioned, three stelae with reliefs over grave V (as numbered by Stamatakis), and one over grave II, two plain stelae each over graves I and IV, and one over grave III. In grave I three women were buried, in grave II one man, in grave III three women and two children, in grave IV apparently three men and two women, in grave V three men, and in grave VI two men. The sculptured stelae stood only over the graves of men. Weapons were found in all the graves of men, but not in those of women. Gold objects were found in all the graves, but those in graves I, II, and VI were simpler than those in graves III, IV, and V. Moreover, in graves I, II, and VI, the proportion of gold and bronze was less, and the proportion of pottery greater than in III, IV, and V. Apparently the simpler and less expensive burials belong to a time later than the more splendid, and even in

those graves which contained several corpses the burials did not all take place at the same time.

In these graves were found about six hundred objects of gold, and though many of these are small, others are of great size and remarkable workmanship. Other materials of objects found in



FIG. 29. — Gold face mask from Mycenae. Athens. (Schuchhardt, *Schliemann's Ausgrabungen*, p. 257.)

the graves are silver, bronze or copper, amber, agate, glass, alabaster, stone, glazed porcelain, ivory, bone, wood, ostrich shells, boar's teeth, oyster shells, and terracotta. The weapons, rings, pins, bracelets, beads, kettles, cups, and vases are evidently such as were worn or used in life by the deceased and their contemporaries, but many of the gold objects are so thin that they must have been made expressly for the adornment of the dead. Certainly no other purpose could be served by the five golden face masks, three of which were

Classifica-
tion of con-
tents

found in grave IV and two in grave V. The gold, though thin, is too thick to have been shaped by pressing it over the actual



FIG. 30. — Gold ornament from Mycenae. (Photograph.)

features of the dead, and moreover, in the finest masks, notably **Face masks** one from grave IV (Fig. 29), details, such as eyebrows and mustache, are rendered by engraved lines, not in relief, as they would have been had the gold been pressed over the face. Evidently a hard core of wood or the like was em-



FIG. 31. — Gold ornaments from Mycenae. (Schuchhardt, *Schliemann's Ausgrabungen*, p. 206.)

ployed, but the difference between the masks makes it quite clear that all are portraits.

Eight sheets of gold about 0.45 to 0.60 m. (ca. 14 to 18 in.) in length, were found in such positions as to make it probable that they were used as ornaments of thin gold. They are adorned with linear patterns, round bosses, and dots (Fig. 30 from grave III), and the most elaborate of all, which has a crest made of small separate leaves of gold, is covered with a pattern of circles in which are small raised bosses and what look like daisies or many-rayed stars. Smaller sheets of gold, shaped somewhat like a leaf (or half a diadem), are decorated with designs like those of the diadems, with which they evidently formed sets or garnitures (Fig. 31 from grave III). Other large objects of thin gold are breastplates, if that is really the proper name for them, sword belts, and a remarkable lion's head, which is unfortunately much flattened and distorted. A bull's head of silver, wrought with wonderful skill (Fig. 32), was a rhyton, or drinking horn, probably for ritual purposes, as was also the golden lion's head just mentioned.



FIG. 32.— Silver bull's head from Mycenae. (Schuchhardt, *Schliemann's Ausgrabungen*, Fig. 248.)

The lesser objects of thin gold are, like most of the objects just described, intended purely for ornament, with the exception of sword belts and some disks and strips of gold, which once formed scales for weighing small commodities. Some of the ornaments consist of very thin sheets, cut into the form of laurel leaves and riveted together; many are disks adorned with conventional rep-

representations of shells, polyps, or butterflies, or with patterns of curves that look like coiled wire, (Figs. 34, 35, 36); and one (five specimens of which were found) represents an altar (Fig. 33). On



FIG. 33.



FIG. 34.



FIG. 35.



FIG. 36.

FIGS. 33-36. — Gold ornaments from Mycenae. (Photographs)

the sides of the altar are doves ; the sacred pillar, with the horns of consecration, is seen three times in the lower part, and on the top is a curious vessel or utensil, now known from discoveries

in Crete to have been used in Minoan and Mycenaean religious rites. Still other ornaments represent various birds and animals, others a nude female divinity with a dove or doves, and one (in two specimens) a seated figure clad in a flounced garment.

It is a generally accepted belief that the face masks were placed directly over the faces of the dead men, the diadems on the heads of the women, and the smaller thin gold ornaments were sewed upon clothing. There are, however, indications that the surface on which these objects were fastened was hard and flat, and it has been suggested that all the thin gold objects, as well as the silver bull's head, were fastened upon wooden coffins, which have decayed and left no traces.¹ Positive proof of either theory is perhaps hardly possible except by the discovery of other similar graves.

Of the eleven gold drinking vessels found in these graves several are simple cups with one handle, others have the same form with ornamentation of arches, lines, or rosettes, and **Cups and** still others have a stem like that of a goblet, the cup **vases** itself being in these instances of a wide and flaring shape. One cup, shaped like a tall goblet, has horizontal handles, upon which birds are sitting. From each handle a straight band of gold descends and is riveted to the outer rim of the disk at the foot, as if to strengthen the vessel. Something like this, though larger and more elaborate, was the cup of Nestor described in the *Iliad*, XI, 632-635. Another striking vessel is of silver, with a short stem. It is adorned with inlaid work of gold, a single design, representing a low flowerpot with a plant growing in it, being repeated three times on the side of the cup. A very striking vessel is a large alabaster vase, about 0.15 m. high, with three freely curving handles that rise above the rim.

Among the many precious objects found in grave IV, which is the largest and richest of all, are two gold rings with large bezels

¹ B. Staës, 'Eφ. Ἀρχ. 1907, pp. 32-60.

(about 0.044 m. long). On these bezels are remarkably fine examples of engraved work (intaglio). The first shows two men in a chariot drawn by galloping horses. One man apparently holds the reins, though these are not represented, while the other shoots an arrow at a stag that is bounding away and turning its head to look at its pursuers. On the second ring is a scene of battle. One man is sitting, doubtless wounded, on the ground, while before him a mighty warrior is about to slay an antagonist whom he has seized by the shoulder and forced to his knees. Still another combatant, armed with a spear and protected by a long shield, seems likely to decide the combat against the victor of the moment (Fig. 37).



FIG. 37. — Bezels of gold rings from Mycenae. (Schuchhardt, *Schliemann's Ausgrabungen*, p. 252.)

Some of the long bronze swords found in the graves are adorned with figures of running animals finely wrought in relief; but far more remarkable and elaborate are five dagger blades, the adornment of which is not wrought directly in the bronze of the blades themselves, but in separate plates inserted in the sides of the blades; two of these were found in grave IV. On one side of the first blade (Fig. 38) are five men fighting with a lion, while two other lions are running away, and on the other side a lion is pulling down a deer or gazelle and four more animals of the same kind are escaping. The figures are here not worked in relief, but are inlaid. They are of gold, for the most part yellow, but the lions' manes and the spots on the deer are of red gold, and the shields and scanty clothing of the men are almost as white as silver. Evidently the workmen

understood the use of various alloys and were excellent designers and extremely skilful metal-workers. On the second dagger are

three lions running one behind the other. Whereas the figures of the first dagger are inlaid, these lions were wrought in relief on the plate, which was afterwards inserted in the blade, and the relief was then covered with thin gold-leaf. The manes are colored red, and the lines on the legs and flanks of the lions are of lighter gold than the rest of their bodies. Three equally remarkable daggers were found in grave V. One of them has on each side two cats, or perhaps panthers, hunting four ducks among aquatic plants by a river. The colors are varied by the use of different alloys, as was the case on the blades previously described. On the second blade is a design of flowers, and on the third a spiral pattern. In this last, the plate set in the blade is of gold, and the design is made with enamel, by the niello process. Three or four rivets fastened the blades to the handles, which were of wood, and were in some cases, at least, covered with thin gold and adorned with rich linear patterns. At the end of the hilt was a large knob. When the hilt was of gold, the knob was also gold.

The terracotta vases found in these tombs exhibit two distinct



FIG. 38. — Inlaid dagger blade from Mycenae. (Schuchhardt, *Schiemann's Ausgrabungen*, p. 263.)

technical methods. Some are painted with dull dark color on the light buff or reddish ground of the clay, others in lustrous dark color. Those painted with dull color are decorated for the most part with horizontal bands and simple patterns of straight or curved lines, while the decoration of those painted with lustrous color consists chiefly of marine plants and animals. In graves I, II, and VI the two kinds of vases were found together, one vase from grave III has leaves among its linear patterns, and one from grave VI, though decorated almost entirely with linear patterns, has ivy leaves about its lower part. These two vases are painted with lustrous color. On one vase from grave VI, which is painted with dull color, various birds are represented, and on another from the same grave is a creature like a polyp with a head resembling that of a bird. It is evident therefore that the two systems, linear decoration in dull color and naturalistic decoration in lustrous color, were practised at the same time. Light decoration on a dark ground is seen on a larger water jar from grave V. Here bands and semicircles are painted in white on the reddish ground of the clay. In grave I two rude terracotta figurines of a style common at Mycenae and other places were found. The arms are raised so that they look like a crescent. The figurines are painted with red stripes on the buff ground, perhaps in rude imitation of drapery.

These graves and their contents are of great importance. The vast number of gold objects and their remarkable technical excellence show that at a time before the introduction of iron the inhabitants of Mycenae had attained a high degree of wealth and luxury. The civilization disclosed by all the graves is the same, but greater wealth and luxury is evident in graves III, IV, and V than in I, II, and VI. Probably there is a difference in date, but there is no reason to suppose that either group is more than a century or two earlier than the other. Which is the earlier it is hard to tell; but the terracotta figurines from grave I and the birds on the vase from grave VI resemble objects found elsewhere which are certainly later than

Vases

**Importance
of the
graves**

these shaft tombs. It is therefore probable that the simpler tombs are in this case the later, that there was, in other words, a period of decline at Mycenae between the first and the second group of burials. That this decline was only temporary is made evident by the splendor of the "Treasury of Atreus" and the importance of various other monuments which are clearly of later date than the shaft graves. For the shaft graves are evidently earlier than the circular wall above them, and this appears to be approximately contemporaneous with the Lions' Gate and the "Treasury of Atreus." The shaft graves, by their position and surroundings, give valuable information regarding the relative age of different products of Mycenaean art. They show, among other things, that the art of the goldsmith reached its highest development at an early date, before the latest development of Mycenaean pottery. It is possible that the gold objects found in the shaft graves may be imported, in which case there is little doubt that they came from Crete, the centre of civilization in the Aegean regions at this time (cp. p. 69).

Outside of the circle under which were the shaft graves, apparently in the ruins of a house, was found a hoard of golden vessels and other objects, among them four cups of graceful shape, with high foot and two handles. More important

than these is a gold ring with a large, flat bezel (0.035 m. or $1\frac{7}{16}$ in. long), on which is very finely engraved a strange scene, undoubtedly of religious significance, as is made evident by the symbol of the double axe in the centre and the sun and moon at the top (Fig. 39).

A second gold ring found in the same place has several bull's heads engraved in its bezel. In these rings, and others found elsewhere, the engraving is done by hand with a sharp tool. The rings were not intended for use as seals, for the figures are so en-



FIG. 39. — Gold ring from Mycenae. (Schuchhardt, *Schliemann's Ausgrabungen*, p. 313.)

graved that the representation as seen on the ring is correct, and is reversed in an impression.

Many fine specimens of Mycenaean metal work have been found in various places, — at Troy, in Crete, in Thessaly, and elsewhere, **Other works of metal** — though no inlaid work has been found to rival that of the dagger blades from Mycenae. Two gold cups, found at Vaphio, in Laconia, are of unusual beauty and interest (Fig. 40). On one of these the hunting of wild cattle is represented, on the other tame cattle appear. The figures are formed

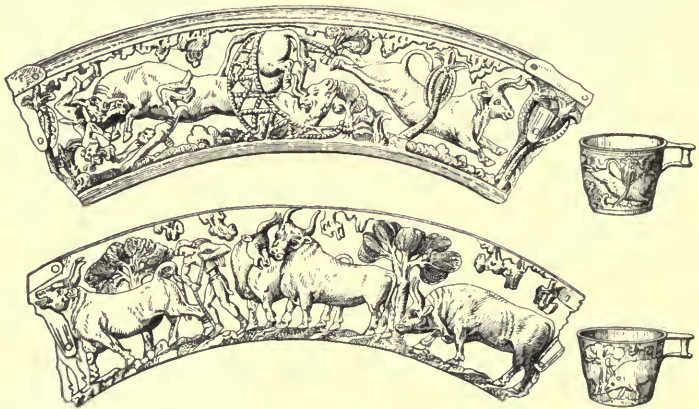

FIG. 40. — Gold cups from Vaphio. (Schuchhardt, *Schliemann's Excavations*.)

by the repoussé process, and the work is exceedingly skilful and delicate. The artist was also evidently a close observer of nature, though the attitudes of the cattle are animated and lively rather than correct. This is especially noticeable in the case of the galloping bull and in that of the bull caught in the net. Comparison with the steatite vase from Hagia Triada and with other works of undoubted Cretan origin makes it probable that these beautiful vases were also made in Crete. One further example of Mycenaean metal work which cannot be passed over is the fragment of a silver vessel, found at Mycenae, on which the siege of a city is

represented (Fig. 41). The fragment is interesting, not only as a specimen of pictorial sculpture on a small scale which is unparalleled in Greek art before the Hellenistic period, but also because it represents the bows, slings, and shields of the lightly clad Mycenaean warriors, and the masonry of the city wall, and the architectural form of the flat-roofed houses. Undoubtedly the perspective is faulty, especially

as regards the size of the women who are encouraging their protectors from the wall; nevertheless the whole scene is clearly represented, not the actual combat alone, but also its surroundings. Pictorial representations of this kind are met with in Assyrian reliefs, in late Greek and Roman works, and in the relief sculptures of the Renaissance and modern times, attaining their highest excellence, perhaps, in the bronze doors of the baptistery at Florence, by Ghiberti, but they are unknown in Greek art of the strictly classical period. A comparison with the reliefs of the so-called Nereid monument, from Xanthus, or with those of the monument at Gjölbäsch, shows the difference between the Mycenaean and the classical treatment of similar subjects. The Mycenaean artist brings before us the battle as it actually takes place, on uneven ground, over which the troops are scattered as occasion demands, without regard to artistic grouping; whereas the classical artist is confined by the conventions of his art, represents the attacking warriors all on one plane, and eliminates entirely the landscape background; only the walls and towers are represented, for without these the scene would not be understood. This remarkable little fragment illustrates



FIG. 41.—Silver fragment from Mycenae.
(*‘Eφ. Αρχ.* 1891, Pl. 2.)

the bronze doors of the baptistery at Florence, by Ghiberti, but they are unknown in Greek art of the strictly classical period. A comparison with the reliefs of the so-called Nereid monument, from Xanthus, or with those of the monument at Gjölbäsch, shows the difference between the Mycenaean and the classical treatment of similar subjects. The Mycenaean artist brings before us the battle as it actually takes place, on uneven ground, over which the troops are scattered as occasion demands, without regard to artistic grouping; whereas the classical artist is confined by the conventions of his art, represents the attacking warriors all on one plane, and eliminates entirely the landscape background; only the walls and towers are represented, for without these the scene would not be understood. This remarkable little fragment illustrates

admirably the naturalness and realism of Mycenaean art, and shows at the same time, both in its details and in its general conception, how greatly Mycenaean art differs in spirit from that of classical Greece.

Somewhat akin to the art of sculpture is that of gem cutting or seal engraving, which was much practised in the Mycenaean age. In the time of the twelfth Egyptian dynasty (2000 to 1788 B.C.), which is sometimes called the "Early Mycenaean" period, **Seals and** the material used by the gem engravers was soft, **Gems** usually steatite, and the designs were rude and engraved or bored by hand, as has already been said (p. 52). Work of this kind continued to be produced throughout the Mycenaean period, but such soft stones, engraved by hand, were wrought, in the time of developed Mycenaean art, only by inferior workmen for the use of poor customers, and differ from the contemporary works in hard stones chiefly by reason of their inferior workmanship and the choice of unimportant subjects. In the decay of Mycenaean civilization this style continued, whereas the better work, in hard stones, was no longer produced.

All the better gems of the developed Mycenaean period are wrought with the wheel in hard stones. The stones used are carnelian, chalcedony, agate, sardonyx, amethyst, crystal; also hematite, porphyry, serpentine, jasper, and, occasionally, basalt. They were probably produced at all the important places. The wheel, which enables the workmen to cut gems by means of hard sand on a revolving bit of moist wood, and also by means of a revolving drill, had long been in use in the East, and was doubtless merely introduced, not invented, by the Mycenaean artists. Gold rings were engraved by hand, since their material is not very hard. Some glass imitations of gems were made in the latter part of the Mycenaean period, but those that are known are for the most part ill preserved.

The best engravings are cut in the bezels of finger rings, chiefly gold, one of the most remarkable of which has been described above (p. 76; see also p. 79). These rings are too

small for even the little finger of a man, and must therefore have been intended for women, or to be worn on a chain or cord. Some rings entirely of stone have been found, but metal rings with stones set in them are nearly, or quite, unknown. The engraved stones¹ regularly have the form of flat beads. They have a hole bored through them in the direction of their greatest dimension, and were worn, with other beads, strung on chains for the neck or arm. Apparently, then, they were amulets or mere ornaments, rather than seals, even though at some times and places their use as seals may have been in vogue. The stones were most frequently circular, with the design cut only on one side, or elliptical (lentoid), or they have somewhat the form of a cylinder thicker at the middle than at the ends. Stones of this last shape are perforated lengthwise. Some stones are rectangular, with rounded corners, and occasionally other forms occur. Stones of these common shapes were in use in early times in Babylonia, Egypt, and Syria, but are usually of poor quality and not finely wrought. They were probably used in those countries, not as seals, but merely as amulets, and it is doubtless from those countries that their use was adopted by the Prehellenic inhabitants of Greece. The cylinder, which was the form of the oriental seal, the scarab, and the scaraboid, were not adopted.

The designs of most Mycenaean gems represent animals. Among these, lions and horned cattle occur most frequently, and show the best workmanship, but deer and wild goats are not uncommon. The lion is evidently not merely borrowed from the art of other peoples, but studied from life, — a fact that seems to indicate a real acquaintance, not merely casual intercourse, with northern Africa on the part of the people among whom the gems were made, unless lions existed in Greece in those days.

Other gems bear religious representations. A draped goddess appears both seated and standing. She has various attributes, and has been interpreted as Artemis, Aphrodite, and Demeter.

¹ Mycenaean engraved stones, or gems, were formerly called *Inselsteine*. "island stones," as most of them were found on the islands.

A nude goddess appears but rarely, and then only through Oriental influence. When the goddess stands between two lions, she is naturally interpreted as Rhea. The small armed idol in the upper left-hand part of the engraving on the gold ring from Mycenae (p. 79) is perhaps a Palladium, or primitive representation of the goddess known in historical times as Athena. A male deity also appears, sometimes leading a griffin, sometimes standing between two partly human creatures (demons), and once between two lions. It is natural to identify him, at least in some of these cases, with the supreme god, the later Zeus. Another, lower, order of beings combines the forms of men and beasts. They have usually the form of a man with the head of a beast, most frequently that of a lion. They seem to be spirits or demons of the chase, and are often represented with the skin of a beast, perhaps a bull, thrown over them. Some other combinations of human and animal forms also occur.

The sphinx, both winged and without wings, occurs rarely in Mycenaean art, less rarely on glass and gold than on gems. The griffin is not uncommon on gems, and sometimes two griffins are placed opposite each other in heraldic fashion. The griffin, a combination of lion and eagle, was borrowed from the East, but its form was further developed by Mycenaean art; whether the same is true of the sphinx, the combination of lion and man, is as yet uncertain, as its occurrence in Egypt or elsewhere before the Mycenaean period is not established. Various representations pertaining to the cult of the gods occur, such as altars, altar tables, sacred enclosures, and columns. There are some scenes of male worship, but representations of female worship, among which that of the gold ring (Fig. 39) is the most remarkable, are more numerous. Hunting scenes, especially bull hunts, and scenes of war are not uncommon, and one or two other scenes of common life are known.

The style of Mycenaean gems is in general picturesque rather than sculptural. There is great freedom of motion, and more attention is paid to scenery and other accessories than in classical

Greek art. Exactness and accuracy are less sought after than liveliness and expression. There is little evidence of study of the osseous structure of men and animals ; on the contrary, the more obvious and external elements of the form, such as the muscles and the female breasts, are unduly emphasized.

The space at the disposal of the artist is, as a rule, well filled, though not always without detriment to the beauty of the design. The foreshortening and perspective are poor. Nevertheless, the freshness and vigor of the design, the originality of conception, and in many instances the fine technical execution, are such as to give the gems a place among the most interesting products of Mycenaean art. Nowhere more clearly than in the gems is the nature of Mycenaean art made manifest (Fig. 42). The artists who designed them received many incentives and much inspiration from Oriental art, but they were not content to imitate. What they received from the East they adapted and transformed, as did the Greeks of the historical period. In this respect the Mycenaean artists are the precursors of the great masters of Hellenic Greece, however much their works may differ in form and spirit from the products of the later art.

Mycenaean vases fall into two main divisions, (1) those decorated with dull (*matt*) color, and (2) those decorated with lustrous varnish (*Firnis*). They are alike in one respect, that they are (with the exceptions mentioned below) decorated with dark color on a light ground, and their decorations are virtually monochrome. This separates them from the polychrome Kamáres ware, as well as from the various wares the ground color of which is



FIG. 42. — Mycenaean gems. (Furtwängler, *Antike Gemmen*, Pl. II, 32, 24, 'Eφ. 'Αρχ. 1888, Pl. X, 2, 3.)

dark. They are also alike in their general tendency to rotund, full forms.¹

¹ Furtwängler and Loeschcke, *Mykenische Vasen*, 1886, divided Mycenaean vases into two divisions: vases with dull painting (*Matmalerei*) and vases with glaze varnish painting (*Firnissmalerei*). Within the first division they recognized two groups: (I, *a*) vases of red clay, a polished surface, sometimes yellowish or greenish, and ornaments in red or purplish brown, with occasionally some white, and (I, *b*) vases of light clay, with unpolished surface, and ornaments in purplish brown. Some of the coarser vases of this group are hand made; all the others are made on the wheel. The second division forms four classes. All are made on the wheel. In class I the clay is coarse, and the entire vase is covered with a slightly lustrous glaze, on which the ornaments, almost exclusively floral, are painted in dull white and dark red. In class II the clay is coarse, but covered with a coating or slip of fine clay, which forms a whitish or yellowish brown surface. On this the ornament, of geometrical or floral patterns, is painted with lustrous dark brown color. Occasionally some white is added. In class III the clay is fine and well levigated; the surface, of a warm yellowish color, is lustrous and smooth. The decoration, which consists chiefly of marine plants and animals, is painted in lustrous color, varying from yellow to brownish black. Occasionally white is added. In class IV the surface is greenish or dull yellow, sometimes yellowish red, and usually dull, not lustrous. The lustrous color of the ornament is black or yellowish brown, sometimes burnt red. The color is less lustrous than in class III. Large figures of quadrupeds and human beings occur. Furtwängler and Loeschcke regarded the first division as earlier than the second. In the latter they regarded classes I and II as contemporary and earlier than class III, which was followed by class IV. Class I is now seen to consist of vases made in Crete (which, when found at Mycenae, are imported), and the same is probably true of most specimens of class II. Furtwängler and Loeschcke recognized that the vases with dull color were made in many places, but thought the invention of glaze or lustrous color was due to the people of Mycenae, and that the pottery with decoration in such color was made at Mycenae. The lustrous color has, however, elsewhere (see below, p. 87) been found on vases much earlier than many of those painted with dull color; the lustrous color cannot, therefore, be a Mycenaean invention. Moreover, pottery with lustrous decoration has been found at many places, and local varieties of shapes and decoration are observed, showing that Mycenae was by no means the only place of manufacture. The term "Mycenaean," as applied to pottery, is now sometimes limited to classes III and IV, which were produced when Mycenae was at the height of its power, and to ware which

When executed in dull color, the decoration consists of lines, generally curved, plants, and occasionally animals. In general, it resembles that of the vases from Thera (p. 51 f.), and, as a whole, the vases with decoration in dull color are earlier than those decorated with lustrous varnish, though the two classes have sometimes been found together. In Crete and some of the islands the lustrous varnish appears before the Mycenaean period, earlier, in fact, than the monochrome decoration in dull color, but in continental Greece, Aegina, and some of the other islands the dull color is earlier, and the lustrous varnish does not appear until Mycenaean times. This seems to indicate that the lustrous varnish, which is the distinguishing peculiarity of Greek vases, and which modern imitators have not been able to produce, was

closely resembles these. Classes I and II may then be classed as "Protomycenaean."

Some of the conclusions reached by Furtwängler and Loeschcke have been modified by later discoveries; but their classification is so generally known that it is employed by most writers on Mycenaean pottery. Two other classifications of the vases with lustrous paint, based on the style, rather than the technique, of the decorations, have been proposed by P. Wolters and by J. C. Hoppin (*The Argive Heraeum*, Vol. II, pp. 74 ff.). According to both of these, class I remains the same as in the classification of Furtwängler and Loeschcke. Class II also remains the same, but the fact that the style of the paintings is naturalistic, not conventional, is emphasized. Hoppin divides class II into subdivisions 1 and 2, and puts in 2, on account of their naturalistic or pictorial style, some vases included by the others in class III. Class III, according to Wolters, consists of two subdivisions, the first of which differs from class II only in its more delicate execution (these are the vases of Hoppin's class II, 2), while in III, 2 the greatest technical excellence is associated with conventionalized design. Hoppin also makes two subdivisions of class III, his III, 1 being the same as Wolters's III, 2, while III, 2 consists of vases with extremely conventionalized ornamentation and of inferior technical execution. Hoppin's III, 2 is the same as Wolters's IV, 1, and class IV, according to Hoppin, is the same as class IV, 2, according to Wolters, and class IV, according to Furtwängler and Loeschcke.

The most common kinds of Mycenaean vases are those of Furtwängler and Loeschcke, class III (Hoppin, class III, 2; Wolters, class IV, 1), and Furtwängler and Loeschcke, class IV (Hoppin, class IV; Wolters, class IV, 2)

invented in Crete. Its use, however, spread to all parts of the Greek world in Mycenaean times, and the characteristic Mycenaean vases are those decorated with lustrous varnish.¹

The better Mycenaean vases are made of fine clay, with an even and brilliant polished surface, which has in the best period a yellow color. Toward the end of the Mycenaean epoch the surface of the vases becomes gray or reddish, and its polish is less brilliant. The vases exhibit great variety of form, and more than one hundred different shapes may be distinguished. One of the most characteristic and widely distributed shapes is the false amphora (*Bügelkanne*), a jar with two handles, which meet over the projecting neck, where one might naturally expect to find the mouth, while the real mouth is formed by a small upright spout. Vases of this shape are usually simply decorated with lines. Another popular, and very graceful, shape is a rather flat two-handled goblet with a high stem. Vases of this shape are regularly decorated with rings on the foot and stem and a conventionalized cuttlefish on each side of the bowl (Fig. 43). Funnel-shaped vases are common, and are usually decorated with murex shells. Other favorite shapes are: a beaked jug (*Schnabelkanne*); a low, small jar or pyxis with three small handles; and a three-handled pear-shaped vessel on a high stem.

Linear decoration is common on vases throughout the Mycenaean epoch, but rectilinear designs are generally avoided, the linear decoration consisting either of parallel lines running horizontally about the entire vase or of curvilinear patterns, such as circles and spirals. But the most characteristic Mycenaean designs are derived from nature, especially from marine plants and

¹ Some of the earliest vases with lustrous varnish differ from the rest in being covered entirely with the black varnish, on which the decoration is applied in white or reddish brown. These are in so far not properly Mycenaean as they seem, at least when found in continental Greece, to be imported from Crete (see p. 48), and this may also be true of vases decorated in this manner which have been found in Cyprus; but at any rate, some of them belong to the early part of the Mycenaean epoch, the time of the shaft graves at Mycenae.

animals. The cuttlefish, murex, nautilus, and several kinds of seaweed are represented in a very lively and naturalistic manner. These naturalistic designs become, however, more and more conventionalized, and the long tentacles of the cuttlefish develop into a pattern of elongated spirals. This is especially noticeable on some terracotta burial chests decorated in Mycenaean style, which have been found in Crete. Birds, especially sea-birds, and occasionally human figures, also occur on vases of the best period, and on the later Mycenaean vases quadrupeds and human figures are not very uncommon. The most important representation of



FIG. 43. — Mycenaean vases. (Furtwängler and Loeschke, *Mykenische Vasen*, Pl. II, 10, Pl. XIII, 81A, Pl. XVIII, 130.)

human figures is on the so-called Warrior Vase, which was found among the remains of houses outside of the circle under which were the shaft graves (Fig. 44). Here, on one side of the vase, six warriors, with helmets, shields, and lances, are marching away to the right, while a woman stands and looks after them; on the other side, a scene of combat is represented. The crudities of execution of this painting are evident, but the liveliness of the representation, and the careful observation, especially in details of costume, are no less apparent. This painting represents two scenes such as were familiar to the painter and his patrons, probably merely typical scenes, with no historical significance, though it is, perhaps, possible that the person for whom the vase

was painted was himself a warrior and wished the decoration of the vase to bear some relation to his own exploits. In this case, the painting might be said to represent particular individuals, rather than general types. But it is hardly possible to attach to it any mythological significance. If it is not intended to represent warriors in general, it doubtless represents the person for whom



FIG. 44.—Warrior vase from Mycenae. (Schuchhardt, *Schliemann's Ausgrabungen*, Fig. 284.)

it was painted and his comrades. Mythological and religious subjects are conspicuously absent from Mycenaean vase paintings, though doubtless some of the patterns that occur, such as the double axe, have religious significance. In general, the decoration becomes less careful toward the end of the Mycenaean epoch. An additional sign of late date, occurring in some vases, is the painting of the inside.

On some of the fine Mycenaean vases, the black or dark brown varnish has turned to red in the firing. This is probably intentional, and certainly the effect is excellent. The wall paintings at Cnossus and the less striking remains of paintings found at Tiryns, Phaestus, and even at Mycenae show that painting in various colors was widely and skilfully practised in Greek lands in the Mycenaean age, and if the characteristic Mycenaean vases are virtually monochrome, the reason is probably a technical one. The brilliant varnish, capable of withstanding the heat of the firing

of the pottery, could not be produced in various colors; otherwise the vases would probably show as much variety of color as do the frescoes. But a certain degree of variety was produced in some cases by firing the pottery at such a heat as to cause the varnish to shade from brownish black to red.

For the comparative monotony in coloring, however, ample compensation is offered by the immense variety of shapes and designs. The qualities of liveliness and imagination, which have been observed in the frescoes of Cnossus, the gold cups from Vaphio, the steatite vase from Hagia Triada, and some of the Mycenaean gems are present also in the decoration of Mycenaean vases. The designers of these vases were doubtless not the great artists of their times, but they were nevertheless real artists in their humble sphere, and their works serve to give us an exalted opinion of the artistic qualities inherent in their race.

The brilliant varnish characteristic of Mycenaean pottery appears to have been invented in Crete; but the great majority of Mycenaean vases cannot be of Cretan manufacture, for the power of Crete was fallen, or at least greatly diminished, before Mycenaean vase painting attained its fullest development and its widest diffusion. Mycenaean vases have been found in great quantities at Mycenae, Tiryns, and other places in the Argolid, at numerous sites in Cyprus, in Rhodes, especially at Ialysus, in Attica, Boeotia, Thessaly, and other parts of continental Greece, in many of the Greek islands, at Troy, in Egypt, in Sicily, and elsewhere. Certain large vases of the crater form, on which human figures are unusually frequent, have been found only in Cyprus, and are therefore probably of Cypriote manufacture. Other local peculiarities may perhaps be distinguished in other places. It is certain that Mycenaean vases were made at various places, and it is probable that their manufacture was carried on at all the chief centres of population and of trade. The vases found in the less important places, and those found in outlying regions, as in Egypt or at Troy, were probably imported from some centre of production, such as Crete in the earlier and Mycenae in the later part of the

long Mycenaean age. The great similarity of the products of different places, which have been found in so many widely separated localities, testifies eloquently to the wide diffusion of a substantially homogeneous civilization.

The ethnological problems connected with the study of the Mycenaean age and the preceding periods cannot be discussed here. It is, however, made very probable by the study of the monuments and of the Homeric poems that the Achaean heroes of the Trojan War are identical with the rulers whose wealth, power, and culture are attested by the fortifications, golden treasures, and works of art of the Mycenaean age.

No exact dates can be given for any events or monuments during the long period of which this chapter treats; but in a general way the chronological sequence is established. The fact that objects of Egyptian origin are found in the Aegean regions, and that objects from those regions have come to light in Egypt, while Egyptian paintings evidently represent people and things from the "islands of the sea," makes it possible to determine the chronological relations between Egyptian civilization and that of Greece and Greek lands. Since Egyptian chronology is more or less accurately known, approximate dates can be assigned to the various parts of the long period that intervenes between the neolithic age and the end of the Mycenaean civilization. As for the neolithic age, no exact date can be assigned to its end, and indeed it may have lasted for some time, even for several centuries, longer in some places than in others; and since its duration is unknown, not even an approximate date can as yet be given for its beginning. But in the stratum immediately above the neolithic remains at Cnossus primitive black pottery was found which is closely connected with vases of foreign origin found in tombs of the first Egyptian dynasty at Abydos, in Egypt; two stone vessels of Egyptian material and belonging to the earliest dynasties were also found at Cnossus, and some Cretan stone vases and engraved stones show the influence of Egyptian work of the same period. At Cnossus, then, the neolithic age appar-

ently came to an end before the beginning of the first Egyptian dynasty, the date of which is now generally believed to be 3400 B.C., though some Egyptologists still prefer a date several centuries earlier. In some parts of the Greek world the neolithic age may have lasted longer than at Cnossus, but the date suggested may be regarded as a rough approximation, and may, as such, be extended to apply to the whole Aegean region.

To the times of the first dynasties in Egypt belong the objects just mentioned, found at Cnossus, as well as vases of local manufacture, of dark or light clay, polished by hand and adorned with geometrical ornaments in white or brown. Similar primitive vases from the Cyclades and other places belong apparently to the same period, from about 3400 to 3000 B.C. The same class of vases, with more developed ornamentation, continued to be made in the following centuries, perhaps until about 2600 B.C. During this period seals with decorations of spiral lines appear in Crete, and the black (bucchero) pottery is decorated with incised lines. Idols of marble and ivory are made in Crete at this time, and the earliest idols and incised pottery of the Cyclades apparently belong to the same or the previous period. The first city at Phylakopi may be dated about 3000 B.C. and later.

The development of art and manufactures in the Aegean regions seems to have continued without striking changes or interruptions throughout the period of the Old Kingdom in Egypt (to about 2500 B.C.); geometric ornament became more regular and elaborate, the "Cycladic" civilization developed, apparently influencing Crete to some extent, while in Crete itself primitive pictographic signs appear on engraved stones, and vases with polychrome ornamentation make their appearance, though perhaps not until some time after the end of the Old Kingdom. At any rate, it is not until the times of the Middle Kingdom, about 2000 B.C., that the "Kamáres" vases, with their developed polychromy, become general in Crete. Such vases have been found at Kahun L in Egypt under circumstances which fix their date in the time of Useratesen II, 1906 to 1887 B.C. The beginnings of the palaces

at Cnossus and Phaestus are probably to be placed at least as early as the beginning of the Middle Kingdom (2160 B.C.). To about the same period belongs the second city at Phylakopi, and it is evident that the trade relations of the Greek islands were already of considerable importance. The palace at Cnossus seems to have been in whole or in part destroyed not far from 1800 B.C. After this the palace was rebuilt, and some of the frescoes from Cnossus date from the succeeding years. The polychrome Kamáres pottery is gradually succeeded by the pottery with naturalistic decoration, usually white on a dark ground, and naturalistic designs become general in Crete, not only on vases, but also on reliefs and on seals or gems, which are now made of hard stones. Fine statuettes of glazed terracotta were found among the remains at Cnossus belonging to this period, which is approximately dated by a monument of the XIII dynasty later than 1800 B.C. The vases from Thera, with plant forms painted in lustreless dark paint also belong to this time, which may be regarded as continuing until 1600 B.C. or slightly later.

After this the system of decoration of pottery at Cnossus changes, and the designs, sometimes very naturalistic, are painted in dark "Mycenaean" varnish on a light ground; the palace at Cnossus is remodelled and richly decorated; the palace at Hagia Triada is built; and the pictographic Cretan script, which had already begun to yield to the linear script, is definitively superseded. Then follows the further remodelling of the palace at Cnossus, and at last its destruction. In Egyptian tombs of the XVIII dynasty (about 1500 to 1450 B.C.) representations of Cretan, or at least of island, men and manufactures are seen. The objects found in the shaft graves at Mycenae belong for the most part to this time, roughly speaking, on the basis of the Egyptian chronology, the fifteenth century B.C. This is also the time of the third city at Phylakopi. From this time on, the naturalistic decoration of vases becomes more and more conventional. The Mycenaean civilization is more widely spread than ever before. It is in this latest period that the great dome tombs at Mycenae, Orchomenus, and elsewhere were built, and

toward the end of the period the palace at Cnossus was partially re-occupied. Products of Mycenaean art are found in various places associated with Egyptian objects produced as late as the XXI dynasty (1090-945 B.C.), and possibly somewhat later, but the end of Mycenaean civilization is evidently reached about 900 B.C.¹

At the end of the Mycenaean age new movements of population took place. New tribes, chief among which were the Dorians, entered Greece; the ancient inhabitants were displaced or subjected, the practice of the arts declined, and Greece relapsed into a state that must have been little better than semi-barbarous. After a period of two or three centuries the arts were revived with much of the old spirit, but with new and different ideals. This dark period, which has aptly been termed the Greek Middle Ages, is the time of germination, after which follows the vigorous and wonderful growth of classical Greek art and civilization. The scanty remains of the primitive art of this period, containing as they do the promise of future development, are best discussed in connection with the various forms of art in the later periods.

¹ The chronological sketch given above is based upon the chronology of Prehellenic Crete as established by Dr. A. J. Evans, but the actual dates given are, especially in the earlier parts, later than those which Dr. Evans proposes, because Dr. Evans follows, with modifications, the traditional system of Egyptian chronology, and the dates here given are in accordance with the chronology resulting from the investigations of Eduard Meyer and others, which has been adopted by Professor Breasted in his *History of Egypt*. Dr. Evans divides the history of Prehellenic Crete into three main periods, Early Minoan, Middle Minoan, and Late Minoan, each of which contains three subdivisions, Early Minoan, I, II, and III, etc. The Early Minoan period comprises the first centuries after the neolithic age; the Middle Minoan period the time from the appearance of polychrome vases in Crete to the virtual abandonment of decoration in light color on a dark ground; and the Late Minoan period the time after the general adoption of decoration in dark varnish on a light ground. The Late Minoan period is practically identical with the Mycenaean period.

CHAPTER II

ARCHITECTURE

BUILDING MATERIALS AND METHODS

CONCERNING Greek building materials and methods of construction, little information is derived from ancient literature, but the study of the so-called building inscriptions and of the actual remains of buildings serves to make our knowledge of the subject nearly complete. The building inscriptions (about twenty in number) are either records of expenses incurred in the course of erection, such as the inscriptions relating to the Erechtheum at Athens, or contracts and specifications, like the inscription which describes in detail the proposed construction of the arsenal of Philo at Piraeus. The actual remains of buildings are found in all parts of the Hellenic world.

At Athens¹ and in its neighborhood the Greeks had a variety of building stones to choose from. The upper stratum of the Acropolis consisted of a hard limestone, ranging in color from pink to blue, which was employed in building the Pelasgic walls about the Acropolis and the foundations of the old temple of Athena. Kará stone, a hard limestone of good weathering qualities and capable of receiving a good polish, was used for the steps of the old temple of Athena. At Piraeus a fossiliferous limestone was quarried, which was generally used for foundations; when used elsewhere it was given a coating of stucco. This is the stone usually called "poros" by modern writers. A

¹ The building stones of other regions differed little from those in use at Athens, though in many places the variety of available stones was less, and in some places, *e.g.* Olympia, Sicily, and Magna Graecia, marble was less easily obtained and therefore less freely used.

conglomerate was also occasionally employed, but always in unexposed places. Marble was not used extensively until the fifth century B.C., and veneering is characteristic of the latest periods.¹

The island of Paros seems to have been the first place to produce marble in any great quantity, and on the Greek mainland Attica was the only region where this material was really abundant. At Athens it was little used for building purposes until the latter part of the sixth century, and was at first employed only for roof tiles, simas, and sculptures, **Marble** where delicate carving was required. The quarries of Mt. Pentelicus were opened at about this time, but Parian marble still continued to be found in the Athenian market. At Olympia the use of marble was nearly limited to parts of the Echo Hall, the Philippeum, the roof and the sculptures of the temple of Zeus, and the veneer of the Exedra of Herodes Atticus. At Delphi, which was in closer communication with districts in which marble was found, this material was more freely employed. Examples of its use there in early times are parts of the temple of Apollo erected in the sixth century and the "treasuries" of the Cnidians and the Athenians. When a coarse stone was used in exposed places, it was almost always covered with a coat of fine stucco carefully smoothed.

Rubble construction laid with clay as a mortar is often found in combination with stonework. Lime mortar as a building material did not come into use until Roman times. Sun-dried **Brick** brick was used where there was a stiff clay and stone was scarce, and even, on account of its cheapness, in places where stone was plentiful, as at Corinth. It was used for the walls of private houses, the upper courses of circuit walls, and sometimes for temple walls. The bricks were laid upon a course of stone work to guard against the danger of disintegration from moisture and injury from wanton or careless passers-by. As

¹ As an exception to this rule, the veneering of marble used to hide the Pelagic stonework of the earlier Propylaea on the Acropolis at Athens may be cited.

examples, the walls of the Dipylon at Athens and of the Heraeum at Olympia may be cited. Burnt brick was unknown until Roman times. As for wood, the Greek builder could choose among many varieties, the most important of which were lotus wood, pine, fir, oak, and ash. Attica imported wood from Thessaly and the islands. The timbers were generally heavier than those now in use, owing to the fact that the weight of a roof with marble tiles was immense, and moreover we find that the timbers were often laid flat instead of on edge.

The quarries on Mt. Pentelicus, at Syracuse, Paros, and Campobello near Selinus give a good idea of the method by which stones were loosened from their native beds. The quarries, as a whole, were worked in a series of steps. To remove a block, a vertical cut was sunk at its back; two other cuts were sunk at right angles to the first and at the ends of the block to be removed; then the block was loosened underneath by driving holes along horizontally, in which wedges of metal or of wood were inserted. If wedges of metal were used, they were struck with a sledge hammer until the block was loosened, and if the wedges were of wood, water was run in about them, causing them to swell and loosen the block.

From the quarries on Mt. Pentelicus to the plain, a chute paved with marble was constructed, along which, at intervals, there are still to be seen square cuttings sunk in the native rock, to which ropes were fastened for lowering the stones gently down the slope.

Moving stones Wagon ruts are plainly visible in certain quarries, and a sort of cart or drag was probably used in transporting light stones. For heavy stones, rollers were employed, as in modern times, and the stones were given a forward motion by means of crowbars. In some cases, we find cuttings for the crowbars, and in other cases projecting bosses, against which the crowbars were worked, were left on the stones. Drums and shafts of columns¹ were sometimes rolled by arranging temporary axles at

¹ Architrave blocks were occasionally moved like shafts by putting hoops of wood about them and rolling them (Fig. 45).

the ends, by which they were dragged along like rollers. For example, at Selinus, in Sicily, some of the ends of the shafts

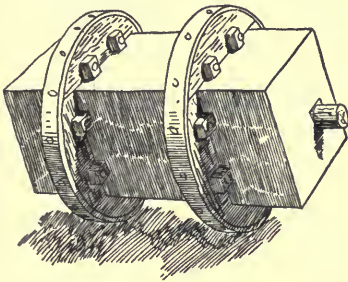

FIG. 45. — Method of moving stones. (Koldewey and Puchstein, *Griechische Tempel, etc.*, Fig. 98.)

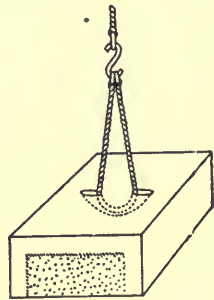

FIG. 46. — Method of hoisting. (*Olympia, Text, Vol. II, Fig. 20.*)

show two sets of cuttings, both at the centre. One of these, generally oblong, was used in rolling the shafts; the other set is square and was used in securing a good bed for the shaft when it was set in place (see p. 107 f. below).

The earliest method of hoisting stones was probably by means of inclined planes, but the derrick, with ropes and tackles, was used in the classical period. A Roman relief in the Museum of the Lateran shows such a complicated system of pulleys

Hoisting

as to justify the assumption that the Greeks understood the use of pulleys, at least in a simpler form. Various cuttings for ropes are

to be found at Olympia, Aegina, in Sicily, and in the old temple of Athena at Athens. There

are three principal types: a loop cut in the middle of the stone (Fig. 46), grooves cut in the end of the stone (Fig. 47), and a groove cut around the stone (Fig. 48).

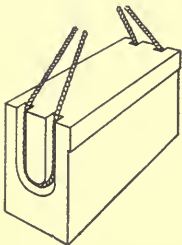

FIG. 47. — Method of hoisting. (Drawing by G.P.S.)

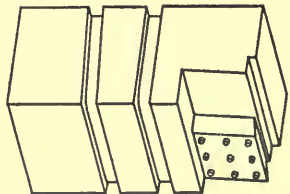

FIG. 48. — Rope cuttings around stone. (Drawing by G.P.S.)

In a variation of the second type hooks were used, which caught on short crossbars (Fig. 49). These cuttings were confined, as a

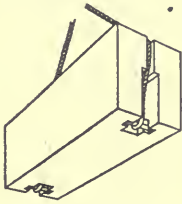

FIG. 49. — Method of hoisting. (G.P.S. after Koldewey and Puchstein.)

rule, to soft stones, for this method of hoisting was discontinued when the use of marble was introduced, and the harder stone permitted the employment of lifting-tongs and the lewis.¹

Projecting bosses were sometimes left on the stones for lifting-tongs to catch under.² Square cuttings on the under surfaces

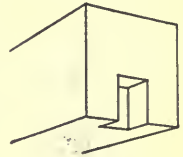

FIG. 50. — Tong cutting. (G.P.S. after Koldewey and Puchstein.)

of the stones, at the edges, for the use of lifting-tongs, are often seen (Fig. 50), and tong cuttings sometimes occur in the ends,

near the top (Fig. 51), or in the upper surface (Fig. 52).

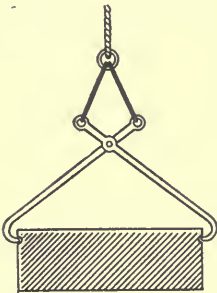

FIG. 51. — Lifting-tongs. (*Olympia*, Text, Vol. II, Fig. 20.)

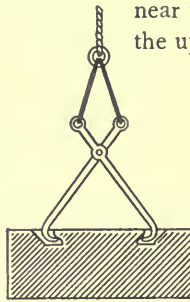

FIG. 52. — Lifting-tongs. (Drawing by G.P.S.)

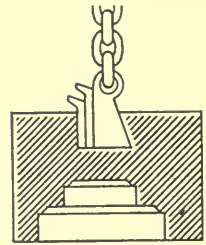

FIG. 53. — Greek lewis. (Clarke, *Assos*, II, Fig. 25.)

These last were employed in dropping the final stone of a course into place. The lewis was used constantly in hoisting hard stones, the Greek lewis holes being undercut at one end only (Fig. 53),

¹ Cuttings for lifting-tongs and lewis are occasionally found in soft stones; but the cuttings had to be so large, to prevent the stones from breaking, that their use was soon discontinued.

² These bosses are generally too small and too imperfectly shaped for ropes to catch hold of.

not like those of Roman and modern times (Fig. 54), at both ends. Both rope cuttings and lewises were so placed as to bring at first only the edge of the stone in contact with the bed, so that an easy and true adjustment of the stone could be made.

The tools used in dressing the blocks differed little from those in use to-day.

Tools

The evidence for this is derived from a careful study of the stones themselves and of the building inscriptions. Heavy tools, swung by both hands, were the sledge hammer and a large axe, the latter useful for work in soft stone. A lighter axe, the edge of which was well tempered, a square-headed hammer used in dressing the edges of stones, and the mallet with which the chisels were struck were swung by one hand.

The chisels in use were the point, for rough work ; flat chisels, sometimes broad and sometimes narrow, for finishing ; and, after the change in the sixth century from soft to hard stone made a better biting instrument necessary, toothed chisels of varying width and fineness, for joints. There is evidence at Tiryns and in certain blocks of marble now (1907) lying to the southeast of the Parthenon that stones were cut with the saw. For work in wood there is evidence of the use of flat chisels, curved chisels, and augers similar to those of to-day. Rulers were sometimes of wood, sometimes of stone, and in building inscriptions mention is frequently made of straightening them. To the list of tools may be added from various sources of information squares, levelling instruments, compasses, and instruments used for scratching lines upon stone.¹

There were three stages in the working of stones ; the rough shaping at the quarry, the cutting into size and shape near the

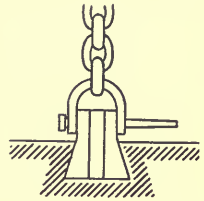

FIG. 54. — Roman lewis.
(Drawing by G.P.S.)

¹ The following tools, taken from the cities buried by Vesuvius, are preserved in the Museum at Naples : bronze compasses, foot-rules, plumb bobs, squares, metal planes, augers, trowels, chisels for use in stone and wood, hammers, picks, shovels, and a complete lewis.

building, and the final finish after the stone was in place. For the rough work at the quarry the hammer and point were used; at the building site the stone was dressed with the point until it reached approximately the size desired, and the block was then worked over with the toothed chisel, the straightedge and square being continually used to test the planes. On exposed surfaces

**Working of
stones**

about a quarter of an inch of stone was left to be removed later. With the bottoms of the stones great care was taken to obtain true polished surfaces along the exposed edges, in order to secure water-tight joints, as no mortar whatever was used. It was the practice in Attica in the fifth century to dress with equal care the upper surface of a whole course from end to end, thus securing the best possible bed for the following course. The vertical surfaces of contact, since there is no pressure at such joints, received a special treatment (see Figs. 46 and

55): the surfaces were picked away, so that there were true smooth bands of contact at the edges only. This treatment, which is known as *anathyrosis*, may occur on one, two, three, or all sides of a vertical joint.



FIG. 55. — Forms of contact.
(*Olympia*, Text, Vol. II, Fig. 15.)

A form of contact common at Olympia is shown in Figure 55, at the right.

The face of the stone, in the best work, was left unfinished until the wall was completed, in order that a true continuous surface and the best possible joints might be obtained. Horizontal and vertical bands, to which plumb lines could be referred, were carefully sunk to the desired depth in the face of the wall. In dressing for the final surface the stones were smeared with a mixture of oil and an ochrous earth (*μίλτος*) from Sinope. The straightedge was applied and twisted about, removing the colored mixture from the high points and thus telling the stone cutter where to chisel. Last of all came the polishing, accomplished by means of a smooth stone and some sort of lubricant, such as water or oil. Great care was taken to avoid splintering the exposed

edges in setting the stones. The usual method was to bevel the edges (Fig. 56), and the groove thus formed was removed in the final finishing of the wall face. When exposed surfaces had to be finished before the stone was set, as in the case of steps which were set along a line scratched in the course below, the treatment was that shown in Figure 57. The same principle



FIG. 56. — Treatment of edge. Horizontal section. (Drawing by G.P.S.)

was applied to the bottom drums of the Doric column and to all capitals and cornice members which might be injured when they or the stones above them were put in place. In soft stones the centres of exposed surfaces were often raised. This was regarded in Hellenistic times as a species of decoration and was used especially in the lowest course of the wall.



FIG. 57. — Treatment of edge. (Drawing by G.P.S.)

In addition to the rope cuttings and lewis holes there are four important kinds of cuttings which have not yet been mentioned ; pry

holes, shift holes, Cuttings
dowel holes, and
cramp cuttings. The first two of these were used in working the stone into its final position, the last two in bonding the wall together. Pry holes are shallow cuttings, from half to three quarters of an inch deep and from two to three inches long, cut in the upper surface of a stone and used in connection with a crowbar in prying the stone in the course above into its place. They

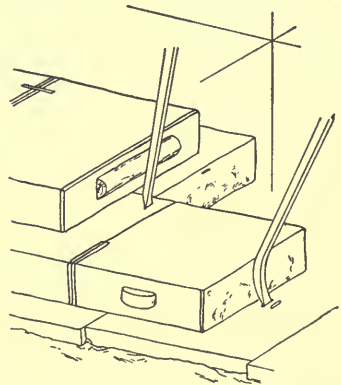

FIG. 58. — Pry holes. (Clarke, *Assa*, II, Fig. 7.)

lie at right angles to the motion to be given to the stone above (Fig. 58). Sometimes as fast as a stone was moved forward a

new pry hole had to be cut, and as many as four or five in a line occasionally occur.¹ Shift holes were cut in the ends of the stones, one set on the under surface and a second near the upper surface (Fig. 59).

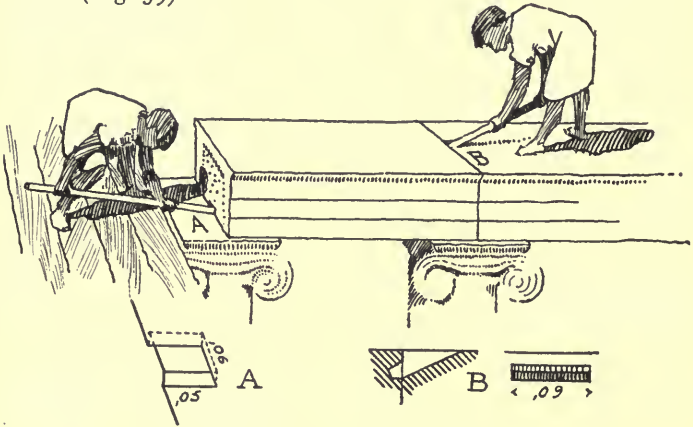

FIG. 59. — Shift holes. (Drawing by G.P.S.)

Dowels, generally of wrought iron and packed with molten lead, were used to hold the stones of different courses together. They had various ingenious shapes to suit special needs. For use in walls the dowel cutting was rectangular and was about three inches long, one inch wide, and two inches deep in both upper and lower stones (Fig. 60).² A special

Dowels

¹ In the Parthenon each pry hole contains a piece of wrought iron, held in place with lead and situated at the side of the pry hole away from the stone to be pried into place. Its purpose was to give the crowbar a solid hold in prying.

² These dowels were placed in the end and at the bottom of the upper stone and sealed with lead before the next stone of the same course was laid. A dowel, then, in the bottom of a stone, tells us in which direction the course was laid. A dowel in the top of a stone is generally accompanied by one or more pry holes. These pry holes cannot exist on both sides of the dowel, as they were used in prying into place the stone which the dowel was to hold. Pry holes and dowels give us, then, not only the direction in which

type of dowel was employed at angles and in other places where sliding in two directions had to be guarded against (Fig. 61). Angle stones, if they were the last stones of their courses to be laid, were sometimes secured by dowels as shown in Figure 62, or, if the stones were thick, as shown in Figure 63, the channel in each case being made for the purpose of pouring in the molten lead.

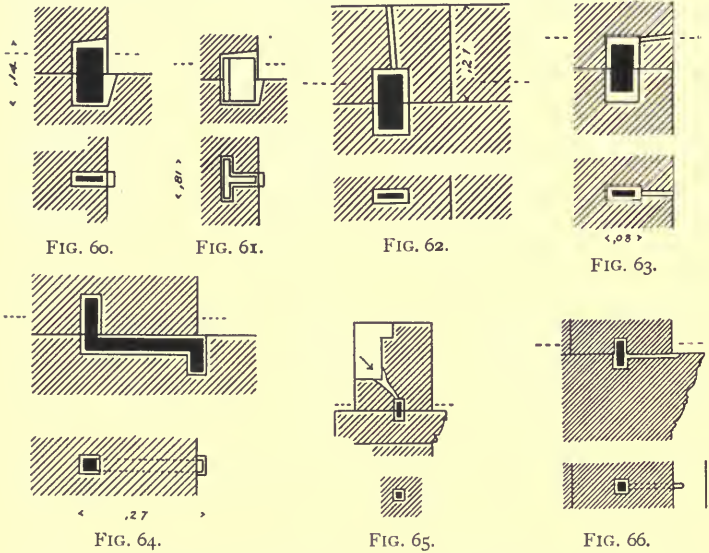

FIGS. 60-66. — Dowels and cuttings. (Drawings by G.P.S.)

first and work away from the angles, thus hiding all dowels. In soft stones the dowels, to be effective, had to be placed at a considerable distance from the joint. Figure 64 shows how this was accomplished in the temple of Poseidon at Paestum. As the course above was laid, but also the approximate position of the end of the stone above, that is, its joint. Shift holes also show in what direction the course was laid (cp. Fig. 59). The extensive use of dowels and cramps in Greek buildings is probably due to the danger from earthquakes.

lead was used on all parts of this dowel, the latter must have been leaded in the upper stone before the stone was set in place. Occasionally an oblique pour-channel leads from the nearest available point in the stone above (Fig. 65), and sometimes dowels are placed in the ends of stones, with vertical pour-channels in the vertical joints. The last type, which was in use from the fourth century on, is the dowel with horizontal pour-channel, as shown in Figure 66. As in the case illustrated by Figure 64, the metal dowel, generally square in section, was fastened with lead in the upper stone before the latter was set. A cutting prepared for it

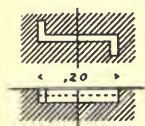

FIG. 67.

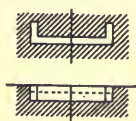

FIG. 68.

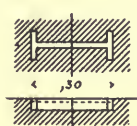

FIG. 69.

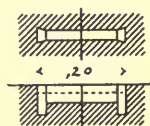

FIG. 70.

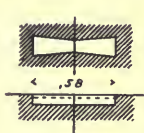

FIG. 71.

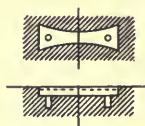
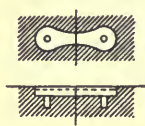

FIG. 72.



FIGS. 67-72.—Cramp cuttings. (G.P.S., Fig. 72 after Koldewey, *Lesbos*, p. 46.)

in the stone beneath received the dowel when the upper stone was set, and lead was then run in through a channel cut in the upper surface of the under stone.

Cramps, generally of wrought iron, but sometimes of bronze, were used to fasten together the stones of the same course. They were usually hidden and carefully sealed with lead. They were apparently employed earlier than dowels, for the **Cramps** *Metroum* and the *Treasury of the Geloans* at *Olympia*, both of early date, had cramps but no dowels in their walls. Cramps afford a good test of the age of a building. There are five types, the first and oldest of which is shown in Figure 67. The cramp

shown in Figure 68 is a variation of this first type. These cramps were used in buildings of the sixth and the early part of the fifth centuries (*e.g.* the treasuries of Gela, Sicyon, and Selinus at Olympia and the stylobate of the old temple of Athena at Athens), and were made by simply bending the ends of a bar. The second type (Fig. 69), known as the "double T" or the "H" type, is characteristic of the Periclean buildings. It was more expensive than the first type, as its ends were formed by welding, not by simple bending. An early instance of its use is in the entablature of the old temple of Athena at Athens, and its latest known occurrence is in the monument of Nicias in the same city. The third type is called the "hook cramp" and differs from the first type in being set vertically (Fig. 70). This was in use during the longest period, for it is found at Assos and in the treasury of the Syracusans at Olympia; it was then out of fashion for a time, but came in again in the middle of the fourth century, and was adopted by the Romans. It was much used at Epidaurus, Pergamon, Samothrace, and Olympia. In Roman times the cutting for the bar was shallower than in the early Hellenic period. The fourth type is the "swallow tail" cramp (Fig. 71), which was used chiefly in soft stones. As it was in use from the sixth to the first century, it does not serve as an indication of the date of a building. The last type (Fig. 72) was found by Koldewey in the island of Lesbos, to which it seems to have been confined.¹

In the best work great care was taken to secure, in the case of column drums, joints of wonderful perfection. In every joint, at the axis of the column, there was a Joints cutting (Fig. 73) for some sort of wooden or bronze pivot, about

¹ The length of cramps varies from 2 in., for holding strips of mouldings on, to 2 ft., as in the temple of Zeus at Olympia, where the head needed to be at some distance from the joint lest the cramp break out through the friable stone. Double T cramps were sometimes used in holding defective stones together. In the Propylaea at Athens several cases of this occur. A cramp cutting in the top of the northwest capital of the main building measures 0.80 m. (31½ in.) in length, 0.018 m. wide, 0.15 m. width of head, and 0.11 m. deep. This is the longest known cramp or cramp cutting.

which the drum, as soon as it was put in place, was turned through a small angle, grinding upon the drum below until a "perfect" joint was obtained, in some cases so perfect as to be completely invisible at a short distance. To make this turning possible, bosses were left on the upper drum to catch hold of. The principle of *anathyrosis* (see p. 102) was employed here also.¹

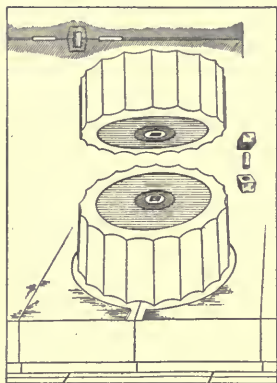

FIG. 73.—Cuttings in drums of columns. (Penrose, *Principles of Athenian Architecture*, p. 22, ed. of 1882.)

Stones were prepared on the ground, with the exception of the last finishing. Each block had a definite position to occupy in the building, and sometimes, in order that there might be no mistake, the blocks were methodically lettered (A, B, Γ, etc.) or, in Roman times, numbered (I, II, III, etc.). In the "Theseum" at Athens the lid of each coffer of the ceiling was marked with a little design, and a similar design was cut at the side of the square opening to which the lid belonged.

ARCHAIC ARCHITECTURE

In the obscure period that followed the breaking up of the Mycenaean civilization and in the first centuries of really Hellenic history, Greek colonies spread from the Black Sea to Italy and even to France. These colonies retained some recollections of Mycenaean art and were, especially in Asia Minor, also influenced by their neighbors (Phoenicians and others), while at the same time the

¹ It is possible that these cuttings, with their wooden blocks and circular centre pins, were employed to secure an accurate centring of the drums as they were set one on top of the other.

In the fourth century, dowels with horizontal pour-channels begin to be used in column joints, e.g. in the Olympieum at Athens.

beginnings of the new Hellenic art were becoming manifest. It was during this period that the Greek temple came into being.

A cult without precious statues and costly votive offerings, such as that of Mycenaean times seems to have been, needed only simple sanctuaries; an altar in an open space with a surrounding hedge or wall would suffice. The origin of the temple Origin of the temple was probably due to a desire to protect the religious emblems from the weather, from theft, or sacrilege, and perhaps also in part to the growth of anthropomorphism in the Greek religion; for gods who are like men should have fitting houses. And what is more natural than to suppose that the Greeks took the noblest building they knew, the Mycenaean megaron, and enriched it for its new purpose, as the house of the god? The altar remained in front of the temple; the entrance gate of the precinct, the propylaeum, was also retained much as it had been before the Dorian Invasion. The first temples then probably had the form of the megaron. Development began at the façade, a natural step being the substitution of four columns for the two columns *in antis* of Mycenaean times. Then came a façade of six columns, with columns along the sides. The lateral colonnades tempted one to walk round the building, and the last feature of the temple was the rear chamber, the opisthodomus, which made the end façades alike (thus completing the beauty of the structure as an isolated edifice) and was also useful as a store room or treasure chamber.¹ Such was the development of the plan. The roof, too, underwent an important change, and from a flat roof of earth became a roof of two slopes (saddle roof) covered at first with terracotta tiles and later sometimes with tiles of marble. The façades at the ends of the temple were now surmounted by gables.

All the extant monuments are entirely of stone, but the forms of their various members may be explained as derived from wooden prototypes. This theory of their derivation is supported by Vitru-

¹ It cannot be proved that the development followed chronologically the order here given, which is merely a possible or probable, because a logical order.

vius, the only ancient writer on architecture whose work has been preserved, and by the work of the Germans on the Heraeum at Olympia (Fig. 110), which is the oldest structure excavated at that site and perhaps in all Greece, with the exception, of course, of the buildings of Prehellenic times. The Heraeum is supposed by some authorities to have been for a long time the only temple at Olympia and to have been shared by Zeus and Hera. It was erected not later than the seventh century B.C. and perhaps even earlier. The stylobate consists of two steps, not three as is usual. Six columns have disappeared completely, and those that remain exhibit the greatest diversity in diameter, number of channels, profiles of capitals, constructional features, and even materials. Pausanias says one column in the opisthodomus was of oak. Evidently the columns were originally all of wood, but as fast as they decayed they were replaced by stone. Moreover, as the distance between the columns is unusually great, and as no stone architraves were found, it is natural to suppose that the entablature was never of any other material than wood. The lowest part of the wall consisted of carefully dressed stonework, but above this rose walls of sun-dried brick. The antae and doors were sheathed with wood. In construction the Heraeum resembles the Mycenaean megaron, and therefore serves as a connecting link between Mycenaean buildings and Greek temples of historical times. The wooden Mycenaean column has been replaced, possibly under Egyptian influence, by the heavier and more durable stone column, which is made more stable by tapering upward. The earliest temple has been translated into a material in which a gradual and continuous process of refinement is possible.

THE ORDERS

Before discussing the more conspicuous parts of Greek buildings it is well to consider briefly the foundations. No architects seem to have appreciated the importance of these better than the Greeks. As basements occur very seldom in Greek buildings, foundations

are naturally found only under walls and columns, an arrangement which saved both material and labor. The depth of foundations varied with the weight to be carried, but when possible the Greek architect laid his foundations upon **Foundations** the natural rock, going down twenty courses of stone on the south side of the Parthenon. The native rock was dressed into horizontal beds, and the foundation stones were then laid without mortar. Where rock foundations were not to be had, a layer of sand, or sometimes of clay, was generally placed at the bottom of the trench to obtain a level bed. At Ephesus the English architect Wood found a bed of charcoal and a kind of mortar used in the same way. At Olympia the Heraeum and some of the treasuries had foundations of irregularly shaped stones, but

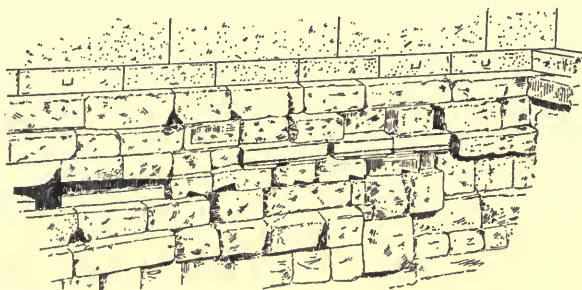

FIG. 74. — Foundations of the Propylaea at Athens, showing second-hand material. (Wiegand, *Porosarchitektur der Akropolis*, Fig. 146.)

most frequently squared stones were employed, of any good, inexpensive material, laid without mortar, and, in the best work, carefully bonded together with iron. Second-hand material was often used in foundations, as in those of the Propylaea at Athens (Fig. 74). The voids about the building were filled in with stone chips, rough stones, and earth.

Upon the foundations rested a series of three steps,¹ called the

¹ Steps are sometimes absent, especially in stoae, where they would interfere with the free circulation of the people. In porticoes one step is common, and in temples (*e.g.* the "Theseum") two are occasionally found. Both the

stylobate,¹ which in its turn supported the columns. The floor of the portico or colonnade, generally flush with the top of the stylobate, was of gravel and earth, or paved with stone. The floor of the cella was raised, as a rule, a step or two above the floor level of the colonnade, and was carefully flagged.

The most striking characteristic of the Greek temple is its use of columns (Fig. 75). There are two styles, the Doric and the

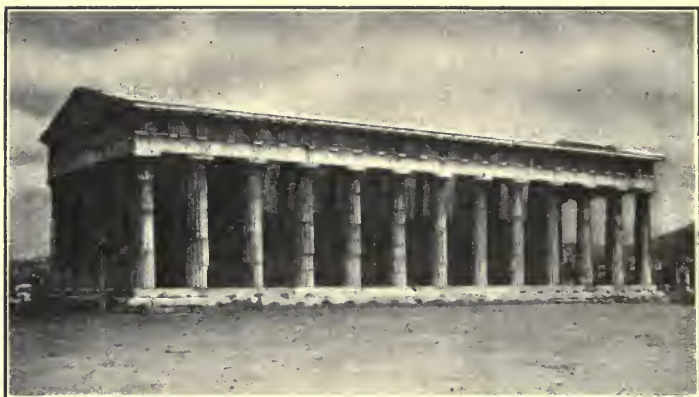

FIG. 75.— The so-called Theseum at Athens. (Photograph.)

Ionic (for the Corinthian style is but a development of the Ionic), distinguished by their characteristic columns and entablatures.

side steps and the front steps were sometimes laid in gentle hyperbolic curves, the highest points of which are halfway between the corners of the temple.

The curve is not noticeable unless one looks for it, but it was probably intended to add life and vigor to the appearance of the building. Similar curves are found also in architraves and cornices. Large temples needed intermediate steps, e.g. the Parthenon, where at the east and west ends steps of convenient height were inserted. In other cases this difficulty was met by a stone ramp or inclined plane, a dignified arrangement for religious processions.

¹ Strictly speaking, the stylobate (*στυλοβάτης*) is only the upper step, on which the columns stand. The entire foundations, both above and below the ground, are called the stereobate (*στερεοβάτης*) or crepidoma (*κρηπίδωμα*).

THE DORIC ORDER

In the Doric order the column had no base, but rested directly on the stylobate. The shaft was usually built up of drums bonded together. Its axis was not vertical, but slightly inclined inwards toward the wall of the cella. The ^{The column} angle columns had therefore an inclination in two directions; that is, along a line bisecting the right angle at the corner of the stylobate.¹ Direction and life were given to the column by a series of channels, usually twenty in number, in section segments of ellipses or of circles meeting in points. The diameter of the shaft was considerably less at the top than at the bottom, but the diminution was not effected in a straight line; there was a gentle outward curve between the foot and the neck, called the *entasis*.² Thus channelling or fluting and entasis gave to this supporting member a firm and elastic appearance.

The conflict between the upright lines of the column and the

¹ With the exception of the bed of the capital and that of the lowest drum on the stylobate, which were horizontal, all the beds of the drums were in planes at right angles to the inclined axis. An inclination similar to that here described has been noted in the columns of the (Ionic) Erechtheum.

² As a rule, small columns had no entasis, and the larger the column the larger the entasis in proportion. The curve, often hyperbolic, always rises from the stylobate with an inclination toward the axis of the column, and the greatest distance between the curve and a straight line connecting the circumference at the foot and that at the neck occurs from one third to one half the way up the shaft.

The fluting and entasis were cut in the following way: Before the lowest drum was set, the channels were carefully marked upon the under surface and cut for a short distance up. The same was done for the top drum, and the intermediate drums were left unfinished until all were in place. The precaution was taken to leave the cutting of the delicate fluting to the last. The top and bottom drums were used as guides for the rest of the work. An entire but unfinished column of the Ionic temple at Didyma is still standing. At the top, the fluting is only started. The base is still buried in débris, but at every joint there are numbers, in the Greek foot and its subdivisions, cut in the stone, which indicate the finished diameter at that particular joint.

horizontal lines of the entablature came at the capital and led to a change from the Mycenaean form. The column was made smaller

The capital at the top than at the bottom, perhaps for statical reasons, causing the Doric architrave to overhang the upper diameter of the shaft. When it is remembered that the weight, both real and apparent, of the Doric stone entablature was much greater than that of the Mycenaean wooden entablature, it will be

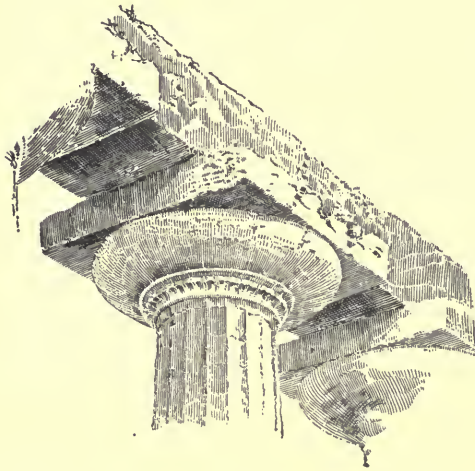

FIG. 76.— Capital of the "Temple of Ceres" at Paestum.
(Koldewey and Puchstein, Text, Fig. 20.)

seen that the problem of finding an appropriate transition was difficult. The egg-shaped moulding of the Mycenaean capital developed into the *echinus* of the Doric capital, the profile of which was in early times much curved (Fig. 76), in the best period a beautiful elastic curve, and in late times a lifeless oblique line.

The concave moulding between capital and shaft disappears in classical times, and the start of the echinus is marked by three or four projecting bands. The capital and the beginning of the shaft were cut from the same block, and the edge of the joint between this stone and the top drum of the shaft was bevelled to prevent chipping. The groove thus formed has been called the *scamillus*.¹ The oft-repeated grooves at this point in late

¹ The same name has been applied to the similar bevelling at the bottom of the lowest drum. Both here and at the neck of the column it is a misnomer, probably due to a misunderstanding of Vitruvius.

times are mere decoration. Upon the echinus was a square block, the *abacus*, which completed the capital.

Upon the capital rests the entablature (Fig. 77), consisting of architrave (*epistylion*), frieze, and cornice (*geison*). The architrave blocks reach from column to column. They are undecorated, save for a small projecting capping moulding (*taenia*), below which, under each triglyph of the frieze, is a small cleat, the *regula*, from which six little *guttae* project downwards (Fig. 78). The beams of the ceiling normally rest directly on the architrave and extend to the cella wall. This construction is expressed by the triglyphs of the frieze, originally a sheathing of the ends of the beams, and thus a reminiscence of wood construction. Between the triglyphs are the metopes. These were generally smooth inserted blocks, but from early times they were often decorated with figured reliefs. There was a triglyph over each column and over the middle of each intercolumniation. A triglyph also regularly occupied the corner. This made a special arrangement at the

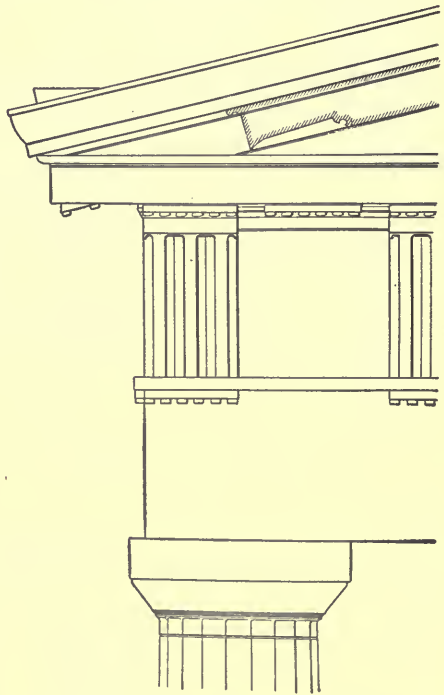

FIG. 77. — Capital, entablature, and cornice of the Propylaea at Athens. (Bohn, *Die Propyläen*, Pl. XI.)

corners necessary, and various expedients were resorted to before the best result was attained. Originally all the intercolumniations

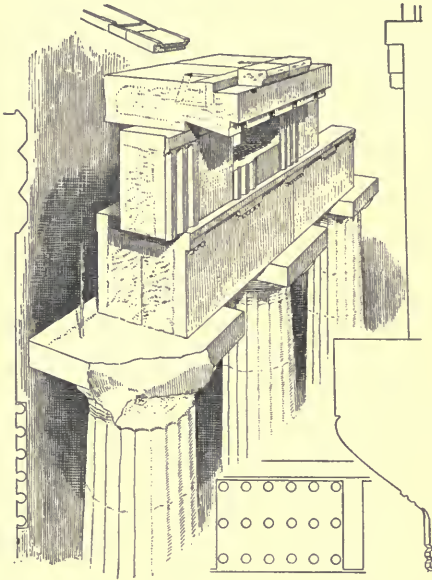

FIG. 78. — Doric entablature. (Koldewey and Puchstein, Text, Fig. 92.)

were equal, and the corner triglyph and the metope next it were widened. At Segesta the axis of the second column from the corner did not come in the axis of the triglyph over it. The most satisfactory solution, that employed in the Parthenon, was to widen the corner triglyph and the adjacent metope slightly and at the same time to place the corner column nearer the axis of the building, making the intercolumniation nearest the end smaller than the rest, and thus giving

to the corner as a whole an appearance of greater strength.

The last principal member of the entablature is the cornice, designed to throw the rain water from the roof away from the building. Here, again, we find, even in historical times, a reminiscence of the Mycenaean cornice, with its beams protected by sheathing, in the applied terracotta decoration secured by nails, such as is seen in the treasury of the Geloans at Olympia (Fig. 79) and the middle temple on the acropolis at Selinus.¹ The cornice is undercut and also provided

¹ This method must be assumed for many of the Western temples (particularly at Metapontum, Selinus, and Segesta), and was handed on to the Etruscans.

with a drip at its front edge, to prevent rain water from running down the frieze and the members below. The mutules, over each triglyph and metope, are a reminiscence of construction in wood. Each of them is enlivened by three rows of six trunnels or guttae.¹

It is a fact to be noted that the same axial unit (*i.e.* the same distance between the axes of regulae, triglyphs, and mutules) appears in architrave, frieze, and cornice. This is a characteristic feature of the Doric order.

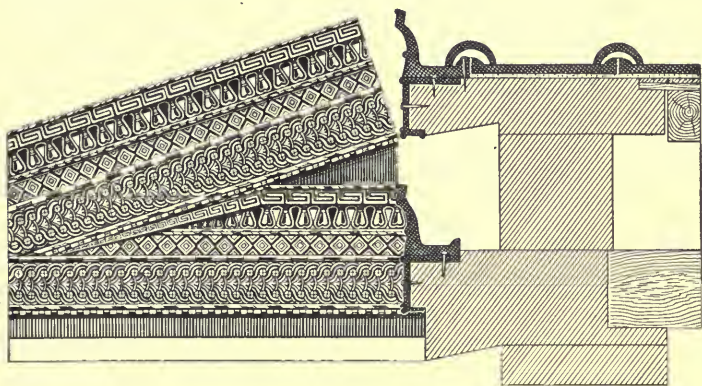

FIG. 79. — Terracotta sheathing, treasury of the Geloans. (*Olympia*, Vol. I, Pl. XLI.)

In early times the intercolumniation is small ; in the old temple of Apollo at Syracuse the free space between the columns is even less than their lower diameter. The columns of this period are heavy, with marked entasis and diminution, their height being from four to four and a half times their lower diameter. In the temple of Zeus at Olympia the proportion is 1 : 4.6, in the Parthenon 1 : 5.5, and in the temple at Nemea 1 : 6. That is, the columns became more slender as time advanced. The diameter at the top and the bottom became more

¹ In the two oldest temples at Selinus the metopes were so narrow in proportion to the triglyphs that only half mutules were placed above them. This was also the case in the old temple of Athena at Athens.

nearly equal (diminution and entasis decreased), while the capital became relatively smaller both in height and breadth (Fig. 80).

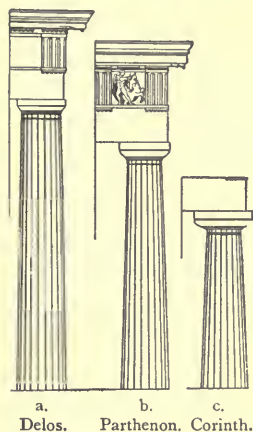

FIG. 80.—Relative proportions at different dates. (Borrmann, *Geschichte der Baukunst*, I, Fig. 78.)

There was a change of proportions in the entablature, also. The architrave, the carrying member, was at first higher than the frieze, but gradually decreased in height until the relation was reversed, as in the Parthenon. The height of the entablature, as a whole, was slightly less than half the height of the column in early buildings and slightly less than a quarter in late times.

The ceiling of the peristyle bound the colonnade to the cella wall. As time went on the relation of the beam ends to the triglyphs was lost; the beams were spaced independently of the triglyphs and were often at the same height as the cornice. Stone buildings sometimes had

Ceiling

ceilings made of wooden beams covered with a sheathing of

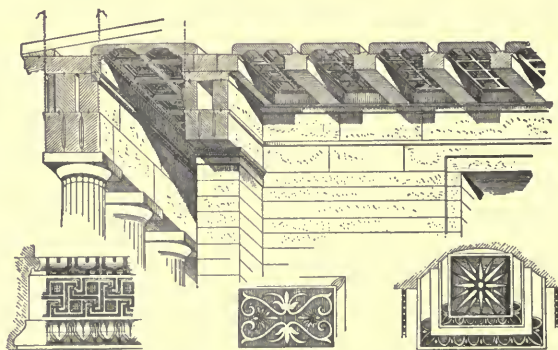

FIG. 81.—Ceiling of the Opisthodomus of the Parthenon. (Durm, *Baukunst der Griechen*, 2d ed., Fig. 114.)

boards and with small mouldings¹ nailed along the upper edges of the beams. This seems to have been the case in the treasury of the Megarians at Olympia. A richer treatment consists of crossbeams, with planking as a covering — the coffered ceiling. Stone ceilings developed from wooden ones; stone coffers rested on stone beams or stretched directly from entablature to cella wall (Fig. 81).

The cella wall was built of uniform blocks, **Cella wall so far as and ceiling possible,** except the lowest course, which was of double height and projected $\frac{1}{4}$ in. to $\frac{1}{2}$ in. from the wall face.² Often the wall had a slight inclination (batter) on its outside face.

At the front and rear porticoes the side walls are terminated by antae (Fig. 82), which project a short distance from the side walls and have a similar batter. The capitals of the antae have an important beak moulding, with a few minor mouldings below, and a slightly projecting neck (Fig. 87).

The ceiling of the cella was of wood. In a wide cella in-

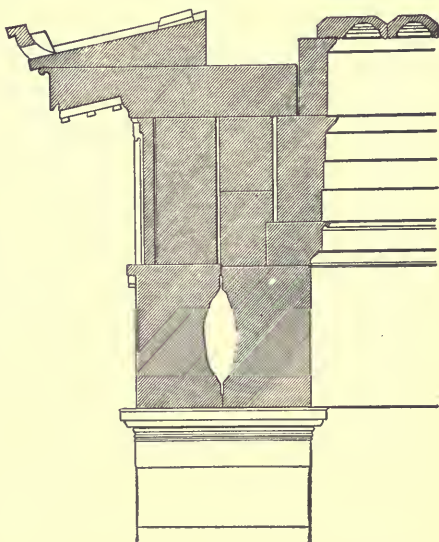

FIG. 82. — Anta capital and section of entablature. Propylaea, Athens. (Bohn, *Die Propyläen*, Pl. XI.)

¹ A much charred separate strip of carved eggs and darts (*ovolo*) found in one of the cities buried by Vesuvius is now in the Museum at Naples.

² The stones of this course are called *orthostatae* (*ὀρθοστάται*). This course is no doubt a reminiscence of the course of stone used to raise walls of crude brick above the danger of injury from the wet, etc. (see p. 97).

terior supports were needed, either a single row in the middle, as in some early structures, or two rows, with the central nave wider than the side aisles, as in most temples. For these supports a single order would have taken up too much space, so one order was placed above another. This is now best seen in the ruins of the "temple of Poseidon" at Paestum (Fig. 83). This arrange-



FIG. 83. — Interior of "temple of Poseidon," Paestum. (Perrot and Chipiez, Vol. VII, p. 383.)

ment lent itself to the installation of a gallery approached by stairs, traces of which still exist in some cases. In late times the double order was supplanted by simple rows of tall, slender Ionic or Corinthian columns.

In the fully developed Greek temple the principal façades had gables, the raking cornices of which differed from the horizontal cornice by having no mutules. The triangular space between the horizontal and raking cornices, the

Roof

pediment,¹ was often embellished with groups of sculpture. Between the two gables is the covering of the whole building, a double pitched (saddle) roof. Upon a ridgepole and intermediate beams parallel to it rested rafters which lay parallel to the slope of the gables. The tiles of the roof rested either directly upon the rafters or upon a bed of clay carried by boarding which was laid upon the rafters. The tiles

were usually of terracotta, a material which weathered at least as well as marble, though marble tiles were used on some of the more elaborate buildings.

The cover tiles at the cornice were often decorated with colored or sculptured disks, called *antefixes*, and the tiles on the ridge were similarly adorned.

The apex of the pediment was usually adorned with a large disk, with a palmette anthemion, or with sculpture, and the two other angles of the pediment received a similar treatment.

These ornaments were called *acroteria*. Several varieties or systems of tiles exist. The earliest system is shown in Figure 84, then follows the system

shown in Figure 85, and last of all that shown in Figure 86.² The

simā extends up the gable to prevent water from running over the pediment (cp. Fig. 79). Along the sides of the temple it is generally omitted; if it occurs, a simple waterspout or a lion's head,

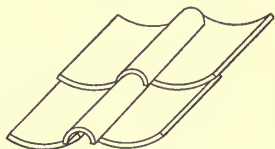

FIG. 84.

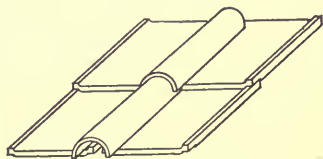

FIG. 85.

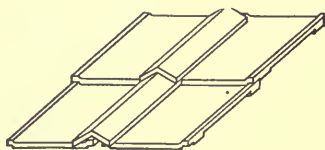

FIG. 86.

FIGS. 84-86. — Roof Tiles. (Drawings by G. P. S.)

¹ The wall of the pediment is called the *tympanum*.

² Flat tiles, pierced for light or ventilation, with rims to prevent water from running in, have been found at Bassae and Pompeii.

through which the water is discharged, generally comes opposite each flat tile of the roof, and the antefixes are then poised upon the sima.

Color, applied according to a fairly consistent rule, completed the general effect of the building.¹ Marble walls were sometimes

entirely colored or sometimes decorated with designs.

Color

Poros and other kinds of coarse stone were covered with a thin coating of fine stucco mixed with any desired pigment.

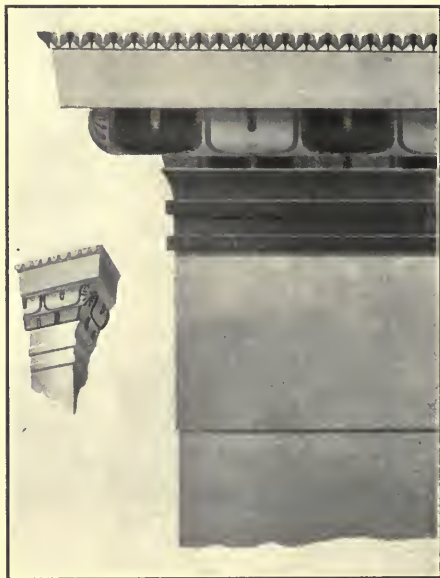

FIG. 87.—Anta capital. (Penrose, *Principles of Athenian Architecture*, Pl. 26.)

sometimes red, sometimes white. Color was thus used to make certain parts stand out. The metopes were white, except when

¹The color scheme here outlined may have admitted variations. It is, however, closely followed on a remarkably well-preserved Doric capital and cornice from Selinus (now in the Museum at Palermo), which is covered with a fine stucco highly colored. There are other good examples of colored decoration at Olympia and Athens.

Thus different materials could be employed and concealed in the same building. The capitals of antae (Fig. 87) received brilliant colors, but there is no proof that the capitals of columns were colored, except that a strong red was applied between the rings at the necking. The soffit of the cornice, the top border of the metopes, and the taenia were red; the mutules, the triglyphs, and the regulae were blue; the guttae on the regulae and on the mutules were

sculptured, in which case the background was usually red. For sculptured friezes and pediment groups the color treatment was simple at first and perfected later. The backgrounds were red or blue, and certain parts of the figures were picked out in color and decorated with accessories of metal. In early times the entire figures were colored. The simas had a palmette decoration with varying colors. The taenia and the band above the triglyphs received a fret. Sometimes on the capitals of the antae the abacus had a fret, the hawk's beak a brilliant pattern of varying colors, and the neck painted palmettes and tendrils growing out from conventional stems. The antefixes often received a palmette pattern (Fig. 88). The ceilings were even more richly decorated than the entablatures. The recessed coffers had a blue ground, on which were stars or other ornaments in light tones or gilding, while the mouldings of the coffers were decorated with painted egg and dart (*ovolo*) or Lesbian patterns (Fig. 81). Sometimes the under surfaces of the beams had a painted fret or honeysuckle pattern, while the crowning mouldings of the beams were decorated like the ovolo mouldings of the coffers.¹ The inner walls of the cella had sometimes a free treatment in color in early times, and were later sometimes adorned with reliefs.



FIG. 88. — Palmette antefix. (*Olympia*, Vol. II, Pl. 118.)



FIG. 89. — Doric mouldings. (G. P. S., after Penrose.)

The mouldings used with the Doric order are few. The ovolo appears in the neck of the capitals of columns and in the sima; the bird's beak is used as a crowning and supporting member; the "cyma

¹ The design was scratched on the moulding and the color applied by the encaustic process, which employed wax and heat.

reversa" is used as a supporting member and occasionally for simas (Fig. 89). Moulded members are subordinated to the rigid lines of the Doric order.

THE IONIC ORDER

The Doric order was developed from a Mycenaean prototype, as we have seen, and its development took place in continental Greece and the Western colonies. The Ionic order, on the other hand, was developed in Asia Minor and the neighboring islands. Only one early Ionic temple, that at Locri, is found in the West. The development of the Ionic order from wooden prototypes is even clearer than that of the Doric order, although no single monument throws so much light upon its early history as is shed upon that of the Doric order by the Heraeum at Olympia.

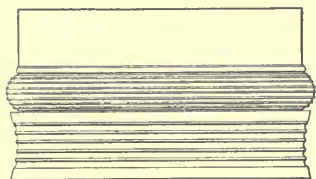

FIG. 90. — Ionic base, Samos. (Perrot and Chipiez, Vol. VII, Fig. 268.)



FIG. 91. — Ionic base, Pergamon. (*Die Ergebnisse der Ausgrabungen zu Pergamon*, Pl. 10.)

The Ionic column consists of base, shaft, and capital. The base (Fig. 90), which lifts the slender shaft above the stylobate and gives it an appearance of stability, consists in early times of *trochilus* (concave), *torus* (convex), and *astragalus* (small, convex). In Asia Minor a common type has two trochili separated by two astragals and surmounted by a torus, the whole standing upon a special plinth (Fig. 91). The Attic base consists of two toruses separated by a trochilus (Fig. 92). This is the type commonly adopted in Roman, mediaeval, and modern times.

The shaft is more slender than the Doric shaft, and has less diminution and entasis. In the earliest examples the channels are

many and meet in sharp edges; in the best period they are twenty-four in number, each separated from the next by a narrow flat surface (*arris*). The section through these channels is a segment of a circle or of a flattened ellipse, and they end at top and bottom in the same curves. In the temple of Artemis at Ephesus (both the temple of the fourth century and its predecessor) the lowest drum of some of the columns was unfluted and decorated with reliefs (see Figs. 157 and 195).

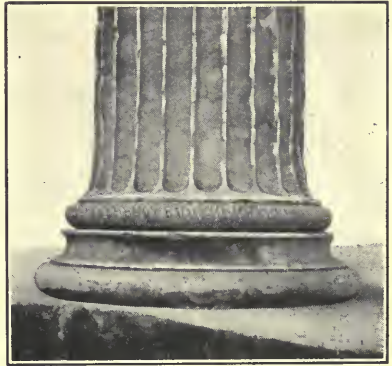

FIG. 92. — Attic base, Erechtheum. (Photograph.)

The most characteristic feature of the Ionic order is the volute capital. This was probably derived from a short rectangular piece

of wood or Volute
bolster, in- capital
serted between the shaft
of the column and the
architrave, the ends of the
bolster projecting down-
ward to give a secure bear-
ing for the shaft. Then
two spirals, not united,
and wound in diminishing
curves each about an eye,
were painted on the bol-
ster. Next the volutes
were transferred to stone
(Aeolic type; Fig. 93)
and finally joined (Fig.
94). The transition from

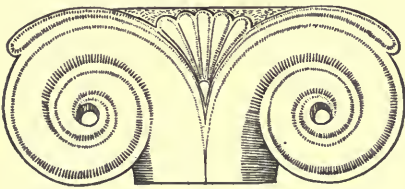

FIG. 93. — Aeolic type of capital. (Koldewey, *Lesbos*, Pl. 16.)

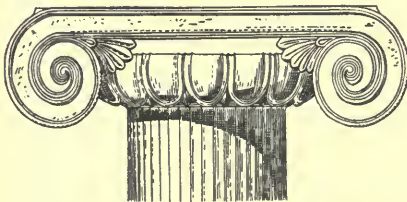

FIG. 94. — Capital of the Naxian column at Delphi. (Perrot and Chipiez, Vol. VII, Pl. 54.)

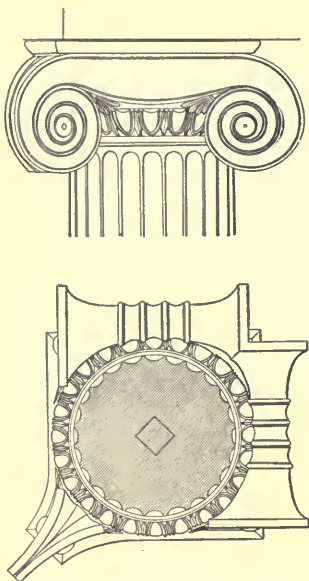

FIG. 95. — Corner capital of temple of Athena Nike. (Ross, Schaubert, and Hansen, *Tempel der Nike Apteros*, Pl. IX.)

the round shaft to the rectangular capital was effected by a circular intermediate member (sometimes called the *echinus*) crowning the shaft and projecting from it. Each of the triangular spaces between the volutes and this crowning moulding was filled with a small leaf (Fig. 95). The front and side faces of the Ionic capital were different. The side face was contracted on the axis with a girth, or sometimes there were several bead and reel (astragal) bands. The two outer faces of a corner capital had to be alike, and this necessity brought a volute along the diagonal on the outside corner of the capital and two intersecting volutes on the inside (Fig. 95). This irregularity led in later times to capitals

with volutes on all four diagonals, a form of Ionic capital much used by the Romans. The transition from capital to architrave was effected by a carved or painted projecting member (sometimes called the *abacus*). As types of early capitals may be cited those of the old temple at Ephesus and of the Naxian column at Delphi (Fig. 94). Some Ionic capi-



FIG. 96. — Capital of the Erechtheum. (Photograph.)

tals are more elaborate, as those of the Erechtheum (Fig. 96) and of the old Ionic temple at Locri, where there is a rich anthemion band at the top of the shaft.

In considering the development of the entablature, it must be kept in mind that the frieze was not an essential part. The en-

Entablature tablature of Lycian tombs, which evidently reproduces in stone a wooden entablature composed of architraves, ends of beams, and gutter, represents, perhaps, the prototype of the Ionic entablature.¹ The arrangement in these Lycian tombs is about as follows: the architrave is composed of two or three slightly projecting fascias, crowned by one or two carved projecting members. On the architrave rest the heads of the closely spaced beams, which support the roof terrace. In the Ionic style, the ends of beams are shrunk into purely decorative dentels, the most characteristic feature of the Ionic entablature. In



FIG. 97. — Ionic capital, architrave, and cornice, Priene. (Wiegand and Schrader, *Priene*, Fig. 71.)

the Attic Ionic style the dentels are lacking, but above the archi-

¹ Possibly the Asiatic megaron, as found at Troy, is the prototype of the Ionic temple.

trave is a frieze, which is often covered with a continuous band of reliefs. The cornice, with or without dentels, rests, then, in the one case upon the architrave, in the other upon the frieze. It has as a leading feature a fascia strongly offset from the face of the architrave (or frieze) and with an important bed moulding. The fascia itself is crowned by a carved member (Fig. 97). Dentels do not occur in the raking cornice.

The height of the Doric column is in later times six times the lower diameter. That of the Ionic column is eight and a half to nine and a half times the lower diameter. The intercolumniation is also much greater than in the Doric style, the axial distance of the columns being two and a half to three times their lower diameter. The height of the entablature of the temple of Athena at Priene, which had no frieze, was about one sixth of the height of the column, or one and one half times its lower diameter. In the temple of Athena Nike and the Erechtheum, which had friezes, the height of the entablature was somewhat less than one fourth of that of the column, or two diam-



FIG. 98.—Ionic anta capital, Samothrace. (Borrmann, *Geschichte der Baukunst*, I, Fig. 92.)

eters. The Ionic order is characterized by slender proportions, richness, and subtlety of design; the Doric order by solidity and simplicity.

The roofing of Ionic buildings was similar to that of Doric buildings, described above. The stone ceilings resembled those of Doric edifices, but were a little more elaborate. The best examples are the ceilings of the north porch of the Erechtheum and of the

main building of the Propylaea, both on the Acropolis at Athens. As in the Doric style, the antae have special capitals (Fig. 98) the Attic examples of which, consisting of carved crowning members with raised anthemion below, are especially fine (Fig. 99). These

members, as well as the base mouldings of the antae, were frequently carried along the wall completely round the building, giving greater unity to the design. In general, the ornamented members are much more important than are those of the Doric order.

The Greeks seem to have been the first to develop highly the use

of pure architectural ornament. The chief ornaments in use were

the bead and reel (astragal), the egg and dart (ovolo), and the Lesbian, for mouldings, and the palmette for flat surfaces, though the latter ornament was also used on simas. The simple palmette forms of the sixth century B.C. became richer in the best period by the addition of acanthus leaves and tendrils; and before Alexandrian times the scroll was introduced. Most, or even all, of these ornaments may have originated in Egypt or the East, but to all that they borrowed the Greeks added something modern and Hellenic.



FIG. 99. — Attic Ionic anta capital, Erechtheum.
(Photograph.)

THE CORINTHIAN ORDER

The Corinthian order is not really a distinct and separate order, but rather a new combination of elements already known. Indeed, the base and the fluted shaft differ in no respect from those of the Ionic order. The capital alone is a more independent invention, and even in this earlier elements are present. The earliest known instance of its use is in the fifth century, in the temple at Bassae, a work ascribed to Ictinus, the architect of the Parthenon, but its greatest popularity was in Hellenistic and

Roman times. In the fully developed Corin-

The capital and entablature is circular in section and has the shape of an inverted bell; the lower part of this is surrounded by a double

thian capital the core is circular



FIG. 100.— Corinthian capital. Epidaurus. (Photograph.)

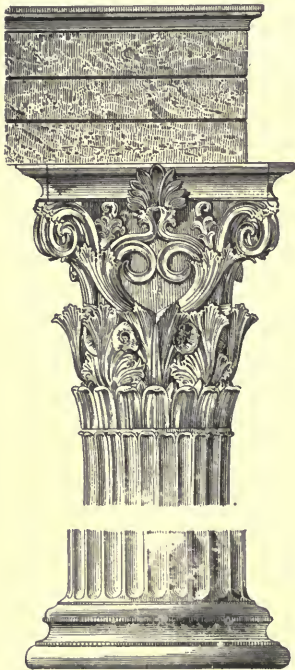

FIG. 101.— Base, capital, and architrave of monument of Lysicrates. (Borrmann, *Geschichte der Architektur*, I, Fig. 97.)

row of acanthus leaves with their points curving over, and behind the leaves rise graceful volutes, which support the angles of the abacus. This last is not square, but slightly concave on its four faces, thus giving space for a palmette or a rosette on each face (Fig. 100). The transition from the cylindrical shaft to the nearly square abacus was managed with great skill. The oldest Corinthian structure at Athens, the monument of Lysicrates (335-334 B.C.), has a pure Ionic entablature (Figs. 101, 134), and the same sort of entablature appears also in connection with the Corinthian order in post-classical works. In late times, the frieze, if not decorated with sculpture, often had a curved outline. Another rather late innovation is the introduction of console blocks in the cornice, which then has three principal members,

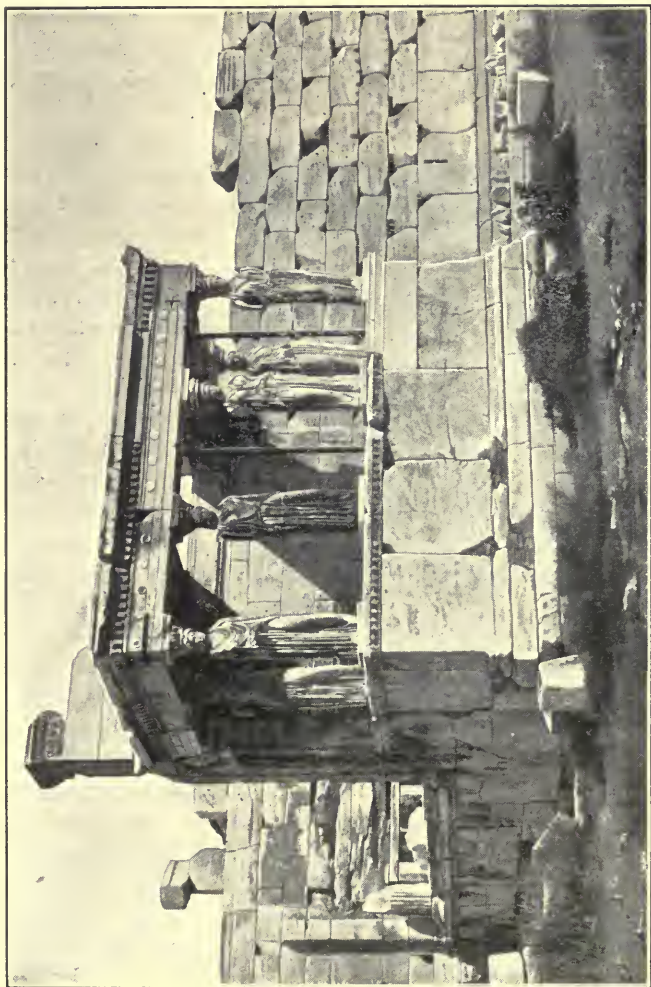

FIG. 102. — Caryatides of the Erechtheum. (Photograph.)

dentels, consoles, and fascia, each with its supporting and crowning mouldings. This is the form of Corinthian cornice adopted by the Romans.

Color was employed with the Corinthian order, as with the Doric and Ionic, but the limits of its use are less easy to define.



FIG. 103.—Treasury of the Cnidians. Delphi.
(Photograph.)

It was applied to backgrounds to make details stand out; where carved members were few, the plain members were painted, and when surfaces were enriched with carving, the greater the relief the less the need of color. Corinthian capitals were sometimes colored, as, for example, those of the propylaea at Olympia, on which the leaves were green and yellow and the background red. In Hellenistic and Roman times color was

very freely used and had to atone for many defects.

The types of supports and capitals employed in Greek architecture were not confined to those already mentioned. Many new and rich motives were used, such as heads, animals, and symbolic emblems. The Greek architect also employed the human figure, sometimes engaged, sometimes standing free, as a support for an architrave. The colossal supporting figures (Atlantes, Telamones) of the temple of Zeus at Girgenti (Fig. 105)

Human
figures

recall the so-called Osiriac columns of Egypt; and the treatment of the Caryatides of the Erechtheum (Fig. 102) solved for all time the difficulties involved in blending the repose needed in an architectural support with the life and movement of the human figure.¹

The orders of the Greeks display not only considerable liberty, but also more thoughtful distinction between supporting and crowning members than any other style, except the Gothic; and while the architecture of other peoples has remained a matter of merely historical interest, the Greek orders still find abundant use in modern architecture.

THE TEMPLE²

The developed Greek temple is merely the Mycenaean megaron surrounded on all sides by colonnades. Raised upon three steps, the temple presents to the east its gabled façade, in front of which stands an altar for burnt offerings. A sacred precinct (peribolus) with one or more entrances (propylaea) generally surrounds the temple. Within the temple is but one room of importance, the cella, in which, opposite the entrance, stands the statue of the deity to whom the temple is dedicated. Before the statue is a table for offerings. Most Greek temples are of moderate size, nearly all the largest being found in the colonies.

The simplest plan is that of the temple *in antis*, in which a vestibule, or pronaos, lies between the prolongations of the side walls of the cella. In temples of this type there is often a vestibule at each end, the western one being called the opisthodomus (the Latin name is *posticum*); but the

Plans

¹ The treasuries of the Cnidians (Fig. 103) and of the Siphnians at Delphi afford early examples of free standing Caryatides, here *in antis*. Pausanias (III, 11) and Vitruvius (I, 1) mention figures in Persian costume used as supports at Sparta.

² The Greek orders were developed chiefly in the building of temples, as the Gothic style was developed in church building. Some of the characteristics of temples have therefore been described in the sections on the orders

cella has only one door, that at the east. If a row of columns extends across the whole façade, the temple becomes prostyle (*πρόστυλος*), or, if both ends are treated as colonnades, amphiprostyle (*ἀμφιπρόστυλος*).¹ If the cella and the vestibules are entirely surrounded by columns, the temple is peripteral (*περίπτερος*) or peristyle (*περίστυλος*). The earliest known example of this form is the Heraeum at Olympia. The typical Doric temple of the classical period is a structure with six columns at each end and from eleven to seventeen (most frequently thirteen) on each side. A few departures from the general type may be mentioned. Occasionally double temples, dedicated to two or more deities, occur, such as the Erechtheum at Athens. In some cases there was a room behind the cella, which might be, as in the Parthenon, a treasure chamber, or, as seems to have been the case in temples at Selinus, an inner sanctuary. In the Ionic temples at Ephesus and Didyma, near Miletus, there were two enclosed spaces, or antechambers, one between the cella and the pronaos, the other between the cella and the opisthodomus.

It is obvious that a broad cella needed interior supports for the roof. The earliest arrangement was a row of supports down the middle, dividing the cella into two equal aisles.

Interior supports Examples of this system are to be found in the old temple at Thermon, in Aetolia, the so-called Basilica at Paestum, and the early Ionic temple at Locri. It may be noticed in passing that this system resembles that seen in porticoes which bordered public squares. This is especially noticeable in the temple at Thermon (with five columns at each end and fifteen at each side), in which the outer and inner supports lined with each other. The row of central supports, a bad arrangement for a temple containing a single statue, was superseded by a scheme of three aisles, in which the central aisle was the widest; the door was at the eastern end, and the statue at the western

¹ The antae and the inner columns of the pronaos and opisthodomus of Ionic peripteral temples are in line with the columns of the peristyle, both at the ends and at the sides. No such rule prevails in Doric temples.

end. The earliest known example of this arrangement is the Heraeum at Olympia, where every alternate interior column was originally joined to the walls of the cella by a short wall, forming a row of chapels at each side of the nave. The interior columns lined with the outside columns, so that the roof had a good system of supports. Perhaps the original roof was a heavy flat terrace of earth. The connecting walls may have been removed and free interior columns put in when the temple received a pitched roof of wood and tiles. The three-aisled system was almost universally adopted, even where, as in the temple of Aphaia at Aegina, the width of the cella was not great enough to require interior supports.

The temples received the daylight only through the door, which was broad and high. It is probable, however, that artificial light was supplied by lamps. The theory, based upon a misunderstanding of the text of Vitruvius, that the Greek temple had a great opening (*hyphaethrum*) in the roof has been entirely abandoned,¹ and the windows in the eastern cella of the Erechtheum² are among the exceptional features of that remarkable building.

The development of Doric architecture may best be studied in the temples at Selinus, Girgenti, and Syracuse, all in Sicily, and at Metapontum and Paestum, in southern Italy, which exhibit interesting variations from the normal type of temple described above. The oldest temple at Selinus (temple C) and the Olympieum at Syracuse have the same number of columns as the Heraeum at Olympia (6 and 17), but no interior supports. At Selinus most of the temples had an inner sanctuary (*ἄδυτον*) for the statue and no opisthodomus, and in two the pronaos was omitted, but the cella could

Lighting
Temples of
Sicily and
Magna
Graecia

¹ At Bassae a roof tile was found in which is a hole measuring 8 by 12 inches, and similar tiles have been found at Pompeii. Such openings might serve to ventilate, or even to light, the space between the ceiling and the roof, but could hardly supply light to the cella.

² See *American Journal of Archaeology*, Vol. X, 1906, pp. 47-71.

still be closed by movable doors. In the great temple of Apollo at Selinus (Fig. 106), and the so-called temple of Ceres at Paestum

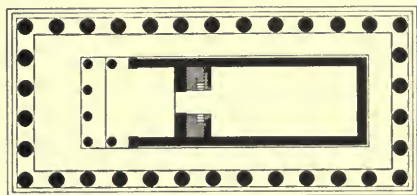

FIG. 104. — Plan of "temple of Ceres," Paestum. (Koldewey and Puchstein, Fig. 23.)

(Fig. 104), the pronaos was very deep;¹ in the temple of Apollo at Syracuse, there were two rows of columns before the pronaos. In temple F at Selinus, which had six columns at the ends and fourteen at the

sides, a stone barrier connected the columns up to half their height,

thus completely enclosing the peristyle.² The Olympieum (Fig. 105) at Girgenti was of colossal dimensions and instead of a peristyle had columns engaged in the walls, while on the upper part of the walls were male figures supporting the entablature. The temple measured on the upper step 46.30 m. by 113.45 m. (151 ft. 11 in. by 372 ft. 2½ in.),

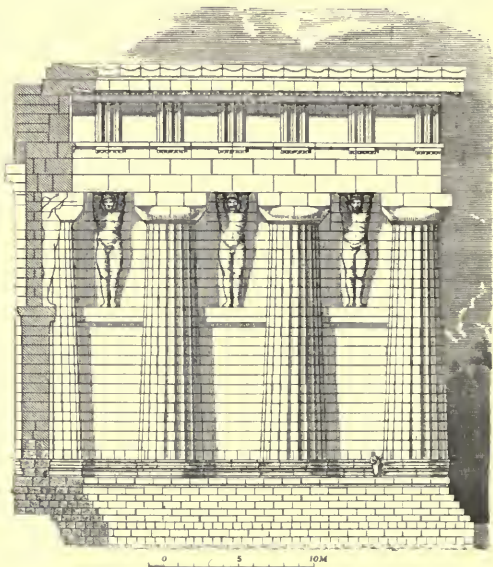

FIG. 105. — The Olympieum at Girgenti. (Koldewey and Puchstein, Fig. 143.)

¹ Similar deep vestibules appear in Etruscan and Roman temples.

² If the temple was dedicated to Demeter, the barrier may have been demanded by the peculiar needs of her cult.

and from the upper step to the top of the cornice 27.50 m. (90 ft. $2\frac{2}{3}$ in.). The interior was divided into three aisles of almost equal width, and the interior supports lined with the external piers. This mighty work was begun about 480 B.C. and was still unfinished when the city was sacked by the Carthaginians in 406. Another variation from the classical

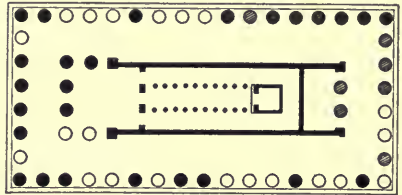

FIG. 106. — Plan of Temple of Apollo, Selinus. (Koldewey and Puchstein, p. 124.)

norm is seen in the temple of Apollo at Selinus. This also was of colossal size, measuring 50.11 m. by 110.36 m. (164 ft. 5 in. by 362 ft. 1 in.) on the upper step, and was never finished. It was a peripteral temple, with eight columns on the front and seventeen on the sides (Fig. 106); the entrance vestibule was unusually deep; the interior had three aisles of almost equal width, each with its entrance door, and at the end, opposite the middle door, was an enclosed space for the statue.

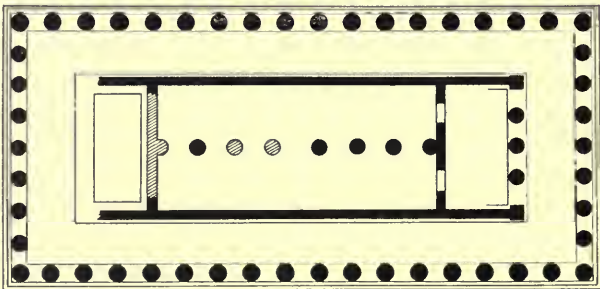

FIG. 107. — Plan of "Basilica," Paestum. (Koldewey and Puschstein, Fig. 15.)

At Paestum there are three important early Doric temples; the so-called Basilica, the so-called temple of Ceres, or Demeter, and the so-called temple of Poseidon. The "Basilica" has nine columns in front and eighteen on the side, and a pronaos *in antis*. A central row of columns divides the interior into two naves (Fig. 107). The

unusual decoration at the necking of the capitals (Fig. 108, a) is not exactly alike on all the columns. Similar decoration is seen on the capitals of the so-called temple of Ceres (Fig. 76, p. 114). These temples both have architraves, the top members of which are with-

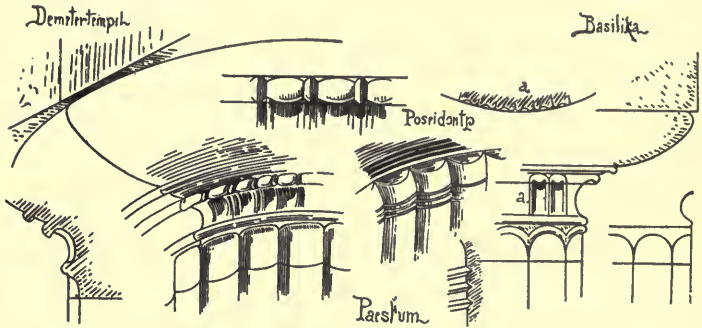

FIG. 108.—Necking of columns at Paestum. (Durm, *Baukunst der Griechen*, Fig. 68.)

out guttae and somewhat resemble the crowning mouldings of the Ionic architrave. The “temple of Ceres” has a Doric frieze, but the cornice is heavily coffered. The raking cornice has a short horizontal portion at each corner of the temple. The “temple

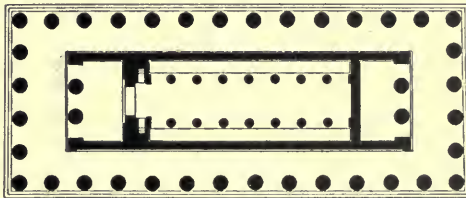

FIG. 109.—Plan of “temple of Poseidon,” Paestum. (Koldewey and Puchstein, Fig. 30.)

of Poseidon” conforms very closely to the normal type of the Doric temple. It has six columns on the front and fourteen on the side, with pronaos and opisthodomus *in antis* and a three-aisled interior (Fig. 109). On the upper step the temple measures 59.90 m. by 24.14 m. (196 ft. 6 in. by 79 ft. 2 in.). The proportions of the façades, the details of the mouldings, and the scientific bonding of the stones all testify to

the ability of the architect and his workmen. Between the pronaos and the cella were stairs leading upward. Within the cella two rows of Doric columns, each with a superposed row of smaller columns, also Doric, supported the roof. Many of these upper columns are still *in situ*, a fact which makes this temple especially important, for it is the only Doric temple which still gives us an idea of the original effect of the interior (see Fig. 83). The columns of the upper order have sixteen channels, those of the lower order twenty, and those of the outside order twenty-four.

On the coast of Asia Minor the temple at Assos is the only important early Doric temple. It had six columns at front and back, thirteen on each side, a pronaos *in antis*, no opisthodomus, and no supports within the cella. This is the only known Doric temple the architrave of which was decorated with reliefs.

Assos

In Greece proper were many early Doric temples, but the existing remains of most of them are unsatisfactory. The Heraeum at Olympia has already been briefly discussed, and mention has been made of the temple at Thermon, with its single row of interior supports. The temple of Apollo at Corinth, which can hardly have been built later than the first half of the sixth century, was the oldest known temple in Greece before the discovery of the Heraeum. Its heavy columns, with very noticeable diminution and entasis and wide, flaring capitals, proclaim its early date. In plan it seems to have had no peculiarities. On the Acropolis at Athens were several early Doric temples, the largest of which was the temple of Athena, 100 Attic feet (32.8 m.) in length. This had originally no peristyle, but at each end two columns *in antis*. Behind the large cella it contained three rooms, which may have served as a treasury, or may have been sacred to Poseidon-Erechtheus. In the latter part of the sixth century, probably under Pisistratus or his sons, a peristyle was added to the temple, which was also adorned with sculptures of Parian marble. So many fragments of this temple have been found that its plan and elevation are known in almost all details. The same is true

Greece
proper

of several smaller temples which once stood on the Acropolis, but were destroyed by the Persians in 480 and 479 B.C. The comparative elegance of the peristyle of the temple of Athena shows the progress of Doric architecture at Athens in the sixth century. The temple of Aphaia, at Aegina, which was built not far from 480 B.C., is better preserved than any of the earlier temples of Greece proper. It had six columns on the ends and thirteen on the sides, and in other respects its plan was normal. In its architectural details, as in its date, it stands between the old temple of Athena at Athens and the temple of Zeus at Olympia.

Olympia, the scene of the Olympic games in which representatives from all parts of the Greek world took part, was one of the most important centres of Hellenic life, and the temple of Zeus, in the Altis, or sacred enclosure (Fig. 110), was, though far less large than some of the great temples of Sicily, the most important and famous of early Doric temples. The building was begun before 460 and finished not long after 457 B.C. It was a peripteral temple with six columns at the ends and thirteen on the sides, with pronaos and opisthodomus, both *in antis*. A ramp at the eastern end provided an easy and dignified approach to the entrance. The temple measured, on the top step, 64.12 m. by 27.60 m. (210 ft. 4½ in. by 90 ft. 6⅔ in.), and the total height of the order, including steps and cornice, was 16 m. (52 ft. 6 in.). The material is a coarse stone, which was originally covered with white stucco. The tiles of the roof, the pediment groups, and the sculptured metopes in the pronaos and the opisthodomus were of marble; the outer metopes were not decorated. A wide door (4.75 m. or 15 ft. 7 in.) led into the cella, which measured 27.84 m. by 8.35 m. (91 ft. 4 in. by 27 ft. 1¼ in.) and had three aisles. Galleries over the side aisles were supported by columns, and the roof beams were supported, as at Paestum, by means of a second order. All the columns were Doric. The steps to the galleries were near the entrance. The central aisle was divided into three nearly equal parts. The part nearest the door seems to have been open to the public; the second part was raised

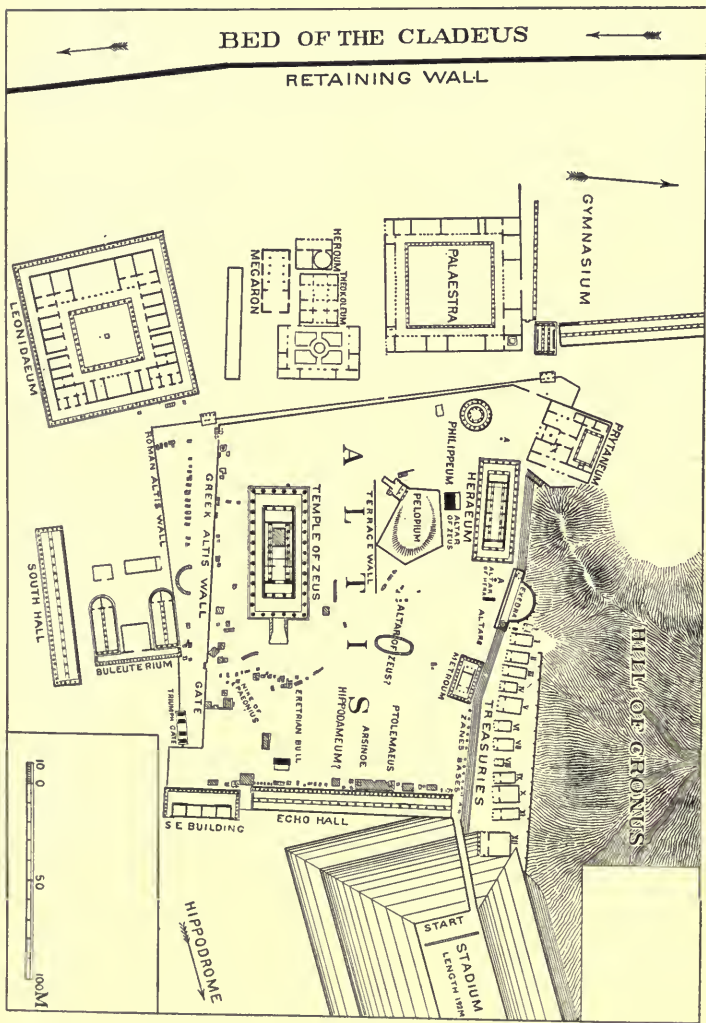

FIG. 110.—The Altis at Olympia. (Luckenbach, *Olympia und Delphi*, p. 11.)

about 0.10 m. (4 in.) and paved with a different material; the western part was occupied by a pedestal measuring 10 m. by 6.64 m. (32 ft. 9 $\frac{3}{8}$ in. by 21 ft. 8 $\frac{2}{8}$ in.) for the colossal chryselephantine statue of Zeus by Phidias. These last two thirds were shut off from the rest of the cella by stone screens or barriers adorned with paintings, but a passage was left from one aisle to the other behind the statue. The ceiling of the cella, as well as that of the peristyle, was of wood.

The precinct of Apollo at Delphi (Fig. 111) was second in importance only to the Altis of Zeus at Olympia. An early temple of

Delphi Apollo was destroyed by fire in 548 B.C. and a new one was erected at the expense of the Alcmeonidae of Athens. This was built of poros stone, but its front was of Parian marble. Little is known of the internal arrangements of this temple or of its predecessor, for the remains now existing belong almost entirely to a temple finished about 340-330 B.C. Within each of the successive temples was apparently a separate room, devoted to the use of the oracle; in this was the tripod, seated on which the priestess received the prophetic inspiration. The sacred precinct is situated on a series of artificial terraces on the lower slopes of Mt. Parnassus. The temple occupies the central position, and immediately to the north, on higher ground, is the theatre. The approach to the temple terrace is from the south, by a winding Sacred Way, which was bordered by votive monuments, statues, exedrae and "treasuries."

In comparison with the great number of early Doric temples in the western colonies and in Greece proper, the number of early **Early Ionic temples** Ionic temples, most of which are in Asia Minor, is small. At Neandria, a town in the Troad, are the remains of an early temple, which had columns with capitals of the so-called Aeolic type and the interior of which was, like that of the early temple at Locri, divided by a single row of supports. Of the temple of Artemis at Ephesus, one of the most important Ionic structures of the sixth century, unfortunately but few fragments remain. The decoration of the lowest drum of some of

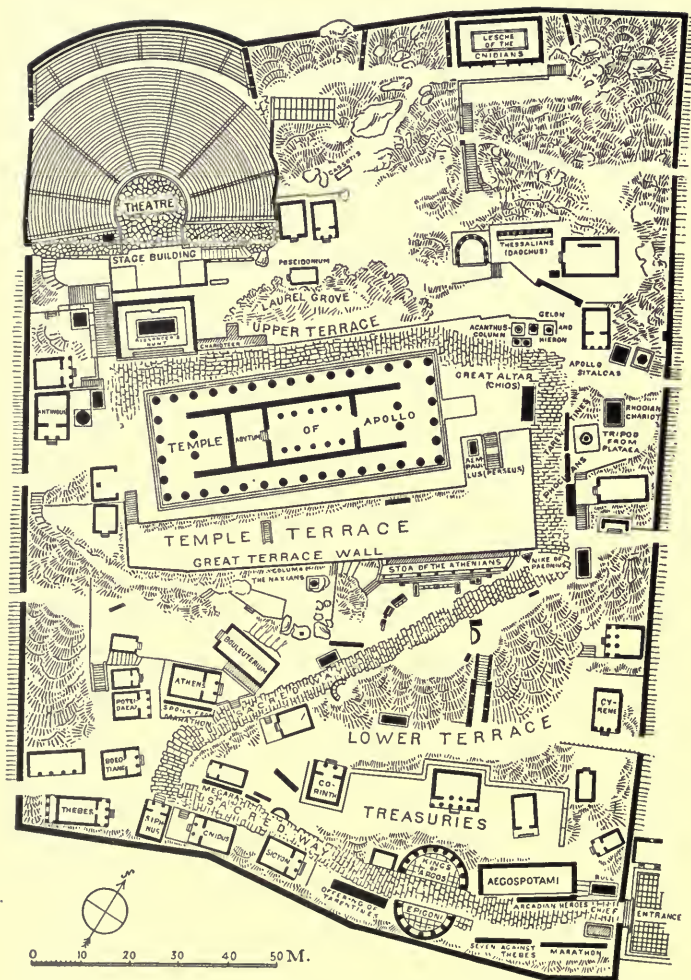

FIG. III. — The precinct of Apollo at Delphi.
 (Luckenbach, *Olympia und Delphi*, p. 45.)

the columns with figures in relief (Fig. 157) was a unique feature of this building.¹ After this temple was burned in 356 B.C., a new one was built on a magnificent scale by the architect Deinocrates, in which the same system of decoration was again employed (Fig. 195). The sanctuary of Apollo at Naucratis in Egypt and the temple at Locri in southern Italy were also early Ionic buildings, but at present little is known of them. Two large Ionic capitals of poros stone, found on the Acropolis at Athens, show that the Ionic style was known in Attica at an early date, though the original position for which these particular capitals were intended is not yet determined.

Even before the Persian invasions, Athens had been an important city and, under the rule of Pisistratus and his sons, a centre of literary and artistic production. But the increased **Athens** power and prestige which followed the victories at Marathon and Salamis and the formation of the Delian Confederacy made Athens the most conspicuous and most cosmopolitan city of the Hellenic world. It is not strange that both the Doric and the Ionic styles found there their most perfect expression. In 480 and 479 B.C. the Persians destroyed the buildings on the Acropolis, and it was natural that the Athenians should plan to rebuild on a scale corresponding with the increased importance of their city. Apparently, however, little was done at first, possibly because funds were needed for the prosecution of the war, but soon after the treasury of the Confederacy was removed from Delos to Athens glorious works of architecture began to rise, while the greatest Greek sculptors and painters vied with each other in decorating the buildings of the imperial city. The beginnings of the new Athens were doubtless made while Cimon was at the head of affairs, but the work was performed under Pericles, who is said to have employed Phidias as general superintendent.

¹ Excavations carried on in 1904 and 1905 by Mr. D. G. Hogarth disclosed the remains of a still earlier structure. In the centre was a rectangular base, probably for the sacred image. Many small votive objects of various materials were found near this base. (Hogarth, *Excavations at Ephesus*, London, 1908.)

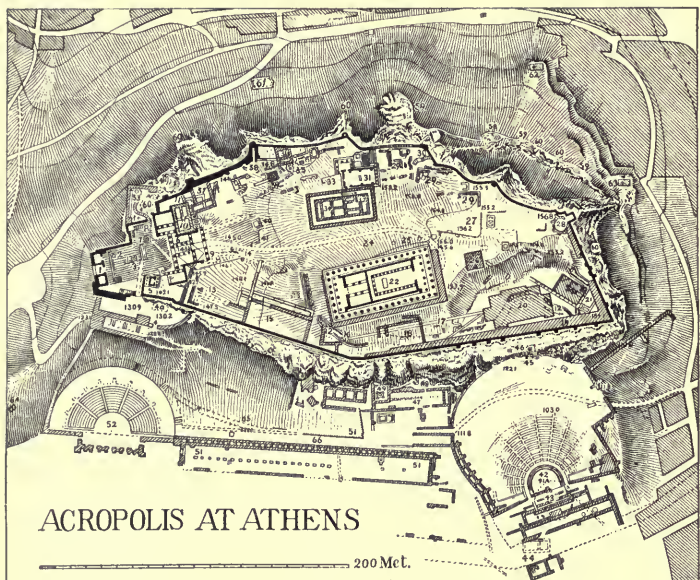

FIG. 112. — The Acropolis at Athens. (Curtius, *Stadtgeschichte v. Athen*, Pl. v.)

The Acropolis (Fig. 112) was the chief scene of action. Here was the Parthenon,¹ in size, plan, material, care in construction, nobility of sculptures, and beauty of proportion unequalled by any Greek temple (Figs. 113 and 114).

The Parthenon

The architects were Ictinus and Callicrates, and the temple, begun in 447 B.C., was dedicated in 438, though some details were still unfinished in 432. All parts above the poros foundations were of Pentelic marble. It was peripteral, with eight columns at the front and seventeen at the side. The pronaos and opisthodomus had each six columns behind the columns of the peristyle and were enclosed with metal gratings for the protection of offerings de-

¹ Even before the sack by the Persians, a temple was begun on the same site, the highest point of the Acropolis, but never finished. Its foundations, still visible, were longer than those of the Parthenon, but slightly less wide.

posited within. The temple measured 69.50 m. by 30.86 m. (228.026 ft. by 101.254 ft.) on the upper step, the height of the columns was 10.42 m. (34.188 ft.), and the total height from the ground to the ridgepole about 20 m. (65 ft.). The slender proportions of the columns (their height is $5\frac{1}{2}$ times their lower diameter) and the use of the bead and reel in the capitals of the antae and just above the triglyphs and metopes betray, perhaps, the influence of the Ionic order. The pediments were filled with groups of sculpture, reliefs filled all the metopes, and round the

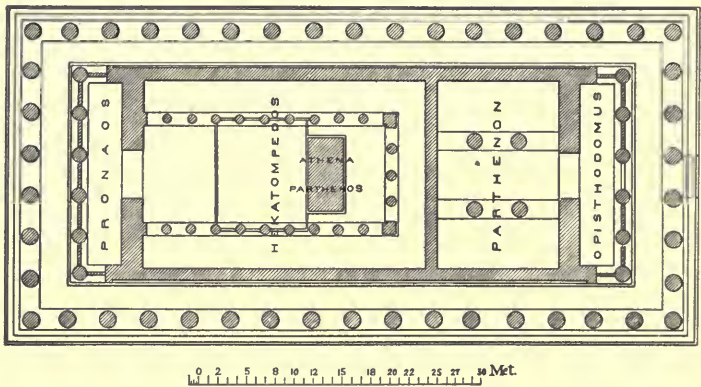

FIG. 113.—Plan of the Parthenon. (Dörpfeld, *Ath. Mitt.* VI., Pl. 12.)

top of the wall of the cella, on the outside, ran a continuous (Ionic) frieze about 1 m. (39.95 in.) high covered with reliefs (see p. 239). In its decoration the Parthenon was richer and more splendid than any other Doric temple. The interior consisted of two rooms. The principal cella, at the east, measured 19.19 m. by 29.90 m. (63.01 ft. by 98.145 ft.) and was known as the Hekatompedos, from the fact that its length was 100 Attic feet. It had a broad nave and two aisles. The supports of the roof were probably two-storied colonnades of the Doric order, one above the other; certainly the lower order was Doric, for traces of the fluting are still visible on the pavement. Near the western end,

opposite the door, stood the famous chryselephantine statue of Athena by Phidias, behind which was a colonnade in two stories, like those at the sides. The western room, to which the name Parthenon was at first confined, was probably a treasury, as it could be entered only from the west. It was only 13.37 m. (43.867 ft.) deep, and its width was the same as that of the



FIG. 114.— The Parthenon. (Photograph.)

Hekatompedos. The ceiling was carried by four interior supports, not of the Doric order, if one may judge by the traces they have left on the pavement.

The so-called Theseum (perhaps really a temple of Hephaestus) does not stand upon the Acropolis, but on a slight rise of ground a short distance to the northwest. It is of ^{The} about the same date as the Parthenon, but is much "Theseum" smaller and less elaborate in its constructional details and its

decoration. In plan it is a strictly regular peristyle temple, with six columns at the ends, thirteen on the sides, and two between the antae of the pronaos and opisthodomus. Its chief peculiarity, apart from the fact that it is raised upon only two steps, not three, is the introduction of continuous friezes across the pronaos and the opisthodomus. The sculptures of the "Theseum" are described elsewhere (see p. 245 f.). To the student of architecture the building is important because its exterior columns, its walls, and entablature are all in place, and it is the only Greek temple which still preserves the essential features of its original appearance (Fig. 75).

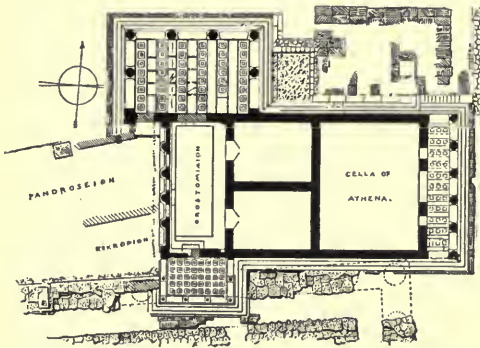

FIG. 115. — The Erechtheum. Plan. (Drawing by G. P. S.)

The Ionic style of Attica reaches its perfection in the Erechtheum (Fig. 115). This temple, which lies about 200 ft. north of the Parthenon, was begun not far from 420 B.C., and was practically finished in 409. The main building measures 22 m. by 11.30 m. (72.18 ft. by 37.07 ft.). At the eastern end was a portico with six Ionic columns 22 ft. high. In the wall behind were two narrow windows, one at each side of the door that led into the cella of Athena, which had a flat coffered ceiling of wood with painted decoration. On the north side a flight of outside steps led down about 9 ft. from the level of the eastern front to that of the northern and western entrances. The beautiful north porch, with four columns, somewhat taller than those of the eastern portico, on its front and two on its sides, leads, through a door of wonderful beauty (Fig. 116), into the western cella, the cella of Poseidon-Erechtheus. The ceiling of the north

The Erechtheum

The Erechtheum

porch was composed of marble beams 20 ft. long, which supported marble coffers, each of which had a gilded rosette in the centre. An opening in the floor discloses some fissures in the rock, which were doubtless regarded as the marks made by the trident of Poseidon when he contended with Athena for the possession of Attica. The porch overlaps the western end of the temple, and

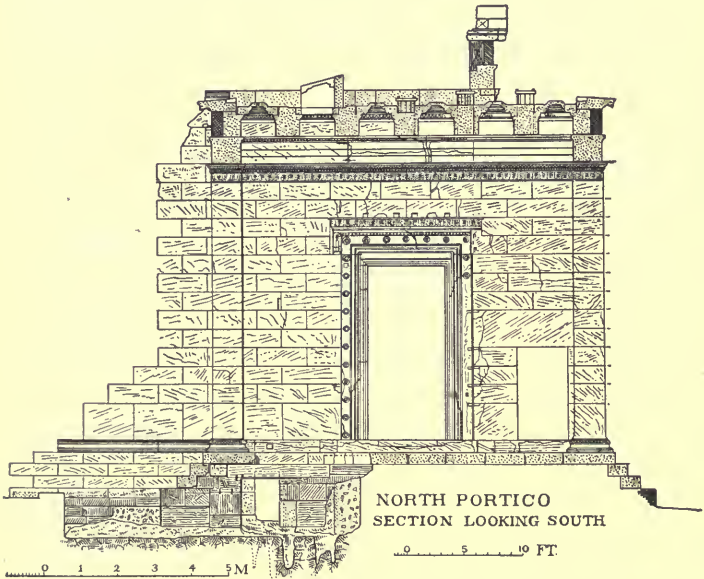

FIG. 116.—The Erechtheum. North portico. (Drawing by G. P. S.)

so gave access through a small doorway to a precinct called the Pandroseum, where grew the sacred olive tree. From the Pandroseum the western cella was entered by a simple doorway pierced in a wall about 10 ft. high. On this wall rose four columns, half engaged for about a third of their height (Fig. 117). The three windows seen in most restorations are of Roman date. Originally the southern intercolumniation was probably filled by some part of the tomb of Cecrops, which lay partially under the

southwest corner of the Erechtheum, and the four others were filled with wooden grilles. At the western end of the south side of the building, and on the same level as the eastern front, was a third portico. Here maidens (Caryatides), standing on a parapet 6 ft. high, carry the entablature, which consists merely of architrave and cornice, without a frieze, as if to lighten the load borne by the Caryatides. Through this porch a small entrance, evidently not intended for general use, led into the western cella.

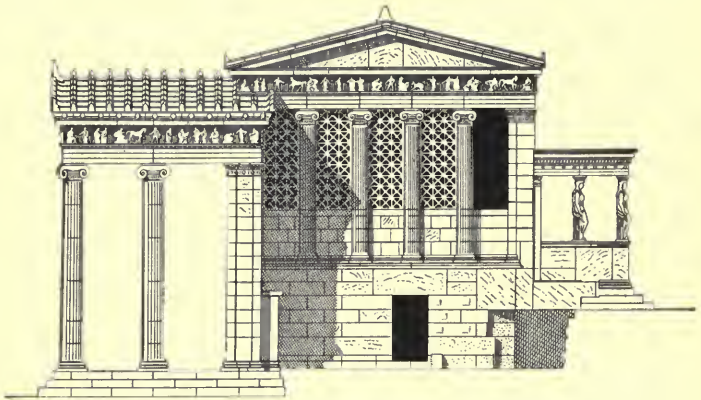

FIG. 117. — The Erechtheum. Western elevation. (Drawing by G. P. S.)

A corridor, beneath which was a tank, connected the north porch and the porch of the maidens ; and the rest of the cella was probably divided by walls about 10 ft. high into two rooms, each of which was connected with the corridor by a double door of marble with inlaid decoration. No stairs and no door connected the eastern with the western cella. A frieze of dark limestone, decorated with a continuous band of white marble figures, ran round the outside of the entire building (see p. 248). In novelty of plan, in variety and beauty of architectural decoration, the Erechtheum is unsurpassed, and it is justly regarded as the most charming monument of Greek architecture.

At Bassae, in Arcadia, on a lonely rocky height, is an interesting temple, dedicated to Apollo Epicurius and said to be the work of Ictinus, the architect of the Parthenon. It forms an **Bassae** exception to the general rule, for its greatest length is (**Phigaleia**) from north to south, and its entrance is at the northern end.¹ It was a Doric peripteral temple, with six columns on the front and fifteen on the side, and with pronaos and opisthodomus *in antis* (Fig. 118). Within were a small room, probably for the cult statue, with a special entrance from the east, and a large room, from each side wall

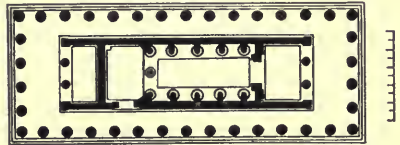

FIG. 118.—Plan of temple at Bassae. (Borrmann, *Geschichte der Baukunst*, I, Fig. 112.)

of which (as had been the case in the Heraeum at Olympia; see p. 135) five short walls projected, which ended in engaged Ionic three-quarter columns. The capitals of these columns had curious volutes, which projected diagonally at the corners. In the entablature above these columns was a frieze decorated with vigorous and animated reliefs (see p. 249). Between the two rooms and lining with the last two Ionic columns stood a Corinthian column, perhaps the earliest known example of this order. The temple at Bassae was the first in which the three orders were combined.²

The beginning of a new period, that of Alexander the Great, is marked by the erection of three important Ionic temples in Asia Minor; the temple of Artemis at Ephesus, the temple of Didymaeon Apollo near Miletus, and the temple of **Ephesus** Artemis Leucophryene at Magnesia. The colossal temple of Arte-

¹ This may be explained on the assumption that the larger room was a sort of courtyard, open to the sky, and that the smaller room was the real temple, which thus had its entrance at the east (see Fig. 118).

² The temple of Athena Alea at Tegea, probably erected early in the fourth century, since Scopas is said to have been the architect, had Doric columns in the peristyle, Ionic columns in the pronaos, and Corinthian columns within the cella.

mis at Ephesus, begun soon after the old temple was burned in 356 B.C., had two rows of columns on each side,¹ twenty in a row, and two rows of eight columns each on the front. Its size, reckoned from the axes of the corner columns, was 104.48 m. by 48.55 m. (nearly 343 ft. by 160 ft.). It had a pronaos and an opisthodomus, both *in antis*, and each of these was separated by an enclosed room from the cella proper, which was divided into three aisles. The exterior columns were 18 m. (about 59 ft.) high, and the lowest drums of some of them were decorated with reliefs (Fig. 195). Square pedestals, also decorated with reliefs, supported the front row of columns, and behind them the podium on which the cella rested rose in nine steps.

The temple of Didymaeon Apollo, at Didyma or Branchidae, near Miletus, was also dipteral. It had 10 columns on the front and 21 on the side and measured 48.55 m. by 107.75 m. (nearly 160 ft. by 353 ft.) between the axes of the corner columns. It had a pronaos but no opisthodomus, and there was here also a small room before and behind the



FIG. 119. — Pilaster capital. Didyma. (Borrmann, *Geschichte der Baukunst*, I, Fig. 94.)

cella. According to Strabo, the interior had no roof. The temple was evidently never finished, and certainly the work was continued for a long time. Perhaps a roof was

intended but never built. The sculptured bases and capitals of some of the columns are rich and unusual, and the capitals of the pilasters which enlivened the interior wall of the cella and lined with the outside columns are exceedingly interesting (Fig. 119).

¹ Such a temple, with double peristyle, is called dipteral (*δίπτερος*). If there is only one row of columns, but that is set two intercolumniations from the wall of the cella, the temple is called pseudodipteral (*ψευδοδίπτερος*).

The Artemisium at Magnesia was reconstructed about 200 B.C. by the famous architect Hermogenes, who removed the inner row of columns which encircled the cella and substituted engaged columns, along the cella wall, thus making a Magnesia dipteral temple pseudodipteral. In beauty of proportions, but not in size, this temple surpassed the other two. Its details, however, were weak when compared with work of the best period (Fig. 120). The frieze was decorated with lively, though rather coarse, reliefs representing the battle of Greeks and Amazons.

In the famous Serapeum at Alexandria, erected under The Sera- the Ptolemies, peum a temple was combined with a library. It stood upon a great terrace approached by more than 100 steps. A domed gateway (propylaeum) led into a courtyard, which had 67 columns on its longer, and 16 on its shorter sides. In the courtyard was a basin of water (probably a fountain) for religious purposes. The library was connected with the courtyard. Beneath the terrace were vaulted rooms, in which the sacred mysteries were performed. Greek and oriental elements were combined in this complex structure, which served in some respects as a model for the great terraced temples of late Greek and Roman times, such as those at Pergamon, Baalbek, and Praeneste.



FIG. 120.—Entablature and sima. Magnesia. (Humann, Kohte, and Watzinger, *Magnesia*, Pl. 5.)

Within the temple enclosures at Olympia (Fig. 110) and Delphi (Fig. 111) were so-called treasure houses of modest dimensions erected by various individuals and cities. In these **Treasuries** were stored votive offerings, weapons, and other things of value. The buildings probably served also as gathering places for the people who came from the cities by which they were erected. The treasuries at Olympia were arranged in line on a conspicuous terrace; they were all of Doric style, and all but one had fronts *in antis*. In the treasury of Gela the stone cornice was encased in a sheathing of terracotta, fastened on with nails (Fig. 79). As such terracotta sheathing has been found at Gela, Selinus, and Syracuse, in Sicily, and at Metapontum, Locri, and many Etruscan sites, its use in the treasury of the Geloans at Olympia may be regarded as an importation into Greece of a Sicilian custom. At Delphi the treasury of the Cnidians (Fig. 103), which dates from the end of the sixth century B.C., is one of the earliest examples of Ionic architecture in Greece proper. The qualities of Ionic art are clearly marked in the cornice, mouldings, and decoration. The frieze is adorned with a continuous band of reliefs (Fig. 159). At the front, two Caryatides on high pedestals stand between the antae in place of columns, and the entrance door has a treatment similar to that of the north door of the Erechtheum.

A further step in the progress of Greek architecture was the combination of a round building with a colonnade. Unfortunately the purpose of these round buildings is not very clear. The Philippeum at Olympia, built by Philip II in commemoration of the battle of Chaeronea (338 B.C.), contained gold and ivory statues of the Macedonian royal family. On the outside was a circular colonnade of eighteen Ionic columns, and in the interior, which was lighted by windows, were nine engaged Corinthian columns on a high continuous base. The round building within the sacred precinct of Asclepius, at Epidaurus (Fig. 121), was begun earlier,

Round buildings but not finished until the end of the fourth century. Polyclitus the younger is said to have been the architect. It was, chiefly on account of its rich and luxuriant orna-

mentation, one of the most striking buildings of classical times. The foundations consist of concentric rings, on which rested the walls, columns, and pavement. The building, 14.50 m. (47.57 ft.) in diameter, was surrounded by a colonnade of 26 late Doric columns; in the middle of each metope was a large rosette; and within the building was a second ring of columns, here Corinthian. Both colonnades had marble coffered ceilings extending to the cella wall. The entablature of the inner Corinthian order consisted of an Ionic architrave, a frieze with a curved profile, and a cornice which harmonized well with the marble ceiling toward the wall and the wooden ceiling over the centre of the cella. The interior was adorned with paintings by Pausias. The round building erected at Samothrace by Arsinoë before her marriage with Ptolemy II was of somewhat different character. It was a two-storied structure, measuring 19 m. (62.34 ft.) in diameter. The lower part had no decoration except the door and its casing; the upper part had 44 pilasters outside and Corinthian half columns inside. The roof seems to have been of conical form. In Roman times round buildings with exterior colonnades were not uncommon.

The sacred precinct that surrounded the temple was generally entered through monumental gateways called *propylaea*, similar to the entrances of Mycenaean palaces. They consisted of a portico facing the approach and a second Propylaea portico facing the temple precinct. The passages between these porticoes could be closed by swinging doors or grilles. There was great freedom in the choice of supports, which might be square, octagonal, or round.

The most imposing of these structures was that at Athens (Fig. 122), where, situated at the west end of the Acropolis, it formed the monumental entrance to the sacred precinct. It was designed

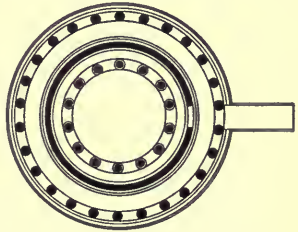

FIG. 121. — Round building at Epidaurus. (Borrmann, *Geschichte der Baukunst*, I, Fig. 115.)

by the architect Mnesicles and erected during the years 437-432 B.C., upon sloping, rocky ground, where a simpler gateway had stood in earlier times. The western front of the main building consisted of a Doric portico, with columns 8.53 m. to 8.57 m. (28 ft.) high, surmounted by a pediment. At each side a wing with Doric columns 5.776 m. (19 ft.) high projected toward the west. These were intended to be symmetrical, but the southern wing was not finished in accordance with the original plan. The southern

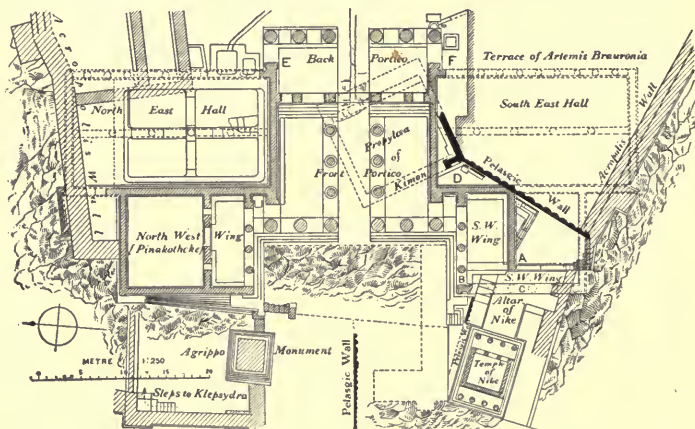

FIG. 122.—Plan of Propylaea. Athens. (J. E. Harrison, *Mythology and Monuments of Athens*, p. 352.)

wall of the northern wing is pierced by a door and two windows. This wing is called the picture gallery, or Pinakothek, because Pausanias says it contained paintings. The nature of the walls renders the supposition that they were covered with mural paintings inadmissible. The eastern façade had also a Doric hexastyle portico and a pediment. To the right and left of this, large open porticoes had originally been designed, but the plan was never carried out. The interior of the main building was 18.12 m. (59.45 ft.) wide, and had three aisles, the middle one of which was higher than the others. Five passages led into the sacred

precinct, the central one of which, broader than the rest, had no steps, in order that it might be used for vehicles, sacrificial animals, and processions (Fig. 123). The other passageways had steps before the doors in the wall that separated the eastern and the western porticoes. The entrances were closed by massive gates. The interior supports, along the central passage, are Ionic columns 10.25 m. ($33\frac{1}{2}$ ft.) high, the architraves above which rested upon the architraves of the western façade and lined with those

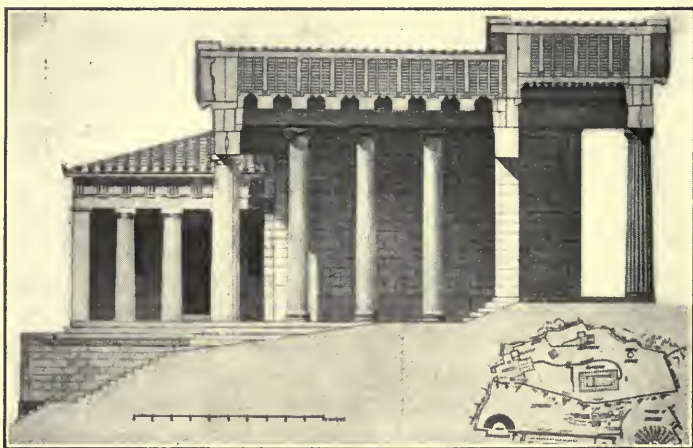

FIG. 123.—Propylaea. Athens. Section. (D'Espouy, *Fragments d'architecture antique*, Pl. 2.)

of the eastern front. The use of the Ionic and Doric orders together is so managed as to seem simple and natural. The ceilings of the main building were, like the walls, columns, and entablatures, of Pentelic marble throughout. They were of wide span, for the distance between the interior columns, from north to south, was 5.44 m. (17.84 ft.), the free span in the aisles 5.42 m. (17.78 ft.), and that in the eastern portico 5.44 m. (17.84 ft.).

In the propylaea at Eleusis, the central part of the propylaea at Athens was closely copied. At Priene the gateway of the precinct of Athena had a simple façade with four columns facing out-

ward, and on the side toward the precinct a small square hall, and again a façade with four columns. At Samothrace the propylaea had an ample façade with six columns raised upon a high podium in which was an arched passage for a stream. So the details of propylaea varied with circumstances, but their general form was that of a hallway with a façade like that of a temple at each end.

CIVIC ARCHITECTURE

Only in comparatively recent years have excavations at Olympia, Pergamon, Eleusis, Megalopolis, Ephesus, Miletus, Priene, Delphi, Epidaurus, Delos, and other places made known the typical forms of Greek public buildings.

The Bouleuterion, or council house, at Olympia (Fig. 110) exhibits in plan a relatively early arrangement. It consists of a **Bouleuterion** square central space and two long wings, each terminated at Olympia by an apse, a form which seldom occurs in Greek architecture. One of these apses is semicircular, the other semi-elliptical. The square central room seems to have been used by the *boulé* or council, and probably contained the statue of Zeus Horkios, the protector of oaths, before which the athletes swore that they had undergone the prescribed ten months' course of training, and would obey the regulations of the games. Each of the side buildings was divided into two aisles by a row of columns in the middle, representing in this respect the same stage of development as the two-aisled temples, and the apses were separated from the principal rooms by walls with strong doors. The principal rooms were probably offices and the apses treasuries or archives. Each side building had at the entrance three Doric columns between antae, and the Doric triglyph decoration was carried along the side walls and round the apses. There were only five guttae on the *regulae* instead of the usual six. A long Ionic portico formed a common front for the three parts of the Bouleuterion.

At Eleusis was a large Telesterion, or hall, in which the Eleusinian mysteries were performed (Fig. 124). It occupied the site of

two earlier temples destroyed by the Persians. In 480 B.C. the work, but interrupted under the Persians, was restored in 480 B.C.

In 396 A.D., when the temple under Alaric, are said to have destroyed the building. The portico of Philon, which formed the front of the building, had twelve Doric columns, with two others behind those at the corners, and was 55.91 m. (183.44 ft.) long and 11.50 m. (37.73 ft.) deep. Two entrances led from the portico into the interior, a room 54.15 m. (178 ft.) long and 51.80 m. (170 ft.) wide, which resembled an Egyptian hypostyle hall, as its ceiling was supported by forty-two columns disposed in six rows. Around the walls ran eight tiers of seats, partly cut in the living rock. There were also side entrances. Behind the hall and approached by steps cut in the rock was a rock-cut terrace, which probably gave access to a second story supported by the columns of the ground floor. Only the initiated were allowed to take part in the mysteries,—a fact which may perhaps explain the enclosed character of the structure.

The assembly hall at Megalopolis (Fig. 125), called the Thersilion in honor of its founder, was larger than the Telesterion at Eleusis, for it measured 61 m. by 52 m. (about 200 ft. by 170 ft.) and could accommodate all the delegates from Arcadia, 10,000 in number. It had a Doric portico which bordered upon the orchestra of the theatre; within, the speaker's position was almost in the middle of the hall, and seats for hearers rose in rectangular tiers on all sides. The columns

was destroyed by the Persians. In 480 B.C. the work, but interrupted under the Persians, was restored in 480 B.C. In 312 B.C., Telesterion at Eleusis was also destroyed. The mysteries were discontinued in

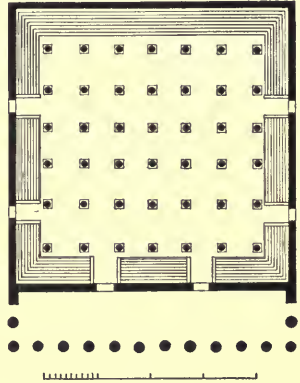

FIG. 124. — Telesterion at Eleusis. (Borrmann, *Geschichte der Baukunst*, I, Fig. 120.)

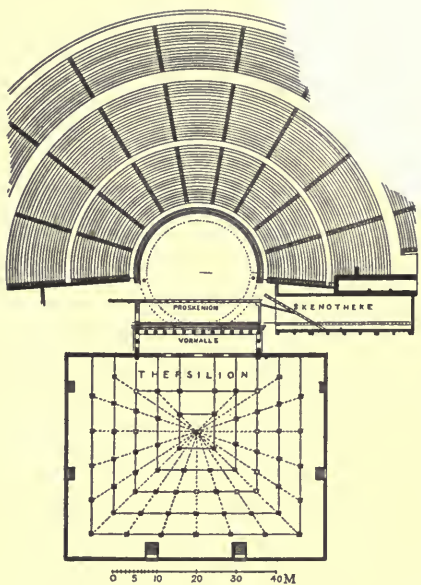

FIG. 125. — Thersilion at Megalopolis. (Borrmann, *Geschichte der Baukunst*, I, Fig. 121.)

four radiating flights of steps which divide the seats into three sections. It has two entrances at the back and four in front of the seats. Before the hall was a court, in which stood an altar, and the entrance to the court was through a propylaeum, so that the whole formed an imposing *ensemble*. The Bouleuterion at Priene was similar, but had no forecourt.

Apart from the types just described, Greek civic buildings were chiefly colonnades cleverly adapted to their special purposes. Porticoes or stoae bordering on public squares and in-

ported the roof arranged that possible visitors could eaker. The near the centre a 2.50 m. (8.20 ft.) lower than those farthest away, for the floor rose in steps toward the walls.

Other halls for meetings had a horseshoe form, with Bouleuterion seats arranged as in a theatre. Among these the Bouleuterion at Miletus (Fig. 126) is remarkable. It is semicircular, and has

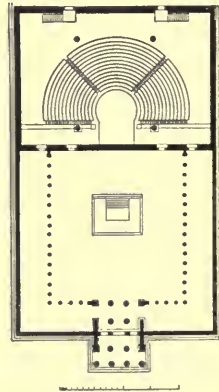

FIG. 126. — Bouleuterion at Miletus. (Borrmann, *Geschichte der Baukunst*, I, Fig. 122.)

tended for the administration of justice had sometimes several aisles and sometimes a second story. Generally the interior supports ranged with every second column of the façade. The basilica of Roman times was perhaps derived from the three-aisled stoa, and it is even possible that the name "basilica" comes from the name of the stoa at Athens in which the Archon Basileus administered justice. At Priene the administrative stoa had two aisles, and at the rear were rooms for private offices or for the safe keeping of money or documents.

A second variety of stoa was devoted to the comfort of the people for protection from the sun or rain, for the Greeks lived but little indoors, and spent their days chiefly in public places. Here the citizens would congregate to discuss matters of public interest, and here, too, the philosophers would gather their disciples. Such stoa were sometimes of great length, especially in Hellenistic times. They generally had two aisles; the Stoa of the Coryraeans at Elis had, however, a dividing wall down the middle, with two aisles on each side of it.

Leschae (*λέσχαι*), or places for conversation, were also a variety of stoa. Their purpose was somewhat similar to that of modern clubs, and indeed the modern Greeks use the word "lesche" to designate a club. The lesche of the Cnidians, at Delphi, measured 17 m. by 18 m. (about 56 ft. by 59 ft.), and two rows of four columns each divided the interior into three aisles. The famous painter Polygnotus decorated the walls with scenes from the Trojan cycle of myths.

The Leonidaem at Olympia (Fig. 110) shows a more developed use of the portico. It was built at some time in the fourth century by a certain Leonidas, and although it was rebuilt in Roman times, the general scheme does not seem to have been changed. It consisted of a central court 29.67 m. (97.35 ft.) square surrounded by Doric porticoes. The outside (80.18 m. by 78 m., or about 263 ft. by 256 ft.) was adorned on all sides with an Ionic colonnade, which gave the building a very impressive appearance. Between the outer and inner colonnades were small

connecting rooms, some of which were apparently used for administrative purposes, and others for the lodging of honored guests.

The gymnasia, where young men received both physical and mental instruction, seem to have risen to special importance at the end of the third century. They consisted of a

Gymnasia large central court, which was used as the exercising place for the runners, wrestlers, boxers, and other athletes, and which was surrounded by colonnades and connecting rooms; in addition there was a smaller court, called the palaestra, communicating with the larger court and surrounded in its turn by rooms for dressing, exercising, lectures, and other purposes. The palaestra was the school in which boxing, wrestling, and other exercises were taught; and in some of the rooms courses of mental instruction were given. The gymnasium at Olympia (Fig. 110) agreed with the theoretical description given by Vitruvius in that it had two parts, the palaestra and the gymnasium proper; the palaestra measured 66.35 m. by 66.85 m. (217.69 ft. by 219.33 ft.) and was a completely enclosed building on the outside. Within there was a court 41 m. (134.52 ft.) square surrounded by Doric porticoes. The portico at the south end of the court had two aisles; from those on the other sides opened apartments of various kinds, with Ionic columns at the entrances, which may have served as lecture rooms, dressing rooms, etc. Some of these still contain their ancient stone benches running round the walls. The entrances to the palaestra were symmetrically placed at the eastern and western corners of the southern façade, and consisted of small vestibules, each with two Corinthian columns between antae. These vestibules were so arranged as to prevent passers-by from looking in, and also to hinder the entrance of a direct draught of air.

Immediately to the north of the palaestra was the main gymnasium, an open exercising place, more than a stadium in length and surrounded by colonnades. Here all the competitors in the great games had to spend at least the last month of their period of training under the eye of an official. The southern colonnade

of the gymnasium abutted on the northern wall of the palaestra; how far it extended towards the west is unknown, as its remains have been destroyed by the changes of the bed of the river Cladeus. The eastern colonnade was in the Doric style, and was divided into two aisles. It was nearly 220 yards long, and was evidently used as a race course in bad weather, for it had the same arrangements for the start which are seen in the stadium. The entrance to the gymnasium was at the southeast corner, through a propylaeum which dates from the Roman period.

At Epidaurus the Greek Archaeological Society has excavated an exceedingly well-planned gymnasium (Fig. 127). It measures 75.36 m. by 69.53 m. (247.26 ft. by 228.13 ft.) and has a stately entrance propylaeum at the northwest corner.

In the rich cities, especially in Hellenistic times, the intellectual uses of the gymnasia often became very important. At Alexandria, for example, under the Ptolemies, the Museum, which was a developed gymnasium, might almost be called an academy of sciences. Unfortunately little is known about this famous building, except that it included extensive gardens, fountains, porticoes, a library, and a spacious restaurant.

The best known of the stadia, in which festival games took place, were at Athens, Delphi, Olympia, Nemea, the Isthmus of Corinth, Messene, and Epidaurus. At Olympia the simplicity of the stadium contrasted strongly with the importance of the games. It was a rectangle, measuring 214 m. by 32 m. (about 702 ft. by 105 ft.). The northern side rested upon the slope of a hill, and on the other three sides were merely artificial embankments of earth. There were no especially

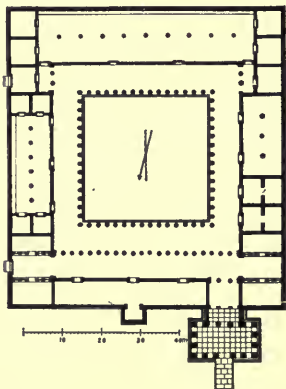

FIG. 127.—Gymnasium at Epidaurus. (Borrmann, *Geschichte der Baukunst*, I, Fig. 123.)

Stadia

constructed stone tiers of seats. The course was drained by a channel for rain water. The start and finish of the course are marked by lines of white limestone sills, with holes for upright posts to separate the runners. The course from start to finish is a straightaway dash of 630.80 English feet or 600 Olympic feet, one of the most important measures of antiquity.¹ In Roman



FIG. 128. — Stadium at Athens. (Photograph.)

times the earthen embankments were made higher to increase the seating capacity, and an arched entrance leading from the Altis was built. The hippodrome, for chariot races, which lay immediately southeast of the stadium, has been completely washed away by the river Alpheus. A late Greek manuscript mentions that the distance once round the course was eight stadia (about

¹ A stadium was everywhere 600 feet, but the foot used as a unit was not the same in different places.

233 ft. less than a mile). The peculiar arrangement for the start is minutely described by Pausanias (VI, 20, 7).

The stadium at Epidaurus dates from the Hellenistic period. It has, like the stadium at Olympia, square, not curved, ends. Its length is 181.08 m. (594.12 ft.). The start and finish are indicated by a line with iron pegs, and there are columns every hundred feet to separate the runners and to mark the distance.

The stadium at Athens, laid out in 330 B.C., was formed by the artificial expansion and adaptation of a natural hollow between two hills. About 140 A.D. seats of Pentelic marble were added by Herodes Atticus, whose example has recently been followed by Mr. Averoff of Alexandria, so that to-day the stadium at Athens, in which the modern "Olympic Games" are held, is entirely of white marble. The length of the plot of ground within the stadium is 670 ft.; there are about fifty rows of seats, and accommodation for 50,000 spectators (Fig. 128).

The most important Greek edifices, after the temples and perhaps the stoaes, are the theatres. The Greek drama developed from the songs and dances at the festivals of Dionysus. At first, perhaps, a chorus sang and danced Theatres about the altar, and the spectators gathered round in a circle. As the performance became more dramatic, its outward setting remained the same—a circular place, the orchestra, about an altar. Then seats for the spectators were provided, rising in tiers on a slope, that all might see. The seats were at first only the natural side of a hill, or were made of wood, but later they were constructed of stones bedded on the slope or on artificial foundations, as the nature of the ground demanded. These stone seats were so cut as to give room for each spectator to dispose of his feet without incommoding the person in front of him. At Eretria and some other places, the theatre did not lean against a hill, and doubtless some theatres never had seats of stone. The seats of Greek theatres embrace considerably more than a semicircle, and the parts beyond the semicircle are either straight (tangential) or on a curve of greater radius than the semicircle,—

an arrangement which gave to those occupying the end seats a better view than if the curve of the semicircle had been continued. In most cases the seats were divided into a lower and an upper section by a horizontal passage (*diazoma*) about halfway up. They were also divided into wedge-shaped divisions by radiating flights of steps about two feet wide. The seats of honor were nearly on the level of the orchestra, from which they were separated by a passage.

The third part of the theatre, at first far less important than the orchestra or the tiers of seats, was the scene (*σκηνή*, *scaena*), originally merely a booth or some other simple structure which served as a dressing room for the actors. It was not connected with the seats. As time went on, the scene building was enlarged. It now contained permanent dressing rooms and places for storage, and its different parts received distinct names. Between the ends of the scene building and the auditorium were the *parodi* (*πάροδοι*), or entrances for the chorus, which could be closed by doors. The arrangement and purpose of some of the parts of the scene building are as yet uncertain. There was the scene proper, or players' booth, and the *proscenium* (*προσκήνιον*), a covered place six to ten feet wide and ten to thirteen feet high, between the scene and the orchestra. The *proscenium* had a front wall composed of columns half engaged, between which were movable painted wooden panels. Its roof, which was carried on beams of wood or stone, was flat or slightly inclined. Sometimes one central door, sometimes three doors, gave the players direct access to the orchestra. Sometimes two symmetrically projecting wings, called *parascenia* (*παρασκήνιαι*), which seem to have been used as storerooms, extended into the orchestra. As a rule, the central part of the scene building had apparently an upper story, which served as a background, though it received no decorative treatment.

The point in doubt is whether the *proscenium* was used as a stage or merely as a background, before which the players performed in the orchestra. The supporters of the latter view admit

that actors representing gods, and even other actors in certain cases, may have spoken from the top of the proscenium, and steps seen in some theatres indicate that access to the top of the proscenium was provided for. But the Greek proscenium was too narrow to accommodate the action of a play. It differed greatly from the stage of Roman times, and still more from that of to-day. In Hellenic times the play was apparently performed on the level ground of the orchestra, and the actors were distinguished from the chorus only by their costume and their action.¹ It was not until Roman times that the actors were separated from the chorus and raised upon a higher speaking place (*λογεῖον*). In the Greek theatre the orchestra remained a circle, in the centre of which was the altar of Dionysus. It is highly probable that theatres were often designed with a view to more than one purpose, since they were used not only for dramatic performances, but also for public assemblies of various kinds.

Nearly all Greek theatres were restored and changed in Roman times, and therefore the remains of earlier structures are few and not always clear; but there is enough to show that in the first stone theatre at Athens and in the theatre at Eretria,² both of which are as early as the fourth century B.C., and also in the theatre at Segesta, the scene building had two wings (*parascenia*) projecting toward the orchestra. There is, however, no indication that a solid wall or permanent structure (proscenium) existed between these wings, at least not until after the middle of the third century.

The theatre at Megalopolis (Fig. 125) presents a number of peculiarities. It dates probably from the fourth century. The

¹ There are no remains which illustrate the scenic arrangements of the fifth century B.C., and not all scholars accept for that time the theory here briefly presented.

² A feature of special interest in this theatre (which is, however, not unique) is a subterranean passage leading from the scene building to the middle of the orchestra. This would permit an actor to appear and disappear at that point.

diameter of the orchestra is 30.16 m. (about 99 ft.). It is the largest theatre in Greece, having twice the seating capacity of the Theatre at Athens. There are two *diazomata*, which Megalopolis divide the seats into an upper, a middle, and a lower section. On the tangent to the orchestra rose the stately Doric façade of the Thersilion, and therefore, on account of the cramped space, the dressing rooms were placed at one side. Part of the orchestra was cut off by a proscenium with fourteen stone columns and with piers at the ends. As there are no traces of a wall or a platform behind these columns, it would seem that the proscenium must have served as a background.

The scene building of the theatre at Delos was also remarkable (Fig. 129). It was a rectangular building, with three doors toward the orchestra and one at the back, surrounded by porticoes of equal height on all sides. On the side toward the orchestra were piers with engaged columns which were

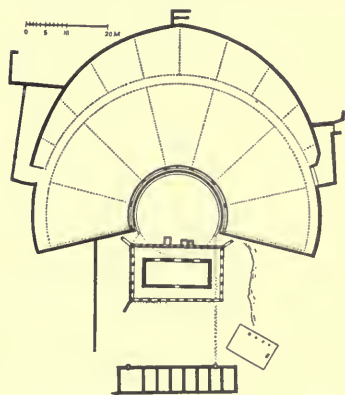

FIG. 129. — Theatre at Delos. (Borrmann, *Geschichte d. r. Baukunst*, I, Fig. 126.)

much nearer together than the square supports on the three other sides, and which formed (perhaps with panels inserted between them) the proscenium. This was, according to an inscription, erected in 269 B.C. to replace a wooden structure. It was evidently regarded as an independent piece of work, not as part of one whole with the side colonnades. As it had no upper story, it can hardly have been used as a stage.

Some of the theatres of Greece proper form a group by themselves, on account of the arrangement of their proscenias and their adjacent passages. First in importance is that of Epidaurus

(Fig. 130), the best preserved of all Greek theatres. The construction and adornment of this edifice, which excelled all known Greek theatres in beauty and richness, are attributed by Pausanias to Polyclitus the younger. The auditorium (*θέατρον, cavea*), laid out on arcs described from three centres, was divided by a broad *diazoma* into a lower section of

thirty-two rows of seats and an upper section of twenty rows. The seats in the first and last rows of the lower section and in the first row of the upper section had backs. The lower section was divided into twelve wedge-shaped divisions (*κερκίδες, cunei*) and the upper into twenty-two by narrow

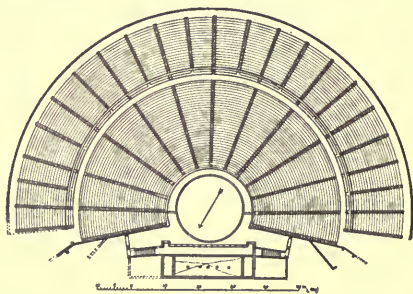

FIG. 130.—Theatre at Epidaurus. (Borrmann, *Geschichte der Baukunst*, I, Fig. 124.)

flights of steps. Behind the top row of seats was a passage seven feet wide running along the outer wall of the building. The orchestra, a circular space about 20 m. (65 ft.) in diameter, was surrounded by a ring of limestone, and between this and the seats was a passage, which widened toward the scene building. The floor of the orchestra was of beaten earth. At the centre stands a stone, on which the altar of Dionysus may have rested. The arrangement of the scene building is quite clear. The proscenium, 22.60 m. (74.15 ft.) long and 3.50 m. (11.48 ft.) high, had a front formed of twelve piers with engaged Ionic half columns. It was flanked by wings (*parascenia*), which projected only 1 m. (39.37 in.) and had engaged three-quarter columns at their corners. Beyond these wings, beside the entrances to the orchestra, were ramps leading to the top of the proscenium. At the eastern end there was a second ramp leading to the upper floor of the scene building. The lower part of the scene building consisted of a room 19.50 m. (about 64 ft.) long and 6 m. (about 20 ft.) wide, with two adjoining

wings, and an additional room at one end. Although the scene building was restored about 200 B.C., the original plan seems to have been preserved. The restored parts are the columns with their entablatures and the doorways in the parodi. The proscenium here is so narrow that it is hard to believe that it can have been used as a stage.¹

The theatre of Dionysus at Athens has undergone many restorations and alterations. The slope of the hill of the Acropolis formed the original auditorium, and it was not until the time of Lycurgus (about 340 B.C.) that the theatre was completed on a large scale in permanent materials. It was rebuilt in Hellenistic times and also in Roman times, so that it is difficult to determine exactly what its earlier appearance was. Neither the orchestra nor the cavea presents striking peculiarities. The front rows of seats consisted of chairs of Pentelic marble, the central one of which was beautifully carved and was reserved, as its inscription (*Ἱερέως Διονύσου Ἐλευθερέως*) states, for the priest of Dionysus Eleuthereus. The present orchestra is due to a restoration dating from the time of Nero and still later. The proscenium of the time of Lycurgus was 20.95 m. (about 69 ft.) long, almost as long as that at Epidaurus, which it probably resembled in its general features. It was 4 m. (13.12 ft.) in height and had fourteen Doric columns flanked by parascenia with six columns. In the middle intercolumniation was a door; in the others were wooden panels. On the south, adjoining the scene building, was a colonnade, which, with the stoa of Eumenes that connected the theatre with the odeum of Herodes Atticus, offered shelter in case of rain.²

In Asia Minor still another arrangement of the scene building is found. At Assos and Priene (Fig. 131) near the parodi were doors leading into the lower rooms of the scene building (the hypo-

¹ The scene building of the theatre at Sicyon resembled that at Epidaurus in most respects.

² Both the stoa of Eumenes and the odeum of Herodes were built long after the time of Lycurgus.

scenia), on a level with the orchestra, and at the ends of the scene building were stairs leading up to the proscenium. The proscenium itself was longer than the building behind it. The theatre at Priene is especially interesting on account of its unusually good preservation (Fig. 132).

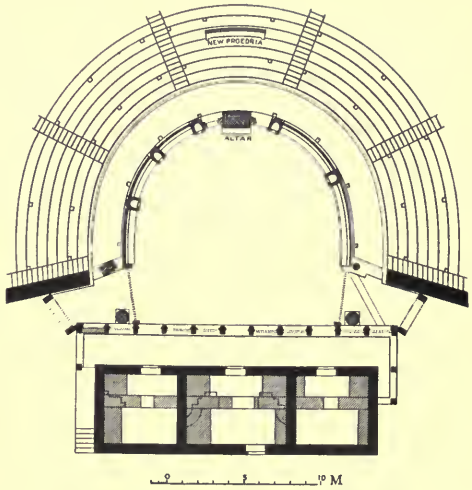

FIG. 131. — Theatre at Priene. (Wiegand and Schrader, *Priene*, Fig. 229.)

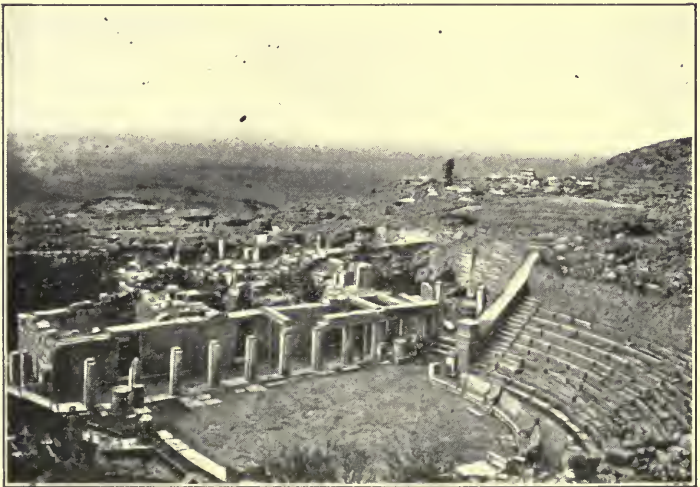

FIG. 132. — Theatre at Priene. (Wiegand and Schrader, *Priene*, Pl. 16.)

There are many theatres (at Athens, Ephesus, Termessus, and other places) in which the progress of the change from the Greek to the Roman form may be traced. The Roman theatre had a low and comparatively broad stage, backed by a wall as high as the outer wall of the auditorium and united with it. This wall at the rear of the stage generally had three doors, and received an elaborate architectural treatment of superposed orders. The circular orchestra of Greek times became, on account of the encroachment of the stage, a semicircle.

In a country so turbulent as ancient Greece, it is not strange to find each city surrounded by walls, with strongly fortified gates and many projecting towers.¹ Usually the lower part of the wall was of carefully constructed stonework, and the upper part of crude brick. Nearly every city had also an acropolis, which could be held even after the city was taken. The passes which led from the territory of one city to that of another were also protected by forts, some of which were of great strength.

The fortifications of Athens included the Acropolis, the city walls with their gates, the long walls to the Piraeus, and the walls of the Piraeus itself. The Dipylon, or double gate, from which the road to Eleusis led, was at the lowest point of the circuit wall, and therefore needed special defences. It consisted of an outer and an inner gateway, each flanked by towers. Curtain walls connected the two gates, forming a court, into which, if the enemy forced the first gate, the defenders could shoot from all sides. The width of the doorways was 3.45 m. ($11\frac{1}{3}$ ft.). A central post divided the passage, which was wide enough for two chariots to pass. Adjoining the southeastern tower was a well house containing a water basin fed from an aqueduct. The wearing of the pavement at this spot shows that the water was constantly used.

At Messene the fortifications (370-369 B.C.) are much better preserved than at Athens. The towers of the city wall are from twenty to twenty-five feet square and project about twelve feet be-

¹ Sparta, trusting in her military organization, was not fortified in the period of her greatest power.

yond the face of the wall. Some of them are circular in plan, and these generally have sally ports. The top of the city wall is reached by stairs on the city side, and from the top of the wall doors give access to the towers, which rise a story higher. The towers have also loopholes and windows. The holes for the ends of the beams that supported the wooden floors are still plainly visible. The Arcadian Gate is one of the best existing examples of a fortified gateway. It resembles the Dipylon at Athens in a general way, having an inner and an outer gate separated by a circular court fifty-five feet in diameter. The walls rise from twenty to twenty-three feet. The outer entrance, fifteen feet wide, is flanked by square towers. The gate toward the city had a centre post nineteen feet high.

Fort Euryelus, at Syracuse, built by the tyrant Dionysius (406–367 B.C.) to help in protecting the city from the Carthaginians, is an extraordinary piece of military architecture. It is placed at the intersection of the southern and northwestern walls, and lies to the west of the ancient quarter known as Epipolae. The fort consists of a spacious court preceded by five massive towers, which are protected in their turn by two deep, rock-cut fosses. Rock-cut subterranean passages connect these fosses with the court and with another, smaller, fort situated to the northeast.

FUNERAL MONUMENTS AND VOTIVE OFFERINGS

Greek funeral monuments which may be classed as architecture show great variety in form and style. A very early custom was that of burial in stone tombs, of which the beehive **Funeral** tombs at Mycenae are the finest examples. The tomb **monuments** of Pelops at Olympia was a mound of earth covered with growing trees and surrounded by a strong wall with an elaborate entrance, and even in historical times the tumulus is by no means uncommon.

The heroum at Trysa (Gjölbaschi) in Lycia is a cemetery 24.50 m. by 19.60 m. (80.40 ft. by 64.30 ft.) in size, surrounded by a high wall. It contained large and small tombs, a small me-

morial portico, and a watchman's house. The enclosing wall was decorated with reliefs which represent scenes from Greek myths (see p. 249), in the style that belongs to the latter part of the fifth century. A magnificent example of the enclosed cemetery in Hellenistic times was the heroum of Antigonus Gonatas at Cnidus, in which there were not only graves and an altar, but also a stadium, a circular colonnade, and a bathing establishment. The type of enclosed cemetery appears also in Roman times.

It was an ancient Greek custom to bury the dead immediately outside of the town gates, along the highways.¹ The individual tombs had, as a rule, simple, but singularly beautiful, emblems.

The earliest tombs outside the Dipylon at Athens were marked by large painted vases of the geometric style (see p. 439), some of which were as much as 1.75 m. (about 5 ft. 9 in.) in height. In the sixth century the stele became popular — a high, narrow slab of stone, tapering upward.² In the early gravestones of this form, almost the whole face of the stele is occupied by the entire figure of the departed in low relief, and the top is finished with a painted or carved acroterion.



FIG. 133. — Attic grave stele. (Photograph.)

In the fourth century the reliefs of the stelae become smaller and relatively higher, and the tops are finished sometimes with a gable, sometimes with a palmette acroterion (Fig. 133). Another type is broader, with pilasters at the sides, a type which

¹ The street of tombs at Syracuse is most remarkable. It begins above the theatre, and is cut in the living rock to a depth of ten feet for a considerable distance. In the sides are numerous cavities and tomb chambers, which are now despoiled of their contents and decorations. The street of tombs at Assos (now almost entirely destroyed) and that at Pompeii are also of special interest.

² The same form was often used for public inscriptions, such as treasurer's accounts, records of treaties, etc.

developed into a niche containing life-sized figures carved in the round (cp. Figs. 202, 203).

Introduced perhaps later than the stele, but to a great extent contemporaneous with it, is the stone grave-vase, of elegant, simple forms, varying in height from two to six or eight feet. Some examples are beautifully decorated with architectural ornament, others with reliefs representing scenes of parting or of everyday family life.

In sarcophagi, such as those found at Sidon and now in the Museum at Constantinople (see p. 274), architectural forms are imitated in sculpture, and with the architectural forms are combined reliefs, which are sometimes of the greatest beauty. Architectural forms are especially prominent in the so-called Sarcophagus of the Mourners (Fig. 204). The sarcophagi found at Sidon were deposited in rock-cut chambers, a type of tomb common in Phoenician countries, which reached a remarkable development among the Christians at Rome.

Votive offerings and monuments, such as statues of gods, men, or animals, tripods, etc., were often supported by round, four-sided, or polygonal shafts or pedestals. The column, with base, fluted shaft, and capital, was frequently used as a support, as, for instance, the Naxian column, which supported a sphinx at Delphi, or, on the Acropolis at Athens, the numerous columns that supported statues which were overthrown when the Persians occupied the city. To this class belong also the twisted bronze serpent column now in Constantinople, which was erected at Delphi after the battle of Plataea, and once supported the bowl of a tripod; the acanthus column at Delphi; at Olympia the three-sided tapering pedestal upon which seemed to float the famous Nike of Paeonius, and two Ionic columns, thirty feet high, which stood in front of the Echo Hall and bore the statues of Ptolemy II Philadelphus and his consort Arsinoë.

About the middle of the fourth century B.C. more importance began to be attached in Greece proper to the architecture of tombs and votive offerings than to the sculpture connected with them.

So the choregic monument of Nicias, at Athens, had a façade like that of a Doric temple, and the monument of Thrasyllus had an architectural façade with square piers, the whole surmounted by a



FIG. 134. — Monument of Lysicrates. (Photograph.)

large statue. Frequently the leading idea was height, rather than width, and many were the imposing and interesting structures designed with this in view. The striving for height led to structures of several stories, but the stories were not mere repetitions one of another. Columns were

Structures in several stories

placed upon heavy substructures, and the principle of contrast in architecture was developed. The chief extant structure of this class at Athens is the choregic monument of Lysicrates (Fig. 134), the date of which (335–334 B.C.) is fortunately known. It was erected by Lysicrates, the winner of a choral contest, to bear his prize, a bronze tripod. The monument is in relatively good preservation. It is 10.50 m. (34.45 ft.) high, and consists of a square base, thirteen feet high, of Piraeic stone, upon which rests a circular structure of Pentelic marble, nine feet in diameter. This is decorated with six engaged columns 3.56 m. (11.68 ft.) high, which have Corinthian capitals of exquisite beauty (Fig. 101). The relief of the frieze represents Dionysus punishing the Tyrrhenian pirates, — a legend which may have been the subject of the musical composition which won the prize. The slightly convex roof, decorated with scales, and the acanthus scrolls which carried the tripod, all carved from one block of marble, are worthy of careful study.

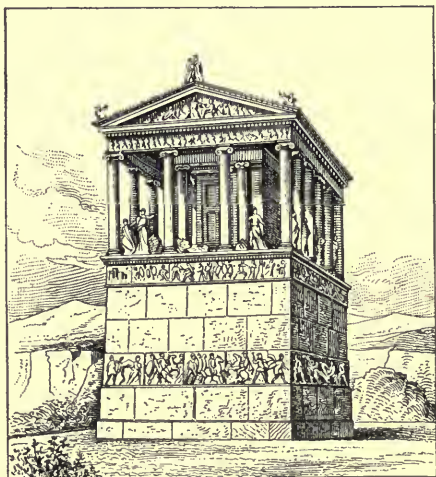

FIG. 135. — Nereid monument. (Durm, *Baukunst der Griechen*, Fig. 257.)

The earliest known example of a building in the form of a temple elevated upon a high, solid base is the Nereid Monument, from Xanthus, in Lycia, now for the most part in the British Museum (Fig. 135). It dates from the end of the fifth century B.C. The upper part was a peripteral Ionic temple, with four columns at the front and six on the side. Decoration and sculpture were important features in the appearance of the

monument, for there are three rich friezes, one of which was apparently in the entablature above the columns, and the others arranged on the podium, and, moreover, free sculptured figures stood between the columns (see p. 249).

The most magnificent of Greek storied structures was the Mausoleum at Halicarnassus in Caria, erected for the local ruler Mausolus. It was probably begun before his death (353 B.C.), but was continued by his wife Artemisia. Pythius, the designer of the temple of Athena at Priene, and Satyrus were the architects, and the sculptured decorations were intrusted to the best Greek sculptors, with Scopas at their head (see p. 263). The restoration of this monument (which was destroyed by the Knights of St. John in 1522 A.D.) has long been a favorite problem. Fortunately the general scheme and the approximate measures of the principal masses are fairly well determined by combination of the existing remains with the information derived from Pliny and Vitruvius. The building consisted of four chief parts: a base or podium forty-two Greek feet high, supporting an Ionic peristyle also forty-two Greek feet high, which in turn was surmounted by a pyramid of the same height, and the whole was crowned by a quadriga fourteen and a half Greek feet high. The total height was then about 140 Greek feet. The podium, which was rectangular in plan, measured less on the eastern and western sides than on the others, and had a perimeter of 440 Greek feet. A sculptured frieze and a protecting cornice crowned this part of the building. Pliny states that there were thirty-six columns, and it is now generally accepted that nine of these stood on each shorter, and eleven on each longer, side. The bases were of the Asiatic type, and the lower diameter of the columns measured 3 ft. 7 in., the intercolumniation 10 ft. 2 in. Authorities differ as to whether there was a frieze above the architrave or not. The peristyle was covered with a stone coffered ceiling. Within the peristyle was a structure which looked like the cella of a temple and carried the weight of the pyramid. The steps of the pyramid numbered twenty-four, each a Greek foot in height, and below the pyramid

was a podium, while at the top there was a pedestal to carry the quadriga. This crowning feature consisted of a four-horse chariot, in or beside which two colossal statues, ten feet high, of Mausolus (see Fig. 193), and Artemisia, may have stood. Many statues and at least three distinct sculptured friezes decorated the peristyle and the podium, and fragments of colossal lions, which may have stood upon the main cornice, were also found. Such was the beauty and impressiveness of the whole, that it was regarded as one of the seven wonders of the world. It was, without doubt, one of the most important works of Greek architecture in the fourth century, uniting in its design the pyramidal stepped structures of the East with the pillared temples of Greece. In the time of the Roman Empire the same *motive* appears in the "Mausoleums" of the Caesars.

THE HELLENISTIC PERIOD¹

The conquests of Alexander the Great wrought great changes in the political, social, economic, and artistic life of the Greeks. The rulers of Mesopotamia, Syria, and Egypt were henceforth Greeks, and Greek art, science, and language spread over all western Asia. Greek architecture, an architecture of the column and the lintel, was confronted with the new task of giving beautiful exteriors to massive oriental structures, and the consequent blending of styles produced a result that was rich and brilliant in effect. The storied structures were more fully developed, and although details became coarse and hard, their defects were partially hidden by free use of color, rich ornamentation, and new building materials. The fine artistic feeling of the classical period was replaced by a love of luxury and splendor, which found encouragement and expression in the rich feasts and pageants of the time.

The new spirit in building was most clearly expressed in the

¹ Some of the buildings mentioned in previous sections, *e.g.* the Thersilion at Megalopolis, the Bouleuterion at Miletus, the round building and the propylaea at Samothrace, and the Serapeum at Alexandria, are of Hellenistic date, but were cited as examples of their several types.

founding of cities, particularly commercial cities. Streets, markets, and public buildings were carefully laid out, and well-planned water supplies and drainage systems were installed. The rulers of these cities vied with each other in building stoas, markets, residences, gymnasia, and temples. The leading city, and a model for still newer foundations, was Alexandria. Situated on a large harbor at the mouth of a navigable channel that led to the Nile, and commanding the trade of Egypt, this city soon became the most important port of the eastern Mediterranean, and remained so until far into the Middle Ages. During the Hellenistic period, Alexandria, the favored residence of the Ptolemies, became, in addition to its commercial importance, a most influential centre of literature, science, and art.

Next to Alexandria in importance was perhaps Antioch, founded (300 B.C.) by Seleucus Nicator. It lay on the Orontes, and the trade between Antioch and the West passed through Seleucia Pieria. Antioch grew rapidly, and even in the last days of Roman rule it was still one of the busiest and most populous cities of the Old World. Syracuse was still, as in the sixth and fifth centuries, the greatest Greek city of the West. On the coast of Asia Minor, Pergamon, Ephesus, Priene, and Miletus were all very important. The island of Samothrace, long celebrated for its religious mysteries, was particularly favored by the Ptolemies and the Macedonian rulers, and many were the gifts they lavished upon it. Delos became, after the conquests of Alexander, the seat of a flourishing commerce, and here various large buildings were erected during this period. Finally the island of Rhodes should be mentioned, an important commercial centre in Roman times and a centre of art noted more for its sculpture than for its architecture or painting.

Athens was no longer the home of original and independent art, but visitors still flocked to see the magnificent monuments of her former greatness, and foreign princes enriched her with their gifts. The long list of patrons begins with Ptolemy Philadelphus, king of Egypt (284-246 B.C.), who founded a gymnasium and a library.

Three kings of Pergamon — Attalus I, Eumenes II, and Attalus II — beautified the city in various ways. The Syrian monarch Antiochus Epiphanes (175–164 B.C.) undertook the completion of the Olympieum, though it was not actually finished until the time of Hadrian. In the Roman period, Julius Caesar and Augustus were friendly to Athens, and later Roman emperors followed their example. But the buildings which date from after the Roman (or even the Macedonian) conquest hardly seem to be the genuine products of Athenian genius.

The most important architectural advance of the Hellenistic period was in the extensive use of the arch. There are examples of Greek arches as early as the fourth and fifth centuries B.C., and indeed the arch is latent in some of the doorways of far earlier times. The arched passage through the podium of the propylaea at Samothrace (p. 158) was built under Ptolemy II in the third century B.C., and an arched window in the assembly hall at Priene not far from 200 B.C. At Athens the rear wall of the stoa of Eumenes (197–159 B.C.), 164 m. (538 ft.) long, was formed by a series of cut stone arches in front of the retaining wall that supports the upper terrace. These arches are all constructed with voussoirs, and were in the first two cases plainly visible. There is, however, as yet no sufficient evidence for the combination of the architrave and the arch, which is one of the most striking features of Roman architecture, as seen, for example, in the Coliseum at Rome. Furthermore there is no proof that the vault was used in Greek times as a ceiling to cover large spaces; the vaulting of the Basilica of Constantine at Rome and kindred structures was a product of the engineering ability of a later age.

The city of Pergamon, owing to the rich results of the excavations carried on by the Germans, deserves especial attention. Although it owed its importance chiefly to its rôle of mediator between Rome and the Asiatic kingdoms, its art was purely Greek. The citadel was a stronghold situated on a high hill between two streams, and the city extended down the western slope to the plain. It is the citadel

The arch

Pergamon,
the great
altar

which has thus far chiefly attracted the excavators. It comprised five terraces supported by great retaining walls, and on each terrace was an important building. The two upper terraces were adorned with temples of the Roman period, which probably occupied the sites on which the royal palaces had stood when Pergamon was independent. On the middle terrace was an earlier temple of Athena, surrounded on three sides by porticoes. It was a peripteral Doric temple, with six columns on the front and ten

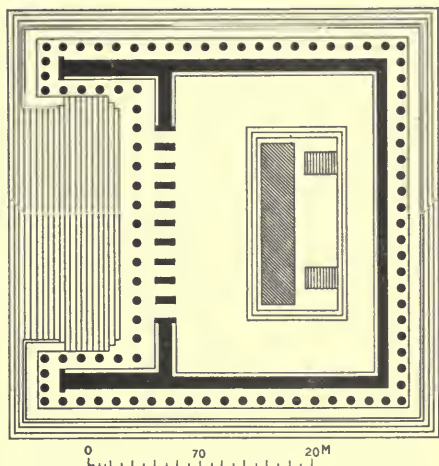

FIG. 136.—Great altar at Pergamon. (Schrader, *Sitzb. Berl. Akad.* 1899, p. 620.)

on the sides, the slender proportions of which proclaim their late date (second century B.C.). Below this terrace lay the great altar of Zeus and Athena (Fig. 136) erected by Eumenes II (197–159 B.C.) to commemorate the Pergamene victories over the Galatians. Its lower part was a solid podium or platform fifteen feet high, measuring 34.60 m. by 37.70 m. (about 113½ ft. by 123⅔ ft.),

with a broad flight of twenty-four steps let into its western side (Fig. 137). Upon this podium stood, in beautiful contrast to its solid mass, an Ionic portico, which surrounded the altar proper on three sides and projected at each side of the steps. The columns of the stoa were on the outer side; the inner side, toward the altar proper, was a solid wall, decorated with a small frieze of sculptured reliefs (p. 286). The colonnade across the front had a row of piers behind it, and over all the colonnades was a coffered marble ceiling. The faces of the podium were adorned with a

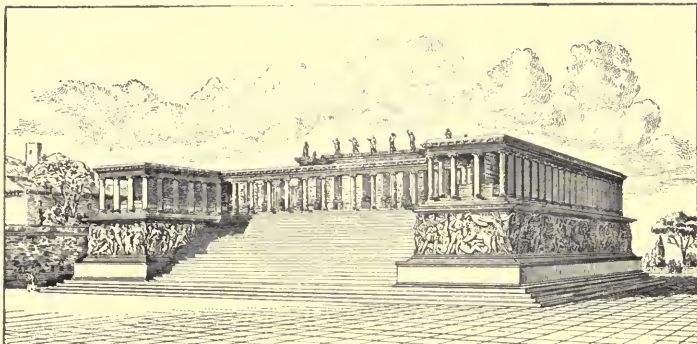

FIG. 137.— Great altar at Pergamon. (*Ergebnisse der Ausgrabungen zu Pergamon*, Vol. III, Pl. 19.)

continuous frieze of almost colossal figures, representing the combat of the Gods with the Giants (p. 284).

Of the sacrificial altar itself, which stood on the centre of the podium at Pergamon, unfortunately little is left, but enough data exist to give us a good idea of the nature of such altars. At Olympia the altar of Zeus was of considerable size, and the accumulation of ashes and remains of bones had raised a high mound. Pausanias (V, 13, 8) states that this altar consisted of two parts—the place where the animals were slain and, on a higher level, the hearth of ashes on which the carcasses were burned. This general arrangement appears in all large sacrificial altars. The largest known is that built at Syracuse by Hieron II in the third century B.C. It was 199.07 m. (about 653 ft.) long and 22.51 m. (about 74 ft.) wide. Of the width over two thirds was occupied by the hearth and less than one third by the place for the sacrificial slaughter. The great size of this altar is explained by the fact that no less than 450 oxen were annually sacrificed at one time to commemorate the expulsion of the tyrant Thrasybulus and that the sacred ashes were kept. This altar had apparently no sculptured decoration. Another important altar, at Magnesia, near the temple of Artemis, meas-

ured 23.10 m. by 15.90 m. (about 75 ft. by 52 ft.), and was even higher than the altar at Pergamon. Like that great altar, it was decorated with reliefs.

A proof of the commercial enterprise of the age, and of Alexandria in particular, was the Pharos, a famous lighthouse on the island of the same name, which lay in front of the harbor of Alexandria. It was begun in 229 B.C. by Sostratus of Cnidus, and was reckoned among the wonders of the world. Ancient coins represent it as a tapering tower, composed of many stories, each slightly in recess of the one below. At the top was the lantern, surmounted by a bronze statue of Pharia. Within, a stair, built about a central well, ascended to the lantern. The total height, as calculated from ancient and Arabic descriptions, was 110 m. (about 360 ft.) and its base 25 m. (about 82 ft.) square. The Pharos stood until 1477 or 1478 A.D., when a fort was built of its stones.

The increased love of splendor and the greater complexity of life which characterize the Hellenistic period are especially noticeable in the increased development of the portico or stoa. The Greeks had always spent their days for the most part in the open air, but protection from rain, wind, and sun was afforded in ever increasing measure by porticoes, which were, in the Hellenistic period, often erected at the expense of some princely benefactor. Great two-aisled porticoes lay to the east and south of the Altis at Olympia (Fig. 110). At Samothrace there was a portico 100 m. (328 ft.) long, and a portico at Corinth was even somewhat longer. At Pergamon the temple terraces were surrounded by colonnades on three sides, so that only the side toward the terrace wall, which was also the side that commanded the view over the city and the valley, was left open. The porticoes about the temple of Athena (Fig. 138) had two stories, with an interesting arrangement of the orders: the lower order was Doric, with four metopes between the axes of the columns; the upper order was Ionic, with an entablature in which Doric and Ionic elements were combined, for the architrave had the fascia

of the Ionic order, while the frieze had triglyphs. Between these upper columns were barriers decorated on the outside with reliefs representing armor. The northern portico, which was deeper than the others, required a row of central supports, and these consisted of columns with round, bell-shaped capitals. Thus three orders were used in the same building, the date of which is the second century B.C.

At Athens there is another interesting stoa, which was built, as an inscription on the lower architrave records, by Attalus II of Pergamon (159-138 B.C.), probably as some sort of a market. Like the usual portico it had two aisles, but in addition it had at the back a row of twenty-one storerooms of various sizes, perhaps for the storage through the night of goods which were exposed for sale during the day. On the ends of

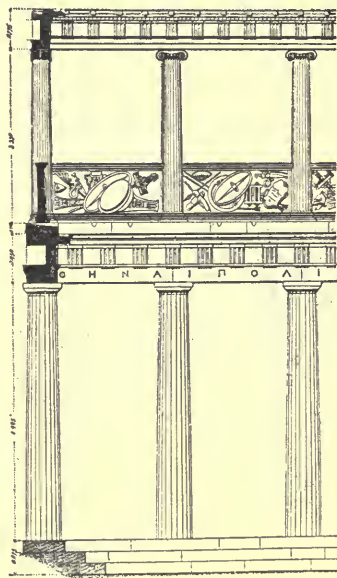

FIG. 138.—Stoa at Pergamon. (*Ergebnisse der Ausgrabungen zu Pergamon*, Vol. II, p. 35.)

the building were extensions, the southern one of which is thought to have contained stairs leading to the upper floor. The total length of the stoa was 110.75 m. (about 363 ft.), its width 12.50 m. (about 41 ft.), and its height 10.65 m. (about 35 ft.). The lower order was Doric, of slender proportions, the height of the columns being $7\frac{1}{2}$ times their lower diameter. Such slender columns would admit much light, and would occupy little space. The columns of the interior ranged with every second column of the façade and had bell-shaped capitals, like those of the interior order of the northern stoa on the terrace of Athena at Pergamon. The upper

order was Ionic and of less importance than the lower. Between the columns of this upper order were barriers of marble, decorated with a crossbar pattern. The almost elliptical plan of the upper columns of stoas in general (Fig. 139) is interesting, as it kept the

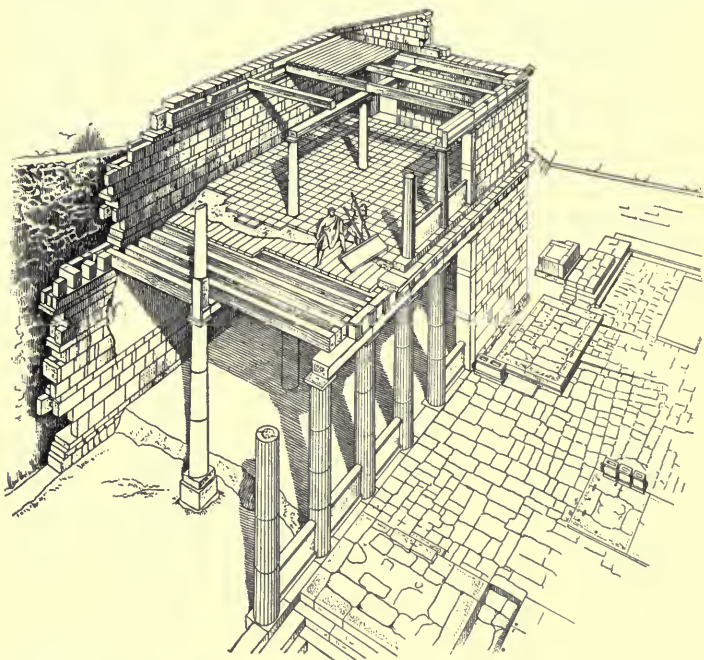

FIG. 139. — Stoa at Assos. (Bacon, *Investigations at Assos*, p. 45.)

apparent diameter of the column, as seen from the front, in the right proportion to the height, and yet permitted the use of an architrave, the soffit of which did not look too thin for the crowning feature of the building considered as a whole.¹

¹ Figure 139 gives a clear idea of the construction of a typical stoa, that at Assos. A stoa similar to that erected by Attalus II at Athens was built by an Attalus, perhaps Attalus I, at Termessus, in Pamphylia.

Every city of any importance had an agora, or open market place, such as one sees to-day in Italy — a large open square where business of all kinds was carried on. At Priene and Magnesia the agoras were surrounded by imposing stoas. That at Priene had on three sides porticoes, behind which were shops, and on the fourth side a portico which formed a long vestibule for a number of public buildings behind. The agora at Magnesia, in form nearly a rectangle, was larger than that at Priene, measuring 97 m. (about 318 ft.) by 188.20 m. (about 617 ft.). It was surrounded by marble, two-aisled porticoes, which were of the Doric order on the outside and of the Ionic order within, the inner columns being spaced, as usual, to line with every second column of the exterior order. There were entrances into the agora on the southeast and southwest corners, and in the middle of the eastern side was a propylaeum of early Roman times, which gave access to the precinct of the temple of Artemis. In the open square stood a temple of Zeus and various statues. The porticoes surrounding the agora had here, as elsewhere, rooms for storage purposes behind them.

The market place at Assos occupied a terrace on the side of a steep hill. It consisted of a long rectangle, terminated on the west, a short side, by a small temple and an entrance gate; on the east by the Bouleuterion, in front of which was a raised platform, or bema, for the use of speakers. On the northern side stood a two-storied, two-aisled stoa, 111.50 m. (365.83 ft.) long, but without rear rooms. On the south was a shorter two-aisled stoa, open both toward the agora and, perhaps for the sake of the beautiful view, toward the lower parts of the city and the sea (Fig. 140). This stoa covered a bathing establishment, which was entered from a lower level. The arrangement of this agora shows advantageously the skill and ingenuity of the Greeks in adapting their architecture to the demands of an inclined site. In some cases such sites led to the erection of structures which, when seen from a lower level, appeared to have three stories; so at Pergamon, on the side of the hill of the acropolis, where there was a

terrace surrounded by two-storied porticoes, the portico farthest from the acropolis appeared as a building of three stories to those who approached it from below.

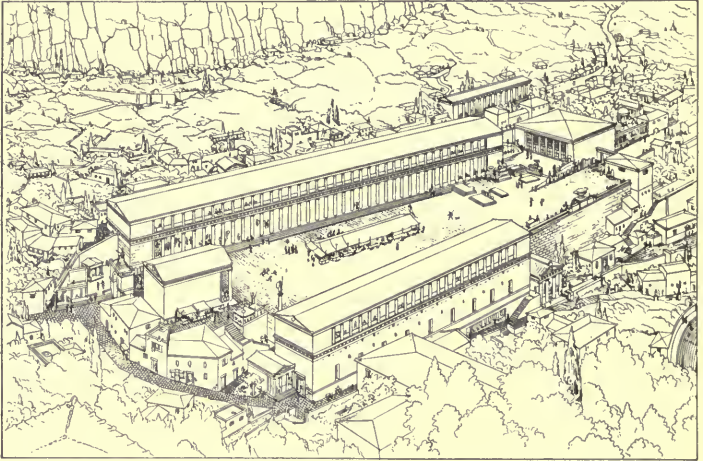

FIG. 140. — Agora at Assos. (Bacon, *Investigations at Assos*, Pl. 27.)

The open spaces in Greek cities were, especially in Hellenistic times, adorned with monuments of various kinds, often of historical as well as artistic interest; porticoes contained statues set in niches or standing between the columns, and their walls were sometimes covered with inscriptions carefully cut in clear and beautiful characters. The arrangement of buildings with especial regard to their architectural and natural environment is also characteristic of this period.

The private houses of the Greeks are far less well known than their public buildings. This is due to the fact that, since the walls of private houses were often built of wooden framework filled in with sun-dried brick, their remains are extremely scanty. Moreover, public life was, until after the conquests of Alexander, much more highly developed than

Private
houses

private life. Literary evidence tends to prove that the houses of the early periods were modest, but Demosthenes, about the middle of the fourth century B.C., complains that private houses were beginning to surpass the public buildings in sumptuousness, and when the Greeks turned from public to private life in the Hellenistic period, their houses became more and more luxurious. A few remains of private houses exist at Athens and elsewhere, but the best are at Priene and on the island of Delos, those at Delos being chiefly of Roman date.

At Priene the houses (Fig. 141) are laid out in almost rectangular blocks, measuring about 35 m. by 47 m. (115 ft. by 154 ft.), separated by narrow streets. These houses present to the passer-by almost a blank wall, pierced only by a door and an occasional window placed well up above

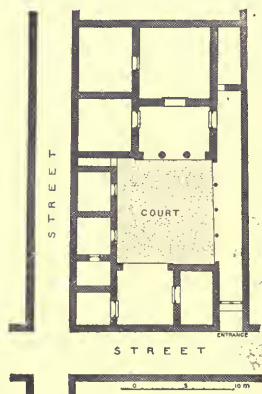

FIG. 141.—House at Priene. (Wiegand and Schrader, *Priene*, Fig. 298.)

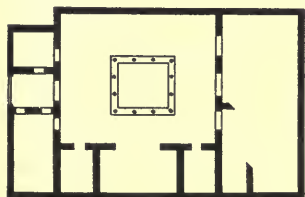

FIG. 142.—House at Delos. (Borrmann, *Geschichte der Baukunst*, I, Fig. 136.)

grouped about the court in various ways, doubtless to suit the taste of the owner.

The houses recently excavated at Delos (Fig. 142) are even more

¹ At Pompeii a second-story balcony which projected over the street is still in part well preserved.

only by a door and an occasional window placed well up above the street and protected by bars or shutters. The appearance of the streets must therefore have been somewhat uninteresting. When the houses had a second story, the upper windows were probably more numerous and larger.¹ Within, the houses were built about a central court, which furnished the necessary light and air. The rooms were

instructive than those at Priene. The courtyard within them is not central, but is surrounded on three sides only with rooms, one of which is almost invariably of ample dimensions and provided with three doors opening from the court. If the house was in an important street, a row of shops, which had no connection with the rest of the house and were let separately, would occupy the ground floor of the front. The walls toward the retired streets had no openings, save here and there a window placed at a considerable height above the ground. There seem to have been no separate quarters for the women, unless they were relegated to the second story. Certainly there was not here, as there was at Pompeii and Herculaneum, a separate court with adjoining rooms reserved for the women.

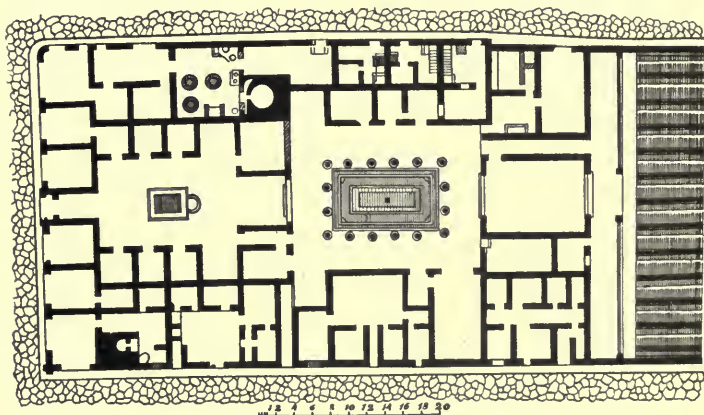

FIG. 143.— House of Pansa at Pompeii. (Overbeck, *Pompeii*, ed. 4, p. 325.)

At Delos, among the oldest houses, of the second and first centuries B.C., besides the simple peristyle dwellings, there are more stately houses with peristyle and atrium. This style the wealthier Romans adopted, and striking examples of it exist at Pompeii and Herculaneum (Fig. 143). In these houses the street level was, as a rule, retained within. To the right and left of the

entrance were a porter's lodge and a stable ; beyond was an atrium surrounded by small rooms for the unmarried sons and the slaves to sleep in—rooms separated from the atrium by curtains only. At one corner of the court was the dining room, near which was the kitchen. The master received business calls in the atrium. This was separated by a strong door from an inner peristyle, open to the sky, around which were grouped the rooms where the matron with her unmarried daughters and the slaves lived and worked. Beyond this was a garden surrounded by a high wall.

At Antioch and Alexandria there were apartment houses of several stories ; but such buildings are characteristic of cities of late growth. In the Museum at Naples are several frescoes in which houses with two, and even three, stories are represented.

The picture of a Greek house would not be complete without some mention not only of the decorations of walls and floors, but also of the furniture of the various rooms. The walls were adorned with sculptured stucco work, with painting done directly on the plaster, and with a combination of the two. Alcibiades is said to have employed a painter to decorate the interior of his house. Sometimes, in the Hellenistic period, above a smooth base the walls were painted to imitate slabs of various marbles. Sometimes the upper parts of the walls were decorated with pilasters or half columns, either in stucco or merely painted, which appeared to carry a cornice or a complete entablature at the ceiling. Ceilings also began to receive stucco decoration at this period, and the floors, which were at first of concrete, were often laid with mosaics, which took the form sometimes of elaborate pictures, sometimes of patterns with interesting borders. The peristyles were decorated with marble benches, works of sculpture in bronze and marble, fountains, flowers, and shrubs. Of all these decorations Pompeii furnishes the best examples.

There were several small shrines in the house. Generally a Hermes stood outside at the entrance. Within were two principal shrines, that of Zeus Herkeios, placed in the men's quarters, and that of Hestia, situated in the important room of the house,

the main dining room. Doors were fastened by locks and keys, some examples of which, found at Pompeii and now in the Museum at Naples, resemble those of modern times. Sometimes storeroom doors were sealed with the master's seal for additional security. Window glass was not used before Roman times, and then not freely. The rooms were heated by open fires, the smoke from which escaped through holes in the roof. Braziers filled with charcoal were also used, as in Italy and the Levant to-day. Lamps of metal or earthenware were lighted at night, or kept burning in dark places.

Greek furniture was simple, but in admirable taste. There were chairs, the general style of which is made familiar to us by the bas-reliefs and vase-paintings in which they are represented, beds and couches, often of bronze and of beautiful turned patterns, adjustable tripods for tables, chests for clothing, sundials and water clocks to measure the flight of time, earthenware for many purposes, and various kitchen utensils.

In the architectural sculpture of the Hellenistic period the tendency seems to be toward a more abundant use of color applied to carved ornament, abandonment of the honeysuckle pattern for scrolls, and a broad, flat treatment of the ornament itself.

Such was the condition of Greek architecture when the Roman conquest began. The Roman architects naturally turned for their models to the most recent achievements of Greek art, not only because they were nearest to the Romans in date, but because they were best suited to the relatively complex Roman civilization and appealed most strongly to Roman taste. The sumptuous and richly ornamented edifices of Alexandria, Antioch, Pergamon, and Rhodes were the prototypes of the buildings of imperial Rome. It is a significant fact that Apollodorus, who seems to have set his stamp upon the architecture of Trajan's time, was a native of Damascus. The best of Roman work, in architecture as in sculpture and the other arts, was undoubtedly executed by Greeks.

CHAPTER III

SCULPTURE

MATERIALS AND METHODS

THE sculpture of the Mycenaean age is preserved to us in comparatively few specimens, but enough to show that considerable technical skill and artistic power had been attained. Doubtless some monuments survived through the period that followed the fall of the Mycenaean civilization, and these may have served as models or incentives to the earliest really Greek sculptors. Moreover, Egypt and the East were near at hand, especially to the Greeks of Asia Minor and the islands. The earliest Greek sculptors were therefore not obliged to develop their art from the beginning utterly without assistance, and it is not without reason that ancient and modern writers have repeatedly called attention to the influence exerted by Egypt upon the earliest Greek art. The fact that many early Greek statues stand stiffly erect, with one foot (almost invariably the left) advanced, in precisely the attitude chosen by Egyptian sculptors for statues of kings and other persons, is not necessarily a proof that the early Greeks learned from the Egyptians, but it confirms our belief in what is *a priori* probable.

Beginnings of
Greek sculpture

Had the Mycenaean civilization left no monuments in Greece, and had the peoples of Egypt and Asia been ignorant of the art of sculpture in stone and bronze, it might be assumed that the earliest Greek sculptors worked in wood, and that their successors advanced from wood to soft stone and then to marble and bronze. But such an assumption takes no account of the environment of the earliest Greek sculptors. Undoubtedly many

early works of Greek sculpture were of wood. This is expressly stated by Pausanias and other ancient writers, and wood has been from the earliest times, and still is, a common material for sculpture, but there is no reason to suppose that all the earliest Greek sculpture was of wood and that the use of marble and other kinds of stone was a later invention. As soon as the Greeks began to practise the art of sculpture, stone, as well as wood, was undoubtedly used, though soft stone was naturally preferred to marble where it was easily obtained.

The wooden statues and reliefs have disappeared, being made of perishable material, and undoubtedly most of the earliest works of sculpture in stone have also been lost, but these lost works were probably not greatly different from those that have been preserved. If the earliest extant works show greater technical skill and higher artistic ambitions than would naturally be possessed by the earliest sculptors of a primitive people, the explanation is to be sought in the surroundings of the Greeks — especially in the influence of Egypt — rather than in the total disappearance of a whole class of primitive wooden sculpture. The period between the fall of the Mycenaean civilization and the sixth century is very imperfectly known, but small terracottas, decorative bronzes, and engraved gems prove that various forms of art were practised in Greece with some success at that time. Since the earliest extant works of Greek sculpture are not earlier than the seventh century B.C., it is probable that before that time the Greeks worshipped their gods chiefly in the form of symbols and unhewn stones, or of beams or pillars draped with real drapery, and that statues were not made — or, at any rate, were unusual — until after 700 B.C.

The material of the earliest sculpture is different in different places. It is possible that in some places wood was for a time the only material in use; but if that was the case, it was due to local causes, and, at any rate, it can never be proved. In Attica the earliest extant sculpture is of the soft limestone from Piraeus, commonly called *πῶρινος λίθος* by the an-

Materials

cients and "poros" by modern writers;¹ but in some other places, where soft stone does not exist, the earliest known works are of marble. At Athens "poros" was superseded about the middle of the sixth century by the bluish marble of Mt. Hymettus and the upper strata of Mt. Pentelicus, then the beautiful white Parian marble was the favorite material in the latter part of the sixth and the first half of the fifth century, and about the middle of the fifth century the white marble of the lower strata of Mt. Pentelicus came into general use. This is, in spite of its beauty, a less perfect material for sculpture than the finest quality of Parian marble, which always continued to be most highly prized. At all times and in all regions various kinds of marble and other suitable stone were used in the places near the quarries.

The early sculptors employed simple methods, and did not, like the modern artist, mould clay models to be transferred to stone by a system of points and careful measurements.

The artist of a relief drew the outlines of his figures on the front of a slab of stone and then chiselled away the superfluous material, so that the figures remained standing forth from the background. Naturally no figure could project further than the original surface of the slab, but the background could be cut away to any depth less than the total thickness of the stone. The background of the relief was therefore not necessarily all in one plane, as it generally is in modern reliefs, which are made from models of clay moulded on a flat surface. Since the early reliefs were always colored,² the carving was often, as in Egypt, little more than a means of accentuating the outlines and suggesting the shadows of the composition. The earliest works are therefore generally in low relief.

The sculptor of a statue in the round worked by a method similar to that employed in carving reliefs. Taking a block of rectangular section, he drew on the front the outline of the figure

¹ The term "poros" is sometimes loosely employed to designate almost any stone not marble.

² This is probably true of all Greek reliefs.

desired, as seen from the front, and on the sides the outline of the side view of the same figure. Then he cut away the stone not included in these outlines, working straight in until the cutting from front to back intersected that from side to side. He then had a rough, angular statue, which he finished in accordance with his ability.¹ His chief tools were a pointed hammer, or a pointed instrument to be struck with a mallet, a gouge or curved chisel, a claw chisel, and files and sand for polishing. Workers in soft stone also used saws of various kinds, as well as cutting tools that were pushed by the hand, not struck with a mallet. In later times drills were much used, especially in representing hair and deep folds of drapery. In later times, too, models of clay or plaster were employed, much as they are at present, but this practice was, apparently, not introduced until the middle of the fifth century, and probably did not become general until much later.

Statues, as well as reliefs, were regularly colored, the extent of the coloring depending upon the kind of stone employed and also upon the taste of the period to which a given work belongs. Pure white statuary did not, however, exist at any period in Greek art.

Even in very early times statuettes and small reliefs were made of bronze, but the statuettes were cast solid, and the reliefs were made of thin plates beaten over a model of wood or stone (*repoussé*) and finished with a sharp tool. Neither of these methods is desirable for statuary. Solid bronze statues involve too great a waste of costly material and are likely to crack in cooling, and although some early statues were made of sheets of bronze beaten into shape over a wooden core and fastened

¹ That some such method was employed is clearly seen in several unfinished statues in the National Museum at Athens, which are discussed by Professor E. A. Gardner, *Journal of Hellenic Studies* 1890, pp. 129-142. One of these, from Naxos, is especially instructive, as it shows a comparatively early stage of the work. A similar statue, found in Attica, is published by Georges Nicole in *Mélanges Nicole*, Geneva, 1905, pp. 401-405. The same scholar (*Rev. Archéol.* XI, 1908, pp. 40-42) regards a statuette found in the same region as a rough model for use at the quarry.

together with rivets (*sphýrelaton*), or cast in separate pieces and welded together, these were disfigured by numerous sutures and must have lacked strength. But after the Greeks learned to make hollow castings, bronze was regarded as preferable to marble for statues, especially for those that were to stand alone in the open air.

The art of bronze casting was said to have been invented by two Samians, Rhoecus and Theodorus, who lived about the middle of the sixth century B.C., but this can only mean that they introduced into Greece the art of casting statues hollow, an art that had long been practised by the Egyptians.

To make a solid casting, all that is necessary is to make a mould and run the molten metal into it. When the metal has hardened, the mould can be broken and removed. **Bronze cast-**
 But if a hollow casting is to be made, an inner core, **ing**
 as well as an outer mould, must be prepared, and the bronze must be run in between them. This is now ordinarily accomplished by the *cire perdue* (lost wax) process. A core of fire-proof material is made of the shape of the object to be cast, but slightly smaller. Over this a coating of wax is applied, and in this coating the details of the work are carefully executed. Then a coating of fireproof material is carefully applied over the wax and made thick and strong enough to serve as a mould. The whole is then heated, for the double purpose of hardening the mould and melting the wax, which runs out. The hollow space between the mould and the core is then filled with the molten metal, and when this has hardened the mould and core are removed, leaving the thin shell of metal. Substantially this process must have been employed by the ancient bronze casters.

Some ancient statues were made of wood incrustated with bronze, and some consisted of a framework of wood and metal incrustated with plates of ivory and gold (chryselephantine statues). **Incrustation**
 Some statues, too, were made of wood with the heads, hands, and feet of marble (acrolithic statues). Statuettes were sometimes made of silver or even of gold, and bronze statues were often gilded.

Works of sculpture fall naturally into two classes: decorative sculpture, designed for the adornment of buildings or the like, and what may be called substantive sculpture,¹ designed without special reference to any larger whole. Decorative sculpture is for the most part carved in relief, though in many instances, notably pediment groups, it consists of statues carved completely in the round, while works of substantive sculpture are almost exclusively such statues. Decorative sculpture is strongly influenced by its architectural or other environment, which determines the space to be decorated and the composition of the groups intended to fill that space. In these respects it resembles decorative painting. Substantive sculpture is more independent of space relations. Therefore the development of the two classes does not necessarily proceed with equal rapidity or along the same lines. In composition especially, decorative sculpture is naturally much influenced by painting, while the fact that substantive sculpture can usually be seen from all sides, while decorative sculpture is visible only from the front, affects the choice of attitudes, the representation of drapery, and still more the choice of subject and the composition of groups. Nevertheless, since few sculptors limited themselves to one class of sculpture, the progress of the two classes was on the whole nearly parallel. They may, therefore, in a brief sketch like this be treated together.

ARCHAIC SCULPTURE

The earliest Greek statues exhibit three main types: a nude, standing, male figure; a draped, standing figure, usually female; and a draped seated figure, which may be either male or female. In all of these the head is erect and turned neither to the right nor the left. A line drawn from the crown of the head through the nose, the middle of the breast bone, and the navel to the ground divides the figure into exactly

¹ This is the term employed by Professor Percy Gardner, in his *Grammar of Greek Art*, London and New York, 1905.

equal halves, except that in the nude figures and some of the draped standing figures one foot is somewhat advanced. Soon the position of the arms offers some variety ; but until the beginning of the fifth century the "law of frontality," which precludes any twisting or turning of the body, is observed. This is characteristic of most primitive statuary, and persists in Egyptian sculpture throughout its entire history.

The striking similarity in attitude of the early Greek nude statues to Egyptian works has already been mentioned ; but in their entire nudity they are distinctly Greek. We do not know what each particular statue represents, and it has long been customary to call them all "Apollo." Some examples, found at the temple of the Ptoian Apollo, in Boeotia, may well represent the god, but others have been found in cemeteries, and their nudity suggests that the type may have been originally intended to represent athletes. At any rate it is important to observe that from the very beginning Greek sculptors represent the human form entirely nude, thereby forcing themselves to represent it undisguised by any drapery that might hide a lack of truth to nature.

An exceptionally fine example of the nude type is the so-called Apollo of Tenea (Fig. 144), found at Tenea, not far from Corinth, and now in the Glyptothek at Munich. Many other examples have been found, some of which are far more primitive than this. The best known are perhaps the "Apollos" of Thera, Melos, and Orchomenus (in Boeotia). They differ from one another in proportions, in the knowledge of anatomy displayed, in the manner of representing the hair, and in technical execution ; but these differences, at



FIG. 144.—Apollo of Tenea.
(Brunn-Bruckmann, Pl. 1.)

least in the earlier specimens, are probably due to the varying degree of skill and knowledge in the individual artists, rather than to different schools of art. The "Apollo" of Tenea, which is carved in Pentelic marble, is probably an Attic work of the latter part of the sixth century B.C. Its proportions are unusually slender, the anatomical details, especially in the rendering of the knees, show careful study, and an attempt is made to give expression to the face by raising the corners of the mouth. From this type of figure the famous athlete statues, as well as the nude figures of deities, of later times were developed.



FIG. 145. — Archaic statue from Delos. (Brunn-Bruckmann, Pl. 57 a.)

A very primitive example of the draped standing female type is a statue found at Delos and now in Athens (Fig. 145). An inscription cut on its left side states that it was dedicated to Artemis by a Naxian woman named Nicanra. The statue is a long, flat block of marble, the edges of which are rounded off. The hair is represented as spreading to right and left (resembling a well-known Egyptian headdress), so that the head has somewhat the effect of a flattened, truncated cone. The features are almost utterly obliterated. The arms are mere vertical cylinders, not cut free from the body. Holes in the hands, if hands they may be called, indicate that some attributes, doubtless of metal, were added. The flat shape of this figure, which resembles a thick plank, has been

regarded as an indication of the strong influence of sculpture in wood upon the earliest works in stone; but however natural the plank or squared beam may seem in an age of sawmills, in the seventh century B.C., to which this figure must be assigned, the natural shape of a log of wood was cylindrical. In extracting stone from a quarry it is, however, generally most convenient to cut roughly

squared blocks. The peculiar shape of this figure is therefore probably due to the fact that the primitive sculptor was too much influenced by the original shape of his block of marble.

The so-called Hera from Samos (Fig. 146), now in the Louvre, is a work of about the middle of the sixth century, and was, according to its inscription, dedicated to Hera by a certain Cheramyas. It exhibits a roundness as remarkable as is the flatness of the Naxian statue from Delos, and has for that reason been supposed to show the influence of wooden statues carved from round logs. It may possibly be an imitation in marble of an ancient wooden figure (*xoanon*), but as such figures were probably always clad in real garments, not carved as draped figures, the style of the drapery, at any rate, can hardly show the influence of sculpture in wood. Other monuments indicate that the peculiar roundness of this figure was a feature of the local style of art, which may possibly have arisen in the first place from a habit of rounding off equally all the edges of a squared block of marble.

A series of statues in the British Museum, which were found by the sacred way that led from the sea to the temple of Apollo at Branchidae, near Miletus, illustrates the type of seated draped figure (Fig. 147). These statues are assigned to the middle of the sixth century as an approximate date, though some are evidently earlier than others. They exhibit great fulness of forms, the drapery is stiff and lifeless, and the whole effect of the figures is heavy. It has been justly remarked that they sit as if they never could rise. The



FIG. 146. — Hera from Samos. (Brunn-Bruckmann, Pl. 56.)

effect was, however, probably better when the statues were enlivened with color. The same general type is represented at a more advanced stage by a statue of Athena, at Athens, with which



FIG. 147.—Seated figure from Branchidae.
(Brunn-Bruckmann, Pl. 142 b.)

the name of the sculptor Endoeus has been connected.

The development of early sculpture is nowhere so clearly to be traced as at Athens, owing to the fact that after the departure of the

Persians, in 479 B.C., the Athenians levelled and enlarged the surface of their Acropolis and used as rubbish for filling, instead of earth, which they would have had to carry up the hill, the statues and decorative sculptures which the Persians had injured. In

this way the works of sculpture were hidden from view and preserved until discovered in modern times, chiefly in 1885 and the following years. Perhaps none of these works is earlier than 600 B.C., and none can be later than 480 B.C.

One of the earliest pieces, perhaps the very earliest, is a triangular relief, which evidently once filled a pediment. The entire right half of the relief is occupied by the sinuous folds of the Lernaean Hydra; Heracles in the centre raises his club against the monster; and behind the hero are his horses and chariot and his faithful companion Iolaus, against whom a gigantic crab advances from the extreme left-hand corner. The

composition is extremely simple and imperfect in its utter lack of symmetry, and the execution is rude and primitive. The outer surface of the figures is flat and their edges insufficiently rounded, apparently not worked with a chisel, but cut (in part at least) with a saw or some tool like a knife. Such a tool might well have been used, as the stone is a soft variety of coarse poros. Sufficient color still remains to show that the entire relief was painted, chiefly with red, blue, and green, though certain parts were colored dark brown or black, and an additional color was gained by allowing the natural hue of the stone to appear in some places. The coloring was conventional, not naturalistic; for instance, one horse is green (perhaps originally blue).

The work just described is executed in low relief. Very different in this respect are two other works carved of a better and somewhat harder variety of poros. These once adorned the pediments of the Hecatompedon, the temple of Athena, to which Pisistratus afterwards added a peristyle. The reliefs of these pediments are so high as to be almost carved entirely in the round.



FIG. 148.— Three-bodied Typhon, Athens. (Brunn-Bruckmann, Pl. 456 a.)

Half of one of the pediments was occupied by a threefold monster, generally called Typhon (Fig. 148). The outer (left) shoulder of the first and the inner (right) shoulder of the third human body had wings, and the three bodies end in a twisted serpentine tail. Another half of a pediment was occupied by a representation of Heracles struggling with the Triton, half man and half fish. Large parts of two great serpents and a few other fragments that belonged to these pediments are preserved, but the arrangement of the sculp-

tures is not as yet certainly determined. It is evident, however, that the serpent forms are well adapted to the shape of the pediments and make the task of composition comparatively simple.¹

The work of these reliefs is more advanced than that of the Hydra pediment, and the effect of the whole, when brightly colored, chiefly red and blue, must have been very striking. The under



FIG. 149. — Moschophorus, Athens. (Brunn-Bruckmann, Pl. 6, Ersatztafel.)

side of the projecting cornice, above the pediments, was adorned with conventional lotus patterns, between which were, at the eastern end, eagles, and at the western end, storks, all in very low relief. The lotus patterns were brightly colored with red and blue, and the birds also showed bright colors, at least in part.

Among the other remains of sculpture in poros stone found on the Acropolis the most striking are two groups of lions pulling down bulls. In these great vigor of form and action appears, and in spite of errors in anatomy and in some details the works show original study of nature and fresh observation. The prevalent qualities of these early Attic sculptures are force and vigor.

The same qualities are seen in the first works of Attic sculpture in marble, which show also in technical details the influence of the habit of working in the softer stone. One of these is the statue

¹ A figure of Athena enthroned, facing the front, and one of a bearded god in profile, may have belonged in one of the pediments, but may perhaps equally well have adorned one of the smaller buildings on the Acropolis.

of a man carrying a bullock (*moschophorus*). An inscription on the base of this work states that it was dedicated by a certain Bombos (Kombos, or Rombos), whom it represents bringing a bull calf as a sacrifice (Fig. 149). In this way his piety was made as enduring as the marble. This work and a few others that exhibit the same qualities, with some modifications, belong to about the middle of the sixth century, the early part of the rule of Pisistratus.

Under his rule and that of his sons, Athens grew to greater importance than it had possessed before, and the increasing prosperity of the city, as well as the taste of its rulers, attracted artists of all kinds. In sculpture the school of Chios was especially flourishing, and many works by

Chian sculptors adorned the Acropolis. This school was justly famous for the care and delicacy it displayed in the elaboration of details, especially in the representation of drapery, hair, and ornaments. The female figure was the favorite subject for these artists, and a series of statues found on the Acropolis at Athens shows their skill in the treatment of marble and the charming elegance of their style, which was, however, already becoming conventional and somewhat monotonous. The Attic sculptors speedily acquired the technical skill of their Chian visitors, and the less original among them lost the strength and vigor of the earlier Attic school and imitated the Chian work in its defects as well as in its good qualities; but the stronger natures,



FIG. 150. — Statue by Antenor (?).
(*Antike Denkmäler*, I, Pl. 53.)

while they did not neglect the opportunity of acquiring technical skill, retained the old Attic vigor and dignity.

An example of an Attic work under Chian influence is a statue probably by Antenor, an artist whose date is approximately fixed by the fact that he made statues of Harmodius and Aristogeiton



FIG. 151. — Early Attic pediment sculpture. (Wiegand, *Porosarchitektur der Akropolis*, Pl. 16.)

after Hippias was expelled, in 510 B.C. This statue (Fig. 150) exhibits greater dignity than the Chian figures of the same general type, with no less technical excellence in detail. What an Attic sculptor, who had studied Chian work without giving up his native vigor was able to accomplish, is even more clearly seen in the

(perhaps somewhat earlier) sculptures from the pediment of the temple of Athena as enlarged in the time of Pisistratus. These are not reliefs, like the sculptures of the earlier pediments, but statues carved completely in the round. Of the entire group, which represented the combat of the gods with the giants, there now remain the figures of Athena and three fallen giants, two of which evidently filled the corners of the pediment. There must have been at least two other gods, probably Zeus and Heracles. Athena occupied the middle of the pediment. Her vigorous pose is admirable, and the details of drapery, hair, and the like are finely executed. As restored in the Acropolis Museum at Athens, the central group in the pediment consists of Athena and a fallen giant, the crest of whose helmet the goddess is supposed to grasp (Fig. 151). Even if this be not entirely correct, the composition of the pediment group as a whole, with the two fallen giants balancing each other in the corners, is decidedly more advanced than that of the earlier sculptures of the same temple before its enlargement.

The gravestone, or stele, of Aristion, found at Velanideza and now in the National Museum at Athens, is perhaps the most widely known example of Attic relief work of the last years of the sixth century. In this, as in the marble figures from the Hecatompedon, the old Attic vigor, here tempered to calm dignity, is combined with exquisitely careful workmanship (Fig. 152). The traces of coloring on this relief are especially noticeable, though far less so than



FIG. 152.—Stele of Aristion. (Photograph.)

when it was found. Evidently the pigment was applied only to hair, beard, eyes, lips, borders of garments, ornaments, and the like, — not, as was the case with the poros sculptures, to the entire surface. The beauty of the marble was appreciated, and was not hidden under a coat of paint. That marble statues were treated in the same way is proved by many examples, especially by those found on the Acropolis at Athens.



FIG. 153. — Statue dedicated by Euthydicus. (Brunn-Bruckmann, Pl. 459.)

technical execution, careful as it is, has no mannerism: the eyes are set horizontally, not obliquely, as in the Chian works; the mouth has not the empty smile dear to the Chian artists, but an expression of individuality; and the whole head is fuller and stronger than the heads of Chian statues. The marble head of a youth in Athens (Fig. 154) exhibits qualities so similar to those of this figure that it has been regarded as the work of the same artist.

Perhaps the most attractive work of Attic sculpture before the Persian invasion, and certainly one of the latest, is the figure of a maiden, dedicated by Euthydicus (Fig. 153). In this the beauty of the sculptures of the Parthenon is foreshadowed. The



FIG. 154. — Head, Athens. (Brunn-Bruckmann, Pl. 460.)

Be this as it may, the two works mark the height that Attic sculpture had attained at the time of the Persian invasion.

The early sculpture of Athens is known to us through a long series of works, preserved, though in a more or less fragmentary condition, by reason of the enlargement and adornment of the Acropolis after the havoc wrought by the Persians. Such a combination of circumstances is not found elsewhere, and the early sculpture of other places is known to us for the most part only in isolated specimens. But Athens was by no means the most important artistic centre in early times. The legendary Daedalus was, to be sure, in after times called an Athenian, but the chief scene of his activity was Crete, and his pupils, Dipoenus and Scyllis, were Cretans, who practised their art in Crete, the Peloponnesus, and elsewhere. Samos, Ephesus, and, above all, Miletus were important centres of artistic production, and the part played by Chian artists in the development of Attic sculpture shows that about the middle of the sixth century the Chian school was more advanced than that of Athens.

The earliest Chian sculptor known to us by name is Mikkiades, whose son, Archermus, and grandsons, Bupalus and Athenis, were also sculptors. The last mentioned were contemporaries of the poet Hipponax, about 540 B.C.

Sculpture
outside of
Attica



FIG. 155. — So-called Nike of Archermus, from Delos. (Brunn-Bruckmann, Pl. 36.)

Archermus was said to have been the first to represent Nike (Victory) with wings; and a statue of a winged female figure about two thirds the size of life, found at Delos (Fig. 155), may actually



FIG. 156.—Statue of Chian style, Athens.
(Brunn-Bruckmann, Pl. 458.)

be the work upon which his claim to distinction was based; for a pedestal, bearing an inscription that mentions Mikkiades and Archermus, was found with the statue. Unfortunately it is not certain that the statue and the pedestal belong together; but, at any rate, the winged figure shows the qualities of the Chian school at the time of Archermus, the first half of the sixth century B.C. Of the wings with which the shoulders and ankles were furnished, little now remains, but some small bronzes show their original form. The goddess is represented in rapid motion, her knees bent in running, so that she almost seems to be kneeling. The legs are in profile, but body and head are in full face. The feet did not touch the ground, but the goddess was

supposed to be flying through the air, and the figure was really supported by the drapery. This was a bold and striking invention. Perhaps the figure was intended as an acroterion, to be placed on the top of a building. The work is careful and elabo-

rate, and already shows some signs of the over-refined delicacy seen in the later Chian works found at Athens (Fig. 156) and Delos. In the end this excessive refinement and care in details led to conventionalism and loss of power. The Nike belongs to the earlier time, when the Chian school was vigorous and inventive.

A primitive specimen of Naxian sculpture has already (Fig. 145, p. 200) been discussed, and there is ample proof that the art of sculpture was practised at Naxos throughout the sixth century. The seated statues from Branchidae (Fig. 147, p. 202) are examples of Milesian sculpture about 550 and earlier, and ancient writers bear ample testimony to the encouragement of art at Miletus, the greatest of the Ionic cities in the sixth century. From Samos came the so-called Hera (Fig. 146, p. 201), and other monuments, among them a standing, draped male figure, which has many points of resemblance to the seated figures from Branchidae.



FIG. 157.—Sculptured drum from early temple at Ephesus. (Brunn-Bruckmann, Pl. 148.)

At Ephesus the temple of Artemis was destroyed about the middle of the sixth century, and rebuilt with great magnificence. The lower part of its columns was adorned with carved reliefs, for which Croesus, king of Lydia, furnished funds; and enough fragments of these reliefs have been found to make possible a partial restora-

tion, in the British Museum, of such a sculptured column (Fig. 157). The work is fine and careful, though not so delicate as that of the Chian works found at Athens, or of the Attic works produced under Chian influence; the forms of the body are full and round, but they lack the vigor of such early Attic works as the Moschophorus.

The general tendency of Ionic art to roundness of form, freedom of outline, and general sumptuousness of effect, rather than to careful study of detail or to athletic vigor, is seen in the reliefs of several Lycian monuments, the most famous of which is the so-called Harpy Tomb, now in the British Museum (Fig. 158). The



FIG. 158.— Relief from the Harpy Tomb. (Brunn-Bruckmann, Pl. 146.)

meaning of these reliefs is not perfectly clear, but they are apparently related to the worship of the dead and the deities of the nether world, and the winged figures on two sides, popularly called Harpies, are probably spirits carrying away the souls of the deceased. The monument is a work of the latter part of the sixth century.

In the last years of the sixth century the Cnicians erected a treasury at Delphi (Fig. 103, p. 132) and adorned it with sculptures. In the pediment was the struggle of Apollo and Heracles for the sacred tripod; the frieze (Fig. 159) represents the combat of the gods with the giants, an assembly of gods, and a procession of chariots, while in the porch two figures of maidens supported the entablature. These works of developed Ionic sculpture are



FIG. 159. — Battle of gods and giants. Treasury of the *Enfidians*, Delphi. (*Fouilles de Delphes*, Pl. XIII-XIV.)

beautiful in themselves, and are especially interesting when compared with the frieze of the Parthenon and the "maidens" of the Erechtheum, works of the greatest period of Attic sculpture, nearly a century later. The influence of Ionic sculpture was widespread, and predominated, with local shades of difference, in northern Greece.

Comparatively few monuments of early sculpture in the western Greek colonies and conti-

The western nental Greece
colonies outside of At-

tica are preserved, but among them are some of great importance. In Sicily, among the ruins of Selinus, a colony of Megara Hyblaea, which was itself a colony of Megara in Greece, some of the sculptured metopes of four temples have been found. The two earliest groups of these metopes are still crude and far from beautiful, though they testify to conscientious work and, in



FIG. 160. — Perseus and the Gorgon. Selinus. (Brunn-Bruckmann, Pl. 286 b.)

the metopes of the temple of Apollo (temple C), to much originality and great ambition on the part of the sculptors (Fig. 160).

They have, on the whole, more resemblance to the Attic works in poros stone than to other works of Greek art. The third group (from temple F) represents the battle of the gods and the giants, and resembles in its careful study of the attitudes and of anatomy the relief representing the same subject which adorned the treasury of the Megarians at Olympia. Like that relief, these metopes are probably works of the last years of the sixth century. They lack the ease and elegance of Ionic sculpture, but are more vigorous and, in the representation of the human form, more accurate. The fourth group of metopes from Selinus belongs to the period after the Persian invasion.

Although ancient writers mention works by several early artists in Laconia, the extant remains of early Laconian sculpture are limited almost entirely to a few reliefs, which seem to show that it was not distinguished for grace or beauty. The reliefs are carved in flat planes, divided by sharp edges. If, as may be the case, they are works of the fifth century, Laconian sculpture was inferior to that of most of the neighboring regions.

Literary tradition mentions Argos, Sicyon, and Aegina as the chief centres of art in the Peloponnesus in the sixth century. A rather clumsy nude statue signed by the Argive Polymedes, found at Delphi, is an assured example of Argive sculpture about the middle of the century, but Polymedes was probably not one of the best sculptors at Argos in those days. We can therefore say little about Argive sculpture in the sixth century, except that it probably resembled the sculpture of Sicyon and Aegina. The "Apollo" of Tenea (Fig. 144, p. 199) is of Pentelic marble, and may be Attic work, though it shows, in its careful attention to finish and to anatomical detail, some of the qualities which seem to have distinguished Canachus, the chief sculptor of Sicyon toward the end of the sixth century. He was a worker of bronze, and made a famous statue of Apollo for the temple at Branchidae, representing the god nude and holding a deer in his hand. The deer was so balanced that if one pushed it, it rocked on its feet, so that a thread could be drawn under them. The general appearance

of the statue is known from small bronzes (see p. 331) and a late marble relief, but its chief merit was doubtless in precision of detail and excellence of finish, rather than in novelty of pose.

The Aeginetan school, the chief member of which was Onatas, was, like the schools of Argos and Sicyon, famous chiefly for works in bronze. Of these nothing remains (unless perhaps a fine bronze head in Athens may be Aeginetan work), but the marble figures from the pediments of the temple of Aphaia, at Aegina,¹ enable us to judge of the quality of Aeginetan sculpture. These figures are now, with the exception of some fragments found in 1901, in the Glyptothek at Munich. They were discovered in 1811 and were restored, not altogether correctly, by Thorwaldsen. The groups in the two pediments were not by the same artist, though they are of the same date. In general character they are similar, but the artist of the eastern pediment was more advanced than his competitor or co-worker. Much more is preserved from the western than from the eastern pediment. In the centre of each stood Athena, wearing a long chiton, her aegis, and her helmet. About her are groups of fighting warriors. In the eastern pediment, Heracles is recognized in the figure of a kneeling archer who wears a lion's head as a helmet. The scene is here, doubtless, the first siege of Troy,



FIG. 161. — Western pediment, Aegina, restored. (Furtwängler, *Aegina*, p. 206.)

and in the western pediment the later and more famous Trojan War is represented (Fig. 161). No doubt, some of the combatants are Aeginetan heroes, but they cannot be identified with

¹ Called at one time the temple of Zeus Panhellenius and for many years the temple of Athena. The ascription to Aphaia is not absolutely certain.

certainty. In the western pediment were twelve figures besides Athena; in the eastern at least ten, arranged in small groups. At the same time the arrangement was strictly symmetrical, each group and each figure on one side of the centre corresponding to one on the other. In the corners were fallen warriors. Many details and accessories were once brilliantly colored, but the beauty of the marble was not hidden by large surfaces of paint, unless it be that the whole of Athena's garment was red.



FIG. 162.— Figure from eastern pediment, Aegina. (Brunn-Bruckmann, Pl. 28.)

The statues are remarkable for their careful modelling, the boldness of their attitudes, and the athletic vigor of their forms. The limbs are perhaps too long, and there are some inaccuracies in anatomy, though these are slight, and in general the study of anatomy is especially noticeable. In the western pediment the faces have a meaningless smile, like that of the "Apollo" of Tenea, but this is not the case in the eastern pediment (Fig. 162). Both groups are remarkable for truth to life, vigor, and excellence of composition, and are striking proofs of the high quality of Aeginetan sculpture at the time when they were created, a time which cannot be far from 480 B.C., though the exact date is unknown.

Early Ionic art aims in general at ease, freedom of outline, and

grace, while the art of continental Greece and the West is more vigorous and athletic, and exhibits greater interest in anatomy. But it must be remembered that artists travelled freely and worked in many places. Canachus of Sicyon was appreciated at Miletus, and tradition associates the Aeginetan Smilis with the Samians Rhoecus and Theodorus. The works preserved to us are preserved by chance, and no group of Ionic sculpture comparable to the pediment statues from Aegina has as yet been discovered. While it is proper to distinguish between the qualities of Ionic and Western (continental or Doric) art, the distinction should not be too strongly emphasized, and the predominant influence of Ionic art must be acknowledged.

THE FIFTH CENTURY

An immediate result of the Persian invasion was the growth of the power of Athens, which was accompanied by the astonishing development of Attic literature and Attic art. Before this time the chief centres of Hellenic culture were the great and flourishing cities of Asia Minor, and the influence of Ionic art was, on the whole, predominant. After the middle of the fifth century, although other local schools of sculpture, the most important of which was at Argos, continued to exist, the influence of Attic art, as of Attic literature, was supreme. Archaic Greek sculpture was chiefly Ionic; developed Greek sculpture chiefly Attic. The period between the Persian invasion and the time of Pericles is a period of transition, the chief monument of which is the sculptural adornment of the temple of Zeus at Olympia, begun soon after 470 and finished in 457 B.C. or a little later.

**Predomi-
nance of
Attic art**

An interesting work of the first years after the defeat of the Persians is preserved in a copy in Naples. This is the group of Harmodius and Aristogeiton (Fig. 163), made by Critius and Nesiotes to replace the group by Antenor, which had been carried off to Persia. The head of the Aristogeiton is lost, and

has been replaced by a youthful head of much later style.¹ The nude figures are powerful and vigorous, and the attitudes striking.



FIG. 163.—Harmodius and Aristogeiton, Naples. (Photograph.)

The hair of the Harmodius is represented by almost circular grooves and dots; the eyes are round and full. Since the artists were probably Athenians (though the name Nesiotes may indicate that one of them was of Ionic origin), this work, in which the qualities of early Attic sculpture are combined with traits of Ionic art, may serve as an example of Attic sculpture immediately after the battles of Salamis and Plataeae.

The most noted Attic sculptor of this time was Calamis, the effect of whose work upon the later Greeks may perhaps be compared with that produced upon modern beholders by the paintings of Botticelli.²

¹ The real head was certainly bearded, and in general appearance must have resembled a head in Madrid, formerly called Pherecydes, even if that be not, as some scholars believe, actually a copy of the head of Aristogeiton. In the [Boston] *Museum of Fine Arts Bulletin*, III, 1905, pp. 27-30, is a brief discussion of this group, by E. Robinson, in connection with a painting of it on an Attic vase.

² Apparently there was a younger Calamis, a contemporary of Scopas and Praxiteles. As ancient writers do not always distinguish between different artists of the same name, our information concerning Calamis and his style is much confused. The references to stiffness probably refer to the Calamis of the fifth century, and those to charm and delicacy to his later namesake.

Unfortunately nothing now exists, even in a copy, which can be ascribed to Calamis with any approach to certainty. The so-called Penelope, in the Vatican Museum, is, however, a copy of an Attic work of his time, and may give some idea of his style as seen in a draped female figure. It is hardly probable that the "Choiseul-Gouffier Apollo" and its replicas at Athens (Fig. 164) and elsewhere reproduce a nude male figure by Calamis; but the uncertainty of the attribution of extant copies of lost works to artists whose names are familiar, but whose styles are known only through the vague expressions of ancient writers, is exemplified in the case of this statue, which has been attributed to Calamis, and also to Pythagoras of Rhegium, a sculptor who was born at Samos, but passed his life for the most part among the Dorian inhabitants of Magna Graecia and Sicily, and was famous for the realism of his statues. Roman copies of many works of this period, as of the succeeding periods, exist, from which a good general idea of its prevailing qualities may be derived, but the attribution of individual works to artists whose names are known is as yet largely a matter of conjecture.

Among the not very numerous extant original works of this time, the most important, apart from the sculptures of the temple of Zeus at Olympia, are the bronze statue of a charioteer at Delphi and the latest metopes from Selinus.

The bronze charioteer (Fig. 165) is, on the whole, the finest Greek bronze statue in existence. It formed part of a group, in which were,



FIG. 164.—"Apollo on the Omphalos," Athens. (Brunn-Bruckmann, Pl. 42.)

besides the charioteer, at least a chariot, horses, and the goddess Nike; but of these only small fragments remain. The original dedicator seems to have been Arcesilas of Cyrene,¹ though this



FIG. 165.— Charioteer at Delphi.
(Photograph.)

is not absolutely certain, as the inscription on the base of the group was altered in ancient times, and is preserved only in part. The youthful charioteer stands quietly, holding the reins in his right hand. The left forearm and hand are wanting. The figure is full of restrained strength and vigor; the expression of the face alert, but dignified. The drapery is admirably represented, especially the small folds on the arms and shoulders. Above the band that encircles the head, the hair is represented by flat curves in low relief, but below the band the short curling locks, cast, in part at least, separately, show greater freedom. The eyes were of paste, white, with dark centres. It is as yet

¹ O. M. Washburn, *American Journal of Archaeology*, X, 1906, pp. 151-153. If this is correct, the artist was Amphion of Cnossus, about whom little or nothing is known. If, as F. von Duhn (*Ath. Mitt.* XXXI, 1906, pp. 421-429) thinks, the original dedicator was Anaxilas of Rhegium, the artist was probably Pythagoras of Rhegium.

impossible to assign this admirable work, in which exquisite workmanship is combined with accurate observation of nature and great dignity of conception, with absolute certainty to any known artist or even to any school. Argos, Aegina, and Sicyon were famous for bronze statuary, but this figure has little resemblance to the Aeginetan pediment statues, and of Argive and Sicyonian sculpture of this period but little is known. The head, especially the hair about the ears, resembles the heads of youths on Attic vases, and the whole statue has something of the charm associated with Attic art, so that it is natural to think of Calamis; but, on the other hand, the Dorian dedicator might perhaps have preferred a Dorian artist. It is therefore wiser not to assign to any particular school this masterpiece of the period that followed the Persian invasion—a period which may be compared with the earlier days of the Italian Renaissance, before the coming of Michael Angelo and Raphael.



FIG. 166. — Zeus and Hera. Metope from Selinus. (Brunn-Bruckmann, Pl. 290 a.)

The latest metopes from Selinus, four of which are preserved, represent mythological scenes (Fig. 166). They are carved, like the earlier Selinuntine metopes, from a coarse local Selinus stone, but the nude parts of the female figures are of marble. In composition and postures, as well as in the treatment of drapery and in various details, they are greatly superior to the earlier metopes, but still follow in some respects, as in the hair and the angular regularity of some of the drapery, the traditions

of earlier times, and are far from attaining the perfect finish and grace of the best period of art. It is interesting to observe the resemblance of these metopes from far-off Sicily to the group of Harmodius and Aristogeiton on the one hand and the more closely related sculptures at Olympia on the other.

The temple of Zeus at Olympia was completed in 457 B.C. or shortly after. Its sculptures are therefore probably to be assigned to a very slightly earlier date. Of the twelve
 Olympia sculptured metopes, which represented the twelve labors of Heracles, two (the Apples of the Hesperides, Fig. 167,



FIG. 167.—Metope from Olympia. (Brunn-Bruckmann, Pl. 442 a.)

and the Cretan Bull) are almost completely preserved, the rest only in fragments. In the finest and best preserved of all, Heracles stands in the middle, holding up the heavens, represented by the entablature above the metope. The cushion on his shoulders, to ease the weight, is an interesting touch of realism. Behind him stands one of the Hesperides, trying to help him by putting her maiden hand also under the mass. Before him stands Atlas, holding out the apples. This seems almost a joke, for Heracles is fully occupied in holding up the heavens with both hands. In composition and treatment these metopes resemble the latest metopes from Selinus, which probably belong to a very slightly earlier date. The drapery is stiff; the hair is represented by parallel wavy lines, and is in part left smooth, probably to be

and the Cretan Bull) are almost completely preserved, the rest only in fragments. In the finest and best preserved of all, Heracles stands in the middle, holding up the heavens, represented by the entablature above the metope. The cushion on his shoulders, to ease the weight, is an interesting touch of realism. Behind him stands one of the Hesperides, trying to help him by putting her

represented by color ; the eyes of heads in profile are, to be sure, no longer represented in full face, as in the reliefs of the sixth century, but they are not yet quite in profile, and the details of the lids are not entirely correct ; on the other hand, the structure and the muscles of the nude male figures are excellent.

In style and execution the metopes are closely akin to the much more important pediment sculptures (Fig. 168). These, though not completely preserved, are more nearly complete than any other important Greek pediment groups,¹ and their composition is determined except in some relatively unimportant details.² In the eastern pediment the preparation for the chariot race between Pelops and Oenomaus is represented. In the centre stands Zeus, with Pelops at his right, and Oenomaus at his left. Next to Pelops stands Hippodameia, who is to be the prize of his victory, and next to Oenomaus his wife Sterope. Then comes on each side a seated or crouching figure, one of which Pausanias says is Myrtilus, the faithless charioteer of Oenomaus ; then the horses and chariot, two more seated or crouching figures, and in the corners reclining youthful male figures, which Pausanias says represent the rivers Alpheus at the left, and Cladeus at the right. The entire scene is quiet. The five figures in the centre stand erect, facing forward, with hardly a semblance of action, the horses stand still, with no sign of spirit or impatience, and the other figures, none of which, except Myrtilus, has much significance, are either quietly holding the horses or resting in easy attitudes. The chief personages form a group in the centre, to which perhaps the persons in front of the horses should be reckoned, the chariots and their attendants two other groups, and the river gods indicate the scene of the story. Within the groups each figure at one side of the centre corresponds to a similar figure at the other side.

The western pediment is very different. Here a scene of wild confusion and violent action, the combat of Centaurs and Lapiths at the marriage of Peirithous, is represented. In the centre stands, with outstretched hand, the majestic figure of Apollo

¹ Except those from Aegina.

² Pausanias, V, 10, 6-9, describes them.



FIG. 168. — Pediments of Temple of Zeus at Olympia. (*Kunstgeschichte in Bildern*, I, Pl. 41.)

(Fig. 169). At each side is a hero, probably Peirithous at the god's right and Theseus at his left, striking at a Centaur who has seized



FIG. 169. — Apollo, from pediment at Olympia. (Brunn-Bruckmann, Pl. 451.)

a woman; then follows at each side a group of two figures, a Centaur with a Lapith and a Centaur with a boy; then on each side a

woman in the grasp of a Centaur who is forced to the ground by a kneeling Lapith ; then an old woman raising herself slightly from a bed or cushion ; and finally in each corner a reclining female figure, probably a nymph, or perhaps a maid who has escaped from the turmoil.

The difference between the two pediments is striking. In one all is quiet, in the other, all, save Apollo and the recumbent female figures, is full of violent action. Yet the principles of composition are the same. In the eastern pediment the central group consists of Zeus, flanked by two closely connected couples, each with an attendant ; in the western, two groups of three are struggling beside Apollo ; in the eastern pediment the chariots and attendants correspond, and in the western a group of three and one of two figures on one side correspond to similar groups on the other ; and in each pediment recumbent figures serve to fill the corners and mark the scene of action. Moreover, within the groups here, as in the pediments of Aegina, each figure on one side corresponds accurately to a figure on the other. The only marked difference is seen in the central groups, for the heroes at each side of Apollo are turned away from him, while those beside Zeus are not, and this difference is merely a natural result of the violent action in one pediment and the inactivity in the other.

The pediments are alike in their divisions into groups, in the number of figures, and in their rigid symmetry. They are also alike in the proportions and contours of the human bodies, in the shape of the heads, the treatment of muscles, hair, eyes, and other details, as well as in technical execution, though in each pediment the execution is very uneven, ranging from careful accuracy to extreme carelessness.¹ Pausanias says that the eastern pediment is by Paeonius of Mende, and the western by Alcamenes, the well-

¹ The two reclining figures at the north end of the western pediment, the old woman and the right arm of the nymph at the south end, which are of Penteic marble, whereas the other figures are all Parian, are later restorations, and show different treatment.

known pupil of Phidias. The similarity of the two works, however, in execution, in design, and in the principles of composition, makes it almost impossible to accept this statement. The two pediment groups are certainly the work of the same school, and almost certainly of the same artist. They are so unlike Attic work that the attribution to Alcamenes can be accepted only by assuming the existence of an Alcamenes distinct from the pupil of Phidias. The style of Paeonius is known through his statue of Nike at Olympia (Fig. 170), and this is more advanced than the style of the pediment figures; but if, as seems probable, the Nike was set up after the affair at Sphacteria, in 425 B.C., the style of Paeonius might have developed in the interval. It is, then, possible that Paeonius was the author of the pediment figures, but hardly probable. It is therefore better to assign them to no individual artist, but to content ourselves with the statement that they are probably the work of a Peloponnesian school which had at some time come under the influence of Ionic art. There is a certain want of delicacy in these splendid figures, but there is no lack of vigor, and the composition is skilful, even though a critical analysis shows that it is too rigidly symmetrical. The unevenness of execution and some minor faults of design would not have been noticeable when the figures were in place in the pediments, high



FIG. 170. — Nike of Paeonius. (Brunn-Bruckmann, Pl. 444.)

above the ground, and they were moreover disguised by the coloring which once added to the brilliant effect of the whole.

At the time when the sculptures of the temple of Zeus were designed and executed, the most famous sculptors of the fifth century, Myron, Phidias, and



FIG. 171. — Discobolus Lancelotti; after Myron. (Brunn-Bruckmann, Pl. 256.)

Polyclitus, were already known, though the youngest of them, Polyclitus, had but just entered upon his career. All three are said to have been pupils of the Argive sculptor Hagelaidas, and even if this tradition be inexact, it has its value as an indication that ancient critics saw no improbability in the assertion that the great Attic artists, Phidias and Myron, received instruction from Argos.

Myron of Eleutheræ, a small town on the borders of Attica and Boeotia, was Myron born probably toward the end of the sixth century, and his chief activity lay in the second quarter of the fifth century. He was younger

than Calamis, but older than Phidias, and a contemporary of both. He was especially noted for his bronze figures of animals and athletes, and his famous bronze cow was so lifelike that it was said to deceive living cattle. Of one of his famous athlete figures, the Discobolus or Discus Thrower, several Roman copies in marble exist, the best of which is in the Palazzo Lancelotti, in Rome (Fig. 171).

The artist has seized the instant just before the cast, when the figure is most contorted, ready to straighten out like a steel spring when the tension is removed by the supreme exertion. Not only the general attitude, but details, such, for instance, as the bent toes of the left foot dragging on the ground, show most accurate observation and careful study. Only the face lacks the intense expression that naturally accompanies physical exertion, and the hair is imperfectly represented, though the improvement over the formal circular curls of the Harmodius of Critius and Nesiotes is surprisingly great. With Myron the last vestiges of the old law of frontality have disappeared. The representation of the human form in motion, however violent, has been mastered. Yet there is in this figure, with all its lifelike vigor and study of detail, nothing like the realism which reproduces the personal qualities of an individual model. The Discobolus is still, in modern parlance, an idealistic, not a realistic, work, but its idealism is entirely on the physical plane and does not rise to the height of great conceptions. Another work by Myron which is known to us through copies¹ is a Satyr (Fig. 253), which originally formed a group with a figure of Athena. This shows qualities similar to those of the Discobolus, though the posture is not so contorted, the hair is less imperfectly rendered, and the face is more expressive. The metopes of the so-called Theseum, at Athens, exhibit the qualities of Myron's art, and are probably the work of his school.

Myron made great progress in the accurate representation of animals and of men, especially in the difficult postures momentarily assumed in the course of more or less violent action.

His far greater contemporary, Phidias, may perhaps have done less to increase the ability of Greek sculptors to represent nature truthfully, but he added grandeur and purity of conception to the technical excellence achieved by others. The types of gods invented by Phidias remained throughout antiquity the accepted types, and his influence is visible in countless works of later ages.

¹ A full-sized marble copy in the Lateran Museum and a small bronze in the British Museum.

The two most famous works of Phidias were the colossal statues of Athena in the Parthenon at Athens and of Zeus in the temple at Olympia, both of which are described in detail by Pausanias.¹ The nude parts of both were incrustated with ivory and the draperies were of gold, a technique which developed naturally, with the increase of wealth, from the earlier method of incrustating wooden statues with bronze. The originals are, of course, gone, but the descriptions enable us to recognize adaptations of both statues in later works, copies of the Athena Parthenos in two statuettes of



FIG 172. — Varvakeion statuette.
(Brunn-Bruckmann, Pl. 39.)

Roman date, and reproductions of the heads in lesser works of art.² None of these, however, suffices to give more than the general form and posture, with details of the ornamentation, of the great statues. The grandeur of the originals, the effect of their great size and of the brilliancy of their precious materials, can be restored only in imagination, and (what is still more important) the imitations do not reproduce the individual qualities, or even the

¹ I, 24, 7, and V, 11.

² The two statuettes are the Varvakeion statuette (1.03 m. in height; Fig. 172) and the unfinished Lenormant statuette (0.934 m. high without the base), both in Athens. A complete list of the adaptations would be long rather than useful. The "Minerve au collier" in the Louvre may serve as an example of adaptations of the Athena Parthenos, and most of the

seated statues of Zeus and other bearded gods (and Roman emperors) stand in some relation to the Zeus of Phidias. The head of the Athena is reproduced in the Aspasius gem (Fig. 336, p. 408) and two gold medallions from the Crimea (Fig. 265, p. 350). The entire statue and the head of the Zeus are reproduced on Elean bronze coins of Roman date (Figs. 277, 276, pp. 363, 362).

technical details, which distinguish the works of genius from the productions of mere artisans.

It is, however, evident that Phidias relied for his effect, apart from richness of material and elaborate adornment, upon simplicity of posture and calm dignity of expression. The drapery of the Athena falls in large, straight folds, without the variety produced by the irregular fall of delicate textures and without the exposure of the details of the body which accompanies the use of thin draperies. There is nothing of that virtuosity in the treatment of drapery which is so marked a feature in the pediment sculptures of the Parthenon and still more in the reliefs of the balustrade of the temple of Athena Nike. In pose, as in drapery, the Athena is, when compared with the pediment figures, almost archaic. The head is strong, but not square, as in the statues by Polyclitus; it is rather of a broad oval shape, resembling in that respect somewhat the head of the Harmodius of Critius.

Ancient writers, in referring to the Zeus at Olympia, speak of the benignity of his expression and also recall the Homeric lines in which Zeus nods with his eyebrows and causes Olympus to tremble. Something of this mingled power and benignity is faintly reproduced on the Elean coin with the head of the Zeus of Phidias; but perhaps our best idea of the head is derived from

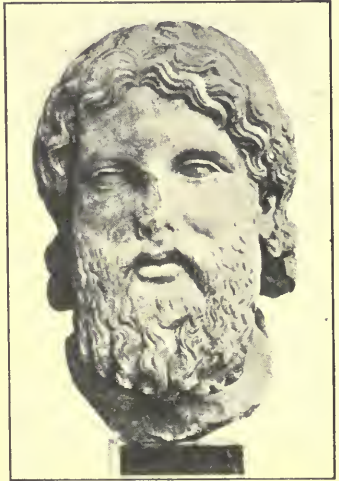

FIG. 173. — Head of Zeus, in Boston.
(Brunn-Bruckmann, Pl. 573.)

a marble head in the Museum of Fine Arts in Boston (Fig. 173), though this is a not especially fine work of perhaps the fourth century B.C., in which benignity has almost become weakness. Nevertheless, comparison with the coin shows that this head re-

produces, with slight modifications, the type of the Zeus at Olympia, which ancient writers unite in praising as the most sublime representation of the father of gods and men.

The statue of Athena Parthenos was dedicated in 438 B.C. and the Zeus at Olympia was probably a slightly later work. Phidias



FIG. 174. — So-called Lemnian Athena. (Furtwängler, *Mastertpieces*, Pl. I.)

is said to have represented himself on the shield of the Athena as a bald-headed old man. Of his life little is known, but he seems to have been, perhaps for political reasons, banished from Athens soon after the completion of the Parthenos, and to have died not long after he finished the Zeus. His earliest recorded works, among them probably a colossal bronze statue of Athena (sometimes called the Athena Promachos) on the Acropolis at Athens, can hardly be later than 470 B.C. He was, then, probably born but little, if at all, after 500 B.C. In spite of the fact that the Athena Parthenos was not finished until 438 B.C., and the Zeus at Olympia probably not until even later, his artistic activity belongs chiefly to the first half of the fifth century. He was a contemporary of Calamis, even of Critius and Nesiotes, and his earlier works cannot have been free from archaism. His great fame justifies us

in the belief that the wonderful progress of Greek sculpture during his lifetime was in great measure the work of his genius. How numerous his works in marble, bronze, gold and ivory, and other materials were we do not know. Many are mentioned by ancient writers, but none, except the Parthenos and the Zeus, has been

identified with certainty in later copies. In recent years Professor Furtwängler, by combining a marble head in Bologna with a torso in Dresden, has reconstructed a statue of Athena (Fig. 174), which is evidently an Attic work of the time of Phidias and agrees with what we know of his style. Whether, as Professor Furtwängler thought, it is a copy of the Lemnian Athena, a bronze statue by Phidias set up on the Acropolis at Athens about 450 B.C., is not so certain, though this view is supported by strong arguments.

The third of the great masters of the fifth century, Polyclitus, was an Argive, though perhaps born at Sicyon. His earliest dated work, the statue of the boy boxer Cyniscus, commemorates an Olympic victory of the year 462 B.C.¹ His **Polyclitus** birth can therefore hardly have taken place much later than 490 or 485 B.C. About 423 B.C. he made the great chryselephantine statue of Hera in the Argive Heraeum. With this exception his works, almost exclusively of bronze, were chiefly statues of victorious athletes. All these figures, so far as is known, stood erect, in a walking posture, with the weight borne chiefly on one foot. This posture was not invented by Polyclitus, but was elaborated and perfected by him. His claim to greatness (and ancient critics regarded him as one of the greatest of artists) rested chiefly upon the perfection of his works, rather than upon fertility of invention or grandeur of conception.

None of his works is preserved in the original, and Argive coins give at best only a general notion of the appearance of the head of the great seated statue of Hera;² but three of his most famous works are preserved in marble copies. These are the Doryphorus,³ the Diadumenus, and the Amazon. All stand

¹ C. Robert, *Hermes*, XXXV, 1900, p. 186.

² C. Waldstein, *Journal of Hellenic Studies*, XXI, 1901, pp. 30-44, finds an adaptation of this head in a marble head in the British Museum. On a cylix with white ground in Berlin, a statuesque figure of Hera has a similar headgear.

³ A fine bronze copy of the head of this statue, signed by one Apollodorus, is in the Museum at Naples.

in the walking posture, and all are alike in the relatively square shape of the head, the square shoulders, and the powerful forms of the body. The Doryphorus (Fig. 175) was called the "Canon," and was regarded as the model of proportions. The attitude is so



FIG. 175.—Copy of the Doryphorus of Polyclitus. (Brunn-Bruckmann, Pl. 273, Ersatztafel.)



FIG. 176.—Copy of the Diadumenus of Polyclitus. (Brunn-Bruckmann, Pl. 272.)

simple, so nearly a mere example of the typical Polyclitan formula of rest in motion, that the figure serves admirably as the foundation for the study of the Polyclitan style.

The attitude of the Diadumenus, with the hands raised to hold the ends of the fillet or ribbon that is to be bound about the head, is more individual (Fig. 176). The proportions are some-

what less heavy than those of the *Doryphorus*, probably because the youth represented is supposed to be younger.

Of the two distinct types of Amazon which are evidently products of the fifth century, one resembles the *Doryphorus* in proportions and general lines as closely as a female figure can resemble the figure of a young man. This is the "Berlin" type (Fig. 177), so called because its best-known representative is in the Royal Museum at Berlin. The original bronze stood alone, without the pillar which serves the marble reproduction as a support, and the wound represented in the breast of the Berlin statue is without doubt a senseless addition of the copyist, which he was led to make because he confounded the motive of the Polyclitan statue with that of the other type, which represents a wounded Amazon.

The marble copies of the works of Polyclitus give us an idea of his style, but not of his technical skill in execution. Even the bronze copy of the head of the *Doryphorus* in the Museum at Naples, although it is no doubt more like the original than are the marble copies, fails to make clear to us why the ancients regarded Polyclitus as almost, if not quite, the equal of Phidias. Since his original works are lost, we can only accept the statements of ancient writers concerning their perfection and estimate his influence by the great number of copies and adaptations of his statues which were produced in later times, as



FIG. 177. — Amazon, Berlin.
(Brunn-Bruckmann, Pl. 348.)

well as by the traces of his style visible in the works of some of the greatest of his successors.

Fragments of marble sculpture found in the American excavations at the Argive Heraeum once formed part of the adornment of the great temple for which Polyclitus made the statue of Hera. They are original works of the time of Polyclitus, and were probably designed and executed by artists who were greatly influenced by the acknowledged head of the Argive school of sculpture. These fragments, therefore, although we have no reason



FIG. 178.—Head from the Argive Heraeum. (Waldstein, *The Argive Heraeum*. Frontispiece.)

to suppose that they are the work of Polyclitus himself, give us original contemporary evidence concerning his style and that of his school. It is important to observe that they exhibit far greater freshness of conception and liveliness of expression than do the dull and mechanical Roman copies of the great artist's famous works. Among the fragments the most interesting is perhaps a female head, frequently called "Hera," which may have had a place in one of the pediments (Fig. 178).

While this head is somewhat less broad or square than the head of the Doryphorus or of the Amazon, and thereby tends slightly toward the Attic type, it is nevertheless Argive work, and shows that the work of the Argive school was less uniform and monotonous than might be inferred were our judgment to be based solely on the copies of the famous statues of Polyclitus. This original work, though doubtless by a less famous artist, serves therefore to supplement and correct the estimate of the style of Polyclitus derived from the copies.

Among the other sculptors of this period Cresilas, Alcamenes,

and Agoracritus should be mentioned, all of whom worked chiefly at Athens, though Cresilas was a Cretan, from Cydonia. A well-known bust of Pericles in the British Museum is regarded with good reason as a copy of an original by Cresilas, who was evidently an artist of great ability and power. Alcamenes and Agoracritus are mentioned as the chief pupils of Phidias. The former was especially famed for the delicacy of his work, and in modern times his "Aphrodite of the Gardens" has been regarded as the original of the type of thinly veiled female figure known as "Venus Genetrix."¹ Alcamenes is also said to have invented the type of the threefold Hecate. That Pausanias can hardly be right in ascribing to him the sculptures in the western pediment of the temple of Zeus at Olympia has already been said (p. 227). Agoracritus is said to have been the artist of the statue of Nemesis at Rhamnus, though some ancient writers ascribed it to Phidias himself. The statue, about fifteen feet high, represented the goddess standing, with a branch of apple in her left hand and in her right a bowl adorned with figures of Ethiopians. On the pedestal were reliefs representing a version of the myth of Helen, who was said to be the daughter of Nemesis and only the foster child of Leda. Fragments of these small reliefs, now in the National Museum at Athens, show that the style of Agoracritus was full of grace and charm. They are exquisite, both in design and execution, and, in spite of their small size, do not lack dignity. They justify us in assuming that the larger works of Agoracritus were of the highest excellence.

Few original works of substantive sculpture belonging to the time of Phidias and Polyclitus are extant; and if by chance any such work is preserved, it is now impossible to assign it with assurance to any individual artist. The famous works of this class are known to us only through inferior copies or the descriptions of Pausanias and other writers. The decorative sculpture of the period has not disappeared so completely, and the sculptures of the Parthenon are, even in

Cresilas,
Alcamenes,
Agoracritus

Sculptures
of the
Parthenon

¹ See p. 290.

their fragmentary condition, among the grandest monuments of human genius. The temple was begun in 447 and dedicated in 438 B.C., but inscriptions prove that it was not entirely finished until 432. The sculptured metopes, above the architrave, must have been finished before 438, as they were carved before they were put in place, and the same is probably true of the Ionic frieze, which ran round the outside of the cella. The statues in the pediments may have been completed and put in their places after the dedication of the temple, though this cannot be positively asserted. At any rate, all the sculptures are approximately dated between 447 and 432 B.C.

The ninety-two metopes, each about four feet square,¹ were all adorned with figures in very high relief; the Ionic frieze was a continuous composition in low relief, 522 ft. 8 in. (159.42 m.) long and 3 ft. 3.95 in. (1 m.) high; the pediments, 93 ft. (28.35 m.) long and 11½ ft. (3.456 m.) high in the middle, were completely filled with colossal statues. The sculptures were all of the same Pentelic marble as the building itself.

Of the metopes forty-three are still in place on the Parthenon, where they have suffered greatly from exposure, fifteen are in the British Museum, one in the Louvre, and fragments are in the British Museum, the Louvre, the Acropolis Museum at Athens, and two in Copenhagen. The rest are lost. The subject of those at the east end is the battle of the Gods and the Giants, of those at the west end the battle of the Athenians and the Amazons. On the south side the metopes toward each end represented Centaurs fighting with Lapiths, as did those in the middle of the north side. The metopes in the middle of the south side and those toward the ends of the north side appear to have represented scenes from the Trojan War. The best-preserved metopes, those in the British Museum, all represent Centaurs in conflict with Lapiths, and are almost the only ones so well preserved as to enable us to judge of the style and workmanship, in both of which they exhibit great variety. In some the figures are stiff, with dis-

¹ 1.20 m. by 1.27 m.

tinct traces of archaism, and the workmanship is not remarkable ; in others the design is vigorous, admirably adapted to the square space to be filled, and full of life, while the execution is both fine and free. One of the best is shown in Figure 179.



FIG. 179.—Metope from the Parthenon.
(Photograph.)

The Ionic frieze represents the Panathenaic procession. At the west end the knights (*ἱππεῖς*), the youths of the best families of Athens, are preparing to mount their horses or have already mounted and are starting on their way.

This part of the frieze is still in place, as is also a small part of the frieze of the south side. Most of the rest is in the British Museum, though several



FIG. 180.—From the northern frieze of the Parthenon.
(Brunn-Bruckmann, Pl. 113.)

ἀποβάται, or armed men, who fought either from the chariot or on foot, cattle and sheep led to the sacrifice, maidens carrying jars,

slabs and fragments are in the Acropolis Museum at Athens. On the north and south sides the procession is seen advancing toward the east end. Here are youths on horseback (Fig. 180), chariots with their drivers, and

in short, the various component parts of the great procession. On each of the long sides of the building the procession is represented, so that the spectator could see it equally well whether he walked along the northern or the southern portico. At the east end the procession turns the corner, headed by priests and maidens who carry ceremonial implements. Before these stand two



FIG. 181.— From the eastern frieze of the Parthenon.
(Brunn-Bruckmann, Pl. 194.)

groups of male figures, apparently the ten eponymous heroes of the Attic tribes. Then come at each side six seated figures, the twelve great deities (Fig. 181), and with them Iris attendant upon Hera and Eros leaning upon the knees of his mother Aphrodite. In the mid-

dle, over the great door, is a group of five persons, two maidens carrying stools on their heads, the priestess, and a priest, who seems to be taking a large folded cloth, the sacred peplos of Athena, from his young attendant. Thus the procession takes place in the presence of the Attic heroes and the great divinities. No more perfect expression of its religious significance could be imagined.

The metopes, destined to be placed on the outside of the entablature, where they were exposed to the full brightness of the brilliant Athenian sunlight, are properly carved in very high relief, which casts deep shadows. The frieze, high up at the top of the wall of the cella, was always in the shade and received only diffused and reflected light from below. It was therefore necessarily carved in low relief. Moreover, since the light came from

below, the shadows must fall upward, and the artist, fully conscious of this fact, made the lower parts of the figures project less from the background than the upper parts and cut the upper outlines in sharply, while the lower parts of the figures reach the background by more gentle curves. In this way the shadows were prevented from destroying the clearness of the design. Even with all this care, however, the design would hardly have been clearly visible from below, had the aid of color (and, in some cases, affixed metal) not been called in. The details of the coloring are lost, but the background was probably blue, and red and gold were freely used on the figures. The variety of design is remarkable, for not one of the hundreds of figures is a reproduction of any other, yet all are dignified, graceful, and beautiful. The workmanship is not of uniform excellence, but there is no such difference as exists in the metopes, and the design of the entire frieze is evidently the work of one consummate artist.

Nearly all the extant remains of the pediment statues are in the British Museum, though many fragments are in Athens, and one head (the so-called Weber or De Laborde head) is in Paris.

The subjects of the pediment sculptures are known from the statement of Pausanias, who says that in the eastern pediment the birth of Athena was represented and in the western the strife of Athena and Poseidon for the possession of Attica. Drawings made by an artist¹ who was in Athens with the Marquis de Nointel in 1674 represent the pediments as they were at that time, when the sculptures of the western end were almost entire; but the central group of the eastern pediment was even then destroyed and its arrangement can be only conjecturally restored. It is, however, certain that Zeus, Athena, and Hephaestus, or Prometheus, were represented, and with them were probably the Eilithyiae, or goddesses of childbirth, while Nike floated above, in the very centre of the pediment. So the scene is represented

¹ Not as was formerly believed, Jacques Carrey. See Vandal, *L'Odyssee d'un Ambassadeur. Les voyages du marquis de Nointel, 1670-1680*, Appendice iii. Paris, 1900.

on a puteal in Madrid. The marks on the blocks of the cornice which once supported the statues, each of which had a separate plinth, indicate that Zeus was seated just at the left of the centre, with Athena standing before him, at the right. The first extant figure toward the left is Iris, bearing the news to the two seated figures beyond, who may be Demeter and Persephone, or the Horae. The splendid recumbent figure beyond these (Fig. 182) is sometimes called Theseus or Dionysus, but has also been interpreted as a personification of Olympos.



FIG. 182.— Figure from the eastern pediment of the Parthenon. (Brunn-Bruckmann, Pl. 187.)

In the corner, Helios, driving his four horses, rises from the sea. The three magnificent draped figures at the right (Fig. 183) have been called the Fates, the three Attic Horae, and also personifications of aspects of nature. So Brunn called them clouds, and Waldstein interprets the two at

the right as Thalassa in the lap of Gaia (the Sea in the lap of Earth). In the corner Selene in her four-horse chariot sinks into the sea.

The central group of the western pediment is preserved in the drawing of 1674, and is reproduced, though with some changes, on a vase from Kertch, now in St. Petersburg. In the centre was Athena's gift to Athens, the sacred olive tree. At the left stands Athena, who has just struck the ground with her spear. At the right stands Poseidon. Both figures draw back from the centre. Behind Athena is her chariot, driven by Nike, and behind Poseidon his chariot, with Amphitrite as charioteer. The nude male figure beside Athena's chariot is probably Hermes, and the draped female



FIG. 183.— The "Fates"; eastern pediment of the Parthenon. (Brunn-Bruckmann, Pl. 190.)

figure that corresponds to him may be Iris. The recumbent figures at the ends are probably a river-god and a nymph, Cephissus (or Ilisus) and Callirrhoe. The remaining figures have been interpreted (1) as the gods and heroes who were present at the contest, (2) as Attic divinities and heroes who symbolize the Attic people and their interest in the event, or (3) as personifications of features of the Attic landscape. Here, as in the eastern pediment, the loss of the heads of the originals, the imperfections of the drawings, and the entire loss of attributes, render a certain interpretation well-nigh impossible.

But if we cannot determine in all its details the meaning which the sculptor intended to convey, we can appreciate the beauty of the individual figures and, especially in the western pediment, the variety and rhythm of the composition (Fig. 184). The astonishing progress made by Greek sculptors in one generation is seen on comparison of these works with the pediment sculptures of Olympia. Here is no trace of archaic stiffness, no lingering influence of the old law of frontality, as in the central figures at Olympia, no difficulty in the treatment of drapery. In some cases, notably in that of the recumbent "Fate" in the eastern pediment, the drapery is

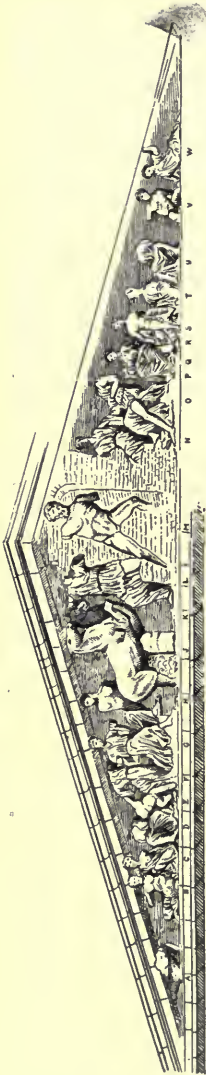

FIG. 184. — Drawing (1674) of western pediment of Parthenon. (Michaelis, *Der Parthenon*, Atlas, Pl. 7.)

treated with almost excessive delicacy and ease, while the massive, athletic figure of the so-called Theseus shows complete mastery in the portrayal of the nude form. As at Olympia, the sculptures of each pediment are divided into groups, but here there is no upright figure to divide the whole space into two equal triangles, and the correspondence of individual figures in the two sides of the pediment is no longer exact, but is varied, a nude form corresponding to a draped figure, a male to a female, or a bearded man to a youth. Here is no monotonous repetition of the same note, but the music of harmonious chords.

Of all the remains of Greek decorative sculpture none equal the sculptures of the Parthenon. The metopes are superior alike to those of Olympia, of Selinus, and of the so-called Theseum at Athens; the frieze, in the variety of its design, the grace and dignity of its human figures, the liveliness and truth to nature of its animals, and its delicacy of workmanship surpasses all other friezes, and the pediment sculptures are, both in composition and execution, unrivalled. According to Plutarch (*Life of Pericles*, Chapter XIII) Phidias was general director of building operations under the government of Pericles. Phidias was also the greatest Athenian sculptor, and the great statue of Athena in the Parthenon

Authorship
of the
sculptures
of the Par-
thenon

was his work. On these grounds the decorative sculptures of the Parthenon have been ascribed to him. But if Plutarch's statement is correct, Phidias would hardly have been able to accomplish such vast works in addition to his work as general director and as artist of the great statue, and if, as may be the case, Plutarch was misinformed, there is no real reason for connecting Phidias directly with the decorative sculptures. Of course no single person could have executed all these works in nine, or even fifteen, years, and the inequalities of execution make it clear that several hands were employed. It has therefore been assumed that Phidias made the models and had the actual carving done by others under his direction. This is possible, though even this would have been a great task for one whose time was occupied with other work. Moreover, the metopes differ among themselves in style as well as in execution, and no one of them has any close stylistic resemblance to the frieze, nor do the pediment sculptures show any such similarity to the frieze or to the metopes as exists, for instance, between the pediment sculptures and the metopes at Olympia. Besides, the drapery of the pediment figures of the Parthenon is treated with vastly greater freedom than was that of the Athena Parthenos, and this cannot be wholly explained by the difference between decorative sculptures and a cultus statue. That all the decorative sculptures of the Parthenon breathe the spirit of Attic art as developed under the influence of Phidias is true, and the great master may even have aided in the work with his advice, but his direct participation in it seems, on the whole, improbable. It is not unlikely that several different artists designed the metopes and that the frieze and the pediment sculptures are due to two artists, not to one. In this case, the glory of Phidias, the acknowledged master of these great masters, is only enhanced.

The so-called Theseum at Athens is, at least on the exterior, the most completely preserved of all Greek temples. The statues that once filled the pediments are lost, unless, as Bruno Sauer believes, one of them is preserved in the Ny Carlsberg Museum at Copenhagen. This is a recum-

**Sculptures
of the
"Theseum"**

bent figure, evidently a work of about the period of the Parthenon, which seems to have formed part of a pediment group and may well have had a place on the "Theseum." The metopes and friezes are still in place on the building. Only eighteen metopes, of Parian marble, are adorned with reliefs, ten on the eastern front and four at the eastern end of the north and south sides. The reliefs represent deeds of Heracles and Theseus. The designs are well adapted to the square field and show great ability in the representation of violent, contorted attitudes, but the figures are now so defaced that the details can no longer be appreciated. The continuous friezes are, on the other hand, well preserved. One extends across the eastern front of the cella and the passage at each side to the exterior architrave, the other, at the western end, only across the end of the cella. These friezes, owing to the smaller size of the temple, are less high above the ground than was the frieze of the Parthenon, and are better lighted. They are in rather high relief. The eastern frieze represents a scene of battle in the presence of seated divinities, who are here, as in the eastern frieze of the Parthenon and the much earlier front of the treasury of the Cnidians at Delphi (p. 212), supposed to be invisible to the human beings whose actions are sanctified by their presence. The western frieze represents the combat of Centaurs and Lapiths. Here, even more clearly than in the eastern frieze, the composition falls into groups of two, as if the artist had been in the habit of decorating metopes. In fact, one of these groups is almost a reproduction of one of the metopes of the Parthenon. In other respects, these friezes are excellent, both in design and execution. In general, the style is such as may reasonably be attributed to the pupils of Myron, rather than to Phidias or his school.

The frieze of the beautiful little Ionic temple of Athena Nike appears to belong to about the same time as the Parthenon and the "Theseum," but may be a little later. At any rate, the tendency to employ floating draperies as a means of filling vacant spaces—a tendency which is very strong in later works—is already noticeable. The frieze is only about eighteen inches high, and

the figures are consequently small. At the eastern end is an assembly of gods, and scenes of combat between Greeks and barbarians, as well as between Greeks and other Greeks, occupy the three remaining sides. It is probable that some battle of the Persian War is intended. Some of the slabs are in place on the temple, the rest in the British Museum.

About the bastion on which the temple stands was a marble balustrade adorned with reliefs which represented winged Victories engaged in various activities. One is decking a trophy, two others are leading a cow to sacrifice, another has raised her foot and is doing something to her sandal (hardly tying it, as even a goddess would not tie a sandal with one hand). These reliefs, which are unfortunately fragmentary, are remarkable for their delicacy of execution and for the extraordinary transparency of the drapery, which discloses almost all the details of the beautiful forms beneath (Fig. 185). The beautiful recumbent "Fate," from the eastern pediment of the Parthenon, shows something of this manner, which here reaches its fullest development. Admirable as these charming reliefs are, they lack something of the exquisite simplicity of the frieze of the Parthenon. The artist of the balustrade seems to wish to show his consummate skill, not merely to express his beautiful conceptions in beautiful form. Since the balustrade was not necessarily made when the temple was built, its date cannot be accurately determined, but it is assigned with great probability to the last years of the fifth century.

The sculptures of the Erechtheum consist of a frieze, which



FIG. 185.—Victory from the balustrade of the temple of Athena Nike. (Photograph.)

Balustrade

encircled the entire building, and six Caryatids, or, as they are called in the inscriptions, maidens, which supported the roof of the small southern porch (Fig. 102, p. 131). Of the frieze only fragments remain; they are of Pentelic marble, and the surface has in almost all instances suffered severely. The work does not seem to have been of surpassing excellence, and the frieze is interesting chiefly because the reliefs were carved separately and fastened with iron dowels on a background of dark gray Eleusinian stone. The representation seems to have been broken up into separate scenes, which were probably connected with the myth and the cult of Erechtheus, and some seated figures doubtless represented deities. The figures on the northern porch were slightly larger than the rest. The "maidens" are more interesting. One is now in the British Museum; the others are in their original position, where the place of the missing figure is supplied by a modern reproduction. Since they take the place of columns as architectural members, these figures naturally stand erect, but they are not stiff and inelastic, like those in the porch of the treasury of the Cnidians at Delphi (pp. 132, 154). One knee of each figure is bent slightly, giving a touch of life and actually adding to the appearance of stability, for the bent knee is always the one toward the interior of the porch, — an arrangement which seems to give an inward tendency to the supports, like the inclination of Doric columns. The drapery, while its folds are for the most part vertical, like the channels of columns, is natural and elegant. The faces are calm and dignified. The tall calathus (or polus) that rises from the heads of the figures at Delphi is here reduced to about the dimensions of a Doric echinus, and the vertical space thus gained is added to the height of the maidens, increasing their importance as architectural members. The heads are somewhat broader than the Attic norm, a peculiarity which may be due to Argive influence, though it may be accounted for by the sculptor's feeling for architectural propriety. These figures have been often imitated in ancient and modern times, but have never been equalled in grace and dignity or in technical execution.

The frieze of the temple of Apollo Epicurius at Bassae (Phigaleia), in Arcadia, is a work of the time of the Peloponnesian War, for the temple was built by Ictinus, the architect of the Parthenon. Probably, though this is not certain, the frieze is the work of an Attic sculptor. It represents the battles of Greeks with Amazons, and of Lapithae with Centaurs. The free **Bassae** and vigorous design is distinguished for its bold, and not always successful, attempts at foreshortening. The use of draperies to fill vacant spaces is also noticeable. The execution is not equal to the design, but the relief is important as an example of a large decorative composition.

Two important series of reliefs of the fifth century are from Lycia. The first, from Trysa (Gjölbaschi), now in Vienna, once decorated the wall that surrounded a tomb. The **Gjölbaschi** reliefs are carved in a soft, porous stone, which has suffered greatly from exposure. The scenes represented are in part historical, like those on Assyrian reliefs, but for the most part mythological, among them the battles of Greeks and Amazons and Centaurs and Lapithae, the deeds of Theseus, and the vengeance of Odysseus on the suitors. The influence of Attic art is apparent, for some of the types are identical with those known from the other reliefs mentioned, while others are repeated in Attic vase paintings. In general, the treatment is pictorial, rather than sculptural, and it is probable that the artist relied upon color for much of his effect. Indeed, since some of the most famous Greek painters, including Polygnotus, were living and working in the fifth century, it is impossible that their influence should not have been felt by decorative sculptors as well as by vase painters.

The second Lycian monument, which must be dated shortly before (or possibly just after) 400 B.C., is the so-called Nereid Monument, now in the British Museum (see Fig. 135, **Nereid Monument** p. 177). This is a small building like a temple, standing on a high foundation. Between the columns are draped female figures, probably Nereids. They are represented in rapid motion, and their floating drapery recalls that of the Nike of Pae-

onius. The style is apparently the result of Attic influence upon the earlier Ionic style. The monument was further adorned with four friezes, — two of which were probably on the high foundation, one above the architrave, and one at the top of the cella. The scenes are in part similar to those of the reliefs from Trysa, battle



FIG. 186. — Relief from Eleusis. (Brunn-Bruckmann, Pl. 7.)

scenes and sieges, but the reliefs of the Nereid Monument, being of Parian marble, are much better preserved, and were probably better executed. Here, as in the figures of the Nereids, the spread of Attic influence to the coast of Asia is plainly to be seen.

Reliefs were employed not only for the decoration of Tombstones of build- and votive reliefs ings, but reliefs also in other ways — for votive offerings at shrines or temples, for headings of inscriptions, and for tombstones. Most of the sculptured tombstones

date, however, from the fourth century. A fine example of the votive class is the large relief from Eleusis, now in Athens, which represents Demeter and Cora (Persephone) with the youthful Triptolemus, or possibly Bacchus. This still retains, especially in the treatment of the hair and the drapery, some qualities of archaism, and should probably be assigned to a time shortly earlier

than the decoration of the Parthenon (Fig. 186). Another relief of exceptional charm, though not of exceptionally fine workmanship, is the so-called Mourning Athena, in Athens. This was apparently the heading of an inscription. It is a work of about the middle of the fifth century, or a trifle later. Perhaps Athena is gazing pensively at a list of the Athenians who had fallen in one of the many campaigns of that period of enterprise and activity. Such works as these serve to show how general was the employment of artists and how great was the ability of even the unknown and unimportant sculptors of this period.

THE FOURTH CENTURY

In the fifth century Greek sculptors advanced from archaic stiffness and mannerism to grace and simplicity, overcame the difficulties in the representation of human beings and animals (both as regards general structure and such important details as the eyes), invented the chief types of gods and goddesses, learned to present floating and clinging drapery with great skill, and created decorative compositions which have remained unsurpassed even to the present time. It might be supposed that further development was impossible, and it is true that in some respects the decadence of Greek sculpture begins with the fourth century. The artist of the fifth century presents his ideal with all the truth to nature he can command, and his ideal is one of dignity and purity, unsullied by excessive desire on the artist's part to show his skill at the expense of the grandeur and simplicity of his work. In the fourth century the personality of the artist is put forward with greater consciousness; there is more striving for effect, and consequently less simplicity and dignity. Herein is the beginning of decadence. But there is also real progress in the fourth century, and even later, for new problems are attacked and mastered. Portraiture becomes more successful as it grows more personal, and the types of the gods, especially of the younger deities, are more completely differentiated and fixed.

The fifth and fourth centuries

Sentiment and emotion (*πάθος*), which are almost completely absent from sculpture of the fifth century, are expressed with increasing ease and with ever greater prominence in the works of the century that follows. This is real progress, in so far as it shows



FIG. 187. — Copy of Eirene and Plutus by Cephisodotus. (Brunn-Bruckmann, Pl. 43.)

ability to do what earlier artists could not do; but unfortunately this progress brings with it a loss of dignity and a tendency to the representation of casual and momentary personal qualities. The desire for novelty in expression, which is apparently restrained in the fourth century on account of the fact that almost any expression of emotion is a novelty, leads in later times to such brilliant but exaggerated and even unlovely creations as the reliefs of the great altar at Pergamon or the Laocoön group.

A characteristic work of the early part of the fourth century is the **Cephisodotus** group of Eirene and the infant Plutus (Fig. 187), by Cephisodotus, who

¹ A better replica of the torso was found not long ago in Rome, and is now in the Metropolitan Museum in New York. A better replica of the child is in the National Museum at Athens.

the original was set up at Athens about 370 B.C., but its date may be somewhat earlier, possibly even slightly before 400 B.C. The goddess of Peace is holding the infant god of Wealth on her arm, and gazing upon him with maternal tenderness. In this expression of sentiment the spirit of the fourth century is evident, but the drapery recalls the style of the days of Phidias rather than the more elaborate technique of the last years of the fifth century, such as is seen in the reliefs of the balustrade of the temple of Athena Nike. A further development of the same tendency is seen in the drapery of the magnificent Demeter of Cnidus in the British Museum, a work of about the middle of the fourth century.

The most famous sculptors of the fourth century were Scopas of Paros, Praxiteles of Athens, and Lysippus of Sicyon. Scopas and Praxiteles worked almost exclusively in marble, Scopas, Lysippus in bronze. Scopas was apparently the eldest, Praxiteles, for he was employed in the building of the temple of Lysippus Athena Alea, at Tegea, probably not many years after the destruction, in 394 B.C., of the earlier temple.¹ But he must then have been a young man, as he took part in the decoration of the Mausoleum at Halicarnassus, which was not finished until after 349 B.C. It is reasonable to suppose that he was born in the latter part of the fifth century and died early in the second half of the fourth. Praxiteles was perhaps twenty years younger than Scopas, for his earliest known work—a group of Leto, Apollo, and Artemis, at Mantinea—belongs to a time not far from 370 B.C. He seems to have died in the third quarter of the century, for there is no record or legend of his coming into contact with Alexander. Lysippus, the favorite sculptor of Alexander, is said to have lived at least to the founding of Cassandreia on the site of Potidaea, in 316 B.C. As he lived to a good old age, his birth cannot well have been later than 386 B.C., and was probably earlier. The

¹ The style of the fragments of sculpture from this temple seems to point to a time somewhat later than 394 B.C. Possibly the temple was not immediately rebuilt. In that case, the birth of Scopas may perhaps have taken place even after the beginning of the fourth century.

three great sculptors were, then, contemporaries, though Lysippus may have been twenty years or more younger than Scopas.

Ancient writers speak of the emotional quality of the works of Scopas, the intensity of expression in his faces. These qualities are very evident in four heads from the pediments of the temple of Athena Alea at Tegea; and since Pausanias says that Scopas was the architect of the temple, and also made some of the statues in the interior, the pediment sculptures were probably his work. In the eastern pediment the Calydonian boar hunt was represented, in the western the combat between



FIG. 188.— Heads from Tegea. (From casts. *Antike Denkmäler*, I, Pl. 35.)

Achilles and Telephus. The extant heads (Fig. 188), of local (Doliana) marble, have the broad form characteristic of the works of Polyclitus, but the eyes are set deep under overhanging brows, and are wide open, with an upward, far-away gaze. The mouths have slightly parted lips, and the whole expression is one of emotional intensity.

At the same place a female head and torso, both of Parian marble, were found, which agree in size with the male heads. If the torso and the head belong together, the figure may well be that of Atalanta, and then belongs to the pediment group, but this is not

probable. The head shows much less facial expression than the male heads, but the distended nostrils and slightly parted lips disclose something of the character of the male faces. On the whole, the probability that the head is a work of Scopas is strong, even should it be proved not to belong to the torso.

The statements of ancient writers, who mention many works by Scopas, make it probable that his earlier years were spent in continental Greece, chiefly in the Peloponnesus. About 350 B.C. he was at Halicarnassus, and the latter part of his life was probably passed in Asia Minor. The titles of some of his works may serve to indicate their variety and, to some extent, their qualities. Among them were a colossal seated Ares, a youthful Asclepius, a Bacchante in frenzy, a group of Eros, Himeros, and Pothos (Passion, Desire, and Yearning), and a composition, probably in relief, representing Thetis and Achilles, with Poseidon, Nereids riding on dolphins or fabulous sea animals, Tritons, and other marine deities and creatures. The three forms of love — Eros, Himeros, and Pothos — must have been distinguished chiefly by variety of facial expression; the frenzied Bacchante doubtless exhibited her frenzy by her violent motion and her expression of wild excitement, and the description of the cortège of Achilles and Thetis suggests a group of varied and fantastic forms in motion restless as that of the sea. Probably many of the representations of marine beings produced in later times were inspired by this composition.

The study of the heads from Tegea enables us to judge in some measure of the means by which Scopas represented facial expression, — such as deep-set, wide-open eyes, parted lips, and significant pose of the head, — and not a few statues, in which some or all of these characteristics are combined with the general qualities of the work of the fourth century, are regarded as copies of statues by Scopas and his school,¹ though the certain identification of any of them with any of his recorded works is difficult. But it is clear that they show his influence, and equally clear that his influence continued to be powerful long after his death.

¹ See B. Graef, *Mitt. d. k. deutschen arch. Instituts, Roem. Abt.*, 1889, p. 199.

Even before the discovery of the heads at Tegea, the Meleager of the Vatican and its replicas¹ were identified as more or less altered copies of a work of Scopas, and this identification has been made only more probable by the study of the heads. This work does not, however, show the qualities of the art of Scopas so clearly as some others; for instance, the Heracles at Lansdowne House.² Of the work of Scopas at the Mausoleum and at Ephesus, it will be more convenient to speak later.

Pausanias mentions, among the statues set up in the Heraeum at Olympia, a Hermes of stone (marble), carrying the infant Dionysus, and adds, "it is a work of Praxiteles." A **Praxiteles** statue corresponding to this description was found by the German excavators among the ruins of the Heraeum, somewhat broken, to be sure, but still in a remarkable state of preservation. This is the only attested extant original work of Praxiteles, and is therefore the basis of all accurate study of his style. It is, moreover, the only certainly identified original work of any famous Greek artist, for the other extant originals are anonymous, and the known works of the famous artists exist only in copies. Comparison of the Hermes with the identified copies of works of Praxiteles shows how far the copies are from reproducing the originals in their finer details, even when there is no difference of material, and certainly when a bronze original is represented by a marble copy, as is the case, for instance, with the works of Polyclitus and Lysippus, the difference must be still greater.

The figure of the Hermes (Fig. 189) is powerful, but graceful and not heavy, more slender than the Polyclitan canon. The rhythmic curve of the body seems to be a development from the curve of the Polyclitan figures, but here the rhythm is more pronounced, and the curve is greater. This would be impossible, or at least unnatural, but for the addition of the tree-trunk, upon

¹ The best replica of the head is in the Villa Medici (the *École française*) at Rome. A good replica of head and torso is in the Fogg Art Museum at Cambridge, Massachusetts.

² Now ascribed by some critics to Lysippus.

which the god leans. This graceful curve is characteristic of all the statues ascribed to Praxiteles, and all have, in one form or another, a support, without which the posture would be almost impossible in marble. Bronze statues, owing to the strength and comparative lightness of their material (since they are cast hollow), require, as a rule, no supports, but the case is different with marble statues, as is seen in the marble copies of bronze originals. Praxiteles displayed great ability in making the necessary supports contribute to the beauty of his works.

Hermes, carrying the infant Dionysus on his arm and his herald's staff in his left hand, has stopped to play with the child by holding up something, doubtless a bunch of grapes, in his right hand. He leans upon a stump, over which he has thrown his cloak. The action is natural and simple, and the artist has seized the opportunity to produce a most perfect example of drapery in marble. Here is nothing affected or artificial, but the natural folds of a rather heavy garment falling over an upright support are most accurately reproduced. The folds are not long, parallel grooves, nor have they sharp dividing lines, but they pass into each other in almost imperceptible curves, while the broader surfaces are broken by small, shallow depressions. All this is a great advance beyond what was attained in the most elaborate drapery of the



FIG. 189. — Hermes of Praxiteles.
(*Olympia*, III, Pl. XLIX.)

fifth century, and testifies to most careful study of real cloth. It is perhaps worth while to note in passing that no such exquisite details are found in any of the Roman copies, by which alone other works of famous Greek artists are known to us. In the figure of Hermes the same accuracy of detail is noticeable, though the difference between this and earlier work is less tangible here than in the drapery. The head is a development of the Attic type of the fifth century, with relatively narrow chin and broad forehead, as if to emphasize the intellectual, rather than the animal, nature. The forehead is not smooth, but is divided by a horizontal groove near the middle of its height and an almost triangular projection above the nose. The eyes are not really fixed upon the infant Dionysus, but rather look beyond him, with a dreamy, almost pensive, expression.

The hair deserves especial attention. In earlier works the hair appears as a layer of uniform thickness, the outer surface of which is divided by nearly parallel grooves, as in the Apollo from the western pediment at Olympia, or marked with circles and dots, as in the Harmodius by Critius and Nesiotes. The locks generally end in stiff, circular curls. Sometimes the hair appears merely as a smooth surface, in which case the details must have been added in color. In bronze works the hair lies flat on the head, the locks being represented in very low relief, except where they are made of separate pieces and fastened on. Marble copies of bronze works naturally reproduce more or less the appearance of the originals. In the Hermes an entirely different method is adopted. The short, thick locks project from the head, forming an irregularly broken surface, and the whole is left comparatively rough. There is no attempt to represent the individual hairs, but the effect of hair is produced by the avoidance of such an attempt. Whether this "impressionist" method was an invention of Praxiteles cannot now be determined. At any rate, it is admirably carried out in the Hermes and entirely supplanted the earlier methods.

The statue of Hermes is a beautiful and almost perfect work ;

but in the treatment of the infant Dionysus, Praxiteles was less successful. The attitude and action are too mature for a child of such small size, unless, indeed, which is not probable, Praxiteles wished to show that an infant god is different from a human infant. The head and body are much broken, but are well enough preserved to show that the child was a far less perfect work than the Hermes. The successful rendering of infantile forms belongs to a later time.

The Hermes of Olympia was not one of the most famous works of Praxiteles. Far more famous were his statues of Eros, of Satyrs, and of Aphrodite; and most famous of all was the Aphrodite of Cnidus, the type of which is known through ancient descriptions and coins. The best copy is in the Vatican (Fig. 190), a less excellent one in Munich. Here we see the same rhythmic curve as in the Hermes, but the support (for such it really is in the marble) has the form of drapery, which the goddess holds and raises from the urn below, unless, indeed, she is letting it fall. The urn indicates a bath, but whether the goddess is about to bathe or is on the point of clothing herself after a bath is uncertain. She stands conscious of her beauty, as of her nudity, but without coquetry or shame. Here, as in the Hermes, the drapery and the hair are not smooth, like the skin, but are so treated as to indicate their texture. The dreamy look of the Hermes is here

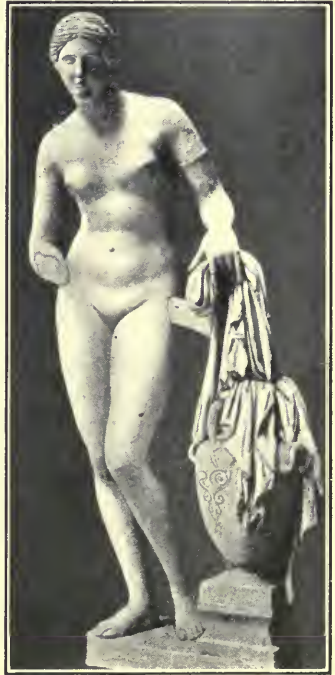

FIG. 190.—Aphrodite of Cnidus; Vatican. (*Jour. Hell. Stud.* 1887, Pl. LXXX.)

further softened and feminized by the narrowing of the eyes, which even in the Hermes are in strong contrast to the wide-open, round eyes of most earlier works. The Aphrodite of the Vatican, though only a copy, needs but to be compared with other statues of the



FIG. 191. — Praxitelean Satyr. Rome.
(Brunn-Bruckmann, Pl. 377.)

nude Aphrodite to prove its superiority in grace, dignity, and purity. Yet here, as in the Hermes, human personality is present, and it is but a step to the representation of human imperfections.

Several types of Satyrs are clearly of Praxitelean origin, and among them none is more beautiful or preserved in a greater number of replicas than that made famous by Hawthorne in *The Marble Faun*.¹ Here the attitude of easy grace has become a posture of graceful indolence. Not only is there a rhythmic curve of the body, but the whole figure is inclined toward the supporting tree (Fig. 191). The same peculiarity is seen in another statue by Praxiteles, the Apollo Sauroctonos (Lizard-slayer), and it has been suggested that the sculptor's progress may be traced in the greater tendency to such inclination. In

this Satyr the different treatment of texture in the nude parts, the fawn skin, and the hair is again to be noticed.

The two famous figures of Eros — at Thespiae and at Parium — have not as yet been certainly identified in copies. Many figures

¹ The replica of the torso in the Louvre is finer than the more completely preserved copy in the Capitoline Museum.

of Eros, as of Satyrs, exist, which certainly owe their origin to Praxiteles, but whether they are copies of his works, or copies of works of his school, or merely later adaptations, cannot in all cases be determined. His influence lasted throughout antiquity, and copies and adaptations of his works must always have been popular, even at times when the general tendency of art seems to have been away from his quiet and gentle sentiment in the direction of greater realism.

Pausanias, in speaking of the group of Leto, Apollo, and Artemis, which Praxiteles made for Mantinea, says that on the base of it



FIG. 192. — Relief from Mantinea. (Brunn-Bruckmann, Pl. 468.)

was “a Muse and Marsyas playing the flute.” On one of three marble slabs found at Mantinea and now in the National Museum at Athens, Marsyas is represented playing the double flute before the seated Apollo, while between them stands a Phrygian with a knife, ready to flay Marsyas for his presumption in challenging Apollo to a contest in music. On the other slabs are figures of six Muses. The brief description of Pausanias refers, without doubt, to this relief. The slabs are of appropriate size for the decoration of a base, and were certainly attached to some structure. The execution of the reliefs is good, but not exquisite, as

is that of the Hermes. Apparently the carving was entrusted to an assistant, but the design is probably by Praxiteles himself, and is the only example of his decorative work (Fig. 192). The calm dignity of Apollo is admirably contrasted with the excitement of his wild opponent; the group is well composed, and the six Muses, with their varied poses and graceful draperies, form an appropriate setting.

The recorded works of Praxiteles, some of which were bronze, are very numerous and include statues of various deities, of nymphs and maenads, and two statues of the famous courtesan Phryne. So far as we are able to judge, and the material is abundant, though not exhaustive, his works were distinguished for grace, elegance, exquisite workmanship, quiet sentiment, and self-restraint. In all this he was the legitimate successor of the Attic school of the fifth century. That his imitators allowed grace to degenerate into weakness, and sentiment into sentimentality, does not detract from his greatness.

Famous contemporaries of Scopas and Praxiteles were Euphranor (who was also a painter), Bryaxis, Leochares, and Thrasymedes.

Euphranor, The last named was the artist of the chryselephantine
Bryaxis, statue of Asclepius at Epidaurus, the general appear-
Leochares, ance of which is known through votive reliefs found
Thrasymedes at Epidaurus. Probably this statue had much influ-
 ence in fixing the type of the god of healing as a dignified, draped, seated figure, with head and face resembling that of Zeus. Timotheus is known to have made some of the acroteria and models for other sculptures for the temple of Asclepius at Epidaurus, about 375 B.C. Some acroteria from this temple, representing Nereids mounted on horses, have been found, as have also some figures from the pediment groups, which represented combats of Greeks with Amazons, and Lapithae with Centaurs. In the extant fragments, the forms and postures are full of life and vigor, and the clinging, floating draperies are wrought in the manner of Attic work of the end of the fifth century. A famous work of Leochares was the statue of Ganymedes carried off by the eagle of

Zeus. A copy of this has been recognized in a small marble group in the Vatican which, although it does not enable us to judge of the execution of the original, shows how Leochares represented the youthful figure borne aloft, while his garment floats about him and his gaze is fixed upon the bright Olympus, where he is to dwell among the gods.

Other works of Bryaxis, Leochares, and Timotheus are

The Mausoleum mentioned by ancient writers, and

Pliny states that they worked with Scopas at the Mausoleum at Halicarnassus,¹ where each artist is said to have decorated one side of the building. The

remains of the rich decorations of the Mausoleum, now in the British Museum, consist of two colossal statues of Mausolus and Artemisia, various other statues, some of which are equestrian, a colossal chariot with four horses, several lions, many slabs of a fine frieze representing Greeks and Amazons, fragments of two other friezes, one of which represented a chariot race, the

other Greeks and Centaurs, and several panels with reliefs. The chariot stood on the top of the building, and the frieze of Amazons was probably above the architrave, but the position of the other sculptures has not been accurately determined.

¹ Instead of Timotheus, Vitruvius mentions Praxiteles.



FIG. 193.—Mausolus. (Brunn-Bruckmann, Pl. 241.)

The statues of Mausolus and Artemisia are dignified and impressive, evidently real portraits, but not emphasizing minor individual peculiarities unduly. Of the two, the statue of Mausolus (Fig. 193) is better, and also better preserved. Here the type of the face and the arrangement of the hair are clearly not Greek, but the Greek artist has produced an admirable likeness of the vigorous and thoughtful Carian prince.

The Amazon frieze, although by no means entirely preserved, is the most extensive extant relief of the fourth century (Fig. 194).



FIG. 194.—Part of Amazon frieze of Mausoleum. (Brunn-Bruckmann, Pl. 97.)

In the frieze from Phigaleia (p. 249) the figures are crowded together; here they are loosely grouped; at Phigaleia each slab contains a group, so that the order of the slabs might almost be changed without injuring the composition, while here one figure frequently occupies parts of two slabs; at Phigaleia the groups consist usually of two persons; here the number varies. There is also here far greater variety in the costumes, weapons, and attitudes, the drapery is better designed, the figures are more individual, more slender, their attitudes more graceful, and their faces more expressive. In some respects this frieze has more resemblance to the small frieze of the temple of Athena Nike than to the frieze from Phigaleia. Evidently the artist, or artists, followed

the traditions and adopted the practices of the Attic school. In execution the parts of the frieze are not uniform, and certain peculiarities of costume and of design occur on some slabs, but not on others. Attempts have therefore been made to assign the various parts of the work to the artists mentioned by Vitruvius and Pliny, but their results have not met with universal acceptance. It is perhaps enough to consider the frieze as whole, remembering that it is the work of a famous artist, or famous artists, and shows at their best the qualities of decorative sculpture at the middle of the fourth century.

The temple of Artemis at Ephesus was burned in 356 B.C. The new temple was therefore strictly contemporaneous with the Mausoleum, and Pliny states that one of the thirty-six sculptured columns was by Scopas. Only one sculptured drum from this temple is sufficiently well preserved to give a good *Artemisium* idea of its style and design (Fig. 195), and here the quiet grace of the figures recalls the style and shows the influence, not of Scopas, but of Praxiteles. The subject is probably Alcestis between Thanatos, the armed and winged god of Death, and Hermes Psychopompus. This drum (and other fragments from Ephesus), no less than the sculptures of the Mausoleum, shows



FIG. 195.—Sculptured drum from Ephesus.
(Brunn-Bruckmann, Pl. 52.)

the extension of the Attic school to Asia Minor in the fourth century.

The famous group of Niobe and her children¹ exhibits characteristics of the styles of Scopas and Praxiteles, which may account for Pliny's statement that it was doubtful to which of the two it should be ascribed. The group was probably brought by Sosias from Asia Minor to Rome in 35 B.C., and is



FIG. 196. — Niobe. (Brunn-Bruckmann, Pl. 311.)

therefore another example of Attic sculpture in Asia Minor. But since the statues combine the gentle grace and sentiment of Praxiteles with the violent motion and passion of Scopas, it is probable that the group is the work of a younger artist, perhaps even an artist of a later century, who had studied the works of the two great masters and developed a composite, though still Attic, style of his own. The picturesque character of the group and the difficulty of arranging it as a decoration for a building add to the probability of its later origin. The individual figures, however, are conceived and de-

signed in the spirit of the Attic art of the fourth century (Fig. 196).

¹The statues in Florence are not the originals, but ancient copies. In the Vatican is a replica of one of the daughters, the work of which is finer than that of the statues in Florence. A beautiful figure of one of the daughters, recently discovered in Rome, does not seem to belong to the same composition

A bronze statue found some years ago in the sea near the island of Cythera (Fig. 197) exhibits the art of Scopas and Praxiteles in a different way, with more reminiscence of the Ar- Two bronze statues
 give school, at least in the physical proportions. The work may be a copy of Roman date, but the original must belong to a time not much after the middle of the fourth century, before the influence of Lysippus was established. Another fine bronze statue, discovered in the Austrian excavations at Ephesus, may be an ancient copy or an original work. The surface of this, as of the statue from near Cythera, was much corroded, — indeed, both statues had to be put together from many pieces, — so that many details of execution are lost. The subject, an athlete scraping himself, the attitude, and the heavy proportions, recall the Argive school of Polyclitus, and it is not an improbable suggestion that this statue (or its original) is the work of Daedalus, son and pupil of Patrocles, who was a pupil of Polyclitus. In that case, the date of the work is the first half of the fourth century (Fig. 198).



FIG. 197. — Bronze statue from Anticythera.
 (Photograph.)

The Hermes is an original work of Praxiteles, and the fragments

from Tegea are by Scopas. No certainly original work by Lysippus exists, and if his works were all of bronze, as nearly all of them certainly were, the existing marble copies are very imperfect reproductions. Pliny says:¹

“His chief contributions to the art of sculpture are said to consist in his vivid rendering of the hair, in making the

heads smaller than the older artists had done, and the bodies slimmer and with less flesh, thus increasing the apparent height of his figures. There is no word in Latin for the canon of symmetry (*συμμετρία*) which he was so careful to preserve, bringing innovations which had never been thought of before into the square canon of the older artists, and he often said that the difference between himself and them was that they represented men as they were, and he as they seemed to be. His chief characteristic is extreme delicacy of execution, even in the smallest details.”



FIG. 198. — Bronze statue from Ephesus.
(Catalogue of exhibition in Vienna.)

Pliny also mentions a statue of a man scraping himself (*ἀποξυόμενος*) by Lysippus, which was very popular in Rome, and a marble statue, discovered in 1849 and now in the Vatican, has long been regarded as a copy of the lost bronze (Fig. 199). In this

¹ XXXIV, 65, translated by K. Jex-Blake.

statue, which is of exceptionally fine Roman execution, we see the hair admirably and freely rendered, the head small and set on a long and slender neck, the body and legs slim and with little flesh, and the whole admirably and naturally poised. All the peculiarities mentioned by Pliny are present.¹

It is true that these qualities are present also to some degree in the works of Praxiteles and of nearly all good later sculptors, but Lysippus, being a bronze-worker, might naturally be compared especially with Polyclitus.

In the French excavations at Delphi seven marble statues were found, which were set up, about 335 B.C., by a certain Daochus from Pharsalus. They represented the dedicator and distinguished members of his family, among them Agias, who had been the first Thessalian to win the Victory in the Pancratium at Olympia, more than one hundred years earlier. An inscription copied by Stackelberg at Pharsalus in 1811 shows that a series of statues similar to those at Delphi, but of bronze, was set up at that place, and that the statue



FIG. 199.—Apoxyomenus; Vatican.
(Brunn-Bruckmann, Pl. 281.)

of Agias was by Lysippus. The presumption is that the statues at Delphi are copies of those at Pharsalus, and that in the statue of Agias we have a contemporary copy of a work of Lysippus.²

¹ The right hand, which holds a die, is restored.

² In *A. J. A.*, XI, 1907, pp. 396 ff., W. W. Hyde argues that the Agias is an original work by Lysippus.

The Agias (Fig. 200) exhibits the qualities mentioned by Pliny, but is not so far removed as is the Apoxyomenus from the traditions of Polyclitus. The hair is less natural and the separate locks less divided; the eyes resemble more the eyes of the heads from Tegea; the pose is more like that of the Polyclitan figures.



FIG. 200.—Statue of Agias.
(*Fouilles de Delphes*, Pl. LXIII.)

In execution the Agias is inferior to the Apoxyomenus, so that a comparison of the minor details would be of little value. It must also be remembered that in Roman times connoisseurs had antiquarian tastes and wished copies of earlier works to be as accurate as possible, whereas in the fourth century even a copyist was likely to retain some individuality. The Agias may therefore not be a perfectly accurate copy of the bronze by Lysippus. But when all allowances are made, the differences between the two statues is very great, and is hardly to be explained by the assumption that the Agias was an early work of Lysippus, for when the statues were set up at Delphi, Lysippus was no longer young. The Agias shows the traditions of the school of Polyclitus modified by the study of Attic sculpture, and especially of the works of Scopas. The Apoxyomenus shows

the same or similar qualities much further developed. In the Agias are found the qualities ascribed by Pliny to Lysippus, developed about as far as one would expect to find them in the work of an artist — even of an original genius — of the time of Lysippus; in the Apoxyomenus the development has gone further. It

may be, then, that the Apoxyomenus should be ascribed rather to a successor of Lysippus than to the master himself. The question is still open.

Lysippus is said to have produced fifteen hundred works, an astounding number, only thirty-five of which are specifically mentioned by ancient writers. Among these are colossal figures, statues of gods and heroes, portraits (especially of Alexander), animals, chariots, and allegorical figures. The most celebrated of these last was the figure of Kairos, Opportunity, represented as a youth resting the toes of his winged feet on a ball. His hair was long above his forehead and temples, but behind he was bald, an intimation that Opportunity is easy to catch at the right moment, but not when it is past. This bold personification shows great originality, but less sense of artistic propriety.

Among the other statues by Lysippus, those of Heracles were especially famous. A copy, or adaptation, by an artist named Glycon, of one of these is the Farnese Heracles, in the museum at Naples. The original was certainly famous, as several replicas exist. In the Naples copy, the qualities to be ascribed to the Heracles of Lysippus are obviously exaggerated. A better idea of the head is obtained from a bust in the British Museum.

It is difficult to determine which of the many existing portraits of Alexander are derived from originals by Lysippus, but perhaps the so-called Azara herm, in the Louvre, has the best claim (Fig. 201). The execution is not remarkable, and the preservation is not perfect, but the great conqueror is here represented without the heroic or divine attributes or the theatrical expression with



FIG. 201. — The Azara herm. (Arndt-Bruckmann, *Griechische und Römische Porträts*, Pl. 181.)

which other, and later, artists endowed him. The portrait is, for its time, realistic, and in so far is characteristic of Lysippus.



FIG. 202. — Monument of Dexileos. (Brunn-Bruckmann, Pl. 438.)

In fact, realism, combined with most careful execution, seems to have been peculiarly characteristic of this great artist. When these qualities are found combined with those specified by Pliny it is safe to assume at least the indirect influence of Lysippus. To identify copies of his own works is less easy, though several have been identified by various scholars.¹

With Lysippus the tendency to realism, exaggeration, and theatrical posing which mark the Hellenistic period may be said to

¹ An interesting hypothesis has recently been advanced by A. Mahler (*Comptes rendus de l'Acad. des Inscr. et Belles-Lettres*, 1905, pp. 623-628; cf. *Rev. Arch.*, II, 1903, pp. 33 ff.; Reinach, *Recueil de têtes antiques*, p. 146) to the effect that the "Venus de' Medici" and its replicas are copies of an Aphrodite by Lysippus. The evidence is derived from a statue, signed with the name of Lysippus, which was found and destroyed at Siena. The comparative realism of the famous Venus, the fact that the original appears to have been of bronze, and the difference between the eyes and mouth here and in the Aphrodite of Cnidus, certainly indicate that some strong influence other than that of Praxiteles must be assumed.

begin, but as yet there is only the tendency to these faults, not the faults themselves. In the works of Lysippus we find rather individuality and freedom of posture and expression, no longer hampered by imperfect execution or traditional limitations.

The Attic gravestones form a peculiarly interesting series of reliefs illustrating the development of sculpture in the fourth century. The earlier among them, such as the monument of Dexileos (Fig. 202), who was killed in the Tombstones Corinthian War in 394 B.C., still exhibit some of the qualities of the frieze of the Parthenon, while the later reliefs show the influence of Praxiteles and even of Lysippus (Fig. 203). The subject of these reliefs is generally

a scene of family life, a seated woman before whom stands a maid with a toilet box, or, as in figure 203, a father gazing sadly at a youth (in this case accompanied by his slave and dog), or two persons clasping each other by the hand. These scenes all symbolize, rather than express, the grief of the survivors, by recalling the beloved presence of the dead. In execution they vary from great refinement almost to clumsiness, but even the most carelessly executed among them are beautiful in their restrained sentiment.



FIG. 203.—Attic gravestone. (Photograph.)

Four sarcophagi, found with others of a different character in a tomb at Sidon, may best be mentioned here. The earliest of these, called the tomb of the satrap, is adorned with reliefs resembling those on Lycian tombs of the sixth century, but more developed, and may be dated about 450 B.C. The next in order is called, from the shape of the lid with its ogival vault, the Lycian sarcophagus. It has in its gables two sphinxes and two griffins, below on the ends two pairs of Centaurs, on the sides Amazons in four-horse chariots hunting a lion, and horsemen hunting a boar. These admirable reliefs, spirited in design and execution, are apparently the work of an Attic sculptor, not far from 375 B.C. The third sarcophagus has the form of a small Ionic temple, between the columns of which are draped female figures in pensive attitudes, from which the name "Sarcophagus of the Mourners" is derived (Fig. 204). Above, on the edge of the roof, is a broad frieze, decorated with a relief that represents a funeral procession. In the gables are seated figures



FIG. 204. — Sarcophagus of the Mourners. (T. Reinach and Hamdy Bey, *Une Nécropole royale à Sidon*, Pl. IX.)

taurs, on the sides Amazons in four-horse chariots hunting a lion, and horsemen hunting a boar. These admirable reliefs, spirited in design and execution, are apparently the work of an Attic sculptor, not far from 375 B.C. The third sarcophagus has the form of a small Ionic temple, between the columns of which are draped female figures in pensive attitudes, from which the name "Sarcophagus of the Mourners" is derived (Fig. 204). Above, on the edge of the roof, is a broad frieze, decorated with a relief that represents a funeral procession. In the gables are seated figures

in attitudes of sorrow. About the base, below the columns, are hunting scenes in low relief. The female figures between the columns are especially charming in their varied similarity. They recall at once some of the women on Attic gravestones and the Muses on the Praxitelean reliefs from Mantinea, as well as the statues of Muses to which these are related. The sarcophagus is an exquisite Attic work of about the middle of the fourth century. Even more important than the Sarcophagus of the Mourners is the "Alexander Sarcophagus," so called because the principal figure of one of its reliefs has the well-known features of Alex-



FIG. 205. — Alexander sarcophagus. (T. Reinach and Hamdy Bey, *Une Nécropole royale à Sidon*, Pl. XXVII.)

ander the Great. This sarcophagus is especially important, because its coloring is more completely preserved than that of any other ancient work of sculpture. Light blue and red, yellow, and brown predominate, though other colors are also employed. The mouldings of this sarcophagus are exceedingly rich. The top, in the form of a tiled roof, is adorned with antefixes and gargoyles, while couchant lions guard its corners. In the gables, as well as on one end and one side below, are scenes of battle, on the remaining end a panther hunt, and on the remaining side a lion hunt. The presence of Alexander in the combat on the long side (Fig. 205, the person at the extreme left) shows that these are all historical scenes, though they have not been identified with com-

plete certainty. The faces of the chief persons are evidently portraits, and many details, especially of Persian costume, are given with realistic accuracy. These are not merely typical combats,



FIG. 206. — Themis from Rhamnus.
(Photograph.)

but battles that actually took place; and yet, with all the lively and crowded action, there is no attempt to represent the actual details as they happened. The main elements of the reality are reproduced in typical form, with even occasional reminiscences of the friezes of Phigaleia and of the Mausoleum. This sarcophagus, one of the best preserved and most beautiful monuments of Greek art, still breathes the spirit of Attic idealism, and yet it shows the beginnings of other things and belongs already to the time when Greek art found its chief mission in the glorification, not of Hellenic gods or Hellenic athletes, but of the rulers of Asia, Egypt, and Italy.

HELLENISTIC SCULPTURE

With the conquests of Alexander and the foundation of great semi-Hellenic kingdoms in Asia Minor and Egypt, the centres of Greek art are removed from Greece to Alexandria, Pergamon, Ephesus, Tralles, and Rhodes. The new art adopts new methods, abandons the self-restraint, *σωφροσύνη*, of earlier times, appeals more directly to love

of splendor, to the emotions, and to personal vanity. At the same time, however, the practice of sculpture survived in its former homes and retained many of the qualities of earlier work. So Chaerestratus, the artist of the dignified and impressive statue of Themis from the temple at Rhamnus (Fig. 206), was evidently inspired by the traditions and ideals of the fourth century; and the less excellent seated Dionysus, which was dedicated by Thrasyclus, the son of Thrasyllus, in 271-270 B.C., exhibits similar qualities, and has the advantage of being accurately dated. In 280-279 B.C. a decree was passed in accordance with which a bronze statue of Demosthenes, by Polyuctus, was erected at Athens. This is without doubt the original of the famous statue of Demosthenes in the Vatican (Fig. 207), and of its replica at Sevenoaks, an admirable work and accurately dated, of strictly Attic style.

Another work of the same period is the beautiful Victory from Samothrace, now in the Louvre (Fig. 208). This was erected by Demetrius Poliorcetes after his victory off Cyprus in 306 B.C., but before the issue (between 294 and 288 B.C.) of the coins on which the statue is represented. Few works of ancient sculpture meet with more general or more enthusiastic admiration than this. The magnificent figure stands on the fore part of a ship, symbolizing the naval victory, her mighty wings half spread, and her garment blown about by the



FIG. 207.— Demosthenes; Vatican (Photograph.)

wind. Originally one hand held a straight trumpet to her lips and the other held a slender cross, which represented the *styliis* at the stern of a ship, and served as a trophy. Here is nothing



FIG. 208. — Nike from Samothrace. (Brunn-Bruckmann, Pl. 85, Ersatztafel.)

that might not belong to the fourth century, except that the spirit of Praxiteles is more intimately and subtly blended with that of Scopas and Lysippus than might have been possible in the lifetime of those masters. There is vigorous action, but no exaggeration, realism in details, but idealism in conception. The execution, as is usual in such large works, varies somewhat, but in the parts which were intended to be most exposed to view is excellent and even delicate. Comparison with the Victory of Paeonius (p. 227) shows how great was the progress made in the treatment of drapery, which is here not a mere accessory,

nor even, as in the sculptures of the Parthenon, a part of the figure which it discloses, but has an independent value and texture of its own.

Symbolism and a tendency to the picturesque are two striking qualities of Hellenistic sculpture. Both are present to some degree in this figure, which stood raised aloft on its ship's prow, gazing down a valley toward the sea on which Demetrius had overcome his foes. The suggestion has been made that this Victory may be a work of Eutychedes, a pupil of Lysippus, whose famous personification of Antioch (or rather of the Fortune of Antioch) is known through a small copy in the Vatican. Be this as it may, at any rate the artist of the Victory was one of the greatest sculptors of his age.

Among works of the Hellenistic period which show the survival of earlier traditions are several which have been assigned by some scholars to the fourth century. Such is the famous Apollo of the Belvedere, the original of which (for the statue in the Vatican is only a Roman copy) has been ascribed, on account of certain resemblances to the Ganymedes (p. 262), to Leochares. But the self-conscious, almost theatrical, pose of the Apollo and his exaggerated coiffure make it more natural to attribute the work to the third century, and the same date should then be assigned to the "Diana of Versailles," now in the Louvre. The so-called Eubouleus, a marble head found at Eleusis, which has been claimed even as an original work of Praxiteles, is also a product of Hellenistic art. Works which exhibit qualities similar to those of the fourth century were produced in the third century, as was natural, by the pupils of the artists of the century before, and in the second century and thereafter works of the great artists of earlier times were copied and imitated. It is therefore often well-nigh impossible, in the absence of external indications, to distinguish between works of Hellenistic date in which earlier traditions are perpetuated and adaptations or copies of lost works of earlier times. So the Niobe group (p. 266), which has been considered a work of the fourth century, is more probably of later date, for it was apparently arranged in a garden or some similar picturesque setting, since it can hardly have decorated a building, and its composition exhibits picturesque

qualities, which are familiar enough in Hellenistic times, but not in the days of Scopas and Praxiteles.

A work which has given rise to much discussion is the famous Aphrodite from Melos (Fig. 209), in the Louvre. With it was found an inscription bearing the signature of Agesander from Antioch on the Maeander, a city which was not founded until 281 B.C. Unfortunately the inscription is lost



FIG. 209.—Aphrodite from Melos. (Photograph.)

and its connection with the statue cannot be absolutely proved. The head is clearly Praxitelean; the statue cannot, therefore, be earlier than the fourth century. The drapery, with its large, heavy folds, recalls work of the fifth century. So it is natural to assign the statue to a time when the styles of the fourth and fifth centuries might readily be combined; that is, to a time after the fourth century; but whether the third century, or later, can hardly be determined without definite external evidence. The statue is not carved from one block, but the upper, nude parts are of finer marble, and more finely wrought, than the lower, draped portion. A left hand holding an apple, and part of an arm, were found with the statue, and are supposed to belong to it, though they do not now appear to be of such good workmanship as the rest. This general type was employed in representations of Victory (*e.g.* the Victory of Brescia) as well as of Aphrodite, either alone (*e.g.* the Aphrodite of Capua) or in a group with Ares. Since parts of the left side of the statue from Melos are comparatively unfinished, it seems that something must have stood beside the figure, but the

direction of the gaze makes it improbable that Ares was grouped with Aphrodite. Perhaps the goddess rested her left elbow on a column about as high as her shoulder, as Furtwängler believed, or possibly her arm rested on a shield or mirror supported by a cippus, as is the case in a small bronze in the Louvre. The right hand probably held the drapery. In all probability the type was not invented, but merely adapted, by the sculptor of this statue, which is, both by reason of its excellent preservation and its inherent beauty, one of the most widely known and generally admired works of ancient art.

But the survival of earlier traditions is by no means the most marked quality of sculpture in the Hellenistic period. On the contrary there is much that is new. Realism, especially in portraits, develops greatly. The bronze head of a boxer from Olympia shows in all their details, with no attempt to represent a type, and certainly with no purpose of creating a work of beauty, the battered features of a professional pugilist, an Olympic victor of the period. In execution this head is marvellous, and it illustrates well the ability of the Hellenistic artist to represent exactly what he saw, even to the most minute details. The same qualities are present in the bronze statue of a boxer, found in the Tiber and now in the Museo delle Terme, in which even the bruises and cracks made by the blows received in the prize ring are faithfully reproduced with consummate skill.

An interesting feature of Hellenistic art is the development of *genre*, representations of persons and scenes without historical, mythical, symbolic, or religious meaning, merely for ornamental purposes. In works of this kind figures of children are especially frequent. In fact, the round, soft forms of infancy were very popular in Hellenistic and Roman times. A group of a little boy struggling with a goose, by Boëthus of Chalcédon (apparently not of Carthage), an artist of the third century, was especially famous, and was imitated and copied with many variations. Other *genre* figures, many of which, especially at Alexandria, partook of the nature of caricature, were numerous, such

as the drunken old woman, by a bronze worker named Myron, a fish seller, and the like. *Genre* reliefs were also popular, and these have landscape backgrounds (Fig. 210). Apparently such reliefs originated at Alexandria, but they were popular elsewhere, especially in Asia Minor. The landscape backgrounds were also employed in mythological reliefs, and these "picturesque reliefs,"

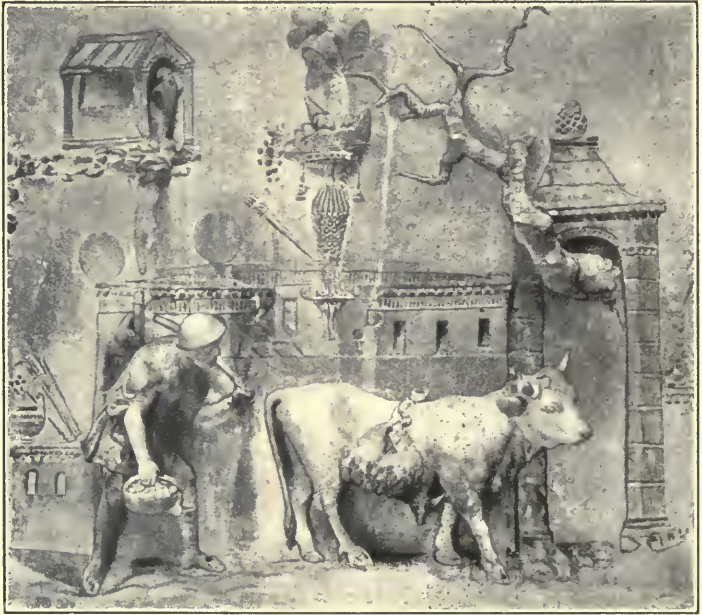

FIG. 210. — Picturesque Relief. (Brunn-Bruckmann, Pl. 343 a.)

whether their subjects were *genre* or mythological, were carved on panels and used like pictures for the decoration of walls.

At Pergamon, Attalus I (241-197 B.C.) strengthened his position and established a powerful kingdom by his victories over the Galatians, wandering tribes of Gauls who had settled in Asia. In commemoration of these victories he caused many works of art to be created by several sculptors, the

Pergamon

chief of whom was Epigonus. Parts of two large groups of figures are preserved in marble copies. To the first group belong the famous "Dying Gaul" (formerly called the Dying Gladiator), in the Capitoline Museum, and the Gaul killing himself after having killed his wife, in the Museo delle Terme,¹ in Rome. These figures are somewhat above life size. Of the other group at least ten figures are extant.² The entire group, in the original, which was of bronze, was given by Attalus to Athens and set up on the Acropolis. It represented the battles of the Gods and Giants, Greeks and Amazons, Greeks and Persians, and Pergamenes and Galatians. The number of figures must have been large, perhaps one hundred in all. Curiously enough, the extant figures all represent defeated combatants. They are only about three feet high, and this agrees with the recorded size (two ells) of the originals. These small figures are remarkably similar in style to the "Dying Gaul" and the group in the Museo delle Terme. In all, realism is the most noticeable feature. The Gauls are distinguished by their mustaches, torques, and stiff, coarse hair, the giants are wild and unkempt, and in the treatment of the skin these two races are distinguished from the more delicate Amazons and Persians. In the "Dying Gaul" (Fig. 211) the blood streaming from the wound in the right side is an especially marked bit of realism. The style is vigorous and the execution admirable, but the Hellenic love of self-restraint and sense of artistic fitness is lacking. Vigor, accuracy, and emotion, rather than beauty, are the chief characteristics of these works. In details the larger are superior to the smaller figures, and their mere size also helps to make them more impressive. Another work of this school is the

¹ This was formerly in the Villa Ludovisi, and was at one time called "Arria and Paetus."

² Four in Naples, three in Venice, and one each at Aix in Provence, Paris, and Rome. They are of a coarse-grained marble, similar to that used in the great altar at Pergamon. Probably they were made at Pergamon before the bronzes were sent to Athens, or possibly a second set of bronzes was made for Pergamon, from which the marble figures were copied.



FIG. 211. — Dying Galatian. (Brunn-Bruckmann, Pl. 421.)

“Arrotino,” or Scythian sharpening his knife, in the Uffizi gallery, at Florence. This figure was undoubtedly part of a group representing the punishment of Marsyas.

The sculpture of the Pergamene school of the time of Attalus I is known by excellent copies, that of the time of Eumenes II (197–159 B.C.) by undoubted originals, found at Pergamon by the German excavators and now in the Pergamon Museum at Berlin. These are the friezes of the great altar of Zeus and Athena (see p. 182), erected by Eumenes II. About the base of the altar ran a continuous frieze over seven feet (2.30 m.) high, and a much smaller frieze decorated the inner side of the wall of the portico. The great stairway cut into the side of the base, and here the frieze turned and decorated the sides of the stairway, decreasing in height step by step. Only fragments, but many large fragments, of the great frieze are preserved. The subject is the battle of the Gods and the Giants (Fig. 212), which no doubt symbolized the conflict of the Pergamiens and the wild Galatians. The subject is an old one in Greek art, but is here

treated with astounding variety and fertility of invention. The relief is very high, parts of the figures being carved entirely in the round. The forms of human beings and of beasts are mingled in the confusion of combat, for some of the giants have in place of legs great serpents with terrible heads and open jaws, some are winged, and some are hybrid forms of men and beasts, while the eagle of Zeus, the serpent of Athena, the panther of Dionysus, and the dogs of Hecate and of other deities take part in the fray,



FIG. 212. — Athena in combat with giants. (Brunn-Bruckmann, Pl. 484.)

marine animals accompany the deities of the sea, and Cybele is seated on her lion. The gods are so arranged that related deities are brought near each other, and the groups of combatants are so connected that the whole action appears to be continuous.

The types of the gods are those established in earlier times, but here their salient points are emphasized and heightened by action. It is noticeable that the figure of Apollo has, in pose at least, a strong resemblance to the Apollo of the Belvedere. The faces of the gods have no Olympic calm, but are full of animation, while those of the giants express hatred, fear, and pain with the

utter absence of restraint that befits their wild nature. One almost feels the tension of the powerful muscles as the gods and giants struggle for the mastery. Here, in this symbolic combat, realism is, if possible, even more pronounced than in the figure of the "Dying Gaul"; for in these superhuman figures the realistic details may be exaggerated, so the sculptors seem to have thought, without ceasing to be lifelike. This frieze is wonderful and brilliant, full of life and vigor, a great monument of inventive ability and technical skill, yet it is grandiose rather than grand, startling rather than impressive, gorgeous rather than beautiful.



FIG. 213.—Fragment of smaller frieze from Pergamon. (Brunn-Bruckmann, Pl. 485.)

Of the smaller frieze (Fig. 213) much less remains. The subject is the myth of Telephus and the foundation of Pergamon. The relief is by no means so high as that of the great frieze, but much higher than that of the frieze of the Parthenon, with which it may be compared in size as well as in respect of the position for which it was intended. The most striking thing about it is perhaps its picturesque background, which

shows how completely taste had changed since the days of Pericles.

An artist of striking originality, who seems to belong to the second century B.C., but whose work stands in no apparent relation

Damophon to the sculptors of Pergamon, and is not a direct development from the styles of the fourth century, is Damophon. Pausanias mentions several colossal statues by him at Lycosura, in Arcadia, and there, among the ruins of the temple of Despoina, parts of them were found (Fig. 214). Damophon was formerly regarded as a contemporary of Scopas and Praxiteles, and a mere glance at his works shows that his date cannot be earlier than theirs. But his methods are different. He exhibits a feeling for texture in drapery and hair that seems to presuppose

Praxiteles, and there is a unique largeness and boldness in his heads, something that reminds one of the impressionists of modern times, which would have been impossible before Scopas, or even before Lysippus.

Damophon was an unique personality, who seems to have founded no school and had no successors; but the influence of the Pergamene artists was widespread in Asia Minor, and seems to have been especially strong in Rhodes even later than the middle of the first century B.C. Thus inscriptions

fix the date of the three Rhodians, Agesander, Polydorus, and Athenadorus, the artists of the Laocoön group, about 40 B.C. It is therefore not impossible that this work (Fig. 215) inspired Virgil to write his description (*Aeneid*, II, 212-224) of the death of Laocoön. The great fame of the group is chiefly due to the following facts: It was discovered at a time (1506) when there was the greatest interest in ancient art, it was the only well preserved example of realistic ancient sculpture then known, it was easily identified as a work mentioned by Pliny, and its subject is identical with that of Virgil's famous lines; moreover, it was exposed in a prominent place, and at a later time it was chosen by Lessing to typify plastic art as opposed to poetry in his essay entitled *Laocoön*, and last, but not least, it is easy to understand. As a work of art it does not merit its fame. The sons are too small for their apparent ages, the serpents are inert and lifeless, the attitude of Laocoön is unnatural, and the agonized expression of his face is rather that of bodily pain than of the



FIG. 214. — Head of Anytus by Damophon. (Photograph.)



FIG. 215. — Laocoön group. (Photograph.)

mingled horror and physical exertion demanded by the struggle in which all his muscles are engaged. In spite of all these faults the group shows skill in composition and execution. The right arm of Laocoön is wrongly restored, and should

be bent so that the hand touches the back of the head; a similar change should be made in the right arm of the younger son. The group was therefore originally more harmonious than it is with its present alterations. In date this work belongs to the Graeco-Roman period, but its evident relation to the reliefs of the great altar at Pergamon makes it natural to regard it as Hellenistic.

Another work which may be regarded either as Hellenistic or Graeco-Roman is the so-called Farnese Bull, by the brothers Apollonius and Tauriscus, of Tralles, who lived probably in the early part of the first century B.C. This was brought from Rhodes to Rome, and is, like the Laocoön, a product of the Asian school which had its latest important centre at Rhodes.

The sculpture of the Graeco-Roman period, when Rome had become the capital of the world and Romans were the chief patrons of art, is confined chiefly to copies and adaptations of earlier works. Roman praetors and proconsuls brought to Italy many Greek statues plundered from the provinces, and some pretence, at least, of appreciation for art was expected of the Roman gentleman. Greek sculptors, chiefly Athenians, were numerous at Rome, and the museums of Europe are full of their works. Sometimes these can be identified as more or less exact copies of earlier originals, and it is chiefly through them that details of the lost originals are known to us. More frequently they are repetitions of earlier types, without the merit or interest of exact copies, even when they are of careful workmanship.

Among these adaptations are the famous Capitoline Venus and the still more famous Venus de' Medici,¹ both of which are developments from the type of the Cnidian Aphrodite of Praxiteles. But in both of these the vague consciousness of nudity has become an almost coquettish consciousness of the spectator, such as would appeal to the Roman

¹ Even if the Venus de' Medici is derived from an original by Lysippus (see p. 272 note) it can hardly be an exact copy.

of imperial times. The goddess has become a mere mortal. The Farnese Heracles (p. 271), signed by the Athenian Glycon, reproduces a Lysippian type, but exaggerates, and thereby debases, the qualities of the original. The "Belvedere Torso," which was greatly admired by Michael Angelo, is also apparently a Roman adaptation of an earlier type. Copies of the statue of Venus



FIG. 216. — Electra and Orestes. (Brunn-Bruckmann, Pl. 306.)

Genetrix, made by Arcesilaus for the forum of Julius Caesar, not far from the middle of the first century B.C., have been recognized in several statues, and the type is seen on some Roman coins. The head, the folds of the drapery, and the general pose recall the style of the fifth century B.C., but the position of the right hand and arm, holding up a corner of the garment to uncover the shoulder, and various details, indicate that this is not a copy, but an adaptation of an earlier type, which may be that of the "Aphrodite of the Gardens" by Alcamenes.

Another sculptor of the first century B.C. was Pasiteles, an Italian Greek, who received the Roman citizenship in 87 B.C. in common with his compatriots. His works in marble and other materials, including gold, silver, and ivory, were numerous, and he also wrote a book on the history of art. His own works are lost, but he evidently founded a school, for works are extant by Stephanus, who calls himself a pupil of Pasi-

Pasiteles

teles, and by Menelaus, a pupil of Stephanus. These are clearly imitations of statues of the Argive school of the fifth century, with archaic traits that indicate the time of Hagelaidas and his contemporaries, just before Polyclitus. The group in Naples, probably correctly called *Electra and Orestes* (Fig. 216), is a good example of these works. The postures are simple, the treatment of hair and the general arrangement of drapery are archaic, but the proportions, in spite of the square Argive shoulders, are rather those adopted by Lysippus, and the upper part of the drapery of the female figure is clearly much later in its treatment than the lower part. This is evidently not a real copy of an early work, but a product of mannerism, of affectation of archaic simplicity, which is not without a certain charm, but shows no real originality. That such works were popular is proved by the number of them that still exists. Besides the works of the eclectic school of Pasiteles, there are many examples of more consistent imitation of the archaic style.

Numerous reliefs, called Neo-Attic reliefs, exhibit qualities similar in some respects to those of the works of Pasiteles and his school. In these reliefs figures are seen which reproduce more or less exactly works of earlier times; but no single period is imitated consistently. On a marble vase in the Louvre, signed by Sosibius, some figures have the stiff drapery of the early part of the fifth century, with its straight folds ending in zigzags, while others have the flowing drapery of the time of Scopas and Praxiteles. On other reliefs Apollo Citharoedus and his attendants are represented in flowing robes, which are archaic only in some details, while in the background are buildings which have been recognized as structures of the imperial period. The relief in Munich¹ representing the wedding procession of Poseidon and Amphitrite is an example of freer and livelier adaptation of earlier types. This work, which was formerly connected with Scopas, was probably made to decorate the altar in front of the temple of Neptune erected in Rome about 35–32 B.C. by Domitius Ahen-

¹ One slab is in the Louvre.

barbus. Although the execution is lifeless and almost clumsy, the design is full of variety, and the whole forms a most effective piece of decorative sculpture.

Much of the sculpture produced at Rome in imperial times was strictly Graeco-Roman; that is, Roman in date and workmanship (though the workmen were, chiefly at least, Greeks), but reproducing Greek types. So the reliefs on sarcophagi which represent Greek myths reproduce types, some of which can be traced back to the fifth century; the winged Victories on the column of Trajan exhibit the type of the Aphrodite of Melos, with some variations; the Dea Roma is a slightly modified Athena; and symbolic figures, wherever found, are imitations of Greek models. Even in portraiture Greek types are often adopted, so far as pose and disposition of drapery are concerned. The history of Greek sculpture continues, therefore, to the end of the Roman period; but, as Greek sculpture, it offers little that is of interest or importance, except in so far as it has preserved earlier types that would otherwise have disappeared. Genuine Roman sculpture — chiefly portraits and historical reliefs — although its technical processes were learned from the Greeks, and the workmen were actually for the most part of Greek blood, has a history of its own. Its chief feature is its preoccupation with historical truth, which leads to intense realism in portraiture and to the attempt to make historical reliefs accurate records of events. The study of its development, interesting as it is, hardly falls within the province of Greek archaeology.

CHAPTER IV

TERRACOTTAS

CLAY was used by the Greeks for various purposes. As brick, crude or baked, it was one of the most important building materials, while its use for purposes of architectural adornment, in the manufacture of pottery, and in the production of images, — generally statuettes of small size,¹ — was common in all parts of the Greek world. The use of brick as building material is sufficiently discussed in the chapter on Architecture, where the architectural ornaments of clay are also mentioned, and a separate chapter is devoted to vases or pottery; the reliefs and the images remain to be considered. These are the monuments generally referred to as terracottas, and among these the statuettes or figurines are the most interesting and in many respects the most important. Uses of clay

In the earliest times the art of the potter was not distinguished from that of the maker of clay images; both moulded the clay with their hands and fired it in an open fire or an oven. So we find among the early vases of Troy and other places some that might almost be called statuettes, inasmuch as they imitate the forms of human beings or animals. Early figure vases But with the invention of the potter's wheel the moulding of figures and the making of vases became two distinct processes, for the vase made on the

¹ Larger images — real statues — of terracotta were not uncommon in early times, especially in Cyprus and southern Italy; but after the sixth century they were unusual, and they seem never to have been common in Greece proper. Toward the end of the fourth, or in the beginning of the third century B.C., terracotta statues formed by hand were made in southern Italy. These resemble in style the other statues of this period.

wheel is round and smooth—except as ornaments, handles, or other things may be added to it—and cannot therefore represent human or animal forms. Not that the combination of human and other forms with vases is entirely given up after the introduction of the potter's wheel, but henceforth the combination takes, as a rule, the form either of a statuette, which, being hollow, is used as a vase, or of a vase to which human or animal forms are added for the sake of ornament. It is therefore possible to discuss the terracotta figures by themselves, with only occasional references to vases.

In various places rude and primitive terracotta figures have been found, formed by hand, the arms and legs hardly indicated, the eyes represented by round holes or by pellets of clay stuck on the surface somewhere near the right place, the nose a sort of beak formed by pinching the soft clay between the thumb and fingers of the maker. Such figures can be dated only by the circumstances under which they are found. In some instances, as at Hagia Triada (in Crete) and at the Argive Heraeum, they may belong to a very early period, before the development of the Mycenaean civilization, whereas in other places, as in Rhodes and Cyprus, they appear to belong to the time after the Mycenaean civilization passed away and to be succeeded by the archaic figures of the sixth century. These primitive, hand-made figures are solid, not hollow, and are therefore always small, since large figures of solid clay would be likely to crack and be spoiled in firing. They generally represent a draped female figure, sometimes, as at the Argive Heraeum, adorned with various clumsily wrought ornaments. These figures have as yet been found chiefly at sanctuaries, not in tombs, and may therefore fairly be interpreted as idols intended to represent a nature-goddess. Such primitive figures may, and doubtless did, continue to be made even after better processes had been invented and better work could be done, because in objects made for a religious purpose traditional forms and processes are likely to survive longer than when beauty or perfection is the sole aim of the maker.

An interesting series of votive figurines found at Petsofá, near

Palaikastro, in Crete, some striking faïence figures of a snake-goddess and her votaries, from Cnossus (p. 46), and less remarkable remains from other places, show that even before the Kamáres ware had given way to pottery of Mycenaean style Cretan artisans had attained considerable skill in the modelling of clay, though their technical processes were rude. The terracotta figures of Mycenaean times show less skill in modelling, and are painted like the contemporary vases. For the most part they represent female figures, though animals also occur. Such figures have been found at Mycenae, Nauplia, Tiryns, Athens, Eleusis, and other places.

Primitive terracottas from Cyprus, representing draped female figures, are sometimes flat, like bits of board, and sometimes almost cylindrical. Other primitive Cypriote figurines represent animals, and still others a nude female figure, perhaps the goddess Astarte, with her hands holding her breasts. In most of these primitive Cypriote figures the modelling is so rude as to be grotesque, though some of them show more skill. Necklaces and other ornaments are formed by pellets of clay stuck upon the figure in the proper places, and color is freely used, especially on the drapery.



FIG. 217.—Boeotian Doll.
Boston. Height, 0.30 m.
(Photograph.)

A limited number of curious figures from Boeotia (Fig. 217) apparently represent draped females. The bodies are hollow and decorated in geometrical style. The other parts are solid. Another class of primitive figures has been found chiefly at Tanagra. They are made of rather thin flat slabs of clay, and represent for the most part standing and seated draped females. On account of their curious high headdress, which resembles that of the modern Greek priests, they

Early figurines from Tanagra

have been called *papades* (*παπᾶς* is the modern Greek word for priest). They are freely decorated with color, in a style like that of the Boeotian geometrical vases. Other primitive figures from Tanagra represent draped males, still others horses with their riders. The earliest figures are limited in the number of types represented and are very rude in workmanship, but as time goes on, chariots, with horses and drivers, occur occasionally, and scenes from daily



FIG. 218.— Barber from Tanagra. Boston.
Height, 0.116 m. (Photograph.)



FIG. 219.— Slab-like figure.
Boston. Height, 0.198 m.
(Photograph.)

life are represented. So we find bakers, barbers (Fig. 218), a man making a fire, a plowman with his team, women washing, grinding grain or kneading dough, and the like. These figures show observation and humor, sincerity of effort, and artistic spirit, but not often any great skill in modelling. They are all fashioned by hand, without the use of a mould, and are solid.

Figures resembling the so-called *papades* and others similar to the various primitive figurines just mentioned have been found also, though in smaller numbers, in other places (Fig. 219). Just as

the invention of the potter's wheel was the most important event in the progress of the potter's art, so the art of the coroplast, or maker of clay images, was raised almost at a bound when the process of making hollow figures by use of moulds was introduced. Moulds had been used by the Egyptians and also by other peoples in the production of clay images at an early date, and solid figures formed by means of moulds were also made in Greece comparatively early, but the Greeks did not use moulds to make hollow figures until toward the middle of the sixth century B.C. This was about the time when Rhoecus and Theodorus of Samos introduced, apparently from Egypt, the process of casting bronze statues hollow, and it is not impossible that the use of moulds in making hollow terracotta figures was connected with their innovation. At any rate, it led to improvements similar to those produced in bronze statuary by the process of hollow casting.

Solid statuettes formed in moulds are comparatively few and unimportant. They **Solid figures** belong for the most part to the **and reliefs** time before the introduction of the improved process, by which the figures were made hollow, but are less primitive than the hand-made figures. They have been found in considerable numbers at the Argive Heraeum and elsewhere, and reproduce the types made familiar by the hand-made figures at the same place, but with some improvement in appearance. The separate parts of jointed dolls (Fig. 220) are usually, perhaps always, solid, to whatever date they belong, and small figures of animals and other objects intended as toys are frequently solid. Certain groups, which may be regarded as statuettes,



FIG. 220. — Jointed Doll.
Boston. Height,
0.262 m. (Photograph.)

though they are more properly reliefs with the background removed, are also solid. These are the so-called Melian reliefs (Fig. 221), archaic representations of mythological scenes. Strictly speaking, these groups, like other terracotta reliefs, are not made in a mould, but the mould, or stamp, is pressed upon the slab of clay. The backs of these groups are flat, and



FIG. 221. — Melian relief from Camirus. British Museum. Height, 0.165 m. (Photograph, W. A. Mansell & Co., London.)

even the fronts are less rounding than real figures. Similar groups were made of bronze and intended, as were perhaps also the terracottas, to be fastened upon the flat surface of a chest, or other article of furniture. Such work is not necessarily confined to any one period, and by no means all terracotta reliefs without background are archaic. Real reliefs of terracotta (Fig. 222) are also found belonging to all periods from the early archaic times down to the days of the Roman Empire. In the form of rectangular plaques they could be used as votive offerings or for the adornment

of walls or furniture. Some of the Roman reliefs of this kind (called Campana reliefs, because they were numerous in the Campana collection) are remarkably fine. As architectural ornaments, antefixes, acroteria, and the like, terracottas (both reliefs and figures in the round) were much used, especially in Italy.

The process of making a hollow terracotta figure with the use of moulds is as follows. In the first place the mould itself is

made of clay and fired hard.¹ Then the workman takes carefully prepared clay, from which all impurities and gritty substances have been removed, and presses it in a thin coating into all the parts of the mould, taking care that it penetrates even the smallest cut or indentation. In order that the shell of his statuette may not be too thin, he adds a second, third, or even fourth thin layer of clay, pressing each layer firmly against its predecessor to ensure proper cohesion. Then the whole is allowed to dry. In drying, the clay contracts sufficiently to allow of its being removed from the mould without difficulty. The workman now has a shell of clay, the outside of which has taken on exactly the form of the mould. If the object to be made is a mask, or anything which is to be seen from one side only and is hollow behind, the process of moulding is now completed. If, however, the object is to be seen from all sides, a second mould must be used to form the back. The two half figures are then carefully put together and cemented by means of thin, half liquid clay. In some instances the back is made of a flat piece of clay, not carefully moulded like the front. A vent hole is usually made in the back, to allow the hot air and vapor to escape during the firing. When the front and

Process of
making hol-
low figures



FIG. 222.—Terracotta relief of fifth century from Locri. British Museum. Height, 0.1275 m. (Photograph, Mansell & Co.)

¹ The moulds were of course themselves made from models. These were fashioned by hand, with the aid of tools. They might be of solid clay, or they might have a core of wood.

back of the figure have been put together, the whole is usually retouched with a smooth, sharp wooden instrument. In retouching, the workman has an opportunity to show his fineness of touch and his delicacy in the rendering of details. After this the figure is fired, usually not at a very great heat, and finally it is painted, for all Greek terracottas were colored. In most cases the colors are put on over a thin white slip or wash. Comparatively few figures could be made with only two moulds. If the arms are made detached from the body, each arm needs two moulds, the head is usually made separately and demands two moulds, and various other parts are frequently made in separate moulds. A figure of a winged Eros, from Myrina, is found by Mr. E. Pottier to have



FIG. 223.—Two figurines from the same mould. Boston. Height, 0.281 m. (Photograph.)

required in all fourteen distinct moulds, and this is not an unusually complicated figure.

The advantages derived from the use of moulds are many. The most obvious advantages of the use of moulds is that the

entire figure, being composed of a thin shell of relatively uniform thickness,¹ is not so likely to be injured by irregular contraction in the firing.

Then, too, since one set of moulds may be used over and over, it is worth while

to make them with much greater care than if each figure had to be made independently from the beginning. Moreover, since the various parts were made from separate moulds, great variety could

¹ The thickness of the shell is only relatively uniform, for additional clay is often spread on irregularly inside.

be obtained with little trouble by changing the position of the head or the arms, by putting different heads upon the same body (Fig. 223), and by adding different ornaments or attributes. These advantages were not all immediately perceived, but they were all thoroughly appreciated by the makers of the finest terracottas, such as those of Tanagra and Myrina. The best Greek terracottas are frequently made of a very thin shell and are consequently very light. In fact, genuine figurines may sometimes be distinguished from forgeries by their lightness.

Among the earliest figurines made from moulds is a series of vases in the form of draped female figures. These are really statuettes, but at the top of the head is an opening, about which the rim or lip of the vase stands out almost like a crown. These figures are almost cylindrical, with the arms not separated from the body, resembling the marble "Hera" figure vases from Samos. They could easily be made from two moulds, one for the front and one for the back. These figures, and with them others similar in style, have been found in many places from Phoenicia to Italy. They are most numerous in Rhodes, and may have been made there. Some found in Sicily seem to be of Sicilian manufacture, but they all belong in style clearly enough to the eastern regions of the Greek world. Perhaps they originated at Samos as a result of the introduction of hollow bronze casting.

Since terracottas are small and easily transported, the place of discovery is not necessarily the place of manufacture, and since the moulds are also easily transported, figures could be made at one place from moulds prepared at another. The quality of the clay is usually a good indication of the place of manufacture, and, as a general rule, the place of manufacture is also the place where the mould was made, but this is not invariably the case. So, for instance, some figures found in Cyprus seem to have been made from moulds imported from Attica. When any site furnishes a large number of figures agreeing in style, especially if they show regular artistic development, it is, of course, certain that the moulds as well as the figures were made at that place.

Archaic terracotta figures, belonging to the sixth and early part of the fifth centuries, follow in style the contemporary sculpture, so



FIG. 224. — Primitive terracotta, from Corinth; inscribed Πασικλῆς καλός. Boston. Height, 0.112 m. (Photograph.)

far as their Archaic dates are Terracottas known. They have been found in many places, the most important of which is perhaps the Acropolis at Athens. These Athenian figures represent draped females, many of which are clearly characterized as Athena, Artemis, Aphrodite, or Cybele. A series of early archaic figures at Corinth represents men on horseback (Fig. 224), beasts, and a few other subjects, while a later, but still archaic, series contains many representations of Aphrodite. Many of the archaic figures found in Sicily represent Demeter or Persephone. To the same period belong many busts and masks, made from one mould, without back, and apparently intended to be set or fastened against a wall. They represent, as a rule, though not without exception, draped females, often characterized as goddesses. Many such masks were found on the Acropolis at Athens, many more in Sicily, and others in other regions (Fig. 225). Busts are also found with



FIG. 225. — Mask, from Rhodes. Boston. Height, 0.23 m. (Photograph.)

the back, as well as the front, completely moulded. After the archaic period busts and masks are comparatively rare. In most places, as at Athens, they were probably intended for votive offerings at shrines and temples. Of all the archaic terracottas known, much more than half represent standing or seated draped female figures of dignified appearance, often with a polos or other high headdress, or with a veil or part of their garment drawn over the back or the top of the head. But many other types occur, such as women with a child or children, draped and nude men, most frequently young, animals, men on horseback, recumbent figures both male and female, Sileni, monkeys, Hermae, sphinxes, sirens, and jointed dolls. Some of the less serious figures are rudely made, and may, in spite of their archaic appearance, belong to a later period.

Terracotta figures of the fifth century, figures, that is, which show the style of Phidias and his contemporaries, are comparatively few, though by no means absolutely wanting. They have

**Terracottas
of the fifth
century**

been found at Athens, Eleusis, Megara, in the Crimea, at Camirus (Rhodes), Gela (Sicily), Eretria, Tanagra, Tarentum, and elsewhere (Fig. 226). The types are for the most part standing and seated draped female figures, sometimes characterized as goddesses. At

Tanagra not a few male figures of this period have been found, and at the Cabirium, near Thebes, male figures predominate. In spite of their small size, the terracottas of this period show the simple grandeur and dignity of the contemporary sculpture (Fig. 227). The comparatively small number of terracotta figures of this period may be due to the great popularity of Attic vases. Not only in Attica, but in many other regions, notably in southern Italy, Attic vases were placed in the graves of the dead at this



FIG. 226. — Figurine from Ovadjik; fifth century. Probably Attic. Boston. Height, 0.152 m. (Photograph.)

time, and this custom must have cut off one great source of demand for terracottas, causing a proportionate decrease in the number manufactured, not only in Attica itself, but also in other places. Terracottas continued, however, to be made, though in



FIG. 227. — Bust, probably Attic. Boston.
Height, 0.438 m. (Photograph.)

diminished numbers, throughout the fifth century, and the early part of the fourth century, showing in style the influence of the great Attic art of the times. But it was not until the art of the Attic potters had decayed that the finest Greek terracotta figurines were produced.

The primitive and archaic terracottas represent, for the most part, draped female figures. The early primitive specimens are, without doubt, figures of a goddess,

who is characterized as a goddess usually by an attempt at rich adornment. Among the archaic figurines many are clearly characterized as goddesses — Aphrodite by a dove held in her hand, Demeter or Persephone by the polos, Cybele by a lion, Athene by helmet or aegis. The other types of this period are also for the most part religious, or at least mythological. Among the figures of the fifth century are some which are not clearly intended as representations of deities, heroes, or worshippers, but which preserve more or less exactly the types employed to represent religious or mythological subjects. In the fourth century the relative number of such figures increases, and the types which once possessed religious or mythological signifi-

cance are gradually changed, until they seem to represent ordinary persons in the attitudes of everyday life. So the group of a woman and a child, which no doubt once represented Ge Kourotrophos, or the nourishing nature-goddess under some other name, now represents a woman and a child, and nothing more ; a nude or partially draped female figure may or may not be Aphrodite ; a youth may be a youthful deity or simply a young man. It is true that in the early times of Greek sculpture the types of deities were not fixed, so that it is often difficult to know whether an archaic statue represents, for instance, Apollo or an athlete ; but by the middle of the fifth century, or a little later, the types of the chief deities, at least, were established. After this there comes a change. The deities lose their divine dignity and become men and women. The Aphrodite of Cnidus is a supremely beautiful woman, and the Apollo Sauroctonos is a very attractive boy, but in these statues no attempt is made to suggest to the beholder anything greater than, or different from, humanity. The gods have again become indistinguishable from human beings, not because the artist lacks the skill, but because he lacks the desire to distinguish them. Terracotta figurines follow the course of the development of sculpture, but in them, even more than in statues, the tendency to give up dignity, seriousness, and grandeur for attractiveness, prettiness, and grace is manifest. Doubtless the small size of the figurines emphasized this tendency, which led to the production of graceful and charming little figures in which no religious significance is visible.

At Tanagra very great numbers of terracotta figurines have been found in graves of different periods. Only one figurine is of Mycenaean style, the so-called *papades* are fairly numerous, a few archaic figurines occur, and there are many of the style of the fifth century. These last are not so beautiful as might be expected, because they are not retouched, and therefore lack delicate finish in detail. It was, then, in the second half of the fourth century, no new thing for the Tanagraeans to deposit terracotta figurines in the graves of their dead ; but at this

Tanagra
figurines

time the custom seems to have increased in popularity. Simultaneously with this increase in the popularity of figurines as offerings to the dead came a great development of skill and taste among the Tanagraean coroplasts, who produced the most charming of Greek terracottas, which have made Tanagra famous throughout the world. The beginning of the new style, that of the "Tanagra figurines" *par excellence*, was probably not much after the middle of the fourth century, but it reached its height in the last quarter of the fourth century, and the production continued into the third century. It is hardly possible to give more accurate dates. "Many details tend to show that the Tanagra figures must be placed in the time of Alexander the Great and his successors, *i.e.* the beginning of the Hellenistic age (B.C. 350-200). One such feature is the treatment of Eros, which is undoubtedly post-Alexandrine rather than Praxitelean. Another is the use of a fan and the wearing of a large shady hat by women. The fan is a luxury doubtless introduced from the East, in the fourth century; it only appears on the later painted vases. The hat was worn by women as early as the fifth century, but only when travelling, whereas in the Tanagra figures it forms part of the everyday costume. It is also found on Pompeian paintings."¹ In style the Tanagra figurines show very strong Praxitelean influence, but also much that is not Praxitelean. The very choice of subjects from real life speaks against direct connection with the school of Praxiteles. It may well be that the coroplasts were influenced by the Boeotian painters of the fourth century, as Mr. Walters has suggested.

Heraclides, who travelled in Greece about the middle of the third century B.C., describes Tanagra as a flourishing and well-ordered town, but does not mention the trade in terracottas. Neither does he mention the women of the place; but in his

¹ Walters, *Catalogue of the Terracottas in the Department of Greek and Roman Antiquities, British Museum*, p. xl. The fan appears on a vase in Boston earlier than the fourth century, but it was evidently not popular until some time after its introduction.

account of Thebes he describes the women of that city, and his description is worth translating in full, as it applies admirably to the women of Tanagra such as we see them in the terracotta figurines. "Their women are in stature, gait, and proportions the most graceful and beautiful of the women in Greece. . . . Their manner of covering the face with their garment is such that the whole face seems to be covered with a mask ; for only the eyes



FIG. 228. — Tanagra figurine. Boston.
Height, 0.217 m. (Photograph.)



FIG. 229. — Tanagra figurine. British Museum. Height, 0.137 m. (Photograph, W. A. Mansell & Co., London.)

show through, and the other parts of the face are all hidden by their cloaks. They all wear white cloaks. Their hair is blond, gathered in a knot on the top of the head. This is called by the natives lampadion. Their shoes are simple, not high, red in color, and small, and laced so that the feet almost seem naked."¹ Nearly every detail of this description is illustrated by Tanagra figurines. The manner of shading the face with the cloak (Fig. 228), the little red shoes, the knot of blond hair (Fig. 229), and,

¹ *Fragm. Histor. Graec.*, ed. Müller, Vol. II, p. 257.

above all, the grace and charm of figure and attitude make it clear that the figurines represent the women of Tanagra as they lived and moved in the street, where a traveller could see them. Heraclides does not mention the hats and fans frequently seen in the terracottas; and the cloaks of the women of Tanagra were, if we can judge by the colors used on the terracottas, generally not white, but in all essential points the description and the figurines agree. The figurines are, however, not limited to representations

of women in street costume. On the contrary, we have many charming figures of young girls in light garments, such as could be worn only in the house, perhaps only in the retirement of the apartments reserved for the women of the family. We see them seated quietly, with head bent in thought (Fig. 229), or playing



FIG. 230. — Girls playing with knuckle-bones. Boston.
Height, 0.212 m. (Photograph.)

ing games with their companions (Fig. 230), — always the same graceful, attractive, and delightful figures. At the same time there is no monotony, but rather great variety. Undoubtedly the Tanagra figurines resemble each other, not only in technical execution, but also in general character, yet no two are alike, and this in spite of the fact that the same moulds were used for different figures. By giving the body a different head, by changing the position of an arm, by putting a garland in the hair, by adding or removing a fan, by using a different combination of colors, the coroplast who possessed a dozen different sets of moulds could

produce a great number of different figures, each as charming and as natural as the other.

The coloring of the Tanagra figurines is especially attractive, though unfortunately in few cases well preserved. It was applied over a white slip or wash, and this is likely to come off in flakes, carrying the colors with it. The garments are usually light blue or rose pink, the hair a reddish brown approaching auburn, the shoes red. The edges of fans and some other small accessories are sometimes gilded. Green and yellow occur, but not in large masses. The nude parts are white, or rather slightly tinted to resemble more nearly the actual color of life.¹ Sombre colors are avoided. The whole effect is light and gay, but not brilliant nor glaring. Since there is no glaze, the coloring, though light, is restful and pleasing.

Most of the Tanagra figurines reproduce the types of standing and seated women; some represent women, usually girls or at any rate young women, in other attitudes, and a comparatively small number of male figures serve to show that the Tanagraean coroplasts were not unwilling nor unable to represent both sexes. The male figures are almost all youths (*ephebi*), the graceful brothers of the Tanagra women. Sometimes they are winged, representing Eros, and some of the Erotes are small and playful, like the *putti* of the Italian Renaissance.

The Tanagra figurines are found in graves, and the question naturally arises, "Why were such things deposited with the bodies of the dead?" The question is difficult to answer. A few of the Tanagra figurines may represent deities, but even these do not represent the divinities especially connected with death or the lower world. A female figure clad in a short tunic and wearing high, close-fitting boots almost certainly represents Artemis the huntress, though one might possibly think of

**Purpose of
Tanagra
figurines**

¹ The surface of nude parts is not the white wash, but a polished coating. This gives a slight gloss — not by any means a glaze — to these parts, and a similar slight gloss is seen on some other parts. In most figures this gloss is not to be found, because the coating has come off.

Atalanta, and the winged Erotes are certainly not ordinary human beings. The figure of a young woman holding a dove or an apple may represent Aphrodite, but doves and apples were doubtless not unknown to the young women of Tanagra. The type may have been invented as a type of the goddess, but the figurines do not necessarily represent the goddess. It may be that the statuettes found in the graves were once the property of the deceased and were placed in the grave to give pleasure after death to one who had enjoyed them in life; but if that is the proper explanation, it is strange that nowhere, except at Priene, in Asia Minor, have similar figurines been found in the houses which they once adorned. The conclusion seems almost inevitable that the Tanagra figurines were made to be deposited in graves. Perhaps the custom of placing terracottas in graves is a relic of the savage rite of human sacrifice according to which captives, slaves, or wives were slain and buried with the dead, or perhaps it originated at a time when the figures really represented deities, and was continued through the changes in artistic style and tradition, until at last the ancient meaning of the custom was forgotten, and figurines were placed within the graves merely as tokens of affection on the part of the survivors, much as now flowers are laid upon the tomb. The same explanation may apply also to other places where figurines of no apparent religious significance are found in tombs.

Figurines of the same style as those from Tanagra are found at various other places, not only in the neighborhood, as at Eretria, but as far away as Myrina, Kertch, and Cyrene.

Figurines similar to those of Tanagra Some of these were probably imported from Tanagra, others were made from imported moulds, while still others are local imitations. Those made from imported moulds are distinguishable from imported figures by the quality of the clay, and also by the fact that they are less skillfully retouched than the genuine Tanagra figurines; indeed, they are sometimes not retouched at all. The productions of various places are sometimes distinguishable by local peculiarities, and are

almost invariably inferior to those of Tanagra. Figure 231, which represents two girls playing a game (*ἐφεδρισμός*), is probably from Corinth. While interesting and attractive, it is less finely wrought than the Tanagra figures of the same period.

In the fourth century Greek art turns from the gravity and dignity of the preceding period to

lighter themes and more familiar treatment. One result of this tendency is seen before the end of the century in the Tanagra figurines, which represent Greek girls and women as they might be seen from day to day. The same general tendency leads also to the frequent representation of youthful deities, of graceful rather than strong forms, of little winged Erotes, and the like. Caricatures also become popular, and realistic representations of old women, peddlers, and other persons of striking, rather than attractive, appearance are not uncommon as the Hellenistic period advances.

At the same time the habit of imitating and copying earlier works of art became established, not only among sculptors, but also among coroplasts.

The art of the Hellenistic age is a natural development from the art of the time of Praxiteles, and is still Greek art; but the spread of Greek civilization over Asia and Egypt had a great effect upon the Greeks themselves, espe-



FIG. 231.—Ephedrismos, from Corinth (?). Boston. Height, 0.248 m. (Photograph.)

cially upon those who lived at Alexandria or in the cities of Asia, even in those cities of the coast which had been Greek for centuries. Alexandria, Pergamon, Rhodes, and Tralles were great centres of Hellenistic art. It is natural that terracottas showing the qualities of Hellenistic art should have been produced in Asia Minor, and it is fortunate that many such terracottas have been discovered.

The most important discoveries of Hellenistic terracottas — or, rather, of later Hellenistic terracottas, since the Tanagra figurines belong, properly speaking, to the early part of the Hellenistic age, have been made at Myrina, a small place not far from Smyrna. The terracottas were found in graves dating from the time of Alexander the Great to the beginning of

the Christian era, but the most numerous and interesting figurines belong to the third and second centuries B.C. Some of them are identical in style with those of Tanagra, and in some instances are evidently made from imported Tanagraean moulds, but such figures are comparatively few.

The great majority of the statuettes from Myrina show an entirely different character. Whereas the Tanagra figurines reproduce human beings in the costumes and attitudes of daily life (*genre* subjects), the subjects of the figurines from Myrina are for the most part mythological, especially Aphrodite, Dionysus, Heracles, Eros, and Nike. Winged figures are especially common. Eros appears, sometimes as a youth (Fig. 232), more frequently as a child (Fig. 233), in all sorts of attitudes and actions,—seated, standing, flying, play



FIG. 232. — Eros, from Myrina. Boston. Height, 0.284 m. (Photograph.)

jects of the figurines from Myrina are for the most part mythological, especially Aphrodite, Dionysus, Heracles, Eros, and Nike. Winged figures are especially common. Eros appears, sometimes as a youth (Fig. 232), more frequently as a child (Fig. 233), in all sorts of attitudes and actions,—seated, standing, flying, play

ing the lyre or the flute, reading, carrying a mirror, a vase, or a cornucopia, playing with a dog, a hare, or other animal (Fig. 234) in a group with Aphrodite, or fighting with a second Eros; in one instance five Erotes are grouped about a table. A special class of Erotes clad in the himation, with bare legs, bent head (often covered with a veil), and sober mien are different from the joyous little figures just mentioned, and seem to have some definite connection with death and the grave, being companions in sentiment



FIG. 233.—Eros with attributes of Heracles, from Myrina. Boston. Hand-made. Height, 0.40 m. (Photograph.)



FIG. 234.—Eros with kid, from Myrina. Boston. Height, 0.125 m. (Photograph.)

of the Sirens with whom they are found. The figure of Nike also occurs frequently, not in any apparent connection with the idea of victory, but simply as a charming winged female figure, — a fitting companion for Eros. Psyche, distinguished from Nike by her butterfly's wings, is but seldom represented. So great is

the liking for winged figures that even Dionysus appears with wings.

Several groups are found. Aphrodite appears grouped with Eros, and with Eros and a female figure, probably Peitho; groups of Erotes have already been mentioned; Dionysus is grouped with Eros, with Ariadne, and with a bacchant; Apollo and Arte-



FIG. 235.— Group from Asia Minor. (Myrina ?) British Museum.
Height, 0.213 m. (Photograph, W. A. Mansell & Co., London.)

mis appear together; Silenus is seen carrying the infant Dionysus; groups of two women (Fig. 235), a woman and a little girl, and a man and a woman sitting on a couch, also occur. Some of these groups are very attractive, and their discovery gave rise to a large number of forgeries, by which many experts were deceived.

The influence of sculpture is perhaps more marked and more direct at Myrina than at Tanagra, though even the Myrina figurines are seldom, if ever, direct copies, but at most imitations

of statues. The works of sculpture imitated are for the most part Hellenistic, showing the influence of the school of Lysippus. The limbs are long and slender, the attitudes varied and graceful. Comic and grotesque figures are less common than figures of the light and airy mythological character already mentioned, but they have been found in considerable numbers. Whereas the average height of the Tanagra figurines is about 20 cm. (8 in.) and none exceed 39 cm. ($15\frac{1}{2}$ in.), at Myrina figures 35 cm. ($13\frac{3}{4}$ in.) to 40 cm. ($15\frac{3}{4}$ in.) in height are not uncommon, and some heads evidently belonged to figures of even greater size.

It is a curious fact that the figurines found in the graves at Myrina are all broken, not by the excavators, but by those who placed them in the graves. Not infrequently portions of the same figure were found in different parts of a grave, sometimes at opposite ends, as if some one holding the figurine in his hands beside the grave had broken it and thrown in one piece with each hand. The explanation of this practice, which is paralleled in other places to greater or less extent, has as yet not been found.

Inscriptions of two kinds are found on the figurines of Myrina. Those scratched on wings, which were often found without the figures to which they belonged, designate the figure to which the wing is to be attached; for instance, ΕΦΗΒΟΣ shows that the wing belongs to the figure of a youth, ΦΕΡΩΝ that a "carrier" is to be aided in his task by the wing, ΘΥΜΙΑΤΡΩΝ that the figure to which the wing belongs holds a censer. Other inscriptions pressed or scratched on the backs of figures or their bases give the names of the makers, either the individual artists of the figurines or the proprietors of the manufactories, probably the latter. Such names are Diphilos, Menophilos, Pythodoros, Hieron, and Attalikos. The former class of inscription is interesting because it shows something of the methods employed in the workshops, the latter because it proves that the makers of the figurines, like the makers of the Attic vases of the fifth century, had so much reputation that they thought it worth while to sign their work as a guaranty of genuineness.

Figurines of the same kind as those of Myrina have been found at Smyrna, Priene, Aegae, in the Troad, and some other places in

Asia Minor, and also at Cyrene and in the Crimea.

Figurines similar to those of Myrina It is in many cases extremely difficult to distinguish the productions of one place from those of another.

Sometimes this can be done by examination of the clay, for the clay used in different places is often very different; but, on the other hand, different varieties of clay are sometimes found in use at one and the same place, as at Myrina, where nine varieties have been distinguished. The different kinds of clay used at Myrina, and at other places where large numbers of terracottas have been found, are now well known, though not always easily distinguished, but it is still often impossible to determine with certainty the place of manufacture of terracottas which have come into the market without any indication of the place of discovery. This is true not only of those figures which resemble the figures from Myrina, but of terracottas in general.

The chief types and the most important series of terracottas have now been described in an approximately chronological order. After the Hellénistic period figurines continued to be made from Asia to Gaul, but they cease to be interesting from an artistic point of view, except in so far as they confirm the persistence of certain types and the wide distribution of certain customs or beliefs, such, for instance, as the worship of Mithras. A detailed discussion of the decadence of art as seen in terracottas would be of little value. It will be more useful to give a list of some of the remaining places where important discoveries of terracottas have been made, with a brief statement of the types and classes of terracottas found in each place.¹

The primitive figures found at the Argive Heraeum, Mycenae, Nauplia, and Tiryns, and the early archaic figure-vases from Rhodes and Samos, have already been mentioned, as have also the archaic

¹ More detailed information is given by Winter, *Die Typen der figürlichen Terrakotten*, Vol. I, pp. i-cxxx, and Walters, *Catalogue of the Terracottas in the . . . British Museum*, pp. xxxv-xlix.

figures from Corinth. The other types of terracottas found at these places are less distinctive, and need not be described. In Cyprus primitive figures of the Bronze Age represent female figures and oxen, the latter better modelled than the former. Some of the female figures seem to carry a child in their arms. Ornaments are added in great profusion by sticking on little pellets of clay. These figures are followed by others that show marked Phoenician or Assyrian influence. A fine series of statuettes from Larnaka, representing a goddess who combines the attributes of Artemis, Aphrodite, Demeter, and Cybele, is completely Hellenic of the fifth or fourth century. Some of the moulds may have been imported from Athens.

The chief discoveries of terracottas in Asia Minor (apart from Myrina) have been made at Smyrna (Fig. 236), Pergamon, Priene, and Tarsus. These figures are for the most part similar to those from Myrina. At Smyrna, however, many figurines were gilded, and there are many imitations of sculpture, sometimes of works of the fifth century. Heads of Zeus, Serapis, and Heracles, which are rare elsewhere, are not unusual at Smyrna, and comic and grotesque figures are common. Among the figures from Priene are some which differ from those of Myrina, not only by superior workmanship, but also by a certain grandeur of style.

In Greece proper many sites have yielded terracottas. At Olympia many very early figures were found, among which male figures are unusually numerous. At Eretria figures of various dates from the sixth to the third century have come to light, among them some good specimens of the fifth century. But the greater num-

Places
where terra-
cottas have
been found



FIG. 236. — Aphrodite, from Smyrna. Boston. Height, 0.374 m. (Photograph.)



FIG. 237. — Figurine from Eretria, Boston. Height, 0.394 m. (Photograph.)

ber of Eretrian figurines are Hellenistic, of excellent workmanship (Fig. 237). These resemble the figures from Myrina quite as much as they do those from Tanagra, and display a marked liking for ornate and lifelike figures, *genre* motives, and Erotes (Fig. 238). From the Cabirium, near Thebes, come numerous male figures, often with cocks or animals in their hands. Many of these are grossly grotesque, and the workmanship is poor. At Eleusis specimens of all periods, from Mycenaean times to the times of the Roman Empire, have been found, but comparatively few are later than the archaic period. Those of this period resemble those found at Athens. Megara has also furnished terracottas of all styles from primitive to late.

In Sicily, Akragas, Syracuse, Camarina, Megara Hyblaea, and various other sites have furnished archaic figures, Gela figures of the style of the fifth century, and many sites attractive figures of the fourth century and later. In general, the Sicilian figures are of less good workmanship than those of Tanagra or Myrina.

Many figurines have been found in Italy (Fig. 239), but the place of discov-



FIG. 238. — Erotes from Eretria, Boston. Height, 0.08 to 0.11 m. (Photograph.)

ery is often unknown. At Tarentum the most striking type is the Sepulchral Banquet, but many excellent single figures have also been found. Some of these are archaic, but the majority belongs to the fourth century B.C. and later. The usual types are equestrian figures, standing and seated female figures, dancing girls, youths, boys, Erotes, and caricatures. Other types also occur. Some of the Tarentine figures are very fine. At Locri, late archaic reliefs, with subjects relating to the deities of the lower world, have been found. Many figures of the third and fourth centuries B.C. have been found at Capua, chiefly representing a woman with a child.

Ruvo, Canosa, Egnatia, Rome, Pompeii, and other places have furnished terracottas, chiefly of the third century and later. Some large vases from Canosa, adorned with figurines, show excellent workmanship, though this method of combining the human form with the vase is utterly



FIG. 239. — Heracles, from Santa Maria di Capua. Height, 0.304 m. (Photograph.)

unpractical. The Pompeian terracottas were made, for the most part, between 69 and 79 A.D. In Etruria few Greek terracottas have been found; but the Etruscans themselves were technically skilful workers in terracotta, since we know they made acroteria, pediment groups, and even cult statues of this material. The extant Etruscan terracottas, however, are chiefly architectural ornaments, ash-chests (*cistae*), upon which scenes, usually from Greek myths, are represented in relief, and sarcophagi, on the lids of which are recumbent figures, often of life size. These works are seldom remarkable for fineness of execution or artistic feeling.

At Cyrene, in Africa, some archaic figures, for the most part representing a seated goddess, and many of Tanagraean style, have

been found. Some of these are evidently imported ; others, which are distinguishable by their inferior finish, are local imitations. These are followed by figures of animals and of Eros or a boy riding upon an animal. Many of these are of poor style and workmanship. Some representations of a boy struggling with a goose may be influenced by the statue of the boy with a goose, by Boethus, a sculptor of the fourth century B.C. At Naucratis, in Egypt, some early figures are known, as well as some imported specimens of Tanagraean style. Later figures are strongly influenced by Egyptian cults.

The terracottas from the Crimea (Kertch) include a few early specimens, imported Attic figures of the fifth century and inferior local imitations, as well as a much larger number of figurines of the Hellenistic period and later. These are similar to the Myrina terracottas, but inferior to them in style and finish.

Greek terracottas are found for the most part in graves, as at Tanagra and Myrina, or on the sites of temples, as on the Athenian Acropolis and elsewhere. Only at Priene have they been found in private houses, except where, as at Pompeii, they belonged to *lararia*, or private shrines. Under these circumstances it seems improbable that they were made primarily for the adornment of the home. Certainly that cannot have been their purpose in the earliest times. But the same types are found in graves and sanctuaries, and the question naturally arises, "For what purpose were the figurines made?" The most reasonable reply seems to be that given by M. Pottier. The figurines had, no doubt, originally a definite meaning and a definite purpose, though this purpose may not have been the same in all places, but as time went on and the types became more varied and less and less distinctly religious, the purpose of each figurine depended chiefly upon the intention of the purchaser. Exactly similar figures might be by one person deposited as a votive offering in a temple and by another placed in a grave. In either case the figure was intended as a pious gift. In some places, as at Tanagra and Myrina, such pious gifts were most frequently deposited in

Purpose of
terracotta
figurines

graves, and therefore the coroplasts of these places undoubtedly made their figurines with the expectation that they would be buried with the dead. In other places the makers must have intended their works primarily for votive offerings ; but the purpose for which the figurines were to be employed had, in the fourth century at any rate, little or no effect upon their style or subject. These charming little works were made to appeal to the taste of the Greeks of that time, and they now delight the eyes of nations never dreamt of by the coroplasts.

CHAPTER V

METAL WORK

(BRONZES, SILVERWARE, JEWELRY)

THE Prehellenic inhabitants of the coast lands and islands of the Aegean attained great skill in the working of bronze, gold, and silver, and some of their beautiful and remarkable works have been mentioned in the chapter on Prehellenic Greece. In the period that followed the fall of the "Mycenaean" civilization, the ancient skill and taste were lost, so that the history of Hel-

Metal work and metals lenic art begins, in metal work as in other branches, hardly before the seventh century, even though some of the earlier traditions did survive, especially along the eastern shores of the Aegean. Throughout antiquity the metals employed for artistic and ornamental purposes were bronze, gold, and silver; for iron, the use of which was first introduced in the last years of the "Mycenaean" epoch, was employed chiefly for nails, clamps, tools, weapons, and other articles which offer little opportunity for the display of artistic ability. Besides, the surface, at least, of iron is so easily destroyed by rust, that even if that metal had been more generally used than it was, little artistic Greek iron work would now be preserved. Lead, on the other hand, is ill adapted to artistic uses, being too soft, too easily melted, and too heavy in proportion to its strength. Moreover, it contracts greatly in passing from the molten to the solid state, and its surface has, after exposure to the air, a dull and unattractive color. Great numbers of small leaden images have been found in the recent excavations at the temple of Artemis Orthia, at Sparta, and leaden figurines or reliefs from other places are not unknown, but these are of little importance in the history of art, and may be passed over without further mention.

BRONZE

The word "bronze" designates, strictly speaking, a mixture, or alloy, of copper and tin. The ancients, however, employed only one word (*χαλκός* in Greek, *aes* in Latin) to designate copper and its various alloys. In ancient bronzes there are found, besides copper and tin, appreciable quantities of silver, gold, and zinc, though the alloy of copper and zinc, known in modern times as brass, seems to have been almost unknown. The composition of ancient bronzes varies greatly. In the early part of the Bronze Age the metal used was almost pure copper, and in the classical period the proportions of different metals in the composition were varied for the purpose of obtaining different colors or other qualities, and probably the presence of various other metals in the copper ores led to various combinations. In accordance with the practice of the ancients, the word "bronze" is used here to denote copper and its various alloys without distinction. At the same time it should be borne in mind that in classical times, as in later ages, the "bronze" employed was chiefly a mixture of copper and tin.

Bronze was far more generally used in ancient than in modern times, not only for purely decorative purposes, but also in the manufacture of furniture, household utensils, and other objects, many of which were beautiful in shape and richly adorned with reliefs. The fibula, or safety pin, which became known in Greece at the very end of the "Mycenaean" epoch, was usually made of bronze, though in its more elaborate and ornamental forms it was sometimes of gold. Fibulae vary greatly in size, the largest bronze specimens being six inches, or even more, in length. The earliest fibulae in Greece are simple safety pins, made of a single wire, sharpened at one end, twisted in a spiral or, rather, circular curve about the middle, in order to give it a spring, and at the other end so bent as to form a catch and shield for the point (Fig. 240). To this simple pin succeeds the fibula with an arch (bow fibula), which is often formed like

Fibulae

a series of beads or adorned with projecting rings (Fig. 241). Sometimes the catch or shield for the point is widened into a broad plaque (Fig. 242), which is often decorated with incised designs; the resemblance of these to the geometrical designs of the Dipylon vases serves to fix their approximate date. Such

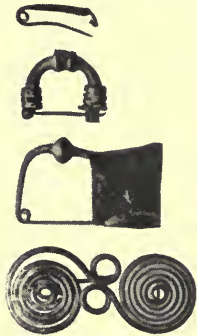

FIGS. 240-243. — Fibulae. (*The Argive Heraeum*, Vol. II. Pls. 84, 87, 86, 85.)

fibulae are sometimes very large. The boat fibula (*fibula a navicella*) has an arch somewhat resembling a canoe in shape, which is often decorated with designs in relief or incised. Sometimes the shield of the point is lengthened, and often the shield and the arch are richly adorned with chasing, animals' heads, and other decorations, or pendants were hung from the arch. Often, too, the arch is flattened and broadened or rounded, and thus the safety pin becomes a brooch. An early and attractive form of flat brooch is made by twisting a wire into a double spiral. This may be made entirely of one wire, one end of which forms the pin, the other the

catch (Fig. 243). Sometimes a quadruple spiral is made, in which case, as in that of the more elaborate brooches, the pin and the catch are made of separate pieces. Other brooches are far more elaborate, and are, like the brooches of modern times, usually of gold. In general, the decoration of fibulae follows the same lines of development as vase-painting and relief work.

Many bronze repoussé reliefs of the seventh and sixth centuries B.C. have been found at Olympia and elsewhere. An especially important relief from Olympia (Fig. 244), which was apparently intended to be fastened as a sheathing on one side of a pedestal or something of the sort, offers an interesting example of the juxtaposition of traditional designs, such as the "Persian Artemis," and new, thoroughly Hellenic representations, such as the combat with the centaur. It is perhaps worth noticing that the hand of the artist seems surer in the execution

Early reliefs

of the traditional than in that of the newer designs. That the art represented by this relief is Ionic, that it belongs, in other words, to the coast of Asia Minor, is evident, though the relief itself may have been made in continental Greece. A series of repoussé reliefs on thin strips of bronze divided into nearly square fields by bands of conventional designs has been called Argive, Argive-Corinthian, or Peloponnesian, chiefly perhaps because in an inscription (*ἄλιος γέρων*) on one of them, found at Olympia, the Argive form of the letter lambda occurs. The designs, however,—sphinxes, griffins, lions, mythological scenes, and conventional patterns,—are such as occur on Ionic vases. It is therefore probable that these reliefs are products of Ionic art, and not unlikely that most of them were made at Chalcis and Athens. Indeed, it is evident that in all branches of art, with the exception of the Doric style of architecture, the Ionic Greeks (that is, the Greeks of Asia Minor and those who had close connection with Asia Minor) were more advanced in the seventh and sixth centuries than the other members of the Greek race, and in nothing is this more clearly seen than in the bronzes.

Among bronze utensils the large and richly decorated caldrons and tripods of the sixth century are especially interesting. The original purpose of tripods was evidently to support the caldron or pot over the fire, but at an early date



FIG. 244. — Bronze relief from Olympia. (*Olympia*, Vol. IV, Pl. 38.)

Tripods.

Ionic style

caldrons and tripods came to be used as prizes for games (much as cups are used in modern times), as votive offerings, or as indications of the wealth and taste of their owner. The caldrons were



FIG. 245.—Bronze tripod. Provisional restoration. (Photograph.)

frequently adorned with griffins' heads or animals riveted on about the mouth or on the shoulder of the vessel, the tripods had claw feet, and the uprights that rose from the feet were adorned with strips of conventional patterns in relief, as were also the horizontal bands that held the uprights together and the handles by which the tripods were moved. The feet of the earlier tripods are rudely cast solid, later they are formed of hammered and riveted plates, and finally they are cast hollow. Technical progress is seen also in the griffins and animals that adorn the caldrons, in the caldrons themselves, and in the ornaments of the tripods. Some tripods, instead of consisting of three uprights joined by horizontal strips of bronze, have the form of triangular pedestals adorned with reliefs and surmounted by a great crown, like the calyx of a flower, in which the caldron rests. Three especially

fine examples of this class, found in Italy, but undoubtedly Ionic Greek work, are the property of Mr. James Loeb, and are now in the Fogg Museum of Art of Harvard University and in the Metropolitan Museum in New York (Fig. 245). Here all the

skill and refinement of Ionic art of about the middle of the sixth century are displayed.

The same style is seen in many smaller utensils and was imitated by Etruscan artisans. Examples of such imitation are, for instance, the fine and wonderfully preserved bronze-sheathed chariot from Norcia, now in the Metropolitan Museum in New York, and the sheets of repoussé reliefs from Perugia (now for the most part in Munich), which once adorned a similar chariot. In these the technical skill displayed is great, but the refinement and the careful

original study of nature, which contribute so much to the beauty of genuine Greek work, are wanting. An especially fine example of somewhat later Ionic work (about 500 B.C.) is a large (height, 0.21 m.) handle of an amphora with volutes (Fig. 246) from Cilicia. The rich ornamentation is beautifully executed, and the running figure (Gorgon?) with four wings shows, as do numerous statuettes from Athens and other sites,



FIG. 246.—Bronze amphora handle, from Cilicia. (*Collection de Clercq*, Vol. III, Pl. lviii, No. 423.)

the popularity of the type represented by the marble statue from Delos ascribed to Archermus (p. 209).

From the sixth century B.C. to the latest period of Greek art, bronze reliefs and utensils, as well as statuettes, reproduce the progressive changes of style and taste. Among the most beautiful bronze reliefs are two in the British Museum Reliefs (*Catalogue of Bronzes*, No. 285, pl. viii), said to have been found in Italy, near the river Siris. They are works of the fourth century B.C., and were anciently attached to a cuirass to cover the shoulder clasps. On each a combat between a Greek and an Amazon is

represented, and although the relief is so high that some parts of the figures are almost detached from the background, yet the whole is

wrought from a single sheet of bronze. In freedom of attitude, grace of posture, delicacy of execution, and breadth of treatment, these two small reliefs are unsurpassed.

Among bronze reliefs, those on circular mirror cases form an interesting series. Some of these, for instance one in the Museum of Fine Arts in Bos-

Mirrors



FIG. 247. — Bronze mirror case. Boston. (Photograph.)

ton (Fig. 247), which was found in Greece and may be attributed to the fourth century B.C., possess something of the freedom and real artistic grandeur seen in the Siris bronzes. Greek mirrors consisted of a polished metal disk. This was in early times supported on a standard, which often took the form of a statuette. An excellent example of a mirror of this kind, which dates from that time in the fifth century when sculpture was not yet entirely free from archaism, but had already attained no little grace and charm, is in the Museum at Boston (Fig. 248). In the fourth



FIG. 248. — Mirror. Boston. (Photograph.)

century, however, the mirror was usually enclosed in a circular bronze case, which was adorned with figures in relief, while the mirror itself was left without ornamentation. This was the Greek practice, but in Etruria mirror cases were little used, and the metal



FIG. 249. — Etruscan mirror. Boston. (Photograph.)

disks were decorated on the back, usually with scenes from Greek mythology. These decorations are very seldom executed in relief, but are almost always engraved. A few fine examples of engraved mirrors of genuine Greek workmanship are known, but nearly all the engraved mirrors are Etruscan. The persons of

Greek mythology are usually designated by inscriptions written in the corrupt form of the Greek alphabet adopted by the Etruscans, and the names are for the most part corrupt forms of the Greek (e.g. *Achle* for *Achilleus*), though some of them are of foreign origin (e.g. *Menfra* for *Athena*). The designs are well adapted to the circular field and show great skill in drawing and execution, but original observation of nature, artistic sentiment, and lively imagination are wanting (Fig. 249). Similar incised drawings were employed by the Etruscans for the decoration of other objects, especially the high, round boxes called *cistae*, the most remarkable of which is perhaps the famous Ficoroni cista in the Museo Kircheriano at Rome.



FIG. 250. — Bronze situla. Boston.
(Photograph.)

Bronze reliefs were employed by the Greeks in the decoration of various objects of domestic use. A bronze *situla*, or pail, found in southern Italy and now in the Museum at Boston (Fig. 250) is an excellent example of early Hellenistic design. The Museum at Naples contains many bronzes from Herculaneum and Pompeii, which once formed parts of the furniture of Roman

houses. Similar objects are found in various other museums. Many of them are beautiful in their execution and in their fitness for the purposes they are intended to serve. Even though they were actually made in Roman times, from the point of view of the history of art they may be regarded as Hellenistic works.

Statuettes Bronze statuettes reflect, even more completely, perhaps, than bronze reliefs or terracottas, the progressive development of Greek sculpture. Often such statuettes

formed parts of utensils, such as mirror standards (Fig. 248), handles of vessels or covers, or decorative additions to caldrons and the like, but frequently they served no such purpose, and were independent works of art, intended to be dedicated at shrines, deposited in graves, or set up as ornaments in houses. The technical processes (p. 197) are the same in making statuettes and statues (except that small statuettes are frequently cast solid), and it is not improbable that really great sculptors occasionally made figures of small size. On the other hand, statuettes intended for votive offerings or to be set up in shrines were often sold to poor persons, and were therefore cheaply made by workmen of no artistic ability. Naturally, therefore, bronze statuettes exhibit even greater differences of quality, both in design and execution, than do terracotta figurines.

As regards the types represented, bronze statuettes show no such predilection for female forms as is seen in terracottas, nor do they at any time or place tend so strongly to the representation of human beings in the common attitudes and activities of daily life as do, for instance, the Tanagra figurines of the best period, though *genre* figures and even caricatures in bronze are not uncommon in Hellenistic and Roman times. It is also to be observed that bronze statuettes are, far more frequently than terracottas, obvious copies of famous statues. While it cannot be asserted that the famous Payne Knight statuette in the British Museum is really a copy of the Apollo Philesius of Canachus, it is nevertheless true that the statuette must have been intended to recall the great statue, both as regards pose and attributes, although it was made some time after the statue itself. It may therefore,



FIG. 251.—Payne Knight statuette. British Museum. (Photograph, W. A. Mansell & Co., London.)

with the fine statuette from Piombino, another statuette, now in the Louvre, a late marble relief found at Miletus, and Milesian coins, serve to give us some conception of the work of Canachus (Fig. 251).

A heavy, somewhat clumsy statuette found at Ligourio, near the ancient sanctuary of Epidaurus, has been regarded as an Argive work of the time before Polyclitus. The fact that it was found in the Argolid does not necessarily show that it is Argive work, as a small statuette is easy to transport, and undoubtedly the impor-

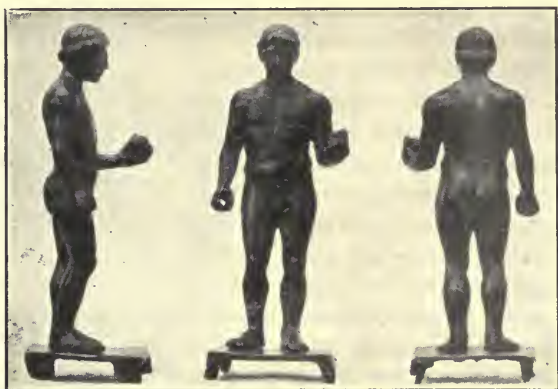

FIG. 252. — Statuette from Ligourio. (*50th Berlin Winckelmannsprogramm*, Pl. 1.)

tance of this small figure has been overrated. It is, however, admissible to regard it as an example of one of the possible preliminary steps leading up to the style of Polyclitus (Fig. 252). A fine bronze statuette in the British Museum is evidently a copy of the Marsyas of Myron, though the treatment of the hair and other details show that the copyist was not in all respects faithful to the style of the original (Fig. 253). Yet this bronze gives the posture of the satyr, and serves to correct the false impression made by the statue in the Lateran with its modern restorations. Statuettes which reproduce the styles of almost all the famous sculptors

are known, and among them are some real masterpieces of art. For the most part, however, even those which are evidently copies of famous works by great masters are somewhat carelessly executed. An example of a statuette of mediocre workmanship, which is nevertheless interesting because it reproduces a famous statue, is the copy of the Aphrodite of Cnidus in the De Clercq collection (Fig. 254). It



FIG. 253. — Statuette of Marsyas. British Museum. (Brunn-Bruckmann, Pl. 209 b.)



FIG. 254. — Aphrodite of Cnidus. (Collection De Clercq, Vol. III, Pl. ii.)

would be a long and difficult task to compile a list of all the bronze statuettes that reproduce directly or indirectly the known works of the great sculptors, and those which are probably imitations of lost or unknown statues are even more numerous. A complete study of bronze statuettes would be little less than an exhaustive treatise on the styles, types, and *motives* of Greek statuary; but the importance and interest of these small works of art may have been made sufficiently clear in the few words devoted to them.

GOLD AND SILVER WORK

Closely connected with work in bronze is work in gold and silver. It will be convenient to treat first of large gold and silver ornaments and utensils, such as cups and other vessels for table use, reserving jewelry for separate treatment. Probably the art of the goldsmith and silversmith began to revive after the fall of the Mycenaean civilization as early as the art of the bronze worker; but few, if any, vessels or utensils of the precious metals exist which can be assigned to a very early date. Some small repoussé reliefs of gold or electrum, ranging in size from less than an inch to about two inches in length and breadth, which resemble in a general way the so-called Argive-Corinthian bronze reliefs, are to be regarded as Ionic, or Asiatic, Greek work of the seventh and sixth centuries B.C. Although these small plaques, which were fastened together to form girdles or necklaces, were intended for personal adornment, the fact that they are executed in repoussé, like the designs on vessels and other larger objects, makes it natural to mention them here, rather than in the category of jewelry.

Several interesting objects of gold, found in 1882 at Vetttersfelde, in Silesia, are evidently Ionic Greek work, executed about the end of the sixth century, or a little later, for some Vetttersfelde Scythian customer, though how they came from southern Russia to Germany is not known. The most remarkable piece is a fish (Fig. 255), 0.41 m. ($16\frac{1}{8}$ in.) in length, admirably executed and adorned with figures of a Triton, fishes, a bird, and animals, while a curious spiral ornament proceeds from the eye, and the tail ends in two ram's heads. Similar ram's heads are found on Ionic bronzes, and the bird, the animals, and the Triton are familiar in Ionic art. That such figures are represented on the body of a larger animal (here the fish) is doubtless due to local Scythian taste, and the same phenomenon occurs on gold objects found in the Crimea. The fish from Vetttersfelde (now in the Museum at Berlin) was evidently fastened upon some object,

probably a shield, and in spite of the Greek quality of its workmanship it cannot have been made to be used by a Greek.

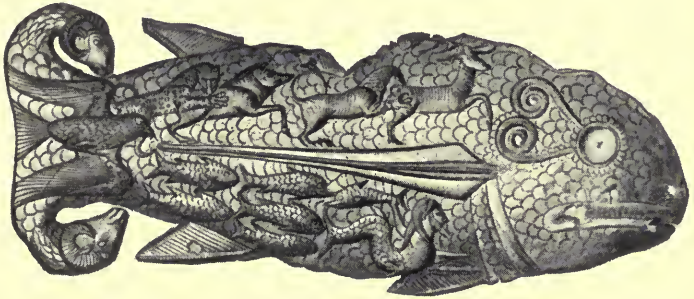

FIG. 255. — Gold fish. (Furtwängler, *Goldfund von Vettersfelde*; 43rd Berlin Winckelmannsprogramm, Pl. I.)

The other objects found at Vettersfelde, and most of the larger objects of gold and silver found in southern Russia, which are now among the most valuable possessions of the Museum of the Hermitage, at St. Petersburg, were also made for Scythian customers, and probably some of the later objects from southern Russia are Scythian imitations of Greek work. A genuine Greek work, though intended for use by a Scythian, is a finely executed and richly adorned sheath for a short sword, which was found near Kertch (Fig. 256). Here the old Ionic designs are seen as they appear in the earlier part of the fourth century under the

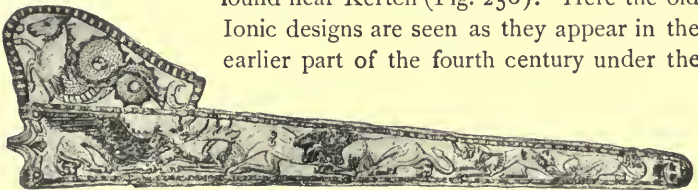

FIG. 256. — Sword sheath from Southern Russia. (*Antiquités du Bosphore Cimmérien*, Pl. 26.)

strong influence of Attic art. Several silver vessels of about the same date show a similar survival of Ionic *motives* among the skilful artisans who supplied the Scythian chiefs and nobles with their

richest adornments and furnishings. Whether these Greek artisans were settled in Scythia or lived in Greece, probably at Athens, as has been supposed, and adapted their work to the tastes and needs of their Scythian customers, cannot be determined with certainty. On the one hand, the fact that Attic delicacy of taste and workmanship is seen in jewelry and other goldsmith's work found as far apart as the Crimea and Spain, leads to the belief that Athenian goldsmiths exported their work to those distant regions; but, on the other hand, the distinctively Ionic character of the earlier objects found in the Crimea (and of those from Vetersfelde), with the survival of Ionic *motives* in work of the fourth century, makes the existence of a local Scythian school of Greek goldsmiths and silversmiths seem almost certain. Probably, as Athens imported more and more grain in the fifth century, her exports of goldsmith's work, as of other manufactures, increased at the expense of her competitors.

That the working of the precious metals was by no means neglected in Greece proper in the fifth and fourth centuries B.C. is **Alexandrian silverware** evident from the great fame of the chryselephantine statues of Phidias and other sculptors of the period, and the existence of gold and silver vessels and the like is known from literary and epigraphical sources. But few such objects are extant which can be proved to have been made in Greece proper, or which can (with the exception of those from the Crimea) be dated earlier than Hellenistic times. In those times the use of such expensive table furnishings must have been far from uncommon, especially at the splendid courts of the successors of Alexander, and the city of Alexandria was the chief centre of their production. This is proved, not by the discovery of vessels of gold or silver at Alexandria, or even in Egypt, though a few silver vessels have been found in Egypt, which may be ascribed to the second century B.C.,¹ but by the study, with the aid of ancient literature, Pompeian wall-paintings, and other

¹ E. Pernice, *Hellenistische Silbergefäße im Antiquarium der königlichen Museen. 58tes Winckelmannsprogramm.* Berlin, 1898.

accessory evidence, of silverware found in other places. Roman writers make it perfectly clear that the makers of the silverware most highly prized by the Romans were Greeks, and it may be confidently assumed that elaborate silverware possessed by a wealthy Roman under the Republic or the early Empire is actually late Greek work, or, at least, copied from Greek work. Such silverware has been found at various times and places, but the most important discoveries were made at Berthouville, in the district of Bernay, Normandy, in 1830, at Hildesheim, in the province of Hanover, in 1868, and at Boscoreale, near Pompeii, in 1896. The vessels and other objects found at Bernay are now in the Cabinet des Médailles, Paris, those found at Hildesheim in the Museum at Berlin, and those from Boscoreale for the most part in the Louvre. The various other objects found at these places, although there are among them interesting and characteristic specimens of Hellenistic work, are, on the whole, less important than the cups and dishes.

The Boscoreale treasure was buried by the eruption of Vesuvius in 79 A.D., and can therefore contain nothing made after that date. It is evident, too, that some of the vessels were wrought long before the treasure was buried, and all are properly classed as works of Alexandrian art, modified, perhaps, in some cases to suit the taste of Roman Italy. One of the ^{Boscoreale} most interesting of these works is a shallow silver dish (*phiale*, *patera*), in the centre of which is a remarkable symbolic representation of the city of Alexandria (Fig. 257). The great and wealthy Egyptian city appears as a woman of massive, almost voluptuous, form, with strong features and an expression of calm pride. On her head she wears the spoils of an elephant, with projecting tusks and raised trunk. The earrings, doubtless fine examples of the goldsmith's art, which once adorned her ears, are now lost. In her left hand, resting on her arm, she carries a cornucopia filled with fruits and covered with significant reliefs. Above its open end a crescent is fixed. In her right hand she holds a sacred serpent; fertility and wealth are perhaps symbolized

by the female panther before her ; the sistium in the lower part of the field refers to the Egyptian worship of Isis. A lion is seen by the right shoulder of the woman. This remarkable piece of symbolic design is executed with consummate skill. The whole is an insertion (*ἐμβλημα*) in the dish, wrought of a separate piece of silver and set in, as are the reliefs and medallions seen in other



FIG. 257. — Silver phiale from Boscoreale. (Photograph.)

dishes of this shape. The silver is hammered so thin that it had to be filled with lead to give the finished work the necessary solidity. Here the relief is so high as to be in parts wrought almost completely in the round, and details are added by engraving. The whole was once gilded, except the nude parts of the female figure. In general, gilding was much used, especially in the inserted reliefs and medallions (*ἐμβλήματα*). In the silverware found at Boscoreale and at Hildesheim, nearly all possible

technical processes — casting, turning, hammering (*repoussé*), soldering, welding, engraving, niello, and gilding — are employed with the greatest skill.

Another dish, of about the same shape as that just described, has for its central adornment the head and bust of a beardless man, with short hair and wrinkled forehead. This is evidently a portrait, and seems to be a careful and somewhat realistic portrait, though the person represented has not been identified. A second dish, which formed a pair with this one, had in its centre the portrait of a woman, not old, but no longer young, probably the wife of the man. The woman's head is now in the British Museum, though the dish is with its mate in the Louvre. Two other peculiarly attractive parts of the Boscoreale treasure are a pair of jugs or pitchers, on each of which two winged Victories are sacrificing at an altar of Athena. The figures on the two vessels are not identical, but similar in attitude and action, as well as in style and execution (Fig. 258). The easy, graceful postures of the Victories, their half-exposed forms, and their waving draperies exhibit the qualities familiar to us from some of the better marble reliefs of Hellenistic times.



FIG. 258. — Silver pitcher from Boscoreale. (Photograph.)

Less attractive, but no less interesting, are two cups, once gilded and evidently forming a pair. Under a garland of roses, skeletons are represented in the attitudes and action of living persons. Some are anonymous and are accompanied by inscriptions, such as "pleasure," "envy," "enjoy life; for the morrow is uncertain."

Other skeletons are designated by the names of Sophocles, Moschion, Zeno, and Epicurus on one cup; Menander, Archilochus, Euripides, and Monimus on the other. Beside Epicurus is the inscription τὸ τέλος ἡδονή, "pleasure is the highest good." The whole preaches, with exquisite art, so far as execution is concerned, the doctrine, which was so popular in Hellenistic and Roman times, "let us eat and drink; for to-morrow we die."



FIG. 259.— Silver patera from Hildesheim. (Pernice and Winter, *Der Hildesheimer Fund*, Pl. I.)

The Hildesheim treasure is not dated by any such event as the eruption which buried the treasure at Boscoreale, but it was probably the travelling table service of some important Roman of the second century after Christ. Most of the vessels found at Hildesheim are finely executed, and may be assigned with great probability to the time of Augustus. They

are Alexandrian in shapes, *motives*, decoration, and technique, except that on some of them garlands and naturalistic leaves are employed in a way apparently peculiar to the Augustan period. A few may, in fact, have been wrought before the time of Augustus. A small number of less well-executed objects are probably Gallic work of a somewhat later date. Evidently the whole service was not originally made as one set, and therefore the date of one part of it does not fix the date of another, unless it be in the case of objects evidently intended as pairs. Perhaps the most interest-

ing and beautiful of the vessels found at Hildesheim is a patera in which a full-length figure of Athena is inserted. The patera itself is more richly ornamented than is usual, and the figure of Athena is a most extraordinary example of dignified design in a comparatively small object, coupled with the greatest technical



FIG. 260. — Silver cup from Hildesheim. (Pernice and Winter, *Der Hildesheimer Fund*, Pl. 14.)

skill in execution (Fig. 259). An equally brilliant, though less beautiful, piece of work is a second patera, the central medallion of which represents, in very high relief, the infant Heracles strangling the serpents. Two other, simpler, paterae have medallions on which the heads of Attis and Cybele, respectively, are represented in low relief. These two, and the patera with the figure of Athena, may be the earliest of the vessels from Hildesheim. Among the others, a pair of cups adorned with masks, garlands, and various theatrical and Bacchic personages and symbols are especially interesting (Fig. 260). Taken together, the treasures of Bos-

coreale and Hildesheim serve to give a vivid and fairly complete idea of the taste and skill displayed by the Hellenistic or, more especially, Alexandrian silversmiths.

JEWELRY

In modern jewelry the stones are, as a rule, the main thing, and the art of the jeweller is exhibited chiefly in setting the stones in such a manner as to show their beauty to the best advantage. In Greek jewelry, on the other hand, the form of the completed object is the main thing; the stone, if any stone is employed, is merely an accessory. It is not until the late times of Hellenistic art, the time, that is, of the Roman Empire, that the relation is reversed, and the stone becomes the chief thing. At the same time, ornaments become exaggerated and overloaded. In general, real Hellenic jewelry is more restrained in design and decoration than that of Hellenistic times, and taste deteriorates as time goes on. Etruscan jewelry is often difficult to distinguish from real Greek work, which it resembles in the general character of its designs, and frequently equals in fineness of execution. In its representation of the human form, Etruscan jewelry is, however, less excellent, and in general it is less artistic than Greek work, because its ornamentation is less restrained.

Ancient jewellers employed the various processes of casting, hammering, welding, and soldering; filigree work was popular at almost all periods, as was also the method of ornamenting a gold background by soldering upon it many minute dots of gold in such a way as to form a pattern or emphasize outlines. Complicated gold objects, which were much more popular than they are at the present time, were made of separate small, and often very thin, pieces of gold soldered together. Genuine enamel work was apparently unknown to the Greeks, and the glass pastes employed in jewelry were not melted in, but were treated exactly as if they were real stones. When stones were used, they were not cut in facets, as in modern

times, in order to increase their sparkling brilliancy, but they seem to have been prized less for that quality than for their color, their lustre (when simply polished), and their adaptability for use as cameos or intaglios.

It is by no means easy to determine the date of pieces of jewelry or the place of their manufacture, for they are small and therefore easily transported; accurate accounts of their discovery are often wanting, and, since such small objects of value are in all ages frequently treated as heirlooms and handed down from generation to generation, it is always possible that jewelry may be much earlier than any coins or other dated objects with which it may be found. Moreover, some forms were in use during long periods. The general lines of development are, however, sufficiently clear, even though many details are as yet little understood.

The chief objects included under the head of jewelry are wreaths or diadems, hairpins, necklaces, earrings, pendants, brooches, bracelets, and rings. All of these are known in many examples, and it is obvious, almost at first sight, that the course of Greek art as seen in jewelry is parallel to its course in other branches. The greatest treasures of Greek jewelry have been found in southern Russia (the Crimea), but many important discoveries of treasure have been made in other places, and isolated objects have been found at almost all points of the ancient world. By far the greater part of the Greek jewelry extant is Hellenistic, or later.

Ornaments for the head may be garlands, diadems, hairpins, or spirals, the last mentioned being intended to twine about the locks of hair to keep them in place. Garlands consist of Diadems
thin gold, cut and pressed into the form of leaves and and garlands
fastened to a curved stem either by soldering, by means of a fine wire (which serves as the stem of the leaf), or occasionally by a rivet. Such garlands, when made merely to be buried with the dead, are very light and usually of rather careless workmanship. When made to be worn by the living, they are likely to be more carefully made and also somewhat heavier, though much Greek jewelry, whether intended for actual use or not, is made of

thinner gold than would be used in modern times. Such garlands as have been mentioned were evidently in use from early times until long after the foundation of the Roman Empire. Diadems were, like garlands, made of thin gold, and most of those known to us were probably made for sepulchral use. In these the workmanship is usually very careless, but the designs, pressed, or, in some cases, hammered out in repoussé, exhibit the styles of all the centuries from Mycenaean to late Roman times. The spiral lock holders are little more than pieces of gold wire, twisted into the required spiral form. Sometimes they have small ornaments at the ends, and occasionally they are further enriched with dots of gold or with slight chasing. Such spirals were used not only to hold locks of hair in place, but also as earrings, in which case they were passed through the ear, and as finger rings. Specimens have been found made of gold, silver, and bronze.

Hairpins were in use throughout antiquity. They were not double pins, like modern hairpins, but single, long pins with, as a rule, large and ornamental heads. The degree and kind of ornamentation vary greatly, not only with the times, but with the individual taste and wealth of the ancient purchaser. Round heads, adorned with concentric rings or other simple patterns, occur at different times. In the fourth century B.C. and later, the heads of pins not infrequently take the form of small statuettes. The human head is also a well-known design. It is comparatively easy to assign a date to pins of this sort, as the relation between minute gold or silver statuettes and sculpture of larger size is close, but some of the pins ornamented with linear designs in filigree or granulated work are less easy to date, though the student is often aided by the presence of some well-marked ornamental form known to him in architecture or some other branch of art. Some of the Greek hairpins are very elaborate, few equalling in this respect a remarkable work in the Museum at Boston (Fig. 261), the head of which is a most curious structure, wrought with marvellous delicacy. Above a round knob is a capital with Ionic volutes, upon which stands a combination of

rampant winged lions, conventionalized plant forms, and naturalistic bees, producing a singularly attractive and admirable whole. This little masterpiece, which may be ascribed to the fourth, or possibly even to the fifth, century B.C., exemplifies the chief qualities of Greek jewelry, exquisite workmanship, beautiful form, and refined imagination. Although it is said to have been found in the Peloponnesus, it is probably Attic work.

Among the earliest Greek necklaces are those that consist of a series of small rectangular plaques adorned

Necklaces with reliefs. These plaques are thin, and the reliefs, wrought by the repoussé process, do not differ in any essential features from the similar reliefs of contemporary bronzes. At all periods necklaces were frequently formed of beads strung together, and the beads varied greatly in form. Sometimes they are small globes with little or no ornament, sometimes they have the form of human or animal heads, or even of entire animals, sometimes they represent shells or resemble small amphorae or other vases, or again they are round medallions, usually adorned with heads in relief. The clasps have various forms, from spirals to lions' heads. Some necklaces consist of fine chains, usually with small beads of colored stone or glass between the links. Others are made of fine gold threads twisted into the form of a rope or braided or woven into a flat strap. All these different forms of necklace may be made richer and more striking by the addition of pendants, sometimes few and large, sometimes small and numerous. The date of necklaces can be determined only in part by their form, for strings of beads were used in all periods, but woven and twisted ropes or bands of fine threads do not occur until the fifth century; rich and



FIG. 261. — Gold pin. Boston. (Photograph.)

striking pendants belong chiefly to the fourth century and later, and the use of colored stones and glass increases in Hellenistic and Roman times. The earliest necklaces exhibit the awkwardness of archaic art, and under the Romans the goldsmiths and jewelers, like the sculptors, produced work that was coarse and showy rather than delicate or refined. In the fifth century B.C. the art of the goldsmith was perfected, both as regards technical processes and beauty of design, and throughout the fourth century it remained at the height of its perfection, though even in the fourth century



FIG. 262.— Necklace and earrings. New York. (Photograph.)

the restraint which gives to Hellenic art its peculiar charm begins to yield to the desire for effect. The changes in the quality of Greek art are almost as easily traced in necklaces as in any other class of monuments, for the beads which form the necklaces themselves, the clasps that fasten them, and the pendants that hang from them are more often than not carefully wrought miniature reliefs or sculptures in the round, and palmettes and other significant ornaments are of frequent occurrence. A fine example of a Greek necklace is in the Metropolitan Museum in New York (Fig. 262). Although its exact date may not be known with certainty, it is to be assigned to the fourth century.

Some marble statues of the sixth century have earrings carved in marble, which have the form of disks or rosettes worn close to the lobe of the ear, not hanging down from it. Metal earrings were fixed in the ears of other statues, but the form of these can no longer be determined. It may have been more elaborate than that of the earrings carved in marble. Earrings with pendants were certainly known to the Greeks at this period, for they were worn much earlier by the Egyptians and also apparently by the Phoenicians, and, moreover, on the François vase (Fig. 383) and on several black-figured vases, earrings with pendants are represented ; but, on the whole, if we can judge by the earrings seen in vase-paintings, the relatively simple rosette form was the favorite, at Athens at least, until about the middle of the fifth century. After this time pendants grow in favor, and tend to increase in size and magnificence. Ancient earrings frequently have the form of a human or animal head, and the ring is then so made that the head is worn close to the lobe of the ear. This style seems to have originated as early as the fifth century and to have continued in vogue throughout antiquity, though earrings with heads as pendants were also common. Indeed, the pendants of ancient earrings have almost all conceivable forms.

One of the most remarkable earrings in existence, in fact, one of the most charming extant specimens of ancient goldsmith's work, consists of an elongated rosette, from which hangs a pendant that represents a winged Victory standing in a chariot and driving her pair of spirited horses up toward Olympus (Fig. 263).¹ The delicacy of the work is extraordinary. The wheels turn upon their axles ; the feathers of the wings, the hair of the Victory, and that of the horses' manes and tails are as carefully represented as in statues of life size. So fine is the work that its beauty is enhanced, not diminished, when it is seen through a magnifying glass. Di-

¹ Said to have been found in the Peloponnesus. It is now in the Museum of Fine Arts in Boston, which acquired it at the sale of the Tyszkiewicz collection. Froehner, in his catalogue of that collection, ascribes it, without hesitation, to the time of Phidias.



FIG. 263. — Earring in Boston. Slightly enlarged. (Photograph.)

minutive as is this admirable example of miniature sculpture, it is still too large and heavy to have been worn with comfort by a living woman. The suggestion that it once adorned the statue of some goddess has therefore much in its favor. The style is that of Attic sculpture of the latter part of the fifth century, though it is possible that the earring itself may have been made a little later.

The brooches worn by the Greeks often had the form of safety pins (fibulae ; see p. 324), not disguised except in so far as they were sometimes of great size and the arch and the shield of the point were adorned with designs in the taste of the period. But the general development of jewelry led to change in the form as well as the decoration of brooches. The fibula form, however, continued in use alongside of the flat brooch, and in Hellenistic times both forms were often enriched with stones. The shapes of brooches were various, the most usual being perhaps that of a circular or oval medallion. Sometimes, too, pendants of various forms were attached to brooches, as to necklaces and earrings.

A fine brooch of the fourth century, resembling in shape a pediment surmounted by an acroterium and ending at the corners in the fore parts of winged horses, is in the Metropolitan Museum in New York (Fig. 264). The horses are modelled in the round, and rest upon triangular Ionic capitals (one is missing). The elaborate and beautiful designs of the acroterium and the pediment, with its cornices, are wrought in filigree thread soldered to a thin



FIG. 264.—Brooch in New York. Slightly enlarged. (Photograph.)

plate of gold. To the back of this a second thin plate is fastened, upon which are the remains of the spring and clasp of the brooch. The whole is $3\frac{1}{16}$ in. (0.078 m.) in length.

Pendants have been mentioned already in connection with necklaces, earrings, and brooches. They were also, apparently, sometimes fastened on garments, and thus worn on the breast, and sometimes they seem to have hung down from the hair over the temples. The form of the pendant was little influenced by the special purpose for which it was intended, except that in general pendants intended as ornaments for the breast or the temples were likely to be flat, while those that hung from earrings, necklaces, or brooches might take various forms, as elongated drops, rosettes, medallions, human or animal heads, tiny statuettes, which are often winged, or combinations of these forms with each other and with chains, colored stones, cameos, or intaglios. Whether the two gold medallions from Kertch,¹ on which the head of Athena Parthenos is represented

Pendants

¹ Now in the Hermitage. The two medallions differ in some details, the chief difference being that in one the head is turned slightly to the right, in the other to the left. Some blue enamel is found on the leaves of the border of the medallions, on some of the flowers, and on some details of the pendants that hang from the medallions.

(Fig. 265), were intended as pendants for a necklace, or were, as is more probable, to be attached to the clothing on the breast, is uncertain. They may even have been worn as pendants from earrings, though their size (about $2\frac{7}{8}$ in., 0.073 m., in diameter) renders this improbable. These medallions, with the rich ornaments pendent from them, are excellent examples of Greek goldsmith's work of the end of the fifth,



FIG. 265. — Medallion from Kertch.
(*Antiquités du Bosphore Cimmérien*, Pl. 19.)

or the beginning of the fourth, century, while the fact that they copy with such apparent accuracy the details of the great statue in the Parthenon makes it almost certain that they were made at Athens.

Greek rings may be divided into four chief types: (1) The ring consists of a piece of gold curved like a horseshoe,

Rings

a stone, usually a scarab or scaraboid, pierced lengthwise, and a gold wire, which is run through the stone and then twisted and fastened about the ends of the curved piece of gold. Sometimes the wire is passed through holes in the curved piece of gold.

(2) The horseshoe (or stirrup) shape is preserved, but the ring is made all of one piece. (3) The third type still preserves something of the stir-

rup shape, but less than the second. The seal stone is not pierced, and is set in the gold. (4) The fourth type is a ring like those of modern times, the bezel, often or usually set with a seal or cameo, forming an integral part of it. Other less important types, common in Hellenistic times, are: a spiral coil, usually in the form of a serpent; a piece of gold so curved as to encircle the finger, but not joined at the ends, which are usually orna-

mented with heads; and a ring made in imitation of a knotted cord or band, in which the knot takes the place of the bezel. Rings of these and similar types are often beautifully wrought. Some special forms of rings have been mentioned in the chapter on engraved gems.

The four chief types follow each other in chronological order, but the earlier among them evidently continued in use after the later types were introduced. Moreover, all four types were employed by the Egyptians. The type of a ring does not therefore always suffice to determine its date, though rings of the first type are not likely to be later than the fifth century, nor those of the fourth type earlier than the fourth century B.C. The most important decoration of rings was the engraving of the bezel, which was sometimes of metal, but was usually set with a stone cut as an intaglio or, in Hellenistic and later times, as a cameo. This kind of work is discussed in the chapter on engraved gems. In Hellenic times, rings were usually rather light and simple plain bands or twisted cords. Later they became heavier and were sometimes elaborately chased.

In form bracelets are like either small necklaces, though without pendants, or

large rings, though without bezels. Following the anal-

ogy of necklaces they were made of links, small plaques joined by links, beads of gold and colored stones, rope twists, braids, and bands; or they consisted, like rings, of gold hoops, spirals like coiled serpents, or hoops not joined at the ends. A fine pair of bracelets from Kertch (Fig. 266) has this last form, though here



FIG. 266. — Bracelet from Kertch. (*Antiquités du Bosphore Cimmérien*, Pl. 13.)

the hoop is actually completed by the knot held in the paws of the sphinxes that form the chief decoration. The historical development of form and decoration of bracelets seems to be exactly parallel to that of rings and necklaces.

The Greeks and the peoples with whom they traded adorned their garments with small pieces of thin gold or electrum cut into various shapes and decorated with various designs executed for the most part in repoussé. Small thin sheets of gold or electrum

Other personal ornaments have also been found, which seem to have been pressed upon a carved background of wood or some other hard material in such a way as to make the whole object seem to be of gold. Such ornaments may be compared with the elaborate buttons occasionally used by ladies in modern times. The Greek ornaments in question are diminutive reliefs, which are interesting chiefly as additional evidence of the close connection between the art of the goldsmith and the other arts. It is therefore unnecessary to discuss them here in detail.

CHAPTER VI

COINS

THE study of Greek coins is of especial importance and may almost be regarded as a distinct science. More than any other branch of archaeology it demands wide and accurate knowledge of ancient history and literature, and at the same time it serves to increase the literary and historical knowledge of those who devote themselves to it. Coins, showing as they do the changes in the political, commercial, and religious affiliations of various cities, often serve to correct or confirm the statements of the ancient historians, and shed many rays of light upon the dark places of Greek religion and mythology. Regarded as works of art, they have a great advantage over most of the extant works of Greek sculpture, because they are originals, not copies. Even now, after the many important discoveries of the past few decades, Greek sculpture is known to us in great measure through Roman copies; but Greek coins have been preserved in a continuous series from the eighth century B.C. until Greek art loses itself in the barbarism of the Middle Ages. Since they exist in great numbers, and many of them are almost as fresh as when they came from the mint, they form an exceptionally instructive series of works of minor Greek art. Moreover, the fact that the coins can almost always be assigned to definite dates and places adds greatly to their value. As works of art, they are to be classed as small reliefs, and a careful and intelligent study of them makes the student acquainted with the whole course of Greek sculpture in miniature. Furthermore, later coins reproduce some of the most important works of monumental art. For many reasons, then, the study of Greek coins is of the greatest importance to the archaeologist.

The history of the development of Greek coin standards is a difficult study, which belongs rather to the metrologist than to the student of ancient art, but even the student of art should know enough about the metals, the standards, and the methods employed in ancient mints to aid him in assigning dates and places to coins. A few pages must therefore be devoted to these and kindred matters before turning to the artistic development of the coins themselves.

The metals used by the Greeks for their coins are gold (*A*), silver (*R*), copper or bronze (*Æ*), and electrum (EL). The last is an alloy (in most cases, at least, natural) of gold and silver.

Metals used Of these metals gold was used in a very pure state, being sometimes almost absolutely unalloyed. The Persian darics contain only three per cent of alloy, and other gold coins of the ancients are equally pure. Silver also was used with much less alloy than is contained in modern coins. So the Athenian tetradrachms of the best period are about .985 fine, those of the period after Alexander about .950 fine, Aeginetan and Corinthian staters about .961 fine, and Alexander's silver pieces about .967 fine. Electrum, sometimes called *white gold* (χρυσὸς λευκός) was regarded as a distinct metal. The proportions of the gold and silver contained in it vary greatly. Sometimes it contains 95 per cent of gold and again not more than 5 per cent; but the most usual proportions vary between 52.25 per cent of gold to 47.75 per cent of silver and 27 per cent of gold to 73 per cent of silver. This metal was used especially in regions where gold alloyed with silver was a natural product, as in Lydia and Lesbos, at Cyzicus, and at Phocaea. Copper or bronze was the metal most widely employed. The ancients called copper and its various alloys (bronze, brass, etc.) made with tin, zinc, and other metals indifferently by the same name (χαλκός, *æs*). In Greek coins the copper is usually mixed with a little tin or zinc. In early times, iron bars are said to have been used as money, and iron money continued in use at Sparta after it was generally superseded by gold, silver, and copper. A few iron coins have been found belonging to Heraea and

Tegea, in Arcadia, and iron coinage is mentioned by ancient authors. It cannot, however, have been usual, nor can coins of tin, lead, leather, or other materials have been of any general importance. We have to consider only the coins of gold, electrum, silver, and copper, and since copper coins have for the most part suffered so much from oxidation that their types are obscured, our attention will be directed chiefly to the coins of the precious metals, among which the silver coins are by far the most numerous.

The process of manufacture was simple. A blank (*flan*) of metal of the desired weight was prepared by casting, and was placed upon a die, in which the type or design of the obverse (face **Process of** or "head") of the coin had been engraved. This die **coining** was set in, or placed upon, an anvil. A punch, roughened to prevent it from slipping, was then held upon the reverse (back, "tail") of the blank and struck with a hammer until the metal of the coin was forced into the engraved die. In some cases the edge of the blank was cut with shears or some other sharp instrument, because the weight obtained by casting was not exact. The coin was struck while the metal was red hot and therefore comparatively soft. In this way the number and violence of the necessary blows was reduced and the wear of the die correspondingly diminished. Since no ancient Greek dies are preserved, the material of which they were made is not known with absolute certainty. In early times it was doubtless some kind of bronze, but in the best days of Greek coinage it may well have been steel, which would then have been cut by the methods of the gem engraver, with a wheel and emery sand. In fact, some coins show clearly the round holes made by this process.

The earliest coins have no type (design) on the obverse further than mere striations, and the reverse shows a rough oblong depression between two square depressions. These are **Shapes and** the marks left by the end of the punch which received **designs** the blows of the hammer (Fig. 267). The shape of these coins is oval or lenticular, and they are much thicker than the coins of

later times. As time went on the circular form was adopted, and the coins were made thinner than at first, but Greek coins were always thicker than our modern coins, and the circular form was never exact, as it is in the products of modern mints, for the



FIG. 267. — Early Lydian coin. (*Coins of the Ancients*, Pl. I, 1.)

Greeks did not drop the blank into a circular frame or collar, but left it free to spread. The design of the obverse is from a very early period a real work of art, while the mark of the punch on the reverse remains a mere incuse square, or (as in the Lydian coin, Fig. 267) an incuse oblong between two squares, or an incuse square with various divisions. Soon, however, the punch becomes virtually an upper die for the reverse, small designs are inserted in the incuse square, then the incuse square is given up, and in the coins of the best period the reverse has a type little, if at all, less beautiful than that of the obverse.

Since the purpose of coinage is to facilitate commerce, it is important that the weights or standards of coins be fixed and be known by those who are to use them. The standards of Greek coins are probably all derived from Babylonia, but in passing from Babylonia to Greece the weights underwent various changes. As a result we find a variety of standards in use in Greece and the neighboring countries. For the coinage of silver, which was the most important, the chief standards employed in Greece proper were the Aeginetan, the stater of which weighed 12.60–11.90 grammes, and the Euboic (Attic, Corinthian), the stater of which weighed 8.75–8.15 grammes. In the Pangaeian district of Thrace a stater weighing about 10 grammes was in use; the Macedonian standard gives a weight of 14.50 grammes, and the staters of some of the Asiatic cities and their colonies were struck according to the Phoenician standard, and weigh 14.90 to 14.25 grammes or a little less. Rhodes and Chios had local standards. Other cities employed the Persian standard (stater

11.50 grammes). For the coinage of gold, a stater of 8.4 grammes was almost universally used. In Etruria, as well as in some cities of Magna Graecia and Sicily, native standards were employed, and in the time of the Roman Empire the Roman standard spread throughout the civilized world. The weights of many coins are now no longer exact, on account of wear, which has diminished them, or oxidation, which has increased them. There was, moreover, a general tendency to diminish the weight of coins as time went on. As a rule, however, it is not difficult to determine the standards of the various coins. This is a matter of more importance than appears at first sight, because the standard of coinage often throws light upon the history of the Greek cities and the course of ancient trade, since those cities which were closely connected by commerce would naturally adopt the same standard of coinage to facilitate exchange. So the earliest coins of Cumae, Rhegium, Naxos, Zancle, and Himera (all colonies of Chalcis) follow the Aeginetan, not the Euboean, standard, and Corcyra, a colony of Corinth, adopted the same standard, though in a reduced form. At a later period the Attic standard became more and more generally adopted as the power and commercial importance of Athens increased, and after its adoption by Alexander the Great it was the chief standard of the Greek world, though even then the Aeginetan standard continued in use in some places.

The divisional systems adopted by the Greeks and the names given to the coins of each denomination are very various. In Athens the unit of value was the drachma ($\frac{1}{2}$ the Attic-Euboean-Corinthian stater). The drachma was divided into 6 obols. Coins were struck of the following denominations: 10, 4, and 2 drachmas, 1 drachma, 5, 4, 3, 2, $1\frac{1}{2}$ obols, 1 obol, $\frac{3}{4}$, $\frac{1}{2}$, $\frac{3}{8}$, and $\frac{1}{4}$ obol, and a bronze coin, the hemitetartemion, or χαλκοῦς, which was worth only $\frac{1}{8}$ obol. At Corinth, and places which derived their coinage system from Corinth, the stater, which was equal to two drachmas in Attica, was divided into three drachmas, two of which would thus be practically equivalent to one Aeginetan drachma. In some of the Asiatic currencies also the

Divisions

stater was divided into thirds and sixths, as in the important electrum currencies of the fifth and fourth centuries B.C. at Cyzicus, Phocaea, and Lesbos. Besides the multiples of the drachma employed in the currency of Athens, any others could be used that convenience or love of display might suggest. So pieces of 3, 5, 6, 8, 10, and 12 drachmas are found at various times and places, but the larger denominations seem to have been seldom struck except on special occasions or by rulers or peoples who delighted in ostentation. So some of the Ptolemies struck gold octodrachms, some of the Thracian tribes struck silver octodrachms, and among the coins of Sicily the Syracusan silver decadrachms are justly famous. As a rule, the denomination of Greek coins is indicated solely by the weight. The addition of numerals or the name of the coin (*δραχμή* or the like) is rare, except in the West or in late times. In a few cases the denomination is indicated by the type. So in a series of coins issued at Syracuse under Gelo the type of the reverse shows the denomination as follows: the tetradrachm (four drachmas) has a quadriga, the didrachm a horseman leading a second horse, the drachma a horseman, and the obol a wheel.

The unit of Greek weights and currency was the stater or, to use the oriental term, the shekel. In speaking of large sums the words "mina" and "talent" were used, but the mina and talent were weights, not coins. The stater was everywhere one fiftieth of the mina and the mina one sixtieth of the talent. A difference in the standards of weights coincides with a difference in standards of currency. The gold stater, weighing 8.4 grammes, is about equal in weight to the five dollar gold piece (129 grains) and slightly heavier than the English sovereign (123 grains), but the ancient coin contains less alloy and is therefore more valuable, about equal to \$5.80 (24s.). The value of the silver coins depends upon the standard employed and upon the relation existing between gold and silver. The Aeginetan stater, for instance, was worth not far from half as much again as the Attic stater (or didrachm). The rate of exchange between gold and silver varied at different times and

**Units and
rate of ex-
change**

places and was generally not fixed by law. At Athens in the fifth and fourth centuries B.C. it fluctuates between $11\frac{1}{2} : 1$ and $14 : 1$. Perhaps $12\frac{1}{2} : 1$ or $12 : 1$ may be regarded as the usual rate throughout the Greek world in classical times, though the popular idea seems to have been that gold was worth about ten times as much as silver. As values were usually reckoned by the Greeks in silver, it is impossible to give their modern equivalents unless we know what standard (Aeginetan, Attic, or other) is referred to, and even then the varying ratio of value between silver and gold causes complications. Roughly speaking, an Attic didrachm (stater) was worth about $44\frac{2}{3}$ cents (1s. $10\frac{1}{2}d.$), and an Aeginetan stater about 66 cents (2s. $9d.$). Electrum was rated at ten times the value of silver.

The invention of coinage is ascribed with great probability to the Lydians, and the earliest coins (Fig. 267) were probably struck in the last part of the eighth or the early part of the seventh century B.C., perhaps in the reign of Gyges, 716–652 B.C. The great peoples of earlier times, Babylonians, Egyptians, and Phoenicians, had carried on their trade without the aid of coins, conducting their transactions by barter and by weighing the precious metals. No doubt bars or rings of metal of fixed weight were also employed, much as coins were used in later times. In fact, the difference between bars or rings of fixed weight and real coins consists merely in the design or type impressed upon the coins, by means of which the person or state issuing them guarantees their weight and quality. The earliest Lydian coins, with mere striations on the obverse and punch marks on the reverse, are, therefore, strictly speaking, hardly coins at all, since there is nothing about them to show clearly by whom they were issued. Probably their shape was at first a sufficient indication, and it was not long before distinct designs or types were added. The earliest coins were of electrum, but silver began to be coined in the early part of the seventh century B.C. in towns and islands of Asia Minor, in the Cyclades, and at Aegina. These coins bear no inscriptions, but their types indicate

Earliest
coinage

the places of issue. The earliest coins of Aegina are said to have been struck by Pheidon, king of Argos, who, according to Herodotus, introduced measures (probably including weights) among the Peloponnesians, and who is said by later writers to have invented coinage. The date of Pheidon is uncertain, but the earliest Aeginetan coins belong to the seventh century B.C. Gold coins do not appear until the sixth century B.C. and were not common before the reign of Croesus, king of Lydia, 561-546 B.C.

Copper coins, which are exceedingly numerous in later times, are not known until the end of the fifth century B.C.

The use of coinage spread rapidly from the Lydians to their Greek neighbors, and

coins were struck in nearly every independent Greek city. The types adopted were religious, for religion permeated the whole life of the Greeks, but in many places the deities were represented not directly, but by signs or attributes. So at Metapontum (Fig. 268) the ear of wheat represents not so much the fertility of the city's territory as the reverence for the city's goddess, Demeter;

at Rhodes the rose (Fig. 269) is a symbol of the sun god, not a mere pun on the name of the city (*ῥόδον*, "rose"). Such instances could be multiplied, and it is certain that in many, and probable that in all,

cases in which the types of Greek coins appear to have no religious significance it is only our ignorance of the local cults



FIG. 268. — Coin of Metapontum. Boston.
(Photograph.)



FIG. 269. — Coin of Rhodes. Boston.
(Photograph.)

which prevents our recognizing what was to the Greeks a clear reference to some deity. When deities are directly represented the type consists more frequently of the head than of the entire figure. Mythological scenes are rare.



FIG. 270. — Coin of Pheneus. Boston. (Photograph.)



FIG. 271. — Persian gold coin. Boston. (Photograph.)

One of the most interesting is on a coin struck about 300 B.C. at Pheneus in Arcadia. Here Hermes is represented carrying the infant Dionysus (Fig. 270) and hastening on his way, not resting, as Praxiteles had portrayed him (see p. 257).

Historical representations do not appear until a comparatively late period, nor is it until Hellenistic times that the likenesses of kings and rulers appear on Greek coins, though Persian coins show from the earliest times the effigy of the Great King (Fig. 271). The representations of deities on Greek coins, whether as heads or as full figures, are not until comparatively late times



FIG. 272. — Coin of Elis. (*Coins of the Ancients*, Pl. 14, 29.)



FIG. 273. — Argive stater. (*Coins of the Ancients*, Pl. 23, 36.)

intended as miniature copies of statues or other works. The head of Zeus on Elean staters of the fifth century is not a copy of the Zeus of Phidias, nor of any other statue, but an original work of the die cutter, who was, of course, a child of his



FIG. 274. — Coin of Alexander. Boston. (Photograph.)

time and much influenced by the sculpture of the period (Fig. 272). So, too, the Hera on Argive staters (Fig. 273) is not to be regarded as an exact copy after the famous statue by Polyclitus. The dolphins and wolf on the reverse of this coin symbolize Apollo as Delphinus and Lycius respectively. But the Zeus Aëtophorus (Eagle-bearer) on the reverse of coins of Alexander, which was imitated with some slight variations by his successors (Fig. 274), may be intended as a copy of an otherwise unknown statue, and there is no doubt that the obverse of the tetradrachms of Demetrius Poliorcetes



FIG. 275. — Tetradrachm of Demetrius Poliorcetes. (*Coins of the Ancients*, Pl. 31, 17.)



FIG. 276. — Coin of Elis. Zeus of Phidias. (Gardner, *Types of Greek Coins*, Pl. xv, 18.)

(Fig. 275) is a copy of the Nike of Samothrace (see Fig. 208). Statue and coin alike celebrate the naval victory over Ptolemy, gained off Cyprus in 306 B.C. The reverse of the coin bears the figure of Poseidon, the sea god, in whose domain the battle was fought. In later times, copies of statues are not uncommon. Among the best known are the head and full figure of the Zeus of Phidias on coins of Elis issued under Hadrian (Figs. 276, 277), the Artemis of Ephesus on

coins struck at Ephesus by Claudius and Agrippina, and the Cnidian Aphrodite on a coin of Caracalla and Plautina struck at Cnidus (Fig. 278). Such direct copying of statues on coins is, however, not to be sought for in the period of Greek independence. Under the Romans, temples and even larger objects, as, for instance, the Acropolis at Athens, were represented on coins.

In addition to the type, or chief design, Greek coins usually bear inscriptions and symbols or accessory designs. The inscription generally gives, either in the genitive case or in the form of an adjective, the name of the people or



FIG. 277.—Coin of Elis. Zeus of Phidias. (Gardner, *Types of Greek Coins*, Pl. xv, 19.)



FIG. 278.—Coin of Cnidus. (Gardner, *Types of Greek Coins*, Pl. xv, 21.)



FIG. 279.—Athenian coin. Boston. (Photograph.)

king by whom the coin is issued (see Figs. 273, 274, above). Often the name is abbreviated, as on Athenian coins, where ΑΘΕ stands for Ἀθηναίων (Fig. 279). Accessory inscriptions occur on many coins, denoting, as on late coins of Athens, the officials responsible for the issue (Fig. 280) or,



FIG. 280.—Late Athenian coin. Boston. (Photograph.)

in some instances, *e.g.*, the splendid Syracusan decadrachm of Evaenetus (where the name is in small characters below the head), the artist (Fig. 281). The inscriptions were often so arranged as to form part of the decoration, occupying the space left vacant by the design. The symbols or accessory designs have sometimes apparently the same meaning borne on other coins by the accessory inscriptions, and indicate by a sign the responsible official; in other cases they are more important. Sometimes several Greek cities entered into a monetary union or alliance and issued coins which were either identical or only slightly distin-



FIG. 281.—Syracusan decadrachm. Boston. (Photograph.)

guished. In the alliance between the cities of southern Italy in the sixth and the early part of the fifth centuries B.C. the coins were distinguished by their types, though alike in weight and fabric; in the monetary union between Phocaea and Mytilene, about 400 B.C., the Phocaean coins were distinguished by the addition to the type of a seal ($\phi\acute{\omega}\kappa\eta$), the symbol of Phocaea, while those of Mytilene bear the inscription M or ΛΕ (Lesbos); in the fourth century B.C. Side in Pamphylia and Holmi in Cilicia issued staters with the types of Artemis and Apollo, but distinguished them by symbols, Side using a pomegranate, Holmi a dolphin. Some earlier coins, bearing a pomegranate and a dolphin combined, were probably issued by the two cities in conjunction. After the reorganization of the Achaean league, in

280 B.C., the cities of which it was composed gave up their previous coinages and issued coins of uniform type, distinguished only by inscriptions or symbols. So the coin represented in Figure 282 is recognized by the symbol of the wolf's head on the reverse as a coin of Argos, which joined the league in 228 B.C. The symbols are sometimes as important as the types themselves.



FIG. 282.—Argive coin. Achaean League. (*Coins of the Ancients*, Pl. 43, 25.)

The artistic development of Greek coins may be divided chronologically into the following periods: I. The period of Archaic Art, from the beginning of coinage to the retreat of the Persians from Greece, 700–479 B.C.; II. The Period of Transitional Art, from the retreat of the Persians to the end of the Peloponnesian War, 479–404 B.C.; III. The Period of Finest Art, from the end of the Peloponnesian War to the death of Philip, 404–336 B.C.; IV. The Period of Later Fine Art, from the death of Philip to the reorganization of the Achaean League, 336–280 B.C.; V. The Period of Decline in Art, from the reorganization of the Achaean League to the destruction of Corinth, 280–146 B.C. To these five periods two more may be added: VI. The Period of Continued Decline, from the destruction of Corinth to the rise of the Roman Empire, 146–27 B.C., and VII. The Imperial Period, from Augustus to Gallienus, 27 B.C.–268 A.D., after which the separate coinage of Greek cities practically ceased. The designations of some of these periods are not, and cannot be, exact, nor are the periods in reality sharply divided; the qualities of the art of each begin to show themselves in the one before and are still to be found in the one after. Nevertheless, the division into periods has the advantage of preparing the student in advance for the general qualities he may expect to find at any given date. One must, however, not forget that the progress of art is continuous, and is not always greatly affected by even the most striking political events. Moreover, in some places art advanced more rapidly than in others, and development in the

types of coins was sometimes (notably at Athens) hindered or prevented by the importance of preserving types which had acquired widespread reputation and circulation.

The earliest coins (see Fig. 267 above) were speedily followed by coins with clear types, though the lentoid or bean-like form

was for a short time retained. The types were for the most part not figures or even heads of deities, but symbolic representations, often animals or heads of animals, frequently more or less grotesque. Such a coin is the Phoenician stater of Miletus (Fig. 283), the obverse of which bears



FIG. 283. — Coin of Miletus. Boston. (Photograph.)

623 B.C. The earliest inscribed coin (Fig. 284), also an electrum stater, was found at Halicarnassus. It bears on the obverse a stag

feeding and the inscription in retrograde letters $\Phi\text{ANO}\xi\text{EMI TO}\xi\text{HMA}$, on the reverse an incuse oblong between two incuse squares. The inscription has usually been translated



FIG. 284. — Earliest inscribed coin. (*Coins of the Ancients*, Pl. I, 7.)

“I am the sign of Phanes,” and the Phanes mentioned has been regarded as a Halicarnassian, perhaps an ancestor of the Halicarnassian Phanes who deserted the service of the Egyptian king Amasis for that of the Persian Cambyses, whom he aided in his invasion of Egypt in 525 B.C. It has, however, been pointed out that the genitive $\Phi\text{ANO}\xi$ (for $\Phi\text{ανοῦς}$) does not belong to the masculine nominative $\Phi\text{άνης}$, but rather to the feminine $\Phi\text{ανῶ}$, an epithet of Artemis. The stag is one of the regular attributes of Artemis. It is therefore probable that the coin is to be as-

cribed to Ephesus rather than to Halicarnassus. Throughout this period the reverse is almost always marked with an incuse square, which is often divided by lines and sometimes, especially toward the end of the period, contains a symbol or type. In some places the incuse square is retained in the second period, and it occurs even later. At different times within the first period several cities adopted the types to which they clung as long as they continued to coin money. So Thebes adopted the Boeotian shield, Aegina the tortoise (Fig. 285, a silver stater, of the second series of Aegina, issued between 550 and 480 B.C.), and Corinth a prancing Pegasus.



FIG. 285.—Early Aeginetan coin.
Boston. (Photograph.)

Heads of deities or human beings do not appear until the middle of the sixth century. The earliest coins of Corinth were issued probably in the reign of Periander, 625–585 B.C.



FIG. 286.—Corinthian coin. (*Coins of the Ancients*, Pl. 6, 31.)

The stater represented in Figure 286 is one of a series of flat coins struck at a slightly later period, but probably still before 550 B.C. The sign under the Pegasus is the letter koppa

(the Latin Q), the initial letter of the name Corinth in the old alphabet. This letter was retained on the coins after the Ionic alphabet was introduced in all other writing. The incuse square is here so varied as to assume the form of a tetraskelion or swastika. Later coins of Corinth substitute for it a beautiful head of Athena or the armed Aphrodite. About the middle of the sixth century Athens began to issue silver coins with the head of Athena on the obverse and an owl on the reverse (Fig. 287).¹ These are

¹ Earlier coins ascribed with much probability to Athens have various types (owl, wheel, horse, amphora, triskelion, knucklebone) on the obverse, and on the reverse an incuse square divided into four triangles by diagonals.

the earliest known coins with a type on each side. In later times these types were only slightly varied.

Throughout the archaic period the types of coins show qualities similar to those of the sculpture of the same epoch. The earliest



FIG. 287. — Athenian coin. Boston. (Photograph.)

work is rude, but as art advances the work grows finer and shows greater care and elegance. There are manifest faults in drawing, as in the contemporary relief work. So the eye is always given in full face, even when the head is in profile (*e.g.* in Fig. 287), the postures of human beings are more or less angular and unnatural, and the muscles are exaggerated. This last quality is especially noticeable in coins of Thrace and neighboring regions, such as the silver coin from Lete (Fig. 288, *rev.* incuse square), but is present in greater or less degree in all coin types of the period which represent complete figures.

The coins are almost invariably thick and irregular in shape. A marked exception is seen in the coins of several cities of southern Italian fabric Italy (see Fig. 268). The style of manufacture, or, to use the technical expression, the fabric of these coins differs widely from that of the pieces struck in other regions. They are not thick, but flat, and instead of bearing on their two sides a type in relief and an incuse square or two different types in relief, they bear on the reverse an incuse reproduction of the type of the obverse. In some instances, as in the coins of Croton with a tripod in relief on the obverse and a flying eagle, incuse, on the reverse, and the federal money of Croton and Sybaris, bearing on the obverse the tripod of Croton in relief and on the reverse the bull of Sybaris, incuse, different types are employed

work is rude, but as art advances the work grows finer and shows greater care and elegance. There are manifest faults in drawing, as in the contemporary relief work. So the eye is always given in full face, even when the head



FIG. 288. — Coin of Lete. Boston. (Photograph.)

without essential change in fabric. This remarkable method has the practical advantage of allowing the coins of the same issue to be piled one upon another, like the flat coins of modern times. The practical convenience, however, cannot have been great, as this fabric was soon given up, and these cities (with the exception of Sybaris, which was destroyed in 510 B.C.) began about 500 B.C. to issue thick coins, of smaller dimensions, with a type in relief on each side.

Since the art of coinage spread from the east to the west, the Greeks of Sicily and Italy naturally began to issue coins somewhat later than their more eastern kinsfolk. Some of the coins of the Chalcidian colonies in Sicily (Naxos, Zancle, and Himera) may belong to the last part of the seventh century B.C., but the coinage of nearly all the cities of southern Italy and Sicily begins little, if at all, before 550 B.C. This accounts in part for the fact that their first coins are finer than the earliest issues of the more eastern Greeks, but does not explain the remarkable development of Sicilian coinage in the fifth and fourth centuries. Whatever the reason may have been, the Italian, and especially the Sicilian, Greeks seem from the first to have paid unusual attention to the beauty of their coins.

Every period in the history of art is necessarily a period of transition from what precedes to what follows it, for art is never stationary, but always progresses to something better or degenerates to something worse. Nevertheless, Period of
transitional
art the transitional nature of the coin engraver's art between the defeat of the Persians and the end of the Peloponnesian War is especially manifest. In the earlier coins of this period the style is still archaic, the eye is represented as if seen from the front when the head is in profile, the forms, attitudes, and muscles of human figures are stiff and exaggerated; in short, the qualities which distinguish the period before the Persian Wars are still present, but are becoming slightly less prominent. The incuse square on the reverse is still common, especially in the East, and in general the coinage of the East is more conservative than that

of the West. By the end of the period nearly all coins show complete mastery of technique, natural treatment of the eyes, muscles, and other details, graceful postures when entire figures are represented, and designs perfectly adapted to the round space they have to fill. Even in the first period the design was usually well adapted to the space, but in this respect, as in all others, the fifth century shows a marked advance.

One might expect that at Athens, where, under the régime of Pericles, art of all kinds was encouraged as never before, where the Parthenon was rising in its matchless beauty to enshrine the glorious gold and ivory Athena of Phidias, where Myron was perfecting the representation of animals and of the human form in motion, while Alcamenes was rivalling his great master, where Polygnotus and Apollodorus were producing pictures which may perhaps have equalled the sculptured frieze of the Parthenon, and where even the humble painters of vases were artists and con-

Athenian summate draughtsmen,—one might expect that at
coinage Athens new and perfectly beautiful coin types would be created. But this is not the case. As the power of Athens grew, her commerce also increased, and the excellence of her coinage was everywhere recognized. Athenian "owls" so-called from the type of the reverse, were the staple currency of the Aegean, and a change of type might cause serious inconvenience and possibly loss of trade. The Athenians therefore preserved the type they had adopted a century earlier, even retaining the archaic representation of the eye in full face (see Figs. 279 and 287). Nevertheless, the new coins, while preserving the essential features of the earlier issues, show a decided advance in clearness and sharpness of outline, and much beauty of detail. The eye of the Athena is no longer round and protruding, but rather elongated, the hair is arranged in two simple waves over the forehead and temples, not in a series of artificial locks, and the ornamentation of the helmet is more carefully designed and executed. On the reverse the body of the owl is now rendered with remarkable liveliness, though the head is singularly conven-

tional. A new symbol, a small crescent beside the head of the owl, now appears. In spite of the strong commercial reasons for the preservation of the old type, the new coins have a beauty that does not belong to the earlier issues.

In other places, where commercial reasons operated less strongly than at Athens to preserve the archaic types, the coins follow more closely the development of contemporary sculpture.

A tetradrachm of Aenus, in Thrace, has on the obverse a head of Hermes which reminds one somewhat of the fine marble head in Athens attributed to a date about 480 B.C. (Fig. 154). The coin was struck not



FIG. 289.—Coin of Aenus. Boston. (Photograph.)

earlier than 450 B.C., and shows that the Thracian die cutter was not quite as advanced as the great sculptors of his day, but had already progressed far toward complete truth and freedom (Fig. 289). The goat on the reverse is a real masterpiece.

To the very beginning of this period belongs a series of decadrachms (or, to use the Sicilian word, pentecontalitra) struck at



FIG. 290.—Syracusan decadrachm. (*Coins of the Ancients*, Pl. 17, 33.)

Syracuse. Diodorus (XI, 26) narrates that after the battle of Himera, in 480 B.C., in which the Carthaginians were defeated by Gelo, a peace was arranged by the intervention of Gelo's wife, Demarete, on

terms so favorable to the Carthaginians that they showed their gratitude by presenting her with a thousand talents of gold. From the proceeds were struck the decadrachms called "Demareteia" one of which is represented in Figure 290.

Demareteia

On the obverse is a head of Arethusa (or perhaps Nike), crowned with olive, and around it four dolphins. If, as has been suggested, the dolphins symbolize the salt water by which the famous spring of Arethusa at Syracuse was surrounded, the head on the obverse represents the nymph of the spring. In that case the olive wreath seems somewhat out of place, unless Arethusa herself be regarded as a symbol for the city of Syracuse. If, on the other hand, the head represents Nike, the wreath of victory is eminently appropriate, but the dolphins can hardly be explained unless they are regarded as symbols of the salt water surrounding the city. The type of the reverse represents a slowly moving quadriga, the horses crowned by a flying Nike. In the exergue (the space below the type) is a lion. The coin is still archaic in many respects, especially in the treatment of the eye and in the figure of the



FIG. 291.—Coin of Naxos. Boston.
(Photograph.)

charioteer, but shows the highest attainment in the coin engraver's art about 479 B.C.

A remarkable coin of about the middle of this period, or perhaps somewhat later, is a tetradrachm of Naxos in

Sicily, with a bearded head of Dionysus on the obverse and a bearded Silenus holding a wine cup on the reverse (Fig. 291). The execution is hard, and the Dionysus has a leering expression, which is probably intended as a benign smile. The eye is, however, given in profile, and the details of hair and beard are accurately rendered. The Silenus shows what a difficult task the die cutter could accomplish. The foreshortening of the right leg is remarkably well done, and the whole figure is admirably arranged to fill the round space. The beard reminds one of that given to centaurs in the western pediment of the temple of Zeus at Olympia and to similar wild creatures on Attic vase paintings. The muscles are lumpy and exaggerated, but

Coins of
Naxos

show careful study of nature. The whole coin impresses us with its vigor, firmness of style, and sincerity. It is instructive to compare with this a second coin of Naxos struck in the latter half of the fifth century. Here the same types are rendered in a softer, more graceful, and more finished style (Fig. 292).



FIG. 292. — Coin of Naxos. Boston.
(Photograph.)

The staters of Elis form one of the finest series of Greek coins, extending from about 480 to 322 B.C. The types are nearly all connected with Zeus. Most usual are the eagle, the thunderbolt, and Nike. On some issues Zeus himself appears, on others Hera, on still others Olympia. A stater struck in the latter part of the fifth century (Fig. 272), still shows something of the dignified severity of the art of Phidias.

Coins of Elis

Indeed, it has been suggested that the style of the Zeus of Phidias may be understood with the aid of this coin better than with that of the later bronze (Fig. 276), though the latter is without much doubt intended to reproduce the features of the great statue. On the reverse the letters FA at the sides of the thunderbolt stand for FAΛEION (Attic Ἡλείων), for Elis continued to use the digamma on her coins even in Roman times.



FIG. 293. — Coin of Elis. Boston.
(Photograph.)

By the end of the fifth century B.C. Greek coinage shows complete mastery of technique, freedom of style, and delicacy of execution; in other words, the period of the finest art in coin engraving is reached. A comparison of an Elean stater of the middle or latter part of this period (Fig. 293) with the coin just

described (Fig. 272) shows marked difference of style. The later coin is far clearer and sharper, which may be, however, in part due

Period of finest art to its better preservation, and it shows far greater freedom and ease in the treatment of details, especially of the hair. On the reverse the eagle is admirable. Another interesting coin of this period is the Argive stater (Fig. 273). Pausanias describes the famous and beautiful gold and ivory statue of Hera by Polyclitus as seated on a throne and wearing a crown (*stephane*) adorned with figures of the Horae and Charites. Such an elaborate adornment would be ill adapted for representation on a coin, and a coin engraver might well adopt a simpler kind of ornament, while still intending to copy the features of the statue. The similarity of this ornament to some of the decorative carving of the temple in which the statue was placed adds to the probability that the coin engraver had the great temple statue in mind; but there is no reason to suppose that in other details, such as the arrangement of the locks of hair, or even in the exact proportions of the face, the coin imitates the statue more closely than in the crown. In fact, there are several issues of Argive coins adorned with the head of Hera, and no two issues offer exactly the same type. It is therefore hardly possible to assume for these beautiful coin types more than a general resemblance to the

head of the great statue. Coins of Elis belonging apparently to this period have a similar type, which may also be inspired by the statue in the Argive Heraeum without being in any proper sense copies of it.



FIG. 294. — Coin of Aenus. Boston.
(Photograph.)

A fine coin of Aenus (Fig. 294) exhibits a peculiarity which shows itself in several places during this period — the representation of a head in full face. Some coins with such heads are exceedingly beautiful, among them especially some

Head in full face

issues of Amphipolis and of Syracuse. But although such types give the engraver an opportunity to exhibit great skill and artistic ability, they are not well adapted for use, as the projecting parts of the face are too much exposed to wear. The fashion of representing heads in full face was therefore not generally adopted and was soon given up, though it appears again later in some Rhodian coins (Fig. 269). This coin from Aenus, like the coin from the same place reproduced above (Fig. 289), has a head of Hermes on the obverse and a goat on the reverse, but in freedom of style and beauty of technique the later coin is far superior to the earlier.

The superb Syracusan decadrachm of Evaenetus (Fig. 281) is one of the masterpieces of Greek coinage. The cities of Sicily seem to have vied with each other in issuing the most beautiful coins possible, and the fact that the engravers signed their names to the coins shows that their standing as artists was duly recognized. Besides Evaenetus, several other artists, among whom Cimon is justly most famous, signed their names on Syracusan coins. Never has the art of coin engraving attained such a height as that marked by these Syracusan coins of the fourth century B.C. On the decadrachm of Evaenetus the type of the obverse represents either Arethusa or (more probably) Persephone, that of the reverse a victorious quadriga. In the exergue are a helmet, thorax, greaves, and shield, no doubt the prizes in the games to which the chariot refers. It is not improbable that these splendid coins were issued annually in connection with the *Assinaria*, games held in commemoration of the defeat of the Athenians by the Syracusans at the river Assinarus, in 413 B.C.

The coinage of Philip II of Macedon (359–336 B.C.) is of unusual interest because it presents the first known example of an attempt to establish a fixed ratio of value between gold and silver and also because its types were long imitated in the coinage of Gaul and Britain after the Gauls invaded Greece in the third century B.C. Until Philip's time the Persian daric was the standard gold coin of the whole Aegean region. When Philip gained possession of the gold mines of Philippi, he proceeded

to issue from mints in various parts of his dominions his own gold staters on the daric standard, but slightly heavier than the Persian daric. For his silver he adopted the Phoenician standard, which made fifteen silver staters, or thirty drachmas, equal in value to one gold stater at the ratio of $12\frac{1}{2} : 1$ for the value of gold and silver. This was the market value at the time, and the round numbers (15 and 30 : 1) resulting from the standard adopted had a natural tendency to keep the standard fixed. Nevertheless, the great increase in the production of gold caused the value of that metal to fall, so that Alexander on his accession was forced to abandon the plan of bimetallism. He coined his gold and silver on the same standard, using silver as the basis of his currency and making no attempt to fix the relative value of the two metals. The obverse of Philip's gold coins bears the head of the youthful Heracles in the lion's skin, or the head of Apollo (sometimes of Ares?).



FIG. 295. — Gold stater of Philip.
Boston. (Photograph.)

Apollo and the youthful Heracles are also the types of his bronzes and occur most frequently on his silver coins, some of which bear the head of Zeus or of Artemis. The reverse types are all agonistic, referring to Philip's victories in the Olympic games

(see Fig. 295, a gold stater of Philip).

In the time of Alexander the Great and his immediate successors, the *Diadochi*, the technical execution of coins remains

Period of
later fine
art

almost, if not quite, at the height attained in the previous period, but the character of the types changes.

The most usual type for the obverse is the portrait of Alexander in the character of Heracles, wearing the lion's head as a helmet. The reverse usually associated with this type represents a seated Zeus holding an eagle in his right hand and a sceptre in his left (Fig. 274). These types were used on coins struck by Alexander in various parts of his great empire, and his successors continued to employ them. It is therefore sometimes

impossible to determine the date or place at which a given coin was struck, though in most cases inscriptions, symbols, and peculiarities of fabric are of assistance to the student. In Figure 274 the cluster of grapes under the hand of Zeus and the monogram under the throne serve to distinguish from other coins of the same types this issue, which may be attributed to Maronea and to the time before Alexander's death (323 B.C.). The portrait of Alexander is not a simple human portrait, but represents him with the attributes of Heracles, and forms in this way a transition from the divine or semi-divine types of earlier coinage to the human portraits of later times. The first king to put his own head on coins, without divine or heroic attributes, was Ptolemy Soter.

Among the many beautiful coins of this period the tetradrachm of Demetrius Poliorcetes mentioned above (Fig. 275) is of exceptional interest because it reproduces the magnificent **Influence of sculptures** statue of Nike from Samothrace. The type of the reverse represents Poseidon in an attitude inherited from earlier times, but in finished and elegant execution. It may be too much

to say that the figure is a product of the school of Lysippus, but it is evident enough that the die cutter, though reproducing a traditional, and even archaic, attitude, is himself trained in the style



FIG. 296. — Syracusan tetradrachm. Boston.
(Photograph.)

of his own times. The Rhodian coin, Figure 269, of about 304 B.C., shows in its brilliant head of Helios, with rays as of light streaming from it, an expression which would have been impossible before Scopas. Other coins show clearly the influence of Praxiteles and his school. Such a coin is a Syracusan tetradrachm struck probably between 310 and 305 B.C. On the obverse is a head of Persephone with the inscription ΚΟΡΑΣ, while the reverse has a winged Nike erecting a trophy (Fig. 296).

In general, the types of this period show more softness of modelling than those of the time before Alexander, more expression in faces, and, in the latter part of the period, greater slenderness of the human form.

In the fifth period (280-146 B.C.) the coin types show in general less originality of design and less care in execution than before. Portraits of kings become the usual type of the obverse, though not to the exclusion of other types; figures of deities, sometimes copies of statues, appear frequently, usually on the reverse, and inscriptions become more prominent, these also for the most part on the reverse (Fig. 280). Among the types of this period the portraits are the best and most



FIG. 297.—Gold coin of Ptolemy II. Boston.
(Photograph.)

interesting, some of them being admirably expressive. The sculpture of this period is best known to us in the striking mythological and historical works of the Pergamene school; the coins show that the art of portraiture was also carried to a high pitch of excellence, and they present a series of portraits of the kings of Egypt, Bactria, Syria, Pontus, Bithynia, Pergamon, Macedon, and Sicily, which possesses great historical, as well as artistic, interest. The reverse types of these coins are generally figures of deities, often in imitation of statues. A striking specimen of portraits on a coin of this period is presented by a gold coin of Ptolemy II (285-247 B.C.). On the obverse are portraits of Ptolemy II and his wife Arsinoë II, with the inscription ΘΕΩΝ ΑΔΕΛΦΩΝ, on the reverse portraits of Ptolemy I and Berenice I (Fig. 297). Here the features of the reigning monarchs and their predecessors are evidently rendered with the utmost realism and truth.

A good example of the work of this period other than portraits

is a silver coin of the Achaean League (Fig. 282). The head of Zeus is well drawn, but not so carefully executed as in earlier times, and the reverse, instead of bearing a real type, is occupied by symbols enclosed in a wreath. The use of wreaths in the decoration of coins is not uncommon in this period. On some Macedonian coins the head of the obverse is placed on a round shield, the ornamental border of which forms, as it were, a decorative frame about the head. In general, the coins of this period are, with the exception of the portraits, far less interesting as works of art than those of the previous periods, and as time advances even the portraits deteriorate. The fabric of the coins is also different from that in use before. The earlier thickness gives place to breadth and flatness, and the space thus gained on the coin is utilized for the longer and more elaborate inscription now coming into vogue. In all these respects the last period of Greek independence shows a great decline in the art of coinage, a decline which was still more marked under the rule of Rome.

In the period from 146 to 27 B.C. the Roman power spread over the Greek world, and in most Greek cities the coinage of gold and silver came to an end, though Athens continued to issue silver coins until 86 B.C., and the privilege of coining was granted to other cities also at various times. Copper coins continued to be struck in various cities under the Republic and also under the Empire. At Athens, no coins were struck after 86 B.C. until the time of Hadrian, when the coinage of copper was recommenced. The work of coins issued under the Republic is rude.

Period of
continued
decline

With the foundation of the Roman Empire under Augustus, the coins in some places improve for a time, and again under Hadrian there is a temporary improvement, but after that the style grows constantly ruder, the coins themselves become, as a rule, flatter, and the field is in many places more and more completely filled with the characters of the inscription. Except in Crete and some places in Asia, the coinage of Greek cities under the Empire was virtually restricted to copper.

The coins issued in Greek cities under Roman sway are often historically interesting, and the student of art values some of them (*e.g.* Figs. 276, 277, 278) because they reproduce famous statues or other monuments, but in themselves, regarded as works of art, they are, with comparatively few exceptions, devoid of interest.

CHAPTER VII

ENGRAVED GEMS

THE engraved gems of the Mycenaean Age (see pp. 82-85), chiefly hard stones of round or lentoid shape, exhibit the general qualities of Mycenaean art — liveliness, freedom of motion, and vigor of design. The subjects represented are animals (chiefly wild), deities and religious scenes, and fantastic or demoniac forms, such as griffins and sphinxes. These gems are very numerous, and often of fine execution.

In the "Greek Middle Ages" all this is changed. The gems are neither numerous nor of good workmanship, their material is serpentine, steatite, or some other relatively soft stone, their shape is generally round or oval, or rectangular with rounded corners. The scarab, of glass paste, "Egyptian faïence," or stone, is introduced, as is also the scaraboid.¹ Some other shapes also occur. In general, the shapes are imitations of those in use in Syria and Egypt, and the imitation extends to the technique, as when scarabs are made of "Egyptian faïence" or of glass. The decoration is, however, geometric in style and European, not oriental, in choice of subjects (Fig. 298). Linear ornaments, horses and wagons, and rude human figures are found, but fantastic and demoniac figures are, with the exception of the centaur, absent. Whereas the Mycenaean gems were engraved with the aid of the

The Greek
Middle Ages.
Geometrical
style



FIG. 298. — Steatite scaraboid, Cyprus. (Furtwängler, *Antike Gemmen*, Pl. IV, 53.)

¹ The scarab is a stone cut in imitation of a beetle. The scaraboid has somewhat the shape of the scarab, but without any imitation of, for instance, the beetle's wings. It is, then, merely an oblong stone, flat on one side and convex on the other. Its shape is probably not derived from that of the scarab.

wheel,¹ the gems of the geometrical period are engraved by hand, with the hand drill and the point. They are most numerous in the southern and southeastern regions, where the influence of Syria and Egypt is strongest. All this shows that both in Syria and in Greece great changes accompanied the breaking up of the Mycenaean civilization, changes caused by inroads from Europe and the north. At the same time the influence of Syria upon Greece is evident, especially in the forms of the stones.

In the seventh century B.C., the oriental influence grows stronger. At this time the Ionians, whose intercourse with Assyria and Egypt was constant, had the greatest influence on Greek art, and in Greece proper Corinth and Chalcis received orientaling tendencies through trade with Ionia and the East. In time the geometrical style disappeared entirely, leaving as its legacy to Greek art the ability

**Seventh cen-
tury.**
**Oriental
influence**

¹ The use of the word "wheel" may not be exact, but certainly the engraving was done by means of rapid rotation. The instrument used was probably of some relatively soft metal, and the actual cutting was done with moist emery sand or some other similar hard, gritty matter, though diamond dust, which is used in modern times, may not have been employed by the ancients. The exact method by which the rotation was produced is not known with certainty, but it is not unlikely that the stone to be engraved was firmly embedded in plaster, and the tool, with its cutting sand, was made to rotate by means of a bow, the string of which was passed round the shaft of the tool. The gem cutter could move the bow to and fro with one hand, thus causing the tool to rotate rapidly, while with the other hand he could hold and direct the cutting end of the tool. In modern times, the rotating instrument is fixed in a lathe, and the artist holds the stone in his hand. The rotation of the instrument is produced by a treadle or by some power such as electricity. It is possible that the treadle was used in ancient times, in which case the rotating instrument must have been fixed and the stone movable, as is the case in our own day, but the other method suggested is more probable, as the ancients do not seem to have been familiar with the use of the belt for the transmission of power or motion from one wheel to another. The rotating tools employed by the ancients in the best periods of art were of various shapes and often of extreme fineness, capable of cutting even the most delicate lines. Some details were occasionally added by hand with a diamond point.

to disregard what is merely casual, the feeling for the essential, and clearness and conciseness in representation. The few and slight remains of Mycenaean traditions in art which had survived, especially in the islands and in Asia Minor, acquire fresh importance in the orientalizing style. But whereas in Mycenaean art oriental and Egyptian elements were assimilated and absorbed, they are now directly imitated, notably in the case of the palmette and the lotus. These changes and tendencies, which are general in Greek art at this time, are even more clearly traceable in bronzes and vases than in gems.

At Melos, some scarabs of "Egyptian faïence" and some stones of Mycenaean shapes have been found, which are ascribed to the seventh century. They are for the most part soft stones, engraved by hand, though some are hard stones, engraved with the wheel. They are frequently engraved on both sides. The designs are often animals in decorative, rather than natural, attitudes and more conventional in style than those on Mycenaean gems. As is the case on the orientalizing vases, horses, ibexes, and other animals are represented with upturned, curved, and pointed wings (Fig. 299). The Chimaera, the Gorgon, and the fish deity (a human form with the tail of a fish instead of legs) occur. The centaur and the fish deity are seen in conflict with Heracles. On one stone Prometheus is represented. Scenes of no mythological import also occur; for instance, a chariot with four horses and a driver. Plants and indeed any forms not of animal nature, are rare on these Melian gems. Stones with designs similar to those on the Melian gems, but of various shapes, including the cylinder, are found in a number of places, even as far east as Babylonia and India. Egyptian scarabs are found in various parts of the Hellenic world; scaraboids also occur, and metal rings with engraved bezels were again in use in the seventh century, as they had been in Mycenaean times. In general, how-



FIG. 299. — Steatite gem. Melos. (Furtw. *Ant. Gem.* Pl. V. 17.)

ever, the engraved gems of the seventh century are neither very numerous nor very important.

In the geometrical period and the seventh century the use of the wheel had been lost, but increased intercourse with Assyria led to the reintroduction of this technique, and at the same time the sources of good, hard stones became known again. The technique was without doubt derived from Assyria, for it had died out at this time in Egypt, but the form now used by the Greeks is the scarab, which is derived from Egypt. The scaraboid is also used, and a few other forms occur. Since the beetle had no significance for the Greeks, the rounded back of the scarab was sometimes not finished with wings. The engraved gems of the geometric period, and probably most of those of the seventh century, were intended to be worn simply as amulets, but by the sixth century the custom of sealing had become common in Greece, and the engraved gem was no longer a mere amulet. The scarab is now a seal. Occasionally an inscription gives the name of the owner or, more seldom, of the artist. The names of only two artists are preserved in this way, Syries, probably from Euboea, and Epimenes, of Paros. The choice of the subject for representation on archaic gems is absolutely free. Often it has religious significance, perhaps in many cases where we are unable to detect it. The types are generally Ionic, and probably the work is also Ionic for the most part. Mnesarchus, of Samos, the father of Pythagoras, was a gem cutter, and the famous ring of Polycrates was made by Theodorus of Samos. These early Ionic gems are probably more or less influenced by Phoenician art.

Metal rings with engraved bezels have been found in considerable numbers in Italy, especially in Etruria. They are Ionic in style and exhibit strong Phoenician (that is, oriental and Egyptian) traits. The bezel is oblong, like the Egyptian cartouche, and its greatest length is across the finger, not, as in Mycenaean rings, lengthwise of the finger. Scenes with chariots, (Fig. 300) which are well adapted to fill an oblong field, are common on these rings, as in Ionic vase-paintings found in Italy, and

winged figures, spirits, pegasi, sirens, and sphinxes are among the favorite subjects. Sometimes the figures are not engraved, but are pressed in the metal, which is then very thin. These rings are probably the work of Ionian immigrants, though some of them may be imitations made by Etruscans. They are virtually confined to Etruria, and few engraved metal rings of the archaic period are found in any other region. Comparatively few engraved stones of this period are found in Etruria, and these are not different from those found elsewhere.



FIG. 300. — Etruscan bezel. (Furtw. *Ant. Gem.* Pl. VII, 4.)

Most of the early archaic Greek gems are small scarabs or scaraboids, though some of the scaraboids attain a greater size. The back of the scarab is occasionally adorned with a relief, and its flat side is entirely occupied by the design, which is surrounded by a border. The favorite stones are the colored

quartzes, though amethyst is seldom, if ever, employed. Occasionally glass paste is used instead of stone. These hard materials are engraved with the wheel, and the soft stones engraved by hand gradually disappear. The designs consist of human figures (Fig. 301) and animals. Some of the early archaic gems, many of which are from Sardinia and Cyprus, show strong Phoenician traits, and are prob-



FIG. 301. — Archaic scaraboid. (Furtw. *Ant. Gem.* Pl. VI, 38.)

ably the work of Hellenized Phoenicians or of Greeks who catered to the taste of Phoenician customers (Fig. 302). The other Greek gems of this period are for the most part products of Ionic art, though not all are necessarily made in Asia Minor, and some are probably of Peloponnesian origin. The attitudes of the human figures are few and stiff, and among them the kneeling posture, intended to represent rapid running, is especially common. The muscles are, as a rule, imperfectly rendered.



FIG. 302. — Archaic gem. (Furtw. *Ant. Gem.* Pl. VII, 38.)

About the end of the sixth century a great improvement takes place, in which Ionian, Attic, Aeginetan, and probably also other artists have a share; and the improvement in execution is accompanied by the introduction of many new *motives*. Representations of the great gods are rare, but the nude Apollo, Artemis, with and without wings, as goddess of animals, Hermes (Fig. 303) as messenger of the gods and (in long garments)



FIG. 303. — Hermes.
(Furtw. *Ant. Gem.*
Pl. VIII, 37.)

probably as a god of the nether world, and Athena are found. The figure of religious significance most frequently represented on archaic gems is Heracles. He appears often in kneeling posture, with bow and club, also striding, with raised club and outstretched bow; he is represented with a lion, with Achelous, with Cerberus, and contending with Apollo for the tripod. Theseus, with Ariadne and the Minotaur, Odysseus under the ram, and a few other scenes from heroic myths occur. More frequent are the representations of lesser divinities and daemones. Among these are Gorgons (Fig. 304); divinities of human shape, but with the heads of lions, bulls, or other beasts, and often furnished with wings; Silenus (Fig. 305) who is represented with a cantharus, kneeling, reclining, or dancing, but always with the ears and tail of a horse and a great, bushy



FIG. 304. — Gorgon,
from Kertch.
(Furtw. *Ant.*
Gem. Pl. VIII,
52.)



FIG. 305. — Silenus,
scarab. (Furtw.
Ant. Gem. Pl.
VIII, 4.)

beard; Sirens; Harpies; a winged male figure usually interpreted as Eros, and a winged female figure, probably Nike. Supernatural beasts are also favorite subjects. Among these the sphinx is very common, the griffin less usual; the winged lion, the winged boar, the sea horse, and various fantastic combinations are found. Real beasts are also frequently depicted, such as lions (Fig. 306), bulls,

rams, and deer. Sometimes one animal occupies the entire field of the seal, sometimes a lion appears pulling down a bull or fighting with a boar, and sometimes beasts are arranged in oriental, heraldic fashion. Human figures, with no mythological or religious significance, are represented in various attitudes and activities (Figs. 307, 308), the figure of a youthful warrior (Fig. 307) being especially common toward the end of the archaic period. A man on horseback is not infrequently represented, and the quadriga is a well-known subject. Human heads, especially those of warriors, not susceptible of any mythological or religious interpretation, are common. Some



FIG. 306. — Lion, scarab. (Furtw. *Ant. Gem.* Pl. VIII, 45.)



FIG. 307. — Youthful warrior. (Furtw. *Ant. Gem.* Pl. IX, 4.)

scarabs, found especially at Carthage and in Sardinia, exhibit the technical qualities of the Greek gems of this period, but *motives* either purely Phoenician or



FIG. 308. — Man and horse. (Furtw. *Ant. Gem.* Pl. IX, 14.) Inscr. 'Επιμηνης ἐπιωιε.

only in part Hellenic. Such scarabs were not worn by Greeks, and if they are actually of Greek workmanship, they are the work of Greeks whose choice of subjects was governed by local demands.

In style the gems of the archaic period resemble the contemporary coins, and, like these, they reproduce in miniature the progress of sculpture. In the early part of the period, stiffness and even awkwardness of posture, accompanied by evident lack of knowledge of anatomy, are noticeable in the representation of the nude human form, the folds of drapery are rendered by simple parallel lines, and muscles are imperfectly and incorrectly reproduced. But after 500 B.C. the knowledge of anatomy that is displayed in the sculptures from Aegina and in other works of the time is evident also in the gems. The muscles are sometimes exaggerated, the postures are not always graceful, and the treatment of drapery, when it occurs, is

Style of
archaic
period

not yet perfect ; but before the archaic period is passed, about 470 or 460 B.C., the Greek gem cutters, as well as the sculptors, have attained such knowledge and such technical skill that the transition to the freer and more perfect art of the following period involves nothing more than the abandonment of the lingering remnants of the earlier severity of style.

To the end of the archaic period and the earlier part of the period of the free style an interesting series of gems is to be ascribed, on which Greek artists have represented Persian subjects. These stones have been found in the greatest number at Kertch. On the earlier stones the representations are purely Persian, though the style is Greek, while in the later specimens the Persian qualities are less pronounced. The stones in the form of a cylinder have very seldom any figures not purely Persian, and those in the form of a cone or bevelled cone have usually purely Persian figures. This last form is not very common. The most usual form is the scaraboid, and another favorite form is a rectangular bevelled or faceted stone, pierced lengthwise. The material is usually bluish chalcedony, but other stones, as well as glass, are also employed. The



FIG. 309. — Persian-Greek gem. (Furtw. *Ant. Gem.* Pl. XI, 8.)

work is often, though not always, careless. In the later Graeco-Persian gems the figures have a vacant space about them and no border, not even a line. The types represented are a Persian king or grandee with his followers or conquered foes, or both ; a mounted Persian in conflict with a lion ; a Persian fighting with a Greek, Persian ladies, various hunting scenes (Fig. 309) ; sometimes, though seldom, single human figures ; and on some of the later stones single animals. Winged animals, especially griffins and other hybrid forms, are common. These gems were evidently made for Persians, and are Greek only in style and execution.

Purely Greek gems, that is, gems made by and for Greeks, of the free style, belonging to the period before Alexander the Great,

are comparatively few. The scarab diminishes in popularity, and is hardly to be found after the fifth century. The most common form is the scaraboid, but the forms that were in use in later times begin to appear. The engraving begins to be put on the convex side of the stone, and when this is the case the convexity is slight. Some stones are engraved on both sides. Gems not pierced, but intended to be set in rings, are not uncommon, at least in the fourth century. At Polis tis Chrysokou, in Cyprus, rings have been found which were evidently intended to serve as settings for gems, though the gems themselves are lost, and at the same place unpierced gems set in gold and silver were found. These were, however, to be worn as pendants, necklaces, and the like, not as rings. Occasionally entire rings are cut from stones. The cylinder (sometimes with a flat side on which are no figures) is not uncommon in the fifth and the greater part of the fourth century; pierced, faceted rectangular stones, rather long rectangular stones, with figures on one or on four sides, and a few other shapes, such as the cone, were also adopted. In the fifth century a border of fine lines sometimes encircles the gem, but no such border is found on later gems. The stone most frequently, though not exclusively, employed is chalcedony, and glass is also of frequent occurrence.

In the entire period before Alexander, most seals worn as rings on the finger were of metal—bronze, silver, and gold. The bronze and silver engraved seals are for the most part ruined by oxidation, but a few have recognizable figures, which in some instances recall statues of the period. Gold seals are well preserved. They have oval bezels, which in the earlier part of the period are long and more or less pointed, but as time goes on tend more and more toward the circular form. Rings of electrum are of eastern (Ionic) origin; for electrum was found in Asia Minor. The rings themselves have been found in southern Russia, Cyprus, and Sicily, and on two of them are inscriptions in Ionic dialect. Both of these rings belong to the fifth century. Some gold rings, apparently of the time before 450 B.C., exhibit the severe style of that

period, others the style of the latter part of the fifth century, and still others that of the fourth century.

Very few Greek gems of the fifth and fourth centuries are found in Italy, for the Etruscans made their own gems after the end of the sixth century. A few gems of Greek style found, and perhaps made, in Italy closely resemble those found in continental Greece. Of the gems found in continental Greece many are Ionic in style, though some of them may have been made at Athens. They exhibit the qualities of Ionic art—softness of outline, breadth and liveliness of treatment, joined with a lack of sharpness in detail. The works of Dexamenus of Chios do not, however, belong to this class, in spite of the Ionic origin of that artist. His clear and concise design and execution show the influence of Attic art. Some gems exhibit the Phidian style, and this style spread from Athens to the West. Phrygillus, who worked at Syracuse, may have been trained at Athens. He is known as a coin engraver, and his name is read on a beautiful gem with a figure of Eros half kneeling and lean-

Style of
Greek gems
before Alex-
ander



FIG. 310.—Gem by Phrygillus. (Furtw. *Ant. Gem.* Pl. XIV. 6.)



FIG. 311.—Gem probably by Evaenetus. (Furtw. *Ant. Gem.* Pl. IX, 49.)



FIG. 312.—Gem by Olympius. (Furtw. *Ant. Gem.* Pl. XIV, 8.)

ing forward with his hand on the ground (Fig. 310). A fine gem with a representation of Heracles and the Nemean lion (Fig. 311) is probably by Evaenetus, as it agrees in style and design with Syracusan coins by that artist and his rival Cimon. It must be assigned to the end of the fifth or the early part of the fourth century. Olympius, whose name is inscribed in very small letters on a gem engraved with a graceful and delicate figure of Eros shooting with a bow (Fig. 312), is probably identical with the

artist of some Arcadian coins of about 370 B.C., on which the seated figure of Pan is represented. To about the same date belongs an exquisite gem on which a half nude figure of Nike arranging a trophy is seen (Fig. 313). This gem is signed, but the characters of the signature are so small and faint that the name Onatas can be assigned to the artist only by conjecture.



FIG. 313. — Gem by Onatas (?). (Furtw. *Ant. Gem.* Pl. XIII, 37.)

The only artist whose progress can be traced through several works is Dexamenus. His earliest signed work represents a seated woman before whom stands a maid holding a mirror in her right hand and a wreath in her left (Fig. 314). The design is not original, as it is often found on Attic vases of the fifth century and on gravestones. There are traces of the severe style,

Dexamenus



FIG. 314.



FIG. 315.

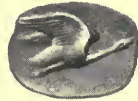

FIG. 317.

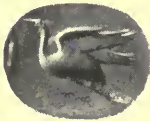

FIG. 316.



FIG. 318.

FIGS. 314-318. — Gems by Dexamenus. (Furtw. *Ant. Gem.* Pl. XIV, 1, 20, 4, 2, 3.)

and the field is surrounded by a border of little lines. The probable date of this fine gem is about 450 to 440 B.C., and the figure of a harp player (Fig. 315), which is closely related to it in style, belongs to the same period. The next signed work is an exquisitely wrought heron with a grasshopper. Here the

stone is still encircled with the border of lines, but there are no traces of severity of style. The fully developed style of Dexamenus is seen in the representation of a flying heron (Fig. 316). Here the execution is of extreme delicacy, the border of little lines is replaced by a single line round the edge of the gem, and the inscription, instead of following the curved edge of the stone, is arranged in two lines. A flying goose on another gem (Fig. 317) is probably by Dexamenus, though the execution is not quite so fine as that of the flying heron, and there is no inscription. The fourth signed gem has, like the gem with the flying heron, a single fine line as a border, and the inscription is arranged in two lines. The design is the portrait of a bearded man, and the artist's delicacy of taste as well as of workmanship is admirably exhibited (Fig. 318). The details are clearly and carefully wrought, but are not carried to excess. If the date assigned to the first of the signed gems by Dexamenus is correct, this last work was probably executed as late as 430 B.C., or even a few years later. A few unsigned gems are attributed to Dexamenus on grounds of style, but these attributions are by no means certain.

The variety of representations on gems of the period that extends from about 460 B.C. to the time of Alexander is very great. Figures of gods and heroes are far from un-
Variety of types usual, but real human beings are most frequently represented. Among the divine figures, Aphrodite, Eros, and Nike are favorites. The coin types at this time tend toward the repre-

sentation of the great deities, the official gods of the Greek cities, but the tendency of the ring types is in the opposite direction. Figures of animals are not uncommon, and sometimes they are very fine. The exquisite herons by Dexamenus can hardly be surpassed. Groups of persons are also represented, and chariots with horses, like those on Syracusan coins, are seen on several gems (Fig. 319). The fantastic combinations of parts of different animals, which were



FIG. 319.—Gem of fourth century. (Furtw. *Ant. Gem.* Pl. IX, 53.)

common in the earlier periods, are now comparatively rare. Inscriptions occur more frequently on gems of this period than in earlier times. Some of these designate the owner, others the artist, others explain the representation, and two inscriptions (*δῶρον* and *χαίρε*) indicate that the gem is a gift and offer a greeting to the person who receives it or a letter or other missive sealed with it. The signatures of artists are always unobtrusive and in small characters, like the signatures on coins.

The dates of the gems are determined in great measure by their style, in some cases also by the forms of the letters of the inscriptions, in many by the choice of subject.

Dates

Those of the middle of the fifth century still show traces of severity of style, those of the latter part of that century exhibit, in spite of their small size, the dignity and grandeur of the great art of the time, together with the greatest perfection of workmanship, and those of the fourth century (Figs. 319, 320) continue to show consummate technical skill and the utmost grace of design, but lack something of the power, dignity, and pure beauty of the works of the fifth century. In the second half of the fifth century seated figures in three-quarter view, which shows the artist's skill in foreshortening, are favorites. In general, a round, soft, plastic effect is desired, and the lines, however long and fine, are not hard nor sharp. The round-headed drill is little used, and the contrast between lines made with such a drill and those made with a sharp point is avoided.

This was the period of great sculpture, and it is natural that the art of the gem cutter occupied a humble place, though at no period were more beautiful gems produced, either in technical execution or in composition and design. In the Mycenaean epoch, when great sculpture had apparently developed but little, and in the late times, when great art fell away and lost its creative power, the art of gem cutting was relatively more important.



FIG. 320. — Gem of fourth century. (Furtw. *Ant. Gem.* Pl. XIV, 22.)

In the Hellenistic period Greek art was more widely spread and less local and national than in earlier times. General artistic tendencies are traceable, but the details of the development of any branch of art cannot always be distinguished. It is therefore not always possible to determine whether certain works belong to this period (the third and second centuries B.C.) or to the Hellenistic-Roman period, when Greek art had become the art of the Roman Empire, and the difficulty of deciding in doubtful instances is, if possible, even greater in the case of gems than in that of works of sculpture.

The gems are now for the most part flat and thin, like the stones in modern seal rings, and for the same reason, because they are intended to be set in rings for use as seals.

Forms of Hellenistic gems Such stones are naturally not pierced. Occasional scarabs, probably of Alexandrian origin, are engraved with Egyptian symbols and are not of very good workmanship. One such scarab is adorned with a sphinx in relief; it is, then, really a cameo.¹ Engraved cylinders are no longer made, but some long, four-sided pierced stones occur, and various other forms, pierced for use as pendants or parts of chains, are also found, but are not common. The scaraboid begins to disappear toward the end of the fourth century, and develops, or degenerates, into the thin, unpierced, but convex seal stone, which is common in the Hellenistic period, alongside of the seal with a flat surface. The stones are sometimes of great size, and their settings are correspondingly broad, but to avoid excessive weight are frequently made hollow.

The favorite stones are chalcedony, carbuncle, garnet, beryl, topaz, amethyst, crystal, carnelian, and sardonyx. Glass is also frequently employed, and is no longer white, as in the previous period, but green, yellowish, brown, or violet, and occasionally the glass seals are engraved with the

¹ Gems on which the design stands out in relief are called *cameos*, those with the design cut in so that an impression made from the stone receives the design in relief are called *intaglios*.

wheel, not cast from impressions made from engraved stones. Rings entirely of metal, with engraved bezels, are comparatively rare. Technically, the gems exhibit remarkable softness and delicacy of forms, and at the same time sharp delineation of details. In the most careful work, the engraved design, as well as the smooth surface of the stone, is highly polished.

The most important innovation of the Hellenistic period is the invention and development of cameos, which are never found in graves of a time earlier than the third century B.C.

The origin of cameos is not due to a desire for improvement in rings; for the engraved gems set in rings were used as seals, a purpose for which cameos are far less well adapted than intaglios. The cameos were to be used merely as adornments, to be worn as pendants, earrings, necklaces, and the like, or to be set in drinking cups, crowns, or articles for toilet use.

Hellenistic cameos are almost without exception made from sardonyx of different colored layers, the number of which varies from two to eight or even nine. The greatest skill is often shown in cutting the design in such a way as to

produce the richest and most varied effect by the alternation of the light and dark colors of the stone. A few cameos have Egyptian figures, though their execution is purely Greek. The chief centres of cameo cutting at this time were Alexandria and Antioch. One of the masterpieces of Hellenistic cameo cutting is the so-called "Tazza Farnese," a shallow dish, 0.20 m. in diameter (Figs. 321, 322.) On one side is a superb head of Medusa, on the other

Cameos



FIG. 321.—Tazza Farnese. (Furtw. *Ant. Gem.* Pl. LIV.)

a symbolical representation of deities of agriculture and fruitfulness, probably Triptolemus, Euthenia (the wife of the Nile), the daughters of the Nile, and two wind gods, grouped before the



FIG. 322. — Tazza Farnese. (Furtw. *Ant. Gem.* Pl. LV.)

god of the Nile, the giver of all fertility to Egypt. An equally remarkable piece of work, though by no means so attractive, is the so-called "coupe des Ptolemées," which is in all probability Hellenistic in date. This is a great, two-handled cup, all of one piece of sardonyx. On both sides is engraved all the apparatus

of a banquet — table, cups, dishes, Bacchic masks, curtains, a statuette, a herm, and at each side of the scene a tree that spreads its branches over the instruments of festivity. This is a most brilliant example of the cameo cutter's art, and bears eloquent



FIG. 323. — Coupe des Ptolémées. (Furtw. *Ant. Gem.* Vol. III, p. 157.)

testimony to the love of ostentation to which that art owes its existence (Fig. 323). Among the various smaller cameos of this period several are portraits of kings and princes, others represent deities, and, in general, the designs resemble those of the contemporary intaglios. Three cameo cutters are known by their signatures on their works. Athenion is the artist of a cameo on which Zeus is represented in conflict with the giants, a work which challenges comparison with the frieze of the great altar at Pergamon (Fig. 324), and another work of Athenion is known by two fragments of ancient glass casts. Here a ruler, perhaps Eumenes II of Pergamon, is represented, with Athena acting as his charioteer. A gem signed by Boëthus represents



FIG. 324. — Cameo by Athenion. (Furtw. *Ant. Gem.* Pl. LVII, 2.)

the lame Philoctetes, and is remarkable for its realism, a quality for which Hellenistic gems are not always distinguished. Pro-tarchus is known by two signed cameos, on one of which Eros is represented riding a lion, on the other Aphrodite with Eros. Many cameos with mythological representations are undoubtedly Hellenistic in design, and Hellenistic execution is probable in the case of a great number of these, though it is hard, or perhaps impossible, to prove that they were not actually made in Roman times.

In style the Hellenistic gems, both intaglios and cameos, exhibit in miniature the qualities of Hellenistic sculpture. They continue and develop, even to exaggeration, the tendencies of earlier artists, the softness and tenderness of Praxiteles, the pathos and passion of Scopas, and the realism of Lysippus and his followers. Pathos, the expression of pain, is seen in a number of heads of Medusa, among them that of the "Tazza



FIG. 325. — Hellenistic gem. (Furtw. *Ant. Gem. Pl.* XXXIV, 19.)

Farnese"; action and passion in such gems as that signed by Athenion, which represents Zeus and the giants, and also in some portraits. More frequently noticeable is the Praxitelean tendency to the representation of figures leaning in easy, graceful postures on columns or other supports,



FIG. 326. — Hellenistic portrait gem. (Furtw. *Ant. Gem. Pl.* XXXII, 18.)

and to the delicate treatment of rounded nude forms, whether female, male, or infantile (Fig. 325). Even in portrait heads the same tendency is visible. At the same time there is great sharpness in details, especially in the rendering of the hair, whether it be smooth or disordered (Fig. 326). Even the hair of the eyebrows is sometimes represented. The eyes are often large and wide open, with the iris and pupil slightly marked. Sometimes,

as in some Hellenistic sculptures, the eyes are set in deep sockets to give passion or pathos to the expression.

A special class of gems is engraved with delicately sketched figures in which the design is not polished as in the other gems of the period. They are not, however, to be mistaken for **Archaistic** unfinished or careless work. On a small group of gems **gems** early types of deities are reproduced in an archaistic manner, and the imitation of the classic style of the fifth century also occurs. The gems that exhibit this imitation have usually a border of little lines, like that seen on gems of the fifth century, but they cannot well belong to that time, as they have the flat form usual in the Hellenistic period. On the other hand, their style is fresher and easier than that of the cold and stiff imitations of classic art produced in Roman times. The very convex long stones usually have only one figure, most frequently leaning in an easy posture on a column or some similar support. Most of these *motives* are derived from sculpture, but some appear to be taken from paintings, as is the case also with some of the *motives* occurring on gems of other shapes. Busts, not mere heads, now appear on gems for the first time, both in portraits and ideal representations. These cannot be reproductions of sculptured busts, for the latter do not occur before Roman times. Heads, both of human persons and of gods, are frequently represented in full front face. Replicas of the same figure, as well as many similar variants of favorite types, are more or less frequently met with. In general, in gems, as in the products of other branches of Hellenistic art, it is difficult to distinguish different regions or schools by type or style.

Among the designs on gems of this period, the portraits are peculiarly interesting and often remarkably fine (Figs. **Portraits** 326, 327). The persons represented are usually kings and rulers and their wives. The portrait of Alexander the Great



FIG. 327. — Hellenistic portrait gem, by Lycomedes. (Furtw. *Ant. Gem.* Pl. XXXII, 31.)

is especially common, that of Mithridates is of frequent occurrence, and portraits of several of the Ptolemies have also been identified. Seals with portraits of great men were worn not only by the persons represented, but also by those who wished to be known as their servants and admirers, a fact that accounts for the comparatively great number of seals with the portraits of kings. Many of the royal personages represented are as yet unidentified, and the portraits on many seals are certainly those of private persons, some of whom are women (generally idealized). That Romans also are represented on Hellenistic seals is not remarkable in view of the relations existing at this time between Rome and the Hellenic East.



FIG. 328.— Woman bathing, by Scopas. (Furtw. *Ant. Gem.* Pl. L. 13.)

Scenes from life are not very numerous, but the lion hunt, perhaps with a reminiscence of the famous hunt of Alexander, and other hunting scenes occur; and besides these, various idyllic scenes are represented, women are seen reading or playing the lyre, and a few other similar representations are found occasionally (Figs. 328, 329). The most usual mythological *motives* are those connected with the less serious deities, especially Aphrodite and Dionysus. These two deities are themselves very common, usually represented leaning on a pillar or the like. Eros and Psyche are also common subjects for the gem cutter, but Psyche is not represented with the wings of a bird, as a mere female counterpart of Eros. As is natural in an age when soft and voluptuous forms were popular, the Hermaphrodite is a not unusual subject for the gem cutters. Egyptian deities, especially



FIG. 329.— Muse, with lyre, by Onesas. (Furtw. *Ant. Gem.* Pl. XXXV, 23.)

Types of Hellenistic gems

Serapis and Isis, are frequently represented, and thus the gems add their testimony to the popularity and wide diffusion of the Egyptian cults. The somewhat abstract deities, Artemis Tyche, Artemis, and Agathe Tyche, as well as some

lesser divinities and some personifications of nature, are seen on a considerable number of gems, but other deities are comparatively unusual. The head of Medusa is popular as a beautiful and easily understood vehicle for the expression of pathos. Comparatively few heroes are represented on Hellenistic gems, and among them Odysseus is perhaps the favorite. Heracles is far less popular than in earlier times. Some scenes from myths appear to derive their form from paintings. The designs of the simpler seals, a head, an animal, or a symbol of some kind, are naturally not often to be distinguished from later work.

Besides the three makers of cameos, Athenion, Boëthus, and Protarchus, who have been mentioned above, eleven gem cutters of this period are known, the most distinguished among whom was Pyrgoteles, who is said to have been the only gem cutter whom Alexander allowed to make his portrait. Unfortunately he is known only through literary sources, as no work signed by him is extant. Of the personality and artistic development of the others nothing is known, as none of them is represented by a series of signed works.¹

¹ The following are to be assigned, on grounds of style and on account of the forms of the letters used in their inscriptions, to the third century B.C.: Lycomedes, who signs a gem in the best style of the time (Fig. 327), on which is a head, probably of Berenice I, in the character of Isis; Daedalus, the artist of a portrait of a bearded man; Scopas, who is known by a portrait of a smooth shaven man and the figure of a woman bathing (Fig. 328), the portrait being a masterpiece of technique and also (which is rare in the Hellenistic period) a model of simple naturalness; Nicandrus, who signs the portrait of a woman, executed in a style similar to that of Scopas; Phidias, the artist of a portrait, probably of Alexander; and Philo, who signs the portrait of a man. In the second century Agathopus and Heracleidas engraved portraits of Romans. The form of his name indicates that Heracleidas was a Dorian, probably of Sicily or southern Italy. Two gems signed by Onesas, a peaceful Athena and a Muse tuning a lyre (Fig. 329), occur in several replicas, especially glass pastes, and are to be assigned to the second century. An Apollonius of this time, not identical with the Apollonius of the Hellenistic-Roman period, is known by an almost effeminate portrait head of a man with thick hair.

The direct continuation of Hellenistic art, as exemplified by gems, is found in the Hellenistic-Roman art of the Roman Empire. But before proceeding to describe the gems of that period, it may be well to devote a few words to the gems made in Italy between the end of the sixth century B.C. and the time of Augustus; for these, although they are not the work of Greek artists, are the products of an art entirely Greek in its origin. The gems produced in Italy and Sicily by Greeks are not to be distinguished from those produced by Greeks in other regions, and need no separate treatment; but Etruscan and Latin, or Roman, gems are different.

The Etruscans adopted the form of the scarab and employed it to the exclusion of all others. The earliest Etruscan scarabs imitate closely Greek art of the latter part of the sixth century and the years before the Persian Wars, and in execution they are not inferior to Greek gems of that time, for the Etruscans were

Etruscan excellent artisans, and even surpassed the Greeks in
scarabs minute and accurate work, though they had little innate artistic sense. They carved the body of the beetle with great care and ornamented the flat base on which the beetle stands. This the Greeks never did, and although the earliest Etruscan scarabs, and poor specimens of later date, are without this ornament, it serves as a convenient and easy means of distinguishing Etruscan from archaic Greek work.

The usual material of Etruscan scarabs is carnelian, but sardonyx and striped agate are not uncommon, and occasionally other stones are used. Glass scarabs are also found. On the most archaic scarabs—those in the style of the times before the Persian Wars—the designs usually represent deities, almost always draped; after the Persian Wars Greek heroes furnish the favorite types, and figures of deities are comparatively rare. The best scarabs exhibit the severe style of Attic and Aeginetan art of the time of the Persian Wars and the following years. These are followed by scarabs in which the influence of Greek art of the middle and second half of the fifth century is visible, but

very few show any influence of Greek types of the fourth century, and after this time there was no further development, though the production of scarabs in Etruria did not come to an end at once. Until about the middle of the fifth century the Etruscan gem cutters seem to have been in close touch with continental Greece, especially with Athens, but after that time they may have drawn their knowledge of Greek art from the Greek cities in Italy; at any rate, the influence of some coin types of those cities has been observed in some scarabs. In general, the style of Etruscan scarabs, while it follows pretty closely the development of Greek art in the fifth century, is drier, stiffer, less lifelike, and more awkward than that of Greek works (Fig. 330). The types



FIG. 330. — Etruscan scarab. (Furtw. *Ant. Gem. Pl.* XVIII, 35.)

represented are usually Greek heroes, for the most part in bent, crouching, or contorted attitudes, which are well adapted to fill the broad oval field of the scarab (Fig. 331). The desire to fill the field may account in part for the



FIG. 331. — Etruscan scarab. (Furtw. *Ant. Gem. Pl.* XVI, 53.)

frequent occurrence of winged figures, which may also be due to the early influence of Ionic art in Etruria. Religious representations or scenes of worship are rare. Inscriptions are common, but do not designate the owner nor the artist; they are all explanations of the design and consist of the names of Greek heroes in Etruscan form.

Scarabs with coarse engravings done only with the round drill have been found in great numbers in Etruria and Samnium, less plentifully in Sardinia, and occasionally elsewhere. They exhibit some traits of archaism, but are evidently not really archaic, for running is properly represented on them, and drapery shows a knowledge of the art of the fourth century. Some scarabs which really belong to this class are engraved with sharp, fine lines in addition to the lines and surfaces engraved with the round drill.

In these there is an affectation of archaism, which is sometimes carried very far. There is nothing to prove conclusively that these gems are Etruscan, but they were evidently made in Italy, and the scarab form in gems, few if any of which are earlier than the fourth century, shows at least very strong Etruscan influence. Among the types that appear on scarabs of this class, Hercules and Silenus are especially common, which may perhaps be an indication that the scarabs were made in great part for people of Italic race, among whom Hercules and Silenus were especially honored.

Another class of Italian gems is neither Greek nor Etruscan, but Latin or Roman. Two groups may be distinguished, in the **Latin or Roman gems** first of which the Etruscan style is imitated, while the second is an Italian development of Hellenistic Greek art. The gems thus exemplify the two forms of civilization which were striving for the mastery in republican Rome. Some of the earliest Roman gems of the Etruscan style have the scarab form, but most of them are flat ring stones, in shape not unlike the flat side of the scarab. The field is usually entirely filled by the figure or the figure stands on a line, the space below which is either left vacant or filled with lines or dots. A border of lines often encircles the field. The most usual material is sardonyx, though carnelian is common and other stones occur. Glass seals were evidently made in great quantities, but these are as a rule very ill preserved. The colors of the glass are in general those of the favorite stones. These gems show some technical skill, but not artistic spirit nor great care in execution. In style they are eclectic, with an inclination toward the severe style of the best period of Etruscan scarabs. The inscriptions on the scarabs of this class are in Latin, but, like those on Etruscan scarabs, designate the person represented; those on the ring stones usually give the name of the owner, in Greek, Latin, or Etruscan characters. The types are commonly Greek heroes, as on Etruscan scarabs, but many scenes of combat occur, as well as a considerable number of scenes of a religious nature. There is no connection between these gems and the types of Greek coins of southern Italy.

The second group of Roman gems has no connection with Etruscan scarabs, but very close connection with Hellenistic Greek gems. They are ring stones, never pierced, generally of a wide oval form, but sometimes long and narrow, almost always very convex, though a few specimens are flat. The favorite material is brown sard, after which carnelian is most common. Gems of this group were also reproduced in glass by the wholesale. Cameos are unknown. The inscriptions designate the owner, and are almost all Latin, with numerous abbreviations and ligatures. In style these gems differ greatly from the preceding group. Full, round figures are preferred; entire figures, busts, and heads are often represented in front face, and there is much good foreshortening, as is the case on Hellenistic gems. There is no trace of the hardness, dryness, and awkwardness of the Etruscan style. The types and *motives* resemble those of Hellenistic gems. One (Fig. 332) reproduces the type of a series of Roman-Campanian coins with the inscription *Roma* and a Campanian and an armed Roman taking an oath over a pig held by a kneeling fetial. These coins were struck between the end of the fourth century and 268 B.C. The gem is therefore presumably Campanian, not later than 268 B.C., and certain closely related gems are assigned with great probability to the same period and the same region; in fact, it is probable that many Roman gems of the third and second centuries B.C., both with and without Latin inscriptions, are of Campanian origin.

The classicism noticed in some Hellenistic gems and prevalent in the Augustan period is absent from gems of this class, in which a humorous element is often to be observed. Favorite types are Eros, Aphrodite, Fortuna on a wheel, Muses, the head of a youthful river god, the bearded Heracles, Diomed and Odysseus, Perseus, and Iphigenia and Orestes; but as a rule the more serious deeds of heroes are not represented. Among representations of men on horseback that of M. Curtius is to be noticed,



FIG. 332. — Coin type on gem. (Furtw. *Ant. Gem.* Pl. XXVII, 34.)

and among the scenes of battle conflicts with Gauls occur (Fig. 333). Single Gauls are also represented. Hunting scenes, dwarfs, Roman officers, orators, and athletes are among the types derived from life. Comic actors and masks are represented, but tragic



FIG. 333.—Combat with Gaul. (Furtw. *Ant. Gem.* Pl. XXVII, 40.)

figures are rare. The portrait heads are sometimes admirably lifelike. Some combinations of human and animal forms occur, and animals are comparatively common. On many seals the designs represent inanimate objects, weapons, and the like.

In the first century B.C. the group of Roman gems with designs imitating the Etruscan style loses its earnestness; Eros, Eros and Psyche, Dionysus, and their followers appear among the types; the severity of the earlier style disappears, and only its stiffness and awkwardness remain. At the same time the Roman-Campanian style loses its freshness, and imitation of classic art is introduced. The style and the inscriptions recall Roman coins of the same period. The two groups lose much of their distinctive character and approach more nearly the Hellenistic-Roman style of the early Empire. Some Roman portrait gems of the first century B.C. are completely Hellenistic in style.

From the time of Augustus no distinction can be made between the gems produced in the various artistic centres of the Roman Empire. All are late Greek, and, in general, classical in style and type. By far the greatest number of extant ancient gems

The imperial period belongs to the time of Augustus. Rome was now the centre of the world, and although works of art were in great part made by Greeks, they were made for Romans. In essence they are Greek, but Greek of Roman times and in Roman taste, which made for classicism, though with free use of all that had been learned and achieved since the time of Alexander. Even before the Augustan period gems of Hellenistic-Roman style had been worn by cultivated Romans, but the fullest development and the widest diffusion of the style belong to the time of Augustus.

tus. The portraits on gems are frequently of great assistance in fixing their dates. Pliny (*N. H.* 37, 8) and Suetonius (*Aug.* 50) state that the portrait which Augustus used as a seal in his later years was by Dioscurides. This portrait seal is lost, but a cameo and several intaglios (Figs. 334, 335) signed by Dioscurides show his style and help to establish the Augustan period as the date of similar works. His extant works show that Dioscurides was a master of all technical skill, but not an inventive or creative artist. His three sons, Eutyclus, Herophilus, and Hyllus, are known by signed gems, and Eutyclus mentions Aegae, in Cilicia, as his home. Evidently the family came from Cilicia to Rome as the best place for the practice of their art. The latest gem cutter who signs his work and can be dated is Euodus, who cut the portrait of Julia, daughter of Titus.¹ The art evidently declined rapidly after the first century after Christ.



FIGS. 334, 335.—Gems by Dioscurides. (Furtw. *Ant. Gem.* Pl. XLIX, 6, 7.)

Under Augustus and until about the middle of the first century many fine cameos were produced, but after that time they are few and poor. Scarabs are no longer made. A few pierced stones, to be used as pendants, with designs Cameos on four sides, exist, but they are of poor quality. Ring stones prevail almost to the exclusion of all other intaglios. They are either flat or convex, with a preference for a flat or only slightly convex form, only in some bright stones, *e.g.*, garnet and amethyst, the convex form is preferred, as it makes the beauty of the material more evident. Generally the shape is a broad oval, but some stones with archaistic designs and a border of small lines are rectangular with rounded corners. The settings are often broad and hollow, and frequently very elaborate. Some intaglios

¹ In all, more than thirty gem engravers of the imperial period are known by their signatures on extant works. The list is given by Furtwängler, *Antike Gemmen*, pp. 353-358.

of this period are too large for rings and were evidently intended, like the cameos, for the adornment of cups, vases, caskets, and the like, or to be worn as pendants or in necklaces. Few ancient settings for cameos exist. Only the smallest could be worn in rings, and even these were not well adapted for use as seals.

The variety of materials employed was very great, but the transparent stones, carnelian, prase, chalcedony, garnet, carbuncle, beryl, topaz, peridot, emerald, and sapphire were especially popular. Red jasper was also employed, especially by Aspasius, the artist of the famous bust of the Athena Parthenos (Fig. 336). Glass



FIG. 336. — Gem by Aspasius. (Furtw. *Ant. Gem. Pl.* XLIX, 12.)

impressions are extremely numerous in the Augustan period, but not common in later times. Glass was also used for the production of cheap cameos, and occasionally cameos were actually cut (not pressed) in glass. Real stone cameos were usually made of sardonyx, but cameos in high relief were made of unstratified stones, as the strata of sardonyx are not thick enough to produce a good effect in high relief. All technical processes were familiar at this time, and the Graeco-Roman gems, so far as they can be distinguished from those of Hel-

lenistic times, show no less technical skill, though they are inferior in freshness and artistic feeling.

A remarkably fine cameo (0.187 × 0.223 m. in size) is the "gemma Augusta" in Vienna (Fig. 337). The design is in two rows. Above, Augustus is seated beside the Dea Roma, and about him are grouped personifications of the earth, the inhabited world, and the sea or the heavens. Over him is the constellation of his nativity, Capricorn. At the left is a chariot, driven by Victoria, from which Tiberius is alighting. Beside the chariot stands the youthful Germanicus. Probably the representation refers to the triumph of Tiberius in 12 A.D. In the lower row, a trophy is being erected, probably with reference to the victories of Tiberius in Germany and perhaps to those of Augustus in Pannonia.

Many other cameos of historical interest exist ; but by no means all the cameos of this period are historical. Many are mythological, and these are Hellenistic, especially Alexandrian, in character. Among the types are Egyptian deities, Aphrodite and Dionysus, and their train. The *motives* are apparently derived in great part from paintings. A few sculptures in the round carved in semi-



FIG. 337. — Gemma Augusta. (Furtw. *Ant. Gem.* Pl. LVI.)

precious stones may be regarded as a branch of cameo work, an example of which is the head of a Roman military person of the first century after Christ, now in the Boston Museum of Fine Arts (Fig. 338). There is also a limited number of cups and vases of sardonyx with reliefs, for the most part of little artistic merit. They are Hellenistic in treatment, even when Roman in subject. Some imitations in glass of such vases exist, the most

beautiful of which is the famous Portland vase in the British Museum (Fig. 339).

The intaglios are more varied in subject and much more nu-

merous than the cameos. The subjects are often derived from Hellenistic paintings, and it is frequently impossible to tell whether the gems are Hellenistic or Graeco-Roman. Statues, especially those of Polyclitan style, are often imitated, sometimes with variations.

Numerous portraits exist, both of Romans and famous Greeks. Many seals are engraved with symbols of good omen, such as the cornucopia, the steering oar, ears of grain, and palm leaves, and the gems called *grylli* are engraved with signs of magic import.

By the end of the first century A.D. the glyptic art had evidently become unfashionable. After this there are some fine portraits, but even the portraits are not always fine, and there is no more good work in ideal representations. Yet there are many intaglios, engraved with protective deities or symbols. The work is all alike, routine work, without character, and showing no local styles. In the second century there are still

signs of good artistic traditions, but after that there is a great falling off, with only a slight revival under Constantine. The stones used are the same as before, except that yellow jasper is added to those previously employed. Glass pastes are very poor and, in compari-

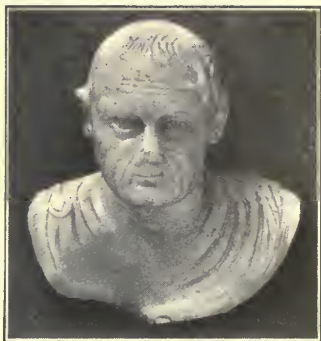

FIG. 338. — Head in Boston.
(Photograph.)



FIG. 339. — Portland vase.
(Photograph.)

son with previous times, not numerous. Technically the work is poor. The choice of deities represented is now more limited, and Fortuna, Muses, and Victoria are favorite types. Astrological and gnostic types and the so-called Abraxas gems are numerous. On these last, mixed forms of deities are represented, especially the god Jao Abraxas Sabaoth, a person with serpents for legs, a cock's (or ass's) head, a breastplate, a shield, and a whip, accompanied by curious inscriptions of mingled Jewish, Christian, and Greek elements. Christian gems are comparatively few and unimportant. The best work is seen in portraits, and some portrait cameos are good. Cameos worn in rings have sometimes merely an inscription instead of a design. A few round sculptures in semi-precious stones occur, some of which belonging to the second century are carefully executed, though somewhat cold and academic in style. Rings entirely of stone are now again made occasionally. These are all large, evidently made for show. As time goes on, the art of gem cutting loses its Hellenic character entirely, and in the later Empire shares the fate of all the other arts.

CHAPTER VIII

VASES

FROM the description of the art of prehistoric Greece it is clear that the manufacture of vases was an important industry in Mycenaean times, and even in still earlier periods. The great skill and refinement of the decoration which some of the best Prehellenic vases reveal were hardly surpassed in later times, but, for all that, the art of vase manufacture gains much additional interest as time goes on. It passes like other arts through a period of crudity during the centuries that immediately precede the first Olympiad, and during the two centuries, indeed, which follow this date; but when the best work of the sixth and fifth centuries B.C. is reached, the importance of the subject to the student of the life and art of ancient Greece can hardly be exaggerated. It remains, of course, a minor and industrial art, but such art in Greece appears to have felt very strongly the influence of the great artists; and thus, since the works of the major art of painting have perished, it is mainly to the vases that we must look to gain some idea of what the character of the lost works was. It is, no doubt, possible to exaggerate the closeness of the connection between the great paintings and the vases, but we know that the vase-painters often chose the same subjects for their pictures that the greater artists used, and it is scarcely credible that they should not often have reproduced some of the famous paintings both in *motive* and style. Vases are furthermore of high importance in the study of mythology. They illustrate with astonishing fulness the myths which make up the subject-matter of Greek epic and dramatic poetry, and hence often throw much light not only upon the work of the poets, but also upon traditional and popular variants from

the literary form of the myths. Nor is this all. Many of the manners and customs of the Greeks are portrayed by the vase-painters. The school, the palaestra, the banquet, the Bacchic rout, the stage, the artisan's workshop, many scenes from the varied happenings of everyday life, all find illustration here. Thus when we consider in addition the high artistic merit of many of the vases themselves, it is hardly necessary to dwell on their importance. To the student of archaeology and art they have an interest which in ancient times no one would have claimed for them, as is shown by the very few allusions to the potters' and vase-painters' art in Greek writers. Then it was merely a subsidiary art, taken by every one as a matter of course. To-day our attitude toward such work must of necessity be very different.

FORMS

(See Figs. 340, 341, 342.)

The manufacture of pottery in Greek lands was an industry of such vast extent that it is impossible within the limits of a handbook to mention all the vase forms. These forms vary considerably in different periods, and certain ones may thus occasionally be associated with particular styles of painting. This is, however, possible only to a limited degree, since certain vases that are more common, like the *amphora* and *crater* and various types of cup, occur in connection with more than one style. But there are many variations of a single form, and these may, like different forms, become characteristic of a style or period. It is, therefore, important to observe not only the painter's work of decoration, but also the shapes which the potter uses. The accompanying illustrations, all from vases in the Museum of Fine Arts in Boston, are typical of the most important forms.

It should be said that the names now generally used to designate some of the shapes are of rather doubtful application. Very likely they were used with considerable latitude in ancient times, and, as is the case with such terms to-day, the usage of different



1 2 3 4 5



6 (15) 7 8 9 (17) 10



11 (14) 12 (16) 13

FIG. 340. — Forms of vases. Boston. (Photographs.) (The numbers in parentheses are repeated on a larger scale in Fig. 341.)



14 15 16 17

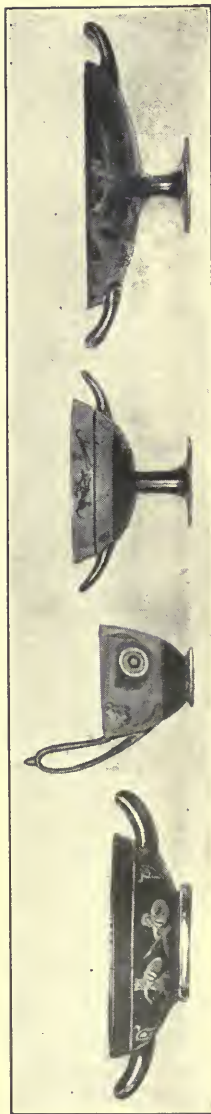

18 19 20 21

FIG. 341. — Forms of vases. Boston. (Photographs.) (Figs. 341 and 342 are on a larger scale than Fig. 340.)



25

24

23

22

FIG. 342. — Forms of vases. Boston. (Photographs.)

places was not always the same. The names, however, of the chief forms are, without doubt, known to us. These appear in some cases to have been determined either by peculiarities of form, as *amphora* (two-handled) or by designations of material, as *alabastrum* (ὁ ἀλάβαστος, a receptacle of alabaster), or *pyxis* (ἡ πύξις, boxwood), but the consciousness of etymology must soon have been lost. In other cases names were given from the chief use to which a vase was put, as *crater* (mixing-bowl), *hydria* (water-jar), *oenochoe* (wine-pourer), but the original use was probably often forgotten when vases were employed, as they not infrequently were, merely for decorative purposes, or in connection with the ritual of the dead.

Nos. 3, 4, and 5 are all forms of the *amphora* (ὁ ἀμφιφορεύς or ἀμφορεύς), commonly used for holding water, oil, or wine. No. 3 is a frequent form in the Geometric style. Nos. 4 and 5 illustrate an earlier and somewhat later type, respectively. These vases are Attic, but the shapes are found in other styles. The very early Attic *amphora*, in Baumeister, *Denkmäler*, Fig. 2079, illustrates a stage of development between Nos. 3 and 4. No. 5 shows some advance in firmness and elegance of outline, and the later practice of moulding the foot of the vase in more than a single curve. No. 1, a *pelice* (ἡ πελίκη, ὁ πέλυξ), and No. 2, a *stamnus* (ὁ στάμνος), may be thought of as variations of the *amphora*. The forms are common in the Attic red-figured technique, but the names, especially *pelice*, are of doubtful application. Characteristic also of this technique is an elongated form of the normal *amphora* shape known as "Nolan" from the fact that many examples of it were found at Nola in Campania (Baumeister, *Denkmäler*, Fig. 2131). The still more elongated *prothesis* (funeral) *amphora* should also be noted (Baumeister, *Denkmäler*, p. 1975).

Nos. 8, 10, 11, 12, and 13 are types of the *crater* (ὁ κρατήρ), or mixing-bowl, which was used primarily for the mixing of wine at banquets and the like. No. 8 represents the *deinus* (*dinus*) or *lebes* (ὁ δείνος, δίνος, ὁ λέβης), a rather uncommon form, but one which is found in several styles, including the Corinthian and the

Attic black-figured and red-figured. For a good example of such a vase in use, see Furtwängler and Reichhold, *Griech. Vasenmalerei*, Pl. 4. No. 10 is a *psycter* (ὁ ψυκτήρ), or wine-cooler. Its peculiar shape made it possible to set the vase in a larger *crater*. The form is most common among the Attic red-figured vases of the early fifth century B.C. No. 11 is a *crater* of calyx form, of a type frequent among Attic red-figured vases, where it affords unusual space for large compositions. The well-known *crater* from Orvieto, which is thought to reflect some of the characteristics of the art of Polygnotus (p. 532 f.), is of this shape. No. 12 is a *crater* with volute handles. It is sometimes classed as an *amphora*, and in some instances its main outline seems to pass into that shape (cp. Collignon, *Histoire de la céramique grecque*, Fig. 116). No. 13, usually known as the *celebe* (ἡ κελέβη) and also as *anfora a colonette*, is especially a Corinthian form. The famous François vase (p. 474), and perhaps also No. 12, appear to be developed from this shape. For a Geometric form of *crater*, see p. 439.

Nos. 6 and 9 are forms which in general outline suggest the *amphora*, but with the handles or handle so arranged that liquids may be readily poured from them. No. 9 is a common form of *hydria* (ἡ ὑδρία), or water-jar. No. 6, a slightly later form characteristic of Attic red-figured vases, is very similar, except that the handle at the neck is set lower. This variety of *hydria* is known as the *calpis* (ἡ κάλπις). No. 7 shows a form of *oenochoe* (ἡ οἰνοχόη), or wine-jug. The type is that of the modern pitcher, jug, or ewer, and naturally shows many variations in size and form. It is found in all styles and in early and late periods.

Nos. 14, 18, 20, 21, 22, 24, and 25 are types of drinking-cups which naturally show great variety in shape. No. 14 is the *scyphus* or *cotyle* (ὁ or τὸ σκύφος, ἡ κοτύλη). This simple shape is common to all styles and periods. Nos. 18, 20, and 21 are forms of the *cylix* (ὁ κύλιξ). No. 18 shows the vase without the stem; No. 20 with the stem, in the form used by the artist Tleson. No. 21 illustrates the flattening and spreading out of the *cylix*, a change which yielded a much more ample field for decoration.

NO. 19 is the *cyathus* (ὁ κύαθος). The long, high handle makes it suitable for dipping out wine from a *crater*. Nos. 24 and 25 are forms of the *cantharus* (ὁ κάνθαρος). That of 24 is most typical, and is often associated in vases with Dionysus (cp. Baumeister, *Denkmäler*, Fig. 2122, and Furtwängler and Reichhold, *Griech. Vasenmalerei*, I, Pl. 44). It is found, too, in connection with representations of the dead (cp. Baumeister, *Denkmäler*, Figs. 343 and 935). There stands upon the altar on the François vase a *cantharus* of this type.

No. 22 is a *rhytum* (τὸ ῥυτόν), a kind of drinking-horn, and is an example of a plastic form of vase. Such vases, of course, show the greatest possible variety of shape. They come into frequent use with the Attic red-figured style, and are very common among the vases of southern Italy.

Nos. 15, 16, 17, and 23 are associated originally with toilet purposes of various kinds. No. 15, a *pyxis* (ἡ πυξίς), is a toilet-box or jar used especially by women. The decorations are often scenes at a lady's toilet. No. 17, an *aryballus* (ὁ ἀρύβαλλος), is a form of oil-flask often found among Corinthian vases. No. 16 is an *alabastrum* (τὸ ἀλάβαστρον). This also is a common Corinthian type, and was used for ointments. The handle is often merely a perforated projection through which a string could be run. No. 23 is that of a typical Attic *lecythus* (ἡ λήκυθος), or oil-flask. In Athens this shape has its most marked development in connection with funeral ritual. The *lecythus* shows considerable variety in its shape, and even the little Proto-Corinthian vases (see p. 444) are usually classed under this form.

Attention may also be called to the irregular shapes, not here illustrated, which are classed under the term *ascus* (ὁ ἀσκός, a sack) from their general resemblance to wine-skins. These date from the time of the Attic red-figured style on. The term *ascus* as applied to vases is not ancient.

NOTE.—The discussion of the manufacture of glass vases is omitted from this handbook because of its slight effect in the development of strictly Greek art. There is a probable reference to glass drinking-vessels in the *Acharnians*

of Aristophanes (vs. 74), and vessels, pretty certainly of glass, are inventoried in the Athenian treasure lists of the fourth century B.C. and in some later similar lists from Cos, but vases of this kind were clearly precious and rather unusual. There appears to be no evidence that the blowing of glass was practised in Greece before Roman times, and then its manufacture seems to be due to Egyptian and oriental influences. Glass pastes, however, were familiar to the gem-cutters and makers of mosaics. Such specimens of glass vases as have been found in Greece proper are chiefly, and very possibly entirely, importations. On the other hand, where Greek civilization came in contact with peoples long acquainted with the manufacture of glass, as at Alexandria and in Cyprus, the art developed to a high degree of beauty and excellence, and continued to flourish in Roman times. Vases of many shapes exist in great numbers, some of which are of clear glass that has taken on a beautiful iridescence. At Pompeii there is evidence of the use of clear glass in window-frames. In the manufacture of colored, translucent glass and of opaque glass in colors extraordinary skill was attained, as is well shown by the celebrated Portland vase (p. 410). The artistic use, however, of such glass was known to the Egyptians from a period that antedates the rise of Greek art, and it was understood by the Phoenicians also at an early date. See Perrot and Chipiez, *Histoire*, III, Pls. VI-IX. The mechanical facility developed by the glass-workers of Hellenistic and Roman times produced rich color effects of the greatest possible variety. This is well shown in the so-called *millefiori* technique, in which sections of a rod made up of fine stalks of different colored glass are fused together to form the surface of the vase. The splendid collection belonging to J. P. Morgan, Esq. (*Collection Julien Gréau, texte rédigé par W. Froehner*), affords very fine illustrations of ancient work in glass. See also Froehner, *La verrerie antique*, Blümner, *Technologie und Terminologie der Gewerbe und Künste bei den Griechen und Römern*, IV, pp. 379 ff., the article *s.v.* 'Vitrum,' in Smith's *Dictionary of Antiquities*, and A. Kisa, *Das Glas im Altertum* (1908).

TECHNIQUE

Since little information can be gathered from Greek writers on the subject of the manufacture of vases, we are forced to gain almost all our knowledge of the subject from a study of the vase-maker's finished work, and from a few pictures which represent various phases of his handicraft.

Greece afforded a large variety of more or less suitable clays. That of Cape Colias in Attica was considered especially fine.

but in Athens itself, in the Ceramicus or potters' quarter, good material was found. The region of Corinth, too, afforded a clay of somewhat lighter color than that found in Attica, but of good quality; and many other places, both among the islands and on the coast of Asia Minor and in Magna Graecia, yielded the necessary material for numerous local centres of manufacture. Chemical analyses of a few of the clays as they appear in some of the different kinds of vases have been made, but these are still inadequate to throw much light on the manufactures of different localities. This question is, moreover, beset with difficulties, since clay from a single manufactory was apparently not always of quite the same composition; and the work of different potters in the same place may be expected to show some variation.

Clays

The first step in the process of manufacture was, of course, the proper preparation of the clay. Until this could be done with skill, the successful outcome of the work must be doubtful. The potters show progress in this respect as their art advances; but at no time can they be said to have excelled the best work of the Mycenaean age.

The clay had first to be purified and washed free from substances which would mar the smooth surface of the finished vase. It was then carefully kneaded (*τὸν πηλὸν ὀργάζειν*) and brought to a consistency suitable for shaping it upon the wheel. During this process other material was sometimes worked in with the clay to deepen its color. This appears to have been usually a red earth (*ἡ μίλτος*) which contained ferric oxide.

The earliest mention of the potter's wheel (*ὁ τροχός*) is in *Iliad*, XVIII, 600, where in a simile a potter propelling his wheel with his hands is described. But the wheel was known long before this to the inhabitants of the eastern basin of the Mediterranean, and except in the case of some vases of plastic form practically all Greek pottery which has any artistic interest was wheel-made.¹ There is no actual evidence that the

Potter's
wheel

¹ The large *πίθοι* and earthenware cisterns were often built up with a free hand, probably about a wooden centring.

simple contrivance known as the "kickwheel" was in use, and yet this would seem probable. The few illustrations here given (Figs 343, 344, 345) are from Corinthian *pinaces* (tablets), dating probably from the seventh century



FIG. 343.—Pinax, Berlin. *Ant. Denk.* I, Pl. 8, No. 17.

and represent a rather primitive type of machine. In the manufacture, however, of the extremely delicate and refined shapes which are found among the vases of the best period, a more perfect method of controlling the wheel was probably in use, but of this we have no definite information.¹ The wheel once set in motion (*τροχὸν ἐλαύνειν*), the potter proceeded to draw (*ἐλκεῖν*) the paste to the required thickness and to shape it as the modern workman does. Large vases were fashioned in sections, which were afterward joined together on the wheel, usually with great skill. The handles, too, were made separately, as were also, in the case of the larger vases, the foot and mouth. How far moulds may have been used in shaping the handles, it is impossible

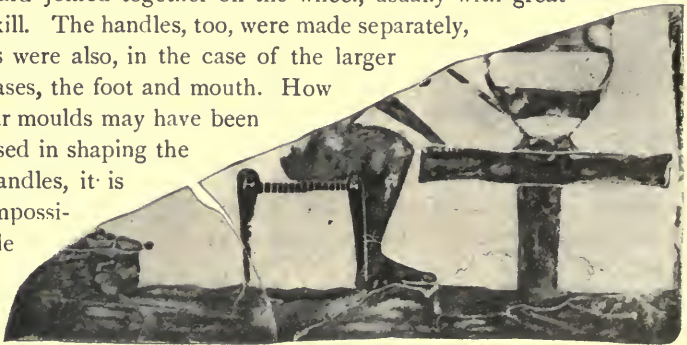

FIG. 344.—Pinax, Berlin. *Ant. Denk.* I, Pl. 8, No. 18.

¹ Figure 350 shows the wheel being turned by a helper, and a similar and somewhat clearer representation of the same process may be found on the fragment of a vase from the Acropolis, published *Ath. Mitt.*, 14 (1889), p. 157.

to say, but the elaborate work which appears upon these in some cases (for example, the François vase, p. 474) presupposes a good deal of free-hand modelling. Nowhere does the potter's art appear to greater advantage than in the attachment of the handles, which in the better specimens rise out of the body of the vase so gradually that they seem really an original part of it, adding distinctly to the beauty of the general outline. So firmly are they joined that a breakage rarely occurs at the point of juncture. When the shaping of the vase was thus completed by the addition of the separate parts, it was allowed to dry, and some authorities believe it to have been then subjected to the first firing (*ὀπτάν*) at a low temperature, before the process of decoration took place. There are, however, strong reasons for adopting the view recently advanced¹ that the decorator's work began before any firing at all, when the vase was "leather-hard."



FIG. 345. — Pinax, Louvre. *Gaz. Arch.* VI (1880), p. 106.

However this may be, it will be most convenient in this brief discussion of technique to treat of that which lies in the province of the potter rather than of the painter, by itself, and hence to speak of the kiln before passing on to the subject of decoration.

Here, again, definite information is lacking. From the illustrations which have been preserved, chiefly among the Corinthian *pinaces*, the kiln appears to have been a dome-like structure, with a kind of projection at the base of the structure through which the fire could be poked, and upon which a person might sometimes stand to reach the opening at the top of the dome (Figs. 346–350). Several illustrations show a man apparently using his poker at the top opening, and as the fire is often

Kilns

¹ Cp. Furt. and Reich., I, Text, pp. 152 and 45.

represented as blazing up out of this, we may suppose that the attendant is seeking in some way to check the draught, since in this



FIG. 346. — Pinax, Louvre. *Gaz. Arch.* VI (1880), p. 105.

place he could hardly be poking the fire. There was a door in the side of the dome through which the oven was no doubt reached, and



FIG. 347. — Pinax, Louvre. *Gaz. Arch.* VI (1880), p. 105.

Figure 349 shows a number of vases inside. That they were always crowded together in the fashion here represented is not to be

supposed, yet it is interesting to note that injuries to vases may occasionally be observed, the origin of which is apparently to be found in their having come in contact with one another through crowding in the kiln. Imperfections due to defective arrangements in firing are frequently to be seen, though at the best period of the Attic red-figured technique they are rare, and it is clear that



FIG. 348. — Pinax, Berlin. *Ant. Denk.* I, Pl. 8, No. 22.

great care must have been taken at that time in this part of the process of manufacture.¹ Of the internal arrangement of the flues

we know little, though some idea of what this was may perhaps be gathered from the remains of Roman kilns.² It would seem likely that the structure was at best somewhat primitive, and that



FIG. 349. — Pinax, Berlin. *Ant. Denk.* I, Pl. 8, No. 19 b.

¹ Cp. Furt. and Reich., I, Text, pp. 153 f., on the general subject of defects in firing. The ruins of a kiln, probably of the fourth century B.C., have recently been found in Attica. These confirm in the main the impression made by the pictures of the *pinaces*; cp. *Ath. Mitt.*, 1908, pp. 177-184.

² Cp. Blümner, *Technologie*, etc., II, pp. 23 ff.

a good result in firing demanded much care and fidelity on the part of the person in charge of the kiln. In the representation of Figure 350 we see a mask affixed to it, no doubt as an *apotropaeum* to ward off bad luck, which might prevent a good result to the work.

As regards the various processes involved in the decoration of vases, even the most careful observers are not always in agreement, and since the order of procedure in some details may vary at different periods, it is probably impossible to give a general description which shall cover all specific examples.

Decoration



FIG. 350. — Hydria, Munich. Furt. and Reich., I, Text, p. 159.

When the vase had been sufficiently dried, its surface must have been smoothed by rubbing, very likely with a piece of wood or leather.¹ This process is apparently represented in Figure 351, and a further stage is illustrated in the same picture by the two black vases shown, which have already been painted over with varnish. The polishing was intended to improve the surface of the vase for the drawing. Speaking generally, there were two different systems of decoration: the first, in which figures appear dark upon a light background (black-figured technique), the second, in which

¹ Cp. Furt. and Reich., I, Text, p. 152, where an experiment is reported, showing the condition of a vase at this stage before any firing. Its surface would apparently have been sufficiently tough to withstand rubbing.

these relations are reversed (red-figured technique). A third system, which will come up for special mention later, and which is in some ways allied to the second, is to be seen in the white vases with outline drawing. From the earliest times down to the middle and latter part of the sixth century B.C. — the period of the Pisistratids at Athens — it was the practice to paint ornaments and figures in black silhouette, either directly on the surface of the vase, or, in some cases, on a light-colored slip. The method in use at Athens during the sixth century B.C. will be taken as typical in describing this technique, and the chief variations from it will be noticed in the later discussion of the different styles of vase-painting.

Black-
figured
technique



FIG. 351. — Kylix, Berlin. Rayet and Collignon, *Histoire, etc.*, p. xvii, Fig. 7.

The distribution of the design on the surface of the vase was naturally the first problem which presented itself to the painter. In a complicated scheme, like that, for example, on the François vase (p. 474), this would have been a very difficult matter, and it has recently been suggested that the painter must have used a pattern vase, in size similar to the one he was working on.¹ We have, however, no certain knowledge of anything of the kind, and the method of such preliminary sketching as was probably employed by the painters in the black-figured technique is a matter of conjecture. The fact that this sketch in black silhouette-painting would in the end be quite covered up, and that minor errors in it might be concealed by slight changes in the design, makes the detection of the process, whatever it was,

¹ Cp. Furt. and Reich., I, Text, p. 13.

practically impossible. When the design had been satisfactorily arranged, the figures were sketched in outline and filled in with the black varnish. The silhouette which was thus formed was at first probably somewhat smaller than the intended figure, and was enlarged to the desired size by further application of the brush.¹ The next step was the addition of details, since the action of silhouette figures, especially if they appear in complicated groups, is difficult to make out.² These details were introduced by means of incised lines, which were cut with a sharp instrument through the black varnish, as yet not fully hardened, into the surface of the clay itself. The outline of the figures, except where they may cross one another, is commonly not incised, though instances of this practice may be found carried out in part or wholly, as in the vases of the potter Andocides. An instance of this may also be seen on the fine "Ionic" *hydria* shown in Figures 379 and 380. The incised lines in good examples are drawn with great firmness and delicacy, and show much of the skill which is so greatly admired in the so-called "relief-lines" of the red-figured technique. In some cases there appears to have been a kind of preliminary sketch for the process of incising the lines,³ but this is true in no such general sense as for the line drawing of red-figured vases, where the sketch both for outline and interior drawing was the rule in all careful work. The effect of such decoration as has been described, consisting solely of silhouettes, with incised details, would of course have been rather dull and sombre, but in reality many black-figured vases must have had a distinctly gay and brilliant appearance. This was effected by the addition of colors superimposed upon the black—white, light brown, and various shades of red and purple being

¹ Cp. Furt. and Reich., I, Text, p. 13; cp. Pl. 4, where above, at the right, the silhouette is represented.

² Cp. Furt. and Reich., I, Text, p. 106, for the representation of a complicated silhouette.

³ Cp. Furt. and Reich., I, Text, pp. 14 and 24; cp. Pl. 4, where above, at the left, such a sketch is given.

found.¹ Authorities do not agree as to the question whether these colors were added after the black had been hardened by firing, or not. It is at any rate certain that they are by no means as hard as the black, that they show less lustre, and that they have to-day in many cases disintegrated and fallen off, disclosing the black beneath. Such a condition of affairs suggests the possibility of their having been somewhat hardened by a second process of firing subsequent to that which hardened the black. On the other hand, if the vase was not fired before the superimposed colors were added, we must believe with Reichhold that the work of manufacture was completed by the firing, and that this took place but once in the entire process.

The nature of the glaze which is to be seen on the finished vase in both the black- and red-figured styles, and the method of its application, raise puzzling questions about which there is as yet no general agreement.² The glaze which we have on modern pottery, a combination of oxide of lead with clay or sand,³ and which is believed to have come into Europe as an Arabian invention in the twelfth and thirteenth centuries, is not found on Greek vases. These, indeed, often show a high lustre, but the impression made is hardly that of a coating over the vase, and some persons have contended that the lustre of the unpainted surfaces, which is distinctly less high than that of the black varnish, is simply

¹ Furt. and Reich., I, Text, p. 12, state that on the François vase the white, or most of it, is laid on directly upon the clay, and that this is also true of one shade of red. In general, however, these colors were superimposed.

² Quite recently Dr. O. S. Tonks of Princeton has made a valuable study of the question (*A.J.A.*, XII, 1908, pp. 417 ff.), and has reached the conclusion by careful experiment that a glaze identical with that on Greek vases may be produced by a combination of eight parts of nitrate of soda to one of clay (pipe clay was used) fritted together, and then mixed in the proportions of two parts of frit to one of ferrous oxide.

³ Blümner, *Technologie*, II, p. 89. Vitriified glaze was known in Mycenaean times and in Assyria and Egypt, and may have been imitated in rare instances by Greeks, but the process appears to be distinctly foreign to real Greek work. Cp. Rayet and Collignon, *Histoire*, Chap. XXI.

the result of polishing by rubbing. The recent investigations of Reichhold, however, appear to prove the incorrectness of this view,¹ and to show that a thin, transparent wash was used on the surface of the vase, which not only heightened its lustre, but which also, through the coloring matter that it sometimes contained,² deepened the reddish hue of the unpainted parts of the clay. The black varnish, however, without doubt, has a lustre of its own, apart from any further application. But it is by no means always clear exactly how or at what stage of manufacture this wash was applied. There are reasons for thinking that in some cases this took place before the incised lines were drawn;³ on the other hand, there are examples of Attic vases of the later fifth century B.C. and of vases from lower Italy, upon which the application of the wash was the last thing to be done. It seems clear, too, from some instances that a brush was used in the process.⁴ That the vase itself was ever dipped in a solution, as has sometimes been thought, seems improbable.

In the red-figured technique, the figures appear, as has already been said, light upon a dark background. Here the painter began the process of decoration by tracing with a blunt-pointed instrument in the partially hardened clay the preliminary sketch. The general nature of this may frequently, usually indeed, be made out by careful examination, for, although the indentations of the instrument used are very slight, the reddish color contained in the glaze-wash has a tendency to collect in the depressions, and thus faintly to indicate their direction.⁵ The sketches often differ considerably from the final forms of the figures, but, even where this

¹ Cp. Furt. and Reich., I, Text, index *s.v.* Technik ("Lasur"). Cp. also Perrot and Chipiez, *Histoire*, VII, p. 218.

² Cp. Furt. and Reich., I, Text, p. 181.

³ Cp. Furt. and Reich., I, Text, p. 26.

⁴ Cp. Furt. and Reich., I, Text, pp. 54, 140, 145, 267.

⁵ Furtwängler and Reichhold have given several reproductions, both on their plates and in their text, of such sketches.

is the case, they were no doubt sufficient to be of material assistance in the distribution of the design. When this had once been determined, the painter next drew with a brush¹ the outlines; but these were traced *outside* of the spaces designed for the figures, and not *inside*, as in the black-figured technique (cp. Fig. 352, a partly finished drawing). Thus a red silhouette and not a black one was formed. In outlining the figures a narrow flat line of thinned varnish appears to have been employed, though at the period when the use of what is known as the "relief-line" was at its height, it may



FIG. 352.— Fragment, Berlin. *Jahrb. d. Inst.*, 14, p. 165.

now and then be a question whether this alone was not used to trace the outlines and the flat line of thinned varnish omitted. To make this technical question clear, however, it will be necessary briefly to explain the use and nature of the "relief-line."

Toward the later part of the sixth century B.C. in the red-figured technique and indeed, though rarely, also on black-figured vases,² a fine line appears which is slightly in relief. Sometimes this has a kind of groove in the middle of it, so that it seems almost double and again it shows a single well-defined edge; but in distinction from an ordinary flat line of varnish, such, for example, as frequently frames the picture on a vase, it stands

¹ A few instances of the survival of the incised line exist in the red-figured technique, but they are sporadic. Cp. Furt. and Reich., Pl. 32, I, Text, pp. 168, 171, and R. Norton, *A.J.A.*, XI (1896), p. 12. Such examples as these here cited are very rare, but in the early stages of red-figured work it is not uncommon that the outline of the heads of figures should be separated from the background by an incised line which is often wavy.

² Cp. Furt. and Reich., I, Text, pp. 165, 167.

out perceptibly from the surface.¹ Now about 500 B.C., or somewhat earlier, this is the quality of line which the vase-painters use for the interior drawing of muscles, drapery, etc., and often for the outline of the red silhouette. But it comes into use gradually, and, except in the work of the painters in the best period of the so-called "severe style," it is not always found on every part of the decoration. Where it was omitted the practice of the painter was unquestionably to outline the silhouette first with a narrow flat line, using a thin varnish, so that the line is dull; that is, lacks lustre (*matt*). Where, however, the relief-line is used to define the outline, it is by no means easy to say in most cases whether it is not laid on over a previously drawn flat line. Excellent observers maintain that this was the invariable practice, and it certainly appears to have been the common one, but there seem to be a few examples where the relief-line alone may have been used to define the outline of the figures.²

The omission of the relief-outline becomes more and more common after about the middle of the fifth century B.C., and in

¹ There has been much discussion in regard to the kind of implement with which this line was produced. Hartwig in an admirable essay (*Jahrb. d. Inst.*, 14 (1899), pp. 147 ff.) has argued that the painters used a small feather of the snipe. Reichhold, on the other hand (*Furt. and Reich.*, I, Text, *passim*, but especially pp. 148 and 230), after many careful experiments in which his opinion underwent considerable change, believes that the line was produced by a single bristle which was, of course, flexible, and which after being dipped in the varnish could be drawn (*schleppen*) along the surface of the vase, thus distributing the color not simply with its point but also with its length. By such a method he believes that the remarkable freedom and firmness of the lines can be accounted for. The consistency of the varnish, which, no doubt, was not always the same, had its influence in producing some of the results which may be observed on the vases. Tonks (see note 2, p. 429) reports interesting experiments in producing the relief-line. He could get no satisfactory result with a bristle, but succeeded when using an ordinary pen or a quill pen. Figure 353 shows a painter decorating a cylix.

² Cp. Hartwig, *Jahrb. d. Inst.*, 14 (1899), p. 162, who denies that the flat line was ever dispensed with. His article is of great value for the general study of technique.

some Apulian vases, for example, only the lines of the interior drawing appear in relief, unless these for any exceptional reason are continued to the outline.¹

When this, the first outline, was complete, a broader line which may be called the contour-stripe was painted over it or painted up to it, in case the relief-line was used. This enclosing stripe no doubt served as a protection to the outline of the figures when the background came to be filled in with black varnish (Fig. 352). If a vase is turned to the light at the proper angle, it is almost always possible to trace the course of this contour-stripe and to distinguish it from the rest of the background. In forgeries it is rarely successfully imitated, so that it is an important thing to look for in determining the genuineness of a vase.

After the outlines of the figures had been protected by the painting of the contour-stripe, there remained only two important steps before the firing of the vase; namely, the drawing of the details within the silhouette,—the faces, lines of the muscles, drapery, etc.,—and the filling in of the background. Thus the sequence of processes would normally be as follows: (1) the preliminary sketch with a dull-pointed instrument; (2) the outlining of the figures with a narrow, dull, flat line (at the height of the "severe style" it is possible that a relief-line was sometimes substituted for this); (3) the laying on of the contour-stripe; (4) the drawing of details (faces, muscles, drapery, etc.) in relief-lines, and the adding of the relief-outline when this was used; (5) the filling in of the background with black varnish, which covers up the thin, flat line of the outline and is painted close up to the relief-outline, where this is used; (6) firing.²

One cannot too greatly admire the skill with which in the best examples this inner drawing of the details was done. The firmness and delicacy of the relief-lines, drawn often to great length without a break, certainly show a power in rapid free-hand drawing which is little short of marvellous, and we should remember,

¹ Cp. the Apulian amphora in Boston, *A.J.A.*, XII (1908), pp. 406 ff.

² For transparent wash, see pp. 429 ff.

too, that this ability is manifested by handicraftsmen. Surely many of them deserve to be styled artists. Almost the same



FIG. 353.—Kylix. Boston. (*Jahrb. d. Inst.*, 14, Pl. 4.)

scene may indeed appear on two or more vases, and yet the copies are never quite alike, so that the painter seems to have worked, even in such cases, with some freedom.¹ Figures 353 and 354 are interesting representations of the painter at work and reveal the fact that he held his brush as the Japanese do

between forefinger and thumb, but turning the little finger toward the brush end. With the filling in of the background the decoration of the vase was



FIG. 354.—Hydria. Ruvo. (*Annali dell' Inst.*, 1876, Tav. d'agg. D, E.)

¹ An interesting unsigned copy or replica of a signed *kylix* by Aristophanes (Fig. 396) is to be seen in Boston (Museum Report, 1900, p. 49). Cp. p. 447, note 3.

complete, except for the occasional addition of some colored accessories. In red-figured vases these include only some minor details, though as this technique advances, it becomes more elaborate, and additional colors and gilding occur not infrequently. As in the black-figured vases, it seems doubtful whether more than a single firing was customary, but it is not improbable that the additional colors were fixed at a second firing.

Allusion has already been made to a third variety of technique which was practised, especially at Athens, during the fifth century B.C. and a little later; that, namely, of drawing in delicate lines on a white ground. This is really a kind of extension of a system the beginnings of which may be traced to a considerably earlier time in the technique that involved covering the surface of the vase with a light-colored slip upon which a black silhouette was painted. We find, for example, in "Rhodian" vase-decoration, and on the sarcophagi from Clazomenae (p. 461), some small portions of the design which are merely outline drawings on a light ground (sometimes spoken of as the "silhouette transparente"), and these are simply rather rude examples of the process which later in Athenian hands produced results of extraordinary beauty.¹ In the best examples of this technique, with which a broad use of bright color is often combined, are found some of the very finest specimens of Greek ceramic art.

STYLES

In the present state of our knowledge, the classification of the various styles of Greek vase-painting is an exceedingly difficult matter. Many theories still unproved have to be weighed and considered, and it would be unwise to insist on the finality of some of the views which now prevail. In spite of the progress

¹ Two exceedingly interesting specimens of this technique are to be seen in Boston (Museum Report, 1900, pp. 73-76), the one an *alabastrum*, the other a covered *cylix*. The *alabastrum* is of somewhat the earlier date. The *cylix* is figured at p. 508.

which has been made in recent years, the student must hold himself ready to modify to-day's opinions in the light of the possible discoveries of to-morrow. A classification based on chronological development is practically impossible, since different styles, even in cases where a later one seems to derive its origin pretty directly from one that is earlier, often exist side by side for a considerable period. It is therefore simpler to adopt in the main a classification by localities, although some deviation from this plan may often be necessary. At the very beginning, for example, in the first or Geometric style many regions are involved, nearly all of which betray some apparently local peculiarities.

Geometric

Geometric vases might very properly be classed in part as examples of prehistoric Greek art, since there is no doubt that this type of decoration existed in primitive rudeness side by side with vases of Mycenaean workmanship. On the other hand, the later limits of the developed style extend down in all probability to about the time of the first Olympiad, and the influence of the Attic Geometric or Dipylon style is clearly to be seen on other vases which are contemporary with or subsequent to this period.¹ It is therefore more convenient to treat it as the earliest of the Greek styles of vase-painting in distinction from the decoration which is classed as Mycenaean.

Geometric decoration is a characteristic manifestation of art among many primitive peoples all over the world. Thus, as might be expected, the primitive pottery of the Eastern Mediterranean

¹ The chronological development within the Geometric style is still imperfectly understood. The Geometric *oenochōē* (*Ath. Mitt.*, 6 (1881), Pl. 3 = Baumeister, *Denkmäler*, Figs. 2073, 2074, and *Ath. Mitt.*, 18 (1893), pp. 225 ff.), which has scratched upon it what is believed to be the earliest Attic inscription, might be of help here if we could be sure that the inscription was as old as the vase. Cp. Perrot and Chipiez, *Histoire*, VII, p. 224, and S. Wide, *Jahrb. d. Inst.*, 14 (1899), pp. 26 ff., 78 ff., 15 (1900), pp. 55 ff.

in its ruder forms shows schemes of ornament which are often of a geometric type. Not, however, until the decline of the Mycenaean civilization does this instinct for geometric decoration come in contact with a sufficient artistic impulse to manifest itself in what may truly be called a style of ceramic art. Even in Athens, where the style reaches its highest development under the specific designation of "Dipylon," derived from the city gate of this name near which much of the pottery has been found, it is always rude and primitive, vastly ruder than good Mycenaean work, and yet it betrays a growing power of imagination and an enlarged conception of the sources of pictorial decoration. Here first, in the Dipylon Geometric, we begin to see manifested in the work of the potter that interest in human activity and experience which is so characteristic of both the minor and major Greek art of a later age. Grotesque and primitive as the Dipylon men and women and animals are, their portrayal by the vase decorators suggests an originality which is full of promise for the future.

As has already been remarked, the Geometric style betrays many local peculiarities that seem to reflect the different traditions of decoration under which the potters worked.

Local types
In Crete, for example, the style appears to have remained in a comparatively primitive state, owing, it has been thought, to the persistence of Mycenaean influence, which tended to prevent the free development into more artistic form of the rude and primitive geometric patterns; in Melos Mycenaean influence is still strong, though here there are good examples of geometric work; in Attica the independent development is more marked, and so on. As to shape, the vases vary very greatly, from the immense grave *amphorae* of the Dipylon style¹ to ordinary portable household ware. The clay, too, shows considerable variety; that of the Attic vases, which is pinkish in tone, is of better quality than is usually found elsewhere, and is more carefully prepared. In some places the vases are treated with a slip upon which the

¹ Cp. the large amphora in the Bartlett collection in Boston and the great vase from Curium in Cyprus, in New York.

patterns are painted. The varnish used, which varies in color from brownish black to reddish brown, has but slight lustre, except in a variety of the Attic pottery known as "Black Dipylon." Here the undecorated surfaces of the vases are covered with a black paint that contains considerable glaze.



FIG. 355.—Amphora, ^{Theran} Athens. (*Jahrb. d. Inst.*, 14, 1899, p. 32, Fig. 8. h. 0.77 m.)

Several differing types are shown in the illustrations. Figure 355 is a form not uncommon in the island of Thera. The lower part of the vase is decorated with simple parallel bands which encircle it, and the principal pattern is on the shoulder and neck. A light yellow slip is ordinarily used on the surface of these vases, and the wheel ornament, though not invariably found, is yet characteristic of Theran geometric ware.¹ A specimen

of a Boeotian vase is given in Figure 356. Here the work is as a whole ruder. A whitish slip in many instances covers the somewhat rough surface of the clay and there is comparatively little variety in the pattern motives. The meander, so effective in geometric decoration as a whole, seems to be entirely lacking. Animals and occasionally human beings are found, and such a flying bird as the illustration shows appears rather frequently. A floral element also occasionally appears in the decoration (cp. Perrot and Chipiez, *Histoire*, VII, p. 214, Fig. 94), which lends it a character foreign to most geometric work. The near-



FIG. 356.—Boeotian bowl. Boston. (h. 0.253 m. Photograph.)

¹ See *Thera*, Vol. II (Dragendorff). Important for the Geometric vases in general.

ness of Attica unquestionably made Attic importations common in Boeotia, and a good deal of Dipylon pottery has been found there; but there is, nevertheless, good reason for believing in the indigenous character of the Boeotian Geometric decoration.

In turning to the Dipylon ware of Attica we meet the most interesting variety of Greek Geometric pottery. In spite of the grotesqueness of many of the scenes represented, the great sepulchral vases, which are the most important specimens

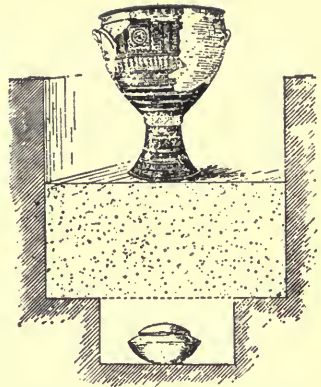

FIG. 357. — Dipylon crater. Athens. (*Ath. Mitt.*, 18, 1893, p. 92, Fig. 4. h. 0.95 m.)



FIG. 358. — Dipylon crater. Athens. (*Monumenti*, IX, Pls. 39, 40. h. 1.21 m.)

of this class, are striking examples of the potter's art.¹ There is in their decoration a distinct indication of a growing power to combine elements of design already known into larger schemes, and a certain flavor of originality which suggests vigor. It is therefore in no way surprising that they form the first step in the development of Attic ceramic art and that their influence may clearly be seen in succeeding generations. Figure 358, an often published vase in Athens, illustrates a scene frequently and appropriately depicted

¹ Cp. Figure 357 for one of these vases in position on a grave. In general see Poulsen, *Die Dipylongräber und die Dipylonvasen*.

on these vases — a funeral procession (*ἐκφορά*) with bands of mourners. The chariots in the lower row we may perhaps conceive of as ready to take part in the funeral games. Sometimes the mourning takes place around the couch upon which the dead person is laid out (*πρόθεσις*), a situation well shown in the fine fragment published by Rayet and Collignon, *Histoire*, p. 27, Fig. 19. The same scene is depicted later in Athenian ceramic art.¹ Thus even in the rude Dipylon style we see that intense interest in things human which is so characteristic of Greek thought in all its forms.² Besides funeral scenes and others of a more or less *genre* character the vase-painters of this period often depicted nautical matters. Figure 359 is one of the best illustra-



FIG. 359. —From a lebes found at Thebes. British Museum.
(*Jour. Hell. Stud.* 19, 1899, Pl. viii.)

tions of this. It has been thought that a bireme is here represented, but it is more likely that, by the primitive convention which is often used to make good an inability to draw in perspective, the upper line of rowers really represents the rowers on the further side of the ship. Of perspective the painters were almost wholly innocent, unless we may perhaps recognize a rude attempt at it in the representation of the further horse in pictures of chariots.

Figure 360 represents a type of small cup not uncommon in Dipylon ware. It shows, too, in the patterns which decorate it, much of the close resemblance to textile work which is evident

¹ Cp. Baumeister, *Denkmäler*, Figs. 217, 2114, and 2115.

² Cp. Butcher, *Harvard Lectures*, p. 42.

in the grouping of the designs of this style. So strong in certain cases is this resemblance¹ that a direct influence of the weaver upon the potter is often assumed. It is difficult, however, to feel sure that this view is entirely correct, since schemes of rectilinear geometric decoration may be seen in the ornamentation drawn by cave-dwellers,² in the work, that is, of men who were in too primitive a condition to be influenced by weavers.

Furthermore, as has already been said, rude geometric patterns exist in very early pottery in Greek lands, so that the material was at hand for the gradual formation of what is



FIG. 360. — Cup from Athens, M. Collignon's collection. (Rayet and Collignon, *Histoire*, Fig. 17.)

known as the Geometric style. The precise influences, however, which brought about the rise of this style are still largely a matter of dispute. Mycenaean elements unquestionably enter into the schemes of decoration,³ and yet as a whole the effect of the vases is quite un-Mycenaean. Some authorities have seen Egyptian influence here,⁴ others emphasize oriental elements⁵ and others attribute the type of art to the immigrating Dorians, who, if tradition be true, gradually put an end to the decaying Mycenaean civilization somewhere about the twelfth century B.C. This non-Mycenaean influence, whatever its source may have been, is certainly strongly individual and shows itself not only on vases, but in other forms of art, as, for example, on some of the early work in

¹ Cp. Perrot and Chipiez, *Histoire*, VII, Figs. 47 and 51.

² Cp. S. Wide, *Ath. Mitt.*, 21 (1896), p. 405.

³ Besides works already cited, cp. S. Wide, "Nachleben Mykenischer Ornamente," *Ath. Mitt.*, 22 (1897), and Böhlau, "Frühattische Vasen," *Jahrb. d. Inst.*, II (1887).

⁴ Kroker, "Die Dipylon Vasen," *Jahrb. d. Inst.*, I (1886).

⁵ That the Dipylon vases show some oriental influences is undoubted. Cp. *Ath. Mitt.*, 18 (1893), p. 113, Fig. 10, and *Ibid.*, 20 (1895), Pl. III, also the interesting vase in Perrot and Chipiez, *Histoire*, VII, Fig. 66.

metal found at Dodona and Olympia.¹ Very likely the Dorians may have contributed something to the new style, but it is also not improbable that the disappearance of the Mycenaean chieftains allowed a freer development to the geometric decoration already established in a rude form among the peasantry. Such a theory will, at any rate, make it easier to account for local peculiarities of style. The oriental influence which becomes so marked a little later is as yet quite subordinated to other elements.

Proto-Corinthian and Corinthian

After the free Mycenaean schemes of ceramic decoration had given way before the Geometric styles, another very strong influence, which was distinctly oriental in character, asserted
Corinth itself. Nowhere does this influence appear to have been so overpowering as at Corinth, where vase-painting at one stage of its development seems almost to lose the Greek flavor. At first thought we might expect that the coast of Asia Minor and the islands would have been the regions to succumb most completely to the invasion of Eastern schemes of decoration, but there Mycenaean traditions were apparently a good deal more persistent, and these entering, as they no doubt did, more or less directly into the formation of the various local styles, tended to weaken the oriental influence more than was the case at Corinth. Furthermore, there is a strong likelihood that the population of Corinth harbored many oriental traditions, and from an early date it was a Phoenician centre of trade. What more natural, therefore, than that local tendencies should here be materially modified, and that the various importations by the Phoenicians from the East should powerfully affect the development of the potter's art? From about the ninth down to the sixth century B.C. the influence of Corinth was carried far and wide. Its commerce extended to the limits of the known world; it became the mother of cities,

¹ Cp. Collignon, *Histoire de la sculpture grecque*, I, Fig. 41, and p. 50.

as of Syracuse and Potidaea, and from its famous family of the Bacchiadae tradition has it that Tarquin the Elder was sprung. Certainly the Corinthian influence in the gradual invasion of Italy by Greek ideas—an invasion which shows itself nowhere more clearly than in the vase-painter's art—must have been immense. With the development of this vigorous life at Corinth, there was, as might be expected, a growth of independence and a manifestation in art of the influence of the legends and traditions about which the civilization of Greece grew up. Thus, near the beginning of the sixth century B.C., the famous chest of Cypselus¹ of Corinth, a very thesaurus of Greek legend, was dedicated at Olympia. It was not only a manifestation of the skill of the industrial artists of Corinth, but it may also have exercised a great influence in fixing the *motives* of the vase-painters. The strong orientalizing tendency which the Corinthian vase-painters show at first is weakened as time goes on; the Greek element becomes the preponderating one, and oriental schemes are relegated to a subordinate position. The social history of the city seems to be reflected in the work of its artisans.

It may be regarded as certain that Corinth was the centre of an immense manufacture of vases, which formed the staple of a large export trade, but we should guard against the inference that all the vases classed as Corinthian were necessarily made in Corinth. No doubt there were other centres of manufacture dominated by Corinthian tradition. The important *celebae*, for example, found at Caere in Italy, are very likely of local manufacture, and the class of *oenochoeae*, an example of which is figured on page 78 of Rayet and Collignon's *Histoire*, is generally held to be of Italian origin. There is also good evidence that "Corinthian" vases were made in Boeotia. "Corinthian" tradition thus probably involves many elements, and its history is little understood.

Before turning to a more detailed consideration of the style, it will be necessary to discuss briefly an interesting and puzzling

- Co. H. Stuart Jones, *Jour. of Hell. Stud.*, XIV (1894), pp. 30 ff.

group of vases which is commonly known by the term "Proto-Corinthian."¹

This ware in its earliest form is as old as the later development of Mycenaean pottery.² Its decoration in this early stage is linear in character, of the type shown in Figure 361. Not infrequently we find added a band with a hare hunt represented on it,³ an example of which appears also in some later vases of this class (Fig. 363). On the shoulder of the vases is



FIG. 361. — *Lecythus*.
Athens. (*Argive
Heraeum*, II, p. 127,
Fig. 55. h. 0.06 m.)

often a radiating tongue-pattern (German *Stabornament*). The vases are commonly small *lecythi* or *alabastra*, finely made, and they were evidently greatly in vogue as toilet jars. The clay is usually pale yellow, sometimes a little pinkish, rarely even of a grayish tone, and the decorations are in brown or red, animal figures appearing as simple silhouettes without incision. As the style develops, it betrays Geometric influence, and

¹ Professor Charles Waldstein in the *Argive Heraeum* and Dr. J. C. Hoppin have substituted the name *Argive* for *Proto-Corinthian*, but with doubtful gain. The excavations at Corinth have yielded a great many of these vases, many have been found in Syracuse, a Corinthian colony, and Corinth itself may easily have been a more important centre of their manufacture than the Argolid. It may be admitted that the objections raised by some archaeologists to the use of *Proto-Corinthian* as a designation for the class of vases which it is intended to describe are reasonable enough, since it is by no means certain that all the vases included in the group should really be classed together, and the later and finer specimens are certainly not earlier than any but the later phases of the Corinthian style. Nevertheless, since the name has now come to be pretty generally applied to a recognized class, it seems better not to discard it, even though its actual meaning may be misleading, until a substitute which has scientific certainty is suggested.

² Cp. Dümmler. *Jahrb. d. Inst.*, II (1887), p. 19; Hoppin, *A.J.A.* (2d ser.), IV (1900), p. 445.

³ This scheme of decoration found on *Proto-Corinthian* and *Corinthian* pottery is apparently directly traceable to oriental influence. Cp. *Jour. Hell. Stud.*, XI (1890), p. 177.

we find such decoration as is shown in Figure 362. The shapes of the vases become somewhat more varied, and besides the *pyxis* a small *scyphus*, often very delicately made, is frequent (Fig. 364); a characteristic shape, too, is a small jug with long neck

(cp. Baumeister, *Denkmäler*, Fig. 2090).¹ Here, too, are sometimes classed, though perhaps incorrectly, a series of vases, both small *le-*



FIG. 362. — Pyxis. Syracuse. (*Annali*, 1877, Tav. d'agg. C, D, Fig. 9. Diam. 0.13 m.)



FIG. 363. — Lecythus. Boston. (*A.J.A.* IV, 1900, Pl. IV. h. 0.067 m.)

cythi and *oenochoe*, which are decorated with an incised fish-scale pattern (*imbrication*) strongly suggestive of metal technique (cp. Fig. 364, and the *Album of the Louvre Catalogue E 347*). These are especially interesting as showing the extension by incision of a pattern known to the Mycenaean period.

The third stage of the Proto-Corinthian ware is well illustrated in Figure 363.

¹ Many specimens of this geometric period of Proto-Corinthian ware have been found at the Argive Heraeum, at Corinth, and notably, near Syracuse; for the latter, cp. *Notizie degli scavi*, 1895, pp. 109 ff.

It is represented chiefly by a goodly number of small *lecythi*, which frequently show exceedingly careful and beautiful decoration. They are veritable masterpieces of Greek miniature painting. The handle often has a most elaborately designed guilloche on it, and even the top of the broad lip is usually carefully ornamented; the shoulder of the vase, in characteristic examples, bears an intricate development of a lotus and palmette design, the foot shows "rays," above which are often one and sometimes two narrow friezes representing animals, and a broad band about the centre of the vase carries the chief design. This is frequently the representation of a mythological scene, as in Figure 363 (Bellerophon and the Chimaera). Various shades of red and brown are used in many examples, and the figures are often incised with wonderful delicacy; the designs, while archaic, frequently show a freedom and life which make them rank high as examples of decorative art.¹

Between the linear and geometric groups and this third group of Proto-Corinthian ware there is a great gap, and yet enough ele-

¹ Perhaps the three most notable specimens of this very interesting type of ware are the so-called "Macmillan lecythus" in the British Museum (*Jour. Hell. Stud.*, XI, 1890, Pls. I and II), a *lecythus* in Berlin (*Jahrb. d. Inst.* XXI, 1906, Pl. 2), and the *oenochoe* of the Chigi collection in Rome, (*Antike Denkmäler*, II, Pls. 44 and 45). The two former vases (height of each about 0.07 m.) are noteworthy not only for the extraordinary delicacy of their ornamentation, but in each example for the shape of the top, which is modelled in the form of a lion's head; the Chigi *oenochoe* commands attention by reason of its form and unusual size (height 0.262 m.) and for its extended and brilliant decoration. The Judgment of Paris was represented on the Chigi vase, and the scene bears an inscription unfortunately however too much mutilated to give certain information as to the place in which the vase was made. The very few inscriptions which exist on Proto-Corinthian vases give little help in determining where the style originated. That in the Chalcidian alphabet incised on the so-called *lecythus* of Tataie from Cumae (*Inscrip. Graec. Antiquiss.*, 524) may be later than the vase, and the inscription painted on the *lecythus* in Boston, published by F. B. Tarbell (*Rev. Archéol.*, 1902, pp. 41-46), is not decisive, though it may be Chalcidian. In any case this vase differs both in shape and in the color of the clay from the usual Proto-Corinthian fabric. See also *Arch. Zeit.*, 1883, Pl. X, and *Mélanges Perrot*, p. 269, Pl. IV.

ments, such as the similar size and form of many of the vases and the narrow friezes of animals, appear to be common to both the earlier and later stages to warrant the usual classification. We must, however, suppose that a considerable period of time elapsed in the process of so marked a development, and that the third group felt the full growth of oriental influence, and very likely also the beginning of its decline before the growing independence of Greek work. Certainly it hardly seems possible to date the finer Proto-Corinthian vases earlier than the latter part of the seventh or even than the sixth century B.C., and so we cannot possibly place the third group before the coarser, orientalized ware of Corinth. Thus, in turning to the earlier phases of the Corinthian style, we must in all likelihood go back a good many years, since there is evidence that it was in use as early as about 700 B.C.,¹ and perhaps it may be placed even somewhat before this.

The clay of the older Corinthian vases is a pale yellow, which sometimes shows a greenish tinge. Often the surface appears to have been prepared for the decoration by the applica-
Corinthian
 tion of a slip which slightly modifies the natural color of the clay. The vases in this early period are small, and the most characteristic forms are the ball-shaped *aryballus* (Fig. 341, No. 17), the *pyxis*² (No. 15), which varies somewhat in type, the *alabastrum*, the *scyphus* (Fig. 365), and a squat form of the *oenochoe* (Fig. 365).³ The field on the vases is thickly strewn with rather heavily made rosettes and groups of dots, and it often seems so overloaded with such ornament that a carpet-pattern is suggested. In early specimens conventionalized vegetable ornament is not un-

¹ The tombs, though not the very earliest ones, near Syracuse, which was founded 734 B.C., have yielded specimens of Corinthian vases. On the general subject of Corinthian vases, see Wilisch, *Die altkorinthische Thonindustrie*.

² The famous Dodwell vase, now in Munich (Baumeister, *Denkmäler*, Pl. LXXXVIII), is a classic example of the *pyxis* with curved sides.

³ The *scyphus* here figured (365) has peculiar interest in that its decoration is almost precisely like that of a larger *scyphus* found in Samos (Boehlau, *Aus ion. u. ital. Nekropolen*, Pl. IV, 1, 1a). Such practical identity of design is very uncommon.

common, covering often the whole body of the vase, but the scheme of decoration which is most strikingly characteristic of the older Corinthian style is the frieze of animals (Fig. 365). The types of these are repeated with monotonous iteration. The deer, so common in the "Rhodian" vases, is less frequent, but the antelope, boar, ram, and lion occur constantly, and the panther, with head turned in full face, appears everywhere. Of birds, there are represented fowls, owls, and eagles, and among mythical animals, griffins, sphinxes, sirens, fish-tailed demons, and the like.¹ The animals are treated conventionally as elements in a scheme of deco-



FIG. 364. — Lecythus (h. 0.092 m.), scyphus (h. 0.089 m.), alabastrum (h. 0.07 m.). Boston. (Photograph.)

ration. They generally follow one another as in a procession, and are very rarely represented as disporting themselves or fighting. Now and then two are placed facing each other, sometimes in heraldic opposition, but they show little of the reflection of real life which we associate with Greek art, and the formality of the East is marked. The color-scheme exhibited on these early vases is that of blackish brown figures, parts of which are commonly rendered conspicuous by the use of a dark red of crimson tone. White is also found occasionally, though at this stage it is used very sparingly. The foot of the vase generally shows "rays." There is,

¹ Cp. Rayet and Collignon, *Histoire*, Pl. 4.



FIG. 365.—Scyphus (h. 0.09 m.), oenochoe (h. 0.142 m.). Boston. (Photograph.)

however, no more noteworthy feature of the Corinthian vases than the incised line, since here we find for the first time the extensive use of this important addition to the vase-painter's technique. Inscriptions, too, in the well-marked alphabet of Corinth, make their appearance (see the Dodwell vase, p. 447, note 2), and as the style advances we even find the signatures of artists coming in.¹ About the end of the seventh or the beginning of the sixth century B.C. is probably the time when a change in Corinthian pottery becomes marked, though no doubt the older type of vase might still continue to be manufactured. The *hydria*, a taller *oenochoe*, the *amphora*, the *dinus*, a *cylix* without the stem, become usual, and, above all, the *celebe* (Fig. 366) appears. This latter form is characteristic of a considerable series of the later Corinthian vases found at Caere in Italy, many of which are noteworthy for their mythological illustrations.² The clay in these later vases often has a reddish

¹ Cp. Klein, *Die griech. Vasen mit Meistersignaturen*, pp. 28 f. Timonidas and Chares are the names which occur. Cp. *Ath. Mitt.*, 1905, pp. 199 ff.

² This form at Corinth itself is rare; see, however, Richardson, *A.J.A.* (2d ser.), Vol. II (1898), pp. 195 ff.

tinge which is foreign to the earlier ones. White applied directly to the clay ground is freely used on extended surfaces,¹ and is regularly employed to represent the flesh of women. In general, the characteristics of the later period are the omission of the bands of animals or their relegation to a subordinate position, and the introduction of human figures and scenes of human interest as the chief element in the scheme of decoration. Eastern formality gives way before Greek freedom. At first the change seems rather tentative, and we have only single human figures ; then rows of war-



FIG. 366.—Celebe. Vatican. (h. 44 m.) (Photograph.)

rriors and horsemen, the latter usually small men on tall horses ; an eagle is often represented following the riders. Occasionally gay dancing scenes are introduced (Baumeister, *Denkmäler*, Fig. 2099), and finally really elaborate compositions, illustrating the current legends of

the people. This latest development of Corinthian pottery associates it closely with the art of the chest of Cypselus, and suggests also the highly probable theory that the vase-painters felt the influence not only of the popular mythology, but also that of the larger art of a school of painting. That the Attic vase-painters of the fifth century B.C. felt such an influence is hardly open to question, and it is a significant fact that Greek tradition in regard to the rise of painting assigned an important rôle to Sicyon and Corinth,² and that the legendary artists, Eucheir and Eugrammus, were said

¹ Cp. *Ath. Mitt.*, IV (1879), Pl. XVIII.

² Cp. Overbeck, *Schriftquellen*, Nos. 381, 382.

to have been Corinthians. Among these Corinthian *celebæ* from Italy, there is perhaps none more interesting than the one in the Louvre upon which is represented the banquet of Heracles at the house of Eurytius (Fig. 367). In its various schemes of decoration the vase seems a kind of summing up of Corinthian *motives*.¹ At the foot appear the characteristic "rays," then next above comes a narrow frieze representing galloping horsemen; above that follows



FIG. 367. — Heracles and Eurytius. Louvre. (h. of vase, 0.46 m.) (*Monumenti*, VI, Pl. 33.)

the broad band upon which on one side of the vase is painted the banquet scene; on the shoulder runs a conventional palmette-lotus pattern, and on the surface of the lip is a row of the stiff Corinthian animals, among which the hare hunt is introduced. The various zones are divided from one another by bands of red and black, and red of a crimson tone is freely used on the figures. The drawing in outline of the woman's face and of the dog under the couch of Heracles, with the unpainted surface of the vase as a background,

¹ Cp. Pottier, *Catalogue*, p. 481 ff.

is not in keeping with the usual Corinthian technique, and may very likely be attributed to Ionic influence. The names of the persons present at the banquet are all given in the Corinthian alphabet — Τόξος, Κλύτιος, Διδαίφρον, Εὐρύτιος, Φίφίτος, Φιόλα (Iole), Ηερακλῆς. Behind Heracles a carver is engaged in cutting up the meat. On the other side of the vase, on this same broad band, is a scene of combat which, with its kneeling archers, suggests the somewhat later Aeginetan pediments, and under one handle is represented the suicide of Ajax witnessed by Diomed and Odysseus. Such a complicated composition certainly betokens a great advance from the period of the conventional rows of animals. But after this stage was reached, the vase-painting of Corinth seems to disappear before the growing importance of Attic ceramic art, and, though it unquestionably affected the latter, as will be noticed when we come to consider the complicated influences which appear in the Athenian pottery of the sixth century B.C., its day was over, and, like Corinth itself, it becomes of relatively small importance.

One other manifestation of the art of the Corinthian potters which is very closely allied to the vases, calls for mention. This is a series of small clay plaques, *pinaces* (πίνακες), found at Penteskouphia, to the southwest of the Acrocorinthus.¹ They are dedicatory offerings to Poseidon and Amphitrite for the most part, with figures of these deities represented upon them. There are, however, also some interesting scenes picturing handicraft — the potter's wheel, kilns for firing vases, miners at work, one or two representations of ships, etc. (cp. Figs. 343-349). The *pinaces* differ a good deal in size, varying from a few centimetres in either dimension to a width of 0.20 m. The clay is of the light yellow color, slightly greenish in tinge, which is so characteristic of Corinthian pottery. The figures are done in a brownish varnish, sometimes simply as silhouettes, and again with the addition of red

¹ See for the publication of this series, *Antike Denkmäler*, I, Pls. 7 and 8; II, Pls. 23, 24, 29, 30, 39, 40; *Gazette Archéol.*, 1880, pp. 101-107; *Monuments Grecs*, Nos. 11-13 (1882-1884). Cp. also Pernice in *Jahrb. d. Inst.*, XII (1897); see also, *Hermes*, XXXVI (1901), pp. 387-393.

and white, and with incised lines. The technique is thus that of the vases. Inscriptions, chiefly dedicatory, which have made an extensive addition to our specimens of the Corinthian alphabet, appear very generally on the plaques.

The difficult problem of the mutual relation between Corinthian and Proto-Corinthian pottery cannot be discussed at length here. Nor is it likely that, with our present knowledge, a solution which will meet with general acceptance can be reached. Strictly speaking, only the two earlier stages of Proto-Corinthian ware are really *proto-Corinthian*, and the third and finest stage seems to betray some other than Corinthian qualities. Emphasize the resemblance between this and the Corinthian vases as we may, there is still not only a delicacy, but a freedom and life about these exquisite little specimens of miniature painting which is not found in the work of the latter style. The Proto-Corinthian background ornaments (*Füllornamente*) are different, too, and of lighter design, suggesting "Rhodian" rather than Corinthian work, and the splendid Chigi vase, already mentioned, in the brilliancy and variety of its colors and in its technique (especially in the outline-drawing of the heads in the group of goddesses), strongly suggests Ionic influence, the influence, that is, of Asia Minor and the islands.¹ Perhaps, therefore, in the finest Proto-Corinthian vases we have the manifestation of an oriental influence which is not transmitted through Corinth as a medium. Chalcis in Euboea, with its Ionic traditions, has often been suggested as the place which may have introduced this style into Greece,² and the theory

Proto-
Corinthian
and
Corinthian

¹ This same outline technique may be seen in a lion's head on a Proto-Corinthian vase fragment, *Argive Heraeum*, Vol. II, Pl. lxiv, No. 3.

² Cp. H. Stuart Jones, *Jour. Hell. Stud.*, XVI (1896), pp. 333 f. Mr. Jones appears to lay an unduly strong emphasis on the resemblance between some of the Syracusan and Cumaean Proto-Corinthian ware and the so-called Proto-Boeotian (early geometric) vases. The linear character of the early Proto-Corinthian style, as Hoppin suggests, may well be a direct inheritance from late Mycenaean. A valuable article on Proto-Corinthian pottery is that of O. M. Washburn, *Jahrb. d. Inst.*, XXI (1906), pp. 116 ff.

may be correct, but as yet we have little knowledge of the local ceramic art which led up to the small class of sixth century vases known as Chalcidian. These do indeed show a strong resemblance to the Corinthian style, and this fact has a significant bearing upon the theories which are advanced to explain the origin and affinities of the Proto-Corinthian vases, especially those of the most finished class.

Ionic

There is at present great difficulty in discussing what have in recent years come to be called the Ionic vases, for as yet our knowledge of the origin and the interrelations of these styles is very imperfect. Much that has been written of them is still no more than suggestive theory. Furthermore, the development of vase-painting in Asia Minor and the adjacent Greek islands is very varied in character and it is extremely uncertain whether the term "Ionic" is applied to certain classes with correctness. Ionic, too, has been made to include more styles of vases than it is possible to discuss in the limits of a handbook, and it is necessary to select for brief treatment those which are best known and which may be deemed most typical. The styles here selected for mention are the so-called Rhodian, the so-called Melian, that of the sarcophagi of Clazomenae, that of some of the vases of Naucratis and Daphnae (Tell Defenneh) in Egypt, the so-called Cyrenaic style, and that of the Caeretan *hydriae*.

In general it may be said that in the development of early Ionic ceramic art there are found more reminiscences of Mycenaean art than appear in the early styles of Greece proper, and this fact is rightly deemed of high importance, since the direct relation of Mycenaean art with that of Greece is as yet insufficiently established. As Ionic art develops, it exhibits a freedom and variety which would be the natural result of the vigorous trade that existed in the eastern Mediterranean from the eighth and seventh centuries B.C. on. There was undoubtedly in these regions at this time a wide intercourse not only with the Greek mainland, but also

with Magna Graecia, with Egypt, with Lydia, and with the farther East, for we find in much of the pottery an oriental influence hardly less marked than in the vases of Corinth. As there, however, it is the Greek spirit which in the end prevails. The important cities more or less closely linked together politically — Miletus, Priene, Ephesus, Colophon, Lebedus, Teos, Phocaea, and Clazomenae — may almost certainly be regarded as the chief centres of intellectual and artistic life in Ionia, even when the manifestations of such activity are found in communities of Doric origin like those of Rhodes.

Speaking generally, Ionic traits of the early periods are the use of a light-colored slip on the clay, which serves as a foundation for the decoration in black glaze, the comparatively rare occurrence of incised lines, the use, commonly for only a part of the figure, of contour lines drawn in outline on the slip,¹ and the "reserving" of narrow lines or patches, to indicate details in the silhouette, which are sometimes colored and sometimes show merely the slip of the ground. *Motives* taken from plant life are characteristic and point very likely to a Mycenaean survival, and the frieze of animals, suggesting oriental influence, is found, though the heraldic opposition of the Corinthian style is rare. As the art advances, in the latest classes the light-colored slip is not used, and human figures appear, incision is common, and the technique of the vases in general resembles that of Attic black-figured work. Details of costume point to oriental influence, and there is great vivacity of movement and often much humor. The figures are heavier than in early Attic work, less dry, but also less elegant. Men and women are in some cases (*e.g.* on "Melian" vases) distinguished by difference in the color of the flesh, but not by the shape of the eye, as in Attica, and there is great variety of physiognomy. Inscriptions are rare. The seventh and sixth centuries B.C. cover the period of most importance in

¹ Cp. *B.C.H.*, 1895, Pl. 2. This practice of outline drawing is occasionally found on early ware elsewhere than in Ionic regions (*e.g.* in Boeotia), but it appears to be a distinctly Ionic practice. Cp. pp. 452, 453.

the development of Ionic vase-painting and, as this corresponds with the time of the chief activity of the earlier Ionic sculptors and painters, we may no doubt assume the existence of a con-



FIG. 368. — Oenochoe. Boston. h. 0.35.
(Photograph.)

nowhere more clearly shown than in the “Rhodian” vases, whether “Rhodian” we consider these of necessarily local manufacture or accept the theory now frequently put forward that they are of Milesian origin. The shapes of the vases vary considerably, but the *oenochoe* (Fig. 368) and *pinax* (Fig. 369) are markedly characteristic. Much of the minor detail seems inherited from the Mycenaean age, though the general scheme of decoration also betrays a strong oriental influence, fostered very possibly by the imitation of Eastern textile fabrics of various kinds. Eastern in origin, too, are many of the animals represented, often hybrid in character, like the sphinx, griffin, chimaera, etc. The light-colored clay is

considerable influence on the minor by the major art. The extant remains of works in sculpture of the early Ionic school, such as the marbles from the earlier temple at Ephesus and the “Harpy Tomb,” show how skilful the sculptors were, and tradition has furnished us the names of artists like Bathycles of Magnesia, who made the throne at Amyclae, and Boularchus whose picture of the defeat of the Magnetes was bought by the Lydian king Candaules for its weight in gold.

The features of the earlier Ionic ceramic art are

covered with a yellowish white slip, and on this as a background the figures are painted. A dark brown is much used and deep red and white are also found. These colors are apparently fixed only by a second firing, for in many instances they have flaked off. The scheme of decoration shown in Figure 368 is most characteristic. Figures of animals following one another are arranged in encircling bands, the heads being usually drawn only in outline. The neck of the vase often bears a geometric pattern or a braided band, and around the foot are commonly lotus flowers and buds. In the field of the bands the ground-ornaments consist of rosettes, stars, circles, the swastika, etc. ; palmettes between spirals are also common, and we sometimes find the conventional eye, very characteristic of later Ionic pottery.¹

The character of the *pinaces* is much the same, only the form makes a leading central design the prominent feature. The tendency to decorate in bands is, however, so strong that beneath the main design a segment of the circle of the *pinax* is often found, and this is filled with some conventional pattern or even with a subordinate drawing of a figure, as in the *pinax* published in Rayet and Collignon's *Histoire* (Fig. 27), where this subordinate design represents a swordfish.



FIG. 369. — Plate or pinax. Boston. Diam. 0.305 m. (Photograph.)

The decoration is, as a whole, very effective, superior in its general simplicity and freedom from overcrowding to that of the earlier Corinthian vases which in oriental tendencies it recalls. Sometimes, however, this greater simplicity is not so evident, as in the decoration of the well-known and often published Euphorbus *pinax* of the British Museum (Salzmann, *La Nécropole de Camirus*, Pl. LIII) which reproduces an incident from Epic narrative mentioned in the *Iliad* (XVII, 82 ff.)—the combat of Hector

¹ Cp. Boehlau, "Die ionischen Augenschalen," *Ath. Mitt.*, Vol. 25 (1900).

and Menelaus over the body of Euphorbus. Here brighter colors are profusely used and the field is crowded with various characteristic ornaments. This *pinax* has the further peculiarity of bearing inscriptions in the Argive alphabet which designate the figures represented, and from various points of view it seems a decidedly exceptional specimen of the "Rhodian" ware.

Another ware has taken its current name, Fikellura, from one of the burial places at Camirus, in Rhodes. In origin it is thought not improbably to be Samian.¹ It may at any rate be counted among the wares which appear to have kept Mycenaean traditions unmodified by having passed through a geo-



FIG. 370. — Fikellura amphora, British Museum. h. 0.285 m. (Boehlau, *Aus ion. u. ital. Nekropolen*, Fig. 25.)

metric era, and so is rightly held to be of importance in showing the preservation of earlier *motives* in decoration. Figure 370, a vase in the British Museum, illustrates one characteristic example of this class, the technique of which is essentially the same as that of the ordinary so-called Rhodian pottery. Sometimes, however, the ware does not have the horizontal division of the design here shown, but spirals, palmettes, etc., are introduced upon the undivided surface of the vase, and in such examples the vase is especially reminiscent of Mycenae. A network pattern is

also not uncommon, and this often shows a considerable variety in the design of the mesh.

Another class of vases which in technique and style exhibits many of the Ionian characteristics is that which is generally known as Melian, because the first specimens of it were found many years

¹ Cp. Boehlau, *Aus ionischen und italischen Nekropolen*, pp. 52 ff.

ago in Melos.¹ Until recently, examples of these vases were few in number and of the form of *amphora* shown in Figure 371. In 1898,



FIG. 371. — Melian amphora. Athens. h. 0.92 m. (Conze, *Melische Thongefässe*, Pl. I.)

however, they were “Melian” much increased by excavations on the island of Rheneia which yielded a large number of “Melian” *hydriae* of the type illustrated by Figure 372. These, it is conjectured with much probability, were brought from Delos



FIG. 372. — *J.H.S.*, XXII, p. 49, Fig. 1. (A drawing made up of typical designs, not an existing vase.)

¹ Cp. Conze, *Melische Thongefässe*, Leipzig, 1862. The classification of “Melian” vases as Ionic is probable, but doubtful. J. H. Hopkinson (*Jour. Hell. Stud.*, XXII, pp. 47 ff.) thinks that the vases are “Delian,” though very likely made from imported clay. They, at any rate, represent an island manufacture, of technique closely resembling the Ionic (yellowish slip, “reserved” spaces, drawing in outline, very little incision, and some of the orientalizing tendencies), but local tradition may have greatly influenced development. Hopkinson recognizes the “Sub-Mykenaeen” character of “Rhodian,” Samian, and “Delian” wares and their kinship with one another, so that the question of calling “Melian” (or “Delian”) Ionic becomes merely one of formal classification.

at the time the Athenians effected a purification of the island in 426-425 B.C. and removed a number of ancient graves. The new series of "Melian" vases, now the chief treasure of the little Museum on the island of Myconos, affords impressive testimony to the importance of this island style of vase-painting. This noteworthy ceramic collection, still unpublished, except for the article of Hopkinson referred to in Note 1, p. 459, everywhere shows what have been called Ionic characteristics, and one or two specimens combine these with motives and technique which are Corinthian, (cp. Boehlau, *Aus ion. u. ital. Nekrop.*, p. 85), thus suggesting how complicated the interrelation of styles may become. In general it may be said that the "Melian" system of decoration shows geometric tradition in much of the distribution of the design and in the ground ornaments, but that the actual ornamentation is largely curvilinear and suggestive of the traditions of Mycenaean art. Oriental influence is also marked, but the representation of the hybrid eastern animals is apparently giving way to scenes from Greek mythology; witness the often published "Melian" *amphora* at Athens showing Apollo and Artemis (cp. Rayet and Collignon, *Histoire*, Pl. 3) and the Heracles and Iole, or possibly Deianeira, on a similar vase ('Εφ. 'Αρχ. 1894, Pls. 12 and 13). This is what might be expected during the seventh century B.C., at which time the vases may be approximately dated. Another "Melian" *amphora* at Athens (*Jahrb. d. Inst.*, II, 1887, Pl. 12) deserves especial attention, since it seems to approach the *hydriae* somewhat more closely than the other *amphorae* do in style of decoration. Here a sphinx is introduced on the chief band, and on the neck a human face in outline, like that shown in Figure 372. At the time when this important class of vases was manufactured, the potter's art had evidently reached in the islands a stage of very considerable advancement. It seems a not improbable theory that on the basis of a geometric style, local in character, Ionic and eastern influences had been imposed, and that these influences had become paramount in the work of the potters. A somewhat

similar process of development appears to have taken place in Attica among other localities, only there the Geometric style was carried much further in the Dipylon vases before the outside influences became effective.

In the sarcophagi of Clazomenae, we have, on the whole,

the most satisfactory examples of Clazomenian sarcophagi

Ionic ceramic painting which exist, for, apart from the high excellence of many of the specimens themselves, their discovery on the site of an important Ionian community makes the evidence which they afford peculiarly trustworthy. Between twenty and thirty specimens are to be found in different museums, though many are in a very fragmentary condition. In general form there are two types, in one of which the shape is on the lines of a parallelogram, in the other the foot of the coffin is somewhat narrower than the head, and the sides converge from the top to the bottom (Fig. 373). The first shape of sarcophagus appears to have had a cover in the form of a gable roof, as is

best shown in the splendid example¹ now in the British Museum, the cover of which is elaborately decorated in every part. The sec-



FIG. 373. — Sarcophagus. Berlin. Length 2.08 m. (*Ant. Denk.* II, Pl. 26.)

¹ Joubin, *De Sarcophagis Clazomeniis*, No. 25; *Terracotta Sarcophagi in the Brit. Mus.*, Pls. 1-7; *Monuments Pict.*, IV, Pls. 4-7.

ond shape was apparently covered merely with a flat slab of stone. Since the chief decoration of most of the sarcophagi is found on the top rim of the receptacle, and this must have been concealed when the coffin was closed, it should no doubt be regarded as an elaborate frame for the exposed body at the time of the funeral. In some examples there are decorations on the sides of the receptacle and even on the interior.

The general character of the decorations is in harmony with such meagre traditions as we have about early Ionic painting.¹ The subjects are prevailingly battle scenes with some scenes of the chase; figures of animals appear frequently, often painted with great delicacy and spirit, and occasionally the scenes betray the influence of Epic tradition, as in the episode, from the *Iliad*, of Diomed and Ulysses with Dolon.² A yellowish white slip is used to prepare the surface for the painting, and on this there appears the characteristic Ionic technique with "reserved" spaces and lines to indicate the drawing within the contour of the figure; for this purpose, however, white or even deep red paint laid on over the black of the silhouette is sometimes employed in the case of what are thought to be later examples. Rarely we find the technique used on the fine specimen shown in Figure 374, where the lion and the boar, done in white with inner drawing in black lines, stand out from a background filled in with black glaze. This last process is analogous to the later technique of the red-figured vases, and thus probably points to the final development in the series of sarcophagi. It should, however, be noted that the earlier practice of reserving spaces and lines persists on portions of even the later specimens, as is shown on the lower parts of Figure 373. In the development of the decoration it is not always easy to be sure of chronological sequence, but speaking generally it may be assumed that those sarcophagi which show the most elaborate designs, involving complicated groups of human figures, are later than those which show the simpler and more primitive schemes of

¹ Cp. Overbeck, *Schriftquellen*, Nos. 375, 377, 381, 611, 612.

² *Antike Denkmäler*, I, Pl. 44.

decoration. The use of bright color, too, and such technique as Figure 374 shows, indicate the later period. The sixth century B.C. may with strong probability be assigned as the time when most of the sarcophagi were made, though a few specimens are somewhat earlier in date.

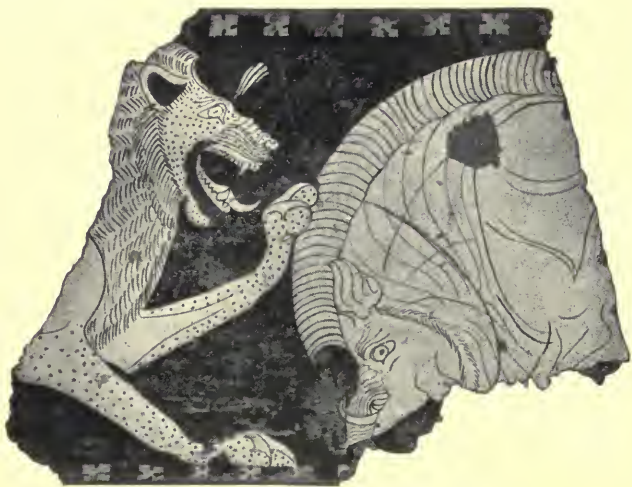

FIG. 374. — From a sarcophagus in Berlin. (*Ant. Denk.* II, Pl. 25.)

In Africa we know that there were at least three places where the influence of the Ionian potters was felt — at Naucratis and Daphnae (Tell Defenneh) in the Nile Delta, and at Cyrene.

There are still many unsolved questions touching the mutual relations of the art of these places, and the line between objects that are of local manufacture and those which were pretty certainly imported is in many cases not easy to draw. At Naucratis, which very likely had a Greek colony in it as early as the middle or toward the close of the seventh century B.C., there are two classes of pottery which claim special attention. The first¹ shows at a

Africa

¹ For illustrations see Walter's *History*, I, Pl. XXIV, Fig. 2, and "Memoirs of the Egypt Exploration Fund," *Naucratis*, II, Pls. V ff.

glance its close relation to the "Rhodian" ware, which, as has been said, is very likely of Milesian origin, — a theory which gains much strength from the fact that Milesian influence was certainly strong in Naucratis somewhat later than the time of these vases. This "Rhodian-Naucratite" ware shows some changes as it develops, and in its more advanced stages incised lines frequently occur. Some of the fragments indicate that mythological subjects were treated, and on the whole the pottery seems to reveal on the part of the vase-painter more originality and skill than the "Rhodian" work does. Without colored plates it is impossible to convey



FIG. 375. — From Naucratis. British Museum (A. 985). (*J.H.S.*, VIII, Pl. 79.)

the general effect of the painting, which in color-scheme is bright and rich. Thus the vases may be regarded as a somewhat later development of Ionic work than the ordinary "Rhodian" ware. The second class of Naucratic pottery, represented by Figure 375, is distinguished by the use of a creamy white glaze as a background for the design,

in which dark red, various shades of brown, and white are employed. Incised lines are not found in the better specimens, and the drawing of contours is in simple outline. The vases which represent this highly polychromatic style are *craters* with a flaring conical rim (*Naukratis*, I, Pl. X, Figs. 1 and 3), and they have on the inside a different style of decoration. Here the designs are in black, with patterns showing the lotus, rosettes and the like, in red and white. This ware with its rich coloring is perhaps the most original of the Naucratic styles which, as time goes on, show that they came to feel strongly the influence of Corinth and Athens.

The characteristics of Ionic pottery are no less marked in many of the vases which have been found at Daphnae, though here the

most important type of ware (Fig. 376) is not closely connected with the "Rhodian" vases, but with the later styles of the sarcophagi of Clazomenae and the Caeretan *hydriae*. Some vase fragments found at Clazomenae, it should be added, are so like this Daphnae pottery that there are those who believe it was imported into Africa and is not to be classed as of local manufacture. This



FIG. 376.—From Daphnae. British Museum (B. 116). (*Ant. Denk.* II, Pl. 21.)

view has been much strengthened by the publication of a series of almost certainly Clazomenian fragments from Benha in the Nile Delta (*Ant. Denk.*, II, Pls. 54-57). The technique is illustrated by a series of tall, slim *amphorae*, and by *stamni* and *hydriae*, though in the case of the latter shapes hardly more than fragments remain. On some of the earlier vases at Daphnae a slip is used for the ground of the decoration, but on the finer ones the figures are painted directly on the clay, which is of a reddish

yellow color and smoothly polished. The flesh of the women is rendered in white, that of the men in brown; but white is also used for other purposes, as, for instance, to represent the dog seen below the horse in Figure 376. Another interesting fragment (*Antike Denkmäler*, II, Pl. 21, Fig. 3) shows two warriors facing one another. Here we find the peculiar hooks at the front of the helmets which appear on the sarcophagi of Clazomenae, and the representation of a boar in white on one of the shields bears a very strong likeness to those on the sarcophagi.

The interesting class of vases known as Cyrenaic offers various difficult problems which will find adequate solution only when the city of Cyrene is explored. This important town¹ was founded by Greek colonists from Thera, probably toward the latter part of the seventh century B.C. It lay near the great Syrtis, on the trade route between Carthage and Egypt, and rapidly attained to a high position in the Greek world. One of the



FIG. 377. — Cylix with representation inside of Arcesilaus. Diam. 0.293 m. (Photograph.)

chief staples of its industry was the agricultural product silphium, and the head of the plant became an emblem on the coinage of the city. It is the weighing out of this product for export which appears to be represented on the inside of an often published *cylix* now in the Cabinet des Médailles in the Bibliothèque Nationale at Paris.² The king Arcesilaus presides over the weighing, while laborers store the silphium, packed in bags, in the hold of a ship. The outside of the *cylix* is represented in Figure 377. Unfortunately it is not possible to be sure which Arcesilaus the designer had in mind, since there were four kings of that name at Cyrene. In all probability, however, it is Arcesilaus II, whose reign is to be dated approximately from 580–550 B.C. This Arcesilaus *cylix* gave the clew to the localizing of the style, and about

¹ Cp. Studniczka, *Kyrene*.

² Cp. Baumeister, *Denkmäler*, III, p. 1664.

it have been grouped a considerable number of vases¹ mostly, though not exclusively, of the *cylix* form. The designs are painted in black glaze upon a slip which varies from a cream color to a somewhat deeper shade; purple is also used freely, and there are skilfully drawn incised lines. Noteworthy are the effective conventionalized flower patterns based upon the lotus and pomegranate, or perhaps upon the silphium blossom. The scenes



FIG. 378. — Cylix. British Museum (B. 4). Diam. 0.266 m. (*Naucratis*, I, Pl. VIII.)

represented by the potters are treated with great freshness and *naïveté*, and cover a very considerable range of subjects, such as Atlas, Prometheus, the blinding of Polyphemus, Cadmus, Zeus, and the representation of Arcesilaus already mentioned. One interesting vase (Fig. 378) discovered at Naucratis, though unfortunately much broken, represents in all probability the nymph Cyrene holding a branch of silphium and a pomegranate. The field is filled with little daemons who move about the central figure. Most of the vases were found in Italy, though a few have turned up

¹ Cp. Walters, *History*, I, p. 344 note; *Jh. Oest. Arch. I.*, 1907, pp. 10 ff.; *Rev. Arch.*, IX, 1907, pp. 377 ff., and X, 1907, pp. 36 ff.

in Samos, and there is the one just mentioned from Naucratis. The finding of this latter vase raises the question whether the pottery is really Cyrenaic at all, but taking everything into consideration, and especially the fact that the relations between Cyrene and Naucratis were probably pretty close, there seems no good ground for doubting the correctness of the commonly accepted view. That it is of Ionic type, there can be no question.¹

The last class of Ionic vases to be considered here, including about twenty known specimens, is that of the so-called Caeretan *hydriae*. They were discovered at Caere (Cervetri) in Etruria, and represent what is commonly considered the late development of the distinctively Ionic ceramic art. Their approximate date may be placed at the middle of the sixth century B.C. In general form these *hydriae* show an egg-shaped body with well-defined shoulder. A moulded ring appears at the juncture both of the neck and of the foot with the body of the vase, and the handle at the back is ribbed. The handles at the side are plain, and where they join the body there is a radiating tongue-pattern. A tongue-pattern is also used on the inner edge of the mouth of the vases, as well as on the foot with concave outline. The main design is on a broad band which includes the handles at the sides, and these separate the design on the front of the vase from that on the back, which is often further divided by a palmette pattern introduced at the point of juncture between the vertical

¹The so-called (*J.H.S.*, XXX, 1910, pp. 1 ff.) Cyrenaic pottery has been found at Sparta, and the vases constitute a full series reaching from Geometric times to the fifth century B.C., when a degeneration of the style sets in. They are thus presumably of local manufacture. This fact has led the excavators to the conclusion that an earlier theory which regarded "Cyrenaic ware as Laconian" is correct. If to regard the pottery "as Laconian" merely means that the newly discovered series is of local manufacture, the reasonableness of this view will probably not be disputed; if, on the other hand, it means that Laconia was the original home of the ware and the chief centre of manufacture, ampler proof is needed. The series of Proto-Corinthian vases from the Argive Heraeum is complete, but the use of the term "Argive" for them has not found general acceptance; see note 1, p. 444.

handle and the body of the vase. There are commonly but two subordinate bands, one just above the foot, decorated with rays, the other with elaborate and often very graceful floral designs; now and then human figures appear to have been introduced here as on the famous Busiris vase (Furt. and Reich., I, Pl. 51). Often, too, extremely beautiful floral designs are found on the shoulder of the vase, an ivy pattern being especially frequent.

The neck is frequently decorated with a palmette and lotus, or with a cross, the arms of which are developed in spirals or in a meander; occasionally, however, rosettes are introduced here, as in Figure 379. The color-scheme is bright, red and white being used, and the black of the figures is laid directly on the clay, without the use of the slip so common in earlier Ionic work. Incised lines are frequent, sometimes surrounding the entire out-



FIG. 379. — Caeretan hydria. Berlin. h. 0.43 m.
(*Ant. Denk.* II, Pl. 28, text.)

line of the figures, as is the case in the example shown in Figure 380.

The Caeretan *hydriae* exhibit a great variety in the subjects, often mythological, which are represented upon them. We find the Calydonian boar hunt, Europa and the Bull, the return of Hephaestus, Heracles and Busiris, Heracles bringing Cerberus to Eurystheus, etc. The vase representing Heracles and Busiris, now in Vienna, is perhaps the most remarkable of the whole series, both in the beauty of some of its floral decoration and in the life and vigor of the scene portrayed upon it. The vase-

painters are still in the period of archaic *naïveté*, but their work shows great freshness and originality, and often apparently a good deal of humor. The *hydria* in Berlin (Fig. 380) has an especial interest in that the treatment of certain of the figures bears a close analogy to the work of the Ionic sculptors of the earlier marbles of Ephesus (cp. Winter, *Jahrb. d. Inst.* 15 (1900), pp. 83 ff.).



FIG. 380. — From the vase shown as Fig. 379.

It is still a moot question where these *hydriae* were made; Phocaea, Clazomenae, and Africa have all been suggested. The fact of importance, however, is that there can be no question of their having an Ionic origin. This is placed beyond dispute by the frequent resemblances which the vases afford, not only to the sarcophagi of Clazomenae, but also to the vases of Ionian tradition in Africa.¹ (Cp. J. Endt, *Beiträge zur ion. Vasenmalerei.*)

¹ Space forbids the consideration of other types of Ionic vases, but the student's attention may properly be called to the important class of cylixes which show large eyes in pairs on the exterior. Cp. Boehlau, "Ionische Augenschalen," *Ath. Mitt.*, 25 (1900), pp. 40 ff. A famous example is carefully published by Furt. and Reich., I, Pl. 41. Another Ionic vase of note, an *amphora*, upon which is a quaint and interesting representation of the Judgment of Paris, is published by Furt. and Reich., I, Pl. 21.

Attic

We have seen that Geometric vases reached a high state of development in the Dipylon style at Athens, and our next step is to follow this development as it advances from a period probably in the seventh century B.C. to the finest Attic ceramic art of the fifth century. What we know of many of the influences which contributed to the active intellectual life of Athens during a good portion of this time, is strikingly confirmed by the progress in Attica of the art of vase-painting.

In the work of the potters as it passes out of the Dipylon period, these influences from other parts of Greece become at once evident, and they are well shown in a series of vases which has come to be known as Proto-Attic. This ware is undoubtedly of Attic origin, and bridges over the period between the passing of the Dipylon vases and the rise of the Attic black-figured style. The vases are few in number, and represent a progressive development rather than a homogeneous type, so that they are hardly to be looked on in the strict sense as a separate class. The earliest specimens closely resemble Dipylon ware,¹ others, like an *amphora* from Hymettus, in Berlin,² or the Nessus *amphora* (Fig. 382), show quite different influences. A jug from near Phalerum (Fig. 381) may be taken as illustrating an intermediate stage. Its general shape and the procession of figures on the neck are of the Dipylon type, so also the procession of animals on the lowest figured band. On the other hand, the chief band which encircles the vase, with its conventionalized curvilinear ornament, among which lions in heraldic opposition are introduced (these do not show in the figure), is suggestive of Ionic, and perhaps even of



FIG. 381.—Jug. Athens. h. 0.525 m. (*Jahrb. d. Inst.* II (1887), Pl. 4.)

¹ *Ath. Mitt.*, 17 (1892), Pl. X.

² *Jahrb. d. Inst.*, 2 (1887), Pl. 5.

Mycenaean, tradition. The general distribution, too, of the ornament in continuous bands, which run around the vase and are not divided by vertical lines, shows the breaking away from Geometric schemes.



FIG. 382. — Amphora with picture of Heracles and Nessus. Athens. h. 1.22 m. (*Ant. Denk.* I, Pl. 57, text.)

A further advance toward the black-figured style is shown in Figure 382. The shape of the *amphora* scarcely recalls the Dipylon vases, and the differences from that style in the general plan of decoration have become much more marked than the resemblances to it. The position of the panel on the neck, and the line of geese on the band about the mouth of the vase, recall Geometric characteristics, but these are about the only features which do so. A marked approach to the early black-figured vases is shown in the representation of Heracles and Nessus in the panel on the neck, and by the use of inscriptions to designate the figures. Indeed, this scene and the other one on the body of the vase—the dead Medusa and her fleeing sisters—

make it clear that here, as at Corinth, definite popular legends had come to suggest subjects to the vase-painters.

The Proto-Attic group of vases includes further two series that might be deemed sub-classes of the main group; namely, the so-called Phaleron vases and the vases from Vourva near Marathon. These show in varying degrees the combination of Geometric and orientalizing influences, presumably Ionic, which enter into the developed styles of Attica.¹ The so-called *Tyrrhenian*

¹ Cp. Boehlau, *Jahrb. d. Inst.*, 2 (1887), pp. 33 ff.; also *Ath. Mitt.*, 15 (1890), pp. 318 ff., and Nilsson, *Jahrb. d. Inst.*, 18 (1903), pp. 124 ff.

amphorae,¹ though forming a distinct class by themselves, also find their place here in the history of Attic pottery, though space forbids more than a passing mention of them. They have been called "Corintho-Attic" because, though bearing Attic inscriptions, they strongly recall Corinthian pottery in some of their schemes of decoration. The vases, however, show affinities with the earlier ones from Vourva and some resemblance also to Ionic work; they serve, therefore, to illustrate still further the complex nature of the elements which were combined in the formation of the Attic style.

The so-called black-figured style was well established at Athens before the middle of the sixth century B.C., and the consideration of its development fittingly begins with the François **Black-figured** vase now in Florence (Fig. 383).² This vase, named **figured** after its discoverer, was found in 1844 near Chiusi in Italy, but in a broken condition, the fragments being scattered through two graves. Probably it had been broken in a previous careless excavation when the graves were plundered. The pieces were put together, and the vase, with a few fragments found after its restoration, has for many years been on exhibition in the Archaeological Museum at Florence. In 1900 it was wantonly broken by an attendant in the Museum, but it has since been successfully restored. The shape of the vase, a large wide-mouthed *crater*, recalls in some measure that of the Corinthian *celebae*, though it naturally shows a very marked advance on this form, a fact that appears nowhere more plainly than in the elegantly moulded handles which are in themselves masterpieces of the potter's art. The distribution of the designs in bands might perhaps be thought to recall Corinthian work, but, as we have seen, this method of decoration had become familiar to the Attic painters before the time of the François vase, which is to be dated, in all probability, in the first half of the sixth century B.C. Thus it is not certain that the makers of the vase felt any very direct Corinthian influence. The nature

¹ Thiersch, *Tyrrhenische Amphoren*, Leipzig, 1899.

² Furt. and Reich., *Griech. Vasenmalerei*, I, Pl. 1, 2, 3, 11, 12, 13.

and distribution of the design may be readily seen by reference to the following diagram. Where the designation of the subject on a given band crosses the dividing line, the representation of



FIG. 383. — François vase, by Clitias and Ergotimus. Florence (Museo Arch.).
h. 0.66 m. (Furt. and Reich., I, Pl. 3.)

a single subject encircles the entire vase. The front in distinction from the back is assumed to be the side on which the central point in the main band is found ; namely, the house toward

which a procession of the gods is moving to honor the newly wedded pair, Peleus and Thetis.

	FRONT	BACK
1.	Calydonian Boar Hunt.	Dance of Theseus and youths on their return from Crete.
2.	Funeral games of Patroclus.	Battle of Centaurs and Lapiths.
3.		Tongue pattern.
4.		Procession of the gods.
5.	Achilles and Troilus.	Return of Hephaestus.
6.		Band of Animals.
7.		Rays.
8.		Tongue pattern.
9.		Pygmies and Cranes.
10.		Tongue pattern.

On the handles, the flat portions of which are divided by horizontal lines into three rectangular fields, are represented Ajax carrying off the body of Achilles, the so-called "Persian Artemis," and a running gorgon. The designs are essentially the same on both handles, though in the corresponding figures there are delicately introduced variations.

The scenes represented can all be identified with certainty, for all but that of the Pygmies and Cranes have inscriptions. The designers evidently intended to celebrate the house of Peleus in their selection for the front, since here the scenes are all connected either with Peleus or with his son Achilles. Those, however, on the other side have to do with Attic legend, unless the "Return of Hephaestus" be excepted, but this subject was a favorite one with the Athenian vase-painters, perhaps because the god was the especial patron of all handicraft.

One cannot too greatly admire the skill with which so complicated a composition has been distributed upon the surface of the vase. On the band which bears the representation of the battle between the Pygmies and Cranes this ability of the painter in purely decorative design is perhaps especially marked, for here our attention is attracted not so much by the designer's

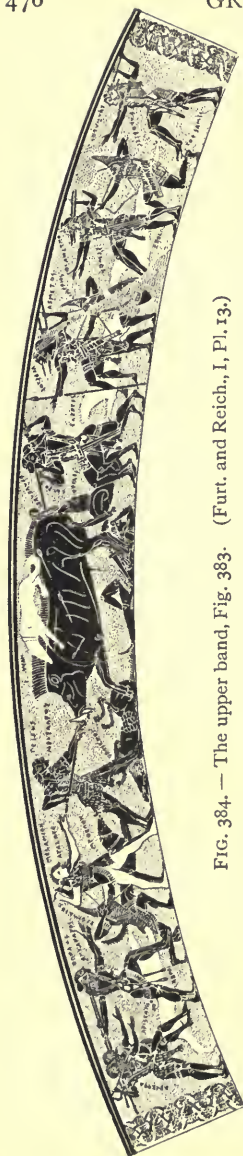

FIG. 384. — The upper band, Fig. 383. (Furt. and Reich., I, Pl. 13.)

interest in the legend as by his ability to use the lines of his composition in a highly effective manner, covering the field at the same time with the greatest skill. Much the same quality, if perhaps less attractively displayed, is seen in the representation of the Calydonian boar hunt (Fig. 384), where the balance of the composition is admirably worked out. The painter used bright colors freely; red and purple were painted on over the black of the silhouettes, but the white so freely used was laid directly on the clay ground. When in an uninjured state, the vase must have presented a very gay color-scheme. To class such vases as black-figured is of course really incorrect, but the term has become fixed by long use. In the early period of the style, however, it is only truly appropriate as describing the vase in what might be called its silhouette stage, before the bright colors have been laid on.

The François vase, as the signatures of the painter (Clitias) and potter (Ergotimus) upon it show (Κλιτίας μ' ἔγραψεν, and Ἐργότιμος μ' ἐποίησεν),¹ was the work

¹ Signatures appear for the most part in the forms shown by the following examples: (1) Ταλειδῆς ἐποίησεν. (2) Ἐπικτήτος ἔγραψεν. (3) As on the François vase. (4) Ἐξηκίας ἔγραψε καὶ ποίησε με. (5) Γλαυκῦτης μ' ἐποίησεν, Ἀρχικλῆς ἐποίησεν, (two potters) the latter form being certainly very rare. The same artist may, however, now sign ἐποίησε and again ἔγραψε (Euphronius is an example), a fact which plainly suggests, as does (3), a differentiation between the work of

of two collaborators who no doubt conducted one of the many manufactories of vases which existed at Athens.

potter and painter. On black-figured vases *ἔγραψεν* does not often occur, and it therefore seems likely that *ἐποίησεν* may be used to cover the painter's work as well as that of the potter in vases of this class, as may indeed have been the case whenever the word is used alone at any period. At a time, however, when *ἔγραψεν* is commonly found, it seems quite possible that, if it is omitted and *ἐποίησεν* alone is used, we have merely a partial record of manufacture, showing only that the inscribed vase comes from a given pottery. The painting would then probably have been done by some subordinate person in the establishment. Thus in the case of Euphronius the theory seems a likely one that he signs his earlier vases *ἔγραψεν*, and that later vases inscribed *ἐποίησεν* merely come from his pottery. (See valuable articles by Pottier, *Gaz. d. Beaux Arts*, 1902, and Hauser, *Berliner philol. Wochenschr.*, 1907, p. 693.)

Besides the several forms of signatures, vases may also bear inscriptions of various kinds expressing ownership or giving explanation of the scene depicted (a practice followed in some early sculpture in relief and employed also by the painter Polygnotus), or they may be invocations or exhortations or may take the form of the so-called *καλός* names. These latter names have been much discussed (cp. Klein's *Griechische Vasen mit Lieblingsinschriften*), but a good deal of obscurity still attaches to their use. They are found in such forms, for example, as *Μιλτιάδης καλός*, that is, "Miltiades is fair," or rarely with a woman's name and *καλή*, or again in the less specific form of *ὁ* or *ἡ παῖς καλός* or *καλή*. The known vases which bear the *καλός* inscriptions number about five hundred and sixty, and the custom of thus inscribing pottery reaches its height in Athens during the fifth century B.C. The names are very generally aristocratic in character, and a few of them are almost certainly those of persons known to history. When this is the case, we have a guide to the date of the vase. The inscriptions are pretty clearly in the nature of compliments to persons often prominent among the *jeunesse dorée* of Athens, and it seems rather significant that they occur more frequently on the *cylix* than on other vases; that is, on the vase which was in common use at fashionable symposia. The host may have complimented his guest or his friend by having the guest's or friend's name inscribed on the cup from which he was to drink his wine. The vase would thus become a kind of "favor." Vases with only *ὁ* or *ἡ παῖς* on them might of course always stand in the potters' shops ready to the buyer's need.

On the not unlikely theory that a youth would not have been called *καλός* for more than about ten years certain chronological deductions have been based (Hartwig, *Meisterschalen*): (1) That vases of one master bearing

As the black-figured style develops in the period succeeding the François vase, a few general characteristics may be noted. The inclination on the part of potters to choose mythological subjects continues, and, though the *genre* scenes which appear often on red-figured vases are found, they are rather the exception. The tendency, however, among Greek artists to follow types in their work sometimes obliterates the distinction between mythological and other scenes. A type, for example, which represents warriors preparing for battle is easily brought into connection with epic legend by the addition of a few inscriptions. The use of bright colors and white is more restricted, and the vases are more truly black-figured, details and patterns being brought out by the elaborate use of incised lines. In drawing generally, and in the skill shown in delineating drapery, there is a steady advance, though the work is still stiff and hard. The eye of the men is round and staring, that of the women almond-shaped, and the flesh of women is commonly white. The chief shapes found are those of the *amphora*, *hydria*, *cylix*, *oenochoe*, and *lecythus*, but the *amphora*, with its principal decoration often in a panel, is especially characteristic of the black-figured style.

The names of over forty potters and painters who worked in this style are known, though most of these are represented by very few vases. Three of the leading artists may here be **Amasis** briefly mentioned,—Amasis, Execias, and Nicosthenes. Amasis,¹ whose name suggests that he was a foreigner, and some of

the same *καλός*-name are contemporary within ten years. (2) That vases by different masters are contemporary within ten years, if they bear the same *καλός*-name. (3) That two *καλός*-names on the same vase show the persons named to be within ten years of one another. The restriction "on the same vase" is necessary because of the pretty regular recurrence at Athens of the same name in different generations. The large series of vases bearing *καλός*-names has been classified in accordance with such names, and this classification has yielded interesting results in the study of the styles of certain potters and painters.

¹ Cp. especially Karo, *Jour. Hell. Stud.*, XIX (1899), pp. 135 ff., and Hauser, *Jh. Oest. Arch. I.*, 1907, pp. 1 ff.

whose work has indeed a strong Ionic flavor, has left seven signed vases (all with *ἐποίησεν*), three *amphorae*, and four jugs.¹ His work, however, shows considerable individuality and hence many unsigned vases have been attributed to him. Figures 385 and 386 show one of his best-known vases, now in Paris. On the front are Athena and Poseidon in conversation, and the corresponding



FIG. 385. — Amphora, by Amasis. Paris, Bibliothèque Nationale. h. 0.33 m.
(*Wiener Vorlegeblätter*, 1889, Pl. III.)

scene on the back represents Dionysus and two maenads. The double "rays" at the foot are characteristic of Amasis. The figures here are somewhat more rigid in their archaic stiffness than on some other vases of this master, but they show well the minute delicacy of his work, and the line of warriors which

¹ The fragment of a cylix in Boston also bears his signature. Cp. *A.J.A.*, 1907, pp. 149 ff.



FIG. 386. — See Fig. 385.

fragments, one of which is part of a fine *dinus* that was decorated with a row of ships about the inside of the mouth.² The signatures are generally simply *εποίησεν*, though in a few instances *εγραψεν* also is added. Figure 387 shows a panel *amphora* by Execias with a representation of Heracles in his combat with the triple-bodied Geryon — a composition which was no doubt traditional in origin and was transmitted with few modifications to the later painters of the red-figured style. The herdsman Eurytus has already fallen,

¹ Cp. especially the fine vase representing Achilles and Ajax playing at *pessi* and the return of Castor and Polydeuces, *Wiener Vorlegeblätter*, 1888, Pl. VI, 1a; and Fig. 387.

² A similar scheme of decoration is shown on a *dinus* in Boston (Catalogue No. 378).

is on the shoulder of the vase exhibits his skill in using a row of figures for purely decorative purposes.

The work of Execias is similar to that of Amasis, though some of his *Execias* vases have an exceptionally picturesque charm.¹ His signature is found on four *amphorae* and four *cylixes*, and on two



FIG. 387. — Amphora by Execias. Louvre. h. 0 50 m. (*Wiener Vorlegebl.*, 1888, Pl. V.)

shot through the head with an arrow, and one body of Geryon has in like manner been put *hors de combat* (this is not clearly shown in the figure); the hero next attacks the remaining bodies with his sword.



FIG. 388. — *Cylix* by Execias. Munich. Diam. 0.304 m. (Furt. and Reich., I, Pl. 42.)

Of all the works of Execias, none is more attractive than the representation of Dionysus on the interior of a *cylix* at Munich (Fig. 388). In general shape and in the scheme of decoration on the outside, which has the conventionalized "eyes," the vase is of Ionic character. It is, however, the design on the inside which is of paramount interest. Dionysus is represented as sailing over

the sea, bearing his gifts to mankind. Such a legend of the god was a part of the current mythology, as is shown in a fragment of the comic poet Hermippus (Kock, *Frag. Com. Graec.* 63), and the vase-painter has illustrated it with real poetic feeling. The god

reclines at ease in his ship, about the mast of which twines a grapevine heavily laden with fruit. The dolphins in the field symbolize the sea. The potter has used a reddish slip to heighten the color of the background, an unusual addition to the common technique, though it is found on a few fine specimens of the red-figured style (cp. Furt. and Reich., I, Pl. 22).

The work of Nicos-
 thenes, the third pot-
 ter of the
 Nicosthenes black-fig-
 ured style selected for
 mention, is strongly
 individual in charac-
 ter. It has much of
 the brightness and



FIG. 389. — Amphora, by Nicosthenes. Vatican. Museo Gregor. (Photograph.) Probably No. 9 in Klein's *Meistersignaturen*. (Unpublished?)

variety that we associate with the Ionic styles and in the shapes used often approaches closely to metal technique¹ (Fig. 389). Some seventy-eight vases bear his signature, and they show great

¹ Cp. *Wien. Vorlegebl.*, 1890, for many of his vases.

variety of form, though the *amphora* of peculiar shape,¹ with flat handles, is the most common. In general the subjects are treated in a purely decorative way, without evidence of much interest in current legend, but there are a few noteworthy exceptions to this rule, like the scenes representing Athena and Heracles, on two jugs in the Louvre, and a group of the gods, on a pyxis in Florence. Though following the black-figured technique in the main, Nicosthenes was an innovator, and he may properly enough be classed with those potters who represent the transition to the red-figured style; indeed, he occasionally uses this latter technique and in one instance he works with Epictetus, an early master of this style. Especially noteworthy at this period is his occasional employment of a white slip for a background, as on the Louvre jugs referred to above; and a further and still more striking innovation is seen in the use on an *amphora* in the Louvre (catalogue no. F. 114) of light, opaque color for the figure represented, this color being laid on the black glaze.² Here Nicosthenes has virtually adopted the underlying principle of the red-figured technique.

Before passing to a consideration of the red-figured style mention should be made of the so-called *Panathenaic Amphorae*,³ a special class of black-figured vases which persisted long after Panathenaic the style had passed out of general use and which show amphorae in their development the decadence of the vase-painters' work. These *amphorae*, found for the most part in Italy, but of undoubted Attic origin, were used as prizes at the Panathenaic festival. They are generally tall and slim in form, at least in the later and more numerous examples, and have an unusually small foot and lightly made handles. Whether they were actually used to hold a portion of the prize of oil is perhaps doubtful. The vases are generally decorated according to the following scheme which naturally shows some minor modifications at different periods: on

¹ The shape may be derived from Tonia. Cp. Pottier, *B.C.H.*, 1893, p. 431 ff.

² Cp. Six, *Gaz. Arch.*, 1888, pp. 193 ff. and 281 ff.

³ Cp. G. v. Brauchitsch, *Die Panathenäischen Preisamphoren*.

the front is a figure of Athena Promachus between two columns which are often surmounted by cocks, sometimes by figures of Nike, and occasionally by some other figure, as that of Triptolemus, for example. Inscriptions running the length of the column are introduced in a regular formula, τῶν Ἀθηνῶν ἄθλων, "from the games at Athens," and in a large number of examples the archon's name is added in a second inscription. In this way there is preserved a series of datable vases which extends from 367 to 311 B.C. On the back of the vases is painted an athletic scene in the games. These scenes, interesting as they often are in themselves, are noteworthy for their frequent combination of the black-figured technique with the freer drawing which belongs to later styles.

Let us now turn to a consideration of the red-figured style. There has been much discussion as to its origin, but thus far the conclusions reached have lacked definiteness.¹ In all probability **Red-figured** the breaking away from the black-figured technique came simply from a tendency to make figures show light against a dark background. This was no new thing. It may be seen on Naucratic ware in the head of the sphinx (Fig. 375) where a lustrous white appears against a cream-colored background, or still better, in the figure of the boar on the Clazomenae sarcophagus (Fig. 374), where the background was black, or on the vases cited on page 483, note 2, or indeed in the frequent use of white for some of the figures on black-figured ware. This practice of showing the light figure against a dark background is the normal principle of the red-figured style, and the establishment of the new system is apparently due, in a measure at least, to the attainment by the vase decorators of great ability in the use of line drawing. In the rendering of details incision disappears and in its place comes the delicate black line, commonly in the form of the relief line; without great skill in draughtsmanship the new technique would have been impossible. The beginnings of the red-figured style reach back somewhat beyond the last quarter of the sixth century B.C., and with its develop-

¹ Cp. R. Norton *A.J.A.*, 1st series, XI (1896), pp. 35 ff., and Louise Nichols, *A.J.A.*, VI, 2d series (1902), pp. 327 ff.

ment through the succeeding century it may fairly be said that Greek vase-painting becomes Attic vase-painting, so entirely do the Athenian potters take the lead in their art. It is often the practice to use a more or less elaborate classification in tracing the progress of red-figured vase-painting, but there seems to be no great gain in this. The essential fact is that we are able to follow the work of the painters through a "severe style," which in itself exhibits a marked growth in skill, into what is commonly known as the "fine style," and then to witness, in florid and careless work, the loss of the earlier originality and vigor. The period of the development of these two styles extends over somewhat more than a century, and the fact that it is possible during most of this time to trace a gradual and steady advance in draughtsmanship and in skillful composition gives the vases of the period a peculiar importance in the study of Greek painting, because in them we no doubt see on a small scale the process that was going on in the development of the works of the greater artists now lost to us.

Before passing to a consideration of a few of the most important painters of red-figured vases, it will be well to note some general features in the development of the style. In the choice of subjects the mythological tradition is still retained, but with it there is a marked tendency to depict scenes from everyday life. This is particularly the case among certain of the earlier masters, who are often spoken of as the Epictetan group, from the most typical painter of this period, Epictetus. A little later, about the beginning of the fifth century B.C., another group of masters of the "severe" style, chiefly *kylix* painters, again portray mythological scenes most frequently, and with great skill and originality. These men, among whom Euphronius, Duris, Hieron, and Brygus are leaders, represent the "severe" style at its best and their works are among the most important specimens of Greek ceramic art. Although, as has been said, mythological scenes predominate in the vases of this group, the painters did not neglect the portrayal of scenes of a contemporary character, and we have from their hands a

**Severe and
fine styles**

**General
character-
istics**

good many representations of subjects taken from Athenian life. Side by side with this tendency toward greater realism in the choice of subjects—a tendency which shows itself in the treatment even of the popular legendary themes—a marked and steady advance is to be seen both in the composition of the pictures and in the drawing. The vase-painters, either directly or because they are familiar with the works of the greater painters, feel an influence that comes from the study of such groupings of figures as might catch the eye of the artist at the symposium or the palaestra. The many vases, for example, which are decorated with scenes from the labors of Theseus, a favorite hero at this period, appear to reflect pretty closely the athletic life of the day, nor is it unlikely that the influence of the theatre may have played a rôle in the increase of dramatic power which the vase-painters show, even though it be impossible to prove any direct connection with the drama.

Again, some of the compositions, like Brygus's *Capture of Troy* (Fig. 394), and many others, suggest the thought that groups may perhaps have been copied with some adaptation from large paintings. At any rate, it is certain that between the Epictetan vase-painters and the later masters of the "severe style" there is a marked difference in the skill shown in the effective and symmetrical grouping of figures. In the earlier period they seem isolated; later, skillfully balanced groups of two and three figures are the rule. The advance in drawing is no less marked. This shows itself chiefly in the gradual growth of the ability to use foreshortening, and it is coincident with the giving up of the so-called "law of frontality" in sculpture, as the archaic period in that art passes away.¹ Through this advance the vase-painters are able to introduce immensely greater variety in the positions of figures, and a hasty comparison of the works of the Epictetan group with those of the later masters of the "severe" period shows how decided a change had taken place.

¹ Cp. P. Gardner, *Grammar of Greek Art.*, p. 56, and more fully Lange, *Darstellung des Menschen*, pp. x ff.

In the treatment of drapery, too, the progress is evident. In the period of Epictetus there remains much of the stiff formality of the black-figured style, but by the time of even the earlier vases of Euphronius there is a feeling for the flow of the garment and for the changes of its lines on the moving figure. Improvement in the delineation of drapery was no doubt aided by the actual change in the fashion of the garments. The stiff, scant garments with their oriental embroidery, such as are seen on the François vase and on the vases of Amasis and Execias, were no longer in vogue, and the simpler, more flowing robes, which came in toward the latter part of the sixth century B.C., carried in themselves a suggestion of graceful line. Another detail in which the growing skill of the painters can be clearly followed is the delineation of the eye in profile, though it is not until the "severe style" is past and the "fine style" well established, about the middle of the fifth century, that this feature is naturally rendered.

In the matter of the forms of vases we find rather a development of earlier types than any radically new inventions. The *amphora* appears in the old form with a panel, in the very graceful type known as "Nolan" (p. 417), and in the less pleasing type of the *pelice*. Allied to the *amphora* is the *stamnus*, which is rather characteristic of the earlier red-figured ware. The *psycter* also appears, but it is at no time a common form. The *hydria* continues in use and often takes the form of the somewhat more curvilinear *calpis*. The *crater* develops with considerable variety, and the so-called calyx form, the bell-shaped form, and the large and often magnificent volute-handled *crater* are introduced; such types are, however, found commonly in the later development of the style. The *oenochoe*, *lecythus*, and *pyxis* are common, and there are many shapes of the *rhyton* and *ascus*. It is, however, in the decoration of the *cylix* that the painters of red-figured vases excel, especially down to the end of the "severe" period. This form of vase in the finest specimens attains to great elegance of outline, and in the first half of the fifth century B.C., the signed

examples are more numerous than those of any other shape. It is thus distinctly the characteristic vase of this time, and holds a position of peculiar importance.

Besides certain of the general features already mentioned, the use of ornamental patterns¹ on red-figured vases affords some indication of chronological sequence, and has thus historical importance apart from its interest in the study of pure design. The matter can here have only the briefest mention. Such ornamentation on red-figured vases is kept rigidly subordinate to the chief subject of decoration, and its *motives* are generally those of the conventionalized palmette in various forms, of the meander, often broken by a cross, of the egg pattern, and not uncommonly of a simple form of net pattern. The lotus also is used, but it is less frequent, and occasionally elegant bands of laurel-wreaths more realistically treated are found. In the earlier stages the black-figured technique is often used on ornamental bands, even when the later style has become fully established. This occurs on vases of the *amphora* and *hydria* types where the picture is framed by a border, a device which comes naturally from the use of the panel on black-figured *amphorae*² and which tends to disappear as the style advances. Beneath the handles a simple palmette is often introduced, and in the progress of the style this develops in a very marked way, so that on such a series of late Attic vases as has been found at Kertch in the Crimea, which may be dated as late as the middle of the fourth century B.C. and possibly somewhat later, a good deal of the surface of the vase is occupied by such floral designs. Upon the *cylixes* the development of the palmette under the handles is especially well marked.³ From a simple single palmette, or from one on either side of the handles, grows an elaborate and very freely treated series connected by tendrils, so that in some examples from about the

¹ Cp. Walters, *History*, II, pp. 209 ff., on the general subject.

² Furt. and Reich., I, Pl. 4, where the same subject is represented on different sides of the vase in black-figured and red-figured technique.

³ Cp. F. Winter, *Jahrb. d. Inst.*, 1892, pp. 105 ff.

middle of the fifth century B.C. the design often attains great richness and grace. The encircling band which frames the picture on the interior of these vases also shows change at different periods. At first it is only a plain line; then a meander of simple pattern is used, and later this assumes a more elaborate character by the insertion, at intervals, of black squares upon which some form of cross or checker pattern is introduced.¹

It has already been said (p. 483) that a stage of transition may be noted before the red-figured style becomes fully established. This is illustrated most perfectly on the vases of the potter **Andocides**, who often employed both the black- and the red-figured technique on the same vase. His signed work and many of the vases allied to it have been discussed in essays mentioned in the subjoined note,² and to call attention to these must serve the present purpose.

Among the names of fourteen or fifteen painters and potters whose work illustrates the "severe" period of red-figured painting in its earlier stages, those of Epictetus, Pamphaeus, and Chachrylion are worthy of special note. Epictetus alone must here serve as the type, but the others, who, unlike him, sign only as potters (*ἐποίησεν*) deserve the attention of students—Pamphaeus for the vigor of some of his work, and Chachrylion from the fact that he marks the transition to the later painters of the "severe style." Individual vases of other masters are indeed often of about equal merit, and some also that are unsigned, or that can be connected with signed ones only by the fact that they bear the same *καλός*-name (see note, p. 476), may be no less valuable as illustrations of style.

Epictetus, who always signs *ἔγραψεν*, and whose signed work we may thus believe to be from his own hand, has left his signature on some twenty-six vases, *kylixes* and plates (*πίνακες*) for the most part.

¹ Cp. A. S. Murray and C. Smith, *Designs on Greek Vases*, *passim*.

² Cp. *A.J.A.*, articles referred to in the note on p. 484; Furt. and Reich., I, Text, pp. 15 ff.; II, Text, pp. 267 ff. Two vases of importance here are the *kylix* in Palermo, published *Jahrb. d. Inst.*, 1889, Pl. 4, and a fine *amphora* in Boston, *Forman Collection*, 305, Report of the Museum of Fine Arts, 1899, p. 81.

A few of these have the interior in the black-figured technique, so that, apart from qualities of style, he is rightly deemed to be among the very earliest of the masters of the newer method.

Epictetus It is worth noting that on one vase (of which Pamphaeus is the potter) he has used the Ionic "eyes." The date of Epictetus may be placed approximately in the last quarter of the sixth century B.C. It has frequently been remarked that the great nicety and care which characterizes his work, and especially its suggestion of miniature painting, betray the influence of the so-called "Minor Artists," of whom Tleson is the chief representative, and who, toward the close of the period of the black-figured vases, manufactured delicately formed *cylixes* with single miniature figures, commonly of animals, introduced on the outside of the rim of the vase. Sometimes, too, these artists decorated the interior of their cups with a small central medallion. In any case, we find in the work of Epictetus a continuation of the spirit of those masters of the black-figured style, who especially love refined detail, and much also of their archaism. His figures often have great charm, but they are stiff, and, like the sculptors of his time, when he seeks to show one part of a figure in profile and another part in full face, he is unsuccessful in rendering the transition between the different points of view. This is easily observed in the representation of the bacchante (Fig. 390). The absence, too, of line-drawing within the figures to indicate muscular detail is in marked contrast to the practice of later vase-painters. Epictetus worked with various potters, Nicosthenes and Pamphaeus among others, and the vase here chosen (Fig. 390) to illustrate his manner was made by Python. It is a work of somewhat more elaborate composition than is usual with Epictetus, and is very possibly one of his later vases, painted at a time when the influence of his younger contemporaries was making itself felt. The picture on the interior of the cup shows two figures—one of a youth playing on the double flute, the other of a dancing bacchante playing the castanets—whereas a single figure is the rule with Epictetus. The scenes on the outside are not related to one another, the one

representing a banquet, the other the favorite legend of Heracles and the Egyptian king Busiris. The hero turns upon the servants who, in accordance with the custom of the king towards strangers, are about to sacrifice him upon the altar. In these groups Epicteus has introduced more figures than is his wont, and in the



FIG. 390.—Cylux, by Epicteus. British Museum. Diam. 0.319 m. (Furt. and Reich., II, Pl. 73.)

symposium scene he has attempted the problem of delineating a reclining figure as seen from behind. This is an advance on his usually simple manner. Nevertheless, the drawings are quite characteristic—archaic in style, very delicate and precise in execution, but entirely lacking in the skilful and balanced grouping of figures that is found in the work of the later masters of the “severe style.”

In this later group of painters the leading names are Euphronius, Euthymides, Duris, Hieron, and Brygus. Other masters of this time, however, have left a few vases of the highest excellence, and certain of the unsigned vases hold rank beside the works of men whose names are known. The single vase, for example, of Sosias (ἐποίησεν) in Berlin, representing Achilles binding up a wound of Patroclus (*Antike Denkmäler*, I, Pls. 9 and 10), is hardly surpassed by any works of this period. Among these

masters of the later "severe" period, Euphronius perhaps ranks first in importance, not so much by reason of the absolute superiority of his work, fine as this is, as from the fact that the series of vases which bear his name affords singularly good illustration of the general progress of contemporary vase-painting. His signed vases are ten in number, and with the ex-



FIG. 391. — From a crater by Euphronius. Louvre. (*Vases antiques du Louvre* (Album), Pl. 100.)

ception of two, a *psycter* and a *crater*, they are all *cylixes*. Three are signed ἔγραψεν and the rest ἐποίησεν,—a fact which suggests certain interesting inferences with regard to the master's work. The vases signed ἔγραψεν, which we may thus fairly assume to be from Euphronius's own hand, are more archaic in style than the others, and they bear the καλός-name Leagrus. The others show much greater freedom from archaic tradition, and illustrate very clearly the advance in the vase-painter's art which was taking place in Athens. These latter vases, and probably certain other unsigned ones which are published in Hartwig's *Meisterschalen*, are

from the workshop of Euphronius, but we cannot assume that he himself painted them. It would thus seem likely that Euphronius himself stood near to the archaic period in his own work, but that the unknown painter or painters who in later years worked in his shop felt the full influence of the contemporary advance in their art. Figure 391 shows the heads of Heracles and Antaeus from the



FIG. 392. — Cylix, by Euphronius. British Museum. Diam. 0.334 m. (Furt. and Reich., I, p. 23.)

crater in the Louvre signed ἔγγραφεν. The vase as a whole strongly recalls black-figured work, and its limitations in portraying the human form are, to some extent, those which are characteristic of the Epictetan period. The resemblance of the head of Heracles to that of the soldier on the stele of Aristion (p. 207) is marked. The same affinity to earlier work may be seen, also, in the fine *cylix* at Munich (ἔγγραφεν), upon which is represented the myth

of Heracles and Geryon (Furt. and Reich., I, Pl. 22), but this vase exhibits greater skill in the arrangement of figures. Figure 392 (*ἔποίησεν*) betrays a distinct advance both in the power to express emotion and in general composition. The interior, framed by a meander pattern, shows the figures of a man and woman in conversation, and the exterior has on one side the episode of Heracles and the boar, with Eurystheus, and on the other a scene of uncertain purport, in which Hermes figures. Though in various ways reflecting archaic tradition, this vase is one of the finest examples of the "severe style" at a period of high development. The precision and elegance of the work on it, whether it be actually by Euphronius or not, are truly remarkable.

The vase-painter Euthymides,¹ who appears to have been a contemporary of Euphronius and a rival also, to judge from one of his *amphorae* (Furt. and Reich., I, Pl. 14), which Euthymides bears the inscription "Euphronius never made the like," affords much instructive material for comparison with the work of the latter master. He avoids the *kylix* form, and his paintings, though less picturesque and interesting than those of Euphronius and his helpers, have a certain largeness of style which is foreign to his rival. He has been regarded, very likely correctly, as the special follower of Andocides. In spite of the fact that the figures of Euthymides in some cases have mythological names attached to them, they lack all legendary spirit, and his tendency is distinctly toward the representation of scenes from everyday life.

The other leading masters of the "severe style" who have been mentioned above — Duris, Hieron, and Brygus — are much nearer the Euphronian school, but each has his distinct characteristics. Duris, though on the whole a less interesting master than either Euphronius or Brygus, has a unique importance because of the large number of his signed vases, twenty-eight in all, of which all but two are *kylixes*. He uses *ἔγραψεν*, except in one instance, so that the series affords an unusual opportunity for the study of an individual's actual work. Moreover, his manner

¹ Monograph by J. C. Hoppin, Munich, 1896.

is pretty strongly marked, and a good many unsigned vases may thus, with more or less probability, be connected with his style. This is characterized by exactness and care, but also in general by a kind of dry stiffness that is not found in the work of Euphronius or Brygus. His figures are tall and slim with rather small heads, and in the symmetrically arranged groups there is a marked tendency to let the individual figures appear separately against the background. Duris, however, shows pretty distinctly an earlier and a later manner, which may be readily observed if one compares the fine archaic *kylix* in the Louvre,¹ representing Homeric conflicts and Eos carrying the body of Memnon, with the Vienna *kylix* shown in Figure 393. The latter vase, upon the outside of which is represented the dispute of Ajax and Odysseus about the arms of Achilles and the vote of the heroes on the question at issue, and on the inside the gift of the arms to Neoptolemus, exhibits not more vigor certainly than the Memnon vase, but a considerably greater power of facile execution. Occasionally, as on the splendid *psycter* in the British Museum (Furt. and Reich., I, Pl. 48), Duris seems for the moment to cast aside his dry manner and to vie with the vigorous vivacity of Brygus, and in one *kylix* at Vienna (Furt. and Reich., I, Pl. 53) he appears to have imitated the style of Euphronius. To compare this vase with the one shown in Figure 393, found with it and by the same potter, Python, is very instructive. A further marked characteristic of Duris is his fondness for scenes of everyday life, and we owe to his hand an interesting and often published *kylix* in Berlin, representing instruction in a schoolroom.²

In contrast to Duris, Hieron³ is a master whose signature, almost always incised on the handle of the vase, is invariably ἐποίησεν. Only one of his vases (Furt. and Reich., II, Pl. 85), a fine *scyphus* decorated with scenes from the story of Helen, bears the painter's name, that of Macron. Whether

Hieron

¹ Pottier, *Douris*, Figs. 8, 9, 10.

² Reinach, *Répertoire*, I, p. 196.

³ In addition to the general works in the Bibliography, cp. Pollak, *Zwei Vasen aus der Werkstatt Hierons*, Leipzig, 1900.



FIG. 393.—Kylix, by Duris. Vienna. Diam. 0.326 m. (Furt. and Reich., I, Pl. 54.)

Macron painted the other vases signed by Hieron is a matter of dispute, but it is at least probable that his hand may be traced in some of them. The work on Hieron's vases shows considerable individuality in spite of a not infrequent repetition of types. A good many of his scenes are amatory in character, but vigorous and forceful conceptions are not wanting. Besides the *scyphus* referred to above, a *cotyle* in the British Museum, showing the sending forth of Triptolemus by the Eleusinian Divinities, and a *cylix* in Berlin, upon which the "Judgment of Paris" is painted, are worthy of especial attention. They are examples of the work of Hieron's school at its best, and show clearly its most marked technical characteristic — the skilful drawing of rich and elaborate drapery. On the *scyphus* signed by Macron, for instance, the painter has almost completely covered the surface of the vase with the drapery of his figures, reducing the black background to a minimum, and distinguishing the individual figures and their intermingling draperies by exceedingly clever line work.

With the potter Brygus¹ we reach the final stage in the "severe style" of red-figured vases. The eight *cylixes* bearing his name he signs on the handle or foot of the vase with ἐποίησεν, **Brygus** and it must thus remain uncertain whether he himself was actually the painter. The vases, however, appear to be painted by the same person, whoever he was. Brygus was working apparently before 480 B.C., since a fragment of one of his vases was found in the pre-Persian strata of the Acropolis, but the general style of the painting indicates that his activity extends to about 460 B.C. The vases of Brygus, both in their general character and in the rendering of certain details, appear to be later than the work of the other masters of the "severe style." The traces of archaism are less marked, the dramatic power is greater, and the symmetrical arrangement of the figures more subtly carried out; facial expression is more varied, and the drawing of the eye in profile, though not yet as it should be, is much more nearly correct. Figure 394,

¹ Cp. O. S. Tonks, "Brygos," *Memoirs of the American Academy*, Cambridge, Mass., 1904.

a representation of the "Sack of Ilium," in which the *motives* are no doubt somewhat traditional (cp. the so-called "Vivenzio vase," Furt. and Reich., I, Pl. 34) or possibly even adapted, as has been



FIG. 394. — Kylix, by Brygos. Louvre. Diam. 0.37 m. (Furt. and Reich., I, Pl. 25.)

suggested, from some larger painting, is an excellent specimen of Brygos's work, though it is perhaps surpassed by some others in the decorative effect of the skilful grouping of figures. One side of the exterior shows Neoptolemus hurling the body of Astyanax

against the old king Priam, who has taken refuge at an altar; on the other side is a scene in the sack of the city, in which Andromache attacks a conquering Greek warrior Orsimes.¹ The scene on the interior represents a maiden (Briseis) pouring wine into a cup held by an old man (Phoenix?). The life and vigor displayed in these drawings is thoroughly characteristic of Brygus's vases and also of a good number of unsigned ones which reflect his manner. In matters of detail, too, the vase shows certain peculiarities which are typical of his work and which point to the enlarged use of gilding and color that came into vogue later in the fifth century B.C. Gilding is here found on the helmet of the Greek warrior, on the tripod, which is itself done in light color, and elsewhere for small ornaments; red, also, is used in rendering some details; and the hair and beards of the old men are done with a creamy white; hair on the bodies of the men is freely indicated, and there is occasionally an attempt to show curving surfaces by shading; some of the garments, too, are ornamented with dots — a favorite practice with Brygus.

This greater elaborateness, then, as well as the increased freedom in draughtsmanship, is rightly held to indicate the passing of the "severe style" into the so-called "fine style," — The fine style a change which in ceramic art is contemporary with the work of the great master Polygnotus, whose career, beginning probably shortly after the close of the Persian War, extended somewhat beyond the middle of the fifth century B.C. A considerable number of vases almost certainly reflect his style and that of other artists who were no doubt influenced by him,² and it is easy to see that about 450 B.C. vase-painting undergoes just about the kind of change which would be expected, if it had felt the stimulus of a greater art showing increased freedom in drawing and a stronger tendency than had apparently yet prevailed to break away from traditional artistic

¹ The difficulties of interpretation are well discussed by Pottier, *Catalogue*, pp. 990 ff.

² Cp. pp. 532 f. for a further mention of these vases.

schemes. Figure 395 is an excellent example of the "fine style," and if it is compared with any work of the "severe" school, the change which has taken place in vase-painting is evident at a glance. Such a change can be adequately explained only by the supposition that the vase-painters have become familiar with the works of the greater artists. The large *crater* in Ruvo upon



FIG. 395. — From a crater in Naples. (Furt. and Reich., I, Pl. 37.)

which the death of the giant Talos at the hands of Medea is painted is another important example of this large and free style.¹ It seems likely, too, that the great sculptors of the day, as well as the painters, influenced the makers of vases. Thus Figure 396 shows groups of fighting Centaurs and Lapiths, which are very like the metopes of the Parthenon, and there are groups of horsemen on vases that afford striking parallels to those of the frieze.²

¹ Furt. and Reich., I, Pls. 38-39. Cp. also a fine Attic *amphora* from Melos, *ibid.*, II, Pls. 96-97.

² Furt. and Reich., I, Pl. 58, and P. Gardner, *Catalogue of Vases in the Ashmolean Museum*, Pl. 13.

This is what might be expected, and it is indeed possible to see resemblances to sculpture throughout the course of the development of vase-painting, only these resemblances are perhaps especially striking in the "fine style" and in certain later Attic vases which have been found at Kertch in the Crimea.

In matters of detail almost any good vase of this time shows a marked advance in the mastery of drawing. The figures have lost their former hardness; the eye in profile is properly rendered; the proportions of the face and of the figure are more natural, and the painters no longer hesitate to represent figures in three quarters or in full face. The hair and beard are painted in greater mass, and there is in the finest examples the nobility of countenance so familiar in Attic sculpture. Occasionally, also, some use of shading to indicate the roundness of limbs is found, as on the Talos vase.

But the vase-painters of this period, although they gained the feeling for a larger treatment of their subjects, did not, for a time at least, lose the power to paint small vases with extraordinary delicacy. At no period is the wonderful skill in the use of the relief-line more admirable.¹ The *lecythus* and *pyxis* are common forms used for this delicate technique, and the *cylix* no longer holds its former prominent position.

It is a noteworthy fact that with the "fine style" the signatures on vases grow rarer, for what reason is not entirely clear. Such signatures during the period of active export very likely served the purpose of a trade-mark, and Athenian trade fell off through war from 430 B.C. on (cp. Pottier, *Catalogue*, pp. 1076 ff.). This fact, however, does not adequately explain why the signatures apparently begin to decrease before this date. But whatever the cause, the result is that the names of barely a dozen vase-painters of this style are known, and they are represented by very few vases.

Such vases as the *cylixes* of Aristophanes in Boston (Fig. 396) and Berlin (published by Furt. and Reich., III, Pls. 127-129), or that

¹ Good examples of this delicate vase-painting may be seen on the vases published, pp. 87 and 88 of the "Handbook" of the Museum of Fine Arts in Boston. But no reproduction of such fine work can be satisfactory.

of Aeson in Madrid (*Antike Denkmäler*, II, Pl. 1) are good examples of the earlier stages of the "fine style," and two small cups signed by Xenotimus (*Antike Denkmäler*, I, Pl. 59) show it in its somewhat freer development. Among the signed vases which are larger, those by Hermonax (*Arch. Zeitung*, 1878, Pl. 12 and *Monumenti*, VIII, Pl. 45) are exceedingly good illus-



FIG. 396.—Kylix, by Aristophanes. Boston. Diam. 0.348 m. (Photograph.)

trations of the transition from the "severe style." Probably a little later in date are three vases signed by a vase-painter named Polygnotus (*Monumenti antichi*, IX, Pls. 1-3). But in signed vases the "fine style" reaches its culmination in the splendid *hydria* (Fig. 397) by Midias¹ (toward the close of the fifth century B.C.).

¹ Furt. and Reich., Pl. 8. For unsigned vases and remarks on the style of Midias, see Pls. 20, 30, 59, 78, with text. Cp. *Meidias et le style fleuri dans la céramique attique*, par Georges Nicole, Geneva, 1908.

On the shoulder of the vase in front is represented the Rape of the Daughters of Leucippus, a subject chosen by the painter Polygnotus for a fresco in the Anaceum, and on an encircling band below Heracles in the Garden of the Hesperides and a group of Attic heroes. The scenes are portrayed in a vivacious and inter-



FIG. 397. — From a Hydria, by Midias. British Museum. (Furt. and Reich., I, Pl. 8.)

esting way, and the general decorative effect is very fine. This vase by Midias, and other unsigned vases of the same style, show great ease and freedom of workmanship and the more advanced skill in composition which is associated with the influence of Polygnotus, but, in spite of their beauty, the drawing lacks the earlier firmness and simplicity of line, and its florid character betokens the approaching decadence. Gilding and the free use of white become

more common, and the figures are occasionally moulded and applied to the surface of the vase. The work of the painters, though done with great facility, is often careless, so that, speaking generally, it may be said that from about the end of the fifth century B.C., Attic vase-painting as a form of art loses its importance. It does not, however, disappear, for Attic vases which must be dated in the fourth century B.C. have been found in many different regions, and a few of these are so fine as to make it certain that the general decline was neither sudden nor universal.

The most noteworthy examples belonging to this period constitute a series generally called Kertch vases, from the place at which a large number of them were found — the Kertch necropolis of Panticapaeum near Kertch in the Crimea.¹ These vases are often dated at the close of the fifth century B.C., but the view of Furtwängler, that they belong in the fourth century, some of them even in the latter part of it, is almost certainly correct.² The drawing of the figures in the better examples shows in many ways a marked difference from that of the period of Midias, when there is still a strong tendency to emphasize the outline of the figure as it appears against the background. On the Kertch vases the figures are often shown against one another in close groups, and there is little effort to get any outline effect of either body or limbs. The use of gilding and white is very characteristic.³ Very marked, too, is the strong resemblance to the figures of fourth-century sculpture and terracottas, and the drawing is strikingly like that on bronze mirrors of the time. It has been suggested (Furt. and Reich., II, p. 43) that this drawing shows the influence of the

¹ Many are published in the *Comptes rendus de la Commission impériale archéologique de Saint Pétersbourg*, and in the *Antiquités du Bosphore cimmérien*.

² Cp. Furt. and Reich., Pls. 40, 68, 69, 70, 79, 87, and text, especially II, pp. 42 ff.

³ The extensive use of white on the Kertch vases seems to have a special development on a rare class of vases which have wholly white figures on a black ground. See Furt. and Reich., Pl. 100.

Sicyonian school of painting in the fourth century B.C., which laid especial emphasis on draughtsmanship. The forms of the Kertch vases have considerable variety, the *hydria* and *pelice* being perhaps the most noteworthy, though one of the finest examples is a covered, stemless *cylix* (Furt. and Reich., Pl. 68). The *lecythus*, too, with outcurving body, a shape frequent among late Attic vases, is also common. Figures 398 and 399 show a characteristic *hydria* with the rich and bold development of palmette design which is a distinctive mark of the Kertch vases. The scene depicted probably represents Paris and Helen,



FIG. 398. — Hydria from Kertch. St. Petersburg. h. 0.33 m. (Furt. and Reich., Pl. 79.)



FIG. 399. — From the vase shown in Fig. 398.

but as this class of vases has no inscriptions, there is often doubt about the interpretation of the figures. With the Kertch series, Attic red-figured vase-painting loses its distinctive importance.

Vases with White Background

It has already been said that the tendency to use a white or light-colored slip as a background appears at quite an early date among the Greek potters. The technique of painted marble stelae or of tablets like that from the Acropolis (p. 526) may very well have helped to its adoption among the Attic vase-painters, who had by the beginning of the fifth century B.C. become familiar with the use of such a background for their paintings. The *alabastrum*, the *cylix*, the *pyxis*, and, above all, the *lecythus* are the forms most used in this technique, although it was not wholly confined to these, and the progress in skilful drawing is along the same lines as that of the red-figured vases; that is, a "severe" style is followed by a "fine" style, and this is succeeded by careless work and consequent deterioration.

The earlier stages in the use of the white background are well illustrated by the jugs of Nicosthenes (p. 483) and by a fine *oenochoe* in the British Museum (*Jour. Hell. Stud.*, Vol. I, Pl. II). These and other similar vases are really black-figured, and occasionally the painters use incised lines. Some specimens, indeed, must be dated well on in the red-figured period, but their technique belongs to the earlier time.¹ As the skill of the vase-painters in line drawing increases, the use of a simple outline in black-glaze varnish becomes frequent, though it is often used for a portion only of the picture. An excellent example of the early period in this technique is an *alabastrum* now in the British Museum (No. B 668) which is signed by Pasiades (*Jour. Hell. Stud.*, VIII, Pl. LXXXIII). Two female figures (maenads) with a crane between them are depicted on the vase. The crane is in solid black; the women are in black outline with black hair. A distinc-

¹ For a series of these vases, cp. *Brit. Mus. Catal.*, II, pp. 283 ff.

tive feature is the yellowish brown glaze with which the chitons of the women are painted, and the same glaze is used for tufts of feathers on the head and breast of the crane. The background is of a rich cream tint. The character of the drawing shows that the vase belongs to the school of Epictetus.¹

In the gradual progress of this style of painting into the Euphronian period, besides the greater skill in drawing which is shown, some technical changes are noteworthy. The black-glaze lines are thinned out and become of a brownish tint. Then toward the period of the "fine" style, the glaze lines take on a golden hue, and later the use of lustrous pigment is abandoned and the lines are painted in dull colors with great variety of tint, red being quite common. Many specimens, of course, show the use of both the glaze and the dull colors. From the beginning there is a tendency toward polychromy,² and this gradually increases. At first black, yellow, purple, red in various tones, and white, when the background has a creamy tint, are common. The darker colors appear on the garments of the figures or on accessory objects. The use of gilding, too, is not uncommon. Later blue and green are employed, and the general use of color is extended, so that the result is a complete colored drawing, and not a drawing in line. In this gradual development of technique it is likely that the vases reflect the work of the great fresco-painters, and they are thus of high importance in their bearing upon major art.

Figure 400, the top of a covered *kylix* in Boston, is an admirable example of painting on a white ground in the early period of the "fine style" when there are still many reminders of *Cylixes* and "severe" drawing. Apollo is shown in conversation *pyxides* with a muse, whose lyre rests on the ground beside her. The lines, drawn in brown glaze, are of great delicacy; the flesh is the white

¹ An *alabastrum* in the Museum at Boston (Museum Report for 1900, p. 73) bears a close resemblance to the British Museum specimen.

² A probably unique specimen of a sixth century B.C. polychrome *pinax* (Ionic?) has been found at Thera. See *Thera* (the publication of the excavations), Vol. II, Pl. 2.

of the background; the mantle of Apollo is purplish red and the chiton of the muse a light brown. There are no Greek vases which surpass these white-ground *cylixes* in pure beauty and refined delicacy. They are comparatively few in number, but there are enough to illustrate the work in this technique through the "severe" and "fine" styles.¹ Those signed by the potter Sotades (see note)



FIG. 400.— Covered Cylix. Boston. Diam. 0.166 m. (Photograph.)

¹ Reference is here made to some of the best specimens of the white-ground *cylixes*. (1) "Severe style," somewhat archaic in drawing: *White Athenian Vases in British Museum*, Pls. XIX (Anesidora essentially equivalent to Pandora) and XV (Aphrodite riding on a swan); Furt. and Reich., Pls. 65 (statuesque figure of Hera) and 49 (Maenad, in manner of Brygus); Hartwig, *Meisterschalen*, Pl., L (*Brit. Mus. Catal.*, III, D, 1, fragmentary), to be supplemented by *Naukratis*, I, p. 52, also LI (subject uncertain, with signature, *ἐποίησεν*, of Euphronius, fragmentary); *Jour. Hell. Stud.*, IX, Pl. VI (Orpheus and Thracian women, fragmentary); *Monumenti*, X, Pl. 37 a (drinking and cottabus scene). On the last *cylix* the white-ground technique is on the outside of the vase. (2) "Fine Style": *White Athenian Vases*, Pls. XVI

are remarkable for the extreme delicacy of the workmanship upon them and for the peculiar form of the handles, which are like the "wishbone" of a fowl. In recent years a good many specimens of *pyxides* with white-ground decoration have appeared. The scenes painted upon them are often of a domestic character, as is the case on the similar vases of the time in the red-figured technique. Mythological subjects are, however, sometimes chosen.¹

Among the vases which show the white-ground technique, the *lecythi* have a special importance and form a group by themselves. Their number is very great, and the fact that their development extends entirely through the fifth century B.C.

Lecythi

and on into the fourth makes them unusually valuable as illustrations of technical progress and change. Their close connection, too, with funeral rites lends them a peculiar interest apart from artistic considerations, for the scenes represented on many of them throw much light upon Athenian customs and beliefs with reference to the dead. Thus they are to be closely associated with the sepulchral monuments. The *lecythi* have been found elsewhere than in Attica, and it may be that a few of them are not of Athenian manufacture, but most of them certainly are, and it is quite possible

(Myth of Glaucus, son of Minos), XVII (girl picking an apple), by Sotades, XVIII B (death of Archemorus), probably by Sotades; *Monuments Piot*, II, Pls. V and VI (woman playing on a lyre in both), in style of the vases by Sotades; Van Brantighem Sale Catalogue No. 167 (figure of a woman) by Hegesiboulus, much like the work of Sotades. For an extended list of these white-ground *cylixes*, see Hartwig, *Meisterschalen*, pp. 499 ff., and *Monuments Piot*, II, p. 42, note 2. Nos. 159-167 in the Van Brantighem Sale Catalogue are useful, though not very perfect illustrations of the series of vases by Sotades and of one or two others in his manner.

¹ Good examples of such *pyxides* are *White Athenian Vases*, Pl. XX; *Brit. Mus. Catal.*, III, Pl. XXII. There is a fine specimen in Boston, Museum Report, 1898, pp. 74 ff., and another, upon which the "Judgment of Paris" is represented, is in the Metropolitan Museum in New York. For an example of an *oenochoe* with white-ground technique, see *White Athenian Vases*, XXI B, and for a *crater* (calyx form), *Museum etruscum Gregorianum*, II, Pl. XXVI = Collignon, *Histoire de la céramique grecque*, Fig. 84.

that those found elsewhere were imported from Athens. The technical development of the vases follows generally the course described above for all white-ground vases, but the *lecythi* are so numerous and exhibit so much variety in their decoration and in drawing that they have been classified in various groups which, besides rendering study easier, often have an important bearing on chronological sequence.¹ This sequence, however, is most surely and continuously indicated by the style of drawing, which illustrates clearly the "severe" and "fine" styles through the early part and middle of the fifth century B.C., and finally becomes so careless as quite to lose its attractiveness. As illustrations of the developed polychromatic painting mentioned above, some of the *lecythi* are of great interest, for they show a technique which practically abandons outline drawing and renders the figures in solid color with some feeling for gradation of light and shade,² thus in all likelihood pointing to the works of the great fresco-painters. Such vases are probably to be dated in the fourth century B.C. or at the earliest late in the fifth century.

Figure 401 reproduces a vase dating from the beginning of the "fine style." It belongs to a series in which a certain stiffness in drawing is found, but also a refinement and elegance which in great measure compensate for the tendency to formality. A

¹ R. C. McMahon, *A. J. A.*, XI (1907), pp. 7 ff., gives an elaborate classification covering the fifth century B.C. *Athenian Lekythoi, with outline drawings in glaze varnish on a white ground*, by Arthur Fairbanks, is the most careful study of these vases that has yet appeared, for the period which it covers.

² Collignon, *Monuments Piot*, XII, pp. 29 ff., Pls. 3-5; Winter, *Berl. Winckelm. Progr.*, 1895.

Reference to a few published examples of *lecythi* is here given, which may serve the student as a rough summary of the changes in drawing which take place during the fifth century B.C.: Fairbanks, *op. cit.*, Pls. I-IV; *White Ath. Vases in Brit. Mus.*, Pls. XIV, XXII, XXIII A, VIII; *Ephemeris Archaeologiké*, 1905, Pl. 1; *Jour. Hell. Stud.*, XVI, Pls. IV-VII; *White Ath. Vases*, Pls. II-V; *Jour. Hell. Stud.*, XIX, Pls. II, III; *White Ath. Vases*, Pls. XII, X, XXVII.

young man and a young woman are shown standing on either side of a sepulchral stele.

The subjects of the pictures on *lecythi* are sometimes mythological, more often *genre*, and still more often they are concerned with death. Moreover, many of the domestic pictures resemble the scenes on the Athenian sepulchral monuments, and thus, though they represent merely the incidents of family life, they may frequently be associated with the dead. Other and earlier forms of vases, like the great Dipylon *craters* and *amphorae* and the *prothesis-amphorae* of the black-figured style, were associated with sepulchral usage, and other shapes appear in tombs at a still later date (cp. *White Ath. Vases*, Pl. XIII), but by the middle of the fifth century B.C. the *lecythi* become preëminently the Athenian sepulchral vases, and the scenes which appear upon them have to do with funeral rites.¹ These scenes appear in four different types, the *prothesis*, or laying-out of the body, the laying of the body in the tomb (*depositio*), the journey to Hades, in which Charon with his boat appears, and the cult of the tomb.² The representation of the *prothesis* occurs on black-figured *amphorae* of the type referred to above, and on black-figured terracotta plaques, and a form of *depositio* is not unknown to this earlier technique (*Monumenti*, VIII, Pl. IV), but this scene on the *lecythi* is commonly idealized



FIG. 401. — *Lecythus*. Athens. h. 0.34 m. (*A.J.A.*, XI (1907), Pl. V.)

¹ Cp. Pottier, *Étude sur les lécythes blancs attiques à représentation funéraires*.

² For these types, see *White Ath. Vases*, Pls. VII (*prothesis*); IX, XI (laying of body in tomb), XII, and *Antike Denkmäler*, I, Pl. 23 (Charon); *White Ath. Vases*, Pl. X, and *Jour. Hell. Stud.*, XIX, Pl. II (cult of the tomb). The cult scenes are very frequent indeed.

by the introduction of winged figures, very likely Sleep and Death, who bear the body. The scenes in which Charon appears are peculiar to the *lecythi*, though it should be noted that Pausanias in his description of Polygnotus's fresco of Odysseus in the nether world speaks of the ferryman and his boat on the river Acheron. The types of the representations of Charon receiving his passengers vary somewhat; in some cases the deceased are merely about to enter the boat, or, as in one instance, a mother is handing the grim boatman her child; in other examples the sepulchral stele and a figure bearing in a basket the customary offerings appear, and Charon with his boat waits near by, ready to receive the dead person who moves toward him or who is seated by the stele. In such scenes there is thus a combination of the journey to Hades with the cult of the tomb. This latter subject is treated by the vase-painters with a good deal of variety; sometimes only one figure is represented with offerings at the stele which is commonly draped with fillets; in other examples more figures are introduced, suggesting the gathering of the family at the tomb. Occasionally little winged figures (*εἴδωλα*), the spirits of the dead, hover about the monument. Throughout the resemblance of these scenes to the beautiful Athenian sepulchral stelae is marked; there is the same idealization of types, the same charming suggestion of happy family life.

GREEK VASES IN SOUTHERN ITALY

This is a subject which stands somewhat apart from the study of vases in Greece proper including the Greek islands and the colonial towns of Asia Minor and Africa, and it must therefore be treated very summarily. The Greek vases of southern Italy have not yet received as much scientific study¹ as has been given to many of the earlier styles, and far fewer specimens of them have been well published. The conditions therefore of their origin and development

¹ There is one monograph on the subject by G. Patroni, *Ceramica antica nell' Italia meridionale*, Naples, 1897, and the excellent catalogue of the British Museum, Vol. IV, by H. B. Walters.

are less thoroughly known. They are unquestionably a more or less direct outgrowth of the Attic red-figured style as it appears in different localities during the fourth century B.C. The Kertch vases are examples of such an outgrowth in the East, though these vases, in spite of some evidence which points to a local fabric in the Crimea may, to a great extent, have been made in Attica and exported. The Italian vases, however, many of which cannot be much later than the Kertch class, though some no doubt are, were certainly of local manufacture.

The vases are commonly classified on the general basis of provenience as Lucanian, Campanian, and Apulian, the latter class being the largest and in many ways the most important.¹ To these may be added a fourth class which seems to stand in pretty close relation to the vases of Lucania and Campania. This is known as the "Style of Paestum," because some of the most important vases which belong to it were found there. Paestum

The Paestum vases include five signed by Assteas and one by Python, and a number of other unsigned ones which may be grouped with these.² They show Attic tradition, and the rich treatment of drapery on them recalls to some extent the school of Midias (p. 503), but the general effect of the pictures is very different, and the large heads of the figures are noticeable.³ The fashion of introducing half figures in the background, which commonly seem to be mere spectators of the action, is a marked peculiarity, though one not wholly confined to the Paestum vases.

¹ Lucanian vases come chiefly from Anzi, Pisticci, Pomarico, and Armento; Campanian from Nola, Capua, Avella, and Santa Agata dei Goti; Apulian from Ruvo, Bari, Ceglie, and Canosa; but the delimitation of the different regions should not be too rigidly understood.

² Cp. Walters, *Hist. of Anc. Pottery*, I, p. 478, and *Brit. Mus. Catal.*, IV, pp. 72 ff.

³ Good examples are a *crater* by Assteas in Madrid on which Heracles slaying his children is represented (Baumeister, *Denkmäler*, Fig. 732), and the vase by Python with Alcmena on her funeral pyre (*Jour. Hell. Stud.* XI, Pl. 6). The picture of Heracles and his children appears to be conceived almost as a scene on the stage.

Of the three other styles the Lucanian, to judge from its general qualities, seems to be the earliest. The designs are usually simple and comparatively severe in type; the treatment of drapery shows no excess, and accessory colors are used with greater restraint than is the case in other vases of this period from southern Italy. The heads are large, as on the Paestum vases; ground lines are almost always lacking when figures are placed on a higher level, and it is characteristic that the garments, which in general show many local peculiarities, are ornamented with broad black borders and with dots which are often arranged in groups of threes. The style does not seem to change appreciably and shows more unity than the others do. The scenes depicted are usually from everyday life, though mythological subjects are by no means infrequent.¹ The vases are generally large, and the *amphora*, *hydria*, and bell-shaped *crater* are common; there is also a peculiar local form of the latter shape usually known as the *nestoris*.² As is the case in the other Italian styles, the influence of both the tragic and comic stage is marked.³

The Campanian vases, which apparently pass through a longer course of development, are in many ways very different. They are commonly rather small, even such forms as the *crater*, *amphora*, and *hydria*; the drawing, though often very careless, is less stiff than on the Lucanian vases; picturesque effect is sought, and there is frequent use of yellow, purple, white in large masses, and, on some examples, of carmine red, as accessory colors. Conventionalized floral patterns of varied designs are frequent and

¹ Cp. *Brit. Mus. Catal.*, IV, p. 19. Baumeister, *Denkmäler*, Figs. 505, 918, 919, 1307, 1308, 1939.

² Cp. *Brit. Mus. Catal.*, IV, p. 6, Fig. 3. This form is represented on a vase of the same shape (*Catal. F.* 175) figured in Millingen-Reinach, *Peintures*, Pl. 53.

³ The comic stage is actually represented on a number of vases from southern Italy, the farces popular at Tarentum probably furnishing the painters with most of their subjects. See Heydeman, *Jahrb. d. Inst.*, I, pp. 260 ff. For tragedy cp. especially J. Vogel, *Scenen Euripideischer Tragödien*.

a large and coarse palmette ornament under the handles is characteristic. Sometimes the floral element has considerable beauty and approaches closely to nature. The so-called "Nolan" *amphorae* of Attic manufacture (p. 417) have plainly influenced this form of vase in the local fabric of Campania, though the fine outline of the earlier type is generally absent from the Italian specimens (cp. Baumeister, *Denkmäler*, Fig. 821). Plates with representations of fish are common, many of which were very likely for actual use at meals (*Brit. Mus. Catal.*, IV, p. 120 f.). There has been an attempt to classify the Campanian vases, associating different types with different places, and to some extent it seems possible to do this successfully. On the other hand, it is sometimes difficult to be sure whether a vase is to be regarded as Campanian or Apulian, for both styles have characteristics in common. In the choice of subjects, the Campanian vases show great variety: there are scenes from comedy (Baumeister, *Denkmäler*, Fig. 904, the *Frogs* of Aristophanes), from everyday life, including the offering at the tomb (*Brit. Mus. Catal.*, IV., Pl. viii), and a good many mythological scenes. Local peculiarities of dress and armor are noteworthy.¹

The Apulian vases are more numerous and as a whole more important than any others from southern Italy, and it is possible to trace in them a long course of development in which the decoration changes from a comparatively severe and simple character into a style that is florid and careless in the extreme. On the later vases the figures of Eros gayly decked out with women's ornaments furnish a distinctive feature. About all the shapes used by the Greek potters appear among the Apulian vases, though often with modification of earlier types, and one form, at least, the *epichysis*, which is an *oenochoe* with a body shaped like a *pyxis*, is peculiar to the style (*Brit. Mus. Catal.*, IV, p. 7, Fig. 12).

¹ The scars from "fring" the legs of horses and donkeys, which are so often seen in the region of Naples to-day, seem to be represented on the vase which has the scene from the *Frogs* and on another published in the *Compte Rendu*, 1863, Pl. V.

The general use of color is much like that on the Campanian vases, and there is the same fondness for accessory white ; elaborate conventional floral patterns are also common. The most important



FIG. 402.—Crater (sometimes classed as amphora). Boston. h. 1.246 m. (Photograph.)

group of these vases consists of large *amphorae* and *craters*, which are not only striking specimens of ceramic art because of the rich effect of their decoration, but they are very noteworthy also for the interesting nature of the subjects represented upon them. These include an important series of scenes from the Lower World which appear to reflect Orphic tradition, sepulchral and mythological subjects, and subjects taken from tragedy. Some of the latter may be connected with plays of Euripides.¹ The chief subject usually covers almost the entire body of the vase, the neck being reserved for some subordinate scene or decorated with a more or less conventional pattern often of rich design. The

¹ Cp. Furt. and Reich., Pl. 10, I, Text, pp. 47 ff., Walters, *History*, Pl. XLV; Furt. and Reich., Pls. 88 (Darius in council considering the invasion of Greece), 89 (the sacrifice of the Trojan youths at the tomb of Patroclus), 90 (Medea and the death of Jason's queen), with accompanying text.

figures are generally ranged in three rather irregular rows and stand on dotted ground lines, and these rows are frequently broken by a building with columns which represents a house or palace. In the case of *craters* the handles often carry moulded medallions. Figure 402 is an excellent example of the class. The chief personages represented are Achilles and Phoenix and the dead Thersites (cp. Paton, *A. J. A.*, XII, 1908, pp. 406 ff.). The drawing on these great sepulchral vases, for such they no doubt are, is frequently careless and sketchy, but it also shows an easy mastery of technique and thus probably reflects to some degree the work of the great Greek painters of the fourth century B.C.

Some interesting questions present themselves in regard to this great development of Greek vase-painting in southern Italy: How did these local styles arise, and how directly are they the outgrowth of the various schools in the mother country? Are there earlier vases of local manufacture which may be considered the forerunners of the southern Italian groups? Furtwängler, in his *Masterpieces of Greek Sculpture* (p. 108 f.), pointed out that there were such vases and called attention to their important bearing upon the later schools. As yet little systematic study has been given them, though a few specimens have been well published.¹ The style of these vases unquestionably reflects that of the Attic masters, and yet the general effect is often different, the difference being largely due to a dissimilar scheme of proportions in rendering the human figure. This is well shown on an interesting *crater* from Pisticci in Lucania (Fig. 403) on which the scene of Odysseus in Hades making his inquiries of Teiresias is represented. Some of these vases may perhaps have been imported from Attica, but most of them are probably the work of the Greek colonists in Italy. The finest specimens can hardly be dated later than the fifth century B.C., and it is significant that some of the *craters* have almost exactly the form of the great Attic *craters* which are usually associated with Polygnotan art

¹ Furt. and Reich., Pls. 60, 98-99; *Monumenti*, XII, Pl. 16; Gerhard, *Auserles. Vasenbild.*, Pls. 153-154. See also Walters, *History*, I, p. 465.

(cp. pp. 499, 531). It seems likely then that the Italian Greeks of the fifth century B.C. began a local manufacture of vases which, while retaining many of the Attic traditions, developed some independence. For many years there had been a large importation of vases from Greece, but this fell off soon after the middle of the



FIG. 403. — From a crater. Paris, Bibliothèque Nationale. (Furt. and Reich., Pl. 60.)

fifth century, partly, perhaps, because of the Peloponnesian War (p. 501). Thus it seems probable that the cessation of importation gave the Greeks of southern Italy the chance to develop more independent work.

VASES WITH RELIEFS AND VASES IN PLASTIC FORM

The combination of the potter's handicraft with that of the maker of terracotta reliefs and with the work of the coroplast

appears very early in the history of Greek art, but it is a combination which can hardly be called really popular before the decadence of vase-painting sets in. Very often when vases are adorned with reliefs or have a plastic form the influence of the workers in metal upon those in clay is evident. This influence may be seen in the plastic treatment of the handles of many vases, and the form of even the plain handles of the typical *amphorae* of Nicosthenes (p. 482) strongly recalls metal technique. In the case of such vases as the so-called Megarian bowls¹ there is a definite imitation of metal repoussé work, and in the Italian successors of this type of ware, such as the so-called Calenian *phiaelae*, and the Arretine pottery of Roman times, there is a similar marked resemblance to vessels of silver and bronze. Thus the technique of vases which bear reliefs or which are moulded in plastic form is not that of the ordinary manufacture of pottery, but is really that of plastic work in terracotta and of modelling for work in bronze or marble; and the classification of such vases in accordance with artistic style depends chiefly upon the principles which obtain in these allied arts.

Early examples of the plastic treatment of vases appear in the primitive pottery of Troy, and the pottery of Mycenaean times, especially as it develops in Cyprus, furnishes many specimens.² In the Geometric period, on the other hand, there are very few, and it is not until about the seventh century B.C. that plastic design in connection with the manufacture of vases becomes at all common in Greece. It may be noted that the interesting *bucchero* ware, the national pottery of Etruria, with its reliefs and plastic forms, begins at this time.³ It is impossible here to do more than call attention to some of the important examples of the plastic decoration of vases as it appears in the course of the development of Greek pottery. Of these none are more noteworthy in the early period than some of large *pithoi* from Boeotia which may be ap-

¹ Cp. Robert, *Homerische Becher, Winckelmannsprog.* (Berlin), 1890.

² Cp. Pottier, "Les vases archaïques à reliefs," *B. C.H.*, 1888., pp. 491 ff.

³ Cp. *Album* of the Louvre Catalogue, Pls. 22-28.

proximately dated at the end of the seventh century B.C., and of which there are two fine specimens in the Museum at Boston.¹

Boeotian
pithoi The general scheme of decoration on the body of this type of vase is the band of animal figures (the same figure being repeated) and the analogy to the orientaling painted vases and metal reliefs of the time is therefore strong. On the neck of the vase there is a freer treatment of the subject represented,

commonly a mythological scene, and here too oriental influence is evident.

Figure 404, the fragment of a *pithos* recently found at Sparta, illustrates a later stage in the development of plastic work on vases. Here the resemblance to Ionic black-figured painting is so strong that the sixth century B.C. may safely be given as the date of the vase. In this case

the reliefs were made separately and affixed

to the vase before firing. Among more delicate vases, dating approximately from this time, which show plastic features, are some of the later and finer specimens of Proto-Corinthian ware (p. 446, note), but in general it is not until the latter part of the sixth century when the transition from the black-figured to the red-figured style begins that there appears to be any marked development in this kind of work. At this time there is a small but



FIG. 404. — Pithos. Sparta. (*Ann. of Brit. School*, XII, Pl. 9.)

¹ Report of the Museum for 1899, p. 52; De Ridder, *B.C.H.*, 1898, pp. 439 ff.

important series of vases signed (*ἔποίησεν*) by an Athenian potter, Charinus,¹ which are moulded with great delicacy in the shape of a female head. The work is black-figured and archaic, and the type of face like that of the female figures from the Acropolis. These vases of Charinus may be regarded as the beginning of a great development in the plastic treatment of pottery, which continues through the whole course of Attic vase-painting and is amply illustrated in the Italian styles. The *rhytum*, or drinking-horn, is the most frequent form for such vases (though other forms, notably the *lecythus*, occur also), and it assumes many shapes, the heads of men and animals being especially common

Charinus



FIG. 405.—Rhytum. Boston.
h. 0.254 m. (Photograph.)



FIG. 406.—Lecythus. Boston.
h. 0.19 m. (Photograph.)

(Fig. 405). The vases are often grotesque rather than beautiful, but others show the qualities of the best Greek work.² Figure 406, a *lecythus*, belongs to a series of elaborately moulded vases which

¹ Cp. Klein, *Meistersignaturen*, p. 215, and especially Reisch, *Röm. Mitt.*, V (1890), Pl. 11, pp. 313 ff. Cp. Kekule v. Stradonitz, *Die griechische Skulptur*, 2d ed., pp. 47 ff.

² *Jour. Hell. Stud.*, VIII, Pl. LXXII, *rhytum* (early "fine style"), in the form of a sphinx, painted with a white slip; XV, Pl. V, *aryballus* (late fifth century), a bust of Athena. These two vases are among the finest of their kind.

represent Aphrodite issuing from a seashell. Such vases are to be dated at the end of the fifth or in the fourth century B.C. They might properly enough be classed with terracotta figurines.

The ornamentation of vases by means of reliefs is exceedingly rare until about the end of the fifth century, probably because of the excellence and popularity of the work of the vase-painters. Considerable interest therefore attaches to the fragment of a *kylix* (*Ath. Mitt.*, V, 1880, Pl. X) now in Athens on which is represented in the interior a figure of Artemis in low relief. The work is exceedingly delicate and the style is that of the red-figured *kylixes* of the "severe" period. The face of the figure and the arms and feet are in white, and white is used for the inscription in raised letters (ὁ παῖ[ς καλός]), for the bow of the goddess and for the surrounding meander pattern. On the back of the *kylix* was a dedicatory inscription, also in raised letters, and a zone of animal figures encircled this.¹ The ground was gilded so that the vase appears to have been an imitation in miniature of ivory and gold technique. Toward the end of the fifth century B.C., the practice of attaching separately moulded figures to the surface of vases becomes common, — *appliqué* relief work, — and of this technique there are some very beautiful examples.² This method of decoration is frequent during the fourth century B.C. and is illustrated on the Kertch vases and on those of southern Italy. The resemblance of the reliefs to those on bronze mirrors is often striking, and the specimens referred to in the note recall the Alexander Sarcophagus (p. 275) in subject, style, and coloring.

Through the fourth and third centuries B.C. the tendency of the

¹ For another example, perhaps from the fifth century, a *crater*, from Corinth, see *Collection Sabouroff*, Pl. 74, 3.

² Cp. *Antiquités du Bosphore Cimmérien*, Pls. XLV, XLVI (Rayet and Collignon, *Histoire*, Figs. 100, 101), a splendid *lecythus* with out-curving sides from Kertch, signed by the Athenian Xenophantus, on which white, blue, and gilding are freely used. The chief subject of the reliefs is a hunt at the Persian court. See also *Monuments Piot*, X, Pls. 6, 7, a very fine pitcher, with figures on a gold ground, flesh white, garments blue and pink, ground lines in blue. The scene represented is the Calydonian boar-hunt.

potters to imitate metal technique is increasingly marked. It is perhaps especially evident in southern Italy, and may be seen among other instances in a well-marked class of *amphorae*, *hydriae*, and *oenochorae* found there. These are covered, except for small decorative designs, often in relief, with lustrous black varnish, and frequently the body of the vase is ribbed or fluted. In some smaller vases the same tendency toward the imitation of metal technique is, if possible, even more noticeable. This may be seen in the so-called Calenian *phiale*, which get their name from Cales in Campania where a good number have been found. There are examples of medallions on this ware which are actual imitations of known coins, and one vase in the British Museum (Walters, *History*, Pl. XLVIII, Fig. 5) was evidently made from the same mould that was used for a pair of silver bowls, also in that museum. In Greece proper during the third century B.C. the vases called **Megarian** Megarian bowls are the best-known illustrations of this **bowls** imitation of metal. They have been found in many places, but since the earlier discussions about them were concerned with specimens from Megara, the name Megarian has clung to them (cp. note 1, p. 519). They have also been called Homeric bowls, because the subjects represented on them are largely drawn from Epic narrative, and Suetonius mentions *scyphi Homerii* on Nero's table which were engraved with scenes from the Homeric poems. One interesting specimen (*Brit. Mus. Catal.*, IV, Pl. XVI) is decorated with scenes from the *Phoenissae* of Euripides. The bowls are commonly hemispherical in shape (sometimes cylindrical), and the red clay was covered over with black varnish and fired at a very high temperature; as a result the surface takes on a metallic appearance, and it is not unlikely that the vases were used by persons who could not afford the more costly vessels of metal which were fashionable in Hellenistic times. The designs on the Megarian bowls are either separately stamped and then attached to the vase, or the vases are made entirely in moulds after the manner of most of the Arretine pottery, with a brief mention of which the discussion of vases is brought to an end.

The vases made at Arezzo in Tuscany, the ancient Arretium, commonly called Arretine, are really Italian, but the designs of their decoration are so strongly Greek in character that they may fairly be classed with specimens of Greek ceramic art. The manufacture of the best quality of this ware extended from about fifty years before the beginning of the Christian era to about fifty years after it, though no doubt these limits may be advanced a good number of years in each direction to cover the periods of rise and decline. The finest specimens are of the Augustan age. At first the pottery was covered with a black glaze suggesting metal, like the Megarian bowls, but very soon this was given up, and it is the fine red hue of the clay, heightened by the use of a red glaze, which is characteristic of the pottery as a whole and which gives its surface something the effect of coral. Plain vases occur, vases with reliefs "applied" to them, and vases made in moulds, the last class being much the largest and most important. Fortunately a great many of the moulds have been found, and some also of the stamps used in making them, so that it is possible to understand the process of manufacture with unusual completeness. Figure 407 represents a cast taken from a mould. The vases, which are generally small, are chiefly bowls, cups without handles, and dishes, though sometimes a *crater* shape occurs;¹ but such larger vases have not the characteristic Greek forms, and the lines suggest merely an enlargement of the smaller vessels. Interesting and curious are the inscriptions on this class of ware; they record the name of the proprietor of the pottery, of the slave who made the vase, or both, and it is a noteworthy fact that most of the names of slaves are Greek. The designs of the reliefs are often exceedingly beautiful, and the figures suggest those of the fine stucco wall decoration from the Farnesina garden, now in the *Museo delle Terme* in Rome. Individual figures occasionally recall Greek works of even the fifth century B.C., and their resemblance to types of the fourth century,

¹ Rayet and Collignon, *Histoire*, Pl. 13, 1, and Fig. 131; Walters, *History*, Fig. 219.

to those of the Hellenistic period, and especially to the so-called Neo-Attic reliefs is strong; they are indeed sometimes identical with figures from these reliefs. The designing of the figures on the Arretine pottery is thus distinctly eclectic, and even for the general types and decoration of their vases the potters appear to have



FIG. 407. — Cast of an Arretine bowl. (Loeb Collection, *Catalogue*, Pl. II.) Diam. 0.175 m. h. 0.101 m.

depended upon the makers of gold and silver vessels; thus their decorative schemes often recall the silver vases of Hildesheim, Boscoreale, and Bernay.¹

¹ A recent and important work on Arretine pottery is the *Catalogue of the Loeb Collection* by G. H. Chase, New York, 1908. This contains an introduction which treats generally of the type of ware. The collection of Arretine pottery at the Museum in Boston and that of Mr. Loeb, now deposited at the Fogg Museum at Harvard, are among the most important that have been made.

CHAPTER IX

PAINTING AND MOSAIC

SINCE this handbook is intended to serve chiefly as an introduction to the study of Greek art as it is known from actual remains, the subject of painting is treated very briefly. That masterpieces of this art existed in Greece there is no doubt, but they have perished utterly.

Our monumental sources for a knowledge of Greek painting, from the beginning of the sixth century B.C. on, are first of all the **Monumental sources** Corinthian *pinaces* (p. 452), the sarcophagi from Clazomenae (p. 461), and the vases — the black-figured, and especially the red-figured Attic vases, for hints as to composition and drawing, and the Attic vases with white ground for the technical effect of the Polygnotan period. Then there are scanty remains of painting on marble, of which the stele of Lyseas (Conze, *Grabreliefs*, Pl. I; *Ath. Mitt.*, IV, Pls. I and II) is a leading example, and there is an interesting terracotta tablet from the Acropolis (Εφ. 'Αρχ., 1887, Pl. 6). Here the terracotta is covered with a yellowish layer of some composition, and the drawing in colors (black and brown, dark red or crimson) is done on this, with some use of incision.¹ Next are the

¹ An important series of painted sepulchral stelae was found at Pagasae in 1907. Only a few of them have as yet been published, and these quite inadequately. Dr. Arvanitopoulos, who has had charge of the excavations at Pagasae, believes them to reflect pretty closely the art of the Greek painters of the fourth and third centuries B.C. Technically, the stelae are valuable illustrations of the use of the encaustic process, but of their importance as throwing light upon the work of such artists as Apelles, Nicias, and Pausias, it is perhaps too soon to judge. See Εφ. 'Αρχ., 1908, pp. 1 ff., Pls. 1-4. Important, too, is the recent careful study by M. Marcel Bulard, of the frescoes and mosaics at Delos, *Monuments Piot*, XIV, 1908.

series of paintings found in the *tombe a camera* of Etruria. Some of the earlier of these are painted on terracotta plaques; others, which are still more important, are wall paintings, sometimes done directly on the wall, sometimes upon a thin layer of stucco. One of the best examples of the later Etruscan painting is on an alabaster sarcophagus from Corneto (*Jour. Hell. Stud.*, IV, Pls. XXXVI–XXXVIII). This may be work of the fourth century B.C. These Etruscan paintings, interesting in themselves, and betraying at every turn Greek, and especially Ionic, influence, are important for the illustration they afford of the development of painting in the period from the sixth to the fourth century B.C.; but, though they yield some suggestions as to the use of color, especially of its highly conventional use in the early stages of Greek painting, it must nevertheless have been a far cry from the paintings of Etruria to the great works of the leading Greek masters. Their chief importance to the student of Greek painting lies in the fact that their own development reflects the similar development in Greece. Marked Greek influence, or perhaps actual Greek work, is found also in a few Lucanian frescoes, notably at Paestum.

A further source of knowledge, though not a contemporary source, is to be found in the paintings of Pompeii, Herculaneum, and Rome, and in the portrait mummy tablets from the Fayûm, which date from the early years of our era. Unfortunately the inferences which may be drawn from Pompeian and similar art are very general. The mythological subjects chosen by the decorators of the houses at Pompeii and Herculaneum no doubt show their entire dependence upon Greek tradition, and it is probable, to take a definite and typical example, that the well-known picture of Medea from Herculaneum (Fig. 408) harks back to an original of Timomachus of Byzantium (first century B.C.), but this cannot be proved, and another picture of the same subject from Pompeii, which is more completely preserved (Baumeister, *Denkmäler*, Fig. 155), shows marked variations of detail. Thus it is impossible to say how close the resemblance to the work of Timomachus may be, and a similar doubt constantly arises in cases where a subject

known to have been used by a Greek painter of note has been chosen by the Graeco-Roman decorator. Nevertheless, the paintings of Pompeian type do give general hints as to the Greek painting of the Hellenistic period,¹ and, in spite of mechanical execution and the air of rather wholesale

production which many of them suggest, they are by no means without real merit. They show much skill in the use of color, often considerable ability in composition, and a knowledge of perspective which, though certainly imperfect, was hardly equalled in later times before the Renaissance. Thus it seems likely that the great Greek painters, from the fourth century B.C. on, must gradually have developed a considerable understanding of perspective. Every now and then these Graeco-Roman paintings show real power, and thus serve to indicate how great the loss of works by masters like Apelles and Protogenes really is.

The pictures from the Fayûm, executed commonly on wooden panels, partly in *tempera*, and partly in encaustic, form an extraordinarily interesting series illustrating Graeco-Egyptian portraiture (Fig. 409). The best of them are lifelike and are works of no inconsiderable merit, but, as in the case of Roman and Pompeian art, when we seek to form an impression of earlier Greek



FIG. 408. — Medea. Naples.
(Photograph by G. Brogi.)

art from them, we are on uncertain ground. In the pictorial relief-sculpture of Hellenistic times we may also get a few hints

¹ Cp. *Jour. Hell. Stud.*, XVI, pp. 143 ff.

with reference to the painting of the time, in such matters at least as the arrangement and balance of figures, the subjects treated, and the general progress of artistic skill.

Besides the monumental sources thus briefly described, there are also literary sources for a knowledge of painting.¹ These consist of statements in regard to artists and their work collected from a wide range of classic literature, the most extended being those of the elder Pliny (*Hist. Nat.*, XXXV) who, though often loose and careless in his statements, has attempted something like a systematic history of Greek painting. Important information, too, is afforded among others by Pausanias and Lucian.

From such sources the following inferences have been drawn, often with uncertainty in matters of detail. A school of painting existed in Ionia by the beginning of the seventh century B.C., with which the names of Boularchus (p. 456), Saurias of Samos, and Philocles, an Egyptian, may be associated. As to this school, we probably get some general hints from the various Ionic vases, and from the sarcophagi of Clazomenae. It seems likely that it was polychromatic in distinction from the early schools of continental Greece. In this latter region Corinth and Sicyon take the lead



FIG. 409.—Portrait on linen of a woman named Aline. Berlin. (*Ant. Denk.*, II, Pl. 13.)

¹ Cp. Overbeck, *Die antiken Schriftquellen zur Geschichte der bildenden Künste bei den Griechen.*

in the seventh century B.C. — Corinth with the artists Cleanthes, Aridices, Ecphantus, and Aregon; Sicyon with Craton and Telephanes; and the legendary names of Eucheir and Eugrammus are also associated with Corinth (pp. 450 f.). Pliny mentions besides three painters with Doric names, Hygiaenon, Dimias, and Charmidas, but the inference from his words that there was a specially Doric school is hardly warranted. With Eumarus of Athens, the father of Antenor the sculptor, and Cimon of Cleonae we reach historic times, probably about the age of Solon in the case of the former, and the end of the sixth century B.C. in that of the latter. It is likely that in their works the Ionic and continental tendencies which met at Athens were united. To Eumarus Pliny attributes great skill in the delineation of figures, and to Cimon the honor of having improved upon the work of Eumarus, and especially of having introduced *κατάγραφα* (*hoc est obliquas imagines, sc. invenit*), which no doubt involved foreshortening; he was skillful also in rendering the anatomy of the figure and the effects of drapery. Cimon's influence may probably be seen in the red-figured vases of the "severe style." Thus the art of painting must have attained to considerable excellence when Polygnotus began his work just after the Persian War. Through his influence and that of other artists more or less closely associated with him there was a marked development, especially in composition and in portrayal of character, and later tradition gives him unstinted praise.

Polygnotus was from the island of Thasos and of a family which apparently possessed considerable artistic talent. It is likely that he inherited many of the traditions of the old **Polygnotus** Ionic school of painting, but he is himself to be associated primarily with the active artistic and intellectual life of Athens to which so many Greeks from other regions were contributors. In the study of his works our sources of information are twofold — the accounts of them which have come down through many generations of Greek writers, with a few remarks of Pliny (such sources are of course not contemporary with Polygnotus), and the contemporary or slightly later specimens which we have of the minor art of

vase-painting.¹ Among the descriptions of his wall paintings, or of similar works by painters associated with him, like Micon and Panaenus, the brother of Phidias, two are of especial importance. These are the long and detailed accounts which Pausanias (X, 25-31) gives of two great frescoes in the Lesche of the Cnidians at Delphi, the one representing "Troy after its capture and the departure of the Greeks," the other, the "Visit of Odysseus to the Lower World." So elaborate are these accounts that there have been many attempts to gain some idea of the composition of the paintings by making drawings from the descriptions, but at best such attempts must involve many uncertainties. The drawings, however, published by Professor Robert (*Winckelmannsprogramme*, Halle, 1892 and 1893) which have been made in connection with a careful study of contemporary vases, are of great value in lending reality to the account of Pausanias. It seems impossible from this to be sure whether Polygnotus represented any one of the many groups of figures in the paintings as distinctly forming a central scene such as would serve to unify the whole composition. Pausanias's description indicates rather a number of more or less separate groups each having to some degree a unity of its own. Some of the large wall paintings of Puvis de Chavannes may perhaps afford suggestive comparisons.

Pausanias often says that persons are above or below those whom he has been speaking of (thus pointing to differences of level), or in a line with them. The remark of itself does not seem particularly important, but there are a number of vases which may be assigned to a period just following the "severe style" of red-figured vase-painting, and these seem to throw light on the matter. They are commonly large vases, and the scenes depicted upon them suggest a relation to wall-paintings of large scale.² A fine *crater* from Orvieto, now in the Louvre, upon which the slaughter of

¹ Cp. Th. Schreiber, *Die Wandbilder des Polygnotus*.

² Cp. Furt. and Reich., Pls. 6, 17-18, 26-28, 55, 75-76, with the accompanying text. There are three fine vases which illustrate this large style in the Metropolitan Museum in New York.

the Niobids (Fig. 410)¹ and a scene from the Argonautic myth (Fig. 411) are painted, is among the most noteworthy of these vases, and from it, as well as from the others of its class, we can probably form some idea of the methods of Polygnotus. There is only the dimmest notion of perspective, and the different levels upon which the figures stand, like those shown on the mountain side in the Niobid vase, are indicated by irregular lines running across the ground of the picture. The more distant figures are on



FIG. 410. — Slaughter of the Niobids. Crater, Louvre. h. of vase 0.55 m.
(*Monumenti*, XI, Pls. 38-40.)

the higher levels, but they are not drawn on a smaller scale. To this general rule the smaller, partly hidden figure toward the top of the Argonautic scene may be regarded as an exception. The groups are simple, and the background is indicated in the symbolical manner characteristic of Greek art; thus a tree represents the forest of the mountain on the Niobid vase. Similar brief indications of locality appear in Pausanias's description of the wall paintings at Delphi, where he mentions the grove of Persephone and the pebbles on the seashore near which

¹ Cp. P. Gardner, *Jour. Hell. Stud.*, X, pp. 117 ff.



FIG. 411. — The Argonauts. (See references under Fig. 410, and Furt. and Reich., II, Pl. 108.)

Nestor stands. So it is probably safe to infer that the much-praised beauty of the work of Polygnotus lay in its simplicity and dignity and in the purity of line-drawing which on the vases has so interested some of the best draughtsmen of modern times, the French artist Ingres, for example. This skill in the use of the simple line is characteristic of all the best vases, but from the nature of the technique it attracts attention especially in the finest examples of those which show line-drawing on a white ground (pp. 506 ff.). These vases are well calculated to supplement those of the class to which the Orvieto *crater* belongs in suggesting the probable appearance of the Polygnotan wall-paintings. In the stage at which the vases with white ground take on a polychromatic character, they probably afford further evidence of the color effect of the paintings. Since we know the subjects of various pictures by Polygnotus besides those at Delphi, such, for example, as Odysseus and Nausicaa, Odysseus's slaughter of the Suitors, and the killing of Aegisthus by Orestes, and since these subjects have been used also by vase-painters, there may sometimes be a question as to whether the *motives* on the vases, or single figures upon them, may not have been taken directly from the greater works of art. But a connection here is difficult to establish, since the legends were common property and were part of the vase-painters' material long before the time of Polygnotus. Aristotle speaks of the idealistic treatment of his subjects which characterized Polygnotus — a remark which seems to bring the painter close to the Phidian school of sculpture — and he says that, in contrast to Zeuxis, Polygnotus was a skilful delineator of character. Thus it seems certain, in spite of very inadequate sources of information, that his art was of a thoroughly strong and elevated quality.

With the fourth century B.C. Greek painting enters upon the period of its most complete development, but a knowledge of it depends to a great extent on literary sources, and on the rather vague suggestions which come from the Graeco-Roman work. The stelae recently discovered at Pagasae (see p. 526, note) may add somewhat to our knowledge.

Fourth
century
painting

The vases of the fourth century offer no such help as the earlier ones do in the case of Polygnotus.¹

The paintings of Apollodorus of Athens (end of fifth century B.C.) appear to mark the transition from the Polygnotan art to the freer style of the next century. He seems to have been successful in introducing the effects of light and shade through gradation of colors, and the power to do this of course means that the art was passing out of the stage of colored drawing into that of real painting. The easel picture, which involves a tendency to lay more stress upon the actual beauty of the work than on the story that is told, is the natural development of this time. A long line of painters carried on their art through the fourth and third centuries; Zeuxis, Parrhasius, Timanthes, Pausias, Apelles, and Protogenes are leading names, but there are many more, and, to judge from the many different places that the artists came from, there must have been very great interest in their work all over the Greek world. The nature of the progress made can be understood only in a general way, but it is certain that a high point of excellence was reached. There was much more skilful use of perspective and color, and technical processes were greatly improved. Painting, no doubt, showed the realistic tendency which was characteristic of the period, but there is no reason to suppose that this spirit, in the work of the greater masters at least, was carried to excess. The spirit which dominates Greek art during and after the fourth century B.C. showed, according to the Greeks themselves, "pathos" rather than "ethos"; that is, it attempted to render more markedly the passing emotion, and did not confine itself so much to the portrayal of that which would suggest permanent qualities of character. The work of Polygnotus, on the other hand, was noted for the portrayal of "ethos."

¹ A small number of large *lecythi*, with polychrome paintings on a white ground, exhibits gradations of colors and some knowledge of perspective. Their date appears to be the latter part of the fifth or the early part of the fourth century B.C., and they probably reflect the progress made by Apollodorus, his contemporaries, or his immediate successors. See p. 510, note 2.

Among the many painters of the later schools Apelles¹ appears to hold the highest place in Greek tradition, and the uniformity of the praise accorded him is impressive testimony to its justice. There were many stories current about his extraordinary skill, and, as might be expected, these touch generally upon technical dexterity, but he certainly must have possessed much more than this, and Lucian's description of his "Calumny" shows he was capable of handling a large and difficult composition. From many of the subjects which he chose—figures of gods and heroes and allegorical figures—it would seem that he had no lack of imagination. There can be no doubt that the loss of his paintings and of others by his contemporaries and successors has made it impossible for us to understand one of the most important phases of Greek art.

There appear to have been three methods of painting, all of which were in use when the highest period of development had been reached,—fresco, *tempera*, and encaustic. How far the fresco process differed in detail from more modern methods has been a matter of considerable controversy,² but the indications are that the differences were considerable. We have unfortunately no remains of the fresco-painting of the fifth century B.C., and therefore cannot tell how closely its technique corresponded to the accounts of the process as given by Pliny and Vitruvius or to that of the paintings at Pompeii and Rome. In general it may be said that the stucco for the fresco seems to have been prepared with the greatest possible care, by the addition to the first coating of coarse mortar of a second and third coating of sand mortar and of mortar made with crushed marble. Thus the various layers applied to the wall evidently formed a much thicker mortar coating than is usual in modern fresco-painting. This would naturally dry slowly, and

¹ Cp. J. Six, *Jahrb. d. Inst.*, 1905, pp. 169–179.

² Cp. E. Berger, *Beiträge zur Entwicklungsgeschichte der Maltechnik, passim*, especially pp. 81–82, and for differing views, F. Gerlach, *Neue Jahrb. für das Klass. Altertum*, XXI, 1908, pp. 127–147.

the painter could thus work more freely at his whole composition. As certain colors are not suited to fresco, the method of *tempera* technique, involving the use of a sticky medium like gum or egg to bind the color, was sometimes employed in a supplementary way in the decoration of walls. Easel pictures were painted in *tempera* process, commonly on wooden panels; though the use of canvas was known, and in some of the mummy portraits from the Fayûm there are examples of it (cp. Fig. 409). In all probability *tempera* painting, though very likely differing in some matters of detail, was essentially similar to the process used by the painters of western Europe before the introduction of oil as a binding medium. Our knowledge of the encaustic technique is gathered chiefly from the inadequate statements of Pliny, from the late Fayûm portraits, and from the stelae of Pagasae. Here the essential feature was the use of wax as a binding medium. In hot countries like Egypt the mixture could readily be kept in a sufficiently fluid state to be applied with the brush; in cooler countries, however, it must have been artificially heated, or it may possibly have been softened by the addition of oil or of some such solvent as naphtha. How far the so-called *cestrum*, a kind of *spatula*, may have been used in this process for the application of the color, is a matter of dispute. On the Fayûm portraits the mark of the brush is plain. A good summary of our knowledge in regard to these technical processes is to be found, *s.v.* "Pictura," in Smith's *Dictionary of Antiquities*.

MOSAICS

The art of mosaic (*opus musivum*), since it seeks to produce decorative and pictorial effects by the use of colored stones, glazed earthenware, and glass, is closely allied to painting, and is therefore briefly mentioned under this head. Such work is of very early origin. It was well known in Mesopotamia and Egypt, and it has been found in the palaces of the Mycenaean chieftains, but evidence of its use during the Greek classical period is lacking. The earliest specimen in Greece proper is probably that in

the pronaos of the temple of Zeus at Olympia,¹ but it is not likely that this is earlier than the Macedonian period. The recent excavations on the island of Delos have brought to light a number of good mosaics in houses there, but these, too, are Hellenistic or Roman. It is thus from about 300 B.C. that the use of mosaic on a large scale appears, and there is no doubt that it was extensively employed in the splendid palaces and gardens of great centres like Alexandria and Pergamon. The simpler private life of earlier times did not call for the elaborate decoration of dwellings, but as soon as the great accumulations of wealth which characterized the period of the successors of Alexander made it possible to gratify even the most extravagant taste for luxury, there was naturally great demand for any art which could contribute to gorgeous effects. The remains of mosaic from the Hellenistic period, so far as dates are at all sure, are not extensive, and literary authorities are few,² but the general indications of the growth of the art are evident. We hear, for example, of mosaics representing scenes from the *Iliad*, which formed part of the adornment of the splendid ship that Hiero II of Syracuse sent to Ptolemy. These, it has been conjectured, were very likely copies of paintings by Theon of Samos (latter part of fourth century B.C.), who executed a series of pictures representing episodes in the Trojan War.

The fact of the great development of mosaic work in later Greek art is further confirmed by the many fine specimens found at Pompeii and elsewhere in Italy. Most of these may properly

¹ See *Olympia*, II, Pl. cv, and Baumeister, *Denkmäler*, Fig. 998. Cp. Furtwängler, *Archäologische Zeitung*, 1879, p. 153.

² Cp. Overbeck, *Schriftquellen*, Nos. 2158-2161. Pliny records the name of a single artist, Sosus of Pergamon, who made a famous mosaic which came to be known as the "Unswept House," since it represented a floor strewn with the leavings of a banquet. Such subjects for dining rooms seem later to have become common. Pliny says further that Sosus introduced into his mosaic a dove drinking, and that the shadow of its head was thrown on the water. Compare the fine group of doves (one drinking) in the beautiful mosaic from Hadrian's Villa, now in the Capitoline Museum.

enough be classed as Roman, yet their relation to Greek art is close, and it is thought by some that certain of the earlier examples may even be Greek work imported into Italy. The Greek names of artists who occasionally sign their work are significant, and the Egyptian subjects which are introduced on the great mosaic at Praeneste are typical of the foreign character of a good deal of the Italian work.

Of all the mosaics which are preserved, the one that throws most light on Greek painting is the well-known picture from Pompeii commonly thought to represent Alexander and Darius at the battle of Issus (Fig. 412).¹ This wonderful work, which measures 5.50 m. by 2.42 m., was found in the *Casa del Fauno* at Pompeii, in 1831, and is now one of the chief treasures of the Museum at Naples. Alexander, mounted and without his helmet, leads a charge against the Persian king. Darius, who is surrounded by his horsemen, is standing in his chariot, and his charioteer, using the whip vigorously, is turning the horses for flight. Immediately in the foreground is a Persian who holds a restive horse. The animal is represented with bold, if not wholly successful, foreshortening. A Persian horseman, who has apparently sought to intercept the charge of Alexander upon the king, has been thrown down; his horse has fallen, and Alexander's spear pierces his side. Darius, with right hand outstretched, and the Persian who holds the restive horse, are looking in consternation at this catastrophe. The attitude of Alexander recalls the representation of him on the great Sidon sarcophagus (p. 275). The artist evidently wished to suggest the moment when the rout of the Persians becomes complete, even if we hesitate to accept the view that the scene represents the actual meeting of the two kings as described in the highly colored account of Quintus Curtius (III, 27).

The whole composition is full of life and vigor, and it is generally believed that the mosaic is a copy of some famous paint-

¹ F. Winter, *Das Alexandermosaic*, with plates. Cp. G. Körte and E. Pernice, *Röm. Mitt.*, 1907, pp. 1-34. Körte thinks the scene depicted was at the battle of Gaugamela (Arbela), and there is much to be said for this view.

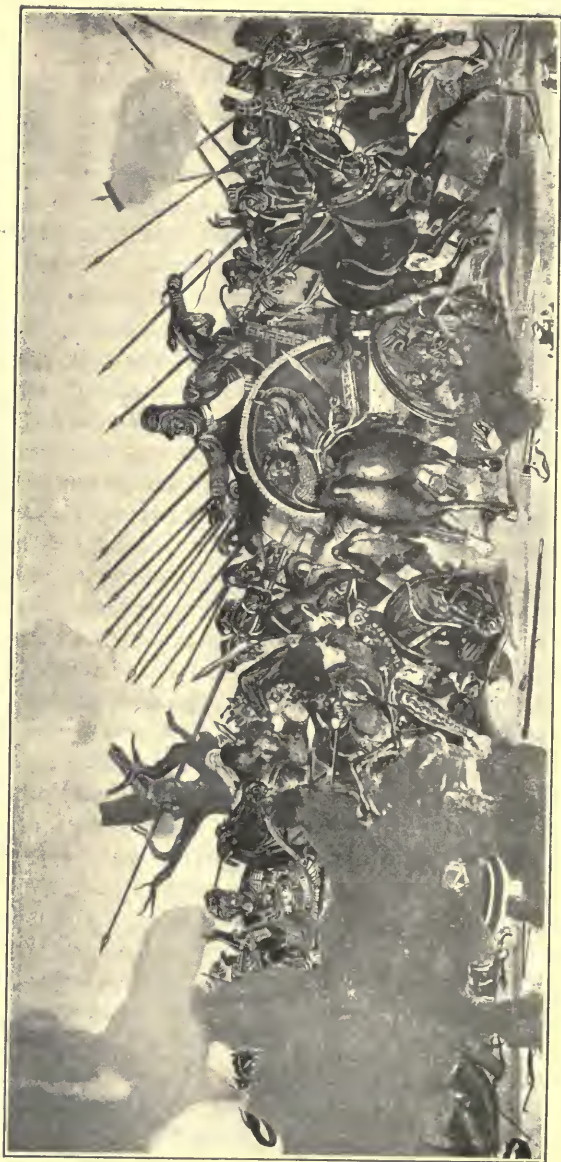

FIG. 412. — Mosaic from Pompeii, representing Alexander and Darius. Naples. (Photograph by G. Brogi.)

ing of Alexander's time. Defects in drawing there no doubt are, but these may in large measure be due to the change from painting to mosaic. Pliny tells of an admirable picture by Philoxenus of Eretria, made for Cassander, which represented a battle between Alexander and Darius, and it is possible that the mosaic is a copy of this. There is also another tradition, resting on the doubtful authority of Ptolemaeus Hephaestion, that an artist named Helena, daughter of Timon, an Egyptian, painted a picture of the battle of Issus. This is said to have found its way to Rome in Vespasian's time, and the statement has been made that it was probably the source of the Pompeian mosaic. The mosaic, however, must be dated, on well-established archaeological grounds, at any rate before 100 B.C., and the most serious injuries which it has suffered are probably due to the earthquake of 63 A.D. Thus, whatever the possible relation of the mosaic to Helena's picture, the presence of the latter in Rome in Vespasian's time could have no bearing on the matter. Probably it will never be possible to know certainly from what particular painting the mosaic was taken, but it remains none the less the most important visible indication that we have of the skill and power to which Greek painting attained.

BIBLIOGRAPHY

[Only the more important books are here mentioned, and only such articles in periodicals as are of especial importance and have appeared so recently that their substance is not yet (1909) to be found in books. Further bibliographical information is contained in many of the books here mentioned. A serviceable bibliography will be found in the *American Journal of Archaeology*, X, 1906. Annual Supplement, p. 181. An excellent bibliography by Professor Michaelis is appended to the seventh edition of Anton Springer's *Handbuch der Kunstgeschichte*. The *Katalog der Bibliothek des Kaiserlich Deutschen Archäologischen Instituts in Rom*, by August Mau (Rome, 1900, 1902), is perhaps the most exhaustive archaeological bibliography at present available.]

PERIODICALS

The chief periodicals devoted entirely or in great part to Greek Archaeology are:—

American Journal of Archaeology (A.J.A.).

Journal of Hellenic Studies (J.H.S.).

Annual of the British School at Athens (B.S.A.).

Jahrbuch des kaiserlich deutschen archäologischen Instituts (Jahrb. d. Inst.).

Mitteilungen des kaiserlich deutschen archäologischen Instituts, Athenische Abteilung (Ath. Mitt.), and *Römische Abteilung (Röm. Mitt.)*.

Jahreshefte des oesterreichischen archäologischen Instituts.

Bulletin de correspondance hellénique (B.C.H.).

Revue archéologique (Rev. Arch.).

Ἐφημερίς Ἀρχαιολογική (Ἐφ. Ἀρχ.).

To these should be added three large illustrated publications appearing somewhat irregularly: *Antike Denkmäler*, *Monumenti Antichi*, and *Monuments Piot*. The *Antike Denkmäler* replaced the *Monumenti Inediti* of the Istituto di corrispondenza archeologica in 1885.

GENERAL WORKS

Perrot and Chipiez, *Histoire de l'art dans l'antiquité*, Vol. VI, 1894 (La Grèce primitive ; l'art mycénien), Vol. VII, 1898 (La Grèce de l'épopée ; la Grèce archaïque, le temple), Vol. VIII, 1903 (La Grèce archaïque, la sculpture) ; other volumes to follow.

A. Baumeister, *Denkmäler des klassischen Alterthums*, 3 vols., Munich, 1884-1888.

Daremberg and Saglio, and later E. Pottier, *Dictionnaire des antiquités grecques et romaines*, in progress, well advanced.

Smith's *Dictionary of Greek and Roman Antiquities*, 3d ed., London, 1890.

Baumgarten, Poland and Wagner, *Die hellenische Kultur*, Leipzig, 2d ed., 1907.

Anton Springer, *Handbuch der Kunstgeschichte*, Vol. I, 7th ed., by Adolf Michaelis, Leipzig, 1904.

L. v. Sybel, *Weltgeschichte der Kunst im Altertum*, Marburg, 1900.

F. B. Tarbell, *A History of Greek Art*, Meadville, 1896.

H. B. Walters, *The Art of the Ancient Greeks*, London, 1906.

P. Gardner, *A Grammar of Greek Art*, London and New York, 1905.

M. Collignon, *L'archéologie grecque*, Paris, 1907.

Franz Winter, *Kunstgeschichte in Bildern*, Abteilung I, das Altertum, Leipzig and Berlin, 1900 (an important and relatively inexpensive collection of illustrations).

H. Brunn, *Geschichte der griechischen Künstler*, 1852. Reprinted, Stuttgart, 1889.

A. Furtwängler, *Einführung in die griechische Kunst*, *Deutsche Rundschau*, 1908, February and March (two valuable articles).

J. Overbeck, *Die antiken Schriftquellen zur Geschichte der bildenden Künste bei den Griechen*, Leipzig, 1868.

K. Jex-Blake and E. Sellers, *The Elder Pliny's Chapters on the History of Art*, London, 1896.

J. G. Frazer, *Pausanias's Description of Greece*, 6 vols., London, 1898.

M. L. D'Ooge, *The Acropolis of Athens*, New York and London, 1908.

The official publications of excavations, especially those of Olympia, Pergamon, and Delphi.

STUDY AND PROGRESS OF ARCHAEOLOGY

C. B. Stark, *Handbuch der Archäologie der Kunst, Erste Abtheilung, Systematik und Geschichte der Archäologie der Kunst*, Leipzig, 1880.

Karl Sittl, *Archaeologie der Kunst*, Vol. VI in von Müller's *Handbuch der klassischen Altertumswissenschaft*, Munich, 1895.

Adolf Michaelis, *Die archäologischen Entdeckungen des neunzehnten Jahrhunderts*, Leipzig, 1906, trans. by Bettina Kahnweiler under the title "A Century of Archaeological Discoveries," London, 1908.

Bruno Sauer, *Antike Kunst* (in *Die Altertumswissenschaft im letzten Vierteljahrhundert*, by W. Kroll), *Jahresberichte über die Fortschritte der classischen Altertumswissenschaft*, Supplementband 124, Leipzig, 1905.

Adolf Michaelis, *Ancient Marbles in Great Britain*, trans. by C. A. M. Fennell, Cambridge, 1882.

Adolf Michaelis, *Geschichte des deutschen Archäologischen Instituts (1829-1879)*, Berlin, 1879.

De Laborde, *Athènes aux XV^e, XVI^e et XVII^e siècles*, Paris, 1854.

Henri Omont, *Athènes au XVII^e siècle (Drawings of the Parthenon and views of Athens)*, Paris, 1898.

PREHELLENIC GREECE

Tsountas and Manatt, *The Mycenaean Age*, Boston, 1897.

C. Schuchhardt, *Schliemann's Ausgrabungen (Schliemann's Excavations)*, trans. by E. Sellers, London and New York, 1891.

W. Dörpfeld, *Troja und Ilion*, Athens, 1901.

Society for the Promotion of Hellenic Studies, *Phylakopi*, London, 1904.

Ronald M. Burrows, *The Discoveries in Crete*, London, 1907.

A. Mosso, *Palaces of Crete and their Builders*, London, 1907.

Harriet Boyd Hawes, *Gournia, Vasiliki, and other Prehistoric Sites on the Isthmus of Hierapetra, Crete*, Philadelphia, 1909.

Père M. J. Lagrange, *La Crète ancienne*, Paris, 1908.

G. Maraghiannis, *Antiquités crétoises, I^e série*. Plates with brief text by L. Pernier and G. Karo, Candia, 1907.

Reports on the discoveries in Crete, by A. J. Evans and others, are published in the *Annual of the British School at Athens*, Vol. VI (1899-1900) and following, by F. Halbherr, L. Pernier, and others in *Monumenti Antichi*, VI, 1896, and following.

ARCHITECTURE

- A. Marquand, *Greek Architecture*, New York and London, 1909.
- Anderson and Spier, *Architecture of Greece and Rome*, London and New York, 1903.
- Russell Sturgis, *History of Architecture*, Vol. I, New York, 1906.
- J. Durm, *Die Baukunst der Griechen* (*Handbuch der Architectur*, II, 1), 2d ed., Darmstadt, 1892.
- Borrmann and Neuwirth, *Geschichte der Baukunst*, I, *Altertum* (by R. Borrmann), Leipzig, 1904.
- A. Choisy, *Histoire de l'architecture*, Vol. I, Paris, 1898.
- D'Espouy, *Fragments d'architecture antique*, Paris, no date.
- Koldewey and Puchstein, *Griechische Tempel in Unteritalien und Sicilien*, Berlin, 1899.
- F. C. Penrose, *Principles of Athenian Architecture*, London, 2d ed., 1888.
- Adolf Michaelis, *Der Parthenon*, Leipzig, 1871.

SCULPTURE

- E. A. Gardner, *Handbook of Greek Sculpture*, London and New York, 1896, 2d ed., 1906.
- M. Collignon, *Histoire de la sculpture grecque*, Paris, 1892, 1897.
- J. Overbeck, *Geschichte der griechischen Plastik*, 4th ed., Leipzig, 1893, 1894.
- R. Kekule v. Stradonitz, *Die griechische Skulptur*, Berlin, 1907.
- A. S. Murray, *History of Greek Sculpture*, 2d ed., London, 1890.
- Lucy M. Mitchell, *History of Ancient Sculpture*, New York, 1883.
- E. v. Mach, *A Handbook of Greek and Roman Sculpture* (to accompany a collection of reproductions of Greek and Roman sculpture, the University Prints), Boston, 1905.
- W. Lermann, *Altgriechische Plastik*, Munich, 1907.
- A. Furtwängler, *Masterpieces of Greek Sculpture*, edited by E. Sellers, London and New York, 1895.
- Catalogues of Museums, especially Friederichs-Wolters, *Gipsabgüsse antiker Bildwerke*, Berlin, 1885.
- S. Reinach, *Répertoire de la statuaire grecque et romaine*, Paris, 1897-1904 (containing a vast number of small drawings of ancient works of sculpture). Vols. II and III contain valuable bibliographical lists.

H. Stuart Jones, *Select passages from ancient authors illustrative of the history of Greek Sculpture*, London, 1895.

H. Brunn and P. Arndt (Brunn-Bruckmann), *Denkmäler griechischer und römischer Sculptur* (a series of large and expensive carbon reproductions, accompanied, after No. 500, by discussions), Munich, 1888-.

P. Arndt and W. Amelung, *Photographische Einzelaufnahmen antiker Sculpturen, nach Auswahl und mit Text*, Munich, 1893-.

Special subjects are treated in the following monographs and articles : A. S. Murray, *The Sculptures of the Parthenon*, London, 1903 ; A. Michaelis, *Der Parthenon*, Leipzig, 1871 ; H. Lechat, *La sculpture attique avant Phidias*, Paris, 1904 ; H. Lechat, *Pythagoras de Rhégion*, Paris, 1905 ; W. Klein, *Praxiteles*, Leipzig, 1898 ; P. Gardner, *The Apoxyomenos of Lysippus*, *Journal of Hellenic Studies*, XXV, 1905, pp. 234-259 ; Ida Carlton Thallon, *The Date of Damophon*, *American Journal of Archaeology*, X, 1906, pp. 302-329 ; G. Dickins, *Damophon of Messene*, *Annual of the British School at Athens*, XII, 1907, pp. 109-136, and XIII, pp. 357-404 ; E. Reisch, *Kalamis*, *Jahreshefte des Oesterreichischen archäologischen Instituts*, IX, 1906, pp. 199-268 ; F. Studniczka, *Kalamis*, Leipzig, 1907.

TERRACOTTAS

- H. B. Walters, *Catalogue of the Terracottas in the Department of Greek and Roman Antiquities in the British Museum*, London, 1903.

- E. Pottier, *Les statuettes de terre cuite dans l'antiquité*, Paris, 1890.

- C. A. Hutton, *Greek Terra-cotta Statuettes*, London and New York, 1899.

- M. B. Huish, *Greek Terra-cotta Statuettes*, London and New York, 1900.

- F. Winter, *Die Typen der figürlichen Terrakotten*, Berlin and Stuttgart, 1903. (Two folio volumes.)

- R. Kekulé, *Griechische Thonfiguren aus Tanagra*, Stuttgart, 1878.

- R. Kekulé, *Die Terracotten von Sicilien*, Stuttgart, 1884.

- Pottier and Reinach, *La nécropole de Myrina*, Paris, 1887. (Two large volumes.)

- Pottier and Reinach, *Terres cuites de Myrina*, Paris, 1886.

- L. Heuzey, *Les figurines antiques de terre cuite du musée du Louvre*, Paris, 1883.

– W. Deonna, *Les statues de terre cuite dans l'antiquité : Sicile, Grande Grèce, Etrurie et Rome*, Paris, 1908.

Catalogues of Museums.

COINS

E. Babelon, *Traité des monnaies grecques et romaines*, Vol. I, 1904, Vols. II and III (plates), 1907, Paris.

B. V. Head, *Historia Numorum, A Manual of Greek Numismatics*, Oxford, 1887.

P. Gardner, *The Types of Greek Coins*, Cambridge, 1883.

B. V. Head, *Coins of the Ancients*, London, 4th ed., 1895.

G. F. Hill, *Handbook of Greek and Roman Coins*, London, 1899.

G. F. Hill, *Historical Greek Coins*, London, 1906.

George Macdonald, *Coin Types, their Origin and Development*, Glasgow, 1906.

J. Ward, *Greek Coins and their Parent Cities*, London, 1902.

The catalogues of the Greek coins in the British Museum.

GEMS

A. Furtwängler, *Die antiken Gemmen. Geschichte der Steinschneidekunst im klassischen Altertum*. Leipzig, 1900. (The most complete and authoritative work on the subject. Three vols., 4to.)

C. W. King, *The Natural History, Ancient and Modern, of Precious Stones and Gems and of Precious Metals*, London, 1865.

C. W. King, *Antique Gems and Rings*, London, 1872.

J. Henry Middleton, *The Engraved Gems of Classical Times, with a Catalogue of the Gems in the Fitzwilliam Museum*, Cambridge, 1891.

British Museum, *Catalogue of Engraved Gems*, by A. S. Murray, revised by A. H. Smith.

BRONZES, METAL WORK, AND JEWELRY

H. B. Walters, *Catalogue of the Bronzes in the British Museum*, London, 1899.

E. Babelon and A. Blanchet, *Catalogue des bronzes antiques de la Bibliothèque nationale*, Paris, 1895.

A. de Ridder, *Catalogue des bronzes trouvés sur l'Acropole d'Athènes*, Paris, 1896.

A. de Ridder, *Catalogue des bronzes de la Société Archéologique d'Athènes*, Paris, 1894.

A. de Ridder, *De ectypis quibusdam aeneis quae falso vocantur "Argivo-Corinthiaca,"* Paris, 1896.

Theodor Schreiber, *Alexandrinische Toreutik*, Leipzig, 1894.

A. Furtwängler, *Der Goldfund von Vettersfelde*, Berlin, 1883.

Antiquités du Bosphore cimmérien (1854), reëdited by S. Reinach (*Bibliothèque des monuments figurés*, Vol. III), Paris, 1892.

A. Héron de Villefosse, *Le trésor de Boscoreale*. *Monuments Piot*, IV, Paris, 1899.

E. Pernice and F. Winter, *Der Hildesheimer Silberfund*, Berlin, 1902.

Kondakof, Tolstoï, and S. Reinach, *Antiquités de la Russie méridionale*, Paris, 1892.

H. de Fontenay, *Bijoux anciens et modernes*, Paris, 1887.

E. Vernier, *La bijouterie et la joaillerie*, Cairo, 1907.

VASES

[Detailed bibliographical information will be found in the notes to the chapter on Vases. Only a selection from the more important general works is given here, with the addition of a few more special studies not mentioned in the notes.]

H. Blümner, *Technologie und Terminologie der Gewerbe und Künste bei den Griechen und Römern*, 4 vols., Vol. II on pottery, Leipzig, 1875-1886. Somewhat out of date, but valuable.

Catalogues of vases: *British Museum*, Vol. II, 1893 (Walters), Vol. III, 1896 (C. Smith), Vol. IV, 1896 (Walters), Vol. I (in preparation); *Louvre*, 3 vols., 1896-1906, with atlas of photographic plates, 2 vols. (Pottier), very important as a general treatise; *Bibliothèque nationale*, vases in the *Cabinet des Médailles*, 1901-1902 (A. de Ridder); *Berlin Museum*, 2 vols., 1885 (Furtwängler); *Oesterreiches Museum für Kunst und Industrie*, Vienna, 1892 (Masner); *Ashmolean Museum*, Oxford, 1893 (P. Gardner).

Furtwängler und Reichhold, *Die griechische Vasenmalerei*, Munich, 1900-, plates and text, the latter containing much bibliographical information and valuable technical observations. Indispensable.

Hartwig, *Die griechischen Meisterschalen des strengen rothfigurigen Stils*, Stuttgart, 1893, with atlas. Indispensable for the study of this class of vases, and generally very valuable.

W. Klein, *Die griechischen Vasen mit Meistersignaturen*, 2d ed., Vienna, 1887; *Die griech. Vasen mit Lieblingsinschriften*, 2d ed., Vienna, 1898; Euphronios, *Eine Studie zur Geschichte der griechischen Malerei*, 2d ed., Vienna, 1886.

P. Kretschmer, *Die griechischen Vaseninschriften ihrer Sprache nach untersucht*, Gütersloh, 1894.

Rayet and Collignon, *Histoire de la céramique grecque*, Paris, 1888. Somewhat out of date, but useful as a general survey.

S. Reinach, *Répertoire des vases peints*, Paris, 1899-1900, 2 vols. Invaluable, and containing much bibliographical information.

H. B. Walters, *History of Ancient Pottery*, London, 1905, 2 vols. The most useful single general work on vases.

E. Pottier, *Douris and the Painters of Greek Vases*. Translated by Bettina Kahnweiler, London, 1909.

Special Studies not mentioned in the Notes

Gisela M. A. Richter, *The Distribution of Vases*, *B.S.A.* XI (1904-1905), pp. 224-242; L. Pallat, *Ath. Mitt.* XXII (1897), pp. 265 ff.; L. Couve, *Rev. Arch.*, 1898, pp. 213-234 (the last two for Proto-Corinthian); L. Kjellberg, *Klazomenische Sarkophage*, *Jahrb. d. Inst.* 19 (1904), pp. 151 ff., 20 (1905), pp. 188 ff.; C. Watzinger, *Griechische Holzsarkophage*, Leipzig (Heinrichs), New York (Stechert), 1905; F. B. Tarbell, *The direction of writing on Attic Vases*, *Studies in Class. Philol.* Univ. of Chicago, 1895.

PAINTING AND MOSAIC

Woltmann and Woermann, *History of Painting* (English translation, edited by Sidney Colvin, London and New York, 1889, Vol. I, Book II).

P. Girard, *La peinture antique* (*Bibliothèque de l'enseignement des beaux-arts*), Paris, no date.

W. Helbig, *Wandgemälde der von Vesuv verschütteten Städte Campaniens*, Leipzig, 1868.

W. Helbig, *Untersuchungen über die campanische Wandmalerei*. Leipzig, 1873.

P. Gauckler, article *Musivum opus*, in Daremberg and Saglio, *Dictionnaire des antiquités* (also separately, *La mosaïque antique*), Paris, 1904.

Gerspach, La mosaïque (Bibliothèque de l'enseignement des beaux-arts), 2d ed., Paris, 1893.

E. Berger, Beiträge zur Entwicklungsgeschichte der Maltechnik, 1 und 2 Folge, Die Maltechnik des Alterthums, Munich, 1904.

Arvanitopoulos, 'Εφ. 'Αρχ., 1908, pp. 1 ff., an article on painted stelae from Pagasae, with exhaustive bibliography on painting in the notes.

P. Hermann, Denkmäler der Malerei. Munich (in progress).

(For GLASS, see p. 419, note.)

INDEX

- Abacus, Corinthian, 130; Doric, 115; Ionic, 126.
- Abraxas gems, 411.
- Accademia dei Lincei*, 26.
- Achaean League, coinage, 364 f., 379.
- Acrolithic statues, 107.
- Acropolis, Athens, 25, 29, 32, 34, 145.
- Acroteria, 121, 174.
- Adler, 27.
- Aegean, term applied to early civilization, 40.
- Aegina, 17, 23, 29, 87, 135, 140, 214 ff., 221.
- Aeginetan, coins, 367; standard, 356.
- Aeson, vase-painter, 502.
- Africa, vases, 463 ff., 470.
- Agathopus, gem engraver, 401.
- Agesander, Rhodian sculptor, 287.
- Agias, statue by Lysippus, 260 f.
- Agora, see Market places.
- Agoracritus, sculptor, 237.
- Alcámenes, sculptor, 226 f., 236 f., 290.
- Alexander, on coins, 362, 376 f.; on gems, 390; mosaic, 22, 530 f.; portraits by Lysippus, 271 f.; sarcophagus, 275, 539; times of, 25.
- Alexandria, 180, 276, 281 f., 312; apartment houses, 191; mosaics, 538; museum, 163; pharos, 184; Serapeum, 153, 179; symbolic figure on patera, 337 f.; work in gold and silver, 336.
- Amasis, vase-painter, 478 ff., 487.
- Amazon, of Polyclitus, 233, 235, 236.
- American School, at Athens, 25, 29, 30; in Rome, 25.
- Amorgos, 40, 43.
- Amphion, of Cnossus, sculptor, 220.
- Anathyrosis*, 102, 108.
- Andocides, vase-painter, 489.
- Angell, Samuel, 17.
- Anta, 50, 110, 122, 123, 128.
- Antefixes, 121.
- Antenor, sculptor, 205 f., 217, 530.
- Anticythera, see Cerigotto.
- Antioch, 180; houses, 191.
- Apelles, painter, 528, 535, 536.
- Aphaia, temple at Aegina, 17, 23, 29, 135, 140, 215 f.
- Aphrodite, Capitoline, 289; of Capua, 280; of Cnidus, 250 f., 333, 363; in the gardens, 200; Medicean, 272 note, 289; of Melos, 18, 280 f., 292; Venus Genetrix, 200.
- Apollo, Belvedere, 279, 285; "Choiseul-Gouffier" type, 219; early type, 199; of Melos, 199; of Orchomenus, 199; Phileus by Canachus, 214, 217, 331 f.; Ptoios, 31; of Tenea, 18, 23, 199 f., 214, 216; of Thera, 190.
- Apollodorus, Athenian painter, 535.
- Apollonius, gem engraver, 401; sculptor from Tralles, 289.
- Apoxyomenus, by Lysippus, 268 ff.
- Apulian vases, 513, 515 ff.
- Arceilaus, sculptor of Venus Genetrix, 290.
- Arch, 54, 55, 61, 181.
- Archaeological Institute, of America, 19, 25, 29; Austrian, 25; Imperial German, 21, 25, 35, 36.
- Archaeology, definition, 11; a science, 37.
- Archaic, sculpture, 23, 108-217; architecture, 108-110; gems, 384-388; terracottas, 302.
- Archerms, 30, 209 f., 327.
- Architecture: 96-192; materials and methods, 96-108; archaic, 108-110; Mycenaean, 56 ff.; orders, 110-133 (Doric, 113-124; Ionic, 124-129; Corinthian, 129-133); temple, 133-158; civic, 158-173; funeral and votive, 173-179; Hellenistic, 179-192.
- Architrave, 115.
- Aregon, Corinthian painter, 530.
- Argive Heraeum, 29, 236, 294, 297, 316.
- Argive sculpture, 214, 236.
- Argos, centre of art in sixth century, 214, 215; in fifth century, 221.
- Aridices, Corinthian painter, 530.
- Ariston, stele, 207 f., 493.
- Aristophanes, vase-painter, 434, 501.
- Arretine pottery, 510, 523, 524 f.
- Artemis, of Versailles, 279; temple at Ephesus, 20, 23, 142 f., 151 f., 211 f., 265 f.; temple at Magnesia, 153.
- Artemisia, statue of, 179, 263, 264.
- Arundel, Thomas Howard, Earl of, 12.
- Asia Minor, 19, 20, 23, 34, 282 ff.; theatres, 170 f.
- Aspasius, gem engraver, 408.
- Assos, 19, 29, 130, 170; bouleuterion, 187; market place, 187 f.; stoa, 186.
- Assteas, vase-painter, 513.
- Assyria, 23.
- Athanadorus, Rhodian sculptor, 287.
- Athena, Alca, temple at Tegea, 31, 151, 253, 254; Lemnia, 233; Mycenaean (?), 84; Nike, temple, 18, 246, (balustrade) 231, 247, 253; old temple at Athens, 139, 203 f., 206 f.; Parthenos, 147, 230, 232 f., 349 f., 408; Promachus, 232.
- Athenian coins, 363, 367 f., 370 f.
- Athenion, cameo cutter, 397, 401.
- Athenis, 209.

- Athens, in the fifth century, 144, 217; in Hellenistic times, 180 f.; fortifications, 172 f.; odeum of Herodes, 170; primitive pottery, 41; private houses, 189; stadium, 164 f.; stoa of Attalus, 185; stoa of Eumenes, 170; terracottas, 295, 302, 303; theatre, 170; vases, 21, 34, 471-512; work in gold, 336. See Acropolis.
- Attic, gold work, 336; sculpture (early, 202-200; in fifth century, 217-219; influence in Asia Minor, 249, 250); vases, 471-512 (see Dipylon; Proto-Attic, 471 ff.; black-figured, 473-484; red-figured, 484-506; with white background, 506-512).
- Babylonia, 23, 39, 83.
- Bacon, F. H., 29.
- Base, Attic, 124; Ionic, 124.
- Bassae, see Phigaleia.
- Bathycles, of Magnesia, made throne at Amyclae, 456.
- Beginnings of Greek sculpture, 193 f.
- Belvedere, Apollo, 279; Torso, 290.
- Benndorf, 27.
- Bernay, silver vases, 337, 525.
- Black-figured vases, 426 ff. (technique), 473-484.
- Blouet, 18.
- Boehlau, 34.
- Boeotia, pithoi with reliefs, 510 f.
- Boëthus, cameo cutter, 397, 401; of Chalcedon, sculptor, 281.
- Boscovale, silverware, 337-340, 525.
- Boularchus, Ionic painter, 456, 529.
- Bouleuterion, at Miletus, 160, 170; at Olympia, 158; at Priene, 160; at Assos, 187.
- Boyd, Miss (Mrs. Hawes), 36.
- Bracelets, 351 f.
- Braun, Emil, 21.
- Brick, 97.
- British Museum, 14, 17, 19, 24.
- British School, at Athens, 25, 32, 36, 41; at Rome, 25.
- Bronze, 42, 43, 323; in sculpture, 196 f.; mirrors, 328 ff.; reliefs, early, 324 ff.; reliefs, various, 327 ff.; statuettes, 330-333.
- Bronze-casting, 197.
- Brooches, 324, 348 f.
- Brunn, Heinrich, 21, 25.
- Bryaxis, sculptor, 262, 263.
- Brygus, vase-painter, 485, 486, 492, 494, 495, 497-499.
- Building inscriptions, 96.
- Bupalus, 209.
- Busts, terracotta, 303.
- Cabirium, near Thebes, terracottas, 303.
- Caeretan hydriae, 454, 465, 468 ff.
- Calamis, sculptor, 218 f., 221, 232.
- Calenian phialae, 519, 523.
- Callicrates, 145.
- Cameos, 304 ff.
- Camirus, terracottas, 303; Fikellura vases, 458.
- Campanian vases, 513, 514 f.
- Canachus, sculptor, 214, 217, 331 f.
- Canning, Sir Stratford, 19.
- Canosa, terracottas, 319.
- Capital, Aeolic type, 125; Corinthian, 130, 132; Doric, 114, 122; Ionic, 125; of Doric anta, 119, 122 f.
- Capua, terracottas, 319.
- Caria, 27.
- Caricatures, in bronze, 331; in terracotta, 319.
- Carrey, Jacques, 14, 241.
- Carthage, gems, 387.
- Caryatides, 133, 150, 154, 248.
- Cavallari, 18.
- Ceiling, of Doric buildings, 118 f.
- Cella, of temple, 133.
- Centuries, sixteenth and seventeenth, 12; eighteenth, 13 ff.
- Cephisodotus, 252.
- Cerigotto (Anticythera), 32, 267.
- Chachrylion, vase-painter, 489.
- Chaeerstratus, 277.
- Chalcidian, vases of sixth century, 454.
- Chalcis, suggested as original home of Proto-Corinthian style, 453.
- Chandler, Richard, 15.
- Charinus, Athenian potter, 521.
- Charioteer from Delphi, 219 f.
- Charmidas, early painter, 530.
- Chian sculpture, 30, 205, 209 ff. •
- Choiseul Gouffier, 16; Apollo, 219.
- Chronology, Prehellenic, 92 ff. See Dating.
- Chryselephantine sculpture, 197.
- Cimon, of Cleonae, painter, his influence seen in vase-paintings of the "severe style," 530.
- Clays used in vase-making, 420.
- Clazomenae (sarcophagi), 34, 435, 454, 461 ff., 465, 484, 526, 529; (Caeretan hydriae), 470.
- Cleanthes, Corinthian painter, 530.
- Clitias, painter of François vase, 476.
- Cnidians, lesche of, 166, 531 ff.; treasury of, 132, 133, 154, 212 f., 246.
- Cnidus, 19, 20; heroum of Antigonus, 174; Demeter, 20, 253.
- Cnossus, 36, 39, 40, 43-95. *passim*; 295.
- Cockerell, 15, 17.
- Coins, 11, 23, 353-380; importance, 353; metals used, 354 f.; process, 355; shapes and designs, 355 f.; standards, 356 f.; divisions, 357 f.; units and rate of exchange, 358 f.; types, 360 ff.; inscriptions and symbols, 363 ff.; periods of development, 365 ff.; Italian fabric, 368 f.
- Color, in architecture and sculpture, 18; in architecture, 122, 132; in sculpture, 196; on terracotta tablet, 526; on terracottas, 300, 309; on vases, 39, 428 f., 448, 452 f., 457, 463, 467, 469, 478, 507, 510, 514, 516.
- Column, 59, 60, 61, 63, 64, 65, 112; Doric, 113, 122; Ionic, 124 f.
- Consoles, 130.
- Contour-stripe, in vase-painting, 433.
- Conze, Alexander, 26, 33, 36.
- Copies of statues on coins, 361, 362, 363.
- Corinth, 30; early painters, 450, 529; stoa, 184; temple of Apollo, 139. See Corinthian.
- Corinthian, coins, 367; order, 129-133;

- pinaces, 422 ff., 526; terracottas, 302, 317; vases, 442 ff., 447-453, 455, 457.
- Corneto, alabaster sarcophagus, 527.
- Cornice, Corinthian, 130 f.; Doric, 115; with terracotta sheathing, 116 f.; Ionic, 128.
- Cos, 29.
- Costume, Mycenaean, 66.
- Cramps, 106 f.
- Craton, Sicyonian painter, 530.
- Crepidoma, 112.
- Cresilas, 236, 237.
- Crete, 36, 39, 40, 43-95, *passim*; Chronology, 92-95; palaces, 45, 56 ff.
- Crimea, 22; gold work, 334 f.; bracelets, 351 f.; terracottas, 303, 320, 336, 343; vases, 504 f.
- Critius, sculptor, 23, 217, 231, 258.
- Croesus, 211.
- Curtius, Ernst, 27.
- Cuttings, for cramps, 106 f.; for dowels, 104 f.; for hoisting, 99; for prying, 103; for shifting, 104.
- Cyclades, 40, 41, 43, 44, 51, 93.
- Cycladic, 40, 43, 93.
- Cylindrical figure vases, 301.
- Cyprus, 35, 41, 44, 91, 294, 295, 301 (terracottas from Attic moulds), 317 (terracottas), 519 (plastic vases).
- Cyrenaica, 35.
- Cyrene, terracottas, 310, 319 f.; vases, 454, 463, 467 ff.
- Cyriacus of Ancona, 111.
- Cythera, bronze statue, see Cerigotto.
- Daedalus, 209; son of Patrocles, 267; gem cutter, 401.
- Damophon, sculptor, 31, 286 f.
- Daphnae (Egypt), 34, 454, 463, 464, 465.
- Doric, 375 f.
- Dating, of gems, 393; of jewelry, 343; of necklaces, 345 f.; of Proto-Corinthian vases, 447; of black-figured vases, 473; of red-figured vases, 484 f., 488; of vases with white background, 506, 507, 508, 510, 517 f.; of pithos with reliefs, 520; of vases with reliefs, 522.
- Decoration, of houses, 191 f.; of vases, 426 ff.
- Decorative sculpture, 198.
- Delos, 30; frescoes and mosaics, 526, note, 538; houses, 189 ff.; Nike of Archermus (?), 209; statue dedicated by Nicandra, 200; theatre, 168.
- Delphi, 24, 25, 30, 142, 154, 212; statues dedicated by Daochus, 260; paintings by Polygnotus, 531 ff. See Cnidians.
- Demareteia, Syracusan coins, 371 f.
- Demeter of Cnidus, 20, 253.
- Demosthenes, statue of, 277.
- Dentels, 127, 128.
- Derrick, 99.
- Dexamenus, gem engraver, 300-392.
- Dexileos, monument of, 272 f.
- Diadems, 73, 343 f.
- Diadumenus of Polyclitus, 233, 234.
- Diana, see Artemis.
- Diazoma, 166, 168, 169.
- Didyma, see Miletus.
- Dilettanti, Society of, 15, 16.
- Dimias, early painter, 530.
- Dimini, 39, 61.
- Dioscurides, gem engraver, 407.
- Dipoenus, early sculptor, 209.
- Dipylon at Athens, 173, 174; vases, 437, 439 ff., 461, 471.
- Dodona, early work in metal, 442.
- Dodwell, 19, 441.
- Dörpfeld, 27, 29, 35.
- Donaldson, 15.
- Dorian Invasion, 24, 27, 38, 40, 109, 441.
- Doric art, 217.
- Doryphorus of Polyclitus, 233, 234, 235, 236.
- Dowels, 104-106.
- Drachma, 357.
- Dubois, 18.
- Duris, vase-painter, 485, 492, 494 f.
- Dying Gaul, 12, 283.
- Earrings, 347 f.
- Echinus, Doric, 114; Ionic, 126.
- Eckhel, Joseph Hilarius von, 14.
- Ecphantus, Corinthian painter, 530.
- Egnatia, terracottas, 319.
- Egypt, 23, 39, 53, 69, 83, 84, 91, 92, 93; chronology, 95; gems, 381, 382; influence in Geometric style, 441; mosaics, 537.
- Electrum, 354.
- Eleusinian relief, 250.
- Eleusis, 31; propylaea, 157; telesterion, 158 f.; terracottas, 295, 303.
- Elgin, Thomas Bruce, Lord E., 16; Elgin Marbles, 17, 23.
- Entablature, Doric, 115; Ionic, 127 f.; Corinthian, 130.
- Entasis, 113, 124.
- Ephesus, 24, 27, 29, 111, 142 (temple of sixth century), 143, 144, note (Hogarth's excavations), 151 f. (temple of fourth century), 172 (theatre), 180, 209, 211 f. (sculpture of early temple), 265 (sculpture of later temple), 267 (bronze statue), 276, 456, 470 (sculpture of early temple).
- Epictetus, vase-painter, 485, 487, 489-491, 507.
- Epidaureus, 25, 31; gymnasium, 163; round building (tholos), 154 f.; stadium, 165; theatre, 168 ff.
- Epimenes, gem cutter, 384.
- Epistylion, 115.
- Erechtheum, 127, 128, 134, 148-150, 213, 247 f.
- Eretria, 30, 35; terracottas, 303, 317 f.; theatre, 165, 167.
- Ergotimus, potter of François vase, 476.
- Eros, by Praxiteles, 260 f.
- Esquiline, discovery of paintings, 22.
- Etruria, 13, 319 (terracottas), 384 f. (metal rings), 402 f. (scarabs), 519 (bucchero ware).
- Etruscan, ash-urns, 21; bronzes, 327; jewelry, 342; mirrors, 21, 329 f.; paintings, 20, 23, 527; rings of metal, 384 f.; scarabs, 402 f.; tombs, 20, 23, 527.
- Eubouleus, head from Eleusis, 279.

- Euehir, Corinthian painter, 450, 530.
 Eugrammus, Corinthian painter, 450, 530.
 Eumarus, early Attic painter, 530.
 Euphranor, sculptor and painter, 262.
 Euphronius, vase-painter, 485, 487, 492-494, 495, 508, note.
 Euthydicus, statue dedicated by, 208.
 Euthymides, vase-painter, 492, 494.
 Eutychedes, pupil of Lysippus, 279.
 Eutyclus, gem engraver, 407.
 Evaenetus, artist of coins, 364, 390.
 Evans, Arthur J., 36, 95.
 Exchange, rate of, 358 f.
 Execias, vase-painter, 478, 480 ff., 487.
 Eye, on Ionic pottery, 457, 470, note.

 Fabric, of coins, 368, 379.
 Faience, 46, 47.
 Farnese Bull, 289.
 Fayûm, painted mummy tablets, 527, 528, 529, 537.
 Fea, Carlo, 14, 21.
 Fellows, Charles, 19.
 Fibulae, 323 f.
 Figure vases, 203; cylindrical, 301.
 Figurines, see 'Terracottas.
 Fikellura, vases, 458.
 Fine style, of red-figured vases, 485, 499-503.
 Firing, of vases, 423 ff.
Firmismalerei, 42, 85, 86.
 Fluting, Doric, 113; Ionic, 125.
 Forms, of Greek gems, 389; of Hellenistic gems, 304; of vases, 413-419, 487 f. (red-figured), 506 (vases with white background).
 Fortifications, 42, 44, 45, 53, 56, 172 f.
 Foster, 15.
 Foundations, 110 f.
 François, Alessandro, 22; grotta, 22; vase, 22, 418, 423, 427, 473-477, 478.
 French School, at Athens, 18, 25, 30; at Rome, 25.
 Fresco, 46, 50, 51, 536 f.
 Frieze, Doric, 115; Ionic, 127, 128.
 Frontality, law of, 199, 220, 243, 486.
 Funeral monuments, 173 ff.
 Furniture, 191 f.
 Furtwängler, 17, 27, 29, 37, 517.
 Furtwängler and Loeschcke, classification of Mycenaean vases, 86.

 Gables, 109.
 Garlands, of gold, 343 f.
 Geison, 115.
 Gela, terracottas, 303.
 Gell, Sir William, 15, 19.
 Gemma Augusta, 408 f.
 Gems, 381-411; primitive, 52, 53; Mycenaean, 82 ff., 381 f.; Prehellenic (chronology), 92, 93, 94; geometrical style, 381 f.; seventh century, 382 f.; archaic, 384 ff.; Persian-Greek, 388; forms, 389; style, 390 f.; types, 392; dates, 393; Hellenistic, 394 ff.; cameos, 395 ff.; style, 398 ff.; types, 400 f.; Etruscan, 402 ff.; Latin, 404 ff.; of imperial period, 406 ff.
 Genre, in sculpture, 281 f.

 Geometric, decoration, 44; style in gems, 381 f.; style in vases, 436-442.
 Gerhard, Eduard, 21.
 German excavations, 27, 28, 29.
 Gilding, of bronzes, 197; of terracottas at Smyrna, 317; of vases, 499, 503, 522.
 Girgenti, 132, 135, 136.
 Gjölbaschi, 27, 81, 173 f., 249.
 Glass vases, 419 f.
 Glaze, on vases, 429 f.
 Gold and silver work, 334-352; Prehellenic, 69-82.
 Gourniá, 36.
 Graeco-Roman sculpture, 289-292.
 Grave-vase, 175.
 Greek Archaeological Society, 18, 31.
 Guttae, 115, 117.
 Gymnasia, 162 f.

 Hagelaidas, Argive sculptor, 228, 291.
 Hagia Triada, 56, 67, 80, 91, 94, 294.
 Hair, representation in sculpture, 258.
 Hairpins, 344 f.
 Haller von Hallerstein, 17.
 Hamilton, Sir William, 14.
 Hansen, 18.
 Harmodius and Aristogeiton, statues by Critius and Nesiotes, 217 f., 222, 231.
 Harpy tomb, 19, 212, 456.
 Harris, William, 17.
 Harvesters vase, 67, 68.
 Hecatompedon, see Athena, old temple at Athens.
 Hegesiboulos, vase-maker, 509, note.
 Helbig, 34.
 Helena, painted the battle of Issus, 541.
 Hellenistic, architecture, 179-192; gems, 394 ff.; mosaics, 538; painting, 528; sculpture, 276-292, 528; terracottas, 311 ff., 318 f.; work in precious metals, 336 ff.
 Hera, of Polyclitus, 233; of Samos, 201, 211, 301.
 Heraclidas, gem engraver, 401.
 Heraclides, description of Theban women, 306 f.
 Heraeum, Argive, 29, 236, 294, 297, 316; at Olympia, 98, 110, 111, 135.
 Herculaneum, 13, 20, 22, 23, 190, 527.
 Hermes, of Olympia, 25, 27, 256 ff.
 Hermitage, Museum, 22, 24.
 Hermonax, vase-painter, 502.
 Herophilus, gem engraver, 407.
 Herzog, R., 29.
 Heuzey, Léon, 20.
 Heyne, Christian Gottlob, 14.
 Hieron, vase-maker, 485, 492, 495-497.
 Hiller von Gaertringen, 28, 29.
 Hipponax, 209.
 Hirschfeld, 27.
 Historical representations on coins, 361.
 Hittorf, 18.
 Hoisting, of stones, 99.
 Homeric bowls, 523.
 Hoppin, J. C., classification of Mycenaean vases, 87; Argive vases, 444.

- Houses, Hellenistic, 188-192.
 Howard, Thomas, Earl of Arundel, 12.
 Human figures as supports, 132 f.
 Humann, 28.
 Hydra, pediment relief, 202.
 Hygiaenon, painter, 530.
 Hyllus, gem engraver, 407.
- Icaria, excavations, 30.
 Ictinus, architect, 145, 151, 249.
 Ida (Mt.), 36, 40.
 Idols, 43, 93.
 Incised, decoration, 41, 42, 44; lines, on vases, 428, 430, 431, note, 444, 449.
 Incrustation, 107.
 Inscriptions, building, 96; on coins, 363 f., 378, 379; on terracottas at Myrina, 315; on vases, (Corinthian) 449, (Proto-Attic) 472, (Attic) 476 ff., (Arretine) 524.
 Instruction in archaeology, 24, 26.
 Intaglio, 304, note.
 Ionic, art, 211, 216, 217, 250, 325 ff., 334, 382, 384; influence seen in Etruscan paintings, 527; school of painting in seventh century, 529; vases, 454-470 ("Rhodian," 454, 456 ff.; Fikellura, 458; "Melian," 458-461; Clazomenian sarcophagi, 461-463; Africa, 463-468; Cyrene, 466-468; Caeretan hydriae, 468-470); relation to paintings, 529.
Istituto di corrispondenza archeologica, 21, 23, 25.
 Italy, terracottas, 318 f. See Etruria, Etruscan, Pompeii, Rome, etc.
 Ivory, 66, 67.
- Jahn, Otto, 21.
 Jewelry, 342-352.
 Joints, of columns, 107 f.
- καλός names, 477 f., note.
 Kamáres ware, 40, 50, 53, 85, 93, 94, 295.
 Kekule von Stradonitz, 35.
 Kertch, bracelets, 351 f.; gold work, 335 f.; terracottas, 310, 320; vases, 488, 501, 504 f.
 Kilns, of potters, 423 ff.
 Kinnaird, 15.
 Klein, W., 33.
 Kramer, Gustav, 21.
 Kul Oba, 22.
- Laocoön group, 12, 287-289.
 Leake, 10.
 Lebas, Philippe, 10.
 Lecythis, white, 500-512; polychrome, reflect painting of Apollodoros and others, 535, note.
 Leochares, 262, 263, 279.
 Leonidaemum, at Olympia, 161 f.
 Lesche, 161; of Cnidians, 161, 531 ff.
 Lessing, Gotthold Ephraim, 14, 287.
 Lewis, for lifting stones, 100.
 Ligourio, statuette from, 332.
 Linckh, 17.
 Lindus, excavations at, 32.
 Lions' Gate, 55 f., 60, 64, 69, 70.
- Locri, Ionic temple, 124; terracotta sheathing, 154; terracottas, 319.
 Loeschcke, G., 86, 87.
 λογείον, 167.
 Louvre, 20, 24, 27.
 Lucanian vases, 513, 514.
 Lycia, 19, 27, 212.
 Lycomedes, gem engraver, 401.
 Lycosoura, sanctuary of Despoena, 31, 286.
 Lydian coins, early, 356, 359.
 Lysicrates, monument of, 130, 177.
 Lysippus, 23, 30, 33, 253, 256, 268-273, 278, 287, 291, 308.
- Macron, vase-painter, 495, 497 f.
 Magnesia, 28, 29; altar, 183 f.; Artemisium, 153; market place, 187.
 Mantegna, 12.
 Mantinea, work of Praxiteles at, 31, 253, 261 f., 275.
 Marble, 97, 195.
 Market places, 187 f.
 Marsyas of Myron, 23, 220, 332 f.
 Masks, terracotta, 302 f.
 Materials and methods, in architecture, 96-112; in coins, 354 f.; in jewelry, 342 f.; in metal work, 322 f.; in painting, 536 f.; in sculpture, 103-108; in terracottas, 293 f., 297 ff.; in vases, 420-435.
Mattmalerei, 42, 85, 86.
 Mausoleum, 19, 23, 178 f., 253, 256, 263 ff.
 Mausolus, statue of, 170, 263, 264.
 Medallions, Athena Parthenos, 349 f.
 Megalopolis, 32; theatre, 167 f.; Thersilion, 159 f., 168, 170.
 Megara, terracottas, 303.
 Megarian bowls, 519, 523.
 Megaron, 58, 100, 110.
 Melian, reliefs, 208; vases, 454, 455, 458-460.
 Melos, Aphrodite, 18, see Aphrodite; Phylakopi, 36, 41, 42, 43, 50; scarabs, 383.
 Menelaus, sculptor, 201.
 Menidi, 35, 61.
 Mesopotamia, mosaics, 537.
 Messene, fortifications, 172 f.
 Metal work, 22, 322-352; metals used, 322; bronze, 323-333; gold and silver work, 334-342; jewelry, 342-352; Prehellenic, 69-82.
 Metals used in coins, 354 f.
 Methods, see Materials.
 Metopes, 50, 115, 116.
 Micon, painter, fifth century, 531.
 Middle Ages, Greek, 95, 381.
 Midias, vase-painter, 502 ff., 513.
 Mikkiades, 209 f.
 Miletus, 20, 23, 24, 34, 180, 209, 455; bouleterion, 160, 179; original home of "Rhodian" vases, 456, 464; seated statues, 201 f., 211; statue by Canachus, 214, 217; temple of Didymaeon Apollo, 152.
 Miller, E., 20.
 Mina, 358.
 Minoan, 40, 95; religious rites, 75.
 "Minor artists," vase-painters, 490.
 Mirrors, Greek, 328 f.; Etruscan, 329 f.

- Mnesarchus, gem cutter, 384.
 Mochlos, discoveries at, 36, 69.
 Montfaucon, Bernard de, 14.
 Mortar, 97.
 Mosaics, 537-541.
 Moschophorus, 204 f.
 Moulded figures on vases, 504.
 Mouldings, in Doric architecture, 123; Ionic, 126 f., 128, 129.
 Moulds, for terracottas, 299, 300.
 Munich (glyptothek), 17, 18.
 Museums, 11, 24, 26.
 Mycenae, 35, 40, 50, 53, 54, 55, 56, 60, 62, 64, 65, 67, 69, 84; dagger blades, 77 f.; face masks, 72; gold and silver work, 69 ff.; rings, 75 f., 79 f.; shaft graves, 70 ff., 94; terracottas, 295, 316; vases, 78.
 Mycenaean, 39, 40, 41, 42; architecture, 56-63; art, 46, 66, 81 f., 95, 383; costume, 66; gems, 53, 82 ff., 381 f.; influence (in Asia Minor), 442, (in the geometric style), 437, 441, (in Fikellura vases) 458, (in "Rhodian" vases) 456; mosaics, 537; religious rites, etc., 75, 83 f.; sculpture, 63 ff.; lustrous varnish, 87 f.; vases, 66, 85-92, (plastic vases) 510.
 Myrina, 34, 35, 310, 312-315, 320.
 Myron, 23, 228 f., 332.
 Mythological representations, on vases, 412, 450, 485, 494; in paintings at Pompeii and Herculaneum, 527.
 Names, of potters and vase-painters (black-figured style), 478; of vases, 413-419.
 Naucratis, 34; terracottas, 320; vases, 454, 463, 464, 467, 468.
 Nauplia, terracottas, 295, 316.
 Neandria, early Ionic temple, 142.
 Necklaces, 345 f.
 Neo-Attic reliefs, 291.
 Neolithic, 39, 92.
 Nereid Monument, 19, 81, 177 f., 249 f.
 Nesiotas, 23, 217 f., 258.
 Newton, Charles, 19.
 Nicandra, statue dedicated by, 200.
 Nicandrus, gem engraver, 401.
 Nicias, choregic monument, 176.
 Nicopolis, 22.
 Nicosthenes, vase-painter, 478, 482 f., 490, 506, 510.
 Niemann, 27.
 Nike, of Archermus (?), 209 f., 327; of Brescia, 280; of Paeonius, 27, 227, 278; of Samothrace, 26, 277 f., 362, 377.
 Niobe group, 266, 270.
 Nointel, Marquis de, 14.
 Nolan amphorae, 417, 487, 515.
 Norcia, bronze chariot, 327.
 256 f.; Leonidaem, 161 f.; Metroum, 106; Philippum, 154; stoaes, 184; temple of Zeus, 140, 217, 222-228, 243, (mosaic in, 538); tomb of Pelops, 173; Treasury of the Megarians, 214.
 Olympius, gem cutter, 390.
 Onatas, Aeginetan sculptor, 215; gem cutter, 301.
 Onesas, gem engraver, 401.
 Opisthodomus, 109, 133.
 Orchestra, 165, 166, 167, 168, 199, 170, 171, 172.
 Orchomenus, 35, 41, 55, 62, 63, 94.
 Orders, 110-133; Corinthian, 129-133; Doric, 113-124; Ionic, 124-129.
 Ornament in architecture, 129.
 Ornamental patterns on red-figured vases, 488 ff.
 Ornaments, personal, 352.
 Orvieto, crater from, 531 ff.
 Otto, King of Greece, 18.
 Outlines, on red-figured vases, 431 ff.
 Paeonius, statue of Nike, 175, 227, 278; reputed author of pediment sculpture as Olympia, 226 f.
 Paestum, 135, 136, 137, 138, 513 (vases).
 Pagasae, painted stelae, 34, 526, note, 534.
 Painting, 20, 21, 22, 23, 26, 32, 33, 34, 42, 46, 90, 450, 462 (Ionic), 526-537, 530, 541; influence on sculpture, 240; monumental sources, 526-528; literary sources, 520 f.; Polygnotus, 530-534; the fourth century, 534-536; technique, 536 f.
 Paintings, copied on vases, 486, 499 f.; Prehellenic, 42, 46, 50 f., 94.
 Palaces, Prehellenic, 45, 50, 56 ff., 93, 94.
 Palace style of vases, 48.
 Palaeolithic, 39.
 Palaestra, at Olympia, 162.
 Palaikastro, 36, 295.
 Pamphaeus, vase-painter, 489, 490.
 Panaenus, Athenian painter, 531.
 Panathenaic amphorae, 483 f.
 Parascenia, 166, 167.
 Parodi, 166, 170.
 Paros, productive of marble, 97.
 Parrhasius, painter, fourth century, 535.
 Pars, 15, 16.
 Parthenon, 145-147, 213, 231; sculptures, 237-245, 246.
 Pasiadas, vase-painter, 506.
 Pasiteles, sculptor, 290.
 Pausanias, 11, 30.
 Pausias, painter, 535.
 Payne Knight, Richard, 14, 16; statuette, 331.
 Pediment, 121.
 Peloponnesian sculpture, archaic, 214-216.
 Pendants, 349 f.
 Penrose, F. C., 18.
 Pergamon, 28, 29, 180, 276, 312, 317; great altar, 181 f., 284-286; mosaics, 538; school of sculpture, 282-286; stoaes, 184 f.
 Periods of coinage, 365 ff.; archaic, 366 ff.; transitional, 369 ff.; of finest art, 374 ff.; of late fine art, 376 ff.; of decline, 378 f.; of continued decline, 379 f.

- Perrot and Chipiez, 37.
 Persian-Greek gems, 388.
 Perspective, understood by Greek painters, 528.
 Perugia, bronze reliefs, 327.
 Petersen, E., 27.
 Petrarch, 11.
 Petsofá, 46, 294.
 Phaestus, 36, 45, 53, 56, 58, 94.
 Phaleron vases, 472.
 Pharos at Alexandria, 184.
 Pheidon, said to have invented coinage, 360.
 Phidias, 33, 228, 229-233; Athena Parthenos, 230 f.; Zeus at Olympia, 231 f.; connection with sculptures of the Parthenon, 244 f.
 Phidias, gem engraver, 401.
 Phigaleia (Bassae), 15, 17, 23, 121, 151, 249, 264.
 Philip II, coins and standards, 375 f.
 Philo, gem engraver, 401.
 Philocles, Egyptian painter, 520.
 Philoxenus, of Eretria, painter, 541.
 Phocaea, possible place of manufacture of Caeretan hydriae, 470.
 Photography, 26.
 Phrygillus, gem cutter, 390.
 Phylakopi, 36, 41, 42, 43, 46, 47, 50, 93, 94.
 Pictorial representation in sculpture, 81.
 Picturesque, sculpture, 279, 281 f.
 Pinaces, Corinthian, 422 ff., 452 f.; Rhodian, 457.
 Plan, of temples, 133 f.
 Plastic vases, 518-525.
 Pliny, 11.
 Polychromy, on lecythi, 510. See Color.
 Polyclitus, 23, 30, 33, 228, 233-236, 256, 267, 270, 332.
 Polyclitus, the younger, 160.
 Polydorus, Rhodian sculptor, 287.
 Polyeuctus, statue of Demosthenes, 277.
 Polygnotus, 33, 249, 418, 499 f. (influence on vase-paintings); 530-534, 535.
 Polygnotus, vase-painter, 502.
 Polymedes, statue at Delphi, 214.
 Pompeii, 13, 20, 22, 23, 24, 34, 190, 310 f. (terracotta), 420 (glass), 527, 536 (painting), 539 (mosaic).
 Poros stone, 96, 105, 202-204.
 Porticoes, 160 ff.; Hellenistic, 184 ff.
 Portland vase, 410, 420.
 Portraits, on coins, 361, 377, 378; on gems, 398 ff.
 Portraiture, 251.
 Poseidon and Amphitrite, relief, 291.
 Potter's wheel, 42, 47, 86, 203, 421 f.
 Pottery, early, 41 ff.; see Vases.
 Pottier, E., 34.
 Praeneste, mosaic with Egyptian subjects, 539.
 Praxiteles, 28, 31, 33, 252, 253, 256-262, 265, 266, 267, 273, 275, 278, 279, 280, 286, 287, 398.
 Predorian, 40.
 Prehellenic, 24, 35, 36, 38-95; chronology, 92-95.
 Premycenaean, 40, 43.
 Priene, 20, 28, 29, 35, 180, 181; bouleterion, 160; market place, 187; private houses, 189; propylaea, 157; terracottas, 310, 317, 320; theatre, 170 f.
 Primitive terracottas, 294 ff.
 Pronaos, 133.
 Proportions, in Doric architecture, 117 f.; in Ionic architecture, 128.
 Propylaea, 155 ff.; at Athens, 155 ff.; at Eleusis, 157; at Priene, 157; at Samothrace, 158.
 Proscenium, 166 f., 168.
 Protarchus, cameo cutter, 398, 401.
 Prothesis, on vases, 440 (Dipylon), 511 (black-figured).
 Proto-Attic vases, 471 ff.
 Proto-Corinthian vases, 444-447, 453.
 Protogenes, painter, 528, 535.
 Protomycenaean, 40.
 Pseira, discoveries at, 36.
 Publications, archaeological, 36 f.
 Pullan, 20.
 Purpose of Tanagra figurines, 309 f.; of terracottas, 320 f.
 Pythagoras of Rhegium, 219.
 Python, potter, 490, 513.
 Quarries and quarrying, 98.
 Realism in Hellenistic sculpture, 281.
 Red-figured vases, 430 ff. (technique), 484-506.
 Regula, 115, 122.
 Regulini-Galassi tomb, 22.
 Reinach, S., 34, 36.
 Relief vases, 518-525.
 Reliefs, bronze, 324 ff., 327 f.; Campana, 298; Melian, 298; Neo-Attic, 291; picturesque, 281 f.; terracotta, 298.
 Relief-line, 431 ff.
 Renaissance, 11, 23, 37, 81.
 Repoussé, 106.
 Revett, Nicholas, 15, 16.
 Rhodes, 35, 276; centre of art, 312; coin type, 360, 377; Mycenaean vases, 91; school of sculpture, 287; terracottas, 294, 303, 316.
 "Rhodian" vases, 435, 448, 454, 456 ff.
 Rhoecus, Samian bronze-caster, 217, 297.
 Rings, 350 f., 384 f., 389; at Mycenae, 75 f., 79 f.; of Mycenaean times, 82 f.
 Robert, C., 33, 36.
 Rohden, von, 35.
 Roma, Dea, 292.
 Roman sculpture, 292.
 Rome, paintings, 22, 527, 536; terracottas, 310.
 Roofs, 50, 109, 120 f.
 Ross, Ludwig, 18.
 Russia (southern), 22, 35; gold work, 335 f.; jewelry, 343. See Crimea, Kertch.
 Samos, 34; artistic centre, 209; cylindrical figure vases, 301, 316; "Hera," 201, 211; Fikellura vases, 458.
 Samothrace, 26, 180; Nike, 277 f.; portico,

- 184; propylaea, 158, 181; round building, 155.
- Sarcophagi, 175; of Sidon, 175, 274-276; see Clazomenae.
- Sardinia, gems, 387.
- Satyr, of Myron, 229, 332 f.; of Praxiteles, 260 f.
- Saurias, Samian painter, 529.
- Scamillus, 114.
- Scaraboid, 381, 384, 388.
- Scarabs, 381, 384, 394, 407; Etruscan, 402 f.; Melian, 383; Phoenician-Greek, 387; Roman, 404.
- Scene (*σκήνη*), 166.
- Schaubert, 18.
- Schliemann, Heinrich, 22, 35, 69, 70.
- Schnabelkanne (Beaked jug), 47, 48.
- Scopas, 33, 178, 253-256, 263, 265, 266, 267, 268, 270, 278, 280, 286, 287, 398; gem engraver, 401.
- Sculpture, 193-292; materials and methods, 193-198; archaic, 198-217; the fifth century, 217-251; the fourth century, 251-276; Hellenistic, 276-292; Graeco-Roman, 280-292; Mycenaean, 63 ff.; decorative and substantive, 198; early Attic, 202-209; in poros, 202-204; Naxian, 211; Peloponnesian, 214-216.
- Scyllis, 209.
- Seager, R. B., 36.
- Segesta, theatre, 167.
- Selinus, 17, 135, 136, 137, 213 f., 221 f.
- Semper, 18.
- Serapeum, at Alexandria, 153, 179.
- Serradifalco, 18.
- Sesklo, Prehellenic settlement, 39.
- Severe style, of red-figured vases, 485.
- Sicily, 35, 44, 53, 91, 213; terracottas, 301, 302, 303.
- Sicyon, 30, centre of art in sixth century, 214, 215; in fifth century, 221; important in the rise of painting, 450, 520 f.; school of painting in fourth century, 505.
- Sidon, sarcophagi, 32, 175, 274-276, 530.
- Signatures, on coins, 364; on vases, 476 f., 480, 489, 492, 495, 501.
- Silverware, 336-342.
- Sima, 121 f., 123.
- Siphnians, treasury of, 133.
- Siris, bronze reliefs, 327.
- Sketch, of vase-paintings, 430.
- Smilis, Aeginetan sculptor, 217.
- Smyrna, terracottas, 316, 317.
- Solid terracotta figures, 297 f.
- Sosibius, sculptor, 291.
- Sosus, of Pergamon, mosaicist, 538.
- Sotades, vase-maker, 508, 509.
- Southern Italy, Greek vases, 512-518.
- Sparta, 30, 32, 468 (Cyrenaic vases), 520 (pithos with reliefs).
- Spatha, 35, 67.
- Sphyrelaton*, 197.
- Spon, Jacques, 14.
- Stadia, 163 ff.
- Stamatakis, 70.
- Standards of coinage, 356 f.
- Stater, 356, 357, 358.
- Statuettes, bronze, 330-333; terracotta, see Terracottas.
- Stelae, 174, 512; of Aristion, 207 f., 493; of Lyseas, 526; at Pagasae, 526, note, 534.
- Stephanus, sculptor, 290 f.
- Stereobate, 112.
- Stoa, of Attalus, 185; of Eumenes, 170, 181.
- Stoae, 160 ff., Hellenistic, 184 ff.
- Stones, used in architecture, 96; methods of moving, 98; working, in architecture, 101 f.; used for gems, 383, 385, 394, 395, 405, 407, 408, 410.
- Stuart, James, 15, 16.
- Stucco, 97.
- Styles, of vase-painting, see Vases.
- Stylobate, 112.
- Submycenaean, 40.
- Substantive sculpture, 198.
- Symbolism, in Hellenistic sculpture, 279.
- Symbols on coins, 363 f.
- Syracusan coins, 358, 364, 371, 375, 377.
- Syracuse, 135, 136, 173, 174; altar, 183.
- Syria, gems, 83, 381, 382.
- Syries, gem cutter, 384.
- Taenia, 115, 122.
- Talent, 358.
- Tanagra, 25, 34, 35, 320; early figurines, 295 f., 305; figurines of fifth century, 303, 305; figurines of fourth century, 301, 305-310, 331.
- Tarentum, terracottas, 303, 319.
- Tarsus, terracottas, 317.
- Tauriscus, sculptor from Tralles, 289.
- Technique, see Materials and methods.
- Tegea, temple of Athena Alea, 31, 151, 253, 254.
- Telephanes, Sicyonian painter, 530.
- Telesiterion, at Eleusis, 158 f.
- Temple, 109, 133-153; origin of, 109; in Sicily and Magna Graecia, 135 ff.; plans of, 133 ff.; Doric, 50; *in antis*, 59, 133; prostyle, 134; amphiprostyle, 134; peripteral, 134; early Ionic, 142 f.
- Tenos, 41.
- Termissus, theatre, 172.
- Terracottas, 25, 33, 34, 35, 46, 47, 94, 293-321; use in architecture, 116, 121, 154.
- Texier, Charles, 19.
- Thasos, 20.
- Theatres, 165-172.
- Themis, statue from Rhamnus, 276 f.
- Theodorus, Samian sculptor, 217, 297; gem cutter, 384.
- Theon, of Samos, painter, 538.
- Thera, 29, 41, 51, 87, 94.
- Thermon (Thermus), archaic temple, 31, 134, 139.
- Thersilion, at Megalopolis, 150 f., 168, 179.
- Theseum, 112, 147 f., 229, 245 f.
- Thessaly, 39, 53, 80, 91.
- Thrasyllus, choregic monument, 176, 277.
- Thrasymedes, sculptor, 262.
- Tiles, 121.
- Timanthes, painter, fourth century, 535.

- Timomachus, painter in first century B.C., 527.
- Timotheus, sculptor, 262, 263.
- Tiryas, 35, 41, 54, 55, 56, 58, 295, 316.
- Tleson, vase-painter, 400.
- Tomb, (Treasury) of Atreus, so-called, 60, 61, 62, 63, 65, 79.
- Tombs, at the Dipylon, Athens, 174; dome or beehive, 61, 62, 63.
- Tombstones, 250, 273.
- Tongs, for lifting stones, 100.
- Tools, used in architecture, 101; in sculpture, 106.
- Tralles, 276, 312.
- Treasuries, at Delphi, 133, 154; at Olympia, 154; so-called, of Atreus, 60, 61, 62, 63, 65, 79.
- Treu, G., 27.
- Triglyphs, 59, 115, 116, 122.
- Tripods, 325 f.
- Troy, 35, 39, 41, 44, 91, 293, 519.
- Trunnels, 117.
- Trysa, see Gjölbaschi.
- Tsountas, 36.
- Types, of bronze statuettes, 331; of coins, 360 f., 366 ff., (Athenian) 370 f.; of gems, 383, 385 ff., 392 f., 400 f., 404, 405, 411; of gods in the fourth century, 251; of gods, invented by Phidias, 229; of rings, 350 f.; of statues (early), 108 f.; of terracottas, 302, 303, 304 f., 309, 312 f.; of vases (local, geometric), 437 f.; on Corinthian vases, 448; of figures on black-figured vases, 478.
- Typhon, pediment sculpture, 203.
- Tyrrhenian amphorae, 472 f.
- Units of coinage, 358.
- Urlichs, H. N., 19.
- Vaphio, cups, 35, 48, 80, 91.
- Vari, 30.
- Vases, 20, 21, 22, 25, 32, 44, 412-525; Cretan, 48; from the Cyclades, 93; Kamáres, 47; at Mycenae, 78; gold and silver at Mycenae, 75; Mycenaean, 85-92; from Thera, 15, 87, 94; forms, 413-419; technique, 420-435; styles, 435-512; (Geometric, 436-442; Proto-Corinthian and Corinthian, 442-454; Ionic, 454-470; Attic, 471-506; with white background, 506-512); in Southern Italy, 512-518; with reliefs and in plastic form, 518-525; relation to painting, 526, 529.
- Venus, see Aphrodite.
- Vettersfelde, objects of gold, 334 f.
- Victory, see Nike.
- Visconti, Ennio Quirino, 13, 16.
- Vitruvius, 11, 12.
- Volutes, 125.
- Votive, offerings, 175; reliefs, 250.
- Vourva vases, 472, 473.
- Waldstein, C., Proto-Corinthian or Argive vases, 444.
- Wall, of Doric cella, 119.
- Walls, see Fortifications.
- Wash, on vases, 429 f.
- Wheel, gem cutter's, 382; potter's, 42, 47, 86, 293, 421 f.
- Wheler, George, 14.
- White ground, vases, 435, 506 ff.; cylixes and pyxides, 507 ff.; lecythi, 509-512.
- Wilkins, W., 17.
- Winckelmann, Johann Joachim, 13, 14, 15, 16, 21.
- Winter, F., 35.
- Wolters, P., on Mycenaean vases, 87.
- Wood, as material for sculpture, 193 f., 200, 201.
- Wood, J. T., 20, 111.
- Wreaths, on coins, 379.
- Writing, in Crete, 52.
- Xenotimus, vase-painter, 502.
- Zeus, on coins of Elis, 361, 362, 363, 373; of Phidias, 231 f., 362, 363.
- Zeuxis, painter, 534, 535.
- Zoega, Georg, 14.

September 193

GETTY CENTER LIBRARY



3 3125 00115 1154

