

NYPL RESEARCH LIBRARIES



3 3433 08191181 4

Digitized by the Internet Archive
in 2008 with funding from
Microsoft Corporation



HANDBOOK OF DRAWING.

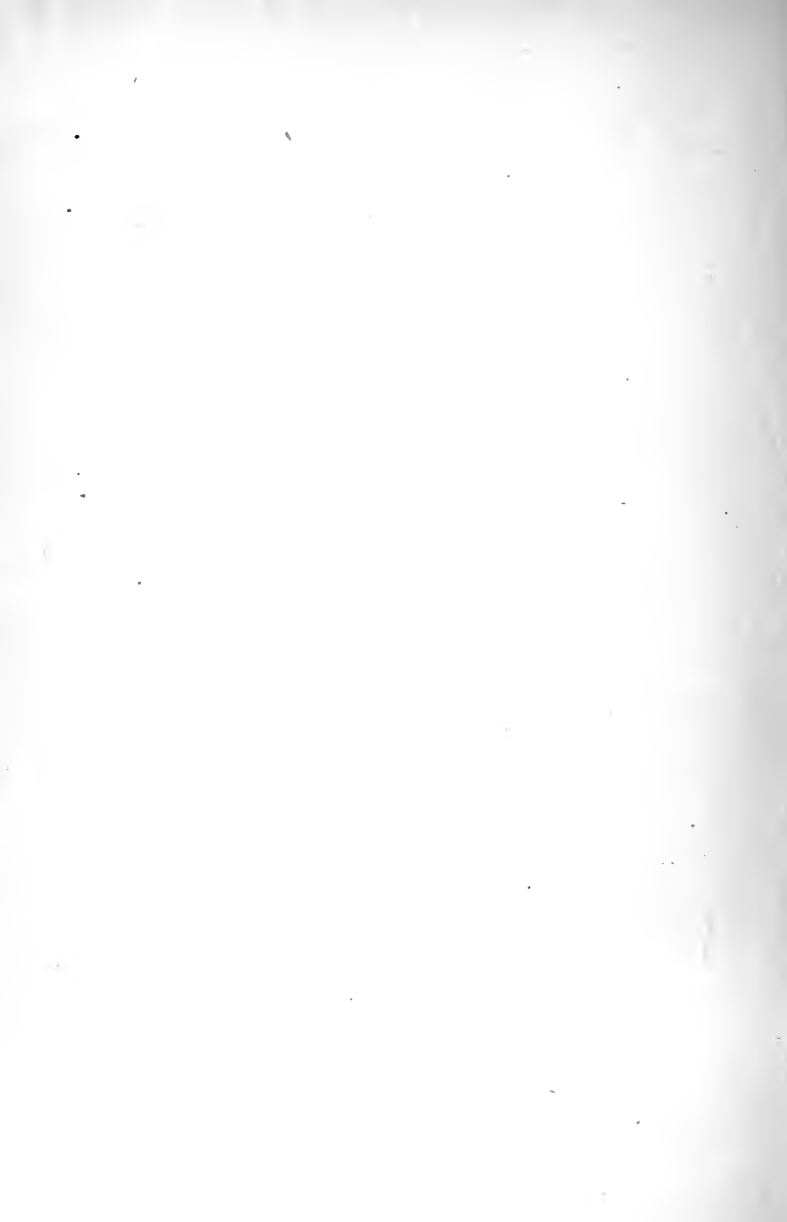



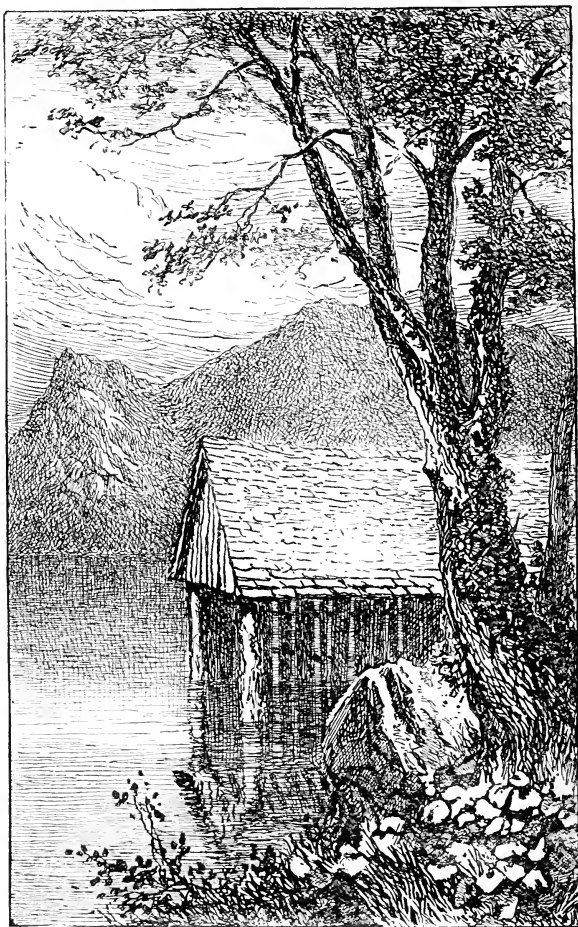

FIG. 152.

HANDBOOK OF DRAWING

BY

WILLIAM WALKER

LECTURER AND TEACHER OF FREEHAND DRAWING IN THE OWENS COLLEGE

WITH UPWARDS OF TWO HUNDRED WOODCUTS
AND DIAGRAMS

'Art is universal in its influence; so may it be in its practice, if it proceed from a sincere heart and quick observation. In this case it may be the merest sketch, or the most elaborate imitative finish. Either will be whole and perfect.'—GOETHE.

First American from the Second English Edition

NEW YORK
CHARLES SCRIBNER'S SONS
743 AND 745 BROADWAY
1880



PREFACE
TO THE AMERICAN EDITION.

THE very fair proposal of Messrs. Scribner to issue this Handbook in America affords me the satisfactory prospect of extended usefulness amongst the real amateurs of a great country; and I shall indulge the hope that it may meet with as kind and appreciative a reception in America as it has done in England.

WILLIAM WALKER.

THE OWENS COLLEGE,

Manchester, February, 1880.

vii

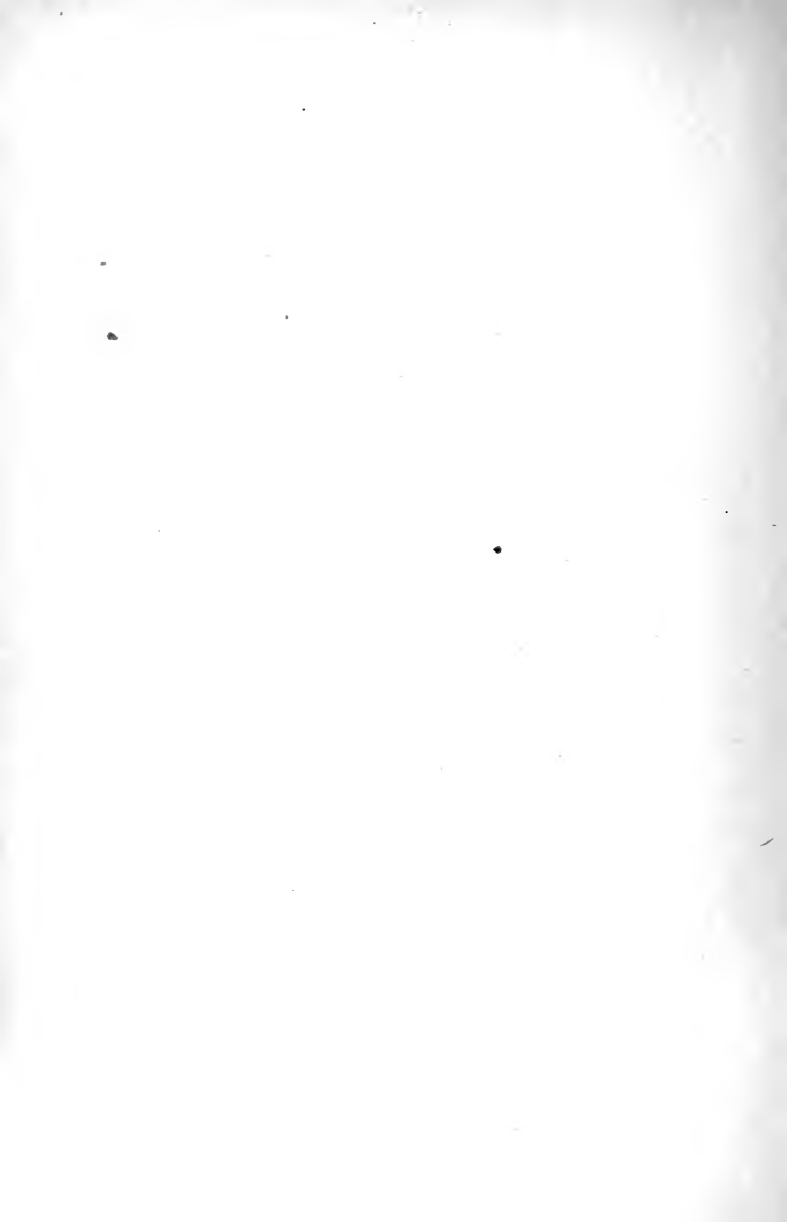

PREFACE

TO THE FIRST EDITION.

THE purpose of this work is to furnish such information on Elementary Art Education as is not likely to be met with in any other compact form. It has been prepared under the guiding principle that *all true education consists in the cultivation of the judgment.*

Books of *Examples*, good and bad, are in abundance ; but the language of Art,—any more than Greek or German,—is not to be learned by merely copying its signs. Art has its grammatical elements and rules, and should be studied in its exact delineative and intellectual aspect, as well as in its more emotional expression. The former will find its sphere in the class-room, the latter amidst the beauties of Nature, or in the studio.

The information here presented, and the practice recommended, will enable the student to make truthful and significant outlines, and drawings from outlines and diagrams put before him in lecture-rooms and elsewhere.

The work has been prepared chiefly during intervals of physical suffering, and has many imperfections. Two courses only were open to me—either to let the hours pass away useless to others as to myself, or to bring out the book in its present form, and I chose the latter. The desire and duty to help my fellows are my reasons and apology for issuing this little volume.

WILLIAM WALKER.

Fairlands, Hayfield.

ADDRESS TO STUDENTS.

As a false start, or a wrong bias, may lead to failure, an inquiry or two, which perhaps has not occurred spontaneously in entering upon this new field of work, is here suggested, and a few indispensable facts are stated which may prevent such wrong tendency at the outset.

In the first place, then, let us ask, Why do we wish to learn to draw? To reply, Because we like it, would hardly be deemed satisfactory, or worthy of thoughtful men; but if our reply should be, Because it may be useful, that certainly would be more reasonable. But, suppose our answer should take a higher form, and we should say that we wish to study Art in order to develop in us those nobler faculties which God has given for the appreciation of His works in nature *æsthetically*, as Science enables us to do *intellectually*, then we at once come to the root of the matter; we start with a worthy motive, and may reasonably expect success.

In beginning, then, the study of this new language, let us ask, What course will be most likely to secure the results we seek? The answer would undoubtedly be, That course which would lead to an acquaintance with the fundamental principles on which the Art is based. Just so. And in the pursuit of any subject of this nature we should naturally expect to go through some labour, perhaps drudgery, of preparation, equivalent to learning

French verbs, or writing Greek hexameters, and not unwillingly, provided always that we were certain that such labour would bring us nearer to the desired goal.

It is just in this temper that we ask a student to study Art, remembering at the same time that, whilst French verbs and Greek hexameters will occasionally be useful and pleasant, the language he now proposes to study is closely related to everything about him; and that, in fact, many of the Arts and Sciences are utterly incomprehensible without its aid. What would be thought of a work on Physics, or Chemistry, or Anatomy, or any physical science whatever, without illustrations? Language alone is one of the worst means of expressing form, while drawing is incomparably the best. Physical science stands still so soon as it becomes 'a reasoned statement instead of a sense-subjected fact.' To a medical student drawing will be as indispensable as Latin; and even Mathematics would be impossible of acquirement without sensible form.

To learn, there should be action with perception, and enjoyment with power; for 'Art is conversant with hand and eye, main sources of power, pleasure, and perception.'

A youthful mind should not stand, phial-like, to receive so much instruction from this master, now so much from that—so much Chemistry, then so much Geology, and so on; but rather it should be treated as a mysterious agent, which, gathering to itself knowledge of all kinds, weaves it into a new development of that which is the image of God Himself.

INTRODUCTION.

IF it were announced on the Manchester Exchange, or amongst any other large gathering of intelligent men, that not one in every hundred of them could see correctly the appearance of the walls or windows about them, it might cause no small amount of surprise, if not disconcert; yet such is probably the fact.

Millions of persons pass through life unconscious of the change that takes place in the *appearance* of things around us, yet each time we move an inch a complete alteration in the appearance of everything is the result. Appearances are constantly at variance with facts, and vision, like any other faculty, requires cultivation. It is not because our eyes are open that we therefore see. The mind requires to be furnished with some means by which the eye may be able to judge accurately of the form which every object assumes under various aspects. This continual change of things is an infinite source of pleasure, especially when we are in the midst of landscape, but is so constant and common to us that we fail fully to enjoy it. If there were not variety both in general form and color, as well as in the detailed appearances of things, the world would be full of monotony. An oblong room is more pleasant to dwell in than a square one. A circular room would be wearisome.

The actually different hues and colours in the world is another infinite source of pleasure, but much enjoyment of it is lost because we are not quick to observe, or we have not been trained fully to appreciate. If a knowledge of music, and a well-trained ear, are necessary to a full appreciation and enjoyment of sound, how important is it that the mind should be furnished with all the helps, both of knowledge and feeling (love), so necessary to the appreciation and enjoyment of the charms of form and colour by which we are surrounded. If it be considered necessary that young persons should spend so much time in the practice of music, is it not equally important to cultivate the eye to observe, and the hand to note things in this beautiful world, which would immensely enlarge and enrich our minds with fine thoughts and imagery ?

As the eye is the most important gateway of knowledge, so far as the physical world is concerned, it ought to receive great culture, even with only a utilitarian motive, for the time is rapidly approaching when drawing will *demand* its right place in education in this country. With the Greeks, writing and drawing were synonymous ; and in France and Germany every child is taught to draw just as he is taught to write, and much time is given to the practice of both ; and if England is to hold her own in the Arts she must pay more attention to the right teaching of drawing and the principles of Art as a primary step.

Every purchase we make of anything with a design or pattern about it, encourages good or bad Art, though

we do not think so at the time. We are too apt to buy what pleases us, instead of what is good in quality and pure in design, as well as suited to its place and purpose.

No doubt everybody has taste ; but taste may be good and pure, or it may be bad and false. If those who buy Art, and are in a sense its patrons, do not know what is good, so as to distinguish it from what is bad, it is useless to expect manufacturers to work artistically, or shopmen to sell that which is true,—they must prepare what the public will buy. It is most desirable, therefore, that the public generally, as well as the manufacturer, should know what is right in Art.

True education in man, whether as applied to Art or morals, is that which fits him to become the highest and best of his nature's capability ; first, in view of the Infinite Creator of all things, the ' Father of us all ;' and, secondly, in view of himself and his surroundings, whether of the material universe—the world, or of the spiritual universe, as manifested in man, and perfectly only in the one perfect Man. In this great work surely the study of Art is an important factor.



CONTENTS.

CHAPTER	PAGE
I. ON DRAWING	1
II. ON THE EYE	7
III. ON SEEING AND OBSERVING	12
IV. ON HOLDING THE PENCIL	20
V. ON LINES	23
VI. ON OUTLINE	26
VII. ON SKETCHING	29
VIII. ON LIGHT AND SHADE	37
IX. ON DRAWING FROM FLAT COPIES	55
X. SUGGESTIONS FOR A COURSE OF STUDY	57
XI. ON CONTRAST	76
XII. ON RELIEF	81
XIII. ON SIZE	83
XIV. ON PROPORTION	86
XV. ON SYMMETRY	89
XVI. ON SECURING CHARACTER IN ART WORK	92
XVII. ON TASTE	95
XVIII. ON STYLE	99
XIX. ON MOTIVE	101
XX. ON BEAUTY	107
XXI. ON FITNESS	110
XXII. ON VARIETY	112

CHAPTER	PAGE
XXIII. ON UNITY	118
XXIV. ON COMPOSITION	120
XXV. ON LIGHT AND SHADE AS APPLIED TO GROUPS OF OBJECTS AND TO PICTURES	130
XXVI. LAWS OF NATURE, AND THEIR APPLICATION AS PRINCIPLES OF ART	138
XXVII. SKETCH, STUDY, PICTURE	145
XXVIII. ON GRASS, HERBAGE, ETC.	153
XXIX. ON TREES	160
XXX. ON PRACTICE FOR TREE DRAWING	181
XXXI. ON WATER	187
XXXII. ON SKIES	193
XXXIII. ON DRAWING FIGURES AND ANIMALS	204
XXXIV. ON CRITICISM	210

PART II.

XXXV. ON PERSPECTIVE. INTRODUCTORY REMARKS	215
XXXVI. ON ARTISTIC PERSPECTIVE	218
XXXVII. ON TECHNICAL PERSPECTIVE	238

APPENDIX.

A.—ON CHILDREN'S DRAWING	263
B.—ON THE DIASCOPE	264
C.—PENCIL-IN-HAND MEASUREMENT	266
D.—NOTE ON TEACHING	267

LIST OF ILLUSTRATIONS.

<i>Frontispiece.</i>	PAGE
Rough sketches of tea-kettle, &c.	2, 3
Figs. 1, 2. Order for a box. Moulding	
„ 3. ‘Effect,’ for Frontispiece	13
„ 4, 5. Lotus plant. Scroll	15
„ 6. Iron bracket for lamp	16
„ 7, 7 <i>a</i> . Hands	20
„ 7 <i>b</i> , <i>c</i> . Hand and pencils	21
„ 7 <i>d</i> . File box	22
„ 8, 9, 10. Rectilinear, curvilinear, and compound forms	24
„ 11, 12, 13. Circle, cube, apple	26
„ 14, 15, 16, 17. Irregular form, shoe, convolvulus, stone	27
„ 18, 19. Sketch of wheel. Outline of picture	30
„ 20. Coast scene, by J. D. Harding	32
„ 21. Female figures, by J. D. Harding	33
„ 22. Outlines of faces	34
„ 23. Outlines of tree trunks	35
„ 24. Window	36
„ 25. Diagram, showing rays of light	39
„ 26. Illumination of objects	40
„ 27. Jar and hoop, showing cast shadows	41
„ 28, 29. Blocks, showing reflections	43
„ 30. Base of pillar and stick, showing cast shadows	45
„ 31. Doorways, showing effect of cast shadow	46

	PAGE
Figs. 31a. Opening in wall, showing retirement of shade	46
„ 32. Wooden platter and knife	47
„ 33. Portion of tree	48
„ 34. Pillar	49
„ 35, 36. Pairs of feet	51
„ 37, 38, 39. Roofs	52
Old twine shed	54
„ 40. Leaves ‘ <i>blocking in</i> ’	59
Flat tint	60
„ 41. Outline sketch of boat	61
Graduated tint	63
„ 42, 43, 44. Different views of squares	65
„ 45, 46. Two views of round table	66
„ 47. Transparent cube	67
„ 48, 49. Angular views of squares	67
„ 50. Angular view of square	68
„ 51. Eye-stand	69
„ 52, 53. Chairs	70
„ 54, 55. Barrel and ‘What-not’	70
„ 56. Portions of cylinders	71
„ 57. Outline sketch, after J. M. W. Turner	72
„ 58. „ „	73
„ 59, 60. Diagrams, to show contrast	77
„ 61. „ „	78
„ 62. Dancing figures, after Watteau, by J. D. Harding	79
Boat	80
„ 63, 64, 65. Arches, showing relative size	84
„ 66. Diagram, showing proportion	87
„ 67. Ovals, showing symmetry	90
Landscape	91

	PAGE
Figs. 68, 69. Twigs, showing character	92
„ 70. Hamper „	94
„ 71, 72. Jugs	96
Scroll	98
Umbrella	100
„ 73, 74. Child's drawing, showing truth, and falseness .	101
Acorn	106
Vase	109
„ 75. Diagram of circle, showing segments	113
„ 76. „ oval „	114
„ 76a, b. „ ovals	115
„ 77. „ showing how to construct ovoids	116
Rhine boats	117
„ 78. Contents of a pocket	121
„ 79, 80. Two compositions, glass, sketch-book, &c.	122
„ 81, 82, 83, 84. Lines, showing relation, &c.	123
„ 85, 86. Crocus, vase	123
„ 87, 88. Composition lines in pictures	124
„ 89, 90. „ „	124
„ 91. „ „	125
„ 92. The discovered letter	125
„ 93. The prisoner	126
„ 94, 95. Composition lines	126
„ 96, 97. Repose and Contrast	127
„ 98. Division of picture	128
„ „	129
„ 99. Bolton Abbey, by J. D. Harding	134
„ 100. Italian buildings „	135
„ 101. Lane in Surrey „	136
Bit of road	137

	PAGE
Figs. 102, 103. Primitive candlesticks	139
„ 104, 105. Candlesticks	140
„ 106. Candlestick	141
„ 107, 108, 109. Cups	142
„ 110. Facsimile of Wilkie's first idea of the 'Rabbit on the Wall'	147
„ 111. Sketch of field-flower	148
„ 112. „ beehive	148
„ 113. Sketch of sheep on a common	148
„ 114. „ old window	149
„ 115. „ Dame Campbell's henroost	149
„ 116. „ bridge	150
„ 117. Study of tree trunk	151
„ 118. „ grass blades	152
„ 119, 120. Outlines of leaf	156
„ 121, 122. Notes of leaves	157
„ 123, 124. Preparation for grass	158
„ 125. Herbage	159
„ 126. Concentric rings of tree trunk	163
„ 127, 128, 129, 130. Oak leaves and spray	164
„ 131, 132. Branches of oak and sycamore	165
„ 133. Oak tree	168
„ 134. Ash tree	169
„ 135. Ash spray	171
„ 136. Umbrella diagram	172
„ 137. Shade exercise	173
„ 138. Sycamore tree	174
„ 139. Birch tree	175
„ 140. Shade exercise	176
„ 141. Beech stems (J. D. Harding)	177

	PAGE
Figs. 142. Scotch fir	179
„ 143, 144. Tree-shade exercise	182
„ 145. Exercise for tree contour	183
„ 146, 147. „ „	184
„ 148. Portion of oak	185
Tree trunk	186
„ 149. Diagrams, showing angle of reflection	188
„ 150. „ „ „	189
„ 151. Looking-glass, &c.	189
„ 152. Frontispiece.	
„ 153. Diagrams, showing curvature of waves	190
„ 154. Cumulus at rest	198
„ 155. „ after travel	199
„ 156. Creeping mist	202
„ 157. Clouds seen from above	203
„ 158. Coast scene (J. D. Harding)	206
„ 159. „ „	207
„ 160, 161, 162. Figures, after Prout	209
„ 163. Figures, after J. D. Harding	209
„ 164. Oak spray	217
„ 165. Transparent cube	218
Cube diagram	218
„ 168. Book	219
„ 169. Cube	220
„ 170. Arm-chair	220
„ 171, 172, 173. Outline blocks	221
„ 174. Transparent cubes	222
„ 175. Twenty cubes	223
„ 176. Transparent cubes upright	224
„ 177. Interior of room	225

	PAGE
Figs. 178. Diagram of room	226
„ 179, 180. Blocks of buildings	227
„ 181, 182. Two views of shed	228
„ 183, 184. Uphill and downhill	229
„ 185, 186. Angular view of square and cube	230
„ 187. Angular view of cube	231
„ 188. Transparent cube	232
„ 189. „ cubes	233
„ 190. Block of buildings	233
„ 191. Angular view of cube	234
„ 192, 193, 194. Chairs and piano	235
„ 195. Group of models	237
„ 196, 197. Square and circle	239
„ 198, 199, 200. Ground plan and views of three cubes	240
„ 201, 202, 203. „ „ six cubes	241
„ 204. Block of buildings from same ground plan	242
Diagram 1. Appliance, illustrative of perspective terms	244
„ 2, 3. Showing same in profile, and flat	245
„ 4, 5. „ how to find distance points and vanishing points	248
„ 6, 7, 8. „ parallel views of square and oblong	251
„ 9, 10. „ „ circle and cube	254
„ 11, 12. Explanatory of angular view	256
„ 13. Angular view of cube	258
„ 14. „ „ tomb-stone	261
Figs. 205. Diascope	265
„ 206, 207. Hands measuring	266
„ Kettle, &c.	268

HANDBOOK OF DRAWING.

PART I.

CHAPTER I.

ON DRAWING.*

1. THE misunderstanding of the term *free-hand drawing* has led to considerable confusion. It was originally applied to the copying, *without instruments*, of a series of outline designs issued by the Department of Science and Art, and has, unfortunately, become associated with that alone. Rightly understood it has a much wider significance, and should be applied to all drawing where instruments, such as compasses, rulers, &c., are not used. In geometric drawing, instruments are used, and therefore this is not *free-hand* work. Strictly speaking, models, flowers, landscapes, drawn without mechanical assistance, ought to be considered as *free-hand* drawing.

* A definition of the term '*drawing*' must be very comprehensive if it is not to exclude some art into which drawing enters more or less. Hamerton says:—'If we say that *drawing is a motion which leaves significant marks*, we are as precise as the numerous varieties of the art will permit us to be.'

2. Its elementary study is the first step towards expressing our ideas through the medium of art, and should be practised more or less from earliest infancy as a most useful language, by which the *perceptive faculties* will be quickened, and knowledge conveyed in a sort of shorthand language requiring no translation, and understood by all.* In this respect it has often a great advantage

* Atkinson, the well-known Russian traveller, told the writer that on many occasions he would have been most seriously inconvenienced had it not been for the readiness with which he could use his pencil. The following anecdote, also, will show the advantage of being ready with this universal language. An artist who had neglected to secure his lunch before going amongst some Welsh mountains for his day's painting, after some hours' work began to feel faint for want of food, and seeing a cottage at some distance, went to inquire if he could have a cup of tea. His reception was not an agreeable one, as he was attacked by a couple of curs, which frightened him and put to flight a number of noisy fowls. On the good woman of the house opening the door a few inches the artist made his request for a cup of tea, to which he got the reply, '*Dim Sassenach*' (No English). After again urging his request, and meeting with the same determined, settled, and settling answer, '*Dim Sassenach,*' he bethought him of his pocket sketch-book, which had been of like service to him among the mountaineers of Switzerland, and he instantly made a sketch like the following, and showed it to the unwilling dame, who, recognising his



want, instantly opened wide the door, beckoned him into the cottage,

over writing, as will be evident if, as in business, we wish to describe in writing almost any common article of daily use—say a sofa, or a coal-vase—instead of drawing it. This is a strong argument in favour of *all* persons learning to draw as well as to write.

3. The question is often asked, ‘Can every one learn to draw?’ and although it may seem an ignorant question, it had better be answered. All persons who can learn to

and offered a chair. In an unknown language two children, who had concealed themselves behind their mother, were hastily despatched, and soon returned, one with a bundle of sticks and the other with a can of spring water. Very quickly the kettle was boiling, and cakes were baking on something like a Scotch ‘griddle,’ hung from a chain in the chimney. Soon the artist was enjoying himself, and the remembrance of the noisy cackling amidst which he was introduced, suggested to his mind the possibility of making his repast more substantial by the addition of a few eggs; so he politely, but thoughtlessly, asked his hostess if she could oblige him with an egg or two. The inevitable ‘*Dim Sassenach*’ soon showed him his mistake; so, getting out his pocket sketch-book, he sketched something like the following:—whereupon the good woman, charmed at her power of interpreting, went off

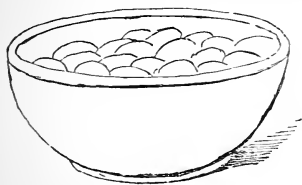

to a cupboard, and immediately returned with a large, clean, wooden bowl, filled with eggs, of which the rough sketch will give an idea. Satisfied, refreshed, and again ready for work, the artist prepared to depart, but not before



he ascertained the power of his hostess to understand, without any sketch, the value of English silver.

write can learn to draw. If it were required, 'Can any one become an artist?' the question might be answered by another, 'Can any one become a poet?' Great painters, like great poets or great composers, may be born, but not made. But though there are not many Beethovens, or Handels, or Mozarts in a generation, there are many persons who add to national happiness by less pretentious efforts than Oratorios and Masses. On the Continent drawing is taught to all children in the best national schools, and it ought to be taught in our own: not because it is insisted on in Continent schools, but because it would be of incalculable service in the business of life to those who had learnt it.*

4. But here arises an important question: What do we understand by learning to draw? There are various kinds of drawing, and that which may be suitable to one purpose may not be applicable to another. For example, the kind of drawing and knowledge requisite for a man of culture is scarcely that best suited to an artisan. The first and elemental requirement of an artisan is that he should

* The following remarks from Professor Huxley appeared in the *Fortnightly Review*, January 1878. Speaking of the preparation for technical teaching he says:—'And especially I should require some ability to draw: I do not mean artistically, for that is a gift which may be cultivated, but cannot be learned, but with fair accuracy. Everybody, or almost everybody, can learn to write; and, as writing is a kind of drawing, I suppose that the majority of the people who say they cannot draw, and give copious evidence of the accuracy of their assertion, could draw, after a fashion, if they tried. And that "after a fashion" would be better than nothing for my purposes.

'I suppose that in nine trades out of ten it would be useful if he (the student) could draw.'

be able to draw accurately, say a brick, and understand it when it is drawn ; for if he can draw a brick he can draw a box, and if a box, then a table ; and thus he has a safe foundation on which to build his knowledge as it may be required.

5. On the next page is given a supposed order for a common box, which, though very rough (as though drawn in haste), would be clearly understood by an intelligent workman without any chance of error. How great the advantage of drawing in this case is over a written description only, may be felt if the student will try to write out instructions for such a box *without any drawing*—instructions that might not only be understood, but that could not be misunderstood.

6. To those who travel, even a little knowledge of free-hand drawing, as here understood, will be not only useful but delightful. The slightest sketch taken by oneself will, in after years, recall more of the circumstances and associations than a lengthened description, or even a photograph. Illustrations of this kind of memorandum sketch will be found in various parts of the work.

7. But if true education be that which fits a person for the after circumstances of life, then the requirements of an educated man will be something far beyond the power to sketch a few simple objects intelligently. He must have a knowledge of the general principles of Fine Art, and such power in practice as will develop in him that æsthetic faculty without which he can neither fully enjoy, nor accurately judge, in matters of taste.

Order.
 Box for packing.
 Deal, $\frac{3}{4}$ inch, not planed
 2ft. 6in. \times 2ft. 1in. \times 9in.
inside measurement.

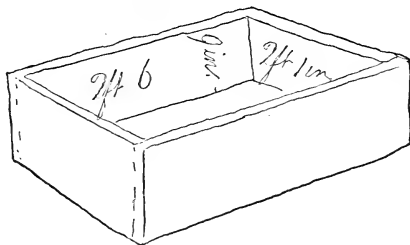
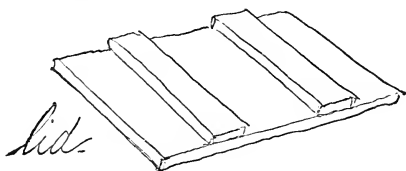

FIG. 1.

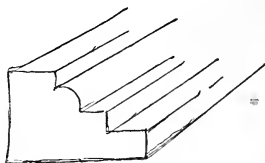

FIG. 2.

CHAPTER II.

ON THE EYE.

8. OF the five senses, or gateways of knowledge—seeing, and hearing, feeling, tasting, and smelling—two, seeing and hearing, belong to the intellectual part of our nature, whilst the other three chiefly supply our animal wants. The sense of seeing is at once the most active, the most comprehensive, and the most intellectual of them all. It is the servant of the soul, and through it the mind receives the richest variety of images, or ideas. F. W. Robertson says that ‘the highest pleasure of sensation comes through the Eye. She ranks above all the rest of the senses in dignity. He whose eye is so refined by discipline that he can repose with pleasure upon the serene outline of beautiful form, has reached the purest of the sensational raptures.’

9. A short description of the eye is given at page 9; but it may here be briefly stated, that when an object is placed before the eye, the light from it passes through the crystalline lens, and an image is formed on the retina, from whence the consciousness of it is conveyed by the optic nerve to the brain.*

* The number of shocks per second necessary to the production of the impression of colour is as follows :—Red, 451 millions of millions; of violet, 789 millions of millions. All these waves enter the eye, and strike the retina at the back of the eye in one second.—TYNDALL.

10. The eye of a fish, or of a sheep, is probably as well adapted to the purpose of their life as is that of a human being; but the lower animals, being chiefly moved by instinct, have their organs available when very young and with little training; whilst a very young infant, though with the eye perfect as an organ, requires long and frequent practice before it can judge even of distance. The moon and its mother's face probably appear equally near. If a person born blind obtains his sight at fifteen or twenty years of age, he is said to have no idea of distance by sight; whilst the little fish that gets its food by shooting a drop of water at its prey scarcely ever misses; and the chick that has only just emerged from the shell pecks away at the crumbs, distinguishing them from grains of sand of similar size and colour.

11. The human eye is a wonderfully adapted, self-acting, self-regulating, and self-minding organ, for seeing things large as mountains or small as motes, very near or millions of miles away; but it requires training.

If a person were to travel, say, from Liverpool to London, and hold a looking-glass so as to have all the objects reflected in it as they were passed, on arriving in London there would be nothing left on the glass but the last image—perhaps the station; all the other myriads of objects would be gone. It is just so, in a lesser degree, with many persons who have not learned to use their eyes; whilst others are more like a sensitised plate in a camera, not only receiving images, but photographing and fixing them by observation.

12. Considered merely as an organ, the eye is a compound lens, consisting of three principal parts, the *aqueous humour*, the *crystalline lens*, and the *vitreous humour*.

The aqueous humour is held in front of the eye by the *cornea*, a transparent, horny capsule, something like a watch-glass in shape. Behind the aqueous humour, and immediately in front of the crystalline lens, is the *iris*, which surrounds the *pupil*. Then follow the lens and the vitreous humour. Behind this is a black pigment, upon which the delicate network of nerves, called the *retina*, is spread. It is this delicate screen, the retina, that receives the images of things with such marvellous rapidity, and conveys them through the optic nerve to the brain.

13. By means of the *iris* the size of the pupil may be caused to vary. When the light is feeble the pupil expands, and when it is intense the pupil contracts; thus the quantity of light entering the eye is to some extent regulated.

14. The pupil also diminishes when the eye is fixed upon a near object, and expands when it is fixed upon a distant one. The image thrown upon the retina is inverted.

15. The eye possesses a power of adjustment for different distances, chiefly by a change in the curvature of the crystalline lens. Two objects at different distances from the eye cannot be clearly defined at the same moment: the adjustment of the eye for seeing one distinctly will cause the other to become indistinct.

16. A line drawn through the centre of the cornea and the centre of the whole eye is called the *axis* of the eye.

17. When an impression of light is made upon the retina it does not instantly subside, but remains for a short time after the cause has passed away. This is called the '*persistence of impression.*' This interval of persistence varies with different persons, and amounts to a sensible fraction of a second.

18. If a succession of images follow each other at intervals less than the time which the impression endures, the images will blend together and form a shady surface, as in the case of the spokes of a wheel when going round rapidly, or the colours in a revolving chromotrope.

19. The image of any object thrown on the retina of one eye differs from that thrown on the retina of the other, because the object is viewed from two separate places. If these two pictures, thrown on to the two retinæ, were combined, we should have the full impression of solidity. This is what takes place in the stereoscope, in which the two pictures always slightly differ. Both eyes, therefore, are necessary to give the idea of solidity and space satisfactorily.

20. A very young child at first sees* things *not as they really are, but as they appear* (on the exquisite little reflector, the eye), unconscious that they often are *actually quite different* from what they appear. As the child grows, he gradually learns the true or actual shapes of things, and if, whilst very young, he does not draw things,* he will lose what is called the '*innocence of the eye;*' so that

* I don't say, have drawing lessons. See Appendix A, on children's drawing.

when he is older, and attempts to draw things from nature, he will have considerable difficulty in seeing retiring forms correctly, and will have to use the rules of perspective : thus to learn back again, as it were, to the simplicity and truth of child-sight.

There are many intelligent persons who cannot draw the top of a tumbler, or of a table or a book, correctly. In this case the mind (with its knowledge of actual shape) interferes with the image of the retina.* It is a fact that, supposing a young child could hold and guide the pencil sufficiently well, he would draw solid forms in perspective more correctly than an upgrown person, and for this reason, that he sees more innocently or truly.

21. The *power* of the eye for judging,—distance, for example,—depends on frequent and earnest practice. A seaman, who is constantly on the look-out, judges much more accurately of distance than a landsman. When two boys at play have their marbles almost equally near a given hole, they very earnestly take the image into their eye, first of one distance and then of the other, again and again, till at last they may determine with almost certainty which of the two marbles is nearest the hole. The image on the retina is true enough ; the difficulty is for the mind to take a correct ‘reading’ of the image. Aiming at a given mark, as in shooting, or cricket, or billiards, tends to give power and accuracy to the eye.

* Though a plumb-line may be used in drawing, it is really seldom necessary, as the eye, if fairly practised, will soon learn to determine whether or not a line be vertical.

CHAPTER III.

ON SEEING AND OBSERVING.

22. BY careful practice, as in drawing, the eye may become astonishingly accurate as a measuring instrument.

Hitherto the eyes have been spoken of as a single organ, for, although we often use both, Art recognises only one, or, more correctly, one point of vision.

If we wish to see clearly the *contour* of any object, especially when near, only one eye should be used, so as to avoid a parallax of vision ;* but if we desire to determine how far an object is from us, both eyes must be used, so as to see, as it were, from two places, for with one eye alone we have little idea of space.

An illustration of this parallax of vision may be seen in the ordinary stereoscope, by placing in it two views exactly the same (*i. e.* taken from exactly the same point). No idea of space will be given beyond what we see without the instrument. But if the two views be taken from two different points, corresponding with the distance of the eyes from each other, the 'relief' of the various objects will be perfect, and we shall have a full idea of space.

* What is meant by parallax of vision may be better understood in the following manner :—Hold a pencil or pen at a little distance from you, and look at it with one eye closed, and observe what object or part of the room it obscures from the view ; now, without moving the head or pencil, open the other eye and close the one just used, and it will be seen that the pencil now screens quite a different part.

We observe, then, that to see the contours of objects clearly *one* eye only should be used ; whilst in judging of distance, or of the location of objects in space, both should be used.

23. But there is yet another way in which the eyes should be used in Art, viz. half closed.

When we wish to observe in a picture or drawing the principal masses of light and shade, apart from detail, the eyes should be *partially* closed, so as to admit only the bright rays. A darkened glass is sometimes used by artists for the same purpose.

The light and shade of a picture or drawing thus seen is often spoken of in Art parlance as the 'effect.' In Fig. 3 is given the 'effect,' or light and shade, of the illustration forming the frontispiece of this work.

24. From what has been said it will be evident that, although the eye is so wonderfully adapted, and so delicately sensitive for the reception of images, it requires the presence of a mind to read or take from it the impression it presents so constantly.

The needle on the telegraphic dial may be moving ever so rapidly, but to little purpose if there be no intelligence ready and willing to receive the information it may be presenting ; and this leads us to make some remarks on the importance of *Observation*.

25. The power of observing varies much in different

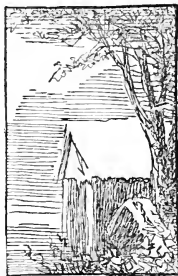

FIG. 3.

persons, but may be greatly improved by intelligent practice. It should never be confined to one class of objects. The physical world, though brimful of beauty for the eye, and of evidences of wisdom for the mind, is a closed book to one who has not learnt to observe; but to one who has learned to see, and to reflect on what is seen, it is literally an endless source of enjoyment. We may, therefore, naturally inquire what part of a liberal curriculum is most likely to be of service to us in forming and developing this important faculty? Certainly, whatever other tangible subjects, such as chemistry and physics, may do, that which brings us into immediate contact with Nature and with Art in their more beautiful aspects must hold an important place. This is what drawing, rightly pursued, does. Let us suppose a simple case. In our rambles we pick up, say, a leaf, or a stone, which we wish for some reason to remember. A verbal description alone would be both tedious and unsatisfactory, but if accompanied with a drawing of it, would be understood distinctly and remembered long.

26. Collateral knowledge often helps observation, and Art should be studied in its twofold character, as a science and as an art—as a science to be known, and as an art to be practised. The pleasure we take in any objects, whether of God's or of man's making, chiefly depends on some of the following considerations: 1st, that by what they present to the eye they suggest to the mind something of deep import, as in symbolic ornamentation; or, 2nd, that which is presented to the eye is of such a form or colour as

to excite our sense of the beautiful—this is æsthetic or sensuous ; or, 3rd, the forms presented to us may be such as to suggest the idea of fitness, either alone or in conjunction with the sense of beauty.

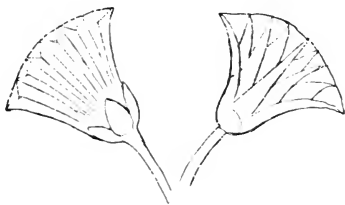

FIG. 4.

27. In Fig. 4 (the lotus-plant) we have a conventional and unpretending ornament, which by itself would not excite much emotion, but when recognised as one of the most significant symbols of Egyptian architecture becomes full of interest.

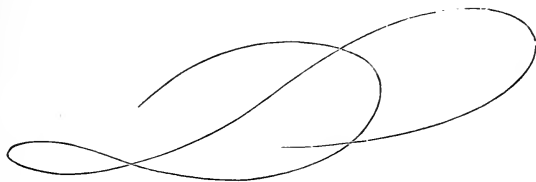

FIG. 5.

Fig. 5 is a form which, apart from any association, is in itself pleasing, as is also the piece of scroll-work in

Fig. 6. But the charm of this latter is greatly enhanced because applied where it not only does the work of a bracket (conveying the idea of fitness), but also because it does it with much grace.

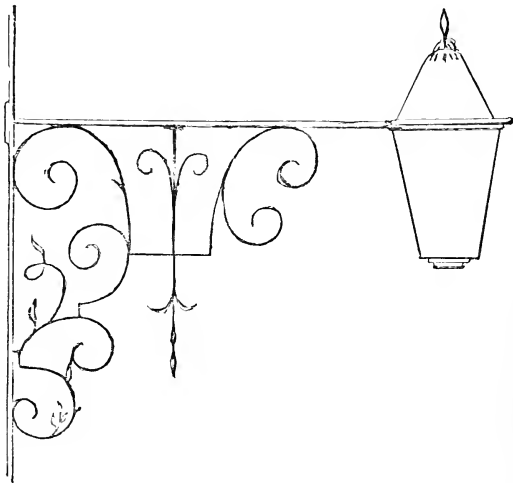

FIG. 6.

It is in thus seeing the *essential characteristics of things* that real observation consists, and it will be evident, therefore, how important it is that the mind should be led not only to see beauty, but also to know what kind of beauty it is, and whence it arises.

28. There is much truth in the remark that we see only that which we look for, and to look energetically we must consciously look *for* something. This will be better

understood by the following anecdote, which Professor Tyndall gives of Faraday. 'And this reminds me,' says Tyndall, 'of an occurrence which took place in this room at the beginning of my acquaintance with Faraday. I wished to show him a peculiar action of an electro-magnet upon a crystal. Everything was arranged, when, just before the magnet was excited, he laid his hand upon my arm and asked, "What am I to look for?" Amid the assemblage of impressions connected with an experiment, even this prince of experimenters felt the advantage of having his attention directed to the special point to be illustrated.' *

29. Now, the difference between artistic sight and ordinary sight arises from the fact that people generally do not look for those truths and qualities which artists look for. For instance, a group of intelligent artisans—botanists—met the writer in one of the most beautiful valleys in Derbyshire, and in a conversation admitted that they had not particularly seen the rocks or the hills, nor even the trees—'They were not in their way.' They were searching for a little plant they had heard of as being in that locality.

Thus, men use their eyes as channels of information about what they want to know. A farmer looks at the sky to see whether it will rain, and at a field of corn with a view to its value. A drove of cattle will not be seen by him as strikingly picturesque, but as objects having their market value. 'Money value' is all that some persons *can*

* Tyndall, *On Sound*, p. 120.

see in the world. With them the æsthetic sense is blind or dead : they have eyes, but no æsthetic faculty behind them ; they are like the man who had bought spectacles to read with, but still could not read, for he did not know his letters.

30. It is an optical fact that no two persons ever saw the same rainbow, and it is equally true that no two men ever saw the same appearance in any object. If we go to a sketching-ground of artists—say, Bettws-y-Coed or Capel Curig—though the same subject may be painted again and again by successive artists, we shall not find two pictures alike. The objects may have been the same precisely, but in each case the representation will have passed through quite a different mind, with quite a different result.

31. Not to see anything is, so far as that particular thing is concerned, equivalent to blindness. When people talk of learning to draw and paint, they ought rather to say they are learning to *see*, for *that* is the main object of artistic education for amateurs. Artistic sight is not a natural faculty, but may be acquired, and the act of acquiring it gradually reveals nature to us æsthetically, and thus develops this new sense, which, being emotional, supplies pure food for the imagination.

Many persons would be indignant at being told that they knew little about the form of an ox or a horse. Let any one of them, however, sit down quietly and write such a description of the form of a horse that we may know it in a group. Or, if he find this too tedious, let him take pencil and paper, and try seriously to *draw* one—the one he

knows so well and rides daily. The exercise may be of value to him.

32. Hamerton tells us, that although 'accustomed to country life, and living summer and winter on a large farm, he never knew anything accurately about horses and cows till he began to make studies of them with a view to painting; and postponed the writing of an article on Rosa Bonheur from the humiliating conviction that, although intimately familiar with all the oxen on the farm, and their labours—personally friendly with them, even, and calling them by their names—he had not, in the deep, critical, and artistic sense, *seen* them.'

33. Observations are of little value without comparison, and for comparison we must have *standards* in the memory. It is recorded of Rosa Bonheur, that when she first began to study animals she bought a sheep, and kept it always by her in a Parisian apartment, and studied it in every detail till she knew it by heart; and no doubt it became her first standard. The haste and restlessness of the present age are such as to make us impatient of anything but the gorgeous and sensational. We should seek for the quieter, but not less wholesome and enduring, pleasure of rambling, sketch-book in hand, through some of our old English scenery; for *the true art of seeing and enjoying rests chiefly in sensitiveness and power of sympathy, and the true value of observation is in the noble thoughts that it excites within us.* It is in this way that we would have students cultivate a love for Nature in her simplicity, and a habit of observing accurately her subtle, hidden teachings.

CHAPTER IV.

ON HOLDING THE PENCIL.

34. THE hand, as a prehensile or handling organ, varies much in different individuals. In some, the fingers and thumb are long and mobile, whilst in others they are comparatively short and stiff; but practice in the latter case will soon surmount almost any want of physical adaptation. One of the most skilful performers on the pianoforte in this country has fingers so short that he can only reach an octave.

Much, however, depends on the way in which the pencil is held in drawing. Only one general rule can be given, and it is this—that it should be held in that position which is best adapted for the particular work to be done; certainly not with the fingers near the point, or with

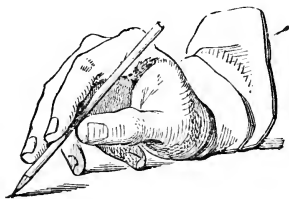

FIG. 7.

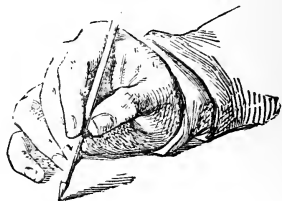

FIG. 7 a.

the knuckles up as when writing, thus (Fig. 7), but rather as in Fig. 7 a. Sometimes the pencil, being held between the thumb and first finger, and supported by the

long one, should pass along the first finger in an upward direction ; sometimes it should pass under the hand, held also by the other fingers, thus (Fig. 7 *b*), according to the

FIG. 7 *b*.

kind of work to be done ; and in all cases it should, as far as possible, be worked from the shoulder, especially when drawing at an easel.

As excellence in Art-work greatly depends on the tools or instruments used, the sharpening of the pencils is important. A set of pencils nicely pointed is quite a temptation to

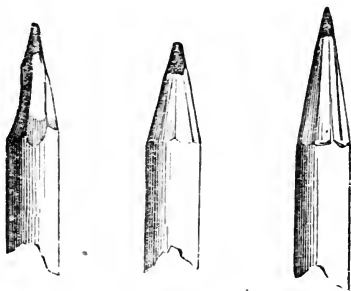
FIG. 7 *c*.

draw with delicacy and refinement. They should never be cut like the first two in Fig. 7 *c*, but like the third one, or even with a still finer point, except where it is intended to

shade broadly with the side of the instrument—then the wood should be left uncut on one side, so as to support the lead and prevent it from breaking. After the cedar is cleared away a small file may be used, or one fixed in a box, as in Fig. 7 *d*.

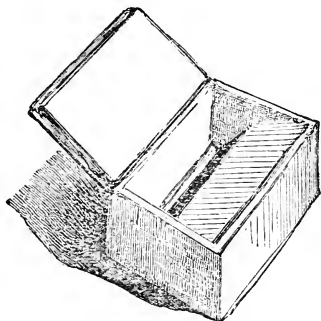

FIG. 7 *d*.

CHAPTER V.

ON LINES.

35. BY a line is not here meant the abstract idea of length without breadth or thickness, but an elongated mark or stroke made by some instrument on a plane or surface.

36. There are only two kinds of lines, straight and curved, and by means of these all the infinitely varied and beautiful forms in creation may be indicated. If you look round the room, you will not find any object or pattern that may not be described by these lines.

37. A straight line may be defined as a point continued in one direction, or as the nearest defined distance between any two points.

Although there are really no lines in nature, we find the *idea* of the straight line in crystals, buildings, and in many things made by man, in which utility is the chief purpose ; because generally it is easier to fit two plain or straight surfaces than two which are curved or irregular, as, for instance, in a box, or in bricks.

38. A curved line is one in which the direction is constantly varied. It is found chiefly, but not altogether, in things that are considered beautiful, as in leaves, flowers, the human form, &c.

39. There is beauty, however, in crystals, and even in the square ; but the beauty of the square arises partly from

a sense of exactness, for if it be not exact it ceases at once to give pleasure and to be a square.

40. Both straight and curved lines are felt to be most beautiful when in combination, as in some kinds of architecture, vases, flowers, and trees.

41. When forms are made with the straight line only (as in Fig. 8) they are called *rectilinear*; when made with

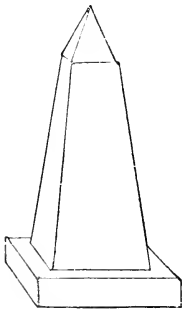

FIG. 8.

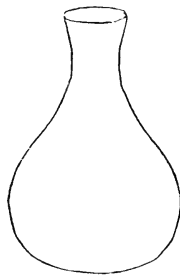

FIG. 9.

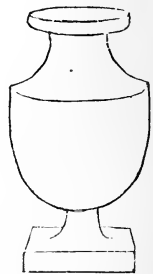

FIG. 10.

curved lines (as in Fig. 9) they are called *curvilinear*; and when composed of both straight and curved lines they are compound forms (as in Fig. 10).

42. A straight line can be placed only in three positions, viz. perpendicular, horizontal, and oblique or slanting. The perpendicular and horizontal positions never vary, and may therefore be considered and used as standard lines. Oblique or slanting lines may incline more or less, and the degree of inclination can only be estimated by comparing them with either perpendicular or horizontal lines.

43. In copying an example or a model, therefore, it is evidently absurd to begin with slanting lines: all the *standard* lines should be first drawn, and the slanting ones judged of by them. The importance of constantly testing all lines by those which are either perpendicular or horizontal can scarcely be too strongly insisted on, as there are no other means, in free-hand drawing, of attaining accuracy. (See, also, ¶ 105.)

44. By means of these two elemental lines all superficies and all solid forms may be suggested. If we continue a line at an equal distance from a point it will result in a circle, which is the archetype of all animal and vegetable forms,—the simplest and most economical form in creation, and perfect in its completeness. It is, however, an unity admitting no variety, and therefore has not in it the element of infinity, which consists in variety rather than in numbers. The square may be considered as the archetype of crystals and of constructed forms, such as buildings. The highest piece of future architecture—the New Jerusalem—is described as being ‘four square.’ This figure, however, like the circle, being fixed—admitting of no change—cannot be considered beautiful *per se*, but only in its application as to structure, and as a contrast to the curve. The most beautiful and the highest forms in Nature and in Art are made up of a combination of these two forms modified by elongation, and by the admixture of one with the other. This combination of the straight with the curve is found in its highest development in the human form.

CHAPTER VI.

ON OUTLINE.

45. **OUTLINE** may be understood to be the mere contour of any form (as Fig. 11). It may also mean a sketch with

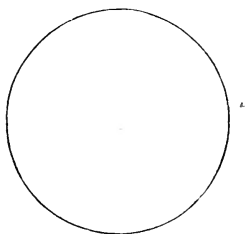

FIG. 11.

lines to indicate its general and leading characteristics, thus :—

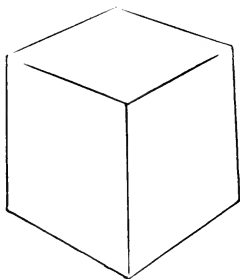

FIG. 12.



FIG. 13.

Some objects may be clearly indicated by outline alone,

as leaves, &c. ; whilst others cannot be satisfactorily expressed without shade—the sphere, for instance.

46. A flat contour may be greatly modified by a few indicative lines or markings on its surface ; for example, Figs. 15, 16, 17 are the same in contour as Fig. 14, but their character is greatly modified by the different markings.



FIG. 14.



FIG. 15.



FIG. 16.



FIG. 17.

Thus it will be seen that outline is most important, and often very effective, as it suggests to the mind an idea of many things which it would require long time and much thought and labour fully to describe. (See page 6, ordering a box.)

47. In drawing a Head, the first twenty lines will indicate more than a hundred lines can do afterwards ; for the former will give the principal facts of eyes, nose, mouth, &c., whilst the latter can only add *lesser* facts.

It is scarcely possible to overrate the importance of correct form as indicated by outline, inasmuch as no amount of shading will make a wrong sketch right.

48. The first efforts at Art with primitive man have always been in *outline*, just as we find in children's work. The aim is to get at the fact which the mind recognises,

rather than the appearance on the retina of the eye—to get the fact clearly stated without much regard to the means—and it is in this sense that drawing in its earliest employment was a kind of writing. The Greeks used the same word for writing and drawing, and there is little doubt they considered the processes the same. All the arts of design or drawing in their early development are essentially conventional, inasmuch as they are produced by lines, and there are no lines in nature. There does not appear to be any evidence to show that the earlier nations, such as the Babylonians, Assyrians, or Egyptians, had any knowledge of the fuller expression of form by means of the gradation of shade. We find them outlining their forms, and almost invariably in profile; then filling up the forms with flat tints of colour. Thus, until the time of the Greeks, the whole civilised world seems to have been satisfied with the impression of form only by outlines and flat tints.



CHAPTER VII.

ON SKETCHING.

49. THE first great mistake which young students in Art make, is in not taking sufficient time to place accurately the points which determine the principal parts of a drawing. Suppose a man were about to build a house, the first thing he would do would be to plot out the ground-plan most carefully and accurately; otherwise all his house would be wrong. And when building, he would first secure the corners, testing them with the plumb-line and square before proceeding with the walls. So, in drawing, very much time, and error, and rubber, and patience, would be saved if young persons would only be persuaded to be sufficiently careful in plotting out, or fixing accurately, the chief lines and points in a drawing.

This can only be done by a constant use of right angles, real or imaginary, and by what is known as 'blocking in.' If the work to be copied be of the nature of scrolls (as in Fig. 5) or of leaves (as in Fig. 40), then straight lines should be used in every available part. This is shown by the lines, *a, a*, &c. (Fig. 18). This plan of using right angles, and of 'blocking in,' is very useful when drawing from casts, as well as from the flat.

Ordinarily it is best to commence near the middle of the drawing, with some leading line or object, and then to work to the right and left. The exact centre of a picture is

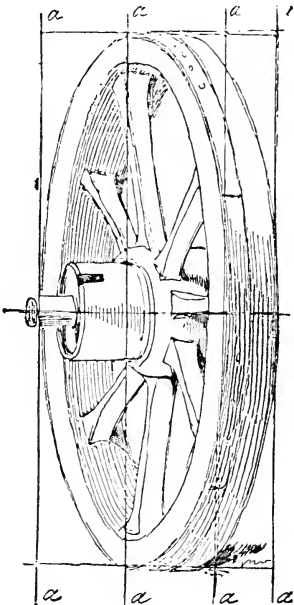

FIG. 18.

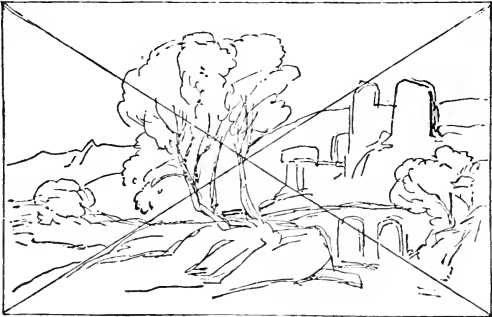

FIG. 19.

readily found by drawing diagonal lines from corner to corner of the paper, as in Fig. 19.

50. If it should happen that there are no important lines near the centre of the drawing, as in the woodcut (Fig. 20), then the principal horizontal lines should first be drawn, and the chief objects sketched in upon them. Never until the work is accurately laid in should the details be added.

Fig. 21 affords an example of forms which it would be almost impossible to reproduce accurately without the aid of perpendicular lines, by which to judge of the various curved and inclined lines, both of figure and drapery.

51. In drawing the human figure, it is always better to use as much as possible straight lines, as at *a* in Fig. 22, and never dotted lines as at *b*. It is only by the juxtaposition of a straight line that we can fully and accurately judge of the value of a curved one.

52. When the subject to be sketched has a clear and keenly defined contour, the lines used should be drawn cleanly and firmly at once, as in the various perspective figures in this work; but when such objects as tree-stems, rustic figures, &c., have to be sketched, then, instead of a cold single line, several approximate lines may be used (as in Fig. 23, *a*), but never dotted lines (as at *b*).

Objects composed of curves, such as Gothic windows, arches, &c. (Fig. 24), may be readily drawn by first setting up a framework of straight lines, by which to determine the degrees of curvature.

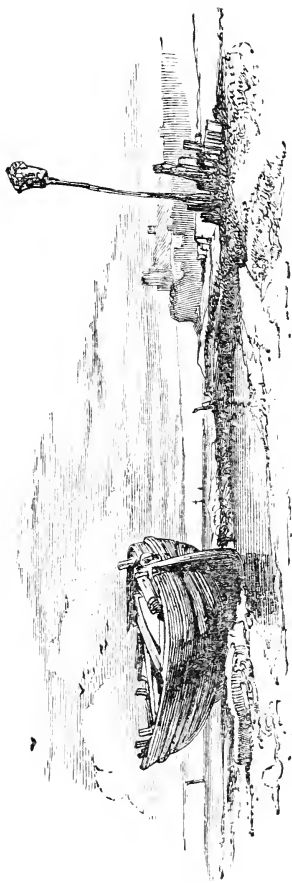

FIG. 20.



FIG. 21.

Showing the value of contrasting straight lines with curved ones.

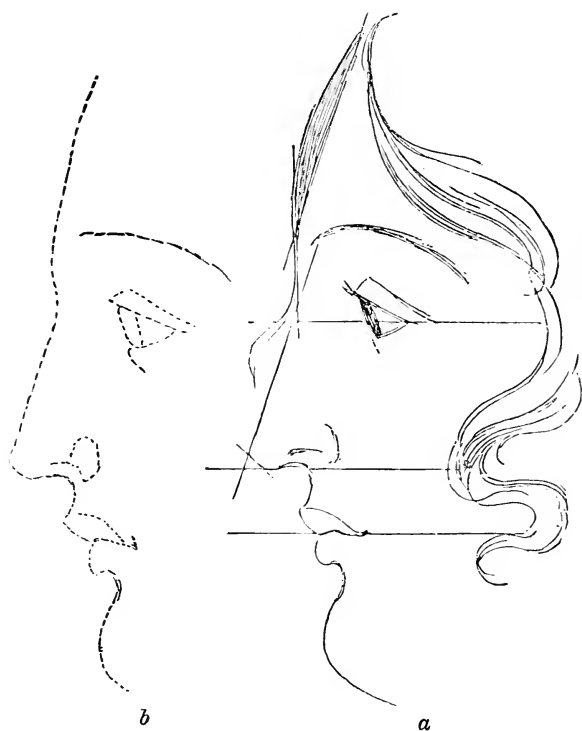

FIG. 22.

Faces should be drawn with straight lines, as at a ; never with dotted ones, as at b.



FIG. 23.

Tree-stems, especially when rough, may be sketched with several lines, as at a, but never with dotted ones, as at b.

53. The reason why in some cases a single line should be used, and in other cases several lines, is, that the eye inevitably follows a single and rigid line ; but where there are several lines, the eye rests on the surface included by them, as it does in nature ; the form is understood, and some idea is obtained of the texture and character of the surface.

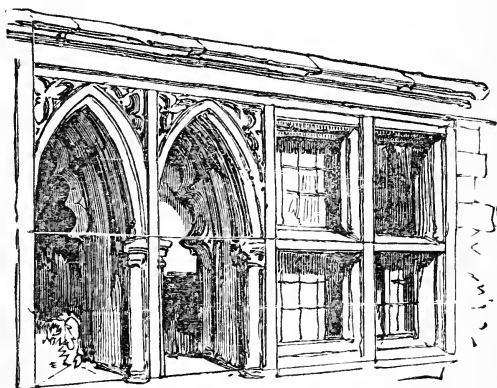

FIG. 24.

54. Any mechanical aids that may have been used in obtaining an accurate form should be cleanly removed before any shading is added, and the sketch or outline itself should be reduced to such faintness as not to interfere or obtrude itself in the completing of the work.

55. Although these remarks have reference principally to sketching from flat copies, they apply also to drawing from the round, and from Nature.

CHAPTER VIII.

ON LIGHT AND SHADE.

56. 'LIGHT AND SHADE' in Art should be considered as the means of modelling the surface confined by contour ; for *outline* is to *contour* what 'light and shade' is to surface—the outline leaves an object superficial, the 'light and shade' makes it solid ; and roundness and projection are the natural outcome of 'light and shade,' which takes away the appearance of flatness of the surface on which the drawing is made. It is nevertheless true that this modelling of a surface may be strongly indicated by lines only, but never fully expressed without 'light and shade ;' and in nature we are largely dependent on the same means for our knowledge of the projection of one thing from another, as, for instance, of the nose from the face, or of the forehead over the eyes. We become conscious of the wrinkles or creases in a face or on a piece of paper only as they may be revealed by the light and shade that is on them.

57. Before treating of light and shade as applied to Art, it may be desirable to state a few facts with reference to light and its action on bodies in various circumstances.

58. Light is defined as an imponderable agent which makes objects perceptible to the sense of sight, but the particles of which are separately invisible. Thus, although we

see things by means of light, we cannot see the light itself. If an object be placed before the eyes, and there be no light, it is of course invisible ; but if a ray, or a number of rays of light, fall upon the object, they are instantly broken by it, and partly absorbed and partly reflected in all directions. Some of these reflected portions entering the eye reveal to us the object, or, in other words, we can then see it. Whether the object is very light or dark will depend upon its nature, and the number of rays which it absorbs into itself, or which it reflects into the eye. Some objects have the power of absorbing many and reflecting few rays, as will be shortly seen.

59. It must be remembered, however, that in drawing and painting, our highest light, which is white paper or white paint, is very much darker (less light) than white *light*, as may be seen by holding a piece of whitest paper in juxtaposition with the blue sky, or even a grey cloud ; and this is one reason why in Art we cannot compete with either the tender gradations or the scope or range of Nature, from her highest light to her deepest dark.

60. When any part or plane of an object is so placed that an equal number of rays are thrown from each part of that plane into the eye, it will appear equally light ; but when the object is so placed as to reflect fewer rays from one part than from another, there is gradation of light into shade ; and although shade may be generally defined as absence of light, yet, as there are degrees of light, so there are degrees of shade.

This will be better understood by reference to Fig. 25. Let a, b, c, d, e , represent equal spaces or planes on any object. Illumined from $*$, it is evident that as more rays fall on $a b$ than on $b c$, this latter plane, $b c$, will be less light

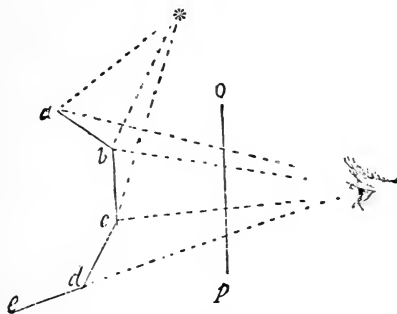

FIG. 25.

than $a b$. Further, as $c d$ receives scarcely any rays it will appear very dark, and $d e$, receiving none, will be invisible or black.

61. An object may be *actually* very light or very dark, but it will only *appear* so to the spectator in proportion to the number and intensity of the rays received on the retina. The quantity of rays that could be reflected into the eye from these various planes is indicated on the vertical line, $o p$. It will be seen that as $c d$ receives no direct rays from $*$, it can throw into the eye only such rays as it may happen to receive from surrounding objects.

The illuminating of objects may be further illustrated

by the diagram below (Fig. 26), where the lines, *a a a*, represent rays of light, and *A B* and *C*, planes intercepting those rays. It will be apparent that as the plane, *C*, intercepts all the rays, it will be lightest; but as *B* is placed obliquely to the rays, it cannot be so light; whilst *A*, being in the direction of the line of rays, must necessarily be quite dark.

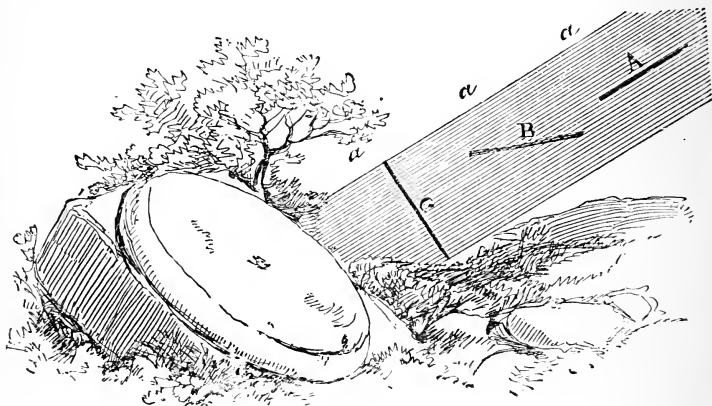

FIG. 26.

62. But there is another fact which must here be observed. When objects are not illumined from one point or focus alone, as the sun, but from surrounding objects, also, and from the particles of atmosphere, that secondary illumination is called reflection, and thus much visible shade is, in fact, but reflected light.

The atmosphere is seldom pure; even our bluest skies are said to be composed of infinitesimally small particles of matter, by which the rays of pure white light are broken.

Clouds formed of particles of vapour break and scatter the rays in all directions.

63. In some respects shade and shadow are one and the same ; for instance, they may both be defined as darkness, or absence of light, and they generally convey the idea of evenness — of an equal and unbroken tone of colour. Moreover, they both, however light or dark, have a degree of depth, transparency, and repose, which in Art should always be expressed.

As a matter of convenience in the practice of Art, and arising in part from its nature, it is desirable to divide this darkness, which we now speak of as shade, into shade, which is natural, and shadow, which is accidental.

64. All opaque objects receiving the light have some portion of their surface turned more or less away from the light, and have therefore an inseparable darkness. This is termed *natural shade*. But when the darkness is caused by an object intervening between the light and some other object it is called *accidental shadow*. For instance, in Fig. 27 you will see the accidental shadow of the hoop on the jar. This would of course be moved on removing the hoop, whilst the shade natural to the jar would remain.

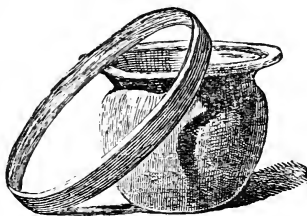

FIG. 27.

65. There is another term used in connexion with this subject which is very important, and but for which all

shades and shadows would be absolutely black: it is *Reflection*, which has been already referred to above.

By Reflection, then, is meant simply light thrown back from one object on to another. ✓

The strength of Reflection varies greatly, according to circumstances, but in some degree it is almost always present.

White and polished surfaces reflect the most, whilst dark and opaque ones, such as black cloth, &c., throw back but little light. Even particles of matter floating in the atmosphere receive and throw off rays, and by these rays from all sides the parts of objects turned away from direct illumination are rendered visible.

As rays of light from illuminated surfaces are thrown off in straight lines in all directions, whether as direct or reflected rays, the position and proximity of objects to each other is very important in Art.

Generally, the greater the light is the stronger the reflections are, and, consequently, all shades affected by these reflections will be lighter.

This is a very important truth, and is so often lost sight of by young students that a few words of further explanation may not be out of place, and as no knowledge is better retained than that which is experimental, the student may gain experience in the following manner.

66. Get several pieces of white cardboard, say six or eight inches long, and as many inches wide, and cut them half through, so that they will fold and stand upright

(something like Figs. 28 and 29), and let one of them so stand on any *white* surface, as a sheet of white paper, and if possible in sunlight. Let another be placed in like manner on a *dark* surface, as a dark table-cover. Now make a comparison of the two, and it will be found that in the first case (Fig. 28) the lower part of the shaded side is much lighter than the upper part, because many of the rays of light from the white paper are thrown back or reflected

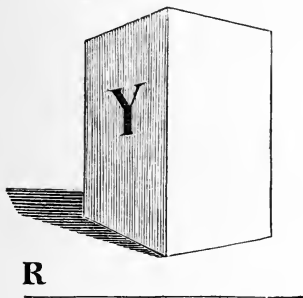

FIG. 28.

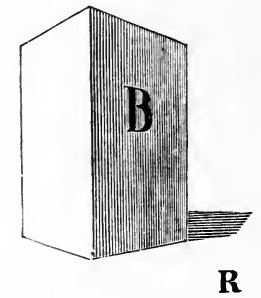

FIG. 29.

against it; whilst in the other case (Fig. 29) little or no perceptible change takes place, because the dark cloth, instead of reflecting the light, absorbs it. Except for reflection, the shade side of objects would inevitably be black—in fact, invisible.

67. If the student will now make the experiment with coloured surfaces, he will learn more fully the universality of these laws. Let *Y* (Fig. 28) represent the cardboard coloured, say Yellow, and *R*, the surface on which it stands,

coloured Red, and as before let it be placed in sunlight. It will be observed that the lower part of the shaded side, γ , is now of an Orange hue, because some of the Red is thrown back or reflected into the Yellow.

If, as in Fig. 29, the cardboard is coloured Blue, and the surface on which it stands Red, then the lower part of B will appear of a Purple hue: and so on, according to the colours and the nature of the material used, *ad infinitum*.*

68. It has been observed that substances vary greatly in their power of reflection. When rays of light fall upon an object, some of them are absorbed by the object, and the remainder are reflected in all directions.† It is these reflected rays thrown on the retina that enable us to see objects. This absorption of light takes place in all bodies more or less, and even water, when very deep, will almost completely absorb rays of light in certain degrees of incidence, and appear black. The difference between the highest known transparency and the deepest opacity (say, pitch or tar) is one of degree merely.

* The laws of reflection of colour, here referred to, apply only to *pigments*, and not to pure light, where some singular phenomena present themselves. For instance, Helmholtz has shown that Yellow and Blue rays thrown together into each other produce White light. In painting, however, we mix Blue and Yellow *substances* to produce Green.

† At a perpendicular incidence water reflects only 18 rays out of every 1000. When the rays strike the water obliquely, the reflection is increased. At an incidence of 40° , for example, water reflects 22 rays; at 60° it reflects 65 rays; at 80° , 333 rays; while at an angle of $89\frac{1}{2}^\circ$, where the light almost grazes the surface, it reflects 721 rays out of every 1000.—*Vide* Tyndall on *Light*, 2nd ed. p. 17.

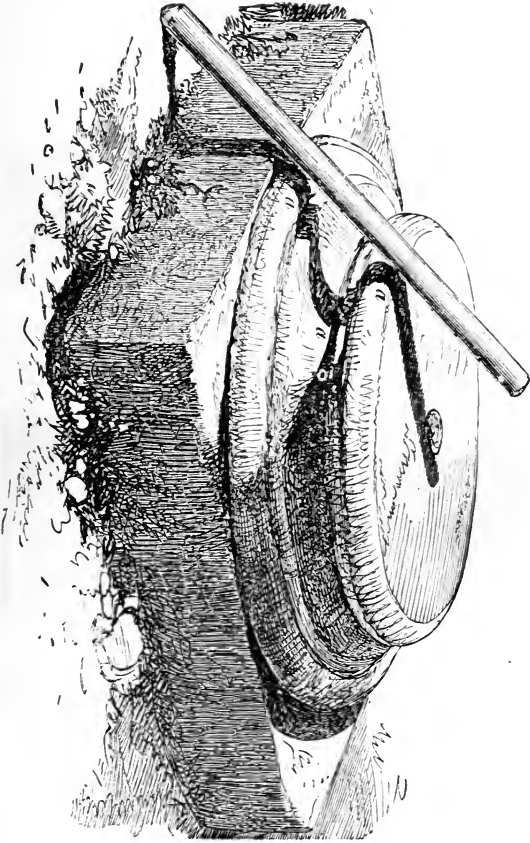
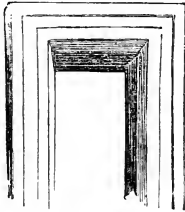

Fig. 30.

It will be evident, then, that if in Nature these laws are invariable and ever present, we can only hope for success in our efforts in proportion as we express them in our work.

69. We have said that when an object is interposed



Ex. 2.

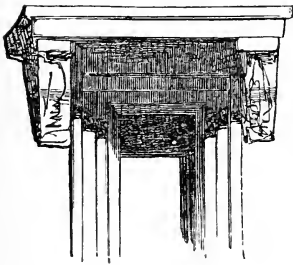
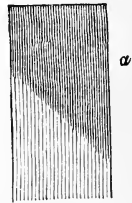

Ex. 1.

FIG. 31.

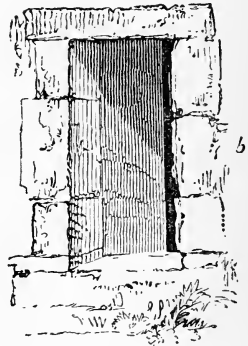

FIG. 31 a.

between the light and another object, the darkness so caused is called accidental shadow (see ¶ 64). *Shadow* does not usually reveal so much the shape of the object casting it as the shape of the *surface on which it falls*, as may be seen in Fig. 30, where the straight stick casts an

irregular shadow, according to the shape of the surface. Also, in the doorways (Fig. 31), the framework of both is the same in appearance, until, as in Ex. 1, a shadow is cast which at once reveals to us the depth or retirement of some portions of the mouldings. Usually the darkest part of a cast shadow is close to the object casting it. Fig. 31 *a* shows in a simple manner how the comparatively flat shade and shadow, *a*, may be made into a retiring space by the addition of a few accessories, as in *b*. Not only does a cast shadow reveal the surface over which

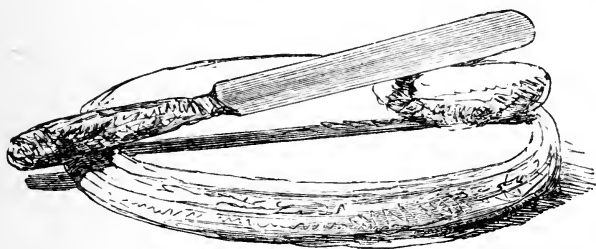

FIG. 32.

it passes, but it is *usually* well defined at the edges, as well as darkest immediately next to the object casting it. Evidence of this may be seen in the wooden platter and knife (Fig. 32). Sometimes, however, when the object casting the shadow stands away from the surface on which the shadow falls, the *edge* of the shadow is darkest, as at *a* in Fig. 33, where the shadow at *a a* is darkest at the bottom.

70. Shadows are ordinarily darker than shades, especially in sunlight and under a clear sky, and for this reason :

—Light passes through *pure* air invisibly ;* but if there be particles, as of dust, or of water in suspension (cloud or vapour), these particles, receiving the rays, scatter them in all directions, and some falling on the shadow prevent it from being absolutely black.



FIG. 33.

71. When, however, the light is not bright, and there are clouds breaking up and scattering the rays they have not absorbed, the shaded parts of objects will be dull, and the shadow from them undefined.

* This may be readily shown thus :—In a room totally dark, bore a small hole in the shutter, so as to let in light *from the sun*. The beam of light will be invisible. Now cause a little dust, or smoke, or vapour from a kettle, to rise, and the beam of light will instantly become visible.

When the local colour of the objects is dark, and unreflective or absorbent of rays, these laws are not so apparent, and it is for this reason that white or light models are the best for students to work from.

72. The attention should now be drawn to another very important property of shade—its gradation on round

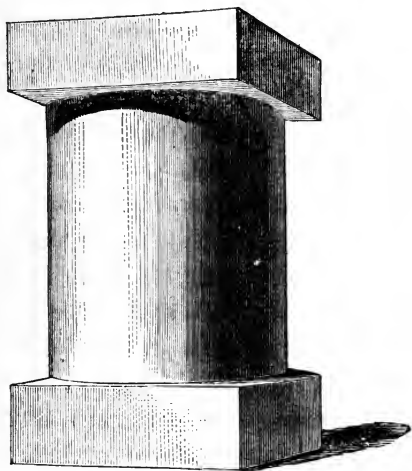

FIG. 34.

objects. We have already said that in all cases shade should be perfectly even and free from spottiness. This fact applies to shade under all circumstances, on round as on flat surfaces. The simplest form on which gradation can be seen is on a cylinder, such as the pillar (Fig. 34), or on a roll of white paper, where the gradation is in one direction only. If you have a sphere, such as an india-rubber

ball, you will see that the shade graduates in all directions, but regularly; whilst on an egg, or on the parts of a face, the gradation is much more complex.

The great aim in the working of graduated shade, however, should be to keep it not only even, but *tender*, for all fine work is delicate, and it is better to sacrifice some of the roundness of appearance than the delicacy of work. The shade on an egg is actually inimitable. The shading on the pedestal in Fig. 34 must not on any account be taken as an *example*—it is quite too imperfect.

73. There is one more property in the use of *cast* shadows which may be briefly noted, namely, that they tell us the direction from which the light comes, and often the location of the object which casts the shadow. It is evident, for instance, that in Fig. 34 the light falls from the left-hand side, because the shadow on the ground from the pillar is on the right-hand side. If the shadow from an object assumes the shape of a cone, we infer that the illuminating body is wide in proportion; but if the shadow diverges as it leaves the object, we conclude that the light is small in proportion—as it might be of a candle.

74. The student may illustrate this for himself in the following experimental manner, by means of a bat's-wing flame, or by a flat paraffine flame. Let any object *narrower* than the width of the *flat* side of the flame be placed so as to cast a shadow on to a piece of paper on the table; it will be seen that it assumes the shape of a cone, and that its edge is somewhat softened. When the *edge* of the flame is turned towards the object, the shadow is sharp and clear,

and if the object be wider than the flame, the shadow will form a divergent cone.

75. In most of the illustrations given it will be observed that the shadow touches the object that casts it, and thus indicates that it is on the ground. In the two following illustrations (Figs. 35 and 36) the two pairs of feet are

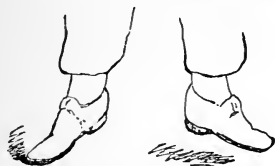

FIG. 35.

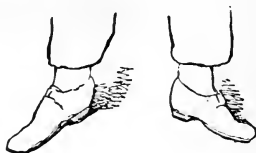

FIG. 36.

precisely the same, but by the shadows which they cast they are made to appear different.

76. Although there are no lines in Nature, it is often necessary to use them in expressing shade in drawing. These lines, however, should always be used in the direction of the surface they are intended to express : never as in Fig. 37, but as in Fig. 38 ; or even better, Fig. 39.

SUMMARY.

77. This chapter on Light and Shade is so important that it may be desirable to give a summary of it.

78. Solidity, roundness, and projection, are the natural outcome of light and shade, and we are greatly dependent on it for our knowledge of projection.

79. Light is an imponderable, invisible agent by which we see objects.

80. Light is in itself invisible, but becomes visible as it impinges on anything.

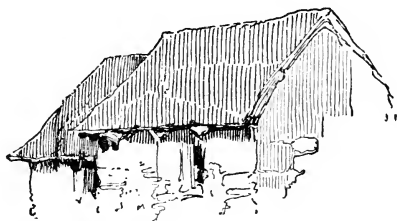

FIG. 37.

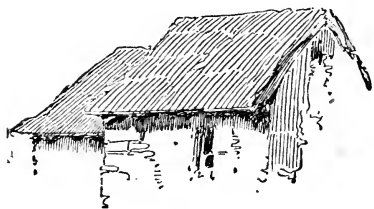

FIG. 38.

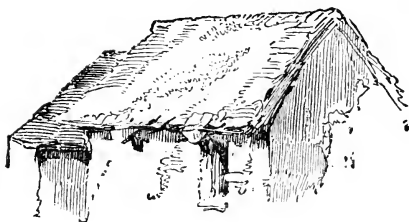

FIG. 39.

81. We see objects by means of the rays of light which are reflected from them into the eye.

82. Objects *are* light or dark in proportion as they absorb many or few rays, and they *appear* light or dark according to the number of rays they reflect into the eye.

83. Few objects appear quite black on their shaded side, owing to light being thrown upon them from surrounding objects or from the atmosphere.

84. Shade may be defined as absence of light in various degrees.

85. For convenience we divide shade into *natural shade* and *accidental shadow*.

86. Reflection is light thrown back on to an object from its surroundings.

87. The laws appertaining to ordinary white light apply also to its component parts—blue, red, yellow, &c.

88. Experimental results with prismatic colours and with pigment colours differ very much.

89. The difference between the highest known transparency and the densest opacity is said to be one of degree only.

90. Shadows usually reveal the surfaces on which they fall more than the shapes which cast them.

91. Shadows are ordinarily clearly defined at their edges, and darkest close to the objects casting them.

92. Graduated shade conveys the idea of roundness, and the simplest form of it may be seen in the cylinder, where the gradation is in one direction only.

93. In shading objects, tenderness and delicacy of work should be aimed at rather than darkness.

94. Shadows indicate the direction from which the

light falls on an object; and not unfrequently the size of the light, whether great or small, in comparison with the object.

95. Shadows often to some extent locate the objects casting them, by showing that they touch a surface, or that they are removed from it.

96. When the light on an object is strong or bright, the shades light (showing much reflection), and the shadows clear, the idea of sunlight is conveyed.

97. We have hitherto spoken of light and shade only as applied to *objects*. Its application to, and uses in a picture, must be briefly treated in another chapter.

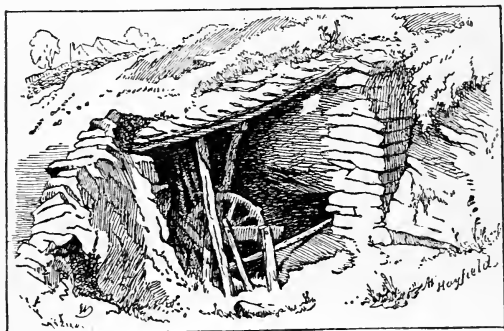

CHAPTER IX.

ON DRAWING FROM FLAT COPIES.

98. FEW departments of education seem to have been more entirely misunderstood than Drawing, and the practice of teaching it. By some it is thought that if good examples, whether of heads or landscapes, are provided, and the student has only patience enough to make a good copy, all is well. Now we do not deny that there are advantages to be derived from careful copying, but it should not for a moment be supposed that this alone is Art education. We have elsewhere said that the study of Art is twofold, a science and an art—a science to be known, and an art to be practised. But the two must operate in combination with each other. A language is not learned by merely copying its alphabetical characters, however skilfully, but by obtaining such a knowledge of its grammar as will enable the student to understand its structure and apply its rules. Few things can be more mischievous to a beginner than setting him to copy heads, such as Julien's, or landscapes, such as Hubert's, and especially such as those bearing the name of Razé. Even the copying of Harding's trees, without attending to the instructions contained in the text, can be of little advantage. The usual result of such a practice with thoughtless and stupid persons is idle deception, inasmuch as they

imagine that they have done something worthy or creditable ; whilst with intelligent and inquiring minds it soon ends in disgust, for, although they are unable to devise a better way, they are conscious of the worthlessness of this as a means of real development.

99. It may be inquired, then, Ought flat copies to be used at all?—and, if so, what kind should they be, and how ought they to be used? We reply, that much advantage may be gained by copying good examples *rightly*. We do not say merely correctly, but rightly ; not by the slavish and laborious imitation of an example, stroke for stroke and point for point, but by the honest carrying out of the *intentions* and spirit or *motive* of the example. Let it ever be remembered that really conscientious effort is as important in Art as in other studies, and its neglect can only tend towards moral delinquency.

100. The Department of Science and Art has issued an almost exhaustless series of outline studies—some of them very graceful—the copying of which affords excellent exercise for eye and hand, and is best suited to intending designers : this, in fact, was their original purpose.

On the other hand, busy publishers have issued an endless mass of lithographic examples, in landscapes, in heads, in flowers, &c., which seem generally to have been prepared more with a view to effect than truth. However these may be regarded by the student, he cannot do wrong in adopting a course that will *educate* his faculties in all that appertains to truth and beauty. It is proposed to sketch such a course here.

CHAPTER X.

SUGGESTIONS FOR A COURSE OF STUDY.

101. IN laying out a course of exercises for the student, it will be perceived that all his faculties will be called into use:—

- (A.) The eye to see contour or outline truly, and the hand to trace accurately what the eye sees.
- (B.) The mind to perceive delicate, even, and subtly varying shade, and the hand to produce it with a point—pen, pencil, or brush.
- (C.) The mind to distinguish the *appearances* of things, and the hand to sketch them from nature.
- (D.) The mind to learn the essential characteristics of things.
- (E.) The judgment to have regard more to the *purpose* of doing (viz. improvement) than to what is done (the drawing).

(A.) Taking this proposed course in detail, we find flat outline resolving itself into—

1. Rectangular figures, such as squares, parallelograms, &c.
2. Curvilinear symmetrical forms.
3. Mixed or compound forms.
4. Natural objects that are flat, such as leaves, and flat copies of objects.

102. In this course it is not to be understood that the entire stage of outline drawing must be completed before beginning the shading exercises or the sketching from objects. All three may be prosecuted simultaneously with advantage.

103. Outline is the simplest means by which form may be suggested or represented, and as an exercise it is best to practise it from outline drawings or from *flat* models. If a student can draw a square and an oblong (parallelogram) accurately, he may proceed at once to symmetrical and curvilinear forms, such as Fig. 40 (*a* and *b*), only much larger.

104. The order of procedure in which such outline drawings should be executed is as follows:—

1. ‘*Block in*’ the general shape, deciding upon the proportions.

2. Draw all the parts definitely.

3. Rub down all the lines with a piece of bread till they are only just visible, and then make the *true* outline, delicately but clearly.

105. To ‘*block in*’ the general shape, the student should proceed much as a sculptor would in preparing his marble; first hewing out the form roughly, and, in the sculptor’s case, rather larger than will be ultimately required, but *always securing the correct general proportions*, and afterwards completing it. In Fig. 40, *a*, half the figure is left, only ‘*blocked in*.’

This method of working is very useful when enlarging or reducing a drawing. In enlarging or reducing always ob-

observe the *proportions* of the copy by dividing it into halves, quarters, or thirds; then 'block in' these quantities of such size as may be determined upon. (See Fig. 40, *b*.)

106. The 'blocking in' need not be done with long curved lines, but with shorter straight ones—truth of quantity and form being the principal aim; but afterwards,

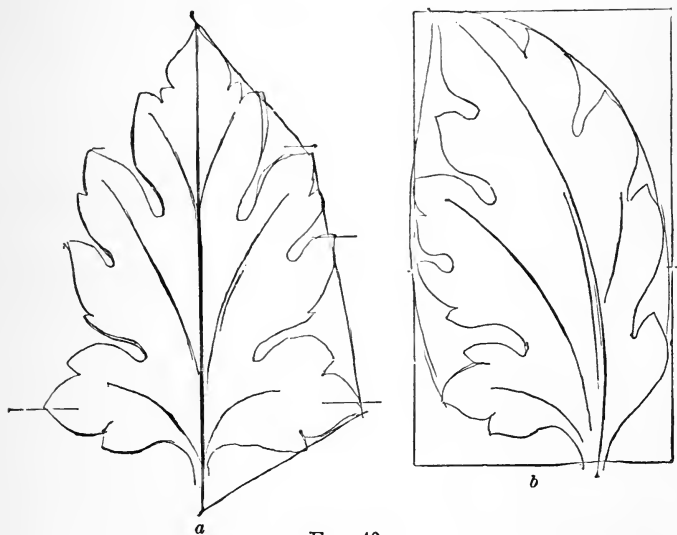

FIG. 40.

when the whole has been subdued with bread and made almost invisible, the pencil should be passed several times over a considerable part of any line *without touching it*, so as to get the hand into an easy and ready position for drawing with neatness and precision the final line. There should be no gradation or expression; all should be *equal* in

depth and regular in appearance. But when copying projecting objects, such as boxes, boats, &c., from flat examples, squares should be used as guides, and varying emphasis may be given to assist in making some parts retire and others stand forward (as in Fig. 41).

When an example is copied the same size as the original, it is a good plan to test its accuracy by means of tracing-paper. This, however, should never be done till the copy is carefully made.

(B.) *The 'mind to perceive,' &c.*

107. The power to see and feel delicately is as important in shading as it is in form, and is the first step towards real success.

The student may begin first with a small piece of equal or flat shading, enclosed in an oblong of, say, one inch by one and a half. This enclosed space may be filled with equal shade in various ways. If the lead pencil be used, the space may be first filled with long, *soft* (never hard or wiry), parallel lines or bars, nearly touching each other, and afterwards the interspaces filled evenly up with a *finely-pointed* pencil. If a pen or the point of a brush is to be used, the work should be what is technically called '*cross-hatched*,' that is, short lines in one direction are crossed with short lines in another direction; but as lines crossing at great angles

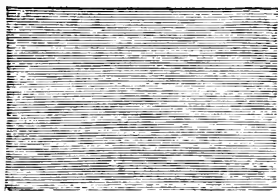
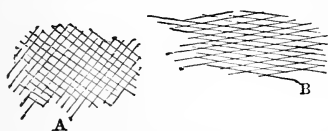

FIG. 41.



produce contrast, the angles formed by the lines should be very acute, as at B, and never as at A. When this



cross-hatching is quite dry the lines may be again crossed, till all the light spaces are filled, and the

whole area made perfectly even.

Sometimes, when the pencil is the instrument to be used, and the paper has sufficient texture or grain on its surface, a faint flat shade is laid over the whole space with a *stump*, made of leather or of paper, and then the work is completed with the point of pencil or chalk.*

108. *On correcting errors.*—In this shade exercise the student may find that some parts will require amending; for each exercise should be worked at till *quite even*. Suppose some part is too dark or spotty, the dark part should be touched gently with a crumb of bread rolled into a shape like— or, if this should fail error, a small hole should be cut in a piece of stiff paper and laid on the drawing; then the offending dark part may be removed with bread or artists' gum (india rubber), and the light thus made stippled up to the required shade. In pen-work the knife must be used for scraping down any dark patches.

109. *Gradation.*—The second exercise in shading is

* This latter mode has been introduced into the Schools of Art throughout the country by the newly-appointed and energetic Art Director, Mr. Poynter, R.A.

similar to the first, but more difficult : for an oblong must be filled in with a perfectly even but graduated tint, the change from light at one end to dark at the other being *by imperceptible degrees*, like the shade on a chalk cylinder or on an egg.

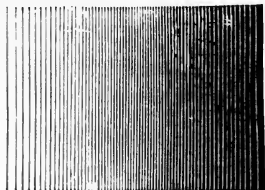

The power of graduating delicately is very important, and should be practised again and again till perfect mastery is obtained,—once obtained, however, the student may know that he has made real progress.

When the stump is used in graduating a surface, it is best to proceed as follows :—First, lay a perfectly flat, even, light tint, over the parts requiring shading, and afterwards proceed to lay in the darker parts, so tenderly as not to be easily perceptible. Never, when shading light objects, such as china, eggs, plaster casts, &c., make the shades dark, but always light and tender. All good work is *delicate*, though not feeble. .

(c.) ‘*The mind to distinguish,*’ &c.

110. If the student has read the Introduction to this volume, he will have learnt that very few persons can see at all truly, and that this is no fault of the eye, but of early training. It would be well if he would now read again the remarks ‘*On the Eye*’ and ‘*On Seeing.*’ (Chaps. I. and III.)

111. It is evident that no representation of an object

on paper can appear quite the same as the original does ; for in nature the image of the object is presented to the mind from two points of vision, represented by the two eyes, and is really a blended image of two views. This, of course, cannot be put down on paper,* for *Art recognises only one eye*. It is, therefore, better for the student at first, when sketching the outline of any form, to use only one eye, and to treat the object as though it were perfectly flat. Some students find it a help to imagine a piece of glass placed in front of them, and the contours of objects traced on the glass. For students who have much difficulty in seeing things as they appear, the 'Diascope' (see Appendix), or a piece of glass with squares ruled on it, will be of great service.

112. It is in this stage of his work that the student will feel the disadvantage of not having drawn *from objects* in his childhood ; and every opportunity of sketching objects should now be seized, not so much in making set and formal studies, as in jotting down very frequently the shape of anything about him, and on any paper that happens to be conveniently at hand. A common, cheap pocket sketch-book, carried in the pocket ready for use, will be convenient.

113. As to systematic work, it is best to go through a regular course of *object drawing*, making such application of perspective rules as artists do ; an explanation of which will be found under the head of 'Artistic Perspective' in the present work.

* This is seen in the Stereoscope.

We may, however, here state, for the benefit of beginners, a few facts in connexion with the appearances of some simple elementary forms.

If a square sheet of paper or cardboard be held in front of the face and parallel to it, the actual shape of the square will be seen (Fig. 42); but if it be laid on the table, still keeping one edge of the paper parallel to the spectator, it will appear foreshortened



FIG. 43.

(Fig. 43). If it be raised a little from the table, keeping it quite

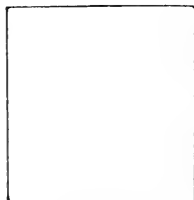

FIG. 42.

horizontal, the figure will appear narrower and narrower, as at *a* (Fig. 44), until it is raised to the level of the eye,

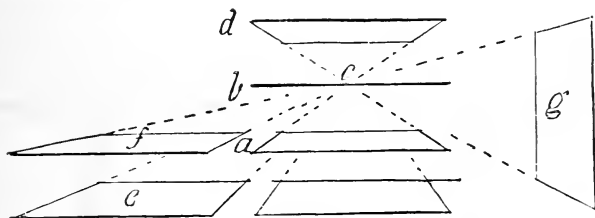

FIG. 44.

when the square is lost in a line, as at *b*. Raising it higher, it assumes the shape seen at *d*. If the retiring side lines of each square be continued or 'produced,' they will all appear to converge towards a point in the centre of the line, *c*, exactly opposite the eye of the spectator. This is parallel perspective.

114. If we now place a square piece of cardboard on each side of the first one, and *still parallel to the spectator*, we shall find a similar result, as shown at *e* and *f*, where all the receding lines appear to converge towards the point opposite the spectator's eye, which in parallel perspective is called the vanishing point, and usually marked v. p. Of course, the same remark would apply to the circle, if placed in any of the squares.

115. If the square cardboard be placed with one edge on the table, and exactly opposite the spectator, and its plane vertical, the sides will not be visible, and it will have to be represented by a vertical line. If, keeping it in the same direction exactly, it be moved a little to the right hand or to the left, the plane becomes again visible, as shown at *g* in Fig. 44; the retiring lines converging towards the v. p. (vanishing point) opposite the eye.

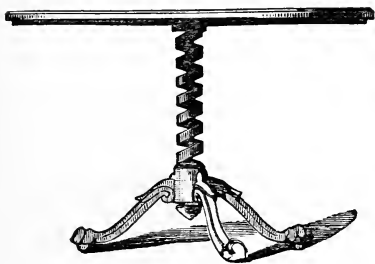

FIG. 45.

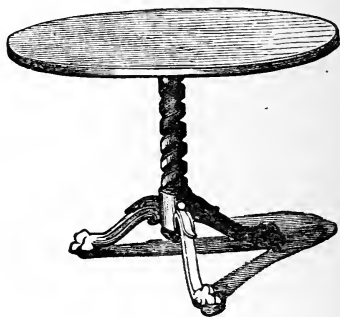

FIG. 46.

116. We have a similar result of foreshortening in the two views of the round table (Figs. 45 and 46),

and in the four retiring planes of the transparent cube (Fig. 47).

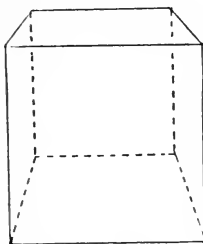

FIG. 47:

117. Now let the square cardboard be laid on the table, with one corner towards the spectator: the appearance will be as seen in Fig. 48. As the cardboard is raised

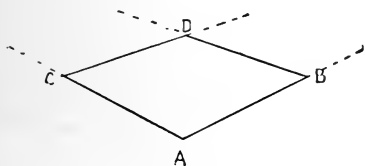

FIG. 48.

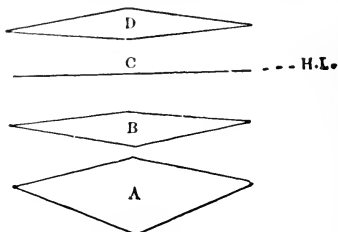

FIG. 49.

more nearly to the level of the eye (still keeping it horizontal), it will appear narrower (as A, Fig. 49). Raising it almost to the level of the eye, it assumes a shape as at B; and finally, when it is exactly level with the eye, the whole square is lost in the line, c, and forms part of the H. L. (horizontal line). If the card is raised above the eye little, its shape will appear as at D. It will be observed,

that in this view of the square the retiring lines go in two different directions, to the right and to the left, but that all those *lines which are parallel to each other recede to the same point*. This view of the square is called angular or oblique perspective.

118. In this instance the two outside corners are at the same distance from the spectator, and therefore on the same level. Further, if the retiring lines on each side be extended, they will meet on the level of the eye (H. L.), at the same distance on each side from the square.

Suppose, now, that the square cardboard be placed so that one outside corner is further from the spectator than the other, we shall have a result as follows (Fig. 50):—

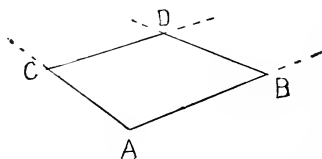

FIG. 50.

The corner, *c*, will be higher than *B*, and the line, *A C*, shorter than *A B*. The angle, *D*, is not over the nearest angle, *A*, and the receding lines, *A C* and *B D*, when continued, terminate on the 'H. L.' much nearer to the figure than do the lines *A B* and *C D*.

119. A few careful exercises drawn from the square cardboard, or from a square of wire, placed in various positions, will prepare the student for entering more fully into the drawing of cubical objects, such as boxes, chairs,

houses, &c., by rule, as shown in the chapter on 'Artistic Perspective.'

120. In drawing from objects the student should be careful not to alter his position when viewing his model, as, of course, it will appear different from each new point of view. Sometimes beginners use an 'eye-stand' (like Fig. 51), which is simply a strong upright wire on a stand, on which a piece of card slides up or down: a knitting-needle stuck into a pincushion, or into a block of wood, will do. In the card is a hole, through which to look at the object again and again without danger of changing the 'point of view.'

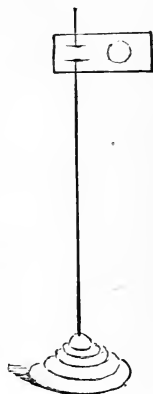

FIG. 51.

121. One of the principal difficulties that the beginner meets with in drawing from objects is in determining the apparent width of their *retiring* planes. Only experience will enable him to overcome these difficulties, though he may be greatly assisted by using the Diascope, or a piece of ruled glass before referred to. The most common mistake is in making retiring planes too wide, as in the chair-seat in Fig. 52, instead of like Fig. 53, which is more agreeable.

122. In drawing cylindrical forms, such as mugs, basins, &c., a frame-work should always be made, so as to keep the lower lines curved in relation to the upper lines. Such frame-work may be drawn as in Fig. 54, or as in Fig. 55. It is a good plan for the student to consider the

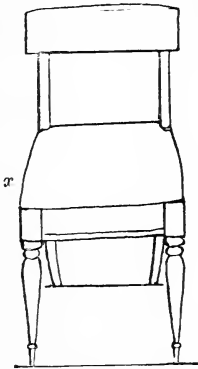

FIG. 52.

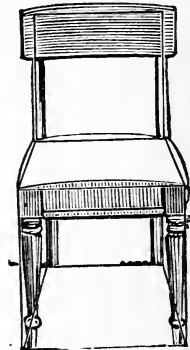

FIG. 53.

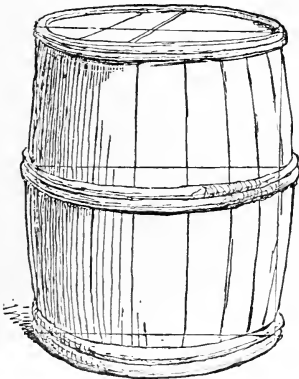

FIG. 54.

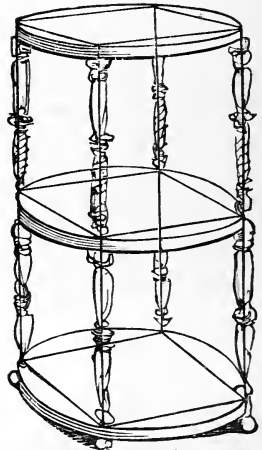

FIG. 55.

object as transparent, and draw it accordingly. The common error in drawing forms of this kind is shown in Fig. 56, at A, where the two outside vertical lines are longer

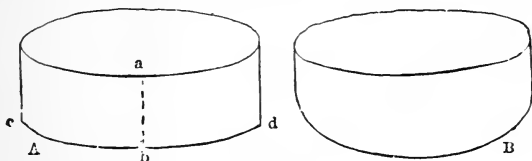

FIG. 56.

than the nearest line, ab , and where the lower curve terminates at each end in a sharp corner, cd .

123. The habit of imagining a plane of glass for the picture plane, between the spectator and the object, and viewing it only with one eye, will often greatly assist in ascertaining accurately either the inclination or the curve of a line.

124. The square, the cube, and the cylinder, form the basis for drawing most other regular forms, and should, therefore, be carefully studied and well mastered before attempting irregular and intricate objects. When the student has gone through this course conscientiously, he will be fitted to proceed to the study of any special department of Art, as landscape, figures, &c.

(D.) *'The mind to learn,' &c.*

125. Another stage in this course will be to gain the habit of so looking at natural objects as to be impressed with those properties or qualities about them by which they are most clearly distinguished from other objects and

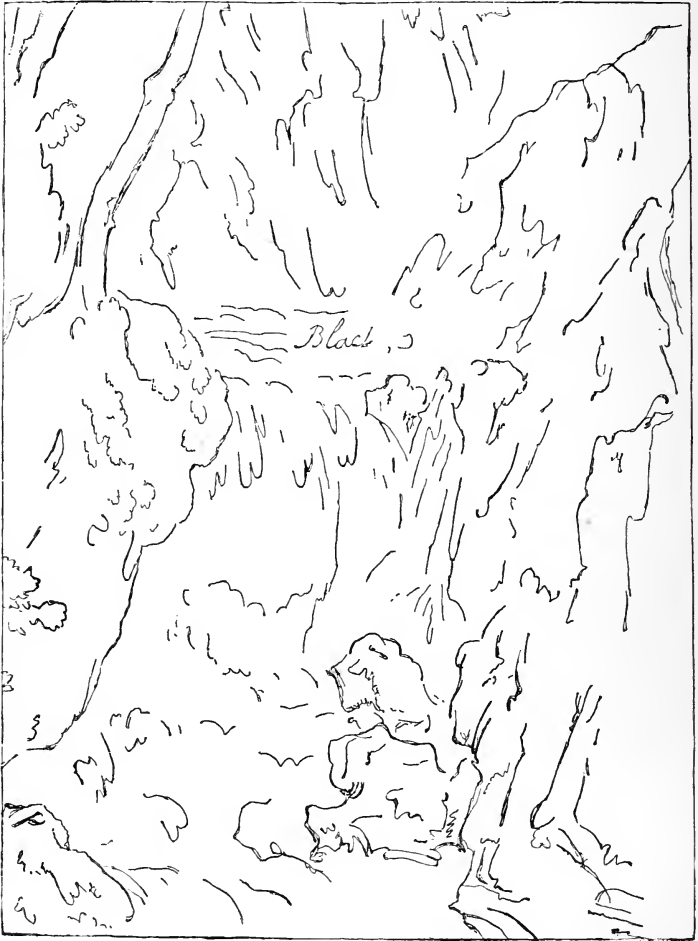
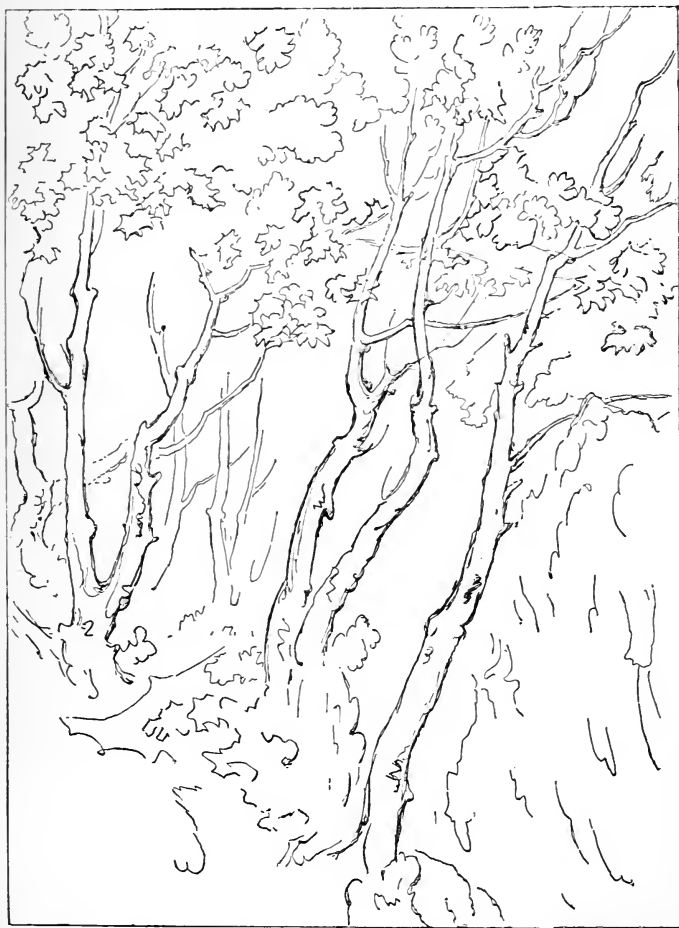

FIG. 57.



After J. M. W. T.

FIG. 58.

from one another. In a simple way this is explained at some length in Chaps. III. and XVI., 'On Observing Nature' and 'On Character.'

This habit is but another term for the power of seeing, which has been elsewhere spoken of. It should be begun in childhood, in what are known as 'object lessons,' and in some of the exercises of the 'Kindergarten' system. A student who has not had such advantages, nor the great advantage of watching others draw, may do much for himself by a few set exercises, both from drawings and from nature. Some good examples of what is here meant may be found in several of our comic serials, where the peculiarities which are strongly characteristic of a thing or of a person are slightly exaggerated, and which, though grotesque, have in them much truth.

126. The power of observing the essential characteristics of a place was one of Turner's most striking peculiarities. Wherever he went he was perpetually observing and sketching; and although some of his sketches were almost unintelligible to others, to himself they were full of meaning. A curious example of this (a Sunrise) is shown by Mr. Ruskin in *Modern Painters*.* The illustrations given in Figs. 57 and 58 are from a slight pencil-sketch of a Waterfall by Turner, in the possession of the author. They are as nearly as possible like the original as the mode of reproduction would allow, and bear evidence of the fact that he had a definite intention in every stroke of his pencil.

* Vol. v. p. 187.

(E.) ‘*The judgment to have,*’ &c.

127. The unreasonableness and impatience of ignorant persons, in expecting large results from small and brief exertions, have been most mischievous to those who have had to do with Art, whether as teachers or as students. A would-be amateur applies to a teacher for a few lessons, to enable him ‘just to dash off a few telling effects from nature with his brush. He has never drawn much, and does not care for the pencil; all he wants is just to be able to paint effectively and quickly.’ Now, in such a case as this, one of two things is certain—either that our would-be amateur must be wonderfully gifted, or that the teacher must be uncommonly stupid to have taken so many years to acquire that which is to be learned in a few lessons.

In all true artistic feeling, the *pursuit*, not the result, is the *reward*; for where Art is rightly pursued, it produces a continual satisfaction in the fact that, however slow, there is progress, and that progress is sure; and although the work done may have no mercantile value whatever, it may be regarded as the effort of an immortal mind striving to improve itself, and, therefore, precious.

128. After going through such a course as is here sketched out, the student will find that his eye and hand have been brought under strict discipline, his perceptions quickened, his feelings made sensitive, and his whole being brought into sympathy with truth and beauty in Nature and in Art. He is thus prepared to enter with confidence of success into any technical application of drawing, or is able to develop his faculties for still higher enjoyments in that outward manifestation of God which we call Nature.

CHAPTER XI.

ON CONTRAST.

129. CONTRAST and gradation in Art may be considered as almost opposite terms—the former revealing, and the latter concealing, many forms and facts. Contrast is exciting and irritating, whilst gradation is soothing and agreeable.

In order properly to understand contrast, the student would do well to make it an experimental inquiry.

130. If, at night, the upper portion of an open book be held vertically against the strong light of a lamp, and the rays from the lamp be allowed at the same time to enter the eye, the letters on the upper part of the book will be invisible, or nearly so, whilst the characters on the lower part of the page can be readily seen. The rays of light entering the eye, being so strong, cause the 'pupil' to be contracted, and the rays from the book are too feeble to render the letters visible.

131. The eye is similarly affected, but in a less degree, in the following diagram (Fig. 59).* Let A and A represent two pieces of paper, shaded with a perfectly even and equal tint. Let B and B likewise represent two similar pieces of paper, with a similar perfectly even and equal tint, only *darker* than A and A. Now let them be placed

* Chevreul on Colour.

as in the diagram, when it will be seen that the order of darkness will be as follows :—A 1 will appear the lightest ; A 2, darker ; B 3, darker still ; and B 4, by its juxtaposition to A 1, darkest of all.

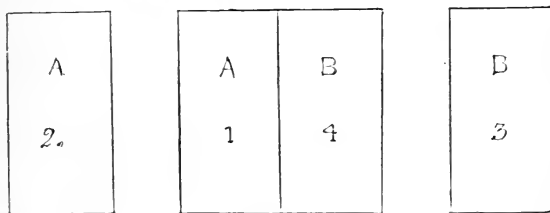

FIG. 59.

132. This force of contrast will be more strongly apparent in the following experiment, which, if made on a moderately large scale, may also be a good exercise for the student. Obtain a number of strips of paper, and let them be lettered, numbered, and cut into widths bearing a similar relation to those marked A, B, C, &c., in Fig. 60.

A	B	C	D	E	F	G	H	I
3	5	4	3	2	1	0	1	2

FIG. 60.

Let G remain clear. On all except G lay a perfectly flat wash of colour (say Sepia) ; now, on all except F, G, and H, lay another flat wash. On all except E, F, G, H, and I, lay a third. Lay a fourth wash on A, B, C, D ; a fifth on B and C ; and, lastly, a sixth on B.

Place these strips in juxtaposition quite neatly on a sheet of white paper or cardboard, and in the order here given. If rightly done they will, when viewed from a little distance, have the appearance of a fluted column.

133. The strongest contrast in Nature is of white against black and black against white, as may be seen in Fig. 61, where the white space in the centre of *b* looks

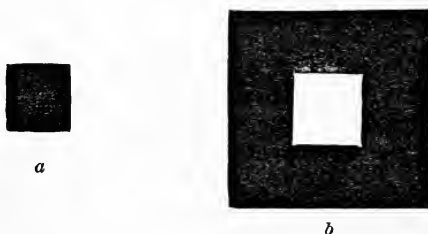

FIG. 61.

lighter than the surrounding paper, and *a* looks darker than it would if laid on a tinted or dark surface.

134. Contrast in Art, however, has a much wider significance than when applied to light and dark alone, and is powerfully felt in the opposition of colours, of objects, and of properties and qualities of things.

Fully to illustrate the contrasts of colour would require very many coloured diagrams, and extend far beyond the limits of this work.

The student may, however, assist himself by making experiments with various coloured pieces of paper or cardboard; and, if he wishes to pursue the subject further, may consult any of the following works:—Field's treatise on

Chromotography; Grammar of Ornament, by Owen Jones; *Principles and Practice of Art*, by J. D. Harding; or one of the many works on Decorative Art.



FIG. 62.

135. The *forms of objects* are contrasted with each other to make them mutually more strongly felt, as when a straight line is set against a curved one, or a square figure

against a round one. The value of this kind of contrast will be felt not only in the dancing figures (Fig. 62), but especially in many of the landscapes in the work. (See Composition, Chap. XXIV.)

136. The *properties* of various bodies are often set in contrast with each other in Art ; as, for instance, the soft, thick, round masses of moss on a roof of hard, square slates, or on a rock ; or a tender spray of leafage by a sturdy stem ; or a hard, flat wall.

137. Contrast in *size* is frequently used to enable us to judge of an unknown quantity by means of that of which the size is known and fixed. This may be seen in the arches on page 84. A portrait of Tom Thumb could only be correctly estimated by comparison with ordinary figures or objects, whose magnitude is known ; and in like manner the stoutness of Sancho is used to make the lanky length of Don Quixote more strongly felt.

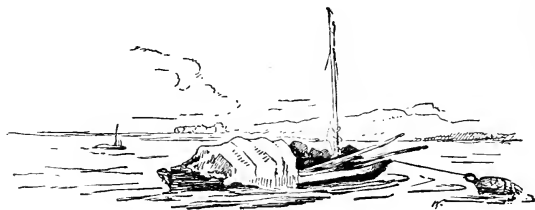

CHAPTER XII.

ON RELIEF.

138. BY the term '*relief*' is simply meant the separation of an object from that which is behind it; and in drawing it is obtained by making the edges of the shading perfectly even and clear, and not necessarily by contrasting strong dark against strong light.

139. In Nature we seldom see things in relief by violent contrast, but constantly by tender and varied, but clear opposition; by which we become so perfectly conscious of their shapes, and of their location in space, that the eye no longer voluntarily follows the outline. It is scarcely possible to trace the precise *contour* or limit of many objects, unless they be either superficial or strongly and equally light or dark throughout their entire surface.

140. The term '*relief*' is also used in relation to colour, where we say one colour is '*relieved*' or set against another; but we think it less legitimately belongs to drawing and painting than to sculpture, where one object is distinctly separated from another *in the solid*.

141. In sculpture proper, which has been well said to be '*an art which can conceal nothing,*' the figure is insulated, and stands quite clear of any background: it is sculpture in the round.

142. Other terms, such as '*basso relievo*' '*alto relievo,*'

and 'mezzo rilievo,' are commonly applied to any work of sculpture connected more or less with any plane surface or background. Basso—low or flat—relief has a very slight projection from the background. Alto relief, on the other hand, is not only rounded to the full bulk, but has generally some portions of the figure detached from the background. Mezzo relief—a style between the other two—though rounded to considerable bulk, has no part entirely unattached to the plain surface behind it.

143. The finest examples of these different kinds of relief, from various Greek temples, may be seen in the British Museum. The commonest examples of bas-relief is a coin—a penny, a shilling, or a sovereign.

144. The gates of the Baptistery of San Giovanni at Florence, known as the 'Ghiberti Gates,' show beautiful examples of relief, though the introduction of landscape is considered by many critics a misapplication. Our own Flaxman produced probably the finest relievos of modern date, of which his 'Shield of Achilles' is a notable example.

145. One of the clearest indications of excellence in the Grecian bas-reliefs is, doubtless, that in addition to the exquisiteness and perfection of work, the forms are so skilfully arranged as not to cast shadows that would interfere with their clear manifestation.

CHAPTER XIII.

ON SIZE.

146. MANY students puzzle themselves by not knowing how large to make a drawing or a sketch, and also by a confusion of the idea of size with that of proportion.

147. By *size* is meant merely magnitude : *proportion* is the relation which one thing bears to another.

148. The size of a sketch or drawing is to a great extent optional, though depending chiefly on the nature of the subject, and partly on the time at the disposal of the student as well as his power, and the ultimate purpose of the drawing. Let us suppose he wishes to represent the lamp on the table before him—it will be equally right to draw it any size, from one to six or eight inches ; but if the object be large, such as a house, an elephant, or a tree, then he must consider how it will be best placed on his paper, without being too little on the one hand, or too overwhelming on the other.

149. There are, however, some objects, such as fruit, flowers, &c., which should, when possible, be drawn the same size that they actually are in nature. Suppose we wish to draw a cluster of grapes, and we make them only the size of peas, there will be danger that at first sight they will be mistaken for currants. A hen's egg on a small scale might be mistaken for the egg of some smaller bird.

150. Objects in a drawing may be made to appear large or small by the juxtaposition of some other objects

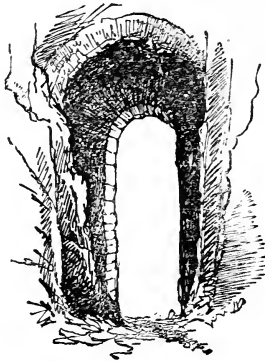

FIG. 63.



FIG. 64.



FIG. 65.

of *known size*. The mind instantly sets up a comparison, and judges the indefinite by the definite. In Fig. 63 is a sketch of an archway, of which we have no means of

knowing, even approximately, the size—it may be five, ten, or fifteen feet high. In Fig. 64 the same arch is given, but it is at once seen, by the figure passing through it, that it is probably about six feet high; whilst in Fig. 65 the same arch, by comparison with the figure, is judged to be about twenty feet high.

It is important when sketching from nature objects whose sizes may be variable, to sketch also something near, the size of which is always the same. In Fig. 65 a ladder would be sufficient to determine the height of the arch, without the figure, for the ‘rounds’ of a ladder are always about nine inches apart.

151. Many persons on visiting, for the first time, the mountains of Switzerland, are not deeply impressed with their magnitude, till by a process of inferential reasoning—comparing the tiny-looking chalets on them with their surroundings—it dawns on the mind that the mountains must be large. In like manner the magnitude of a grand mass of distant *cumuli* is scarcely perceived, except by a similar process of reasoning. It has been stated elsewhere that some of these masses reach an elevation of twenty thousand feet from the earth.

It is evident, then, that only by a process of reasoning can we make ourselves accurately acquainted with the size of many objects—the clock-face, tree, mountain, or moon.

CHAPTER XIV.

ON PROPORTION.

152. THE simple meaning of the term 'proportion' is the relation which one thing bears to another; but the application of the term in Art is both wide and varied.

There may be such a relation between the various parts of an object as to produce in the mind a consciousness of beauty, arising solely from the relation of parts to each other and to the whole, and quite independent of any function to be performed. An illustration of this is seen in the kaleidoscope, and in many kinds of ornament. In this case it is an appeal to the æsthetic faculty alone.

153. A second sense in which the term proportion may be used is when it is applied to the varied relations of parts or things to each other in view of something to be accomplished or done; as in a column to support a superincumbent weight, or a horse to draw a load, or an athlete to run a race. In this case the appeal is made not to the feelings, but to the intellectual faculties and the judgment.

154. An object may have fixed and unalterable proportions, as in the sides and angles of a square. In some cases the proportions are variable, as in the human figure, the proportions of which differ much, the male from the

female, and various male forms from each other, as the Discobolus, or the wrestler from the Athlete.*

In Architecture the various parts of a building should bear such a relation and adjustment of parts to each other and to the whole, as to produce on a pure and unbiassed mind a sense of agreeableness, satisfaction, and rest.

155. The diameter of the Doric column is large in comparison with the length of the column, and conveys to the mind the idea of solidity, durability, and deep repose. The Corinthian column, containing more diameters than the Doric, suggests to the mind the idea of *elegance* and repose.

A horse may be said to be in good proportion when the parts bear such a relation to each other that it is well adapted to its purpose, whether of speed or power. But to speak of a horse being in good symmetry indicates a confusion of ideas, for the term symmetry refers to the corresponding sides or parts of a thing. (See Symmetry, Chap. XV.)

156. The proportions of A and B in Fig. 66 are exactly the same, and, therefore, though they are different in size, they are the same in shape.

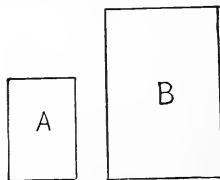

FIG. 66.

Proportion in Art seems to be almost equivalent to 'harmony' in Music. It will gener-

* The proportion in length of the Discobolus is said to be seven heads; an Athlete might be eight. There is an interesting chapter on this subject in the *Handbook of Pictorial Art*, by the Rev. St. John Tyrwhitt.

ally be found that those forms whose parts are arranged on certain definite proportions—where the whole and each particular member is a multiple of some simple unit—are most satisfactory. Those proportions will be most beautiful which the eye can least readily detect, provided, as we have said, that they be multiples of some simple unit. Thus, the proportions of a square being all alike, as 1 to 1, it is the most palpable and least pleasing. The proportion of a double square, or 4 to 8, though better, will be less beautiful than the more subtle ratio of 5 to 8; so also, 3 to 6 than 3 to 7, 3 to 4 than 3 to 5.

157. ‘Harmony of form,’ Owen Jones says, ‘consists in the proper balance and contrast of the straight, the inclined, and the curved;’ but what this ‘proper balance and contrast’ is we are not told: and though Hay, in his various works, especially in his *Principles of Symmetrical Beauty*, gives a great number of figures by which to secure beautiful proportions, the changes that may be made with a few different lines—like the changes that may be rung on a given number of bells—are so great and so subtle as far to exceed the power of the eye to calculate, but not of the æsthetic faculties to appreciate, and the mind then reposes in the sensation of the beautiful.

CHAPTER XV.

ON SYMMETRY.

158. THE term 'symmetry' (so often misapplied) should be allowed its true significance, viz. the correspondence of two opposite sides of a thing.

It seems to be a law of Nature, that almost every individual thing shall be composed of two *laterally* similar parts in its outward appearance. As the internal arrangement is often different from the external appearance, as in animals, &c., it would seem as though it was intended as a designed principle of beauty. This similarity of parts is found constantly amongst flowers and trees; and in the decoration of our houses, both on the walls and in the furniture, we find this law of symmetry quite a necessity.

159. A distinction must be made between the symmetry of the parts, and the symmetry of the group or cluster. Take man, for example—a compound form, a group of trunk, limbs, and extremities. The outer *contours* on each side of the body correspond with each other, whilst the *contours* of the sides of each arm do not correspond, nor the *contours* of the two sides of legs and feet. Whatever part of the group is balanced by a similar member on the other side is itself without symmetry. The arm, therefore, is in itself not symmetrical, because it is balanced by a similar member on the other side; but

the head, which has not this plurality, is perfect in the repetition of the two halves. The two ovals (Fig. 67) will illustrate this principle more clearly.

160. So also in the arrangement of groups or clusters of any objects, — the mind does not require an exact repetition of forms, so much as the recognition of the *law* of repetition. In a triptych, for instance, the two outer panels may contain different subjects, provided that they

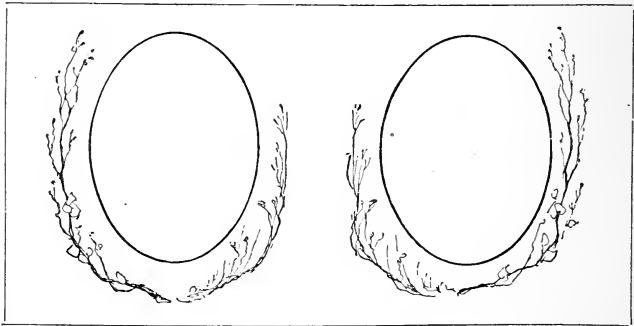

FIG. 67.

bear some relation to each other, and do not interfere with this law of repetition. It would, however, be manifestly wrong to have a figure subject in one panel and a landscape in the other.

161. In the spandrils of a Gothic doorway, the geometric lines forming the spandril will give the idea of repetition; then the subjects filling the spandrils may be different, but must be the same in treatment, and should bear some relation to each other, or to the edifice they are intended to decorate.

162. It will be evident, then, that as we must obtain from Nature the principles intended for our guidance, and as in most beautiful natural objects there is found the correspondence of one side to another and reciprocal balance, so in all our works, whether of Fine Art, properly so called, of architecture, or of adornment simply, we are bound to recognize, in some degree, this beautiful law of symmetry, which seems to lie at the foundation of all true ornamentation.

We cannot ordinarily apply this term to an animal (to a horse, for instance), as indicative of some special excellence of form, for if it were not symmetrical it would be simply monstrous.

163. In a limited sense the term may be applied to Landscape, as when the 'balance' of a picture is spoken of, which means such a disposition of parts, whether of light and shade, or of colour, as shall prevent us from feeling that one side of the picture is heavier than the other.



CHAPTER XVI.

ON SECURING CHARACTER IN ART-WORK.

164. IF we look at the furrows in a ploughed field, or at a fissured rock, we shall see a good illustration of this very descriptive word 'character.' Used in relation to Art, it means all those peculiarities, whether of age,



FIG. 68.



FIG. 69.

newness, roughness, or any other qualities which most strongly impress themselves on the mind, and by which the object is remembered, or its representation recognised. For instance, if we consider the two bits of twig given in Figs. 68 and 69, which at first sight are not very dis-

similar, we shall soon discover that whilst the one is full of life and promise, the other, wanting those markings which indicate life—the buds—is actually dead.

165. In making a drawing, whether from a copy or from Nature, it is a good plan, before beginning, to write on a separate paper the leading peculiarities by which the work is distinguished or characterised, that in our representation of it we may not so much copy the strokes of the example, as the *intentions* of those strokes.

Thus, Expression in Art is but another word for Feeling, and is more clearly explained than defined. When we endeavour to make a perfectly straight line, or produce a piece of perfectly even shading, considerable care is required to keep such equal pressure of hand that no part may be darker than the rest; but when we attempt to represent, say, a tree, we have to ask ourselves what about it most strongly impresses our minds—in other words, what are its characteristics? These we endeavour to put down with such feeling or sympathy as we can command. In the case of a tree, our efforts should be directed to the expression of *leafiness* and rotundity, more than to an imitation of the leaves; but it will be evident that some knowledge of the shape of the leaves, of their arrangement on the twigs, and of the way in which the branches strike off from the stem and from one another, will be necessary to enable us fully to get at and depict it, not only as a tree, but as some particular kind of tree, such as oak or ash.

166. In like manner, if the subject be a mossy rock, we

should strive to express ideas of softness and thickness of moss, and the hardness and angularity or rotundity, the solidity, and the granularness of the rock.

If a thatched roof be the object, the essential qualities will be those of thickness, weight, age, &c. ; and failing to express these, however carefully the object may be *copied*, it must be considered a failure.

167. Speaking generally, character is most clearly seen on the light parts of objects and at their edges, but chiefly

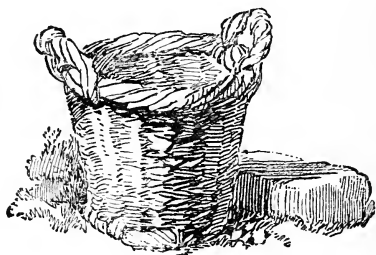

FIG. 70.

where the light and shade separate—as may be seen in the hamper (Fig. 70).

168. In drawing from Nature it would be as impossible as useless to put *all* down that is before us—the camera can do that for us: it is the business of Art to select and express those essential and striking truths by which a scene may be identified by the mind and impressed on the feelings.

CHAPTER XVII.

ON TASTE.

169. VOLUMES have been written on this much disputed word. Mr. Ruskin says,* and we cannot do better than quote, as far as possible, his words,—‘Perfect taste is the faculty for receiving the greatest possible pleasure from those material sources which are attractive to our moral nature in its purity and perfection. He who receives little pleasure from these sources wants taste; he who receives pleasure from any other sources has false or bad taste.’

If an object, a form, or a colour be right, it *is* right, independently of our intuitive choice or ‘taste.’ If we admire it, our taste is good or pure; if we do not admire it, our taste is bad.

170. The term ‘taste’ must not be confounded with that of ‘judgment,’ which is a term expressing a definite action of the intellect. We may reason whether a thing be right or wrong, and arrive at a definite conclusion; but this is not ‘taste.’ ‘All exertions of the intellect are totally distinct from taste, properly so called, which is the instinctive and instant preferring of one material object to another without any obvious reason, except that it is proper to humanity in its perfection so to do.’

* *Modern Painters*, Vol. I.

171. This intuitive faculty may be affected to an unlimited extent by the circumstances of life. A child educated amidst the surroundings of the true and the beautiful in Art is much more likely to develop into a man of good taste than one who continually has about him only the common and not beautiful objects of life. But this faculty can be developed by direct effort, as well as by the subtle influence of things of beauty; and we ought, therefore, to make ourselves acquainted with those principles or laws by which objects may be determined to be

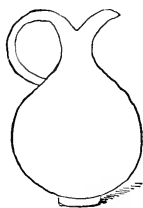

FIG. 71.



FIG. 72.

right or wrong. It is possible that of the two slight sketches (Figs. 71 and 72), some persons might at first sight prefer the first: if so, the taste is bad. If we proceed to analyse them, we shall soon arrive at a definite and unalterable decision that the second is the more beautiful, both on account of the variety of its *contour* and from its suitableness. Whether or not it might be made more beautiful by, say, a little alteration in the proportions or in the curves, would be ascertained by a mixed exercise of the feelings and intellect, under the control of the judgment.

172. Taste, then, is the instant and spontaneous operation of a faculty of our moral nature, which is good or bad in proportion as it is affected agreeably by that which is pure and beautiful, or by that which is false.

173. We are liable, however, to be misled by the artificial value which 'the World' puts on some things. When we are told by the learned connoisseur that 'that little china vase, only twelve or fifteen inches high, cost 800 guineas, and would fetch 1000 guineas at Christie's to-morrow,' we are in danger of having our judgment prejudiced; and before accepting the stated pecuniary value of the vase as its *real* value, we ought to satisfy ourselves with regard to its true excellence, and ascertain wherein that excellence consists.

Our willingness to be pleased, and to please, in speaking of matters of Art, should not be allowed to lead us into the position of the enthusiastic old gentleman who, when his friend remarked, as they passed through a picture-gallery together, how beautiful *that* was, replied 'Oh! very beautiful, very beautiful indeed; which is it, sir?' Let us know clearly and distinctly what we are to admire, and why. Is it beauty of form or colour? or is it the antiquity of the object? or has it a history? If it possesses any of these qualifications, it may rightly command our attention; but the reason of its worth must be distinctly maintained. It is not 'pretty' because fashionable, nor beautiful because old; if it has age or history it may be venerable. If we are told that it was excavated from the ruins of some ancient city, it is interesting as a relic; or it

may be the work of some once famous but now extinct pottery, and has been in the possession of some royal family, and, moreover, is the only specimen of the kind known to exist; then it becomes a thing of history, and we must admire it accordingly.

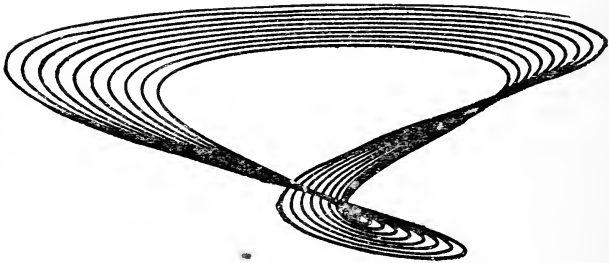

CHAPTER XVIII.

ON STYLE.

174. STYLE in drawing is what 'manner or 'hand' is in writing. One person may draw in a broad style (not necessarily bold), as with a piece of charcoal ; another in a fine style (not niggling), as with a pen. It has nothing to do with *truth* of work, for a drawing may be broad and true, or fine and false, or *vice versa*. Some styles of working, however, may be peculiarly adapted to the expression of some particular kinds of truths : for example, nothing could be better than the reed pen, used as Prout used it, to express the kind of truth that he aimed at in his old buildings ; or than the common, coarse, whity-brown paper that David Cox was so fond of, and used in some of his wild wind and moorland pictures.

175. But the term style may apply not only to the manner of particular individuals in their way of working, but also to Schools and communities ; as, for example, the 'Byzantine style' of ornament, or the 'Dutch style' of painting, and the 'Elizabethan style' of architecture.

Not that Schools are determined or known by their style alone, but by their *motive*. The motive of some of the early Italian Schools was fidelity of imitation—so, also, the Dutch Schools ; the motive in Art as represented by Fra Angelico, Bartolomeo, and others, was expression ;

whilst colour seems to have been a chief motive of the Venetian School.

176. It will be seen, therefore, that inasmuch as Style is but the *mode* of expression employed by a person or a School, and is not either the expression itself nor what is to be expressed, it is of secondary importance, and indeed entirely subservient to MOTIVE.



CHAPTER XIX.

ON MOTIVE.

177. ON *Motive* in Art-work, whether in a child or a School, depends the ultimate issue in good or ill, truth or



FIG. 73.



FIG. 74.

falseness. The motive exhibited severally in the two little woodcuts (Figs. 73 and 74) would, if pursued, be whole-

some or disastrous. In the first one, our child aims at something clever, regardless of individual truth; whilst in Fig. 74, truth of flower, of stone, of tree, is strongly aimed at, though feebly expressed: the ultimate issue of such aim, however, would be natural and healthy.

178. There is a well-known law in morals which seems closely to apply to Art. 'All virtue and goodness tend to make men powerful in this world; but they who aim at the power have not the virtue. Again: Virtue is its own reward, and brings with it the truest and highest pleasures; but they who cultivate it for the pleasure-sake are selfish, not religious, and will never gain the pleasure, because they never can have the virtue.*' The same formula, transposing the word 'Art' for 'virtue,' seems to hold good here.

If this be true—and we scarcely think it can be doubted—the *motive* of the student should be a very high and pure one. As Ruskin truly says, 'Every action, down even to the drawing of a line or utterance of a syllable, is capable of a peculiar dignity in the manner of it, which we sometimes express by saying it is truly done (as a line or tone is true), so, also, it is capable of dignity still higher in the MOTIVE of it. For there is no action so slight, nor so mean, but it may be done to a great purpose, and ennobled therefore; nor is any purpose so great but that slight actions may help it, and may be so done as to help it much, most especially that chief of all purposes, the pleasing of God. Hence George Herbert:—

* Shairp, *Culture and Religion*, p. 61.

“ A servant with this clause
Makes drudgery divine ;
Who sweeps a room, as for Thy laws,
Makes that and the action fine.”

‘Therefore, in the pressing any manner of acting, we have choice of two separate lines of argument: one based on the inherent value of the work, which is often small; the other on proofs of its acceptableness, so far as it goes, to Him who is the origin of virtue.’* Better far for the student that he be a disciple of George Herbert or Fra Angelico, both in humility and motive, than of Salvator Rosa, with his grand effects but monstrously impossible geology, or of Gustave Doré, with his insinuating and dangerous exaggerations.

179. Regarding this last-named artist we wish not to be misunderstood. That Gustave Doré is a remarkable genius there can be little doubt. His creative power is wonderfully prolific, and his imaginative faculties are marvellous. As Dante’s exponent he stands alone, and as the illustrator of Don Quixote he is unrivalled. We do not much care, even, if in *Elaine* a female figure seven or eight feet high appears; the error does not dawn on us at once, and in many cases is never noticed. Here is the legitimate sphere for the imagination, which has its laws, and we are not aware that he often goes beyond them. But this imaginative faculty is just what entirely unfits him, we think, to become a representer of *facts*, and it is for this reason we protest against him as an illustrator of the Bible.

* Ruskin, *Seven Lamps*, p. 5, Introduction.

Here we do not want man's imagination ; we want facts, and such clear statement of them as will help our judgment to the realisation of the truth. There is more help and comfort in Holman Hunt's sketch of an Eastern workshop, which forms the frontispiece to Canon Farrar's *Life of Christ*, than in all the dramatic imaginings that hold a thoughtless public all a-stare during several years of London exhibition seasons.

180. We may as well explain here a little more fully what is meant by motive. It is generally understood that the purpose of a picture is in some way to teach, instruct, or enlighten, and in this way painters may be our teachers. Let us, then, for a moment consider what is done by two classes of men—taking Holman Hunt as representative of the true. He proposes to instruct us concerning the 'Scape-goat' in Leviticus, chap. xvi. An ordinary painter of the sixteenth century might supply himself with materials from his own country, probably not unmixed with anachronisms ; and not a few nineteenth-century artists would be content with such materials as could be gathered in a tour through Switzerland, or the Riviera—possibly visiting a friend's shooting-box in Scotland for a background. Holman Hunt, however, must go to the land where the scenes about which he is to instruct us were enacted ; and not only so, but to the very dreariest of the weary scenes of that waste wilderness below the Dead Sea, that not only his eyes may see, but that his whole soul may be imbued with the sentiment he would press upon us. What was the result ? A picture of which Fashion, in

her blindness, for once spoke the truth, though she could not appreciate. The picture was ugly!—no interest in it!—the goat wretched!—and so on. How could such a subject be otherwise, and yet the truth? How could a wilderness with sin in it be otherwise?—and should not that creature look wretched that is represented as bearing a nation's sins?

181. When Millais exhibited his picture of 'An Enemy Sowing Tares' in the Royal Academy, about twelve years ago, it was hung high, and people said, 'What an ugly thing!' The sower looked bad, and it was dark and gloomy, and there were wretched-looking reptiles crawling about. And yet how could the picture of such a deed of darkness be otherwise, and at the same time true?

182. If pictures are to read to us lessons, we might inquire what lesson are we to learn from 'The Otter-hunt,' by Landseer, or 'The Boar-hunt,' by Schneider, or 'The Bull-fight,' by Ward? Grand in their exhibition of artistic power, but what of their teaching? What is the difference between the teaching of 'The Otter-hunt' and a visit to Hurlingham on a *fête* day? or between that of a boar-hunt and a place at a pigeon-shooting match near a Lancashire town? And are these the pictures to be hanging on the walls of our homes, to be seen by our children? Surely, in our house decoration we might use a little more thought and common sense.

Further, it should not be forgotten that in an illustrated work the artist or illustrator always gets the attention of the reader before the author does, for the picture

appeals instantly to the eye on the opening of the page, whilst the truth which the author presents has to be obtained from the type by a much more laborious process. How important, then, that painters and illustrators should be true men! Many people look at illustrations, but do not read the text; few read the text without looking at the illustrations.

183. Returning, then, from this digression, we cannot too strongly urge on the student the importance of examining his motives in pursuing Art, that they may not be either thoughtless or selfish, but such as will develop in him the faculty of appreciating that which is true and of avoiding that which is false.



'In the acorn lies the Oak.'

CHAPTER XX.

ON BEAUTY.

184. 'BEAUTY' and 'goodness' are names we give to that which approximately satisfies our taste or our conscience. Just as appetite of the intellect is stayed by truth, so our æsthetic and moral faculties are capable of like satisfaction in the recognition of beauty and goodness. It is sometimes said that that which is beautiful or good to one, may be the opposite to another. This, we think, is a fallacy. Truth and goodness are entities quite independent and unchangeable; but our faculties for the appreciation of truth and goodness may be untrained or perverted, or they may be cultivated to the highest point of sensibility. As we have elsewhere stated, they are *capable* of education, and they suffer by neglect. If any object—such as a vase, for instance—be beautiful or ugly, it is so independently of all opinions, for it is a matter of *fact* and not of opinion. We cannot justly say that it is a matter of *taste*, for taste may be good or bad, and cannot alter the *fact*; and if we wish to ascertain what the fact is, it must be by the gathering together of evidences, and the exercise of a sound judgment on those evidences. When Mr. Ruskin says, 'Any material object which can give us pleasure in the simple contemplation of its out-

ward qualities, without any direct and definite exertion of the intellect, I call in some way, or in some degree, beautiful,' we cannot but think that very much depends on the 'us'—that is, whether *we* (the 'us') have true or pure taste.

185. Dugald Stewart says, 'Notwithstanding the great variety of qualities—physical, intellectual, and moral—to which the word *beauty* is applicable, I believe it will be admitted that, in its primitive and most general application, it refers to objects of sight.'

186. Besides beauty of form, there is beauty of colour, of composition, of light and shade, and of expression; all of which are referable to certain principles. The various constituents that go to make up beauty are infinite, but there are some few which are generally present in anything we call beautiful, and are briefly referred to in various parts of the work, especially in the next three chapters.

'All our moral feelings are so interwoven with our intellectual powers that we cannot affect the one without in some degree addressing the other; and in all high ideas of beauty it is more than probable that much of the pleasure depends on delicate and untraceable perceptions of fitness, propriety, and relation, which are purely intellectual. . . . Ideas of beauty are amongst the noblest which can be presented to the human mind, invariably exalting and purifying it according to their degree, and it would appear that we are intended by the Deity to be constantly under their influence, because there is not one

single object in nature which is not capable of conveying them.' *

187. To a right and full enjoyment of beauty, whether in Nature or in Art, there must be a knowledge of the philosophy of Nature, and of the principles of Art. But to this end there must also be the operation of the feelings, made sensitive by the intelligent practice of Art ; thus the mental faculties, the feelings, the eye, and the hand, act in concert.

* Ruskin, *Modern Painters*, Vol. I.

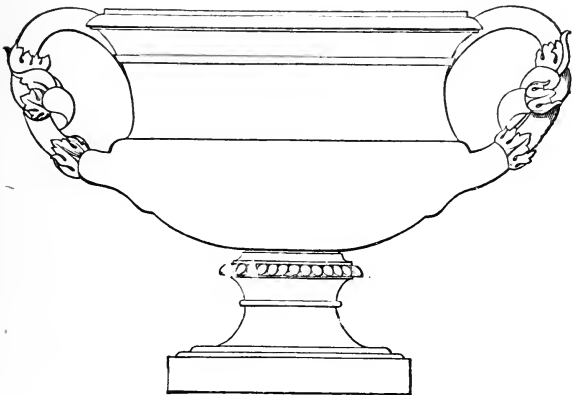

CHAPTER XXI.

ON FITNESS.

188. IN a perfect sense of beauty of form, fitness constitutes an essential element; for though many things may in themselves be beautiful, yet from the want of fitness in their application they may become at least nugatory.

In all complete works there must be a sense of agreement and suitability of parts, not only in their individual forms, but in their kinds. An Italian greyhound is a beautiful creature, but would be quite out of place in a stable; and a calf, though very picturesque in a lane, would be oddly out of place on a lawn.

189. We must not forget, however, that this idea of fitness is of a twofold kind, in one case appealing to the senses, in another to the intellectual faculties and the judgment. In the former case a number of objects may be so related to each other, as to give the idea merely of agreeableness, like sounds, apart from all function, and give pleasure; or, an object not essentially beautiful in itself may become so to the mind by the recognition of its adaptation to perform some particular function. Take, for instance, the hand for handling, or the foot for walking: if we are acquainted with the mechanical appliances of the foot in walking, we are charmed, and look at it, apart

from its form, as a thing of beauty; and in proportion as we know and are charmed with Nature's appliances in the human foot, so shall we be disgusted with and intolerant of the utter vileness and tyranny of fashion, in dictating to a world of reasonable but unreasoning votaries, heels two inches higher than the Wise Designer saw fit to make them.

190. The principle here referred to will apply not only to architecture, sculpture, painting, and ornament, but to almost everything by which we are surrounded. Thus it will be seen, then, that in a work of true art there must be a fitness, both in form and in function, of the various parts composing it, which must precede everything else. The walls and furniture of our rooms, the floors and carpets on which we tread, the crockery and silver on our tables, the ornaments on our mantel-shelf, and even the very fire-irons themselves, all should be subject to this principle. How often do we see highly elaborate fenders and pokers—the latter so heavy and ornate that a deputy has to be appointed, which is sometimes, in irony, called the 'curate.' About the hearth there should be as little ornament in 'relief' as possible. And as the carpet is intended as a surface to be walked upon, all striking patterns on it should be avoided. The principle will apply continually, because (as will be shown in Chap. XXVI.) it is founded in truth.

CHAPTER XXII.

ON VARIETY.

191. VARIETY in Art, as in Nature, is one of the chief sources of beauty, and forms one of the trio of essential elements in its production. Like every other essential quality in Art, it is subject to laws naturally belonging to it—for without obedience to law there can be neither beauty nor truth. The extent of its operation is simply infinite, and infinity is a characteristic of Nature. No two things, from a blade of grass upwards, are exactly alike. Variety seems to be a necessity of our nature. This is well shown by the late J. D. Harding,* ‘by supposing a number of beautiful women to be seen together, and that each merited the appellation. It would be found, on examination, that, however great the number, they all varied; and that this variety, in fact, constituted the aggregate beauty of the whole number, and was inseparable from it. Again, supposing we could select one from among them, who by universal consent was admitted to be the *most beautiful*, what beholder would desire that some magician’s wand should make the rest exactly like her? Who, if such a change could be effected, would not feel a desire to return to that variety which must ever be the captivating constituent of beauty, both in the individual

* *Principles and Practice of Art.*

and in the aggregate? Without the one, we cannot have the other. Were beauty always to take the same form and expression, the eye and the mind would be fatigued by its perpetual recurrence. But, as variety is given to beauty, and is inseparable from it, the eye and the mind are excited and gratified by fresh and unanticipated combinations of form and expression.'

192. Mr. Harding afterwards proceeds to show, in a

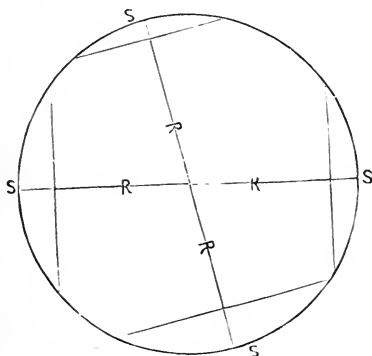

FIG. 75.

palpable manner, that variety is an indispensable constituent of beauty, and that perfect beauty is constituted of infinite variety, thus:—‘On cutting segments of the circle of different sizes, *s s s s*, we shall find that the curvature of the arcs is precisely the same, whatever may be the difference in size; since, from the construction of the circle, the circumference is, during its whole circuit, equally distant from the centre, and consequently all the radii, *R R R R*, are of equal length, and the curvature is in

every point the same. This form, therefore, cannot be the *most* beautiful, because it wants variety.

‘On the other hand, if we cut segments from the egg, $s s s s$, we shall find that, whether their chords be equal or not, their curvature and assumed radii, $R R R R$, are unequal, so that no part of any segment would repeat part of another, or of itself on the same side; for as the curvature of these segments is perpetually changing,

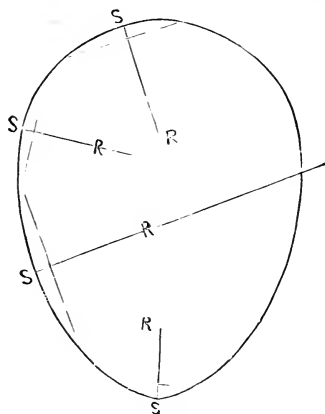

FIG. 76.

they could not be represented by radii such as I have been here obliged to place in order to make myself understood. Here, then, is greater variety, and therefore more beauty. This, so far, is only offering the test to the eye, or the limited power of the compasses; but if, instead of this, we take a mental view, we shall feel yet more thoroughly conscious of the sameness of curvature in the sphere, and of the infinite variety which

the ovoid, or egg form, admits of. If we should conceive segments infinite in number to be cut from a sphere, we should still have the same curves ever occurring; but should we conceive an egg so cut, the curvature and radii of the segments would be of infinite variety, and consequently, of the two, this is the *most* beautiful form.' He then demonstrates how the most beautiful of Nature's works, the human form, is made up almost entirely of ovoid forms.

193. To get a correct idea of the infinity of this beauti-



A
FIG. 76 a.

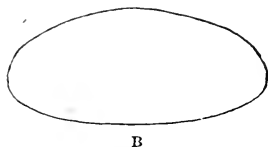

B
FIG. 76 b.

ful figure, which combines in one so much variety with the law of symmetry, we must not confine our observations to one form or proportion of the ovoid. It will be evident, when we consider it mathematically, or when we attempt to construct it, that as the longitudinal and transverse diameters can be varied in every possible relation, so we may obtain, not only one ovoid with constantly varying curvature, but an infinite variety of ovoids, from the very elongated (Fig. 76 a) to the very compressed (Fig. 76 b), each having the law of infinity stamped upon it.

Ovoids of various proportions may be made by an instrument specially adapted for that purpose; but they may also be roughly made as follows (Fig. 77):—

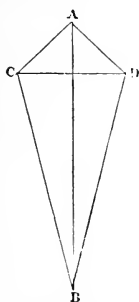

FIG. 77.

Draw any line, $c d$, and bisect it as with the line $A B$. Now fix pins at the points, $A B C D$, and tie a string tightly round them. Remove the pin at c , and the string will lie loosely about the three remaining pins, $A B D$. If a pencil be now introduced within the string, so as to restore it to its original tension, and be carried round so as to keep it always equally stretched, it will trace the ovoid, or composite ellipse.

It will be evident that the shape of the ovoid will depend on the relation to each other of the two isosceles triangles, $C A D$ and $C B D$. If the angles, $C A D$, for instance, be, say 108° , and $C B D$ 27° , we shall have a form suited to the human face; but if we make $C A D$, say 120° , and $C B D$ 15° , we shall have a shape suited to a tall vase or jar, and *vice versa*.

The student is recommended to work out for himself this simple plan for constructing an ovoid.

194. It is the judicious combination of lines giving infinite variety that has caused so many Greek forms, especially vases, to remain unsurpassed during all the Art efforts of 2300 years.

It would occupy too much space in a work of this kind to follow this element of variety throughout its almost endless applications, not only in ornamental art, but also in

architecture, sculpture, and painting. It applies equally to the form of a leaf or to the shapes and modelling of a mountain—not only to shapes, but to the quantities and directions of shapes, and in composition (as in the Rhine boats below), and as we shall presently find, it is in constant requisition.



CHAPTER XXIII.

ON UNITY.

195. IN the consideration of the various elements, the combinations of which are necessary to secure beauty in a work of Art, it will be found that they almost inevitably overlap or impinge on each other to some extent.

Variety has been spoken of as productive of beauty; but this variety must not run riot, and be introduced merely for its own sake, but under certain restrictions and relationships, so as to allow—or, perhaps, rather to suggest—the idea of Unity.

This idea of Unity, or oneness, which is the subordination of all the parts to the completeness of the whole, is as essential in a work of pictorial art as in a piece of music. We find it, like a cord, running through and tying together all nature; and it seems to have been a divine idea in the creation of all things, binding organic forms, from the highest to the lowest, in one complete cycle; and although the completeness of any individual natural form may in itself convey this idea of unity, it is only one of an infinity of individuals, the whole of which are governed by this same idea. And thus it is that in contemplating any object, we do so with the conviction that the designer of this one object was also the designer of the whole visible universe. Unity, then, being that

which connects all individuals into one whole, is the element which expresses and produces completeness.*

196. In Art, as in morals, the mind may enjoy for a time, but cannot obtain rest in the incomplete or in the imperfect, and the higher the work, the more strongly is the necessity of completeness felt: it is like a beautiful piece of music performed with the omission of a few notes at the beginning and ending of it.

197. A *sketch* may be incomplete, but the mind, taking cognisance of the fact that it does not aim at or pretend to completeness, enjoys it as a fragment, or as a part only of some whole.

198. The idea of unity has nothing to do with uniformity, but is an aggregation of differences which form one whole.

* There are some extraordinary parallelisms and relationships recently discovered between sound and form confirming this idea, but they are scarcely suited for an elementary work of this nature.

CHAPTER XXIV.

ON COMPOSITION.

199. 'COMPOSITION may be defined to be such a collocation of the several objects in a work of Art, both relatively to each other, and with respect to the whole, that each and all may most efficiently contribute to the perfection of the general design.' It may also be defined as the *help* given by everything in the picture to everything else to make a whole.

Composition brings to us a higher degree of beauty, and therefore of satisfaction, by the association of objects in such a combination as will most agreeably and most powerfully affect us; but in every case the objects must be so arranged as to appear perfectly natural, both with reference to the things introduced, and to the places they severally occupy in the group.

200. We will endeavour to illustrate this in a familiar manner. Let us empty on to the table before us the contents of a general and promiscuous pocket. We may have something like what is given in the rough sketch (Fig. 78),—several keys, including a railway key and a watch key, a knife, a railway pass-book, a piece of lead pencil, and several coins. Now we at once find that we have more objects of the same kind than are necessary for a group, and so we proceed to eliminate by taking

away several coins (which are repetitions of the same form), and several keys. The objects for our group now feel more under control. But we inquire, What natural relation exists among them? None, except perhaps between the knife, pencil, and book; and so we remove the coins and the keys. We further discover that as the knife happens to be a fruit knife (silver), it bears no relation to the pencil, or book; nor, finally, the pencil to the 'Pass;' and so these also must be eliminated. In

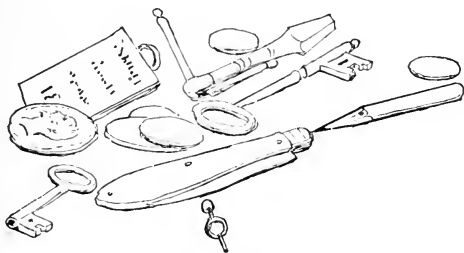

FIG. 73.

fact, out of the whole of the dozen or more articles, we cannot form a natural and consistent group.

201. We will try again, however, beginning with a single object, say a piece of ordinary lead pencil, and inquire what will naturally go well with this. A knife, or a piece of eraser, or a pocket-book,—any or all of these; and we try to arrange them agreeably: but we find, as they lie flatly on the table, we have no upright object with which to vary the group, and so we add, say, a tumbler with water in it. But as this tumbler bears no relation to the other objects, we may instantly, by intro-

ducing a paint-brush into the group, suggest a relationship, and especially if we show also a bottle of Chinese white.

We have now materials for our proposed composition which bear some relation to each other, and we will proceed to arrange them.

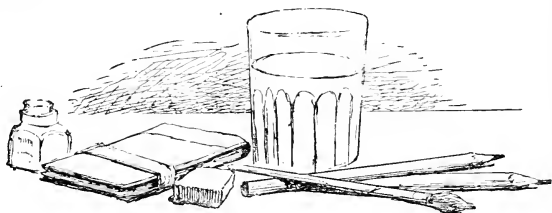

FIG. 79.

They may, perchance, be as in Fig. 79; but though this may be said to be natural, or according to Nature, it will not satisfy the necessities of Art. We had better

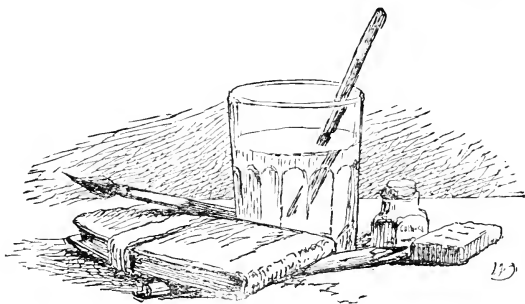

FIG. 80.

begin by letting the principal object occupy the chief place, *near* the centre, and then arrange the other objects about it so as to secure both variety and unity. We have done so in Fig. 80, with a satisfactory result.

202. The relation of the parts of a composition to each other, and to the whole, may, perhaps, be better under-



FIG. 81.



FIG. 82.



FIG. 83.



FIG. 84.

stood by considering them as lines only. If we place two or more lines parallel to each other, we shall not feel that they bear any real relation. If we place them as in Fig. 81, we shall feel that they more oppose than combine; and by placing one line perpendicular to another we have them in strongest contrast, as in Fig. 82; whilst if we place them as in Figs. 83 and 84, they compose towards each other; and thus combining, we may go on till we get to Fig. 85 (our Crocus), one of the most beautiful, simple



FIG. 85.



FIG. 86.

flowers we have, which conveys the idea of variety with unity, and in some degree of symmetry also, though not absolute, as in Fig. 86. But how, it may be asked, will this apply to landscape?



FIG. 87.



FIG. 88.



FIG. 89.

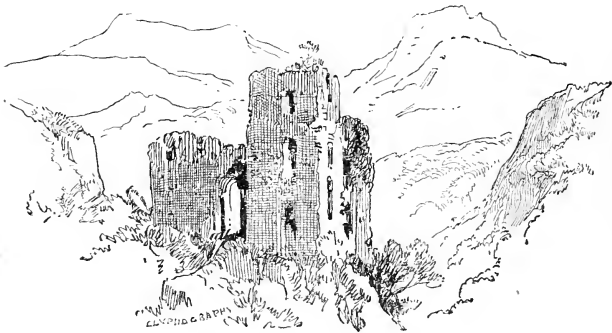

FIG. 90.

Let Figs. 83 and 84 be placed horizontally, as in Figs. 87 and 88, and we have at once the general direction of the lines forming the foundation of Figs. 89 and 90,



FIG. 91.



FIG. 92.



FIG. 93.



FIG. 94.



FIG. 95.

and also for Fig. 91. If we analyse the two following examples (Figs. 92 and 93), we shall find that they resolve themselves into the simple elementary lines of

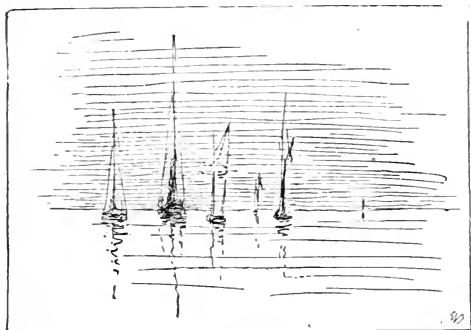

FIG. 93.



FIG. 97.

Figs. 94 and 95. It is by such means that the mind may often suggest what the feelings require, but cannot discover; for the mind and the feelings should act in concert in the production of a work of Art as well as in its analysis.

203. There are some qualities and characteristics which are more readily expressible by lines and by light and shade than others. The sentiment produced by these is sometimes easily traced to its exact source. To some extent the ideas of repetition and monotony associate themselves with that of stillness, which is allied to repose; and stillness is a condition of things with which we may become quite familiar—a condition in which Nature is

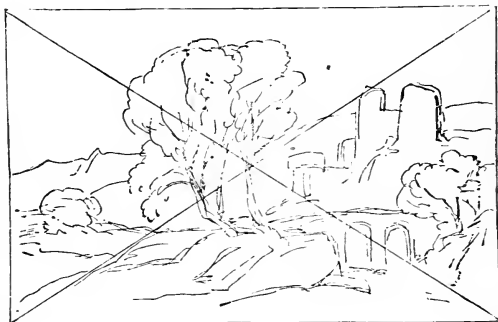

FIG. 98.

most easily represented by a tone of shade, by repetition of lines, and by certain positions of lines, as in the rough sketch (Fig. 96); whilst contrast of light and dark, and opposition of lines, as in Fig. 97, give rise to a contrary feeling.

204. If we take any rectangular parallelogram as our picture, and divide it into equal parts, as in Fig. 98, the intersection will mark the part of the picture space which is the weakest place for the principal object of a pictorial composition, for it divides the picture into two equal

halves. In the case of merely ornamental design, where exact symmetry is an important constituent, this of course does not apply.

By dividing the parallelogram into thirds or fifths, we shall obtain what may be called the strong positions of the picture; but if some of these parts or positions on one side are occupied with points of interest, the corresponding parts on the other side become neutralised for any equally important feature of interest.

205. Thus it will be seen that the various methods of composition, especially in landscape Art, have for their aim the introduction of pleasing, or at least mentally satisfactory qualities, without disturbing what we might almost call the idiosyncrasies of Nature. For rules and helps we should ever study, not so much the customs of men, as the works of Nature herself. Whichever way we look, we always find in her the assertion of three grand laws,—Fitness, Variety, and Unity.

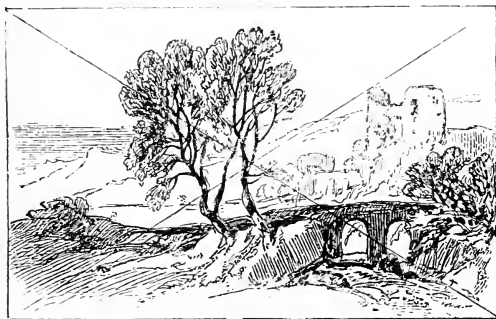

CHAPTER XXV.

ON LIGHT AND SHADE AS APPLIED TO GROUPS OF OBJECTS AND TO PICTURES.

206. IN Chapter VIII. the remarks on 'light and shade' had reference only to individual objects: we are now to see how light and shade operate on objects, individually or grouped, when considered in relation to the whole picture. This can only be done here in a very limited manner; fully to show its importance would require many costly plates.

207. As the purpose of light and shade in the representation of an object is to give the idea of projection, and to show the space it occupies, so the purpose of light and shade, when applied to a picture, is to fill it with space, and to locate, to conceal, or to reveal, the various objects it may contain, whether houses or trees, figures or mountains, and lead the mind of the spectator to consider chiefly those parts of the work that the artist wishes him to see.

208. If the student will, as before, make simple experiments, he may more easily understand some important truths in connexion with the subject.

Let him, on a stout piece of cartridge or of grey paper, make two accurate but delicate outlines in ink of any clearly defined subject, such as Fig. 96, or Fig. 97,

only considerably larger. With a piece of charcoal,* or a pencil that will easily rub out, he may now treat the subject under different aspects, and then compare them with each other; his feelings will soon inform him which is the most agreeable treatment, and his intellect and judgment will furnish him with the reasons *why* it is so.

In attempting such exercises he must consider the position and kind of light that is to illumine his picture, its effect on the large masses, the local colour of the various parts; and when these considerations have been attended to, he may greatly modify and complete the whole by the introduction of accidental shadows of various shapes and intensities.

When these experiments have been made with a few simple subjects, those of a more extensive and intricate kind may be attempted: for instance, such as Figs. 91 and 93.†

209. It is not unfrequently the case that when an artist has determined to paint a particular subject from Nature, he has to commence it under very unfavourable circumstances of light and dark; but he is ever watchful for any happy moment when the scene may be lit up by some bright gleam of light which may instantly transform it from the commonplaceness of a dull day into a beautiful picture.

This instantaneous 'effect' he rapidly secures (perhaps

* Charcoal must be *dusted* off the paper, not rubbed.

† If grey or tinted paper be used, the light parts of the sky, and the brightest parts of near and very light objects, may be put in with a piece of extra soft white chalk, or with Chinese white.

only on brown paper with charcoal and soft white chalk), and by it he is assisted in completing his work, by adding to beautiful forms and accurate drawing the charms of ever-changeful lights and shadows.

210. And now let the student, in imagination, climb, on this fine April morning, to the top of some hill, and watch the marvellous effect of the cloud shadows as they travel over hill and down dale, concealing, revealing, gladdening, saddening; our spirits going up or down as one moment we stand in the bright light, and in the next in deep shade—a picture of our human lives. The winding stream, the rustic bridge crossing it, the woody hill-side, the fortress-like rock, and the hills in the distance; these are the features that the mind loves to dwell upon and the memory to recall, as the clouds cast their fleeting shadows across the scene alternately bright in light, or falling into shade to be revealed anew.

These accidental cloud shadows are a most important means in the hands of a painter for expressing space and light, and for inducing the eye and mind to dwell on whatever is most interesting.

211. If the student, with these thoughts in his memory, will look over a work like Turner's *Rivers of France*, his *Harbours of England*, or the *Liber Studiorum*; or go through an exhibition of old (English) masters' works, especially of water-colour drawings by such men as De Wint, Varley, Barrett, Cox, Copley Fielding, and Harding, he will have a mass of evidence that will convince him of the grand power which these accidental cloud

shadows place within the reach of artists for the expression of space, light, and beauty.

212. These accidental shadows must not appear in spots, or be clearly visible throughout their entire forms, but should usually run continuously from side to side of the picture, as they generally do in nature. Being irregular in form, and passing over irregular surfaces, their exact shapes cannot be traced; but being subject to that foreshortening which all retiring surfaces show,—whether a table-top, a room, or a vast landscape,—they will almost invariably appear to extend from side to side of the picture, as in Fig. 99, and not into it.

213. As illustrations of what we mean by the distribution of light and shade in a picture, let us consider the two Figs. 100 and 101. In the former, the upper and more interesting part of the building is left light, whilst the other part becomes darker as it gets lower, and ultimately blends with the dark shadow on the ground, the nearer part of which is in strong light. To prevent the monotony of so large a mass of dark, a figure is introduced, the white and black dress of which prevents the dark shade on the building from looking heavy. But to make this more strongly felt, let the student with a soft pencil shade over the light parts of the building, the figure, and the foreground,—he will instantly perceive that all space and light are destroyed,—in fact, that the drawing is spoilt. It can be made right again by cleaning with a piece of bread.

214. Now let us take the second one. In this subject

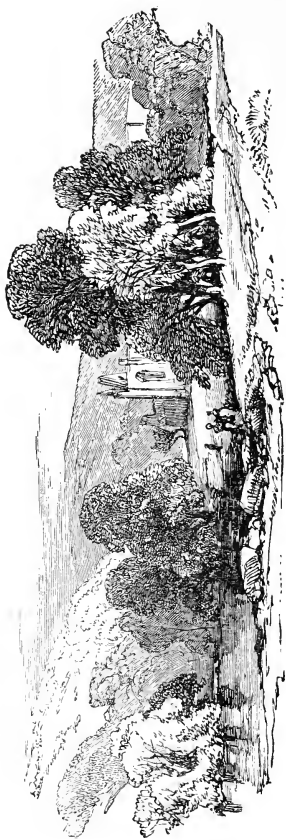

FIG. 99.

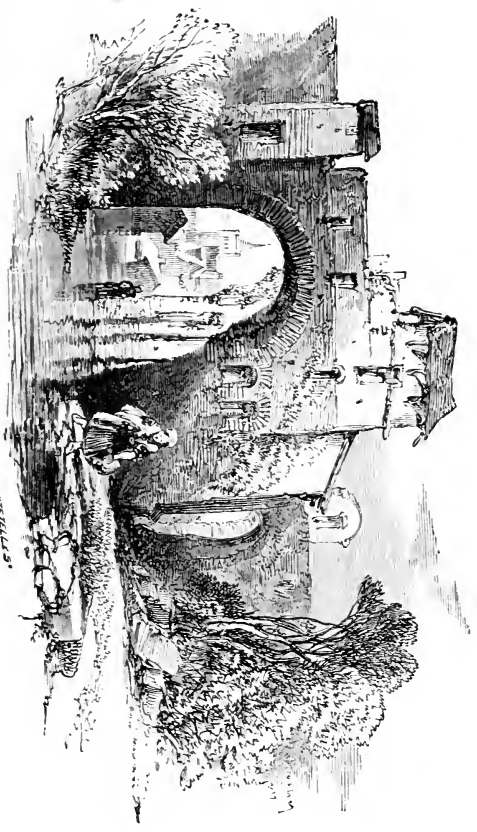

FIG. 100.

WILKINSON'S

we have at once such elements of the picturesque as would, independently of well-arranged light and shade, be interest-



FIG. 101.

ing ; a lane, fine aged trees, old railings, a clear sky, and a church spire. Moreover, these features are so combined as to make the '*lines*' of the picture harmonious and agree-

able. A dark cloud shadow is thrown over the trees in the middle distance, and passes across the field behind the old railings and the nearer trees on the left, causing them to be much more clearly visible. Now let the student pass a little white chalk over all the dark parts of the drawing, and shade over the light parts with a pencil, so as to make all equally dark, and he will again feel that all space and light are gone, and the work ruined.

It will thus be seen that the purpose of light and shade, as applied to a picture, is but an advanced stage of its application to an object ; it is the means by which the artist gets rid of the idea of the flat surface of his paper or canvas, and invests it with such ideas of Nature as have been mentioned.



CHAPTER XXVI.

LAWS OF NATURE, AND THEIR APPLICATION AS PRINCIPLES OF ART.

215. 'PRINCIPLES in Art are those primary generalised truths, founded on or deduced from universal laws, which lead not only to its successful practice, but to a more complete and just appreciation both of Nature and Art.'

'Principles make us more susceptible of the beauty of Nature, and the power of Art in representing her; of what is essential to beauty, whether developed in the more noble productions of the pencil, or in all the varied objects, useful or ornamental, with which we are surrounded.'

216. As these laws of Nature are perfect, and as from these our principles are deduced, we adopt a true standard by which to test Art works, quite independent of fashion or the dictum of ignorance. The laws of material beauty can only be discovered by determining the laws of the Divine mind in the fact of creating, or by a study of the manifestation of those Divine operations in what we call Nature.

We will imagine a case in illustration of what has just been said, by supposing that we wish to design any simple object, say a candlestick; and to make our work of design-

ing quite simple and clear, we must first enunciate a few laws which we invariably find in Nature, and then apply them to our work.

1st. It is a law of Nature that everything intended for service has a certain size and character defined for it according to the purpose for which it is destined.

2nd. It is a law of Nature that, in things of use, ornament is an *addition*, and secondary to utility—never a principal or chief.

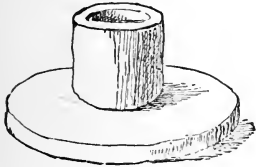

FIG. 102.

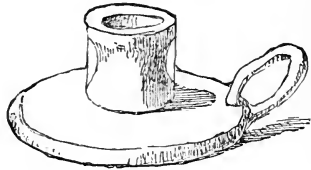

FIG. 103.

3rd. Natural ornament is always in harmony with the thing to which it is applied.

Now, we have here three laws which will to some extent guide us in the designing and ornamenting of our candlestick. First, we require a socket to hold the candle, and a base, that it may stand safely, as in Fig. 102; but as we may wish to move it, we must have convenience for doing so, and we add a handle accordingly (Fig. 103); or we may wish the light to be held well up, in which case we lengthen the shaft, and so shape the top of it as to protect it from grease or running wax, and as we have now a shaft to take hold of, we do

not require a handle (Fig. 104); but if it is intended to be carried about, we had better add a screen, as in Fig. 105. We have thus conformed to this first law of Fitness, and now that our candlestick will do its work well, we may proceed to add that by which it will do it gracefully also, viz. ornament. Before we can do this safely, however, we must consider the *material* of which the candlestick is to

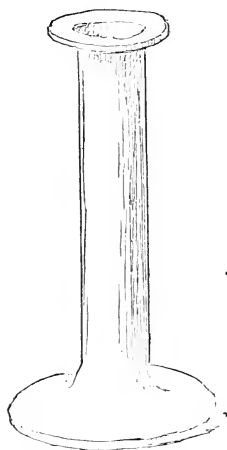

FIG. 104.

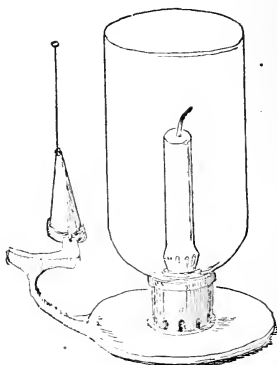

FIG. 105.

be made, whether of metal, such as silver, or of clay, such as china, as a design suitable for the one may be quite wrong for the other. In the former material we may add much to the lightness and elegance by varying the thickness of the shaft and the shape of the base, as in the rough sketch (Fig. 106); but this would be quite wrong if produced in china—a material so easily broken. On

neither material should there be such deeply incised or highly 'relieved' work as would interfere with the cleaning of it from dust, wax, or grease. The most suitable treatment for the china candlestick would be a surface ornament, such as paint or gold, quite flat.

Here, then, are principles of Art legitimately deduced from the laws of Nature, which should guide us, not only in designing a thing in common use, but in judging correctly of that which is already designed.

217. We will take another simple object of every-day life — a tea-cup. Our first inquiry ought to be, What shape of vessel is best adapted for drinking from? Certainly not one like Fig. 107; nor wide and shallow like a saucer, which may be suitable for cooling liquids in, or evaporating them, but not for drinking from. A shape like Fig. 108 would be

much better; moreover, it is agreeable in form, for we have slanted the sides, and affixed a handle convenient for taking hold of. Suppose the design is for a child's cup, this shape is not well adapted, as it might be easily upset; so we will simply invert it, make the handle a little larger, affixing it a little lower on the side, that

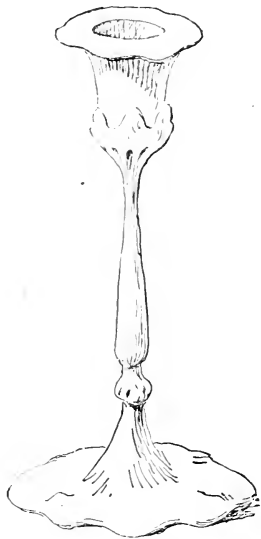

FIG. 106.

the cup may be more easily lifted and balanced without danger of upsetting (Fig. 109). In both cases the *forms* of our tea-cups must be admitted to be right, and we may proceed to ornament.

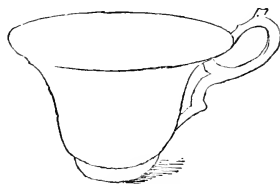

FIG. 107.

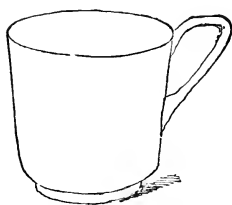

FIG. 108.

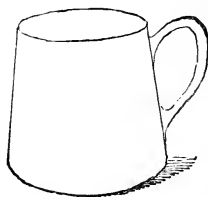

FIG. 109.

218. But here, again, we are bound by the nature of the subject to avoid highly 'relieved' ornament, and to adhere to that which is flat, such as painting and gilding.

As to the kind of painting most proper for such articles as tea or dinner services, we can only here state in general terms that close imitations of Nature, such as landscapes, flowers, fruits, &c., are undesirable; and that simple geometric designs and conventional work are most satisfactory. The general colour will depend much on the surroundings, but white and gold are always safe, and

generally the primary colours, *in small quantities*, may be admitted; but much strong red, especially on dinner services, is decidedly out of place.

219. The application of the general principles here named is endless,—furniture, such as fire-irons and fender, carpets, chairs, tables, wall decoration,—everything, in fact, to the architecture of the house itself, must be amenable to these laws; because they are not founded on man's knowledge, but on the laws of God's works, and on man's nature.

220. It may, however, be said by some, that all this is a matter of taste and feeling. Granted, but as there is false taste as well as true (see Chapter XVII., on 'Taste'), it becomes of paramount importance that we should make ourselves acquainted with those principles on which true taste depends. The *fact* remains that a thing is right, or is wrong, whatever our taste and our opinions may be in regard to it; in either case it will be right or wrong for some reason, and in either case the laws of Nature must be followed or violated.

221. 'Principles, then, whether they relate to architecture, painting, sculpture, or design, must be known, in order that the eye may not become accustomed to admire or acquiesce in what is wrong, but be taught to discover and correct it, and in new applications of truth to develop new and higher manifestations of beauty. To illustrate this, let us suppose a person little skilled in Art to have produced something in which, from his want of knowledge, his eye detects no fault; and that he takes it to

some accomplished artist, who, instantly perceiving its defects, informs him of the principles he has violated, and thus makes him sensible of the faults he has committed, and tells him how they may be remedied in his present performance, or avoided in future. The consequence is that the production which but a few minutes before was viewed with complacency, and perhaps pride, is now found to possess so many faults, that instead of affording satisfaction, it annoys and displeases. To what is the change to be ascribed? Not to any alteration in the sight, but to the fact that the eye, looking through the medium of the mind, now in possession of the truth, can no longer be satisfied with what the reason disapproves of. Every effort is consequently made to satisfy the mind and the feelings, now become more acute and more sensitive, by closely adhering to that truth, which is felt to be so powerful and so essential.'

222. We are 'prone to rely on our feelings alone; but as these are extremely liable to be excited by mere inconsiderate impulse, it is necessary that they should be controlled, regulated, corrected, and strengthened, by the judgment; and the judgment can only be in a condition to decide correctly, when it is rendered independent of the bias of prejudice or fashion, by a knowledge of the true principles of Nature and Art.'

CHAPTER XXVII.

SKETCH, STUDY, PICTURE.

223. It might be thought unnecessary to define for the student such terms as stand at the head of this brief chapter; but there is often a considerable confusion arising from the want of clearly defined terms, especially in the use of technical language.

224. The original meaning of the word 'Sketch' may be gathered from its Latin root, together with its synonyms in other languages. The primary sense of the verb is to throw off, or shoot, and in this sense it may be used in Art—the first ideas of a work hastily thrown on a paper or canvas, and with such materials as offer the greatest promptitude and facility. The term applies equally to historical, landscape, and *genre* subjects, whether originated by the historical painter in his studio, or by the landscape painter when before Nature.

225. The term is also used to mean the outline of a drawing or picture laid in for the artist's guidance, but cannot, we think, be so legitimately applied to the delineation of the human figure when it is done slowly, and, it may be, with much rubbing in and out. This we should call an *outline* in preference to a *sketch*.

226. It not unfrequently happens that when an artist proposes to paint a picture and has produced his *sketch*,

he may find it necessary to prepare from Nature, with great care and thought, the various parts of his picture separately; such as, in some instances, entire figures; in others, human heads, hands, or feet, animals, trees, plants, &c. These are properly called '*studies.*' The purpose of these *studies* is to assist a painter to such an intimate knowledge of the details of a future work, that he may with more freedom give full and complete expression to his feelings. When we sit down before Nature, and spend much time and thought in working out a portion of a landscape, so as to make ourselves thoroughly acquainted with it, whether in view of some definitely intended future picture or not, the work is not a sketch, it is a '*study.*'

227. A *picture* is a full and complete representation of a thought, idea, historical incident, or landscape, on any material, whether plaster (fresco), wood, canvas, or paper,—usually understood to be in colours,—and is the natural outcome and full development of the '*sketch*' and '*studies.*'

228. When the members of the Old Water-Colour Society held their first winter exhibition some years ago, there was a wonderful and most instructive display of studies and '*sketches,*' properly so called, many of them incomplete except as sketches, and very slight. It was unique, and so successful that an annual '*Winter Exhibition of Sketches*' has been the result. Much of the work exhibited, however, cannot be fairly classed as '*sketches,*' but rather sketches changed into pictures.

229. The first idea of the 'Rabbit on the Wall,' by Sir David Wilkie, was a scrawl of only a few inches (see Fig. 110).* He afterwards made separate studies of some of the principal figures, and ultimately painted the picture so well known.



FIG. 110.

230. Two of the 'most eminent landscape painters whose works annually adorn the walls of the Royal Academy, pursue quite opposite modes of procedure in the production of their works. Of one of them it is said—speaking figuratively, of course—that he makes innumerable sketches, out of every hundred he destroys fifty, and from the remaining fifty he produces five complete works. The other rarely makes a sketch, but completes his pictures on the spot. Considered by the public very fortunate in selling his pictures, he himself says, 'My good fortune in selling my pictures is a misfortune, for when I sell my pictures I sell all, and have no sketches to fall back on.'

231. The 'sketches' of an artist are a sort of store-house, from which the imagination of the artist draws its food; and ideas thus originated, being revolved in his mind, may ultimately be re-presented in the completed picture.

232. Still, there is no clear demarcation by which always to distinguish a 'sketch' from a 'study,' and a 'study' from a 'picture.' As examples of 'sketches' we may refer

* From Jackson's large work on Wood-cutting.



FIG. 111.

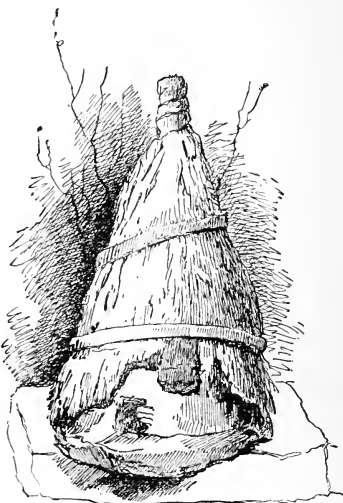

FIG. 112.

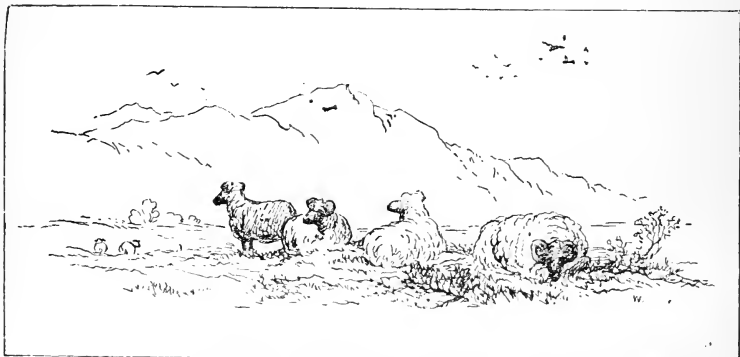

FIG. 113.



FIG. 114.

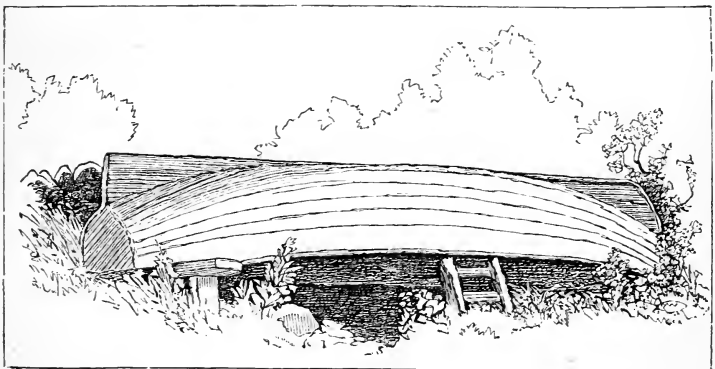

FIG. 115.

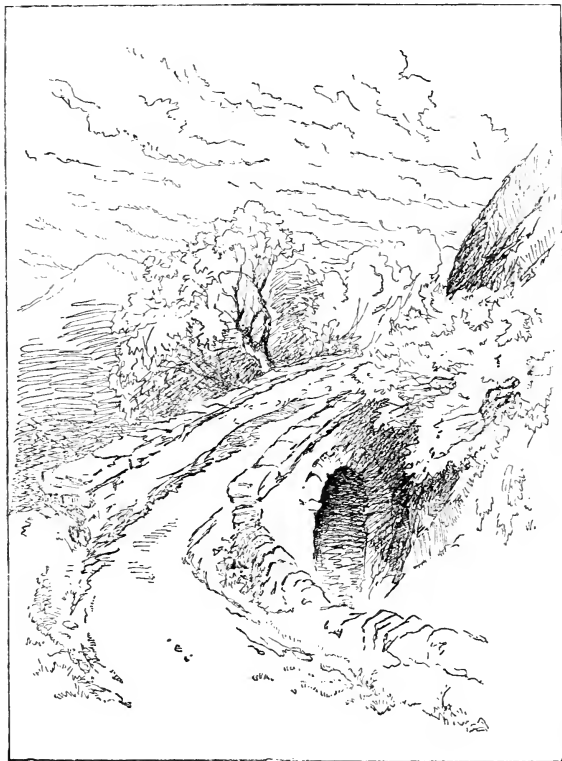

FIG. 116.



FIG. 117.

to Figs. 110, 111, 112, 113, 114, 115, and 116. Figs. 117 (tree-trunk) and 118 (grass-blades) are of the nature of 'studies,' each part having been carefully put down from Nature. The Frontispiece, although without colour, may be considered as a picture.



FIG. 118.

CHAPTER XXVIII.

ON GRASS, HERBAGE, ETC.

233. IN the midst of our scientific investigations, whilst the mind is on full stretch after exact calculations and mathematical formulas in the study of Nature, there is necessity for some pursuit which will in part and for a time release us from the dry, hard facts of science. And such a pursuit is not always without advantage. One of the most beautiful scientific generalizations of modern times was the result of the dreamy reverie of Goethe. On his meditative mind the idea dawned that the flower of a plant is not a separated or superadded organ, but only the highest development and transformation of its leaves—that all the parts of a plant, from the seed to the blossom and fruit, are only modifications of the leaf.

234. The study of Nature should be not merely sensuous, but intellectual—not only æsthetic, but religious; for however we may reason on the evolution and development of things, there still remains the grand, irresistible, and inevitable truth, which lies at the back of all our logical sequences and inferences, and towards which all lines of life seem to converge,—the great eternal Fatherhood, ‘God over all, blessed for evermore.’

Let us in this spirit look, with pencil in hand, at some

of the things in nature which are manifestly designed for our pleasure, beginning with what may be under our feet, —Grass.

235. If we look at a field of grass we may see little more than a mass of green, agreeable in colour, but with no striking character about it; but if, instead of looking at an entire field, we take a millionth part of it—a few blades of grass—and carefully study that, we may have a more tangible, definite idea of the beauty that lies about our path. Taking a simple example, like Fig. 118, and reflecting on it, we observe that in the tissues of grass the inorganic becomes organic, the dust of the earth becomes vital — vital in giving off life and beauty, vital also in giving nourishment both to body and mind, showing purposes far beyond what is necessary to its utilitarian destination. In many grasses and cereals, the stems, with their bearded plumes, are models of symmetry, elegance, and strength. The structure of grass throughout exhibits interesting evidences of design; and it will not hurt our artistic efforts if we take some of these into account when, in our unwise haste, we attempt by a few clever dashes of the pencil to express that which is so perfect. The root, in proportion to its size, is more fibrous and tenacious than that of any other plant, and is often what is known as a running root (see Fig. 118), sending up a new shoot at each joint, thus causing the grass blades to cluster closely together, and cover the ground as with a carpet. In this way also it propagates itself, and thus makes compensation for the absence of

blossoms, which animals will sometimes crop, though it may be observed that they generally prefer the blades and eat round many flower-stalks.

236. The stem is hollow, and so constructed that, were it the work of a human mechanic, it would be held up before the world as an example of marvellous ingenuity, and perfect for its purpose. May not our engineers have taken a hint from a straw in the construction of their long boilers and tubular bridges? The blade or leaf is so formed, being long and narrow, as to offer the least resistance to the earth and wind, and yet get an abundance of light and air. The flowers of some grasses are wonders of design. They are often produced from the upper sheath which encloses them when young, and are disposed in simple or in branching heads, each head consisting of two or more chaffy scales, inserted one above another; and from these scales hang slender threads, terminating in yellow knobs of dusty-looking pollen. It is said that there are more than three hundred *genera*, and upwards of five thousand different species of grass in the world.

The *colour* of grass is that which is most soothing to the eye.

Altogether, the exquisite perfection of it—in its form, colour, adaptation—enables us to see not only God's care for helplessness and lowliness, but His care, too, for beauty as an end, and not as a mere means.

The Great Teacher spoke wisely when He said, 'CONSIDER the flowers of the field.'

237. It is good and pleasant practice, especially for a

beginner in drawing, to copy leaves in flat symmetrical form, like the Ivy-leaf in Fig. 119, and if he has a correct eye and steady hand he may soon draw detached leaves very beautifully. But here is the danger: he is likely to become mechanical, for the drawing of flat scroll-work and flat leaves has little art in it. But if a leaf is so placed as to show its varied and delicate curves in front one of another—in other words, if it be foreshortened—then we are no longer drawing from the flat, but from an

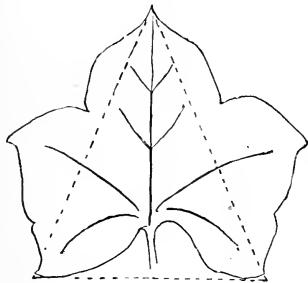

FIG. 119.

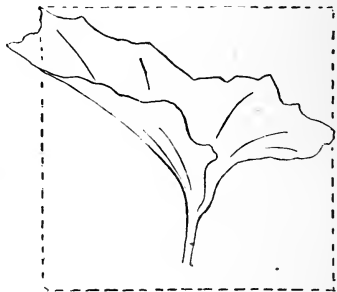

FIG. 120.

object in space, with all the exquisite changes of curve and surface, and there is now more properly a field for Art-expression (see Fig. 120).

In this kind of work two things should be observed: first, to draw the leaves with strict botanical accuracy, whether in the correct veining and serrating of a leaf, or in the careful copying of petals and calices of a flower; and secondly, to do all this without losing the beauty of natural curve and delicacy of expression which would render it a real work of Art.



Wall.

2/10/77.

FIG. 121.



N.
13 in. high
2^d year
from seed

FIG. 122.

This conscientious and artistic mode of drawing grasses, leaves, and flowers, separately, forms a good stepping-stone to more advanced sketching out of doors. It is desirable



FIG. 123.

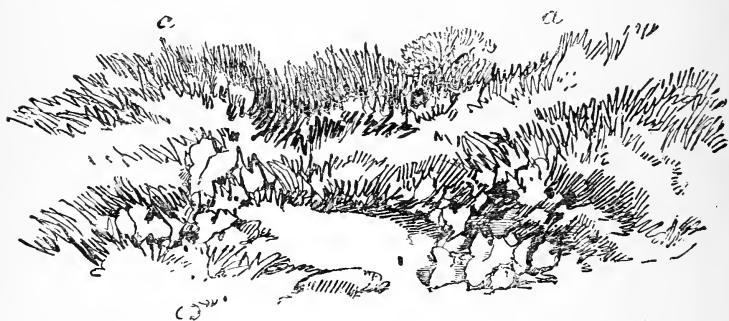

FIG. 124.

sometimes to draw them their natural size, at other times they may be drawn in the pocket sketch-book, as shown in Figs. 121 and 122, when they partake more of the character of 'notes' or memoranda.

238. When sketching grass *in quantity* from Nature, especially when the ground is uneven, it is well to lay in the shade for the denser masses first, as in Figs. 123 and 124, and afterwards to complete by the addition of distinct organic shapes. Sometimes it may be desirable to make quite a study of herbage, as in Fig. 125, but larger. Whatever is attempted should be done with a view to structural truth and artistic beauty.



FIG. 125.

CHAPTER XXIX.

ON TREES.

239. THE representation of these beautiful landscape adornments is confessedly difficult. They are so complex and so varied, that in order to study them satisfactorily we must in some way classify them. But as Art has to do with the *appearances* of things rather than with their physiological structure, our classification must have chief reference to appearances and the modes of representation; and in doing even this we can only notice the broad characteristics, as of Oak, Ash, Birch, &c., and not those finer differences by which we distinguish the Sycamore from the Maple, or the Oak from the Alder, especially when expressed only in black and white. And in this classification we shall, for the present at least, leave out the coniferous trees, and all shrubs such as Rhododendrons, that we may more strongly fix our attention, and more clearly understand the few which we may consider as typical of many.

240. For the satisfactory expression of trees, especially with a point—*e. g.* pen or pencil—considerable practice is absolutely necessary, less in drawing or copying particular trees than in that kind of exercise of shade or of character which will enable us successfully to attempt *any* tree: just

as a vocalist who, before a concert, practises not the song but the 'scales,' so as to prepare the voice for the effort about to be made.

241. It must not be supposed, however, that there is one '*touch*' for one kind of tree and a different '*touch*' for another kind of tree. Even great men have been in danger of falling into this mistake. Constable is said to have told an eminent artist that he had got a 'capital touch for trees.' 'But for what kind of trees?' inquired his friend. 'Oh,' said Constable, 'it will do for almost any sort of tree.' Such an idea we deprecate. In these days of intense observation, arising chiefly from the joint influence of pre-Raphaelism and photography, we are not, or at least ought not, to be satisfied with indefinite and non-characteristic work.

242. If we study carefully a few of what we are calling typical trees, such as the Oak, the Ash, and the Beech, others which are less forceful in their character will readily yield to our efforts. That this may be better understood, we will place them in tabulated form, thus:—

Oak.	Ash.	Beech.
Alder.	Chestnut.	Birch.
Sycamore.	Horse-chestnut.	Poplars.
Thorn.	Willows.	
	Olive.	
	Acacia.	

243. We will consider then, as briefly as possible, each of these leading trees; and in doing so—in trying

to get a tangible idea of them—we must take a sort of diagnosis, and ascertain the *causes* for their appearances. All trees have some things in common, such as roundness and leafiness; but some have a hard and angular appearance, and may be looked upon as masculine in character, whilst others convey the idea of tenderness and gentle beauty. Of the former, the Oak is an example; of the latter, the Birch and the Beech.

244. The appearance of a tree depends mainly—1st, on the shape of the leaves; 2nd, on the arrangement of the leaves on the twigs or on the peduncles; 3rd, on the arrangement of the twigs on the branches, and the branches on the stem.

Although physiologists tell us that each kind of tree has its particular angle of branch divergence, the circumstances of life in the growth of a tree are so varied as altogether to change the normal condition of branching. The great business of a branch is to carry its buds out and up into the warmth and light, and the efforts to accomplish this are sometimes most curious and erratic. Suppose, for instance, that there is a young shoot growing from the stem of a tree, and that the tree is blown down by the wind, but in such a manner as not to tear away all its roots from the earth, though the shoot may remain underneath the tree for a time, the following spring it will be found to have bent round from under the stem, and thus to be carrying its new buds to the light.

Hence it will be observed that leaves and flowers are

more abundant on that side of the tree which receives the most light and warmth, so that the centre of the concentric rings is seldom in the centre of the bole of the tree, as may be seen when a tree-stem has been *sawn* through, as in the rough Fig. 126.

In fact, we may then not only count the years of its growth, but tell, also, the position in

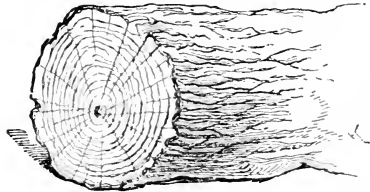

FIG. 126.

which it has grown, and the kind of summer it has probably had for many years past.*

245. The almost infinite variety of leaves, which at first may stagger us, is one of the chief sources of æsthetic enjoyment and of scientific inquiry, for all are obedient to the laws both of variety and of unity. Each kind of tree has its own kind of leaf, which may be distinguished from the leaves of all other trees, yet no two leaves from any one tree are found to be exactly alike—a beautiful example of infinity with unity.

246. We have alluded to the *causes* of this variety in the appearances of trees. We will consider these very briefly, and consequently but imperfectly.

First, then, taking them in the inverse order given, and beginning with the stem, we notice the way in which the leaves start away from the parent stem. They all, of

*This is only the case with exogens—trees which increase from the outside—and not with endogens, such as Palms and Canes.

course, originate in the buds of the previous summer, and it is thus that

‘Another year is hidden along the bough.’

Some leaves diverge from the stem alternately ; others opposite ; others, again, opposite and alternate, as shown in the shoot of Sycamore (Fig. 122). Many trees have their leaves arranged in whorls, as the Oak (Fig. 127), where five leaves form a whorl, the sixth beginning a new cycle.

247. The next cause of variety in tree appearance we



FIG. 127.



FIG. 128.



FIG. 129.



FIG. 130.

may find in the leaf arrangements as they emerge from the buds. The vernation of leaves exhibits in a most exquisite manner the special provision for an endless variety of leaf form and leaf arrangement, and no student should let a spring season pass without making some examinations and observations in this interesting subject, apart from his study of Art.

248. It may be observed that there are cases in which the vernations and shapes of leaves on different trees at first appear almost the same. Comparing the Sycamore

and the Horse-chestnut, we find in each an arrangement similar to that shown in Fig. 132 at *b* ; but as they



FIG. 131.

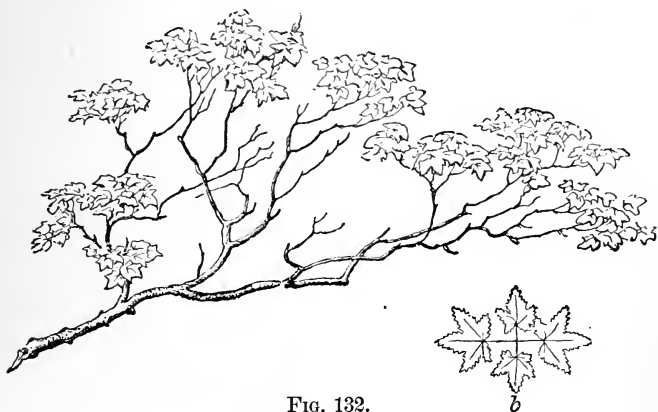

FIG. 132.

develop, the peduncles of the latter lengthen and carry the leaves far out, and form those beautiful digitate masses with which the tree is covered ; whilst the peduncles of

the Sycamore, remaining short, allow the leaves to be sessile, or nearly so, thus making a great difference in the general appearance of the entire tree (Fig. 138).

249. A third cause of variety in the appearances of trees, we have said, arises from the shape of the individual leaves. This, however, has not so powerful or striking an effect as might at first be imagined, as trees are usually viewed at some distance away, and the leaves are seldom separately visible. Still, in some trees, where the leaves are large in proportion to the size of the tree, they are distinctly seen, as in the Horse-chestnut; but this presence of individuality in the leaves of a tree, although pleasant sometimes to look upon, so interferes with the idea of infinity and mystery of leafiness as to make it but seldom used as the object of artistic representation.

250. We must now take one of our typical trees—the Oak (Fig. 133)—and consider how we may best put it on paper, so as to call up in the mind those emotions which the same tree in Nature would give rise to. One thing is certain,—*we cannot copy it*. Even the camera does this but very unsatisfactorily. But though Art cannot copy, it may express on paper many of those properties and peculiarities by which not only the kind of tree, but the individual tree itself, may be recognised. Thus the author some time ago received from a young artist a drawing of a branch of a tree. It was at once recognisable as an Ash branch; and knowing it to be taken from one of some half-dozen trees, and being wishful to verify the work,

he went into the lane, and soon discovered not only the tree but the branch from which the drawing had been made.

In the Oak it is not the serrature of the leaf which affects its appearance in the mass, but the arrangement on the stalk. The shape of the leaf is given in Fig. 128, and its sessile arrangement in Fig. 129, of which a rough contour is given in Fig. 130. It must not be supposed, however, that by covering a given surface of paper with such markings as these, or even with carefully copied Oak-leaves, we shall produce any likeness to a tree. We forget that a tree in Nature does not appeal equally to us from every part. It is only the light parts and the edges that are impressed strongly on the sensorium, and it is, therefore, to these parts that our special efforts should be directed. But what of the shade? it may be inquired. Simply that it must be quiet, for repose is its chief quality, if not its purpose, also; not the confusion or the destruction of detail, but its partial concealment, that those other portions by which we are to recognise the tree may be more conveniently and clearly perceived.

251. In the practice of tree drawing it is often desirable, after a light but accurate sketch or outline has been made for guidance, to divide the work as follows:—First, to lay in the shade, paying attention to its evenness, its gradation, and its intricacy; then to lay in the character or leafage on the light parts and at the edges, with a strong intention of introducing, where possible,

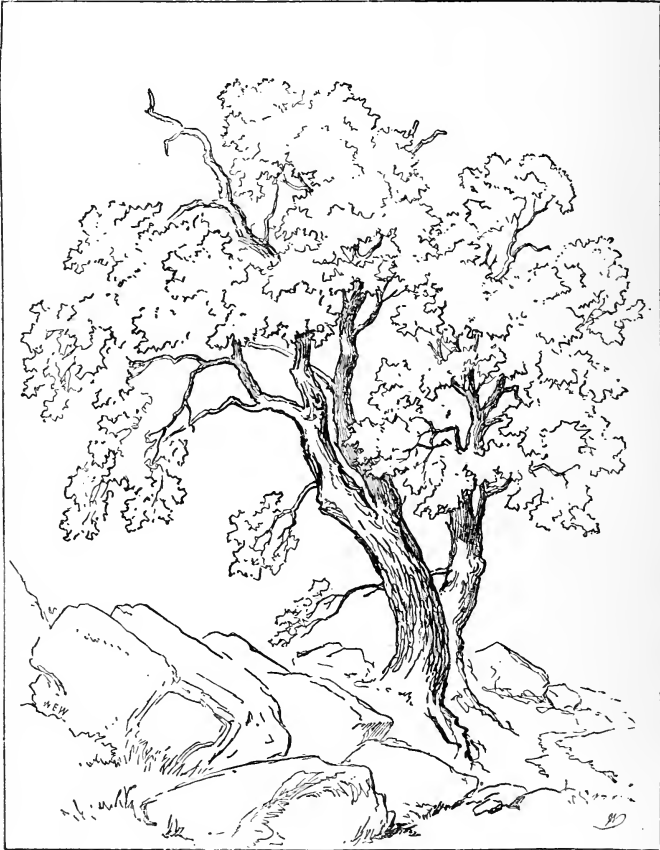

FIG. 133.

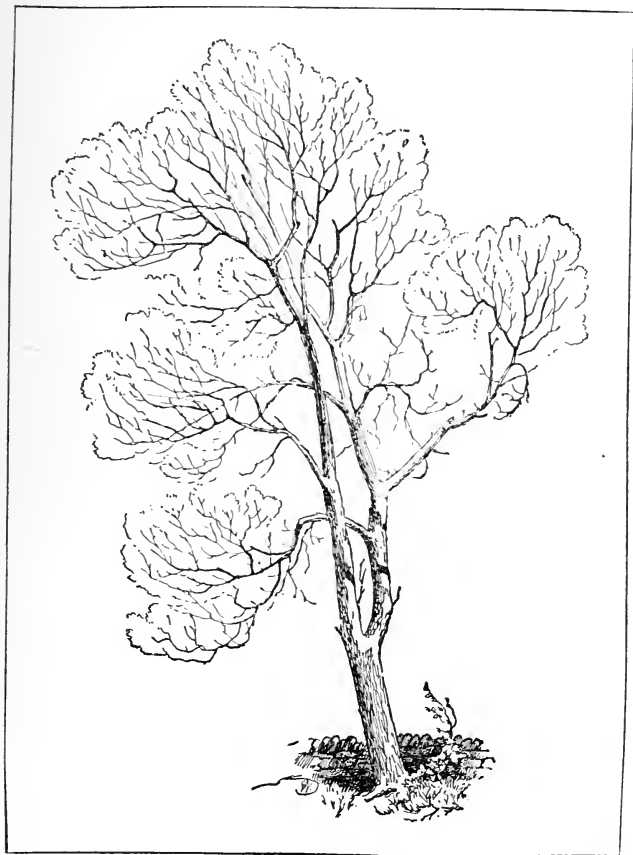

FIG. 134.

actual shapes of leaves instead of mere '*touch*;' and finally, to draw the stem, the branches, and the twigs, keeping the former inside and *under* the tree, and causing the latter to do their work of holding up their leaves to the light. This systematic method of working will be found applicable to any kind of tree drawing. It was the constant practice of that prince of tree-draughtsmen, J. D. Harding.

252. In Figs. 131 and 132 are given small portions of Oak and Sycamore. At first sight they may not seem very dissimilar, but careful examination and repeated inspection, till they become familiar, will reveal a wide difference between them, especially if they be compared with Nature.

253. Taking the next division of our typical trees, we may observe that the normal branch divergence of the Ash, though calculated* as an angle of 60° , does really vary very much, as may be seen in Fig. 134, which was sketched from a tree of probably fifty years' growth. It already shows a great difference of angle between the lower and upper branches, and we may consider this as a usual habit of branches, for they certainly would not grow laterally if they could otherwise get towards the light. This may be well seen in the Sycamore (Fig. 138), where a vigorous branch at *a*, not being able to get to the light by any other means, strikes off almost horizontally to the right, and thus obtains that which was necessary to its existence. The leaves of the Ash are compound and pinnate, as shown in Fig.

* McCosh and Balfour.

135. In studying trees whose masses of leaves are somewhat long and which have a tendency to droop, we should be careful to observe the manner in which they foreshorten, as they retire at the sides of the tree. It might be supposed that perspective had but little to do with trees: in reality it is most important, though greatly neglected even by artists.

254. We will endeavour in a very simple manner to make this understood. The term 'perspective' (*perspicio*)



FIG. 135.

has to do (apart from the atmosphere) with two properties of bodies, their shape and their size: with their shape according to the position in which they are viewed, and with their size according to their distance from the spectator. Figs. 119 and 120 were carefully copied from the same Ivy-leaf, but in different positions. If they were removed to a distance they would look smaller, but the same shape. We may see little perspective in a plain sphere; but if we cover it with a pattern we instantly cover it with perspective. A reference to the rough

sketch (Fig. 136) will make this evident. The centre space has a pattern receding only towards the top; but the other divisions, as they retire to the right and left, have their patterns foreshortened. This is precisely what takes place in trees, and what ought to be expressed in our representations of them. We ought to have regard not only to the foreshortening of large branches and masses, but also to the diminished size of the leaves at the top and sides of the tree, which, being so much further



FIG. 136.

away than those in the front, must of necessity appear much smaller.

255. This application of perspective to trees is very well seen in the Ash, now under consideration, but is equally important in all trees.

256. The many different kinds of Willows, the Olive, and the Acacia, though differing from the Ash both in shape and arrangement of leaf, are placed in the same division, and the same kind of exercise for the one will assist in the expression of the others. The leaf shape

and arrangement of the Olive and of some of the Willows are very similar, and, apart from the colour, scarcely distinguishable.

257. At the head of our third typical division of trees we have placed the Beech, which we will briefly examine.

In most of the trees we have had under review, their arrangements of leaves have been such as to form comparatively large and simple masses of light and shade. In the Beech, as also in the Birch and Poplar, the leaves



FIG. 137.

are so isolated as to make them very difficult to represent except by separate leaf-like shapes; and consequently a readily produced shade, like that in Fig. 137, is no longer applicable, and the danger of laying in a shade with small points is, lest the evenness, so essential to shade, should be disturbed.

258. In the upper part of Fig. 140 is represented a mass of shade, and in the lower a small leaf spray and branch of Beech and Birch, showing the way in which

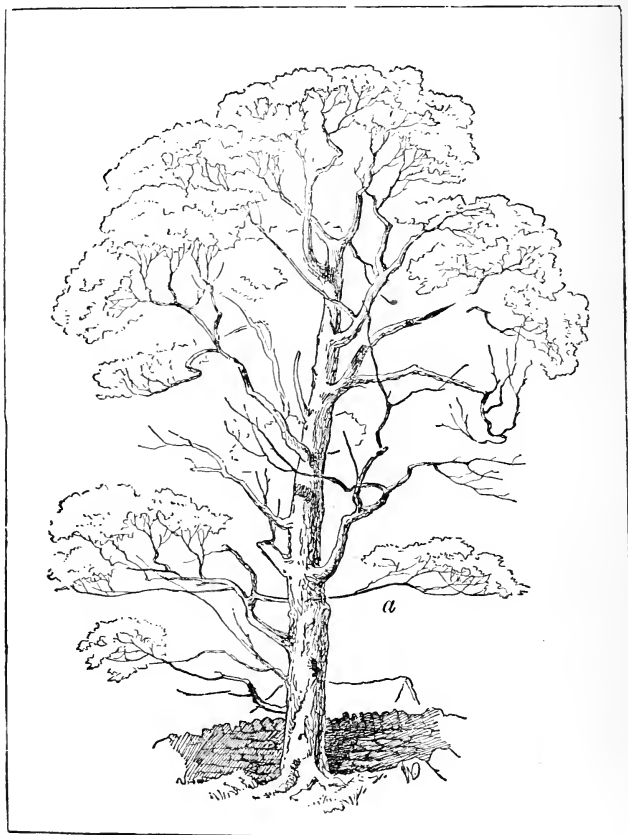

FIG. 138.



FIG. 139.

the leaves are given off from the twigs and branches. The treatment of them in Art, as well as of the White and Black Poplar, is very similar; but the chief difference in the appearance of the entire tree arises from the character of the branches and twigs. The Lombardy Poplar affords an example of extreme acuteness in the branching.



FIG. 140.

The Black and White Poplars, and also the Black Birch, although very divergent in their branching, are sometimes elegant in form, but for exquisite gracefulness of line the Silver Birch (Fig. 139) stands unrivalled.

The stem of the Birch, like that of most young trees, is smooth, and covered with beautiful striated markings; but as it ages, and especially in some soils, it becomes



FIG. 141.

deeply corrugated, like the Oak and Horse-chestnut. The Beech stem retains its smoothness throughout its entire growth, as may be observed in the grand old Burnham Beeches, and in Fig. 141.

259. We have thus briefly glanced at some of the principal English forest trees, with the exception of the Conifers, which seem to form a division by themselves. The principal individuals are the Stone Pine and Scotch Fir, the Spruces and the Larches. In this division we must also place the Yew, whose solemn shade and usual locality so greatly assist artistic sentiment.

260. Until these trees attain considerable age, so as to form large masses, they are difficult to represent truly. Their spike-like leaves, properly called 'spines' can be treated only in the aggregate. In the Larches and Spruces the branch divergence is such as causes the tree to assume a form resembling the cones they bear, strongly contrasting with most other trees. The Stone Pine and the Scotch Fir, when full grown, become very imposing and picturesque, often carrying their dark heads high against the sky.

261. In representing them with a point, the same methodical procedure which has been recommended for trees generally, should be adopted here. In expressing the masses of spines, however, it will be observed that as their position is vertical, the shade preparation for them should be treated more like the preparation for grass in Figs. 123 and 124. The twigs are very numerous and

reticulate, each carrying on its tip a little tuft of spines, as at *c* in Fig. 142.*

262. In a separate Chapter we will endeavour to assist the student in his practice by summarising some essential principles always to be observed in drawing trees, leaving this part of our subject, in the strong hope that he may be induced to study, earnestly and lovingly, these beautiful



FIG. 142.

manifestations of wisdom which form so important a link in the great cycle of created organisms.

263. It would not be desirable, even if it were possible, to give *rules* for drawing all the different kinds of trees: there is, however, one general principle almost universal

* The cones themselves, especially those of the Scotch Fir, are very beautiful objects, and serve as excellent examples for copying practice. When covered with a thin wash of Chinese white, the light and shade on them become more apparent; but this should only be done in early practice.

in its application, which we will illustrate by an anecdote of one who became a giant as a draughtsman of trees. About the year 1824, the late J. D. Harding, then an energetic, inquiring young artist, had fruitlessly sought from eminent artists and 'drawing-masters' some principles for his guidance in Art, which might also assist him in his lithographic work—then a new discovery. He was curtly recommended, instead of asking questions of his 'master,' to go and sketch from Nature, and ask Her. This he did, and on one occasion, when sketching some trees by a large gravel-pit near Greenwich Park, almost in despair at his ill-success, a bright thought crossed his mind. 'These trees,' he said to himself, 'obey laws in their growth: if I can only observe and put down those laws in my drawing, I shall put down TRUTH!' Charmed with his bright idea he gave up his sketching, and hastened to the Park close by, to observe the laws of growth peculiar to the different kinds of trees, and this, he told the author, was the foundation of his success as a representer of trees. His success soon became complete, as was shown in the production of *The Park and Forest*, a work which still remains unrivalled.

CHAPTER XXX.

ON PRACTICE FOR TREE DRAWING.

264. THE beautiful components of the forest—the trees—are so varied and so free in their growth, their long arms waving in the wind, whilst their strong stems sturdily face the blast, that he who in his drawing of them would give the expression of their freedom of life, must himself feel free in manipulation—must work with a sort of controlled *abandon*—full of knowledge of their general character, and of watchfulness of their wayward peculiarities.

265. The student, in practising the exercises here suggested, must be careful to make a distinction between quasi-work and real, intentional work. We have defined drawing as ‘a motion which leaves significant marks,’ and although some of these exercises may at first sight seem insignificant, there must be constant *intention* in producing them, or the result will be mere scribble.

Beginning, then, with the first exercise in shade (Fig. 143), the qualities to be aimed at are three,—*evenness*, *gradation*, and *intricacy*,—keeping the strokes shorter and paler at *b*, *c*, *d*, and *e*.

266. The strokes composing the second exercise (Fig. 144) are not so nearly horizontal, but are tilted, first on one side, then on the other, so as to give a somewhat

angular appearance ; but in all cases of shade, for whatever purpose, there must be such evenness of work as will secure *repose*, without which shade would cease to be. This kind of shade would be suitable for Oak-like trees.



FIG. 143.



FIG. 144.

267. A third exercise may be practised from the upper part of Fig. 139, by making the strokes much shorter, but still keeping the essential conditions of shade just alluded to. As the first example would be suitable for Ash-trees, &c., so this would be for Beech, Birch, Poplar, &c.

268. We now come to the expression of the outer and projecting surfaces of trees. In Chapter IV. it was shown that a flat contour or outline could be greatly modified by the addition of surface markings. The direction of a line will often indicate the direction of a surface; and this should be constantly borne in mind in practising the exercises which follow. In the first one, Fig. 145, which should be repeated very often, the lines at *a* and *a* should incline upwards, so as to form the groups like *c c*,

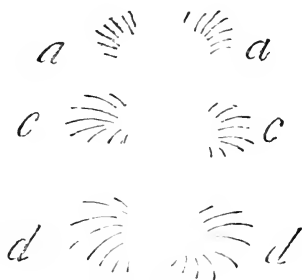

FIG. 145.

and afterwards bend down in the manner of *d d*, always being emphasised at their outer edges. These should be drawn of various sizes, gradually increasing, so that the power may be acquired of expressing them perfectly, and with great facility.

269. This may be followed by Fig. 146, which assumes a little more the appearance of tree form.

In Fig. 147, at A, is given a simple outline, with no detail on it; but in B some additional character is added, as shown at *b b* and *c c*, by which considerable rotundity is



FIG. 146.



A



B

FIG. 147.

given to the original disc-like shape of A. It is this rotundity and flexibility which must be continually aimed at in the expression of foliage.

270. When these outline and shade exercises have been well practised separately, we may attempt to put them



FIG. 148.

together, and add stems and branches; but in doing this let it be well borne in mind, that as most of the shade parts are intended to retire, the outline of the light masses should impinge a little on the shade, and also that the stems, being cylindrical, must be shaded accordingly. This is shown in Fig. 148.

271. We have thus endeavoured to show a *modus operandi* by which trees may be successfully attempted with the point, as of a pen. The pencil and the brush are, however, much more suitable and powerful instruments for Tree representation, and when the student has leisure to follow up the subject further, he may be referred for help to *Elementary Art*, and to *Lessons on Trees*, by J. D. Harding, or to the author's own work, *Forest Trees of British Landscape*.



CHAPTER XXXI.

ON WATER.

272. THE representation of water in drawing, owing to its mobility and transparency, is difficult, except when perfectly still; and much unnecessary difficulty in the study of reflections in water also arises from confusing the idea of *Shadow** with that of Reflection. For the existence of the former some opacity is necessary; for the latter, no opacity, but at least a polished surface.

273. By 'reflection' is here meant the image or picture caused by rays or beams falling from any object upon a smooth surface, such as glass, water, polished metal, &c., and being thrown thence on to the eye.

In all cases where light falls, or, speaking technically, is incident upon the surface of a solid or a liquid, the reflection is partial; that is, some of the rays are absorbed.†

* The fable of 'The Dog and his *Shadow*' is quite a misnomer; it ought to be the Dog and his Image.

† At a perpendicular incidence water reflects only 18 rays out of every 1000.

At an angle of 40° water reflects 22 rays out of every 1000.

"	"	60°	"	"	65	"	"	"
"	"	80°	"	"	333	"	"	"
"	"	89° $\frac{1}{2}$	"	"	721	"	"	"

TYNDALL.

274. When a beam of light passes obliquely from one medium to another, as from air into water, *refraction* (a breaking or bending of the rays) takes place, as may be seen by putting a spoon or a pencil obliquely into a tumbler of water; but as refraction takes place *in* the water, and reflections are seen *on* the water, we need not at present trouble ourselves about it.

275. For the full understanding of this complex subject some knowledge of the laws of optics is necessary; nevertheless, much may be learned by a few simple experiments and observations: and first, it had better be

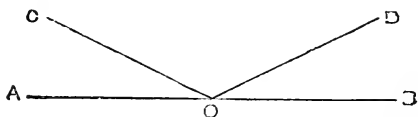

FIG. 149.

studied in its simplest form—reflection on an absolutely calm surface, and for our purpose now, a mirror (an ordinary hand-glass will suffice) laid flat on the table shall represent our sheet of water.

276. Before proceeding further with the experiment, it had better be explained that the angle of reflection and the angle of incidence are always the same. Thus, in Fig. 149, let A B represent the level surface of water. It will be seen that the angle, A O C, is equal to the angle, B O D. It is just so in Nature.

277. Or it may be put thus (Fig. 150):—Let A B, as before, represent the level water, and A O C and B O D equal

angles. Further, let the eye be supposed at *c*, looking towards *o*, and *E* be an imaginary spectator *under* the water. *c* would see reflected at *o* what *E* would see on the line *o D*. Returning now to our sheet of water—the

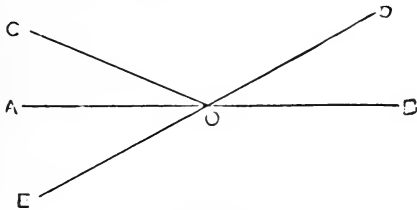

FIG. 150.

hand-glass—put upon it some oblong bits of wood or cork, fixing into them pins for masts, and pieces of paper for sails. Behind these, on the edge, we may place a book to represent upright rocks, and a crumpled pocket-handkerchief or piece of newspaper for the retiring banks.

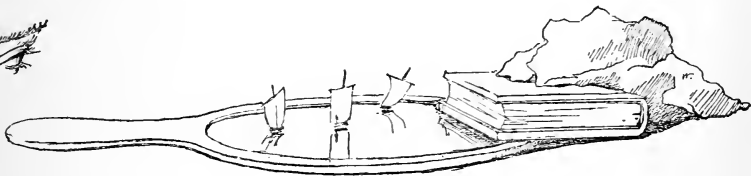

FIG. 151.

We can now observe the various reflections from various elevations, from the shore or looking-glass level, higher and higher. (See Fig. 151.)

278. The picture or image in calm water is, however, not an exact inverted reproduction of the object as we see

it on the shore, but often a reproduction under an entirely new arrangement. For instance, a spectator viewing Fig. 152 (Frontispiece), though he could not be cognisant of what was under the roof, would readily see it reflected in the water. So, also, the reflections of birds must be inverted.

We are at present only on the very confines of the infinity of facts to be observed in water reflections, and we shall not here attempt to go beyond the threshold. We have hitherto been on smooth water: let there come a breath of wind, and the water is broken up into millions

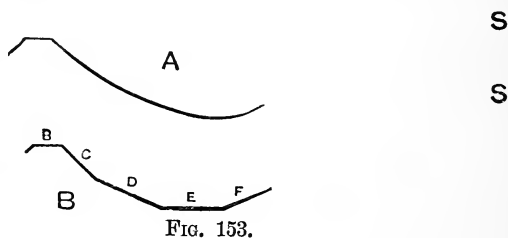

of surfaces, each little wavelet carrying on its back or in its bosom an expanded or contracted image of all it reflects. When we consider the rendering of a single wave in colour, the difficulty becomes more manifest. For instance, let us imagine an artist attempting to paint a wave in a sunset, as represented by the rough diagram in Fig. 153, seen from s.

But, to make our explanation more simple, instead of the curved lines as at A, we will substitute a few straight lines, which shall indicate the general direction of the principal curves as in B.

In accordance with what has been said, the colour of the sunset sky would be reflected chiefly on the planes, B and E; at C would be reflected the sky behind the spectator, S, whilst at D would be seen the image of the sky at the zenith.

279. What is here shown is only a part of the difficulty, for in the diagram only one direction of curvature is supposed, and a wave is often made up of curved surfaces in every direction, and has its sides covered with minor waves. When, in addition to this, we remember that water as found in lakes is seldom quite colourless, owing to particles of earthy matter held in suspension, each particle receiving its ray of variously coloured light, and affecting the colour of the water accordingly, the complexity becomes infinite and inimitable.

280. Sometimes on a smooth lake there is what Hamerton appropriately calls '*invisible motion*'—a slightly tremulous movement in water, *entirely invisible in itself*, yet strong enough to elongate a reflection. It is only by this elongation of reflection that we can become conscious of this '*invisible motion*.'

281. Sometimes a very gentle wind will come down on to some parts of a lake, rasping its surface into myriads of wavelets, and leaving other parts in perfect calm. As the wind increases, the condition of the water becomes a '*ripple*,' in which every *recognisable* reflection is destroyed, and then the water often becomes leaden in colour.

282. Although water in itself may be considered colourless, there is usually in it some matter which gives

it a decided colour. The Rhine, Lake Lucerne, Loch Awe, are all different in colour from this cause.

283. From what has here been said respecting reflections in water, it will be evident that, though the principal laws respecting it are few and simple, the *facts* connected with it are so varied and varying that it is seldom safe to attempt a representation of it, either in its wave form or in the rippling brook, except in the immediate presence of Nature. Neither is it desirable that we, in our ignorance, should be too ready to criticise the works of those who, after having lived near and on the water, and studied it in its infinitely varying phases, declare the impossibility of truly representing it.

284. Perhaps the most truthful painter of these restless forms at the present time is Mr. Francis Powell, who, by living amongst them, and for many years making them his objects of special study, has attained great knowledge of their nature and great skill in depicting them.

CHAPTER XXXII.

ON SKIES.

285. THE reasons why this subject is brought into this work are—1st. Because it is usually utterly ignored by most teachers, or seldom alluded to in the drawing-class except in the most casual way. 2nd. That the intelligent study of it is a source of highest and purest gratification. And, 3rd. That there does not seem to be known any recent small work that could be put into the hands of a student as a sort of first stepping-stone towards more advanced knowledge of the subject.

286. Ruskin says :—‘It is a strange thing how little in general people know about the sky. It is the part of creation in which Nature has done more for the sake of pleasing man, more for the sole and evident purpose of talking to him and teaching him, than in any other of her works, and it is just the part in which we least attend to her. There are not many of her other works in which some more material or essential purpose than the mere pleasing of man is not answered by every part of their organization ; but every essential purpose of sky might, so far as we know, be answered, if once in three days, or thereabouts, a great rain-cloud were brought up over the blue, and everything well watered, and so all left blue again till next time, with perhaps a film of morning

and evening mist for dew. And instead of this, there is not a moment of any day of our lives when Nature is not producing scene after scene, picture after picture, glory after glory, and working still upon such exquisite and constant principles of the most perfect beauty, that it is quite certain it is all done for us, and intended for our perpetual pleasure.'

287. By sky we do not here mean merely the blue space above us, but, using the term in an artistic sense, the clouds also, with all their various visible phenomena and infiniteness of variety.

We shall give only such hints respecting it as will in some measure prepare a student for the enjoyment of that part of our world to which we owe so much, and yet of which we observe so little.

288. The earth is surrounded, to a height of from forty to fifty miles, with what is known as the atmosphere, which is composed of various fluids, such as air, aqueous vapour, &c., and which, like other bodies, gravitates towards the earth.

Air, one of these fluids, is invisible, colourless,* elastic, and easily moved, rarefied, and condensed. It is seldom pure, but is generally mixed with water in a vaporous and invisible state. When there is very little water or vapour in the air, the sky appears blue—not like a painted ceiling or vault, but blue space, that we cannot so much look at as *into*. Let this be well remembered.

289. If we blow from a pipe of tobacco some fumes

* Like water, its colour is perceptible only in deepest depths.

(unconsumed tobacco), the particles will be so distended that they will float in the form of clouds in the air.

If we get a little cotton wool and roll it into a pellet or marble form, we by this means make it so dense that it may be thrown some distance, or it may fall quickly to the earth. Let this pellet of cotton wool represent our drop of water. If it be pulled out or extended as much as possible, it will become so light, relatively to its bulk, that it may be blown about. This will represent, in a rough way, our drop of water with its particles so separated that it will float in the form of cloud.

290. When some of the invisible moisture with which the air is charged is condensed (*i. e.* its particles become closer) through a chill, it immediately assumes visible form as vapour.

If the air happens to be heavily charged with this invisible moisture, and is then suddenly condensed, the clouds become thick, opaque, and heavy, as in a thunder-storm, and fall to the earth in large drops.

When a cloud is formed, it will float high or low according to its density in proportion to the surrounding atmosphere. Thus, then, we have an atmosphere about us more or less charged with invisible moisture, amongst which there may float that same air, locally condensed and made visible, in the form of clouds. How or why these forms should float separately in a liquid of the same constituents as themselves was asked many thousand years ago, but we doubt if it has yet been fully or satisfactorily answered.

291. For convenience of study clouds are usually arranged in groups, and we cannot do better than adopt Mr. Ruskin's arrangement and nomenclature : though not fully complete, it will prepare the student for further and fuller observations.

‘ Thus the atmosphere may be conveniently considered as divided into three spaces or regions—the upper region, or region of the *cirrus* ; the central region, or region of the *stratus* ; the lower region, or region of the *rain-cloud*.’

292. ‘ The CIRRI may be looked upon as never formed below an elevation of at least 15,000 feet’—never touching even the highest mountains of Europe. ‘ They are the motionless multitudinous lines of delicate vapour with which the blue of the open sky is commonly streaked or speckled after several days of fine weather.’ According to their shapes they are vulgarly known as ‘ mares’ tails’ or ‘ mackerel’ skies, and are often arranged in almost parallel lines, and sometimes, when driven by the wind and seen in perspective retirement, present a most exquisite appearance. Mr. Ruskin says, ‘ They differ from all other clouds in having a plan and system ; whereas other clouds, though there are certain laws which they cannot break, have yet perfect freedom from anything like a relative and general system of government.’

The direction of the wind may generally be determined by the shape of these clouds, though they themselves may for a time appear motionless. Owing to their quietness and multitude they may, as the same author remarks, be conveniently designated as ‘ cloud-flocks.’

293. The CENTRAL CLOUD region, or STRATUS, may be considered as including all those masses of visible floating vapour lying between the *cirri* and the true rain-cloud. They are known also as the *cumulus*, from the fact of their piling up in huge masses over each other. They are often so large that they cannot be seen entire, except at a distance of some miles away, and as they are often so seen in perspective, we are liable to forget their true shapes and formation, and what is going on amongst them. If we were to stand in a dye-house, and were surrounded by cauldrons of boiling water, we should have a very miniature of what takes place in the formation of these grand shapes on some of our high mountains.

Sometimes a huge mass of *cumulus* will be piled up, and for a time appear almost motionless, till, moved by a gentle wind, it may float slowly away, gradually changing its form, till, having travelled perhaps fifty or a hundred miles, it becomes elongated, and is then called *cumulo-stratus*. If these elongated masses are at a great elevation they are called *cirro-stratus*. Mr. Ruskin gives them the appropriately poetic name of 'cloud-chariots.'

The Figs. 154 and 155, here sketched, will give only a very rough and imperfect idea of the piling up of clouds, which sometimes rise to a height of 20,000 feet, and of the effects of travel upon them.

294. It must not be supposed, however, that the wind is the only or chief agent in the formation and shaping of clouds, so much as the change of temperature arising from electric and other conditions, for in some cases the cloud



Fig. 154.

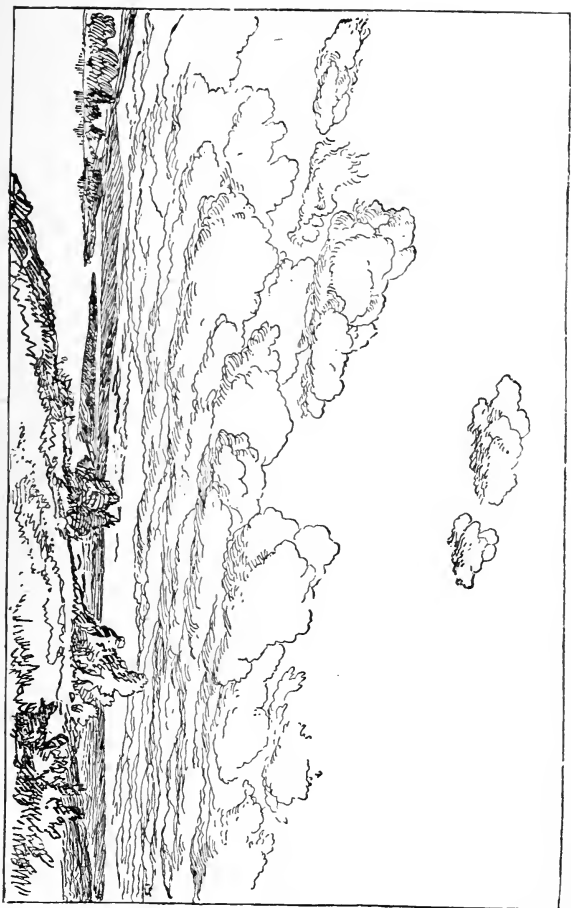

FIG. 155.

is the cause of the wind. The author has often watched from his window* masses of vapour, following each other up the valley, disappear at one particular place, and re-form again as soon as the (probably) warm air had been passed.

295. The third division of this cloud arrangement is the rain-cloud region, possibly at first thought not so pleasant to contemplate, yet that to which is attributable most of the daily beauty of English landscape. It must not be supposed that when a rain-cloud is spoken of it is necessarily in a state of rain; far from it. The clouds of the middle region already referred to deposit moisture, if not rain, have mostly pure aerial greys for their dark sides, and, owing to their distance, can be more definitely seen in their entirety than the rain-clouds proper. The nearness of these latter prevents some of the characteristic phenomena and the sometimes definite outline being easily studied. They are often only thin mist, the outline of which cannot be traced, and by which the landscape is rendered indistinct. Sometimes this mist is seen in definitive form moving along in columns, and its lower edges fringed, and sometimes twisted, by the wind. At other times, viewed from a high mountain, it may be seen miles away, floating over a sunny landscape towards the spectator; and presently it may envelop him, completely conceal everything more than ten feet away from him, pass away, and leave him entirely unwetted. Occasionally amongst the mountains a cloud may be seen like a huge monster crawling slowly about, as indicated in Fig. 156.

* Under Kinder Scout.

Fig. 157 was etched from a photograph taken on Pike Mount, looking down on to an ocean-like mass of clouds. As there were no clouds above to reflect the light back on to the shade side of the rocks, they are nearly black.

296. To the region of the rain-cloud belong all those phenomena of drifted smoke, heat-haze, local mists in the morning or evening, in valleys, or over water, white steaming vapour rising from moist and open surfaces, and everything that visibly affects the condition of the atmosphere without actually assuming the form of cloud. These phenomena are as perpetual in all countries as they are beautiful, and afford by far the most effective and valuable means which the painter possesses for modification of the forms of fixed objects.

297. In giving this brief and necessarily imperfect description of the principal regions into which, for convenience of study, the firmament is divided, no allusion has been made to the marvellous exhibitions of colour which frequently present themselves. In a work though devoted to this subject alone it would be utterly impossible, even in these days of advanced scientific inquiry, to account satisfactorily for many of the infinite phenomena, or to explain lucidly what is already ascertained of their nature. If the earth on which he treads is covered with objects for the student to study, so also are the 'heavens' and the firmament filled with ever-changing material for contemplation; but let the reverent inquiry be on his lips,—'Dost thou know the balancings of the clouds?' and the constant conviction on his heart that 'HIS ways are past finding out.'



FIG. 156.

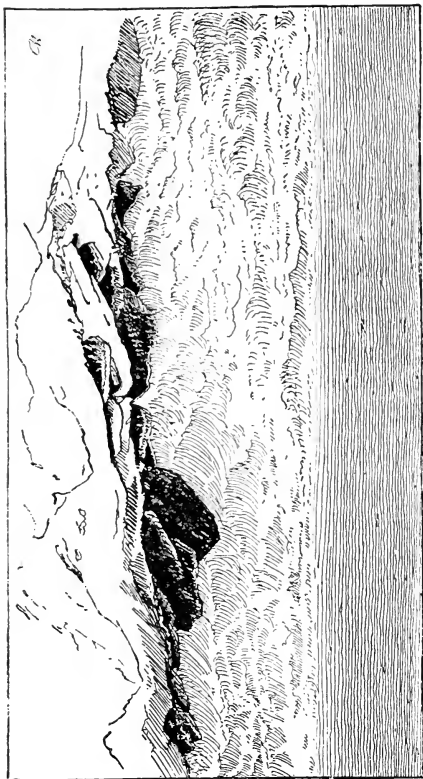

FIG. 157.

CHAPTER XXXIII.

ON DRAWING FIGURES AND ANIMALS.

298. It may have been observed that the teaching of this book has reference chiefly to Landscape Art; therefore figures are here treated of only in the aspect of accessories, and not as principal features in a picture.

299. If the student wishes to draw the figure otherwise than in a subordinate relationship—if he seeks to make it the prominent part of his picture, as in Historical subjects—he must patiently go through a regular and severe course of study from the cast and from the living model, supplementing it with Artistic Anatomy. How certainly necessary this is may be discovered if the student will attempt to draw the figure of a man from Nature on a moderately large scale, either still or in motion, previously to this suggested course of training.

Hence, Figure-drawing should be made a specialty, and studied apart from all else, that, by knowledge and practice, the power may be the more quickly gained to draw it with perfect accuracy, for of all false representation, bad figure-drawing is the most intolerable.

300. When figures occupy an important place in the

foreground of a Landscape, they require a proportionate amount of attention to individuality and detail.

Speaking generally, rocks, trees, foregrounds, &c., are principal elements of Landscape, as figures are in Historical pictures, and the same amount and kind of study that is spent on the one ought to be devoted to the other.

301. But even when figures occupy only a subordinate position in Landscape work, and their *general character only* is required, there are yet difficulties and peculiarities which will demand careful attention and study.

When it is proposed to make this use of figures or animals, a primary consideration ought to be, *Why* should they be introduced? What purpose have they to serve? What figures or animals, and what positions or arrangements, will best answer the purpose, whether for the idea of activity, or repose, or any other?

The introduction of figures in a work must, of course, be governed by the laws of composition and perspective: in the former as to position, posture, and relationship to surroundings (see Chapter on Composition); and in the latter as to size.

The importance of the right introduction of living objects in a drawing will be more strongly felt if the student will cover with his finger the figures which are used in Fig. 158, or even the birds in Fig. 159.

302. Perhaps the best way to obtain the power to draw the figure for Landscape purposes is to be constantly making notes and memoranda in the pocket sketch-book of all sorts of figures, in every variety of

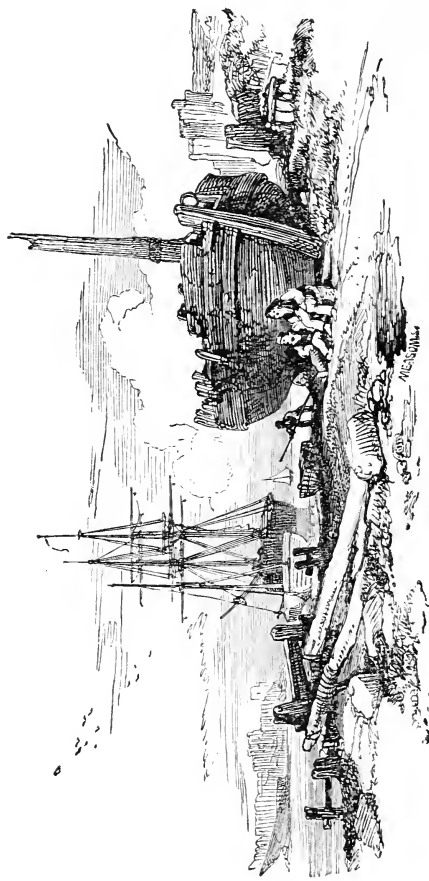

FIG. 158.

Fig. 150.



circumstance, costume, and position, combined with more deliberate effort on a larger scale whenever opportunity may occur. And in making such notes and studies a first inquiry should be,—In what does the vitality, and spirit, and charm of that figure lie? and then the aim must be to express this. It will often be found in a scarcely perceptible bend of line, or touch of dark, or in some subtle arrangement of colour.

303. If we consider well the works of Turner, Stanfield, Copley Fielding, J. D. Harding, David Cox, and many others, we shall find that they appear to have aimed at expressing their figures and animals in a *general* way, but always truly in their forms and tendencies, seldom attempting any detailed facial or bodily expression. They should be drawn as they would be *felt* when looking at the picture, rather than as seen when looking directly at them alone. If, when we observe one of Prout's figures, we expect to find in it a likeness to nature, we shall be disappointed; but his figures taken as parts of a whole picture are in admirable 'keeping' and harmony.

304. Some elementary rules applicable to the drawing of figures have already been given in the earlier chapters of this book. In all cases both figures and animals should be 'blocked in,' so as to secure their correct proportions, and in this respect no examples can be better than the figures in such a work as Prout's *Microcosm*.*

As Prout's work may not be readily accessible to the

* A number of these are reproduced in *Lessons on Animals*.

student, a few simple illustrations are given in Figs. 160, 161, and 162. They are expressed by few but *main* lines, which suggest blocks in shape.



FIG. 160.



FIG. 161.



FIG. 162.

In Fig. 163, after J. D. Harding, the block-like shapes are somewhat softened and rounded, so as to accord with the work for which they may be intended.



FIG. 163.

CHAPTER XXXIV.

ON CRITICISM.

305. No person goes through an Art Exhibition without criticising, and usually the most uncompromising critics are those persons who, when asked, will be ready to say they don't know much about it, only they know what they like. A great many mistakes are made by persons who ought to know better. No sensible person would venture to question the accuracy of a work on Chemistry or Geology, but almost everybody has his opinion one way or other about Art, and seems more anxious to get truth over to his side than to get himself on to the side of truth. F. W. Robertson says, 'For every kind of truth a special capacity or preparation is indispensable.' Criticism, like most other arts, has its rules and modes of procedure. It should be indulged in sparingly by a student; *his* work should be that of inquiry rather than criticism—to seek knowledge rather than to pass judgment, except on his own works. Safe and accurate Art criticism can only result from a knowledge of the history of Art, of its principles and practice, and from a correct taste. And by a correct taste is meant the faculty—whether the gift of nature or the result of culture—by which we intuitively and instantly select that which is

true and beautiful in preference to that which is false or ugly.

306. Whether we are in a position justly to judge of an historical work will depend largely on our knowledge of the history and circumstances of the particular event represented. In the case of a landscape, too, so varied are the appearances in any one locality in the course of a few hours, that in the work of an able and honest painter there is great danger of error in criticism. In such instances we should remember that the work we propose to examine is probably the result of much deliberate thought, knowledge, and victorious battle with difficulties, totally unknown to the critic, and that the artist, having put his expressions on to the canvas, however unjust his critic may be, has no means of reply. It is quite painful to a sensible man to hear the silly and thoughtless remarks of ignorant pigmies, as they sit in judgment on the thoughtful works of great artists.

307. In public criticism the attitude of the critic is supposed to be strictly judicial, and this implies not only the presence of evidence, but a knowledge of the character, condition, and application of such evidence. Further, in criticism, especially when it happens to be of an adverse kind, it should always be considered whether the author whose work is under review has the opportunity of reply or defence.

308. When, as students, we *have* to form an opinion of a work of art, it is desirable to make ourselves acquainted with the central or main idea of it, and then to consider

whether or not the artist has fully and fairly overcome the difficulties that may have surrounded his work, whether that work be imitative and simple, or great and creative.

309. 'There are two marks which characterize every really great work of fine art.'* The *first* of these marks is that it must embody a *creative thought*, that it must exhibit the power of the human spirit to seize, shape, vivify, and subdue under its own dominion the dead matter of unformed impression presented to the mind in the two universes of external nature and internal feeling. And then, in addition to this character of creativeness, a *second* mark is required to distinguish æsthetic from scientific production. While Science values each new thought only as a fresh step towards the intellectual comprehension of the whole universe, the artist confines himself to thoughts which possess for him a value quite independent of the inference that may be drawn from them for a more general body of truth—thoughts to which he can give a more general expression, without caring to use them as a means to a remoter end. In a word, every work of art is a product of creative thought, having its end within itself. In Science the joy of each new attainment is absorbed in the fresh impulse to further pursuit of truth; the search for knowledge knows no rest till the whole universe has been subdued. A work of Fine Art points to no end beyond itself, and urges directly to no activity save that of enjoying to the full the satisfaction that accompanies

* This view of the character of Fine Art is ably expressed in an article in the *British Quarterly Review* for January, 1877.

‘every exertion of completed mastery of thought over matter.’

310. Although a fine work of art must in some measure, and sometimes in a great measure, be imitative of nature, yet it is so only in the highest sense when it partakes of the nature of a creative act.

It is with such views of Art in our minds that we should approach the object of criticism; for assuredly, if we criticise a work ignorantly or unjustly, whether we injure the work or its author or not, we damage ourselves, and criticism indulged in without reason, large knowledge, and a sound mind, may soon develop into cynicism.

311. We cannot but think that the unmeasured and severe remarks of our most elegant Art critic, John Ruskin, in some of his early writings on the works of living artists, was not only a presumption and an ungenerous act, but also mischievous in making a precedent which has unfortunately become a fashion amongst unlearned people. *Obiter dicta*, equally in criticism as well as in discussion, should have no place; and criticism, when it condemns, should give its reasons.

PART II.

CHAPTER XXXV.

ON PERSPECTIVE.

INTRODUCTORY REMARKS.

312. MANY people imagine that anybody with eyes must surely be able to see correctly the appearances of things without the trouble of learning Perspective; but most persons need only make the attempt to draw a few rectangular objects, such as books, boxes, or doors, to discover how uncertain and helpless they are in the matter of seeing.

313. The fundamental principles of Perspective are extremely simple, and may be understood by a child; but the technical application of its rules to irregular and complicated forms is difficult, and may tax the powers of an able mathematical mind.

314. It is important that the term should be well understood, as there is often much misapprehension and confusion respecting it as a science, both theoretically and in its application.

In nine-cases out of every ten objects appear different from what they really are; Perspective, therefore, may be

briefly defined as the *art* of representing things as they appear to the eye of a spectator, and as the *science* which enables us to represent objects when they appear different from what they really are.

315. Practically, Linear Perspective may be divided into Artistic Perspective, as used by artists, and Technical Perspective, as used by architects and others. In the one case the Perspective *is evolved from the object*, as when an artist sketches from Nature; whilst in the other, the object *grows out of the application of the rules of Perspective*.

When an artist sketches from Nature—say, some buildings—he makes certain *observations*, such as the level of his eye on the buildings, the inclination of any principal receding lines, by which he determines his vanishing points, &c.; and these observations, together with pencil-in-hand measurement, furnish him with much of what he will require to get the work in true perspective.

These '*observations*,' accurately made, form the '*data*' by which he will work out his outline, and thus, as his observations are made from the objects themselves, the Perspective grows out of the act of drawing.

316. An architect often requires a view of buildings, which he intends to erect, before they have any existence in fact. Of these intended buildings he will require to have '*ground-plans*,' '*elevations*,' '*measurements*,' &c., together with certain '*data*' (to be hereafter explained); and from these, by the rules of Perspective, he will be able to show his edifice as it will actually appear when erected.

317. The purpose of Perspective covers much more

than the representation of regular forms, such as boxes, buildings, &c. ; it has to do with the form and size of every object, regular or irregular, that comes before the eye—with the *form* according to its position, and with the *size* according to its distance. Even in the little sprigs or whorls of Oak (Figs. 164 and 165), every leaf is in perspective; so, also, it is with an entire tree. It is the forgetting of this fact that causes many persons in drawing trees to fail, because



FIG. 164.



FIG. 165.

they make the leaves at the top and sides of the tree as large as those which are nearest. In figure drawing it is equally applicable, from the foreshortening of a finger-nail to that of an arm or a leg.

The work of Perspective, then, is to translate FACTS into appearances.

318. There are two kinds of Perspective, Linear and Aerial; the former concerns itself with the appearances of objects as they are represented by lines, and the latter as they are affected by the atmosphere. (See Chapter on Skies.)

Hence we should never forget that we are constantly surrounded by Perspective—Aerial or Linear—in almost everything we look at.

CHAPTER XXXVI.

ON ARTISTIC PERSPECTIVE.

319. WHAT is here termed 'Artistic' or 'Pictorial Perspective' is the method constantly used in drawing

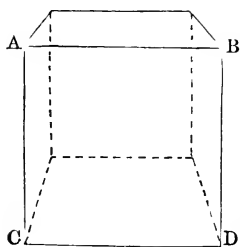

FIG. 166.

from Nature; and some hints and illustrations respecting it are given, beginning with a very simple example, the *parallel* view of a cube, as seen in Fig. 166. Here the cube* must be put not only parallel, but directly in front of the spectator.

In copying it from the model, first draw the front square; then determine the relative height of the eye with regard to it in order to fix the vanishing point, which in parallel perspective is not only on a level with the eye, but always

* A cube—the larger the better—should be placed before the student in all exercises in Perspective. One may readily be made of cardboard, thus:—Cutting the board half through where the dotted lines are, that it may fold more easily (see Fig. 167). A set of cubic models would be of great service, as affording greater variety.

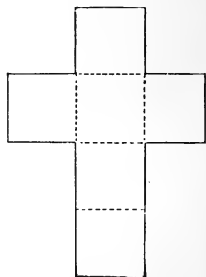

FIG. 167.

opposite to it. Towards this point draw lines from A and B. Next ascertain by pencil-in-hand measurement (see Appendix C) the apparent height of the back line from A B, and draw it parallel to A B. A book placed in front of the spectator, like Fig. 168, would be drawn in this manner. A parallel view of an object may be defined simply as one having its principal plane parallel to the spectator, and clearly visible without moving the eye. If the eye moves, the view at once becomes panoramic. The angle of vision,* though to a limited extent optional,

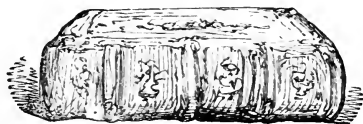

FIG. 168.

should not exceed 60° , especially in the representation of right-angled forms. This limited angle of vision is less important when representing irregular forms, such as mountains, trees, or clouds.

320. Fig. 169 is the same cube as seen when placed a little below the eye and to the left of the spectator, and should be drawn in the same manner from the model. The height of the back line from the front square, obtained as in the previous case, determines the width of the side. The chair in Fig. 170 would be drawn in the same manner.

321. Where there are several parallel faces, as in Fig. 171, all the front planes should first be drawn, and

* Known as the 'cone of visual rays.' (See Chapter XXXVII.)

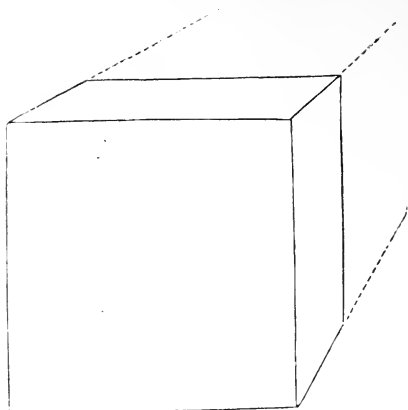

FIG. 169.

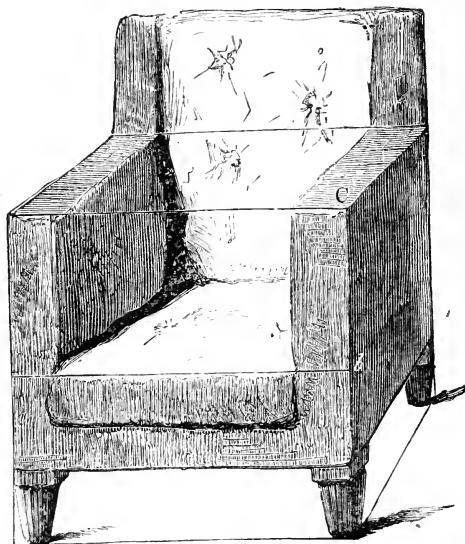

FIG. 170.

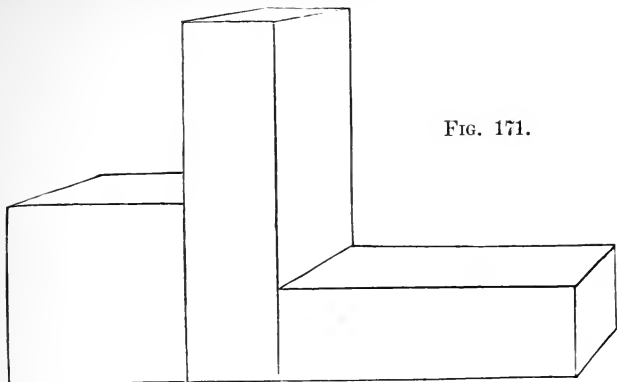

FIG. 171.

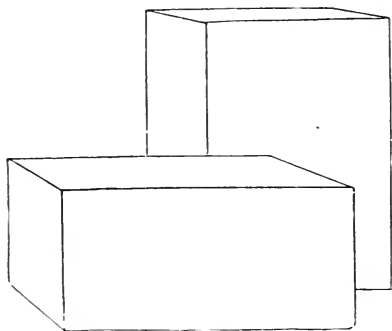

FIG. 172.

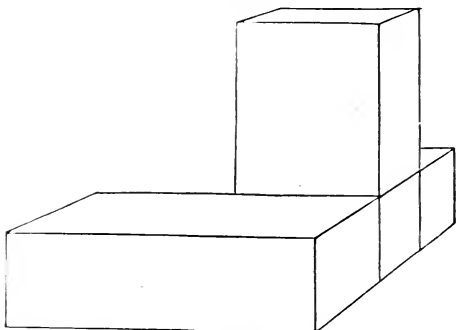

FIG. 173.

then the vanishing point and distance of back line determined on, as in the previous cases. Some objects—as, for instance, a flight of steps—it would be almost impossible to draw correctly without a fixed vanishing point,

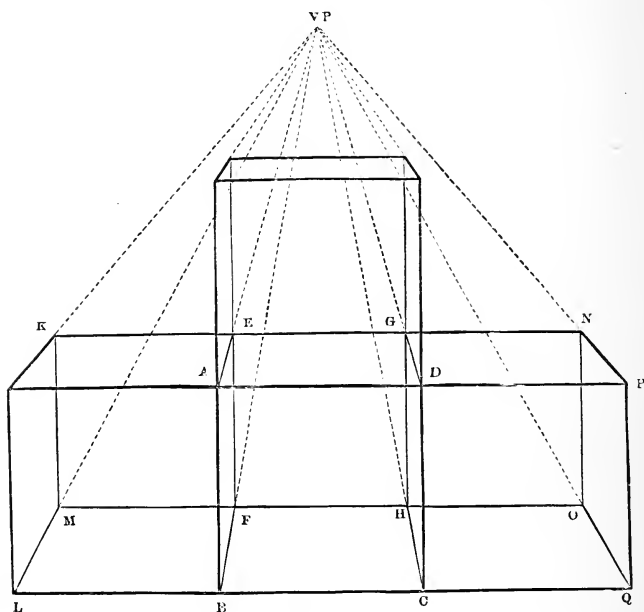

FIG. 174.

whereas with a point, and by means of this simple mode of procedure, the work is made quite easy.

322. When one block or object stands nearer to the spectator than another, as in Fig. 172 or 173, it is best to complete the front block first, and afterwards to draw the one behind.

323. In Fig. 174 is shown how cubes may be represented when transparent, and in Fig. 175 how a number may be represented in proper retirement behind each other. When the first, or middle cube, has been accurately drawn, the others may be readily found by using

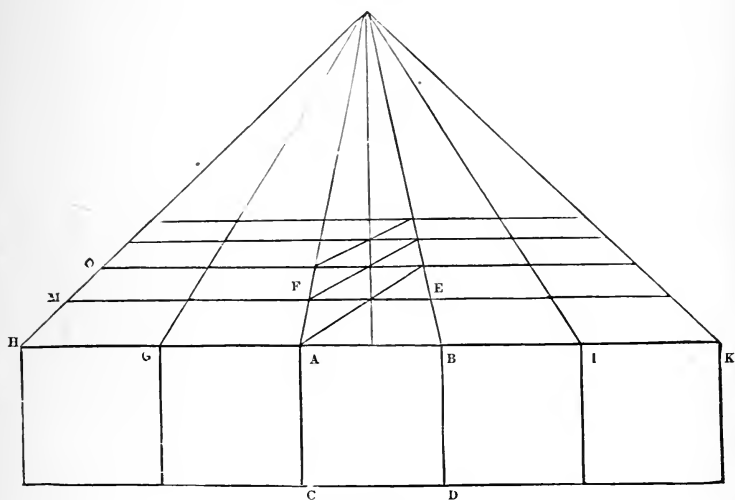

FIG. 175

the same vanishing point, and in the latter figure the diagonal line from A, which bisects F E, and gives the proportionate width of the next squares.

324. In each of the foregoing examples the object has been represented as seen *below* the eye, and consequently with all the receding lines slanting *upwards* towards the vanishing point opposite to the eye. If the objects,

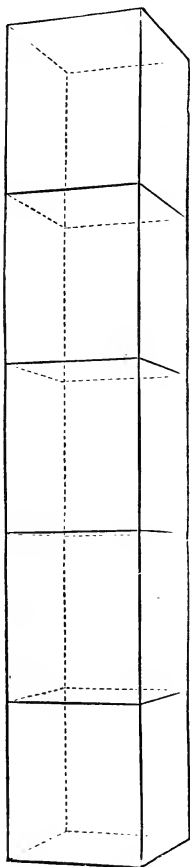

FIG. 176.

however, be placed *above* the eye, like the upper cubes in Fig. 176, the receding lines will slant *downwards* towards the horizontal line. The iron-wrought covering of a large railway station, seen from one end, affords a good illustration of this recedence of lines to a point.

325. The room given in Fig. 177 presents an instructive example of parallel perspective. The farther end of the room, being parallel to the spectator, remains its true shape, but the sides, together with the pictures, and the floor and ceiling, are all retiring planes; consequently the retiring lines bounding them all tend towards a point opposite the eye—the vanishing point, those lines which are above it slanting downwards, those which are below it slanting upwards. The same rule will govern the lines of the sofa, fender, and the two distant chairs, but not the door and nearest chair, as these are not in the same plane. It

may be remarked, however, that the

representation of ordinary rooms is seldom satisfactory, from the fact that the spectator cannot get far enough

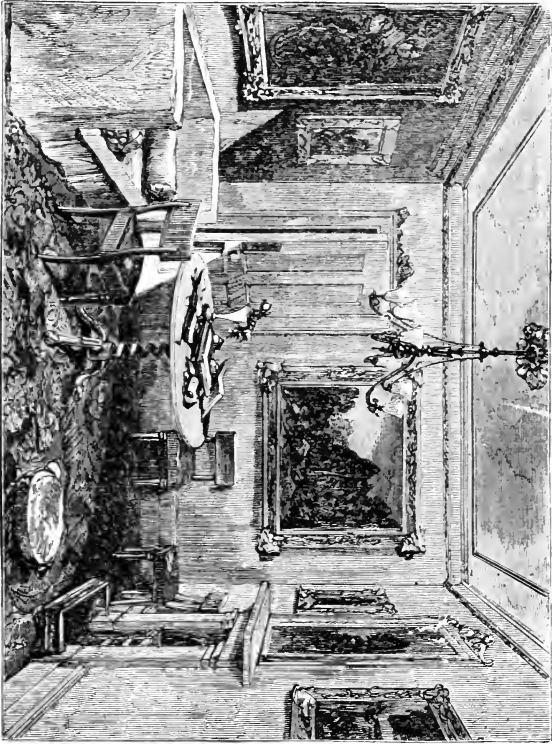

FIG. 177.

back, so as to see the distant end of the room without having too wide a visual angle; unless, indeed, the apartment be a very long one.

The readiest way to represent an apartment in parallel perspective is to begin by drawing the further end of the room (its true shape), fixing the vanishing point, then placing the ruler to it, and ruling through each corner of the room *backwards*, as shown in the small diagram (Fig. 178).

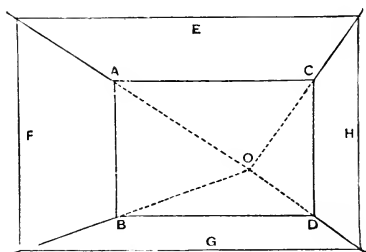

FIG. 178.

326. When large objects, such as trees, buildings, &c., are represented with their receding lines slanting upwards, thus indicating that they are below the eye, as in Fig. 179, the spectator has what is known as a bird's-eye view.

327. Hitherto we have concerned ourselves only with receding lines which were parallel to the ground plane, and at right angles to the plane of the spectator. In Fig. 180 there is a receding plane on the top of A B C D, which is not horizontal, and the receding lines of which would not vanish on the level of the eye, but far above it,

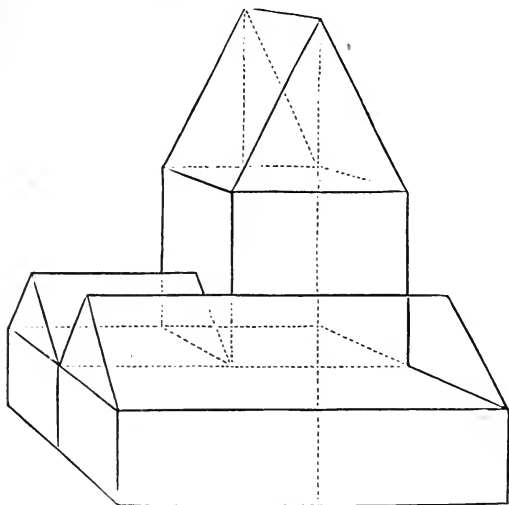

FIG. 179.

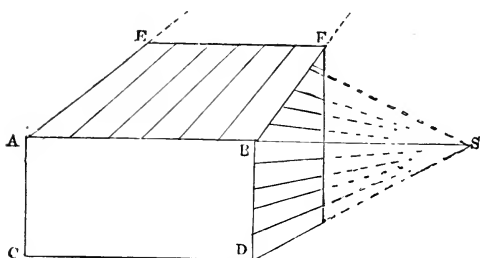

FIG. 180.

as shown by the dotted lines, E F. The point in which these lines would meet is called an '*accidental*' vanishing point. Figs. 181 and 182 are further examples.

The rough sketches (Figs. 183 and 184) may better illustrate this. In each case the receding lines formed by

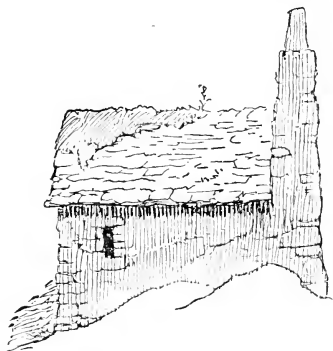

FIG. 181.

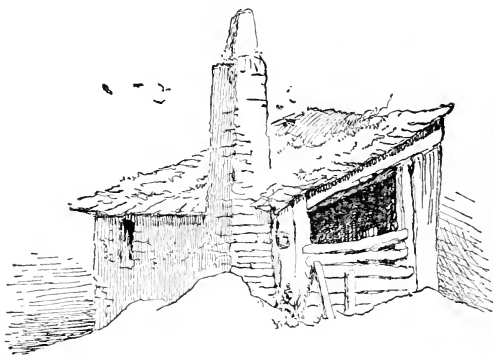

FIG. 182.

the divisions of the stones are felt to be retiring towards a vanishing point that would be level with the eye, because 'coursed' buildings have always their stones in horizontal layers or 'courses;' but the retiring markings



FIG. 183.

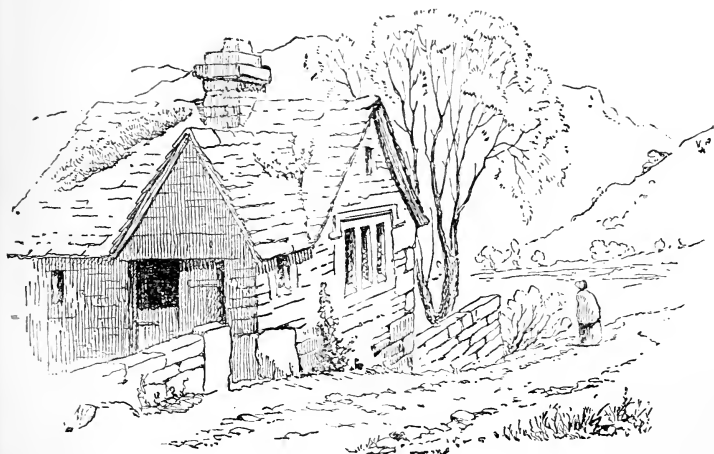

FIG. 184.

on the road, in the former, would evidently terminate far above the horizontal line, which is in this case about the bottom of the window: consequently we are conscious that the road rises as it recedes. In Fig. 184, because the lines of the road are retiring below the horizontal line, we infer that the road is down-hill. In all these cases the views are parallel to the spectator.

ANGULAR PERSPECTIVE.

328. Angular or Oblique Perspective is the term used when objects have an angle presented towards the spectator, as in Fig. 185, also in Fig.

186, where it will be seen that as both the right and left-hand sides of the cube retire, there must be two vanishing points towards which the receding lines will tend.

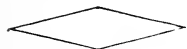

FIG. 185.

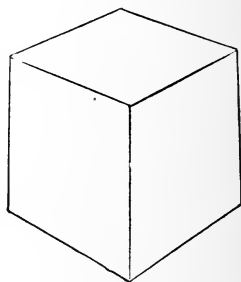

FIG. 186.

329. In drawing objects from Nature, when they are thus oblique to the spectator, it is well to adopt a methodical mode of operation, thus:—

(1.) First determine the length, and draw the front line, as A B, Fig. 187.

(2.) Determine the distance laterally of the lines C D and E F, and draw them indefinitely.

(3.) Ascertain the relative height of the eye above the

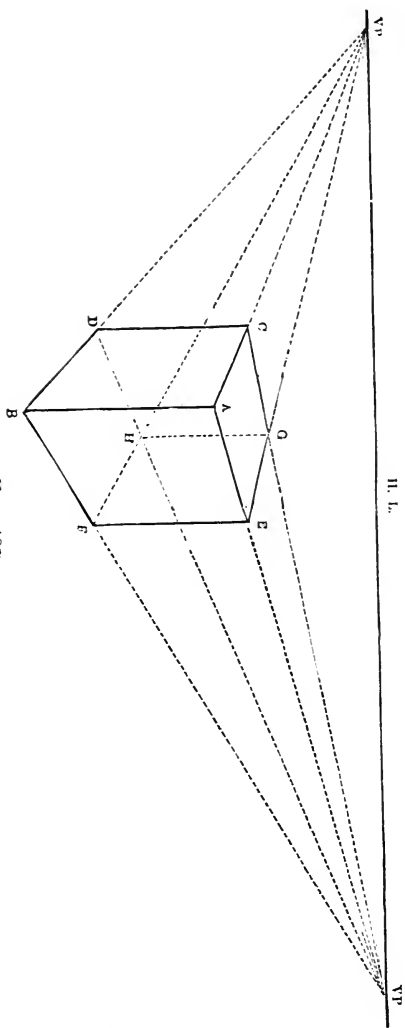

FIG. 187.

cube, and at that height draw a line across the paper. This line is known as *the H. L.*, and is used for placing the vanishing points on.

(4.) Ascertain accurately the angles at which the lines, *B F* and *B D*, respectively retire (by comparing them with a horizontal line), and produce them until they meet the *H. L.* This junction will give the vanishing points to which all the other receding lines must be drawn; and thus the figure will be completed.

In adopting this method of drawing from Nature, it is of little consequence whether the sides of the object retire at an equal angle from the spectator or not. It must be observed, however, that the vanishing point will be near on the side which retires rapidly, whilst on the side which does not retire so suddenly it will be further away on the *H. L.* If the sides retire equally, the points will be equally distant on each side of the spectator.

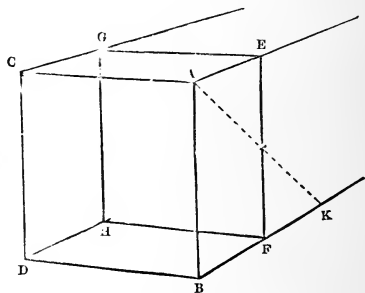

FIG. 188.

330. Suppose it is desired to represent another cube immediately behind that which has been already drawn, a diagonal line from *A* (Fig. 188), bisecting *E F*, and continuing to the receding line, will give the proportionate distance of the next vertical line, as at *K*, from the top of which a line must be drawn to the left-hand vanishing point, and the second cube

will be completed, in exact proportion with the first. This process may be carried further to any extent, as in Fig. 189.

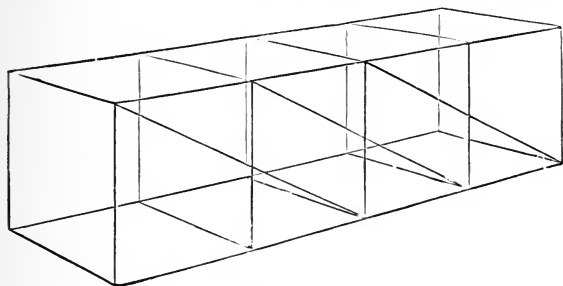

FIG. 189.

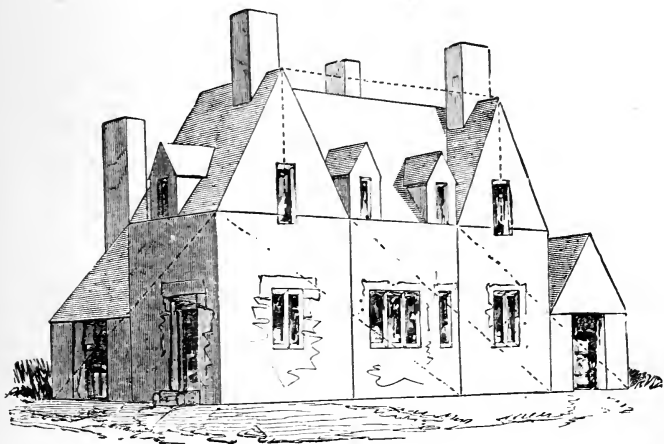

FIG. 190.

331. If the object be so placed as to be partly above and partly below the eye, as we ordinarily see in buildings (Fig. 190), the receding lines, as before shown,

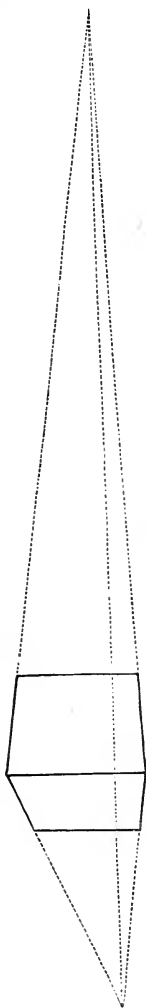

FIG. 191.

will appear to slant down or up respectively towards the H. L., as the case may be. Fig. 191 will illustrate this in the single cube, and when several are placed on each other they will appear as shown in Fig. 176. The application of these rules may be seen in the representation of many familiar household objects, as in Figs. 192, 193, and 194, as well as in the various woodcuts of buildings throughout this work.

332. When an object is so placed that its receding lines are not parallel to the ground plane (level ground), they will meet in what is known as an accidental vanishing point, above or below the H. L., according to the inclination of the object, as already referred to in ¶ 327.

333. From the remarks which have here been made respecting Artistic Perspective, it will be seen that when the artist has obtained certain facts (which in Technical Perspective would be *data*), he may proceed with his sketch easily, and with as near an approximation to truth as in any ordinary circumstances

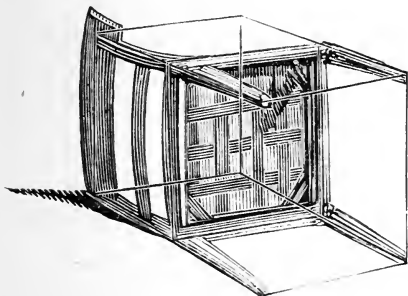

FIG. 192.

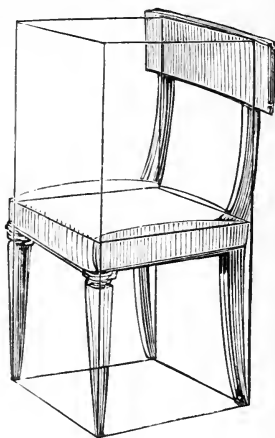

FIG. 193.

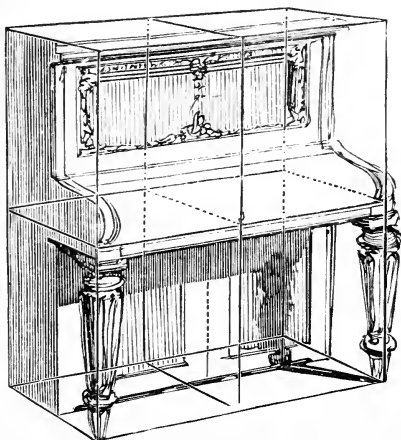

FIG. 194.

would be required ; whereas, where there is no knowledge of perspective rules, the student must be constantly on the watch to get every part in its proper place, and even then he cannot be sure of anything approaching absolute accuracy.

Even when a complicate group of objects has to be drawn, to which these simple rules do not altogether apply, as in Fig. 195, and where we are greatly dependent on auxiliary lines, the knowledge of these rules will greatly assist the draughtsman in obtaining an accurate representation. And although these auxiliary lines, vanishing points, receding lines, &c., may not necessarily be drawn on the paper, they should be in the mind (like the rules of grammar), ready for instant application, to determine the direction of a line or to test the accuracy of one already drawn. They always exist in the mind of an intelligent artist, and constitute, in fact, part of the mental mechanism by which he sees, and, so far as lines are concerned, delineates accurately. Neither must these aids be supposed to apply to buildings or cubes alone, for they are of great service when drawing trees, animals, and the human figure.

334. It may be remarked, that when the student has clearly understood and can put in practice the hints contained in this chapter, he will have acquired all the perspective that is necessary to the practical work of a landscape artist. These lines, after all, are but the skeleton of various forms, and are science rather than art. Their rigidity should be broken, and they should afterwards be clothed with all the artistic feeling of which the student is capable.

FIG. 195.

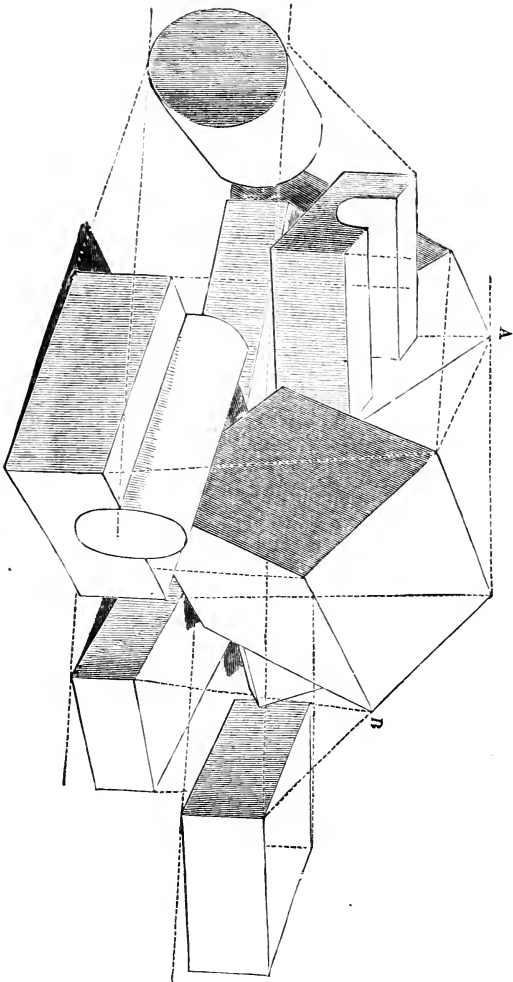

CHAPTER XXXVII.

ON TECHNICAL PERSPECTIVE.*

335. TECHNICAL Perspective, as used by architects, is of little service to a student in drawing from Nature, as the simplest object cannot be drawn truly without a wearisome array of measurements according to scale, elevation, ground plan, and other data. From these, by the aid of various rulers and compasses, a correct drawing may with some labour be obtained.

Nevertheless, the mode of developing an object by measurements and the rules of Perspective, will here be shown, that the student may have some idea of what labour is involved in such architectural presentations as are often seen before an important building is erected, and also that he may have some knowledge of the science in its elementary stages. †

And first we will name, and afterwards explain, some of the terms used in this science, in various works, and as illustrated in Diagram 1:—

GROUND PLANE.	CENTRE OF VISION.
GROUND PLAN.	STATION POINT.
PICTURE PLANE.	STATION LINE, OR LINE OF DI-
PICTURE LINE, OR GROUND	RECTION, OR DISTANCE LINE.
LINE, OR BASE LINE.	HORIZONTAL LINE.
ELEVATION.	CONE OF VISUAL RAYS.
POINT OF SIGHT.	VANISHING POINTS.

* In going through these problems the student should place models before him whilst working.

† It must be remembered that this is not a treatise on Perspective.

THE GROUND PLANE is the ground on which the plan is placed.

GROUND PLAN.—If the foot be pressed on some soft clay, so as to make an impression on it, that impression would be the ground plan of the foot; or if a house were lifted away from its place on the ground, the marks left on the ground would be the ground plan of the house. The square (Fig. 196) is the ground plan of a cube, a pyramid, or any object having a square base, and viewed with one side parallel to the spectator. The circle (Fig. 197) is the ground plan of a cone or a cylinder.



FIG. 196.

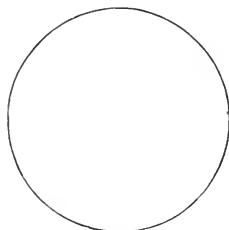

FIG. 197.

Fig. 198 shows the ground plan of three cubical forms, when seen in angular perspective, and might, by the rules of Perspective, be developed into Figs. 199 or 200; and Fig. 201 might in like manner be developed into Figs. 202, 203, or 204.

THE PICTURE PLANE—the ‘plane of delineation,’ or ‘the picture’—is the plane (whether of glass, paper, canvas, &c.) on which the drawing or ‘projection’ is to be made. It is quite indefinite in extent, and in working may be considered as transparent.

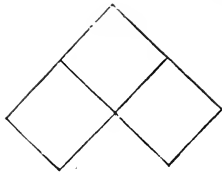

FIG. 198.

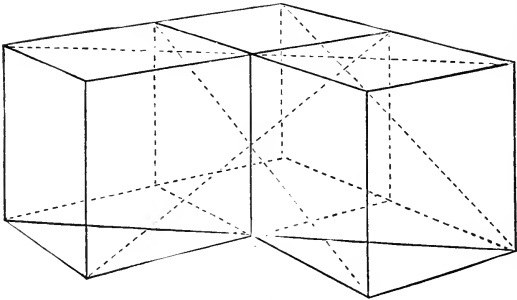

FIG. 199.

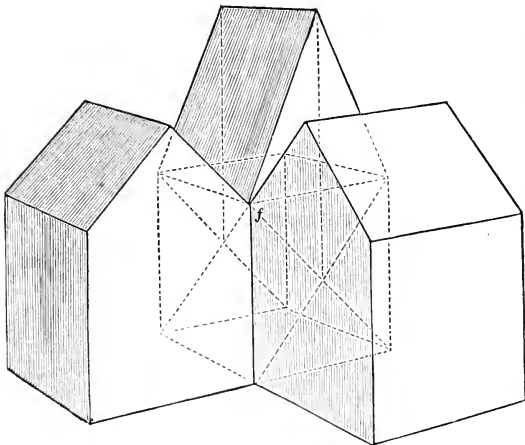

FIG. 200.

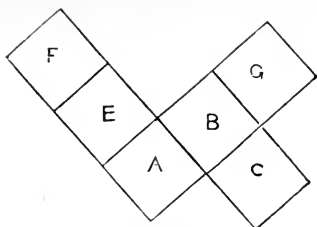

FIG. 201.

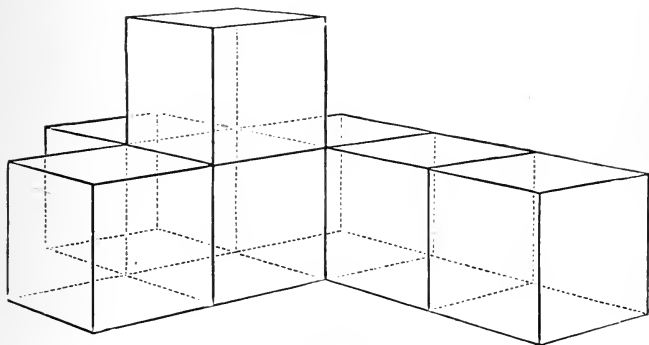

FIG. 202.

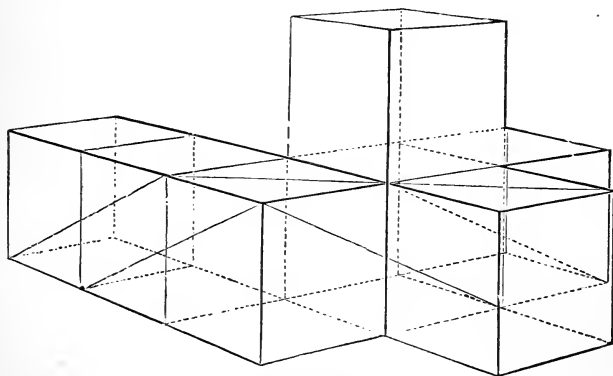

FIG. 203.

THE PICTURE LINE, or Ground Line, or Base Line, is the line forming the bottom edge of the picture plane, and resting on the ground plane.

THE ELEVATION is the upright view of an object, as seen when directly in front of the spectator. A square is the elevation of a cube, as well as its ground plan.

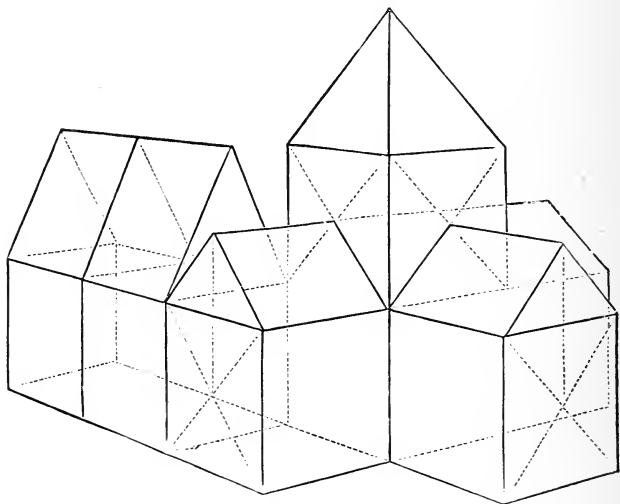

FIG. 204.

THE POINT OF SIGHT is the point on the picture plane exactly opposite the spectator's eye, and is sometimes called the 'Sight Point.'

THE CENTRE OF VISION is that point on the picture plane which is exactly opposite to the *point of sight*—*i. e.* the eye of the spectator—and is sometimes called the Sight Point, or the principal visual ray.

THE STATION POINT is simply the distance of the spectator's eye from the picture, and is called in various works either Station Point or Point of Distance.

THE STATION LINE, or 'Line of Direction,' or 'Distance Line,' is the line between the spectator's eye and the centre of the picture. It is the same as the 'principal visual ray.'

THE HORIZONTAL LINE (imaginary in Nature) is a line drawn across the picture, always and exactly on a level with the spectator's eye. If he be high up, then the H. L. is high; if he be low down, then it is low.

THE CONE OF VISUAL RAYS.—This is but another term for Angle of Vision,—the angle at which we can comfortably view any objects. It is usually limited to 60° , *i. e.* 30° on each side of the Line of Direction. This limitation is necessary only when representing regular bodies, and does not apply to mountains, trees, &c.

THE VANISHING POINTS are points on the horizontal line in which all horizontal receding lines meet. When receding lines are oblique to the ground they meet in Accidental vanishing points, above or below the horizontal line.

This array of terms may at first sight appear formidable, but it will be made clearer by reference to Diagram 1, showing a simple appliance used by the Author in elementary teaching, and Diagrams 2 and 3, showing the same in profile, and also laid down as a flat diagram.

336. Before we proceed to work the problems, we must urge the student to make himself familiar with

Explanation.

C. Centre of Vision.

Data-Fine Lines.

Working Lines-Dotted.

Result-Broad Lines.

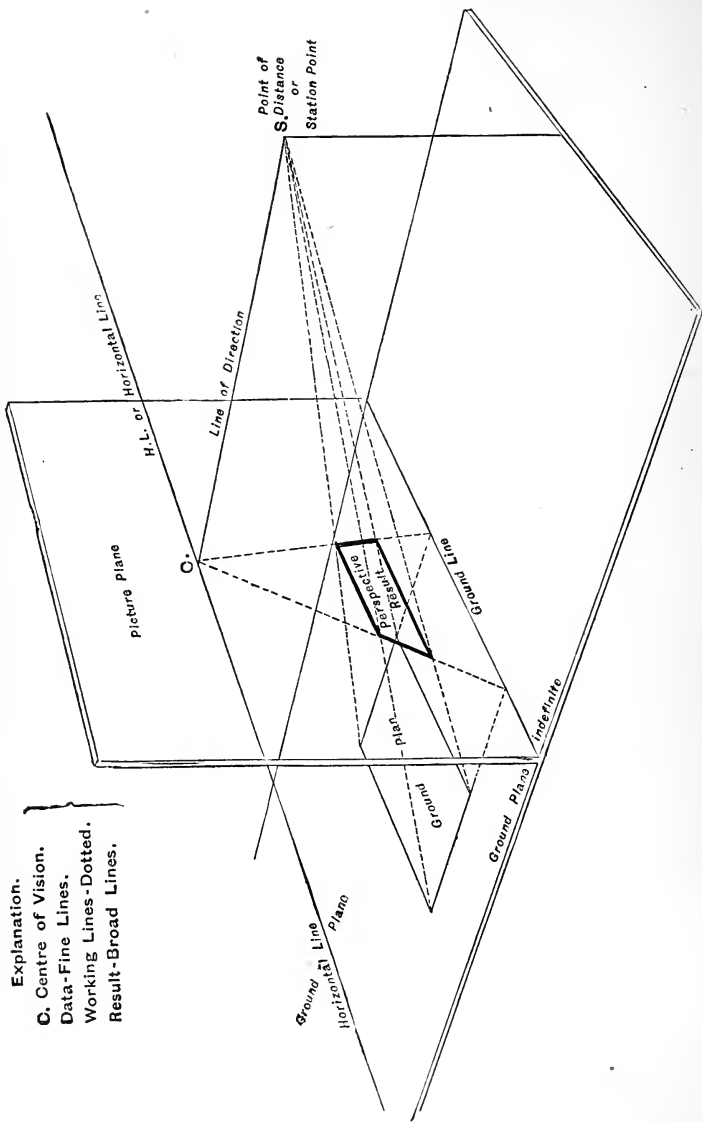

DIAGRAM 1.

every part of these three diagrams, as his success in the following figures will be thereby greatly facilitated. In working, the diagrams should be made to scale, and much larger than those here given.

It will be observed that in all perspective problems the picture or ground line, the ground plan, the horizontal line, and the line of direction (one end of which is the station point and the other the centre of the picture), are given, and form the data.

To render the diagrams and explanations more simple, these 'data' are shown in *thin*; the working lines in *dotted*; and the result in *broad* lines.

EXPLANATION OF DIAGRAM 4.

HOW TO FIND DISTANCE POINTS AND VANISHING POINTS.

Always first lay down the ground line, horizontal line, and line of direction. Place the compass point on *c* (centre of vision), and with space *c s* (station point) mark on the horizontal line to the right and left of *c*. These are the Distance Points.

NOTE.—The distance points are the vanishing points for all lines receding at an angle of 45° .

Receding lines will touch the H. L. according to the angle at which they are to the plane of the spectator: *i. e.* if the line retires suddenly away, its vanishing point will be near the centre of vision; but if the line retires gently, or is nearly parallel to the spectator, its vanishing point will be far away from the centre of vision, yet on the H. L.

To find the vanishing point for any line, first draw a horizontal line at *s*, then set off on it the angle which the line forms with the G. L. (ground line); produce the line thus set off till it meets the H. L., which will give the vanishing point of that line.

DIAGRAM 5.

In this diagram the means by which vanishing points for various lines, *A B D E F*, may be found are shown, but the student should work each of these various lines separately.

Beginning with line A, it will be found to form an angle of 60° with the base or ground line (G. L.); therefore from the horizontal line s draw a line to the left at 60° , and produce it till it touches the H. L., which will give the vanishing point for the line at *a*.

The line B is at an angle of 40° with the base or ground line, therefore from the line s draw a line to the left at 40° , and produce it till it meet the H. L. at *b*, which is the vanishing point for the line.

The line D forms an angle of 50° with the ground line, therefore from the line s draw a line at the same angle (50°) to the right, and extend it to the H. L., which will give the v. p. of the line at *d*.

The line E is at an angle of 35° with the ground line, therefore from the line s draw a line to the H. L., at an angle of 35° , which will give the v. p. at *e*.

Lastly, it will be seen that the line F, being at an angle of only 10° with the ground line, is nearly parallel to the spectator, and, therefore, that its vanishing point will be at a considerable distance from the centre of the picture, as will be evident on drawing a line from s at an angle of 10° to the left. Of course there is not room to show it on this sheet.

NOTE.—*It will be observed, that if a line whose vanishing point is required inclines to the right, the vanishing point will be to the left, on the horizontal line.*

It has already been observed, that lines retiring from the ground line at an angle of 45° have their vanishing points in the distance points.

DIAGRAM 6.

In the whole of these figures the scale is of $\frac{1}{4}$ an inch to a foot, the H. L. being 5 ft., and the point of distance, or station point (s), 10 ft. c is the Centre of Vision.

When lines recede directly from the spectator, or, in other words, are at right angles to the plane of the picture, they vanish towards the point of sight. This is an invariable law, and we will apply it in the next problem.

To draw in perspective a square of 4 ft. lying on the ground, with one of its sides parallel to and touching the picture plane, 1 ft. to the left of the spectator.

Now it is clear that if one side of the square be parallel to the picture plane, two of its sides will be at right angles to it, and consequently, according to the rule just laid down, will retire to the Point of Sight, or Centre of the picture (c). To work the problem, then, first measure 1 ft. to the left side of the spectator, or line of direction, on the Picture or Ground Line (G. L.); then 4 ft. further for the side of the square (A B), which is to touch the Picture Plane. From A and B rule lines to the Point of Sight. To obtain the distance of the back (D E), mark off 4 ft. from A towards the Line of Direction (which of course will be to B), and then draw a line from B to Distance Point 1; or, measure off 4 ft. from B to the left (A), and then draw a line from A to Distance Point 2. The intersection at D or E will cut off the 4 ft. required; then a line parallel to the front line will complete the square in perspective.

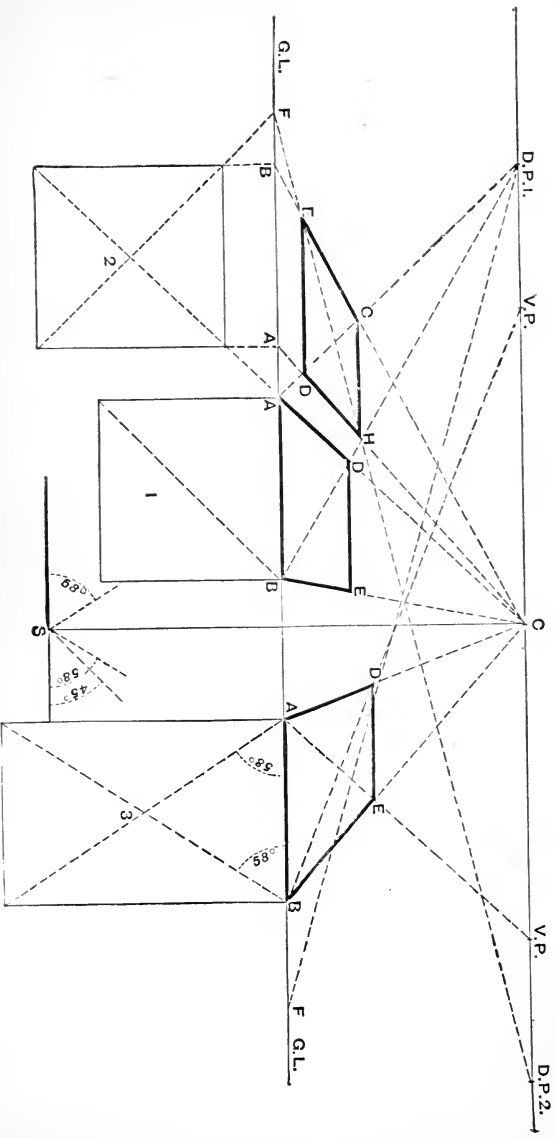

DIAGRAM 7.

DIAGRAM 6.

DIAGRAM 8.

DIAGRAM 7.

To draw in perspective a square of 4 ft. lying on the ground, with its nearest side 6 ft. to the left of the spectator, and 1 ft. beyond and parallel to the picture plane.

First measure 6 ft. to the left of the Line of Direction on the ground line (G. L.) as at A, and the size of the square, 4 ft., to B, and then from A and B draw receding lines to the centre of the picture c. Now as the square in this case is to stand 1 ft. in the picture, or beyond the picture plane, mark 1 ft. to the right of A, and draw to Distance Point 1, which will intersect the line A c, at 1 ft. in the picture (at D). Or, mark 1 ft. to the left of B, as at F, and rule to Distance Point 2, which will intersect the line B c at E, 1 ft. in the picture as before, thus proving the accuracy of the rule.

But as the figure required is a square, the retiring lines just drawn also give the intersection necessary for drawing the back line, G H, thus completing the square in perspective as required.

DIAGRAM 8.

To draw a right-angled parallelogram of 4 ft. by 6 ft., one side (4 ft.) being parallel to and touching the picture plane, its nearest side 2 ft. to the right of the spectator.

Mark off 2 ft. to the right of the spectator, on the

G. L., and then 4 ft. more for the width of the parallelogram, A B, and rule to the centre, c. Now as the parallelogram is to be 6 ft. long, mark 6 ft. to the right from A, as at F, and draw a line to Distance Point 1, which will intersect the line A c at D, 6 ft. (in perspective) from A : draw the line D E parallel to the G. L., and thus the parallelogram will be represented in perspective.

NOTE.—The three diagrams that have just been explained may also be worked from their ground plans, 1, 2, and 3. Diagram 6 is very simple : first draw from A and B to the centre of the picture c ; then, for the width of the square, find the perspective of the diagonal line of the original square 1, according to the rule laid down for Diagram 5 ; and as this diagonal line happens to form an angle of 45° with the Ground Line, its Vanishing Point will be in the distance point, for, as has been already explained, lines forming an angle of 45° with the G. L. always vanish in the Distance Points.

In Diagram 7 extend the lines of the square to the G. L. as at A B ; whence draw to the Centre of Vision, c. The front and back lines will be found by extending the diagonal lines to the G. L., and then drawing to either of the Distance Points. Diagram 8 will not require explanation.

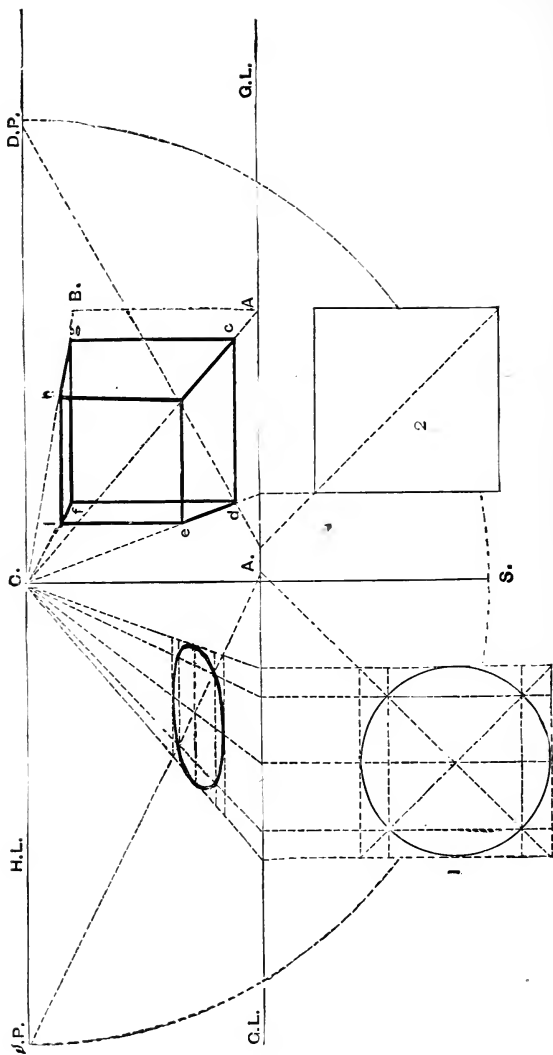

DIAGRAM 10.

DIAGRAM 9.

DIAGRAM 9.

To represent a Circle in Perspective, 2 ft. to the left of the spectator and 2 ft. in the picture.

It will be evident that, as only straight-lined figures are amenable to the Perspective *rules*, it will be necessary to find a number of points in Perspective through which to trace the required circle; therefore a ground plan will be required, which must be surrounded with a square, and intersected as shown at 1. The working of the problem will then be simple. Extend the perpendicular lines of the Ground Plan to the Ground Line, and from thence to the Centre of Vision, *c*. Now produce one of the diagonal lines of the Ground Plan to the Ground Line, as at *A*, and from thence to one of the Distance Points, which is the Vanishing Point for lines at 45° . At each intersection of the line with the lines going to the Point of Vision, *c*, draw horizontal lines, which will give points through which to trace the required circle in perspective.

DIAGRAM 10.

To represent a Cube 4 ft. square in Perspective, 2 ft. to the right of the spectator, and 1 ft. in the picture.

First find the base of the square, as in Diagram 7; then, at *A*, raise a perpendicular line 4 ft. for the height of the cube, as at *B*, and from *B* draw to the Centre of Vision, *c*; at *c*, *d*, and *e*, erect perpendiculars; from *g* draw a horizontal line to *f*, and complete the Cube in Perspective by drawing from *i* to *h*.

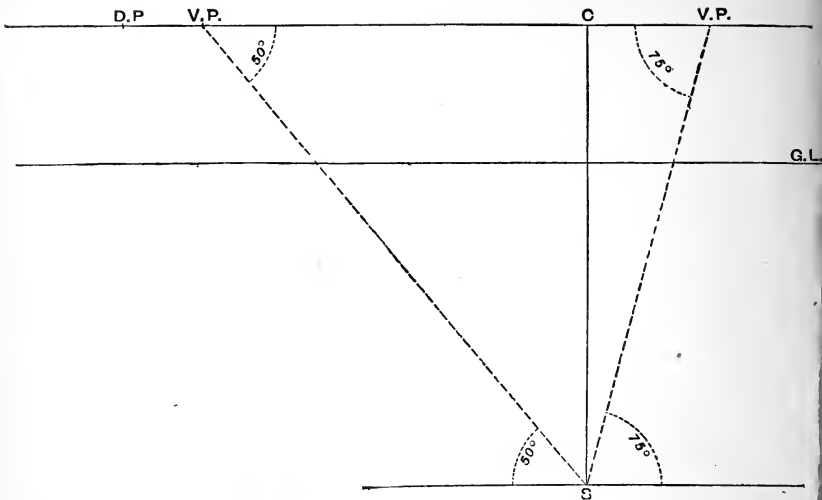

DIAGRAM 11.

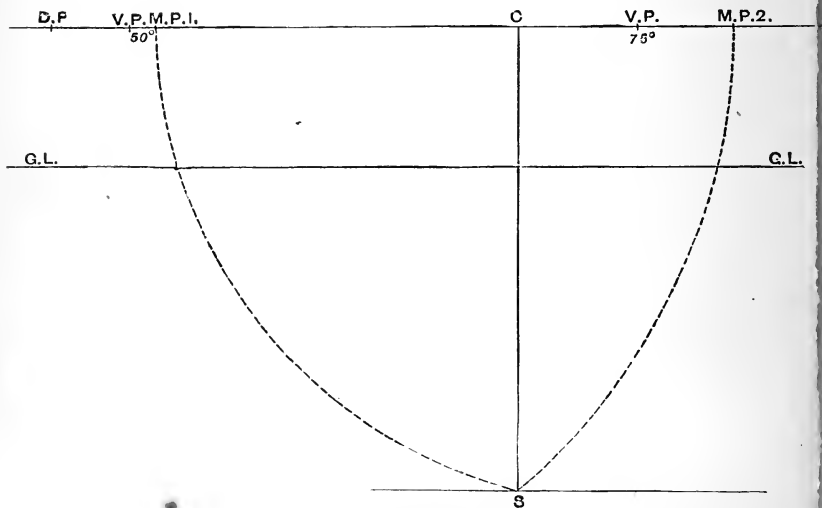

DIAGRAM 12.

DIAGRAM 11.

Hitherto the diagrams have been explanatory of the Parallel view; this diagram and the next are preparatory to the clear understanding of the Angular view.

The method of finding the Vanishing Point for any line has been shown in Diagram 5, and is here repeated, so as to impress it more strongly on the mind. It has also been shown that the Distance Points will be the Vanishing Points for lines at an angle of 45° . If a line should slant at any other angle to the Ground Line, it will have its own Vanishing Point, which will be the Vanishing Point for *all lines at that angle*. In this diagram the line to the right of the spectator is shown at an angle of 75° to the Ground Line (and consequently to the H. L.), and the one to the left at an angle of 50° .

DIAGRAM 12.

Measuring Points are the points by which any distance may be measured on a receding line as it retires into the picture, and may be found as follows:—*Measure from the Vanishing Point to the Station Point with the compasses, and then set off on the Horizontal Line from the Vanishing Point towards the Line of Direction, which will give its Measuring Point.* It must be remembered that every Vanishing Point has its own Measuring Point, which is always on the opposite side of the Line of Direction.

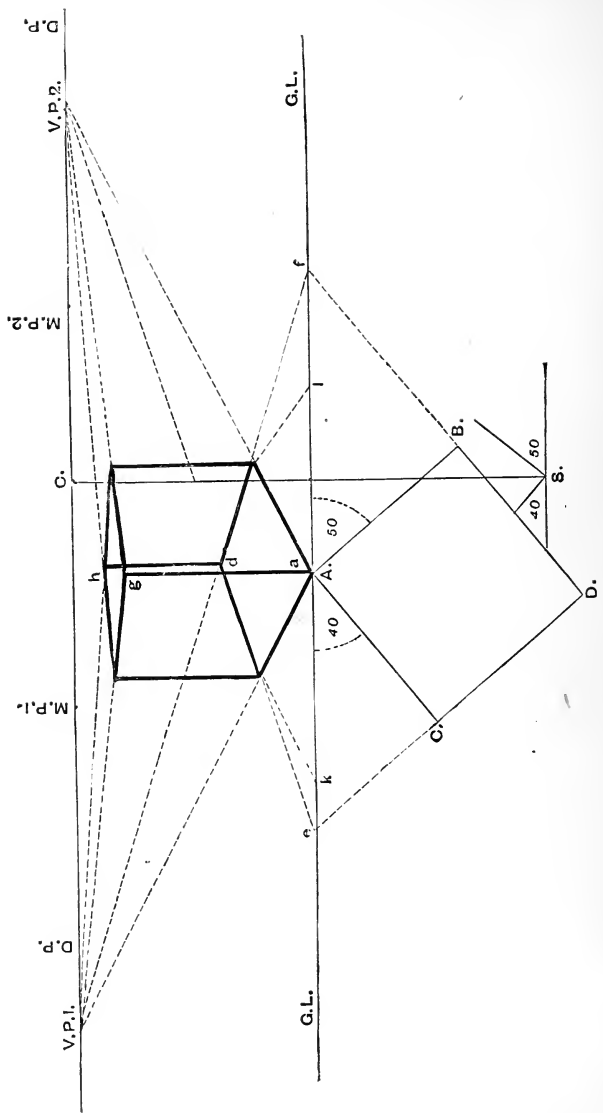

DIAGRAM 13.

DIAGRAM 13.

To represent a cube in Angular Perspective.

This may be done in two ways. First, draw the ground plan, $A B C D$, at the desired angle, and (in this case) touching the G. L. Extend $D B$ and $D C$ respectively to the G. L. and observe the angles they make with it (viz. 40° and 50°). Set off these angles from a horizontal line at s (as shown in Diagram 5), and extend them till they meet the Horizontal Line (H. L.), which will give the Vanishing Points. From A draw to the two Vanishing Points, and cut off the proper length of the receding line by drawing from e and f to the Vanishing Points, which will give the base of the Cube in Perspective.

If, instead of ruling from e and f to the two Vanishing Points, we measure the side of the square—in this case 4 ft.—to the right and left from A , as at k and l , and then rule to the Measuring Points 1 and 2 (found as in Diagram 12), the same intersection will take place, and the Square in Perspective be obtained.

At A erect a perpendicular line (4 ft.) to g , and rule to the two Vanishing Points. At each corner of the square also raise perpendiculars till they meet the receding lines, and from the top of these, again, by ruling to the Vanishing Points, the Cube will be completed.

This problem should be repeated till the student finds it quite easy.

DIAGRAM 14. -

This diagram is given as a further illustration of the foregoing rules, and if the student has understood and worked the previous problems, he will have little difficulty in understanding and executing this. He will also have prepared himself for more readily and intelligently appreciating any plans and perspective drawings of buildings or machinery that may come before him in the business of life.

The student who has gone carefully and thoughtfully through this little book will find that he has been moving on some of those only safe lines of true education which fit a man for the highest purposes and business of his being.

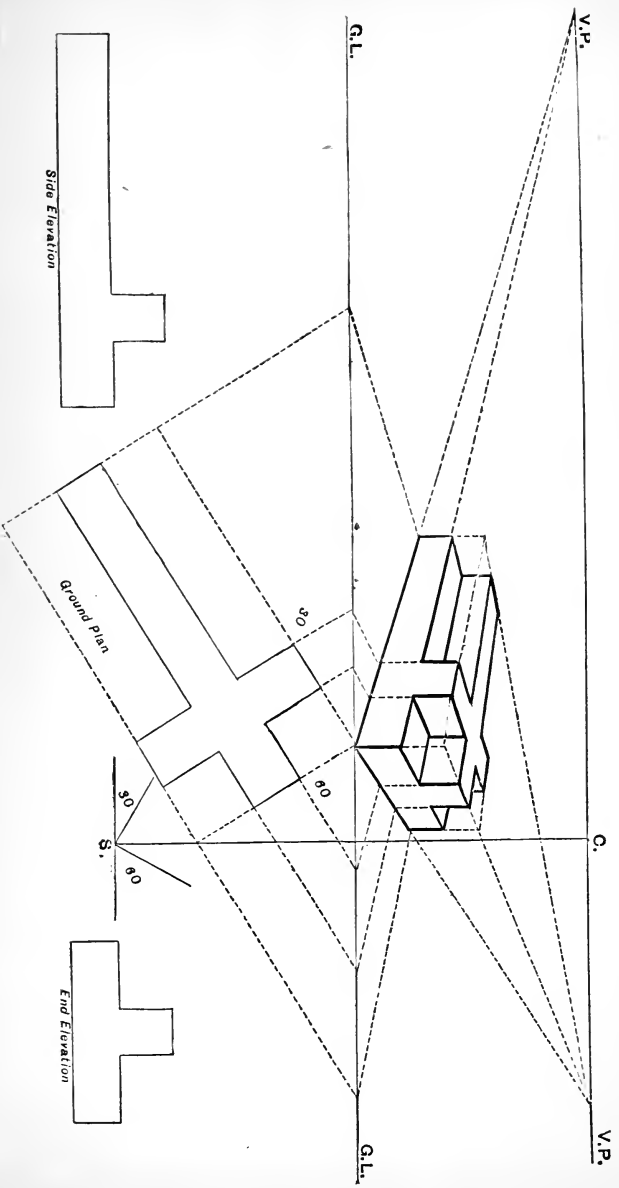

DIAGRAM 14.

APPENDIX.

A.—ON CHILDREN'S DRAWING.

THE question is often asked, 'Ought young children to learn to draw?'

We answer decidedly in the affirmative, but not necessarily by set lessons, except on the Kindergarten system.

The chief purpose in letting a young child draw is that it may not lose the power of seeing things as they *appear*, whilst at the same time it is learning what their shapes *really* are. It is quite remarkable how few persons do see things as they appear. The cause is, that the *knowledge* of the actual shape is allowed to interfere with the image the shape makes on the retina. The image on the retina is perfect, but it requires to be correctly read by the mind, and this can only be accurately done by long and careful habit; hence the difficulty that many grown-up persons have in sketching even a book or a box.

Further, it may be asked, 'What kind of drawing should young children be encouraged in practising?'

We again answer decidedly,—Let them draw from the things around them, unless there be some systematic set of models to draw from; and these should be very interesting, otherwise the child will not care to draw

them. In work of this kind children should always be interested, or more harm will be done than good. Children should never be *praised* for the drawings they make, but simply commended for any rightness, neatness, cleanness, or special effort. Nothing weakens a child's efforts more than false or injudicious praise.

Ought young children to be allowed to rule lines ?

Most assuredly. A nice flat ruler, a triangle or square, and in some cases a pair of compasses, are excellent instruments to put into the hands of a child ; but neatness and exactness should be the consequence, for this is their purpose.* But instruments should never be used in the free-hand drawing class until a sketch is completed, and then only for the purpose of showing the student where he has failed.

Children who have been encouraged in early life to draw the things about them on scraps of paper, on insides of old envelopes, or on slates, seldom have any difficulty in understanding perspective, especially such perspective as is ordinarily used by artists.

B.—THE DIASCOPE.

THE '*Diascope*,' as its name implies, is in its simplest form merely a piece of cardboard or thin wood, with an

* A neat flat ruler may be made with a long slip of cardboard, or by folding over and over a half sheet of foolscap paper and gumming the last lap. A child should have *inches* marked on his ruler.

aperture cut in it through which to view the best parts of a landscape and conceal the remainder. It may be of any size and proportion, but a convenient one may be made with a piece of cardboard, say seven inches by five, or larger, with an opening five inches by three. This opening may be divided at the inches by intersecting threads, perpendicularly and horizontally (Fig. 205).

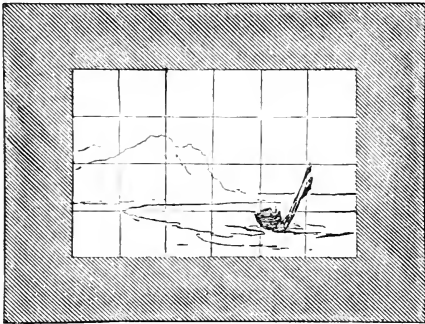

FIG. 205.

When a student goes to Nature, and has an extensive view before him, he is often perplexed to know how much, or what part, of what lies before him, he should take as his sketch. Let him with one eye look at the landscape through the 'Diascope' when held at from six to ten inches from him, and move it to the right or left, and up or down, till he has found that part of the landscape which will give him the best material.

C.—PENCIL-IN-HAND MEASUREMENT.

THIS simple and convenient method of measuring the *proportions* of distant objects is often misunderstood, by applying it to the *size* of objects, with which it has nothing to do. It is, therefore, here described.

Shut one eye ; hold the pencil, as in Fig. 206, *at arm's length* ; let the end of the pencil come exactly between the

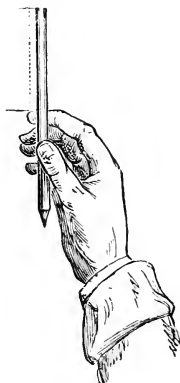

FIG. 206.

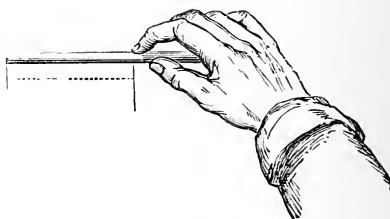

FIG. 207.

eye and any point on the object you wish to measure *from* ; then let the thumb or first finger move along the pencil as required, till it reaches the point you wish to measure *to*. Having obtained this measurement, it can now be compared with, or measured into, any other part of the object or picture (being most careful in moving not to bring the hand nearer to the eye), and thus ascertain its proportion.

In all measurements the pencil should be held *at arm's length*, and *parallel* to the plane of the face. It should always be remembered that these measurements have reference only to the *proportions* of objects, and *not to their size*. Fig. 207 shows how the pencil is held when measuring horizontally.

D.—NOTE ON TEACHING.

A LONG, varied, and extensive acquaintance with teaching has brought the conviction that Art has not had its proper place as a subject to be taught, nor, as a rule, its proper treatment as a factor in education. Its importance is underrated, and the teaching of it is often a farce. At best it has been taught pretty much as writing is taught; and, to a very limited extent, this may be right. But the twenty-six letters of the alphabet do not constitute a language; they are merely arbitrary and conventional signs by which, when properly arranged and understood, we are able to make thought visible.

Art is as truly a language as is Greek or German; more easy to read, and universal in its application. What is language, but that by which thought is conveyed from one mind to another? If we place six of these English signs before a very young child, or an intelligent person not conversant with English, thus—kettle, or tea

pot, or three of them, cup—they will be utterly meaningless; whilst the roughest possible sketch will convey a correct idea to the mind at once.

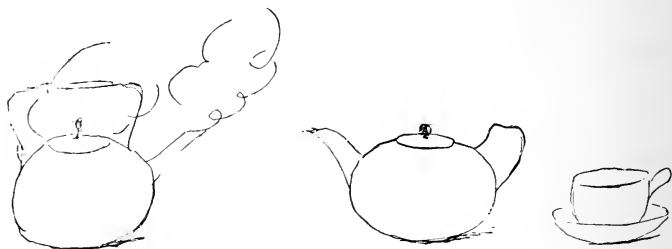

Instead of these twenty-six arbitrary signs, Art has two lines as fundamental, the straight and curved, with which we may express almost any physical fact—or, to state the case more accurately, without which scarcely any physical fact can be satisfactorily expressed.

In the teaching of Art, then, we claim that the grammar which governs these two lines, and all that belongs to them, ought to be taught in a like practical manner, day by day, with black board or other illustrations, the same as Geography, Mechanics, or any other science, and thus be thoroughly incorporated in our educational system.

It is true that Art—and the teaching of it, also—has two aspects: first, the commonplace, utilitarian one, such as should be taught in *all* schools, just as regularly as writing is taught: and, second, the emotional aspect, such as applies to higher Art or to pictures.

In this utilitarian work, *objects* should be used in *preference* to flat copies, though both are important. Copying from the flat is a mechanical operation to improve eye and hand; but the copying from solid objects implies much more of a mental conception, and is most important to artisans (as well as to those who rank above them), that they may be able instantly to write down (draw) a thing itself in the universal language of Art, as well as understand that which is drawn.

There is yet one more point in Art instruction to which we wish to make reference, viz., the teaching of Perspective, as it is usually done in common schools. In some middle-class schools it is not taught at all. Many works on Technical Perspective, both cheap and excellent, have made their appearance during the last few years, and these are used largely in our National Schools in preparation for Government examinations. In view of what we have seen in the preparation for, and the consequences of, these examinations, we cannot but agree with Professor Huxley, when, in writing on Education, he says: *—‘The educational abomination of desolation of the present day is the stimulation of young people to work at high pressure by incessant examinations. . . . They are conceited all the forenoon of life, and stupid all its afternoon.’ Although he is speaking here of education generally, his remarks apply with special force to Art teachings and examinations. These examinations have a reflex effect on the teachers also, and in honesty we must

* *Fortnightly Review*, January 1878.

say (and we speak that which we do know) often a very mischievous effect. Professor Huxley says :* — ‘There is much to be done before the’ (present) ‘system can be said to be thoroughly satisfactory. The instruction given needs to be more systematic, and especially more practical; the teachers are of very unequal excellence, and not a few stand much in need of instruction themselves, not only in the subjects which they teach, but *in the objects for which they teach.*† I dare say you have heard of that proceeding, reprobated by all true sportsmen, which is called “shooting for the pot.” Well, there is such a thing as “teaching for the pot,”—teaching, that is, not that your scholar may know, but that he may count for payment among those who pass the examination; and there are some teachers—happily, not many—who have yet to learn that the examiners of the Department regard them as poachers of the worst description.’

The great aim, then, of the true Art teacher ought to be to develop all the quickness of eye and power of hand possible to his pupils (the utilitarian aspect); and then, as time and circumstances will permit, to call out of—or, if necessary, instil into—their minds such emotional and intelligent power of observation as will make them correct judges of Art and intense lovers of Nature.

* *Fortnightly Review*, January 1878.

† The italicising is not Professor Huxley’s.

MANUAL OF MYTHOLOGY

FOR THE USE OF

SCHOOLS, ART STUDENTS AND GENERAL READERS,

FOUNDED ON THE WORKS OF PETISCUS, PRELLER
AND WELCKER.

By ALEXANDER S. MURRAY,

Department of Greek and Roman Antiquities, British Museum.

**With 45 Plates on tinted paper, representing more than 90
Mythological Subjects.**

REPRINTED FROM THE SECOND REVISED LONDON EDITION.

One volume, crown 8vo. \$2.25.

There has long been needed a compact, manageable Manual of Mythology, which should be a guide to the Art student and the general reader, and at the same time answer the purposes of a school text-book. This volume which has been prepared by the Director of the Department of Greek and Roman Antiquities in the British Museum, upon the basis of the works of Petiscus, Preller, and Welcker, has had so extensive a sale in the English edition, as to prove that it precisely supplies this want. This American edition has been reprinted from the latest English edition, and contains all the illustrations of the latter, *while the chapter upon Eastern Mythology has been carefully revised by Prof. W. D. Whitney, of Yale College.*

N. B.—Teachers wishing to examine this work with a view to introducing it as a text-book, will have it sent to them, by forwarding their address and \$1.35.

. *The above book for sale by all booksellers, or will be sent, post or express charges paid, upon receipt of the price by the publishers,*

CHARLES SCRIBNER'S SONS,

743 AND 745 BROADWAY, NEW YORK.

"These volumes contain the ripe results of the studies of men who are authorities in their respective fields."—THE NATION.

Epochs of Modern History.

Each 1 vol. 16mo., with Outline Maps. Price per volume, in cloth, \$1.00.

EACH VOLUME COMPLETE IN ITSELF AND SOLD SEPARATELY.

EDITED BY EDWARD E. MORRIS, M.A.

The ERA of the PROTESTANT REVOLUTION. By F. SEEBOHM, Author of "The Oxford Reformers—Colet, Erasmus, More." *(Now ready.)*

The CRUSADES. By the Rev. G. W. COX, M.A., Author of the "History of Greece." *(Now ready.)*

The THIRTY YEARS' WAR, 1618—1648. By SAMUEL RAWSON GARDINER. *(Now ready.)*

The HOUSES of LANCASTER and YORK; with the CONQUEST and LOSS of FRANCE. By JAMES GAIRDNER, of the Public Record Office. *(Now ready.)*

The FRENCH REVOLUTION and FIRST EMPIRE; an Historical Sketch. By WM. O'CONNOR MORRIS, with an Appendix by Hon. ANDREW D. WHITE, Pres. of Cornell University. *(Now ready.)*

The AGE OF ELIZABETH. By the Rev. M. CREIGHTON, M.A. *(Now ready.)*

The PURITAN REVOLUTION. By J. LANGTON SANFORD. *(Now ready.)*

The FALL of the STUARTS; and WESTERN EUROPE from 1678 to 1697. By the Rev. EDWARD HALE, M.A., Assist. Master at Eton. *(Now ready.)*

The EARLY PLANTAGENETS and their relation to the HISTORY of EUROPE: the foundation and growth of CONSTITUTIONAL GOVERNMENT. By the R. WM. STUBBS, M.A., etc., Regius Professor of Modern History in the University of Oxford. *(Now ready.)*

The BEGINNING of the MIDDLE AGES; CHARLES the GREAT and ALFRED; the HISTORY of ENGLAND in its connection with that of EUROPE in the NINTH CENTURY. By the Very Rev R. W. CHURCH, M.A., Dean of St Paul's. *(Now ready.)*

The above Ten Volumes in Roxburg Style. Leather Labels and Gilt Top. Put up in a handsome Box. Sold only in Sets. Price per Set, \$10.00.

The AGE of ANNE. By EDWARD E. MORRIS, M.A., Editor of the Series. *(Now ready.)*

The NORMAN KINGS and the FEUDAL SYSTEM. By the Rev. A. H. JOHNSON, M.A. **EDWARD III.** By the Rev. W. WARBURTON, M.A., late Her Majesty's Senior Inspector of Schools.

FREDERICK the GREAT and the SEVEN YEARS' WAR. By F. W. LONGMAN, of Balliol College, Oxford.

* * * The above book for sale by all booksellers, or will be sent, post or express charges paid, upon receipt of the price by the publishers,

CHARLES SCRIBNER'S SONS,

743 AND 745 BROADWAY, NEW YORK.

Now in process of publication, uniform with EPOCHS OF MODERN HISTORY, each volume in 12mo. size, and complete in itself,

Epochs of Ancient History.

A Series of Books narrating the HISTORY OF GREECE AND ROME, and of their relations to other Countries at Successive Epochs. Edited by the Rev. G. W. COX, M.A., Author of the "Aryan Mythology," "A History of Greece," etc., and jointly by CHARLES SANKEY, M.A., late Scholar of Queen's College, Oxford

Volumes already issued in the "Epochs of Ancient History." Each One Volume 12mo, cloth, \$1.00.

The GREEKS and the PERSIANS. By the Rev. G. W. Cox, M.A., late Scholar of Trinity College, Oxford: Joint Editor of the Series. With four colored Maps.

The EARLY ROMAN EMPIRE. From the Assassination of Julius Cæsar to the Assassination of Domitian. By the Rev. W. WOLFE CAPES, M.A., Reader of Ancient History in the University of Oxford. With two colored Maps.

The ATHENIAN EMPIRE from the FLIGHT of XERXES to the FALL of ATHENS. By the Rev. G. W. Cox, M.A., late Scholar of Trinity College, Oxford: Joint Editor of the Series. With five Maps.

The ROMAN TRIUMVIRATES. By the Very Rev. CHARLES MERIVALE, D.D., Dean of Ely.

EARLY ROME, to its Capture by the Gauls. By WILHELM IHNE, Author of "History of Rome." With Map.

THE AGE OF THE ANTONINES. By Rev. W. WOLFE CAPES, M.A. With two Maps.

OPINIONS OF THE PRESS.

"Brief but comprehensive in its narrative, it is written in a plain and simple style which will attract the attention of the general reader as well as the philosophical student."—*The Providence Journal.*

"It would be hard to find a more creditable book (*Greeks and Persians*). The author's prefatory remarks upon the origin and growth of Greek civilization are alone worth the price of the volume."—*The Christian Union.*

"The volume is compact, convenient, clearly written, and well illustrated by maps. It is a very valuable series for general readers."—*The Watchman.*

. The above books for sale by all booksellers, or will be sent, post or express charges paid, upon receipt of the price by the publishers,

CHARLES SCRIBNER'S SONS,
743 AND 745 BROADWAY, NEW YORK

Now Complete.

THE SECOND SERIES OF The Illustrated Library of Wonders,

ENLARGED IN SIZE, IN A NEW STYLE OF BINDING, AND
EDITED BY PROMINENT AMERICAN AUTHORS.

THE extraordinary success of the ILLUSTRATED LIBRARY OF WONDERS has encouraged the publishers to still further efforts to increase the attractions and value of these admirable books. In the new series, which has just been finished, the size of the volumes is increased, the style of binding changed, and the successive volumes are edited by distinguished American authors and scientists. Each 1 vol. 12mo. Price, \$1.50.

THE SECOND SERIES.

FIRST SECTION.

METEORS: Aereolites, Storms and Atmospheric Phenomena. With twenty-three illustrations by **LEBRETON**.

WONDERS OF VEGETATION. Edited, with additions by Prof. **SCHLE DE VERE**. Profusely illustrated.

WONDERS OF ELECTRICITY. Edited, with additions, by Dr. **J. W. ARMSTRONG**, President of Normal Institute at Fredonia, N. Y. With over fifty woodcuts.

WONDERS OF WATER. Edited, with additions, by Prof. **SCHLE DE VERE**, of the University of Virginia. Illustrated with over seventy engravings and charts.

WONDERS OF THE MOON. Edited, with additions, by **MARIA MITCHELL**, of Vassar College, Poughkeepsie. One vol. 12mo. fifty illustrations.

Price of above 5 volumes in a box..\$7.50

Second Series Complete, 10 volumes, in a box, \$15 00.

SECOND SECTION.

THE WONDERS OF ENGRAVING. By **GEORGES DUPLESSIS**. With thirty-four illustrations.

THE WONDERS OF SCULPTURE. With chapter on American Sculpture by **CLARENCE COOK**. With over sixty illustrations.

ARMS AND ARMOUR, in Antiquity and the Middle Ages, also a descriptive notice of Modern Weapons. And an additional chapter on Arms and Armour in England. By **CHARLES BOUTELL, M.A.**

MOUNTAIN ADVENTURES. Compiled from the Note-Books of Distinguished Travelers, including Whymper and Tyndall. Edited, with additions, by **HON. J. T. HEADLEY**. With forty-one illustrations.

DIAMONDS AND PRECIOUS STONES. A Popular Account of Gems. Translated from the French of **LOUIS DIEULAFAIT**, by **FANCHO? SANFORD**. 126 illustrations.

Price of above 5 volumes in a box..\$7.50

THE FIRST SERIES.

ILLUSTRATED LIBRARY OF WONDERS,

The First Series comprises:

<i>Illus.</i>		<i>Illus.</i>		<i>Illus.</i>
Wonderful Escapes.	26	Optical Wonders.	71	Bottom of the Sea.
Bodily Strength and Skill. 70		Wonders of Acoustics.	110	Italian Art.
Balloon Ascents	30	The Heavens.	48	European Art.
Great Hunts.	22	The Human Body.	43	Architecture.
Egypt 3,300 Years Ago.	40	The Sublime in Nature	44	Glass-making.
The Sun. By Guillemain	58	Intelligence of Animals.	54	Wonders of Pompeii.
Wonders of Heat.	93	Thunder and Lightning.	39	

Price per single volume, cloth. \$1.25
The Same in sets of 20 volumes, cloth, with a rack. 25.00
The 20 volumes in half roan, gilt top, with a rack. 30.00

Any or all the volumes of the ILLUSTRATED LIBRARY OF WONDERS sent to any address, post or express charges paid, on receipt of the price.

CHARLES SCRIBNER'S SONS,

743 AND 745 BROADWAY, NEW YORK.

A NEW BOOK BY IK. MARVEL.

About Old Story-Tellers.

OF HOW AND WHEN THEY LIVED AND WHAT STORIES THEY TOLD

By DONALD G. MITCHELL,

Author of "The Reveries of a Bachelor," etc., etc.

WITH NUMEROUS ILLUSTRATIONS.

One volume, square 12mo, Holiday Style, cloth extra, gilt top, \$2.00.

The long silence of this favorite author is at length broken, and it is the young people whom he now invites to the feast which he has prepared for them. The somewhat quaint title of the book faithfully indicates its contents

In the Preface, which is addressed to "Grown up People," Mr. Mitchell very charmingly says: "In the matter of books, as in the world, I believe in old friends, and don't think they should be laid away upon the shelf without good cause, and age is hardly cause enough. In short, I must confess a lurking fondness for those good old-fashioned stories which were current forty years ago and some of them, may be a hundred years ago—written in good straightforward English, with good straightforward intent."

IK. MARVEL'S WORKS.

REVERIES OF A BACHELOR; or, A Book of the Heart. A new edition. One vol. 12mo, Turkey antique, \$4.00; cloth, \$1.75.

THE SAME. Cabinet edition, 16mo, half calf, \$3.00; cloth, \$1.75.

DREAM LIFE. A Fable of the Seasons. One vol. 12mo, Turkey antique, \$4.00; 12mo, cloth, \$1.75.

THE SAME. Cabinet edition, 16mo, half calf, \$3.00; cloth, \$1.75.

SEVEN STORIES, WITH BASEMENT and Attic. One vol. 12mo, cloth, \$1.75.

DR. JOHNS. Being a narrative of Certain Events in the Life of an Orthodox Minister in Connecticut. Two vols. 12mo, cloth, \$3.50.

MY FARM OF EDGEWOOD, A Country Book. By the author of "Reveries of a Bachelor." One vol. 12mo, cloth, \$1.75.

THE SAME. New and cheaper edition. One vol. square 12mo, cloth, \$1.25.

WET DAYS AT EDGEWOOD. With Old Farmers, Old Gardeners, and Old Pastorals. By the author of "My Farm of Edgewood." One vol. 12mo, \$1.75.

RURAL STUDIES. With Practical Hints for Country Places. By IK MARVEL. Illustrated by the author. One vol. 12mo, cloth, \$1.75.

PICTURES OF EDGEWOOD Being Photographic Views (by Rockwood), with Text and Illustrative Diagrams by the author of "My Farm of Edgewood." One vol. 4to. Only 300 copies printed. \$12.00.

* * * *The above books for sale by all booksellers, or will be sent, post or express charges paid, upon receipt of the price by the publishers,*

CHARLES SCRIBNER'S SONS,
743 AND 745 BROADWAY, NEW YORK

A VALUABLE LITTLE BOOK.

A Concise History of Music,

FROM THE COMMENCEMENT OF THE CHRISTIAN ERA TO THE PRESENT TIME.

By H. G. B. HUNT, B. Mus.,

Christ Church, Oxford.

One volume neat 12mo, with numerous Tables, etc. Cloth, \$1.00.

Mr. Hunt has produced a well-arranged and really concise history of the subject with which he deals. The book is divided into three sections, the first of which is a general review of musical epochs and events, while the second presents a series of chronometrical tables, and the third summarizes a history of the art. The student "is warned" in the preface "that he is not to expect what is called a readable book," but we feel bound to say that Mr. Hunt's work is, in the proper sense of the word, far more readable than books which attempt to combine valuable information with attractiveness by tricks to which Mr. Hunt has not condescended. Those who care to follow the fortunes of opera and music in general cannot do better than to turn to Mr. Hunt's little book.

CRITICAL NOTICES.

"As the book now stands, it is the most concise and correct history of music that we have ever seen compiled as a text-book. . . . No musician, and in fact, no connoisseur or person making any pretension to musical taste, should be without this little work as a ready reference."—*Chicago Tribune.*

"The book is not only a remarkable example of skillful condensation, but, for the vast amount of valuable information that is crowded within its narrow limits, is without comparison. We recommend it warmly to the attention of musical students."

—*Boston Saturday Eve. Gazette.*

"The entire book, admirably made, is the best specimen of *multum in parvo* that we have seen in a long time."—*N. Y. Mail.*

"The subject is one of the most appropriate for study in schools, and we know no other book to be compared with this one for such use. There are bulky books full of information, but this one is concise and methodical."—*New York Observer.*

"As a text-book for school study or private reference, we have seen nothing so compact and useful. . . . It is a comprehensive survey of the whole field, from the earliest Greek and Egyptian art down to the performance of Wagner's Trilogy at Bayreuth, in 1876."—*Springfield Union.*

"Altogether, this is an admirable compend, worth more than many pretentious works, and quite indispensable to the student of music. As a text-book, it seems to be one of the best possible."—*Boston Globe.*

** The above book for sale by all booksellers, or will be sent, post or express charges paid, upon receipt of the price by the publishers,

CHARLES SCRIBNER'S SONS,

743 AND 745 BROADWAY, NEW YORK.





