

HANDBOOK OF LITHOGRAPHY

DAVID CUMMING

UC-NRLF



\$B 391 409



THE LIBRARY
OF
THE UNIVERSITY
OF CALIFORNIA

GIFT OF
The Estate of
Miss Bertha Newell

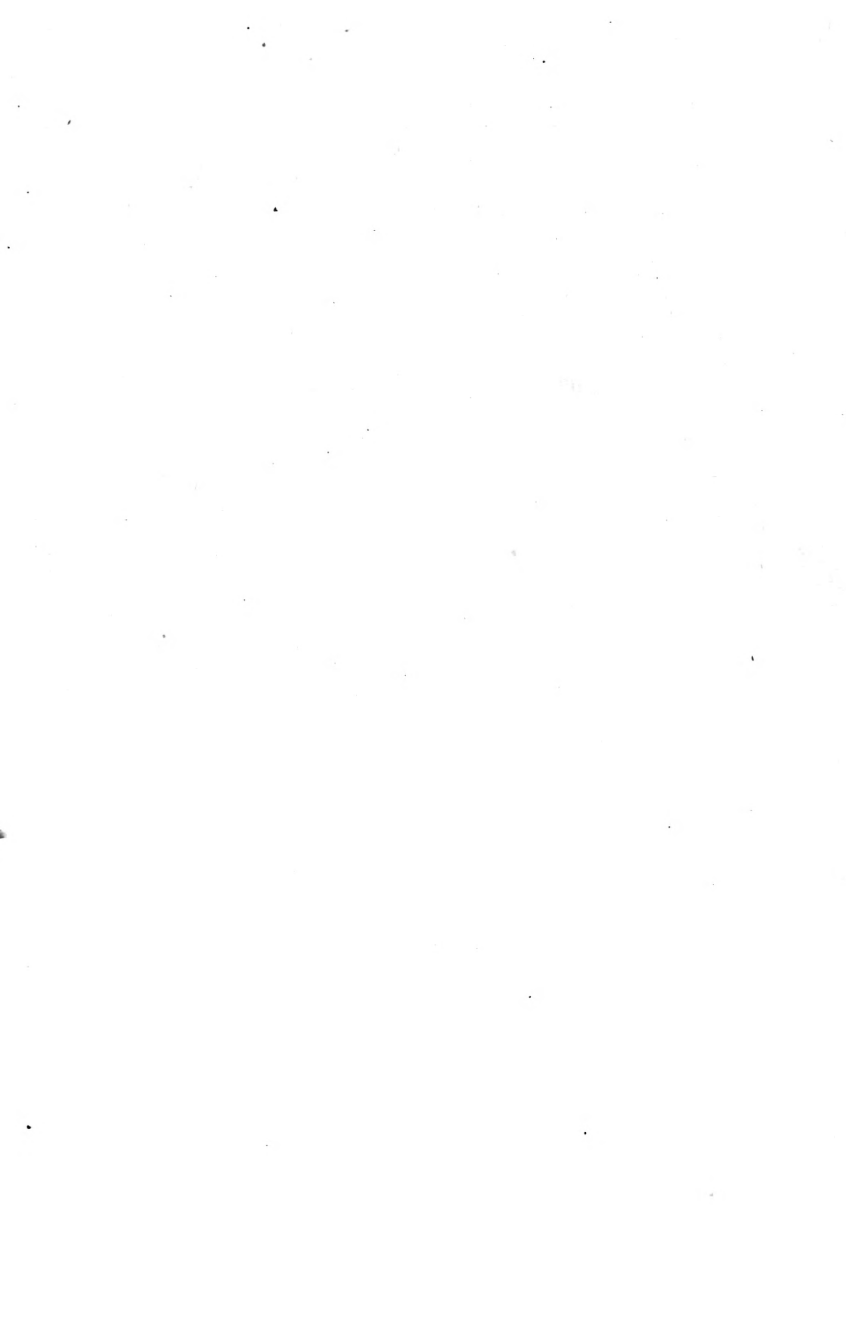

HANDBOOK OF LITHOGRAPHY

Digitized by the Internet Archive
in 2007 with funding from
Microsoft Corporation



Frontispiece.

M'Lagan & Cumming, Edin.

ALOIS SENEFELDER.

Reduced facsimile of portrait in "A Complete Course of Lithography."

Drawn on Grained Stone and Printed at Machine.

H. G. Well
New York 1928

HANDBOOK OF LITHOGRAPHY

A PRACTICAL TREATISE FOR ALL WHO ARE
INTERESTED IN THE PROCESS

BY

DAVID CUMMING

*Of Messrs M' Lagan & Cumming, Chromo-Lithographers, Edinburgh;
First Lecturer on Lithography in Heriot-Watt College,
Edinburgh; and Examiner for Lithographic
Class, Technical College, Glasgow*

WITH ILLUSTRATIONS AND COLOURED PLATES

LONDON
ADAM & CHARLES BLACK
SOHO SQUARE
1904

Add to Lib.
GIFT

NE2425
C8

Preface.

THE pleasure experienced in trying to impart knowledge of any kind to a fellow-being can only be compared with that which an earnest mind may enjoy in receiving the same. The writer has received much pleasure while endeavouring to put in a simple, readable form, the experience he has gained in a most interesting and delightful business, during a lengthened period. He hopes readers and fellow-workers may find the pages both enjoyable and profitable; and that the volume may assist, as Senefelder desired for his work, in "producing many excellent Lithographers."

At the same time, the writer would desire to thank very heartily the many friends who have so ably and willingly given assistance and information in regard to technical points which were outside his own observation and experience, and who have also read and corrected the proof sheets of various sections.

EDINBURGH, 1904.

Contents

CHAP.		PAGE
	INTRODUCTION	xi
I.	DISCOVERY AND APPLICATION OF LITHOGRAPHY	1
II.	PRINCIPLES OF THE PROCESS	5
III.	STONES—THEIR PROPERTIES, DEFECTS, AND PREPARATION	8
IV.	TRANSFER INKS	16
V.	TRANSFER PAPERS	27
VI.	SOME MATERIALS AND ARTICLES USED IN THE PROCESS	34
VII.	VARIOUS KINDS OF TRANSFERS	59
VIII.	ARRANGING AND PATCHING UP WORK FOR TRANSFERRING	75
IX.	DRAWING ON STONE FOR BLACK AND COLOUR WORK	78
X.	TRANSFERRING WORK TO THE STONE	90
XI.	PREPARATION OF STONES FOR PRINTING	101
XII.	HAND-PRESS PRINTING	105
XIII.	MACHINE CONSTRUCTION	115
XIV.	MACHINE MANAGEMENT	126
XV.	MACHINE PRINTING	132
XVI.	LIGHT AND COLOUR	144
XVII.	PIGMENTS	155

CHAP.		PAGE
XXVIII.	PRINCIPLES OF CHROMO-LITHOGRAPHIC DRAWING AND PRINTING	173
XIX.	PAPER—VARIETIES, QUALITIES, AND PRINTING CON- DITIONS	182
XX.	ZINC AND ALUMINIUM PLATES.	192
XXI.	TRANSPOSITION OF BLACK TO WHITE	211
XXII.	PHOTO-STONE AND INK-STONE METHODS	214
XXIII.	REDUCING AND ENLARGING MACHINES	217
XXIV.	ROUGHENING AND EMBOSsing	223
XXV.	ESTIMATING	226
XXVI.	CONCLUSION—QUESTIONS	231
GLOSSARY.	238
INDEX	240

List of Plates

	<i>To face</i> Page
Frontispiece	
I. Specimens of different Grains, used in Chalk Drawing	60
II. Specimens of different Grains, used in Chalk Drawing, in Colour	64
III. Specimens of various Stipples, etc., for Transferring	98
IV. Specimens of various Stipples, etc., for Transferring, in Colour	100
V. Example of Treatment for Map or Plan Colouring	100
VI. The Solar Spectrum — Primary, Secondary, Tertiary Colours, etc.	144
VII. Examples of harmonious Colour Combination	150
VIII. Examples showing want of Harmony in Colour Combina- tion	152
IX. Examples of Colours in juxtaposition, combining to give the secondary Colours	154
X. Specimens of Coloured Inks used in Chromo-Printing	160
XI. Specimens of Coloured Inks used in Chromo-Printing	166
XII. Specimens of Coloured Inks used in Chromo-Printing	170
XIII. Specimens of Transposed Work, Black to White	210
XIV. Specimens of Reductions by Indiarubber Machine	216

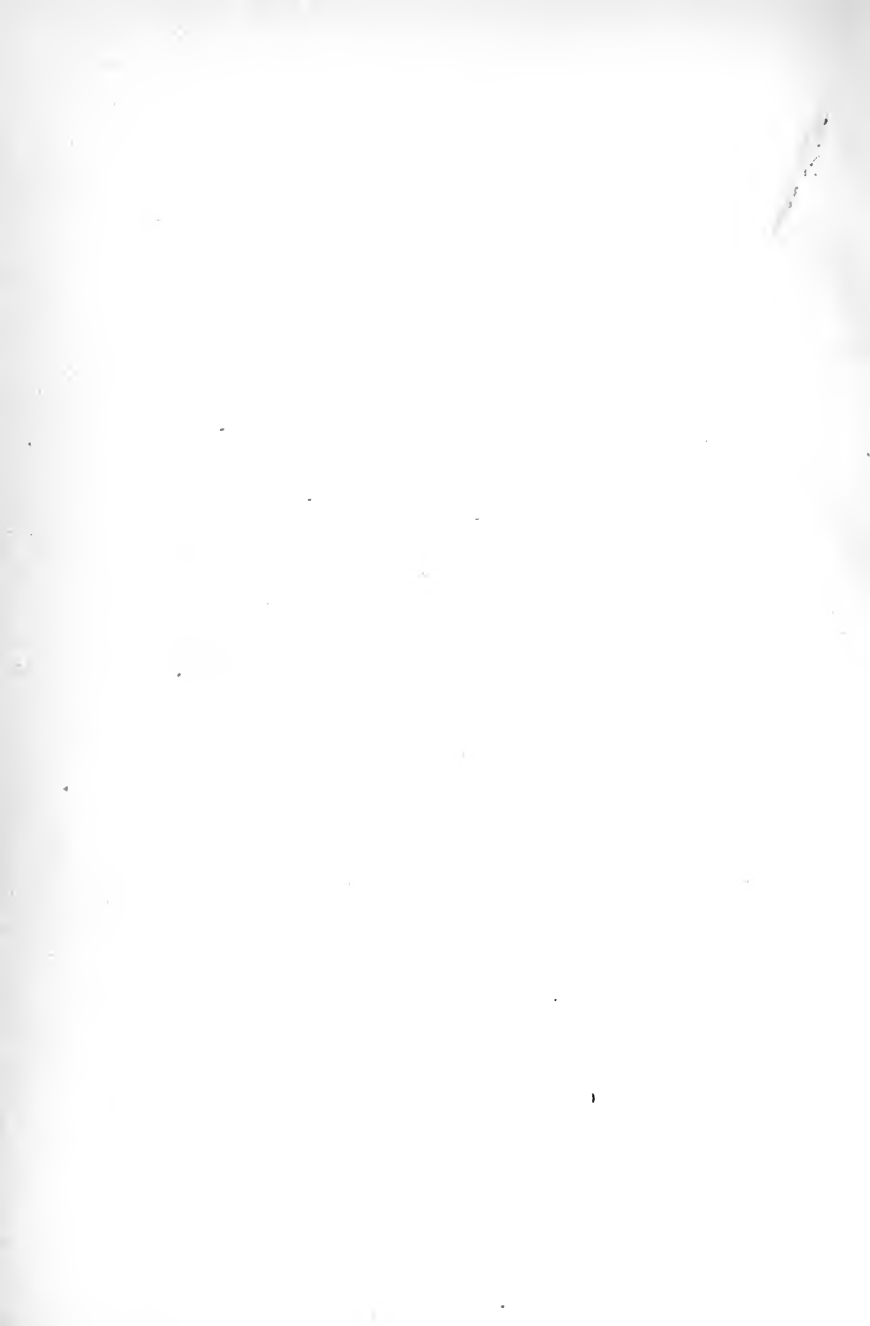

Introduction

LITHOGRAPHY, especially in its higher branches, is one of the most interesting of those arts which give pictorial illustrations to the multitudes that throng our streets or read our books. It should never fail to be interesting to those who are engaged in its pursuit from day to day, and who by its means earn their daily bread. But, though interesting in itself, it is not easy to gather together all the details of the process; neither is it easy (even for those trained to the business) to pursue it to a successful end. The principles involved, the various methods pursued, and the many different materials employed, all go to make the work complicated, and to give very different results in the hands of different individuals. The division of labour also, which is now unavoidable in the conducting of large businesses, has not passed over the Lithographic Trade, hence we find men, who are well up in one department, quite ignorant of and incapable of working in another. This ought not to be so; at least, the higher qualities of man's nature should teach him to seek knowledge in every department of his business; as by possessing such knowledge, he not only increases his own pleasure, but is able to produce better work and earn better wages than he would otherwise do.

A practical treatise on the subject appears to be one of the best means of giving this knowledge.

The writer, having had forty years experience, hopes that this volume may be of service both to the lithographic draughtsman and printer, and be of assistance in maintaining a high standard of quality, in the work turned out by the Lithographic establishments of this country, as well as by those situated in the many parts of Greater Britain.

HANDBOOK OF LITHOGRAPHY.

Chapter I.

DISCOVERY AND APPLICATION OF LITHOGRAPHY.

TO one man we are indebted for the sum and substance of Lithography. Though many improvements have been made in the methods of working, and great changes have taken place in the manufacture of machines, inks, and paper, we still find the principles, as well as the primary inks and transfer papers which are at present in use, practically the same as those given to the world by Senefelder a hundred years ago.

History. A short account of the discovery of the Lithographic process may therefore form the best introduction to the practical part which will follow.*

Lithography is based on certain natural principles which exist in connection with Calcareous Stone, grease and water, which were discovered and applied to produce practical results by Alois Senefelder in 1796. He was born at Prague, the Capital of Bohemia, in 1771. His father, who was an actor in the Royal Theatre of Munich, did not wish his son to follow his own profession and sent him therefore to study law in the University of Ingolstadt. Soon after the young student had commenced his college studies, his father died. He was thus deprived of the means of continuing his college career and had to seek some way whereby he might earn a livelihood.

Senefelder always had a desire to follow Musical and Dramatic Art, and in the circumstances in which he now found himself, he sought to carry out his inclinations. He composed several musical pieces which he endeavoured to publish, but without success. The necessity for economy in his expenditure led him to engrave or etch these pieces of music himself, on copper plates, and not only to

* The substance of this Historical sketch is taken from Senefelder's very interesting work, "A Complete Course of Lithography," English Edition, published by R. Ackermann, London, 1819.

engrave but also to print them. In this also he was doomed to much disappointment, making little progress and still less profit. While engaged in these labours and experiments, he bought a piece of what was then known as Kelheim Stone, which was obtained in slabs of various thicknesses, from the quarries in the neighbourhood in which he lived. He intended to use this piece of stone as a slab, on which to mix the ink he used in his etching experiments, but finding that it was of a very compact nature and took on a very smooth polish, the idea struck Senefelder that he might use it, instead of copper, to etch his musical pieces upon. He tried to do this, but was not so successful as he expected and was brought to very great straits in his financial affairs.

One day while experimenting, and having one of those Kelheim stone slabs clean and well polished, his mother came into his room and asked him to write out a bill for the washerwoman. Having no paper, pen, nor ink at hand, he jotted down the items of the bill on the clean stone, using for this purpose the ink he had prepared as an etching ground, which was composed of Soap, Wax, and Lampblack. Some little time after, when about to rub the writing from the stone, it occurred to Senefelder that he might etch it in relief, and if successful, it might prove an easy method of getting his musical pieces printed. For this purpose he wrote one of his musical pieces on a stone with the ink he had already been using as an etching ground. He then put a border of wax round the edge and poured a quantity of dilute nitric acid over the work. In a short time the acid had dissolved the surface of the stone sufficiently to leave his musical work quite in relief and ready for further experiment.

This relief method was very different in every way, from the difficult process of etching and printing from an intaglio or sunken surface, which he had hitherto been practising. It was not Lithography however, as now understood, but it led the way to its discovery.

In this new departure, Senefelder had more success and was able to print several of his musical pieces, which raised his hopes and gave him encouragement to persevere in his efforts and experiments in Stone Block Printing. His experience was gained however, under very trying circumstances. He had not only to prepare the stone blocks, by carefully drawing the music on the surface in a reversed position, and etching it in relief, but also to print from them after

being so prepared. Besides this, he had to make his own ink, and devise and build a printing press. This press was naturally of a very primitive description, and gave him immense trouble in the working, so much so that he almost gave up in despair. Senefelder's patience and perseverance in trying circumstances, were most wonderful, and bore him on, till a new discovery dawned upon him—Lithography.

From the point of printing from a raised stone surface, he was led by gradual steps (making as he tells us, many thousand experiments) up to the great fact, that the stone he was working with had a chemical affinity for grease; also, that being of a porous nature, it retained for a considerable time any moisture applied to its surface. In short, a daub of grease on a clean polished stone, would receive printing ink and refuse water, while the other parts of the stone, not affected by the grease, would retain moisture and refuse to take on ink—the natural principle of the mutual repulsion of grease and water, coming into play. This made it possible for a roller charged with a somewhat greasy ink, to be rolled over the stone's surface (which was previously damped) without parting with any of its ink, except to those portions which were previously prepared by grease.

He next found out that writing or drawing could be done on paper, with a prepared greasy fluid and transferred to stone; and further, that this work transferred to stone, if washed over with very dilute Nitric Acid and given a thin coating of dissolved Gum Arabic, would give remarkably clear and good impressions when printed.

Thus Lithography came into existence, and printed copies could be obtained from a stone, the work on which was neither raised in relief, nor sunk in intaglio, but consisted of a chemical union between particles or molecules of limestone and grease on its surface.

When this point was reached, Senefelder wrote out a minute description of his discoveries and applied for patent rights in Germany, Austria, and England, during the years 1800-1803. Since then the art has made great progress, and Senefelder had the pleasure before his death (which took place in 1834) of seeing his wonderful discovery established as an important printing industry in all the principal towns in Europe.

In concluding this short sketch, it only remains to say, that with the introduction of the steam cylinder printing machine between 1860 and 1870, and also with the new methods of drawing and preparing work

for stone, Lithography has made extraordinary strides, both in quality and quantity of work turned out. Could Senefelder pass through some of the large lithographic establishments which now exist in Britain, on the Continent, and in America, he would be pleased and astonished beyond measure at the important place his discovery now holds among the reproductive arts.

Chapter II.

PRINCIPLES OF THE PROCESS.

THE term Lithography is derived from two Greek words—*Lithos*, a stone and *Graphein*, to write, and therefore, simply means stone-writing or writing on stone. The word is now used in a wider sense however, and covers the whole process of drawing, preparing, and printing from stone, in the same way as “Photography” is used to denote the whole process of printing by Light, and the further preparation by mechanical and chemical means.

As already noticed in the short sketch of Senefelder’s life, there are certain natural principles involved in the art of Lithography without which it would be impossible to proceed one step in working out the process. It is well to have these thoroughly understood, as they will in themselves explain many things, while the knowledge will be of great assistance to the lithographic draughtsman or printer, in producing the best results.

Principles of Lithography.

The FOUNDATION PRINCIPLE is, that limestone (or any other calcareous stone) has a natural affinity for grease, so that when brought into contact with each other they combine to form a third substance, which chemists call Oleo-Margarate of Lime—a substance which is insoluble in water or spirits and very durable even under considerable friction.

To illustrate this principle, take an ordinary school slate, a piece of glass, and a small lithographic stone. Wash them with water perfectly clean and allow them to dry. Take a piece of tallow or soap and rub it over a part of the surface of each. After allowing them to stand for a short time (half an hour or so), take some turpentine and a clean cloth and remove the grease. It will be found that the tallow may be dissolved and perfectly removed from the slate and glass, but not from the lithographic

stone. On those parts of its surface where the tallow or soap has been rubbed, there remains a film of apparently a greasy nature. It will also be found that no washing or cleaning (even with boiling water) will remove this film, and that water will immediately run off if applied, which it naturally does from a greasy surface. The usual way to remove this film of grease and limestone combined, and give the stone a new natural surface, is to grind the face with sand and water, and afterwards polish it with Water-of-Ayr or Snake stone. This however, will be noticed more fully further on.

The **SECOND NATURAL PRINCIPLE** in the process is the mutual repulsion of grease and water. These do not mix, they do not combine, but on the contrary, fly from each other as natural enemies. This principle is well illustrated and utilised in lithographic printing. Some lines, or dots of grease are put or drawn on a polished slab of limestone which at once combines with it and cannot be removed. There is thus the phenomenon, of one part of a stone's surface ready to repel water and the remaining parts ready to receive and retain moisture for a considerable time. This makes it necessary in all lithographic printing, to have the surface of the stone continuously in a damp state.

The **THIRD NATURAL PRINCIPLE** involved, is that the stone is very quickly acted upon by acids, which are used to prepare it for further treatment. Thus, Nitric Acid in a diluted form, is used to etch the stone (after the work is put on) and make it more susceptible to the action of Gum Arabic solution.

The **FOURTH PRINCIPLE** is the chemical action of dissolved Gum Arabic on the stone's surface. The Gum itself not only fills up the minute pores of the stone, but the Arabin Acid appears to combine with the Lime and forms a tender insoluble film which prevents the stone "taking on" grease during printing.

These natural principles show that Lithographic Printing is not a mechanical process. It greatly depends on chemical action, and chemical preparation of the materials used in its pursuit. They also show that it requires a considerable amount of skill, and very great care on the part of both draughtsman and printer, in order to produce the best results from such combinations.

Each of these principles will again be noticed when they come to be treated in connection with practical work.

To apprentices and journeymen it may be useful to say here, that no good work will be accomplished without the greatest attention to, and close observation of the working of these principles in daily practice. They are, so far, antagonistic one to another, but are all united in trying the patience, temper and ability of the printer, in every possible way.

Chapter III.

STONES—THEIR PROPERTIES, DEFECTS, AND PREPARATION.

WITHOUT stones there could be no Lithographic art. It will be of advantage, therefore, to notice these first in order. The Kelheim Stone used by Senefelder in his experiments, and now used for litho-printing, is a very fine and pure quality of **Stones.** Limestone. It contains from 94 to 98 per cent. of Carbonate of Lime, with the remaining small per centage (2 to 6 per cent.) of foreign matter, such as Iron, Manganese, and Aluminium. It has been deposited in the earth's surface in by-gone ages in layers, varying in thickness from that of a sheet of paper to 8 or 10 inches. Before the era of Lithography, these layers or slabs were used for paving purposes. This special quality of Limestone is found in various parts of the world, including the United States, Canada, Turkey, Italy, Spain, France and Germany, also, it is said, in Britain. British stones are however practically unknown. In no country are stones found equal in quality to those brought from the original quarries of the town and district of Solnhofen. Germany was the birthplace of the art, and very remarkably, has held a practical monopoly in supplying the world with lithographic stones, ever since the days of Senefelder's discovery.

The Solnhofen quarries are situated in Bavaria, on the Franconian Jura Mountains, at a height of about 2500 feet above sea level. The towns of Pappenheim and Solnhofen are on the banks of the River Altmühl, a tributary of the Danube, into which it falls near the town of Kelheim. These two towns form the centre of the Lithographic stone district, and the inhabitants are largely dependent for employment on the quarries, which extend over an area of from 12 to 15 square miles.

In starting a quarry the surface layer of earth is first removed, and there is then found a stratum of common "Jura" limestone of variable

thickness. When this is removed there is found in perfect horizontal position, the various thin and thick layers of Lithographic stone which can be worked to a depth of about 100 feet. It is very remarkable that this particular stone (which for Lithographic purposes must necessarily be perfectly level and of equal thickness) should be found to exist in such wonderful horizontal strata and to have remained in that position during all the ages that have elapsed since the deposits were made. There can be no doubt that the Creator of all good has arranged and preserved this wonderful storehouse of material, with the same consideration that He has granted, the inexhaustable mines of coal and other mineral riches for the welfare and enriching of mankind.

One would naturally think that such an area and depth of strata would give an inexhaustable supply of stones. But owing to thin layers, faulty and broken slabs, and the waste incurred in cutting the stones to a suitable square shape for printing purposes, the supply of really good stones is not now plentiful. This scarcity helps to keep up the price, notwithstanding the competition of zinc and aluminium plates.

There is still however, a large reserve and a large demand, which enables the quarry owners to make steady shipments to all parts of the civilized world all the year round.

The stones are not difficult to quarry, being damp right through and rather soft; but considerable care and some skill is required in raising the slabs, so that they may be as perfect and as large as possible. After being dug out, they are cut to the recognised sizes for the trade, and assorted according to thickness, size, and quality. Though soft when first quarried, they soon get very hard when exposed to the air.

The thin layers are of no use for printing purposes. Sometimes the larger sized thin stones are cemented, two together, in a very neat and clever manner. These are not to be depended on however, and should not be used for valuable work, as sooner or later they come apart and generally break in doing so. Small stones may be used, 2 inches thick, but larger stones for machine printing should be from 3 to 4 inches, while for very large sizes the thickness may be from 4 to 5 inches. The following table will give the more regular sizes in use, with prices and average weights:—

SIZE	Average Thickness in inches	Average Weight in Pounds	Price per Pound	SIZE	Average Thickness in inches	Average Weight in Pounds	Price per Pound	
8 by 6	...	11	3/4d.	27 by 21	3	185	1 1/4d.	
9 " 7	2 1/4	13		28 " 20		178		
10 " 8	...	16		28 " 22		196		
12 " 10	...	24		30 " 20		191		
14 " 10	...	27		to	210	1 1/2d.		
15 " 11	...	32					31 " 21	
16 " 12	...	43					32 " 22	
17 " 11	...	42					32 " 24	264
17 " 13	...	49		4	277	1 3/4d.		
18 " 12	...	50					34 " 24	
18 " 14	...	58	36 " 24				294	
19 " 13	3	66	36 " 26				319	
19 " 15	...	77	38 " 26				336	
20 " 14	...	75	38 " 28	362				
20 " 14	...	75	40 " 28	394				
21 by 15	3	85	1 1/4d.	4	422	2 1/4d.		
22 " 15	...	89					40 " 30	
22 " 16	...	96					42 " 28	414
22 " 18	...	106					42 " 30	443
23 " 17	3 1/4	128		to	473	3d.		
24 " 16	...	125					60 " 40	
24 " 18	...	130					62 " 42	1016
25 " 19	...	144						
26 " 20	3 1/2	165						

These prices vary a little with different agents. Intermediate sizes may also be had.

The nature of these stones may be summed up in a few words. They are very hard but brittle, and liable to break or chip, which necessitates great care in handling. They break with a conchoidal fracture. They are of a close, compact texture, yet porous, so that moisture when applied to their surface, is retained for a considerable time. They vary in colour from a yellow-buff to a dark stone-grey, and this colour is the index to their hardness and quality. The darker the colouring, the harder and more dense is the stone. The French and Spanish stones, which have come under the notice of the writer, were of a dark blue-grey, and following the above rule were much harder than the German grey stones. This extreme hardness and dark colouring has prevented them coming into use to any extent in this country. The surface of the stone takes on a remarkably smooth polish—a glass-like surface—which is essential for fine work.

Natural Defects of Stones. Stones of every description have natural defects or blemishes, and lithographic stones are no exception to this rule. These defects require careful attention, as they often cause much trouble in practical working. They may be stated in the following order:—

1. In many of the light-coloured stones there are red marks or stains, as if caused by iron in solution. They sometimes cover large parts of the stone's surface, but do not materially affect the working qualities, and are not therefore to be regarded as a serious defect.
2. There is often on the surface a grey-white mottled appearance called "chalk marks." These marks are of a softer nature than the stone proper and do not take on an equal polish. Neither do they take on work in a perfect manner and are more easily affected by the acid in the "preparing." They are generally found in groups, sometimes covering the larger part of the stone's surface. When this is so, the stone should be considered bad and only used for very coarse work. Fine work would be rotten and stipple work blotchy on such stones.
3. Sometimes there is found embedded in the stone "glass marks," which are felspar crystals, the same as are found so largely in granite. These crystals, being quite different from the limestone in which they are found, have no affinity for grease, and will not therefore take on work. Fortunately they are not found in groups, but singly, here and there in some stones. This being the case, they can generally be avoided when work is being transferred. If any stone contains a large number of these, it must be considered useless for lithographic purposes.
4. Another defect, the most serious and most common of all, is veins. These appear to be vertical or oblique cracks which have occurred in bygone ages in the horizontal strata of the quarries. In course of time they have become filled with a foreign substance, which acting as a strong cement, has joined the pieces firmly together again. These veins are mostly composed of silicon, which has no affinity for grease, neither is it acted on by acid. When they happen to cross black work they often refuse to take on ink, and so cause white lines to appear; but very curiously, when crossing a part of the stone where there

is no work, they as often take on ink in a mechanical way, and print a dirty line on the clean paper. There is no remedy for the first fault, but the other may be modified, if not altogether removed, by scraping the vein down below the level of the stone's surface. When stones break it is very often along the line of such veins. In selecting stones it is of great importance to get them with as few defects as possible, and if the veins are many, or strongly marked, the stone should be rejected. There is hardly anything so troublesome to a litho-printer as a stone with black veins running through it.

When so many faults are to be found in stones, the question may be asked, are there any perfect? It must be confessed there are very few such. Imperfect stones form one of the real difficulties of the business, and much care is required to select and use stones best suited for the work in hand, avoiding as much as possible the defects that have been mentioned.

To get a stone properly prepared and fit to receive a drawing or transfer is the first step in the lithographic process. To do so the following articles are required:—

- | | |
|-------------------|---|
| | A Levigator with upright handle. |
| Stones, | Two or three wire sieves—about 36, 56, and 76 mesh to |
| Grinding | the inch. |
| and | A supply of sea sand. |
| Polishing. | A supply of fine Silver sand. |
- A rough file or rasp.
- A smoother file.
- Some blocks of Pumice Stone. The artificial stone is the best for the purpose.
- Some blocks of Water-of-Ayr or Snake Stone.
- An iron straight-edge, perfectly true on its edge.
- A Squeegee, very useful in clearing away the water from the face of the stone.
- A pair of calipers.
- A water-trough with wooden bars across the top, on which the stone rests. This trough should have a water-tap in a convenient position, and an over-flow pipe standing up about 6 inches from the bottom. This should be removable to facilitate the cleaning out of the trough periodically.

Having these things ready, the stone should have the edges well rounded, using first the rasp and then the smooth file, and polishing afterwards with a piece of pumice stone and water.

Rounding the edges is necessary for several reasons. The round edge does not take on dirt or ink so easily as a sharp edge. It prevents the stone face being easily chipped while in use in the printing-room. It saves the blanket of the machine being cut during printing, and last, but not least, it is the sign of a good workman when he has the edges of his stone in good condition.

The next step is to have the stone put on the trough and evenly covered with the coarser sand passed through the sieve. Some water is sprinkled over it and another stone is placed on the top face down. This upper stone is moved rapidly backwards and forwards till the sand is reduced to a pulp, when it is washed off, and the operation repeated till the stone is ground level over its whole surface. It is then washed till every particle of sand is removed. This washing is important, as if any sand remains on the surface it will cause scratches which will be very troublesome to remove.

After washing it is polished with pumice or grit stone, until the granular appearance gives place to a polished surface. Both the pumice or grit stone however, leave a series of fine scratches, and to remove these it is again polished with Ayr stone and perfectly clean water. This gives the stone a smooth, glass-like finish. The stone is again thoroughly washed with running water and allowed to dry, when it is ready to receive a drawing or transfer. To test the stone if properly polished or not, pass the hand very lightly over a part of the surface, the feeling should be as if you were passing it over a sheet of glass.

The important points to attend to in the polishing of a stone are—1, to see that the sand marks or granular appearance caused by the grinding are entirely away; 2, that no scratches are on the face of the stone; 3, that the surface is perfectly true to the straight-edge. This is ascertained by placing the straight-edge along the surface of the stone. If any daylight appears between the stone and the straight-edge it is evident that the stone is hollow at that place and requires further treatment in grinding or polishing: the latter will generally be found sufficient.

Instead of using one stone on the top of another in grinding, the

Levigator is generally substituted (see Fig. 1). This tool is an iron disc about a foot in diameter and three or four inches thick, having an upright handle, placed nearer the edge than the centre; this arrangement makes it easy to obtain a circular motion when grinding. Messrs Seggie & Son of Edinburgh make a very useful machine having a revolving disc, and overhead driving gear, which grinds the stone more rapidly, and at the same time gives a truer surface than could be obtained by mere hand work (see Fig. 2). There are also larger stone-grinding as well as stone-planing machines in the market; but as they are expensive and only to be found in a few of the largest establishments, it is not necessary to notice them further in detail. The use of these large machines is now greatly curtailed by the introduction of Rotary Printing Machines for Zinc and Aluminium Plates.

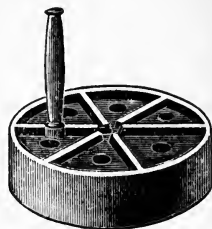

Fig. 1. LEVIGATOR.

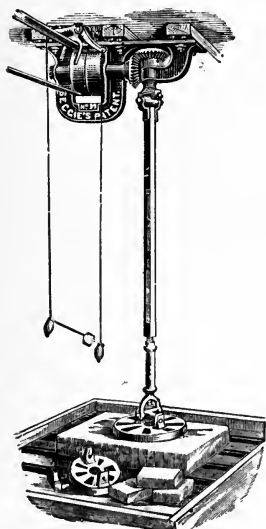

Fig. 2. OVER-HEAD STONE GRINDING MACHINE.

All the above instructions apply when stones are wanted with a smooth surface. When stones are required with a grained surface, either of a fine or a coarser character, further operations are necessary. To prepare these the usual grinding and pumice stone polishing is gone through. The stone is allowed to dry, when it should be carefully examined to see that no scratches are on the face. If there are any such, the pumice stone will again have to be used. A small circular piece of stone, 6 or 8 inches in diameter, is then used, with a supply of the "Silver" sand passed through the fine sieve. Water is sprinkled over the surface and the small grainer passed over the stone with a moderately rapid circular motion, varying it as much as possible, so that every part of the stone's face may receive the same amount of graining. This operation is repeated

several times till there is a regular granular surface over the whole stone. A gentle pressure is necessary on the small stone when thus

graining, and the edge of the same should be carefully rounded to prevent scratching.

With some practice, any degree of fineness of grain may be obtained, by continuing the graining operation till the sand is reduced more or less to a creamy state. If continued too long, it gives flatness, which is not suitable for general work. Should the grain be too flat, add more sand and water, and grind carefully for a few minutes, not long enough to allow the sand to get into the creamy state. If too coarse, use finer sand with a finer sieve, or grain again till the sand is brought to a finer pulp. Experience in this, as in all things, is the best teacher. When the grain is thought correct, wash the stone thoroughly with running water and allow to dry. The artist should always test the grain to see if quite suitable for the work in hand. Very beautiful effects may be produced from the grained stone, and very much depends on the quality of the grain.

Chapter IV.

TRANSFER INKS.

TWO other most important articles used in the lithographic process are Transfer Inks and Transfer Papers. The one needful quality in Transfer Inks is, that they contain a large proportion of grease, and the one needful quality of Transfer Papers is, that they are capable of receiving that grease from the hands of the artist or printer, and of conveying it in its entirety to the stone. Thus the one is the complement of the other, and the two together may be called the complement of the stone in the production of lithographic work.

Transfer Inks are of different kinds and are used in as many different ways:—

Varieties of Transfer Inks. 1. Lithographic Writing Ink: used in a liquid state for drawing on stone or paper. This, in a somewhat more diluted state, is also used as an Autographic Writing Ink, when such writings are desired to be printed from stone.

2. Lithographic Chalks: used for drawing on grained stones or grained papers.
3. Rubbing in or Stumping Ink: used in producing tints on grained stones.

These three inks 1, 2, and 3 belong to the artists' department.

4. Stone to Stone or Re-transfer Ink: used in pulling transfers from "original" stones, to be transferred to "printing" stones.
5. Plate Transfer Ink; used to pull transfers from Copper or Steel plates.
6. Type Transfer Ink: used to pull transfers from engraved blocks or type.

These three inks 4, 5, and 6 are used in the printing-room.

All of these six different inks have peculiarities, which belong to themselves, and which make them most suitable for the special work for which they are intended.

The face of the lithographic stone, when perfectly clean, as we have already noticed, is extremely sensitive to grease. If we put a few drops of a solution of soap or other fatty substance on the face of the stone, it will immediately absorb what it can, and the basis for lithographic printing is formed. But although this is the case, it will be easily seen that an artist could not draw a portrait on stone, with a piece of soap or with the end of a tallow candle. Neither could a draughtsman draw a map or plan, on stone or transfer paper, with oil or with a lather of soap and water, nor could a printer get a proper transfer from a copper plate, with a mixture of tallow and lamp-black. These substances must therefore be prepared in such a way as will form a suitable and convenient working medium, while at the same time, retaining the necessary amount of grease to be conveyed to the stone, which will form the basis for printing.

The materials used in the manufacture of Transfer Inks are Soap, Bees Wax, Tallow, Spermaceti, Shellac, Mastic, Pitch, Venice Turpentine, Lamp-Black and Black Lithographic Printing Ink. These may be easily divided into classes such as Soap, Tallow, Bees Wax, Spermaceti, which are of a greasy nature; Shellac, Pitch, Mastic, which are hard and go to bind the softer materials together; Lamp Black and Black Ink may be termed neutral elements, which are used to give colour to the writing inks, and in larger quantities in the Lithographic Chalks and Plate Transfer Inks to give freedom in working; Venice Turpentine, when used, may be termed a solvent for the other materials.

We would notice shortly in detail these various substances,

Soap, which enters very largely into the composition of transfer inks, is a chemical compound formed by the union of fats and fatty oils with alkaline bodies. It is this alkaline nature that gives it the property of dissolving in water and combining with other greasy bodies. It appears that the amount of fatty acid varies in different soaps, and the more fatty acid there is, the better is it adapted for lithographic purposes. The following table taken from the *Encyclopædia Britannica* may be useful:—

Pale Soap . . .	contains 62 %	fatty acid.
Palm Oil Soap. . .	49 %	” ”
Cocoa-Nut Oil Soap	32 %	” ”
Tallow Soap . . .	58 %	” ”
Marseilles (mottled) Soap	76 %	” ”

The last mentioned would appear to be the most suitable for the purpose, but as Pale Soap may be had at all times of a uniform quality, and contains a large proportion of the necessary fatty acid, it is mostly used, and answers the purpose well. Senefelder states that “Venetian or Oil Soap is not so good for ink as it renders it more slimy when dissolved in water, and does not resist so well, the action of the acid,” *i.e.*, the acid used in preparing the stone. The fatty acid, contained in soap, gives a large part of the grease required in transfer ink preparations, and acts as a solvent towards the other materials, while the alkali makes it possible to dissolve one of the kinds in water, for use in a liquid state.

TALLOW is a pure fat, and is used to give greasiness and softness to the inks in which it is introduced. It also reduces the proportion of alkali which the soap imparts.

BEE WAX is a familiar substance produced by the bee. It is of a greasy nature, but much firmer when cold than tallow. It is used to give consistency to the soap and tallow.

SPERMACETI is of much the same nature as wax. It is obtained from the oil of the spermaceti whale. It is now seldom used.

SHELLAC and MASTIC are natural resins obtained from trees, they are of a hard nature, though easily melted by heat, and are used to give hardness and to bind the other materials together. Shellac occupies a very important place in transfer inks.

PITCH, Burgundy, is also used to give hardness in plate transfer inks, and also to give, along with the shellac, the melting property when heat is applied.

LAMP-BLACK is a carbon obtained by burning resin and oils and collecting the soot. To make this black very pure, it is heated to redness, when the impurities are mostly driven off in the shape of yellowish fumes. This is put in the writing ink to give colour only, and in larger quantities into chalks and plate transfer inks to give body and freeness in working qualities. Senefelder mentions that a coloured pigment

might be used with advantage for some kind of work. Black, however, appears to be universally adopted as the best for all purposes.

Referring now to the various transfer inks we would notice each of them in the order already given.

The first of these, Lithographic Writing Ink, is used in a liquid state for drawing on stone or paper. It is manufactured in the form of cakes

by several makers. Those mostly in use in this country are made by Vanhymbeeck, Lemerrier, and Stroeger. Some lithographic draughtsmen mix Stroeger's with either of the other two, as it is rather more fluid but has not

quite the strength or greasiness of the others. In this as well as in other transfer inks, we find that Senefelder laid a good foundation for their manufacture. The same ingredients which he used are still used, though perhaps not exactly in the same proportions, showing that his experiments must have been conducted most carefully and exhaustively, to enable them to stand the test of one hundred years practical work, these years being crowded with scientific and chemical research, in every branch of art and manufacture.

The following recipes will show the component parts of Lithographic Writing Ink :—

	Wax.	Shellac.	Tallow.	Soap.	Lamp-Black.
Senefelder . . .	12	—	4	4	1 parts.
„ . . .	12	4	—	4	1 „
„ . . .	8	4	4	4	1 „
Hulmandell . . .	4	4	4	4	$\frac{1}{2}$ „ or less.
Lemerrier . . .	4	4	4	4	1 „

The necessary qualities of Lithographic Writing Ink are :—

1. It must be capable of being reduced with water to a liquid state. The alkali in the soap gives this quality.
2. It must contain the necessary amount of grease to combine with the stone, even in the finest possible drawn or written line. The tallow and soap give this quality.
3. The ink should not wash away while being transferred to stone. The shellac and wax give this quality.
4. It must be visible in the finest line or dot when being worked. The lamp-black gives this quality.

It is thus seen that each of the ingredients has its place and work. A little too much of any of these would materially affect the working qualities of the ink.

To make this ink, the ingredients are all melted together in an iron pot, except the lamp-black and one half of the soap. The mixture is kept on the fire till it takes flame, and is kept burning till the mixture is reduced to about one-half. The flame is then put out, and the other half of the soap and the lamp-black is added. The soap being cut into thin shavings and the black finely powdered. The whole is then thoroughly mixed, and when cooled a little, is poured into any convenient flat dish and cut into cakes.* In this form it will keep any length of time, which is a great convenience for sending abroad.

When required for use, a cake is rubbed backwards and forwards on one of its edges in a saucer, to which it adheres and gradually accumulates. If the saucer is slightly warmed it gathers more quickly. Water is then added and the ink gradually mixed by rubbing with the fingers till it comes to be about the consistency of thin cream. A good way of testing whether the ink is thick enough is to let it run from one side of the saucer to the other, if it quickly leaves the saucer white, it is too thin, but if it leaves a coating of blackish ink on the surface, it is about right for working. It is very easy to add a few drops of water afterwards should it be rather thick, but you cannot easily add the solid ink if too thin, it is better therefore to have the ink stronger than weaker. For fine work on stone or paper, fresh ink should be made every morning. What is left over night may be used for filling in on stone and for coarser work.

The water to be used in reducing this ink is of importance. Most waters contain a quantity—more or less—of lime or carbonate of lime, which gives the well-known quality of hardness. If this hard water is used, the lime will immediately unite with the fatty acid in the prepared ink, and cause it to curdle, and in so doing, it will lose a

* We would desire to point out, that though the composition and the general method of preparing the various transfer inks is given, it is not intended that private individuals should attempt to make them, except it may be in the way of experiment. They may all be bought from manufacturers, who make these inks a special line of business, and are therefore better able to give a reliable and more equal quality, than could be obtained by an amateur, however careful he might be. Experiment we heartily recommend, in the making of ink as well as in every other department of the business.

portion of the strength which is required for combining with the stone. Soft water, boiled water, or best of all, distilled water, should be used for mixing down lithographic ink. To show the effect of lime on this ink, get a small quantity of lime water from your chemist, pour this into a saucer containing lithographic ink, and immediately the ink will become so curdled that it will be quite useless. The ink has parted with all its grease to the lime and so has lost its properties as lithographic ink. The same thing occurs in a less degree when hard water is used for this purpose, showing that it is not suitable for making lithographic ink.

The second transfer ink noticed was Lithographic Chalks, which are used for drawing on grained stone, grained paper, or it may be, grained zinc, aluminium, or gelatine. Limestone being the original material on which subjects were drawn, chalks were at first prepared to suit its natural qualities, but it has been found that these prepared chalks are quite as suitable for drawing on any of the grained materials above mentioned, as on stone.

The required qualities of Lithographic Chalks are as follows:—

1. They must contain the necessary amount of grease, which will enable the most minute particle to combine with the stone, when brought into contact with it. The soap gives this quality.
2. They must be of a nature that will take on a sharp point for drawing, and also be of a shape suitable for holding in a Port-Crayon. These qualities are not required in any of the other five kinds of transfer ink mentioned, and are therefore not provided for in these. The absence of tallow, and the addition of more lamp-black, gives the necessary pencil qualities, and being cast in tube moulds, gives them the appearance of black pencils and makes them suitable for use with Port-Crayons.
3. That as most drawings on stone take a considerable time to finish, it is necessary that the parts drawn first will not flow or thicken in any way. The combination of wax and lamp-black gives this quality.
4. In the case of drawing on grained paper, a process unknown to Senefelder, it is very necessary that the ink should be of such a hard nature that the drawing will not flow when being transferred

to stone, even when the stone is slightly warmed. The shellac and lamp-black give this necessary hardness.

5. When a subject drawn on paper is transferred to stone, it should not wash away when water is applied. If it does there is too much soap in the chalk, and is a serious difficulty for the printer to overcome.

The component parts of Lithographic Chalks vary a little, which may be seen from the following recipes :—

	Wax.	Shellac.	Tallow.	Soap.	Lamp-black.
No. 1.	8	—	—	6	2 parts.
„ 2.	4	—	—	4	2 „
„ 3.	8	4	—	5	3 „
„ 4.	8	4	2	5	3 „
„ 5.	8	—	4	6	3 „
„ 6.	4	—	—	6	2 „

It will be noticed, that in comparison with the cakes prepared for liquid ink, there is no tallow in most of the recipes, but more soap and much more lamp-black. These chalks are made in different degrees of hardness, and for the harder qualities the shellac is added.

“Copal” is the hardest and is used generally for drawing on grained paper. When carefully sharpened very fine lines may be drawn with it.

No. 1 is used generally for drawing on stone, or for poster work on stone or paper.

Nos. 2 and 3 are a good deal softer, and are used for broad and rough work where no fine detail is required. The softness of the chalk is obtained by the addition of tallow, as seen in the recipes given, or by a less quantity of shellac and lamp-black.

The third transfer ink mentioned was rubbing-in, or it may be better known to some as stumping ink. This variety is not so much in use

now as formerly, when drawing on grained stones was more

Stumping Ink. common and printing was done at the hand-press. It is prepared in the following way: take a quantity of chalk

ends and parings, which are usually kept in the artists' room, with a little tallow and melt together in a pot, thoroughly mix them and pour out on a stone slab. It can be made in the form of

thick cakes or round balls, and when cold is ready for use. How to use it will be seen when we come to speak of artist work in another chapter.

The fourth transfer ink mentioned, is that which is used to pull transfers from stone, and is called stone-to-stone or re-transfer ink.

Re-Transfer Ink. This ink is so far different from those already noticed, that it is used by the printer, not by the artist, and must therefore, in a certain measure, be a printing ink.

It is also an ink that can be more easily modified in working than any of the others, by adding ordinary printing ink or varnish.

The qualities which stone transfer ink should possess are as follows :

1. It should have, as all the others, a sufficient amount of grease to make each line of any drawing combine with the stone when transferred to it.
2. It should not be over greasy. If so, it will cause the stone to take on a scum, and prevent a clean transfer or impression being taken. The remedy for this fault is to add a little good black litho-printing ink, and use perhaps, a little mid instead of thin varnish in reducing.
3. It should possess good printing qualities. The very finest black only should be used in the manufacture, and the grease quality obtained by tallow rather than soap.
4. It should not have in any degree a drying nature. This negative quality need hardly have been mentioned, had it not come under the writer's observation. Some tins of transfer ink had been sent in, which when opened, had a hard skin on the top ; this ink was at once returned to the makers as unsuitable. This special ink would likely have had the needful printing qualities, and with it good transfers might have been pulled, but it would not have been safe to keep them over-night before transferring, which is often required to be done.

Re-transfer ink should be bought from a reliable maker. As however, it may be required at some time in an emergency, it may easily be made as follows :—Take about three parts rubbing-in ink and two parts lithographic printing ink, with a small quantity of varnish, and mix them well together, either on a slab or by melting them in a small pan over a slow fire ; when thoroughly incorporated together the ink is ready

for use. A little more of either of the two inks may be added with the palette knife if required to make the ink stronger or weaker, and the necessary varnish will also be added when the transfers are to be pulled.

The intelligence of the printer will lead him to see that other combinations will give him the same result. What is wanted is a printing ink with the necessary amount of grease to combine with the stone. The writer has pulled transfers with a mixture of black ink and soap, but would not recommend anyone to use such a crude material. Having at hand lithographic chalks, tallow, lithographic writing ink, and plate transfer ink, with printing ink, no one need be brought to a stand-still for the want of re-transfer ink.

The fifth transfer ink to be noticed is plate ink. This is used by the printer, or rather the copper-plate printer, to take transfers from engraved copper or steel plates. Plate transfer ink is a very important article in every lithographic printing office, as a great deal depends on its quality and its proper use in turning out satisfactory work. There are many recipes for this ink, and when it was more home-made than is now the case, each foreman had his own special recipe, which of course was better than any other. Senefelder had no recipe for either this ink or re-transfer ink, from which we gather that these processes were unknown to him, at least in the earlier period of his work.

The best recipes for this ink may be taken as follows, though each maker has his own proportions of the ingredients required:—

	Wax.	Shellac.	Tallow.	Soap.	Pitch.	Black Litho. Ink.	Lamp- black.	Asphal- tum.	Venice Turpentine.
No. 1,	4	4	4	4	4	4	—	8	9 parts
„ 2,	8	4	8	4	8	—	I	—	8 „
„ 3,	4	4	4	4	2	4	—	2	— „
„ 4,	4	5	1½	3	5	2½	—	—	— „

These ingredients are all melted and set on fire in an iron pot, and allowed to burn from twenty to twenty-five minutes, being constantly stirred with an iron rod or spoon. When sufficiently burned it is poured on a slab, and when somewhat cooled, but still soft, is made into rolls or balls with the hand. Very few printers, if any, now make

this ink themselves. It is important for every printer however, to know the constituent parts, so that he may be able to guide his work aright, both in pulling transfers and transferring. There are several makers of this ink. It should be bought from one who can be depended upon to supply a good and uniform quality. The price is from 8/- to 12/- per lb.

It will be noticed that in comparison with the others, there is in this transfer ink a considerable difference in the proportions of the materials used, as well as a new ingredient introduced—viz., pitch. These differences give it quite a different character from the other transfer inks, but which is necessary for the purpose it is afterwards to be put to.

The qualities of plate transfer ink may be stated as follows:—

1. It must contain the necessary amount of grease, as in all the other transfer inks.
2. It must be of a sealing-wax nature. To melt when rubbed across a heated copper-plate and harden again immediately when cold. The shellac, and particularly the pitch, give this quality.
3. Following No. 2 quality, it should not be soft when perfectly cold. Should it be soft, the impression from the plate may look well, but when being transferred to stone, the lines will spread, and give a blotched appearance to the work when printed. The remedy for this is the addition of a little more pitch or shellac or both, or it may be hardened by a little more burning. The longer the burning is continued the harder it becomes and at the same time of a less greasy nature.
4. It should not be too hard. If so, it will be much more difficult to get a good impression from the plate, especially in the finer lines, and these lines will not transfer to stone with sufficient strength to enable them to stand proper working. If too hard, the ink requires the addition of a little more wax and tallow. The proper hardness of plate transfer ink is shown, when you can with some effort, put your thumb nail into it and leave a mark. Also, if you can break with a clean fracture a stick of the ink by knocking it smartly on the edge of a table. If soft, it will bend not break; if too hard, it will likely break into more pieces than two.

5. It should wipe clean and easily from the copper-plate. Sticky transfer ink will hardly clean off at all, and will therefore cause a great waste of time and material in getting a transfer pulled. Ink of this quality requires a little less shellac or asphaltum, or more lamp-black.

The sixth, and last transfer ink mentioned, is that used for type or woodcuts. The best quality of letterpress ink without dryers will answer the purpose very well. If a little lithographic re-transfer ink be added to the letterpress ink, it will be a great improvement and will give more satisfactory results in transferring.

**Type
Transfer
Ink.**

In ending the description of transfer inks, we would again say to users, do not attempt to make these except in the way of experiment. Test a few samples from different makers, and choose that which seems best and most suitable for your special work. This refers more particularly to plate and re-transfer inks, which vary a good deal more in quality than chalks or writing ink.

Chapter V.

TRANSFER PAPERS.

THE complement of Transfer Ink is Transfer Paper—the one cannot do without the other. As the ink is prepared for the stone, the paper is prepared for both. It receives the ink in a proper way, and is the means by which it is conveyed to the stone so as to give the best results.

We have seen that there are various kinds of transfer inks, so also there are various kinds of transfer papers, each one suited for its respective ink and work.

Senefelder, shortly after his discovery of the properties of the Kelheim stone, found out, that in drawing a subject on paper, with the same ink which he used in drawing on stone, he could with a little manipulation, transfer it to the stone. This was a most important advance in the art of Lithography. Previously, he had necessarily to draw the subject on stone reversed, so that it would appear correct when printed. Now he could draw in the natural position on paper, and when this was put on stone face down, it was of course, reversed in the act of transferring. Drawing on paper is a very easy and simple method when compared with doing the same work on stone.

Before noticing the different varieties of transfer paper, there are a few general observations to be made, which apply to all, and which are important to keep in mind.

Transfer paper consists of two parts—the paper itself and the composition with which it is coated. This composition is the medium to receive and hold the transfer ink—in a way, separate from the paper itself. When a transfer is put on a stone in the usual manner by pressure, the paper is damped many times till it is quite soft, and may then be lifted easily from the stone, leaving the entire coating and with the coating the transfer or drawing itself. This is a most important

**Transfer
Papers,
Necessary
Qualities.**

point to be understood and appreciated. If any of the transfer ink remains on the paper when lifted away, it shows, either that the coating was too weak, or too thinly put on, or that the coating had not left the paper properly; * in either case, preventing the stone receiving the full complement of grease which the transfer contained, and so far giving an inferior result.

Another point to be noticed, and which is also applicable to each variety of paper is, that the coating must not be too soft and absorbent. It should be of such a quality that a transfer will remain a reasonable time on its surface without losing its greasy nature. Keeping this in view, the paper should not receive a thicker coating of composition, than is necessary for the purpose intended. Again, it is necessary that each and all of the transfer papers should be of an adhesive quality when slightly damped. This is required, to enable the transferrer to pass the transfer through the press many times, without it moving a hairsbreadth. Should it do so, the transfer is spoiled, and the work must be done over again. It may also be noticed that the coating should be equal, and without streaks, over the entire surface of the paper. Streaks will not do much harm when the transfer being pulled, is line work or maps, but for colour work, where there is gradation and chalking, they may prove fatal to the work in hand.

The different kinds of transfer paper may be just mentioned and afterwards noticed more in detail.

- | | |
|---|---|
| Varieties of
Transfer
Paper. | <ol style="list-style-type: none"> 1. Paper used for drawing or writing on, with the liquid transfer ink. 2. Grained paper used for drawing on, with lithographic chalk. 3. Paper used in pulling transfers from stone. 4. Paper used in pulling transfers from copper or steel plates. 5. Miscellaneous papers. |
|---|---|

The materials used in the composition for coating the paper are very simple—viz., flour, starch, gelatine, glue, plaster-of-Paris or stucco, flake-white, gamboge, and sometimes a little spirits of wine. These materials are not all used in making each of the above-mentioned transfer papers. A selection is made of those found to be the most suitable for the particular paper required. Flour and starch are used in the form of

* This and other points in connection with transferring will be more fully considered when we come to that part of the subject.

paste to bind the plaster-of-Paris together. Gelatine and glue are also used for the same purpose, and to give the adhesive quality to the composition, which is so necessary. Gamboge, a natural gum, contains a large amount of yellow colouring matter. It is used to give a yellow tone to the transfer paper (No. 1) used by lithographic writers, and as it is in itself of an adhesive nature, it assists that quality which is required in the composition. Flake-white is a lead pigment used in painting and printing, when reduced with water it is of a peculiarly soft nature and and is very suitable for making some of the transfer papers—taking the place of plaster-of-Paris.

The first transfer paper noticed is that used for drawing or writing upon, with pen or brush, using liquid ink. The qualities required are:—

Writing Paper.

1. It should have a surface capable of being written upon—viz., smooth, and of a hard nature.
2. It should be strongly adhesive when very slightly damped. The composition should leave the paper when the writing is transferred to stone.
3. The paper used should not be of so hard a nature as will prevent the damp going easily through, in the process of transferring.

It is prepared as follows:—Dissolve 6 oz. of gelatine in 2 quarts hot water, add 6 oz. flake-white finely ground in as small a quantity of water as possible, add also about $\frac{1}{2}$ oz. gamboge, which will give the mixture a yellowish tone. Strain through fine muslin, and while still warm, smoothly coat a good hard-sized printing or soft wove writing paper, using a broad camel-hair brush. Hang the sheets up to dry. When dry, this paper is generally plate-glazed and kept in rolls ready for use. Tracing transfer paper is coated in much the same way, but, as its name implies, tracing or transparent paper is used. A few drops of spirits of wine, added before coating, will make the composition go more smoothly over the paper. To keep the composition in a liquid state while coating, place the bowl in another basin containing hot water.

Grained Paper.

The second transfer paper is that used for drawing upon with lithographic chalk. The qualities required are very different from those which go to make a good writing paper.

1. It must have a *very thick coating* of composition, to enable it to

take on a grained surface. This thick coating also enables the artist to scrape cleanly out, any lights required in the drawing.

2. The composition must not be too hard ; if so, the drawing is apt to smudge in transferring ; neither must it be too soft, or it will quickly absorb the grease in the drawing and make it weak or rotten.
3. It must have sufficient adhesiveness to adhere to the stone when slightly damped.

The composition is prepared from 12 parts plaster-of-Paris, 9 parts flour and 2 parts starch. The plaster-of-Paris is slowly added to water by sprinkling it from the hand and constantly stirred ; if inclined to set or thicken add more water. It is properly mixed for the required purpose when it will stand for some time and not "set" and when a thin film of water rises to the surface. This film of water should be poured off if there is a quantity. The plaster-of-Paris is simply required to absorb all the water it can and no more.* The flour is made into a smooth paste by first mixing in cold water and afterwards boiling, care being taken that it does not come too stiff or contain hard lumps : this is added to the plaster-of-Paris, by mixing with the hands as thoroughly as possible. The starch is made in the usual way and then added to the above mixture. The whole is then passed through a fine muslin cloth and is ready for use. It should be of the consistency of very thick cream.

The paper to be coated should be the best quality of printing and very thick—120 to 150 lb. double crown size. The composition is spread over the paper with a soft sponge or large brush, and afterwards smoothed with a broad Camel-hair brush. It should then be laid flat on boards to dry, not hung up. Sometimes the paper is coated twice to get a sufficiently thick coating of composition, in either way there should be no hard streaks seen after drying.

The paper is grained in the same way as a plate transfer is taken. The paper is damped, laid on the prepared face of a copper or zinc plate and passed several times through the copper-plate press. It is

* Plaster-of-Paris or stucco is always thus mixed for transfer papers and will not again be explained. Care must be exercised, as it has such an absorbing power, that if there be too little water, and left but for a few minutes, it will set quite hard and be rendered useless.

then heated off by means of the gas stove in the usual way. A grained paper surface may also be obtained from grained stones, which for some subjects gives a beautiful result, as the grain is not of a mechanical nature. After the paper is grained it is ready for the artist.

The third paper noticed was that used in taking transfers from stones. The qualities required are :—

- Stone Transfer Paper.**
1. It should *not* have a thick coating of composition. The composition should be of a harder nature than that used for grained paper, as it is required to receive printed impressions from stone ; this harder quality is obtained by a larger proportion of paste and the addition of a little gelatine or Russian glue.
 2. The sheets should not be crinkled or curly ; if so, there is too much paste or glue in the composition.
 3. If too hard, especially with an over proportion of paste, it will not take on a good impression, the print will appear gray and rotten ; on the other hand, if too soft, the composition will break away from the paper, being too weak to lift the ink from the stone. Soft composition also absorbs the grease rapidly, so that transfers of fine work will hardly keep over night before transferring.

The recipe for this paper is 18 parts flour, 12 parts plaster-of-Paris, 1 part gelatine, 1 part starch. These are prepared and mixed in the same way as for grained paper, but the composition should be of a thinner consistency, about that of cream. The paper to be used should be a good printing, substance 20-24 lb. demy.

The fourth paper noticed, is that used for taking transfers from Copper Plates.

- Plate Transfer Paper.**
1. The stone transfer paper already described may be used for this purpose, or what is about to be described as Plate Transfer Paper may be used for stone. It is better however, to have both kinds, as the one is more suitable than the other for its own particular work.
 2. The qualities required in Plate Transfer Paper are just between the grained paper and the stone paper. There should be more starch and less paste than in the composition used for stone

transfer paper, and rather more should be used in coating, to give a thicker film.

The proportion of materials used is 12 parts flour, 12 parts plaster-of-Paris, 1 or 2 parts starch, mixed as already described, and laid on the paper with a 4 or 6 inch flat camel hair brush.

Should the paper not rise easily from the plate, there is too much paste. Starch is the ingredient which enables the transfer to leave the plate easily. The paper used should be a soft printing, substance about 30 to 40 lb. demy.

Besides the transfer papers which have been described, there are several other kinds which we would notice shortly.

“French” Transfer Paper is the most important and is used for stone transfers ; it is quite unsuitable for plates.

French Transfer Paper. This paper is thin and very transparent, and is largely used for shining up colour work. It is very adhesive, and is therefore more suitable than any other for transferring to damp stone. The same quality also makes it less absorbent than other papers, and transfers therefore, may safely be kept for some days before being transferred.

This paper is difficult to make, and should therefore be bought from the dealers. The price is from 30/- to 45/- per ream, demy size.

Type Transfer Paper. Transfers from type or blocks may be taken on any of the papers mentioned, except graining paper, care being exercised that too much ink is not used if a hard paper is adopted. French paper is difficult to use, but gives a beautiful result when the forme is properly made ready.

India Transfer Paper. India transfer paper is, as its name implies, India paper coated with starch. It is not greatly used in this country, but largely so in America, where a good deal of work is drawn on grained stones. The India paper is found very suitable for this class of work.

Damp Transfer Paper. Damp transfer paper for stone work is simply the writing transfer paper, with a larger proportion of gelatine and a small amount of glycerine to keep it in a semi-moist state.

This paper is intended to adhere to the dry stone without damping, and is supposed to take better transfers from stone than a dry paper. It is however, not to be commended, any little advantage being more than counter-balanced by the greater difficulty in manipulation.

This paper is intended for preserving transfers for an indefinite time, in order to release the stones for other work. It is coated with an extra hard composition which will not absorb the grease from the transfer impression. After it is pulled, the transfer is further treated for preservation by being dusted with powdered asphaltum or rosin. This paper may be used for strong line work, which is expected to be printed again after a time, but the need for it in an ordinary lithographic office will not often be felt.

**Imperishable
Transfer
Paper.**

Photo-litho. transfer paper is used to take prints from photographic negatives. These are afterwards inked up with lithographic transfer ink and transferred to stone. The paper is made as follows:—

**Photo.
Transfer
Paper.**

6 parts gelatine are dissolved in 60 parts water and passed through fine muslin. A fine wove bank post writing is coated by floating the composition over its surface. When dry, the coating is repeated, in order to get the necessary thickness of gelatine film. It is afterwards sensitised by a 3 per cent. solution of bi-chromate of potash being floated on, or the same effect may be obtained by immersing the sheets in the solution for three or four minutes. The sheets must now be dried in a dark room, and carefully rolled up to exclude the light. They are then ready for printing from the negative in the usual way. The bi-chromate may be mixed with the gelatine solution if desired, in which case the whole of the operations must be carried out in the dark room.

Autographic transfers may be written on ordinary writing paper uncoated. This, of course, is not adhesive, and in transferring must be passed through the press once only.

In concluding this chapter on transfer papers, we may notice that all of them may be bought from dealers in litho. materials. Some of them however, are easily prepared, and cost little in comparison with what is charged by those who make them for sale. It is recommended that the following varieties be made in the printing office:—

No. 1. For Writing.

No. 3. For Stone.

„ 2. For Graining.

„ 4. For Plate.

Nos. 3 and 4 are called Scotch transfer papers.

If the directions given are followed, there should be no difficulty in preparing these, and a little experience should soon enable any litho. printer to turn out a satisfactory quality of paper.

Chapter VI.

SOME MATERIALS AND ARTICLES USED IN THE PROCESS.

IN the lithographic process there are many articles and a great variety of materials used. Some of these have been already noticed, such as transfer papers, transfer inks, and the requirements for the preparation of stones for receiving work; others may be incidentally noticed when describing the work with which they are connected. There are however, various materials which occupy a more or less important position, and which it will be advisable to consider, and, when necessary, discuss more in detail than could conveniently be done when referring to them in the ordinary course of this manual. In this chapter we will devote our attention to these articles.

Lithographic Printing Inks, as received from the makers, are generally stiff or strong in body, and require to be reduced with some medium before they can be used for printing purposes, and for lighter tints the medium bears a large proportion to the amount of ink employed. This medium is principally varnish, which is used in several degrees of consistency. It is prepared in various ways and from various oils; but for lithographic work that obtained from the best linseed oil alone gives a good result.

This oil is obtained from the seed of the Flax plant, which is cultivated largely in France, Germany, Russia, and other countries. The best quality comes from Russia, and is known as Baltic seed. It contains from 30 to 40 per cent. of oil, although only from 20 to 25 per cent. is realised in the manufacture. The oil is extracted by first crushing and grinding the seed, after which it is placed under hydraulic pressure, either with or without heat, when the oil flows out and is received in vessels suitable for the purpose. Oil obtained by pressure without heat is less in quantity but purer in quality, and is considered the best for all purposes.

There are many methods employed to purify the oil. Some of these

are by natural, but more by chemical means. One of the former is to heat the oil by means of steam piping in a large air-tight vessel and at the same time force through it a current of ordinary air. The heat and the oxygen of the air combined, exert a powerful purifying influence on the oil, and add at the same time to its drying properties. Another method is natural bleaching, by exposure to the atmosphere and the sun's rays. Any of these more natural means of purifying the oil, when it is intended to be used for making litho. varnishes, appears to us to be by far the best. The great differences in the drying qualities of varnish experienced by litho. printers may very easily be accounted for in the different treatment of the oil in the first place. Some of the chemical methods of treatment will take away rather than add to the good qualities required in this important article. Linseed oil improves greatly by being kept for a lengthened time, which, we presume, will often take the place of the purifying mentioned above. For the manufacture of lithographic varnish, the longer it is kept standing, the better is the varnish obtained from it. For this purpose, manufacturers have a number of large storage tanks, each of which has two taps, one about the middle and the other near the bottom. These tanks are filled and emptied in rotation. When the oil has been standing some months, and the sediment and impurities have all settled at the bottom of the tank, it is considered well seasoned. The oil drawn from the upper tap is used for making lithographic varnish, and that from the bottom tap for letterpress and other kinds. It is evident from this, that even in the earliest stages in the manufacture of material for lithographic work, great pains are taken to obtain the purest and best possible result. Lithography is a delicate process, and requires in its working the best of everything, from water itself, to the ink and machines which give the finished impression. When the oil is "drawn" it is put into large enamelled pots and boiled for a longer or shorter period, according as thin, medium or strong varnish is required. In the olden time the oil was set on fire in order to get rid of the grease which it contained, but this has given place to more scientific methods, which give the required result, and at the same time keep the varnish pure and colourless. The varnish obtained by setting the oil on fire gave a very good working material, but was useless for fine colour work, which indeed was hardly attempted at that period.

The varieties of varnish in use are—extra thin, thin, mid, strong and extra strong, or in vulgar terms, horse-leg. It is important that all these should be, as nearly as possible, colourless. The first and second, with a proportion of the “mid,” are those most generally used for all kinds of work, colour printing included; the strong and extra strong are reserved for bronze and any other special printing that requires ink with some tackiness.

In warm weather it will seldom be found necessary to use the extra thin, which, having had the least boiling, contains the greatest amount of grease, and so affects the stone sooner than the other kinds, and this naturally more so in hot than in cold weather.

Cheap varnish is sometimes adulterated with rosin, which gives a false consistency and will prevent the ink drying with a smooth, hard skin. Do not let any colour-printer be tempted to buy cheap varnish, as it may turn out to be very expensive in the end. The market prices for the best qualities are—

Extra thin,	.	.	.	4/-	per gallon.
Thin,	.	.	.	4/-	” ”
Mid,	.	.	.	5/-	” ”
Strong,	.	.	.	8/-	” ”
Extra strong,	.	.	.	10/-	” ”

GUM is one of the essentials of lithographic printing. It will therefore be necessary to devote a little space to its consideration.

There are various kinds of gums, gum-resins and resins, which are the products of various trees. To the eye, some of these resemble each other so closely, that it might be difficult to tell the one from the other. There is however, this remarkable difference in character, that the gums proper are all soluble in water and insoluble in spirits; while the resins proper possess exactly the opposite quality, being soluble in spirits and insoluble in water. These two opposite properties are invaluable in the lithographic process.

The gum used for lithographic purposes should be pure Gum Arabic, sold, it may be, under different names, which generally indicate the district from whence it has come.

Gum Arabic is obtained from various species of *Acacia* trees, which belong to the Leguminous order of plants, *i.e.*, Pod-bearing. These

trees grow in warm latitudes, but more particularly in Asia Minor, Arabia, and the northern parts of Africa. The variety which gives the pure white and most expensive gum is *Acacia Vera*, which grows most abundantly in Arabia and the Soudan. It grows to a height of about twenty feet, and the gum exudes naturally from its trunk and branches in the form of tears, which harden with exposure to the air, and are gathered direct for the market. It is said, that if the tree is not in a good state of health, the flow of gum is greater; it also yields more abundantly in hot than in cold seasons. Pure Gum Arabic should dissolve easily and completely in cold water.

There is a variety of Gum Arabic which should properly be called Gum Senegal. It is the product of a somewhat different species of *Acacia* tree which abounds in Western Africa. There are two varieties of this gum, viz. white, obtained from the *Acacia Vereck*, and red, obtained from the *Acacia Nebuel*. Both of these, as far as they can be analysed, are of the same chemical composition as Gum Arabic, but were always thought to be an inferior quality, and not quite the best for lithographic work. Gum Senegal is also cheaper than Gum Arabic, and very often took its place. This gum may easily be known by its much larger drops or tears, some being as large as nuts, and the red variety by its rich brown or amber colour.

The composition of gum does not appear to be very clear to chemists, but is generally said to consist of Potassium and Calcium Salts combined with Arabic Acid. The acid is not strong, but sufficient to change the colour of Litmus test paper to a reddish purple.

The action of gum on the lithographic stone is not thoroughly understood. It is certain however, that it *has* a powerful action in giving the surface of the stone a certain grease-resisting property, which no other substance has been found capable of producing. It may be safely assumed that the arabic acid combines with the carbonate of lime, and forms a delicate film, which W. Hanhart calls a gummate or metagummate of Calcium, which is insoluble in water as well as grease-resisting.

Senefelder was aware of this fact, and says "Gum Arabic alone prepares the stone, or, in other words, imparts to it the quality of rejecting the colour or printing ink." Again he says, "The gum creates a certain alteration on the surface of the stone, which can only be taken away with repeated testing with weak *aqua fortis*."

The powerful action of Gum Arabic on the stone is seen in the fact that it is quite impossible to wash a stone chemically clean with water, after a solution of gum has been applied to its surface. It is also impossible, if there be the least trace of gum on the stone, to transfer work properly, the gum preventing the chemical union between the stone and the grease which the transfer contains. If it is desired to clean a stone which has had gum applied to its surface, it must either be polished with Ayr stone, or washed with a solution of acetic or citric acid and water, washing afterwards with plenty of pure water; when practicable however, polishing should always be resorted to.

The writer recently made some careful experiments as to the qualities, solubility, and action on lithographic stone of various samples of gum, which he obtained for the purpose. The results were both interesting and instructive, and quite upset the opinion which he held along with others, that the finest qualities of Gum Arabic, such as Turkey, Soudan and Egyptian, were the most suitable for lithographic purposes. He now thinks, that Senegal, Amrad, Aden, and even Barbary gum, have a more powerful effect on the stone than the finer sorts.

The above mentioned and other varieties are all called Gum Arabic, but bearing distinguishing names as already stated. A few comments will be made on these, and the results afterwards given in a tabulated form.

TURKEY PICKED or TURKEY SORTS.—This is the finest quality, and is obtained by picking out the purest and whitest pieces from Egyptian, Kordofan or Soudan and Asia Minor varieties.

Gum Arabic Varieties. It is principally to be found in chemist's shops, and is used for medicinal, confectionery and other purposes.

SOU DAN or KORDOFAN GUM.—This variety is found in medium-sized tears or pieces, rather brittle and broken in appearance. It has always been esteemed as the best for lithographic work, so much so, that generally no other gum was thought worthy of being placed alongside with it. It is a beautiful gum, quite soluble and suitable for litho. purposes. The solution should be very pale, almost colourless.

EGYPTIAN GUM (from the Coast) is similar in all respects to Soudan, but not quite so soluble.

SENEGAL GUM is obtained, as already mentioned, from the western

parts of Africa. It consists of large round or Vermicular-shaped tears, brown or white, is quite soluble and very suitable for lithographic purposes.

AMRAD GUM is similar in all respects to Senegal.

ADEN GUM is found in large, rather round-shaped tears, some of which are not soluble, and for this reason it cannot be recommended for lithographic work.

BARBARY GUM is very dirty and mixed with pieces of bark. When dissolved, it forms a thin watery solution with a bitter taste and unpleasant smell. Although so watery, its action on the litho. stone appears to be excellent.

GHATTI GUM consists of twisted round or Vermicular-shaped pieces. It is the least soluble of all the gums, and must be avoided for lithographic work.

AUSTRALIAN GUM consists of large and small drops of a dirty red colour. When dissolved it produces a frothy watery solution, and gives no response to the Litmus paper acid test; it is quite unsuitable for lithographic work.

EAST INDIAN GUM is a spurious kind, being obtained from an altogether different species of tree.*

SOUTH AMERICAN GUM has only 75 per cent. of its bulk soluble, and is unsuited for lithographic work.

Most of those gums were used in the experiments just mentioned, which were conducted on the following lines:—one ounce of gum was dissolved in three ounces of water in each case, and passed through fine muslin. A perfectly clean polished stone was taken and a part of the surface gummed over with the different solutions. Both the muslin and the brush were carefully washed for each of the different gums so that there could be no mixing. The stone was allowed to stand a night, and the next day was put under the tap on a water trough and washed as clean as it was possible to do with cold water. A transfer sheet of fine ruling from a copper-plate was then transferred over the whole stone. This experiment was repeated three times, using stipple or a different ruling for each trial.

The results showed clearly that some parts of the stone took on the transfer fairly well; on other parts the transfer was rotten, while

* East Indian Gums are said to be merely African products sent to the Indies, and there collected, classified, and re-exported to Europe.

some parts were quite clean, showing that the gum on these parts had prepared the stone so well, that it refused altogether the transfer and the grease it contained, thus completely fulfilling the purpose for which Gum Arabic is used. It must be clearly noted that the same gums gave the same results in each of the experiments. The only conclusion that could be drawn from these results was, that the three or four gums, which so thoroughly prepared the stone, that it entirely refused the transfer, even after careful washing, would be the best to use for preparing the stone after etching, as well as for daily use.

The following table will give the information in a more precise form. The gums are placed in the order of merit for use in connection with the lithographic stone, according to the results obtained from the experiments :—

GUM.	Characteristics, when dry.	Solubility.	Characteristics, when dissolved.	Power of imparting a grease-resisting Surface to Lithographic Stone.
SENEGAL (coast)	Large, round and oval tears, white and rich amber colour.	Complete.	Slightly bitter taste, pale amber colour, good body.	First place.
SENEGAL (interior)	Small tears and pieces, white with a proportion of amber colour.	Do.	Slightly bitter taste, rich amber colour, good body.	Equal to above.
AMRAD	Medium-sized tears, mixed, white and amber.	Do.	Little more bitter than Senegal, amber colour.	Second place.
ADEN	Large irregularly shaped tears, somewhat dirty, mostly amber colour.	Not quite soluble.	Pleasant taste and smell, amber colour.	Third place.
BARBARY	Broken pieces, very dirty, and mixed with bark.	Complete.	Bitter taste, unpleasant smell, thin watery solution, dirty colour.	Fourth place.
TURKEY PICKED	Small pieces, pure white.	Do.	Pleasant taste and smell, white.	Fifth place.

GUM.	Characteristics, when dry.	Solubility.	Characteristics, when dissolved.	Power of imparting a grease-resisting Surface to Lithographic Stone.
SOUDAN and KORDOFAN	Medium-sized tears, mostly white.	Complete.	Pleasant taste and smell, palest amber colour.	Equal to Turkey picked.
GHATTI	Large twisted tears.	Least soluble of all the gums experimented with.	Almost tasteless, pale amber colour.	Sixth place.
EGYPTIAN (coast)	Medium-sized tears, white and amber.	Inclined to a jelly state.	Pleasant taste, pale amber colour.	Seventh place.
AUSTRALIAN	Large and smaller tears, dark red amber, mixed with bark.	Complete.	Slightly bitter taste, dark, dirty amber colour, thin watery frothy solution.	Eighth place.

All these gums, except Australian, gave much the same response to the Litmus paper acid test, changing the colour to a red purple. This fact shows that the preparation of the stone does not depend entirely on the acid, which is in the gum and forms a part of its composition. If it were so, the effectiveness of each variety would be the same, with the exception of the Australian. What causes the variation in effective power the writer is unable to say, and even expert chemists would find it very difficult to discover.

From the preceding table and notes it will be seen that the first seven gums might be used for lithographic purposes. But we find that Aden gum is not quite soluble, which is a serious objection to its use. Barbary gum dissolves completely, but the solution is thin and watery, the gum apparently having no body; besides this, it has a nauseous taste and smell, and for these reasons must be laid aside. Turkey picked is a beautiful gum, but much too expensive for printers' use. There now remain the following varieties, available and most suitable in the order given, for lithographic work—1, Senegal; 2, Amrad; 3, Soudan; 4, Kordofan.

A few hints on the use of gum may now be given. The solution should not be allowed to get sour, which it will do in eight or ten

days in winter, and half that time in summer. There are certain preventatives, such as the addition of a little camphor, carbolic acid, or the essence of cinnamon; and there is a remedy for the sourness when it has taken place, in the addition of a little powdered chalk. But by far the safest plan is not to allow it to get sour at all. This is easily effected, by dissolving only a few days' supply at a time and keeping the pot and sponges perfectly clean. The action of sour gum on the stone and work is most detrimental; the acid generated is not a preparer of the stone, but the opposite, and eats away the work very rapidly.

When the stone is gummed up, it may be damp but should not be wet, neither should the gum be watery. Under either of these conditions, the gum will run away from the lines or edges of the work, leaving these portions of the stone next the work without that gum protection, which they require more than any other part.

Stones in the machine are more apt to be spoiled through bad gumming up than hand-press stones, for the simple reason that there is more ink used, and that of a thinner nature than is required for hand-press printing. The quantity and thinness of the ink on the lines of the work naturally drive the gum away from them, and so the lines spread and thicken. A very good plan of avoiding this danger, is to give the stone a second rub over with the gum sponge, a minute or two after it has been done the first time. The life and quality of work on stone depend very much on careful attention to the gumming up, and also in having the gum always fresh.

After gumming up chalk work, whether on flat or grained stones, it is an excellent plan to dab the whole stone with the palm of the hand, or, better still, with the under side of the arm. This removes any streaks and gives the gum a granular texture; in doing this, the gum should be half dry in order to obtain the best results.

Dissolved gum should always be strained through a muslin or cotton cloth before using. If this is not done, the small pieces of bark and grit which are mixed with it will be found very troublesome, and may cause serious damage to the work on stone, either when gumming up or when washing off before re-starting to print.

NITRIC ACID is a chemical compound of hydrogen, nitrogen and oxygen, represented in its purest form by the symbol HNO_3 . It is

still known by its older name, *aquafortis* = strong water, and is manufactured on a commercial scale by distilling nitrate of soda and sulphuric acid. The acid as supplied to printers and others, consists of 60 per cent. pure acid and 40 per cent. water. Even in this strength it is a most powerful corrosive compound, and gives off a deadly vapour. It must be kept in glass stoppered bottles, and when being used, care should be exercised that none of the vapour is inhaled.

Its use in lithography is to etch the stone, before, or at any time if required, during printing. This etching, along with the application of dissolved gum arabic, keeps the stone in a wonderfully prepared state for printing. If applied to the stone, even diluted with an equal quantity of water, it attacks the lime most energetically and sets free the carbonic acid gas in violent effervescence.

In daily work it is used in various strengths suitable for the different kinds of transfers. For ordinary etching before printing, it ought to effervesce just a little when applied. When wanted to give work in relief, as in reversing black to white, it should effervesce a little more briskly. Some men do not add gum to their etching solution, but from lengthened experience the addition of a little gum to all etching solutions is recommended.

Occasionally the acid is not pure, in that a quantity of sulphuric acid is found mixed with it, possibly through carelessness in the manufacture. Such impurity will show itself by leaving a deposit of sulphate of lime or gypsum on the surface of the stone. This deposit will not wash away with water, but will require an application of a pure acid and water solution to remove it.

ACETIC ACID is the active principle of vinegar. Indeed the latter is but acetic acid in a diluted form, and containing impurities which do not exist in the acid in its pure state. In lithography **Acetic Acid.** it is used diluted with water to clean any parts of the stone on which alterations are required to be made. Its action is to remove or dissolve the gum film which combines so powerfully with the stone, and give a chemically clean surface, which will readily receive the lithographic ink. To ensure this result however, the gum must first be washed off as thoroughly as possible with water, and after the application of the acid, the parts must again be carefully washed. A sponge should be specially laid aside for this work, and used for nothing else.

CITRIC ACID is obtained from the lemon, lime, and other fruits, and is similar in all respects to acetic acid in nature and in use.

Citric Acid. Some printers prefer the one, and some the other. Neither of these acids should be used in the pure form, nor so strong as to cause any effervescence when applied to the stone.

Carbolic Acid. CARBOLIC ACID, Phenol or Phenic Acid is a preparation obtained from coal tar. It does not appear to be an acid as usually understood; it gives no response to acid tests, but is more allied to alcohol as an oily spirit. This property is shown in its action as a powerful grease solvent. It is largely used in various forms as a disinfectant and antiseptic. It is of a poisonous nature, and must not be allowed to come in contact with the skin in its full strength.

Its usefulness in connection with Lithography has only come to be recognised during the past few years; but, while a very valuable product, great care must be exercised in using it.

An addition of two or three teaspoonfuls to a bottle of turpentine, will be very helpful in washing out old work which has become hard and dry. If used in larger proportions, it will weaken the work on stone. A few drops added to the water when wetting the damping book will prevent mildew, and if two or three drops are added to a pot of gum, it will prevent fermentation or sourness.

Machine rollers, in working, very soon take on a hard glassy surface. To remove this, a strong solution of carbolic acid and turpentine should be washed over the surface. Having been allowed to stand a few minutes, they should then be scrubbed with a wire brush or pumice stone, after which the dissolved ink may be scraped off. The rollers should afterwards be washed with pure turpentine and again scraped.

The following facts, in connection with carbolic acid, may be of interest to those who give real attention to the principles which govern lithographic work. There is a doubt in some minds whether the combination of grease with the litho. stone forms a true chemical compound, or is merely, more or less, a mechanical union. The former is the generally accepted theory, and is, we believe, correct. It is however, a curious fact that of all known substances, carbolic acid appears to be the only one that will dissolve the grease on the stone and permit of another piece of work being put in its place. It will form a most interesting experiment to try this in the following

way :—take a small stone which has had work on it for some time, wash off the gum thoroughly, and wash out the work with turpentine,

Experiment. then pour a little pure carbolic acid on the stone and rub with a sponge or cloth and wash the stone with pure water. The acid has now removed most if not all of the grease, but has not had any effect on the gum film, the principle holding good, that gum arabic is unaffected by spirits or oils; the gum then which is still on the stone must be removed, before it will be in a state to receive new work. Wash the stone now with diluted acetic acid and afterwards with plenty of pure water. Something may now be transferred to the stone in the usual way and rubbed up, to test if any of the old work will come back. Whether it does so or not, its image will be clearly visible, and will continue so for an indefinite time. This is not given as a practical working method, but shows in a striking manner the properties of both carbolic and acetic acid.

OXALIC ACID has sometimes a place in the litho. printing room. It is mentioned here just to point out that it should never be allowed to enter the establishment, as it is an irritant poison and **Oxalic Acid.** very dangerous in use. It is used to keep the edges of the stone clean in machine printing; but the danger lies in allowing it to come in contact with the work, which can hardly be avoided in the rapid machine movement.

Lithographic work on stone must always be etched with nitric acid. In some cases a weak solution may be applied to the stone quite **Acid Resists.** safely without the work being protected. A skilful workman may do this at times with great advantage, but it requires care and good judgment. If a stronger solution was put over the same work, the acid would attack not only the stone but the work as well, and make the lines rotten and bad. To avoid this and enable the printer to etch the work slightly in relief, it is necessary to have it protected by some substance, in the shape of a powder, which may be dusted over the work, and which will at the same time resist the action of the acid and remain insoluble when the etching solution is applied.

Under the section on gums it was noticed that resins are insoluble in water but quite soluble in spirits; they are also capable of being reduced to a fine powder; these qualities render them very suitable as acid resists. But while that is the case, it is also true that almost

everything which could be had in the shape of a powder, and not soluble in water, has been tried; but most of these have been found wanting in some respect as true resists.

The common metals are all quickly affected and dissolved by nitric acid, and this quality excludes ordinary bronzes from being used. Gold and pure aluminium are not affected by the acid, but gold is too precious to use in such a way. Aluminium bronze might be used, but as it is sometimes alloyed with zinc it is not to be depended upon.

FRENCH CHALK or TALC is not affected by nitric acid in the slightest degree. It is therefore used and answers the purpose of a resist fairly well. It has however in itself no uniting power, either dry or under water; in this respect it is like fine sand, and is not to be recommended as an absolute resist. No doubt when it is dusted over the work it adheres to the ink, but when the acid and water is applied, the particles do not blend together, but rather separate the one from the other; it should then only be used as a resist, in the absence of a better.

ASPHALTUM is in its nature a perfect acid resist. It is however difficult, if not impossible, to get it in the form of an impalpable powder. Its hard and gritty nature is therefore much against its general use. It is also an expensive substance as compared with French chalk or rosin.

ROSIN is the residue left over in the distillation of turpentine, and besides many other useful properties, it answers every requirement of an absolute acid resist. These qualities are:—

1. It can be easily ground to an impalpable powder.
2. It can be passed or dusted through the finest muslin.
3. It is insoluble in water.
4. It is soft, and easily dissolved with turpentine.
5. It is easily melted by heat.
6. Its particles bind themselves together rather than separate when acted upon by the acid, and the stronger the acid, the more is this the case. In this particular quality it is far more suitable than French chalk.
7. It is cheap and may be obtained anywhere.

Since it possesses these qualities, the writer, from long experience with its use in the printing room, considers it the most perfect and useful acid resist for all lithographic purposes.

OIL OF TURPENTINE, or Turps., its more familiar name, is a spirit, greatly used in various arts. It is obtained in its crude form from

Turpentine. various trees but most abundantly from the pine and fir. The trees do not yield the fluid till about forty years old, and those which have the thickest bark and are well exposed to the sun give the greatest quantity. The supply for this country mostly comes from America, where there are immense forests of pine trees. It is gathered from March till October, and is obtained by making incisions in the bark, when the liquid flows out as a yellowish syrup and runs into "cups" dug out at the foot of the tree. These "cups" are emptied periodically into barrels for future refining.

The crude turpentine is quite unfit for use and must therefore be purified. This is done by distilling it along with a proportion of water; the product, which passes over and condenses, is the spirit or oil of turpentine of commerce. The residue left in the retorts is the common rosin, referred to in the present work, under Acid Resists.

Turpentine, being a spirit, evaporates very quickly when exposed, which is one of its good qualities in lithographic use. It is an excellent grease solvent without being harsh, and is used for washing out work on stone, cleaning ink rollers and ink tables. It does not dissolve gum arabic, so may be used to wash out any part of a subject, if the other parts are protected with gum.

A wash of pure turpentine put over a polished or grained stone will be found of great advantage in increasing its sensitiveness to receive work of a delicate nature, either transfer on polished, or chalk work on grained stone. The explanation of this appears to be that the turpentine contains a very minute quantity of rosin which has been carried over in the process of distillation; this, with a still less quantity of greasy matter, is left on the stone when the spirit evaporates, and so imparts to it a greater sensitiveness to receive the work.

In doing this however, it must be borne in mind that the cloth or muslin which is used to give the wash must be absolutely clean; a new cloth or piece of muslin will not do, but they should be boiled and rinsed in water over and over again before using.

PARAFFIN OIL is a well-known product obtained from shale by distillation. Being much cheaper than turpentine, it is used as a substitute in cleaning ink rollers, slabs and knives. It is greasy in its nature, and is therefore unsuitable for

use in washing out work on stone. It does not evaporate and will not dry. It is advisable therefore, after rollers are washed with it to give them a final wash with a little turpentine. It is very useful in cleaning machinery, especially polished parts, as it keeps them bright and free from rust by its greasy and non-drying qualities.

PRINTOLENE or PRINEEN are conventional names for an artificial preparation, which makes a most excellent substitute for turpentine at about one half the price. The mode of its manufacture **Printolene.** has not been made public, but it is said to be chemically prepared or distilled from Camphor. It is a spirit, quite volatile and may be used in every way as turpentine.

LIASINE is also a conventional name for an artificial preparation for removing work from stone without the usual grinding and polishing.

Liasine. In using this substance, the work on stone must first be washed out with turps., or, if at all raised in relief, polished away till the surface is level. The Liasine is now put on and well rubbed into the stone with a sponge or piece of felt, after which it is allowed to stand for two minutes or so and then thoroughly washed with plenty of water.

It is claimed that the stone receives from this preparation an insoluble coating which prevents any of the grease of the old work coming to the surface again, while, at the same time, the surface is made perfectly clean and absorbent for new work.

Messrs J. Curwen & Son, Warwick Lane, E.C. will send detailed directions with the preparation to any who wish to use it.

As the firm with which the writer is identified still continues to grind and polish the stones as of old, he is not in a position either to criticise or commend the preparation.

In all printing it is necessary that the ink printed on the paper should become dry or hardened, so that the sheets may **Driers.** be handled without smearing and the plates bound into the volumes without setting off.

Drying may take place in three ways, by evaporation, by absorption or by chemical action. The first is applicable to water, spirits and other liquids, which are taken up by the atmosphere, and is exemplified in spirit varnishing, where the spirit evaporates and leaves the film of shellac hard and dry on the paper. The second may be seen in hand-press printing, more especially in former times, when the

paper generally used was of a soft absorbent nature. The sharp intense pressure of the hand-press assisted the absorbing process by forcing the ink into the pores of the paper, so that it was seldom necessary to employ artificial driers. With the modern rapid machine printing and the varied qualities and descriptions of paper now in use, the conditions are entirely altered, and the ink must therefore be made to dry in the third way, *i.e.*, chemically.

The principle of chemical drying is simply that the ink receives, more or less rapidly, oxygen from the air, which changes slightly its nature and at the same time hardens and dries it. The absorption of oxygen in chemical drying adds to, rather than takes away from the bulk of the material drying, while in evaporation the bulk is reduced, if not largely done away with.

Air itself and especially warm air has a powerful chemical action, so that almost any ink will harden and dry under its influence alone, provided it gets sufficient time to act, which may be from one week to six months or more.

The greater affinity any ink or pigment possesses for oxygen, the quicker it will dry. Inks differ very much in this respect; hence there are quick-drying inks, such as Umber, Bronze Blue, Flake White and Chrome Yellows; others are slow drying, such as Vermilion, Black, Violet, and Lakes in general.

There are many substances which have a large proportion of oxygen in their composition or possess a strong affinity for the oxygen of the air. From these are selected the most suitable mediums for driers or aids in drying litho. printing inks.

It should be thoroughly understood by the printer that drying *is* a chemical action proceeding from the air, and that the more freely it gets in contact with the printed surface, the better will the ink dry, whether there has been an addition of driers or not. Spon in his "Encyclopædia of the Industrial Arts" puts the matter so clearly that we cannot do better than quote his words. He says, "The principal function exercised by a drier, is that of acting as a carrier of the atmospheric oxygen to molecules of oil in its immediate neighbourhood, and this action, so to speak, should be regenerative and continuous. Each molecule of the drier, after giving up some of the oxygen it contains, and thus becoming reduced to a lower degree of oxygenation, should have the power of immediately re-taking the lost oxygen

on exposure to the air and reforming the higher oxide, ready to give up a quantity of fresh oxygen to the oil and so on *ad infinitum*. Manganese oxide possesses this power in a very high degree." In accordance with the principles set forth in this extract, the driers generally supplied by ink makers are preparations of the Oxides of Lead, Manganese or Zinc.

OXIDE OF LEAD is a chemical preparation called Litharge or Massicot.

ACETATE OF LEAD is a chemical compound of oxide of lead with acetic acid.

SULPHATE OF ZINC, called also White Copperas, is obtained by the action of sulphuric acid on oxide of zinc.

BORATE OF MANGANESE, a pure white powder, is the most important of manganese compounds used for driers.

It is not necessary to go into the methods of preparing driers, as it is advisable to purchase these for daily use from the manufacturers. They are supplied either in paste or powder form; of the latter, there is an excellent preparation, "French driers," which possesses the useful quality of not thickening the ink, and is also said not to affect the most delicate colours. It dries slowly and with a dull surface, whereas the paste or gloss driers gives a hard and glossy surface to the ink. To have both at command is a valuable acquisition to the printer, if he judiciously uses them as occasion requires. Different paste or powder driers should not be mixed together, unless there is an intimate knowledge of their chemical properties and effects. A drier composed of sulphate of zinc, and another composed of acetate of lead, if mixed together, would entirely neutralise each other, and form another substance which would not dry at all.

As the printer will have neither the time nor the ability to analyse these different substances, the safest ground for him to work upon will be to carefully test one or two different driers and fix on, say one paste and one powder, which will best answer his purpose, and on no account to change, unless very clear evidence is seen, which would justify him in doing so.

TEREBENE is prepared by distilling turpentine and sulphuric acid, and forms a powerful liquid drier. It does not evaporate so quickly

Terebene. as turps., and is useful in reducing a stiff ink when it is wanted to dry quickly. It may be used in conjunction with either paste or powder driers, and intensifies the drying property

of these in a remarkable degree, causing the ink, to which they are added, to dry very quickly and very hard.

GOLD SIZE, an old-fashioned drier, is not much in use now among printers, but appears to have good drying qualities, and might be used with advantage in many cases. One printer said he found it the best all round drier he had come across. Passing from the subject of Driers, some other materials will now claim attention.

PALM OIL is obtained from the fruit of certain palm trees. It is of the consistency of butter, and of a yellowish colour. It mixes with, but will not dissolve in turpentine, and this quality makes it useful as a "doctor" for rubbing up or strengthening work which has not a firm hold of the stone. It is also used for reducing transfer ink for the photo-litho. transfer process and also in connection with transferring by means of Shading Mediums.

TALLOW is a well-known substance obtained from the fat of animals. It is a pure fat, and contains a large proportion of fatty acid. As already noticed, it holds an important place in the composition of all kinds of transfer inks. It is also used as a lubricant for the leather and metal tympan of the hand-press, to enable them to slide through more easily under pressure.

WATER-OF-AYR STONE is so called because it is found on the banks of the river Ayr, in Ayrshire, Scotland. It is of a beautiful, soft, close texture, and although found in other places, that obtained from the above-named district is considered the finest. It is used largely as a whetstone, or oilstone, to sharpen all kinds of fine tools. It is well-known as Snake Stone and also as Tam-o'-Shanter Stone, the latter name being adopted to distinguish a special brand of excellent quality. In lithography it is used in large blocks to give the final glass-like polish to litho. stones before transferring, and in small slips or pencils to clean or polish away spots and any superfluous work, when preparing the stones for printing, and also to give a fresh surface to any small parts of the stone for alteration purposes. It is bought by the lb. or cwt., at 4d. to 6d. per lb. in blocks, or 1/- to 1/6 per lb. in slips.

PUMICE STONE is volcanic lava of an extremely porous nature, and is exported largely from the Lipari Islands in the Mediterranean, which are mostly composed of this volcanic matter. It is used for many

purposes, both in the form of blocks and powder, but more especially for cleaning and polishing all kinds of material. It is of a fine, gritty nature, and most useful for polishing litho. stones after they have undergone the grinding process with sand and water. It takes away very quickly the granular surface, but leaves minute scratches, which have in turn to be removed by the Ayr stone already mentioned. It is also used in the powder form to grain or grind zinc and aluminium plates.

Pumice Stone. There is now sold an artificial pumice stone which is made in suitably sized blocks. This is an excellent article for litho. work, and answers the purpose fully better than the natural stone. It is sold by lb. or cwt., at about 6d. per lb.

Bees Wax. BEES WAX is, as its name implies, the production of the bee, and forms the walls of the cells in the honeycomb. After the honey has been pressed out, it is prepared by melting in boiling water, when the wax rises to the surface, and is collected when the water cools, in the form of flakes. It is again melted without water, which forms it into thick cakes. In this form it is known and sold as virgin wax. This virgin wax is of a golden-brown colour, should break with a clean fracture, and has a very pleasant smell; it is impervious to damp and is not affected by acids. In lithography it is used as one of the compounds in transfer inks and chalks. It is also used in the printing room to coat engraved steel plates to prevent rusting. The plate is first heated by means of the gas stove; and the wax, being rolled in a piece of cotton in the same way as plate transfer ink is used, is gently pressed over its surface till there is a film of wax over the entire plate. Steel plates very soon take on rust, and should not be put past, even for a few days, without being thus waxed.

Alum. ALUM is chemically a double salt composed of sulphate of potash and sulphate of alumina. In its preparation it takes the form of crystals, and is soluble in cold water. It is also an acid, and in solution gives the reaction when tested with Litmus paper. In lithography a solution of alum and water is sometimes used to give a greater sensitiveness to the stone for transferring delicate work. While doing so it has the great disadvantage of causing the stone to take on scum and dirt when being rolled up. It requires therefore to be used with caution so that the benefit may not be more

counter plates
 * Solution: 5 grs 1/4 tea spoon Alum to glass of Cold water
 { Gum water
 { Gum arabic + nitric; 8 or 9 drops.
 Dust with Resin

than counter-balanced by this fault. Alum is also used to give a more sensitive surface to zinc plates. It is indeed supposed to leave an infinitesimal portion of the metal aluminium on the surface. Aluminium itself, as is well known, has a great affinity for grease.

Alumina is prepared from alum solution by the addition of ammonia, and often forms the base in the manufacture of lake pigments. It is insoluble in water, and not affected by acids, and is therefore of great value for this purpose.

MAGNESIA, the oxide of manganese is the well-known ingredient sold by druggists. It is a soft, extremely light, white powder. In litho. printing it is used to mix with and give some body to tints which are too thin or too greasy for clean working. It absorbs the grease and makes the tint work more freely. In chromo printing it assists to keep down the gloss, which is so apt to come with repeated printings on the top of one another. It should be specially noted that used in excess, it will take away the work from the stone and also prevent the ink drying properly.

SPONGE. This is a familiar and interesting article which was for a long period classed by naturalists as belonging to the vegetable kingdom. It has all the appearance of a plant when growing from the sea bed, or attached to pieces of rock, coral, or other substance which will give a holding for its roots.

It is now understood to belong to the animal kingdom, occupying a place in the lowest order of animated nature. It manifests wonderful growth and means of sustaining life, as well as possessing most beautiful structure and varied form. What is sold to us as sponge is really the skeleton of the animal, composed, not of bones, but fibrous matter, many examples of which are found of most beautiful and delicate form.

Sponges are found in warm latitudes in many parts of the world. The finest qualities come from the Levant, and are called Turkey sponges. Divers are employed to bring them up from a depth varying from two to twenty fathoms. Those found in the shallower parts are much inferior to those brought from the greater depths. The deeper the water the better is the quality; it is however, precarious and trying work to get these from their hidden homes, as they must be carefully detached from rock or sea bottom, which is not easily accomplished, at a depth of perhaps fifty to one hundred feet.

They are indispensable in litho. printing for damping, gumming and etching the stone, as well as for damping and coating paper. The quality for these purposes should be the best, of a firm, close texture, and when wet should not be hard. A good sponge will cost double the price of an inferior one, but will last three times longer, and will give satisfaction all the time. A practical point to notice is, that as they come from the dealers they are filled with fine sand, which has to be paid for at the sponge rate of from 8/- to 12/- per lb. This sand must be entirely got rid of before attempting to use it for any purpose. The simplest method of doing so, is to beat the sponge against the back of a stone standing upright, with a wooden block and then thoroughly wash it in running water. A separate sponge must be kept for each of the operations—damping, gumming and etching.

Along with the sponge is always associated the DAMPING CLOTH. Scrim was formerly used for this purpose, but is now superseded by the softer cotton fibre. The cotton sheets, in which beef and mutton are wrapped when imported from abroad, are now very generally used, and answer the purpose well. These cloths are bought up by dealers, who get them thoroughly washed from grease and dirt, and then sell them at about 8d. per lb. A damping cloth for hand-press work should be washed every morning, without fail, and should be at all times free from gum, grease, acid and other substances.

**Damping
Cloth.**

**Damping
Book.**

The best DAMPING BOOK is made up with thick blotting paper, such as Craig's "Spongia" quality, with sheets of ordinary printing paper between. The size of the "book" will vary according to the work requiring to be done; it may be from royal to double demy or quad crown. It should be kept at a uniform state of dampness, so that with a little experience the printer may know how many minutes a transfer will require to remain in the book in order to be properly damped for transferring. As already noticed, a few drops of carbolic, added to the water when damping, will prevent the book from becoming mildewed.

PLASTER-OF-PARIS or STUCCO is obtained by roasting gypsum in an oven and afterwards grinding it to powder. It is pure white, and has the peculiar property of taking up water with great rapidity, and then quickly solidifying or "setting" hard. It is largely used in making all kinds of moulds, for room cornices, and for architectural

and sculptural work. In lithography it is used in preparing the composition for coating transfer paper, and also for cementing thin stones to slates or to one another for press work. It is extremely difficult to get the powder fine enough for the first named purpose, but the finest possible should be obtained, such as is prepared for dental purposes. The method of using this has been described in section on transfer papers.

Plaster-of-Paris.

BOXWOOD SCRAPERS for hand-press work are bought ready-made. Various kinds of wood have been tried and tested from time to time for these indispensable articles, but none have been found so suitable as that obtained from the box tree.

Wooden Scrapers.

Wood engravers some years ago used a large quantity of this beautiful fine grained wood, so much so, that it was getting both scarce and expensive. Photo-mechanical processes having now taken the place of wood-engraving, the demand for boxwood has fallen off, so that now there is no difficulty in getting the article, which experience has proved to be the best for litho. purposes. Since the advent of the cylinder machine the demand for wooden scrapers has fallen greatly.

The scrapers should be free from knots, and exactly the same depth from end to end. The edge should be V shaped, but instead of having a sharp angle, which would soon tear up the leather tympan, it should be nicely rounded. Should the edge become flat in using, it will not give a satisfactory impression from the stone, besides requiring much more power to take the carriage through the press. The use of a plane, or a piece of glass and sand paper will soon rectify this fault and give the necessary sharpness of edge.

STEEL SCRAPERS are used to take away from the stone all spots, dirt, or work which is not required for printing; in other words, for "cleaning up" the stone before it is handed over to the machineman. Triangular files, which have been used for sharpening saws, form excellent scrapers; any saw maker will give half-a-dozen for a few pence. A handle is put on one end and the thinner end of the file broken off, this end is then ground down to a point, sharpened on an oil stone, and is ready for use. In grinding, it is necessary to keep a triangular point. The steel should be hard and capable of taking on a keen edge, otherwise much time

Steel Scrapers.

will be lost in keeping it in working order. Artists very often use this for stone work, but a flat scraper is a useful article in their department (see Figs. 3 and 4). Other forms of steel scrapers will no doubt commend themselves both to artist and printer for special work.

INK KNIVES are required both by pressmen and machinemen. The usual palette knife is the best form for mixing up tints, a small size for hand-press and larger size for machine work. As these are flexible and not well adapted for mixing stiff ink, a broad flat knife will be found very convenient for this purpose, and should always form a part of a machineman's equipment (see Figs. 5 and 6).

GELATINE is a most useful substance manufactured from the hides, horns, bones and other parts of the ox, cow, sheep

and other animals. It is made in various forms, which are found to be the most suitable for the purposes for which it is to be used. It holds a very important place in photographic work, and is also used as food when prepared as a jelly. In the lithographic process it forms one of the ingredients in the composition used for making transfer papers, giving them the adhesive quality required; and in the form of transparent sheets it is used by the litho. artist to etch the outline or "key" of colour subjects, no other substance being so suitable for this purpose. It is also used to give a glass-like finish to mounted showcards, and may be made insoluble by the addition of bichromate of potash, so that the cards may be washed.

ISINGLASS, which is Gelatine in its finest and purest form, is obtained from the skin and intestines of certain fishes. It sometimes holds a place in recipes for transfer paper preparations, but is now superseded by gelatine or glue.

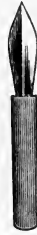

Fig. 3.
ARTIST'S
FLAT
SCRAPER.



Fig. 4.
STEEL
SCRAPER.



Fig. 5.
PALETTE
KNIFE.



Fig. 6.
MIXING
KNIFE.

GLUE is of the same nature as gelatine, but of a more crude form. There are different qualities produced, according to the materials from which it is obtained and the amount of purifying it undergoes. The quality known as "Russian" is often used instead of gelatine in making transfer papers.

BRONZE POWDERS are largely used in connection with litho-printing, to give to printed sheets metallic surfaces, such as gold, silver, aluminium and copper. They are also made in various colours, such as orange, green, violet, blue, crimson, etc. These colours are artificially given to the metals in the process of manufacture. The production of this article belongs entirely to Germany, and more particularly to the province of Bavaria, where it has been manufactured for a century or more. From small beginnings, the trade has grown to large dimensions, and now holds an important position in the manufactures of the country. Bavaria now supplies the world with bronze powders, with apparently no outside competition, and, owing to the cheapness of the product, need now fear no opposition. During the past ten or fifteen years the price has fallen to about one-half, so that good bronze may now be obtained at from $1/6$ to $2/6$ per lb.

GOLD BRONZE is made from an alloy of copper and zinc, the best and most ductile quality of both metals being required. SILVER BRONZE is made from tin, ALUMINIUM and COPPER from the respective metals. A great number of operations requires to be gone through before the finished article is ready for the market. The metals are first melted to form the alloy, and run into long narrow moulds. These bars of metal are then hammered and rolled into long ribbons, which are again hammered and rolled till they are as thin as a thin sheet of paper. These ribbons are next torn into small shreds and passed on to the stamping or grinding mill, where they are transformed into a powder. This powder is composed of particles of various sizes, which require to be separated. For this purpose it is put into upright rotary drums and made to fly all about as a cloud of dust. In falling, the heavier particles fall first, and the different sized grains, taking a regular course downwards, are collected in rotation by a mechanical contrivance, thus giving as many degrees of fineness as there have been collections from the drum. The powder then undergoes several operations, to clean it from impurities, to

polish and brighten the particles, and to give the necessary richness of colour.

The usual shades of gold bronze are obtained by using different proportions of the two metals copper and zinc. The darker shades however, including citron, are obtained by heating the powder in copper vessels with a proportion of oil and vinegar. Different degrees of heat give different shades of colour, and as the powder changes very rapidly when being fired, great care is necessary on the part of the workman, or the whole charge will be spoiled. When finally cleaned and polished it is put up in packets ready for sale.

Printed work, when bronzed, receives a very thin coating of metal, and as most metals oxidise very easily when exposed to the air, it is evident that bronzed surfaces will soon get tarnished, and even under certain conditions quite black. To prevent this, a good plan is to print a varnish right over the metal; this, while not diminishing the lustre of the bronze to any extent, will preserve it from tarnishing for years to come.

ALUMINIUM gives us a bronze of great value and has now completely taken the place of what was formerly sold as silver. When pure it does not tarnish, neither is it affected by acids and has a beautiful white silver appearance when used as a bronze powder. It may be adulterated with zinc, which greatly reduces its value. To test it for this adulteration, put a little pure nitric acid in a saucer and add some of the bronze; if pure it will not be affected; if zinc forms a part, it will at once effervesce violently, the cause being that the acid attacks the inferior metal and liberates hydrogen gas.

METAL LEAF or Dutch Metal is now so little used for litho. work, that it is not necessary to notice it, except to say that before the introduction of steam machines it was largely used for labels and showcards, its great brilliancy compensating for the slow process of laying the sheets of metal on the printed work, and of afterwards clearing the superfluous metal away.

The superior and more brilliant bronzes now sold at so moderate a price, along with the mechanical means introduced for bronzing the sheets, have rendered metal leaf unnecessary in the litho. printing-room.

There are a number of other articles and materials which may be used in ordinary course, or, it may be, only now and again, but which do not call for special reference at this stage. If necessary, they will receive consideration in the course of our study.

Chapter VII.

VARIOUS KINDS OF TRANSFERS.

HAVING noticed the three essentials required for the production of lithographic work, viz., stones, transfer inks, and transfer papers, we come now to the transfers themselves, which form a very important and interesting part of the process.

Before the era of steam machines there were comparatively few re-transfers used, a large proportion of the work being drawn direct on stone and printed from these original drawings. The introduction of power machines at once gave the lithographic process a very wide field of operation, and made the use of re-transfers imperative for rapidity in printing and cheapness in production. Instead of a few labels being put on a stone 10×15 or 15×20 and printed at the rate of a few hundred sheets each day, printing stones are now made up double or quadruple these sizes, and printed at the rate of from six hundred to one thousand sheets per hour. It will thus be easily seen that the production of lithographic work is now enormous when compared with what it was thirty or forty years ago.

The technical meaning of a lithographic transfer is anything that is capable of being transferred to a stone or metal plate for printing purposes. Transfers are of various kinds, and as most of them are met with in the course of every-day work, they will be noticed in the same order as the transfer papers and inks with which they are associated.

Transfers may be divided into two classes, those prepared or drawn by hand and those printed with transfer ink. It will be evident that of the former only one transfer of a subject is available, while of the latter as many as are required may be printed. Those transfers which are drawn by hand, when transferred, form what are technically known as "original" stones, while the printed transfers as a rule, are used to make up printing stones. The various kinds are as follows:—

WRITTEN TRANSFERS.—These are drawn or written on smooth yellow transfer paper (No. 1, see page 29) with liquid ink by means of fine pen or brush. They embrace such work as Maps, Plans, Diagrams, Labels, Commercial Invoices, Circulars, Cards, etc. The quality of the work depends largely on the ability of the draughtsman, and on the inks and instruments he uses. Many beautiful specimens of Writing, Lettering and Map work have been so produced, almost rivalling copper-plate engraving in delicacy and symmetry.

The ink used should not appear raised or shining on the surface of the paper; if so, the ink has been used too thick or has been too thickly laid on. This fault may cause the work to spread when being transferred to stone. Every line of a good transfer should appear dull but fairly black. On the other hand if the ink used is too watery, the lines will appear quite pale and may not have sufficient grease to combine with the limestone and form a satisfactory stone transfer. The same fault may also happen if the ink is old; it should be made fresh every morning for fine work; the ink a day or two old may be used for filling in coarse work. Although in all cases it is expedient to put transfers on stone as soon as possible, written transfers, if the paper and ink are good, may be kept for two or three weeks.

The method of preparing this ink for use has already been described, and should be carefully noted (see page 20).

GRAINED PAPER TRANSFERS.—These are drawn with lithographic chalks on grained paper, which may be coarse or fine, mechanical or natural. Copal chalks are the hardest and therefore the best suited for drawing fine work, such as Figures, Medical and Scientific Plates, etc. A good deal of experience is necessary and great care must be exercised by the artist in order to produce a drawing that will neither be too heavy nor too light when transferred to stone. If drawn too heavily or a soft chalk used, the transfer will thicken or smudge when transferred. Again, if too lightly drawn or not properly “worked up” it will likely appear rotten or blotchy on stone. To gain the ability to avoid both of these faults requires considerable training, which can only be obtained in practical work. On the other hand, the grained paper itself may be faulty: for example, the grain may not be equal all over the sheet,

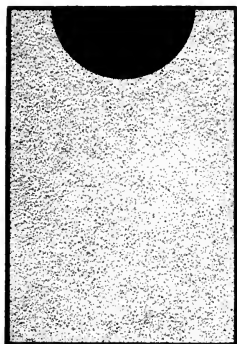

FINE STONE GRAIN.

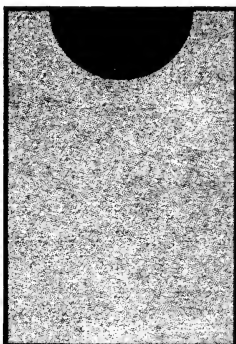

FINE GRAIN, NO. 1.

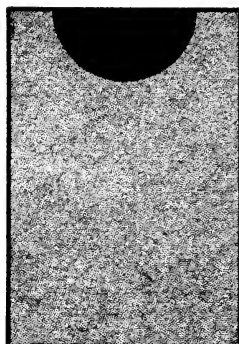

FINE GRAIN, NO. 2.

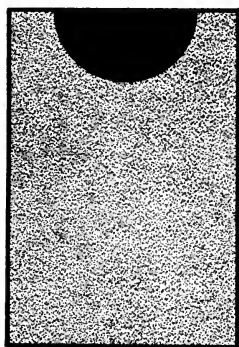

MEDIUM GRAIN.

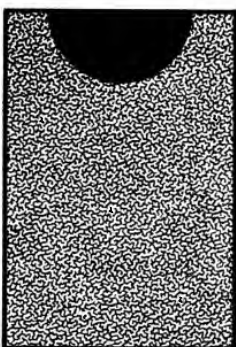

COARSE GRAIN.

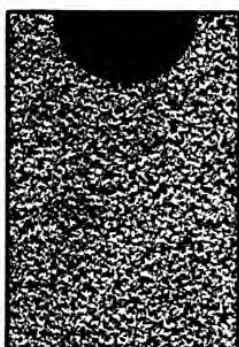

ROUGH GRAIN, CLOSE.

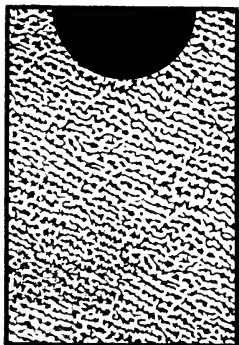

ROUGH GRAIN, OPEN.

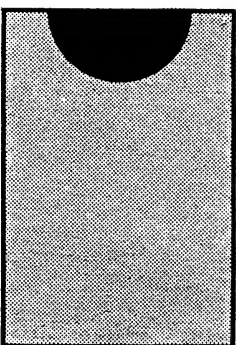

HALF TONE GRAIN.

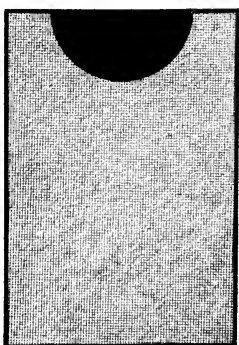

TEXTURE GRAIN.

or it may be too flat or too raspy. These faults are all serious both for artist and printer, but the last, a raspy grain, is the worst, and no good work can be produced with paper in this condition.

Grained paper may be called coarse or fine, having larger or smaller grain elevations. This entirely depends on the granulation of the copper-plate from which the paper receives its grain. But though the grain may be coarse or fine, neither should be rough, *i.e.*, each grain elevation should be smooth in itself, capable of "taking on" the chalk without rasping it down. When rasping occurs, it causes the minute hollows of the grain to be more or less filled up with loose particles of chalk, which it is difficult, if not impossible, altogether to remove by brushing, and which, when the drawing is being transferred to stone, are also transferred and give a sooty appearance to the prints. The cause of this harshness in the grain is a badly-etched plate. At the same time, all new plates are found to have this fault in a greater or less degree, until they have been for some time in use, when naturally they become smoother and more mellow. To modify this fault, the sheets should be passed through on a smooth dry stone, under more or less pressure according to the state of the paper.

A chalk drawing or transfer should have all the appearance of a fine stipple engraving, having no scratches or the least indication of white spots. White spots, scratches or other faults, will all appear intensified when they are transferred from the paper to the stone.

The finest and most artistic colour printing done by the lithographic process is produced by drawing the individual colours on grained paper. If these are transferred to stone in correct position and printed direct, *i.e.*, not re-transferred, very delicate and beautiful work may be produced.* If however transferred as originals and re-transferred for printing, which is so often necessary for work required in quantity, the result is generally somewhat inferior. It is almost impossible to get grained paper work re-transferred, so as to give the softness that exists on the original stone, and this difference is rather intensified than otherwise when it comes to the machine printing.

The method of procedure in drawing these transfers of individual

* Some very fine specimens of Turner's and Ruskin's water-colour paintings have been lithographed by the writer's own firm, which are, in the opinion of those able to judge, most excellent examples of colour printing. These and such other work show the possibilities of the process from an artistic point of view.

colours is as follows: after the gelatine key stone is prepared, having the register cross lines on each side of the subject, as many impressions in pale blue ink are taken as there are colours to be drawn. These impressions are pulled on the graining transfer paper, which should be well damped, so that the paper may keep as near as possible its normal size when re-damped, before graining from the copper-plate (see Fig. 7). After graining, the artist proceeds to draw



FIG. 7. SHOWING REGISTER MARKS AND KEY LINES FOR COLOURS.

each colour on these outline impressions, using ink and chalk as required respectively for solids and lighter tints. When finished, these form grained paper transfers, ready to be transferred to stone. This transferring process will be considered further on.

The next class of transfers to be noticed is that taken from one stone to be transferred to another. These are known in the trade as **Re-transfers**. "re-transfers," for the obvious reason that the work has been once transferred already. It may be noted again that the artist has nothing to do with this department; it is the work of the printing-room, and the foreman is the judge as to the quality of the work done by the printer. The ink and the paper used for re-transfer work having already come under review, it is only necessary to make some observations on the transfers and the printing of same.

The first requisite is a good roller. One which has been thoroughly worked in, by printing black work for three or six months, and which has a fine close grain or nap is the most suitable. It should not be soft, two plies of flannel underneath the skin being all that is required. It should be carefully scraped each morning and as

often during the day as is necessary, four or six or eight times if the work is fine. The result gained by scraping is two-fold; the soiled ink is removed from the skin, and the grained surface of the roller, when used, comes into closer contact with the stone, which gives a clearer and better transfer.*

In pulling transfers from stone, it is necessary for the printer to bear in mind that he is working with an ink which is more than usually greasy, which has a tendency to thicken every line and dot of the work, and that this thickening of the lines will not decrease, but rather increase in the operation of transferring. The one object of the printer should be to obtain a transfer which will give a result on the transferred stone as near the original as possible. In ordinary line work this should not be difficult to attain: should the result be otherwise, there is carelessness or inability somewhere, more likely in the transferring or preparation of the transferred stone than in the actual transfers.

In pulling transfers of work not requiring to be registered, the paper should be put face to face in the damping book for a minute or two. The ink should be used as stiff as possible; if required to be reduced, a little mid and thin varnish mixed together may be used. If the stone gets greasy and liable to smudge, roll the work up with a black roller, give a very gentle etch, better without than with rosin, roll smartly up, gum over, and allow to dry. During the time the gum is drying, scrape the roller, wash the damping cloth, and the transfers will most likely come all right. If still apt to be greasy, the ink may be too fat, add to it a small piece of best black ink with a little mid varnish and proceed as before.

Transfers of colour work, especially if drawn with chalk, are more difficult to manage. This is evident when it is considered that on each

of the different colour stones there may be gradation of tone from solid or darkest, to the lightest possible tint.

Re-Transfers of Colour Work. To obtain each of these in their true relative value on the transferred stone is the task set before the transfer printer, the transferrer, the preparer, and the machineman, all of whom have a part in the process.

We notice again the transfer roller—it has always a tendency,

* When a roller is in good order for pulling transfers it should not be used for any other purpose. The roller will be again noticed under hand-press printing.

owing to the greasy nature of the ink, to get flat, which is not a favourable condition for printing transfers. To put it in good order it should be cleaned out by scraping with a sharp knife, the wrong way of the grain, which should then be smoothed back again with the flat of the knife. This operation is of great service, as will be seen when the roller is charged with ink on the slab. It will now ink up the chalk work much clearer than before, and give the best possible result in the transfer.*

The paper now generally used for colour work is "French." It takes on an impression easily, and is, as all transfers of register work must be, pulled dry. This paper is very smooth and has a hard surface; the transfers therefore, are very liable to be thick, when there is on the roller the slightest amount of ink more than is necessary. Owing to this tendency, the printer should carefully compare each transfer (supposing he is pulling a number) with the first, or he may afterwards find they have been gradually getting thicker and thicker, which would give a bad result on the printing stone. The surface of the "French" paper being hard and non-absorbent, it is necessary to pull the transfers very spare, almost to greyness; and to prevent them rubbing, they should be put between clean sheets of printing paper as they are pulled.

Work on original stones, after having been stored for some time, is often found to be hard and difficult to wash out with ordinary turpentine; a little carbolic acid added to the turpentine forms a very useful solvent in such cases.

RE-TRANSFERS from grained stones form another variety which the printer has sometimes to deal with. In many offices this class of work is never seen, but in London, in America, and on the Continent it is still largely worked. For scientific and medical plates this method may be found very useful, and if the same beautiful soft effect could be obtained from re-transfers as from the original drawing on stone, it might still be recommended as the first and best means of obtaining high-class results.

To print what was originally known as "chalk" work was considered

* It may sometimes be necessary to give the roller a good scrub with pumice stone or a sheet of coarse sand paper and turpentine; this will open the grain and put the roller in good working order.



FINE STONE GRAIN.



FINE GRAIN, NO. 1.

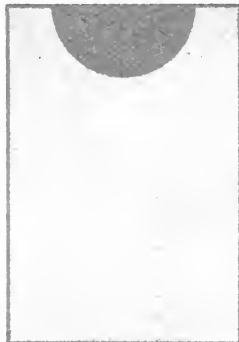

FINE GRAIN, NO. 2.

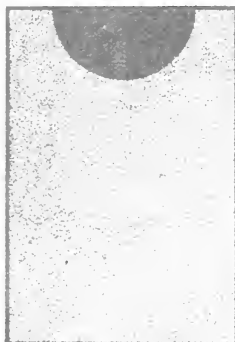

MEDIUM GRAIN.

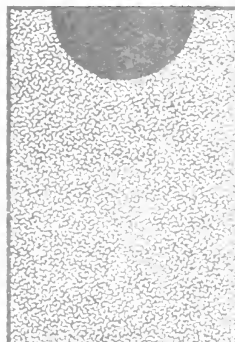

COARSE GRAIN.

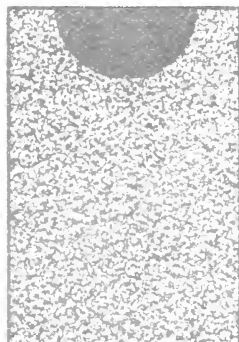

ROUGH GRAIN, CLOSE.

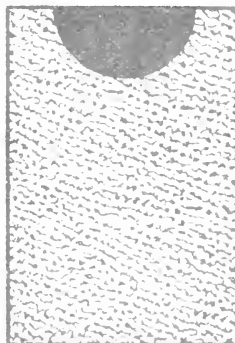

ROUGH GRAIN, OPEN.



HALF TONE GRAIN.

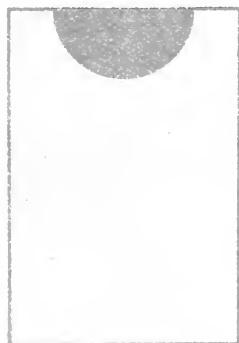

TEXTURE GRAIN.

as requiring the highest skill, and before the era of steam-machines, men engaged on it were highly paid. To pull transfers requires even more care than the printing of "chalk" work, owing principally to the very different quality of ink employed. Black chalk printing ink should be the very best that can be produced, and with this properly mixed and good grained rollers, very beautiful impressions may be obtained. Transfer ink, on the other hand, is soft and greasy, just the opposite of what is required to give a good result from grained stone.

For this work the roller must have an open grain, and should be softer than what is required for flat stone work; a smooth, hard-skinned roller will never give a good impression. The transfer ink should be mixed with a small proportion of the best chalk printing ink and a little mid varnish to keep it free. Transfers pulled on these lines will not have a super-abundance of grease, and they should therefore be transferred the same day as they are pulled. In damping grained stones a soft sponge must be used, not a cloth, which soon wears down and leaves on the stone a vast amount of cotton fibre and dirt, which the roller immediately takes up, and is thus rendered useless for the work in hand. The stone should be just damp and no more; if wet, the roller will not give nor take the ink freely. The work should be rolled without much pressure till the stone is almost dry. The drier the stone just before the inking is finished, the better will be the impression. The roller should be fully charged with ink, and well rolled up on the slab before each application to the stone, which requires gentle rolling. If the ink does not take to the work with this treatment, it is probably because it is too stiff, or the roller not sufficiently charged.

The transfer paper for non-register work should be slightly damped face to face in the damping book. In regard to the pressure required for hand-press printing from grained stones, it may be noticed that the ink, after rolling up, is, or should be, only on the top of the minute raised points of the grained surface. Heavy pressure, along with a soft backing, will force the ink down the sides of these points and will give a dirty and sooty transfer. The object to be kept particularly in view is to get the transfer impression from the tops of the grain. The means necessary to attain this, are a light pressure with everything about the stone and press level and true, using at same time two or three sheets of thick paper for backing.

✓
but the
moisture
must be
there

every
4-5
sheet
wet
to
be
oil
over
might

For the benefit of young men who may never have had an opportunity of seeing grained stone work, we would summarise the directions as follows, noting that while we are treating of transfer pulling, the same directions are applicable to hand-printing from grained stones :—

An open grained roller is necessary, and it is better to have two rollers, one to change every other pull.

Wash out with turpentine, using a soft cloth.

Damp with fine sponge, using as little water as possible.

Careful steady rolling, no "hammering" the stone.

Roll up till the stone is nearly dry.

If prints are at all smudgy, scrape the roller and put on fresh ink.

Paper slightly damped; if dry, more pressure will be required.

Lighter pressure than for flat stones.

Two or three thick sheets for backing.

Tympan tight and free from all inequalities and dirt.

After gumming up, dab the stone with under side of arm to give granulation to the gum.

Wash out with turpentine before rolling up to lay past.

Lay past in rosin.

Stones should be stored in a perfectly dry place.

Plate Transfers. PLATE TRANSFERS are taken from engraved work on copper, steel or other metal plates, copper being now universally used, except for music work. The paper and ink employed in taking these transfers have already been considered in the chapter treating on these articles, and need not again be noticed in detail.

Taking transfers from plates is really a branch of a different trade, viz., copper-plate printing. This business, which was formerly a very important one, has now almost died out, owing to the many new printing processes which have been introduced; so that now, lithographers are supposed to be able to pull transfers from plates, along with their other duties. Several things are necessary for this work, which require a little attention.

First, there is a gas stove to heat the plates, the best form of which is simply a bunsen burner arrangement with a small iron plate or table over it. The flame from the burner is made to pass through a circular piece of wire gauze several inches in diameter, which spreads the flame and uniformly heats the iron plate above. The bunsen burner gives

the maximum of heat with the minimum of smoke and soot. The iron table, for ordinary work, may be about 15 x 12 inches. It should not be fixed, but the legs should have pointed ends, which will sink a little into the wooden table and so keep the iron plate steady, and at the same time enable the workman to lift it bodily away from the burner when required (see Fig. 8).

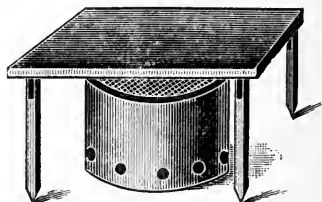

Fig. 8. GAS STOVE.

A wooden box is required to rest the plate on, when inking in and cleaning it. This box should have a partly open front, convenient for holding the whiting required for cleaning the plate (see Fig. 9). A supply of refined whiting and several soft cotton or muslin cloths are also necessary.

Copper-plate presses for pulling the transfers are made in different sizes. A 15 or 18 inch will be large enough for all commercial work; while for map plates a 24 inch will be found necessary, both for size and power. These presses are so simple in construction that it is not needful to describe them in detail, except to say that the pressure is regulated by two screws, one at each side, which act on the bushes below. An illustration of one is given (Fig. 10) to enable younger apprentices to become acquainted with its appearance and parts. The spoked handle in this illustration works with pinion wheels which give greater power; but in small presses, there are no pinion wheels and the handle is placed direct on the cylinder spindle which is seen projecting towards the handle.

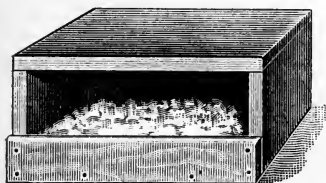

Fig. 9. WHITING BOX AND PLATE REST.

The blankets required for the press are one or two plies of the finest texture made for printers' use. These are put next the plate and one or two plies of a thicker quality above. These fine face blankets will require to be washed occasionally to keep them in a soft, pliable condition.

Before beginning work it is essential that the tables, press, cloths and other articles in use be entirely free from dust or grit of any kind. The plates are easily damaged by scratching, and it is not easy to remedy these faults.

3 bla
fine
below

To proceed to work, a stick of transfer ink is rolled in a double ply of fine cloth or muslin. The plate is put on the iron table, and, when hot enough, is dabbed all of ink, the melted ink oozing. This cloth answers two purposes; ink being put on the plate, and being along it sends the ink into

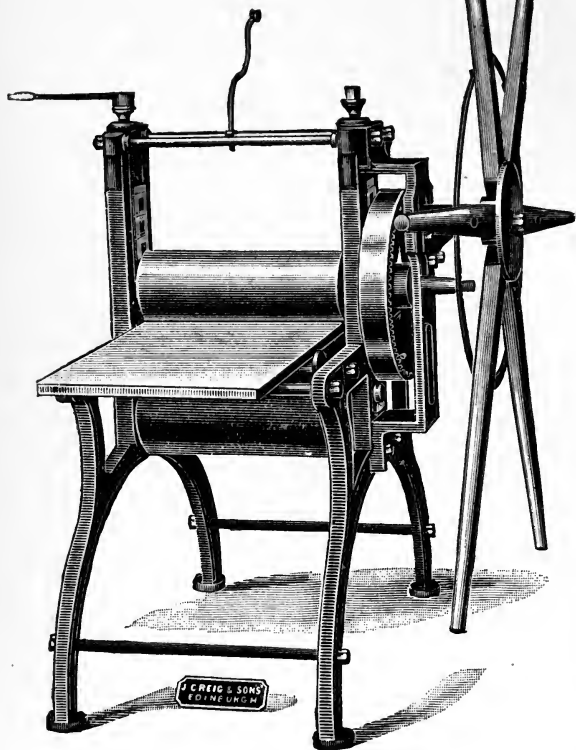

Fig. 10. COPPER-PLATE PRINTING PRESS.

over with the stick through the cloth. It prevents too much in the process of dabbing the engraved lines. The plate while being inked requires to be just so hot, that it will melt the ink and no more. When the plate has received a film of ink all over its surface, and while still hot, the superfluous ink is wiped off with a cloth. This first cleaning should both rub the ink into the engraved lines and clean away a good deal of what is not wanted. Should the plate be too hot, there is the danger of wiping the ink out of the lines, instead of rubbing it in. If it is too cold, the ink will not wipe off at all. The plate is now removed to the wooden box and wiped over and over

again, taking care rather to wipe across than along the engraved lines. When well cleaned, and the plate just warm, a little whiting is put on the cloth and the plate well rubbed in every direction, and

finally, a very little whiting is rubbed on the palm of the hand, which is passed swiftly over the plate. This should polish the plate and remove the last vestige of ink which might be still adhering to its surface. Just before polishing with the hand, it may be necessary to heat the plate more or less, so that the last trace of greasy ink may be perfectly removed.

While the work of inking and cleaning the plate is being carried on, the transfer paper should be damped two or three times with a wet sponge till it is quite limp. The plate, still warm, is then put in the press, the transfer paper is laid on the top of it, a sheet of thin printing paper and two or three blankets over that, and the whole passed quickly through the press three or four times; it is then turned round and passed through another few times, so that each part of the plate may receive equal pressure. The plate is then carefully put on the stove and gently heated all over, till the damp in the paper has quite evaporated, when, with a little assistance, the sheet will rise from the plate, taking with it an impression of the engraved work. over-
night

These instructions are general and are applicable to all kinds of plates. Some however, require special and skilful treatment, in order to obtain a satisfactory transfer. A few days practical work will be the best teacher in regard to these conditions, while the following notes may be of assistance to those who have little or no experience in pulling plate transfers:—

- (a) The ink should not be too soft; if so, it will melt too easily and be liable to be wiped out of the engraved work.
- (b) If the ink is too soft it will be apt also to spread or thicken when being transferred to stone.
- (c) If the ink is too hard it will be found difficult to clean the plate properly, which means much labour and dirty transfers.
- (d) The lines of the transfer may appear black and thick looking in some parts. This is caused by allowing the plate—while heating off—to become too hot or burn at these places; the ink consequently is really melted and spreads on the paper. In heating off, the plate should never be allowed to get *hot*, and the hand should be kept continually rubbing it.
- (e) The opposite may occur—the lines may look as if they had no ink on them. There may be several reasons for this; the plate

may be so worn that the lines will not receive ink, or the plate may have been too much wiped out when it was hot, and the ink almost in a liquid state in the engraved lines; or the lines may not have been properly charged with ink. It should be remembered that a grey bad transfer may also be caused by the coating of the paper having too much paste in its composition. When the paper is in this condition, good transfers cannot be obtained either from plate or stone.

- (f) The transfer is incomplete; lines are broken and white, which should be continuous and black. This may happen when the paper is not sufficiently dampened. If a transfer were pulled with dry paper the fault would appear in an intensified form. The paper for plate transfers should be rather over than under dampened, just the opposite condition from that required for stone transfers. It may also be caused by the composition on the paper breaking away, being too soft to lift the ink, or the plate may have been too cold when placed in the press, or there may have been too little pressure applied when passing the plate through the press.
- (g) Should the paper be apt to stick to the plate, a little more starch in the coating composition will help to remove this irritating fault.
- (h) To prevent steel plates rusting, they must always be coated with bees wax before being put past. *or paraffin*
- (i) It is a good rule, which should invariably be carried out, to pass all plate transfers through the litho. press, face down on a sheet of smooth printing paper, afterwards heating them off before a fire or stove. This operation takes off superfluous ink and will give a sharp and clear transfer when put on stone.

GELATINE OUTLINE or "KEY" TRANSFERS are prepared first by the artist and completed by the printer. When a coloured design is to be reproduced it is necessary to obtain a correct outline drawing of the subject. This was formerly done on tracing paper, but is now more easily and more accurately worked out on a sheet of transparent gelatine. A sheet of this beautiful substance is pinned over the drawing, so that it will not move in the slightest degree. The drawing pins should, if possible, be put through both the drawing and the gelatine sheet at the four corners. With

Gelatine Key Transfers.

a very sharp etching point, the drawing in every detail, is outlined on the gelatine, care being taken not to cut too deeply nor to have a burred edge, neither of which will give a satisfactory transfer. The steel point in working should take the gelatine out of the lines in minute curls. If it does not do this, it is simply indenting the gelatine or causing the edges to rise in a burr on each side. If the burr is not great, it may be rubbed off with the finger as the work is being proceeded with. When completed, the foreman printer fills all these etched lines with re-transfer ink. For this purpose a piece of stiff ink is reduced with a little thin varnish; then by means of a small pad of cloth, it is smeared all over the face of the gelatine sheet and well rubbed into the cut lines; another cloth is then used to clean away the superfluous ink, by rubbing it over and over again; when comparatively clean, a third cloth is used with a small quantity of whiting, to polish the surface and free it from every particle of grease, the transfer ink remaining in the lines only. This process of inking and cleaning is exactly the same as described for taking transfers from copper plates, but without heat. These transfers will keep a night or two before transferring, if necessary, but it is advisable, as with all other litho. transfers, to put them on stone as soon as possible.

It should be kept in mind that gelatine expands rapidly when damped, so that all gelatine keys when damped and transferred, will be a little larger than the original drawing. In most cases this will not matter, but occasionally absolute correctness is required, in which case the "Key" should be drawn on transparent tracing transfer paper with litho. writing ink and transferred to a damp stone.

PHOTO-LITHO. TRANSFERS are more properly the work of the photographer than the lithographer, but an outline of the process may be given as interesting and instructive. This method of producing transfers is specially adapted for line or stipple work, such as maps, plans, engravings, writings, and black and white illustrations. Wash drawings, or nature photographs are not suitable for reproduction by this process. It may be noticed that all original work for photo-transfers should be drawn with a dense black ink and on smooth paper or Bristol board.

Line work which has received colouring may be photographed and transfers prepared, if the colouring is not too positive or opaque. A wash of pale blue will not hinder a good negative being taken, but

**Photo-
Litho.
Transfers.**

yellow, brown, red, or green will photograph more or less black, along with the lines of the drawing, while grey and violet will, if at all strong, give a dirty negative. By skill on the part of the operator, a good deal may be done to overcome these difficulties, so that even from a coloured drawing a fairly good transfer may occasionally be obtained.

The negative is taken in the usual way, using an Anastigmatic lens, with a camera adapted to the purpose of preserving each side of a given square perfectly straight and at right angles one to another. It is quite evident that, say a map, would never do, if in photographing, the sides were curved or distorted.

To obtain good transfers a first-class negative is of the utmost importance. The ground should be quite dense or opaque, and the white lines—corresponding to the black lines of the drawing—sharp and showing perfectly clear glass.

Prints may now be taken on specially prepared transfer paper (which has already been described, page 33), in the usual way by means of a photographic printing frame. In the process of printing, the clear lines of the negative give the brown image of the print, which is at the same time rendered insoluble by the action of the light on the bi-chromatised gelatine surface, while the other parts or ground having been protected by the opaque parts of the negative, are still soluble. The print is now placed on a flat surface* and rolled up with lithographic re-transfer ink, till the whole sheet has received a thin film of the ink. It is now placed in a trough of cold water for half an hour or so, which causes the gelatine surface to swell, except where it has been acted upon by the light in printing; after this it is again placed on the flat surface and well rubbed with cotton wool or a soft sponge. This removes the ink from all the parts except those which have been acted upon by the light. There is now a print in ink of the original drawing, which forms the photo-transfer, and which may now be sent to the printer between damp sheets of blotting paper. The necessity for a sharp, clear negative may now be fully realised, as the sharpness and quality of the lines of the transfer depend entirely on the clearness of these same lines in the negative.

The transfer requires to be dried a little by exposure to the air

* A lithographic stone gives a very suitable flat surface, and a small letterpress composition roller may be used for inking up the print.

before transferring, as the swollen gelatine ground is soft and liable to squash under pressure.

If a thoroughly damp photo-transfer is carefully examined, it will be found that the lines are a little sunk, or rather, the gelatine ground is swollen, so that the transfer itself is in intaglio. Some workers prefer to dry the transfers and damp again before transferring. If they are to go by post or train it may be better to do so, but it will be found more satisfactory for the printer to receive them in a damp state, and dry them himself as much as may be necessary just before transferring.

AUTOGRAPHIC TRANSFERS are writings in lithographic ink which may be transferred to stone, and printed as an exact facsimile of the person's handwriting. It is a very useful method for multiplying **Autographic Transfers.** autographic circulars, and is largely used for business purposes. The ink to be used may be bought in a liquid state from stationers, or obtained from any lithographic printer. It is necessary to use a clean or rather a new pen, as the least trace of ordinary writing ink (which contains acid) coming in contact with the lithographic fluid renders the transfer useless.

Any ordinary writing paper will do for writing these transfers on. The ink should run freely from the pen, but not so freely as to cause the writing to be thick and heavily charged; if so, the writing will most likely spread when transferred to stone, and so lose the character of the original.

Transfers may be taken from type or engraved woodcuts, using **Transfers from Type.** stone transfer paper and the ink already described (see page 26). The paper for these should be plate glazed or passed through the litho. press on the face of a smooth stone. Great care is required in pulling these transfers, which should be clean, sharp, and as dense as possible.

A transfer of a line subject may be taken from stone and reversed on to another sheet of the same paper, by passing it through the litho. press under good firm pressure. This gives a right and left hand transfer of the same design, and is useful in making up a complete **Reversed Transfers.** border from an original drawing on stone, of one half or one quarter only, or for completing an ornamental design which repeats itself on the opposite side of the page. In order to obtain the best result, the yellow writing transfer

paper should be used, and the transfer to be reversed printed a little full, and with ink a little softer than usual.

Imperishable transfers are taken from stone to be preserved for future use. They are pulled on specially prepared paper, or on writing transfer paper, the composition of which has been

**Imperishable
Transfers.**

made specially hard. The ink should contain an extra amount of grease, and the transfers when pulled are dusted over with powdered rosin or asphaltum. They are then carefully rolled up and kept as much as possible from exposure to the action of the atmosphere. They may be kept for months or even years and then transferred to hot stones. For fine work however, the result is seldom satisfactory, but it may be tried as an interesting experiment, which will bring home very vividly to the mind the nature of the lithographic process.

The need for such transfers is largely done away with, when a transfer can now be put on a thin zinc or aluminium plate and stored without inconvenience.

Chapter VIII.

ARRANGING AND PATCHING UP WORK FOR TRANSFERRING.

TRANSFER work generally requires some careful arranging and pasting down on sheets of paper, in order that the transfers may be kept in proper position while being transferred to stone. This is technically called "patching" or "shining up." There are a few articles required for this purpose, viz., pair of scissors, dividers, tweezers, wooden straight-edge, parallel squares, an angle, a **T** square, and a smooth sloped table; also a frame with glass, so arranged that it can stand on a table in front of a window.

Any one engaged in this work should have a knowledge of the different sizes and varieties of paper in general use, which are as follows:—

Writings.	Printings.
Post, $15\frac{1}{4} \times 19$ ins.	Demy, $17\frac{1}{2} \times 22\frac{1}{2}$ ins.
Large Post, $16\frac{1}{2} \times 21$ „	Royal, 20×25 „
Medium, 18×23 „	Double Crown, 20×30 „
Foolscap, $13\frac{1}{4} \times 16\frac{1}{2}$ „	Double Demy, $22\frac{1}{2} \times 35$ „
Double Foolscap, $16\frac{1}{2} \times 26\frac{1}{2}$ „	Double Royal, 25×40 „
Royal, 19×24 „	Quad Crown, 30×40 „

All work, for cutting and binding purposes, as well as for appearance, must be arranged on the sheet absolutely square. To obtain this the **T** square or straight-edge and angle may be used to give a starting right angle for small sheets. For large sheets, or sheets of any size, a most convenient, simple and correct method is the following:—

On the sheet to be used for patching, draw a straight line the whole length, either along the centre or nearer one edge, then fold the sheet over, making the two ends of the line coincide the one

absolutely on the top of the other ; hold the sheet firmly on the table and press the fold right down. This fold will give a perfect right angle with the horizontal line drawn on the sheet, and, by drawing a pencil line along this fold, there is obtained an absolutely correct base to work from, in marking off the sheet in any way desired.

The transfers are now marked off on two sides with square and pencil, or cut to the corners of the work, and pasted accurately down on the sheet in the position required.

In arranging catalogues or other such work, where both drawing and descriptive letterpress transfers are to be placed in position, skill and good taste are required to set off the pages to best advantage. The drawings must be placed perfectly upright and the lettering as perfectly horizontal ; the need of lines at right angles to one another as a guide in patching is thus very apparent. The balance of the page should be carefully seen to, by laying down all the transfers required for it and moving them about—without being pasted—till they are in the best possible position, when, by a little manipulation, they can be safely pasted down. All page work should have less margin at the top and binding edges. If placed lower down, or even exactly centred, the page will appear out of balance and offend the eye. The difference in the margin will depend on the class of work and the amount of matter you have to deal with for each page.

The one thing required for successful patching is to allow the intelligence to follow the work step by step, understanding what is required, and what is the object aimed at in the work in hand. An efficient patcher must therefore have an active intelligent mind, as well as good taste and a neat hand. With these qualifications there is no fear but that he will attain a good position in any establishment requiring such services. It scarcely requires to be said, that a foreman should possess the necessary qualifications for patching.

“Shining up” colour work is comparatively a simple operation, there being no planning or arranging necessary. Impressions of the key or black printing stone are pulled on well-seasoned drawing paper, one of which is pinned up in front of the glass frame. The transfers, which are generally pulled on the transparent French paper, are then cut to the required size and pasted in correct position ; this is easily seen by the light shining through the sheet of drawing-paper against the glass. The register marks on the transfers should absolutely

coincide with those on the key sheet. When all the transfers are in position, the sheet is removed from the frame and transferred, or placed till required in a close drawer to prevent any shrinking or expansion of the paper by exposure to the atmosphere.

A few general directions may be here given as to procedure in this part of the process:—

The transfers should be pasted very lightly at the four corners, or here and there in addition if they are large. Care must be taken that no paste is allowed to get on the face, and that the fingers do not press on any part of the transfers.

The tweezers mentioned are those used by watchmakers, and are most useful in picking up and placing in position small transfers; indeed, without them it will be impossible to patch small work in a clean and efficient manner.

In “shining up” colour work to be transferred to damp stone, the paste should be mixed with a little treacle or glycerine, which will enable the sheet to be more easily removed from the transfer in the process of transferring.

In arranging or planning out a sheet of work, allowance must always be made for the machine gripper, the margin of paper for which must extend over the edge of the stone a clear half inch. Thus, if the sheet is 20×30 , the work can only be arranged for 19×30 , or to allow for trimming $19 \times 29\frac{1}{2}$.

For colour work, register marks or crosses + must always be put on the key stone, and corresponding marks on each of the colour stones. Marks are also put at each end of the printing key stone, which are independent and in addition to those on each transfer. These are required to obtain register on the whole sheet while printing at machine; corresponding marks are put on each colour stone, which should fall exactly on the top of each other in the course of printing.

It is very important that the sheets of drawing paper on which the key impressions are pulled should be thoroughly seasoned. They should be hung up about the printing room for some weeks, then plate glazed, or passed through on a stone several times, after which they should again be hung up for another week or two.

Chapter IX.

DRAWING ON STONE FOR BLACK AND COLOUR WORK.

THIS division of our subject is important as well as most interesting. It brings us to the stage of getting the work or drawing chemically united with the stone's surface. This is done either by direct drawing on the stone, which is carried out in the artist department, or by transferring work to stone, which has previously been drawn or engraved, this operation forming part of the printer's duties. The former naturally comes first, and leads us to bring under review the work of the artist department, and the methods employed to produce the various classes of work that ultimately come to the printer's hands.

The stones, inks, transfer papers and transfers have already been noticed separately, it will now be our object to bring these elements together in order to produce a certain result, viz., the basis of lithographic printing.

The **ARTIST DEPARTMENT** in a chromo-lithographic printing office may be called the life-giving part of the establishment, and it cannot be too strongly impressed on the minds of both master and assistants, that everything in connection with this branch should be of the best possible quality. It is also advisable, knowing that a piece of work may be reproduced in several ways by the artist, to carefully consider which will give the best result, when the work is being printed at machine. By one method a very satisfactory proof may be obtained at the hand-press, but which may not be the best for machine printing. This last and most important stage in the lithographic process should largely influence all that goes before it.

The instruments used by the lithographic draughtsman are those generally found in all drawing offices, viz., a box of good mathematical instruments, steel point and scraper, **T** and parallel squares, angles,

curves, brushes, pens, port crayons, etc. The drawing and bow pens should be made of hardened steel for drawing on stone. Other accessories will readily come to mind, such as a box of water-colours, drawing board, tracing paper, drawing pins, etc.

Drawing on grained stones is one of the earliest as it is one of the most beautiful methods of lithographic reproduction. Unfortunately the necessities of a commercial age and steam-printing machines have caused it to die a natural death in many places, so that now, to a great number of lithographic artists and printers, it is an unknown department of their business. In the hands of capable draughtsmen, very charming results may be obtained, which makes it desirable that it should again be cultivated as a means of producing really artistic work. The possibilities of grained stone work may be seen in many of the earlier examples of lithographic reproduction, more particularly Portraiture, some of which are equal to Mezzotint or engraved work.*

Drawing on Grained Stone. Graining the stone has already been described, but we would emphasise the point that whatever else the grain may be, it should not be flat. The stone being placed on the drawing table should at once be covered with white printing paper, pasted down at the extreme edges. Only a part of the stone's surface should be exposed at a time, as required for drawing. The subject is traced in the usual way on tracing paper and placed face down on the stone; a sheet of red kiel paper is then put between the tracing and the stone, and by means of a steel point the drawing is traced down in faint red. Another method of tracing down is to take a sheet of gelatine, and with a steel point etch or engrave the necessary outline, taking care not to leave a burr on the edges of the cut line. This engraved outline is then filled in with red Kiel and burnished down on the stone, or it may be passed through the litho. press under heavy pressure, when a complete key outline will be at once obtained.

The chalks for drawing on stone are sharpened from the point upwards to prevent breaking, and as the work proceeds, a fine point may be obtained by rubbing it over a sheet of rough paper.

* Major-General J. Waterburn, I.S.C., in an article on Photo-Lithography in Penrose's Annual, 1900, speaks very highly—but not one bit too highly—of this grained stone method of reproduction, and also expresses his regret that it should have fallen into disuse.

With a finely grained stone, the most delicate drawing required for scientific and medical work may be produced,* while with a coarse open grain, broad poster work may be drawn out with good effect. The former should be printed at hand-press in order to obtain the fullest delicacy, while the latter can be printed at the machine with excellent results, as seen on the many bill-posting stations throughout our large cities. Considerable time is required, and much patient practice gone through, before really fine work can be executed in this way. When titles or lettering are required they are done by means of a brush or pen and liquid ink. As titles are best drawn on a smooth stone, this is generally attended to, after the chalk drawing has been prepared and inked up, when water can be applied and the part required for this purpose polished.

A few hints as to working with chalk on grained stone may not be out of place at this stage.

Hints for drawing on Grained Stone. No particles of chalk must be allowed to fall on the stone. Should such a thing happen, they must at once be carefully dusted off with the camel-hair brush; on no account must they be blown off with the mouth.

No specks from the hair should be allowed to fall on the stone. It will be more difficult to notice these, but the matter should be carefully watched, as if allowed to fall and lie on the stone, the result will be black specks in the finished drawing, the stone having absorbed grease from these minute particles.

The hand must not rest on the face of the stone, and clean white paper should be at all times at hand to cover up the work at any moment. A hand board, resting on two thin slips of wood or mill-board at either end of the stone, will enable any one to work over any part of the stone without danger of rubbing.

No particles of spittle must be allowed to get on the stone's surface: hence the necessary prohibition of blowing with the mouth over the stone for any purpose whatever. A sneeze may spoil a good week's work if unguardedly indulged in.

The stone should not be allowed to get wet or even damp, which

* In the Scientific Journals issued by most of the learned societies, there may still be seen many fine examples of this class of work. The "Challenger Expedition" volumes, which can be referred to in most Public Libraries, also contain a large number of beautiful plates which have been executed by the same method.

it is very liable to do when breathing over it while working; dampness will cause the work to thicken.

In cold weather the stone naturally absorbs a little moisture from the atmosphere, which it is better to get rid of before starting to work. It should therefore be placed in a warm, dry room for a little time, or placed before a fire for a few minutes, but at least three or four feet away from it, as the stone must on no account get hot.

Depth of shading and mellowness of texture are obtained by carefully working over the parts again and again with a very gentle touch, until the necessary depth is obtained, the object being to get the chalk beautifully worked or rounded on the top of each of the minute grains, which form the granular surface of the stone. If the chalking is done quickly or roughly, loose particles will be, as it were, rasped off, and getting into the hollow parts between the elevated grains, will cause the finished drawing, when printed, to have a dirty or sooty appearance, if not altogether spoiled.

Pen or brush work may go along with chalk when great depth of tone is required, or may be worked as outlines in special subjects. For outline drawing there will be no difficulty in using pen or brush, but when introduced to give depth to chalk work, it will require very careful and patient working to make the chalk merge into the solid ink part, so as not to leave a decided and apparent junction.

A keen edge and thin blade are required to sharpen the chalks, which, as already noticed, is done from the point upwards.

The whole of these hints in regard to working on stone are also applicable to grained zinc and aluminium plates, which however, should not be polished for lettering or titles.

As some artists prefer to etch or prepare their own work on stone, the method of doing so may be given here. Should the
Etching
Chalk Work. artist not do this part of the process, it ought to be carried out by the master himself or his foreman, as it requires great care and good judgment.

Dissolved gum arabic of the consistency of thin cream is passed through a muslin cloth to get rid of all gritty particles. To a small basinful is added about 2 per cent. of nitric acid, and well stirred. This solution should be tested on the corner of the stone, and should show just the slightest amount of effervescence. It is now spread quite freely over the whole stone by means of a flat, four or five

inch wide camel-hair brush. After passing the brush two or three times over the stone, and giving the darker shaded parts an extra application, it is raised on its edge, and put in a sloped position against a wall, face out, and left all night. The superfluous solution runs off, and the remainder dries on the stone's surface, chemically preparing it for rolling up by the printer. *or blot off with clean news print*

The acid strength of the solution is of the greatest importance, and should vary a little according to the nature of the work drawn. If effervescence is brisk, there is too much acid, and more gum must be added. On the other hand, if there is no effervescence, there is not sufficient acid to prepare the stone properly, and the work, if etched with this, would come flat. The addition of a few drops of acid will generally give the required strength.

As artists sometimes also prefer to prove or superintend the proving of their own work, we may here proceed to describe the method of doing so, although it belongs more strictly to the printing department.

Proving Chalk Work.

The stone is lifted on to the lithographic press, and the dried etching solution washed off with a soft sponge and clean water; this is repeated several times to get the acid and gum quite away. Some oil and turpentine is then sprinkled on the stone, and the drawing is washed out with a cloth, which should be kept for this purpose only. A little water is then sprinkled over the stone and the oil and turpentine is partly cleaned off with the same cloth. In rubbing the cloth backwards and forwards a few times, the drawing should assume a grey appearance and is then ready to be rolled up. As the work will not take its full strength at once, it is advisable to roll up and take impressions on ordinary paper several times; each impression will appear stronger than the preceding one; when about a dozen are pulled the work should be right; it is now rolled and gummed up and left to dry. In the meantime the inking roller should be scraped, fresh ink put on and thoroughly rolled on the ink slab. The gum may now be removed from the stone and good proofs taken in the usual way. Should the work be for machine printing, a second etch in rosin will be required.

Should any spots or dirt appear on the stone outside the drawing, they may be removed with pumice stone, Ayr stone, or steel scraper, touching the places with gum and acid. If any spots appear on the

drawing, the artist will require to remove them with a steel point, touching the places afterwards with etching solution a little stronger than what was first used; a fine brush should be kept for this purpose, so that the acid may only be put on the spot that has been picked and no more.

For grained stone work a soft sized printing, preferably "plate" paper slightly damped, will give the best results. Further directions as to printing will be found under "Transfers from Grained Stones," pages 65-66.

Up to about twenty-five or thirty years ago colours were mostly prepared and printed from grained stones which gave excellent results, but not being adapted for machine printing with glazed rollers, they have been almost entirely superseded by other methods. It will be well however to describe, as both interesting and instructive, how these grained tint stones were prepared.

Having got an off-set on a grained stone, the most direct way to produce the tint required is to use the chalk and ink as described for grained stone work, using Nos. 1 and 2 chalks instead of the harder "Copal" quality.

Ink may be freely used wherever a solid or full tint is required, by painting over that part with a brush, while for half or quarter tint the chalk is used, working it up to any desired depth of tone.

Another and perhaps easier method to get a grained tint stone is by stumping. A stump is made of cloth or soft leather, exactly the shape of a large cigar. Some chalk parings or stumping ink are smeared on a small stone, from which a supply is taken on the stump as required. The grained stone with the off-set is then worked upon with the stump, giving both variety and delicacy. For work which may be printed direct, either at hand-press or machine, such as facsimile reproductions of old charters or documents, or shading on the top of a previously printed colour, this method gives very excellent results, but is not suitable for commercial work, as it will not re-transfer well. Etching and preparing are the same as for chalk work on grained stones, but, being more delicate than ordinary chalk drawing, a weaker etching solution is required.

A third method of obtaining a grained tint stone is by "rubbing in." An off-set is put down in the usual way on a rather finely-grained stone.

Those parts of the stone not to be tinted, along with the margins, are gummed over, while those parts which are to be solid require to be cut round with a steel point. The stone is now warmed, laid on the table and rubbed over with the cake of rubbing-in transfer ink; then with a piece of firm woollen cloth it is rubbed backwards and forwards till the ink is spread over its entire surface in the form of a thin grey film. The stone may require a further heating before this can be satisfactorily accomplished. This inking and rubbing obliterates all traces of the off-set: hence the necessity of making needle holes and pointing the parts that are to be solid, *before* the rubbing in ink is applied.* Lights or quarter tints are obtained by scraping out with a flat scraper: to obtain a very light tint, the grain of the stone has to be taken away till the part is almost flat. After the scraping is done, those parts which are to be full strength are filled in with ink. When the ink is quite dry, the stone is etched in the same way as described for chalk drawings. The solution however, must be considerably strengthened with acid, in order to keep the different shades of tinting in their proper proportions, and should effervesce quite freely if applied to a clean part of the stone.

Grained stones are only used to reproduce shaded drawings, and are not suitable for pure and simple line work. The artist must therefore draw his line subject on smooth or flat stones. These are polished, as already described, and must be absolutely clean. The stone is placed on the table and covered with white paper to avoid any accident in the shape of dirt or grease getting on its surface. This paper is secured from moving about by a touch of gum here and there along the edge of the stone. The artist measures off with pencil, or traces down the subject in hand, and then proceeds to draw it with liquid ink. A draw-pen, sable brush or fine steel pen is used for this purpose, the operation being much the same as drawing on the yellow transfer paper, with this important difference that it must be drawn reversed, *i.e.*, as it would be seen in a mirror. This reversing naturally applies to all work drawn direct on stone or metal plate.

The very close and beautiful texture of the stone makes it possible to draw very fine lines on its surface either with the draw-pen, pen, or brush. When broad lines form part of the subject, it is advisable to

* This rubbed-in film of grease gives a strong half or three-quarter tint.

draw two or three or more thinner lines and fill afterwards the space between them with the draw-pen or brush. To attempt to draw broad lines with one operation of the draw-pen will likely end in having a ragged or spread result, caused by the ink running. When the plan, map, or drawing is finished, it is handed to the printer to prepare and prove.

The stone is prepared by covering it with a solution of gum containing a very little nitric acid and allowing it to dry. The gum is then washed off, the work washed out with turpentine, rolled up, etched again in rosin if necessary, and proved in the usual way.

HAND STIPLING is another variety of smooth stone work. It is really an imitation of grained stone drawing, and is well adapted for machine-printing. In artistic effect and softness it comes far short of grained stone or grained paper work, but for commercial purposes it answers admirably, and possesses the great advantage of not being easily spoiled either in transferring or printing.

An outline of the drawing is made and transferred, which forms the "key" stone. As many off-sets are now made on separate stones, as there are colours required in the reproduction. The artist makes up the scheme of colouring required and proceeds to put each on its respective stone. The lighter colours are drawn first, and when the result of these is seen in proving, he proceeds to finish the darker tint and outline drawing stones.

Stippling on stone is more laborious and requires more careful judgment than drawing the same work on grained paper. The ability of the artist is shown in the regularity and smoothness, as well as the differentiated amount of work which he puts on the stones for each colour, in order to obtain a faithful reproduction and a satisfactory printing result.

Either a fine steel pen or brush may be used for stippling, and the ink must be of a consistency to flow, but not too freely, from the point, so that the slightest touch of the pen or brush on the stone may give its corresponding microscopic dot. Very beautiful stipple work is done on the Continent in the production of Christmas cards, children's books and pictorial designs. The draughtsmen of this country have either not the patience or the ability to compete with their continental brethren in this particular class of work. There are

however, deficiencies in this as well as in all other things, and the defect most often met with is the absence of artistic feeling, the reproduction being more often pretty than artistic. The method is at its best mechanical; and the result is often stiff and laboured in effect, and as a rule, cannot compare with what may be obtained from other and more natural grain methods.

In all businesses there are many little plans of doing work or of doing it in a peculiar way, in order to obtain a better or out-of-the-way effect. Clever lithographic draughtsmen may do wonders with the material at their command. By the use of gum and the gum brush an artist may receive great assistance in gaining certain effects for his work. The slightest touch of gum on the stone will prevent any transfer combining with its surface. Accordingly, to obtain high lights, or white lettering on a black ground, it is only necessary to put a little gum solution over the parts desired to be white, and the transfer may be filled in solid on the paper; or if working on stone, litho. writing ink, reduced with turpentine instead of water, may be spread over gummed parts. The gum will not be acted on by the spirit but will preserve the lettering or lights from the greasy fluid.

Again, a part of some intricate and delicate subject on stone may require to be deleted, which would be very difficult and tedious to do by scraping, but it may be done very simply by gumming out. To do so, carefully gum over the parts which are to remain, let the gum dry, then wash out the work with turpentine and carbolic acid.* This treatment will so weaken the work washed out, that with a slight etch it may be quite removed, while the parts covered with gum will be preserved in full strength. It may be more satisfactory to dust the work with rosin before gumming out, as it will then stand a stronger etching. The gum for this purpose must not be thin or watery.

We have already noticed the usefulness of gumming out for grained tint stones, and its use in connection with Shading Mediums will be noticed under that heading.

Drawing on grained paper has been already considered under grained paper transfers, see pages 60-62.

There have been introduced from time to time different mechanical

* One part carbolic acid to about ten parts turpentine may be used.

means to assist the tedious work of hand stippling on stone. The original and best of these is Day's Shading Mediums. This contrivance consists of transparent gelatine sheets, smooth on one side and embossed on the other, giving in good relief, stipple dots, natural grains, ruled and cross lines. All of these may be had of various degrees of fineness, thus giving a large range of tints for different classes of work.

Shading Mediums. The method of working these films is very simple and at same time very accurate. Two square bars of wood are screwed firmly down on a table from front to back and three or four feet apart. On these bars are two movable sockets which are kept in any required position by screws. From the top of these, a cross-bar runs so that a stone may be conveniently placed underneath. On this bar are fixed two adjustable screws with centre pivot holes, in which points, that are on each side of the film frame, work as on a hinge. There is also the frame just mentioned which receives the films after they are inked up, and forms the carrier to the stone. The gelatine films are rolled up on the relief side, with stone transfer ink reduced with a few drops of turpentine or palm oil, a small hand letterpress roller being the most suitable for this purpose. After being inked up, the film is placed in the frame, and this is put in position on the cross-bar face down. A burnisher or very small India rubber roller may be used to press the film on to the stone, and so transfer the ink to the parts intended to receive it; the parts of the stone not requiring the stipple must be gummed over before the films are applied. Great variety in texture and depth of shading may be obtained by this means, as after one film has been transferred, another of a different nature may be laid down on the top of it, producing what it would be impossible to obtain by hand work. The adjustable screws on the cross-bars can move the film frame 1000th part of an inch or more as required. This makes it possible to broaden any of the dots on any particular part of the subject, thus giving a vignettted tint which is so often required.

In an office where there is plenty of commercial colour work, the Medium will prove a valuable acquisition, and in the hands of a skilful operator excellent results may be obtained. Unfortunately a heavy royalty is charged each year for the apparatus and films, and the right to use them, which makes it quite prohibitive except for large establishments.

There are other shading mediums of a more simple kind which may be bought outright.

The AIR BRUSH or AEROGRAPH is another means by which a soft gradated tint may be obtained on a flat stone. As its name implies, the ink is sprayed by the action of compressed air, worked from an india-rubber ball by the hand, or through an air pump by the foot. In map work, where gradated tints are often required for sea coasts and country boundaries, it forms an excellent auxiliary and gives a good result. The work done however, is so close and fine in texture that it is not quite suitable for re-transferring, though regularly done in some establishments. The quality of work obtained, which does not lend itself to re-transferring, is however, the more favourable for direct machine printing. The general appearance of the brush may be seen from the illustration below, which however, does not show the air tube connection. The finger knob on the top is easily worked to give a greater or less supply of ink, as well as variation in grain texture. It may be obtained from Messrs Hunters Ltd., London, who will readily give any information required.

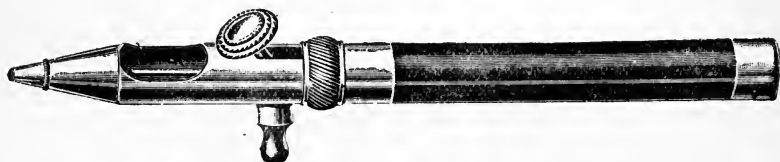

Fig. 11. SHOWING THE BRUSH WITHOUT AIR TUBE CONNECTION.

SPRINKLING or SPLASHING may be done both on stone and transfer paper. A fine tooth brush is saturated more or less with lithographic writing ink; it is held upside down in the left hand, and the edge of a knife blade is drawn across the hair towards the handle. This gives a shower or spray of fine dots of ink which falls on the stone or paper, giving a sprinkled surface. The quality of grain or texture may be greatly varied in this method and depends entirely on the skill of the person using it. In contrast with hand stippling, the work is not mechanical, and is useful where a little irregularity in the grain is not a great objection. After spraying, the work may require a little picking to reduce the larger dots, or touching up to give it a more regular appearance. Of course it will be necessary to gum or cover over the parts that are not to receive

the sprinkling. The grain obtained by this means is generally so open and strong that it is quite suitable for re-transferring. There is another "French" apparatus for spraying, which, in skilful hands, is said to give a finer and more regular grain than the tooth brush and knife. This consists of a sheet of steel with parallel slits in the centre. A rather stiff hog's hair brush is saturated with ink and rubbed across the grating which is held in a horizontal position with the brush perpendicular to it, the spray falling below on paper or stone.

ENGRAVING ON STONE direct is so little practised now-a-days that though very beautiful work has been produced by the artist engraver, it requires only to be mentioned as a method of the past. Microscopic and scientific plates, maps, machinery, and other line work were at one time largely engraved by this method. The mode of working is as follows: a good hard stone, quite free from veins and chalk marks, is smoothly polished, and slightly etched with gum and acid. The stone is then washed with water, leaving just a little of the gum behind; some powdered lamp-black or red kiel is then rubbed over its surface, which forms a working ground. The subject is traced down with red on the black ground or with black on the red ground, and the engraver proceeds to cut the subject on the stone by means of suitable etching points or needles. When finished, the lines appear white and are filled in with oil and allowed to stand for a little time. The oil is then washed off and the work inked up by means of a flat circular dabber and soft ink. The ink which is left on the surface of the stone is wiped off with a muslin rag. The paper having been previously damped is now laid on the stone and printed in the usual way. This is old hand-press work and now obsolete; it is therefore very unlikely that any reader of this book will be called upon to practise it.

In concluding this chapter on the artist department, it must not be imagined that the methods and modes of working have been exhaustively treated. On the contrary, the artist only displays his skill and originality by not following literally the beaten tracks. Lithographic methods are so many and so complicated, and the works to be reproduced are so varied and require so different treatment, that it is impossible in any such work as the present, to go into all the detail and technical methods which may be successfully carried out both in the artist and printing departments. It is this that should

Engraving on Stone.

give real pleasure to every earnest worker, that he may improve the product of his hands by thoughtful attention and practical ingenuity. On the other hand, the want of these qualities will give, at the best, but commonplace style and mediocre quality, which in lithographic work is too often apparent.

Chapter X.

TRANSFERRING WORK TO THE STONE.

PASSING from the artist department, we now come to the printing-room to notice the method of transferring to stone work which has previously been written, drawn, or engraved, apart from the stone itself.

The order to be followed in noticing the transferring, will be the same as in chapter VII., on Transfers, which is naturally followed by what we are now to consider.

In transferring, there are several articles required and points to be attended to, some of which may not be quite essential for ordinary work, but all are essential for the production of the best. **Transferring.** It is quite evident and need not be emphasised, that if the same care is taken with the more common, as is required for the best work, the former will not suffer but be all the better for it, and thus the standard of quality, without special effort, will be raised all round. It will be advisable for each one who takes this book as a practical guide, to follow the directions given as closely as possible; if this is done the author expects the result will be satisfactory to both men and masters alike. No one need expect to transfer work successfully to stone, unless he gives the utmost attention to what he is about: quality depends so much on the skill and care of the operator.

A former chapter has been devoted to a description of the various articles required and materials employed in the lithographic process. It will not therefore be necessary to describe again each article as we go along, except where it is needful to make the subject more clear.

There are several points which are applicable to whatever kind of work is to be transferred, and these will be noticed first.

The Press should be clean, the bushes and rails oiled, and the roller seen to, that it is not greasy. A greasy or dirty roller will slip

and so fail to take the carriage quickly through, thus running the risk of spoiling the transfer. The boxwood scraper must be tested :

Transferring. if not true with the face of the stone on which the work is to be transferred, it is made so by laying two
The Press. sheets of sand-paper right across the stone, having a sheet of paper on the surface to keep it perfectly clean ; the edge of the scraper is then moved backward and forward till it coincides with the face of the stone. This properly should be done with every stone, but it is absolutely necessary if the work and stones vary in size, as they often do. It is not advisable to use a scraper much broader than the stone. The reason is obvious ; the projecting ends do not receive pressure, which causes the edge or face to become hollow. For transferring work for hand-press printing, the scraper should be narrower than the stone. The work to be printed at machine, being necessarily close to one edge of the stone, the scraper must come over that edge.

On the carriage of the press there should be two sheets of Kampulican, and over these as a preservative, a sheet of zinc This bed will give just sufficient elasticity to equalise the pressure over the stone, while more than two sheets would most likely give too soft a bed and might be the cause of stones breaking. The tympan sheet should be an 8 or 10 sheet cardboard or two or three sheets of thick paper. The Damping Book is of great importance and should be carefully attended to each day, damping it at night when required, and interleaving it in the morning with dry sheets if it should happen to be over-damped.

The stones should in all cases be washed with running water from the tap before transferring, even although previously washed quite clean. They are then put into the heating-box or before
Transferring. the fire with the object of both drying and giving
The Stones. them a gentle warmth. The amount of heat required is not great, just enough to feel a little warmer than the hand. If a fire is used, the centre of the stone should not be put before the centre of the fire ; but should be kept to one side and in a few minutes moved to the other side, which will generally give an equal warmth all over. The reason for doing so is, that if the centre of the stone gets quickly heated it naturally expands, and, the ends being still cold, there is great danger of breakage, especially in cold weather.

After heating, the stone is placed in the press, covered over with thin printing paper, and tested to see if level. This is done by adjusting the pressure at one end, raising the lever and pushing the carriage through and then testing the other end. If the pressure is not equal at both ends, the difference is made up with layers of brown paper, taking care to graduate the sheets from large to smaller pieces; if the stone is thin, it will be safer to put the paper packing under one of the Kamptulican sheets; it is also safer to use a number of sheets of brown, rather than two or three plies of thick packing paper. The object in all this treatment is to get an equal pressure with the minimum risk of breakage. When all is ready the sheet of transfers is taken from the Damping Book and laid on the stone in the position required, in the centre for hand-press, and close to one edge for machine printing. One or two sheets of "setting" paper are put over the transfer, the tympan sheet laid over all, the tympan lowered and the carriage passed through the press a few times under light pressure. The transfer sheet is now uncovered, damped with a sponge, and again passed through two or three times under firmer pressure. This treatment will send the damp through the sheet on which the transfers were pasted, so that it may be easily lifted off, using the damping sponge again if necessary. The transfers are now sticking individually to the stone, and may be wiped over several times with the damp sponge, in order to remove all the paste which had been left when the patching sheet was removed, as well as to damp and soften the transfers themselves. Another sheet is now laid over the stone and it is again passed through the press several times, under light pressure first, increasing a little each time. The stone is again uncovered, the transfers damped again, and passed through two or three times under very light pressure. The actual transferring having already been completed under the previous heavy pressure, the object now is simply to get the damp thoroughly through the transfer paper. For this purpose the stone is again uncovered and a sponge full of water freely rubbed backwards and forwards, rubbing also at the same time with the hand, till the transfers are thoroughly soaked through. The transfers lying on the stone should now be so limp that they may be lifted off, either entire or in pieces, leaving the ink impression or transfer intact on the stone's surface. Besides the ink impression, there is also left on the stone

the film of composition which was on the face of the transfer paper; this is now removed with the sponge and water, which completes the process of transferring, and the stone is then generally laid aside for further preparation.

The object to be attained in transferring is to get the whole of the ink which forms the transfer removed from the paper to the stone and left there. The pressure must be regulated according to the work in hand, which will soon be learned in practical work. The principal points to be attended to may be summarised as follows:—

The transfers must not be wet, but damped sufficiently to cause them to stick to the stone with the first pull through the press.

They must not on any account rise from the stone **Transferring.** after being once passed through the press; if they do, it **Summary.** may be taken that the work is spoiled.

After passing through the press several times, the stone must be turned round, so that any inequality of pressure on one side or end may be rectified. Any packing under the stone at one end, must of course, be changed to the other end when it is turned.

Equal pressure over every part of the stone must be obtained.

Damping the transfer while transferring should be gradually but thoroughly done. The final pass through the press, under very light pressure, is not to finish the transferring, but simply to send the water completely through the paper.

If the stone is too hot, it may cause the transfer to “flow,” and so thicken the lines. A colder stone is at all times to be preferred to an over-heated one.

Heavy pressure may also cause the work to “flow,” especially in transferring plate and chalk work.

Transferred work should, if at all possible, be laid aside for twelve hours before being cleaned and prepared.

Some work is better to be “rubbed up” before being laid aside for preparation, and some men prefer to “rub up” all kinds of work immediately after transferring. This “rubbing up” is carried out in the following way: a piece of soft cloth or sponge is used to take up a little printing ink from the ink slab; this ink should be stiff and a few drops of turpentine used to soften it. Having a gum sponge in one hand and this ink sponge in the other, they are applied alternately to the stone, rubbing it all over, first gum then

ink, till the whole of the work has received a supply of ink and appears quite black. The advantage of this operation is that the work is strengthened by an addition of ink. The disadvantage is, that it may bring up a good deal of dirt which has afterwards to be cleaned away. Rubbing up is not to be highly commended.

The proportionate degrees of pressure which may be used in transferring different kinds of work may be taken as follows: Photo-Litho, 4; Grained Paper, 6; Plate, 10; Stone and Writings, 16—that is to say, Writing and Stone transfers will stand four times the pressure required for Photo-transfers, and be the better of it.

The transferring operations are the same in all cases, with a few modifications for different classes of work, which we will now notice.

WRITING TRANSFERS may be taken as the simplest and most easily managed. The paper used for these is necessarily hard **Transferring.** for writing upon, and the coating is not very soluble in cold water; it is therefore necessary, after the transferring **Writing** is completed, to use clean hot water by pouring it over **Transfers.** the stone, so that the paper may be easily lifted off and the transfer left behind. The whole operation may be done with cold water, but it will take longer time, and there will be the risk of weakening the transfers by the amount of rubbing that will be required. These transfers are the better of being “rubbed up” before being laid aside for preparing.

GRAINED PAPER DRAWINGS.—These require very great care both in damping and transferring. If too damp, the finest parts of the work will be lost; while if too dry the sheets are liable **Transferring.** not to stick to the stone. Again, this work is apt to **Grained** thicken more than any other, if a little too much **Paper Work.** pressure is applied.

The chalks used in drawing on this grained paper contain a large proportion of soap, and the work is apt to wash away when the water is applied. To prevent damage, some gum should be used along with the water when washing off the composition. Should the chalk work wash away badly, a free use of the gum sponge and the application of the rubbing up sponge will be the best means to secure the work from being spoiled. The pressure in transferring this class of work must be very carefully attended to.

GRAINED PAPER TRANSFERS of colour work are transferred in the

following way: the key stone having been made up in position for printing, there is made from it as many off-sets on separate stones as there are colours to be printed. These off-sets have, of course, all the register marks which are on the original key stone.

Suppose there are four plates on a "royal" stone, the grained paper drawings—for say the yellow—are taken, and with a sharp pair of scissors, the four register marks are cut exactly through the cross lines, two sides are cut away, leaving an angle of paper so—L—as a point to lay to the corresponding angle on the stone.

They are then put into the damping book, and, when thought ready, are laid loosely on the stone to see if the length and breadth correspond in size with the off-set; if too small they are again put in the damping book, if too large they may be laid for a few minutes, face up, on some sheets of printing or blotting paper, which will cause them to shrink a little. If correct, the two which go nearest the tympan are laid down absolutely in position, angle to angle, and passed through the press a few times; then the other two are laid down and the whole passed through the press. Afterwards the transferring is completed in the usual way.

It is not necessary to draw in ink all the register marks which appear on the off-set stone, but only those on each end which are necessary to control the register of the whole sheet when printing.

These transfers are often transferred dry to damp stones. Great care is required to do this successfully, as the composition on this paper is less adhesive than on any other; there is danger therefore, that the transfer may "rise." If it should do so, the work is certain to be spoiled. The procedure is described below, under "Transferring Stone Transfers." Whether transferred damp or dry, it will be always better to rub up Grained Paper Transfers.

STONE TRANSFERS.—These are treated much in the same way as writings, but as the paper is usually a printing, or thin transparent "French," they are more easily managed in the damping
Transferring. off, and require only cold water.

Stone Transfers. These transfers, more often than any others, are put on damp stones, instead of being damped in the damping book. This method is adopted, so that correct register of colour work may be obtained. The stone is damped with a fine muslin cloth and perfectly pure water; when evenly damped all over, the

sheet is laid quickly down, and passed through the press as rapidly as possible three or four times, with good firm pressure. When the sheet adheres closely to the stone, the usual treatment may be proceeded with more leisurely. The damp stone method may be used for other kinds of work, including grained paper drawings, but it must be very quickly and skilfully gone through to obtain a satisfactory result. It should be noted that the muslin must be of the finest and softest quality, absolutely clean,* and the water absolutely pure; also that an equal and very slight film of water should be laid over the entire stone.

PLATE TRANSFERS.—Plate transfer ink being very susceptible to heat, the stone should be almost cold. A soft tympan sheet should also be used, and a medium pressure employed. The **Transferring.** paper coated for this class of transfers being a soft **Plate** printing, the water used in damping the transfer sheet **Transfers.** and transfers will be found to go through rather quickly. In damping off therefore, it will be necessary to use rather less water in the sponge, until the actual transferring has been finished, when the ease with which the transfer paper takes in the water will be found quite an advantage.

GELATINE "KEY" TRANSFERS.—In transferring these, they should not be allowed to remain too long in the damping-book, just till the gelatine feels soft and pliable. It must also be kept in **Transferring.** mind that, if over-damped, they will expand considerably, and so cause the outline to be larger than the original **Gelatine** drawing. After transferring, the sheet of gelatine should **Transfers.** peel off from the stone with a gentle pull, without being damped. The transfer will appear as a grey line drawing on the stone. It can now either be gummed and rubbed up a little, or gummed only, or else laid aside without gum for after-preparation by the prover or preparer.

PHOTO-LITHO. TRANSFERS.—To put these on stone properly is a simple operation, but requires care. If the transfer is received from the photographer in a damp state, it will require to be exposed a short time till the gelatine feels firm but not dry; if received in a

* Muslin as bought, is not clean in the sense we refer to; it must be boiled and rinsed afterwards in both hot and cold water, to get rid of every trace of starch or stiffening which is used in its manufacture.

dry state, it will require damping in the usual way. The stone should be almost, if not quite cold. It is necessary that the stone should

be absolutely clean and the surface quite true, as less pressure is required for these than for any other variety

Transferring. of transfers; it should also be even more smoothly polished than for other work. In transferring, very

Photo-Litho. Transfers. light pressure is at first applied, increasing a little each

time it is passed through the press, but at no time must the carriage be difficult to pull through with the hand. It must be kept in mind that the transfer is on a film of soft gelatine, and apt to squash under any extra pressure. As in the case of Gelatine Keys, the sheet, after transferring, should lift and peel off the stone without the application of water. A little damping, after the first few pulls through the press will do no harm, though, as a rule, this is not necessary. After it is transferred it may be treated as indicated for Gelatine Key Transfers.

AUTOGRAPHIC TRANSFERS, as already noticed, are written on plain writing paper, uncoated. These are laid face down on a clean sheet of paper and damped several times on the back with

Transferring. water containing a few drops of nitric acid, just sufficient to give it a sour taste. They are then laid on the stone

Autographic Transfers. and passed through the press, once only, under heavy pressure. The acid in the water combines with the

alkali in the ink, and sets free the grease, which thus more readily combines with the stone when pressed on its surface. These transfers require strengthening, and should therefore always be "rubbed up" after being put on stone.

All transfers should be transferred as soon as possible after being drawn or printed, in order to give the stone the full benefit of all the grease which the transfer ink contains. This grease

Time Transfers will keep. naturally becomes absorbed by the composition on the paper, as well as affected by the atmosphere, so that

within a limited time the transfers are rendered useless; some however, keep longer than others. We therefore give the following as a safe approximation of time that the respective transfers may be kept before transferring.

Type Transfers should certainly be transferred same day as pulled.

Photo-Litho. Transfers should be transferred same day as received.

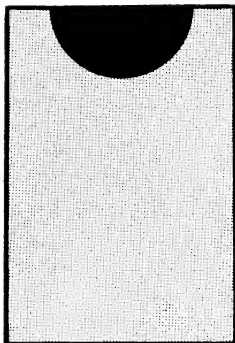

FINE STIPPLE, OPEN.

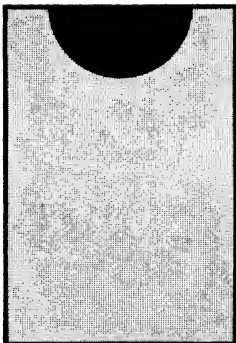

FINE STIPPLE, CLOSE.

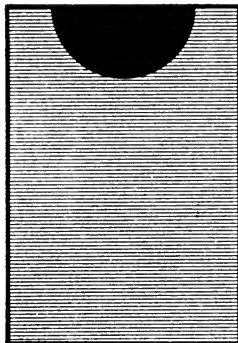

FINE RULING.

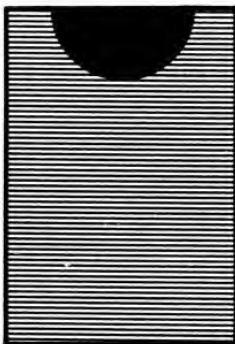

STRONG RULING.

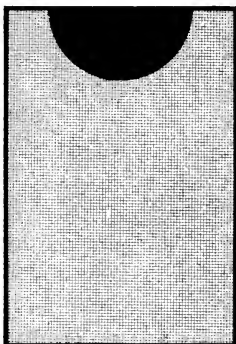

CROSS RULING.

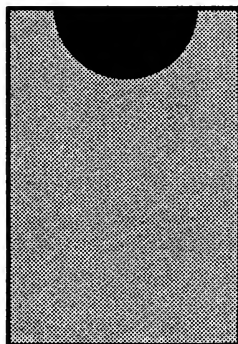

HALF TONE.

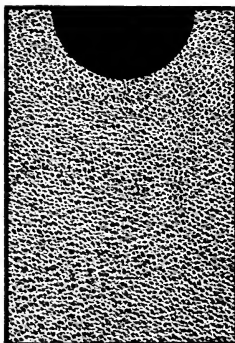

MOROCCO TEXTURE.

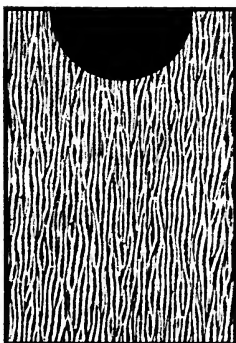

EMBOSSED CLOTH TEXTURE.

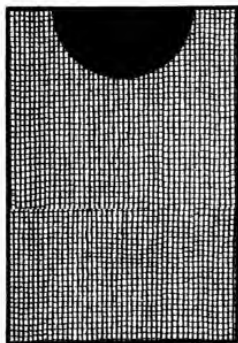

WOVEN TEXTURE.

the same time rubbing it with a perfectly clean sponge. For a third transferring, in addition to repeating the above, a wash with a very weak solution of acetic acid and water should be given. Too much care cannot be taken to ensure the entire removal from the pores of the stone of any particles of composition which it has received from the transfer paper, or any trace of gum from the gumming out. When the stone is washed, the draughtsman again gums round the parts which are to receive the second or third transfers. It is then slightly warmed and the stipple transferred in the usual way.

PLATE III. shows a variety of these ruled and stippled plates.

PLATE IV. shows the same printed in a colour; the semi-circle at the top of each specimen will show the contrast between solid ink work and the half-tone ruling or stipple.

PLATE V. shows the practical use of ruled and stipple plates for map work. The three colours are shown separately and combined, producing in the finished map seven distinct colours, viz., yellow, pink, blue, brown, green, purple, and a neutral grey; the last is obtained by using the three primary tints on the top of one another.



FINE STIPPLE, OPEN.

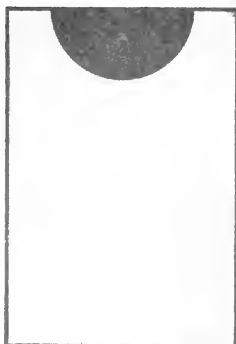

FINE STIPPLE, CLOSE.

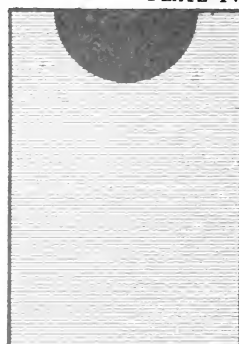

FINE RULING.

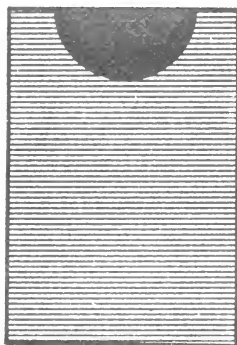

STRONG RULING.

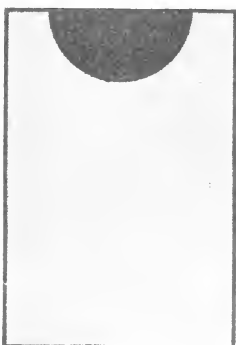

CROSS RULING.

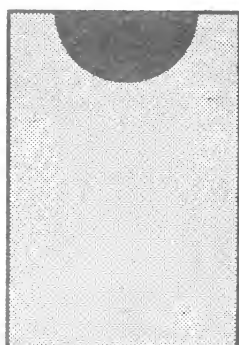

HALF TONE.

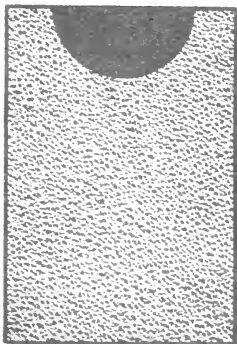

MOROCCO TEXTURE.

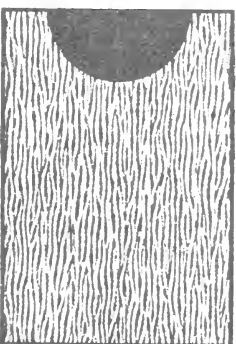

EMBOSSED CLOTH TEXTURE.

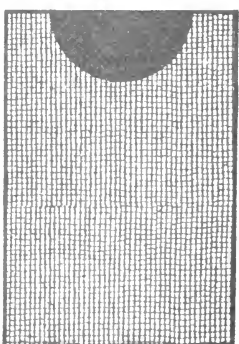

WOVEN TEXTURE.





FINE STIPPLE, OPEN.

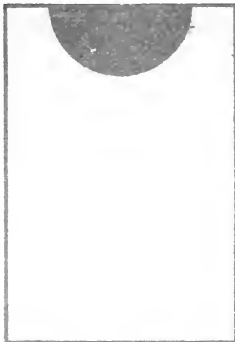

FINE STIPPLE, CLOSE.

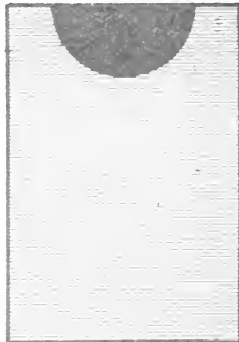

FINE RULING.

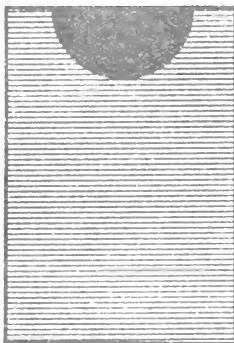

STRONG RULING.



CROSS RULING.

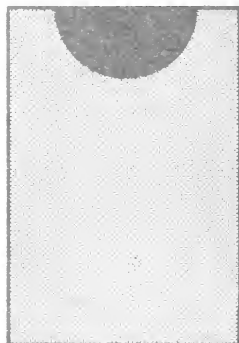

HALF TONE.

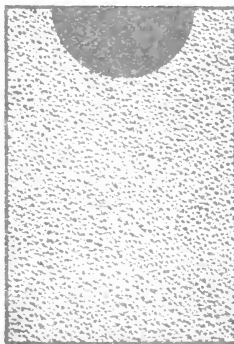

MOROCCO TEXTURE.

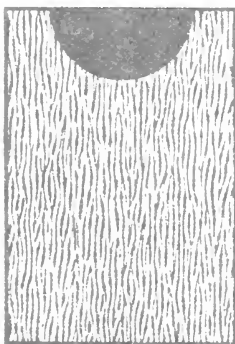

EMBOSSED CLOTH TEXTURE.

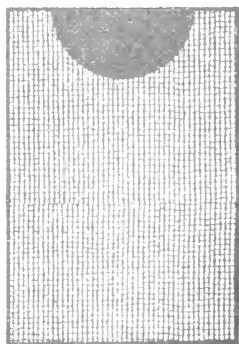

WOVEN TEXTURE.

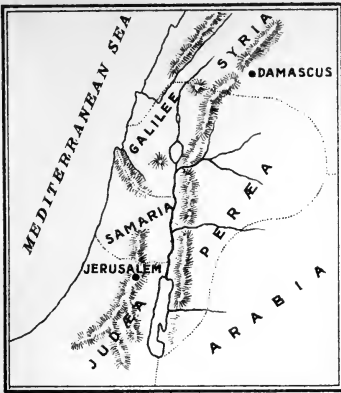

BLACK.

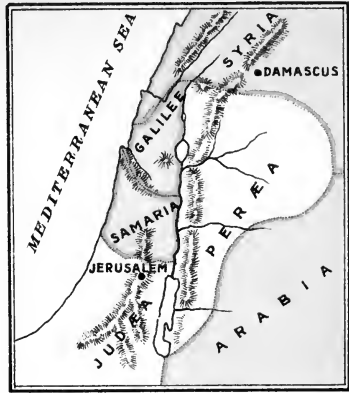

YELLOW.



YELLOW and PINK together.



PINK.



YELLOW, PINK, and BLUE together
(seven colours from three).



BLUE.

Chapter XI.

PREPARATION OF STONES FOR PRINTING.

PREPARATION or PREPARING is the technical term for making ready for printing work which has previously been drawn on or transferred to stone. Although the process is much the same in all cases, it will be better to take the work progressively, much in the same order as we have already considered transfers and transferring, noticing as we go along any difference in treatment which may be necessary.

Before proceeding to describe the *modus operandi* in detail, a few observations on the work itself may not be out of place. A good deal of ignorance and some difference of opinion exists "Preparing," as to what "preparing" the stone really consists in. Some parts of the operations are mechanical, about what it is. which there can be no difference of opinion. But in regard to the chemical action of the substances employed, no one appears able to give a clear and explicit explanation. The different stages of this important part of the process may first be given:—

1. While the stone is still clean, *i.e.*, without having been touched with gum sponge or damping cloth, any broken lines to be completed, or additions to be made, are attended to by the draughtsman. *See 4 - then 2*
2. The stone receives a coating of gum.
3. The work is charged with printing ink, first by rubbing up, and afterwards by rolling up.
4. The whole stone should receive an etch, using a very weak solution of gum and acid. *nitro - dig of - wash*
5. The stone is "cleaned up," *i.e.*, all dirt, superfluous spots and work, is removed by Ayr-stone or steel scraper. *See 1 - 2 - 3 - 4 - 5 - wash*
6. The work is again rolled up so that every line receives a full charge of ink.

7. After drying the stone, it is dusted over with an acid resist, powdered rosin or asphaltum being used.
8. The stone is again etched, using a stronger solution, which should effervesce slowly when applied.
9. The solution is washed off and a good coating of gum put on and allowed to dry.
10. The preparer may now wash off the gum, wash out the work with turpentine, and roll up, to satisfy himself that the work is right; it is then re-gummed and is ready for printing.

The real object in "preparing" the stone is to give it, in a measure at least, a grease-resisting surface, and it is in regard to this point that there is a lack of definite knowledge. Some men think it is given by the action of the acid, others by the action of the gum, while many do not think about it at all, but go through the whole operation because it is the custom to do so.

It seems quite clear from experience and experiment that acid in itself will not give what is required. Gum solution itself will answer the purpose, but not to the degree required for practical work. Both acid and gum must therefore be used to obtain the grease-resisting surface; not that even they together give all that the printer would be most happy to receive, but they act in the proper direction with more power than any other known substance, and must therefore be used till a better is found.

The true position appears to be this: the nitric acid dissolves a portion of the stone's surface, and thus in a mild way roughens it and opens the pores, so that the gum is allowed more readily to penetrate the stone, and come in contact with a greater number of its molecules than it would do, if the acid had not previously prepared the way. Again, the arabic acid, which forms a constituent part of gum arabic, combines with the carbonate of lime and creates a fine film, which forms the real preparation of the stone for printing. In the process of printing this film becomes less effective, but is renewed day by day in the necessary gumming up of the stone, whenever for any reason the printing is stopped.

**Preparing
Ink
Drawings.**

When the draughtsman has finished his work on stone it is coated or sponged over with a solution of gum and acid, in the same way as grained stones are treated. The solution should barely effervesce on application to the stone. Though not essential, it is better to allow this gum and

acid to dry, which will give the greatest amount of chemical action between the gum and the stone. This coating of gum is then washed off and the drawing washed out with turpentine, after which it is thoroughly rolled up in black, and any dirt or work not required is removed with Ayr-stone or steel scraper. After this it is again rolled up and again etched slightly. It should now be smartly rolled up and gummed over, when it is ready for proving or printing. The rolling up smartly with a spare roller at any time before gumming is important, as it lifts off any superfluous ink, clears the lines, and permits the gum to get close into the work, which will greatly assist in keeping the lines afterwards in a sharp and clear state. If the work is dusted with rosin before the final etching, the direction as to rolling up smartly will not apply. In this case the acid is simply washed off and a good thick coating of gum put over the whole stone, which is then laid aside as ready for printing.

The preparing of grained stone work has already been noticed in the chapter on chalk drawing on stone, pages 81, 82.

After grained paper drawings are transferred they are generally rubbed up by the transferrer, then gummed up and laid aside. To prepare these, the gum is washed off and the work carefully rolled up with a newly-scraped roller and a little good stiff ink. It may now be slightly etched, gummed up, and the gum allowed to dry. The work is then washed out and again carefully rolled up several times till all the work is firmly charged with ink. It is now dusted with rosin, which is rubbed over the entire surface with a piece of wadding, and etched more or less according to the nature of the work. It is then gummed up afresh and laid aside for printing.

A good roller and rather stiff fresh ink, is essential for satisfactory work of this class; to roll up with thin ink is a sure way to ruin the drawing.

Writing and stone transfers are generally first gummed, then inked up with a sparely-charged roller, so that the lines may not thicken. The stone is then cleaned up and again rolled up till it has received a full charge of ink, after which it is dusted with rosin and etched in the usual way.

The composition of plate transfer ink, containing as it does shellac and pitch, makes it the best acid-resisting ink used in lithography. For this reason the work should be able to stand a slight etch

**Preparing
Grained
Paper
Drawings.**

**Preparing
Stone
Transfers.**

before rolling up; this will keep the stone clean and save much time in cleaning up. It may not be safe at all times to do this, and some experience is necessary so that it may not be overdone. This is one of the older methods which were generally founded on the true principles on which lithography is based, and is worthy of attention.

**Preparing
Plate
Transfers.**

After the slight etch just noted, the stone is cleaned, rolled up, dusted with rosin, and etched. If not advisable to etch *before* rolling up, the usual procedure is gone through.

From what has been written above, it will be seen that there is but little variation in the method of cleaning up and preparing work for printing. The result however, may be very different in the hands of a skilful and an unskilful workman. A preparer should have complete knowledge, gained by observation and experience, of the nature and capabilities of the stone as well as of the materials he is working with. The general failing in transferred work is that it thickens, and, when this happens in a number of colours belonging to the same piece of work, the result is easily foreseen; the whole subject is rendered in a coarse and rough manner.

The following conditions in preparing may be mentioned as tending to bring about this inferior quality of transfer work. The ink may be too thin or it may be bad in itself, or the roller may be too heavily charged. The roller may be in a dirty state, requiring to be scraped, or it may be in a half-glazed condition. The rolling up may be too laboured or too long continued. The etching solution may have lost its power from being too long in use. And last, but not least, the preparer may take two or three times longer than is necessary to clean away what is not required. It cannot be too strongly insisted upon that if the work is smartly inked up, cleaned and etched, the result is likely to be the best possible. Nothing thickens and spoils work more frequently, than long continued damping, rubbing and rolling up of the stone, before it is finally etched in rosin.

Chapter XII.

HAND-PRESS PRINTING.

HAVING seen the work transferred to stone and "prepared," it is now time to consider hand-press printing. As this was the only method pursued for sixty or seventy years, and is still the best means of gaining a true practical knowledge of the process, it will be necessary to consider it somewhat in detail.* Hand-press printing, except for very small work, is practically non-existent, but in every litho. establishment of any size there is always a considerable amount of proving, which is most important and is an excellent means of imparting a real knowledge of the business.

The lithographic press has undergone little change since the early days of lithography. It is composed of various parts, and is very simple in construction, as will be seen from the illustration, Fig. 12, which may be noticed shortly in detail.

The Press.

1. There are two side frames of cast iron, A A A, longer or shorter, according to the size of the press. These are bolted together by means of cross-sections, which should make the frame quite rigid.
2. A cross-bar, B, between the uprights of the frame in which the screw works for regulating the pressure.
3. The screw, C C, which regulates the pressure, passes through the cross-bar and carries the scraper box at the bottom. It is turned by means of the cross-key, which is seen at the top of the engraving, and gives more or less pressure as required.

* It is essential that every lad, whether intended for transferrer, preparer, or machineman, should have two or three years training at the hand-press. Nothing will afterwards make up for the want of this practical work. For this reason masters should encourage their foremen to get some work done at the hand-press week by week, if for no other reason, than that the lads should really learn their business.

4. The scraper box, D, is hung from the cross-bar, and being free at each end is self-adjustable to the stone when pressure is applied. The boxwood scraper is kept in position by two or three small screws which are placed at the back of the box.
5. The carriage or bed, E, is made of one solid piece of well-seasoned wood, Plane-tree or mahogany, about $1\frac{1}{2}$ inches thick. There are iron straps on the under side which bear the pressure when working. It is necessary that this wood be planed perfectly true and that it will not warp. On each side of this carriage are runners, consisting of two or more thick blocks of small wheels, or some-long bar of iron screwed to each

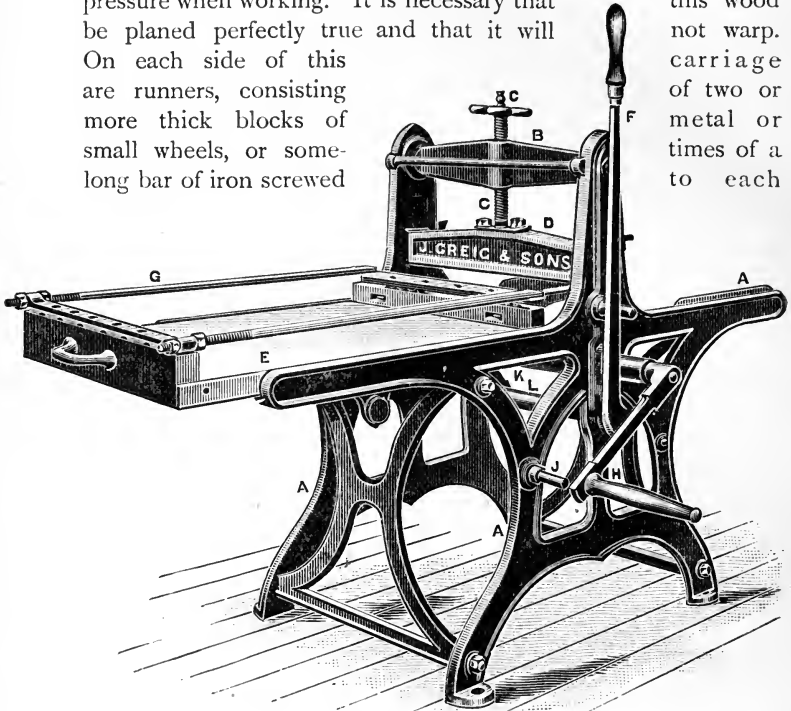

Fig. 12. LITHOGRAPHIC HAND-PRESS.

side of the wooden plank. These runners take the carriage backwards and forwards on the iron rails or flanges which are on the inside of each of the frames. On each end of this carriage is a square block of wood; at one end to receive the tympan hinges, and at the other to act as a rest for the

tympan frame when brought down in printing, as shown in the engraving.

6. The lever, F, is composed of three parts, the handle, the connecting rod, L, underneath the roller, and the oval cams which act immediately under and on the bushes which hold the roller spindles. In working, the upright handle is lowered to a horizontal position and rests on the projecting pin J. This action turns the cams from a horizontal to an upright position; and the carriage, which has previously been pushed into the proper place, is caught between the roller and the wooden scraper, and so receives the pressure required for printing. In large presses there is a lever handle at each side, so that two men may give the pressure required for large stones. For the same reason, the roller is worked by pinion wheels, with a handle at each side, by means of which a great amount of power is obtained with little exertion on the part of the workman.
7. The tympan consists of an iron frame, G, on which is stretched a sheet of cow hide leather and kept under proper tension by means of the plate and screws at either end. To prepare the leather for working, it is first placed in position at the hinge end of the iron frame. A stone is put in the press which must be broader than the breadth of the leather. A scraper the full breadth of the tympan is put in position, the leather is laid down on the stone and pulled through the press several times, under as heavy pressure as can be given by two men pulling together. When the leather is well stretched at the final pull through, the lever is not raised until the loose end of the leather is firmly secured by the plate and screws. Tallow, black lead, with the addition of a little gum are smeared several times over the outside of the leather, which lubricates it, so that the scraper may slide smoothly over with the minimum of friction. When the leather gets slack after being worked a while, it is tightened up by means of the screw nuts on the two ends of the frame. The smooth side of the hide is put on to face the stone, and the grain on the other side must run with the pull, not against it.

8. The handle, H, fixed at the end of the roller, which takes the carriage through the press.
9. The roller, K, which bears the carriage to and fro by means of the handle or handles attached to it. From its position this roller readily catches the grease which falls from the tympan, and if this is allowed to gather, it will cause the carriage to slip instead of being carried right through. This should be avoided by keeping it quite clean with turps. and rubbing it over occasionally with chalk. The use of sand is a drastic remedy and should not be allowed.

The breadth of the carriage gives the size of the press: thus, if the carriage is 18 inches wide, it is called an 18-inch press. The price of new presses is generally about £1 per inch, so that an 18-inch press costs about £18.

For hand-press work, a suitable roller is of the first importance, and its condition should be carefully attended to by the printer.

Hand-Roller. It consists of a turned wooden block, 12 to 15 inches long and about 4 inches in diameter, with slightly tapered spindles at each end. It is covered by two or three plies of flannel and the leather covering is slipped on and tied firmly at each end. The leather covering should be so tightly put on that it will not slip or move in any direction, but, at the same time, the roller should feel rather soft than hard when completed. Two pieces of thick leather are used by the printer as handles, in which the spindles revolve when the roller is being worked. These are shown in the illustration in position for working, Fig. 13.

The leather covering should be of the finest French calf skin, specially prepared for the purpose, and possessing a velvet-like grain.

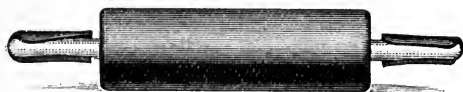

Fig. 13. HAND-PRESS ROLLER.

To prepare new rollers for working, they should first of all receive a good soaking with any ordinary oil. After lying a day or two they are rolled up on

an ink slab with strong varnish; this brings away all the loose particles of leather and at same time opens out the grain, and relieves the roller of a good deal of the oil previously received. This rolling up has to be continued more or less for some days,

scraping away the old and putting on fresh varnish every few hours. Thinner varnish may then be used and the roller gradually worked in for printing. A good plan is to get a boy to damp a stone and work the roller over it till a comparatively smooth grain is obtained. After being rolled for some time the grain assumes a beautiful, regular, and soft appearance, capable of receiving and laying down a perfectly flat film of ink. Rollers are always scraped the smooth way of the grain; should this get too flat or short, a good hard scrape against the grain will improve it, keeping in mind to smooth it back again with the flat of the knife. For preparing work, and printing at hand-press in black, grained rollers must always be used, and for proving colour work, they should be used whenever possible, as they give a much softer and finer result than can be obtained by those having a glazed surface.

Glazed rollers may be bought, or grained rollers may be glazed by coating them two or three times over with a drying ink—umber, mixed with a little driers, being generally used. After coating, they are rolled over a clean, wet stone and laid aside to dry. These are not suitable for grained stones, but commend themselves for ordinary colour work, being so easily washed when changing from one colour to another.

Where there is a considerable amount of colour work to be proved from day to day, there should be a good supply of grained rollers for the primary colours—yellow, red, and blue. Unless these are at hand and kept in a proper condition for printing, much time will be lost and expense incurred in cleaning out for the different tints. At the best, a good deal of this cleaning out is unavoidable.

Having the stone ready and the press and roller in proper order we come now to the actual printing.

For ordinary black work the procedure is comparatively simple.

Hand-Press Printing. In the first place the lay for the sheet is marked off on the stone with a piece of ordinary printer's lead.

If this is done on the damp stone it will leave a line which will not rub away, neither will it take on ink when printing, which it will do if done on a dry stone. If more exact lines are required for register work, they may be scratched in on the stone with a steel point and straight-edge, and if these lines are filled in with ordinary writing ink, very clear and distinct marks will be

obtained for laying the edge of the paper to. For register work these marks must be drawn on the original or key stone, so that when the off-sets are made, they will appear in exact position on each colour stone, to be also scratched in as described above.

Lay and Register Marks.

Another method of hand registering may be noticed here, viz., by means of needles. On all original or key stones there should be crossed lines, thus + at each end of the stone, and these are repeated on each colour stone by the artist, or drawn on the paper if the colours are to be transferred. At the centre of the crossed lines a needle hole is drilled by means of a steel point, in all the stones except the first, noting that the holes must be absolutely at the crossing of the lines.

The needles are made and used in the following manner. Prepare a few pieces of wood to a pencil shape and fix in each a needle, head in, leaving about $1\frac{1}{4}$ inches projecting. The extreme points of the needles should be broken off, and the ends just touched on an oil stone to give them a slightly rounded point. For the first colour the sheets are *laid* on the stone, and the cross lines at each end must in all cases be printed. For the second colour, the sheets are pierced with a needle at the centre of the cross lines at each end. The needle used for piercing should correspond in thickness with the needles to be afterwards used. A holder needle is then put through the sheet at the pierced point at each end, and when the stone is inked, the man and boy each take hold of the sheet and put the point of the needle into the small hole previously drilled into the stone. The sheet is then dropped and the man gently holding it down with one hand to prevent any movement, the needles are withdrawn and laid on the sheet next to be printed. The sheet is then passed through the press, and if the sheet has been properly laid, the cross lines will have printed, so that with the first colour they form but one line. To do this appears very simple but it requires some early training to do it quickly and accurately. Small sheets may be laid down with needles by one man, but larger sheets require two at the operation. For each subsequent printing the process is repeated, except that the sheets being already pierced are ready to receive the needles. This method of registering sheets was adopted for all kinds of colour work before the introduction of the steam machine, and is

still the best means of obtaining good register when proving at the hand-press.

Coming again to the printing, we notice that the gum is washed off, the stone damped with the cloth, and the work, being
Black Printing. generally first washed out with turps., is rolled up; the sheet is then laid on the stone, the tympan sheet placed above it, the tympan lowered, the carriage passed through the press, the impression taken, and so on.

Too much ink on the roller or the ink too thin will give blotchy impressions; too little ink or too little pressure will give grey impressions. Firm regular rolling with moderately stiff ink, along with the proper paper and a fairly good pressure in printing, will give satisfactory copies. Warm weather will require stiffer ink and stronger varnish to be used than in cold winter days. Paper varies so much in surface and quality, that experience alone can teach a man what will be the most suitable ink to use for any particular variety.

For printing chalk work on grained stones, the best possible quality of ink must be used, generally known as "Chalk" ink, and only the finest grained roller is of any use for this class of printing. See notes on printing from grained stones, pages 64-66.

Before the artist can proceed with his part of the process, off-sets and grained blue impressions require to be made at the hand-press.

Off-sets. The former of these are prepared by taking impressions, rather fully charged with ink, from the key stone, on drawing paper, and dusting them over with powdered lamp black. The object in dusting is to give an impression on the clean stone, which may be afterwards wiped off without any risk of the ink adhering to its surface. For stipple work, the off-set stones are taken to the artist room, where they are filled in with ink so far as solid colour is required, then stippled to various depths for the lighter tints. For shading and transferred mediums, the stones are gummed out as required by the artist, and afterwards treated with the medium or sent to the printing-room for transferring the required stipple or ruling.

For grained paper drawings for colour work, the off-set stones are kept in the printing-room, ready to receive the transfers when drawn by the artist. Some gumming out may be done on stone before transferring these, when there is any advantage to be gained in doing so.

For grained stone work, the stones must be grained before the off-sets are made, after which the entire work is done by the artist.

If the subject is to be drawn on grained paper, blue impressions are required, as already noted at page 62. One blue impression is required for each colour, except, as sometimes is the case, it is easier to fill in one or two on the stone with ink. The gold stone is always filled in thus.

The paper used for blue impressions is transfer paper No. 2, prepared for the purpose, and must be damped as much **Blue Impressions.** as possible before printing, so that, after being drawn upon, it may be damped again for transferring without altering the size of the key impression.

It is very necessary that the blue ink used should have a good proportion of flake white and driers in its composition, so that it may contain the minimum of grease and the maximum of drying power. One of the difficulties met with in transferring and preparing these grained papers is, that the key lines so readily transfer along with the drawing, and cause great trouble and also danger to the work proper. For this reason the blue prints should be as free from grease, and should dry as quickly and as hard as possible.

The blue impressions, after being pulled, should lie for a night. They must again be damped to receive the granular surface, which is obtained by being passed through the copper-plate press on suitably grained copper or zinc plates.

One of the most important points in regard to these blue impressions is, that they should be when being transferred to stone, exactly the same size as they were when printed from the key stone. If smaller or larger, then, of course, the colours drawn on them will be out of register and spoil the work. This danger may be more apparent when it is stated that the sheets are first damped to print the blue impression, then dried, then damped to receive the grain from the copper-plate, then again dried; then a third time they are damped for transferring to stone. The hand-press printer should see that the paper for all the blue impressions for one job, is cut at one time and in one way only, out of the sheets of transfer paper. This will go a long way to help matters, and if he can say from looking at the paper, which direction it will stretch most, and make the narrow way of the prints coincide with that, it will help very

materially to obtain accurate register throughout the whole series of colours.

In proving colour work the lighter and opaque yellow tints are printed first in order, as—1, buff; 2, yellow; 3, pink; 4, light blue; 5, light gray; then the stronger colours, as—6, red; 7, dark blue; 8, brown; 9, drawing stone; and lastly, the darker gray, which will tone the picture and give the shadows. The light gray may sometimes with advantage, be printed after the red and dark blue.

The colours should not be too rapidly printed after each other, if the subject is in ten colours, the proving should be spread over several days.

The best working condition or strength of a coloured ink for hand-press printing, for stronger ink is, that it freely leaves the roller and adheres to the stone when a little steady pressure is brought to bear while rolling up; for tints mostly composed of varnish, when the same result is obtained without pressure beyond the weight of the roller itself. The latter point is most important, as no smooth and regular tint will be obtained on paper without very special attention being paid to the manner of rolling. The roller charged with tinting ink should be smoothly and steadily run from one end of the stone to the other. It will be found quite easy to give the same number of roller runs for each impression by mentally counting for the first few. There seems to be a special art in rolling or inking in the stone for colour, tint, and chalk work, which can scarcely be explained, but is essential for the best work. It might be best conveyed to the mind by the word light-handedness.

If the prints have a marled appearance there is too much ink or varnish being used, and the slab must be scraped or washed up. There should just be sufficient ink on the roller to print the stipple dots or chalking sharp and clear, not running together.

Tinting ink should have a small proportion of mid varnish (more in summer than in winter), which will keep the work in good order and the stone free from grease. Too much mid or strong varnish will have the effect of making the printing rough and of a dirty appearance.

✓ Hand-press printing is carried through with much less ink on the roller than is required for machine work. The proofs therefore have generally a softer appearance than machine-printed copies.

As each colour is proved, the ink must be washed off the stone with turpentine and the work inked up with a black roller. A slight wash over with a very weak solution of acid water and gum will put the work in good condition for gumming up and laying past. If the stone is to be kept for any length of time before being printed, it should be dusted over with rosin previous to the slight etch.

In proving chromo work, the printer receives from the artist a wash of each colour required. This wash should represent the strongest tone that is required in the reproduction. The printer brings his ink as near to that tone as possible and submits a proof. The artist will compare this with the original drawing, and, if correct, initial the proof for press. The printer must always keep this proof before him so that he may compare the prints with it as he goes along.

As there may be from ten to fifteen or more colours required to produce a certain result, it will be apparent how careful the artist must be that each printing gives its proper quota of tone and form to the whole drawing, and it is equally important that the printer gives the necessary and same strength of colour to each print.

When proving, it is necessary to keep an impression of each colour on sheets of the same paper as is being used, noting on each the different inks used in producing the required tone of colour. When possible, a progressive set of proofs will be found very helpful, *i.e.*, one sheet with the first colour alone, another sheet with the first and second colours, another with the first, second, and third colours, and so on; as many copies, each in a different stage, as there are colours to be printed. These are of course, in addition to the single impressions of each colour, which are absolutely necessary as a guide in machine printing.

Chapter XIII.

MACHINE CONSTRUCTION.

THE advent of the cylinder machine quite revolutionised lithographic printing. It also at the same time, by practically putting an end to hand-press printing, destroyed to a large extent the means, which in the best possible way, gave to apprentices and men practical training, and a true insight into the principles and possibilities of an art, which requires very special care and effort if good results are to be obtained. The machine however, has created a vast field of work for itself, which would never have been thought of in connection with hand-press printing. The work produced by the machine is often of a very high standard, and reflects great credit on artist and printer alike. To reach and maintain this high standard of excellence it is necessary, among other things, that the printer should become well acquainted with the complicated machine which is under his control from day to day. Its construction therefore will claim our first attention.

In the building of machines there are three primary principles brought into play, by means of which, we are told by those who have studied the subject, all the various motions are produced whether they be simple or complex. These are:—1, the lever; 2, the pulley; 3, the inclined plane. Besides these there are other three which may be called secondary principles, viz.:—4, wheel and axle; 5, the wedge; 6, the screw. Thus there are six principles which govern the construction of every kind of machine, including that one with which we are now more immediately concerned.

The word Machine is derived from a Greek term *Mēchanē* which means contrivance, a word that conveys in a very beautiful and striking manner the true idea of a machine; a contrivance to attain a certain end.

The principles just mentioned, which govern the construction of machines, we must leave with the reader, as it is not possible to enter further into their consideration in a work of this sort. We would only state that the best machines of every description, are those which are most simple in their construction and most direct in their motions. In confirmation of this, it is worthy of note, that nearly all real improvements in the construction of machines are on the lines of greater simplicity and fewer working parts, thus following the laws of nature, which take the most simple and direct means to obtain the greatest possible result.

In the lithographic machine there are seven principal parts or combination of parts.

- | | |
|---|--|
| Parts of
Lithographic
Machine. | 1. The frame. |
| | 2. The carriage or bed to carry the stone. |
| | 3. The cylinder to give the impression. |
| | 4. The driving gear. |
| | 5. The inking apparatus. |
| | 6. The laying in and taking off apparatus. |
| | 7. The damping apparatus. |

These we will notice shortly in their order.

The frame is the part first put together; it consists of two sides, each of one casting, with cross sections or stays and the centre bearer. These are firmly bolted together and should then be perfectly rigid in order to ensure solidity and steadiness when running. For the same reason, the machine-room, if possible, should be on the ground floor, which should be concrete. The tops of the sides and all the bearing parts are planed perfectly true; the former when placed in position, must also be perfectly level from end to end when tested with the spirit-level.

The frame must be set at a right angle to the driving or counter shaft; if great care is not exercised on this point it will cause endless trouble in working. In other words the driving shaft of the machine should be dead parallel to the main shaft of the printing-room.

On the two cross sections and centre bearer are laid two long rails, which are firmly bolted down to prevent any possible longitudinal movement when the machine is running full speed. On these rails are put a number of wheels or runners, which bear up and take the carriage backwards and forwards. These are kept in relative position

by a connecting bar on the side of each set, which in turn are connected with the driving wheel or wheels which run with, and underneath the bed.

The two large driving wheels, driving shaft, connecting rod, and fly wheel are next placed in position.

The connecting rod between the centre wheel and the two large driving wheels is fixed by means of an eccentric pin, which, by being turned round, gives the power of lengthening or shortening the stroke or travel of the carriage. Another method of doing this in some machines is by means of a screw at the end of the connecting rod. This is an important point, for on its careful adjustment depends very largely the smooth running of the machine; when out of order the carriage will go to either end with a hard thump, which, if allowed to continue, may cause serious damage both to the machine and the work it is performing. A skilful machineman should be able to grasp this point and make the adjustment himself when it is out of order.

The carriage is now placed in position, the bed or bottom of which is made of one strong movable iron plate, planed quite true on its upper sur-

face to receive the stone; on the underside of this plate are cast four wedges, one at each corner,

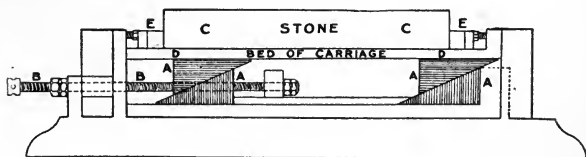

Fig. 14. SHEWING WEDGE ARRANGEMENT FOR RAISING AND LOWERING THE STONE.

corresponding wedges underneath. To these latter wedges are attached two long screw rods which are worked from the front of the machine, and give power to raise or lower the bed to meet the different thicknesses of stones. When the under wedges are screwed back, the plate with the stone is lowered; when brought forward it is raised. This will be more clearly seen from the illustration, Fig. 14.

1. A A A A are the wedges which are at each side of the carriage.
2. B B, one of the screw rods. As will be seen from the outer end it is worked with a tommy-key, and the binding nuts may be seen close to the face of machine. At the other end

the rod passes through an iron block which takes with it the two wedges when the screw is turned.

3. C C, the stone resting on the iron bed of the carriage D D.
4. E E, wooden blocks screwed against the stone to keep it in position and immovable when printing.

The cylinder is next put in its place, the pressure screws, or (as in Furnival machines) the levers, are fixed and the various other accessory parts such as springs, checks, etc., put in position.

The cylinder should not, although occasionally defective in this point, have the slightest indication of yielding in the centre when taking the impression from the stone. To avoid any such fault it is necessarily made very strong and of great weight, the cylinder for a quad. crown machine weighing about a ton.

The great difficulty experienced at first in machine printing was that of getting sufficient pressure. It was thought by those who were accustomed to hand-press work that this was insurmountable, and they had very good reason for believing so. In the first place there is naturally no raised surface in lithographic work on stone; the pressure therefore when printing bears not only on the work itself, but right along the stone on the line of cylinder contact. In hand-press printing the sharp bevelled edge of the wooden scraper, combined with the immense power exerted on it by the lever, gave an enormous pressure on the stone, and it required means to obtain a corresponding pressure in the steam machine, before litho. printing could be satisfactorily obtained from it.

After many trials and a great number of experiments, various adaptations were found necessary, and these coming gradually into operation gave the conditions required for good practical printing. These conditions are—

1. A heavy cylinder ground dead true on its surface and braced internally to give perfect solidity.
2. The stone ground and polished perfectly true or level to meet the corresponding face of the printing cylinder.
3. Powerful springs or levers to give additional weight or resisting power to the cylinder.
4. The paper for printing made as smooth as possible, so that its entire surface may come in contact with the stone when pressure is applied.

5. The work on stone etched very slightly in relief, not more than the thickness of a sheet of paper.

With these conditions carefully attended to, the question of pressure in lithographic printing was solved, and attention to them in daily work will go far to make machine printing both pleasant and profitable.

Coming again to the cylinder we notice that it gives the impression and is therefore an important part of the machine. There are two methods of obtaining the required pressure, viz. :—By means of powerful springs on each side bearing on the cylinder bushes by means of screws, as shown in Fig. 15, or by means of powerful levers at each side of the machine, bearing heavy weights at the end of each arm, as shown in Fig. 16.

Both methods appear to work well and give the required power. Messrs Furnival & Co. have from the first adopted the lever principle, and have continued it right on, which fact bears the strongest testimony to its practical usefulness. Most of the machines used in the Royal Ordnance Survey

Printing Office, Southampton, are of this type, and were supplied by Messrs Furnival & Co. All other British firms abide by the former method in obtaining the desired end.

Fig. 15 shows the application of the spring arrangement, and the different parts are indicated as follows :—

1. A, shows spring in position.
2. B B, screws which hold down the resistance plate.
3. C C, the brass bushes in which the cylinder shaft, F, turns.
4. E, shows the division of the bush into two halves, the upper and the lower.
5. D, regulating screw.

With the spring arrangement, when the stone passes underneath the

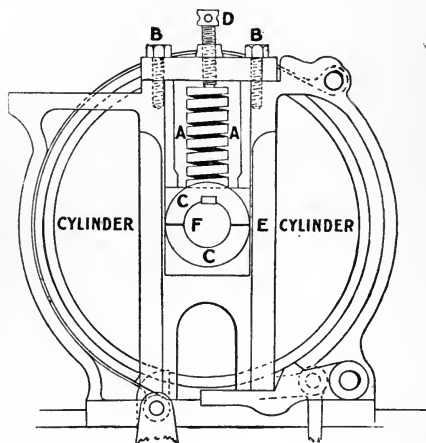

Fig. 15. SHOWING SPRING ARRANGEMENT FOR OBTAINING PRESSURE.

cylinder, the latter is raised just as much as the upper part of the bush is shown to be raised from the under part at the point E in Fig. 15. This should not exceed one-sixteenth of an inch. An increase of pressure may be obtained by causing the stone to raise the cylinder a little more, but this is not advisable. If circumstances

really make it necessary to have more pressure, it may be obtained by pressing down the spring to a greater degree of tension by means of the screw D. In some later machines of a large size there are two springs at each side which give a much greater resisting power.

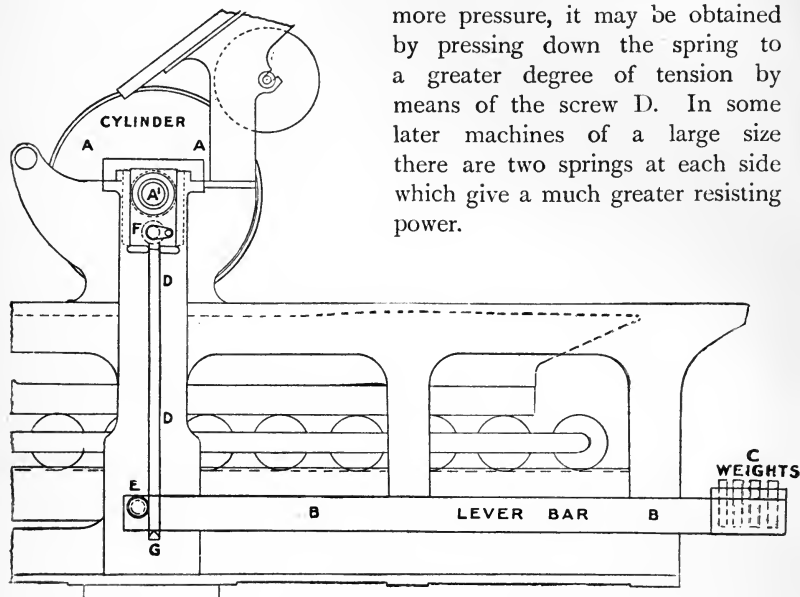

Fig. 16. SHOWING LEVER ARRANGEMENT IN FURNIVAL MACHINE FOR OBTAINING PRESSURE.

The lever arrangement is very clearly shown in the above illustration, and the parts are indicated as follows:—

1. A, cylinder.
2. B B, lever bar or arm.
3. C, lever weights.
4. D, upright rod connecting the cylinder bush and the lever bar.
5. E, fulcrum.
6. F, cylinder bush (not divided), which carries the cylinder shaft A'.
7. G, point where the force or power is applied to raise the lever bar and weights.

In the lever arrangement it will be quite apparent that immense power is required to raise the weights at the end of the lever bars, when the power or force is applied at the least possible distance from the fulcrum, shown as between the points E and G in the illustration.

In a quad crown machine the pressure obtained by means of two lever bars, $5\frac{1}{2}$ feet long, with 130 lb. weight at the end of each, is about 7 tons. If an additional weight of 25 lbs. be put on the end of each bar this will give about 1 ton more pressure to the cylinder; when the weight of the cylinder is added there will be a pressure of about 9 or 10 tons along the line of contact between the stone and the cylinder as it revolves.

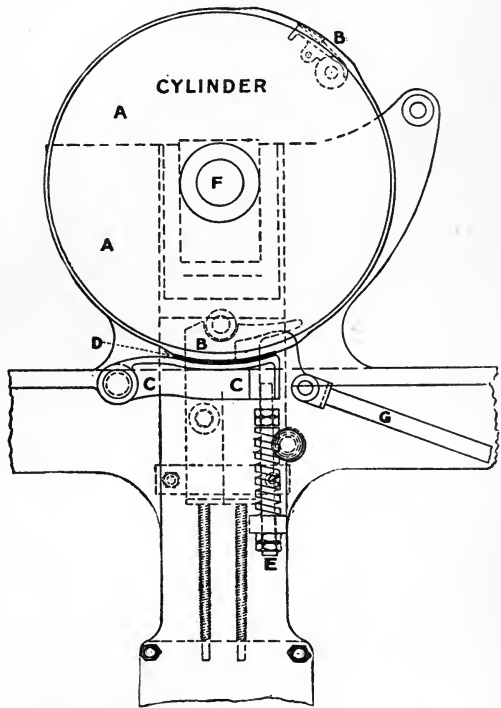

Fig. 17. FURNIVAL BRAKE.

The rising of the weights at the end of the lever bars, when the stone passes under the cylinder, indicates that the pressure is on. They should not rise to any extent, as if raised one inch, which would be dangerous, it will make little difference in the pressure to that obtained when the lift is normal, say $\frac{1}{4}$ of an inch.

In connection with the cylinder we have to consider the cylinder brake, which is intended to govern its movement when in two positions.

1. When, after receiving the sheet, it is about to take the stone, the brake operates and draws the cylinder tightly up, so that there may be no play in the movement to cause mis-register.

2. As the cylinder comes home after the revolution, the brake again draws it up tightly and prevents it coming into its stationary position with a bang.

There are several forms in use, all of which answer the purpose very well. Three of these are illustrated in the following diagrams.

Fig. 17 (page 121) shows the simple and effective brake used with the Furnival machine.

1. A A, the cylinder.
2. B B, two bulged parts on the cylinder wheel.
3. C C, brake shoe.
4. D, leather facing of shoe.
5. E, pressure spring and regulating nuts.
6. F, cylinder shaft.
7. G, cylinder push rod.

It will be seen from the diagram that the wheel A will run free from the brake, until the bulged parts come round, when the drag will come into operation and hold the cylinder tightly back at the two positions mentioned above. When *nearly* brought home the push rod comes into play and sends the cylinder into its proper place. Thus, between the brake and the push rod, the cylinder of any machine should be brought smoothly and silently into its stationary position to receive the next sheet. The shoe is faced with thick leather,

which is shown by the black line D, and is made to bear more or less pressure by means of the spring and regulating nuts, E.

Fig. 18 shows a brake working on a different principle.

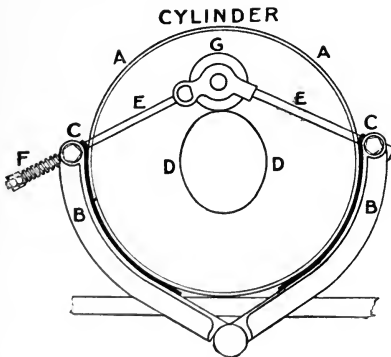

Fig. 18. SHOWING BRAKE USED ON MANN'S MACHINE.

For this brake there are no bulges on the cylinder wheel. The shoe is in two parts, and by means of the cam, D, raising the

1. A A, the cylinder.
2. B B, brake shoe.
3. C C, leather facing of shoe.
4. D D, cam.
5. E E, connecting rods.
6. F, regulating spring and nuts.
7. G, pressure wheel

pressure wheel, G, it is made to grip the cylinder wheel at two points, corresponding with the position of the bulges on the previous illustration, thus attaining the same end by a different arrangement. More or less brake power is given by means of the regulating spring and nuts, F.

Fig. 19 shows a brake with different mechanism, but working on the same principle as that shown in Fig. 18.

1. A A, the cylinder.
2. B B, brake shoe.
3. C, connecting bar.
4. D, pressure rod worked by a cam which is not shown.
5. E, regulating screw and nuts.
6. Leather facing of shoe shown by black semi-circular line.

It will be seen that the shoe embraces about one half of the cylinder wheel, and is made to grip it at the necessary points by means of the forward movement

of the rod D. The pressure is regulated in this instance by the screw and regulating nuts, E, at the end of the rod, D.*

The section of the machine which now calls for attention is the inking apparatus, which consists of various parts, viz. :—the Duct, Duct Roller, Feed Roller, Ink Slab, Distributing Rollers, Inking Rollers, Roller Forks, Riders, and Ink Regulator.

The ink duct is placed in a convenient position at the back of the machine, and is made up of two parts, the revolving roller and the knife. The supply of ink is regulated by means of a series of

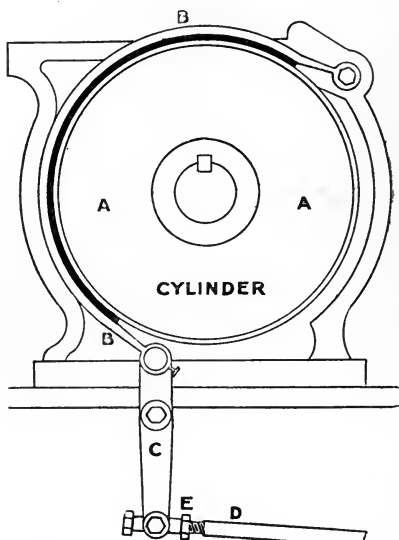

Fig. 19. SHOWING BRAKE ON RATCLIFF'S MACHINE.

* Drawings to illustrate this section on Machine Construction have been kindly furnished by Messrs Furnival & Co. and Messrs Ratcliff & Sons. These have been reproduced in a more diagrammatic form, in order to make the special points more clear to the younger minds.

screws, which are made to act on the knife from behind; when these are tightened or slackened, the space between the roller and the knife is contracted or opened, and this allows a flow of ink more or less as required.

The roller in the ink duct is made to revolve continuously or intermittently by means of a ratchet wheel and check at the side, which still further regulates the supply of ink. The feed roller, rising and falling automatically, receives a supply of ink from the duct roller and gives it to the ink slab, which is fixed to the carriage of the machine and travels with it backwards and forwards.

The distributing rollers are placed at an angle across the machine so that they may spread the ink as much as possible on the slab as it passes underneath. These rollers have ordinary glazed skin coverings, which are easily washed when a change of colour is required.

From the slab the inking rollers take their supply of ink and in turn give it to the stone. These inking rollers also have a lateral motion, which is obtained by their being placed at a slight angle across the machine; or, as in the case of Mann's type of machine, by a sleeve and socket arrangement, the spindles of each roller working in a "sleeve," which in itself has no lateral motion. This is an excellent arrangement and gives good results in inking.

The roller forks are placed at each side of the machine, standing upright from the top of the frames, and are movable. By shifting them so that they are not directly opposite each other the angled position referred to above is obtained.

A very clever and useful arrangement has lately been added to both letterpress and lithographic machines by means of which the supply of ink from the duct is stopped whenever the cylinder is checked, so that when one sheet is missed the next does not get a double supply of ink although it gets a double rolling. Those who may be ordering new machines should see that this accessory arrangement is included.

The portions of the machine still to be put in position include the Damping Apparatus, Lay Guides, Flyers, and Tables. All these require careful adjustment by the engineer, and should also be thoroughly understood by the machineman.

There are several automatic arrangements for damping the stone, but all work on much the same principle. They consist of a narrow

water trough the breadth of the machine, with a revolving brass roller inside. By simple mechanical methods the water is regulated and conveyed to the damping table as it passes underneath with each revolution of the machine.

Movable guides should be fitted to every machine, as they are absolutely necessary for obtaining accurate register. They should be tested when the machine is fitted up, by running a few sheets through several times, when, lines repeatedly printed should have no appearance of doubling.

Further consideration will be given to various points which arise in the course of working a machine when we come to notice Machine Management and Machine Printing, but before passing from this section one point should be carefully attended to by every machine-man, viz., that it is of the utmost importance that a new machine, for the first few weeks, should receive abundance of oil. All the bearings are then raw and easily fired. After a little working they take on what may be called a skin, and will run for a considerable time even if neglected, but this they will not do if neglected at the beginning of their career.

Chapter XIV.

MACHINE MANAGEMENT.

IT is quite evident that before a man can be entrusted to drive a locomotive he must understand its working parts, since he is entirely on his own responsibility while on the road. It is also evident that the more thoroughly he understands the details of his engine the more trustworthy he will be.

Litho. printers are now supposed to have some little knowledge of mechanics and engineering, in addition to their own particular line of business; and although they are, as a rule, not entirely put upon their own resources, as in the case of the above mentioned driver, it is very important that they should understand the principle and construction of the machine which they have charge of from day to day. In the previous chapter we have considered in a simple way how the machine is put together, and in continuation of the subject, Machine Management will now claim our attention.

A litho. printing machine is a valuable tool, costing from £150 to £400, according to size and quality. It requires, therefore, a due sense of responsibility before any one is able to manage it to the best advantage.

The first requisite we would notice as necessary for a machineman, is method in working. Some people always take hold of the wrong end of the poker and so get their hands blackened to no purpose. Without method in the head and order through the hands, there is sure to be endless trouble and worry to the worker, as well as needless waste and expense to the master.

In starting a new machine, or even an old one in a different workshop, it is well to see that all the oil vents are clear and that each part receives a proper amount of lubricant. New machines, as already stated, should be well oiled several times a day for two or

three weeks; by that time the risk of firing or injuring the journals and bearings will have been reduced to a minimum. Having attended to this essential part of the day's work, the mind is so far relieved from duty, and is free to act in another direction. In connection with the use of the oil-can it is worthy of notice that there are some parts which are *not* to be oiled, but are very apt to get a share of what is going, these are the brake, cams, and smaller wheels, which are meant to work by friction, the one against the other with each revolution of the machine. The axles of these require oil, and the difficulty is to prevent the oil getting on the parts where it is not required.

The next point in order will be to see that the blanket on the cylinder is the proper size and in a proper state to print the prospective job. If that is right, then another item requires no further thought and may be left to take care of itself.

The stone may now be placed in the machine. One man will level it, and then block up gently, so that it may be readily adjusted if alteration of set is required. Another man who has no method will screw it up till you imagine he is screwing himself out of joint, only to find when the first sheet goes through that it is all wrong, and requires to be unscrewed again; this time he leaves it far too loose and the stone shifts, then he screws the machine and himself up again, and so on and on he flounders with his register work, tiring and irritating himself, driving his layer-on into a nervous state, and causing the overseer to tremble for the result. Do *not* thou likewise, but with an orderly mind and a firm hand do one thing at a time, carefully and correctly, so that there may be no going back on that particular action. In this way the mind will be at ease and free to proceed with the next item of preparation.

The ink should now be mixed and a portion spread on the distributing rollers for a proof. The ink should not be put into the duct till a proof is passed for colour. A good impression is the object to be attained by each machineman, so all previous efforts must lead up to this point. Each step ought to be carefully and quietly finished in order that the final operations may be successfully carried out and a good proof taken, and equally good prints worked off afterwards.

The rate of printing is particularly a part of machine management. No master who desires good work will insist on the machine being always run at its highest speed. At the same time it will generally

do its work as well, if not better, at 900 or 1000 an hour as at 600 or 700. The machineman should act accordingly, not forgetting that quality should always be the first consideration. In connection with speed, the belts have an important bearing. If too slack great waste of time and power will ensue; if too tight there may be danger of heating the bearings. A machineman should be able to keep his belts in a proper state and at a proper tension.

Good management does not stop at the length and breadth of the machine, but will be seen in all its surroundings. "A place for everything and everything in its place" should be engraved in the head if not in the heart of every man who is entrusted to look after a litho. machine. The result will be that his place is clean and tidy and the machine itself shining, which should be a continual pleasure both to himself and those around him.

A machineman above all, requires to be quick in thought and active in body. This implies a certain amount of nerve, but not nervousness. A machine runs at such a rate, that unless the man in charge can both think and act very quickly, work may be spoiled or damage done, before he can collect his thoughts as to what he should do to prevent it.

There are a few things in connection with the machine itself, which require special attention, in order that the work may be turned out in a satisfactory manner.

Machines coming direct from the engineer's workshop are generally quite reliable as far as construction is concerned, but those parts which are in constant use are more liable through tear and wear to get soon out of order, and will require attention on the part of the man in charge. These parts are the inking rollers and duct, the damping apparatus, the gripper and lay guides, and the brake, each of which may be noticed shortly.

It was an axiom in the days of hand-press printing that good rollers meant nearly everything in the production of the best work.

Machine Rollers. This still holds good in regard to machines, for unless the rollers are kept in a proper condition it is vain to expect the best work. Rollers then should not be hard but in a state that will yield to the firm pressure of the finger on their surface. If hard, they should at once be taken down and re-flannelled, keeping in mind that two plies put on easily are much

better than forcing the skin over three or four plies to form a hard unyielding surface. Smooth rollers, with ordinary working, soon take on a glassy surface, which is very detrimental to good printing. To remove this fault, they may be scrubbed with pumice stone and turps., or washed with carboric and turps., or a solution of caustic-soda, gently using, at the same time, the pumice stone or wire brush, and scraping afterwards. If carboric is used, the rollers must afterwards be thoroughly washed with turpentine and scraped; if caustic-soda, they are washed with water and scraped several times, so that no trace of the soda may remain to harm the work on stone. The result from this operation should be a dull matt surface, showing in a very slight degree the natural grain of the leather. A roller in this condition will receive a good charge of ink, and part with it readily and smoothly when rolling over the stone.

Inking power is an important part in the work of a machine, and good management will be apparent when the machineman regulates the number of rollers which he has at his command to the requirements of the work in hand. Some trifling job may print quite well with two, but, generally, the more rollers that can be used the better will be the printing.

The Ink Duct requires careful attention in colour printing. The knife should have a true bearing on the duct roller along its entire length, and the feed roller underneath should be as soft as possible, so that its surface may press gently against and receive an equal supply of ink from the duct roller, which is necessarily iron. Letterpress composition makes an excellent feed roller, and, when possible, should be adopted for colour work. With the knife carefully adjusted by means of the set screws at the back of the duct, and the feed roller in good order, it is possible to go on a whole day, keeping the printing of the sheets absolutely regular in colour. This is of great assistance to the machineman and should enable him to give all the more attention to his other duties.

An Automatic Damping Apparatus is a necessity for the best class of work, as it ensures a steady and equal supply of water all day long. The damping table and rollers must be kept quite soft so that they may receive and give up the water in a kindly way. They should be washed and scraped as often as necessary, especially when changing from one

colour to another. It is quite evident, that with running backwards and forwards over the stone several thousand times a day, they will gather a large amount of dirt and scum, which will have a very detrimental effect on the printing, unless cleared away. To obtain pure colour, it is essential that there should be a clean damping table and clean damping rollers.

The Gripper should take the sheet evenly from end to end, and the tongues should be a shade lower towards the centre. Should they happen to be the opposite way, higher towards the centre, accurate register will never be obtained. In this case, the edge of the sheet will actually be resting on a convex surface, and will topple either to the one end or the other when laid in. The same thing will happen if the tongues of the gripper are in a dead straight line and the sheets happen to have a convex edge. The safest condition, as noted above, is to have the tongues of the gripper in a very slightly concave position the one to the other. The paper will then rest more at the ends than in the centre, unless the edge of the paper is convex, in which case it will coincide exactly with the whole range of the tongues. Experience in this important matter should soon come to an intelligent workman.

The gripper should never strike the edge of the stone. Each machineman should have the means of knowing and taking the proper amount of grip, so that such accidents as spoiling the gripper plate or tongues, damaging the stone, or cutting the paper should never happen. The fact that they do happen is evidence of careless machine management.

The lay-guide should be a matter of constant interest and care to the machineman, as on its proper working depends to a large extent accurate register. Machines have generally movable guides, which, acting at the instant, previous to the shutting of the gripper, move the sheet to a certain point. It should move both freely and smoothly, and there should just be sufficient space between the tongue of the guide and the feed-board to allow a thick cardboard to pass easily; if there is too much space, the sheets are apt to turn up at the edge at the point of contact. The condition of the guide face also requires close attention. With the sharp edge of paper working on it for weeks and months, cuts are formed in which the paper naturally runs, but at times the sheet may not go

into the cut and a mis-register takes place. To avoid this, the guide should be examined periodically and the face filed smoothly down when such cuts exist.

The Cylinder Brake or Drag will require regulating according to the work in hand and the speed of the machine. The **Brake.** heating of the brake wheel will not matter a great deal, if it does not extend to the cylinder axle and bushes.

In regard to the other parts of the machine it need only be said that they should receive careful attention day by day. Good management will be apparent in every detail connected with the working of the machine itself, as well as in the quality and appearance of the work turned out; specially will it be apparent when it foresees what will be the effect of anything out of place or out of order, and avoids that result by getting the thing that is wrong put right at once.

Chapter XV.

MACHINE PRINTING.

THIS chapter will naturally divide itself into several sections, such as :—

1. BLACK PRINTING, which embraces commercial work, maps, plans, copy books, etc.
2. SOLID COLOUR WORK, required for show-cards, posters, advertising sheets, labels, etc.
3. CHROMO or TINT COLOUR WORK, required for labels, show-cards, maps, book illustrations, and coloured plates of all kinds.
4. BRONZE WORK.

Any of the above may be required to be printed on writing paper, printing paper, drawing paper, dull or bright enamelled paper, cardboard, Manilla paper, Japanese paper, or even on silk or satin.

From the above variety of work, variety of papers, and, we may add, variety of inks required, it is evident lithographic machine printing is not easy; on the contrary, it is inherently a difficult process to manage. It requires much skill, care, and attention on the part of the printer and also the best of materials if a good result is to be obtained. There is no business in the world where it is so easy to turn out bad work, and the amount of inferior and mediocre work produced is appalling.

Printing with black ink is the most simple of all. Given a well constructed machine with good rollers and fairly good ink, it requires but an ordinary amount of skill to produce a satisfactory result.

Black Printing. Black work may be printed with the usual glazed rollers, but it is not advisable to do so. A set of grained black rollers should be the complement of every machine, and they should be used whenever black printing is required. Grained or nap rollers are infinitely better than glazed for all kinds of lithographic printing, but in the

present order of things it is not possible to carry this out in practice. From this it may be gathered how important it is to keep the glazed rollers in as near a nap condition as possible.

Grained black rollers will print 10, 20, or 30,000 impressions from a stone, where 5000 would be the limit for glazed rollers in the hands of an ordinary man.

The ink should always be used as stiff as the nature of the work in hand will allow, and reduced when necessary with thin varnish. A large proportion of mid or strong varnish will cause the printing to be hairy in the line and not quite dense in the solid parts.

Black being one of the slow drying pigments it will be necessary to add some driers, or perhaps better, some bronze blue, which, while improving the colour, will also act as a drier.

A hard blanket on the cylinder, firm pressure, smooth paper, a perfectly true stone, together with the work *very* slightly etched in relief are conditions which will aid the machineman in obtaining good results.

What is meant by solid colour is work printed with a full body ink, in order to get as strong and brilliant an effect as possible in the colour desired.

This again leads us to say, even though it appears repetition, that the rollers should be soft and mellow to the feel, capable of laying down the ink on the stone in a kindly way. Should the rollers be hard and glassy no one need expect to obtain a good solid piece of printing.

The ink used should not be of a transparent nature, and should be reduced as little as possible, using thin or extra thin varnish. With some inks, in order to get the best possible result, it may be permissible to use a little pomade or bees' wax melted down with a little varnish. This will make the ink "short" and enable the stone to take on a full charge from the rollers.

With the machines so perfect as they now are, there should be no great difficulty in getting a satisfactory result with any of the ordinary inks, on printing or dull enamelled paper. On bright enamelled paper or boards the case is a little different. It is required not only to get the solid printing, but means must be taken to prevent the ink rubbing off or getting damaged after it is printed. This is generally attained by using a proportion of strong varnish with an

Solid Colour Printing.

addition of driers and terebene. The strong varnish will act as a cement to hold the ink on the glazed surface, but at the same time will give a quality to the ink which is not favourable for smooth printing. To counteract this fault the terebene is used to soften the ink, and as it soon evaporates, it allows the tack of the strong varnish to exert its adhesive quality.

Some coloured inks, such as bronze blue, pure blue, umber, and chrome yellow will require little if any driers when printed in full body, while vermilion and other reds, with browns, violets, greens, and lakes of all kinds, require a good proportion of driers to permit the sheets being handled a day or two after printing.

Special work may require double inking, which often gives an excellent result. The best machines have a double inking motion thus causing no extra work to the layer-on. If this mechanism is wanting the cylinder must be checked each time to obtain the double rolling.

Double printing however, is much better than double rolling. Two printings of any coloured ink, one of which may be half or quarter strength, will give a far richer and smoother effect than any quantity of ink forced on the sheet in one operation. To obtain effective work this method is strongly recommended.

Solid printing is rather difficult to manage on cardboard owing to its bulk and weight. Should the boards be thin, and the work allow it, they may be interleaved with brown paper and put on wooden boards or trays in small quantities. If however, the cardboards are thick, the only safe method is to put them on their edge, one by one, gathering them together the following morning into small lots, and leaving them still standing on their edge for a day or two longer. For extra thick cardboard it may be found necessary to take the flyers off the machine, substituting hand labour.

Colour printing, as generally understood by the trade, is no doubt the most interesting and beautiful part of the litho. process.

Tint Colour Printing. In it we see the drawing or design built up, colour by colour, each requiring the utmost care in every particular, till the result is reached in a faithful reproduction of that of which the individual colours only formed a part.

The chapters on pigments and the principles of chromo-lithographic printing should be carefully read in connection with this section,

which deals with the subject more in the light of machine printing and the technical points connected therewith.

Colour work may be printed at machine from original stones or from transfers. Unfortunately, for many reasons, very little direct printing can be obtained, 80 per cent. or more of all colour work being printed from transfers. This being the case, there arises at once, one of the difficulties which machinemen have to deal with, as well as one of the shortcomings of lithographic work in general.

Colour stones are executed either in chalk or stipple, and transfers from these, especially chalk work, lose a portion of their delicacy as well as some of the contrast between the solid and lighter tints which exist on the original stone. To minimise this as much as possible, great care must be exercised in preparing the stone. In the hands of the preparer the transfer may be kept sharp and clear, or it may be allowed to thicken and run together, thus losing much of its value in giving definition and contrast. Yet, with all possible care in making the stone ready for printing, the transfers will be found to have thickened a little, so that the work is passed on for machine printing, in a state one or two degrees removed from the original.

Another condition which is rather against the machineman is the fact that proofs are generally taken at the hand-press with grained rollers, which give them a very soft and delicate feeling.

These are adverse conditions for the machineman to start with; but on the other hand, he has certain things in his favour which go far to compensate, and, in certain cases, more than compensate for these deficiencies. He has within his power the means of perfect register, and also the means of printing the sheets more regular and uniform in tone from beginning to end than is possible at hand-press. In this connection, Senefelder's prophetic statement may again be called to mind.*

It will be the machineman's duty to minimise as much as possible the inherent deficiencies of re-transfer work. If he carefully tries to do so, he will, with the compensating conditions just noticed, be able

* "Till the voluntary action of the human hand is no longer necessary, and till the impression can be produced wholly by good machinery, I shall not believe that the art of lithography has approached its highest perfection."—"Complete Course of Lithography," by Alois Senefelder, 1819

to come very near to the ideal which was in Senefelder's mind when he wrote the paragraph quoted on previous page.

Colour-printing at machine will be greatly helped by the machine-man attending to the following :—

1. The rollers should be in a good, soft, workable condition.
2. That the rollers run on the bearers till they take the *face* of the stone, just where the work begins.
3. Using ink as strong as the nature of the work will allow. For this there can be no fixed rule, as much depends on the nature of the work and the quality of the paper.
4. The damping rollers and table should be in good order and thoroughly cleaned of all refuse taken on in previous printing.
5. After all preliminary work is done the stone should be washed out with turps. before starting to print. A cloth should be kept specially for this purpose, and only clean water put on the stone when so washed out.* It is important to note, that if a stone is kept in good order for the first 500 impressions, it will be comparatively easy to keep it right for the next 5000 or 10,000 runs. Work on stone is more liable to receive damage during the first hour or two than during the whole run afterwards.
6. There are other helps of a minor nature which will come to the mind of an intelligent workman as he proceeds with the printing, such as suiting his ink to the temperature of the room; using as small a quantity of water as the paper and work will allow; mixing with his ink a judicious amount of mid or strong varnish, etc., etc.

In mixing a tint for machine printing, especially when it is composed of several colours, it is necessary to make it rather stronger than what is actually required for printing. The reason is obvious; when strong,

* Men are apt to use for this purpose the contents of a dirty sponge, even one that has been used to wash off gum and acid from the stone. This shows a want of knowledge as to the sensitiveness and power of the materials they are working with. Another failing of machinemen is to ink up a stone in black on the top of the thin varnish tint they have been printing, not realising that this is a sure way of damaging the work, which is at all times so difficult to preserve in a perfect state. When it is necessary for any purpose to roll up a colour stone in black, the coloured ink should invariably be washed off with turps.

it can easily be reduced with a little varnish ; whereas, if too weak, there must be added a proportion of each of the colours first used, which will almost certainly make a difference in tone and cause much trouble and waste of time.

Another important point in this connection is to use the fewest colours possible in producing a given tone of ink or tint ; two or three, or, at the most, four colours, should give any required tint for any subject ; if a greater number is used it will be found that they only neutralise each other and so practically reduce the many colours mixed together, to the two or three which are really necessary. Colour printers are invited carefully to consider this point.

Another condition which requires careful attention is the quantity of tint ink a paper will carry, and show, at the same time, smoothness in quality and correctness in tone. A large supply of thin varnish ink on the rollers will generally give a smooth enough tint on plain, but not on enamelled paper. The latter will only take up a portion of the ink offered to it, and the tint will have a marled appearance. To meet this difficulty, tint inks require to be mixed much stronger for enamelled paper, and will therefore be printed more sparsely to obtain the desired smoothness. A rough appearance on plain paper may be caused by spareness of ink or roughness in the paper ; in either case the ink will require to be reduced with varnish and the rollers more fully charged, exactly the opposite treatment to that required for enamelled papers.

Tinting inks are made up with thin and mid varnish ; the lighter the tone, the more varnish being required. Thus, there is only a small proportion of pigment used to a large amount of varnish, which has a tendency to grease the stone and thicken the work. To counteract this fault, a little flake or tint-white or magnesia may be added. If too much tint-white is used it will give the prints a soft clammy feel and will prevent drying ; if too much magnesia be added the work on stone may suffer ; a very little of either is all that is required.

The all-important matter of "Register" will now claim our attention. Colour work generally requires a key-stone, either an original or one made up with transfers. This key-stone should be set
Register. correctly in the machine, and one or two dozen copies printed off in black, using the same paper as the job is to be printed on. The first colour stone is then put in the machine and set

absolutely in register with the key copies. A further safeguard in printing a first colour is to put a short line on the stone, so that it will print at the extreme edge of the paper where the guide strikes; any variation in position of this mark should be seen at once and the cause of it attended to. One of the key copies should, as a further test, be passed through occasionally to see if all is right.

Accurate register of colour work greatly depends on the paper, the gripper edge of which should be perfectly true and at right angles with the guide edge. Two sheets out of the middle of a ream may be laid on a flat table, edge to edge; if true, they will meet along the whole length of the sheet, if concave, they will touch only at the ends, if convex, only at the middle. A convex edge is the most dangerous, and will never give correct register unless the tongues of the gripper are made to meet it. An edge just a little concave is quite safe unless the paper is very thin, in which case it is apt to droop in the centre and cause creasing.

If paper is crinkled round the edges it will be impossible to obtain good register. This state indicates that the outside margins are expanded by exposure to the atmosphere, while the centre of the ream is still in a dry condition, the same as when it left the mill. For further consideration of paper and its treatment before printing, see chap. XIX. In certain circumstances it may be advisable to run the paper through the machine on a clean wet stone, using a good supply of water. If it stands this treatment without creasing, it will generally be most effectually seasoned.*

A few other points may be noticed. The stones may not all be transferred exactly the same size, owing to the sheets on which the transfers were shone up having shrunk or expanded a little. If all the sheets have gone one way it may not cause much trouble, as, even though the key-stone is out, the colours will register one to another. But if some colours only are wrong, the case is serious, and new stones may have to be prepared.

* The writer noticed lately in a trade journal a statement to the effect that this operation was antiquated and of little use. As the principle involved, of giving moisture to the paper is absolutely correct, it can never become antiquated; and no better method could be devised for giving the paper the necessary amount of moisture for proper seasoning. The only objection is the expense involved in adding what is equal to an extra printing.

Again, the sheets may be irregular length ways ; this may be caused by the layer-in not bringing the sheets up to the guide each time. It is evident that the guide will not move a sheet which is laid outside the range of its movement, which is about $\frac{1}{8}$ of an inch.

Again, the sheets may be in correct register at the guide, but out at the other end. This fault is caused by the sheets shrinking or expanding, and shows the paper has not been at the first properly seasoned. It is very difficult to give a remedy for this state of affairs, beyond stating that the sheets may be interleaved with paper which is drier than the sheets in question, if expansion has taken place ; or damper, if the sheets have shrunk.

If the register is out by expansion the narrow way of the sheet, it may partly be cured by putting one or two sheets of paper on the cylinder. This will naturally increase its circumference and take the outside edge of the sheet a little sooner round to its place on the stone and so cause it to fall in more correctly. If the sheets are shrunk in the same direction it will hardly be possible to remedy this fault, and new stones may require to be prepared.

Occasionally the sheets are found to vary, gripper way, with no fault in the paper or the laying in. This may be caused by having too little brake power on the cylinder, permitting it to run before instead of being pushed by the side racks. With the excellent arrangement of push-rod, checks and cylinder brake, which are now a part of every machine, this fault will rarely be met with.

Another point, which may be noted, is the necessity of having the stone squarely and firmly blocked up so that no movement is possible, and also that its surface is true and level with the cylinder.

To get the best register it is hardly necessary to state that the sheets should be kept together as closely as possible during the whole time of printing, and that the sheets on the feed-board should be covered up whenever the machine is stopped for any length of time, as at meal hours.

The result of accurate register should be that the crossed lines at each end of the sheet are, in each colour, absolutely on the top of each other, so that whether there be three, six, or ten printings the lines should appear as one.

With all these directions and explanations a great deal will depend on "the man on the bridge." An active, intelligent mind will, in

many ways, prevent mis-register, and prevention in this matter is infinitely better than cure.

In chromo-printing, many colours have necessarily to go on the top of one another. To get this properly done, the first few printings must not be allowed to get dry or hard. In such a case, they might refuse to take on the succeeding tints, or, if they did lift them, the result at the finish might be a glossy, varnished surface which is so objectionable. To avoid this difficulty, especially if the first tints are yellow or other opaque colours, it is advisable to soften the ink with a little pomade or solidified oil. It requires careful judgment on the part of the printer or overseer to know how much, and in how many printings, grease of any sort should be allowed. If carried to excess, the ink will be too greasy, and will neither print nor dry well; it is safer to add too little than too much. This expedient will be quite unnecessary for maps, medical plates, or other work of a light nature.

A little magnesia and powder drier will generally keep any ink from giving too much shine and will dry slowly with a dull surface.

For colour-printing, the paper can hardly be too smooth. An enamelled surface gives this quality, and for labels, showcards, and commercial work it answers well, but for artistic subjects it cannot be recommended. For book illustration a fine litho.-printing paper is the most suitable, and for work of the highest class a pure white paper made from a mixture of rags and esparto will give the most pleasing and artistic results. This latter paper is much improved if it is very slightly damped and plate glazed before printing.

No machine engaged in printing colour work should be without an indicator, which tells the machineman at a glance how he stands in regard to the number of copies required and printed. There are several of these in the market; the one known as Cuthbertson's answers the purpose admirably and does not get out of order.

Bronze Printing holds the unfortunate position of being the most troublesome and disagreeable branch in the litho. business, but as it must be done, it should be done in the best way.

A satisfactorily bronzed sheet should be smooth and brilliant, and quite free from loose powder on its surface, while the bronze should adhere so firmly to the printed medium, that it will not rub off.

Bronze work may be required on any kind of card or paper, but is generally printed on good litho.-printing or enamelled paper. The latter is by far the best for the purpose, and gives a fine brilliant metallic surface. In order to get bronze work printed in a proper manner, there are a few requisites which require attention.

1. An ink or printing medium containing as much pigment, mixed with a strong varnish, as will lie on the surface of the paper to receive the metallic powder.
2. A paper strong in substance that will lift the film of ink from the stone.
3. A bronze powder entirely free from grease, and of rather a coarse nature, that will not stain or rub into the paper. Very fine bronzes are unsuitable for litho. work.
4. The means of applying the bronze in a cleanly and efficient manner.

The first of these requisites is found in an ink composed of burnt umber and chrome yellow, reduced as little as possible with a mixture of mid and strong varnish, with the addition of a little driers.* The latter indeed, should hardly be required, as umber is an excellent drier in itself. Thin varnish, pomade, or anything of an oily nature should never be added to a bronze-printing medium.

The second requisite is much more difficult to obtain, as eight out of every ten papers supplied for this class of work are found to possess faults which make them more or less unsuitable. Ordinary printing paper will, as a rule, take the ink fairly well, and if not too absorbent will receive the bronze and hold it fast, though its appearance will not be so brilliant as when enamelled paper is used.

All sorts and conditions of enamelled paper come to the hand of the printer, the surface of which is very often too soft and absorbent. In this state it either refuses to lift the ink from the stone and breaks up, or, if it does lift it, the varnish in the ink is so quickly absorbed that only a film of dry pigment is left, which has no power to receive the bronze, or only in a way that rubs off with the least friction.

To meet these perplexing conditions in the paper, the printer is often forced to reduce the ink with thinner varnish, which in itself is the worst thing possible for a satisfactory result. A great number

* For silver or aluminium bronze a printing medium composed of flake white, blue, and a little umber should be used.

of substances have been advocated as an antidote to this serious fault, such as paste, glue, gold size, copal varnish, venetian turpentine, wax, rosin, etc. A little of some of these may be added to the ink with advantage, but if the coating of the paper is really soft it will be very difficult indeed to get any mixture that will take on bronze in a satisfactory way. The real cure will be to get another paper, even though it involves a good deal of trouble and extra expense.

There are two ways of testing enamelled paper as to the hardness of its surface for bronze printing. 1. Fold a corner of the coated sheet face in and rub the two faces together between the fingers; if the composition is soft, it will powder down where the fold has been made; if sufficiently hard, the fold will retain the enamel intact. 2. Wet the tip of the finger with the tongue and press it hard on the enamelled surface; if soft, the composition will be left on the finger when taken away; if hard and good, the finger will leave the paper with a sharp click and none of the composition will adhere to it. Paper in this condition will be found quite satisfactory for bronze, and the work may be safely proceeded with.

The third requisite is a good bronze powder entirely free from grease, which is necessarily employed in its manufacture. It is difficult to say when a bronze is or is not in this condition; the printer therefore must depend on the assurance of a trustworthy firm, and pay a fair price to get a good article. It is evident that the greater the care that is taken to extract all grease and impurities from bronze powder in the course of manufacture, the higher will be the price. The fineness of bronze may be tested by rubbing a little over the thumb nail; the coarser will appear a little open, while the finer quality will give a smooth covering. A little experience will soon enable any printer to say if it is correct for the purpose required. Very fine powder should be avoided, as it will adhere so closely to the paper that it will be almost impossible to get it thoroughly dusted off.

It is often found after bronze work is printed that it will not receive on its surface, to show well, any work printed in black or another colour, such as outlines of lettering or the design of a medal. To remedy this failing, it will be found of great assistance to print a thin coating of varnish, with the addition of a little driers, over the bronze. This will cause it not only to take on the

design, but will also, as already stated, preserve the gold from being tarnished if exposed to the atmosphere.

A very brilliant effect is obtained by plate-glazing the bronzed sheets. This however, can only be done when sheets are printed in gold alone, or when sheets, with other colour printings, are finished and have become perfectly dry.

The fourth requisite is found in the bronzing machine, although for small and particular jobs the hand is still the best machine in the market. For larger work and long runs, and to meet the requirements of Government supervision, the machine is absolutely necessary.

A description of the various bronzing machines as made by different engineers is not required, but the requisite features may be mentioned.

A machine should be able to give a good and continuous supply of bronze powder to the sheets; it should rub this well in to the printed surface, and should also polish the bronze work to give brilliancy, and afterwards dust the sheets quite clean from all loose powder. These results are sought to be attained in the best constructed machines by a series of rollers, covered with specially prepared lambs wool and heavy

plush, revolving with some pressure against a large cylinder, which take the sheets round to the delivery board. The writer is indebted to Messrs A. Seggie & Son, engineers, Edinburgh, for the annexed wood engraving, which will convey in a clearer manner the general construction of a machine suitable for the purpose.

In the illustration the feed-board is at the top right hand, the bronze box and rollers at the left hand; the polishing and dusting rollers are in position round the cylinder, which occupies the centre of the machine, while the delivery-box is underneath the feed-board. The sheets are cleaned both sides and delivered face down.

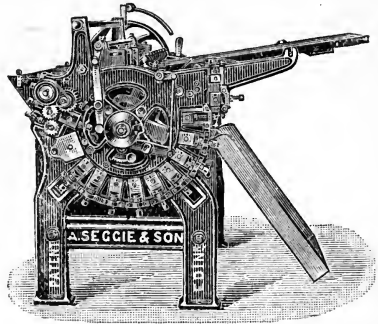

Fig. 20. BRONZING MACHINE.

Chapter XVI.

LIGHT AND COLOUR.

IN nature there are three distinct harmonies which are more or less evident to the senses of all intelligent beings, viz., of Sound, of Form, and of Colour. Most individuals have a greater appreciation of one of these than of the other two, though a few individuals who are favoured with highly sensitive natures and keen intellectual ability may be able to appreciate the whole range, and be, at the same time, musician, sculptor, and painter. The great majority of people however, even after receiving a liberal education, are found to possess the power or faculty of appreciating one of these harmonies much more than the others; so that we have quite naturally painters who are not musicians, musicians who are not sculptors, and sculptors who are neither painters nor musicians. At the same time, it must not be overlooked that a true artist must possess as fully a developed faculty to appreciate form, as that by which he is enabled to appreciate colour, otherwise he would not be able to put on canvas subjects which would be true to nature in symmetry as in colouring.

As there is diversity in appreciating the individual harmonies, there is also great diversity in the amount of that appreciation, ranging from a scarcely existent perception to a highly developed faculty, which enables the possessor to produce important works of art that claim the admiration of those not so highly gifted.

In relation to Colour, it need hardly be said that the statement in the preceding sentence holds good in a very marked degree. Some men have no idea or feeling for harmonious colouring, while the perception of others is so keen, that they are enabled to judge swiftly and accurately as to what is correct, tasteful, and harmonious.

These statements are in strict accordance with what science teaches,

Fig. 2. Primary, Secondary and Tertiary Colours.

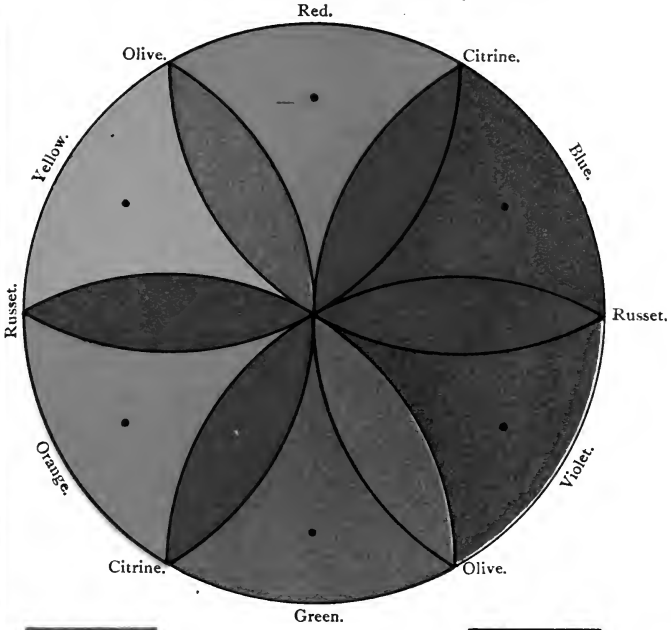

Fig. 1. SOLAR SPECTRUM :—DARK "FRAUNHOFER" LINES NOT SHOWN.



Fig. 4.

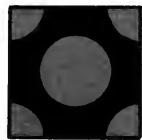

Fig. 6.

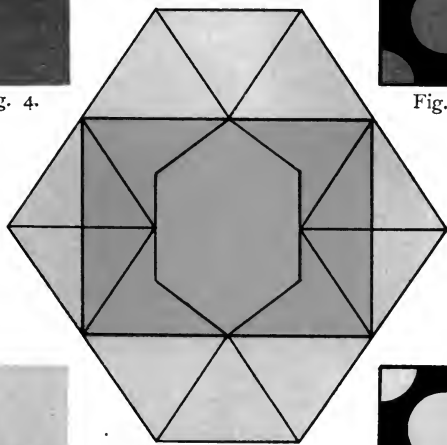

Fig. 3.

Harmonious proportions of the Primary Colours.
Yellow 3, Red 5, Blue 8.



Fig. 5.



Fig. 7.



that colour is a sensation, determined by a set of nerves which exist in the retina of the eye. It therefore depends on the degree of sensitiveness in these nerves whether there is a due appreciation of colour or not. This faculty, like the others which belong to man, may be cultivated by intelligent study and practical observation. It would be well, therefore, for all litho. workers to take advantage of every opportunity offered, to increase their experience and enlarge their perception of what is tasteful and harmonious in colouring, so that naturally and with pleasure they may give assistance in turning out work which will be both beautiful and artistic.

It cannot be expected, nor is it needful, that much be said here concerning colour in the abstract, as our work is entirely with colour as it exists in the various pigments which are in use from day to day. These pigments differ as much from colour as the brain differs from the mind for which it acts as the working medium; in something like the same way the various pigments are used to give expression to, or make visible, the colour which respectively belongs to them. We will also discard the now generally accepted scientific theory, that red, green, and violet are the primary colours, and go on the old lines that yellow, red, and blue still hold the place as the true primaries, which was given to them by the older school of scientists. As far as the material pigments are concerned, they may still be quite correctly termed the primary colours, as with them, and them only, can the painter or colour printer produce the various shades and tints he may require.

Light and Colour are very closely associated in nature, so much so, that the latter is entirely dependent upon the former for its existence. In darkness there is no colour, while from the light of the sun we receive and enjoy the whole range of colour sensations. To the senses, the light of the sun is of a pure white nature, but in reality it is composed of various coloured rays, which, co-mingling in certain proportions, form the bright, beautiful sunlight, which is so wonderful in its effects on all animated nature.

The light of the sun may be divided or broken up into its different coloured rays by refraction. We have a natural example of this in the rainbow, which is caused by the rays of the sun being refracted

through the rain drops and reflected against a dark background of cloud. The same result on a flat surface may be obtained by causing the sun's rays to pass through a glass prism, and throwing them on a white sheet in a dark room, when the solar spectrum will be seen, exactly corresponding with the colours of the rainbow. These colours are red, orange, yellow, green, blue, and violet. For practical purposes we omit the indigo, which was reckoned by Sir Isaac Newton as one of the seven colours of the spectrum. These colours gradate so softly the one into the other, that it is not possible to say where the one begins and the other ends. In passing, it may be stated as interesting and instructive, that there are other rays from the sun which are not revealed by the colour spectrum, but which form what are termed invisible spectra. Some of these are heat-giving rays, and come before the red of the spectrum; while others are chemical, and are in position beyond the violet. It appears that very little chemical action exists in the red rays, but it gradually increases towards the violet and beyond it, in the invisible chemical spectrum; and also, that very little heat is given out by the violet rays, but it increases towards the red and beyond it, in the heat-giving spectrum. The difference in action of different sets of the sun's rays is well illustrated by the photographic dark room, in which the non-chemical or non-actinic red light, alone can be used to show the operator what he is about. The orange rays, next in order in the spectrum, are also next in order in non-actinic power; and the colour produced by these is also used in photographic work. It has also been demonstrated that the blue rays are the most active in causing the fading of colours, while the red rays cause little if any change even after prolonged exposure to their influence.

Science teaches us that the outward colour of any object is caused by the constituent particles of that object absorbing or reflecting certain of the above-mentioned coloured rays. Captain Abney states that the colour of any body depends on three conditions:—

1. The composition of the light falling upon it.
2. The material on which the light falls.
3. The eye of the person observing.

Snow is white because its crystals reflect all the rays which fall upon them, while soot is black because its particles absorb all and

reflect none. A red flower absorbs most of the yellow, green, and blue rays and reflects the red; if it is a crimson red then a few of the blue and violet rays are reflected as well, which give it the crimson hue. On the other hand, if the colour is a vermilion red, the blue rays are all absorbed, while some of the yellow or orange rays are reflected, which, combining with the normal red, give the paler vermilion hue. A purple flower absorbs entirely, the yellow, orange, and green, and reflects a portion of the red and blue and all the violet rays. A yellow flower absorbs all the colour rays, except the yellow or orange, which are reflected; and so on, each flower or object selecting and reflecting its own colour rays and absorbing the others. How each and every object in creation possesses the power of doing so is a great mystery, which science may be able some day to solve.

That colour is not in the object itself is apparent by its taking on to a certain extent the colour of whatever kind of light falls upon it. It is a well-known fact that it is not wise to judge the colour of anything by gas-light, for the simple reason that it contains a large proportion of yellow rays and therefore imparts to every article a more yellow tone than it appears to possess when seen in the pure white light of noon day. These yellow rays of gas-light also lower the tone of any yellow object, making it appear less yellow than it really is. This takes place simply by the object being surrounded by a yellower tone than was natural to it in daylight.

Sun-light is the standard medium in which it is possible to judge colours correctly. Hence, in painting or printing, when it is necessary to use an artificial light, the nearer it comes to daylight the better it will answer the purpose. Incandescent gas appears to give the most perfect artificial light for use when printing colour work.

Coming back to the solar spectrum, we noticed that it gave six colours as the composition of the sun's rays. Of these, yellow, red, and blue are termed elementary or primary colours, because it is not possible to reduce them further, and also because from these three the other colours of the spectrum may be produced. The other three colours—orange, green, and violet—are termed secondary colours, because each of these, though forming separate sections of the spectrum, may be produced

**Primary
Colours.**

by a mixture of two of the primaries. By no combination of material substances can yellow, red, or blue be produced, but orange may very easily be obtained by a mixture of yellow and red, green by a mixture of yellow and blue, and purple by a mixture of blue and red.

The colours of the spectrum are very different from those which may be obtained from a mixture of coloured printing inks. The former are brilliantly pure, luminous to a degree, and appear to mock the painter and printer alike in their efforts to obtain a corresponding brightness or purity. The nearest artificial approach to these beautiful gradations of colour is to be seen in the stained glass window, which, allowing light itself to pass through, receives from it a high degree of luminosity and brilliancy. But however far short the material colours of every-day use come to those of the solar spectrum, there is the consolation of possessing in them a perfect standard of purity and richness, which cannot be too often placed before the minds of those who are engaged in the process of colour printing.

The Secondary colours are also called Complementary colours, indicating that they give, when in combination or conjunction with the third primary, the range of colours contained in the sun's rays, and so are capable of producing white; or in the case of pigments, when used in design or decoration, a harmonious result.

A writer in "Constable's Oriental Miscellany, Vol. II. (Popular Readings in Science)," gives a very simple definition of Complementary colours. He says: "Any two colours which, when mixed together, produce white are said to be complementary. From this it follows that the colour which is complementary to any one of the seven colours of the spectrum is obtained by mixing together in proper proportion the other six."

Red has its complementary in green, which is composed of yellow and blue; blue has its complementary in orange, which is composed of yellow and red; and yellow has its complementary in violet, which is composed of red and blue. Thus each of the three sets, primary with complementary, supposing they were spectrum colours, contain all the constituents of white light.

Following the Secondary, there are three other colours termed Tertiary, which are formed by a mixture of two of the secondaries. They are named Citrine, Olive, and Russet, and each contains a proportion of all the primaries, but a double proportion of one of them, as may be seen from the following table :—

CITRINE is composed of	{ Orange, which is composed of Green " "	{ Yellow & Red Yellow & Blue	} Citrine has a double proportion of Yellow and is therefore a PALE colour.
OLIVE is composed of	{ Green, which is composed of Violet " "	{ Blue & Yellow Blue & Red	} Olive has a double proportion of Blue and is therefore a COOL colour.
RUSSET is composed of	{ Orange, which is composed of Violet " "	{ Red & Yellow Red & Blue	} Russet has a double proportion of Red and is therefore a WARM colour.

Plate VI., Fig. 1, shows the Solar Spectrum with its gradation of colour from red to violet ; Fig. 2, the Primary, Secondary, and Tertiary colours ; Fig. 3, in diagrammatic form, the harmonious proportions of the Primary colours according to Field.

In the Solar Spectrum we have an example of complete harmony, both in quality and proportion of colour, and in all departments of nature, perfect harmony and contrast is always maintained. Whether we look on flower, bird, or butterfly, or atmospheric phenomena, there is no colouring obtrusive or out of place to disturb the sensation of pure pleasure that arises in the mind, when beholding the perfection that belongs to natural objects.

In preparing colour designs for decoration or printing, the natural harmony and balance in every part should be carefully studied, and the due proportion of primary, secondary, or tertiary colours carefully guarded if success is to be attained.

Field in his "Grammar of Colouring"* tells us that the relative proportion of the primary colours for harmonious combination is as

* Field's "Grammar of Colouring," published by Crosby Lockwood & Son. A most interesting and useful book which should be in the hands of every colour printer.

follows:—Yellow, 3; Red, 5; Blue, 8 (see Plate VI., Fig. 3); and in accordance with these quantities the combining proportions of the Secondary with the Primary colours are:—

Orange, 8; and Blue, 8	. . .	being of equal power.
Green, 11; and Red, 5	. . .	„ two to one.
Violet, 13; and Yellow, 3	. . .	„ four to one.

We might go a step further here, and state for the information of designers and printers alike, that if any design is required to be carried out in two colours, a secondary and a primary, when the former is toned in one direction, the primary, to produce complete harmony, must also be modified to meet that change. For example:—

A Red-Orange colour	should be combined with	Blue inclined to	Green.
A Yellow-Orange	„ „ „	Blue „	Violet.
A Yellow-Green	„ „ „	Red „	Violet.
A Blue-Green	„ „ „	Red „	Orange.
A Blue-Violet	„ „ „	Yellow „	Orange.
A Red-Violet	„ „ „	Yellow „	Green.

Plate VII. is intended to illustrate the above examples and show the harmonious and brightening effect of Complementary colours when in combination one with another.

Gold enriches and harmonises well with any colour, except yellow or pale browns. Black contrasts well with gold, yellow, orange, and red, full body; and also with green in lighter tones.

In close connection with Colour Harmony stands Colour Contrast, which must be considered briefly.

Pleasing contrast is only another expression indicating harmony.

Colour Contrast. If the contrast between any two or more colours is not pleasing, it is evident they are out of order and out of harmony the one with the other, and were not intended by the great designer to be placed in such a position.

Contrast may be between different colours, as green and crimson, orange and violet, or between black and white; or between a light tint and a strong colour, such as a pale background with a design in full strength of one of the primary, secondary, or tertiary colours; or between different strengths or tones of the same colour. A drawing or print in the last-mentioned style is called Monochrome, which may be in any colour, but generally of a subdued tone.

EXAMPLES OF COLOURS WHICH HARMONISE WITH AND TEND
TO BRIGHTEN EACH OTHER.

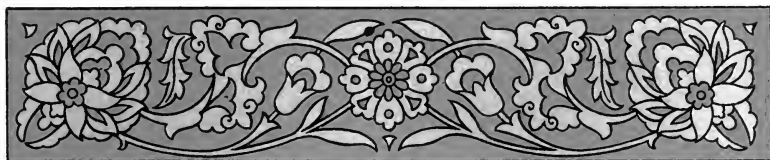

Yellow-Orange with Violet-Blue.



Red-Orange with Green-Blue.



Yellow-Green with Crimson-Red.

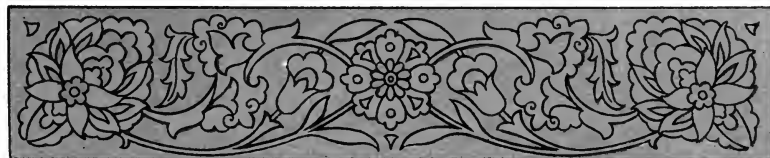

Blue-Green with Orange-Red.



Red-Violet with Green-Yellow.



Blue-Violet with Orange-Yellow.



When printing on white ground, pleasing and proper contrast can only be had by following the natural laws of the Complementary colours, or in using inks which have a large proportion of these in their composition. Thus, citrine would have a proper contrast in purple, olive in orange, and russet in green. Black and white, the negative and positive of all colours, form the most complete contrast; the one, as already noticed, absorbing very nearly the whole of the colour rays; while the other, as nearly, reflects all. Chevereul, in his work on colour, states that black and white may be considered complementary to one another. This contrast is the most useful, among those that are available for illustrative art, for "black and white" neither tires the mind nor irritates the nerves. By its means we read our books and write our letters with ease and comfort, which would not be the case if we were compelled to have, say, our paper yellow and printing green, or our paper blue and printing red. Pleasing and restful colour contrast seems to be one of those natural blessings which surround us everywhere, and which we unconsciously enjoy from day to day.

Contrasting colours should intensify as well as brighten each other. Red and green will perhaps form the best example of this principle, while violet and blue or violet and grey will show the opposite tendency, to dull and subdue each other.

This will be more clearly seen by reference to Plate VIII., which contains examples of colours that are not complementary, and do not harmonise well one with another. Plate VII. is given to show colours toned to meet each other in harmony, whereas Plate VIII. is arranged to show exactly the opposite effect, that of colours subduing or dulling each other.

A pleasing contrast is obtained with a tinted ground and a design printed in the full body of the colour from which the tint is reduced, along with a complementary colour. There is in this combination the harmony between the light tint and strong body of the same colour, and also what may be called the double contrast of the secondary colour with the two former.

Taking for an example of contrast the conditions mentioned in the previous paragraph, it will be found that the best effect will be obtained by the secondary colour being concentrated in certain parts of the design. For instance, a design worked up in two or three

shades of blue, if picked out here and there with a dense orange, will be much more effective than if the orange was weak and spread all over the design. This principle is often apparent in pictures, which are executed in a quiet, subdued style, being greatly improved and made charming by the introduction of one or two bright touches of primary colour, red especially.

It would be easy to give, in addition to what has been written in the few previous pages, a list of colours which form pleasing contrasts with one another, but it would be of no practical value, as almost any combination of colours, as in nature, may be made pleasing to the eye and harmonious in contrast by conditions which are not subject to any given rules. These conditions are—the relative strength or tone, and relative proportions of the colours used; the design itself, its composition and surroundings; the object for which the design is intended to be used; and that which governs all other conditions, the skill of the designer.

All proper contrasts should be pleasing to a person possessing a normal aptitude for colour, and sufficient taste to discriminate, what constitutes proper surroundings; if otherwise, the colours are misplaced.

In regard to colours in general, especially when they are brought into close relationship by being printed on the top of each other, or by juxtaposition as in decorative design, luminosity, and the influence of one colour on another have an important bearing.

Luminosity and Influence of Colour. That which gives the great charm to water-colour paintings is the luminosity or purity of tone of the colours employed. In the first place these are generally of a transparent nature, and when the moisture has evaporated there only remains a slight film of pure pigment through which light from the white paper underneath is reflected in a greater or less degree. In oil painting this means of obtaining purity or brightness is not available, and luminosity can only be secured by means of the light being reflected from the appropriate, though opaque pigments used by the artist.

It is difficult to obtain luminosity in litho. printing, as the ink used, instead of being liquid and transparent, is more of the nature of opaque oil paint, and except in the case of light tint, generally obscures the surface of the paper altogether.

It is interesting to note that stipple work lends itself to luminosity

EXAMPLES OF COLOURS WHICH DO NOT HARMONISE BUT TEND
TO DULL EACH OTHER.

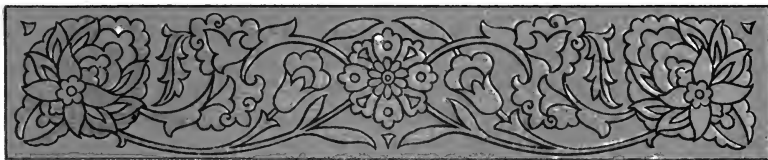

Yellow-Orange with Red-Violet.



Red-Orange with Violet-Blue.



Yellow-Green with Orange-Red.



Blue-Green with Red-Violet.

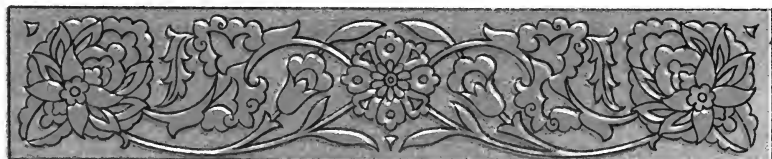

Red-Violet with Red-Orange.



Blue-Violet with Yellow-Green.



in two ways. First, there are always minute portions of the white paper not covered with the stipple dots, and the light from these white points illuminates the colour and gives it brightness. Second, in order to obtain from only a partially covered surface the strength of colour required for a given tone, it is necessary to use a tint of about double the strength that would be required for the same surface if drawn solid. Thus these two conditions, the reflected light and the brighter, because stronger toned ink, give a decided degree of luminosity, which is pleasing to the eye.

Plate IX. illustrates this principle. Fairly strong tints of the three primary colours are produced by single lines, and similar strengths of tints of the three secondary colours are produced by lines in juxtaposition. All these tints are pure and bright, or in scientific language, luminous, the two conditions mentioned above coming into play. This plate also illustrates the influence of one colour on another when in juxtaposition. There are here, yellow and red lines producing an orange brown, red and blue lines producing a purple, and yellow and blue lines producing a green, although none of these are in actual contact.

Plate VI., Fig. 2, also illustrates the principle of one colour influencing another but in a different direction. The left-hand section of the tertiary colour, russet, is seen to be decidedly more purple in tone than the right-hand section. This is explained by a pale tone of the complementary colour to yellow, which is violet, and of that to orange, which is blue, spreading over the intervening russet section and imparting to it a more purple tone; and in like manner on the right-hand side a tone of the complementary colour to blue, which is orange, and of that to violet, which is yellow, spreading over the russet section lying between, and imparting to it a more orange tone.*

* To further illustrate this principle the reader is again referred to Plate VI., Fig. 2. Black dots will be seen in the centre of each of the primary and secondary colours. If one of these dots is looked at very steadily for half a minute, and the eye then turned to a white sheet of paper a beautiful pale tint of the complementary colour to that which has been looked at will be seen, and if the eye is then quickly turned to one of the other colour sections it will be seen to be toned with that same complementary tint, the eye retaining it for some little time and colouring whatever is looked at. To get the proper result all the colours on the plate should be covered up except the one to be looked at.

These illustrations will show the difficulties which the printer has to contend with in matching a combination of colours on the same sheet; one colour when standing alone may be absolutely correct, but when another one or two or more are printed alongside of it, or perhaps crossing each other, it may be found that the first has changed its tone considerably.

From the above it will be seen that much experience and a keen appreciation of colour is required in order to guide colour printing aright.

In closing this section it may be helpful to quote a few of the principles laid down in regard to colour treatment by Owen Jones in his "Grammar of Ornament," a work of very great utility to designers and artists. He states:—

1. "No composition can ever be perfect in which any one of the three primary colours is wanting, either in its natural state or in combination."
2. "Colours should never be allowed to impinge on each other."
3. "The primary colours should be used on the upper portion of objects, the secondary and tertiary on the lower."
4. "When ornaments in a colour are on a gold ground, the ornaments should be separated from the ground by an edging of a darker colour."
5. "Gold ornaments on any coloured ground should be outlined with black."
6. "Ornaments of any colour may be separated from grounds of any other colour by edgings of white, gold, or black."

EXAMPLES OF TWO COLOURS IN JUXTAPOSITION, COMBINING TO FORM A THIRD
AND ALSO SHOWING GREAT LUMINOSITY.



Yellow Lines.

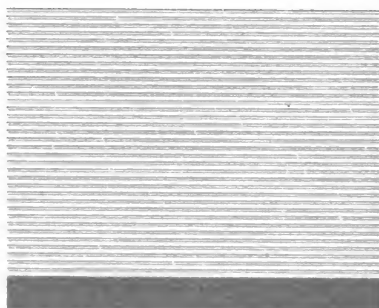

Yellow Lines with Red between
forming Orange-Brown.

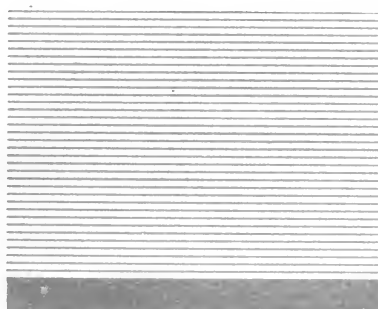

Red Lines.

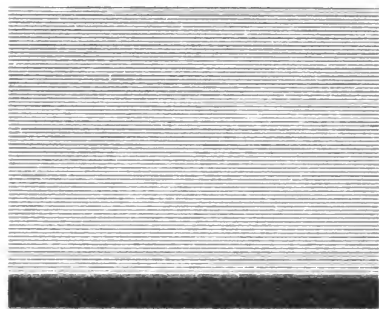

Red Lines with Blue between
forming Purple.

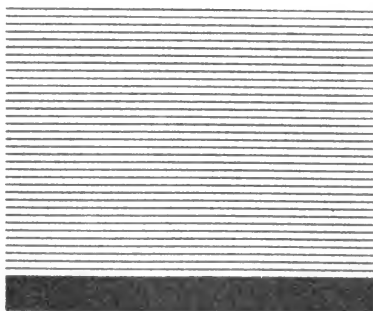

Blue Lines.

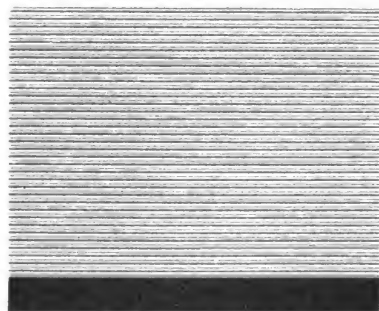

Blue Lines with Yellow between
forming Green.



Chapter XVII.

PIGMENTS.

PASSING from the consideration of Colour, which is in itself so intangible, we come to that part of our subject which treats of Pigments, or what may be termed colour in a concrete form.

Colour Pigments. These have various properties and characteristics, which may belong to them individually or as groups. Some acquaintance with these properties will be found most helpful to the colour printer, and may be the means of assisting and guiding him in the difficult problems which so often arise in the process of printing.

Pigments may be roughly classified as yellows, reds, blues, browns, greens, and purples, with the negative and positive of all colour—black and white. There are many other pigments made
Classification. and sold under an endless variety of names, but all are more or less modifications or mixtures of the above series, which, it will be noticed, consist mostly of the Primary and Secondary colours.

Some pigments are native or earth colours, such as ochre, indian red, umber and sienna, which only require washing, purifying
Properties. and grinding to make them fit for use. There are other pigments in addition to those just named which are of native origin, such as ultramarine blue, cobalt blue, cinnabar, terre verte, etc.; but as artificial preparations of these respective pigments have entirely taken their place, at least as far as colour printing is concerned, they do not require to be here considered as belonging to that class.

Others are chemically prepared, such as chrome yellows, red lakes, various blues, aniline colours, etc.

Some are dense and opaque, as flake white, vermilion, chrome yellow, bronze blue, and the earth colours when calcined.

Others are transparent, as the whole series of lakes and aniline colours, raw sienna, raw umber, etc.

Some are in various degrees permanent, such as the earth colours, vermilion, chrome yellows, madder lakes, and blues.

Others are more or less fugitive, as geranium lake, carmine, mauve lakes, yellow lake, and all aniline colours.

Some have inherent drying qualities, such as flake white, umber, bronze blue, and chrome yellow.

Others have little or no drying power, as black, purples, scarlet and maroon lakes, some greens, zinc white, etc.

These various properties, so different and opposite the one to the other, will make very evident the need of closely studying the qualities of the various inks which come to be used in a litho. printing-room. In noticing then in a cursory manner Pigments and their properties, the object to be kept in view will be to give as much practical information as possible to the colour printer, so that he may be enabled to carry on his work in a more efficient and intelligent manner, and also that he may have a greater interest in the materials which are daily passing through his hands.

BLACK PRINTING INK, litho. or letterpress, is generally made from Lamp-black, or what is perhaps a more familiar name, soot. This soot or carbon is obtained from the smoke of crude oils and fats, which are burned very slowly in a lamp or furnace, hence its name Lamp-black. The object to be attained in burning is to get as much smoke as possible, which is allowed to pass through a series of chambers, where it is deposited all over in the form of soot. The heavier particles, together with a small proportion of unburnt material, fall in the first and second chambers, while the lighter smoke travels onwards to the chambers farther away from the furnace. The lightest particles travel the farthest and consist of the finest and purest quality of carbon, which is used in the manufacture of lithographic and the finer qualities of letterpress inks. The heavier and coarser quality of black, which is collected in the chambers nearest the furnace, is used in making the cheaper qualities of letterpress ink.

The finest quality of Lamp-black, as obtained from the chambers farthest from the furnace, is still of a brownish tinge however, and contains a minute proportion of foreign matter. To obtain a jet-black tone and purify it still further, it is calcined in covered iron pans. This operation destroys or drives off any vegetable or animal

matter still remaining, the result being a pure carbon known as Calcined Black. The lighter and purer the carbon, the more dense and beautiful is the ink obtained from it.

Some blacks are obtained from burning coal-tar grease and the residue from the distillation of shale. This is said to contain a proportion of oily matter, and unless carefully purified cannot produce a good printing ink. This may explain why some inferior inks neither work well nor dry properly.

Black is a non-drying ink and therefore requires an addition of a little bronze blue or lead driers, or both, so that the printing may dry within a reasonable time. When wanted to dry very quickly, a few drops of Terebene along with the driers will have the desired effect.

FRANKFORT BLACK is obtained from various vegetable substances of a woody or fibrous nature. These are thoroughly charred and afterwards ground into a fine powder. It contains about 30 per cent. mineral matter which leaves only 70 per cent. carbon, as compared with almost 100 per cent. in calcined black.

Frankfort Black. This mineral matter gives the ink made from it a brownish hue, and a want of density which is so essential for a good printing ink. It is used for copper-plate and photogravure printing, for which purpose it is very suitable, the brownish tone being in this case rather an advantage than otherwise.

IVORY BLACK.—One would gather from this name that the black was produced from ivory, which, no doubt, at first was the case.

Ivory Black. Ivory is however, much too scarce and expensive to be used for such a purpose now, and bones have taken its place, the product of which is sometimes called bone black. To obtain the pigment the bones are calcined in covered crucibles and afterwards carefully ground to powder. It contains only 18 or 20 per cent. of pure carbon, the remainder being mineral matter. It is quite unsuitable for the manufacture of black printing ink. Owing, we suppose, to the difference in the quality of bones and the care exercised in its manufacture, there is great diversity in the quality and price of this pigment, which varies from 1/- or less to 2/6 per lb.

Ivory Black of good quality is one of the most valuable pigments a litho. colour printer can possess. When reduced with varnish it gives a beautiful pearl grey tint, which may be brought to any degree

of warmth or coldness by the addition respectively of a little burnt sienna or royal blue. Besides producing this pearl grey when used alone, it is most useful for modifying the positive tone of tints obtained from the primary or secondary colours; and, possessing a brownish hue, it does not impart a dirty or low quality of tone.

It does not work well by itself in body, or even as a strong tint. The mineral matter separates from the varnish and gathers on the ink table and stone, thus preventing a smooth or flat effect being obtained.

WHITE PIGMENTS, as we have already had occasion to observe, reflect most, if not all, of the colour rays contained in white light, and are therefore in direct opposition to black, which reflects few or none. They are obtained from various sources and have different names, some of these indicating from whence they are derived.

**White
Pigments.**

The Whites most generally known are Flake White, Kremitz White, Silver White, Zinc White, Chinese White, Paris White, Spanish White, etc. The first three are carbonates of lead, and of these Flake White is the most important, as it is the best for all litho. purposes. Chinese White and Zinc White are oxides of zinc, but as they are more expensive, and do not possess the covering power of the Lead Whites, they are little used in the printing world. Paris and Spanish White are simply purified and refined chalks, and being unsuitable for printing purposes do not require further comment.

FLAKE WHITE is used very extensively in many of the arts, and is therefore manufactured on a large scale. There are several methods of preparing it from lead, but the oldest, which is **Flake White**, known as the Dutch process, still holds the field in producing the best quality. A short description of this may be of interest.

A great number of crucibles are made ready, each with a shelf or ledge placed a little way up from the bottom. A quantity of vinegar or weak acetic acid is put in each of these, and on the shelf is placed a spiral ribbon of lead; this spiral form is used to give the largest possible surface for exposure to the chemical action of the acid and fermentation which afterwards takes place.

Inside a shed there is put down very firmly a layer of tan about three feet thick, and on this ground the crucibles are placed in rows.

On the top of the crucibles is placed a grating of lead, over this again, leaving a clear space of a few inches, a flooring is laid, and on this floor another layer of tan is put down; then another tier of crucibles, lead grating, flooring, and so on till the shed is well filled and the "stack" complete; 10,000 or 12,000 crucibles, 800 gallons of vinegar, and 70 to 80 tons of lead may be used in building one stack. The shed is now practically closed up and left for about three months. During this time great heat is evolved through the active fermentation of the tan, and large quantities of carbonic acid gas are given off. The heat causes the vinegar to evaporate and the vapour, permeating the whole stack along with the carbonic acid gas, attacks the lead and changes its nature from the metal to the carbonate. At the end of three months the stack is taken down and the flake white lead removed. After passing through several operations of washing, purifying and grinding, it is ready for sale as White Lead or Flake White.

This pigment is very heavy and opaque in body, and stands first in the list of whites for covering power. In the dry state, it is in the form of lumps, somewhat brittle, and breaks with a clean sharp fracture. It should not crumble easily into powder when pressed between the fingers; if it does, it is possibly adulterated with chalk or Paris white. If pure, it should entirely dissolve in a weak solution of nitric acid and water; this purity is apart from chalk or Paris white, which will also dissolve in the solution. When prepared as a printing ink it possesses a strong drying nature, and acts as a drier in any other ink of which it forms a part.

It is used in reducing the tone or strength of other inks and to give delicate shades in tint work. Owing to its heavy body it does not work well by itself in full strength. It has a tendency to bleach all colours except madder lakes; and inferior qualities, probably adulterated, will give a white bloom on the printed surface which may seriously affect the result desired. Litho. printers would require to bear in mind that in mixing this pigment with another ink the impression will appear a little lighter after drying. It will therefore be necessary to keep the printing rather to the dark than the light side. It is acted upon by sulphuretted hydrogen gas which causes it to blacken, but in practical work this danger is so remote that it need not be taken into account by the printer.

YELLOW stands next to white in the scale of luminosity, and may be called the first primary colour. There are many shades and qualities of this pigment, and many sources from whence it is obtained, which in some cases is indicated by the name it bears.

The principal varieties are: Yellow Ochre and Sienna, which are earth pigments; Gamboge, a vegetable substance; and Zinc, Cadmium, Naples, and Chrome Yellows, which are chemically prepared.

YELLOW OCHRE has been used for many centuries by painters and decorators, and is a natural production. It is found as an earth or clay in many parts of England and the Continent, the finest quality in Britain being found near Oxford. It only requires to be purified by washing and grinding to make it ready for use as a colour pigment. Even with this refining treatment it still retains its hard gritty nature, and is therefore seldom used in lithographic printing.

Ochre. **SIENNA** is also an earth or clay, similar to ochre, but of a finer texture. It received its name from Sienna in Italy, the place where it was first found. Raw Sienna is of a brownish tone and gives a beautiful brownish yellow tint. When calcined it is known as Burnt Sienna and becomes more dense, and changes its colour to a rich warm brown. The longer it is exposed to the heat of the furnace the deeper it becomes in tone.

Sienna. Raw Sienna is weak and transparent in body, and can only be used with discrimination in chromo-printing.

Burnt Sienna is a most useful pigment, and could be used with advantage more freely in the printing-room than is generally the case. It is somewhat gritty, though not so coarse in this respect as Ochre, and possesses drying qualities in a moderate degree. It is very opaque and will cover up any printing that may be underneath. It must therefore be used at an early stage in printing any illustration that requires it in full strength.

These earth pigments are all quite permanent, and may be mixed with any other colour without harm.

GAMBOGE is a natural gum or gum-resin, obtained from certain trees which grow in Siam, Ceylon, and other tropical countries. It gives a brilliant yellow colour and is much used in water-colour painting.

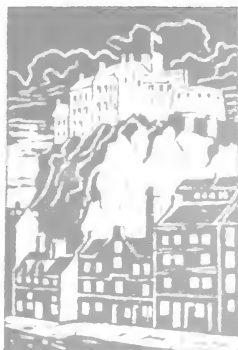

LEMON CHROME.



PRIMROSE CHROME.



ORANGE CHROME.



DEEP ORANGE CHROME.

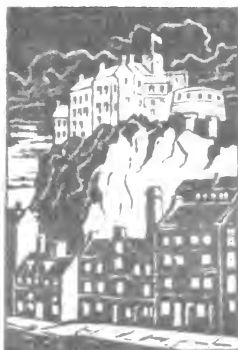

RAW SIENNA.



BURNT SIENNA.



YELLOW LAKE.

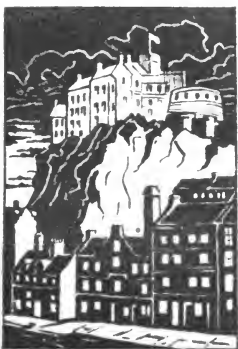

RAW UMBER.



BURNT UMBER.

The twenty-seven colours shown on the three consecutive plates comprise the whole range necessary for any chromo-lithographic establishment.



In lithography it is used, when reduced with water and mixed with the coating composition, to give colour to certain transfer papers.

CHROME YELLOWS are by far the most important section of yellow pigments which are chemically prepared, and form very nearly the only class made use of in colour printing.

Chromes.

The method of preparing these may be shortly described, and, being very simple, it is hoped many of our readers may be disposed to try the experiment of making them on a small scale. Three wooden tubs are used (glass dishes for experiment), in one of which is put a solution of Acetate of Lead and water, in another a combined solution of Bi-chromate of Potash and Sulphate of Soda. These two tubs are then emptied simultaneously into the third and from the mixture there falls a yellow precipitate—Chromate of Lead. When this settles down the clear water is run off and another supply of clean water run in; the whole is then thoroughly mixed and allowed again to settle. This is done a second and a third time, when it is considered thoroughly washed. After the water is finally run off, the sediment is put into a filter press which separates most of the remaining moisture. It is afterwards dried with a moderate degree of heat and is ready for sale as Chrome Yellow.

The proportion of the chemicals and the methods employed vary of course with different makers, but the result is much the same.

The proportions also vary for the different shades. The following may be given as approximate for experimental purposes:—

	LEMON.	PALE.	DEEP.
Acetate of Lead	10 parts.	10 parts.	10 parts.
Bi-chromate of Potash . .	2½ ”	3 ”	3½ ”
Sulphate of Soda	2½ ”	2 ”	...

It will be seen from the above table that the deeper shades of chrome yellows are obtained by less soda and more bi-chromate being used. For paler shades there is sometimes added a proportion of white; if this is flake white, the printing qualities will not suffer, but if any of the refined chalks are added, the pigment will make very inferior printing ink.

The washing of chrome yellows is a very important part of the process, particularly from the litho. printers' point of view. Should the precipitate not be thoroughly cleaned, and every trace of the chemicals removed, the lithographic stone may be so affected that the work will gradually disappear, notwithstanding all the efforts of the printer to keep it right. Cheap qualities are naturally less thoroughly washed than the more expensive kinds; the former will therefore generally be unsatisfactory and prove the dearest in the end.

The varieties of Chrome Yellows are known as Primrose, Lemon, Golden, Orange, and Deep Orange. All of these are of value in a chromo-lithographic printing-room, and the printer should know at once which will best serve his purpose for any particular piece of work.

Having a lead base they possess rapid drying qualities. The dry pigment is obtained in lump form, much the same in appearance and texture as flake white. The pieces break with a clean sharp fracture, and should not easily crumble into a powder. They are permanent, even when reduced to a tint, and may be freely used with other pigments except those having a sulphur base. They are very opaque, being similar in this respect also to flake white.

CADMIUM YELLOW is a compound of Cadmium and Sulphur, which gives a brilliant and beautiful colour. It is very expensive, and for this reason, as well as from the fact that the chromes give the whole range of yellow tones required, it is scarcely used in the printing world of to-day.

Cadmium Yellow.
YELLOW LAKE is prepared from a decoction of Persian berries and Cream of Tartar with Alum. It gives a rich, brilliant yellow colour, although it appears quite brown in the mass. It is also quite transparent, which makes it very useful in a printing-room; apart from this quality however, the chromes will give all that is required.

Yellow Lake.
The second primary colour is Red, which opens up to us a large field of manufacture and chemical research. We can only notice here a few of these pigments which are more generally used, and make up what may be called the printer's palette.

Red Pigments.
The Earth Reds, with Vermilion and a few expensive Lakes, were for a long period the only red pigments that were available for colour printing. During the past twenty years however, chemical research,

along with the skill and energy of ink manufacturers, has given us a whole range of reds and red lakes, possessing not only rich and permanent tones, but also full body and good printing qualities.

There are, as in the case of yellow pigments, a few natural earth reds, such as Indian Red, Venetian Red, Red Ochre, and native Vermilion or Cinnabar. These have been known and used for painting and decoration from the earliest times, and are both beautiful and permanent, as testified by ancient decorative work still in existence. As they have however, almost entirely given place to pigments of artificial manufacture, they do not call for further notice in a work such as this.

VERMILION is one of the oldest and most permanent of red pigments. It has been made for centuries by the Chinese, who still produce a quality which for purity and brilliancy is not approached by any other country in the world. It is a compound of Mercury and Sulphur, and known chemically as Mercuric Sulphide. The method of preparation is somewhat as follows: 200 parts Mercury and 32 parts Sulphur are well mixed together in a large pot, which is then gently heated over a furnace. These two elements combine and form a third substance, Black Sulphide of Mercury. A number of earthenware pots with iron lids are then arranged in a furnace and fired till they attain a dull red heat, when a portion of the black sulphide is put into each. The strong heat causes the sulphide to sublime on the lids and upper parts of the pots. When these are cooled the red deposit is taken off and put through a washing and grinding operation, after which, when dried, it is ready in the form of a soft red powder for sale as Vermilion.

Vermilion is the heaviest of all pigments and forms one of the most opaque printing inks, and dries so slowly that it may be termed non-drying. It is manufactured in different shades, the palest being found to possess the best working qualities for litho-printing. Though possessing great covering power, its weight and small bulk makes it a very expensive ink to use in large quantities. When pure, it may be considered quite permanent, but if adulterated with red lead it will in a short time become blackened. When ground in pure litho. varnish it gives a bright colour, known by its own name, vermilion. It is very useful for mixing with the more transparent

lakes, imparting some of its own density and brightness. Reduced to a tint it forms an excellent flesh colour, either alone or toned with ivory black.

CARMINE is the most beautiful and also the most expensive of red lakes. Formerly it was prepared from the body of the cochineal insect, *Coccus Cacti*, seventy thousand of which are said to have been required to make 1 lb. of the pigment. Though beautiful, it is not permanent, and could only be used for work that was not to be exposed to light and which required the brightest possible colouring. Some years ago the cochineal insect was largely cultivated in some tropical countries, but owing to the wonderful advance in chemical manufacture of pigments, the cultivation has practically gone out of existence, while the pigment, as obtained from the insect, is now unknown for printing purposes.

Before proceeding further, it may be stated that all lake pigments, of whatever colour, are prepared much in the same way. There is
Madder Lakes. 1st, the colouring matter; 2nd, the base, which may be alumina or one of the white pigments; and 3rd, the precipitating agent, which varies with the colouring matter and the base that is being used. In simple language, which may convey the idea better than a lengthened description, a lake is simply a white pigment or substance (the base), with which colouring matter is chemically combined, and which, of course, will not wash out. This explains why lakes are so often of a weak, transparent body; there is too much base and too little or too weak colouring matter in the combination to give a good body to the printing ink.

In preparing lakes, the colouring matter is mixed with water and boiled, the base is prepared in a different vessel and mixed with the colouring matter; the precipitant is then added, when a chemical combination takes place between the colouring matter and the base, forming a coloured pigment which falls to the bottom of the vessel. When the sediment is quite settled the water is run off, the pigment is washed, purified and dried, and is ready for the market.

MADDER LAKE was originally prepared only from the roots of the Madder plant, and was highly prized both by artist and printer as a beautiful and perfectly stable pigment. The plant was largely cultivated in the south of Europe, and formed an important article

of commerce, so much so that about thirty years ago the annual value of the imported roots was about one million sterling. Since then the active principle of the colouring matter of the root—*Alizarin*—has been discovered and prepared from one of the coal tar products—*Anthracene*. This discovery has practically stopped the cultivation of the madder plant and the preparation of the pigment from its roots.

Ink manufacturers, with the aid of chemistry, can now give us red lakes of any shade, of a permanent character and possessing a good printing body, at about one half the price which ruled some twenty years ago.

Red lakes are more or less transparent, and accordingly do not possess great covering power, but with the addition of a little vermilion or other dense red a good working body may be obtained.

Some lakes print well from stone, others do not. The cause of this difference in quality will most likely be found in the different bases employed in their manufacture. As it is not possible for a printer to say what base has been used in the manufacture of any particular lot of ink, which would form a proper subject for analysis by an expert chemist, it should be the aim of litho. ink manufacturers to find out which base will work best in connection with lithographic stone, and so adapt their processes, if possible, to the requirements of the work to be performed. For letterpress or block printing, the conditions required for printing from stone do not apply.

GERANIUM LAKE is a beautiful bright scarlet pigment forming one of the coal tar series of colours, and may be obtained in a great variety of shades. It is very transparent, and therefore has not great covering power. It is also one of the fugitive colours, and does not dry quickly. For purity and brightness of tone it can be highly recommended to the chromo printer for such work as medical and other book illustrations, when the exposure to light is not prolonged.

**Geranium
Lake.**

The third primary colour, Blue, is represented by a few pigments obtained from different sources, and known by different names. Those most familiar are: English or Pure Blue, Prussian Blue, Royal Blue, Ultramarine and Cobalt Blue.

**Blue
Pigments.**

PURE or ENGLISH BLUE has a copper base. It is prepared in various ways, each method giving a different name to the pigment,

such as Mountain Blue, Bremen Blue, Hamburg Blue, etc. In the process of manufacture it is first produced as a green, which is changed into the blue pigment by the addition of a large proportion of caustic soda. The most important operation in the manufacture of blues, as it also is in preparing most of the pigments for litho.

Pure Blue. inks, is the washing. If this is not most carefully and thoroughly attended to, a portion of the acid or other chemicals used in the process still remains after the pigment is ground and mixed with varnish for printing purposes. A very small proportion of these chemicals retained in the printing ink may have a most disastrous effect in destroying, by chemical action, the transferred work, making it necessary to stop the machine and prepare a new stone.

Pure Blue possesses a powerful body, dries well, and is quite permanent either in full strength or reduced. It is affected by acids. Mixed with primrose or lemon yellow it forms an excellent green, and is much used in the printing-room for this purpose. It is largely used for litho. colour work, giving a bright blue with inclination to a green shade. For this reason it is very useful in general illustration work where green foliage and green foreground have to be obtained by a combination of blue and yellow printings.

Prussian Blue. PRUSSIAN or BRONZE BLUE is quite different from Pure Blue in composition, in process of manufacture and in quality. It is prepared from green copperas, yellow prussiate of potash, and nitric acid. It is a most dense, powerful pigment, and in the form of printing ink possesses a depth of blue bordering on black. It has also a peculiar metallic lustre or sheen, which, when well printed, adds greatly to its brilliancy. It is an exceedingly hard pigment and very difficult to grind sufficiently fine for printing purposes. It has powerful drying qualities, and may be used with advantage to mix with black ink, as it both improves the colour and acts as a satisfactory drier. It is quite permanent, but is acted on by alkalies and therefore cannot be used for labels or work which has to come in contact with articles of an alkaline nature, such as soap.

This is one of the inks with which pomade may be used with safety. A little of this or other softener will enable the printer to obtain a beautiful solid film of ink on the sheet. Should the work



VERMILION.



MADDER LAKE.



SCARLET LAKE.



GERANIUM LAKE.



ROSE LAKE.



MAUVE LAKE.

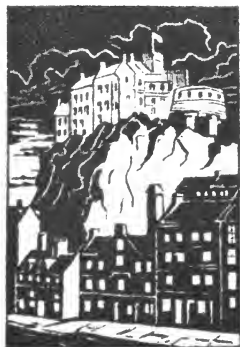

ULTRAMARINE BLUE.

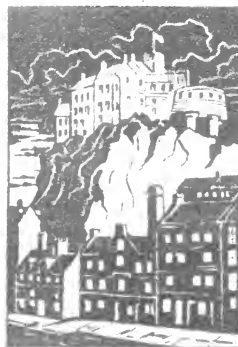

ROYAL BLUE.



ORIENTAL BLUE.

be quite solid and on enamelled paper care will require to be exercised that it does not set off.

Chinese Blue is another name for Prussian, but considered to be of a finer quality.

ULTRAMARINE BLUE was originally prepared from the mineral *Lapis Luzali*, and was highly prized by artists for its beautiful bright tone, which was quite away from any green shade.

Ultramarine Blue. The scarcity of the mineral and the difficult process of manufacture made it so expensive that it could not be used in a modern printing office. It is now made artificially in large quantities from China clay, carbonate of soda, sulphur and coal. It is quite permanent and possesses a moderately good printing body. It is a little difficult to work in full strength, being inclined to print with a marled surface. In colour it is bright sky blue, and is therefore useful when tints of that nature are required. It is acted on by acids but not by alkalis, and in this respect holds the opposite position to that of Prussian Blue.

ROYAL and ORIENTAL BLUE are very similar in composition and properties to ultramarine, but different in shade.

Royal and Oriental Blue. Royal is a bright but dark blue inclined to grey, so much so that when reduced it forms quite a grey-blue tint.

Oriental Blue is of a brighter purer tone, and is useful for sky tints and brilliant colourings.

PURE COBALT was formerly the blue, par excellence, for obtaining the necessary tone and brilliancy in sky colouring, but, being most expensive, it has given place to other pigments in chromo-printing. **Cobalt Blue.** Ultramarine, Royal or Oriental blue, form on the whole excellent substitutes, and give satisfactory results for both purity and permanence.

Besides the blues mentioned, there are many others which are known by fanciful names. Some of these are useful as giving, without the trouble of mixing, certain tones which may be used with advantage for special work or to obtain a given effect. These however do not call for particular notice.

Brown Pigments. **BROWN PIGMENTS** in simple form are not numerous, being limited to the earth colours and a few lakes. Compounded browns however, may be had in all shades and are

known by a great variety of names given to them by the different makers.

UMBER is the most important brown pigment, and perhaps the most largely used for printing purposes.

It is a pure earth pigment and is found in the form of a soft rock in various places in England, also in France, Italy, Island of Cyprus, and America. That found in Cyprus is considered the **Umber.** finest and is sold as Turkey Umber. It contains a larger proportion of oxide of manganese than any of the other brands, which imparts to it a more powerful drying quality.

The mineral is very easily mined and is obtained in large lumps which are ground, washed, and purified for use. In this state it is known as raw umber, and when made into printing ink gives a very nice transparent brown.

Raw Umber when calcined at a red heat in a furnace, changes both in colour and quality, becoming a much darker brown and more dense in body. This is sold as Burnt Umber which is so largely used throughout the trade. It holds the place as the best medium for bronze-printing and also as a very useful brown for general use. Darkened with a little black or blue it gives a dense brown bordering on black.

It is of a hard gritty nature and requires careful grinding to form good litho. ink. It contains a large proportion of manganese, which gives it the property of an excellent drier, so much so that it is used by manufacturers as a siccativ in making drying oils.

It is quite permanent in all its shades which vary from a reddish to a violet brown, according to the amount of calcination it has received.

SIENNA, both raw and burnt, has been already noticed under yellow pigments. It may just be mentioned here, that in its calcined state it possesses a rich golden brown hue, is very useful **Sienna.** in litho.-printing, and quite permanent either in body or when reduced to a tint.

VANDYKE BROWN gives a very dark brown ink. It is named after the celebrated painter who used it extensively in his **Vandyke** works. It is found as an earth pigment and is also **Brown.** prepared by artificial means. The name itself now represents a certain shade of brown, which is almost all that can be said about it from a printer's point of view.

SEPIA is a peculiarly rich, dark pigment, possessing a charming tone which it is extremely difficult to get from any mixture of printing inks.

Sepia. True Sepia is obtained from certain sea animals of the cuttle-fish nature. These animals possess a peculiar sac or gland filled with a dense dark fluid which is used as a means of defence from their enemies. When attacked or alarmed they eject this fluid, which darkens the water all around and enables them to make good their escape. The fluid, when dried and prepared, gives the beautiful pigment in its purest form. It is used mostly in water-colour painting for the production of what are so well known as sepia drawings.

This pigment could not be obtained in quantity, sufficient for the wants of the printing world. It is therefore prepared artificially by the ink manufacturer.

Each maker will probably turn out a different shade according to the recipe that is used for mixing the pigments. It will therefore lie with the printer to judge which is the best for his purpose. Umber, ivory black, and a little burnt sienna will give this sepia tone if the ink itself is not at hand.

A useful brown may be obtained by a mixture of pure blue and one of the ordinary reds. This gives a good printing ink free from grit and should work well from stone.

Brown Lakes. BROWN LAKES are prepared in the same way as red lakes. There is required the base, the colouring matter, and the precipitant. The precipitate may be made of any shade according to the chemicals and the proportion of these used. Manufacturers have therefore a great variety of brown lakes to offer to the printer.

Green Pigments. GREEN forms one of the secondary colours, and is made up in practical work by a mixture of yellow and blue. This is so easily done, and any shade obtained, that pure green is not so often used as might be supposed.

There are however, various green pigments, such as Emerald Green, Brunswick Green, Chrome Green, Zinc Green, and various Green Lakes.

There are many beautiful bright greens found among the aniline series of colours, but they are quite fugitive, and must be avoided even for work which is not to be exposed to the action of light.

CHROME GREEN is chemically prepared from bi-chromate of potash and boracic acid, and also from bi-chromate of potash and ammonium chloride. It is of a yellowish tone and is quite permanent.

BRUNSWICK GREEN is an artificial compound of chrome yellow, Prussian blue and white, and may be had in various shades. It also is quite permanent.

EMERALD GREEN is a chemical preparation of copper and arsenic. It possesses a brilliant hue but is of a poisonous nature and is now seldom used by printers.

GREEN LAKES.—These are prepared in the same way as other lakes, on a variety of bases and from different colouring matters. Those obtained from the coal tar colours are, as already noticed, quite fugitive; others are good and permanent, possessing a fair body and work well from stone.

VIOLET and PURPLE LAKES are generally of an unsatisfactory nature, both as regards working qualities and permanence, and should be sparingly used by litho. printers. When a piece of work is wanted in a mauve or violet, the permanence of the colour will be greatly helped by printing a varnish right over it. Should this not be possible, it may be preferable to do with a less brilliant hue, and use a mixture of madder lake and Oriental blue, which will give a permanent colour.

Having noticed in a very cursory way the pigments which are available and which are in general use in the production of Lithographic colour work, it may be helpful to give the substance of what has been written in a tabulated form, noting in particular those points which it is important that a litho. printer should bear in mind.

In closing this chapter on pigments, or to use a more familiar term, inks, we would say that inferior qualities of the whole series are often sold, sometimes with the aim of obtaining larger profits, but more frequently from inability on the part of the manufacturer to produce better. These inferior qualities will produce bad work and cause a great deal of trouble and worry. To obtain a good result from lithographic stone the best possible ink is required, and the master-printer should not grudge a higher price to procure it, as in all cases it will prove the most economical and satisfactory in the end.



BRONZE BLUE.



ITALIAN BLUE.



PURE OF ENGLISH BLUE.



LIGHT GREEN LAKE.



DARK GREEN LAKE.

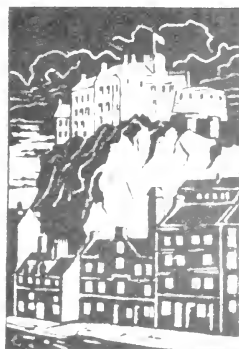

PEACOCK GREEN.



IVORY BLACK (Tint).

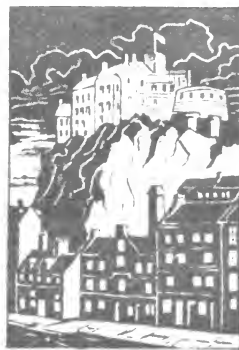

COMMON BLACK (Tint).



SEPIA.

TABLE OF PIGMENTS AND THEIR PROPERTIES.

PIGMENTS

NAME OF PIGMENT.	Composition, Base, or Method of Manufacture.	Permanency.	Drying Quality.	Opacity.	Working Quality.	REMARKS.
BLACK . . . Do. FRANKFORT . Do. IVORY . .	Carbon Carbon and Mineral Carbon and Mineral	permanent do. do.	very little slow do.	opaque do. semi-transparent	good bad bad in body	Cheap blacks are to be avoided. Not suitable for litho. work. Gives beautiful pearl grey tint and is excellent for toning positive colours. Will not work from stone in full body.
FLAKE WHITE . .	Lead	permanent	powerful	very opaque	rather heavy	Will bleach most colours a little when mixed with them.
ZINC WHITE . .	Zinc	do.	none	opaque	..	Not used in litho-printing. Flake white being in all respects better.
GLOSS WHITE . .	Artificial	do.	do.	transparent	..	Only to be used as a mixing white for tints.
YELLOW OCHRE . . SENNA, RAW . . Do. BURNT . .	Earth do. do.	permanent do. do.	moderate do. good	semi-transparent transparent opaque	gritty weak body rather sandy	Not used in litho-printing. Gives a quiet yellow tone, in tint. Gives a rich golden brown, being of a sandy nature, not suitable for long runs.
UMBER, RAW . . Do. BURNT . .	do. do.	do. do.	moderate powerful	transparent opaque	weak body a little gritty	Gives a beautiful yellowish brown tint. Forms the best medium for bronze-printing.
YELLOW, CHROME . . Do. CADMIUM . . Do. LAKE . .	Lead Sulphur Vegetable colouring	permanent fair do.	quick	opaque semi-transparent transparent	good do. do.	May be had in all shades from primrose to deep orange. Very expensive, rarely used. A brilliant yellow when printed, in bulk has the appearance of a brown ink.
VANDYKE BROWN . . SEPIA	Earth, also artificial Animal, also artificial	Permanent do.	moderate do.	opaque do.	good do.	A dark dense brown. Pure sepia is semi-transparent and only used for water-colour painting.

TABLE OF PIGMENTS AND THEIR PROPERTIES—Continued.

NAME OF PIGMENT.	Composition, By Method of Manufacture.	Permanency.	Drying Quality.	Opacity.	Working Quality.	REMARKS.
VERMILION . . .	Mercury and Sulphur	permanent	very slow	very opaque	generally good	Imitation vermilion or vermillionettes are not good and now seldom offered.
LAKE, Madder . . .	Vegetable	do.	slow	semi-transparent	fair	Madder Lake obtained from the Chemically prepared pigment.
Do. Do.	Chemical	do.	do.	do	good	
Do. ROSE	do.	fugitive	do.	transparent	fair	A beautiful and useful colour for maps and finely-coloured plates.
Do. SCARLET . .	do.	fair	do.	semi-transparent	good	These vary in density, permanence, and working qualities, as prepared by different makers.
Do. GERANIUM . .	do.	fugitive	do.	do.	do.	A useful colour for general illustration and medical work.
BLUE, PURE . . .	Copper	permanent	quick	opaque	good	Useful for all kinds of work, is inclined to green tone.
Do. BRONZE, PRUSSIAN, or CHINESE	Chemical	do.	powerful	very opaque	do.	Acted on by alkalis not by acids.
Do. ULTRAMARINE	do.	do.	moderate	moderate	difficult	Possesses the opposite quality from Prussian Blue in that it is not affected by alkalis but is affected by acids.
Do. ROYAL and ORIENTAL	do.	do.	do.	do.	difficult to work in body	These blues are warm and bright, possess good depth in body, and give rather a grey blue when reduced to a tint.
CHROME GREEN . .	Chemical	permanent	..	opaque	good	Seldom used.
BRUNSWICK GREEN .	Artificial	do.	quick	do.	do.	An artificial mixture of chrome yellow, bronze blue, and white, possessing the qualities of these pigments.
EMERALD GREEN . .	Chemical	do.	..	opaque	bad	This pigment is poisonous and seldom used.
GREEN LAKES . . .	do.	do.	moderate	fair	good	These work well in any shade.

Chapter XVIII.

PRINCIPLES OF CHROMO-LITHOGRAPHIC DRAWING AND PRINTING.

SUCCESSFUL colour printing depends very largely on the ability and energy displayed in two distinct departments of the lithographic establishment, viz., the artistic and the printing. These are so dependent on one another that it is important for the artist to possess some knowledge of the methods and art of printing; and it is also necessary for the printer to understand what the artist wishes to produce, and with some degree of intelligence and feeling to give effect to his ideas and instructions.

The remarks in this chapter will therefore be in connection with the work of both artist and printer, and may in some cases blend together the work of both. This chapter may appear somewhat superfluous, but it is intended to be read as an addition to, or a commentary on, what has been already written in Chapter IX. regarding drawing on stone or grained paper, and in Chapters XII. and XV. regarding hand-press and machine printing.

When a coloured drawing is presented for reproduction by lithography the first question to be considered is, how many printings are to be allowed? This will depend on the nature of the **Artist Work.** work and the price to be paid for the finished copies. Should there be ten printings arranged, the next step is to analyse the drawing and see what these ten colours are to be, and the artist will then draw up a scheme of colouring for guidance in lithographing and proving. This scheme will consist of a wash of each colour put on a strip of drawing paper in the strongest tone which is intended to be used in the reproduction. This wash should represent the solid ink parts of the respective colours, and the gradation from this strength will be obtained by chalk-work, stippling, or transferring from plates. Unless there is special colouring in the design, the following scheme will give a good variety of colour and enable the artist to work a.

strong body and also a lighter tint of the three primaries, along with two greys, a drawing-stone, and one other colour as required:—

SCHEME.	REMARKS.
1. PALE YELLOW.	Any shade most suitable for the subject in hand.
2. DEEP YELLOW OR ORANGE.	The discriminating use of the pink over parts of the pale yellow, will often enable the artist to do without the second yellow printing, which will allow another colour to be used instead, if required.
3. PINK OR ROSE COLOUR.	This, with a little yellow underneath, will give agreeable flesh tints, and may be used pretty freely.
4. PALE BLUE.	This, worked over the pale yellow, will give a pale green, and over the pink a pale violet. It is a useful colour and the artist will obtain general toning by using it freely.
5. RED.	For picture work it is generally advisable to use a madder or crimson ink, as by having yellow underneath, a vermilion tone is obtained, while with blue worked over it, a purple tone is produced, thus obtaining a variety of reds with one printing.
6. DARK BLUE.	To be worked as required to give best effect and fullest value.
7. BROWN.	On the top of dark blue will give deep shadows.
8. LIGHT GREY.	Used to tone generally.
9. BLACK OR OUT-LINE COLOUR.	Gives the form and drawing of the picture.
10. DARK GREY.	Will give shadows and tone positive colours where required.

These ten printings as a rule will give a good result in the hands of a careful artist, who will, in drawing, give to each its best value, and blend them together as much as the subject will allow.

They should be printed in order as arranged above.

Artists and others who are not acquainted with the limitations of

lithography sometimes give expression to the idea that, given the three primary colours and an outline drawing, any subject may be reproduced. This is true in a very limited sense indeed, and only when a diagrammatic flat reproduction will answer the purpose, such as is often required in advertisement leaflets and show bills, and occasionally in books for children. This limitation is caused by the stone not being able to receive or print dots sufficiently minute to represent a soft light tint, while printing, at the same time, a strong body colour. In this respect it is very different from the three-colour process blocks, from which there may be printed at one operation the darkest possible blue or red and the most delicate tint of the same. This result is obtained by means of most minute dots which, in many cases, are invisible as such to the naked eye. The fineness of these dots may be realised from the fact that there are from ten to twenty thousand in each square inch, and that each one is perfectly distinct and separate from the other.

In order to obtain soft and delicate effects in litho. printing, it is necessary to use a reduced colour in the form of tint, as indicated in the above scheme, such as pale yellow, pink or rose, pale blue, etc., using other printings afterwards to obtain the stronger colour effects. The litho. artist will know from experience where and how far he may use a strong or full body colour to blend with, or deepen a lighter tint.

A very important point in connection with drawing the colour stones of a pictorial or nature subject is the artist's ability to grasp what effect each colour in his scheme will give, when used either in full strength or in gradation, and how far he may use each one in combination with the others to give variety and value in tone. Owing to want of training or natural ability, or both, on the part of artists, the full value of each of the colours or printings is not so often obtained in actual work as might be expected.

Another important point which the artist should be able to grasp is the subduing effect of the stronger colours. A tint, or even a pretty strong tone, will often lose a third or even one half of its strength value, when it is cut up or surrounded by a more powerful colour. For this reason it is necessary to print the first paler tints rather full, and also to print the toning grey last, after the outline or drawing stone has had full effect in throwing back the previous printings.

An illustration of this principle may be seen in Plate VI. where Figs. 4 and 5 represent a blue and russet tint, and Figs. 6 and 7, the same tints appearing much lighter when surrounded with black. Any strong colour surrounding a weaker will show the same result though perhaps not to the same extent.

The means used to obtain gradation of tone in colour printing may now be considered shortly. The methods or mediums may be divided into five varieties :*—

1. Grained stone.
2. Grained paper.
3. Hand and medium stippling.
4. Plate transfers of stipple and ruling.
5. Air brush.

It has always been a great objection to lithographic work on the part of professional artists, and also publishers who desired artistic illustrations for their publications, that the mechanical grain employed in the process is so often apparent throughout the whole series of colours used in the production. On the other hand, many practical men in the trade, both artists and masters, who felt that there was good ground for this objection, have made an earnest endeavour to minimise the fault by using grained paper or other media which had a more or less natural granulation.

There is no doubt that the grained stone gives the most delicate and artistic feeling of any method of lithographic reproduction, and it was this beautiful mezzo-tint style, with all its capabilities, that attracted to its side so many artists of repute in its earlier days. Since then, many things have arisen which have brought about a great change. In the first place, the grained stone method is slow and requires in a special manner skilful treatment, which make it too antiquated for present day use. Then photography, with the development of its many beautiful and more economical methods of portraying nature, took away a large amount of work which might have been produced by lithography. Still another cause has operated very powerfully within its own borders, viz. :—the advent of the cylinder machine, which is

* These methods of working have already been under consideration, but more in regard to their technical points, and, as already stated, what follows is to be considered as a commentary on that part of the subject.

not well adapted for printing from grained stones. Other methods of drawing had therefore to be introduced to meet the requirements of rapid machine printing. All these, and other conditions as well, have made grained-stone lithographic work fall very much in the background, so that now, comparatively few artists take any interest in its pursuit.

Beyond explaining how grained stones are prepared and giving directions and hints as to drawing, which we have already done, it does not seem necessary here to describe further the method; but we would recommend any artist who wishes information on the subject to read C. Hullmandel's work on "The Art of Drawing on Stone." In this volume there are, besides other plates, two exquisite examples of chalk work; one a portrait, the other a landscape. Hullmandel goes very carefully over all the points which demand attention, and it only requires some careful practice, along with artistic ability, to enable any one to produce satisfactory work. Those who have been trained in a litho. establishment should very easily take it up.

The frontispiece to this volume, a portrait of Senefelder, has been drawn on a grained stone and printed at machine. It was drawn by a young litho-artist who had very little experience in this method.

As we have already considered the preparation of, and drawing on, grained paper, we would now more especially draw attention to the results obtained from its use.

Grained plates are generally of copper, though sometimes of zinc, and the grain is obtained by etching, which is a difficult and delicate operation. Very few plates are quite perfect, so when a really good and regular grained plate is obtained, it should be prized as a valuable possession. In a litho. establishment which lays itself out for colour-printing, there will be plates of different grains or textures, and it will be the artist's duty to choose that which will give the best result, not only in obtaining a proof, but particularly in the machine printing. The foreman printer should be consulted in regard to important pieces of work, as he may be able to make suggestions which may assist both the drawing and printing operations.

For commercial work, a mechanical or stippled grain may do very well, and will give the least trouble during the operation of printing. For book illustrations or pictorial work, a grain as near as possible

to the sand grain of the stone is very desirable. Should a plate of this description not be available, a good substitute may be found in a nicely grained stone, rather rough than smooth. To receive the grain the transfer paper is damped just as much as is permissible without allowing it to stick to the stone; the sheet is then laid face down and passed through the press under sufficient pressure to ensure a good emboss. In this operation the paper will, of course, receive the natural grain which the stone possesses, with this difference, that the hollow parts of the stone grain will give the raised parts of the paper grain, which will, therefore, receive the work. This difference will not be found a disadvantage, neither will it affect the natural character of the grain.

It is quite evident that if several colours, having a mezzo-tint texture, are worked and printed together in producing a coloured illustration, they will blend with one another, and give a harmonious result very superior to the same number of colours prepared by means of a more mechanical grain or hand stippling. With natural grain, skilful artistic drawing, and good printing, it is possible to produce some wonderful effects by lithography, which might easily be mistaken for original water-colour drawing.

Hand stippling is necessarily a slow mechanical process, and the stipple dots, especially if visible in the stronger colours, are very offensive from an artistic point of view. As already noticed, it is admirably adapted for commercial colour-work and also for machine printing. For these reasons, it will often be more profitable to pay double or treble the usual charges in getting a label drawn on stone in this way, so that he may have a clear run at the machine, and a good piece of work at the end, which will be both satisfactory and profitable.

Shading mediums and the air brush have already been noticed at pages 87, 88, respectively, and do not require further consideration here.

Transferred stipple or ruling is one of the earliest and most simple methods by which flat, half or quarter tints are obtained, to print along with a solid colour. For maps, plans, or diagrammatic drawings it is most useful. A variety of tones, as well as distinct colours, may be obtained by crossing two or more of these rulings over each other, or by double

**Hand
Stippling.**

**Transferred
Stipple.**

transferring of the same grain (see Plate V., page 100). Beautiful examples of this class of work may be seen in the coloured contour maps issued by Messrs. J. Bartholomew & Co. of Edinburgh. For flat colouring, so often required for children's picture books, this method is also very suitable. Light-and-shade effects may be obtained in these transferred grounds, by gumming out before transferring, and also by hatching and touching up the work with a pen or brush, the latter before, the former after the stipple is put on stone.

Hints regarding Chromo Work. It should be the one aim of the litho. artist to use any or all of these methods in his work, so that ultimately he may obtain the best possible printing result, keeping in mind whether the subject in hand is to be printed direct or from transfers.

The artist need not expect that his handiwork, by whatever method he may have produced it, will be improved in the process of transferring, preparing, proving, and printing; each of these operations has unfortunately a deteriorating effect, often so marked that it is quite discouraging to a young artist who has put heart and soul into the subject he has been seeking to reproduce. He has not yet realised the weak points of the process. Part of this deterioration is inevitable, the other part, which is generally the major part, may be avoided or minimised by skill and care on the part of the workmen. For this reason it will bear repeating, that it is important to consider carefully which is the best method to adopt in producing any given subject or design, so that the minimum of deterioration may take place in the after preparation.

In proceeding with litho. reproduction the lighter colours should be drawn first. Three or four of these should be completed and proved, then, after comparing the partly proved subject with the original sketch, and noting what may be required in the succeeding printings, two or three more colours are finished and also proved, and so on till the subject is completed. In important work the later colours are those which require the greatest judgment and care, both in drawing and proving. When printing is started, a proof should be passed and signed by the artist or overseer, and this should be kept before the printer till the work is finished. Very few men, if any, can carry the proper tone in the mind's eye, and

unless there is a standard kept continuously before the machineman the work may vary in colour to an alarming degree.

It should also be kept in mind by the person who passes the proof, as well as by the printer, that an impression taken direct from the machine always appears a little stronger than it will do after lying for a few hours. For this reason, sheets of colour work immediately printed should appear just a shade stronger than the standard proof. This may apply to all colours with the exception of yellow, which has a tendency to assert itself rather strongly.

The order in which the respective colours are printed will depend on the artist and on the effect desired. As a rule however, the order will be as already indicated, viz., the lighter and opaque colours first, the stronger colours following, then the outline, followed by the grey which gives tone to the whole.

The first light colour should be put, as much as the subject will allow, well over the paper, especially when it is *not* enamelled, this will give a ground and tone for succeeding printings.

In closing our remarks in this section, we might call attention to the differences which exist between lithography and the three-colour process.

It was thought by some that the latter might almost put the former out of existence as far as colour reproduction was concerned. This however, is not the case; as, although a large amount of work which might have been done by lithography has been handed over to its competitor, the greater proportion of the three-colour work being done at the present time would never have been done at all if the process for doing it had not come into existence.

The decided advantage of the process lies in the fact that the artist obtains a photographic reproduction of his work, for which, in many instances, a good deal will be sacrificed.

The decided *disadvantage* lies in the general limitation in printing to three colours, and those of the purest and most positive nature. Though these blend together in a wonderful way they still often exhibit a rather crude and inartistic appearance in the printed plate.

Another disadvantage is the necessity for using an enamelled surface paper, which, though curiously enough termed "Art," is very far removed from lending itself to artistic feeling.

There is undoubtedly a wide and, it may be, a growing field for

three-colour printing, but we still think that lithography possesses so many possibilities and so great an amount of artistic merit, that it will hold its own for a very long time to come. To assist this, it would be well if all those who are engaged in its pursuit would do their utmost to carry real artistic feeling through all their work, and educate themselves for this end. The reader is also referred to a previous notice of three-colour printing at page 175.

Chapter XIX.

PAPER—VARIETIES, QUALITIES, AND CONDITIONS FOR PRINTING.

IN lithographic printing, the paper holds an important position in relation to the class and quality of work to be produced. Some papers are good, some are bad; some are suitable for one class of work and just as unsuitable for another; while the endless variety in quality and substance gives the ordinary litho. printer many "a bad half-hour." A short chapter on paper, therefore, appears a necessity in a work dealing with the practical side of litho-printing.

Paper Varieties. Paper is manufactured from a variety of substances possessing a fibrous nature, such as linen and cotton rags, esparto grass, jute, hemp, manilla, wood, straw, etc.

LINEN is used in making bank note, bank post, type-writing, parchment, and other high-class writing papers. All these are extremely strong and durable and do not take on a smooth surface, this being one of their special features which is prized by those who use these qualities. Unless the surface of these papers is very rough they print very well from stone, taking on a fine sharp black impression of the engraved work, which is generally what is required to be printed for commercial stationery.

COTTON RAGS for many years was the principal material used in paper manufacture, and nothing has yet been found so suitable for the purpose, though, owing to the inability of the civilised world to provide a sufficient supply, substitutes have been found in the articles enumerated above. Rag paper, as it is called, is considered the best and most durable of printing papers, and "Plate" paper is the purest and best of the kind. Rag paper is only used at the present time in the production of very high-class publications and works of art.

ESPARTO GRASS is largely used in making fine printings and is

admirably adapted for the purpose. Spanish grass is considered the best, and this, when mixed with a small proportion of cotton rags, gives a printing paper which is the best possible for general lithographic work. The fibre of esparto grass seems to possess a soft and kindly nature which lends itself to the reception of the printing ink, being quite opposite to that of wood fibre which is hard and harsh.

JUTE and HEMP are used for making wrapping, sealing, tea and biscuit bag, and other papers, all of which require to be of a strong tough nature.

MANILLA is used for making the well-known paper bearing its own name. It is very similar in substance to jute and hemp and gives a strong, almost untearable, sheet of paper, which is used for address labels, boxes, book covers, etc.

WOOD FIBRE has come more recently into the market as a paper-making material and as a substitute for esparto grass. It is now very largely used in the manufacture of printings for journals, newspapers, and cheap booklets. The better qualities are used, along with a proportion of other fibres, such as esparto, in making ordinary printings. Paper which has a large proportion of wood fibre in its composition is recognised by being rather brittle and of a hard unkindly nature, which makes it unsuitable for lithographic colour work.

STRAW is used along with wood in the production of the cheapest quality of news printings. This paper is extremely brittle and easily torn, as seen in what is generally used for evening newspapers.

The difference in price of paper manufactured from the first and last mentioned substances will give a very good idea of their relative value. That made from fine linen and cotton rags is sold wholesale at from 8d. to 1s. 4d. per lb., while wood and straw papers may be bought at from 1d. to 2d. per lb.

The whole vegetable world has been explored, and experiments made with every likely plant with a view to obtaining suitable fibrous material for the manufacture of paper, but without great success. Esparto grass and wood are the two principal, if not the only additions, made during recent years to the list of substances available for the papermaker's use, and these have enabled him to meet the enormous demand which has arisen in connection with the cheap literature of the day.

The different processes of picking, boiling, bleaching, and reducing the materials to pulp, and the further operations of manufacturing that pulp into paper are most interesting, and may be studied with great advantage by all practical litho. printers. The means for this study will be found in the technical works which are so easily obtainable

Paper Making. from the public libraries throughout the country. It will only be necessary for us to notice here, the general properties and conditions of paper in so far as they affect the subject of this work. Each of the above mentioned substances,—cotton, esparto grass, etc.—is largely composed of fibres, differing respectively the one from the other, and on these differences mostly depend the great variety and qualities of paper to be found in the market.

The raw material after being picked and assorted is boiled with caustic soda in large steam boilers for several hours. This operation softens the fibres and dissolves the vegetable matter which surrounds them. It is then bleached by means of chloride of lime or other agents and afterwards passed through “breaking” and “beating” engines where it is further purified and reduced to a fine pulp. A great deal depends on the work done in the beating engine, and the time given to the different fibres requires careful regulation in order to obtain the best result from each. The “stuff” is then mixed with a large proportion of water, along with other necessary materials, and run on to the paper-making machine in a broad continuous stream. This stream of liquid paper is first led along on an endless band of wire-cloth, which permits the water to pass through, leaving the film of paper behind. This film, very soft in its present state, is passed from the wire-cloth to a thick blanket, which takes it on between two or three sets of press rolls; at this stage it becomes really a sheet of paper, though still in a very limp state. It then travels onwards between a series of drying cylinders, and still further onwards to the calender rolls, which give it a smooth surface, and lastly to the reel at the extreme end of the machine, which receives and forms it into the well known webs. The width of the machine determines the width of the web, which may be from 60 to 120 inches. These rolls or webs of paper are afterwards cut to any required size and made up into reams, generally of 480 sheets.

Coming back to the endless band of wire-cloth which receives the liquid stream from the pulp vat, we note that it is from this wire-cloth that the paper receives the crossed pattern on its underside, which is known to printers as the "wrong" side. The water-mark and "laid" appearance are also given to the paper at this stage by means of brass cylinders, which have the design worked in relief on their surface. These are called "dandy" rolls, and run on the top of the paper, impressing the water-mark design, or the "laid" appearance on the surface of the soft sheet as it travels along. For "wove" paper the dandy roll has a covering of wire cloth, which imparts a wire-mark similar to what is on the under side of the sheet, but so light that it is scarcely discernible. Printing papers, except in special cases, are also "wove" though not known by that term, the dandy roll being employed on this class of paper, to give closeness and firmness to the sheet.

**The
Wire Mark.**

It is quite evident that the fibres which really form the paper, and which have length with little breadth, will naturally flow along the surface of the wire-cloth in line with the running water. To make these fibres cross or "felt" with each other the wire-cloth is given a sharp, vibrating motion from side to side. But, as by this means they cross and are interwoven with each other only to a limited degree, we may conclude that the fibres of any paper run practically in one direction, forming more a continuous length than a network of the materials used.

From this may be deduced several very important points for a lithographic printer's consideration.

We note first that the paper will bear the greatest tearing strain, across the fibres, or from side to side of the machine or web, while the way the paper is rolled corresponding with the length of the fibres will be weaker and tear more easily. But although the paper is strongest across the web, in that it will stand the greatest strain in tearing, it is weakest in bearing the strain of tension or expansion. This is clear when we consider that fibres which lie alongside each other must have less cohesion than these same fibres possess when felted or interlaced with one another lengthways, in however small a degree. If, then, there is less cohesion between the fibres of the paper one way than another, it is quite evident that atmospheric

conditions will affect the sheets more in that direction than the other, and this is found to be exactly the case in practical experience.*

The knowledge of these conditions has been acted upon by the writer in the choice and ordering of paper for nearly thirty years, and has been found of great advantage in obtaining the best possible register in colour work. The length of the fibre is given to the breadth of the cylinder, and conversely the way of least cohesion to its circumference.

To enable any one to judge as to which way the fibre runs in any sheet of paper, it is only necessary to look at the wire-mark on the wrong side. These marks are roughly elongated diamond-shaped, and the fibres always run the longer way of the diamond.

The wire-cloth in the paper-making machine has generally an equal-sided mesh, and the paper, after receiving in its soft state the impression of this mesh, in drying, shrinks a good deal more sideways than lengthways. This shrinking sideways, along with the tension which the paper bears lengthways, as it passes round the various drying cylinders, gives the elongated shape to the wire-mark referred to, which forms a sure indication as to how any sheet of paper has been cut from the web, and enables one to judge in which direction it will stretch or shrink the most.

The two illustrations, Figs. 21 and 22, will give a fair idea of the appearance of the wire-mark on the paper before and after drying. Fig. 21 is a reproduction of an actual impression from a piece of wire-cloth. Fig. 22 is a larger piece of the same impression shrunk one way only by means of the Indiarubber reducing machine. The shrinking is somewhat exaggerated to show more distinctly the difference between the two.

One other point in this connection may be noted. Thick paper will fold more smoothly the length way of the fibres than across. The reason is obvious; in folding across the web the fibres are

* Should any one desire to test this, let him take a sheet of printing paper, say 25 inches square, draw a line across the centre of the sheet each way and mark it at each extremity exactly 24 inches, taking the same measurement on an iron or glass straight-edge, damp the sheet with a sponge and let it lie for half-an-hour, it will then be found that one of the measured lines is considerably longer than the other. The line which has stretched least, or perhaps not at all, runs with the length of the fibres, which corresponds with the length of the paper-making machine and the circumference of the web.

broken, while in folding with the run of the web the fold comes as it were between the fibres and so gives it a smoother appearance.

All papers intended for printing or writing purposes require to be sized or hardened. Blotting is the typical example of paper which is unsized and therefore quite absorbent. Writing papers may be either "tub-sized" or "engine-sized," while printing papers always belong to the latter class.

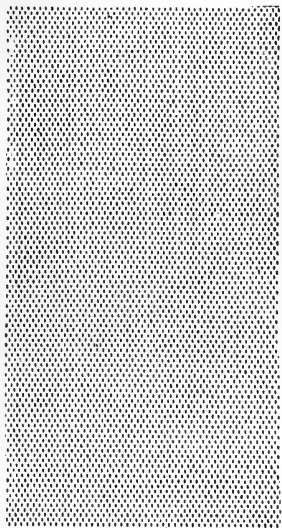

Fig. 21. WIRE MARK.

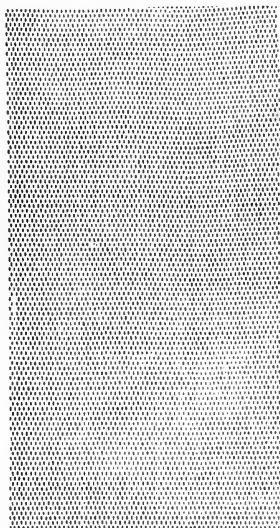

Fig. 22. WIRE MARK, SHRUNK.

The sizing material for printings and cheap writings is put into the beating engine and mixed with the paper while still in its pulp state. This hardening material, which is generally a chemical preparation of rosin and alumina, is thus mixed and thoroughly incorporated with the substance of the paper and renders it more or less non-absorbent, according to the quantity and kind of material used. This hardness is however, only comparative, as all kinds of paper will absorb water more or less, though very slowly when compared with blotting or plate paper.

Good writing, bank, cartridge, and drawing papers receive their

hardness of surface after the sheets are made. To do this, a tub or trough is filled with glue or animal size; the web is gradually unwound and passed through and then dried quickly by artificial means. Papers receiving this treatment in sheet or web are called "tub-sized," and are suitable for writing upon. They will also stand a coating of spirit varnish if required.

All litho. printers know full well that cheap wove writing or printing paper will lift the ink much better at machine than a tub-sized writing will do. The hard, unkindly surface of the latter requires different treatment both in regard to ink and pressure, while the printing will take a much longer time to dry because the surface is non-absorbent.

The paper as it comes from the mill is supposed to be quite, or "bone dry." In this state it is not suitable for printing from the wet flat surface of a litho. stone. Some classes of paper, and more particularly those which are to be super-calendered, are sprayed with water or steam to enable them to take on a smoother surface as well as to reduce the stretching tendency to a minimum. This is so far good, but if it were done a great deal more, and to all classes of paper intended for litho. printing, it would be still better, and would prove a benefit to both printer and paper-maker alike.

Paper coming from the mill in this "bone-dry" state is much drier than the atmosphere around; the natural action therefore immediately comes into play, in that the edges of the paper absorb moisture which causes expansion, and the paper becomes crinkled at the outside margins. This condition of the paper forms a serious difficulty to the printer, and many things have been proposed and tried as remedies. The simplest and most efficacious plan is to hang the paper up in a cool room so that the atmosphere may freely reach every sheet and thus give equal expansion to every part. To gain the desired effect, the paper should hang up for two or three days, or longer if possible. After this has been done the paper should lie quite flat, and give no indication of creasing while passing through the printing machine.

There are different ways of hanging up paper; the best perhaps is by means of strong spring clips, two of which will bear ten to twenty sheets, and permit the air to circulate very freely between them. In summer, the floor should be well watered several times in the twenty-four hours. In winter, there is always sufficient, some-

times more than sufficient moisture in the air to answer the purpose. This is a most important matter for successful litho-printing, and requires the careful attention of an intelligent warehouseman so that it may be carried through in a proper way.

The surface of papers requires to be carefully looked to, so that a good result may be obtained in printing. "Litho-printing papers"

Paper Surface. have generally a sufficiently smooth surface, and being made from esparto grass, mixed with a little rag and bearing a proportion of China clay, are about the best possible for taking good impressions from work on stone.

PURE RAG PAPER possesses a beautiful pure texture, but having little, if any, China clay in its composition, has not a kindly surface for litho-printing. Before being used it should be very slightly damped and plate-glazed, in which state very beautiful work may be obtained from its use.

SUPER-CALENDERED PAPERS are always smooth to a degree. If the paper is soft sized, and the appearance of the work will not suffer from the ink being absorbed, this extra smoothness will be a decided advantage in printing. But if the paper is hard or of an inferior quality, super-calendering will give too much of a glass surface, and cause the work to smear very easily on the paper. It will be advisable to interleave work printed on super-calendered paper after the first few printings, if not from the commencement of the job. "Machine finish," which can now be given almost as smooth as a calendered surface, we consider the kindest and best for ordinary litho-printing, whether in black or colours. Using a paper of this quality will often save a great deal of trouble with interleaving.

ENAMELLED PAPER is used for all kinds of label and chromo work.

Enamelled Paper. It is specially suitable where there is a gold or other bronze printing. It is also the best paper to use when the work is to be spirit varnished.

Bright enamelled paper is used for labels and box wrappers. From a lithographer's point of view, it is not a desirable paper to print on. It is difficult to get the ink to take a proper hold, and there is always the danger of it rubbing off when dry. The qualities, and how to test the hardness of the enamel surface have been already noticed pages 141, 142.

"JAPANESE" is the most expensive, and when of fine quality is the

most beautiful of all papers. It is made by the Japanese people from the inner bark of the Mulberry tree. The fact of it being hand-made, no doubt, accounts for its irregularity in thickness, which is found to occur even in the same sheet. It is practically untearable, has a beautiful tone, with a charming silky texture, and takes a very fine impression from the stone. Its use is confined to printing etchings, photogravure and other plates for *editions de luxe* of valuable works.

Ten to twenty years ago, when the demand was not so great, the quality appears to have been at its best. Unfortunately for the printer, as well as the producer, it has greatly deteriorated since that time, and is often rough and unnecessarily irregular both in thickness and quality. The price is about $2/6$ per lb., which appears to be much above its intrinsic value.

There are many other varieties of paper which do not call for particular notice in a work of this sort, as ordinary experience gained in the printing-room, should enable any workman to adapt his methods of printing so that the best results may be obtained on each variety.

The sizes of paper most generally used in the printing-room have already been given, but a more complete list in a tabulated form is annexed.

SIZES OF PAPERS.

WRITINGS.		PRINTINGS.	
	Size in inches.		Size in inches.
Pott - - -	$12\frac{1}{2} \times 15$	Crown - - -	15×20
Foolscap - - -	$13\frac{1}{4} \times 16\frac{1}{2}$	Demy - - -	$17\frac{1}{2} \times 22\frac{1}{2}$
Double Foolscap	$16\frac{1}{2} \times 26\frac{1}{2}$	Double Foolscap	17×27
Pinched Post - - -	$14\frac{1}{2} \times 18\frac{1}{2}$	Royal - - -	20×25
Post - - -	$15\frac{1}{4} \times 19$	Super Royal - - -	21×27
Large Post - - -	$16\frac{1}{2} \times 21$	Double Crown - - -	20×30
Book Medium - - -	$17\frac{1}{2} \times 22$	Imperial - - -	22×30
Medium - - -	18×23	Double Demy - - -	$22\frac{1}{2} \times 35$
Royal - - -	19×24	Double Royal - - -	25×40
		Quad Crown - - -	30×40

Some of these sizes vary a little with different makers.

A quire of paper is 24 sheets, a ream is 20 quires = 480 sheets. For convenience, reams are often made up to 504 sheets = 21 quires; or

to 516 sheets = $21\frac{1}{2}$ quires. The last mentioned number of sheets given to the ream is very useful for colour printing, as it gives 32 sheets to the 1000 for overs and waste. Paper is sent from the mill in reams either flat, folded, or lapped; for lithographic purposes it should always be flat.

The following simple rules will enable any one to reckon up, mentally, and with ease, the equivalent weights of the three sizes of paper which are most in use.

Demy size has a little under 400 square inches in area; medium has a little more, but both may be reckoned for convenience at 400; royal has exactly 500; and double crown 600 square inches.

1st Rule.—Royal is one-fourth heavier than Demy	. 400 + 100 = 500
2nd ,, Double Crown is one-half heavier than Demy	400 + 200 = 600
3rd ,, Demy is one-fifth lighter than Royal	. 500 - 100 = 400
4th ,, Demy is one-third lighter than Double Crown	600 - 200 = 400

Examples :—If a demy ream weighs 24 lbs., a ream of royal, same substance, will weigh one-fourth more = 30 lbs.; a ream of double crown will weigh one-half more = 36 lbs.

On the other hand, if a ream of double crown weighs 60 lbs., a ream of royal, same substance, will weigh one-sixth less = 50 lbs.; a ream of demy will weigh one-third less = 40 lbs.

To estimate the weight or price of a ream of paper of 504 sheets, as compared with an ordinary ream of 480 sheets, it is only necessary to add $\frac{1}{6}$ to weight or price. Thus, if a ream of 480 sheets weighs 50 lbs., a ream of 504 sheets equal 21 quires, will weigh $52\frac{1}{2}$ lbs.

A ream containing 480 sheets, contains as many sheets as there are pennies in £2.

If a ream costs 40/-, one quire will cost 2/-, or 1d. per sheet.

„ 20/-, „ „ 1/-, or $\frac{1}{2}$ d. „

„ 10/-, „ „ 6d., or $\frac{1}{4}$ d. „

It will be seen that by using the above rules, a great deal of every-day calculation may be done in a very simple manner.

Paper, when brought into the warehouse in bales, should be opened out as soon as possible, and piled with a wooden board between every few reams. This assists the seasoning, and prevents that heavy creasing which spoils so much paper when kept for a length of time in the original bales.

Chapter XX.

ZINC AND ALUMINIUM PLATES.

FROM an early period in the history of lithography, various substances and artificial materials have been tried as substitutes for the cumbrous slabs of limestone, which form the groundwork of the process.

Zinc was one of those substances which was tried at an early date, and has been, more or less, in use ever since, though never giving very satisfactory results. The Government have perhaps used it the most successfully in their printing establishments, in the reproduction of ordnance maps, plans and diagrams. In private establishments, where work is of a varied character, and requires to be turned out not only quickly and well, but also at a profit, zinc plates do not seem to have found great favour, up to at least a recent period of time.

About twenty years ago a new plate was introduced, which was a marked advance on what had previously been in use. It was the ordinary zinc plate, coated with a calcareous film, which gave it somewhat the character of stone, possessing at the same time a beautiful matt surface. These plates are now made by the Hull Zinc Plate Co., and are known as "Hull Zinc Plates." They may be had with matt or a grained surface, the latter, either fine or coarse, as required.

The advantages which metal plates possess over stones, are in certain respects very decided. (1) They occupy very little space in storing; (2) they are light and easily handled; (3) they may be obtained any size, and are suitable for either flat-bed or rotary machines; (4) they do not break or chip.

While possessing these advantages, it must also be stated, that the printing qualities of zinc are not to be compared with those of stone. The principal disadvantage is the absence of the porous nature, which is so characteristic of the stone, and enables it to retain water for so long a time on its surface; for this same reason the plate does not

permit grease to penetrate its surface ; the work is therefore more superficial, and consequently more easily damaged, both in the preparing and printing operations. This want of porosity, and what may be called unkindliness of surface, makes it more difficult to print from, and also more liable than stone to take on scum.

Notwithstanding these disadvantages, zinc plates have now for a lengthened period been largely used by many firms, principally for original work, which necessitates storage. For printing posters of a large size, they have proved to be of great service, and for this purpose, no doubt, will come into more general use, as the rotary machine becomes more firmly established ; the one being the complement of the other.

Zinc plates are prepared to receive transfers or drawings in different ways. (1) They may be polished with pumice and Ayr-stone.

Preparation of Zinc Plates. Polished plates however, are now seldom used, a matt or grained surface being more suitable ; (2) they may be grained with pumice, emery or glass powder, much in the same way as stones are made ready ; (3) they may receive a fine grain or "tooth," by means of an acid bath ; (4) they may receive a grain by means of a sand blast, which gives a fine granulated surface not unlike a very finely grained stone ; this method is more German than British ; (5) they are prepared with a calcareous film, as already mentioned. To re-prepare plates in the last-mentioned way, the Company send out specially prepared solutions with directions as to procedure, so that any lithographer may renew them himself. Till some experience is gained in the use of these solutions, it is recommended that the plates should be returned to the maker, who will re-surface them, and send them back as new plates in a few days.

The only method of preparing plates that requires some explanation, is that by means of the acid bath. The plates are first polished with pumice and Ayr-stone, so that all scratches and other inequalities are removed. The bath consists of 6 parts nitric acid, 50 parts saturated solution of alum, and 500 parts water,* in this bath the plates are immersed and are kept rocking, by mechanical means, for about ten minutes ; if not kept continually in motion, the acid will act irregularly, and give an inferior grain or "tooth." After the acid bath they are thoroughly washed with water, treated with a weak solution of ammonia,

* This recipe is taken from the "British Lithographer," the four volumes of which contain much interesting and valuable information.

and again thoroughly washed with running water. After washing, the plates must be quickly dried to prevent oxidation. When finished, they should possess a beautiful uniform matt surface. A stoneware or enamelled trough is required for the bath, and it will be better and more economical in the end, if the backs of the plates are protected with an acid resist, such as a coating of asphaltum.

The operation of transferring work to zinc or other metal plates is almost the same as that for stone. The plates being thin, require for convenience in working to be placed on a stone, with a **Transferring to Zinc.** wet sheet of paper underneath to prevent slipping. It is not advisable to heat the plates; if any heat is required for some special work, the stone may be slightly warmed, which will answer every purpose. The work is damped and transferred in the usual way, but keeping in mind that the zinc is much harder and less porous than stone, and will not therefore receive fully charged plate or even stone transfers without spreading. Plate transfers should be passed through on sheets of paper twice, to remove all superfluous ink, as described on page 70, note (i); stone transfers must be pulled with stiff ink.

Chalk drawings will require careful treatment to prevent spreading. They should be fairly well damped, but not in a *wet* book, so that both paper and composition will form a soft backing to the chalk work. Transfer to plate with light pressure, having scraper in perfect condition, using a tympan-sheet of two or three sheets of soft paper. A leather tympan is the best for zinc plate work, as it is, in our opinion, for all transferring purposes.

Plates with a fine grain or "tooth" or matt surface are most suitable for all classes of transferring and printing. The fine granulation makes up somewhat for the want of porosity, so that the plate retains the moisture, and rolls up much better than a polished metal surface would do.

There are different methods of preparing work on zinc plates, and each may be quite successful in the hands of those who practise it.

Preparing Work on Zinc. The simplest method, which will be noticed first, is perhaps the best.

When transferred, the work is sparingly gummed up with pure fresh gum, to which is added, if the work is strong, a few drops of phosphoric acid. It is even more important for zinc than for stone, that the gum solution should be strained before using, and also that it be perfectly fresh. The plate is

allowed to dry, then wash out with turps, using neither water sponge nor damping cloth, as the gum must be kept on the plate in a dry state. Now rub the work up with a little transfer and printing ink mixed together, and reduced with a few drops of turps, using a soft cloth. When well rubbed over, turn the cloth and rub again and again till there is a uniform thin grey film of ink left on the work.

Instead of rubbing up the work thus, a thin coating of dissolved asphaltum may be rubbed or rolled over the stone and allowed to dry.

Now wash off the gum and roll up, allowing a little of the gum to remain on the plate, which will help to keep it clean and the work sharp. Spots, etc., may now be removed with a wooden point and the etching solution, or by first touching the spots with point and turps, and using the solution afterwards. Avoid using pumice, Ayr-stone, or steel scraper, as these make bare the metal surface, which would soon cause trouble by "catching." (After cleaning, roll up, dust if necessary with rosin, etch with the proper solution, gum up, and allow to dry thoroughly. It is now ready, after washing out, for printing.)

Another method, differing a little from the foregoing, is, that instead of rubbing the work up with transfer ink, the whole plate is rolled firmly up in black, so that the work receives a solid charge of ink. A little water is now sprinkled and roughly spread over the plate with the damping cloth, and then vigorously rolled up; gradually the ink which was over the whole plate is taken up by the roller, and the work comes out sharp and strong; it is then cleaned up and prepared, as already described.

The objection to this method is that it is not very cleanly, neither does the work receive the strengthening film of greasy ink which the first method gives.

A third method is by using bi-chromate of potash. After the work is transferred, and the gum dry, wash out with turps, as before described; spread very quickly over the plate a thin coating of bi-chromate solution. After standing for some time, a quarter to half an hour or so, wash the gum off, roll up, and proceed as in first method.

Bi-chromate of potash is hardened, and rendered insoluble by exposure to light, there is thus left on the work an insoluble film, which forms a ground to receive the ink, and partly acts as an acid resist.

Penrose's description of how to work this third method is as follows:—
"Gum up the plate with strong fresh gum, pour some bi-chromate

solution on the plate, and distribute gum and bi-chromate solution evenly over the plate, leaving only a slight film, and dry thoroughly. Wash out the work with turps and a dry piece of felt or flannel, without water; when all the work is removed, roll up the plate solid black; the ink should be of medium strength. The plate is now sponged over with water, damped with a cloth and rolled up, when the work will appear nice and sharp; when sufficiently rolled up, the work is dusted with rosin and French chalk and etched with our plate etching solution, which is left on to dry. The plate is now well washed over with clean water, and thinly gummed up. When the gum is dry, wash out the work with turps on the top of the gum with dry flannel or felt till all the work is removed, sprinkle a few drops of water on the plate, and with a rubbing-up rag and a little ink and turps, rub up the work till it is gently charged with ink, then roll up till work and transfer looks fully rolled up, when the plate is ready for printing."

A fourth method, worked very successfully by a teacher of lithography in one of our technical colleges, is as follows:—After the work is transferred and rolled up, dust with rosin, and wash over with a weak solution of etching fluid, No. 4; dry the plate, and gum over, using a soft cloth so that only a thin film of gum may be left on the surface. Wash out on the top of the gum, and roll up the plate solid black, then sprinkle a little water over it, and roll up till the work is clear and well charged with ink. Dust with rosin, and do any cleaning required. After this, place the plate in an acid bath, the strength of which should be just sour to the taste, adding to the bath one ounce powdered alum to each quart of solution. The bath is rocked till a black deposit forms on the plate, which is removed by means of a soft sponge fastened to the end of a stick; the plate, which should now be of a white appearance, is removed from the bath, and well washed with water. It is then etched with the etching solution, full strength, which, after remaining on the plate a minute or two, is washed off, and the plate dried and gummed. The gum is the better of having a few drops of the etching solution or tannic acid added to it. The plate should now possess a slight "tooth"; the work should be a little in relief, and is ready for printing.

**Solutions
for Zinc
Plates.**

Etching and other solutions are supplied by those who manufacture the various plates, and it is well to use such, and follow out the

directions given. After some experience in working, some modification of these will very likely be found to answer as well, if not better than attempting to carry out the directions in a literal way; careful observation and practice will greatly assist the printer in these matters.

The following recipes may be given for etching or desensitising solutions:—

- | | |
|--|---|
| <p>1. Gum Solution, . . . 20 oz.
Phosphoric Acid, . . . 1 ,,</p> <p>2. Gall Nut Decoction, . . . 20 oz.
Gum Solution, . . . 10 ,,
Phosphoric Acid, . . . $\frac{1}{2}$,,</p> <p>3. Gum Solution, . . . 20 oz.
Tannic Acid (dry), . . . 1 ,,
Phosphoric Acid, . . . 15 drops.</p> | <p>4. Gum Solution, . . . 30 oz.
Phosphoric Acid, . . . 1 ,,
Tannic Acid, . . . $\frac{1}{2}$,,
Dissolve the tannic acid in hot water.</p> <p>Mix together, and let stand for a day or two; pour off the clear liquid for use. The precipitate is not used.</p> |
|--|---|

The gall nut decoction is a very old recipe for zinc plate work, and was used by Senefelder himself. It is prepared by steeping, about $\frac{1}{2}$ lb. of nuts in $\frac{1}{2}$ gallon of water for about 24 hours, then boiling the mixture for a short time and straining; when cold it is ready for use.*

Chalk work may be drawn direct on grained plates, as on stone, and is prepared as follows:—To a pint of fresh gum, add a few drops of phosphoric acid, coat the plate, and let it dry.

To prepare Chalk Work. Then wash out carefully with turps and a little oil, using a soft rag, roll up, using a clean roller and fresh ink, pull several impressions to see if the drawing is all right. When properly worked up, dust with rosin, etch with the solution, gum up and allow to dry. When required, wash out carefully, and proceed to print.

To make offsets on zinc plates, follow the same method as for stone, with this proviso, that while the stone may be washed over with turps, to get a stronger offset, this must not be done with zinc plates. A stout, bright enamelled paper is recommended by the "British Lithographer," but there is nothing better than a

* Gall nuts are excrescences on the branches of a species of oak tree, and are formed by the puncture of an insect, the gall wasp, which deposits its eggs therein. The nuts vary in size, from that of a pea to a good sized nut, and contain a larger proportion of tannic acid than any other vegetable product. Tea also contains this active principle, hence its usefulness in working zinc plates.

good drawing paper for both stone and zinc. The offsets must be printed spare, and well dusted with Frankfort black or red chalk powder. No particle of the ink must be allowed to pass through the powder to the plate, which would cause great trouble by catching.

Metal plates require, for printing in machine, a support in the shape of an iron bed, this may be obtained from those who supply the plates or from any printers' engineer. These beds have a movable gripper at back and front, so that the plates may be firmly secured. The mechanism, which varies a little with different makers, is simple and the method of fixing the plates will be at once apparent to those engaged in machine printing.

It need hardly be said that the bed must be perfectly true, and that when the plate is being put into position, the greatest care must be exercised, that no sand or grit of any sort is allowed to remain underneath it. This remark equally applies when transferring or printing at the hand-press.

In starting to print, the work should not be weakened by washing it out with pure turps; use a very little oil or aluminium washing-out fluid with the turps, and a soft cloth, which should be kept specially for this purpose. When working, the same rules apply as for stone, except that nitric acid is not used. If a plate is inclined to be greasy, use a little weak acetic acid or etching solution, and gum up. To keep edges clean, a piece of flannel and a little weak caustic soda solution may be used, taking care that it does not touch the work. Damping with weak tea continuously for the first thousand runs is strongly recommended; the tannin or tannic acid, which it contains in small quantity, acts on the metal, and keeps the work clear and the plate free from scum.

It may be necessary to use the printing ink a little softer than is generally required for stone. This means greater watchfulness on the part of the printer, as in softening the ink, the danger of smearing and also of filling up the work is increased.

Alterations, whether on stone or metal, are always troublesome, and often only partially successful. Instead of giving varied directions, it may be better to give verbatim, those of the Hull Zinc Plate Co., which may also stand for other varieties of zinc plates, but apart from the special solution used for giving the calcareous surface, which is prepared by the Company and is applicable to their plates alone.

**Machine
Printing.**

**Alterations
on Zinc
Plates.**

“The work should be rolled up with a strong black ink and dusted over with French chalk (Talcum). Remove the part which requires altering with a mixture of half etching solution and half turpentine on a small clean piece of felt or flannel, and rinse well with water, then apply our No. 1 solution, which consists of a strong alkaline (potash) to destroy the grease, care should be taken not to touch the remaining work, as this solution would destroy it. The No. 1 solution is gently rubbed with a small piece of felt or flannel in all directions, for one or two minutes, over the part where the old work has been removed, and then well rinsed with water, hereafter pour a few drops of the No. 2 solution on a small clean piece of sponge, and rub over the part which should receive the alteration, and rinse with plenty of water, this operation should be repeated two or three times to secure success, now the plate is dried, then a few drops of coating solution is poured on the plate, and brushed with a soft clean nail-brush till the coating is thoroughly dry, when the prepared part of the plate is ready to be drawn upon.”

The one thing needful, in order that alterations may be satisfactorily made, is to have the plate perfectly free from all grease, gum, and dirt; in short, to have a chemically clean or sensitive surface, such as existed when it came from the makers.

To prepare these altered parts for printing, proceed as already described for transferred work.

Printing from aluminium is closely associated with that from zinc, and in many respects the procedure is similar if not identical. The former possesses however, some decided differences in character which call for special attention, both in preparing the work and printing the same. It possesses several advantages over zinc, and so far as we know, keeping to the same comparison, has no disadvantages; if this is correct, aluminium must be considered the better of the two materials for use as a printing medium. The advantages are:—

Properties of Aluminium.

1. It is a beautiful white metal, and shows very clearly the work drawn or transferred upon it, and is therefore more agreeable to work with.
2. It is extremely light, its specific gravity being about 2·5, while zinc is about 6·9, showing that it is not far short of being only one third the weight of zinc.

3. It is very ductile, and though this does not count for much in comparison with zinc, which is also ductile in a lesser degree, it is yet a favourable quality when taken into consideration with its lightness of weight.
4. It is not affected by nitric or sulphuric acid, neither will it tarnish or corrode by exposure to damp or impure air, this latter quality is a valuable one in storing plates for future use. It is acted upon more or less actively by hydrofluoric, hydrochloric and phosphoric acid, and also by strong alkalies.
5. It possesses a more porous nature than zinc, being in this respect nearer the litho. stone than any other metal we are acquainted with.

The metal, which was previously very scarce and expensive, has in recent years been produced on a commercial scale, being now obtained in large quantity by means of electricity, from a certain mineral or clay called Bauxite. Aluminium was found to possess so many good qualities that it was soon experimented with as a printing medium by a German lithographer, whose experiments were in a large measure successful. After further careful experimenting and testing in the lithographic establishment of Herr Jos. Scholz at Mainz, in Germany, the process assumed more definite shape, and patent rights were obtained in various countries for working it.

In America also, aluminium plates were, at an early stage, experimented with as a substitute for stone and zinc, and are now largely used in that country, principally on rotary machines, for printing all classes of colour-work.

The process became known and was introduced to the printing trade in England under the name of "Algraphy" which is now its distinctive title, as well as forming the name of the Company (Algraphy Limited), who hold the patent rights connected with its use in Britain.*

* In connection with this section on Printing from Aluminium Plates, the writer desires, with great pleasure, to acknowledge the kindness and courtesy of Mr J. S. Morriss, author of "Algraphy, or the Art of Printing from Aluminium Plates," in granting permission to use the material contained in his work. It will therefore be understood, that much of what is written here on the subject is derived from that source. Those who wish practically to learn more of the process should procure a copy of this interesting work from the office, 57-59 Ludgate Hill, London, E.C.

The ductility of the metal made it very suitable for forming into plates, and these plates possessing a semi-porous nature lent themselves in no ordinary degree to the requirements of the lithographic basis of printing, viz., the mutual repulsion of grease and water. This porosity is further assisted as the means of retaining moisture, by having the plates prepared with a fine granular surface. This fine grain or "tooth" gives a very suitable surface for printing, and permits the rollers taking kindly to the plate when passing over it.

The plates as sent out by the makers are ready for immediate use, having a beautiful white matt surface, consisting of the fine grain mentioned above.

To prepare plates after having been used in printing, the following procedure is gone through. The work is washed out with turps, the back also being well cleaned. They are then placed in an upright position in an acid bath for about six hours in summer and from ten to twelve hours in winter.

The bath is composed of about one-third nitric acid and two-thirds water, the proportions not requiring to be absolutely correct, as the acid does not affect the metal, but thoroughly clears away all impurities from its surface.

The plates, while in the bath, must be kept in an upright position and must not be allowed to come in contact with each other. The rack or other means employed for doing this, requires to be of aluminium, glass or porcelain, which will not be affected by the acid. For the same reason a pair of aluminium pinchers are necessary for immersing, and also for removing the plates from the bath.

As nitric acid readily attacks and dissolves zinc, iron or copper, great care must be taken that none of these metals or any other foreign material comes in contact with the bath, as, if this happens, it will at once spoil the surface of the aluminium plate.

After the plates have been a sufficient time in the bath, they are taken out one at a time and well rubbed with a piece of felt under water, after which they are thoroughly rinsed and dried quickly, standing on end.

In order to give the plates a proper surface for new work, after the acid bath treatment has been finished, they are roughened. To do this, a plate is placed on a perfectly flat, thick wooden board, or

on a litho. stone, with a sheet of damp felt underneath to prevent movement. It is then damped and pumice powder sifted over it. A wooden block covered with a piece of close felt or flannel is then used as a grainer, the operator bearing heavily upon it and moving it continuously with a circular motion over every part of the plate. When the powder, in working, assumes a black slimy condition, it should be washed off with water from a tap or through an india-rubber tube and fresh powder sifted over the plate. It will take about forty minutes and three or four renewals of powder to properly roughen a double-crown plate. When the roughening is completed and the plate thoroughly washed, the water may be removed by means of a squeegee. The plate will now dry quickly and should have a beautiful dull silver-like appearance, and is ready for use.

The above treatment will only give the matt or roughened surface suitable for ordinary transfer work. To obtain a more decided grain for chalk drawing, a different treatment, owing to the difficulty in graining the metal, is required. This treatment consists of the plate being fastened in a wooden tray and a large number of smaller or larger glass balls, with finer or coarser sand, according to the quality of grain required, along with a supply of water, being moved about on the surface of the plate by means of a rocking motion given to the tray containing the plate and balls.

A special apparatus for this purpose is supplied by the proprietors of the process or their agents, who will give full instructions to purchasers how to use it.

When there is no time for the acid bath, small plates may be prepared as follows:—After the work is washed out, rub the plate well with a piece of felt and a solution composed of five parts fluorsilicic acid, three parts nitric acid and forty-two parts water, along with some pumice powder. Rub the plate till it assumes a white colour, wash with water and roughen with pumice powder as described above.

Drawing on aluminium plates is done exactly as on stone, with pen or brush and liquid ink on the ordinary plates, or with chalk on plates grained for the purpose. A soft lead pencil,

Drawing on Aluminium.

B or BB, may be used for sketching or outlining on the plate, or charcoal, if the subject is a large one. For tracing, red chalked paper is the safest and most useful. Oily tracing paper must be carefully avoided. It is necessary not to

attempt to pick or scrape the plate for alteration, anything drawn wrong will be better left alone, and altered after the plate has been rolled up and prepared. The work requiring to be altered may then be easily deleted and the part re-sensitised for again drawing upon. Aluminium, like zinc, being very sensitive to grease, the same care must be exercised by the artist when working upon the former, as he takes when working upon the latter metal.

For offsets the same rules apply as for zinc, the powder only being permitted to give the reverse copy. This is most important, and to obtain the desired result, the offset must be pulled with spare ink and very thoroughly dusted with finely powdered Frankfort black or red chalk; no ink must be allowed to pass through the powder to the plate.

In transferring, work which is damped in the book is treated in all respects as for stone or zinc. For register work to be transferred to damp plate, it is recommended by some printers to put a little common washing soda in the damping water, a teaspoonful to a quart being sufficient, this is said to make the transfer go down stronger. A difficulty which is not so easily overcome, is to damp the plate so that no streaks of water, or loose fibres which come so easily from the muslin or cotton cloth, remain on the surface. A sponge of the softest and smoothest quality will leave the least amount of fibre, though it may still leave streaks of water. The following plan will be found to obviate both of these faults. Make a damping book of good thick plate paper, by putting one sheet, passed through water, to two dry sheets, or even one to one. When equally damp through, take one of these sheets, lay it on the plate, and pass through the press under very light pressure, and lift off. This method of damping gives a beautifully smooth film of moisture. The transfer is then laid down and passed through the press *very quickly* to prevent it rising. After the transferring process has been gone through, warm water is poured over the plate, so that the transfer paper may be easily lifted off, the plate is washed clean, then dried, and given a very thin coating of gum, or laid aside for future preparation. If any touching up is required, it should be done before applying the gum; lines may be joined or touched up with the hardest possible lead pencil, four H or five H, other parts with pen or brush in the usual way.

Work on aluminium may be prepared much in the same way as on zinc, and some workers use practically the same etching materials for both. As however, the Algraphy Co. and those who make a specialty of aluminium plates and presses, give somewhat different treatment, it will be better to state more precisely the methods adopted for this particular metal.

**Preparing
Transfer
Work.**

After the transferring is completed, the plate is placed on its end and quickly fanned dry, it is next very thinly but evenly gummed over; in this state, when dry, the plate may be laid aside for future preparation, or it may be prepared at once. To do so, the work is washed out with the washing-out fluid without removing the gum, and, of course, without using water in any way. A film of the solution is allowed to remain on, and when somewhat dry, the plate is washed over with warm water, which removes the gum along with the superfluous washing-out fluid. The work is now rolled up and etched with the "original etching solution," then dusted with Talc* and cleaned up.

For cleaning up, instead of using the Ayr-stone and steel scraper, finger marks and weak spots are removed with indiarubber, charcoal, or a touch of pumice powder on a piece of felt or soft wood; strong spots and lines may be deleted by the use of sulphuric acid, or a solution composed of oxalic acid and terra di Siena. These acids are applied with a quill or glass hair pencil. After the work is cleaned up, it is etched with the "transfer etching solution," which is immediately washed off, the plate is now gummed up and is ready for the printer.

For direct drawing, the plate is slightly warmed and dusted with Talc, a soft sponge is then filled with the original etching solution and spread quickly over the entire plate, the solution should then be soaked up with the sponge till there is very little remaining, after which, the plate is wiped over with the gum sponge and allowed to dry. The work is afterwards washed out with the washing-out fluid and treated as already described for transfers.

**Preparing
Original
Drawings
on Plate.**

* All through the section on Aluminium plates, the reader will notice Talc, or French chalk, has been introduced as an acid resist. This is done because the Algraphy Co.'s instructions give this material, but we consider rosin a much better resist.

To make alterations or additions, the plate is rolled up and well gummed; after drying, the work is washed out with the washing-out fluid as already described and afterwards washed with water. The parts to be deleted for alteration are treated with concentrated sulphuric acid, applied by means of a glass brush; after being allowed to remain for three or four minutes, it is quickly washed off with plenty of water. For small corrections the oxalic acid solution may be used with a quill or glass pencil.

Alterations on Plate.

The "Algraphy" directions state here that: "After the plate has been properly rinsed and dried the operator applies the counter-etching solution, allows it to act for about five minutes, goes over the plate with a cotton-wool pad, rinses and dries. A plate thus prepared will stand for months without the drawing getting thicker or drying in."

The alterations or corrections are dusted with Talc, etched with the original etching solution, gummed, dried and afterwards prepared as described under "preparing."

The real point to be aimed at, in deleting the work as described above, is to get the parts of the plate required for alteration in the same state as they were at first, when prepared ready for transferring. The grease from the transfer or drawing has not penetrated the surface of the metal, as it does when applied to the stone, the plate therefore does not require grinding or polishing, but simply to have the ink removed first and the grease afterwards, along with any trace of gum which may still remain.

For proving and preparing work on aluminium plates, the usual litho. nap or an indiarubber roller is used. Glazed leather rollers are quite unsuitable, either for hand-press or machine printing, they have a hard glassy surface, which, besides being unkindly, would not take up the dust and grit which accumulates more or less on all printing surfaces. These rollers would therefore, soon destroy the work, and scratch the plate through the friction that arises when running. From our experience of litho. printing we consider that nap rollers are greatly to be preferred even to rubber rollers, for all manner of metal plate printing. The Algraphy Co. however, appear to prefer rubber rollers, more especially for machine printing. When these are employed, paraffin oil is used to clean them instead of turps, and they are afterwards rubbed dry with magnesia.

Rollers.

There are various solutions necessary for the proper working of aluminium plates. They are happily not of a complex nature, but at the same time it is imperative that they should be carefully attended to, if successful printing from these plates is to be obtained. Further, it is only reasonable to expect, that those who have had experience in the process since its inception, and have passed through all the experimental stages of its progress, should be able to give the best possible means to attain the desired end. The following recipes are therefore given in full confidence that they are the best possible for the purpose intended :—*

ORIGINAL ETCHING SOLUTION.

12 parts Gum Solution and 1 part 20 per cent. Phosphoric Acid.

This is a weak etching mixture and a few drops of Red Ink should be added to colour it, so that it may be easily distinguished from the stronger solution.

TRANSFER ETCHING SOLUTION.

8 parts Gum Solution and 1 part 20 per cent. Phosphoric Acid.

Both of these solutions should be prepared two or three days before they are required, and well shaken or mixed before using.

No. 4 recipe given for Zinc Etching Solution is also used very successfully for Aluminium by a teacher in one of our technical colleges.

COUNTER ETCHING SOLUTION.

Add Crystallised Oxalic Acid to a pint of warm water till a saturated solution is obtained, *i.e.*, when no more crystals will dissolve.

4 parts of this Oxalic Acid Solution are mixed with 96 parts distilled water.

CLEANING PREPARATIONS.

Pulverise finely 2 parts Crystallised Oxalic Acid and 2 parts Terra di Siena, and dissolve in water. Apply with quill or glass hair pencil.

Concentrated Sulphuric Acid may also be used as a cleaning preparation.

ACID BATH.

1 part Nitric Acid, 45 per cent. Bé, free from Chlorine, and 3 parts water.

* The writer has already acknowledged his indebtedness to the author of "Algraphy," but he would again call the reader's attention to the fact that these recipes, except where otherwise noted, are extracted from the above-mentioned work.

ACID BATH SUBSTITUTE.

3 parts Nitric Acid, 45 per cent. Bé, free from Chlorine, 5 parts Fluorsilicic Acid, and 42 parts water.

WASHING-OUT FLUID.

Melt over a moderate fire :—

150 grammes or about 5 oz.	Yellow Wax.
200 " " "	7 oz. Venetian Turpentine.
50 " " "	2 oz. Oil of Tar.
Add last 250 " "	9 oz. Finest Black Ink.

When the whole is perfectly melted, and in a fluid state, add, while still stirring, 500 grammes or about 18 oz. Pulverised Asphalt, dissolved in $\frac{1}{2}$ pint Benzoline.

The whole mixture is then diluted with 3 litres or about 5 pints Turps, and is then fit for use.

For a smaller quantity than the above recipe will give, the proportions may be halved.

The following recipe for the same fluid is given by Mr J. Goodman, in Penrose's Annual for 1902 :—

		Dissolve together	
Wax,	1 oz.	Terebene,	1 tablespoonful.
Stearine,	1 "	Turpentine,	1 $\frac{1}{2}$ pints.
Asphalt,	2 "	Re-transfer ink,	$\frac{1}{2}$ oz.

The reader will notice that in the recipes for the washing-out fluid there are two distinct classes of ingredients. First, the grease solvents ; secondly, the greasy bodies which do not evaporate, but will, with the aid of the solvents, be spread over the work, which thus receives a coating of greasy matter which strengthens the transfer, and enables it to take on more readily the ink for further preparation, while, at the same time, the dry gum still remaining protects the other parts of the plate, so that they do not receive the grease from the solution.

We have already noticed, under zinc plate printing, the iron beds which are necessary for use in the ordinary litho. machine.

Printing Machines. These are also used in the same way for aluminium plates. Rotary machines however, have become more associated with aluminium than zinc printing, and may be noticed very shortly.

The fundamental difference between the ordinary litho. and a rotary printing machine is, that the latter has no "travel," which saves time, and enables it to run at a high rate of speed. The printing plate is fixed round one cylinder, and the impression is taken by another cylinder in front, the sheets being delivered by means of flyers on a table underneath the feed board. These cylinders taking

the place of the long travelling bed and ink-table of the litho. machine, give the rotary a compact appearance, and enable it to occupy a small space when compared with the size of sheet which may be printed from it.

The damping and inking arrangements are the same in principle and action as those on the litho. machine, but adapted to the circumference of the cylinder instead of the flat bed.

It is an important point in these machines that the two cylinders should be perfectly true in themselves and to one another, and that they should be perfectly rigid from end to end. Rubber inking rollers are considered by some machine makers and printers as the best for aluminium printing, while others prefer the usual litho. nap rollers, *i.e.*, those covered with French calf skins. The latter class of roller is undoubtedly the best possible for printing either from stone or metal plate. The obstacle to their general use is the difficulty and loss of time incurred in cleaning them from one colour to another. True economy in large establishments might be found in having several machines of the same size and make, so that the rollers would be interchangeable, or, in having one or two extra sets of rollers for the same machine; either of these courses would obviate the necessity for cleaning out so often.

There should be no great difficulty in a litho. machineman becoming acquainted in a short time with all the little differences that exist in a rotary machine. The more difficult part will be, for him to print as well from the plate as he has been accustomed to do from the stone. It is a fact that no metal plate possesses the same kindly nature, or will ever give the softness and at the same time the depth of tone in printing, that may be obtained from stone. Nevertheless, aluminium printing has come to stay, and has already an immense field before it which is daily growing larger. It will therefore be to the advantage of litho. printers in general, to become acquainted with the methods of working both the process and the machines.

Whether rubber or nap rollers be used, they must be soft, and take kindly to the plate; if they are hard or glazed no good work will be produced; indeed it will always be found, that where

Machine Printing. the best quality of machine-work from zinc or aluminium plates is turned out, the rollers there, are kept in the best possible condition. The damping rollers should also be soft

and absorbent, so that while the plate is kept in a damp state it may not be wet. It should not, on any account, be flooded with water from the damping sponge, which is so often carelessly done when printing from stone. It should be kept strongly in mind that printing from plates has a greater tendency to flatness than from stone, and an over supply of water will greatly increase this fault.

Should the plate be inclined to scum, it may be rubbed over with the gum sponge, the gum containing a small proportion of phos. acid. Should it still scum it will require to be inked up, dusted with talc, and etched, as when first prepared. Water must not be allowed to dry, nor the damping rollers to rest for any length of time, on the plates. Warm water is recommended in cold weather for damping. When gumming up, a thin film is all that is required; the gum must not be sour, and be quite free from grit. It is recommended that the temperature of the printing-room should be kept at about 65 degrees.

In printing from metal plates a great deal will depend on the intelligence of the printer, for as with stones, so with plates, many little difficulties will arise from time to time in connection with special work, which cannot be met by specific rules or recipes; these must be met as they arise, and overcome in the best way possible, which indeed will be a proof of the skilfulness of the machineman in charge.

When the proving or printing is finished, and the plate is required to be kept, roll and gum up and let it dry, then wash out with the washing-out fluid on the top of the gum, rubbing the cloth backwards and forwards a few times so that a film of the solution is left over every part of the work. Let this dry thoroughly, interleave with soft paper, and put past. Do not gum paper over the face of the plate.

**Storing
Plates.**

Metal plates may also be rolled up, dusted with rosin, slightly etched, and gummed in the usual way, and put in a dry place. A good method of storing is to have a hole at one corner, and hang them up with or without a sheet of paper between each.

There has lately been put on the market for sale a new zinc plate called the "Noliston." A superiority over others is claimed for it, owing principally to the fact that the chemicals used in its preparation are incorporated with the metal, so that transfers are put down, not on any artificial surface, but on the prepared metal itself.

**Noliston
Zinc
Plates.**

The directions given for transferring, preparing, and printing are simple, so that, with ordinary care, as good work may possibly be obtained from them as from any other variety. The proprietors place great importance, and rightly so, on having the plate always gummed up, if the printing is stopped for however short a time, and they also advocate the use of tannin or tannic acid in the water used for damping. The writer not having great personal experience with metal plate work, and none at all with the "Noliston," he must leave the matter in the hands of those who are interested in the subject, who ought to take every opportunity of testing carefully the various plates which are now available for printing purposes.

As already stated however, the quality of work turned out greatly depends on the ability of the workman, and the interest he takes in printing from plates as a working process.

In all the operations connected with printing, whether from zinc, aluminium or stone, it cannot be too strongly impressed upon the minds of all, but especially of the younger men in the trade, that cleanliness and care, along with a knowledge of the materials being worked with, are the essential conditions for success in this, as indeed they are in every other department of art or craft.

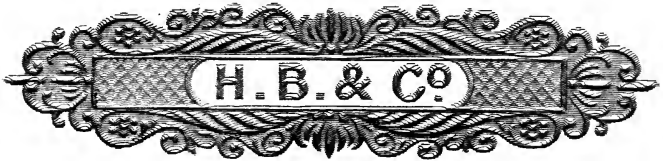

EXAMPLES OF WORK BEFORE AND AFTER TRANSPOSITION FROM BLACK TO WHITE.

Chapter XXI.

TRANSPOSITION OF BLACK TO WHITE.

A STRIKING effect in lettering or design for advertising purposes, is obtained by having them brought out in white on a dark ground. Should the character of the lettering be of a reasonable size, the engraver or litho. writer may give the outline only, when it will be very simple to fill in the background after the transfer is put on stone. Smaller lettering and designs, which will not admit of an outline being drawn, must be treated in some other way in order to obtain the desired effect. The following is the usual and most practical method of procedure :—

Etching and Polishing Method. The transfer or work on stone is prepared in the usual way, and etched, in rosin, with acid a little stronger than is generally used, and continued a little longer than usual. The operation of careful rolling up, dusting with rosin and etching, is repeated as often as required, till the work is felt to be decidedly in relief, about the thickness of a card. The stone is now washed clean and dried. Litho. writing ink is then applied over all the stone, and left for half an hour or so to dry. The whole is now washed out with turps, and rolled up in black, using preferably a soft roller. Should the ink not be taken on at the edges of the relief work, it will require to be carefully dabbed in with a cloth or other means; when properly charged, the ink should be removed from the surface of the relief work only, by taking two or three impressions at the hand-press, with the slightest possible pressure.

The object in removing the ink will now be apparent. With a flat piece of Ayr-stone the relief work is polished till it appears white on a black ground. The stone is now very slightly etched, and any scum remaining on the whites is removed by rubbing with the fingers with plenty of water. The raised parts should now be nearly, but not quite level with the surface of the stone. The whole is now rolled

up, dusted with rosin and etched, which will still further reduce the relief and give a clear white subject on a black ground.

Several points require special attention in order to obtain the best possible result.

1. There must be a good firm transfer to begin with, a weak or rotten subject will be of no use.
2. In the second inking up, the roller should be very fully charged with ink, so that the sides, as well as the surface of the relief work may receive a covering, which will act, after it receives the rosin, as a protection from the action of the acid.
3. It will be found much better to etch a longer time with a weak acid, than a shorter time with a stronger solution; the latter will give a rough, if not a ragged edge to the work. The etching solution should slightly effervesce when applied.
4. The work must be in proper relief before attempting to polish it down.
5. When polishing, the relief parts only should be touched with the Ayr-stone. Sometimes however, it is difficult to avoid having parts of the ground white, in which case they will require to be touched up before etching.

There are other methods of transposing, one only of which may be mentioned.

An impression is taken rather full on yellow or glazed transfer paper. This is dusted over with finely powdered gum arabic and must

Gum Method. again be dusted with clean wadding, to remove every particle of gum from the paper itself; it is now passed through the hand-press a few times with firm pressure on a damp stone. The result of this operation is a *transfer in gum* of the work previously dusted. This must now be allowed to dry thoroughly, after which litho. ink reduced with turps instead of water is spread over the stone in the usual way. When dry, it is washed off with turps and a dry cloth, which will still leave the gum transfer unaffected. The stone may now be rolled up solid without water, and afterwards damped and rolled up again, or it may be damped at once and rolled up. In either case the gum transfer is washed off, leaving a white subject on a black ground. The work is now dusted with rosin and etched in the usual way.

It is important to note that the litho. writing ink must be reduced

with turpentine so that the gum transfer may not be dissolved; also, that the gum must be reduced to a very fine powder, so that every part of the impression may receive its portion when dusted on.

Transposing may sometimes be used to advantage, when two colours of a design are required to register closely the one into the other, such as tartan or floorcloth patterns. One colour only is drawn, a transfer of which is taken and put on another stone; one of these is now transposed to white as already directed, and there is obtained, as it were, a negative and a positive of the design, which will accurately register the one into the other. The risk in this work is the absolute register that is required in printing the one into the other, there being no margin to come and go upon. To reduce this risk to a minimum, the first or original transfer should be the one to be transposed, and the transfer taken from it, should be printed quite full so that it may become a little broader when transferred. By this means the first stone will give the thinnest possible white space, while the second or re-transfer stone will give a slightly broader line, which should rather more than fill up the whites of the other transfer.

The first-mentioned method of transposing appears to be the most simple and effective, and will give beautiful results if properly and carefully carried out. Plate XIII. gives a few examples of simple work before and after transposition.

It may be interesting to describe here a method of obtaining transposed work on aluminium, as given by Mr J. S. Morriss in his work on "Algraphy."

Transposing on Aluminium. A plate is nicely rolled up all over with transfer ink. An impression is then taken of the work to be transposed on smooth transfer paper, and dusted over with finely powdered oxalic acid, the superfluous powder being dusted off with a soft brush. This is now laid on the plate and passed through the press several times, with a damp sheet of paper for a covering. The sheet is now lifted and the plate put under the water tap and well sponged and then gummed over. The transposed white work should now be visible. When the plate is quite dry it is washed, rolled up sparely, slightly etched, rolled up again and etched a second time. The principle in this operation appears to be that the oxalic acid destroys the union between the ink and the metal plate, which then shows white.

Chapter XXII.

“PHOTO-STONE” AND “INK-PHOTO” METHODS.

AN interesting “help” for the artist department has lately been introduced to the trade as the “Photo-stone” process. The method of preparing the transfers, which have a granular texture, has, of course, not been made public, but the results speak so far for themselves, that it will be quite sufficient for our purpose to give an outline of the operations, so far as the work on stone is concerned.

A coloured or monotone drawing is photographed, so as to obtain the best possible value of all the colours in one negative. Transfers are then prepared from one or more granulated surfaces in different degrees of density or depth of tone. Thus, a full printed transfer is used for a light tint, which is intended to go pretty generally over the whole subject, while another transfer with only about one half or one third of the work developed or printed, will be given to form the black or cutting up stone, intermediate transfers being used for the other colours as found most suitable.

Photo-Stone Process. Stated shortly, the principle of the process appears to be, that grained photo. transfers are given to form colour stones; when these are transferred, the litho. artist works on them, adding to, or taking away as required for each printing.*

The transfers are received dry and transferred in the same state to finely grained stones, which are damped, preferably as described under transferring to aluminium; in any case no streaks of water and no fibres from cloth or sponge must be on the stone when the transfer is about to be laid down.

When transferred, the stones may either be at once handed over

* The Linotype and Machinery Company are the proprietors of the process and will give all necessary instructions in regard to it.

to the artist, or before doing so, they may be rolled up and etched in the usual way. The latter is, perhaps, the safest, as greater liberty may be taken with the subject when it is thus protected with rosin.

As the artist generally has, on some of the stones at least, a good deal of work to take away, gumming out may come in here with great advantage. The parts that are wanted to remain are covered over with a strong solution of gum; when this is quite dry, the work is washed out with turps and carbolic, the gum meantime preserving the parts that are to remain. The stone may now be etched, which will perfectly delete all the work that was desired to be taken away. This simple operation will save an immense amount of work if properly carried out.

It is claimed for this process that a coloured drawing may be reproduced in seven or eight printings, which would in the ordinary course, require twelve or fourteen. This may be so, but a good deal of artist work is necessary, and great care is required in transferring and preparing the stones. In a recent competition, the difference in the length of time taken by the competitors to prepare and prove the subject, varied from twenty to upwards of two hundred hours with an average of about ninety; indicating clearly how much depends on the ability and dexterity of the artist and the prover employed.

Some good work has been done by this method, and it is worthy of consideration and trial, by those who have a large amount of coloured pictorial work in hand. One distinct advantage attending this photo. process, is the faithful reproduction of the artist's own drawing, which is so important, but often so difficult to obtain.

Ink-Photo. "INK-PHOTO" is another photographic method of preparing litho. transfers which are put on stone in the usual way.

The process appears to be founded on the ordinary photo-litho. principle, with the difference that the lines are somewhat broken up by a non-mechanical grain, which gives the work more the appearance of a grained stone drawing. It also differs from the usual photo-litho work, in that nature photographs and wash drawings may be treated and transfers given. These transfers are not unlike half-tone work, but the grain when closely examined is found to be entirely different, being more like that of a collotype impression with its grain much enlarged.

Very good specimens of work done in this way have been sent out by the proprietors, Messrs. J. E. Everett & Sons. They say that the process is suitable for nearly all classes of line and shaded work, including reductions or enlargements of the colours of any drawing or label. For the latter, black impressions of each of the colour stones are sent, when transfers in the required size and possessing the same gradation of tone as the originals will be returned for transferring to stone.

Like all other methods of producing lithographic work, good results may be obtained by means of the "Ink-photo" process, if placed in the hands of careful workmen who thoroughly understand the principles on which lithography is based and who work accordingly.

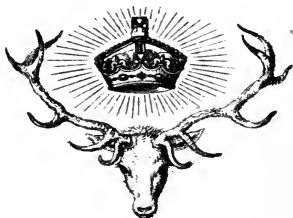
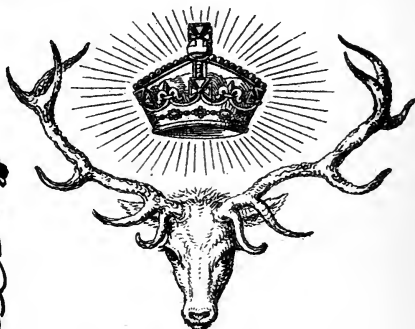

EXAMPLES OF WORK, ORIGINAL SIZE, AND REDUCED BY THE INDIARUBBER MACHINE.

Chapter XXIII.

REDUCING AND ENLARGING MACHINES.

IN lithographic reproduction many subjects require to be altered in size, and it is often necessary that labels be printed in two or more sizes, to suit larger or smaller bottles or tins. Independently of re-drawing the subject to the size required, there are two ways of doing this, either by photography or by means of the india-rubber reducing machine. The latter useful accessory will be found of great assistance in a well-equipped printing-room. With its aid a reduction may be made in a very short time, compared with what is required to send the subject to the photographer and await its return. Another very decided advantage is in the fact, that the machine will reduce or enlarge more one way than another, so that a square label may be brought to an oblong shape, or a circle to an oval, which, of course, is not possible by photography.

The French machine, by Fougeadoire, was introduced some twenty years ago, and though the work produced by its means, as far as the transfers were concerned, was often very beautiful, there has always existed the difficulty of obtaining these without distortion. This led many firms to give up using the machine after a few trials, which was unfortunate in more ways than one. It is worth a good deal of trouble and expense, in order to get a reduced transfer of a map or drawing, on stone, such as may be obtained by means of a rubber sheet. Rubber appears to be the most perfect substance in existence for transferring work to stone, and impressions from transfers thus prepared are in many cases so beautiful, that they look as if they had been taken from an engraved plate. Unfortunately this material can only be used as yet, in connection with a machine such as we are now considering.

The machine consists mainly of four parts, which may be briefly described—

1. There is a square iron frame or base, with short legs, suitable for placing on a table; on the outside are small cog wheels, with two endless chains to connect, so that by means of a handle they are turned simultaneously.
2. Inside the stand are four iron rods, each having, at one end, a right-hand and at the other a left-hand screw. On these screws are carriers which receive the movable frame and travel with it when being expanded or reduced. At the end of these rods are the small cog wheels mentioned above.
3. An iron frame, which receives the rubber sheet. It consists of four iron rods, which are movable on each other, and are fixed together, as required, by means of thumb screws at each corner. Round each of these rods are spiral wires, which, being fastened at each corner, expand and contract with the movement of the rods, and carry with them the brass hooks which hold the rubber sheet.
4. The indiarubber sheet, which is bound with tape, and has eyelit holes along each side. One of the brass hooks is put in each of these, thus connecting the rubber sheet with the movable iron frame.

The mode of working this machine is not difficult, but requires a little care and a good deal of patience.

To reduce a subject, the frames are adjusted and the rubber sheet stretched out to its full extent, or nearly so if the subject is a small one. The surface of the sheet is then washed clean with sponge and water, wiped nearly dry, and a little of the coating composition spread very evenly over it, using a fine smooth sponge. When the composition is dry, and the frame fixed tightly together by means of the thumb screws at the four corners, it is lifted off the machine and placed over the stone face down, to receive the transfer. Just before doing this, it is advisable to breathe over the coated surface, which will soften the composition, and enable it to take the transfer better. With a larger proportion of treacle or syrup in the coating composition, the breathing over the surface of the rubber sheet may not be necessary. When the transfer is pulled, the rubber sheet will be found sticking to the stone, but not sufficient to prevent it being lifted, which must be done slowly, assisting the operation by placing the hand underneath.

The frame is now put in its former place in the machine, the four screws slackened, and the subject reduced. When ready, the frame is again fixed, and taken to the press for transferring; in doing so the frame must be adjusted to the thickness of stone, so that the face of the rubber is kept quite clear from its surface. A sheet or two of paper, and a sheet of rubber blanket are then laid over the rubber, and on the top of these a thick flat zinc plate, well greased. This must be passed through the press, once only, which will finish the transferring. Should the zinc plate get into a curved state, it will cause slurring. To remedy this, the plate should be passed a few times through the copper-plate press, convex side up.

The following points may be noted for guidance in working:—

Just before transferring, the rubber sheet should, if necessary, be again breathed upon, rather longer than when doing so for taking the transfer.

For exact measurement, and also to test squareness after enlargement or reduction, a line should be drawn on stone at each side of the subject, and at right angles to one another; these lines should be divided in any convenient way for measuring. The rubber sheet should be kept as flat as possible, which will be best attained by keeping the hooks equi-distant from each other.

When taking a transfer for an enlargement, it is necessary, of course, to contract the rubber sheet, but while doing so there must always be some degree of tension left, as it will not work if at all slack. The greater the degree of tension the rubber is kept at, either when reducing or enlarging, the better will be the result.

These machines will give an enlargement of one-half, or a reduction of one-third of the size of any subject, thus 10 inches will enlarge to about 15, and 18 inches will reduce to about 12.

This description of the first reducing machine placed on the market is given, because many of these are still in use throughout the country. It has now however, been superseded by a greatly improved pattern sent out by the same maker. The indiarubber sheet on this new machine is held quite flat by means of clips, so that the risk of distortion is reduced to a minimum. The spiral wire is replaced by a lattice arrangement, and instead of the connecting chain, a more steady and regular movement is obtained for the rubber sheet, by means of bevelled cog wheels at each of the four

corners. There is also introduced a very ingenious arrangement of thumb screws, for setting the rubber frame perfectly square and for keeping it so; while by simply disconnecting a cog wheel, the machine will enlarge or reduce in one way only.

Altogether, the new machine is much superior to the old pattern and should prove very useful in any moderate-sized office and still more useful in a large one. It is made in five sizes, the rubber sheet, when

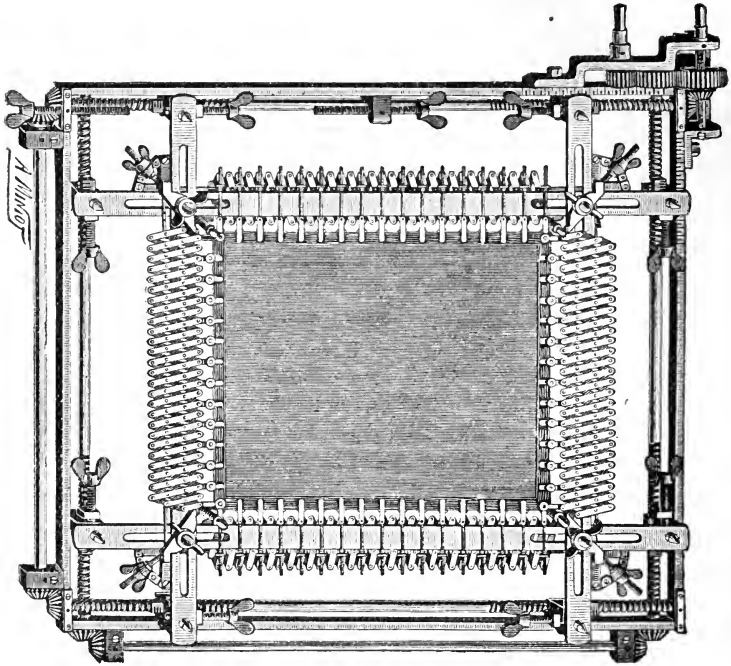

Fig. 23.—FOUGADOIRE'S IMPROVED REDUCING AND ENLARGING MACHINE.

expanded, ranging from 17×19 to 25×34 and the price from £17, 15s to £30, 10s. Fig. 23, gives a good idea of this improved machine.

Messrs B. Winstone & Sons, London, are sole agents in Britain for the machine and its accessories. The coating composition may also be had from them, or it may be made by melting a portion of the finest glue, not gelatine, and mixing with it a little flake white finely ground in

water, adding a little treacle or syrup. The proportions are not so important, but the composition, when cold, should have the consistency of soft indiarubber. When required for coating, the pot must be put inside another pot or pan containing hot water, when it will soon dissolve and be ready for use.

It will be understood that the tympan of the litho. press must be removed for this work, the zinc plate taking its place. As the transferring, as already stated, is completed with one pull through, it is necessary to have the scraper, stone, etc., in perfect order, or the result may be faulty.

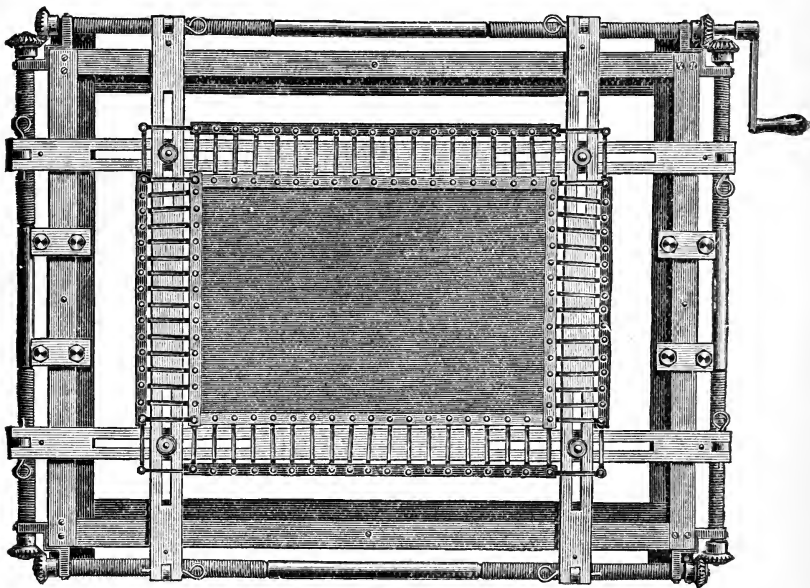

Fig. 24.—PIEPER'S ENLARGING AND REDUCING MACHINE.

Instead of a litho. press, a roller similar to what is used for hand letterpress printing may be employed, both for pulling transfers and transferring. It should be small, about 6 inches by $1\frac{1}{2}$ in diameter, made of iron and covered with flannel or indiarubber, so that it will work kindly with the rubber sheet. When working, the roller should be started from the centre of the subject one way, and then in the

opposite direction, taking great care that the rubber does not rise or shift after the rolling has been commenced.

Most of the instructions given above will apply to any of the reducing machines on the market, as the principles of construction and methods of working are all very similar.

**Pieper's
Machine.**

The German machine, the name of which appears at the margin, is beautifully made and fitted together. The arrangement for reducing more one way than another is a little complicated, and requires some manipulation, but is quite workable.

The engraving, Fig. 24, will illustrate the main features of this machine, and show how the rubber sheet is attached to the frame, and kept in position. This machine is made in several sizes, the price ranging from £19, 5s. to £24, 15s. Messrs Hunters, Ltd., are the selling agents, who will give all necessary information and directions.

The foregoing rather detailed instructions, and also illustrations of two machines are given, because the writer thinks a great number more, of what has proved to be a most useful accessory, might be profitably employed in a number of offices which are as yet without them.

Chapter XXIV.

ROUGHENING AND EMBOSSING.

COLOURED plates are sometimes improved in appearance by having their surface roughened, or by having some canvas texture imparted, as seen in the chromo-lithographic imitation of oil-paintings called oleographs.

Customers, who are not acquainted with the process, sometimes inquire as to the possibility of having their illustrations printed on a rough paper. The litho. printer however, knows that this is impracticable, as whatever else the paper may possess, it must have the essential quality of smoothness, in order to print from stone. Roughening or texture must therefore be given to the sheets after the printing is finished, and the ink dry.

A natural grain or roughness, such as that possessed by hand-made paper, is perhaps the most effective in giving an artistic feeling, and the means for doing this may be obtained in the following way:—

A hard grey stone is grained as roughly as possible by passing sea sand through a sieve with an open mesh, say of about 24 to the inch.

Grained Stone Method. When graining, the sand must not be allowed to get into a fine or pulpy state, which would at once give flatness. To prevent this the sand must be often renewed. After graining, the stone is inked up with a mixture of transfer and black ink, using a glazed roller, the object being to ink up the tops of the grain only. It is then dusted with rosin, and etched with acid of medium strength. This inking, dusting with rosin and etching, may be repeated several times, till there is a decidedly deep and rough grain on the stone's surface. The stone is then set in the machine, and the sheets, which should, if at all possible, have been previously damped, are passed through under heavy pressure.

Another method is to take an impression from the surface of a sheet of rough drawing paper, or, if a woven texture is desired, from

a piece of open scrim cloth, with transfer ink, using a glazed roller. The paper used for this transfer-impression should be smooth and fairly hard. The impression is then laid on a clean stone and passed once through the press, when a transfer will be obtained. The stone is now prepared and etched several times till the transfer stands well up in relief. When this is done the ink is washed off and the stone is ready for embossing purposes.

Before inking up the scrim or any other similar substance, it will be necessary to mount it on a stiff sheet of paper or cardboard, so that it may remain flat and stand the necessary inking. Almost any texture may be obtained by thus transferring and etching in relief. The difficulty lies in getting it open and deep enough to give an emboss on the sheet, even with all the pressure that can be obtained from a cylinder machine; hence the need, as already noticed, of having the sheets previously damped.

Instead of attempting the difficult operation of giving an embossed, or woven texture, as described above, an excellent effect may be obtained by printing the texture pattern in grey ink, right over the illustration.

EMBOSSING is another name for roughening, but is more generally associated with giving relief to lettering or a design by means of prepared blocks or engraved metal cylinders. The latter are used to give patterns or distinct textures to paper in sheets or roll. This is mostly carried out by paper makers or manufacturing stationers. Embossing labels or book cover designs is best done by means of prepared blocks at a letterpress platen machine, which comes under typographic rather than lithographic work. The same operation however, may be carried out, but in a more crude manner, by preparing the work in relief on a litho. stone, and forming a matrix on the machine cylinder, by means of blotting-paper soaked with thin paste or glue and allowing it to harden. The sheets are passed through the machine with the back to the stone, which gives the relief design on the front. To prepare this relief stone the transfer must be reversed, *i.e.*, to read, when transferred, from left to right, and means should be taken to prevent the soft sheet and the stone from sticking together when preparing the matrix.

This stone method however, is not recommended, as it is difficult to get a good result by its means. The litho. stone is not adapted for etching in high relief, and, as already noticed, more pressure is required than can be readily obtained from the litho. machine.

The writer had lately some coloured medical plates, very beautifully roughened with a drawing-paper texture. It was executed by a manufacturing stationery firm, and the small charge made showed that the work had been done very quickly, it is presumed by revolving, engraved or etched metal rollers.

Chapter XXV.

ESTIMATING.

A WORK of this description would hardly be complete without some reference to the rather difficult subject of Estimating. Many firms, no doubt, have fixed rules and rates to guide them when quoting for work, but with the greatest care and wish to estimate, so that a fair profit may be obtained, it will be found very **Estimating.** difficult to do so correctly in all circumstances. The conditions are so varied and the quality of work may be so different, that an estimate which would give a profit to one firm might quite easily turn out a loss for another.

To estimate correctly, there are certain things that should be taken into consideration which are very apt to be overlooked. These may be termed establishment expenses and include:—

Rent of Premises.	Taxes.	Lighting.
Insurance.	Travelling Expenses.	
Interest on Cost of Machinery.	Office Outlay.	

The expenditure in connection with some of these items, taken individually, would amount to a very small sum as the share for any given piece of work, but, taken collectively, they will work out at at least 10 per cent. on every £5 worth of work to be quoted for.

Some offices make allowance for all these items when estimating, others only allow for a few of them, while a certain number of firms would appear to have no rent to pay and no liability for taxes, lighting, or motive power; and as to travelling and office expenses a very inadequate idea prevails as to their amount. These expenses however, are very real and must be met in some way or other, the best plan therefore, will be to make them a standing item of expense, to be included in every estimate of any importance.

Establishment expenses, as detailed above, naturally vary according

to the extent of the premises and business, and the method of working. But each firm should have a clear idea of the aggregate amount of these outlays and allocate them in their charges, in the way best suited to their business.

The other class of expenses, though not more real, are perhaps more tangible to the ordinary mind, as they come more directly and frequently before the head of the house for consideration and payment; they consist of:—

Workmen's Time.	Paper, Ink, and Material used.
Foreman or Overseer's Salary.	Warehouse Expenses.
Motive Power.	Freight and Discounts.

We would now endeavour to ascertain the amount that would be reckoned as the general expenses of a business carried on in premises rented or valued at, say £200 per annum, the taxes on which might be £50, with a complement of eight lithographic machines, also hand-presses, and other needful accessories.

Items of general expense might be reckoned as follows:—

Rent or equivalent,	. £200	0	0	
Taxes and Insurance,	. 70	0	0	
Lighting and Heating,	. 40	0	0	
Upkeep of Buildings,	. 25	0	0	
Upkeep of Machinery,	. 40	0	0	
Loss in tear and wear—				
Machinery	. .	50	0	0
Stones, 5 % on £500,	. .	25	0	0
Sundries Plant, 5 %				
on £250,	. .	12	10	0
		<hr/>		£462 10 0 = £9 0 0 per week.

Working expenses might be reckoned as follows:—

Office Outlay,	. .	£150	0	0
Foreman,	. . .	150	0	0
Fireman,	. . .	70	0	0
Coal, Oil, Waste,	. .	125	0	0
Warehouse Management,		100	0	0
		<hr/>		595 0 0 = £12 0 0 per week.
		<hr/>		<u>£1057 10 0</u>

From the above it will appear that before any profit can be expected by the firm, there must be provided for, a sum of at least

£21 per week to meet current expenses. This alone, means fully $12\frac{1}{2}$ per cent. on a turnover of £8000 a year. In the imaginary establishment referred to above, there is understood to be a complement of eight machines. As these form the backbone of the whole business, it is essential in estimating, that the time which they are occupied in printing, should be reckoned at its proper value. We will now proceed to find out what are the expenses in connection with these, and what ought to be charged per running hour for each.

In this connection, there should be charged (1) interest on the value of the machinery employed, (2) wages paid in attending machine, (3) a share of other working expenses.

Working Expenses per week, as above,	£12 0 0
Interest on value of Eight Machines per week,	1 15 0
Interest on value of Engine, Boiler, Shafting, Bronzing Machine, etc.,	0 10 0
	£14 5 0

This sum divided by eight gives the average weekly expense of each machine, to which must be added wages paid, as follows:—

Share of Working Expenses,	£1 15 9
Average Wage for Machineman,	1 16 0
Average Wage for Layer-on,	0 10 6
Extra assistance for washing up, etc.,	0 5 9
	£4 8 0
	$\div 50 = \text{about } 1/9 \text{ per hour.}$

This statement shows that the average cost of each machine is $1/9$ per hour, reckoning 50 hours per week. To cover this expense, and also a share of the establishment expenses, the estimate rate for running should not be less than, for

Quad Crown Machine,	2/6 per hour.
Double Demy ,,	2/3 ,,
Double Crown ,,	2/- ,,
Demy ,,	1/9 ,,

In estimating, it should be remembered that the actual time which a machine runs is not more, very often less, than two-thirds of the

working hours. It is therefore necessary to allow a share of this waste time to every job whether large or small.

Having the above data before us, two examples of estimating may now be given:—

1. For 50,000 labels in bronze and five colours; size, to give 36 out of double crown sheet; paper, dull enamel, ungummed and unvarnished.

Sketch of Label, separate charge, £1, 5s. to £2, 10s.

Lithographing,	£2	0	0
Proofs,	0	10	6
Transfers, Transferring and Preparing			
6 Printing Stones, at 7/6,	2	5	0
Making ready and Printing 1440			
Sheets, 4 hours at 2/- = 8/- × 6,	2	8	0
Bronze, 2 lbs. at 2/-.	0	4	0
Bronzing Machine, 4 hours at 1/6	0	6	0
Ink and Varnish	0	15	0
Turpentine, Waste, etc.,	0	2	0
Paper, 3 Reams dull Enam. at 15/-.	2	5	0
Warehouse—Cutting and Packing, at			
2d. per 1000	0	8	4

£11 3 10

Add 10 % on Paper, 0 4 6

„ 15 % on Work, 1 7 0

£12 15 4 = £0 5 1 per 1000.

„ for Carriage and Discount, 0 0 5

£0 5 6 per 1000.

A fair price for 50,000 such labels would therefore be as calculated, 5/6 per 1000. If required to be varnished the price would be 6/3; if gummed and varnished, 6/6 to 6/9 per 1000.

2. For 10,000 Catalogue Covers, demy 4to., in bronze and nine colours. Design to be furnished by the customer or charged separately.

Lithographing Front Page,	£6	10	0
Type, etc., for Fourth Page,	1	2	6
Polishing 10 Stones for Originals, at 6d.,	0	5	0
Transferring Key and making 10 Offsets,	0	5	0
10 Grained Blue Impressions, at 9d.,	0	7	6
Transferring Colours and Proofs,	2	2	0

£10 12 0

Carry forward, £10 12 0

HANDBOOK OF LITHOGRAPHY

Brought forward, . . .	£10 12 0
Polishing 10 Double Demy Stones at 2/.,	1 0 0
Transfers, Transferring and Preparing 10	
Printing Stones, at 8/6 . . .	4 5 0
Making ready and Printing 2500 Sheets,	
7 hours at $2/3 = 15/9 \times 10 =$. . .	7 17 6
Bronzing Machine, 7 hours at 1/6. . .	0 10 6
Bronze, 4 lbs. at 2/., . . .	0 8 0
Ink and Varnish, say, . . .	2 15 0
Turpentine, Waste, etc., . . .	0 3 6
Paper, 5½ Reams dull Enamel, at 30/.,	8 5 0
Warehouse and Packing, . . .	0 15 0
	<hr/>
	£36 11 6
Add 10 % on Paper, . . .	0 16 6
,, 15 % on Work, . . .	4 4 9
	<hr/>
	<u>£41 12 9</u>

Covers may thus be reckoned at . . .	£4 3 0 per 1000.
Add for Carriage, Discount, etc., . . .	0 5 6
	<hr/>

The charge should therefore be £4 8 6 per 1000 covers.

These examples will give a fair idea how to estimate for lithographic work. If such prices are obtained, the business should be profitable enough to pay the general expenses, give a return for capital invested, and also leave a margin on the right side of the profit and loss account. But this can only be accomplished if there is a fairly continuous supply of orders. There is no business where a loss is so easily made as in colour printing, and it requires studied and close attention to every detail to ensure a profitable return.

Chapter XXVI.

CONCLUSION—QUESTIONS.

IN concluding this treatise, it may give a more practical value to the whole work, if there is placed before the reader a series of questions bearing on the various divisions of the subject.

The answers to these will be found by careful perusal of the matter contained in the preceding pages, along with attentive observation of the practical work carried on from day to day in the printing-room. The writer recommends very strongly, that all young men who read

Questions. this book and are engaged in Lithographic work, should write these questions out, and answer them in the same way.* This exercise will prove of the greatest possible value in after life, and will bring its own reward by enabling them to grasp what Lithography really is, and what may be accomplished by its means. To those who go through this exercise, the knowledge gained will not only be a benefit in itself, but will form one of the first steps towards advancement when such opportunity presents itself.

The questions will be found both simple and practical, each one being intended to illustrate, or bring home more strongly to the mind, some important point in the Lithographic process.

The writer may be permitted to say further, that it is too much to expect that there will be no mistakes found in the pages which have been written, or that all who read the volume will consider that nothing more is to be desired in the way of information or explanation. Should any one have the idea that he knows everything in connection with Lithography, he may be at once put aside as of little use in this interesting but complicated process.

* A ruled essay book is perhaps the best thing to use for this purpose, writing the questions on the left and the answers on the right hand pages. It will be advisable not to try and answer too many questions at one sitting, four to eight will be found quite sufficient.

The author expects therefore, that mistakes may be found in these pages, although great care has been taken to ensure accuracy. He is also aware that there are many different methods of attaining the same end in different offices and in different parts of the country. For these reasons, he will be most thankful to receive information or hints of any kind, relating to the process on stone or on metal plates, or in regard to the machinery in use, which might prove helpful in preparing any future edition of the work.

QUESTIONS.

1. State the principles which make litho-printing possible.
2. Describe how Lithography is not a mechanical process.
3. Describe how Senefelder's first attempt to print from stone was of a mechanical nature.
4. What is the nature of the stone used in litho-printing?
5. Give examples of substances possessing a similar nature.
6. State some of the natural defects that are found in litho. stones.
7. What would be the most suitable quality of stone to use (1) For chalk drawing on grained stone; (2) For transferring ordinary commercial work?
8. Describe how the stone is prepared to receive work (1) Polished; (2) Grained for chalk drawing.
9. When graining a stone, describe what is necessary to be done to prevent flatness in the grain.
10. What are the necessary qualities required in (1) Chalks; (2) Litho. writing ink; (3) Plate transfer ink; (4) Re-transfer ink?
11. State what are the ingredients of (1) Plate Transfer Ink; (2) Re-transfer Ink.
12. What kind of water is it necessary to use for mixing Litho. Writing Ink? Give the reasons why.
13. What effect on the writing and transferring has the addition of a little Nitric Acid to the water used for damping Autographic Transfers?
14. What are the materials and proportions used in making the coating composition for (1) Plate Transfer Paper; (2) Writing Transfer Paper?
15. What would be the effect of using an over-proportion of (1) Paste; (2) Plaster-of-Paris in transfer paper?
16. What is Gamboge, and why is it used in preparing a certain transfer paper?

17. What are the qualities required in transfer paper for graining? and describe how they are obtained.
18. What oil is used in the manufacture of Litho. Varnish? Name the different kinds of varnish and state what work they are respectively used for.
19. What is Gum Arabic? and describe as far as possible its properties.
20. Mention some varieties of Gum Arabic, and state which are the most suitable for Litho. purposes.
21. What action has Gum Arabic on Litho. Stone?
22. What would be the result, if a stone, while being worked, was left some hours without gum?
23. What is the action of Nitric Acid on Litho. Stone?
24. Will pure Nitric Acid and water affect the condition of a stone that is polished and ready for transferring? If so, in what respect?
25. What is the essential difference between Gum Arabic and Resins in general?
26. Give some examples of the utility of the difference, referred to in Question 25, in the Litho. process.
27. What is the nature of Acetic Acid, and what is its effect when applied to Stone?
28. State the nature of Carbolic acid, and some of its uses in the Litho. process.
29. Why does work on stone require to be protected while being etched?
30. What are the necessary qualities required in an Acid Resist?
31. Name a few substances which may be used as Acid Resists.
32. What substance is considered the best Acid Resist? and give reasons for same.
33. State why (1) Bronze Powder; (2) Powdered Chalk; (3) Powdered Gum Arabic, would not answer the purpose of Acid Resists.
34. State what strength of Acid Solution is required to etch (1) A piece of work before it is protected; (2) Line work to be printed at machine; (3) A chalk drawing on a grained stone; (4) Work required to be in relief for transposing black to white.
35. What is Turpentine? How is it prepared? What are its uses in Lithography?
36. What is the main difference between Turps. and Paraffin Oil, and how does that difference affect the use of the latter in litho-printing?
37. State the essential qualities of Dricks and describe their chemical action.

38. Name some inks that are self-drying and some that are non-drying, or nearly so.
39. Describe the good points in a carefully drawn subject on grained paper, and say how it should be transferred to stone.
40. What are the qualities or conditions of a good Transfer Roller?
41. Describe the method of printing Transfers from Grained Stone, and what points require special attention.
42. State three faults which may exist in Plate Transfers, and give remedies for each.
43. What are Gelatine Key Transfers? and describe how they are produced by the artist.
44. Describe what is done to complete Gelatine Transfers by the printer, and how they are transferred to stone.
45. What are Photo-litho. Transfers, and how are they prepared?
46. Should Photo-litho. Transfers receive the same pressure in transferring as stone transfers? If not, give the reasons.
47. Describe how Autographic Transfers are treated and transferred to stone.
48. Describe the operation of "Patching up" and "Shining up."
49. State how a right angle may be correctly drawn on a sheet of paper.
50. Why is it necessary to have less margin at the top and back of a page, than at the bottom and front?
51. State what articles are necessary, and their use, in "Patching up."
52. State what articles and instruments are necessary for drawing on stone.
53. In drawing on grained stone, what effect would a drop of pure water, a drop of saliva, and a drop of gum water, respectively have, if allowed to get on the surface of the stone before drawing?
54. What are the differences between Hand Stipple and Chalk Work?
55. Whether is Chalk, or Hand Stipple work best suited for machine printing? and give reasons for the answer.
56. State how "Blue impressions" are prepared for artist work.
57. Describe the general operations gone through in transferring work to stone.
58. What is the real object sought to be attained in the process of transferring work to stone?
59. What work is generally damped before transferring, and what work is transferred dry to a damp stone? State the reason for adopting the latter method.

60. Give an idea of the relative pressures required in transferring various kinds of work.
61. State the best way to transfer a chalk drawing on grained paper to stone, so as to avoid flowing.
62. Why is it necessary to have work for machine printing, a little in relief?
63. How is the relief mentioned in Question 62 obtained?
64. Describe the effect on work when it is slowly and when it is smartly cleaned up and prepared.
65. Give some reasons why French Chalk should not be used as an acid resist.
66. Describe the qualities of a good hand-press inking roller and how it should be kept in good working order.
67. Describe the use of register marks in hand-press proving.
68. Describe the method of making off-sets, and the precautions necessary to obtain correct register.
69. What kind of work may be proved with glazed, and when is it necessary to use grained rollers?
70. What position should a machine bear to the main shaft? and give reasons.
71. What is the action and purpose of the cylinder brake?
72. What is the action and purpose of the fly wheel brake?
73. What is the effect on a machine when its travel or stroke is too long? What regulates the travel?
74. Describe the two methods of obtaining pressure in a cylinder machine.
75. Describe the proper condition of machine rollers for fine printing.
76. When is it advisable or necessary to use grained or nap rollers?
77. What thickness of stone is most suitable for machine printing, and what special danger arises, apart from breaking, in using very thin stones?
78. What is the best medium for printing Bronze work? and give reasons.
79. Why should Pomade or Oil never be used in connection with Bronze printing?
80. For what colours and when should Pomade be used in moderate quantity?
81. State the usual consecutive order in printing the colours of an illustration having ten or twelve printings.
82. State and explain the result in regard to register, when the paper being printed has a convex edge.

83. Explain how an extra sheet of paper put on the machine cylinder, will assist the register of a sheet that is too large.
84. Give name and sizes of paper in general use in the printing-room.
85. Name the Primary, Secondary, and Tertiary colours.
86. State what colours go to form the Secondary and Tertiary series.
87. Name the complementary colours to Purple, Green, Orange.
88. What colours harmonise well with Gold?
89. Describe the effect of a yellow light on colours.
90. From what substances are Chrome Yellows produced?
91. What is the base of (1) Flake White; (2) Vermilion; (3) Pure Blue?
92. How is Lamp-black in its purest form obtained?
93. Name some earth colours, and describe how they are prepared.
94. State a few characteristics of Aniline colours.
95. What is the active colouring principle of the Madder plant, and from what other source is it now obtained?
96. Name some harmonious colour contrasts.
97. What materials give the best quality of paper for machine printing?
98. State the reason why a sheet of paper stretches more one way than another.
99. How is creasing to be avoided?
100. What result is obtained by hanging up paper, and what gives this result?
101. What are the principal differences between Zinc and Stone; and between Aluminium and Stone?
102. What advantages are gained in using Zinc or Aluminium Plates as compared with Stone?
103. What disadvantages are found in using Zinc and Aluminium instead of Stone?
104. What precautions are necessary in transferring work to Metal Plates?
105. Describe the method or methods of preparing work on Zinc Plates.
106. State as far as possible the component parts of the various solutions used in connection with working Zinc and Aluminium Plates.
107. Describe as far as possible the effect produced on the plates by the various solutions
108. Describe the procedure in making alterations on Zinc or Aluminium Plates.

109. What is the essential difference between a Rotary and an ordinary Litho. Machine?
110. How is scum to be prevented and removed when it appears while working on Metal Plates?
111. Describe the method of reversing or transposing black work to white.
112. State precautions to be observed in transposing.
113. State what is the basis of the Photo-stone process.
114. Give a short description of transferring and preparing Photo-stone transfers.
115. Give a detailed estimate for 100,000 Labels in gold and six colours, printed twenty-eight on double crown enamelled paper of usual weight. Lithographing and proving to be included in the price.

Glossary

of a few Technical Terms and Contractions.

ACID, Nitric acid.

AC. ACID, Acetic acid.

AYR-STONE, Water-of-Ayr stone or Snake stone.

BONE DRY, thoroughly dried.

CAM, an irregularly curved piece of metal, which, revolving, gives a certain motion to parts of a machine.

CARBOLIC, Carbolic acid.

CATCHING, stone or plate taking on grease.

CHALK MARKS, soft, white parts on the surface of litho stones.

CLEANING UP, see "preparing."

DESENSITISING, giving stones or metal plates a grease-resisting surface by etching and gumming.

DOCTOR, a greasy fluid for strengthening work on stone.

DUCT, machine receptacle for holding ink.

ENGINE-SIZED (PAPER), paper, with sizing received in the beating engine.

ETCHING, application of an acid solution to stone or metal plate.

FEEDER, see "Layer-on."

FLOWING, work spreading or thickening on stone.

GLASS MARKS, Felspar crystals in litho stone.

GUMMING-UP, application of gum to the surface of stone or metal plate.

GRIPPER, part of machine; margin of paper required for machine grip.

KEY (DRAWING), outline drawing of any subject.

KEY (TOOL), an iron tool, made to grip screw-nuts, so that they may be tightened or loosened.

LAYER-ON, assistant (male or female) who lays in sheets to machine.

LEVIGATOR, iron disc for grinding stones.

LITHO, lithographic.

MATT, dull, roughened surface, see "Tooth."

N. ACID, Nitric acid.

NAP (ROLLER), having a surface grain.

NATIVE (PIGMENT), natural earths or rocks used for colour pigments.

OFF-SET, a faint impression on stone, or metal plate from "Key" stone.

ORIGINAL STONE, stone with original transfer or drawing.

PACKING, sheets of paper put underneath stone, to equalise thickness.

PATCHING, arranging transfers on a sheet for transferring.

PHOS. AC., Phosphoric acid.

- PREPARING STONES, polishing or grain-
ing the surface of stones.
- PREPARING WORK, to clean and etch
work on stone or plate; to make
ready for printing.
- REGISTER, accurate position of one
colour in relation to another.
- RE-TRANSFER, a transfer impression
from an "original" stone.
- REVERSE, see "Off-set."
- SENSITISING (METAL PLATE), renew-
ing or cleaning the surface to receive
work again.
- SETTING, placing stone or plate in
proper position for printing; solidify-
ing, as in the case of plaster of
Paris and water.
- SHORT (INK), soft; not of a stringy,
tacky nature.
- SNAKE STONE, see "Ayr-stone."
- STONE, lithographic stone.
- SHINING UP, placing transfers of colour
work in position on a "Key" sheet.
- TALC, French chalk.
- TOMMY-KEY, a short, iron rod, with
ends bent in opposite directions, to
turn screw nuts.
- TOOTH, having a very fine grain or
roughness.
- TRAVEL (MACHINE), movement of
machine bed, etc., backwards and
forwards.
- TUB-SIZED (PAPER), paper sized on its
surface.
- TURPS, turpentine.
- WASHING-OUT, removing (with turps)
black ink from work, so that it may
be ready for proving or printing.
- WASHING-UP, cleaning machine ink-
rollers, and slab.
- WORKED UP, in drawing, to go over
the parts again and again to obtain
smoothness and depth.

Index.

Counter Note 52

- ACIDS, Acetic, 43; Carboic, 44;
Citric, 44; Nitric, 6, 43; Oxalic,
45; Phosphoric, 197; Tannic, 197.
Acid resists, 45, 204.
Air brush, 88.
Algraphy, 200, 205-6.
Alum, 52.
Alumina, 53.
Aluminium, 199.
Aluminium bronze, 58.
Aluminium plates, alterations on, 205;
drawing on, 202; offsets on, 203;
preparing, 201; preparing work
on, 204; printing from, 208;
printing machines, 207; solutions
for, 206-7; storing, 209; trans-
ferring to, 203.
Arabic Acid, 17.
Artist work, 78, 173.
Asphaltum, 46.
- BEES WAX, 18, 52.
Black pigments, 156.
Blue impressions, 112.
Bronze blue, 166.
Bronze powders, 57.
Bronze printing, 140.
Bronzing machine, 143.
Brown lakes, 169.
Brunswick green, 170.
- CADMIUM, yellow, 162.
Calendered paper, 189.
Carboic acid, 44; experiment with, 45.
Chalk work, 79-83.
Chalks, qualities, 21; composition, 22.
- Chrome, green, 170; yellows, 161.
Chromo work, hints, 179.
Citric acid, 44.
Cobalt blue, 167.
Colours, 144-5; cause of, 146; com-
plementary, 148; contrast, 150;
harmony, 149; influence on each
other, 153; luminosity, 152; prim-
ary, 147; printing, 133-4-5; pro-
portions, Field's, 149; scheme,
174; secondary, 148; spectrum,
146; tertiary, 149.
Copperplate press, 67-68.
Cotton rags, 182; paper, 189.
- DAMPING APPARATUS, 129.
Damping book, 54;
Damping cloth, 54.
Double printing, 134.
Drawing on aluminium, 202; on grained
stone, 79-80; grained paper, 60;
smooth stone, 84; zinc, 197-8.
Driers, 48; French, 50.
Drying, 48-49; inks, 49; danger of
hard, 140.
Dutch metal, 58.
- EMBOSSING, 224.
Emerald green, 170.
Enamelled paper, 141-2, 189.
Engraving on stone, 89.
Esparto grass, 182.
Estimates, examples of, 229-30.
Estimating, 226; establishment ex-
penses, 224-7; general, 227; work-
ing, 227; machine time, 228.

FIELD'S COMBINING PROPORTIONS OF
COLOUR, 149.

Flake white, 158.

Fougeadoire's reducing machine, 217.

Frankfort black, 157.

French chalk, 46.

French transfer paper, 32, 64.

GALL NUTS, 197.

Gas stove, 67.

Gelatine, 56; key transfers, 70.

Geranium lake, 165.

Glue, 57.

Gold size, 51.

Grains, quality of, 176.

Grained paper, 61.

Grained plates, 177.

Graining stones, 14-15.

Grained stone, drawing on, 79; etching, 81; hints for drawing on, 80; proving, 82; tints, 83; work, 177.

Grammar of ornament, 154.

Green lakes, 170.

Green pigments, 169.

Gum, 6, 36; action on stone, 37, 102; experiments with, 39; varieties of, 38-41.

Gumming-up, 42.

Gumming-out, 86, 215.

HEMP, 183.

Hullmandel, 177.

Hull zinc plates, 192.

INK DUCT, 129.

Ink, tinting, 137.

Ink-photo process, 215.

Isinglass, 56.

Ivory black, 155.

JAPANESE PAPER, 189.

Jute, 183.

KNIVES, Ink, 56.

LAMP BLACK, 18, 156.

Lead, oxide of, 50; acetate of, 50.

Levigator, 14.

Liasine, 48.

Light and colour, 145.

Linen rags, 182.

Linen rag paper, 182-3.

Litharge, 50.

Litmus paper, 41.

MACHINE, construction, 115-125; management, 126-131; printing, 132-145,

Madder lakes, 164.

Magnesia, 53.

Manganese, borate of, 50.

Manilla, 183.

Map colouring, 99-100.

NEEDLES, 110.

Nitric acid, 6, 43.

OCHRE, 160.

Offsets, stone, 111; zinc, 197; aluminium, 203.

Oleo-margarate of lime, 5.

Oriental blue, 167.

"Original" stones, 59.

Oxalic acid, 45.

Oxide of lead, 50.

Oxygen, in drying, 49.

PALM OIL, 51.

Paper, calendered, 189; making, 184; register conditions, 138; seasoning, 188; sizes, 75, 190; varieties, 182; wire mark, 185.

Paraffin oil, 47.

Patching, 75.

Photo-stone process, 214.

Pigments, 155-172; properties of, 155; table of, 171-172.

Pitch, 18.

Plaster of Paris, 30, 50.

Pomade, 140.

Preparing stones, 13.

Preparing work, 101-104.

Press, copper-plate, 67-68; litho, 91.

- Pressure, in transferring, 95; cylinder, 118.
- Principles of lithography, 5-6.
- Printing, hand-press, 109-114; machine, 132-143.
- Printolene, 48.
- Proving, colour work, 113.
- Prussian blue, 166.
- Pumice stone, 51-52.
- Pure blue, 166.
- Purple lakes, 170.
- QUARRIES, Solnhofen, 8.
- Questions, 231-237.
- RAG PAPER, 189.
- Recipes, aluminium plate solutions, 206-7; chrome yellow, 161; Gall nut decoction, 197; litho. chalks, 22; transfer ink, plate, 24; writing, 19; transfer paper, graining, 30; plate, 32; stone, 31; writing, 29; zinc plate solutions, 197.
- Reducing machines, 217; coating, composition for, 221; Fougeadoire, 217; Pieper's, 222; prices of, 220-222.
- Register, 137.
- Register, hand-press, 110; machine, 137-139; marks, 62, 77.
- Resins, 36.
- Right angles, 75-76.
- Rollers, for aluminium printing, 205; for hand-press printing, 65, 108; for machine printing, 128, 132; rubber, 205.
- Rosin, 46.
- Rotary machines, 207.
- Roughening sheets, 223; methods, 223-4.
- Royal blue, 167.
- Rubbing-in, 83.
- Rubbing-in ink, 22.
- SCRAPERS, boxwood, 55; steel, 55.
- Senefelder, 1-4.
- Senefelder's saying, 135.
- Sepia, 169.
- Shading mediums, 87.
- Shellac, 18.
- Shining up, 75-77.
- Sienna, 160.
- Soap, 17.
- Snake stone, 51.
- Spermaceti, 18.
- Sponges, 53.
- Sprinkling, 88.
- Stippling, 85, 178.
- Stipple plates, 100.
- Stones, composition, etc., 8; defects, 11-12; graining, 14-15; grinding, 12-13; grinding machines, 14; polishing, 13; quarries, 8-9; sizes and prices, 10.
- Straw, 183.
- Stucco, 54.
- Stumping, 83.
- Stumping ink, 22.
- TALC, 46.
- Tallow, 18, 51.
- Tam-o'-Shanter stone, 51.
- Terebene, 50.
- Three-colour process, 175, 180.
- Tint, printing, 134.
- Transfer ink, 16-17.
- Transfer ink, plate, 24; re-transfer, 23; type, 26; varieties, 16; writing, 19.
- Transfer paper, 27-28; French, 32, 64; varieties, 28-33.
- Transferring, 91-100.
- Transfers, autographic, 73, 98; gelatine, 70, 97; grained paper, 60, 95; imperishable, 74; keeping properties, 98; plate, 66, 97; photo, 71, 97; stone, 62, 66, 96; type, 73; written, 60, 95.
- Transposing, black to white, 211; on aluminium, 213; register work, 213.
- Turpentine, 47.
- Tweezers, 77.
- Tympan, 107.

ULTRAMARINE BLUE, 167.

Umber, 168.

VARNISH, 34 ; varieties, 35 ; prices, 36

Vandyke brown, 168.

Vermilion, 163.

Violet lakes, 170.

WATER, 20.

Water-of-Ayr stone, 51.

Wood fibre, 183.

YELLOW, chrome, 161.

Yellow, lakes, 162.

ZINC PLATES, 192 ; acid bath for, 193 ;

alterations on, 198 ; chalk work on,

197 ; Hull, 192 ; Noliston, 209 ;

offsets on, 197 ; preparation of, 193 ;

preparing work on, 193-6 ; printing

from, 198 ; solutions for, 197 ; trans-

ferring to, 193.

Zinc, sulphate of, 50.

M·LAGAN & CUMMING,
Chromo-Lithographers and Printers
EDINBURGH

PRINTING INKS and VARNISHES

For all Climates.

Lithographic 

Letterpress 

Copperplate



B. Winstone & Sons Limited

WRITE
for

New

Price List

and

Specimen Book.



100/1 Shoe Lane,

LONDON, E.C.



Works : Stratford, Essex.



TELEGRAPHIC ADDRESS : "FULGENCY."

TELEPHONE No. 414 HOLBORN.

Backhouse & Coppock, Ltd.,

SUTTON MILLS,

TELEGRAMS: "BACKHOUSE, MACCLESFIELD."

TELEPHONE 35 MACCLESFIELD.

Macclesfield,

MAKE A SPECIALITY OF

ALSO

Coated
Boards
and
Art . .
Papers

**Chromo
Papers**

*Single and
Double Coated.*

Samples and Prices on application.



LONDON: 15 Little Trinity Lane.

TELEPHONE 5561 BANK.

MANCHESTER: 13 Bank Buildings, Cannon St.

TELEPHONE 3345.

MANDER BROTHERS

Makers of Varnishes, Colours and
Lithographic and Letterpress

INKS

For the assistance of Craftsmen who
aim at the production of really

Artistic Work

by the Lithographic, as well as all the

**Most Recent
Processes.**

An Illustrated Priced List of a
very beautiful character
sent on application.

MANDER BROTHERS, Noel St., Oxford St., LONDON, W.

GEBRUDER MANDER, 36 Kurstrasse, BERLIN.

FRATELLI MANDER, 11 Piazza SM. Novella, FLORENCE.

MANDER BROTHERS, 218 St Paul Street, MONTREAL.

&c. &c. &c.

Offices and Factories: WOLVERHAMPTON.

JOHN GREIG & SONS,

Fountain House Works,

EDINBURGH.

Established 1810.

Telegrams :
"GREIG, EDINBURGH."

Telephone No. 1472.

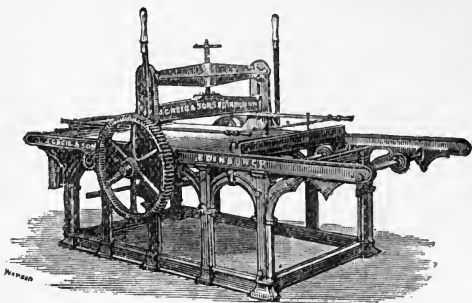

LARGE SIZE STEAM LITHO. PRESS,
Carriage with Automatic Movements, and
Anti-friction Rollers.



OVERHEAD LITHO. STONE GRINDING
AND POLISHING MACHINE.

*Performs perfect work with
extraordinary rapidity.
Soon saves its first cost.*

Engineers and Machine Makers

to the

Paper, Printing,

Bookbinding, Lithographic,

Manufacturing Stationery,

and Kindred Trades.

CORRESPONDENCE INVITED.

ILLUSTRATED PRICE LISTS

AND

SPECIAL QUOTATIONS

Furnished on receipt of enquiries.



Is Your Work hard ?

DO YOU KNOW
that it is much easier and
more economical to do Litho.
Work from the Plate on the

L.&M.
Rotary

than from Stone, full par-
ticulars of which we will
send you on application.

Linotype & Machinery, Ltd.

OFFICES AND SHOWROOMS:

188 and 189 Fleet Street, LONDON, E.C.

7173
Works: { LEEDS,
776

TELEPHONES:
Branches: { LONDON, BIRMINGHAM,
1798 North 04480

EDINBURGH,
271 Y 5

TELEGRAMS: "HORSELL, LEEDS."

F. Horsell & Co. Ltd.

Manufacturers of

Printing Inks, Colours and Varnishes
for LITHOGRAPHIC,
ALUMINIUM,
LETTERPRESS,
ROTARY,

and all Graphic Arts.

Manufacturers of

Transfer Papers and Inks,
Woollen Cloths for Printers,
and Lithographic Materials.

Litho. Roller Experts.

Manufacturers of

French and English Leather Roller Skins,
Patent Rubber Roller Covers,
Horsell's Patent Seamless
Woollen and Cotton Roller Covers.

Importers of Bronze Powders, Litho. Stones,
Foreign Litho. Materials, etc.

OFFICES AND WORKS:

33 Victoria Road, Holbeck, LEEDS.

Branches: LONDON, BIRMINGHAM, EDINBURGH, Etc.

GUSTAV 
HERRMANN

NUREMBERG
BAVARIA

*LIEBER'S CODE and
A. B. C. CODE used.*

*Cable and Telegraphic Address :
BRONZEHERRMANN.*

MANUFACTURER OF

Bronze Powder

Specialities :

EXTRA

ORDINARY

BRILLIANT

BRONZES

BRONZES

for

Substitute for Metal Leaf.

Cheap Label Work.

NO AGENTS !

NO TRAVELLERS !!

Save heavy London Office Expenses !

BUY DIRECT!

HUNTERS' Specialities

For LITHOGRAPHERS.

Litho. Printing Machines.
Hand Presses.
Stone Grinding Machines.
Enlarging and Reducing Machines.
Ink Grinding Mills.
Shading Mediums.
Roller Skins (Best French Leather).
Hand Rollers (Best French Leather).
Transfer Papers.
Grained Transfer Papers.
Non-Stretching Cardboard.
"Lightning" Stone Facing Blocks.
Roller and Cylinder Covering Materials.
Vanhymbeeck's Inks and Chalks.
Lemercier's Inks and Chalks.
Aerograph, and all
Artists' Materials.

Everything for Lithographers

State Requirements and ask for Price Lists and Samples.

HUNTERS, Limited,

26/29 Poppins Court, Fleet Street, LONDON, E.C.

3500 PER HOUR.

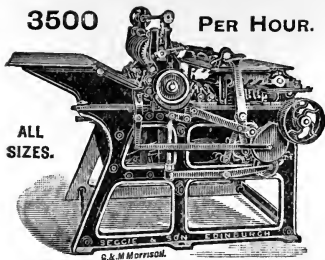

ALL SIZES.

"ART SWIFT" PRINTING MACHINES.

G. & M. MORRISON.

300 MADE.

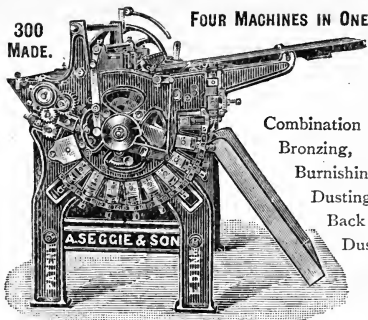

FOUR MACHINES IN ONE.

Combination
Bronzing,
Burnishing,
Dusting and
Back
Dusting

See List of Users.

LITHO. MACHINE.

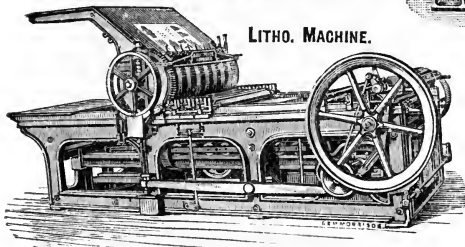

PRINTED WORK BURNISHING MACHINES.



Double Output—Half Power.

VARNISHING
AND
GUMMING
MACHINES,

WITH AUTOMATIC
HYDROSTATIC WELL, &c.

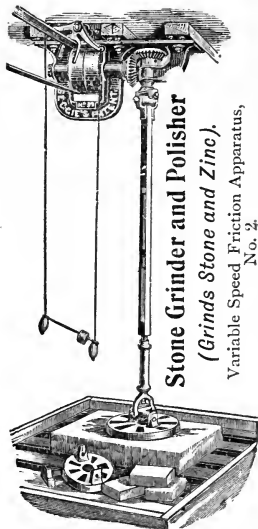

Stone Grinder and Polisher
(Grinds Stone and Zinc).

Variable Speed Friction Apparatus,
No. 2.

LITHO.
PRESSES.

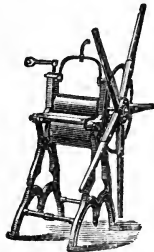
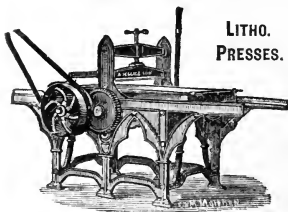

COPPERPLATE PRESSES.

LABEL
PUNCHES.

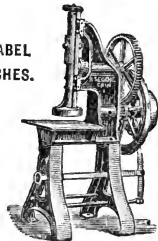

ROTARY CARD
CUTTERS.
MILLBOARD
CUTTERS.

A. SEGGIE & SON, Patentees and Manufacturers, EDINBURGH

195
Counter used p 5-2
Alum 5-2
206
206

COATES BROS.

Algraphy = 200
& CO. LIMITED,

Manufacturers of all kinds of

*Mid-vanish 113
Ink on rollers* Grained Stones 64-

BRONZE BLUE,

2/6 and 5/=

per lb.



Lithographic Inks



JAPANESE
RED,

3/6 per lb.

and **Sundries.**

HEAD OFFICE:

8 Salisbury Court, Fleet St., London, E.C.

Works:

ABBAY MILLS,
WEST HAM, ESSEX.

Branch:

72a GEORGE STREET
MANCHESTER.



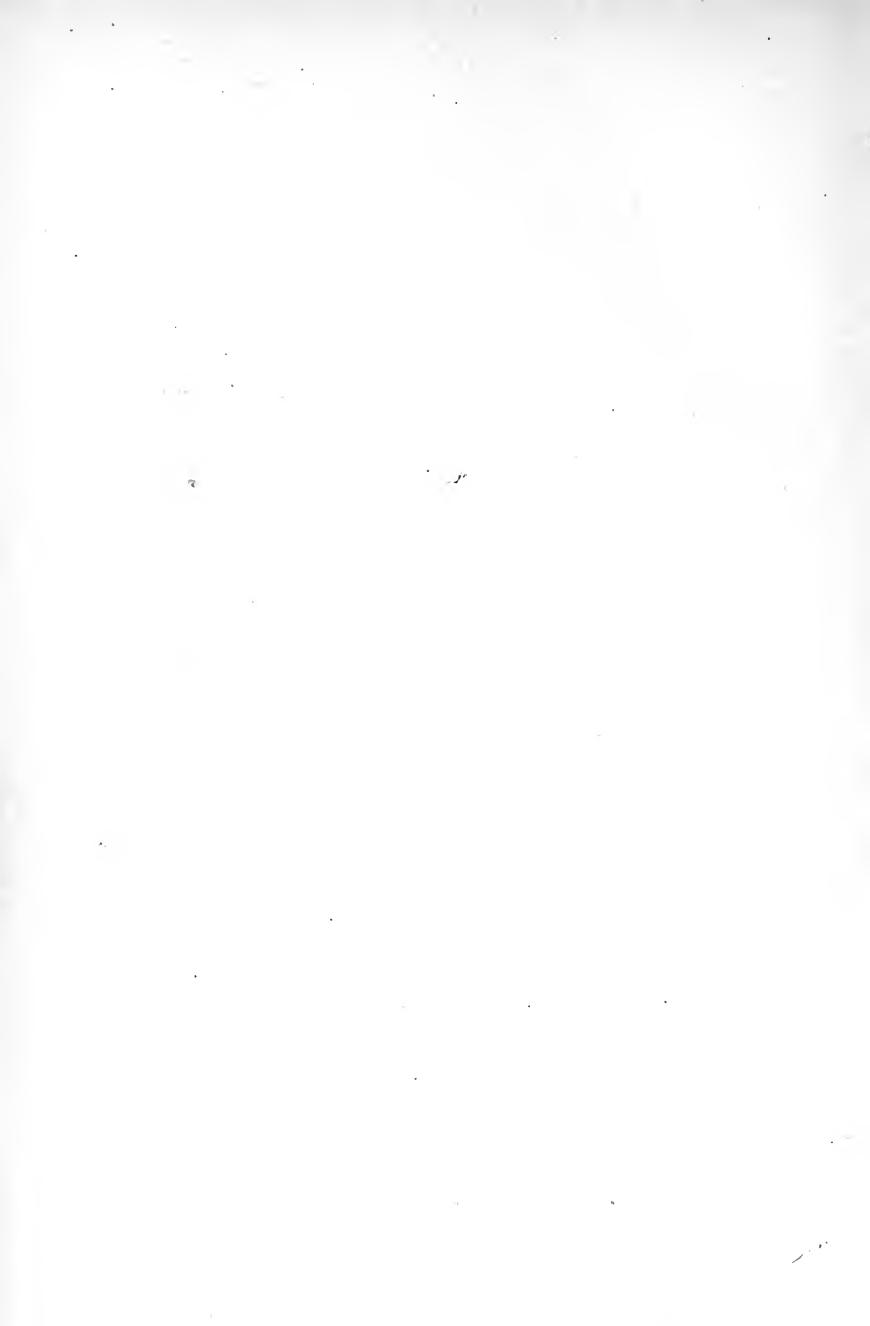



14 DAY USE
RETURN TO DESK FROM WHICH BORROWED

LOAN DEPT.

This book is due on the last date stamped below, or
on the date to which renewed.
Renewed books are subject to immediate recall.

3Feb'63LEX	APR 1 1978
REC'D LD	REC. CIR. MAR 12 1979
FEB 3 '64 - 1 PM	
APR 24 1967 1 1	
FEB 7 1968 5 4	
MAR 9 '68 - 12 AM	
Due end of WINTER Quarter subject to recall after	FEB 11 '71 8 0
REC'D LD MAR 17	- 11 AM 5 4
APR 17 1974 8 0	
REC'D CIRC DEPT	APR 20 '74

LD 21A-40m-4,'63
(D6471810)476B

General Library
University of California
Berkeley



