

TS

1032

R6

UC-NRLF



\$B 29 890

# HARNESSES REPAIRING

Louis M. Roehl



YC 18240

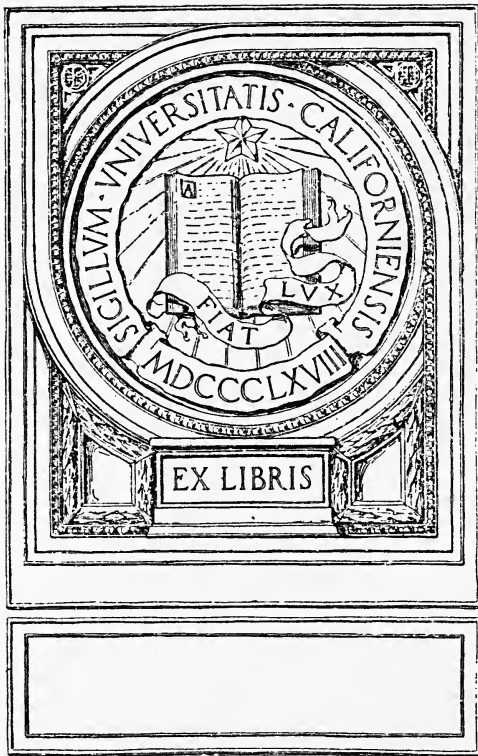

EX LIBRIS





Univ. of  
California

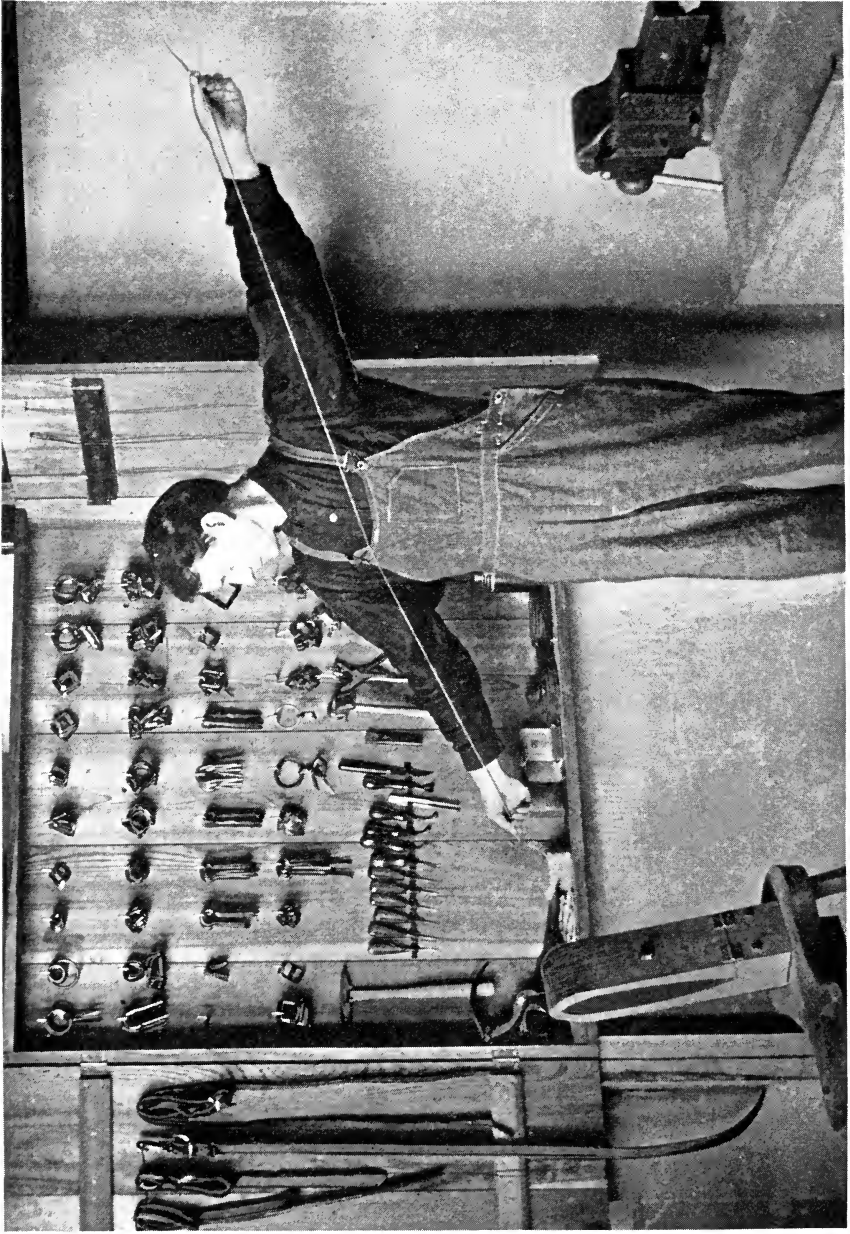

Typical Harness Repair Outfit.  
(Drawing Out a Piece of Thread.)

# HARNESS REPAIRING

---

LOUIS M. ROEHL

Supervisor of Farm Shop Work, New York State College  
of Agriculture at Cornell University

ITHACA, N. Y.



THE BRUCE PUBLISHING COMPANY  
MILWAUKEE, WIS.

TO THE  
ASSOCIATION

T  
T

Copyright 1921  
THE BRUCE PUBLISHING COMPANY  
Milwaukee, Wis.



## INTRODUCTION



THE development of vocational agricultural education work in secondary schools under the stimulation of the Federal Vocational Act has especially directed attention during the past few years to practical farm shop work for boys enrolled in these agricultural courses. There has been a rapid movement of this work away from the former manual training phases which characterized it in many ways in the early stages of its development. There has been an attempt to determine what tools, what constructions and what repairs are essential and desirable to the vocation of farming. It is expected that the farm shop work will involve the use of such tools as are justifiable on the farm, in such construction and such repair work as the farmer would ordinarily engage with profit.

In its first stages this work was largely woodshop work with forge work added in some places. Lately it has been supplemented by recognition of the need for harness repair work, soldering repair work and general construction and repair work involving the use of tools designed to work cold metal. Rope work is passing from the stage of many and involved knots and splices to the selection of knots and splices significant in farm practice.

The author's efforts in this book are additions to the farm shop work presented in his books "Agricultural Woodworking" and "Farm Woodwork" along the line of harness repair. Many teachers, who have seen the necessity of the introduction of work of this kind, have been at a loss as to what equipment should be provided and what exercises could find justification in the vocation of farming. The author's contribution in this book will go far in aiding the teacher in settling these questions. Many years of experience in teaching, coupled with a broad contact with the actual field of farming, make his point of view particularly sound. His technical training has enabled him to put up a body of information in this book that should be peculiarly useful to the vocational teacher of agriculture who is concerned with farm shop work.

WM. F. LUSK,  
Professor of Agricultural Education,  
Mississippi A. and M. College.



## TABLE OF CONTENTS

---

	Page
Harness Repairing .....	7-9
Making a Harness Thread .....	9-14
Making a Stitched Splice .....	14-19
Attaching a Buckle with a Conway Loop .....	20
Attaching a Buckle with Rivets and the Riveting Machine .....	20, 21
Replacing a Hame Clip on a Tug .....	21, 22
Repairing a Trace or Trace and Tug with Hame Clips and Link .....	22, 23
Replacing a Broken Hame Staple .....	24, 25
Use of Buckle Shields .....	25, 26
Repairing the End of a Trace with a Wrot Concord Clip .....	26
Attaching Heel Chain to Trace with a Hame Clip .....	27
Repairing a Trace and Tug with a Trace Square and Two Wrot Concord Clips .....	27, 28
Splicing a Trace with a Trace Splicer or a Metal Plate .....	28, 29
Repairing Bottom End of Hame .....	29
Harness Stitching Clamp to be Used with Metal Vise on Workbench .....	29-32
Harness Stitching Clamp to be Used with Farm Shop Workbench Vise .....	32
Stitching Clamp and Farm Workbench .....	32-36
Farm Shop Workbench .....	36-40
Stitching Horse .....	41-47
Saw Horse Stitching Clamp .....	47-51
Cleaning and Oiling a Harness .....	51, 52
Harness Repair Tools and Harness Repair Parts .....	53

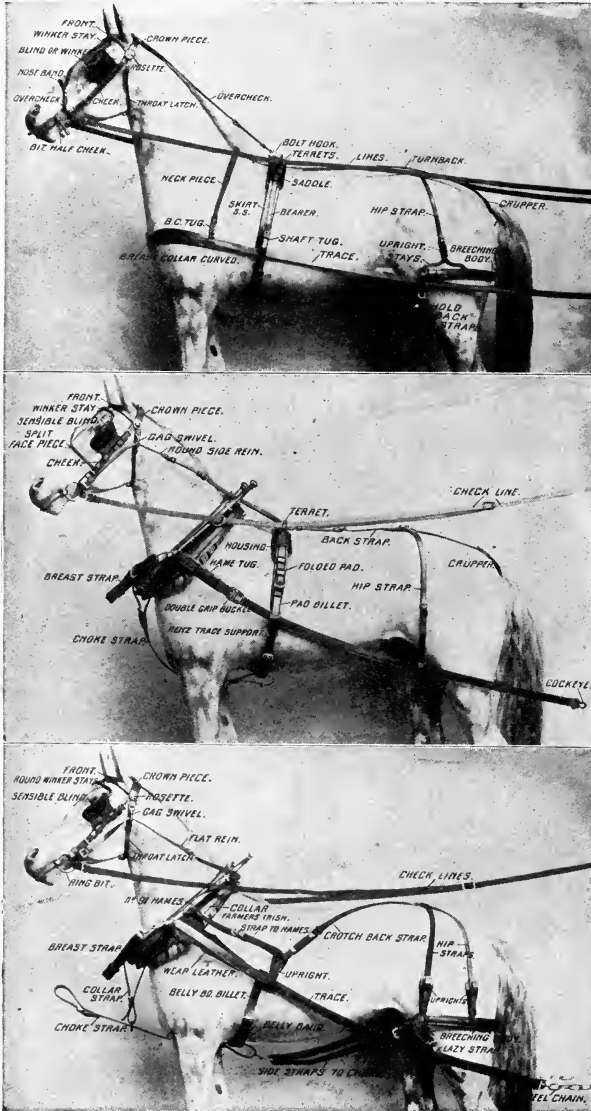

Fig. 1. Typical Harnesses with Principal Parts Named.

## HARNESS REPAIRING

Just as the individual cobbler can no longer compete with shoe factories in the manufacture of shoes so the individual harnessmaker can no longer compete with the factories in the manufacture of harnesses. The shoemaker, so-called, is not a shoemaker at all, he is a shoe mender and spends all of his time doing mending only. So the harnessmaker, so-called, does repairing of harnesses only. With the increasing use of power machinery and the decreasing use of horsepower the harness repair men are rapidly decreasing in number and many rural communities that were favored with the services of a first rate harnessmaker a decade ago now have to depend on a shoe repair man to do their harness repairing or do the work at home on the farms. The shoe repair man has in most cases not had any training in the repair of harness and often does not want that kind of work. It thus more and more becomes the work of the farmer to repair his own harnesses.

The lessons of this book are not apt to be of interest or great value to harnessmakers. They are not intended for them. They are merely a brief series of repair jobs so illustrated and described that a farmer or farm boy can do the more ordinary repair jobs as they occur or at a suitable time.

Harness repair parts are carried in most of the local hardware stores and by the mail order houses and the repair work consists largely of putting the repair parts on to the harnesses. In addition to the tools for the repair work it is highly desirable for farmers to carry those of the repair parts that are most apt to be needed in emergencies so that repair work may be quickly done.

On all well regulated farms all harnesses are thoroughly cleaned, oiled and repaired at least once a year. If this is done the harnesses not only last longer but are less apt to break when time is valuable for other work in the busy season.

It is felt that the farm boys should learn to clean, oil and repair harnesses as a part of their shopwork at school and all schools where farm boys are in attendance should have equipment to make it possible for them to have such training. If, then, the farms also are equipped with a few of the repair tools they will be in a fair position to take proper care of their harnesses.

There are repair jobs on harnesses that are not covered in these pages. An attempt has been made to cover the more usual ones only.

Harnesses consist principally of straps and connections and as a usual thing they wear out where the straps are fastened to the connections. There are about a dozen places where the wear causes breaks to occur and the farmer who has the tools and repair parts

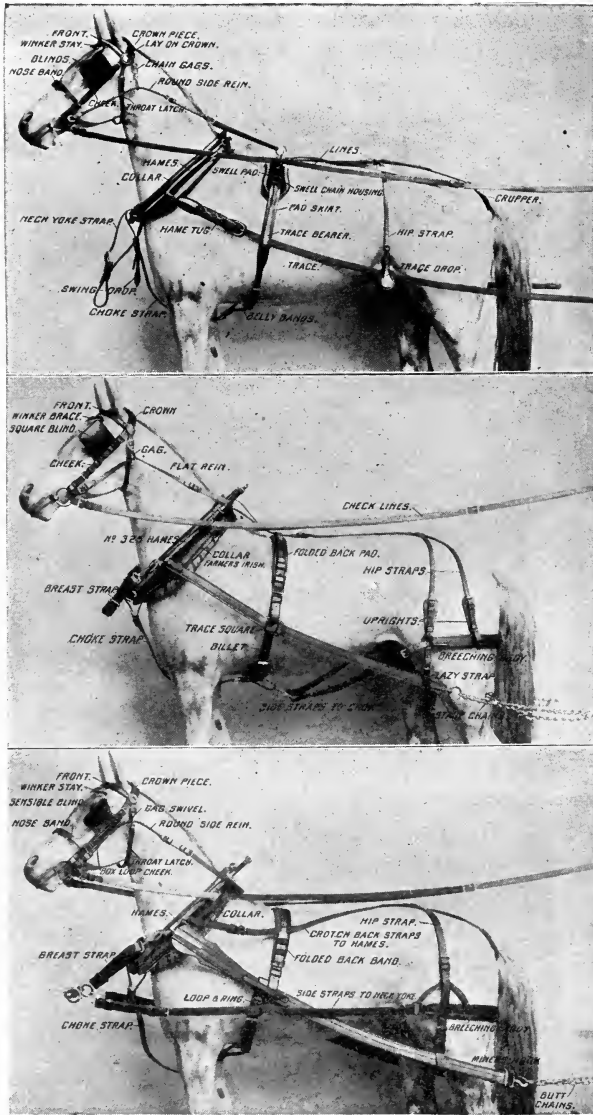

Fig. 1A. Typical Harnesses with Parts Named.

at hand and has a fair degree of skill to do repair work has all that is necessary to keep the harnesses looking well and in good working condition at all times. The purpose of these lessons, then, is to make it possible for the farm boy to learn to do the ordinary harness repair jobs.

## MAKING A HARNESS THREAD

### Material required:

- 1 ball of linen thread.
- Harness wax.
- Harness needles.
- 1 piece of beeswax.

1. Take the end of the thread in the left hand and draw out a required length—at least five feet. See Frontispiece.

2. With the thumb and index finger of the left hand hold the thread firmly at a point five feet from the end, or whatever length is



Fig. 2. Untwisting the Thread.

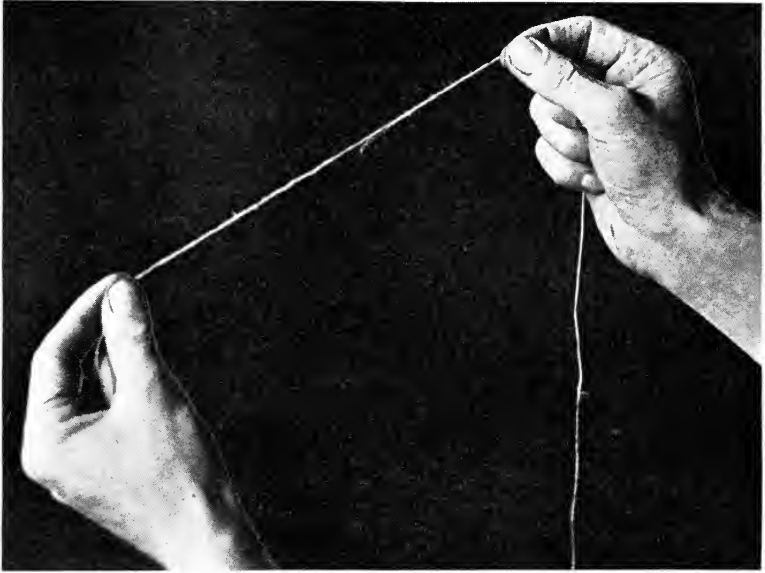

Fig. 3. Tearing the Thread.

desired, and untwist the thread by rolling it on the right thigh with the palm of the right hand. Fig. 2. Watch carefully and stop the untwisting when all the twist is out of the thread in the six or eight inches of thread next to the left hand. Then also hold the thread



Fig. 4. Waxing the Ends of the Thread.



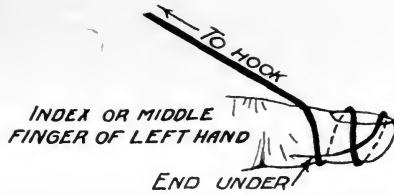

Fig. 5. Method of Holding the Thread and Protecting the End While Twisting.

between the thumb and finger of the right hand at the point six or eight inches from the left hand. Clasp the thread firmly and tear it. Fig. 3. If the twist is all out it will tear easily and unevenly. The unevenness is desirable as it makes it possible to make a fine point on the finished thread.

3. Draw three, four, five or six threads in like manner; the number depending on the use to be made of the thread. For tugs and traces six strands are desirable; for reins, hip straps, hame straps and other rather light straps four threads may be used. The threads should be exactly the same length but in placing them together the second should project slightly past the first, the third slightly past



Fig. 6. Rolling the Thread on the Thigh to Twist It.

the second, etc. This is to provide a fine end to the thread which when passed through the needle and doubled back will be as small as possible.

4. Throw the thread over a hook and draw both ends toward you with ends even. Clasp both ends between the thumb and the top of the index finger of the left hand and wax the ends by drawing the wax pad quickly and vigorously over the ends. Fig. 4. Then twist the ends by rolling each over the right thigh. Fig. 6. Both ends may be waxed at the same time. The wax is manipulated to the



Fig. 7. Waxing the Thread.

best advantage if a quantity is melted about one-eighth inch thick onto a piece of leather about the size of the palm of your hand.

5. Draw the two waxed ends apart and while holding one end with the index finger of the left hand (Fig. 5), twist the other thread by rolling it on the thigh. Fig. 6. When the one end has been sufficiently twisted place the end of the twisted thread on the index finger of the left hand (Fig. 5), and give the other end of the thread the same treatment.

6. Equalize the twist by drawing the thread back and forth

around the hook. The purpose of holding the thread is to grip it firmly and to protect the fine end.

7. Wax the thread. This is accomplished by holding both ends of the thread with the first two fingers of the left hand. Then hold the wax pad in the right hand, place the thread on the pad and press the thread firmly with the ball of the thumb. Fig. 7. Draw the pad vigorously back and forth over a short piece of thread at a time. The heat caused by friction melts the wax onto the thread. When all the thread is waxed remove the pad and draw the thread vigorously through between the thumb and index finger of the right hand. This equalizes the wax. Fig. 8.



Fig. 8. Equalizing the Wax.

It will be noted that the thread is sticky and when in this condition won't draw well. This is remedied by rubbing with beeswax. Do not rub beeswax on the ends as this will prevent the threads from holding the needles.

8. Thread the needles. This is accomplished by drawing the end of the thread through the eye of the needle about two inches.

Then double the thread back and clamp it close to the needle with the thumb and index finger of the left hand. Turn the needle between the thumb and the index finger of the right hand gradually moving the left hand back on the thread away from the needle. Fig. 9. The fine end should twist down into the waxed thread so as to be invisible and secure. If the thread has flat surfaces it is an indication that it was not twisted sufficiently. The finished thread should be round and smooth.



Fig. 9. Twisting the End of the Thread Back at the Needle.

### MAKING A STITCHED SPLICE

1. Cut the ends of the straps to be spliced, square. This is accomplished by placing the strap flat on the bench and rolling the round knife over the point on the strap at which the cut is to be made. Fig. 10.

2. Skive off the ends by the use of the round knife. The skiving should be done on the flesh side of the leather which is the rough side. It is accomplished by placing the strap flat on the bench and giving the knife a slant of shearcut. Fig. 11. A smooth cut is difficult to obtain in any other way than by a shearing cut yet it is essential to neatly finished work. It is suggested that the beginner practice getting smooth cuts on scraps of waste leather.

A very satisfactory way of skiving the end of a strap is shown in Fig. 12. Place the strap on a bench hook or board so that the end is flush with the edge of the bench hook or board, then by holding the strap firmly with the left hand and the jack plane in the right

hand, as illustrated, the skiving may be done. The plane must be sharpened to a keen edge to cut the leather satisfactorily.



Fig. 10. Cutting the End of the Strap Square.

3. Place one strap on top of the other so as to lap about two inches and lay them on the bench with the smooth side up. Hold the pricking wheel firmly in the right hand and by guiding it against the edge of the strap space off the stitches the full length of the splice. Fig. 13.



Fig. 11. Skiving the End of the Strap with the Round Knife.



Fig. 12. Skiving the End of the Strap with the Jack Plane.

4. Place the straps in the stitching clamp so as to lap about two inches with the strap nearest you to the right and with the



Fig. 13. Spacing Off the Stitching with a Pricking Wheel.

marked side of the straps to the right. Clamp the strap so that the stitches will be rather close to the jaws of the clamps and thus held firmly.

5. Having prepared the thread and needled the ends make a hole with the sewing awl through the single strap farthest away from you in the clamp at a point just beyond the splice. Keep the awl in your right hand and draw the thread through the hole in the strap so that an equal length of thread is on each side.

The awls commonly used are diamond shaped. The holes through the straps are made so that one corner of the hole is about half way between the top and the point farthest from the worker. A size of awl should be used which will make a hole sufficiently large to permit the second needle to pass through freely when the first thread is in the hole.



Fig. 14A. Holding Awl and One Needle in Right Hand and Passing Other Needle Through Hole—View from Side of Workman.

6. Make the second hole through the straps. Place the left needle in the hole, grab it with the thumb and index finger of the right hand, draw it about three inches, then hook the hand over it and draw it about a foot.

7. With both needles and the awl in the right hand, pass the needle of the right hand thread through the upper corner of the hole, grab the needle with the left thumb and index finger, draw it through about three inches, then hook the hand over it and draw it through as far to the left as the other thread is to the right. Fig. 14A. Keeping the needle and awl in the right hand and the left

needle in the left hand grab the threads firmly between the thumbs and index fingers and draw them up tight. There is little danger of a beginner drawing them too tight.

8. Continue stitching in this manner until the last stitch through the two straps. The right hand needle and thread is then passed through the single strap at a point one stitch beyond the splice. Fig. 14B.

9. Turn the strap end for end and clamp in place. Cross the threads on the left side of the strap and bring one thread through a hole in the single strap just beyond the splice and proceed stitching as before.



Fig. 14B. Holding Awl and One Needle in Right Hand and Passing the Other Needle Through Hole—View from Side Opposite Workman.

10. To finish the stitching place the left needle and thread through as usual, then place the right needle in the hole and when in this position wind the left thread once or twice around the needle. Then draw both threads up tight as before. This winding locks the threads in the leather. Another small hole is then made back on the splice at a point about  $\frac{1}{8}$ " below the next to the last stitch and the right thread is passed through, drawn up tight and both threads cut off close to the strap.

11. Pass the wheel marker over the stitching on the same side





Fig. 15. Finishing the Stitching by Pressing the Wheel Marker over the Stitching.

as before, pressing firmly. Fig. 15. Trim the edges with the trimming knife so as to make them smooth. This adds greatly to the appearance of the work. The appearance may be further improved by placing the splice flat on the bench or a metal surface and tapping lightly with a hammer.

12. Finish by brushing on a leather stain so that all will be black.

## ATTACHING A BUCKLE WITH A CONWAY LOOP

1. Punch a hole at  $\frac{1}{2}$ " from the end of the strap and another hole about 5" from the hole at the end. Fig. 16.

2. Place the strap through the Conway Loop, beginning at point A in the illustration, then strip the snap, buckle or D on the

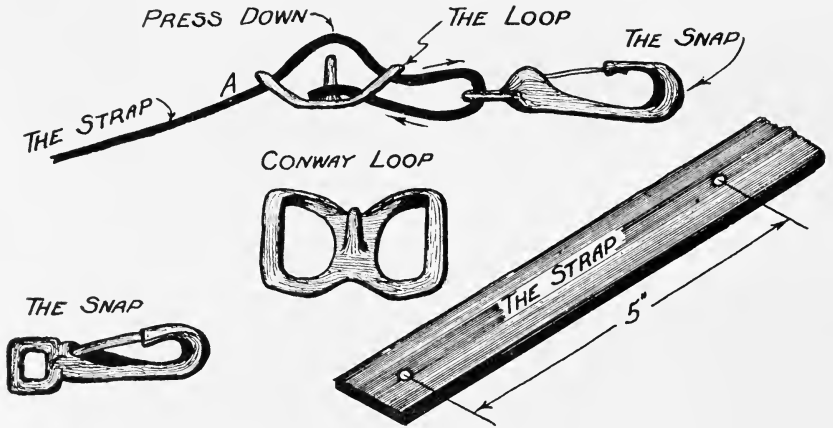

Fig. 16. Attaching a Buckle with a Conway Loop.

strap with the spring up, bring it back in the loop under the part which is already in the loop, then press the strap down on the loop, forcing the pin on the loop through the two holes.

## ATTACHING A BUCKLE WITH RIVETS AND THE RIVETING MACHINE

1. Place the strap on the work bench with the rough or flesh side up, and with the round knife or jack plane skive about two inches of the end to a wedge shape.

2. With a straight or round knife or jack knife taper the end as shown at A in Fig. 17.

3. Punch two holes with the belt punch about 1" apart, the first one about  $2\frac{1}{2}$ " from the end of the strap. B in Fig. 17.

4. Fold the end back so that the holes line up and hold firmly with the left hand; then cut an opening into the folded end to receive the tongue of the buckle as shown at C in Fig. 17.

5. Place the buckle on the strap as shown at D in Fig. 17.

6. Drop a tubular harness rivet in the riveting machine with the head down; place the strap in the machine with the cut end up as shown at E in Fig. 17, and drive the rivet in place. The first rivet should be placed close to the hole.

7. Place another rivet near the end of the strap as indicated at E in Fig. 17. In placing the second rivet don't let the buckle end of the strap drop down or the end of the strap will not fit tight against the strap in the finished job.

8. With a small brush swab on enough edge ink to blacken the newly cut leather.

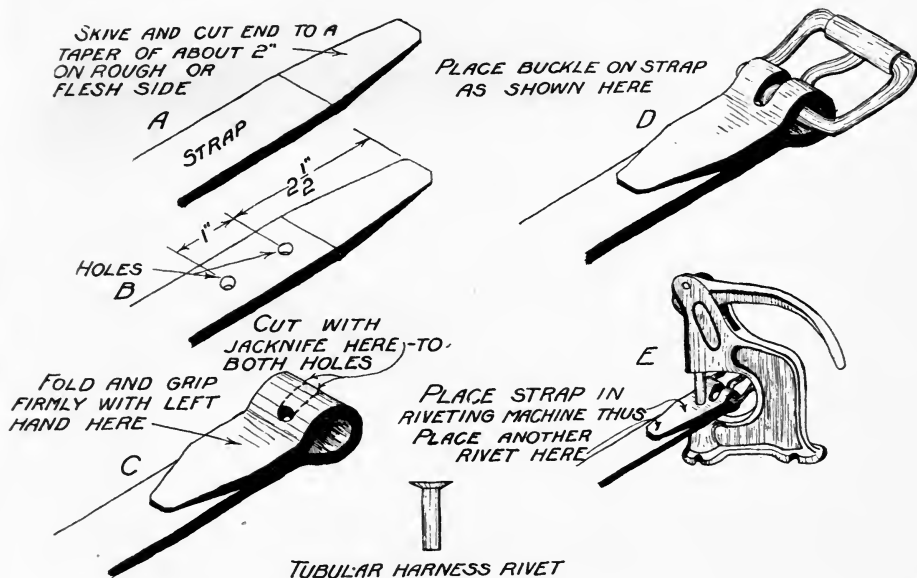

Fig. 17. Attaching a Buckle with Rivets.

## REPLACING A HAME CLIP ON A TUG

The replacing of a hame clip is a harness repair job which occurs often, as the hame clip is a part of a harness which often wears out due to the constant friction between the hame clip and hame staple. It may be accomplished as follows:

1. With pinchers or cold chisel and hammer remove the old rivets.

2. Place the new clip on the tug in the position which it is to assume when riveted, A, Fig. 18, and mark the holes for the rivets with the scratchawl.

3. Punch the holes for the rivets with the belt punch or saddler's punch.

4. Insert the hame clip in the hame staple, and draw it onto the end of the tug. The clip is stripped over the tug,—it need not be inserted in the tug as the hame will hold the metal away from the horse and prevent chafing.

5. Draw the hame clip tight against the leather by placing the ring of the clip on the anvil and striking the other side of the ring firmly with the hammer. B, Fig. 18.

6. Draw the holes in line with the scratchawl.

7. Place a rivet through the hole in the clip and tug nearest the head from the horse side and rivet just enough to hold in place.

8. Place the other rivet or rivets in the same way and hammer all rivets tight.\*

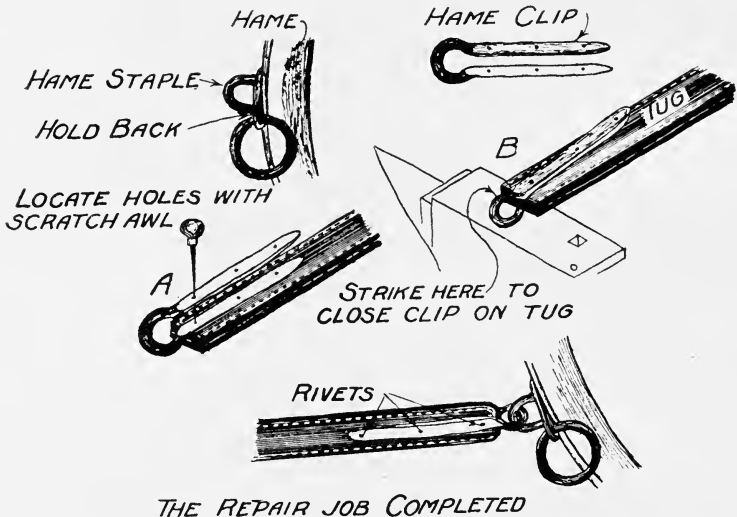

Fig. 18. Replacing a Hame Clip on a Tug.

## REPAIRING A TRACE OR TRACE AND TUG WITH HAME CLIPS AND LINK

A broken trace may be neatly and substantially repaired by the use of a link from a chain and two hame clips. (Fig. 19.) It may be accomplished as follows:

1. Cut the two broken ends of the trace square. Enough should be cut off to make the trace its original length when the hame clips and the link are in place.

2. Place a clip on the trace in the position which it is to assume when riveted, A, Fig. 18, and mark the places for the rivets with the point of a scratchawl.

3. Punch the holes through the trace for the rivets with the belt punch or saddler's punch.

\*Note:—If rivets at hand are too long they should be cut so as to be of proper length. The rivets should be neatly rounded and smoothed and not hammered out flat with edges split out. A rivet set may be used to smooth the work.

4. Insert the link in one of the clips and force one end of the clip into the cut end of the trace so that there will be one thickness of leather between the clip and the horse. If the clip were stripped over the trace instead of one end being inserted it would chafe the horse. Drive it into the trace with a hammer so that the holes will line up. Further draw the holes in line by forcing the scratchawl through a hole in the strap and a corresponding hole in the clip.

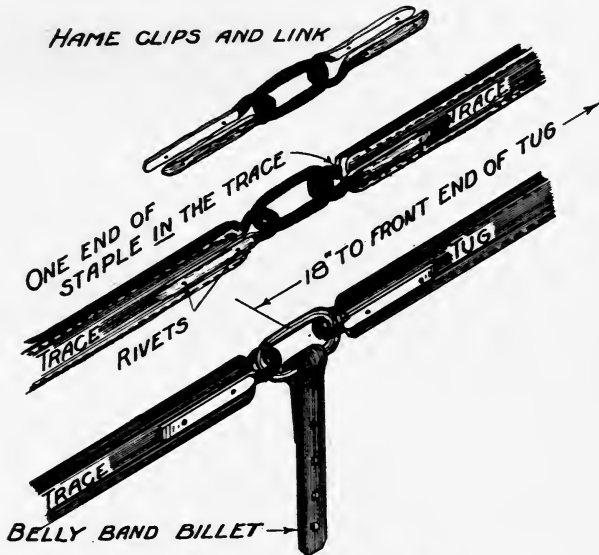

Fig. 19. Repairing a Trace or Trace and Tug with Two Hame Clips and a Link.

5. Place the head of the clip on the anvil, vise or other metal support and firmly strike the other edge of the head with a hammer, thus drawing the clip tight on the leather. B, Fig. 18.

6. Again draw the holes in line by the use of the scratch-awl.

7. Place a soft iron rivet into the hole nearest the link from the leather or horse side of the trace and rivet just enough to hold the rivet in place.

8. Place the other rivet in the same way and rivet the parts firmly together.

9. Place the other clip into the link and fasten to the other piece of trace in the same manner as the first.

10. This method of repair is often used where the trace and tug are joined. The distance from the front end of the tug to the center of the link should be 18".

If this method of repair is used at this point on the trace a belly band billet  $1\frac{1}{4}$ " wide by 14" long is riveted or sewed onto the link. (Fig. 19.)

## REPLACING A BROKEN HAME STAPLE

Due to the constant friction between the hame clip and the hame staple, the hame staple very frequently becomes worn through and must be replaced with a new one. It may be accomplished as follows:

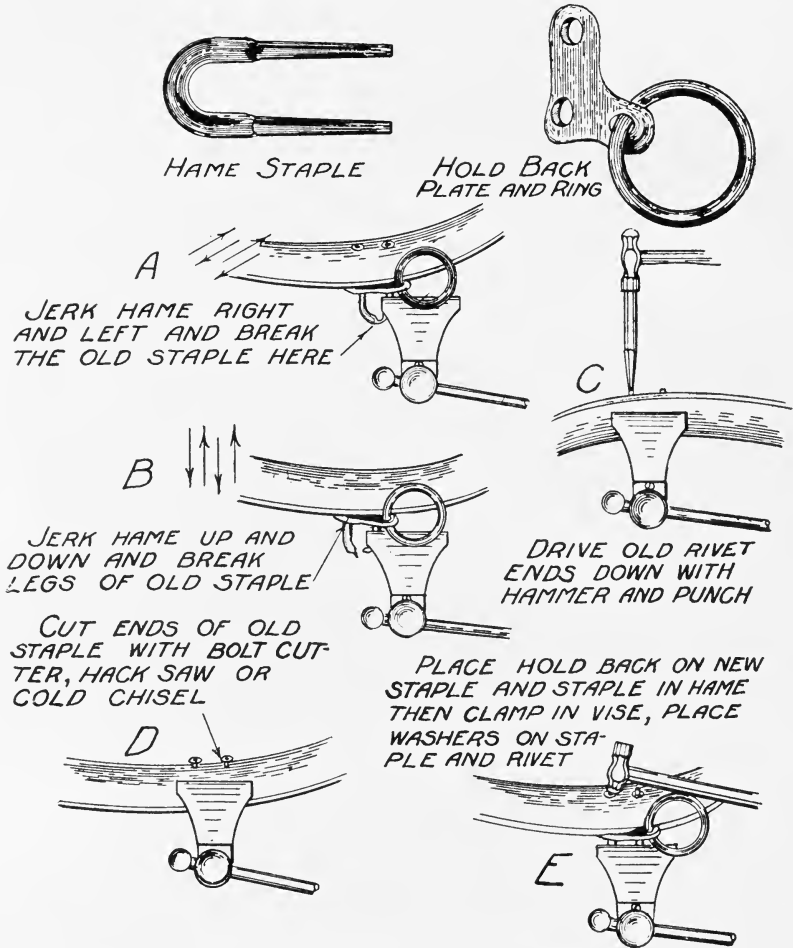

Fig. 20. Replacing a Broken Hame Staple.

1. If the old staple which it is desired to replace isn't entirely worn through it may be broken by placing one side of the staple in the vise as shown at A, Fig. 20, and vigorously jerking the hame back and forth, left and right.

2. When the staple is broken as shown at B, Fig. 20, place one side in the vise as shown, grab the end of the hame in both hands and jerk it up and down and thus break the staple off close to the hame.

3. Hame staples are tapered and cannot be driven through to

the riveted side. The hame is placed in the vise as shown at C with the riveted edge down and the rivets driven down with punch and hammer as far as possible.

4. The hame is reversed in the vise so that the riveted ends of the staple are up as shown at D. The riveted ends are then cut off with a hack saw, bolt cutter or cold chisel. If a cold chisel is used the rivets must be held on a solid metal surface. Having cut off the ends the rivets are punched out with a hammer and punch.

5. Place the right or left hold back plate and ring, depending on right or left hame, in place on the new staple and drive the staple in place.

6. Clamp the staple in the vise as shown at E and place washers on the staple. Then rivet firmly in place.

### USE OF BUCKLE SHIELDS

It is quite desirable that the buckle that attaches the breeching to the hip strap of harnesses be provided with a buckle shield so as to prevent the hair of the tail of the horse from being caught on the tongue of the buckle and pulled out. Metal buckle shields of

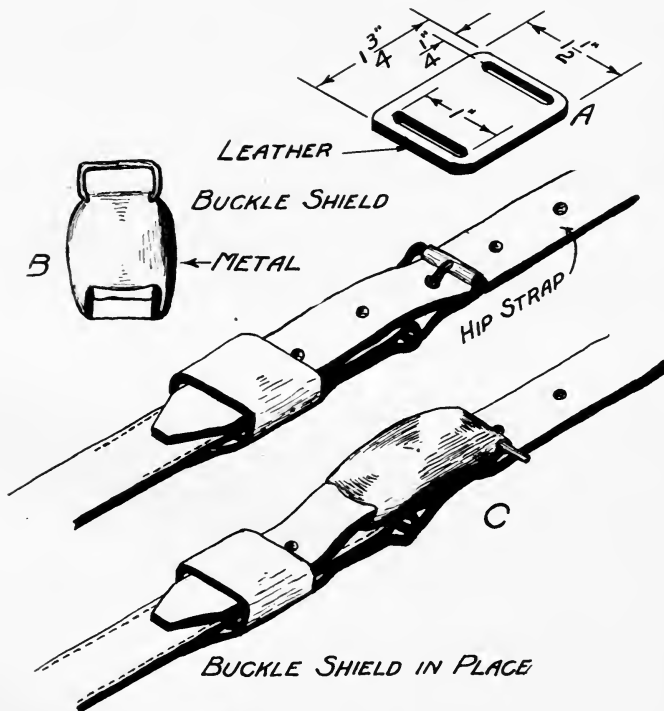

Fig. 21. Making and Use of Buckle Shields.

various sizes, B, Fig. 21, may be purchased and used for this purpose. They are attached as shown at C, Fig. 21.

A very satisfactory buckle shield may be made with a piece of leather as shown at A, Fig. 21. The size of the piece of leather to be used depends on the width of the strap. The one shown is  $1\frac{1}{2}$ " wide and  $1\frac{3}{4}$ " long and is designed for a strap 1" in width. On a line drawn parallel to each end of the strap  $\frac{1}{4}$ " or  $\frac{5}{16}$ " from the ends, make oblong holes with the belt punch of sufficient width to permit the strap to pass through. In this drawing it is 1" wide. The edges of the strap should be somewhat rounded and the corners should be cut round so as to make as smooth a shield as possible.

Leather from an old shoe may be used. Leather from an old belt may also be used, but may need to be skived off so as to be sufficiently flexible. Stiff leather should not be used as it is apt to chafe the horse.

## REPAIRING THE END OF A TRACE WITH A WROT CONCORD CLIP

1. Cut the end of the trace to be repaired square. Fig. 22. If the leather is badly torn so as to be somewhat ragged, it may be stitched.

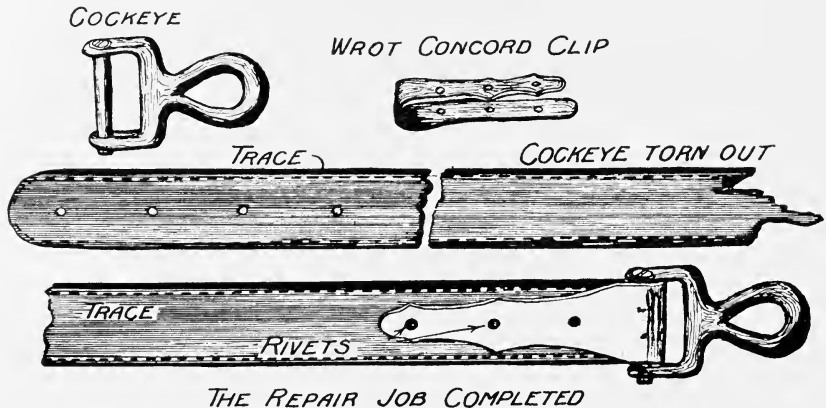

Fig. 22. Repairing the End of a Trace with a Wrot Concord Clip.

2. Place the trace in the clip and mark the holes for rivets. The trace should be kept far enough from the cockeye to permit the cockeye to swing freely.

3. Remove the trace from the clip and punch the holes.

4. Place the cockeye and the trace in the clip and the rivets in place. Place the heads of the rivets on the anvil or other solid metal surface and rivet the clip tight onto the trace.



## ATTACHING HEEL CHAIN TO TRACE WITH A HAME CLIP

If a cockeye tears out of the end of a trace it may be neatly and substantially repaired by hooking a hame clip into the heel chain and

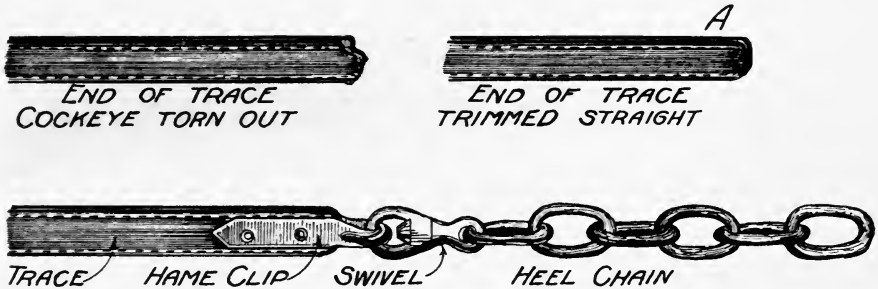

Fig. 23. Attaching Heel Chain to Trace with a Hame Clip.

riveting the clip onto the end of the trace. It may be accomplished as follows:

1. Trim the torn end of the trace, A, Fig. 23.
2. Place the hame clip on the trace and mark the places for the rivet holes A, Fig. 18.
3. Punch the holes with the belt punch or saddler's punch.
4. Place the clip on the trace.

Place the clip on the anvil, vise or other solid metal support and close it tight on the trace by a blow of the hammer, B, Fig. 18.

5. Force the scratchawl through the holes in the clip and trace to line them up.

6. Place rivets from the horse side of the trace and rivet smooth.

## REPAIRING A TRACE AND TUG WITH A TRACE SQUARE AND TWO WROT CONCORD CLIPS\*

1. Place the square in the clip and the end of the trace in position in the clip and mark the holes for the rivets on the trace, Fig. 24.

\*Note:—Cut and shorten the length of the trace or tug a distance equal to the length of the trace square so that the total length of the trace will be the same as it was before the break occurred.

This method of repair is one often used where the trace and tug are joined. The distance from the front end of the tug to the center of the trace square should be 18". If this method of repair is used at this point on the trace a trace square billet  $1\frac{1}{4}$ " long is riveted or sewed onto the trace square.

2. Remove the trace and punch the holes for the rivets.
3. Place the trace in the clip and the rivets in the holes and with the heads of the rivets resting securely on an anvil or other metal surface rivet the ends of the rivets securely on the clip.
4. Fasten the other end of the tug in the same way.

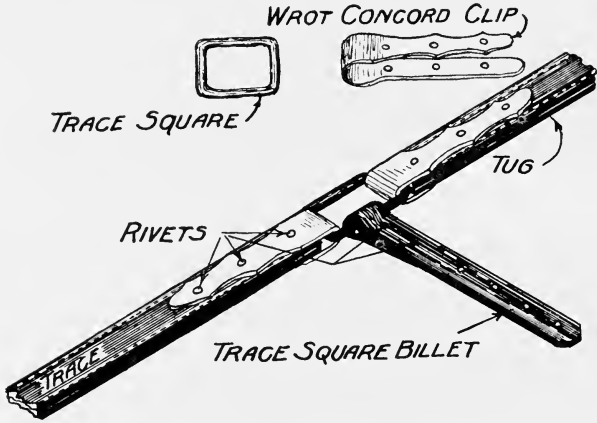

Fig. 24. Repairing a Trace and Tug with a Trace Square and two Wrot Concord Clips.

### SPLICING A TRACE WITH A TRACE SPLICER OR A METAL PLATE

1. Cut the broken ends of the trace square.
2. Place the square ends together; place the plate on the trace and mark the points for the rivets with the scratchawl.
3. Make the rivet holes and place the plate in the center of the trace as shown in Fig. 25.
4. Place the repair job on an anvil or other solid metal surface,

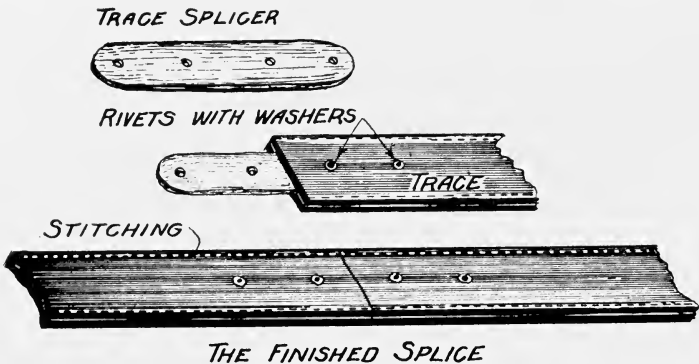

Fig. 25. Splicing a Trace with a Trace Splicer or a Metal Plate.

place the rivets in the holes, with a washer on the rivet and rivet in place. Rivets should be used which have flat heads and just long enough to rivet well. The rivets should be placed with the head on the horse side of the trace and smoothed as neatly as possible so as to prevent rubbing the horse.

5. If a narrow plate is used the edges and ends of the plate should be filed smooth. The edges of the trace may be sewed as shown in the illustration and thus the appearance of the job greatly enhanced.\*

## REPAIRING BOTTOM END OF HAME

If a hame iron wears through where it holds the bottom loop it may be repaired with a repair clip.

1. Clamp the hame in the vise and remove the old rivet and the broken end with the hammer and punch.

2. Place the bottom loop in the repair clip and strip the repair clip on the end of the hame under the old hame iron.

3. Place the rivet through from the back of the hame through the old hole in the iron and while resting the head of the rivet on an anvil or vise rivet snugly in place.

4. At a point on the iron just below the rivet cut a notch in the iron with a file and break the end of the old iron off. Note in Fig. 26, "Cut the old metal here."

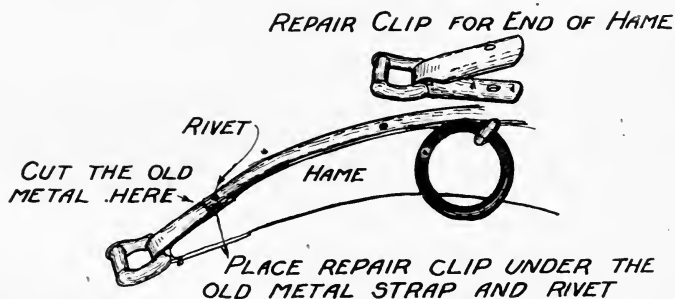

Fig. 26. Repairing Bottom End of Hame.

5. Hammer the end tight against the hame and smooth with a file if necessary.

## HARNESS STITCHING CLAMP TO BE USED WITH METAL VISE ON WORKBENCH

The harness stitching clamp which is shown in the picture and the drawing of which is shown in Fig. 27, is made of two pieces of

\*Note:—Any piece of metal approximately  $\frac{1}{8}$ " thick by  $\frac{3}{4}$ " or 1" wide by 6" to 8" in length may be drilled and used for the plate.

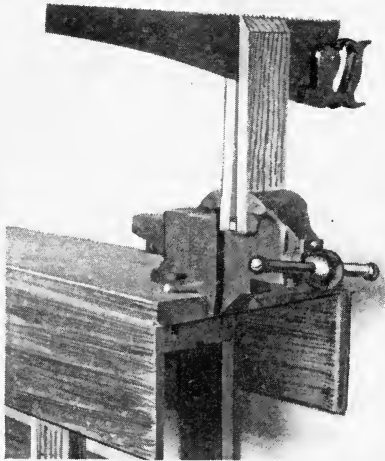
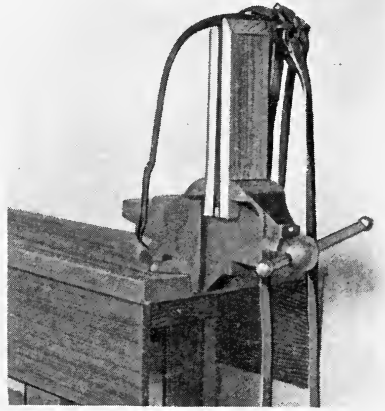
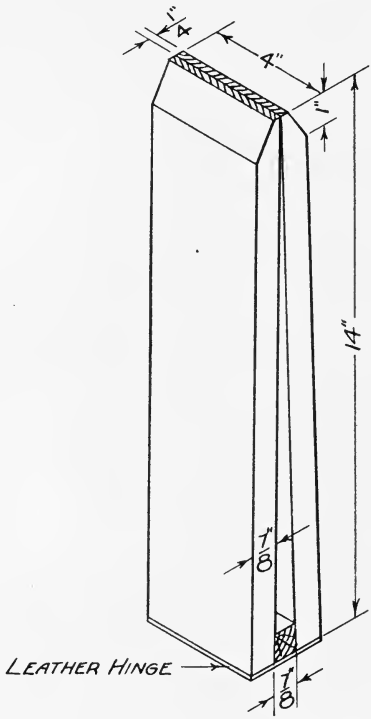

HARNESS STITCHING CLAMP  
TO BE USED WITH  
METAL VISE

Fig. 27.

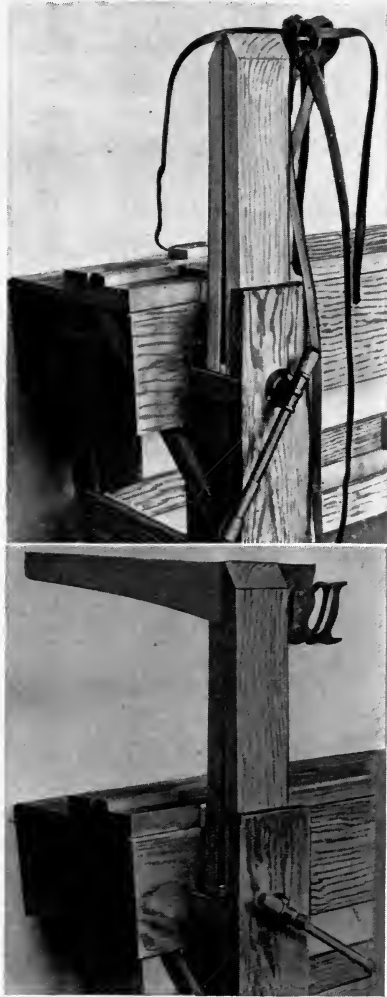
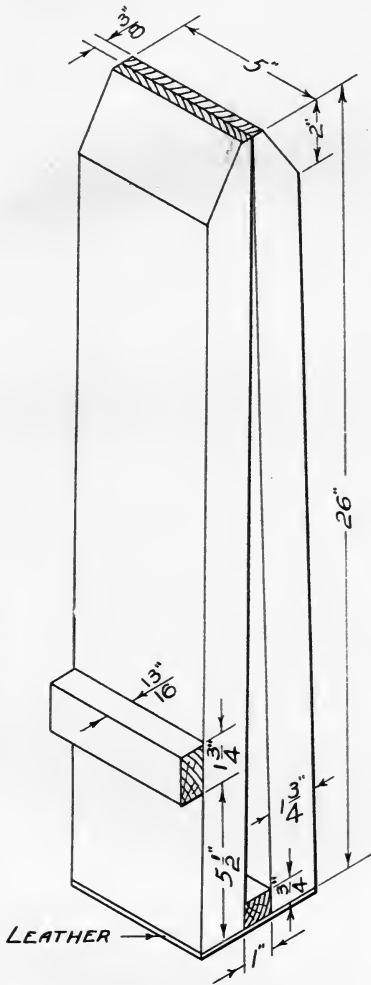

HARNESS STITCHING CLAMP  
TO BE USED WITH  
FARM SHOP WORKBENCH VISE

Fig. 28.

hardwood  $\frac{7}{8}$ "x4"x14", one piece of any wood  $\frac{7}{8}$ "x $\frac{7}{8}$ "x4", and a piece of leather  $2\frac{5}{8}$ "x4". If leather of these dimensions is not at hand, two or three pieces of strap, or trace or tug of any width, which is available,  $2\frac{5}{8}$ " long may be used. The block between the two members of the clamp is nailed to one member only. The leather hinge is nailed to both members of the clamp but not to the block. The clamp may be made 14" long or longer or shorter to suit the height of the vise and the person using the clamp.

The clamp may also be used to hold a crosscut or hand saw for filing.

### **HARNESS STITCHING CLAMP TO BE USED WITH FARM SHOP WORKBENCH VISE**

As shown in the picture this clamp is used with the wooden vise on the farm shop workbench. Fig. 28. A piece of wood  $\frac{3}{4}$ "x1"x5" is placed between the two pieces of the clamp at the bottom and nailed to one member of the clamp. A piece of wood  $1\frac{3}{16}$ "x1 $\frac{3}{4}$ "x5" is nailed to one member of the clamp at one side at a point  $5\frac{1}{2}$ " from the bottom. This piece fits against the top plank of the bench. When the vise on the bench is closed it draws the top of the clamp tight onto the leather for stitching. Any piece of leather may be used for the hinge at the bottom. It should be nailed to the bottom ends of the clamp but not to the block between the members of the clamp.

The height of the clamp may be made 26" as called for in the drawing or more or less to suit the workman.

The clamp may also be used for holding a crosscut or handsaw for filing.

Since the two horizontal bars of the vise are more than 5" apart the clamp has a tendency to tip when not tight in the vise. This may be overcome by placing a narrow, thin board in the vise on the horizontal members and then placing the clamp in place.

### **STITCHING CLAMP AND FARM WORKBENCH**

A very satisfactory harness stitching arrangement is that of using a clamp which is held in the vise of the farm workbench. Figs. 29, 30, 31. The clamp and strap are made entirely apart from the bench and are only placed in the vise when stitching is to be done. When the stitching job is completed the strap is unsnapped from the lever, the clamp is removed from the vise and the outfit hung on a nail in some out-of-the-way place as shown in Fig. 33, until further call for its use. The following bill of material is for the lever arrangement and stitching clamp only.

**Material Required.****Lumber.**

Pieces	Dimensions	Use
1	$\frac{7}{8}$ "x4"x22"	Post for clamp
1	$\frac{7}{8}$ "x4"x18"	Clamp
1	$\frac{7}{8}$ "x2"x4"	Block between clamp and post
1	$\frac{7}{8}$ "x1"x5 $\frac{1}{2}$ "	Fulcrum
1	$\frac{7}{8}$ "x1"x20"	Lever

**Hardware.**

- 2 machine bolts  $\frac{3}{8}$ "x3  $\frac{1}{2}$ " to bolt post, block and clamp together.
- 2 2" fast joint, light, narrow butt hinges with screws.
- 2 carriage bolts  $\frac{1}{4}$ "x2  $\frac{1}{2}$ " to fasten fulcrum to brace of bench.
- 1 machine bolt  $\frac{1}{4}$ "x2  $\frac{1}{2}$ " to fasten lever to fulcrum.
- 1 piece of metal  $\frac{1}{8}$ "x1"x2" for lock.
- 1 piece of metal  $\frac{1}{8}$ "x1"x5" for clamp.
- 6 round head blued screws  $\frac{7}{8}$ " No. 8 to fasten lock and clamp.
- 1 1  $\frac{3}{4}$ " fence staple for fastening snap to lever.
- 1 1" harness snap for fastening strap to staple.
- 1 1" strap 3' 6" long.
- 1 1" harness buckle.
- 1 piece of tin 1"x2" to place in mortise in post for strap to slide over and prevent wear of strap.
- 2  $\frac{3}{4}$ " brads to fasten end of strap to clamp.
- 1 coil spring to spread clamp.

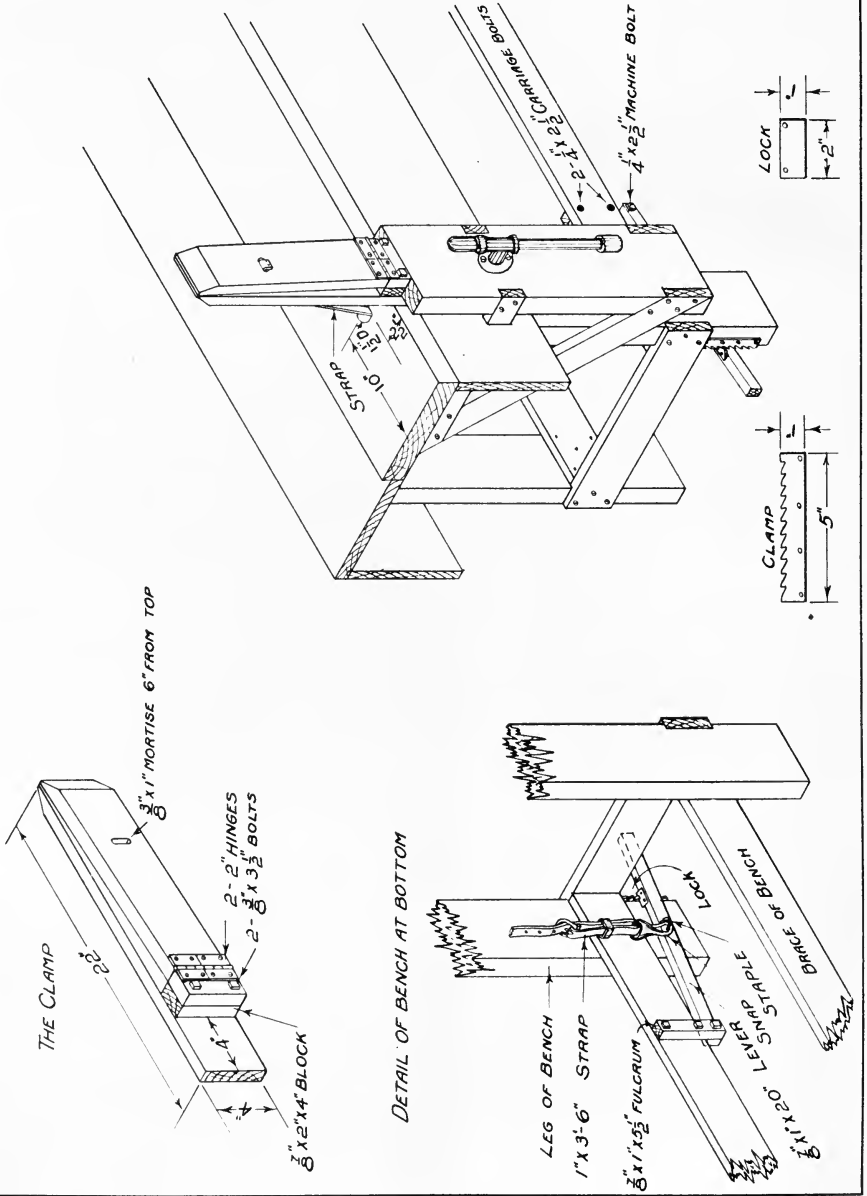

Fig. 29. Lever and Lock of Stitching Clamp and Farm Workbench.



Fig. 30. Stitching Clamp and Vise of Farm Workbench.

STITCHING CLAMP AND TANNING WORKBENCH





**Directions for Construction.**

1. Reduce all pieces to length, width and thickness.
2. Bevel the top ends of the post and clamp as shown in the drawing.
3. Make mortises  $\frac{3}{8}$ "x1" for the strap through the post and clamp at 6" from the top.
4. Bend the piece of tin in the mortise in the post and fasten with brads. This provides a smooth surface for the strap to slide over.
5. Bolt the clamp and post together with  $\frac{7}{8}$ "x2"x4" block between them at the bottom, using the  $\frac{3}{8}$ "x3 $\frac{1}{2}$ " machine bolts.

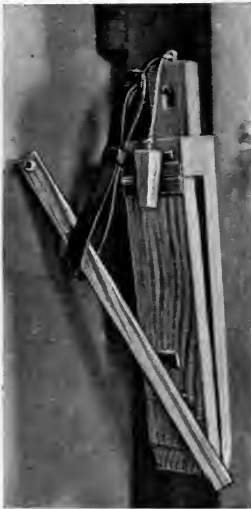

Fig. 32. Clamp, Lever, Wedge and Strap Hung on Nail.



Fig. 33. Clamp Hung on Nail.

6. Fasten the hinges in place, then remove the hinges and saw the clamp in two at two inches from the bottom. Then replace the hinges. This leaves a saw kerf between the parts and permits the clamp to close at the top.
7. Fasten the coil spring between the clamp and the post.
8. File notches similar to the teeth on a rip saw in one edge of the metal clamp as shown in the detail drawing.
9. Drill four holes through the metal clamp near the back edge for the screws.
10. Fasten the metal clamp to the leg of the workbench as shown in the drawing.
11. Drill the holes through the metal piece for the lock and

fasten to the upper edge of the lever so as to lock onto the clamp. The lock should be gained in at the back so as to stand at a slant. The lower edge may be ground or filed so as to fit up into the notches of the clamp. The lock should be placed at  $3\frac{1}{4}$ " from the end of the lever.

12. Fasten the fence staple to the side of the lever at a point  $8\frac{1}{2}$ " from the end of the lever.

13. Fasten the lever to the lower end of the fulcrum with the  $\frac{1}{4}$ " x  $2\frac{1}{2}$ " machine bolt.

14. Fasten the fulcrum to the inside of the brace of the bench at a point  $9\frac{1}{2}$ " from the leg.

15. Assemble the buckle, slide loop, snap and strap; pass the end of the strap through the mortises in the post and clamp and fasten to the clamp with the two  $\frac{3}{4}$ " brads.

16. Locate a point on the top, front plank of the workbench at the vise end  $3\frac{1}{4}$ " from the front edge and 10" from the front end, and bore a hole  $1\frac{1}{2}$ " in diameter through the plank for the strap to slide through.

17. With the keyhole saw, chisel and mallet make the front edge of the hole square so as to permit the strap to slide through flat.

18. Place the clamp in the vise, drop the snap end of the strap through the hole in the top of the bench and snap it to the staple on the lever.

19. Draw the strap up tight at the buckle so that pressure on the end of the lever will draw the clamp shut and lock it.

20. Bore a hole through the bottom end of the post of the clamp so that it may be hung on a nail in some out-of-the-way place when not in use. Fig. 33.

## FARM SHOP WORKBENCH

### Bill of Material.

#### Lumber for bench:

Pieces	Dimensions	Use
1	$1\frac{3}{4}$ " x 10" x 8' 0"	Top (maple or other hard-wood)
1	$\frac{1}{8}$ " x 10" x 8' 0"	Top (soft wood)
4	$1\frac{3}{4}$ " x $5\frac{3}{4}$ " x 2' 7"	Legs
2	$1\frac{3}{4}$ " x $5\frac{3}{4}$ " x $18\frac{3}{8}$ "	Sills
2	$\frac{1}{8}$ " x 4" x $18\frac{3}{8}$ "	End braces
2	$\frac{1}{8}$ " x 4" x $6' 5\frac{1}{4}$ "	Long braces
1	$\frac{1}{8}$ " x 4" x $13\frac{1}{4}$ "	Cross brace
2	$\frac{1}{8}$ " x 10" x 8' 0"	Aprons
2	$\frac{1}{8}$ " x 3" x $18\frac{3}{8}$ "	Drawer guides
2	$\frac{1}{8}$ " x $\frac{1}{8}$ " x $18\frac{3}{8}$ "	Drawer guides
1	$\frac{1}{8}$ " x 6" x 18"	Drawer front
2	$\frac{1}{8}$ " x 6" x 19"	Drawer sides
1	$\frac{1}{8}$ " x $4\frac{1}{8}$ " x 17"	Drawer back
2	$\frac{1}{8}$ " x $9\frac{3}{8}$ " x $16\frac{3}{8}$ "	Drawer bottom

**Lumber for vise:**

1	1 3/4" x 7 1/2" x 24"	Jaw (oak, maple or other hardwood)
2	1 1/8" x 2" x 17"	Horizontal braces (oak, maple or other hardwood)
2	1 1/8" x 2" x 2' 7 1/2"	Diagonal braces (oak, maple or other hardwood)

**Hardware for bench:**

- 7 carriage bolts 3/8" x 6 1/2" with washers, for holding sills to legs.
- 1 carriage bolt 3/8" x 6" with washer, for holding sill to leg.
- 4 carriage bolts 3/8" x 7" with washers, for holding top to sills.
- 40 flat head bright wood screws, 1 3/4" No. 8 or 9 for fastening top board, aprons, braces, and drawer guides.
- 20 6d common nails for fastening long braces to legs.
- 1 doz. 4d common nails for assembling drawer guides.
- 1/4 lb. 6d finishing nails for assembling drawer.

**Hardware for vise:**

- 1 iron bench screw 7/8" or 1" with handle.
- 4 flat head bright wood screws 1 1/2" No. 12 for fastening bench screw to jaw.
- 8 flat head bright wood screws 2" No. 12 for fastening braces to jaw.
- 8 flat head bright wood screws 3/4" No. 8 for fastening braces at joints.

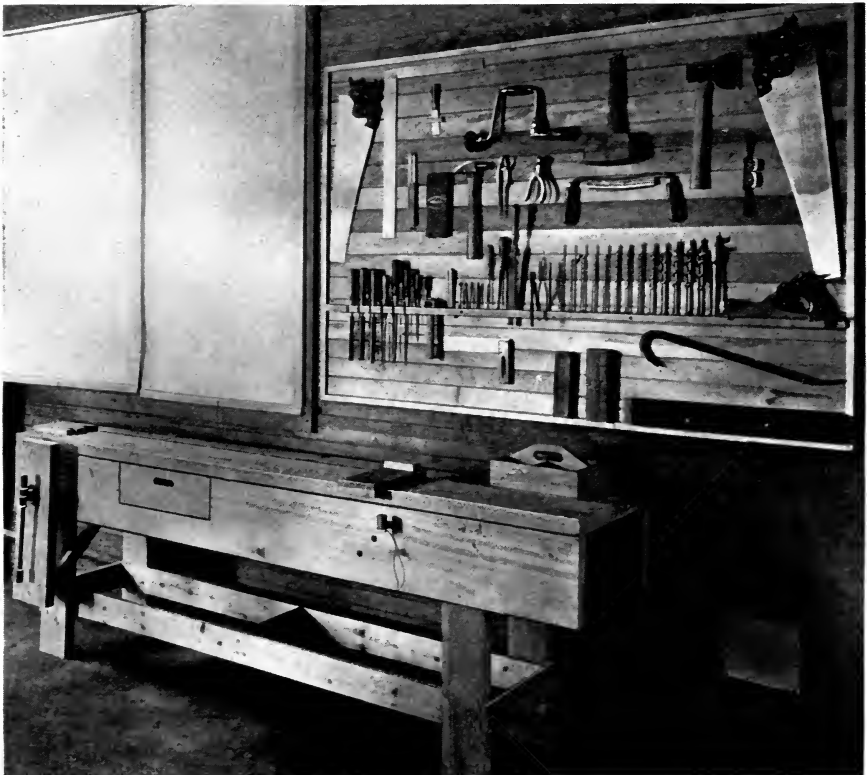

Fig. 34. Another View of the Farm Shop Workbench and Farm Woodworking Tools.

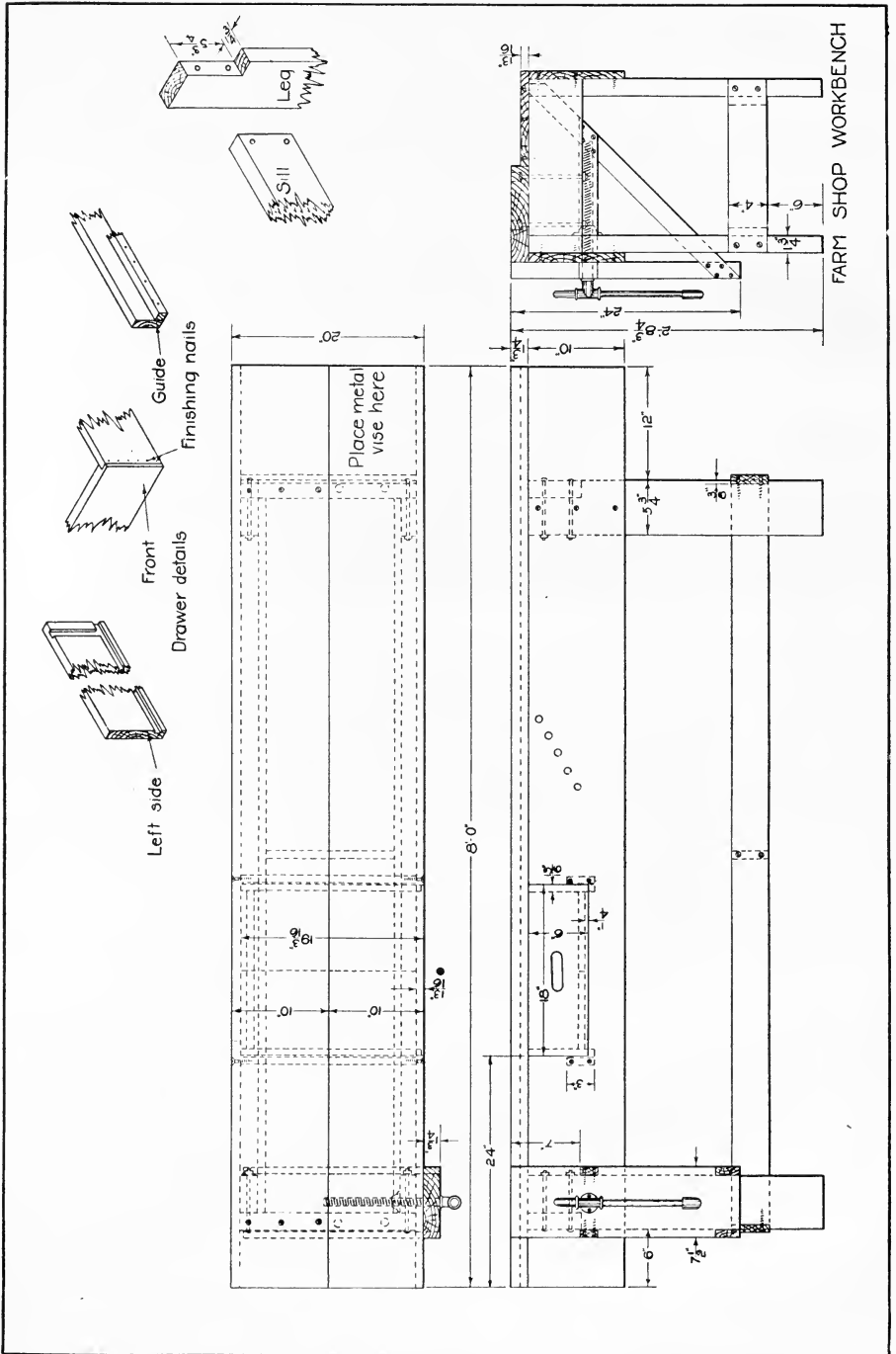

Fig. 35.

**Directions**

Dry lumber should be used for all parts of the bench and vise. Soft lumber may be used for all parts excepting the vise and top plank. Oak, maple, hard pine or other hard lumber should be used for these members. All lumber should be surfaced on two sides to the thickness called for in the drawing. Figs. 34, 35.

1. Cut the legs to length 2' 7", and lay out the mortises at one end of each leg to receive the ends of the sills as shown in the detail drawing  $1\frac{3}{4}" \times 5\frac{3}{4}"$  removing the stock with the cross cut and rip saws.

A  $6\frac{1}{2}"$  bolt at the top of the back leg at vise end would prevent the vise from closing. This is overcome by cutting  $\frac{1}{2}"$  out of the edge of the leg at the top and using the 6" bolt.

If the lumber for the legs is only  $5\frac{1}{2}"$  wide instead of  $5\frac{3}{4}"$  as called for in the bill of material, which is often the case, the bolts for holding the sills to the legs may be  $\frac{1}{2}"$  shorter, thus being  $\frac{3}{8}" \times 6"$  and  $\frac{3}{8}" \times 5\frac{1}{2}"$ .

2. Lay out the gains on the outside edges of the legs,  $\frac{3}{8}"$  deep, 4" wide and 6" from the bottom ends to receive the cross braces.

3. Cut the sills to length,  $18\frac{3}{4}"$  and fasten them to the legs with two  $\frac{3}{8}" \times 6\frac{1}{2}"$  carriage bolts at each joint. Use the square to assure right angles between the legs and sills.

4. Fasten the cross braces to the legs, using two  $1\frac{3}{4}"$  No. 8 or 9 flat head screws at each joint.

5. Cut the long braces to dimensions and fasten them in place, using five 6d. common nails at each joint. Make sure that the legs stand at right angles to the long braces.

6. Cut the middle cross brace to length  $13\frac{1}{4}"$  and fasten to the two long braces with two  $1\frac{3}{4}"$  No. 8 or 9 flat head screws at each end.

7. Cut an opening in the upper edge of the front apron 18" long and 6" deep, 24" from the front end of the board for the drawer.

8. Fasten the aprons to the legs, using three  $1\frac{3}{4}"$  No. 8 or 9 flat head screws at each leg except the vise leg, on which the middle screw is omitted because of the bench screw.

9. Lay out the mortises on the front apron for the horizontal braces of the vise so that the top of the mortises are 7" from the top of the bench or  $5\frac{1}{4}"$  from the top of the apron, and so that the inside of the mortises fall flush with the sides of the legs. The mortises should be made slightly larger than the braces to provide a free working of the braces through the mortises.

10. Locate and bore a hole for the bench screw with a bit  $1/16''$  larger than the bench screw through the apron and leg on a center line of the leg  $7\frac{1}{2}''$  from the top of the bench, or  $5\frac{3}{4}''$  from the top of the apron.

11. Place the bench screw through the hole and fasten the screw washer in place on the inside of the leg with two  $1\frac{3}{4}''$  No. 12 flat head wood screws.

12. The braces for the vise are assembled at the half lap joint and placed through the apron from the inside and fastened to the jaw of the vise with two No. 12 flat head wood screws at each brace.

13. Assemble the drawer guides as shown in the detail drawing, using six 4d. common nails for each guide, and fasten in position, using two  $1\frac{3}{4}''$  No. 8 or 9 flat head screws at each end of each piece.

14. The method of constructing a drawer depends somewhat upon the tools and machines at hand. If a grooving plane, buzz saw or dado saw are at hand, the method suggested in the detail drawings is to be preferred.

It will be noted that grooves are cut in the side pieces near the lower edge and also near the rear end to receive the bottom and end pieces. A groove is also cut in the drawer front at the inside near the bottom to receive the front end of the bottom. The drawer front should be constructed at both ends as shown in the detail drawings. If the above tools are not at hand this may be done with saw, chisel and mallet. Simple box construction where only butt joints are used makes a very substantial drawer if securely nailed. Sixpenny finishing nails may be used.

15. For a drawer pull in this place an opening 1" wide by 4" long is preferable to a drawer pull which is fastened to the outside of the drawer, as it is out of the way.

16. Lay the top plank in place, clamp tightly, and draw lines across over the center of the cross sills.

17. On each line just drawn locate two points; one  $1\frac{1}{2}''$  from the back edge and one  $3\frac{1}{4}''$  from the front edge.

18. Bore holes  $\frac{3}{4}''$  deep on points just located with  $\frac{7}{8}''$  bit.

19. Continue holes through plank and into sills with  $\frac{3}{8}''$  bit.

20. Remove plank and continue holes through sill.

21. Place plank in position and fasten with  $\frac{3}{8}'' \times 7''$  carriage bolts, using one washer for each bolt.

22. Plug the holes in the top of the plank.

23. Fasten the top board by using three  $1\frac{3}{4}''$  No. 8 or 9 flat head screws through the board into each sill.

## STITCHING HORSE

## Bill of Materials.

(Figs. 36, 37, 38, 39.)

Lumber: Oak, maple, beech, birch or other hardwood.

Pieces	Dimensions	Use
1	1 3/4" x 10 1/2" x 26"	Seat
4	1 1/4" x 1 1/4" x 24 1/4"	Legs
1	1 1/4" x 1 1/4" x 21 3/8"	Brace (left side)
1	3/4" x 3/4" x 23 3/4"	Brace (right side)
2	3/4" x 3/4" x 13 3/4"	Braces (end)
1	3/4" x 1 1/4" x 22"	Lever
1	1 1/2" x 5" x 20 3/4"	Post
1	1 1/2" x 5" x 16 3/4"	Clamp
1	1" x 1 3/4" x 5"	Key

## Hardware.

6 flat head bright wood screws 2 1/2" No. 12 for fastening legs to seat and brace to legs at left side.

6 flat head bright wood screws 1 3/4" No. 9 for fastening braces at ends and right side.

7 round head blued wood screws 1" No. 9 to fasten lock on leg and catch to lever.

2 machine bolts 5/8" x 3 1/2" to fasten clamp to post.

2 fast joint steel butts 1 1/2" x 1 1/2".

1 coil spring 1" x 3".

1 leather strap 1" x 44".

1 1" harness buckle.

3 lining nails to fasten end of strap to clamp.

1 piece of heavy wire 2 1/2" long to hold strap in place on lever.

1 piece of metal 1/4" x 1 1/2" x 5" for the lock.

1 piece of metal 1/4" x 1 1/2" x 2 1/2" for the catch.

1 piece of metal 1/4" x 1" x 5 1/2" for the U iron.

2 machine bolts 1/4" x 2" to hold the U iron to brace and lever in U iron.

## Directions.

1. Reduce all pieces to finished dimensions.
2. Draw a centerline lengthwise of the seat piece and also lines across the stock 5 1/4" from each end, and at the intersection of lines swing arcs with a 5 1/4" radius.
3. With the compass set at 9 3/4", swing an arc at each side tangent to the arcs at each end.
4. Remove the stock to a line with a turning saw, keyhole saw, or by making saw kerfs to the line and removing the stock with the draw shave. The edge may be smoothed with a wood file.
5. The stock on the upper side of the seat where the worker's legs rest on the seat may be further removed with the draw shave and smoothed with the wood file.
6. To lay out the mortise for the post on the seat locate a point on the line across the front end of the seat 1/4" from the centerline as shown in the detail drawing. Set the T-bevel at 1/8" pitch using the figures 12 and 3 or 4 and 1 on the steel square and draw lines





for the sides of the mortise. The end lines of the mortise are at right angles to the sides. The mortise extends through the seat at the above angle and the T-bevel may be used as a guide in boring out the stock.

7. Remove the stock for the mortise with a bit, chisel and mallet. It may be noted in the detail drawing that the mortise is  $1\frac{5}{8}'' \times 3\frac{1}{2}''$ .

8. Set the T-bevel at  $22\frac{1}{4}''$  and  $4\frac{3}{4}''$  on the steel square and lay out the cuts at both ends of the legs and left side brace. A shoulder is cut at the upper end of the legs 1" from the end so that the end will go into the  $\frac{3}{4}''$  holes which are bored in the lower side of the seat.

9. At a point 6" from the lower end of the left legs and on the inside lay out gains  $\frac{1}{4}''$  deep and  $1\frac{1}{4}''$  wide across the stock to receive the ends of the left side brace. The stock may be removed with the saw and chisel, making the saw kerfs close together. Use the T-bevel as set for the ends of the legs. This will place the top and bottom edge of the brace parallel to the floor when the horse is assembled.

10. Assemble the brace and left legs by the use of one  $2\frac{1}{2}''$  No. 12 flat head bright wood screw at each joint. The holes for all flat head screws should be counter-sunk so as to place the screws slightly below the surface of the wood. In placing the screws it is well to use two wood twist drills, one the diameter of the wire of the screw to bore a hole as deep as the screw up to the thread on the screw and another  $\frac{1}{32}''$  smaller to bore the hole slightly deeper.

11. Locate points on the inside of all four legs on a centerline and 8" from the bottom end of the legs and bore  $\frac{3}{4}''$  holes  $\frac{3}{4}''$  deep for the ends of the end braces. The holes are bored at the same



Fig. 37. Front View of Stitching Horse.

angle as is used for the ends of the legs. The ends of the braces are rounded so as to draw snugly into the  $\frac{3}{4}$ " holes.

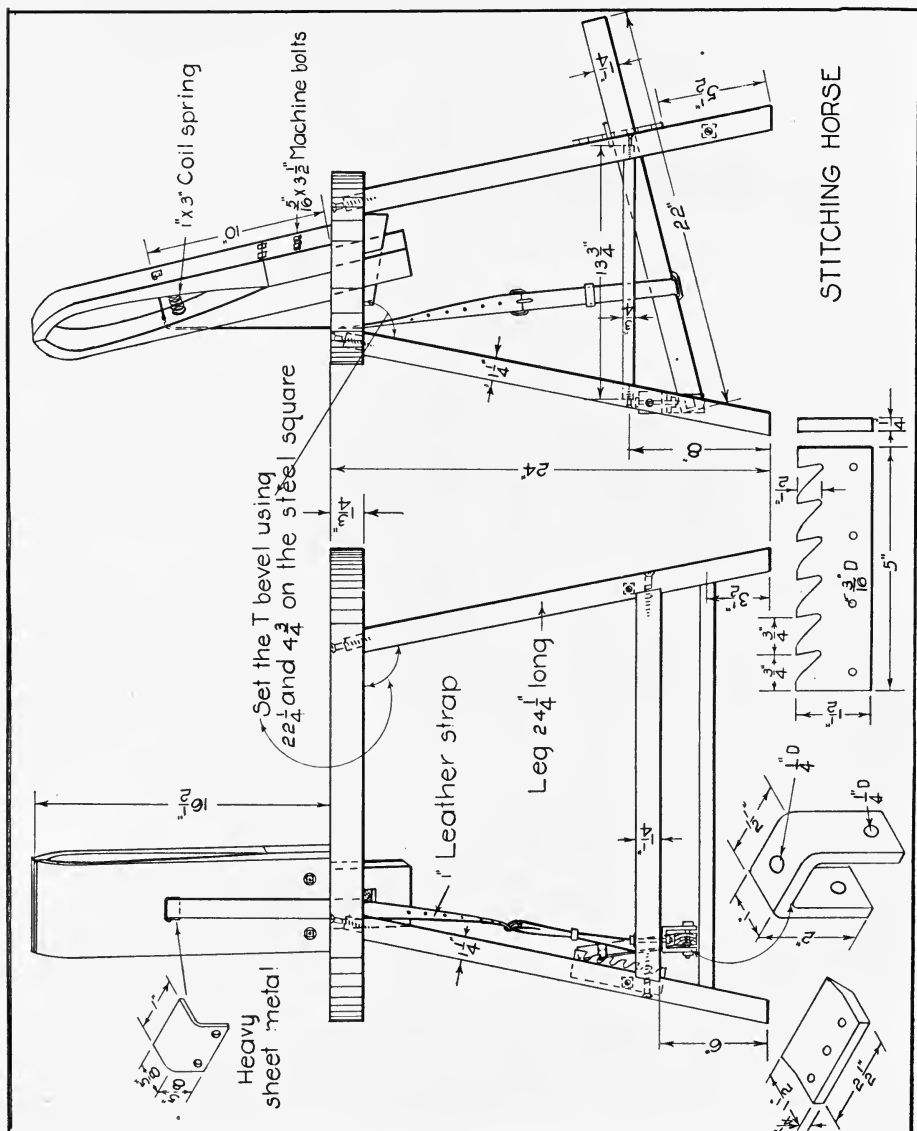

Fig. 38.

12. Locate points on the two right legs  $3 \frac{1}{2}$ " from the bottom ends and bore  $\frac{3}{4}$ " holes for the right side brace.

13. Fasten the braces to the legs by using one  $1 \frac{3}{4}$ " No. 9 flat head bright wood screw at each joint.



Fig. 39. Side View of Stitching Horse.

14. Lay the seat on the bench with the bottom side up. Draw a centerline lengthwise of the stock and lines across the stock  $5\frac{1}{4}$ " from each end. Locate two points on each line across the stock 4" from the centerline. At these points bore  $\frac{3}{4}$ " holes 1" deep, using the T-bevel set as for the ends of the legs for a guide.

15. With a twist drill of the size of  $2\frac{1}{2}$ " No. 12 screws continue the holes through the seat from the same side. Countersink the holes from the upper side of the seat.

16. Place the legs in position and with a twist drill  $\frac{1}{32}$ " smaller than the above bore a hole into the top end of each leg for the screws.

17. Fasten the seat to the legs using one  $2\frac{1}{2}$ " No. 12 flat head screw at each joint.

18. By use of the T-bevel as set for the mortise through the seat lay out the lower end of the clamp and post and remove the stock with saws as shown in the detail drawing of the clamp.

19. Lay out the mortise for the key through the post at the dimensions shown in the detail drawing of the clamp. Remove the stock with a bit, chisel and mallet.

20. To lay out the clearance space on the clamp and post, draw seven lines across the inside and both edges of each as shown in the detail drawing; the first  $\frac{3}{4}$ " from the end and the other 2" apart. Locate points on the lines across the edges as shown in the detail drawing and lay out the curves free hand. The stock may be removed by making saw kerfs close together across the stock and removing the wood with the chisel and draw shave. The surface may be smoothed with a wood file.

21. Draw lines across the upper ends of the post and clamp  $\frac{1}{4}$ " from the inside edge and a line across the outside of each  $2\frac{3}{4}$ " from the end. Lay out a curve free hand for rounding the corners and

remove the stock with the draw shave. The surface may be smoothed with the wood file.

22. Draw a line across the outside of the clamp, 10" from the lower end, and on this line make an opening for the strap through both clamp and post, using the  $\frac{3}{8}$ " bit as shown in the detail drawing.

23. Bolt the clamp and post together with two  $\frac{5}{16}$ "x $3\frac{1}{2}$ " machine bolts placed as indicated in the detail drawing.

24. Place the two steel butts as shown in the detail drawing 4" from the lower end of the clamp.

25. Remove the hinges and saw the clamps in two below the center of the hinges; then replace the hinges. If it were sawed first and then the hinges placed in position the clamp would drop down the thickness of the saw kerf and not match at the top with the post.

26. Shape the key as shown in the detail drawing of the key.

27. On a line drawn parallel to the side of the mortise,  $2\frac{3}{4}$ " from the side of the seat and 6" from the front end of the seat, make a slot through the seat  $\frac{5}{16}$ " wide and  $1\frac{1}{8}$ " long for the strap to pass through.

28. The coil spring is placed directly below the strap between the clamp and the post. It may be held in place by bending about  $\frac{3}{8}$ " of one end of a wire at a right angle to the length of the spring and forcing this bent end into a hole in the post.

29. Cut a piece of galvanized iron or other heavy sheet metal  $1$ "x $1\frac{1}{4}$ " and bend to a right angle as shown in the detail drawing; place it in the strap opening in the post and fasten with two small flat head screws.

30. With the hack saw cut a piece of metal for the lock  $\frac{1}{4}$ "x $1\frac{1}{2}$ "x $5$ ". The notches are  $\frac{1}{2}$ " deep and shaped as indicated in the detail drawing. They are cut with the hack saw and the corners are rounded with an iron file. Centerpunch for holes for the screws as shown and drill  $\frac{3}{16}$ " holes, using the drill press or breast drill. Fasten the clamp to the right front leg with four 1", No. 9, round head blued screws so that the lower end is  $5\frac{1}{2}$ " from the bottom of the leg.

31. By the use of the hack saw cut a piece of metal for the catch  $\frac{1}{4}$ "x $1\frac{1}{2}$ "x $2\frac{1}{2}$ ", heat to a cherry red heat and forge to the form shown in the detail drawing. If a forge is not available it may be filed or ground to the form and bent slightly with a hammer and vise. Centerpunch for three holes and drill  $\frac{3}{16}$ " holes. Fasten to the top edge of the lever with three 1", No. 9, round head blued screws.

32. Cut a piece of metal with the hack saw  $\frac{1}{4}$ "x $1\frac{1}{2}$ "x $5\frac{1}{2}$ ". Centerpunch for the holes and bore three  $\frac{1}{4}$ " holes as indicated. Heat the metal to a cherry red heat and bend to a U form to the dimensions shown in the detail drawing.

33. Bore a  $\frac{1}{4}$ " hole through the left horizontal brace at a point 2" from the front end and fasten the U iron in place with a  $\frac{1}{4}$ "x2" machine bolt.

34. Bore a  $\frac{1}{4}$ " hole through the left end of the lever and fasten into the U iron with a  $\frac{1}{4}$ "x2" machine bolt.

35. File both ends of the  $2\frac{1}{2}$ " heavy steel wire to a point; bend  $\frac{1}{2}$ " of each end at a right angle. Drill holes and fasten to the lower edge of the lever so as to hold the strap at 7" from the lower end of the lever.

36. Fasten the buckle to the end of the strap; strip a leather loop on the strap; draw the strap around the lever through the bent wire guide and again through the leather loop and through the buckle. Draw it up through the slots in the seat, post and clamp and fasten to the outside of the clamp with three lining nails.

37. With the belt punch make holes in the strap 1" apart and draw the strap up so that the lever works the clamp and locks it.

38. Wood deteriorates in value and strength as it constantly increases and decreases in moisture content. This may be largely prevented by covering with a coat of paint or shellac. It is suggested that the stitching horse be finished with two coats of shellac.

## SAW HORSE STITCHING CLAMP

A stitching clamp may be made by a clamp and lever arrangement attached to a saw horse. Figs. 40, 41. The clamp is removed from the saw horse by driving the key out of the keyway, and the lever is removed by loosening the nut on the bolt in the leg. The clamp may then be hung some place in the shop or barn until further call for its use and the saw horse used for other purposes. Fig. 32.

### Material Required.

#### Lumber.

Pieces	Dimensions	Use
1	$1\frac{3}{4}$ "x $5\frac{3}{4}$ "x3' 0"	Top
4	$\frac{1}{8}$ "x3 $\frac{3}{4}$ "x $25\frac{1}{4}$ "	Legs
2	$\frac{1}{8}$ "x $5\frac{1}{2}$ "x $10\frac{1}{4}$ "	Braces
1	$\frac{7}{8}$ "x4"x22" (hardwood)	Post for clamp
1	$\frac{7}{8}$ "x4"x18" (hardwood)	Clamp
1	$\frac{7}{8}$ "x2"x4"	Block at bottom of clamp
1	$\frac{3}{4}$ "x1"x3" (hardwood)	Key
1	$\frac{7}{8}$ "x1"x20" (hardwood)	Lever

SAW HORSE STITCHING CLAMP.

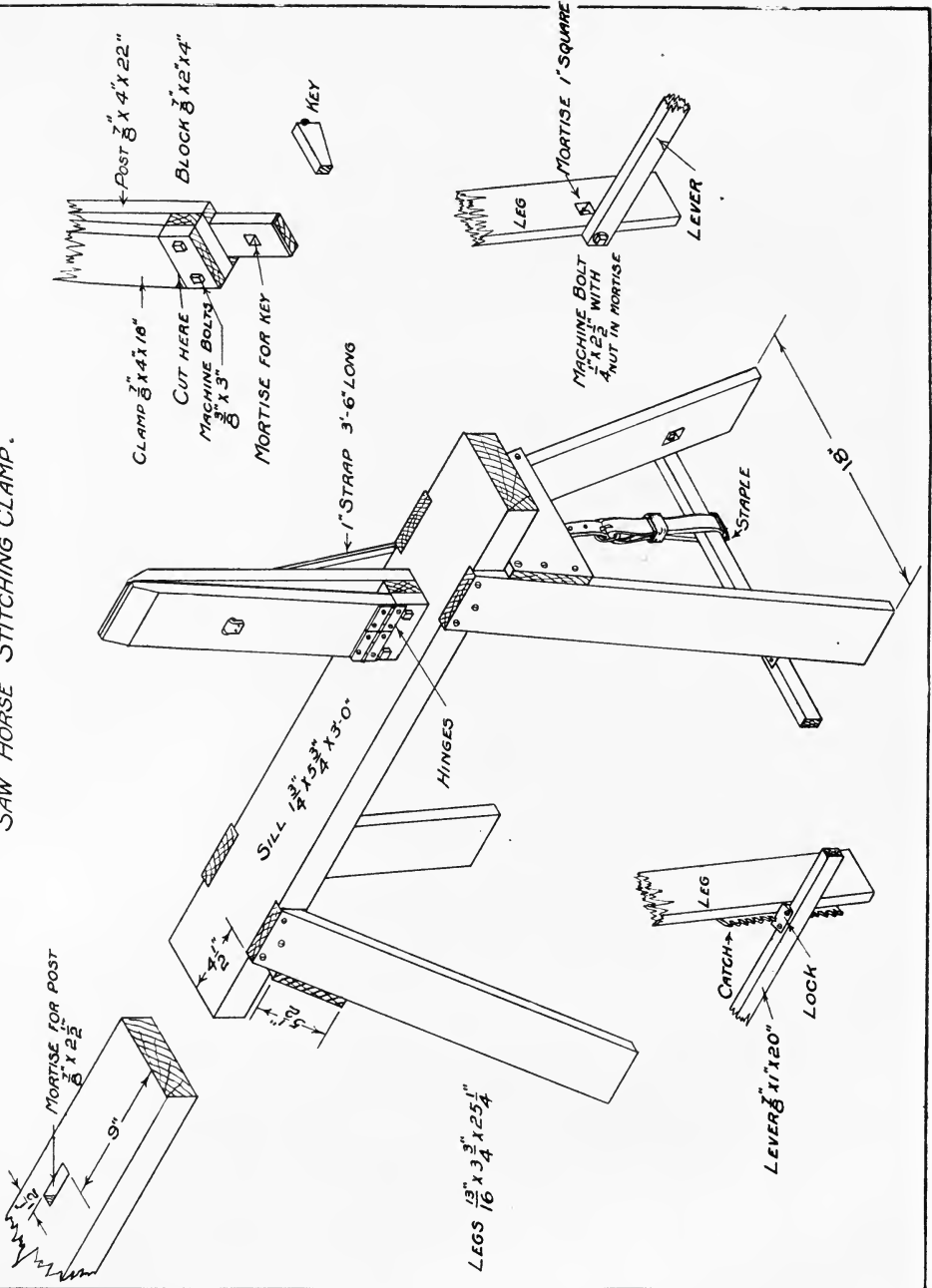

Fig. 40.

**Hardware.**

- 24 flat head bright wood screws 1  $\frac{3}{4}$ " No. 10.
- 2 machine bolts  $\frac{3}{8}$ "x3" to bolt clamp, block and post together.
- 2 2" fast joint light narrow butt hinges with screws.
- 1 machine bolt  $\frac{1}{4}$ "x2  $\frac{1}{2}$ " with two washers for end of lever.
- 1 piece of metal  $\frac{1}{8}$ "x1"x6" for catch.
- 1 piece of metal  $\frac{1}{8}$ "x1"x2" for lock.
- 1 1" strap 3' 6" long.
- 1 1" buckle.
- 1 1  $\frac{1}{2}$ " fence staple to hold strap in place on lever.
- 1 1" slide loop.
- 1 piece of tin 1"x2" to place in hole in post for strap to slide on.
- 2  $\frac{3}{4}$ " brads to fasten end of strap to clamp.
- 1 coil spring to spread clamps.
- 6  $\frac{7}{8}$ " No. 7 or 8 round head blued screws to fasten catch to leg and lock to lever.
- 2 poultry netting staples to fasten key to end of post by use of a string to prevent its being lost.
- 1 piece of heavy string 8" long to fasten key to end of post.

**Directions for Construction.**

1. Reduce all pieces to length, width and thickness.
2. With the T-bevel set at 22" on the beam and 4  $\frac{1}{2}$ " on the blade of the steel square lay out the bevels at the ends of the legs across the side of the boards.
3. With the T-bevel set at 22  $\frac{1}{2}$ " on the beam and 5  $\frac{7}{8}$ " on the blade of the steel square lay out the bevels at the ends of the legs across the edges of the boards.
4. Bevel the edges of the legs with the T-bevel set at  $\frac{1}{4}$ " on the beam and 6" on the blade of the steel square.
5. Lay out and cut openings in the top for the legs  $\frac{1}{2}$ " deep at the top with the T-bevel set at the same angle as for the ends of the legs.
6. Lay out and cut the bevels at the ends of the braces.
7. Bevel the top edges of the braces so that they fit tightly against the top.
8. Lay out and cut a mortise in the top for the post  $\frac{7}{8}$ " wide by 2  $\frac{1}{2}$ " long, 9" from the front end and 1  $\frac{1}{2}$ " from the left side.
9. Assemble the parts of the horse by placing the screws as indicated in the drawing.
10. Bevel the top ends of the post and clamp as shown in the drawing.
11. Cut a  $\frac{3}{4}$ " shoulder on the lower end of the post so as to make a tenon 2  $\frac{1}{2}$ " wide and 4" long.
12. Cut an  $\frac{1}{8}$ " chamfer on the end of the tenon of the post.
13. Mortise a hole for the key through the tenon of the post.

The top edge of this mortise is straight through the stock; the bottom edge is slanted like the key. The mortise is placed about  $1/16''$  nearer the shoulder on the post than the thickness of the sill so as to cause the key to draw the post down tight onto the sill.

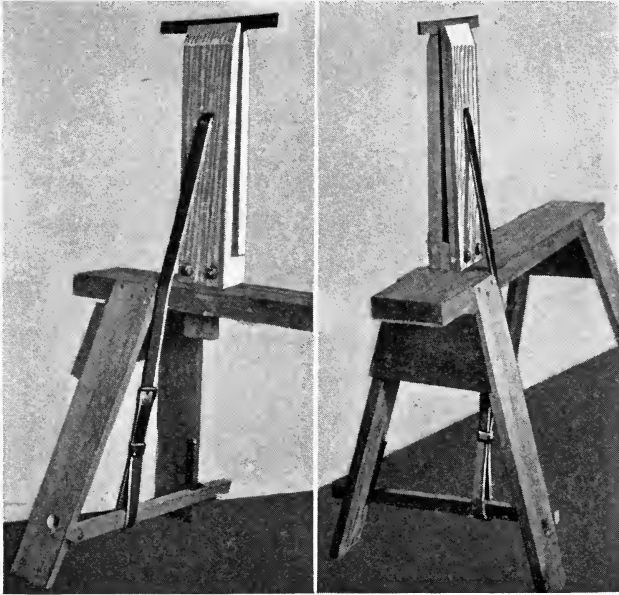

Fig. 41. Side and Front Views of Stitching Clamp.

14. Make mortises  $3/8'' \times 1''$  for the strap through the post and clamp at 6'' from the top.

15. Bend the piece of tin in the mortise in the post and fasten with brads. This is to provide a smooth surface for the strap to slide on.

16. Bolt the post and clamp together with the  $7/8'' \times 2'' \times 4''$  block between them at bottom using the  $3/8'' \times 3''$  machine bolts.

17. Fasten the hinges in place, then remove the hinges and saw the clamp in two at two inches from the bottom. Then replace the hinges. This leaves a saw kerf between the parts and permits the clamp to close at top.

18. Fasten the coil spring between the post and clamp.

19. Make a mortise 1'' square in the front, left leg 4'' from the bottom and 1'' from the inside edge.

20. File notches similar to the teeth on a rip saw in one edge of the metal catch as shown in the detail drawing.

21. Drill four holes through the metal catch near the back



edge for the screws. Then fasten the catch to the right front leg as shown in the detail drawing.

22. Drill two holes through the metal piece for the lock and fasten to the upper edge of the lever so as to lock onto the catch. The metal piece should be gained in at back so as to stand at a slant. The lower edge may be ground or filed so that it will fit up into the notches of the catch.

23. Straighten out the fence staple and bend so as to make it wide enough for the strap to slide through and fasten to the lower edge of the lever at 6" from the back end.

24. Assemble the strap, buckle and slide loop onto the lever then pass it through the mortises in the post and clamp and nail it to the clamp.

25. Fasten the lever to the leg by use of the  $\frac{1}{4}$ "x $2\frac{1}{2}$ " machine bolt. This bolt should not be drawn up tight thus allowing the lever to slip in and out of the catch freely. Two nuts may be placed on the bolt to lock it.

26. The nuts and bolt should be oiled and the tenon of the post fit freely so that the clamp and lever may be removed easily and quickly and hung aside when it is desired to use the saw horse for other purposes.

## CLEANING AND OILING A HARNESS

The appearance of a harness may be greatly improved and considerable time added to its life if it is frequently cleaned and oiled. Fig. 42.

The materials and tools needed for the work are as follows:

A washtub about three-quarters full of warm water.

A quantity of sal soda.

A scrubbing brush.

One board 10 in. to 12 in. wide and 6 feet long with strips nailed to the sides to use as a scrubbing board.

A bench or stool to support the scrubbing board.

Harness oil.

A piece of burlap or other rag.

A piece of harness soap or dressing.

The job of overhauling the harness is usually done in the following order:

1. Take all the harness apart taking off all the buckles, snaps, loops, dees, cockeyes and other parts which can be taken off without cutting rivets, stitching or straps.

2. Do all the repair work which needs to be done on the harness.

3. Having filled an ordinary washtub about three-quarters full

of warm water and thrown into the water a handful of sal soda place all parts of the harness in the tub.

4. Place one end of the scrubbing board in the tub in a position similar to a washboard and support the other end of the board on a bench, stool or other support so that the water will drain from the board back into the tub.



Fig. 42. Cleaning a Harness.

5. Having left the harness parts in the water long enough to thoroughly soak place each piece on the board and scrub it with the scrubbing brush.

6. Spread paper on the floor and as each piece is clean lay it by itself on the paper.

7. The harness oil should be warm and may be applied with a rag. It is not necessary that the harness be thoroughly dry before the oil is applied. As the water is drying out the oil will draw in.

8. Having applied the oil and allowed overnight to dry, wipe off all grease with burlap, then hang the harness up. Apply one, two, three or four coats of oil depending on the condition of the harness. The room where the harness is drying should be warm.

9. Put soap in a wash dish of water and with a damp sponge apply soap same as when greasing. If harness dressing is used follow carefully the directions on the container.

10. Assemble the harness.

## HARNESS REPAIR TOOLS

To do harness repairing a few tools other than those used for other farm shop work are needed. The following is a list of the tools needed for the average farm shop. If work is done by a class of boys at school more than one of each kind may be needed so that all members of a class may work at the same time.

- Three assorted sewing awls.
- Three awl hafts.
- Pricking wheel.
- Harness maker's straight knife.
- Saddler's punch.
- Four-tube revolving belt punch.
- Small quantity shoemaker's wax.
- Paper of needles of assorted sizes.
- Ball of No. 10 white harness thread.
- Round knife, 5-inch.
- Riveting machine.
- Common edge tool.
- Finishing wheel.
- Rivet set.
- Scrubbing brush.

## HARNESS REPAIR PARTS

The following is a list of the harness repair parts which it is deemed advisable to carry in stock in the farm shop. Where repair work is done by a group of boys at school it is advisable to obtain the repair parts in quantity.

- Harness oil.
- One-inch sham roller buckles.
- One-inch wire bent heel harness buckles.
- Repair clips for the ends of hames.
- Wrot iron hame clips.
- Hame staples with washers.
- Bottom hame repair loops.
- Common line rings and studs.
- Pair of hold back plates and rings.
- Soft iron hame rivets,  $1\frac{1}{4}$  inch.
- Cake of harness soap.
- Box of assorted tubular harness rivets.
- Box of assorted split rivets.
- Conway loops,  $\frac{3}{4}$ , 1,  $1\frac{1}{4}$  inch.
- Screw cockeyes.
- Wrot concord clips.
- Repair dees,  $\frac{3}{4}$ , 1,  $1\frac{1}{4}$  inch.
- Buckle shields.
- Repair roller buckles.
- Snaps, assorted sizes.
- Team tracer splicers.
- Edge ink.
- Hame buckles and loops.
- Halter squares.
- Assorted rings,  $\frac{3}{4}$ ,  $\frac{7}{8}$ , 1 inch.
- Assorted slide loops,  $\frac{3}{4}$ ,  $\frac{7}{8}$ , 1,  $1\frac{1}{4}$  inch.
- Harness leather for general work.
- Assorted copper rivets.
- Assorted soft iron rivets,  $\frac{3}{8}$  inch to  $\frac{7}{8}$  inch.

#### Acknowledgment

For the illustrations of typical harnesses on pages 6 and 8 the author is indebted to J. H. & F. A. Sells Co., Columbus, O.



THIS BOOK IS DUE ON THE LAST DATE  
STAMPED BELOW

AN INITIAL FINE OF 25 CENTS  
WILL BE ASSESSED FOR FAILURE TO RETURN  
THIS BOOK ON THE DATE DUE. THE PENALTY  
WILL INCREASE TO 50 CENTS ON THE FOURTH  
DAY AND TO \$1.00 ON THE SEVENTH DAY  
OVERDUE.

APR 29 1939	16 Nov '55 GB
	NOV 2 1955 LU
AUG 13 1941	
	LIBRARY USE
	JUL 1 6 1959
LIBRARY USE	REC'D LD
APR 3 1951	JUL 16 1959
26 May '75	
16 Jun '51 LD	
1951 LU	
30 Oct '51 LU	
3 Mar '54 MA	
MAR 6 1954 LU	LD 21-95m-7,'37

w  
YC 18240

494393

TS1032

R6

UNIVERSITY OF CALIFORNIA LIBRARY

