

June 1915

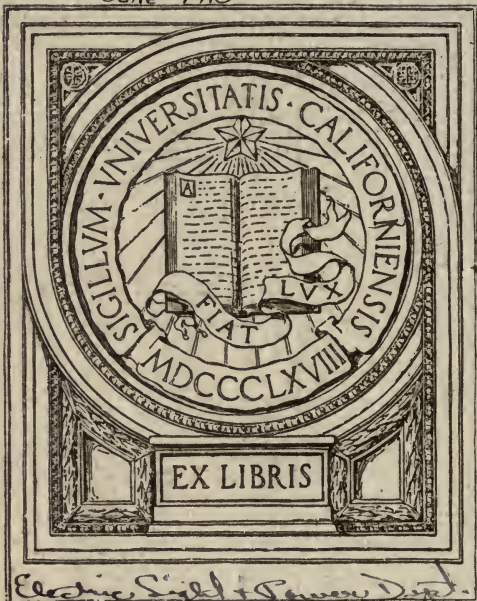

Electric Signal + Power Dept.

Engineering
Library



WORKS OF
PROF. R. C. CARPENTER

PUBLISHED BY

JOHN WILEY & SONS, INC.

Heating and Ventilating of Buildings.

Sixth Edition, Revised and Enlarged. 8vo.
xiv+598 pages, 290 figures. Cloth \$3.50 net.

By **PROFS. CARPENTER AND DIEDERICHS**

Experimental Engineering and Manual for Testing.

For Engineers and for Students in Engineering
Laboratories. Seventh Edition, Rewritten and
Enlarged. 8vo, xix+1131 pages, 636 figures.
Cloth, \$6.00 net.

HEATING AND VENTILATING BUILDINGS

A MANUAL FOR HEATING ENGINEERS AND
ARCHITECTS

BY

ROLLA C. CARPENTER, M.S., C.E., M.M.E., LL.D.

PROFESSOR EXPERIMENTAL ENGINEERING, CORNELL UNIVERSITY
*Past President American Society Heating and Ventilating Engineers;
Member American Society Mechanical Engineers*

SIXTH EDITION, REVISED AND REWRITTEN

· TOTAL ISSUE, TWELVE THOUSAND



NEW YORK
JOHN WILEY & SONS, INC.
LONDON: CHAPMAN & HALL, LIMITED

1915

TH 7222
C3
1915
Engineering
Library

Copyright, 1895, 1902, 1909, 1915

BY

ROLLA C. CARPENTER

E. S. ...

THE SCIENTIFIC PRESS

THE SCIENTIFIC PRESS
ROBERT DRUMMOND AND COMPANY
BROOKLYN, N. Y.

PREFACE TO SIXTH EDITION.

THE first edition of this work was published in 1895, since which time five complete editions have been printed and sold. The sixth edition has been very largely rewritten and considerable new matter added; the size of the book as compared with the first edition being increased by nearly one-half. Since the first edition, several new chapters have been added: relating to fans or blowers for moving air; to the general subject of mechanical systems of heating and ventilating; to school-house heating and ventilation; and to air conditioning. It is believed that the book in its present form describes the latest improvements in the art of heating and ventilating; it also gives directions for the construction and installation of all the various systems of heating and ventilating now in use.

The writer is under obligation for assistance and material in preparing the sixth edition of this book to the various heating engineers who have taken active part in engineering societies and in the technical papers devoted to the subject of heating and ventilation, to various practicing engineers, and especially to C. K. Carpenter, M.E., of Harvard University, L. A. Wilson, M.E., of Cornell University, and W. M. Sawdon, M.M.E., of Cornell University, who did the greater part of the labor of preparation of the new edition.

The purpose of the book is clearly set forth in the following extract from the preface of the first edition:

The art of heating and ventilating buildings is that branch of engineering which is devoted to a practical application of the general physical laws of heat, of pneumatics, and of hydraulics to the construction of heating and ventilating apparatus. The object of the book is to present to the reader, in as con-

cise a form as possible, a general idea of the principles which apply, and of the methods of construction which are in use at the present time, in various systems of heating and ventilating. In preparing the book, the writer has endeavored to present, in as clear and concise a manner as possible, first, a statement of the general principles of pure science which apply, second, a discussion of data and results of important investigations for showing the application of rational principles to practical construction; third, the various practical methods employed in heating and ventilating buildings; fourth, the methods of designing various systems of heating and ventilating; fifth, a collection of useful tables for practical application of the principles stated.

The writer has endeavored to arrange the matter so that it can be understood by any person possessing a thorough and practical knowledge of English and Arithmetic. Algebraic demonstrations and formulæ, when introduced, are usually printed in smaller type; and if a general conclusion is deduced by algebraic methods it is usually restated in the form of a rule of practice.

It has been the desire of the writer to arrange the work in a scientific manner, and to give methods or rules of practice which are based, as far as possible, on a rational foundation. In the case of nearly every system of heating this has been possible. It is believed in this respect that the book will be an improvement over anything which has preceded it.

The book generally presents such information as the writer has found in an extensive practice in the erection and operation of heating apparatus to be that which is required by contractors and by engineers in charge of the erection of plants.

For the literary part of the work obligation is due to nearly every writer who has preceded him. In nearly every case special credit has been given, but in the back part of the book will be found a complete list of authorities. The writer has had the cordial assistance of many noted heating engineers, many manufacturers of heating apparatus, and all the publishers of current literature devoted to this subject.

The principal portion of the practical part of the book is devoted to construction of gravity-heating systems, using steam and hot water; but systems of heating with hot air, with or without blower, with exhaust steam and with electricity, are considered, and practical directions for construction are given. The general character of the contents will be best seen by consulting the table which follows.

ITHACA, N. Y.,

December 15, 1914.

TABLE OF CONTENTS.

CHAPTER I.

NATURE AND PROPERTIES OF HEAT.

ARTICLE	PAGE
1. Demand for Artificial Heat.....	I
2. Magnitude of the Industry of Manufacturing and Installing Heating Apparatus.....	I
3. Nature of Heat.....	2
4. Measure of Heat—Heat-unit.....	4
5. Relation to Mechanical and to Electrical Units.....	4
6. Temperature—Absolute Zero.....	5
7. Thermometer Scales.....	7
8. Special Forms of Thermometers.....	9
9. Electric Resistance Thermometers and Pyrometers.....	11
10. Maxima and Minima Thermometers.....	15
11. Use of Thermometers.....	15
12. Specific Heat.....	16
13. Latent Heat.....	17
14. Radiation.....	18
15. Reflection and Transmission of Radiant Heat.....	19
16. Diffusion of Heat.....	20
17. Conduction of Heat.....	20
18. Convection, or Heating by Contact.....	22
19. Systems of Warming.....	23

CHAPTER II.

PRINCIPLES OF VENTILATION.

20. Relation of Ventilation to Heating.....	24
21. Composition and Pressure of the Atmosphere.....	24
22. Diffusion of Gases.....	27
23. Oxygen.....	28
24. Carbonic Acid, or Carbon Dioxide, CO_2 , and Carbonic Oxide, CO	28
25. Nitrogen—Argon.....	30
26. Analysis of Air.....	31
27. Approximate Methods of Finding Carbon Dioxide (CO_2).....	33
28. Humidity of the Air.....	36
29. Measurement of the Relative Air Supply.....	39
30. Influence of the Size of the Room on Ventilation.....	43

ARTICLE	PAGE
31. Force for Moving the Air	45
32. Measurements of the Velocity of Air	46
33. Calibration of the Anemometer	50
34. The Effect of Heat in Producing Motion of Air	53
35. Distribution of Air	56
36. The Outlet for Air	58
37. Ventilation-flues	61
38. Summary of Problems of Ventilation	62

CHAPTER III.

AMOUNT OF HEAT REQUIRED FOR WARMING.

39. Loss of Heat from Buildings	64
40. Loss of Heat from Windows	64
41. Loss of Heat from Walls of Buildings	66
42. Heat Required for Purposes of Ventilation	69
43. Total Heat Required	70
44. Peclet's Computation of Loss of Heat through Walls and Windows	73

CHAPTER IV.

HEAT GIVEN OFF FROM RADIATING SURFACES.

45. The Heat Supplied by Radiating Surfaces	81
46. Heat Emitted by Radiation	82
47. Heat Removed by Convection (Indirect Heating)	84
48. Total Heat Emitted	85
49. Heat Transmission Varies with Circulation	89
50. Methods of Testing Radiators	90
51. Measurement of Radiating Surfaces	94
52. Effect of Painting Radiating Surfaces	95
53. Results of Tests of Radiating Surface	96
54. Tests of Indirect Heating Surfaces	104
55. Conclusions from Radiator Tests	108
Temperature Produced in a Room by a Given Amount of Surface when Outside Temperature is High	111
Correcting for the Wind Velocity	113
Protection of Main Pipe from Loss of Heat	113
Pipe Coverings	117
Tests of Pipe Coverings	119
Transmission of Steam Long Distances	119

CHAPTER V.

FLOW OF WATER, STEAM AND AIR.

Flow of Water and Steam	124
Gravity Hot Water	125
Flow of Water through Pipes	128

TABLE OF CONTENTS.

ix

ARTICLE	PAGE
The Flow of Air and Gases.....	130
Experiments on the Flow of Steam through Pipes.....	135
Charts for Flow of Steam in Pipes.....	141
Dimensions of Registers and Flues.....	142
Dimensions of Registers.....	144
Size of Ducts for Indirect Heating.....	144
Roof Ventilators.....	147
Power for Moving Air through Ventilating System.....	147

CHAPTER VI.

PIPE AND FITTINGS USED IN STEAM AND HOT-WATER HEATING.

56. General Remarks.....	148
57. Cast-iron Pipes and Fittings.....	148
58. Wrought-iron and Steel Pipe.....	150
59. Pipe Fittings.....	153
60. Valves and Cocks.....	159
61. Air valves.....	165
62. Expansion-joints.....	169

CHAPTER VII.

RADIATORS AND HEATING SURFACES.

[63. Qualities of an Efficient Steam Radiator.....	172
64. Radiating Surface of Pipe.....	172
65. Vertical-Pipe Steam-radiators.....	175
66. Cast-iron Steam-radiators.....	176
67. Hot-water Radiators.....	177
68. Direct-indirect Radiators.....	182
69. Indirect Heaters.....	182
70. Proportions of Parts of Radiators.....	185

CHAPTER VIII.

STEAM-HEATING BOILERS AND HOT-WATER HEATERS.

71. General Properties of Steam—Explanation of Steam Tables.....	187
72. General Requisites of Steam-boilers.....	188
73. Boiler Horse-power.....	189
74. Relative Proportions of Heating to Grate Surface.....	190
75. Water Surface—Steam and Water Space.....	193
76. Requisites of a Perfect Steam Boiler.....	194
77. General Types of Boilers.....	195
78. The Horizontal Tubular Boiler.....	197
79. Locomotive and Marine Boilers.....	199
80. Water-tube Boilers.....	200
81. Hot-water Heaters.....	202

ARTICLE	PAGE
82. Classes of Heating-boilers and Hot-water Heaters.....	203
83. Heating-boilers with Magazines.....	209
84. Heating-boilers for Soft Coal.....	209
85. Boilers in Batteries.....	210

CHAPTER IX.

SETTINGS AND APPLIANCES—METHODS OF OPERATING BOILERS AND HEATERS.

86. Brick Settings for Boilers.....	211
87. Setting of Heating Boilers.....	215
88. The Safety-valve.....	216
89. Appliances for Showing Level of Water in Boiler.....	220
90. Methods of Measuring Pressure.....	222
91. The Bourdon Pressure Gauge.....	222
92. Damper-regulators.....	224
93. Blow-off Cocks and Valves.....	225
94. Form of Chimneys.....	226
95. Sizes of Chimneys.....	226
96. Chimney-tops.....	228
97. Grates.....	228
98. Traps.....	230
99. Return-traps.....	233
100. General Directions for the Care of Steam-heating Boilers.....	236
101. Care of Hot-water Heaters.....	238
102. Boiler Explosions.....	238
103. Explosions of Hot-water Heaters.....	243
104. Prevention of Boiler Explosions.....	244

CHAPTER X.

GRAVITY STEAM-HEATING SYSTEMS.

105. Systems Employed in Steam-heating.....	245
106. Definitions of Terms Used.....	246
107. Systems of Piping.....	248
108. Pipe Connections, Steam-heating Systems.....	251
109. Piping for Indirect Heaters.....	254
110. Vacuum Circulating Systems.....	255
111. General Principles.....	257
112. Amount of Heat and Radiating Surface Required for Warming.....	258
113. Wolfe's Diagram.....	260
114. The Amount of Surface Required for Indirect Heating.....	262
115. Summary of Approximate Rules for Estimating Radiating Surface.....	266
116. Computation of Steam Piping.....	268
117. Rules for Steam Pipe Sizes.....	270
118. Size of Return-pipes, Steam-heating.....	272
119. Summary of Various Methods of Computing Quantities Required for Heating.....	274
120. Short Method of Computing Radiation.....	276

TABLE OF CONTENTS.

xi

CHAPTER XI.

PUMP RETURN STEAM-HEATING SYSTEMS.

ARTICLE	PAGE
130. General Remarks	280
131. Systems of Exhaust Heating	281
132. Proportions of Radiating Surface and Main Pipes Required in Exhaust Heating	282
133. District Heating	286
134. Systems of Exhaust Heating with Less than Atmospheric Pressure	286
135. The Webster System	289
136. Diagrams with Cochrane Steam Stack Heaters	292
137. The Paul System	294
138. The Johnson System of Hermetic Heating	297
139. Combined High- and Low-pressure Heating Systems	298
140. Pump Governors	298
141. The Steam Loop	300
142. Reducing Valves	302
143. Transmission of Steam Long Distances	303
144. Pipe Sizes for Vacuum Steam Heating Systems	305

CHAPTER XII.

HOT-WATER HEATING SYSTEMS.

145. Gravity Circulating System	306
146. Methods of Piping Used in Hot-water Heating	306
147. Expansion-tank	309
148. Closed Systems	310
149. The Honeywell Pressure System	312
150. Accelerated Hot-water Systems	313
151. Hot-water Circulating Systems	313
152. Pipe Connections, Hot-water Heating Systems	315
153. Position of Valves in Pipes	318
154. Sizes of Pipes for Hot-water Radiators	319
155. Combination Systems of Heating	323

CHAPTER XIII.

HEATING WITH HOT AIR.

156. General Principles	327
157. General Form of a Furnace	329
158. Proportions Required for Furnace Heating	331
159. Air-supply for the Furnace	335
160. Pipes for Heated Air	336
161. The Areas of Registers or Openings into Various Rooms	339
162. Circulating Systems of Hot Air	341
163. Heating with Stoves and Fireplaces	341
164. General Directions for Operating Furnace	342

ARTICLE	PAGE
165. Practical Arrangement of Furnaces.....	343
166. The Federal Furnace League.....	346
167. Rules for Furnace Heating.....	350
168. Abstract for Furnace Specifications.....	350

CHAPTER XIV.

MECHANICAL VENTILATORS.

169. General Conditions.....	352
170. Steel Plate Fans or Blowers.....	353
171. The Guibal Chimney.....	356
172. Multivane Fans.....	357
173. Propeller or Disk Fans.....	359
174. Volume or Positive Blowers.....	361
175. Theoretical Work of Moving Air.....	361
176. Work of Moving Air through Pipes.....	365
177. Dimensions of Pipe-lines for Air.....	366
Formulas for Approximate Dimensions and Capacities of Fans.....	368
178. Characteristic Curves of Multivane Fans.....	371
179. Maximum Pressure Produced by Fan or Blower.....	373
180. Velocity and Volume.....	377
181. Work Required to Run a Fan.....	379
182. Application of Theory.....	379
183. Practical Rule for Capacity.....	380
184. Practical Rule for Power.....	381
185. Tests which Verify the Rules.....	381
186. Relative Efficiency of Fans or Blowers and of Heated Flues.....	382
187. Disk and Propeller Fans.....	387
188. Measurement of Air Supplied to a Room.....	388
189. Introduction of Air into Rooms.....	389

CHAPTER XV.

HOT BLAST HEATING.

190. General Remarks.....	392
191. Various Forms of Mechanical Ventilating and Heating Systems.....	392
192. Volume- or Regulating-dampers.....	396
193. Form of Steam-heated Surface.....	397
194. Ducts or Flues—Registers.....	398
195. Blowers or Fans.....	403
196. Heating Surface Required.....	404
197. Size of Boiler Required.....	405
198. Practical Construction of the Hot-blast System of Heating.....	406
199. Description of Mechanical Ventilating Plant.....	408
200. Tests of Blower Systems of Heating.....	415
201. Charts for Vento Heaters.....	420
202. Table for Wrought-iron Pipe Heaters.....	421
203. Carrier's Theory of Convection with Forced Ventilation.....	424

TABLE OF CONTENTS.

xiii

CHAPTER XVI.

HEATING WITH ELECTRICITY.

ARTICLE	PAGE
204. Equivalents of Electrical and Heat Energy.....	427
205. Expense of Heating by Electricity.....	427
206. Formulæ and General Considerations.....	430
207. Construction of Electrical Heaters.....	434
208. Connections for Electrical Heaters.....	435

CHAPTER XVII.

TEMPERATURE REGULATORS.

209. General Remarks.....	436
210. Regulators Acting by Change of Pressure.....	437
211. The Powers Regulator.....	438
212. Regulators Operated by Direct Expansion.....	441
213. Relative Rates of Expansion.....	442
214. Regulators Operated with Motor—General Types.....	442
215. Pneumatic Motor System.....	444
216. Construction of Pneumatic Thermostat.....	446
The Johnson Positive Thermostat.....	449
Johnson Intermediate Thermostat.....	450
217. Humidity Regulators.....	451
218. Saving Due to Temperature Regulation.....	451

CHAPTER XVIII.

SCHOOLHOUSES, SHOPS, AND GREENHOUSES.

219. Schoolhouse Warming and Ventilating.....	453
220. Complex Character of the Problem.....	453
221. Relation of Pure Air to Vitality.....	454
222. Limitations to the Supply of Pure Air.....	454
223. Draughtiness in Large Halls.....	454
224. Means for Reducing Draughtiness.....	455
225. Little Draughtiness in Outflowing Currents.....	457
226. Air-supply for Schoolroom.....	457
227. Cost.....	458
228. Methods of Saving Heat.....	458
229. Successive Ventilation.....	458
230. Supply of Air for Rooms not Frequently Occupied.....	459
231. Course of Air Supply.....	460
232. Quick Preparatory Warming.....	462
233. Warming by Rotation.....	462
234. Heat Commonly Wasted.....	463
235. Solar Heat.....	463
236. Automatic Control of Temperature.....	464
237. Double Glazing.....	464

ARTICLE	PAGE
238. Double Sashing.....	465
239. Waste of Heat at Night.....	465
240. Plenum and Vacuum Methods.....	465
241. Location of Inlets.....	466
242. Local Ventilation.....	466
243. Air Filtration.....	467
244. Heating of Greenhouses.....	467
245. Heating of Workshops and Factories.....	475
246. Summary of Approved Methods for Design of Steam and Hot-water Systems of Heating.....	476

CHAPTER XIX.

SPECIFICATION PROPOSALS AND BUSINESS SUGGESTIONS.

247. General Business Methods.....	479
248. General Requirements.....	480
249. Form of Uniform Contract.....	483
250. Duty of the Architect.....	487
251. Methods of Estimating Costs of Construction.....	488
252. Suggestions for Pipe Fittings.....	489
253. Protection from Fire—Hot-air and Steam Heating.....	492
254. Heating and Ventilating Laws.....	495

CHAPTER XX.

AIR CONDITIONING.

255. Air Conditioning.....	515
256. Useful Results of Air Conditioning.....	515
257. Percentage of Humidity Desirable.....	515
258. Humidity and Its Determination.....	517
259. Dust.....	520
260. Solubility of Gases.....	521
261. Combustibility of Gases.....	522
262. Regulation of Relative Humidity.....	522
263. Automatic Humidity Control.....	524
264. Relative Humidity Variation.....	525
265. Power Required for Operating Humidifiers.....	526
266. Relation of Cooling Effect to Percentage of Relative Humidity.....	527
267. Dehumidifier.....	529
268. Refrigeration Required for Dehumidifying.....	530
269. Air Washers.....	531

APPENDIX.

Literature and References.....	533
Current Literature of the Day.....	535
Explanation of Tables.....	535
Tables.....	538
Index.....	585

HEATING AND VENTILATING BUILDINGS.

CHAPTER I.

NATURE AND PROPERTIES OF HEAT.

1. **Demand for Artificial Heat.**—The necessity for artificial heat depends to a great extent upon the climate, but to a certain extent on the customs or habits of the people. In all the colder regions of the earth artificial heat is necessary for the preservation of life, yet there will be found a great difference in the temperature required by people of different nations or races living under similar conditions. On the continent of Europe, about 15 degrees centigrade, corresponding to 59 degrees F., is considered a comfortable temperature; in America it is the general practice and custom to maintain a temperature of 70 degrees in dwellings, offices, stores, and most work-shops, and a heating apparatus is considered inadequate which will not maintain this temperature under all conditions of weather.

2. **Magnitude of the Industry of Manufacturing and Installing Heating Apparatus.**—The industry connected with the manufacture and installation of the various systems for warming is a great one and gives employment to many thousand workmen. The manufacture of heating apparatus is not only of great magnitude, but it is varied in its nature; all kinds of apparatus for heating—as, for instance, the open fireplace built at the base of a brick chimney, the cast-iron stove with its unsightly piping, the furnace and appliances for warming air, apparatus for heating by steam and also by hot water—

can be readily bought on the market in almost every form, from that of the simplest to that of the most complicated design.

The exact amount of capital invested in this industry could not be determined from the census of 1910, as only a part of this industry is separately reported. Under the heading of "Stoves and Furnaces, including Gas and Oil Stoves," there are reported 576 establishments, with 42,921 persons engaged in the industry, and with a combined capital of \$86,944,000, and a yearly output to the value of \$78,853,000. The manufacture of steam fittings, etc., and the installation of the heating apparatus is not included in the above heading, which probably would give more than double the capital and yearly output, so that both the probable capital invested and the value of the yearly output will each be in the neighborhood of \$2 per inhabitant of the United States.

3. Nature of Heat.—Before consideration of the methods of utilizing heat in warming buildings a short discussion of the nature and scientific properties of heat seems necessary.

Heat is recognized by a bodily sensation, that of feeling, by means of which we are able to determine roughly by comparison that one body is warmer or colder than another. From a scientific standpoint heat is a peculiar form of energy, similar in many respects to electricity or light, and is capable, under favorable conditions, of being reduced into either of the above or into mechanical work. We shall have little to do with the theoretical discussion of its nature, but, as it is well to have a distinct understanding of its various forms and equivalents, we will consider briefly some of its important properties.

Heat was at one time considered a material substance which might enter into or depart from a body by some kind of conduction, and the terms which are in use to-day were largely founded on that early idea of its material existence. The theory that heat is a form of energy and is capable of transformation into work or electricity is thoroughly established by fact and experiment. It probably produces a molecular motion among the particles of bodies into which it enters, the

rate of such motion being proportional to the intensity of the heat.

Heat has two qualities which correspond in a general way to *intensity* on the one hand and *quantity* on the other. The intensity of heat is termed *temperature*—this can be measured by a thermometer; while the *quantity* of heat is termed the British thermal unit, called the Thermal unit or the B.T.U., and is $\frac{1}{180}$ of the amount of heat required to raise one pound of water from the freezing to the boiling point. The following sketch shows in a graphical manner, the relation between the temperature of water, and of dry air, and the amount of heat that each contains measured above the freezing-point of water.

It is a fact which will appear from later statements that the

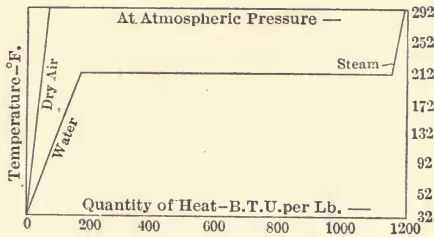

FIG. 1.—Heat and Temperature Relation.

amount of heat contained in two bodies of different kinds, but of the same weight and temperature, may be essentially different. A familiar analogy might perhaps be seen in the case of the dimensions and weight of bodies. The weight depends upon the dimensions and the density of the material, for example; a ball of wood and an iron ball of the same dimensions would have quite different weights. In a similar manner the amount of heat depends upon the temperature and also upon the weight of the body and that property of the material termed its specific heat. In addition, when a solid material is melted or a liquid is boiled, a considerable amount of heat is added in effecting the change of state of the material without raising its temperature.

Note that heat is equivalent, not to mechanical force,

but to mechanical work. Work, defined scientifically, is the application of force in overcoming some resistance; it is the result of a force acting through a certain distance, the distance moved through having as much effect on the result as the force acting. The work done is proportional to the product of the force exerted, multiplied by the space passed through. In English measures the unit of this product is a *foot-pound*, which signifies one pound raised to a height equal to one foot; it is itself a complex quantity resembling heat in this respect. Heat can be transformed into work.

4. Measure of Heat—Heat-unit.—As explained heat cannot be measured by the thermometer; it can, however, be measured by the amount that some standard is raised in temperature. The standard adopted is water, and heat is universally measured by its power to raise the temperature of a given weight of water. In English-speaking countries the mean *heat-unit* is $1/180$ of the heat required to raise one pound of water from the freezing to the boiling point, and this quantity is termed a British thermal unit; this will be referred to in this work by its initial letters B.T.U., or simply as a heat-unit. The amount of heat required to change the temperature of one pound of water one degree is not the same at all temperatures; the variation, however, is slight and for practical purposes can be entirely disregarded. The unit of heat used by the French and Germans, and for scientific purposes generally, is called the *calorie*; it is equal to one kilogram (2.205 pounds) of water raised one degree centigrade (1.8 degrees Fahrenheit) and is equal to 3.967 B.T.U. The *calorie* is referred to water at a temperature of $15-16^{\circ}$ Centigrade ($59-60.8$ degrees Fahrenheit).

5. Relation to Mechanical Work and to Electrical Units.—The relation of heat to mechanical work was accurately measured by Joule in 1838 by noting the heating effects produced in revolving a paddle-wheel immersed in water. The wheel being revolved by a weight falling a given distance, the mechanical work was known; this compared with the rise in temperature of the water enabled him to determine that the value of one heat-unit estimated from 39° to 40° F. was equivalent

to 772 foot-pounds. Later investigation has slightly increased this result, so that when reduced to a temperature of 62 degrees F., and for this latitude, it is 6 foot-pounds greater, so that at present the work equivalent of one heat-unit is generally regarded as 778 foot-pounds. This signifies that the work of raising 1 lb. 778 feet is equivalent to the energy required to change the temperature of 1 lb. of water from 62 to 63 degrees F.

The equivalent value of heat and mechanical work is now thoroughly established, and under favorable conditions the one can always be transformed into the other. As illustrations of the transformation of heat into work we have only to consider the numerous forms of steam-engines, gas-engines, and the like. A transformation from mechanical work into heat is shown in the rise of temperature accompanying friction in the use of machines of all classes. The heat produced in the performance of any mechanical work is exactly equivalent to the work accomplished, 778 foot-pounds of mechanical work being performed in order to produce a heating effect equivalent to raising 1 lb. of water 1° F.

The term horse-power has been used as the measure of the amount of work. It has been fixed as 33,000 foot-pounds per minute. This is equivalent to 42.42 B.T.U. per minute, or to 746 watts in electrical measures. For the work done in one second the above numbers should be divided by 60; for that done in one hour they should be multiplied by 60. In all English-speaking countries the capacity of engines and machinery in general is expressed in horse-power, so that it is necessary to become familiar with this term and its equivalents in heat and electrical units.

6. Temperature—Absolute Zero.—One of the properties of heat is called temperature; this property can be measured by a thermometer and is proportional to the intensity of the heat. All our knowledge of heat as obtained by the sensation of feeling deals only with the temperature and the terms in common use by means of which bodies are compared and denominated hot, hotter, hottest, have reference not to the heat actually in the different bodies but to the temperature.

There is always a tendency for heat to flow through intervening mediums from a hotter to a colder body and there is no tendency for heat to flow from a cold to a hot body, although the relative amounts of heat in the two bodies might be different from that indicated by the thermometer. Thus, as an illustration, a pound of water requires about eight times as much heat to raise it one degree in temperature as a pound of iron, and hence when equal weights of both of these materials are at the same temperature the water contains eight times as much heat as the iron, although in common parlance the two bodies would be equally hot.

The tendency for the hotter body to cool off and give up its heat to surrounding objects is characteristic of all materials, and if no other heat were supplied all bodies would come sooner or later to one common temperature. This temperature, when finally reached by all bodies in the universe, will represent the ultimate limit of all cooling and almost the entire absence of heat. It will be near absolute zero for all thermometric scales, and no greater cold will be possible or even conceivable. The inter-planetary space is believed by many to be very nearly at this limit, at the present time. Scientific men have made very careful determinations to ascertain what such a temperature must be, compared with the ordinary thermometric scales.

A perfect gas which remains under constant pressure will contract in volume an amount directly proportional to the change of temperature when reckoned from the point of greatest cold, which point is known as the *absolute zero*. By experiment it is found that when air is at a temperature of 32 degrees its volume is reduced one part in 492 whenever the temperature is lowered one degree. From this fact it has been concluded that the absolute zero is 492 degrees on the Fahrenheit scale or 273 degrees on the centigrade scale, below the freezing-point of water. Strictly speaking there is no perfect gas, yet the results obtained with different gases by different observers are so nearly in accord that there is no question but that the results as given above are for all practical purposes correct.

7. Thermometer Scales.—The thermometer is an instrument used to measure temperature. The effect of heat is to expand or to increase the volume of most bodies. For perfect gases the amount of this expansion is strictly proportional to the change of temperature; for liquids and solids the expansion, while not exactly proportional to the increase of temperature, is very nearly proportional to it, and these bodies can be used for an approximate and even a close measure of difference of temperature. In nearly all thermometers the temperature is measured by the expansion of some body, mercury, alcohol, or air being commonly used as the thermometric substance.

The first thermometer was probably made by Galileo before 1597. It consisted of a glass bulb containing air, terminated below in a long glass tube which dipped into a vessel containing a colored fluid. The variations of volume of the enclosed air caused the fluid to rise or fall in the tube, the temperature being read by an arbitrary scale. Alcohol thermometers were in use as early as 1647, being made by connecting a spherical bulb with a long glass stem, on which graduations were made by beads of blue enamel placed in positions corresponding to one thousandths of the volume.

Fahrenheit, a German merchant, in 1721 was the first to make a mercurial thermometer, and the instrument which he designed, with certain modifications, has been retained in use by the English-speaking people up to the present time. Fahrenheit took as fixed points the temperature of the human body, which he called 24 degrees, and a mixture of salt and sal-ammoniac, which he supposed the greatest cold possible, as zero. On this scale the freezing-point is 8 degrees. These degrees were afterwards divided into quarters, and later these subdivisions themselves, termed degrees. On this modified scale the freezing-point of water becomes 32 degrees, blood-heat 96* degrees, and the point of boiling water at atmospheric pressure 212 degrees. Unscientific as this thermometer is, it has been retained by two of the principal nations of the

* As determined later, this should be 98°.

world, the English and the American; it is awkward to use, it was borrowed from a foreign nation which had itself adopted a more scientific instrument, and except for the fact that it has been long in use it has not a single feature to recommend it.

In 1724 Delisle introduced a scale in which the boiling-point of water was called zero and the temperature of a cellar in the Paris Observatory was called 100 degrees. This thermometer was used for many years in Russia, but is now obsolete. In 1730 Réaumur made alcohol thermometers in which the boiling-point of water was marked 80 degrees. This thermometer is still in use in Russia.

Celsius adopted a centesimal scale in 1742 on which the boiling-point was marked zero and the freezing-point of water 100 degrees. This instrument is not now in use, although the centigrade scale is often called after Celsius. The botanist Linnæus introduced the centigrade thermometer, in which the freezing-point of water is marked zero and the boiling-point of water 100 degrees. This thermometer is now adopted for ordinary use by the nations of continental Europe and for scientific use by every nation in the world.

The relative values of the degrees on the different thermometers used by various nations are given in the following table:

THERMOMETRIC SCALES.

	Fahren- heit.	Centigrade.	Réau- mur.	Celsius.
Degrees between freezing and boiling.	180	100	80	100
Temperature at freezing-point.....	32	0	0	100
Temperature at boiling-point.....	212	100	80	0
Comparative length of degree.....	1	9/5	9/4	9/5
Comparative length of degree.....	5/9	1	5/4	1
Countries where used.....	England and America	France and Germany	Russia	Not in use

In all thermometric scales as given above, fixed points are determined by reference to the freezing and boiling points of water, with barometer at 29.92 inches, and most thermometers

are constructed by marking these two points and then subdividing into the required number of degrees. The boiling-point of water changes with the atmospheric pressure and with the purity of the water, the greater the pressure the higher the boiling-temperature. A table on page 25 of this book shows the relation between the barometer pressure and the temperature of boiling water at atmospheric pressure. Mercury, alcohol, liquids and solids generally do not expand uniformly for each degree of temperature, or, in other words, they are not perfect thermometric substances. The error, however, is slight and is of more scientific than practical importance. Any perfect gas, however, does expand uniformly and is a perfect thermometric substance, but gas varies in volume with slight change in barometric pressure, and, while of great value as material for a scientific thermometer, is too bulky and awkward for ordinary use. It is at the present time considered doubtful if there is any perfect gas in existence, or one which cannot be liquefied by intense cold and great pressure. Air, hydrogen, and nitrogen act like perfect gases at ordinary temperatures; the same is true in a slightly less degree of oxygen. Yet oxygen is a liquid whose boiling-point is 183 degrees centigrade (297 degrees Fahrenheit) below zero. Nitrogen and air are liquids boiling at approximately 193 degrees centigrade (315 degrees Fahrenheit) below zero. Pictet and Cailletet have reduced the temperature to 200 degrees C. below zero, finding air at that temperature to be a liquid as limpid as water and, like water, having a decided blue tint when seen by transmitted light.

FIG. 2.

8. Special Forms of Thermometers.—The mercurial thermometers, as ordinarily constructed (Fig. 2), consist of a bulb of glass joined to a capillary glass tube filled so as to leave a vacuum in the upper part of the glass stem, above the mercury; they cannot be used for any temperature higher than that of the boiling-point of mercury, which is about 675° F.



More recently these thermometers have been filled with nitrogen or carbonic dioxide in the upper part of the glass stem, which by pressure prevents the mercury boiling. Thermometers constructed in this way can be used safely in temperatures as high as the melting-point of ordinary glass, say to 1000° F.

Mercurial thermometers are made in various ways; the cheaper ones have graduations on an attached frame of wood or metal, but the more accurate and better grades have the graduations cut directly into the glass stem, Fig. 2. It has been found that the glass from which these thermometers are made changes volume slowly for many months after construction, so that it is necessary to fill the thermometer with mercury a long time before graduation. In the better grade

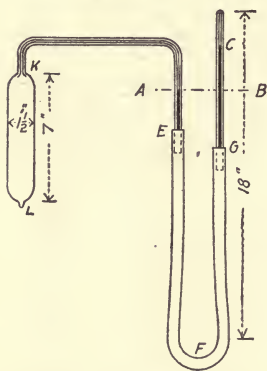

FIG. 3.—Air Thermometer.

of thermometers the graduations are obtained by comparing point by point with an accurate standard; in the cheaper ones by simply subdividing into equal parts between freezing and boiling points. At very low temperatures (-38° F.) mercury solidifies and its rate of expansion changes; alcohol or spirits of similar nature are not so affected, and hence are better suited for use in thermometers for measuring extremely low temperatures. Air thermometers, while difficult to use and of somewhat clumsy construction, are accurate through a wide range of temperature. These are made either by confining the air in a constant volume and measuring the increase in pressure (Fig. 3), or else by maintaining the pressure constant and noting the increase in volume. If the volume be maintained constant, the pressure will increase directly proportional to the increase in absolute temperature. In the air thermometer (Fig. 3) the volume is kept constant and the increase in pressure is measured by the rise of mercury in the tube *OC* above the line *AB*. That is, in passing from the freezing to the boil-

ing-point of water, the barometer being at 29.92, the pressure will increase $180/402$, as expressed on the Fahr. scale, or $100/273$ on the Cen. scale

The determination of temperature with the air thermometer, even if the instrument is calibrated to read in degrees, needs a correction for barometer-reading, since the height to which the mercury will rise in the tube will depend on the pressure of the air. The directions for using the instrument would be: 1st. Find the constant of the instrument by putting the bulb in melting ice, and dividing the absolute temperature, 492, by the sum of barometer-reading and reading of tube of the thermometer; 2d. To find any temperature, multiply the *constant* as found above by the sum of barometer-reading and reading of thermometer, and subtract from this product 460° .

NOTE.—In using the instrument always keep the mercury at or near point *A*, so as to keep volume of air constant.

9. Electric Resistance Thermometers and Pyrometers.—

Instruments utilizing the change of electric resistance of metals with variations in temperature and the thermo-electric power of metals are used to indicate temperature.

Electric Resistance Thermometer.—In this instrument use is made of the variations in the electric resistance of platinum wire with change of temperature. As electric resistances are measurable with great accuracy, this method of estimating temperature offers great sensibility. The resistance may be measured by balancing it against a known resistance by the use of a Wheatstone Bridge. This gives an instrument which is independent of the accuracy of the galvanometer used to indicate a balance, but the apparatus must be adjusted by hand for each reading.

The above principle is also applied in another form of instrument in which the resistance and therefore the temperature is indicated directly by the deflection of the pointer of an instrument similar to an ammeter. Fig. 4 shows a form of Electric Resistance Thermometer having an indicator of the Wheatstone Bridge type. This instrument is not in extensive commercial use.

Thermo-electric Thermometer.—The electromotive force generated at the junction of two metals is a function of the temper-

ature, and as instruments are available for measuring electromotive forces with great accuracy, this principle is utilized to indicate temperature.

There are a great many metals that could be used in constructing the thermo-electric elements or thermo-couples, but platinum and its alloys with iridium and rhodium have given the

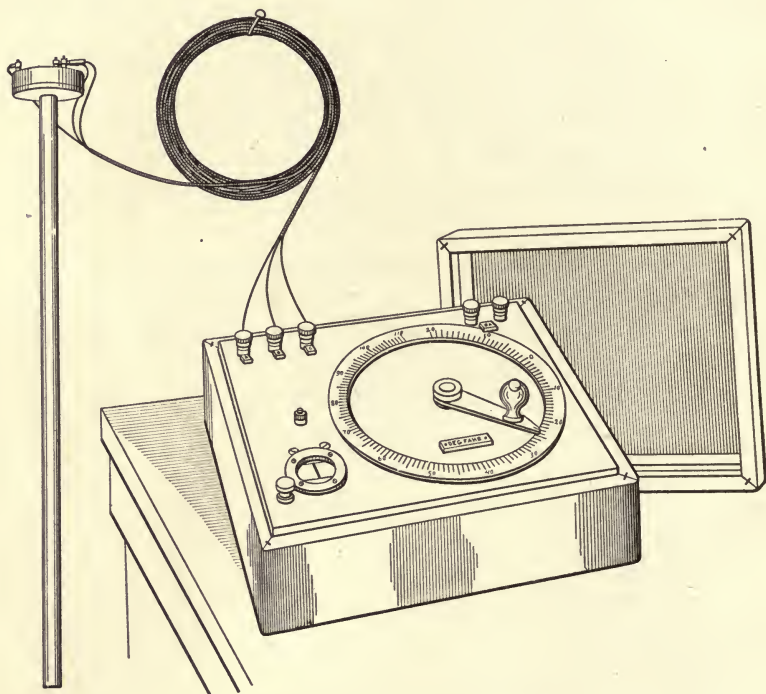

FIG. 4.—Electric Resistance Thermometer.

best results and are generally used. In commercial instruments where extreme accuracy is not required, a high resistance millivolt meter graduated to read the temperature in degrees directly is generally used as an indicator. This instrument is now in extensive commercial use. Fig. 5 shows one of these instruments arranged to indicate the temperature of a furnace.

With either the resistance or the thermo-electric thermometer the "bulb" may be placed at any desired distance from the

indicator, and by providing suitable switches any number of bulbs may be used with one indicator. The resistance thermometer may be constructed to give the average temperature over a large area, while the thermo-couple gives the temperature of a point.

Metallic Pyrometers.—Most metals have rates of expansion which differ sensibly from each other, and this fact has been utilized in the construction of thermometers.

Metallic thermometers are frequently used for high temperatures and have often been called pyrometers. If two bars of metal with unequal rates of expansion be fastened together

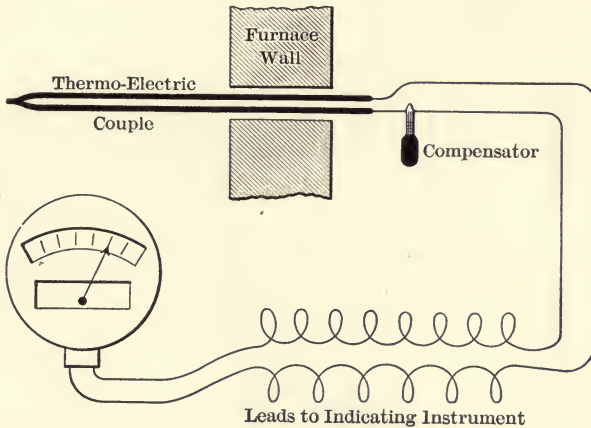

FIG. 5.—Thermo-Electric Pyrometer.

at one end and heated, the difference of extension of the two ends can be utilized in moving a hand over a dial graduated to show change of temperature (Fig. 6). The metal may also be bent into the form of a helix, in which case the heating will tend to change the curvature and thus move a hand which can be used to measure the temperature.

A thermometer consisting of an iron bulb and a dial, very much like the metallic pyrometer in appearance, is made by filling the bulb with ether or hydrocarbon vapor, and constructing it on the same principle as gauges used to register pressure on boilers. The vapor has a temperature correspond-

ing to a given pressure, so that the dial can be calibrated to read in degrees of temperature instead of pounds of pressure.

These instruments are extremely convenient and answer admirably for temperatures not exceeding 1000° F.

Calorimetric Pyrometers.—The principle of operation used in determining specific heat, Art. 12, can, if the specific heat is known, be employed to ascertain the temperature of any hot body.

Temperature by the Color of Incandescent Bodies and by Melting-points.—Pouillet, as the result of a large number of experiments, concluded that all incandescent bodies have a definite and fixed color corresponding to each temperature.

This color and temperature scale was given as follows:



FIG. 6.—Metallic Pyrometer.

Color.	Temp. C.	Temp. F.
Faint red.....	525	977
Dark red.....	700	1295
Faint cherry.....	800	1472
Cherry.....	900	1652
Bright cherry.....	1000	1832
Dark orange.....	1100	2012
Bright orange.....	1200	2192
White heat.....	1300	2372
Bright white.....	1400	2552
Dazzling white.....	1500	2732

This scale applies only to bodies that shine by incandescent light and not from actual combustion. A pyrometer making practical application of this scale has been invented by *Noel*, and consists of a telescope with polarizing attachment and a scale so fixed as to read the angle through which a part of the instrument turns while a sudden transition of color takes place.

Temperature by the Melting-points of Bodies.—The melting-points of bodies often provide an excellent means of deter-

mining temperature. The temperature is obtained by using metallic alloys having known melting-points, it being higher than those which have melted, but lower than those which remain unmelted. A table of temperature of melting-points is given in the Appendix. In Germany a carefully prepared set of alloys can be purchased for temperature determinations in this manner.

10. Maxima and Minima Thermometers.—The ordinary method of making a thermometer for recording the highest temperature is by introducing a small piece of steel wire about half an inch in length and finer than the bore of the thermometer into the tube above the mercury, in a mercurial thermometer. The thermometer is placed with its stem in a horizontal position, and the steel index is brought into contact with the extremity of the column of mercury. Now when the heat increases and the mercury expands the steel wire will be thrust forward; but when the temperature falls and the mercury contracts the index will be left behind, showing the maximum temperature. For showing minimum temperature a spirit thermometer prepared in a similar manner is used, as the spirits in contracting draw the index with the alcohol because of the capillary adhesion between the alcohol and the glass; but when the alcohol expands it passes by the index, without displacing it, so that its position shows the lowest temperature to which the instrument has been subjected.

11. Use of Thermometers.—In the use of thermometers for determining the temperature of the air, they should be exposed to unobstructed circulation in a dry place and in the shade. Any drops of moisture on the bulb of the thermometer tend to evaporate and lower the temperature. For determining the temperature of steam or water under pressure thermometers are set into a brass frame so that they will screw directly into the liquid (Fig. 7) without permitting leakage. In other cases the thermometer can be inserted into a cup made as shown in Fig. 8. Cylinder-oil or mercury is put into the cup, and the reading of the thermometer will then indicate the temperature of the surrounding fluid. When the thermometer is inserted

into a cup some time will be required to obtain the correct temperature. The temperature of steam-pipes or hot-water pipes cannot be obtained accurately by any system of applying the thermometers externally to the pipes, and in case thermometers are used they should be set deep into the current of flowing steam or water, not placed in a pocket where air can gather.

12. Specific Heat.—The capacity which bodies have of absorbing heat when changing temperature varies greatly; for instance, the same amount of heat which would raise one

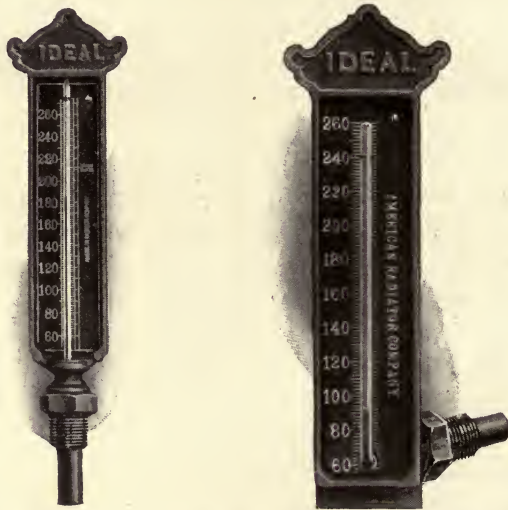

FIG. 7.—Hot Water Thermometers. Straight and Angle Stems.

pound of water one degree in temperature would raise about 8 pounds of iron 1 degree in temperature or would raise 1 pound 8 degrees in temperature. The term used to express this property of bodies is *specific heat*, which is defined as follows: Specific heat is the quantity of heat required to raise the temperature of a body one degree, expressed in percentage of that required to raise the same amount of water one degree, or in other words with water considered as one. Specific heat can always be found by heating the body to a given temperature, cooling it in water, and noting the increase in tem-

perature of the water, Thus if 1 pound of iron in cooling 8 degrees heats one pound of water one degree, its specific heat is $\frac{1}{8} = 0.125$. A table of *specific heats* of the principal materials is given in the back of the book, from which it will be seen that the specific heat of water is greater than that of most other known substances.

A knowledge of the specific heat of various materials is of considerable importance in the design of heating apparatus, since it indicates the capacity for heat for a given increase of temperature. The heat which is absorbed in raising the temperature of a



FIG. 8.—Portable Thermometer-cup. Sectional View.

body is all given out when the body cools, so that although there is a difference in the amount absorbed, there is no difference in the final result due to heating and cooling.

The total heat which a body contains is equivalent to the product obtained by multiplying difference of temperature, specific heat and weight. The results will be expressed in heat-units or in capacity of heating one pound of water.

The specific heat of bodies in general increases slightly with the temperature, the value in the table being the average from 32° to 212° .

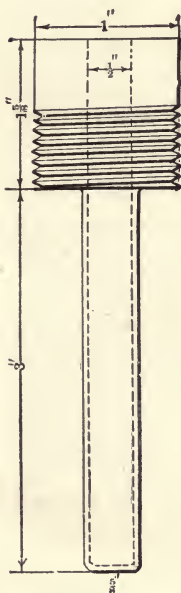

FIG. 9.—Thermometer-cup.

13. Latent Heat.—When heat is applied to any liquid the temperature will rise until the boiling-point is reached, after which heat will be absorbed; but the temperature will not change until the entire process of evaporation is complete, or until the liquid is

all converted into vapor. The heat absorbed during evaporation has been termed *latent*, since it does not change the temperature and its effects cannot be measured by a

thermometer. In the evaporation of water about five and one-half times as much heat is required to evaporate the water when at 212 degrees, into steam at the same temperature, as to heat the water from the freezing to the boiling point. Heat stored during evaporation is given out when the vapor condenses, so that there is no loss or gain in the total operation of evaporating and condensing. A similar storage of heat takes place when bodies pass from the solid to the liquid state, but in a less degree. Although similar in some respects, latent heat differs in nature from specific heat. In both cases, heat not measured by the thermometer is stored; when the temperature is lowered the stored heat is given up in both cases: in the first it represents a change in the physical condition, as from a solid to a liquid or a liquid to a gas; in the second the condition remains unchanged.

14. Radiation.—Heat passes from a warmer body to a colder by three general methods, each of which is of considerable importance in connection with the methods of heating. These methods are *radiation*, *conduction*, and *convection*. The heat which leaves a body by radiation travels directly and in a straight line until it is intercepted or absorbed by some other body. Radiant heat obeys the same laws as light, its amount varying inversely as the square of the distance, and with the sine of the angle of inclination. The amount of radiant heat which is emitted or which is absorbed depends largely, if not altogether, upon the character of the surface of the hot and cold body; it is found by experiment that the power of absorbing radiant heat is exactly the same as that of emitting it. The relative amount of heat emitted or absorbed by different surfaces is given in the following table.

RELATIVE EMISSIVE POWERS AT THE BOILING TEMPERATURE

Lamp-black	100	Steel	17
White-lead	100	Platinum	17
Paper	98	Polished brass	7
Glass	90	Copper	7
India ink	85	Polished gold	3
Shellac	72	Polished silver	3

Radiant heat passes through gases without affecting their temperature or being absorbed to any appreciable extent. It is probably true that a very large body of air, especially air containing watery vapor, does absorb radiant heat, for it is known that the earth's atmosphere intercepts a sensible proportion of the heat radiated from the sun.

15. Reflection and Transmission of Radiant Heat.—Radiant heat, like light, may be reflected and sent in various directions by materials of various kinds. Thus in Fig. 10, heat radiated from *K* is reflected to *L*, and *vice versa*. The following table shows the proportion of radiant heat which would be reflected by various substances:

REFLECTING POWER.

Silver-plate.....	97
Gold.....	95
Brass.....	93
Speculum-metal.....	86
Tin.....	85
Polished platinum.....	80
Steel.....	83
Zinc.....	81
Iron.....	77

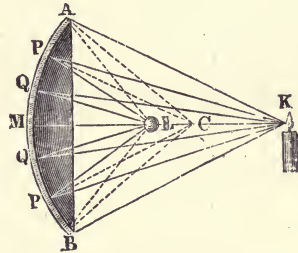

FIG. 10.—Reflection of Heat.

Radiant heat also possesses the property of passing through certain substances in very much the same manner that light will pass through glass. This property is called diathermancy. The following table gives the diathermanous value of various substances, the heat being obtained from a lamp. The transmission power varies with the source of heat.

CRYSTALLIZED BODIES 63.62 MM. THICK.

COLORLESS.		COLORED.	
Rock-salt.....	92%	Smoky quartz (brown).....	57%
Iceland spar.....	12	Aqua-marina (light blue).....	29
Rock-crystal.....	57	Yellow agate.....	29
Brazilian topaz.....	54	Green tourmaline.....	27
Carbonate of lead.....	52	Sulphate of copper (blue).....	0
Borate of soda.....	28		
Sulphate of lime.....	20		
Citric acid.....	15		
Rock-alum.....	12		

PER CENT OF HEAT TRANSMITTED THROUGH DIFFERENT SUBSTANCES.

WHEN RECEIVED FROM AN ARGAND LAMP (DESCHAUD'S PHYSICS).

SOLIDS.		LIQUIDS 9.21 MM. THICK.	
<i>Colorless Glass, 1.88 mm. thick.</i>		<i>Colorless Liquids.</i>	
Flint-glass.....	from 67 to 64%	Distilled water.....	11%
Plate-glass.....	62 to 59	Absolute alcohol.....	15
Crown-glass (French).....	58	Sulphuric ether.....	21
Crown-glass (English).....	49	Sulphide of carbon.....	63
Window-glass.....	54 to 50	Spirits of turpentine.....	31
		Pure sulphuric acid.....	17
		Pure nitric acid.....	15
		Solution of sea-salt.....	12
		Solution of alum.....	12
		Solution of sugar.....	12
		Solution of potash.....	13
		Solution of ammonia.....	15
		<i>Colored Liquids.</i>	
		Nut-oil (yellow).....	31
		Colza-oil (yellow).....	30
		Olive-oil (greenish yellow).....	30
		Oil-carnations (yellowish).....	26
		Chloride sulphur (reddish brown).....	63
		Pyroligneous acid (brown).....	12
		White of egg (slightly yellow).....	11
<i>Colored Glass 1.85 mm. thick.</i>			
Deep violet.....	53		
Pale violet.....	45		
Very deep blue.....	19		
Deep blue.....	33		
Light blue.....	42		
Mineral-green.....	23		
Apple-green.....	26		
Deep yellow.....	40		
Orange.....	44		
Yellowish red.....	53		
Crimson.....	51		

16. Diffusion of Heat.—Various materials possess the property of reflecting the radiant heat in such a manner as to diffuse it in all directions, instead of concentrating the heat in any one direction. If the heat were all returned, the temperature of the body would not rise, but would remain constant. The diffusive power as determined by Laprovostaye and Desains was found to be as follows for the following substances, the heat received being 100:

White-lead.....	.82
Powdered silver.....	.76
Chromate of lead.....	.66

17. Conduction of Heat.—When heat is applied to one end of a bar of metal it is propagated through the substance of the bar, producing a rise of temperature which gradually

travels to the remote portions. This transmission of heat is called conduction. It differs from radiation, first, in being gradual instead of instantaneous; second, in exhibiting no preference for travelling in straight lines, the propagation being as rapid through a crooked as a straight bar. In heating a body the heat is at first largely absorbed by the body without changing its temperature, then for a time it is applied in raising the temperature; the time required for this operation will depend upon its specific heat. After a certain time the temperature of the body will remain constant, the heat being removed as rapidly as it reaches a given position, and in this case we have an illustration of the transmission of heat by conduction. The amount of heat which passes is directly proportional to the area of cross-section, to the difference of temperature divided by the thickness, and to a coefficient which depends upon the character of the material. The *coefficient* is the quantity of heat which flows, in unit time, through a cross-section of unit area, when the thickness of the plate is unity and the difference of temperature is one degree.*

The conducting power of materials varies greatly. The metals are in general good conductors of heat, but differ greatly among themselves. The following table gives the relative values of the conducting powers for different metals:

RELATIVE CONDUCTING POWERS.

Silver.....	100	Steel.....	5.7 to 10.2
Copper.....	65 to 95	Iron.....	15
Gold.....	53	Lead.....	7.6
Brass.....	19 to 23	Platinum.....	8.2
Zinc.....	28	Palladium.....	6.3
Tin.....	14	Bismuth.....	1.62

Rocks and earthy materials have very much less power of conducting heat than the metals. Table XVII in Appendix

* This can be expressed in a formula as follows:

$$Q = kA \frac{t_2 - t_1}{x},$$

in which Q = quantity of heat, k = coefficient, A = area, x = thickness, $t_2 - t_1$ = difference of temperature on the two sides of the plate.

of the book gives the value of the coefficient of various materials in terms of the absolute amount of heat conveyed. The relative conductive powers of stone is about 4 per cent of that of iron and $\frac{2}{3}$ of one per cent of that of copper. The conducting power of woods does not differ greatly from that of water, and is about $1\frac{1}{2}$ per cent of that of iron. The conducting power of the air and gases is very small, and for practical purposes may be considered as zero. As compared with iron the conducting power is about as 1 to 3500. A knowledge of the conductive powers of bodies is of very great importance in connection with the loss of heat in buildings of various classes.

The bodily sensation of heat or cold is affected to a great extent by the conducting power of the material with which the body comes in contact. Thus if the hand were placed upon a metal plate at a temperature of 40 degrees, or plunged into mercury of the same temperature, a very marked sensation of cold is experienced. This sensation is less intense with a plate of marble of the same temperature, and still less with a piece of wood. The reason is that the heat is more rapidly conducted away in the case of the metals, and this causes a more marked sensation of cold.

Where heat is applied to one surface of a metallic body, it passes through the body by conduction and is given off on the opposite side, usually to the air or to bodies in the surrounding room, by radiation and convection. It will be found that the rate of conduction through the metallic body is many times greater than the rate of passage of the heat from the metallic substance. The knowledge of the conductive power is of little practical importance, as regards heating surface, because of this fact, but it is of great value in the selection of materials which will prevent the escape of heat from dwellings. This subject will be taken up in Chapter III, and applications given showing the loss of heat from different constructions of building.

18. Convection or Heating by Contact.—When bodies are in motion there is more or less rubbing contact of their particles with each other and against stationary objects. When the particles rub against hot bodies they will themselves become

warm; it is only by such motion that liquids or gases can be heated any appreciable amount. The heating of the air of a room is practically all accomplished by currents, which brings the particles into contact with radiators, heated pipes, or even the walls of a room. If the air enters a room at a higher temperature, then by the reverse process the heat is given up to the colder objects, and the air is lowered in temperature. The heating of water in steam-boilers is largely due to a circulation which brings the particles of water in direct contact with highly heated surfaces, so that the heating in that case is accomplished largely by convection.

19. Systems of Warming.—Any general consideration of a system of warming must include, first, the combustion of fuel which may take place in a fireplace, stove, steam or hot-water boiler; second, a system of transmission by means of which the heat shall be conveyed with as little loss as possible to the position where it can be utilized for heating; third, a system of diffusion of heat so that it shall be conveyed from any reservoir, radiator, etc., which is heated to objects, persons, or to the air of a room, in the most economical way possible.

In case stoves are used the heat is directly applied by radiation and convection to heating the objects and air in the room in which the stove is placed. There is in this case no special system for the transmission of heat. In the case of hot-air heating, the air is drawn over a heated surface and then transmitted by pipes while at a high temperature to the rooms where heat is required. In the case of steam-heating, steam is formed in a boiler, transmitted through pipes to radiators which are placed either directly in the room or in passages leading to the rooms, and the condensed steam is returned either directly or by means of a pump to the boiler. In the case of hot-water heating the general system is much the same—water instead of steam circulates from the heater to the rooms where heat is required and back to the heater, the motive force which produces the circulation being the difference in weight between the hot and cold water.

CHAPTER II.

PRINCIPLES OF VENTILATION.

20. Relation of Ventilation to Heating.—Intimately connected with the subject of heating is the problem of maintaining air of a certain standard of purity in the various buildings occupied. The introduction of pure air can only be done properly in connection with the system of heating, and any system of heating is incomplete and imperfect which does not provide a proper supply of air.

The subject of ventilation often receives very little consideration in connection with the erection of apparatus for heating.

21. Composition and Pressure of the Atmosphere. Atmospheric air is not a simple substance, but consists of a mechanical mixture of nitrogen and oxygen, together with more or less vapor of water, and almost always a little carbonic acid and a peculiarly active form of oxygen known as ozone. The nitrogen and oxygen are combined in the ratio of 79.1 to 20.9 by volume, and these proportions are generally the same in all parts of the globe, and at all accessible elevations above the earth's surface.

The amount of carbonic acid in the air varies in the open country from 4 to 6 parts in 10,000 by volume. The amount of moisture in the atmosphere sometimes forms 4 per cent of its entire weight, and sometimes is less than one-tenth of one per cent.

The pressure of the atmosphere is measured by the height in inches at which it will maintain a column of mercury in an instrument called a barometer. The pressure of the atmosphere is less as the distance from the centre of the earth becomes greater. For that reason points of different elevation give

different average readings of the barometer. The normal reading of the barometer at sea level, which corresponds to a boiling-point for pure water of 212° F., is 29.905 inches.

The pressure of the atmosphere, even at the same place, is constantly fluctuating with various conditions of the weather. The variation in barometer-reading from the mean may be 1.5 inches in either direction.

The fall of the barometer due to different elevations from the sea level would be approximately as follows:

At 970 feet the barometer sinks 1 inch.			
“ 1970	“	“	2 inches
“ 3000	“	“	3 “
“ 4080	“	“	4 “
“ 5190	“	“	5 “

The atmospheric pressure has great effect upon the boiling-temperature of water; thus pure water will boil at the temperatures corresponding to the various barometric pressures, as shown in the following table: *

Boiling-temperature F.	Barometer, Inches.	Boiling-temperature F.	Barometer, Inches.
212	29.905	205	25.990
211	29.331	204	25.465
210	28.751	203	24.949
209	28.180	202	24.442
208	27.618	201	23.943
207	27.066	200	23.453
206	26.523		

The weight of a cubic foot of air is inversely proportional to the absolute temperature; if freed from aqueous vapor and under a pressure of 30 inches of mercury, it weighs, according to Regnault, at 0 degrees F., 0.0866 pound. The rate of expansion in volume or decrease in density is $\frac{1}{461}$ for each degree Fahrenheit above zero.

* Smithsonian Physical Tables, 1903.

Table X in the Appendix gives the weights of air for different temperatures. For the temperature of 60° and $30''$ barometer, water is 814 times as heavy as air. Various other units are sometimes used to measure the head or pressure, and for convenience of reference these equivalents can be arranged as follows, standard pressure at sea level being 29.92 inches.

$$\begin{aligned} 30 \text{ inches of mercury} &= 14.73 \text{ lbs. pressure per sq. inch.} \\ &= 408 \text{ in. water} = 33.92 \text{ ft. water.} \\ &= 27750 \text{ ft. air at } 60^{\circ} \text{ Fahr.} \\ 1 \text{ inch water} &= 0.577 \text{ oz.} \end{aligned}$$

The atmosphere contains more or less impurities, in the form of dust, bacteria, and various gases. In places where the ventilation is poor, the air may contain carbon monoxide (CO), ammoniacal compounds, sulphureted hydrogen, and sulphuric and sulphurous and nitric and nitrous acids. It also contains some ozone, which is a peculiarly active form of oxygen, and is believed by many to have an important influence in the preservation of the purity of the atmosphere. Authorities, however, differ very widely as to its distribution and action. A new constituent called *argon* has been discovered, which forms about 1 per cent of the atmosphere and being extremely inert is generally classed with the nitrogen in the air.

Air contains more or less solid matter in the form of minute particles of dust. The dust particles are thought to bear an important part in the propagation and distribution of the bacteria of various diseases, and also in the production of storms.

Air contains microbe organisms, or bacteria, in greater or less numbers. The number of bacteria may be determined by slowly passing * a given volume of the air through a glass tube coated inside with beef jelly; the germs are deposited on the nutrient jelly, and each becomes in a few days the centre of a very visible colony. In outside air the number of microbe organisms varies greatly, being often less than one per litre (61 cubic inches); in well-ventilated rooms they vary from

* Encyc. Britannica, article "Ventilation."

1 to 20, while in close schoolrooms as many as 600 per litre have been found. Carnelley, Haldane, and Anderson found in their researches in mechanically ventilated schoolrooms an average number of 17 microbe organisms per litre. The results of stopping the mechanical ventilation was to increase the carbonic acid without changing the number of microbe organisms.

22. Diffusion of Gases.—Gases which have no chemical action on each other will, regardless of weights or densities, mingle with each other so as to form a perfectly uniform mixture. This peculiar property is called *diffusion*, and is of great importance in connection with ventilation, since it indicates the impossibility of separating gases of different densities.

Liquids of different densities do not make uniform mixtures, unless they have a special affinity for each other; the heavier invariably settles to the bottom.

Perfect diffusion is a process which requires some time, so that the composition of samples from the same room may in some instances be sensibly different. The time required for the diffusion of gases is inversely proportional to the density, and directly proportional to the square root of the absolute temperature. Diffusion is a molecular action, and can be calculated from the kinetic theory of gases. One computation of this character indicates that the time required for the equal diffusion of carbonic acid throughout the atmosphere was 2,220,000 years.

Dr. Angus Smith found the following percentages of oxygen present in the air, in samples collected in various places, which serve to show the variation which may exist under different conditions: *

Seashore of Scotland, on the Atlantic.....	20.99%
Top of Scottish hills.....	20.98
Sitting-room, feeling close, but not excessively so.....	20.89
Backs of houses and closets.....	20.70
Under shafts in metal mines.....	20.424
When candles go out.....	18.50
When difficult to remain in air many minutes.....	17.20

* Ency. Brit.

The variation in amount of carbonic acid is equally great, the quantity being as follows:

London parks	0.0301%	In workshops	0.3%
On the Thames	0.0343	In theatres	0.32
London streets	0.0380	Cornwall mines	2.5
Manchester fogs	0.0679		

23. Oxygen.—Oxygen is one of the most important elements of the atmosphere, so far as both heating and ventilation are concerned. It is the active element in the chemical process of combustion, and also of a somewhat similar physiological process which takes place in the respiration of human beings. It exists in a free state mixed with about four parts of nitrogen in the air, and is essential not only for the support of any combustion, but for the support of life. It is not to be considered as having any properties as a food, but is rather the necessary element which makes it possible to assimilate and utilize the food. Taken into the lungs it acts upon the excess of carbon of the blood, and possibly also upon other ingredients, forming chemical compounds which are thrown off in the act of respiration. The chemical action of oxygen with the other elements can generally be considered as a sanitary one. In many respects the process of respiration resembles that of combustion; for in both cases oxygen is derived from the air, carbon or other impurities are oxidized, and the products of this oxidation are rejected. In both cases heat is given off as the result of this process. Its weight is sixteen times that of hydrogen. It is sometimes found in a peculiarly active form called *ozone*.

24. Carbonic Acid or Carbon Dioxide, CO₂, and Carbonic Oxide, CO.—The first is a product resulting from the perfect combustion of carbon; it is always found in small quantities, 3 to 5 parts in 10,000 in the atmosphere of the country.

This gas, although very heavy as compared with that of pure air (44 times that of hydrogen), will, if sufficient time be given, mix uniformly with the air. It is not a poisonous gas, although in an atmosphere containing large quantities of carbonic dioxide a person might die from suffocation or for want of oxygen.

While carbonic dioxide is not of itself injurious, yet as it is a product of combustion and respiration, and is usually accompanied with other injurious products, and for the lack of a better standard, it is regarded as an index of the quality of the air, and the amount of it present in the air is taken as the standard by which we can judge of the ventilation.* In such a case pure air, containing 4 parts of carbon dioxide in 10,000 would be the standard for comparison. Authorities differ as to the greatest amount of carbon dioxide which might be permitted. It is quite certain that any unpleasant sensation is not experienced until the amount is increased to 10 or 12 parts in 10,000; yet authorities are generally agreed that the maximum amount should not exceed 10 parts in 10,000, at least for sleeping-rooms. The standard of good ventilation usually adopted at present would permit about 8 parts in 10,000 in the air. There has been a tendency to make the standard of ventilation higher, thus requiring the introduction of greater quantities of air.

The importance of the carbon dioxide test of air is too easily over-estimated. The CO_2 percentage is used only as a measurement of the vitiation of the air by respiration and combustion. Where CO_2 is produced in such a manner that the oxygen in the air is not depleted or where the air is contaminated otherwise than by the presence of people, animals, or an open flame, the use of the CO_2 test may give misleading results.

* J. S. Billings, in his work on Ventilation and Heating, cites an experiment by Carnelley and Mackie, showing that the ordinary theory of increase of organic matter with increase of carbon dioxide is a reasonable one. The results of the experiment were as follows:

Proportion of Organic Matter. Oxygen required to Oxidize 1,000,000 Volumes.	Average Carbonic Acid in 10,000 Volumes of Air.	Number of Trials.
0 to 2.5	2.8	20
2.5 to 9.5	3.0	20
4.5 to 1.0	3.2	20
7.0 to 15.8	3.7	20

When air has a bad or a close odor it is generally objectionable, even if it has a very low CO_2 content.

Carbonic acid is continually increased by the processes of combustion and respiration, yet for the past thirty years the amount in the air has not sensibly changed.

Plant-growth and vegetable life assimilate carbonic acid and give off oxygen.* There exists in the air about 28 tons of carbonic acid to each acre of ground, yet an acre of beech-forest annually absorbs about one ton, according to Chevandier; and no doubt the total vegetation growing is sufficient to absorb the excess due to combustion and respiration, so that the total does not experience much change.

Carbonic Oxide, CO.—This compound is not found in the air except under unusual circumstances. It is distinctly a poison, and has a characteristic reaction on the blood. Hempel,† the German chemist, experimented on its poisonous effects with a mouse. No symptoms of poisoning were detected until there were 6 parts CO in 10,000 of air, in which case after 3 hours' time respiration was difficult; in another case the mouse could scarcely breathe in 47 minutes. With 12 parts in 10,000 the mouse showed symptoms of poisoning in 7 minutes; with 29 parts in 10,000 the mouse died in convulsions in about two minutes.

25. Nitrogen—Argon.—The principal bulk of the earth's atmosphere is nitrogen, which is almost uniformly diffused with oxygen. This element is practically inert in all the processes of combustion or respiration. It is not affected in composition either by passing through a furnace during combustion or in passing through the lungs in process of respiration. Its action is to render the oxygen less active, and to absorb some part of the heat produced by the process of oxidation. It is an element very difficult to measure directly, as it can be made to enter into combination with only a few other elements, and then under peculiarly favorable circumstances.

* "How Crops Feed," by Johnson, page 47.

† Hempel's Gas Analysis. Macmillan & Co.

A very small amount of ammonia, which is a compound of nitrogen and hydrogen, is found in the atmosphere.

Water Vapor.—The atmosphere always contains more or less water vapor or moisture. The greatest amount of vapor that may exist in the air depends upon the temperature and varies from 0.00007 lb. per cu. ft. at 0° to 0.00282 lb. per cu. ft. at 100° F. Besides controlling the rain fall the degree of saturation of the air with moisture influences health and to a large extent our bodily sensations of warm and cool air, by varying the rate of evaporation from the lungs and skin.

26. Analysis of Air.—The accurate analysis of air requires the determination of aqueous vapor, carbon dioxide, carbon monoxide, oxygen and ozone, but for sanitary purposes the determination of carbon dioxide and water is the most frequently called for.* The nitrogen of the atmosphere cannot be determined by any known method of analysis; it is obtained by deducting the sum of all the other elements from the total. The approximate determination of the oxygen is done very readily by drawing a certain volume of the air into a measuring-vessel and then passing it over a mixture of pyrogallic acid and caustic potash or solid phosphorus; the oxygen is absorbed, reducing the volume of gas in amount proportional to the quantity of oxygen. This process is, however, not of extreme accuracy, and for minute quantities very much more complicated methods must be resorted to. In getting a sample of air to be analyzed, care should be taken that no air exhaled by the operator enters the sample.

Method of Finding Carbon Dioxide (CO₂).—The amount of this material present in the atmosphere is so small that the most delicate methods are required in order to measure it. The writer gives first an approved method which can be rapidly applied, and which is accurate to one part in ten thousand. This system of finding CO₂ was devised by Otto Pettersson and A. Palmqvist, two European chemists. The instrument used

*For a complete discussion of these various methods the reader is referred to "Gas Analysis" by Professor L. M. Dennis, and published by The Macmillan Co.

for this determination is shown in Fig. 11, and can be had from any dealer in physical apparatus. It consists of a measuring-vessel, *A*, connected with a U-shaped burette, *B*, from which communication can be made by a small stop-cock, *b*; a manometer, *fg*, containing a graduated scale nearly horizontal; and two stop-cocks, *f* and *g*, by means of which communication can be made with the air. One side of this manometer, *f*, is in communication with the closed compensating vessel *C*; the

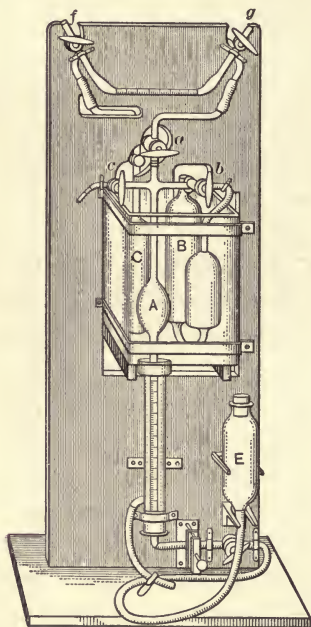

FIG. 11.—Portable Form as Modified by Dr. Rogers.

other side can be put in communication with the measuring-vessel *A*. The burette *B* contains a saturated solution of caustic potash (KOH). The flask *E* contains mercury, and by raising it, when the stop-cock *c* is open, the mercury will rise in the flask *A*, and the air will be driven out. If the flask *E* be lowered the mercury will flow from the measuring-tube, and the amount of air entering *A* can be measured by the graduations. When the measuring-tube *A* is full of air, the stop-cocks *c*, *b*, *f*, and *g* being open, the position of the drop of liquid in the horizontal tube of the manometer is accurately read. The stop-cocks *c*, *a*, *f*, and *g* are then closed, that at *b* opened, and the vessel *E* raised, driving

the air out of the measuring-tube *A* into the absorption burette *B*. This operation of raising and lowering the flask *E* is repeated several times; it is then lowered, and the air is drawn over into the measuring burette; the cock *a* is then opened and the vessel *E* manipulated until the reading of the manometer on the horizontal scale agrees with that in the beginning of the test. The reading of the graduated tube

A gives directly the amount of CO_2 . A slow motion screw is provided for accurately adjusting the mercury level. The caustic potash should on no account be allowed to get beyond its own stop-cock. The effect of changes of the barometer and of the air temperature and of the jacket water are eliminated by this apparatus, as the changes of volume are measured against an equal volume of untreated air confined in the compensating flask C. The determinations are made with air of ordinary humidity, and there is a very slight correction due to this fact, which is not likely to equal, in any case, one part of CO_2 in one million parts of air.

The methods of determining accurately the amount of carbon dioxide in the air are in general based upon one of the three following principles: 1, the measurement of the volume of carbon dioxide by methods similar to that already described and which, with proper precautions, is probably the most satisfactory of any device; 2, the determination of the amount of carbon dioxide by the increase in weight of a substance, such as caustic potash, which is capable of absorbing it, and through which the air is passed. This is open to the practical difficulties of weighing very small quantities and of keeping the air perfectly dry; 3, the transformation of the carbon dioxide in the air into a chemical compound by use of an absorbing chemical, as, for instance, caustic baryta, which is subsequently analyzed and the amount of the gas thus ascertained. This process was employed by de Saussure and Pettenkofer and requires extreme care and great skill in laboratory experiments.

27. Approximate Methods of Finding Carbon Dioxide (CO_2).

—In addition to the accurate methods there are a number of approximate methods which may be used with satisfaction for the purpose of ascertaining the relative quality of the air as to whether good or bad, but which give no accurate indication of the percentage of carbon dioxide present. Some of the more important of these methods are described below.

The carbocidometer of Professor Wolpert is highly recommended by Professor J. H. Kinealy. It consists of a glass cylinder about one inch in diameter and seven inches long,

closed at one end and provided with a rubber piston. The cylinder is graduated in cubic centimeters (c.c.) from the bottom upward to 50. The piston-rod is hollow and arranged to be closed by a rubber cap. A solution made by adding to one litre of water one-twentieth of a gram of sodic carbonate and to this .075 gram of phenolphthalein is recommended. This solution is of a pink color so long as alkaline, but is made lighter in color by the addition of carbon dioxide, and it becomes colorless when made neutral. To use the Wolpert air-tester, press the piston down several times so as to drive the contents of the cylinder out through the hollow piston-rod, then add 2 c.c. of the solution, then push the piston to the position showing 20 c.c. in the cylinder, and after stopping the piston-rod hole thoroughly shake the instrument so that the solution will absorb the CO_2 . If the air in the cylinder is still pinkish, draw out the piston and add more air, then close the admission opening and shake as before. Continue this operation until the mixture in the cylinder is colorless. Try this operation first in the outside air, then in the room where contents are to be tested. As an example, if the piston stands after this operation at 46 after using the outside air and at 32 after using that in the room, deduct 2, since there is taken up by the solution 2 c.c., leaving 44 and 30 as a remainder. We understand from this that the amount of CO_2 in 44 c.c. of outside air would combine with the same amount of chemical as with 30 c.c. of the air from the room. Hence the amount of CO_2 present in the room is to that in the air as 44 is to 30; that is, the air in the room would contain 1.46 as much CO_2 as the air outside. If the air outside contain 4 parts in 10,000, that in the room would contain 5.84 parts in 10,000. Great care is needed to prevent the sodic carbonate from decomposing by exposure to the atmosphere. This apparatus can be purchased from dealers and importers in philosophical apparatus.

Carbonic dioxide has the property of forming a precipitate in lime-water, thus rendering it turbid. Several methods of ascertaining the amount of CO_2 in the air have been based on this property, all of which, however, are extremely inaccurate.

The Smith method requires the use of six well-stoppered bottles holding respectively 100, 200, 250, 300, 350, and 450 c.c., a glass tube or pipette graduated to contain exactly 15 c.c. to a given mark, and a bottle of perfectly clear and transparent lime-water. The bottles are to be made perfectly clean and dry, then filled with the air to be examined, then add to each of the bottles in succession, commencing with the smallest, 15 c.c. of lime-water, shake thoroughly, and if turbidity appears we have the following results:

Contents of Bottle, c.c.	Parts of CO ₂ in 10,000.
100.....	16
200.....	12
250.....	10
300.....	8
350.....	7
450.....	6 or less.

The degree of turbidity can be determined by looking through the bottle at an ink-mark on a bit of white paper.

There is another instrument of the same class as the Wolpert air-tester, in which is used, however, a test-tube holding 3 c.c. of lime-water with a white bottom on which is a black figure. Air is blown through by means of a rubber bulb containing 28 c.c. which is fastened to a glass tube. The number of times which the bulb has to be filled and emptied in order to render the lime-water turbid determines the amount of CO₂. If the bulb is discharged 40 times to produce opacity, we have 10 parts in 10,000; if 50 times, we have 4 parts in 10,000, etc.

The Lunge-Zeckendorf method is recommended by Billings as the most accurate of the ready methods of determining the amount of CO₂ present in air, especially when it is in excess of 10 parts in 10,000. The analysis is made by the use of a solution consisting of desiccated sodium carbonate, 5.3 grams, dissolved in 1000 c.c. of distilled water which has been recently boiled and quickly cooled and to which one gram of phenolphthalein is added. The apparatus consists of a bottle with

cubic contents of 125 c.c., which is provided with a cork containing two glass tubes, one of which terminates near the top of the bottle, the other at the bottom. The short tube opens into the air, the other connects with a rubber tube leading to a bulb of 70 c.c. capacity. The bulb is arranged to draw in air at one end and discharge through the rubber tube into a long glass tube leading to the bottom of the bottle.

When the analysis is to be made 4 c.c. of the solution are added to 100 c.c. of freshly boiled and cooled distilled water, and of this 10 c.c. are used for each determination by pouring in the bottle. The air is replaced by the air to be analyzed; then the air to be tested is forced through the solution by alternately expanding and contracting the bulb, the number of times required to make the solution colorless being a measure of the CO_2 . The various parts in 10,000 corresponding to the compressions of the bulb are as follows: 12 parts, 16 compressions; 20 parts, 8 compressions; 22 parts, 7 compressions; 25 parts, 6 compressions; 30 parts, 5 compressions.

28. Humidity of the Air.—Humidity is the water vapor or moisture mixed with the air in the atmosphere. The weight of water vapor a given space will hold depends entirely on the temperature and pressure and is entirely independent of the presence or absence of the air.

The effect of any changes of the barometric pressure upon the humidity are slight and may usually be disregarded. More time is required for the water vapor to diffuse in air than in a vacuum.

Absolute Humidity is the weight of a cubic foot of water vapor at a given temperature and percentage of saturation. It is usually expressed as grains per cubic foot.

Relative Humidity is the ratio of the weight of water vapor in a given space, to the weight which the same space will hold when fully saturated at the same temperature, and is expressed as a percentage. The term "Humidity" as usually employed signifies relative humidity.

Dew Point is the temperature at which saturation occurs for a given weight of water vapor. It is the temperature at

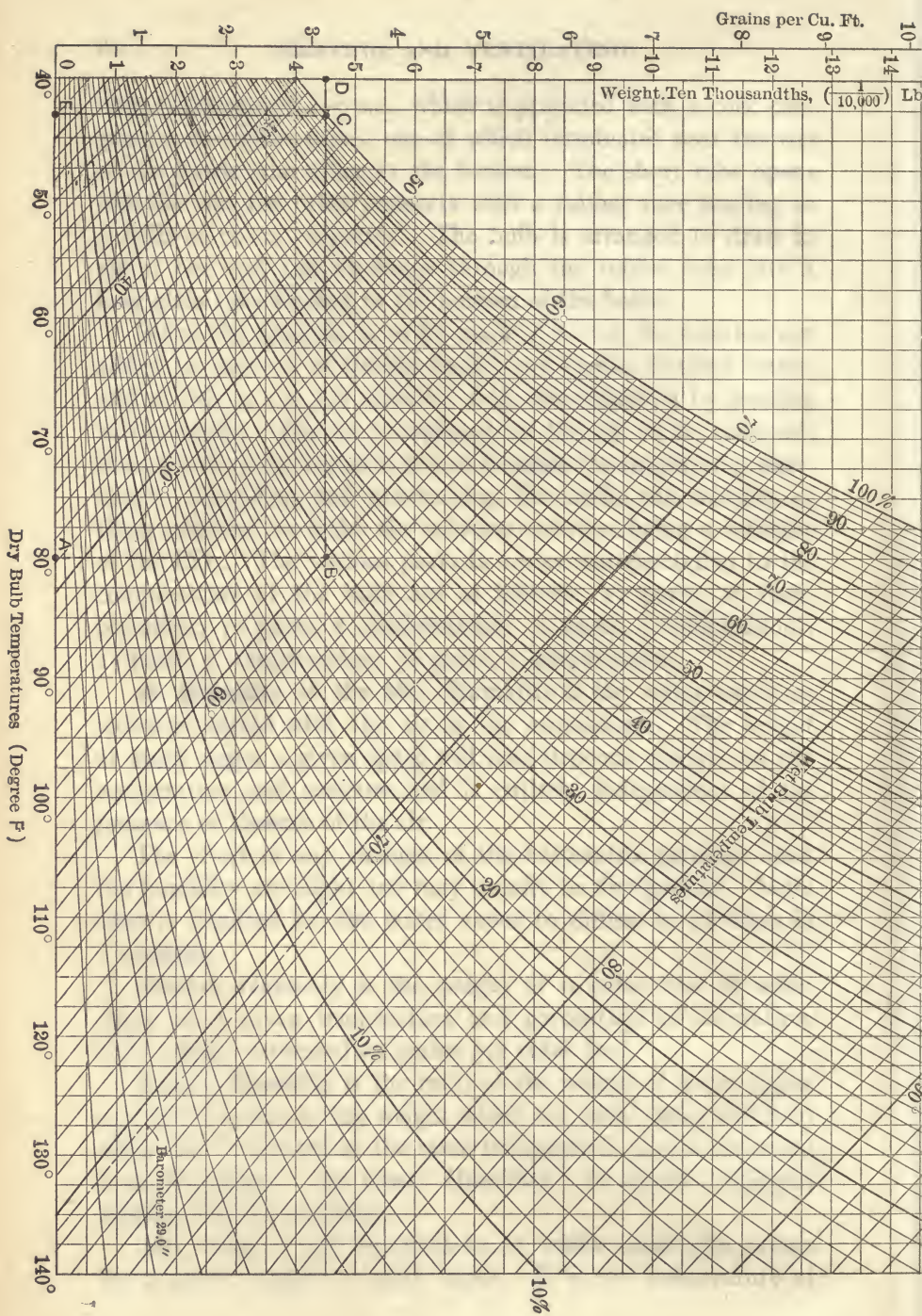

Grains per Cu. Ft.

Weight, Ten Thousandths, ($\frac{1}{10,000}$) Lb

Dry Bulb Temperatures (Degree F)

Barometer 29.9"

10%

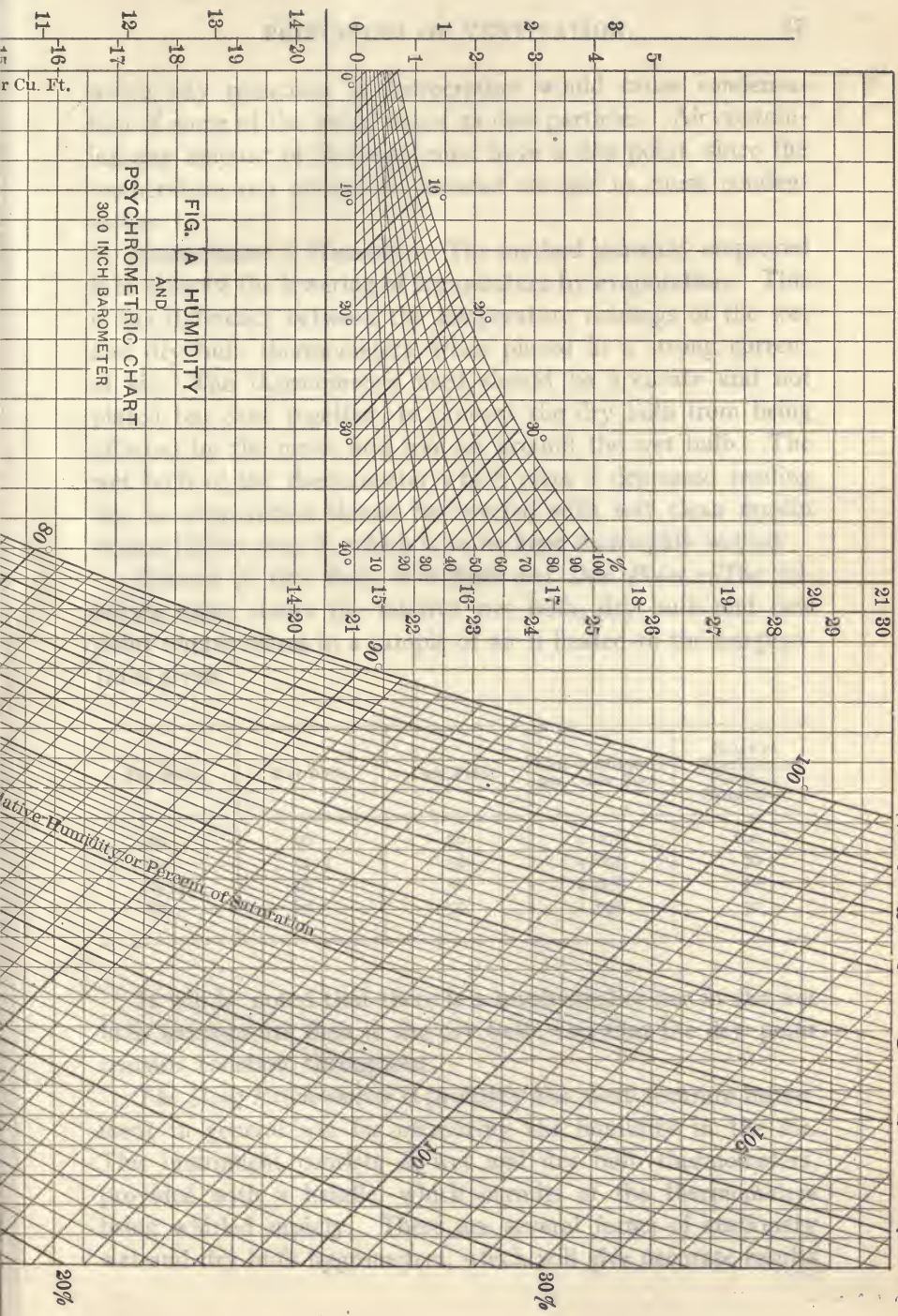

FIG. A HUMIDITY
AND
PSYCHROMETRIC CHART
30.0 INCH BAROMETER

which any reduction in temperature would cause condensation of some of the water vapor as dew particles. Air containing any amount of moisture must have a dew point, since the temperature can always be lowered enough to cause condensation.

Measurement of Humidity.—The method generally employed is to observe the lowering of temperature by evaporation. This is the difference between the temperature readings of the wet and dry bulb thermometers, when placed in a strong current of air. The thermometers used should be accurate and not placed too close together, to prevent the dry bulb from being affected by the moist and cool air around the wet bulb. The wet bulb of the thermometer which gives a depressed reading due to evaporation should be covered with soft clean muslin drawn tightly over it, which is to be kept thoroughly wetted.

Relation of Dry Bulb, Wet Bulb and Dew Point.—The following table shows the relative wet bulb, dry bulb and dew point temperatures in a sample of air if heated to the temperatures given.

Dry Bulb.	Wet Bulb.	Dew Point.	Grs. of Moisture per Cubic Foot.	Relative Humidity or Per Cent Saturation.
50	50	50	4.076	100
60	54.5	50	4.076	70
70.5	59	50	4.076	50
87	65	50	4.076	30

It will be noted that there is a much smaller rise in the wet bulb temperature than in the dry bulb, and that the dew point remains constant throughout.

The Sling Psychrometer is probably the most accurate instrument in general use for measuring the humidity in the air. This instrument consists of wet and dry bulb thermometers, provided with a handle, which permits of the thermometers being whirled rapidly. There are several forms of stationary wet and dry bulb hygrometers, which will give accurate results

if placed in a current of air. Two forms are shown here, one with an attached humidity chart so that the relative and absolute humidities can be read directly without further calcula-

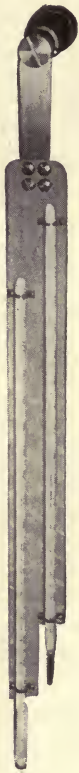

FIG. 12.—
Sling Psy-
chrometer.



FIG. 13.—
Wet and Dry Bulb
Thermometers.

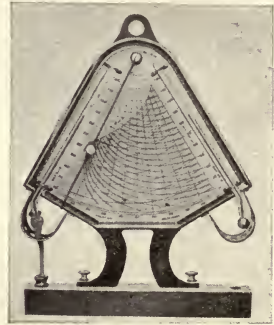

FIG. 14.—
Hygrodeik.

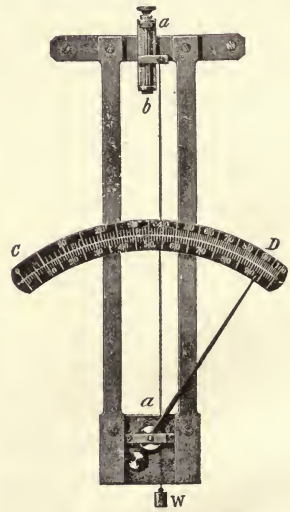

FIG. 15.—
The Hair Hygrometer.

tions. In the hair hygrometer, Fig. 15, the hair increases or diminishes in length, in proportion to the amount of moisture in the air, and moves a pointer of the instrument. A scale

graduated by comparison with an accurate sling psychrometer serves to show the relative humidity of the air. This instrument is subject to a gradual deterioration and needs to have its accuracy checked up where any dependence is placed upon its indications:

The weight of any vapor that air can possibly contain at various temperatures may be obtained by consulting tables of the properties of the vapor as for instance the Steam Tables. Steam Tables are principally devoted to the properties of steam at high temperatures although a limited number of quantities are given for the low temperatures. Accurate values are given in the Marks and Davis Steam Tables, of which an abstract is presented in this work.

The degree of moisture in the air has an important influence on ventilation. When air is saturated with moisture water is deposited on all bodies which conduct heat readily and have a lower temperature than the air. On the other hand, if the air is entirely deprived of watery vapor it evaporates moisture from the body, and thus causes an unpleasant sensation. When the air is saturated no evaporation can take place from the body. When the air is very dry, very rapid evaporation will take place. A mean condition between these two extremes is required in every case. The air should be from 50 to 70 per cent saturated in order to feel pleasant, and be of the most value for ventilating purposes. The higher the temperature the more noticeable are either excessive moisture or excessive dryness.

29. Measurement of the Relative Air Supply.—The air is vitiated mostly by high temperature and humidity. It is also probably vitiated by organic matter thrown off by respiration and perspiration; and the bad effects due to "close air" are partly due to the accompanying rise in the temperature and the humidity of the air. Since the latest researches have shown that a man's breathing is regulated so that the average CO_2 content inside the lungs is from 5 to 6%,* and that air containing up to 2% of CO_2 and otherwise pure can be breathed

* Ency. Britannica.

without noticeable discomfort, it follows that the CO_2 is in itself harmless, only acting to dilute the air and its oxygen. But since the CO_2 in the air is the only available measure of the percentage of respired air in the room, it is used as a check on the amount of impurities introduced by respiration and combustion.

It is estimated, provided that the CO_2 is only introduced by respiration, that at each respiration of an adult person 20 cubic inches of air on the average are required, and that 16 to 24 respirations take place per minute; so that from 320 to 480 cubic inches, or about one-fourth of a cubic foot, are required per minute.* The air is ejected from the lungs at 90 to 98°, is nearly saturated and contains from 3 to 5% CO_2 , hence is from 1 to 3% lighter than air inhaled.

The following table shows the approximate effect of respiration on the composition of air:†

	Entering Air.	Respired Gases.
Oxygen, per cent of volume.....	20.26	16
Nitrogen, " "	78.00	75
Watery vapor " "	1.70	5
Carbonic acid " "	0.04	4

The carbon dioxide may indicate the relative amount of air respired. Thus if we consider that each person uses one quarter cubic foot of air per minute, and that the respired air contains 400 parts in 10,000 of carbonic acid, while the entering air contains but 4, we can calculate the amount of air which must be provided to maintain any standard of purity desired. The formula for this operation would be as follows: If a = the number of parts of CO_2 in 10,000, thrown out per person per minute in respiration; if b = the cubic feet of air used per minute; if n = the standard of purity to be preserved, expressed as the number of units of CO_2 permissible in 10,000, and C = the

* This is estimated by Box as 800 cubic inches, but is given by recent physiologists as above. See works of Dalton, Dr. Carpenter, Art. Respiration in Ency. Brit., etc. This is increased by violent exercise, and to make the allowance liberal 576 cubic inches or $\frac{3}{4}$ cubic foot is taken as the amount to be supplied.

† Ency. Britannica, Art. Respiration.

number of cubic feet of air required per person per minute—we shall have

$$C = ab / (n - 4).$$

For the condition we have just considered, for each adult person $a = 400$, $b = \frac{1}{4}$, so that the formula becomes

$$C = 100 / (n - 4).$$

The following table shows the amount of air which must be introduced for each person in order to maintain various standards of purity:

AMOUNT OF AIR REQUIRED PER PERSON FOR VARIOUS STANDARDS OF PURITY.

Standard Parts of CO ₂ in 10,000 of Air in the Room. (<i>n</i>)	Cubic Feet of Air required per Person.	
	Per Minute. (<i>C</i> .)	Per Hour. <i>C</i> × 60
5	100.0	6000
6	50	3000
7	33	2000
8	25	1500
9	20	1200
10	16.7	1000
11	14.3	857
12	12.5	750
13	11.1	667
14	10	600
15	9.1	546
16	8.3	500
18	7.1	428
20	6.2	375

The combustion of one cubic foot of gas per hour contaminates about the same amount of air as one person, so that an allowance, equivalent to that required for four or five people, should be made for each gas-burner.

Authorities differ greatly as to the amount of air to be provided per person, but at the present time they seem well united in considering the admission of 30 cubic feet of air per minute

for each person as giving good ventilation, and this amount is required by law for school buildings in Massachusetts, New York, and other states having ventilating laws.

Some authorities insist that a higher standard should be required, but there is little doubt that present conditions would be very much improved could the above amount be obtained in every case.

The supply of fresh air necessary for these standards is high on account of the low efficiency by which the air is distributed. The manner in which the air is supplied to the occupants is of more importance than the amount of air supplied or the air space allowed each occupant. Air that short circuits through the rooms without displaying or mingling with the air in the room is manifestly of little real value for ventilating purposes. Five hundred cubic feet per hour well distributed is of more value than 4000 cubic feet per hour which goes through the room without coming down to the breathing zone.

Air samples for carbon dioxide should be taken in the breathing zone of a room in order to show the relative purity of the air. If the samples are taken in the air leaving a room a low CO₂ content may be a sign of poor distribution of the fresh air rather than a sign of good ventilation. If the amount of air supplied the room be measured and the CO₂ sampled in the exit air, and the size of the room and the number of occupants known, the method given on the preceding page will give the relative efficiency of the air distribution by comparison of the results with the table on the preceding page.

Dr. W. A. Evans states before the A.S.H. & V.E., 1911, that—"As to ventilation, is not the standard the complex standard of everything in hygiene and sanitation? For example: If a building is so located that it gets lots of sunshine in its interior, the ventilation standards can be lowered twenty per cent with safety to the occupants. If the ventilation is of a basement where sunshine cannot get in, then the standard should go twenty per cent over the normal or, in a hospital, the standards must be higher than elsewhere, because the gen-

eral health rate is lower; or, if people bearing potential infection are jammed very close together the standard must be higher than where occupation is very sparse; or, if hygiene and cleanliness are of a very high standard the ventilation standard can be lowered."

Without doubt, it is true that so far as quality is concerned our best standard is the external air surrounding the building to be ventilated. Investigation also indicates that the utilization of the external air for natural ventilation by raising the windows and regularly admitting the air to the apartment to be ventilated is desirable when the conditions are favorable. Generally speaking, it is not desirable to have a system of ventilation which will not permit the direct communication with the outside air by the opening of windows. It however must be recognized that no supply of a definite amount can be obtained by merely connecting a room with the outside air by opening a window, and that as a consequence a system of ventilation which depends alone on the opening of windows will be certain to fail and will be certain to give air which will differ largely from the external air surrounding the building.

30. Influence of the Size of the Room on Ventilation.—The purity of the air of a room depends to some extent on the proportion of its cubic capacity to the number of inmates. This influence is often overestimated, and even in a large room if no fresh air be supplied the atmosphere will quickly fall below the standard of purity. It must be considered that no room is hermetically sealed. Ventilation takes place through every crack and cranny, and even by diffusion through the walls of the room. Such ventilation is generally, however, uncertain and inadequate. Large rooms have the advantage over small ones that they act as reservoirs of air, and also because there is chance for intermittent ventilation such as occurs when doors or windows are opened, and for the casual ventilation which takes place through the walls and around the windows. They are also advantageous, because a larger volume of air may be introduced with less danger of producing disagreeable air-currents or draughts. The following table, taken in part

from article "Ventilation," Encyc. Britannica, gives a general idea of the cubic capacity per person usually allowed in certain cases, and the time which would be required to reduce the air inclosed to the lowest admissible standard of purity (12 parts of CO₂ in 10,000 of air), provided no fresh air was admitted.

Class of Building.	Cubic Contents.	Time required for Contaminating the Air.
Hospitals.	1200 cu. ft. and above	70 min.
Middle-class houses.	1000 " " " "	59 "
Barracks.	600 " " " "	35 "
Good secondary schools.	500 " " " "	29 "
London Board schools.	130 " " " "	8 "
Workhouse dormitories.	300 " " " "	18 "
London lodging-houses.	240 " " " "	14 "
One-roomed houses.	212 " " " "	13 "

It is seen from the above table that in the ordinary grade of middle-class houses it would require about one hour to render the air unfit for breathing, while for the lowest grade of houses the time required would be only 13 minutes. It may be said, however, respecting the cheaper grade of houses, that while the amount of space allowed per person is small, the character of construction is such that air can usually enter or leave the room without very great retardation, and consequently this table does not fairly represent the character of ventilation actually secured.

Pettenkofer found that, by diffusion through the walls, the air of a room in his house containing 2650 cubic feet was changed once every hour when the difference of exterior and interior temperatures was 34 degrees. With the same difference of temperature, but with the addition of a good fire in a stove, the change rose to 3320 cubic feet per hour. With all the crevices and openings about doors and windows pasted up air tight the change amounted to 1060 cubic feet per hour; with a difference of 40 degrees the ventilation through the walls amounted to 7 cubic feet per hour for each square yard of wall surface. The effect of diffusion in changing the air of a room

should generally be neglected in practical ventilation, because it is very uncertain in amount and character.

31. Force for Moving the Air.—No definite ventilation can be secured unless provision is made for (1) power for moving the air, (2) passages and inlet for admitting the air, (3) passages and outlet for escape of air. Air is moved for ventilating purposes in two ways: first, by expansion due to heating; and second, by mechanical means.

The effect of heat on the air is to increase its volume and lessen its density directly in proportion to the increase in absolute temperature. The lighter air simply because of its less density tends to rise, and is replaced by the colder air below. The head which induces the flow is a column of air corresponding in weight to the difference in heights of columns of equal weight of cold and heated air. The velocity can be computed, since theoretically it will be equal to the square root of twice the force of gravity into this difference of height. The result so computed will apply only when there is unrestricted openings at both ends. It is scarcely ever applicable to chimneys, for the reason that the flow of air is retarded by passing through the fuel.

The theoretical amount of air which will pass through ventilating flues of ordinary construction and of different heights is given in Table XVI in Appendix.

The available force for moving the air which is obtained by heating is very feeble, and quite likely to be overcome by the wind or external causes. Thus to produce the slight pressure equivalent to one-tenth inch of water in a flue 50 feet in height would require a difference in temperature of 50 degrees. In a flue of the same height a difference of temperature of 150 degrees would produce the same velocity as that caused by a pressure of 0.15 inch of water. To produce the same velocity as that due to a pressure sufficient to balance 0.1 inch of water will require that the product of height of chimney and difference of temperature should be 1760.

It will in general be found that the heat used for producing velocity, when transformed into work in a steam-engine is considerably in excess of that required to produce draught by

mechanical means. In a rough way, an increase in temperature of one degree increases the head producing the velocity only about one part in 500.

Ventilation by Mechanical Means is performed either by pressure or by suction. In the first case the air is increased in density and discharged by mechanical force into the flue, the flow being produced by an excess of pressure over that of the atmosphere, so that the air tends to move in the direction of least resistance, which is outward to the atmosphere. In the second case, pressure in the flue is less than that of the atmosphere, and the velocity is produced by the flowing in of the outside air. By both processes of mechanical ventilation the air is supposed to be moved without change in temperature, and the force for moving it must be sufficient to overcome effects of wind or change of temperature, otherwise the introduction of air will not be positive and certain.

32. Measurements of the Velocity of Air.—The velocity of air or other gases may be measured directly by an instrument called an anemometer, or indirectly by difference of pressure. The anemometer which is ordinarily employed for this purpose consists of a series of flat vanes attached to an axis and a series of dials. The revolution of the axis causes motion of the hands in proportion to the velocity of the air. In the form shown in Fig. 16 the dial mechanism can be started or stopped by a trip arranged conveniently to the operator. In some instances the dial mechanism is operated by an electric current, in which case it can be located at a distance from the vanes. For measuring the velocity of the wind an anemometer, which consists of hemispherical cups mounted on a vertical axis, is much used.

It was shown by Mr. Combes in 1838 that if n be the number of turns of the vane wheel and a and b constants, the velocity of the air would be expressed by the formula

$$V = a + bn.$$

The pressure on any confined fluid can be expressed in any units desired, as pounds or ounces per square inch, or in terms

of the height of a column of the same fluid which would give an equivalent pressure, and which is termed the *head*. When motion takes place, a portion termed the *velocity head* is transformed into velocity, while another portion, termed the *pressure head*, acts to produce pressure.

The pressure head can be measured by a simple manometer arranged as shown at *A*, Fig. 17, which in this case consists of a U-shaped tube with one side or leg open and the other connected to a tube *n* opening at right angles to the current. The manometer

reading is equal to the difference of level *ab* of the liquid in the two legs. The head will be equal in every case to the manometer reading multiplied by *r*, the ratio of specific weights of the manometer liquid and the air.

The resultant velocity and pressure head can be measured by a *Pitot* tube arranged as shown at *B*, Fig. 17; this consists of a manometer connected to a tube *e* opening to squarely face the moving current. The liquid in the manometer will balance the velocity head $h_1 = v^2/2g$, and also the pressure head. If the opening of the entering tube face in the opposite direction, as at *f*, the current will cause the fluid in the manometer to vary in the opposite direction, but probably by an indefinite amount.

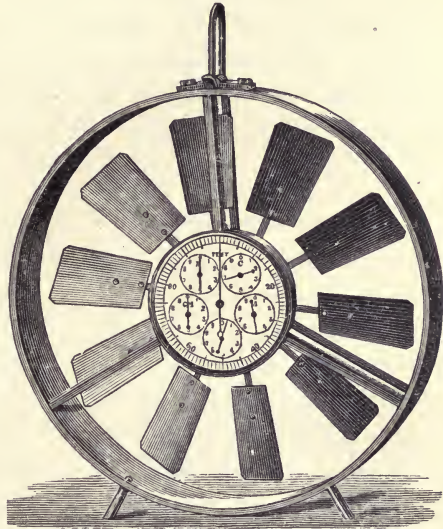

FIG. 16.—Biram's Portable Anemometer.

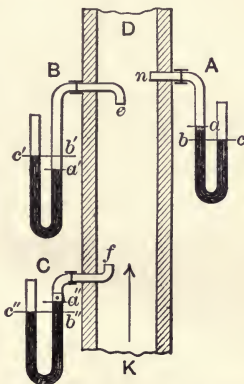

FIG. 17.—U-shaped Water Gauge.

at *f*, the current will cause the fluid in the manometer to vary in the opposite direction, but probably by an indefinite amount.

By finding the pressure head as at *A*, and the resultant pressure and velocity readings as at *B*, we can determine by simple subtraction the manometer reading corresponding to the velocity head; this multiplied by ratio of specific gravity *r* of the manometer liquid and the air will give the velocity head. From this the velocity can be computed from the formula

$$v = \sqrt{2ghr.}$$

By connecting one side of the manometer to the tube facing the current and the other to the tube entering at right angles, as shown in Fig. 18, the reading will show directly the equivalent velocity head.

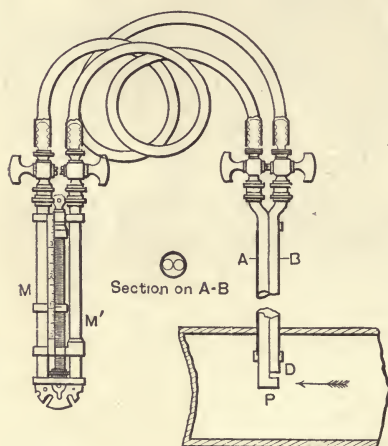

FIG. 18.—Pitot Tube.

When water and dry air under a pressure of 29.92 inches of mercury are the two fluids considered the ratio of weights, *r*, is 773 at 32° F., 815 at 60° F., and 905 at 120° F., from which it follows that 1 inch of water would balance a column of dry air 64.5 feet high at 32° F., 67.9 feet high at 60° F., and 75 feet high at 120° F.

In case water is used in the manometer and the gas is air at a temperature of 60° *r* will equal 815. Hence the velocity *v* will equal $230\sqrt{h}$, in which *h* is in feet, and will equal $66.7\sqrt{h'}$ when *h'* is in inches of water. For any other temperature than 60 degrees this quantity must be multiplied by the square root of $460 + \text{the temperature}$, and then divided by $\sqrt{520}$. Practically for air the velocity will equal 230 times the square root of the difference in the heights of the columns.

The Pitot tube should be located in a straight length of the air piping or passage, free of any dampers or other partial obstructions, with a length of at least ten diameters upstream

and four diameters downstream from the Pitot tube. It is necessary to take a traverse across the pipe to get the accurate velocity, as the velocity of the air varies across the pipe from a variety of causes and in no regular manner, such as the eddying and swirling of the air, the retarding of the air next to the walls by friction, and the distortion due to the space occupied by the Pitot tube. The static head does not vary appreciably across the pipe. To make a traverse of any shaped pipe, the cross-section area should be divided mathematically into five equal concentric areas. Then the Pitot tube should be moved across the pipe taking readings in the middle points

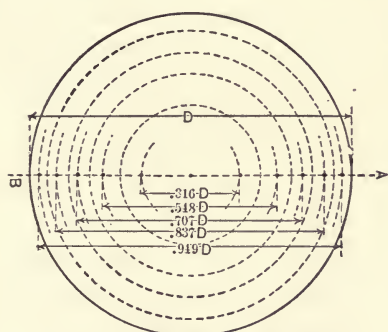

FIG. 19.—Ten-point Method.

of these rings on both sides, giving what is sometimes called the ten-point method. Fig. 19 gives this method for a circular pipe. Where the air velocities are low the average velocity will differ but little from the velocity in the centre of the pipe. The area occupied by the Pitot tube should be subtracted from the pipe area in computing the volume of air discharged.

The velocity of air may also be computed by the heating effects, provided the amount of heat is accurately measured and the increase in temperature of the air be known. The specific heat of air is 0.238, hence the heat sufficient to warm one pound of water would heat $(1/.238) = 4.2$ pounds of air. This at 60 degrees would correspond to about 55 cubic feet. By consulting Table X the volume heated 1 degree by 1 heat-unit at any other temperature can be found.

The total number of cubic feet of air heated would be equal to the total number of heat-units absorbed divided by the number of degrees the air is heated, and this result multiplied by the volume of one pound divided by the specific heat (this computation is simplified by the use of Table X). Having

the total amount of air in a given time, the velocity can be obtained by dividing by the area of the passage.

NOTE.—In the shape of a formula these results are as follows: Let T equal temperature of discharged air, t that of entering air; H equal the total number of heat-units given off per unit of time; V equal the number of cubic feet of air heated 1 degree by 1 heat-unit (see Table X); A equal area of passage in square feet; v equal velocity for the same time that the total number of heat-units are taken. Then we shall have

$$C = \text{Total amount of air in cu. ft.} = \frac{HV}{T-t}; \quad v = \frac{C}{A}.$$

33. Calibration of the Anemometer.—The anemometer is a delicate instrument, not being adapted for velocities in excess of 1200 feet per minute, and its continued use is liable to increase

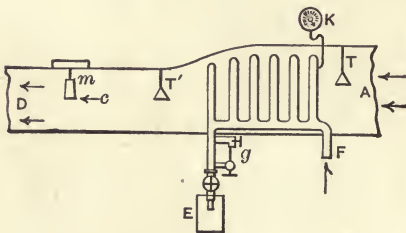

FIG. 20.

the friction of its working parts and cause variation in the constants a and b ; for this reason it should be calibrated from time to time. The method usually prescribed for calibrating an anemometer is to fix it to a revolving arm of considerable length and swing it through still air a known number of revolutions corresponding to a certain distance of travel. The error of the instrument is determined by comparing the reading of the instrument with the distance passed through by the anemometer. Another method of calibration is by comparing the reading of the anemometer with air moving at a known velocity. The velocity of air moving through a duct of a given cross-section can be computed by measuring the amount of heat required to warm the air through a certain number of degrees, as already explained and as illustrated in the diagram Fig. 20. A duct, A, B, C, D , is supplied with air by means of a blower located in some convenient position. A steam-coil is placed in one end of this duct, as at F , the ane-

mometer to be tested is placed beyond the coil at some point, as m , and arranged so that successive readings may be taken in all portions of the cross-section; the starting and stopping mechanism is arranged so as to be operated from the outside of the box. One or more thermometers are located at TT' , thus permitting the measurement of the difference in temperature of the air. Dry steam is supplied the heater at F , and the water of condensation is drawn off at E , being maintained at a constant level by aid of the gauge-glass g . Every pound of steam at known pressure and quality contains an amount of heat which is accurately obtained from the steam-table, so that means are provided for computing the heat-units given off. As this must all have been used in warming the air through a temperature $T' - T$, we have means of computing the weight, volume, and velocity of air as explained.

The constants of anemometers can also be obtained by direct comparison with instruments having known constants and used in a similar manner.

The velocity of air flowing through a duct of given size may also be determined by the use of large measuring-tanks which are alternately filled and emptied with air in such a manner as to give accurately the volume of air discharged. As an illustration, an arrangement similar to that shown in the diagram, Fig. 21, could be used. F and G are two tanks like gasometers, which may be alternately filled and emptied, being raised by ropes attached to drums, D and E , which are operated by friction-clutches, A and B , which are thrown into

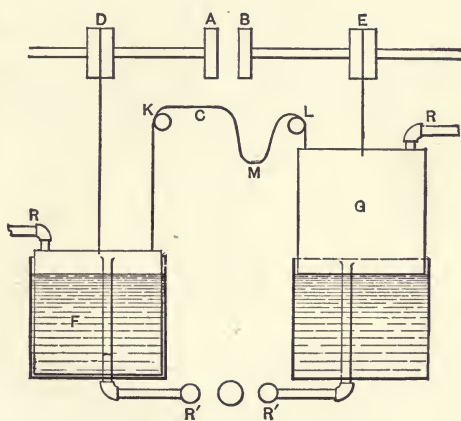

FIG. 21.

action automatically and so as to raise the tanks alternately. R and R are rubber check-valves opening to permit flow into the tanks; R' and R' , checks which open to permit flow from the tanks. The volume of air discharged in a given time divided by the area of cross-section of the discharge duct will give the velocity.

In 1884 the Prussian Mining Commission investigated, by means of a large gas-holder which contained over 70,000 cubic feet, the methods of measuring air, with the following results:

(1) That the anemometers calibrated by swinging in still air show errors which range between 7 and 13 per cent, the anemometers always reading high.

(2) A Pitot tube may be used with accuracy for measuring the velocity of air, the formula being as follows:

Velocity of air in meters per second at zero centigrade

$$= \sqrt{\frac{2gh}{d}}$$

$$= 4.265 \sqrt{\frac{\text{head of water in mm.}}{\text{density of air}}}$$

This reduced to the average temperature and density of the air becomes $4\sqrt{h}$, h being the head in millimeters of water. The velocity in feet per second reduced to average temperature and density of the air becomes $v=66.7\sqrt{h}$, h being the head in inches of water.

(3) The fall in pressure between one side and the other of a thin orifice may be used. If H is the difference in pressure represented by feet of air, the formula for flow would be

$$Q=CA\sqrt{gH},$$

in which A is the area and C a coefficient which equals 0.64 for circular orifices and 0.61 for square orifices.

(4) The resistance due to friction as obtained in a cast-iron pipe 14.3 inches in diameter was found to vary as the

diameter of the pipe affected by the exponent 1.37, as the square of the velocity and as the density affected by the exponent $2/3$.

The general results of the tests show that the anemometer gives an exaggerated value of the air discharged by a fan, especially when standardized by rotating in still air. In computing the volume of air delivered, the error in the result would be directly proportional to the error of the anemometer, which, as shown by the previous tests, averages not far from 10 per cent high. In practice the area over which velocity is to be measured should be divided into a number of equal parts and the anemometer allowed to remain in front of each part a constant interval of time. Twelve openings and five seconds each give very good satisfaction.

34. The Effect of Heat in Producing Motion of Air.—The effect of heat is to expand air in

proportion to its absolute temperature for each degree of increase. If a column of air be heated it will expand and occupy more space. In other words, a given bulk will have less weight as its temperature is increased; which has the effect of producing lack of equilibrium, and the warmer air will be replaced by colder air, causing a velocity which

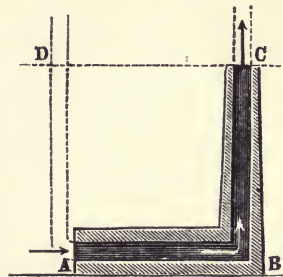

FIG. 22.

is in proportion to the change in temperature. The case is analogous to the action of two fluids in the branches of a U-tube, Fig. 22, *DABC*—the heavier fluid in *DA* and the lighter fluid in *BC*. The action of gravity causes the heavier fluid to flow downward and displace the lighter fluid, causing an upward motion in *BC*. If a column of the lighter fluid with height greater than *BC* balances the weight of the heavier fluid *DA*, the flow which is produced will take place with a head equal to the difference in height of *AD*, and an equal weight of the lighter fluid. The flow will take place in the same manner whether the heavier fluid be confined in a tube arranged as in the dotted lines, Fig. 22, or whether it be drawn from a

large vessel, or from the surrounding air. Let the head which produced the draught be equal to h' , the height of the flue BC be h ; let t be the temperature of the outside air or heavier fluid and t' that of the lighter fluid above 0° ; a the coefficient of expansion, which for one degree of temperature of air will be $\frac{1}{481}$. Since the expansion is directly proportional to the increase in temperature, we shall have in general:

$$\frac{h}{1+at} = \frac{h+h'}{1+at'} \quad \text{from which} \quad h' = \frac{ha(t'-t)}{1+at}$$

By substituting for a its value $\frac{1}{481}$ we shall have the following for the head producing the flow in case air is the moving fluid:

$$h' = \frac{h(t'-t)}{461(1+\frac{1}{481}t)} = \frac{h(t'-t)}{461+t}$$

$461+t$ is the absolute temperature of the air.

The velocity is equal to the square root of twice the force of gravity, 32.16, into the head which produces the flow, as follows:

$$V = \sqrt{2gh'} = \sqrt{\frac{2gha(t'-t)}{1+at}} = \sqrt{\frac{2gh(t'-t)}{461+t}} = 8\sqrt{\frac{h(t'-t)}{461+t}}, \quad \text{nearly.}$$

The velocities given above, multiplied by 60 and by the area of cross-section, will give the discharge in cubic feet per minute. Mr. Alfred R. Wolff takes the actual discharge as 0.5 of that given by the formula, so that the actual discharge in cubic feet per minute would be, with 50 per cent allowance for friction,

$$Q = 240F\sqrt{\frac{h(t'-t)}{461+t}},$$

in which F equals the area of cross-section of the flue in square feet. Table XVI, appendix, gives the velocity in feet per second for various temperatures and heights computed from the formula page 52.

Multiplying the figures in Table XVI by 3600 gives the cubic feet of air discharged per hour per square foot of cross-section. Multiplying by 60 gives the discharge in cubic feet per minute, with no allowance for friction.

In order to find the work performed by the heat applied to moving the air the following calculation may be made:

Let R equal the total heat used to warm the air in heat-units, c the specific heat of air (equals 0.238), T the absolute temperature = $461 + t$, P the total weight of air passing from the chimney in a given time. As the weight of air multiplied by its specific heat and also by the difference in temperature is equal to the total heat supplied in heat-units, we have

$$R = Pc(t' - t),$$

from which, by transposing, we have

$$P = \frac{R}{c(t' - t)}. \quad \dots \dots \dots (a)$$

The mechanical work in every case is to be found by multiplying the weight of discharge by the square of the velocity divided by twice the accelerating force due to gravity ($2g$). From a preceding formula,

$$\frac{V^2}{2g} = \frac{h(t' - t)}{T}. \quad \dots \dots \dots (b)$$

The product of the second members of the last two equations gives the mechanical work in foot-pounds required to discharge the air, neglecting friction, as follows:

$$W_a = \frac{PV^2}{2g} = \frac{Rh}{cT}. \quad \dots \dots \dots (c)$$

Had the chimney been perfect, all the heat would have been converted into mechanical work, in which case we should have had 778 foot-pounds of work for every unit of heat expended, or, as a condition of perfect utilization of heat,

$$W_p = 778R. \quad \dots \dots \dots (d)$$

The efficiency E of the chimney must be the quotient obtained by dividing equation (c) by (d):

$$E = \frac{W_a}{W_p} = \frac{h}{778cT} = \frac{h}{185.2T}$$

When the temperature of the outside air is 60 degrees the absolute temperature T is 520, and for that temperature the efficiency

$$E = \frac{h}{96.304}$$

From this discussion it is noted that by the application of a given amount of heat the useful work done in discharging air from a chimney varies directly as the height of the chimney and inversely as the absolute temperature of the outside air; when the outside air is 60 degrees the chimney would need to be 96,304 feet in height in order to convert all the heat applied into useful work.

The preceding discussion relates to the discharge of air from the chimney. The velocity of air entering the chimney will be equal to the velocity of discharge multiplied by the ratio of absolute temperatures of outside and entering air. If V' represent the admission velocity, T' and T the absolute temperatures, we shall have

$$V' = \frac{VT}{T'} = \frac{T}{T'} \sqrt{\frac{2gh(T'-T)}{T}},$$

from which

$$\frac{V^2}{2g} = \frac{hT}{T'^2}(T'-T).$$

The work in foot-pounds per second will be found by multiplying the above value by the value of P as follows:

$$W_c = \frac{PV'^2}{2g} = \frac{RhT}{cT'^2}. \quad \dots \dots \dots (e)$$

The above equation gives the useful work performed in delivery of air into the chimney. The efficiency for this condition is determined by dividing formula (e) by formula (d), in which case we have

$$E_c = \frac{W_c}{W_p} = \frac{hT}{778cT'^2}. \quad \dots \dots \dots (f)$$

In order to utilize all the heat in the mechanical work of moving the air, the height for this case will need to be somewhat greater than for the preceding one. It will be noted, however, that the efficiency is exceedingly low for any chimney of ordinary height, whether we consider the case of supplying air to the chimney or of delivering air from the chimney.

35. Distribution of Air.—The most difficult problem connected with ventilation is that relating to the uniform distribution of air; it is comparatively easy to introduce a definite volume of air into a given space in any time desired, but it is

exceedingly difficult to prevent the formation of air-currents and eddies which interfere with efficient ventilation. The air for ventilation should be uniformly distributed throughout the room; it also should be warmed sufficiently to prevent a sensation of chilliness on the part of the occupants; in many instances all the heat needed for warming a room is obtained from the air for ventilation.

It is found from experience that if the velocity of the entering air is very great it produces a disagreeable current, which is generally known as a draught, and is more or less dangerous to health. The following table from Loomis' Meteorology gives the relation between the velocity and the sensation produced:

RELATION BETWEEN VELOCITY AND FORCE OF AIR.

Sensation.	Velocity.		Pressure, Lbs. per Sq. Ft.
	Miles per Hour.	Feet per Second.	
Just perceptible.....	2	2.92	0.02
Gently pleasant.....	4	5.85	0.08
Pleasant brisk.....	12.5	18.3	0.750
Very brisk.....	25	36.6	3.0
High wind.....	35	51.5	6
Very high wind.....	45	66	10
Strong gale.....	60	88	18
Violent gale.....	70	105	24
Hurricane.....	80	117	31
Most violent hurricane.....	100	146	49

It is quite generally agreed that the velocity of the entering air should not exceed four to six feet per second unless it can be introduced in such a position as to make an insensible current. The table which has just been given, while only approximately correct, gives a very fair idea of the sensations produced by air-currents of different velocities and pressures, and is useful in fixing limiting values.

The most effective location for the air-inlet is probably near the ceiling of a room, when the height does not exceed ten or twelve feet. The advantages of introducing warm air at or

near the top of the room are: first, the warmer air tends to rise and hence spreads uniformly under the ceiling; second, it gradually displaces other air, and the room becomes filled with pure air without sensible currents or draughts; third, the cooler air sinks to the bottom and can be taken off by a ventilating-shaft. So far as the system introduces air at the top of a room it is a forced distribution, and produces better results than other methods. When the inlet is placed in the floor it is a receptacle for dust from the room, and a lodging- and breeding-place for microbe organisms. In the ventilation of large and high rooms it is usually necessary to introduce the air at the lower part and discharge from the ceiling to obtain satisfactory results.

Some experiments were made by Mr. Warren R. Briggs, of Bridgeport, Conn., on the subject of the proper method of introducing pure air into rooms and the best location for the inlet and outlet. The experiments were conducted with a model having about one-sixth of the capacity of a schoolroom to which the perfected system was to be applied. The movements of the air in the model of the building were made visible by mingling the inflowing air stream with smoke, which rendered all the changes undergone by it in its passage apparent to the eye.

The results of the experiments are shown graphically in the six sketches, Figs. 23 to 28. In each case the distribution of the fresh air is indicated by the curved lines of shading. A study of these sketches is very suggestive, as it indicates the best results for small rooms when the inlet is on the side near the top, and the outlet is in the bottom and near the centre of the room. The tendency of the entering air to form air-currents or draughts, which in some instances tend to pass out without perfect diffusion, is well shown. This tendency is less as the velocity of the entering air is reduced, and we probably get nearly perfect diffusion in every case where the outlet is well below that of the inlet, provided the velocity of the entering air is small—less than 4 feet per second.

36. The Outlet for Air.—The outlet for air should be as near the bottom of a room (except in large rooms) as possible,

and it should be connected with a flue of ample size maintained at a temperature higher than that of the surrounding air, unless

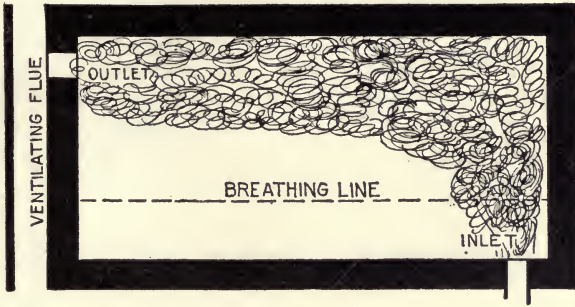

FIG. 23.—Air Introduced at Bottom, Discharged at Top.

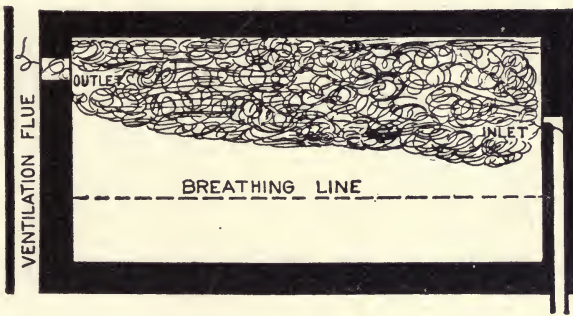

FIG. 24.—Air Introduced on Side, Discharged at Top.

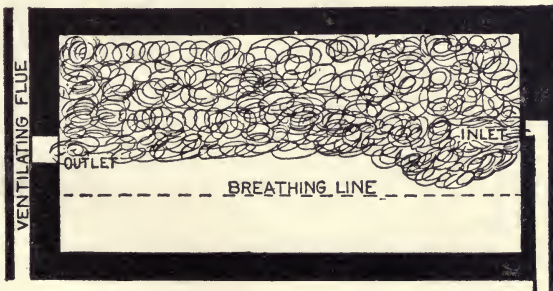

FIG. 25.—Air Introduced on Side, Discharged on Opposite Side.

forced circulation is in use, in which case the excess of pressure in a room will produce the required circulation. If the temperature in a room is higher than that of the surrounding air, and

if the flue leading to the outside air can be kept from cooling and is of ample size and well proportioned, the amount of air

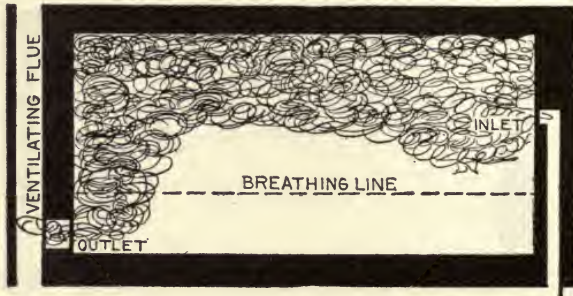

FIG. 26.—Air Admitted on Side, Discharged near Bottom.

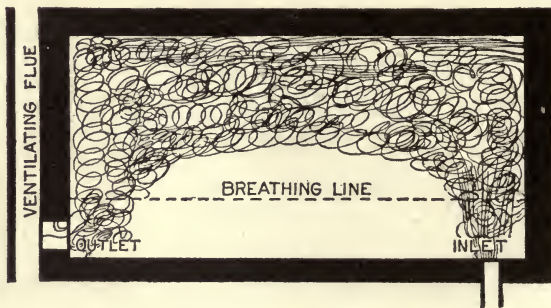

FIG. 27.—Air Admitted at Bottom, Discharged near Bottom.

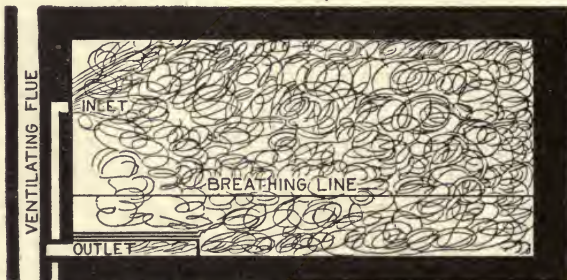

FIG. 28.—Inlet near Top, Discharge near Bottom.

which will be discharged will be given quite accurately by the tables referred to. These conditions should lead us to locate vent-flues on the inside walls of a house or building, and where

they will be kept as warm as possible by the surrounding bodies. If for any reason the temperature in the flue becomes lower than that of the surrounding air the current will move in a reverse direction, and the ventilation system will be obstructed. Vent-flues built into the sides of the chimneys are efficient because they employ the waste heat from the furnace gases to promote the flow of the air.

The conditions as to size of the outlet register are the same as those for the inlet; the register should be of ample size, the opening should be gradually contracted into the flue, and every precaution should be taken to prevent friction losses.

37. Ventilation-flues.—The size of ventilation-flue will depend to a great extent upon the character of system adopted, but will in all cases be computed as previously explained. A practical system of ventilation generally is intimately connected with a system of heating, and the various problems relating to the size and construction of ventilating ducts will be considered later. In general the ducts should be of such an area as not to require a high velocity, since friction is to a great extent due to this cause.

The size of the ventilating duct can be computed, knowing its rise, length, and the difference of temperature, by dividing the total amount to be discharged by the amount flowing through one square foot of area of the flue under the same conditions. (See Table XVI, Appendix.)

In introducing heated air into a room, it is very much better to bring in a large volume heated but slightly above the required temperature of the room rather than a small volume at an excessively high temperature. If the temperature of the air entering be 25 degrees above that of the air in the room, the discharge in a flue one square foot in area would be, in cubic feet per second, 5.7 for a height of 10 feet, 9.0 for a height of 25 feet, 11.4 for a height of 40 feet, if no loss from friction, as given in Table XVI. The actual discharge can be safely taken as 50 to 60 per cent of the theoretical.

As the difference of temperature of the air in the room and outside may usually be taken as 20°, the velocity in feet

per second for heights corresponding to the distance of floor to roof in a building of 3 stories would be about as follows: 1st floor, 5; 2d floor, 4; attic or top floor, 3—or about one-half the theoretical. For air entering, the order of the velocities would be reversed on the particular floors. The area of the flue would be found by dividing the total air required per second by these numbers.

38. Summary of Problems of Ventilation.—From the foregoing considerations it is to be noted that the practical problems of ventilation require the introduction, first, of thirty or more cubic feet of air per minute for each occupant of the room, and in addition sufficient air to provide perfect combustion for gas-jets, candles, etc., which are discharging the products of combustion directly into the room. Second, the problem requires the fresh air to be introduced in such a manner as to make no sensible air-currents, and to be in such quantities as to keep the standard of contamination below a certain amount. This problem can be solved by either, first, moving the air by heat, in which case the motive force is very feeble and likely to be counteracted by winds and adverse conditions; second, by moving the air by fans or blowers, in which case the circulation is positive, and not influenced by other conditions.

The methods for meeting these conditions will be given under appropriate heads in later articles.

It will generally be found much more convenient to estimate the air required, not in cubic feet per minute for each person, but by the number of times the air in the room will need to be changed per hour. If the number of people who occupy a room be known, and each one requires 30 cubic feet of air per minute or 1800 cubic feet per hour, one can easily compute the number of times the air in a room must be changed to meet this requirement. Thus a room containing 1800 cubic feet, in which five people might be expected to stay, would need to have the air changed five times per hour in order to supply the required amount for ventilation purposes.

By consulting Table X, Properties of Air, it will be seen that one heat-unit contains sufficient heat to warm 55 cubic

feet of air, at average pressures and temperatures, one degree; so that practically to find the number of heat-units required for warming the air one degree we must simply divide by 55 the number of cubic feet to be supplied. If the cubic contents of the room is to be changed from five to ten times per hour, we can very readily make the necessary computations by knowing the volume of the room.

Even in the case of direct heating, where no air is purposely supplied for ventilation, there will be a change by diffusion of the air in a room that the writer has found practically met by an allowance equal to one to three changes in the cubic contents per hour. The heater must supply heat for ventilation purposes in addition to that transmitted by the walls.

The number of times that air will need to be changed per minute in a given room will depend upon its size as compared with the number of occupants. If we take the smallest size of rooms, in which we allow only 400 cubic feet of space per occupant, a supply of 30 cubic feet per minute would change the air in this space in $13\frac{1}{3}$ minutes, or at the rate of $4\frac{1}{2}$ times per hour. If 600 cubic feet are supplied per occupant, the air of the room would be changed once in 20 minutes, or at the rate of 3 times per hour. The following table may be of practical value, as it shows the number of changes per hour required to supply each person with 30 cubic feet per minute when the space supplied is as given in the table:

Space to Each Person. Cubic Feet.	Number of Times Air to be Changed per Hour.
100.....	18
200.....	9
300.....	6
400.....	4.5
500.....	3.6
600.....	3
700.....	2.6
800.....	2.25
900.....	2

CHAPTER III.

AMOUNT OF HEAT REQUIRED FOR WARMING.

39. Loss of Heat from Buildings.—Heat is required to supply the loss due to the radiation and conduction of heat from windows and walls, and to warm the air required for ventilation. The amount of heat required for these various purposes will depend largely upon the construction of the building and the air needed for ventilation purposes.

This question was investigated experimentally by Péclet, and it also received attention from Tredgold at about the same time, and has been more recently investigated by the German Government. Péclet's investigations were carried out with extreme care, and reduced to general laws. He divides the loss into two parts: first, that from the windows; second, that lost by conduction through the walls. He considers the loss in each case from the exterior of the wall as due in part to radiation and in part to convection.

40. Loss of Heat from Windows.—The values which Péclet found for glass, reduced to English measures, were as follows (see Art. 44 for full translation): *

LOSS PER SQUARE FOOT PER DEGREE DIFFERENCE OF TEMPERATURE FAHR. PER HOUR FOR WINDOWS.

Height of Window.	3 ft. 3 in.	6 ft. 7 in.	10 ft.	13 ft. 3 in.	16 ft. 3 in.
Loss in B. T. U. per square foot per degree difference of temperature.	0.98	0.945	0.93	0.92	0.91

* The general formula which Péclet gives as expressing this loss is as follows: $M = \frac{1}{2}(T - T')(K + K')$, in which T equals temperature of the room, θ = temperature of the air, K = coefficient loss for radiation, K' = coefficient loss for con-

AMOUNT OF HEAT IN BRITISH THERMAL UNITS PASSING THROUGH WALLS PER SQUARE FOOT OF AREA PER DEGREE DIFFERENCE OF TEMPERATURE PER HOUR.

Thickness, Inches.	Single Wall.		Wall with Air-space.
	Brick or Stone.	Wood.*	Brick or Stone.
4	0.43	0.12	0.36
8	0.37	0.065	0.30
12	0.32	0.045	0.25
16	0.28	0.033	0.21
18	0.26	0.031	0.19
20	0.25	0.03	0.18
24	0.24	0.029	0.17
28	0.22	0.027	0.15
32	0.21	0.025	0.13
36	0.20	0.020	0.12
40	0.18	0.018	0.10

* This experiment applies to solid wood; it is evidently of little use when applied to wooden buildings, since these buildings generally present so many opportunities for loss of heat through crevices.

For multiple glass the above numbers are to be multiplied by the following coefficients:

$$\text{Double } \frac{2}{3}, \quad \text{Triple } \frac{1}{2}, \quad \text{Quadruple } \frac{2}{5}, \quad n \text{ layers } \frac{2}{1+n}.$$

The coefficients given above do not differ greatly from unity for each square foot of single glass and two-thirds as much for each square foot of double glass per degree difference of temperature.

Mr. Alfred R. Wolff, M.E., in a recent pamphlet gives coefficients adopted by the German Government, as follows:

Heat transmission in B.T.U. per square foot per hour, per degree difference of temperature: Single window, 1.9; single skylight, 1.118; double window, 0.518; double skylight, 0.621.

vection. K' varies with the height. K is constant, and in all cases equal to 291 when the temperature is measured by a centigrade thermometer. The values of the coefficients K and K' were determined by experiment.

These coefficients are to be increased, as explained in the next article, for exposed buildings.

41. **Loss of Heat from Walls of Buildings.**—The loss of heat depends upon the material used, its thickness, the number of layers, the difference of temperature between outside and inside surfaces, and air exposure.

The problem is one very difficult of theoretical solution, and we depend principally for our knowledge on the results of experiments.

The table on the preceding page was computed from formulæ given by Péclet and reduced to English measures by the writer.*

Mr. Alfred R. Wolff, in a lecture before the Franklin Institute,† gives coefficients for loss of heat from walls of various thicknesses, which he translated from and transformed into American units from tables prescribed by the German Government as follows:

FOR EACH SQUARE FOOT OF BRICK WALL.

Thickness of Wall =	4"	8"	12"	16"	20"	24"	28"	32"	36"	40"
Loss of heat per square foot per hour per degree difference of temperature	0.68	0.46	0.32	0.26	0.23	0.20	0.174	0.15	0.129	0.115

1 square foot, wooden beam, planked over or ceiled	{ as flooring..... $K=0.083$ { as ceiling..... $K=0.104$
1 square foot, fireproof construction, floored over	
1 square foot, single window	{ as flooring..... $K=0.124$ { as ceiling..... $K=0.145$
1 square foot, single skylight	$K=1.09$
1 square foot, double window	$K=1.118$
1 square foot, double skylight	$K=0.518$
1 square foot, door	$K=0.621$
1 square foot, door	$K=0.414$

Prof. J. H. Kinealy in a recent book, "Formulas and Tables for Heating," has given a translation from the German work by Recknagel and Rietschel of the values adopted for

* $M=CQ(T-\theta) \div (2C+Qe)$, in which $Q=K+K'$, e =thickness, and C =coefficient of conduction. See Table XVII. See also Art. 44 for full explanation.

† Lecture on Heating of Large Buildings, published in pamphlet form.

AMOUNT OF HEAT REQUIRED FOR WARMING. 67

computing loss of heat from buildings, which results are somewhat nearer the results obtained by Péclet than those given by Wolff. The following tables are taken from that work, the heat expressed in B.T.U. per square foot per hour per degree difference of temperature being represented by *K*:

	Coefficient of Heat-loss, K.		Coefficient of Heat-loss, K.
Single window.....	1.03	Doors.....	0.410
Double window.....	0.472	Plaster 1.6 to 2.6 in. thick.....	0.615
Single skylight.....	1.090	Plaster 2.6 to 3.2 in. thick.....	0.492
Double skylight.....	0.492		

LOSS OF HEAT THROUGH BRICK WALLS, BRICKS 8¼×4×2 INCHES, LAID WITH MORTAR JOINTS ⅜ INCH THICK.

Thickness of Wall.	Outside Walls.		Inside Wall, Both Sides Plastered.	With Additional Stone Face.			With Air-space of 2.4 Inches Plastered.
	No Plaster.	One Side Plastered.		4 Inches Thick.	8 Inches Thick.	12 Inches Thick.	
½ brick	0.52	0.49	0.43				
1 “	.37	.36	.33	0.31	0.29	0.26	0.25
1½ bricks	.29	.28	.26	.25	.23	.21	.21
2 “	.25	.2422	.20	.19	.19
2½ “	.22	.2119	.18	.17	.16
3 “	.19	.1817	.16	.15	.14
3½ “	.16	.1615	.14	.13	.13
4 “	.14	.1412
4½ “	.12	.12

LOSS OF HEAT THROUGH STONE WALLS.

Total Thickness, Inches.	Sandstone, K.	Limestone, K.	Total Thickness, Inches.	Sandstone, K.	Limestone, K.
12	0.45	0.49	32	0.26	0.28
16	.39	.43	36	.24	.26
20	.35	.38	40	.22	.24
24	.31	.35	44	.21	.23
28	.28	.31	48	.19	.21

These coefficients are to be increased respectively as follows, as stated by Rietschel:

Ten per cent where the exposure is a northerly one and the winds are to be counted on as important factors.

Ten per cent when the building is heated during the daytime only, and the location of the building is not an exposed one.

Thirty per cent when the building is heated during the daytime only, and the location of the building is exposed.

Fifty per cent when the building is heated during the winter months intermittently, with long intervals (say days or weeks) of non-heating.

Mr. Wolff has arranged the results in a graphical form (Fig. 29), so that the values for heat losses can be obtained by inspection.

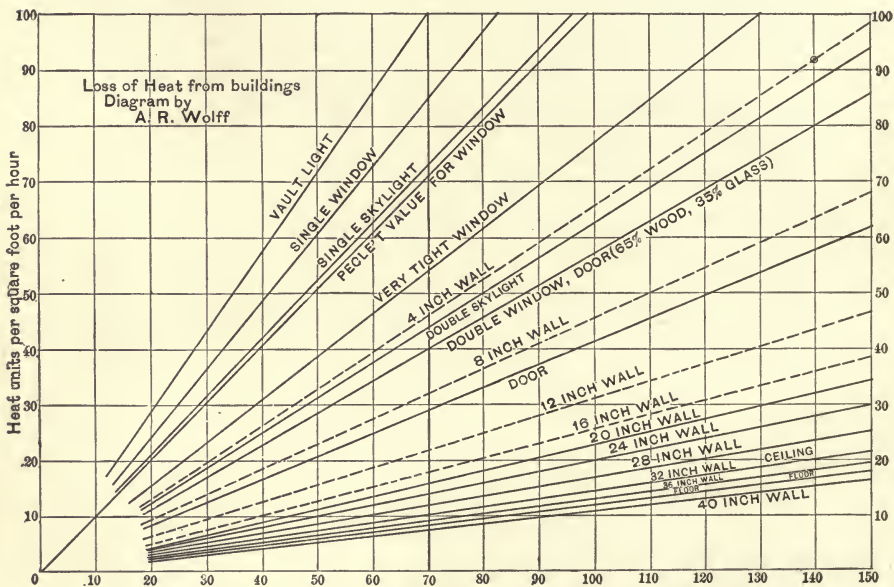

FIG. 29.—Wolff's Diagram of Loss of Heat from Walls.

In this diagram distance in horizontal direction is the required difference in temperature between that of the room and the outside air; the various diagonal lines correspond to the different radiating surfaces of the building, floors, ceiling, doors, windows, etc. The heat transmitted per square foot of surface per hour is given by the numbers in the vertical column.

The German Government requires computations to be made on the following assumed lowest temperatures: *

* Lecture by Alfred Wolff before Franklin Institute.

External temperature.....	4° Fahr.
Assumed lowest temperature of non-heated cellar and other portions of building permanently non-heated.....	32°
Vestibules, corridors, etc., non-heated, and at frequent intervals in direct contact with external air.....	23°
Air-spaces between roof and ceiling of rooms,	{ Metal and slate roofs... 14° Denser methods of roofing, such as brick, concrete, etc..... 23°

As the temperature to be attained in rooms of various kinds, the German Government prescribes for:

Stores and dwellings.....	68° Fahr.
Halls, auditoriums, etc.....	64°
Corridors, staircase, halls, etc.....	54°
Prisons, occupied by day and night.....	64°

In making calculations for heat losses for buildings in America the minimum external temperature is usually assumed as zero F., and the required temperature in stores and dwellings as 70 degrees. In many portions of the country the corridors, staircase, halls, etc., are required to be from 65° to 68°; while in other portions of the country the halls are required to be as warm as the living-rooms. In the preceding computations no allowance has been made for the heat carried off in the process of ventilation, nor for that supplied from the bodies of people in the room, gas, electric lights, etc.

42. Heat Required for Purposes of Ventilation.—In addition to the loss of heat through walls of buildings, more or less heat will be carried off by the air which escapes from various cracks and crevices.

By consulting Table X it will be seen that, for ordinary temperatures and pressures, 55 cubic * feet of air will absorb one heat-unit in being warmed one degree F., and hence can be considered the equivalent of one pound of water.

The heat-units required for ventilation can then be found by multiplying the number of cubic feet of air by the differ-

* This quantity varies somewhat with barometric pressure and temperature.

ence of temperature between warm and outside air, and dividing by 55,* which is essentially the same as multiplying by 0.02.

43. Total Heat Required.—By referring to the values for heat losses given by Wolff and Péclet, it will be noted that a fair average value would be 1 heat-unit for glass and 0.25 heat-unit for walls per degree difference of temperature per square foot per hour. Usually we can neglect all inside walls, floors, and ceilings, and consider with sufficient accuracy only the exposed or outside walls.

For direct heating of residences it seems necessary to consider the air of halls changed 3 times per hour, that of rooms on first floor 2 times per hour, and that of rooms on the upper floors once per hour, to account for changes taking place by diffusion.

If C represent cubic contents of room, W the area of exposed wall surface, G the area of glass, n the number of times air is changed per hour, t the difference of temperature between air in room and outside, we have, as a general formula for heat required, in heat-units per hour,

$$h = (0.02nC + G + \frac{1}{4}W)t.$$

By representing the interchange or leakage of air by l , and considering this a function of the exposed surface, the formula for the heat required becomes

$$h = l(G + \frac{1}{4}W)t.$$

l should have a value for different conditions varying from $\frac{1}{3}$ to 2.

It seems necessary to remark here that the coefficients obtained by Péclet † are accurate only under the conditions governing his experiments. A translation from Péclet's work

* If C =cubic contents of room, n the number of times air is changed, t the difference of temperature, h the heat-units for ventilation, $h = \frac{nC}{55} = 0.02nC$, nearly.

† *Traité de la Chaleur*, Paris.

is given at the end of this chapter, which indicates that in some cases there is a decrease in the heat transmission per unit of area for increase in height, and also that the total loss of heat from a building is greater per unit of area when one side is exposed than when all sides are exposed, because of reciprocal radiation. Practically it is doubted that these last statements are often correct, because the conditions which usually apply are different from those assumed in his computations, but otherwise the results of Péclet's investigations will be found accurate and reliable.

In the practical application of the formula given on the preceding page the author considers W as the total exposed wall surface, including any windows or doors which it may contain. This increases the amount obtained by the computation somewhat over that required by theoretical considerations, which is desirable in view of the fact that if any errors are made it is better to make them in the direction of excess requirement than otherwise. In computing the loss of heat in rooms which are separated from unheated spaces by partitions, the difference in temperature between that in the heated room and that in the unheated space should be considered instead of the difference in temperature between inside and outside air. As an illustration, in the case of rooms with an attic overhead, the ceiling should be considered as exposed wall surface with a difference of temperature equal to that between the attic and the outside air; for such cases the author has found that the requirements are satisfied if the effect of the ceiling surface is considered as one-third of that of the outside wall surface.

Practically there is little or no difference in the amount of heat required to warm a wooden or a brick building, which is due to the fact that air-spaces lined with heavy building-paper make the heat losses in the one practically as small as in the other. There is, however, a great difference in the amount of heat transmitted through the walls of different buildings, due to good or bad construction or to use of inferior or superior materials; this fact renders any elaborate formula for this

purpose abortive. The best that can be expected of any rule is agreement with the average condition.

The author in two cases measured the loss of heat, with the following results.* In the first case a room on the second floor with exposed side and end had 246 sq. ft. of wall surface and 96 sq. ft. of window surface. When the air in the room was 28 degrees above that outside the loss was 4247 B.T.U. per hour, and when 27 degrees above, was 4240 B.T.U. per hour. To supply loss of heat by the rule stated would require respectively 4410 and 4253 B.T.U. per hour, the error varying from a fraction of one per cent to nearly five per cent. In the second case a test was made in the N. Y. State Veterinary College; this showed that to maintain the room 31 degrees warmer than the outside air 16,000 B.T.U. were required per minute, of which 39 per cent escaped in the ventilation-flues, and 61 per cent passed by conduction through the walls and windows. The building was exposed on all sides, was 3 stories in height, had 9281 sq. ft. of glass and 31,644 sq. ft. of exposed wall surface. By the rule quoted the building loss should be 532,952 B.T.U. per hour. The actual loss by experiment was 9120 B.T.U. per minute or 547,200 B.T.U. per hour, which is within two per cent of that called for by the rule. In this case the building was of brick, the thickness of walls varied from 24 to 16 inches, and the windows had single glass.

The above experiments, which were made on a large scale and on actual buildings, indicate the substantial accuracy of the rule quoted.

Data regarding the number of changes of air which take place per hour under different conditions of direct heating in buildings are still very deficient. The following seems to be reliable:

	Number of Changes of Air per Hour.
Residence heating.....	Halls, 3; sitting-room, etc., 2; sleeping-rooms, 1.
Stores.....	First floor, 2 to 3; second floor, 1½ to 2.
Offices.....	First floor, 2 to 2½; second floor, 1½ to 2.
Churches and public assembly rooms,	$\frac{3}{4}$ to 2.
Large rooms with small exposure,	$\frac{1}{2}$ to 1.

* Transactions of American Society of Heating and Ventilating Engineers, vols. iii. and iv.

Heat Transmission through Corrugated Iron. (A test by A. H. Blackburn reported in "Power"—October 29, 1913.)—"A modern tightly enclosed corrugated iron shop building required approximately 1.5 B.T.U., per square foot per hour, per degree difference of the inside and outside temperatures, figuring the superficial area of the corrugated iron, only. It was practically the same as for a single window computed for the actual iron surface, being 1.13 per square foot against 1.2 used for the average window surface."

44. Pécelet's Computation of Loss of Heat through Walls and Windows.*

Let M represent the quantity of heat that will traverse in a unit of time a plate with parallel faces, having an area of one superficial unit and a thickness represented by e . Let t equal the temperature of the plate (not the adjacent air) on one surface and t' the temperature on the other. Let C equal the coefficient of conductivity. We have

$$M = \frac{C(t-t')}{e} \dots \dots \dots (1)$$

If the body is formed of two plates in contact having a respective thickness of e and e' and coefficients of conductivity of C and C' , and a temperature of θ for the faces in contact, we shall have

$$M = \frac{C(t-\theta)}{e}, \text{ also } M = \frac{C'(\theta-t')}{e'}$$

from which, by eliminating θ ,

$$M = (t-t') \div \left(\frac{e}{C} + \frac{e'}{C'} \right) \dots \dots \dots (2)$$

If there are a number of plates connected in the same way, we shall have in a similar manner

$$M = (t-t') \div \left(\frac{e}{C} + \frac{e'}{C'} + \frac{e''}{C''} + \frac{e'''}{C'''} \right) \dots \dots \dots (3)$$

If the temperatures of the surfaces could be exactly known, it would be possible to calculate the amount of heat transmitted; but while it is

* Translated from *Traité de la Chaleur* by the author.

possible to measure the temperature of the air in contact with the plates, it is not possible to measure the actual temperatures of the surfaces of the plates themselves.

Denote the temperature of the air inside an apartment by T and that outside by T' . It is evident that heat will flow from the warm room to the cooler air outside, and that the inner surface of the wall will be cooler than the air of the room, and the outer surface will be warmer than the outside air. It will be possible to obtain three values of M in terms of the coefficient of conductivity C , that of radiation K , and that of convection K' , since the amount of heat received by the inner surface is equal to that conducted through the wall and discharged from the outer surface. In forming these equations it is assumed that the heat transmitted is in every case proportional to the difference of temperature, which, although not quite exact, is sufficiently near for practical purposes, especially for small differences of temperature. We have three equations as follows:

$$M = \frac{C(t-t')}{e}, \quad M = (K+K')(T-t), \quad M = (K+K')(t'-T');$$

by combining these equations and substituting $Q = K + K'$, we have

$$t = T - \frac{M}{Q}, \quad \dots \dots \dots (4)$$

$$t' = T' + \frac{M}{Q}, \quad \dots \dots \dots (5)$$

$$M = \frac{CQ(T-T')}{2C+Qe}. \quad \dots \dots \dots (6)$$

If Qe is relatively so small with reference to $2C$ that it may be neglected in the last formula, we have

$$M = \frac{1}{2}Q(T-T'), \quad \dots \dots \dots (7)$$

in which case the heat transmitted is independent both of the thickness of the material and its conductivity. As an example consider several plates of glass varying in thickness and with a conductivity in metric measures as given in various tables in this book as follows:

$$C = 0.75, \quad Q = K + K' = 2.91 + 2.20 = 5.10, \text{ from which}$$

$2C + Qe = 1.50 + 5.10e$. Taking e equal to the following values, we have

<i>e</i> meters	0.001	0.002	0.003	0.004	0.005
<i>e</i> inches	0.04	0.08	0.12	0.16	0.2
2 <i>C</i> + <i>Qe</i>	1.5005	1.50102	1.501503	1.502013	1.502523

The above calculation indicates that within practical limits 2*C*+*Qe* remains constant, and that the heat transmitted through glass is independent of the thickness and the coefficient of conductivity.

If, on the other hand, the coefficient of conductivity *C* is very small and the thickness *e* is very great, we can neglect 2*C* in the value of *M*, giving us as a consequence

$$M = \frac{CQ(T-T')}{Qe} \dots \dots \dots (8)$$

As the value of *C* is never less than *Q* for any except the poorest conductors, such as hair felt and filamentary bodies, it is necessary to have the thickness *e* very great in order to have the conditions as above practically realized.

If there are two walls built in close contact and without air-space between them, with a temperature of *x* at the junction surface and a thickness *e*, *e'*, and coefficients of conductivity *C*, *C'*, we shall find as before several values of *M* as follows:

$$M = \frac{C(t-x)}{e}, \quad M = \frac{C'(x-t')}{e'}, \quad M = Q(T-t), \quad M = Q(t'-T'),$$

from which can be obtained the following value of *M* in terms of *T* and *T'*:

$$M = \frac{Q(T-T')}{2+Q\left(\frac{e}{C}+\frac{e'}{C'}\right)} \dots \dots \dots (9)$$

If there are several walls in contact without an air-space between them, the value of the heat transmitted would be, with notation as before,

$$M = \frac{Q(T-T')}{2+Q\left(\frac{e}{C}+\frac{e'}{C'}+\frac{e''}{C''}\right)} \dots \dots \dots (10)$$

The foregoing computation, as stated by Péclet, applies to apartments in which exposed walls are not opposite to each other, it being assumed that heat is radiated to an exposed wall by an inner unexposed wall of the same temperature as the room. For the condition where all the

walls are exposed the temperature of each wall will be less than that of the room and there will be no reciprocal radiation. In considering this case mathematically we shall have to substitute in the last set of equations K' the coefficient of convection for $Q=K+K'$, since, in accordance with this hypothesis, K becomes equal to 0. This hypothesis gives lower values than in the preceding case as will be shown by example.

There is little doubt but that the mathematical conclusion drawn by Péclet follows from the hypothesis adopted, viz., that all the radiant heat passing through the exposed walls must be reciprocally radiated from the interior walls. In most modern examples of heating, however, radiant heat is probably supplied the outside walls from furniture and heaters situated in the room to such an extent as to make the actual amount of heat transmitted practically as much in the one case as in the other, and in the tables already given the condition which gives the greatest transfer of heat only has been considered.

As explaining the use of the formulas we take the following example from Péclet. Assume a wall 10 meters (32.8 ft.) in height formed of stone masonry, with coefficient of conductivity $C=1.7$ (see first column Table, p. 79, slightly smaller than limestone). Coefficient of radiation $K=3.60$ (see Article 48, p. 85) and coefficient of convection $K'=1.96$ for a wall 10 meters high (see last formula Article 47). Assume the interior temperature $T=15^{\circ}$ C. (59° F.) and the exterior temperature $T'=6^{\circ}$ C. (42.8° F.) as corresponding with mean conditions in Paris.

From this $Q=K+K'=3.60+1.96=5.56$. Substituting these various values in equations (4), (5), and (6), and assuming different values of the thickness (e) as follows, we have for a single exposed wall:

Thickness (e) meters...	0.10	0.20	0.30	0.40	0.50	0.60	0.70	0.80	0.90	1.00
" (e) inches...	3.9	7.9	12.8	15.7	19.7	23.6	27.6	31.5	35.4	39.4
Temperature inside face of wall (t) deg. C....	11.15	11.6	12	12.3	12.56	12.77	12.96	13.1	13.2	13.3
Temperature outside face of wall (t') deg. C....	10	9.7	9.4	9.2	9.0	8.8	8.7	8.6	8.5	8.4
Calories per square meter per hour, M ...	25.4	22.3	19.8	17.9	16.2	15.0	13.8	12.8	12.0	11.2
B.T.U. per sq. ft. per hr.	9.3	8.2	7.4	6.6	5.9	5.5	5.1	4.7	4.4	4.1

For the case when all the walls are exposed we have:

t deg. C. (inside face) ..	8.9	9.3	9.7	10	10.3	10.6	10.8	11.0	11.2	11.9
t' deg. C. (outside face).	8.2	8.0	7.9	7.7	7.6	7.5	7.4	7.4	7.3	7.3
Calories per square meter per hour, M ...	12	11.1	10.4	9.7	9.1	8.6	8.2	7.8	7.4	7.0
B.T.U. per sq. ft. per hr.	4.4	4.1	3.8	3.6	3.3	3.1	3.0	2.8	2.7	2.6

For walls with air-spaces, having a temperature of x and x' at the respective sides of the air-space, we shall find without sensible error that the heat transmitted through the space is by radiation and convection, of which the coefficients are $K+K'=Q$. The heat transmitted through

each space can be represented by $Q(x-x')$. The value of the heat transmitted will be expressed by substituting $\frac{e}{C} + \frac{1}{Q}$ in equation (9) for $\frac{e}{C}$. Preserving the same notation, we shall have walls with two air-spaces:

$$M = \frac{Q(T-T')}{2 + Q\left(\frac{e}{C} + \frac{1}{Q} + \frac{e'}{C'} + \frac{1}{Q} + \frac{e''}{C''}\right)} \dots \dots \dots (10)$$

If the walls are n in number and each of the same material, it follows that

$$M = \frac{Q(T-T')}{2 + \frac{nQe}{C} + n - 1} \dots \dots \dots (11)$$

If the construction consisted of several thin walls or parts without an air-space of the same total thickness of the wall with air-spaces as above, we should have $n-1$ parts filling the air-spaces and n parts constituting the remaining part of the wall. By substituting in equation (10) the heat transmission will be for this case:

$$M' = \frac{Q(T-T')}{2 + n\frac{Qe}{C} + \frac{(n-1)Qe}{C}} = \frac{Q(T-T')}{2 + \frac{Qe}{C}(2n-1)} \dots \dots \dots (12)$$

By finding the ratio in the above equations Péclet proves that a wall with air-spaces 0.02 m. (.8 inch) thick, as compared with the same wall with the spaces filled with baked clay, transmits the following proportion of heat:

Number of walls or parts of walls.....	2	3	4	5	10
Proportion of heat transmitted in wall with air-space.....	0.75	0.64	0.57	0.53	0.43

He shows that the thickness of the air-space should always be such that

$$e \text{ is less than } \frac{C}{K + \frac{0.04}{e}}$$

The heat transmitted through the solid walls is by conduction, that through the air-space principally by radiation and convection, which latter quantity may under the same conditions with thick spaces be so large

as to overbalance the gain due to the air-space. This demonstration shows what has been found to be practically correct: that the less the radiation from the surfaces of the walls the more efficient will the air-spaces prove to be.

Transmission of Heat through Glass.—As already explained in connection with equation (7), the heat transmitted through glass when one side only is exposed to the air can practically be represented by the equation

$$M = \frac{1}{2}Q(T - T').$$

It also follows that if x be the mean temperature of the glass,

$$M = (T - x)Q, \quad M = (x - T')Q, \quad \text{whence } x = \frac{1}{2}(T + T'). \quad \dots (13)$$

When the entire enclosure is surrounded with glass Pécelet states that the heat transmission will be somewhat less, because of the reduction in the temperature of the glass due to the lack of reciprocal radiation, and that the following equations apply:

$$M = (T - x)K', \quad M = Q(x - T'),$$

from which we obtain

$$x = \frac{K'T + QT'}{Q + K'} \quad \text{and} \quad M = \frac{QK'(T - T')}{Q + K'}. \quad \dots (14)$$

Pécelet calculates the heat transmitted by the above formulas with the following results:

Height of windows, meters.....	1	2	3	4	5
“ “ feet.....	3.28	6.56	9.84	13.1	16.4
Value of K' (coefficient of convection), <i>one exposure</i>	2.4	2.21	2.13	2.08	2.05
Heat transmission per hour per degree C. per square meter, calories.	2.65	2.56	2.52	2.496	2.479
Ditto per degree F. per square foot, B.T.U.....	0.98	0.945	0.93	0.92	0.91
<i>Room surrounded with glass.</i>					
Heat transmitted per hour per degree C. per square meter, calories.	1.65	1.54	1.49	1.47	1.45
Ditto per degree F. per square foot, B.T.U.....	0.608	0.568	0.55	0.542	0.535

It is quite probable that the hypothesis from which the equations are derived when the room is entirely surrounded with glass is erroneous.

By neglecting the thickness e in the general formula it can be shown that the heat transmitted by multiple glass will bear the following proportion to that transmitted by a single thickness:

Number of glass.....	1	2	3	4	n
Proportion of heat transmitted.....	1	$\frac{2}{3}$	$\frac{1}{2}$	$\frac{2}{5}$	$\frac{2}{1+n}$

The following tables of the coefficients for the thermal conductivity of poor conductors are taken from Péclet's work and are included here for reference. The results will be found essentially the same as given by various authorities in the table in the appendix.

CONDUCTION OF HEAT FOR ONE DEGREE DIFFERENCE OF TEMPERATURE PER HOUR.

Material.	Per Degree Cent.	Per Degree Fahr.
	Per Square Meter, 1 Meter Thick. Calories.	Per Square Foot, 1 Inch Thick. B.T.U.
Gray marble, fine-grained.....	3.48	28
White marble, coarse-grained.....	2.78	22.5
Limestone, fine-grained (mean of three samples).....	1.82	14.8
Limestone, coarse-grained (mean of two samples).....	1.3	10.5
Plaster of Paris.....	0.44	3.6
Brick.....	.69	5.6
Powdered brick, coarse-grained.....	.139	1.1
Fir at right angles to the fibres.....	.093	0.75
Fir parallel with fibres.....	.17	1.4
Walnut at right angles to the fibres.....	.103	0.83
Walnut parallel with fibres.....	.174	1.4
Cork.....	.143	1.15
Glass.....	.75	6
Sand.....	.27	2.2
Wood ashes.....	.06	0.5
Powdered charcoal.....	.079	0.65
Powdered coke.....	.160	1.3
Cotton, raw or woven.....	.040	0.32
Paper.....	.034	0.27

The following table for coefficient of convection K , as calculated from the last formula, Article 47, is taken from Péclet's work:

TABLE GIVING VALUES OF K' FOR VARIOUS HEIGHTS IN METERS FOR A PLANE VERTICAL SURFACE.

Heights, Meters.	K' .	Heights, Meters.	K' .
0.10	3.848	2	2.21
0.20	3.186	3	2.13
0.30	2.926	4	2.08
0.40	2.770	5	2.05
0.50	2.66	10	1.96
0.60	2.585	15	1.92
1.00	2.400	20	1.90

The table shows a decrease in the coefficient of convection with increase in height in a vertical wall as explained in Article 47. This decrease is calculated from the hypothesis that the air which is heated rises while remaining in contact with the body, and for this reason has its capacity diminished for absorbing heat. This hypothesis is doubtless true in the case of absorption of heat by air-currents from radiators or heated bodies, but is probably considerably in error for walls of buildings, and may be entirely neutralized by the fact that the air against the interior wall is likely to be much warmer near the top, thus making an increasing temperature difference.

CHAPTER. IV.

HEAT GIVEN OFF FROM RADIATING SURFACES.

45. **The Heat Supplied by Radiating Surfaces.**—The heat used in warming is obtained either by directly placing a heated surface in the apartment, in which case the heat is said to be obtained by *direct radiation*, or else by heating the air which is to be used for ventilating purposes while on passage to the room, in which case the heating is said to be by *indirect radiation*. As air is not heated appreciably by radiant heat, this latter term is very clearly one which is used in a wrong sense. In this treatise we shall use the terms *direct heating* or *radiation* and *indirect heating*.

Direct heating is performed by locating the heated surface directly in the apartment. This surface may be heated by fire directly, as is the case with stoves and fireplaces; or it may receive its heat from steam or from hot water warmed in some other portion of the premises and conveyed in pipes. The general principles of warming are the same in all cases, but for the case of stoves the temperature is greatly in excess of that for steam or hot-water heating surfaces. The heat is carried away from the heated surface partly by radiation, in which case the heat passes directly in straight lines and is absorbed by people, furniture, and objects in the room, without warming up the intervening air directly, and also by particles of air coming in contact with the heated surface, which may be the radiating surface, or the people and objects in the room which have been warmed by radiant heat.

The sensation caused by radiant and convected heat is quite different; the radiant heat has the effect of intensely heating a person on the side towards the source of heat, and of producing

no warming effect whatever on the opposite side. The heat which has passed off by convection is first utilized in warming the air, and the sensation produced on any person is that of lower temperature-heat equably distributed. Radiant and con-
 vected heat are essentially of the same nature; in the one case it is received by the person directly from the source of heat, and at a high temperature; in the other case it is received from the air, which is at a comparatively low temperature.

The heat in passing through any metallic surface raises its temperature an amount which depends upon the facility with which heat is conducted by the body and discharged from the outer surface. The phenomena of the flow of heat through any metallic substance can be illustrated by the sketch

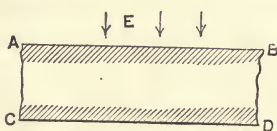

FIG. 30.

in Fig. 30. If E represents the source of heat, and $ABCD$ a section of a metallic wall surrounding, the flow of heat takes place into the metallic surface, then through the solid metal, and finally through the outer surface.

It is noted that the heat meets with three distinct classes of resistances: first, that due to the inner surface; second, that due to the thickness of the material; and third, that due to the outer surface. The first and third resistances are due to change of media, and when the material under consideration is a good conductor, constitute the principal portion of the resistance to the passage of heat.

If the resistance on the inner surface AB is small and that on the outer surface CD is great, the temperature of the metallic body will approach that of the source of heat, for the reason that the heat will be delivered to the surface CD faster than it is discharged. In this case the thickness of the material is of little or no importance, and the rate at which heat will pass depends entirely upon the rapidity with which it can be discharged from the outer surface.

46. Heat Emitted by Radiation.—Heat emitted by radiation, per unit of surface and per unit of time, is independent of the form and extent of the heated body, provided there are no

re-entrant surfaces which intercept the rays of radiant heat. The amount of heat projected from a surface of such form as to radiate heat equally in all directions, depends only on the nature of its surface, the excess of its temperature over that of the surrounding air, and the absolute value of its temperature.

Du Long's law is empirical and only good through a limited range of temperature, but gives no practicable error in the temperatures occurring in heating buildings.

Stefan's Law which is correct for perfect black bodies is that the total energy radiated is proportional to the fourth power of the absolute temperature. The total energy radiated from a hot body with an absolute temperature of T to a cold body of absolute temperature T_0 , where E = the total energy radiated,

$$E = f(T^4 - T_0^4)$$

where f is a constant per unit of surface.

However, no commercial radiating surface used is a perfect black body, so as to give a constant coefficient with varying temperatures. Again the coefficients of the inside walls and windows of the room affect the amount of heat radiated back which has to be deducted from the total heat radiated out from the heating surface, in order to get the net amount of heat radiated per square foot of H. S. Also about 40 to 60 per cent of the heat given out by a radiator is taken by the convection or rubbing contact of the air and strictly speaking is not by radiation.

Du Long's Law.—"The rate of cooling due to radiation is the same for all bodies, but its absolute value varies with the nature of the surface." It is represented by the formula

$$r = ma^\theta(a^t - 1),$$

in which m represents a number depending on the nature of the surface of the body, a represents a constant number, which for the centigrade thermometer is equal to 1.0077 and for the Fahrenheit above 32° to 1.00196, θ the temperature of the sur-

rounding air, and t the excess of temperature of the body over that of the surrounding space.

Péclet found that if the radiant heat be received by a dull surface the value of m becomes equal to a constant 124.72 multiplied by K , a coefficient which depends on the nature of the surface.

The results of the experiments by Péclet accord very well with recent experiments made in testing radiators for steam and hot-water heating. For these cases either wrought or cast iron is used, and the difference in radiating power is immaterial. The construction of the ordinary form of radiator is such as to present very little free radiating surface, as all the heat which impinges from one tube on another is radiated back, and consequently not of use in heating the apartment.

47. Heat Removed by Convection (Indirect Heating).—The heat removed by convection is independent of the nature of the surface of the body and of the surrounding absolute temperature. It depends on the velocity of the moving air, and is thought to vary with the square root of the velocity. It also depends on the form and dimensions of the body and of the excess of temperature over that of the surrounding air. Péclet's experiments were, however, made in ordinary still air, and if the velocity is increased it should be multiplied by factors which will be given later. The formulæ which Péclet found as applying to bodies of different form were as follows, the results below being given in heat-units per square foot per hour.

The general formula for loss by convection is, in metric units,

$$A = 0.552K't^{1.233}.$$

The values of K' depend upon the form and surface of the body and are as follows:

For a sphere, radius r ,

$$K' = 1.778 + 0.13/r.$$

For a vertical cylinder, circular base, radius r , height h ,

$$K' = (0.726 + 0.0345/\sqrt{r})(2.43 + 0.8758\sqrt{h}).$$

For horizontal cylinder, radius r ,

$$K' = 2.058 + 0.0382/r.$$

For vertical planes, height h ,

$$K' = 1.764 + 0.636/\sqrt{h}.$$

Numerical values of these various quantities are given in tables, Art. 48.

48. Total Heat Emitted. Péclet's Tables.—The amount of heat given off by radiation and convection for various differences of temperature and from any surface when K or K' is unity is given in the first table in this article, as computed from Péclet's experiments. The total heat emitted by any surface will be obtained by multiplying the results given in the first table by the factor of radiation and convection for the required conditions. This table is exact for the surrounding air at 15° centigrade or 59° Fahrenheit.

HEAT-UNITS PER HOUR.

RADIATION.						CONVECTION.			
Excess of Temperature.		Total Radiation.		Per Degree Difference.		Total.		Per Degree Difference.	
Deg. Cent.	Deg. Fahr.	Calories per Sq. Meter.	B.T.U. per Sq. Ft.	Calories per Sq. Meter.	B.T.U. per Sq. Ft.	Calories per Sq. Meter.	B.T.U. per Sq. Ft.	Calories per Sq. Meter.	B.T.U. per Sq. Ft.
10	18	11.2 K	4.1 K	1.12 K	.228 K	9.4 K'	3.4 K'	0.94 K'	.189 K'
20	36	23.2 "	8.6 "	1.16 "	.239 "	22.2 "	8.2 "	1.11 "	.228 "
30	54	36.1 "	13.2 "	1.20 "	.243 "	36.6 "	13.5 "	1.22 "	.245 "
40	72	50.1 "	18.5 "	1.25 "	.257 "	52.2 K	19.2 "	1.30 "	.265 "
50	90	65.3 "	24.2 "	1.31 "	.269 "	68.6 "	25.3 "	1.37 "	.284 "
60	108	81.7 "	30.2 "	1.36 "	.281 "	86.0 "	31.8 "	1.43 "	.295 "
70	126	99.3 "	36.6 "	1.42 "	.291 "	104.0 "	38.4 "	1.49 "	.306 "
80	144	118.5 "	43.7 "	1.48 "	.304 "	122.6 "	45.0 "	1.53 "	.311 "
90	162	138.7 "	51.2 "	1.54 "	.317 "	141.7 "	52.2 "	1.57 "	.32 "
100	180	161.3 "	59.5 "	1.61 "	.33 "	161.5 "	59.5 "	1.61 "	.33 "
110	198	185.3 "	68.5 "	1.69 "	.305 "	181.5 "	67.0 "	1.64 "	.334 "
120	216	211.3 "	78.0 "	1.76 "	.361 "	202.1 "	75.5 "	1.68 "	.345 "
130	234	239.3 "	88.3 "	1.83 "	.377 "	223.1 "	82.2 "	1.72 "	.35 "
140	252	269.5 "	99.0 "	1.92 "	.395 "	244.4 "	90.0 "	1.74 "	.355 "
150	270	302.1 "	112 "	2.01 "	.416 "	266.1 "	98.0 "	1.76 "	.36 "
160	288	339.0 "	125 "	2.12 "	.435 "	288.1 "	106 "	1.79 "	.365 "
170	306	371.4 "	139 "	2.22 "	.454 "	310.5 "	115 "	1.82 "	.372 "
180	324	418.5 "	155 "	2.32 "	.478 "	333.2 "	123 "	1.85 "	.38 "
190	342	463.2 "	172 "	2.43 "	.503 "	356.1 "	132 "	1.87 "	.384 "
200	360	511.2 "	188 "	2.55 "	.523 "	379.4 "	140 "	1.89 "	.39 "
210	378	563.1 "	208 "	2.68 "	.553 "	402.9 "	149 "	1.91 "	.394 "
220	396	619.0 "	229 "	2.81 "	.573 "	426.7 "	157 "	1.93 "	.40 "
230	414	679.5 "	255 "	2.95 "	.617 "	450.4 "	166 "	1.95 "	.403 "
240	432	744.8 "	275 "	3.10 "	.665 "	475.0 "	175 "	1.97 "	.406 "
250	450	848.7 "	314 "	3.39 "	.700 "	498.6 "	184 "	1.99 "	.408 "

FACTOR TO DETERMINE RADIATION LOSS FROM VARIOUS SURFACES.

Value of Coefficient *K*.

Polished silver.....	0.43	Powdered wood.....	3.53
Silvered paper.....	0.42	Powdered charcoal.....	3.42
Polished brass.....	0.258	Fine sand.....	3.62
Gilded paper.....	0.23	Oil painting.....	3.71
Red copper.....	0.16	Paper.....	3.71
Zinc.....	0.24	Soot.....	4.01
Tin.....	0.215	Building stone.....	3.60
Polished sheet iron.....	0.45	Plaster.....	3.60
Sheet lead.....	0.65	Wood.....	3.60
Ordinary sheet iron.....	2.77	Calico.....	3.65
Rusty sheet iron.....	3.36	Woollens.....	3.68
Cast iron, new.....	3.17	Silk.....	3.71
Rusty cast iron.....	3.36	Water.....	5.31
Glass.....	2.91	Oil.....	7.24
Powdered chalk.....	3.32		

NOTE.—To find the total heat emitted by radiation, multiply the value of *K* as given in the above table by the numbers corresponding to radiation due to difference of temperature as in the preceding table.

FACTOR TO DETERMINE CONVECTION LOSS FROM BODIES OF VARIOUS DIMENSIONS.

Diameter.		Sphere.	Horizontal Cylinder.	Vertical Cylinder, Height in Meters and Feet.							
Meters.	Inches.			$\frac{h}{d}$	$\frac{h}{0.5 \text{ m.}}$	$\frac{h}{1 \text{ m.}}$	$\frac{h}{2 \text{ m.}}$	$\frac{h}{3 \text{ m.}}$	$\frac{h}{4 \text{ m.}}$	$\frac{h}{5 \text{ m.}}$	$\frac{h}{10 \text{ m.}}$
					1.64 ft.	3.28 ft.	6.56 ft.	9.84 ft.	13.12 ft.	16.4 ft.	32.8 ft.
0.025	0.984	5.114								
0.05	1.968	6.9	3.59	3.55	3.2	2.95	2.84	2.79	2.73	2.62	
0.10	3.94	4.38	2.82	3.22	2.9	2.68	2.57	2.52	2.48	2.38	
0.20	7.88	3.08	2.44	3.05	2.75	2.54	2.44	2.39	2.35	2.26	
0.40	15.74	2.43	2.25	2.93	2.65	2.45	2.35	2.30	2.26	2.17	
0.60	23.62	2.18	2.88	2.60	2.40	2.31	2.26	2.22	2.13	
0.8	31.50	2.10	2.15	2.85	2.57	2.37	2.28	2.23	2.20	2.11	
0.10	39.38	2.83	2.55	2.36	2.26	2.22	2.18	2.09	
0.16	63.0	1.94	
			ratio $\frac{l}{d}$	20	20	20	15	13 $\frac{1}{3}$	12.5	20	

The following table gives the total loss from various forms of direct radiating surfaces in still air, calculated by Péclet's coefficients, slightly modified by recent experiments.

The loss of effective surface due to rays of radiant heat impinging on hot surfaces can be approximately calculated as follows:

Thus in Fig. 31, supposing pipes equally hot, occupying the relative positions of *C* and *B*, the effective radiating surface of *C* will be diminished by that portion of the circumference intercepted by the lines *CD* and *CE*. The

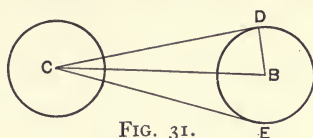

FIG. 31.

HEAT-UNITS EMITTED PER HOUR PER SQUARE FOOT FROM VARIOUS SURFACES, DIRECT RADIATION, STILL AIR.

Differ- ence of Tempera- ture.	Coefficient or Amount per Degree Difference of Temperature.				Total per Square Foot per Hour.*			
	Horizontal Pipe, Diameter.				Horizontal Pipe, Diameter.			
	6 in.	4 in.	2 in.	1 in.	6 in.	4 in.	2 in.	1 in.
	Radiator, Height.				Radiator, Height.			
Deg. F.	40 in. Massed Surface.	40 in. Thin.	24 in. Massed.	12 in. Thin.	40 in. Massed Surface.	40 in. Thin.	24 in. Massed.	12 in. Thin.
10	0.55	0.62	0.66	0.85	5.50	6.7	6.6	8.5
20	1.11	1.25	1.32	1.72	20.2	24.9	26.4	34.4
30	1.18	1.34	1.42	1.84	35	39.7	42.7	55.2
40	1.24	1.40	1.48	1.92	49.6	56.2	59.0	77
50	1.29	1.46	1.54	2.01	64.5	73.0	77	100
60	1.33	1.50	1.58	2.06	79.8	90	95	124
70	1.36	1.54	1.63	2.12	95.2	108	113	148
80	1.40	1.58	1.67	2.18	112	127	133	173
90	1.43	1.63	1.72	2.24	128	147	153	199
100	1.47	1.66	1.76	2.28	147	167	175	228
110	1.51	1.71	1.80	2.34	166	188	198	257
120	1.54	1.74	1.84	2.39	184	208	219	287
130	1.57	1.78	1.88	2.44	203	230	242	318
140	1.61	1.81	1.91	2.48	223	252	266	346
150	1.64	1.84	1.94	2.53	244	276	291	378
160	1.66	1.87	1.97	2.57	265	300	316	410
170	1.69	1.91	2.02	2.62	286	324	341	443
180	1.72	1.94	2.05	2.65	307	348	367	475
190	1.75	1.98	2.09	2.71	330	375	393	512
200	1.78	2.01	2.12	2.76	356	403	415	552
225	1.87	2.12	2.24	2.91	420	477	500	650
250	1.97	2.23	2.35	3.06	493	557	587	762
275	2.07	2.34	2.47	3.22	563	637	670	872
300	2.17	2.45	2.58	3.37	654	742	780	1020
325	2.27	2.55	2.70	3.50	740	840	882	1150
350	2.37	2.67	2.82	3.66	835	945	995	1295

* Results divided by 1000 give approximate weight of steam condensed per hour.

angle DCB has for its sine DB/BC . DB is the external radius of the pipes, BC the distance between the centres, which is usually not far from two diameters. In Figs. 32, 33, and 34 the shaded areas show the position of surface, by which the radiant heat coming from a single pipe or a single section is intercepted.

Supposing the distance apart to be as given above, the fol-

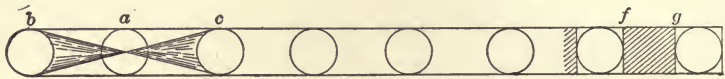

FIG. 32.

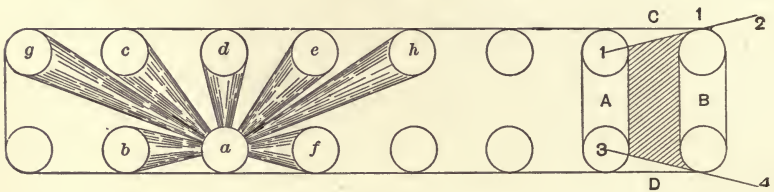

FIG. 33.

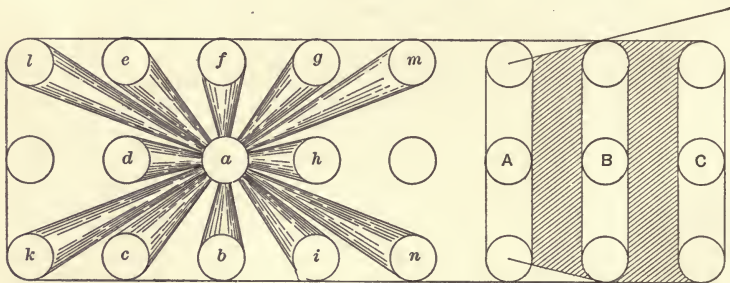

FIG. 34.

lowing table gives the percentage of reduction in amount of heat transmitted due to this cause, compared with single pipe:

Number of Rows of Tubes.	Amount of Surface from which no Radiation takes Place.	Probable Reduction in Heat Transmitted.
	Per cent.	Per cent.
1	16	8
2	42.7	21.3
3	55	27.5
4	66	33
5	73	36.5
6	79	39.5

49. **Heat Transmission Varies with Circulation.**—Prof. A. W. Richter made a series of experiments under the general supervision of the author for determining the rate of transmission of heat through plates of different thickness and of different materials from steam to water. From these experiments it was shown that the total heat transmitted from steam to water was a quantity which varied with the velocity of the water in contact with the plate, the thickness of the plate, and with the difference of temperature of the steam and water.

The following table gives the results of tests with steam at atmospheric pressure for sea level:

TRANSMISSION OF HEAT, STEAM TO WATER, IN B.T.U. PER SQUARE FOOT PER DEGREE DIFFERENCE OF TEMPERATURE PER HOUR.

Weight of Water per Square Foot per Hour, Pounds.	Mild Steel, Very Smooth Surface. Thickness, Inches.				Cast Iron. Thickness, Inches.			
	0.01	0.1	0.5	1.0	0.01	0.1	0.5	1.0
0	417	368	242	171	252	228	164	121
1000	476	422	277	195	288	261	187	139
2000	536	475	312	220	324	294	212	156
3000	597	527	347	245	360	327	236	174
4000	656	582	383	269	397	363	259	191
	Mild Steel, Rough Surface. Thickness, Inches.				Brass. Thickness, Inches.			
	0.01	0.1	0.5	1.0	0.01	0.1	0.5	1.0
0	416	368	243	170	487	427	274	190
1000	462	409	269	189	557	489	314	218
2000	509	450	297	208	629	551	353	246
3000	558	491	324	227	700	613	393	274
4000	610	532	350	245	772	675	431	301

Experiments made by Adams and Gerry* show substantially the same results for the transmission of heat through iron or steel plates from steam to water. When, however, the hot medium was one that parted with its heat slowly, as oil or air,

* See Transactions of American Society of Heating and Ventilating Engineers, vol. 1.

the rate of transmission was found to vary much more rapidly than the difference in temperature between the two media, and to be practically independent of the rate of circulation of the cooler medium; this is doubtless explained by the fact that the rate of transmission was limited to the rate of delivery of heat from the heated body. This in the case of air or oil is so small as to render insignificant the extra resistance caused by different kinds of metals, such as cast iron or wrought iron of different thicknesses.

50. Methods of Testing Radiators.—So far as the writer knows, no standard method has been adopted for use in the testing of radiators, and while numerous tests have been made by different engineers and experimenters, they are often not concordant either as to the method of testing or as to the results obtained. The results in the testing of radiators are greatly affected by small variations in temperature, by irregular air-currents, and by the amount of moisture contained originally in the steam. Obscure conditions of little apparent importance and often disregarded greatly influence the results. The heat emitted by the radiator is in all cases to be computed by taking the difference between that received and that discharged. This result is accurate, and easily obtained. This heat is utilized in warming the air and objects in the room, and to supply losses from various causes, which take place constantly; it is diffused so rapidly, and used in so many ways, that it is practically impossible to measure it, although it is, of course, equal to that which passes through the radiator. The radiating surface is almost invariably heated either by steam or by hot water. In the case of a steam radiator the heat received may be determined, by ascertaining the number of pounds of dry steam condensed in a given time, multiplying this by the heat contained in one pound of steam, and deducting from this product the weight of condensed water, times the heat rejected per pound. To make a test of this kind with accuracy requires, first, a knowledge of the amount of moisture contained in the original steam; second, the pressure of the steam or its temperature; third, an arrangement for permitting water of con-

densation to escape from the radiator without the loss of steam and means of accurately weighing this water, and also of determining its temperature. The radiator can be located in any desired position in the room, on the floor, or slightly elevated therefrom. The temperature of the room during the test should be maintained as nearly constant as possible, and no test should be less than from 3 to 5 hours in length. The method adopted by Mr. George H. Barrus in making a radiator test is shown in Fig. 35.

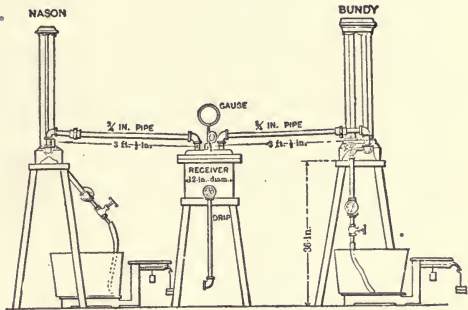

FIG. 35.—Radiators Arranged for Testing.

A similar method adopted by the author at Sibley College, shown in Fig. 36, is as follows:

First, the steam supplied to the radiator is passed through

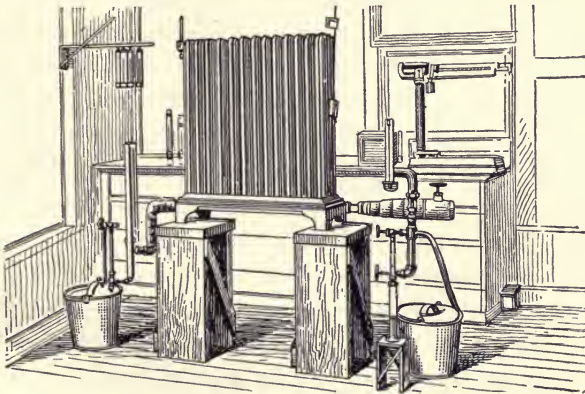

FIG. 36.—Radiator Arranged for Testing.

a separator and a reducing-valve to remove entrained water and maintain a constant pressure during any given run. Second, the amount of moisture in the steam is measured by a calorimeter, and corrections made to the result for the

entrained water. Third, the pressure and temperature of the steam in the radiator are measured by accurate gauges and thermometers. Fourth, the amount of heat passing through the radiator is obtained by weighing the condensed steam, measuring its temperature, and computing by this means the heat discharged.

Fifth, the air from the radiator is effectually removed. Large errors are caused by leaving varying amounts of air in the radiator. The ordinary air-valve is often very unsatisfactory for this purpose; if used, it must be closely watched, or the results may be seriously affected.

The heat supplied is computed by knowing the weight, the percentage of moisture, and the heat contained in one pound of steam. Various methods were tried for drawing off the condensed water; in some tests a trap was used, but better results were obtained by employing a water-column with gauge-glass and drawing off the water of condensation by hand, at such a rate as to maintain a constant level in the glass. To prevent loss by evaporation, this water needs to be received either into a vessel containing some cold water, or else into one with a tight cover, the latter being generally preferred.

Methods of Testing Indirect Steam Radiators.—For this case the general methods of testing should be the same as those previously described, and in addition the volume of air which passes over the radiator should be measured; also, its temperature before and after passing the radiator. For measuring the velocity of air, the anemometer which was described in Chapter II is used. In measuring the velocity the anemometer should be moved successively to all parts in the section of the flue, and the average of these results should be used. The velocity in feet per minute multiplied by the area of section in square feet should give the number of cubic feet. The number of cubic feet of air heated can also be computed by dividing the heat emitted by the radiator by the product of specific heat of air and increase in temperature.

The heat which is absorbed by the air can be computed

by multiplying that required to raise one cubic foot one degree, as given in Table X, by the total number of cubic feet warmed multiplied by the increase in temperature. Fig. 37 shows an arrangement adopted by the author in testing indirect radiators, the air-supply being measured by an anemometer not shown.

Testing Hot-water Radiators.—The amount of heat transmitted through the surfaces of a hot-water radiator can be determined in either of two ways: first, by maintaining circulation at about the usual rate, measuring the temperature of the water before entering and after leaving the radiator; also, measuring or weighing the water transmitted. The heat transmitted would be equal in every case to the product of the weight of water, multiplied by the loss of temperature. In making these tests the same precautions as to removing the air from the radiator must be adopted as in testing steam radiators.

These radiators can also be tested by filling with water at any desired temperature and noting the time required for the water to cool one or more degrees. In this case the iron which composes the radiator would cool the same amount, and a correction must be added. The easier way to correct for the metal composing a radiator is to consider the weight as that of the water increased by that of the iron multiplied by its specific heat. The specific heat of wrought iron is 0.114 and that of cast iron 0.130; hence for a cast-iron radiator the effect would be the same as though we had an additional amount of water equal to 0.130 times the weight of the radiator.

In the practical operation of this test the water in the radiator must be kept thoroughly agitated by some sort of stirring device.

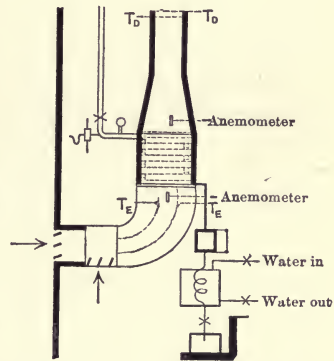

FIG. 37.—Apparatus for Testing Indirect Radiators.

51. Measurement of Radiating Surface.—The amount of radiating surface is usually expressed in square feet, and the total surface is that which is exposed to the air, and includes all irregularities, metallic ornaments, etc., of the surface.

Where the surface is smooth and rectangular or cylindrical it is easily measured, but where it is covered with irregular projections the measurement is a matter of some difficulty and uncertainty. The only practical method of measuring irregular surface seems to be that of dividing it up into small areas and measuring each one of these areas separately by using a thick sheet of paper or a bit of cord, and carefully pressing it into every portion of the surface. The sum of all the small areas is equivalent to the total area.

This method is at best only approximate, and even when exercising the utmost care different observers are likely to differ three or four per cent in their results. The writer has tried several other methods of measuring surface, but so far without marked success. One method, which promised good results, was to cover the whole surface with a thin paint and compare the weights with that required for covering one square foot of plain surface. This method proved even more approximate than the other, and had to be abandoned, as the paint was not of equal depths on all portions of the surface.

The total contents of the radiator in cubic feet can be easily determined by filling it with a weighed amount of water of a known temperature and dividing the result by the weight of one cubic foot. The volume displaced by the whole radiator can be determined by immersing it in a tank whose cubic contents can readily be measured. The difference between the cubic contents when the radiator is in the tank and when taken out is the external volume of the radiator. For this test the openings in the radiator must be tightly stopped.

The same method applied with the radiator immersed in both cases; but in one case with the radiator filled with air and the other with water would give as a result the water displaced

by the metal actually used in the construction, or, in other words, the cubic volume of the metal. This could no doubt be more accurately obtained by dividing the weight of the metal by the weight of one cubic inch or cubic foot. These methods give accurate means of measuring the total external and internal volume of the radiator, but not the surface.

52. Effect of Painting Radiating Surfaces.—In the experiments of Péclet which have been given in Article 48 the effect of different surfaces has been fully considered. From these experiments it would appear in a general way that the character of the surface affects the heat given off by radiation only, and not that given off by convection. In ordinary cases of direct radiation, because the surfaces are closely massed together, the radiant heat does not probably exceed on an average 40 per cent of the total heat emitted, and is negligible in indirect heating. From the experiments quoted, it would appear that if we consider the radiant heat given off as 100 from a new surface of cast iron, that from wrought iron would be 87, from a surface coated with soot or lampblack 125, from a surface with a lustre like new sheet lead $20\frac{1}{2}$, from a polished silver surface $13\frac{1}{2}$. These results make very much less difference, when applied to total heat emitted, since the total radiant heat is only a small portion of the whole heat given off. Calling the radiant heat as 40 per cent of the total, we should have the following numbers as representing the heat emitted from various surfaces:

Cast iron, new.....	100	Rusty surface.....	102
Wrought iron.....	93	Bright iron surface.....	72
Dull lampblack.....	106	White lead, dull.....	106

The writer had some experiments made in Sibley College, the results of which showed that the effect of painting was to increase the amount of heat given off.

It was found that two coats of black asphaltum paint increased the amount 6 per cent, two coats of white lead 9 per

cent. Rough bronzing gave about the same results as black paint.

On the other hand a coat of glossy white paint reduced the amount of heat emitted about 10 per cent.

“Recent tests by Prof. John R. Allen at the University of Michigan give the following relative transmission value of radiator paints:*

Kind of Surface.	Relative Transmission.
Bare iron surface..... 1.	No lustre green enamel..... .956
Copper bronze..... .76	Terra cotta enamel..... 1.038
Aluminum bronze..... .752	Maroon glass Japan..... .997
Snow white enamel..... 1.01	White Lead Paint..... .987
	White zinc paint..... 1.01

“The effect of painting is entirely a surface effect, as the number of coats of painting on a radiator produce very little difference. The heat transmission depends entirely upon the last coat put on.”

Prof. C. L. Norton, Boston, Mass., reported in Transactions of American Society of Mechanical Engineers, 1898, that the heat transmitted from different surfaces was proportional to the following numbers:

New pipe..... 100	Painted glossy white..... 100.4
Fair condition..... 115	Cleaned with potash..... 115
Rusty and black..... 118	Coated with cylinder oil..... 116
Cleaned with caustic potash..... 118	Painted dull black..... 120.5
Painted dull white..... 115	Painted glossy black..... 101

53. **Results of Tests of Radiating Surface.**—The results of the experiments of Péclet have been given quite fully, and they will be found to agree well with best modern tests when the conditions are similar. The radiating surface ordinarily employed for direct systems of steam or hot-water heating consists of a number of pipes or columns closely grouped together. In some instances long coils or series of parallel rows of pipe are employed arranged horizontally, but ordinarily

* From “Notes on Heating and Ventilation,” by John R. Allen, published by the Domestic Engineering Company, Chicago.

EXPERIMENTS ON DIFFERENT STEAM-HEATED SURFACES AND DIFFERENT MATERIALS.
Wrought-iron, Cast-iron, Steel, and Brass Pipes. Corrugated, Ringed, and Plain Surfaces.

Description of heating surface.	Temperature.			Lbs. of Water Condensed per Sq. Ft. per Hr.	Heat-units per Degree Diff. Steam and Air.
	Steam.	Air of Room.	Difference B-C.		
	A	B	C	D	I
33.30	212	70	142	.41	2.89
4.02	212	70	142	.344	2.42
4.02	212	70	142	.344	2.42
8.87	212	70	142	.24	1.60
10.70	212	70	142	.275	1.95
9.20	212	70	142	.280	1.98
4.02	212	70	142	.36	2.54
10.70	212	70	142	.245	1.72
14.14	212	70	142	.269	1.80
44.30	212	70	142	.21	1.60
21.00	212	70	142	.237	1.67
25.00	222	70	152	.312	2.06
25.00	228	70	158	.312	1.98
25.00	230	68	162	.39	1.80
10.00	230	62	168	.351	2.09
10.00	228	65	163	.412	2.53
12.00	230	60	163	.269	1.60
48.00	228	60	168	.214	1.20
20.00	228	77	151	.369	2.43
32.00	228	77	158	.343	2.04
48.00	228	72	156	.219	1.80
25.00	228	70	158	.32	2.03
40.00	230	65	165	.275	1.67
40.00	228	63	165	.219	1.70
18.00	228	74	164	.204	1.71
36.00	228	70	158	.199	1.25
40.00	228	73	155	.256	1.65
10.00	228	70	158	.375	2.37
25.00	228	70	158	.347	2.20

J. H. Nason, 1862.

J. H. Mills, 1888.

the pipes are vertical and grouped together in two to four rows. The usual height of radiator is 36 to 40 inches with the bottom placed about 3 inches from the floor, making the actual height of radiating surface about 3 feet. In some instances radiators are lower, in which case the results per unit of surface are considerably increased.

The value of a radiator in which the surface is grouped so as to prevent the free escape of radiant heat will depend largely upon the effectiveness with which the air-currents strike the heating surfaces. There is a tendency for heated air to move in a vertical current in contact with the radiator surface, and thus to keep the upper portion in a very hot atmosphere, which has the effect of materially lessening its efficiency. The practical effect of these restrictions is to reduce the heating power of radiators which are composed of a large amount of surface closely grouped. The following summary of a series of radiator tests made by J. H. Mills shows that with very small radiators the results are in practical accordance with those of Péclet's experiments, but as the radiators increase in size they fall off about in proportion to the loss of effective radiating surface.

Sq. Ft. of Radiating Surface.	Difference of Temperature.	B.T.U. per Sq. Ft. per Hour per Degree Difference of Temperature.	
		Péclet's Formula.	Actual.
10	155	1.86	2.10
20	150	1.84	2.08
30	158	1.87	2.06
40	175	1.92	1.75
50	155	1.86	1.73
60	165	1.89	1.67

The table on page 97 is abstracted from one published in "Warming and Ventilation of Buildings," by J. H. Mills.

The following table gives the abstract of a large number of radiator tests made under the supervision of the author:*

* Vol. I., Transactions American Society Heating and Ventilating Engineers.

HEAT GIVEN OFF FROM RADIATING SURFACES. 99

Name or Kind of Radiator.	Dimensions.				Tests of Kelsey & Jackson		Tests of Camp & Woodward.		Tests of Dunn & Mack.		Péclet's Coefficient.
	No. Sections.	Rows of Tubes.	Surface, Sq. Ft.	Height, Inches.	Difference of Temperature, Deg. Fahr.	Coefficient.	Difference of Temperature, Deg. Fahr.	Coefficient.	Diff. of Temp. Deg. Fahr.	Coefficient.	
W. I. vertical pipes.	12	4	53.6	36	94	1.62					
W. I. vertical pipes, Nason .	16	3	47.94	36	90 146.6	1.669 1.83	145 144 133	1.70 1.69 1.62	1.81 1.81 1.78
W. I. hot-water, Western No. 2	12	4	41.19	32½	133.2 130.1 137.6	1.62 1.56 1.60	1.78 1.77 1.79
W. I. steam, Western No. 2 .	12	4	43.33	32½	144.8 148.2 158.5	1.81 1.68 1.79	1.81 1.82 1.87
Steel, hot water, Western No. I	12	4	45.13	35	146.2 147.6 159.5	1.60 1.79 1.95	1.82 1.82 1.87
Steel, steam, Western No. I .	12	4	47.24	35	144.6 143.0 155.0	1.59 1.50 1.55	1.81 1.81 1.86
Cast-iron, Bundy	16	1	45.11	37	153.2 154.4 159.4	1.76 2.14 2.02	1.85 1.85 1.87
" " Elite	10	3	79	37	149	1.64	153.1 157.1 171.1	1.88 1.71 1.96	1.85 1.86 1.91
" "											
" Reed	13	1	48.7	151 147 136	1.688 1.627 1.523	1.83 1.82 1.78
" Royal Union	11	3	49.12	37	151	2.08	151 139 130	1.688 1.565 1.582	150 137.5 157	1.73 1.88 1.88	1.83 1.79 1.87
" Royal Union	26	3	52.81	17	153 152 159	2.46 2.37 2.75	
" Perfection Steam	13	1	49.9	...	91	1.63	147.8 147 144	1.456 1.374 1.433
" " "	12	1	48.17	37½	147.0 156.3 166.5	1.77 1.59 1.89	1.82 1.86 1.89
" " "	10	2	40.2	37½	151.5 145.4 165.6	1.59 1.51 1.71	1.83 1.81 1.89
" Perfection Hot Water	12	1	48	37	89 150	1.664 1.55
" Ideal Steam	10	1	40	38	155.3 158.7 155.1	1.73 1.70 1.74	1.86 1.87 1.86
" Ideal Hot Water	10	1	40	38	140	1.61	154.5 167.6 158.4	1.91 2.01 1.99	1.85 1.90 1.87
" National Steam	10	1	40	38	154 153 160	1.67 1.69 1.76	1.86 1.85 1.88
" Whittier Ex. Sur.	3	1	38.65	30	142	1.13	152.6 164.3 151.0	1.51 1.56 1.45	1.83 1.89 1.83
" Michigan Indirect	1	58.2	...	91 140	1.434 1.27
2-inch pipe, single, horizontal	155.6 167.1 194.5	3.3 3.7 4.3	
1-inch pipe, single, horizontal	213.2 151.9 165 182.4	4.3 5.5 5.7 5.8	

TESTS OF RADIATORS WITH EXTENDED SURFACE SO AS TO FORM AIR-FLUES, COMPARED WITH PLAIN CAST-IRON RADIATORS *.

	Description of Radiator.	Number of Loops.	Height above Floor, Inches.	Width of Loop, Inches.	Area Surface, Sq. Ft.	Steam-pressure.			Temperature.			Wt. Steam Condensed per Hour per Sq. Ft., Lbs.	Ditto, per Deg. Diff. Temp.	B. T. U. per Sq. Ft. and per Deg. per Hr.	B. T. U. per Sq. Ft. per Hr.	B. T. U. by Péclet's Rules.	
						5	6	7	8	9	10						11
A	Extended surface	1	2	3	4	5	6	7	8	9	10	11	12	13			
a	Joy flue.	9	37	8	57.8	3.96	225	52.1	173	3.12	0.00170	1.65	302	312			
	Do. Do. Do.	1	37	8	6.40	4.0	226	67.6	158	0.332	0.00212	2.05	323	312			
A'	Same as A with flues planed off. .	9	37	8	40.4	3.9	224	57.8	172	0.329	0.00197	1.97	318	288			
a'	Do. do. do.	1	37	8	4.24	3.9	224	70.5	154	0.379	0.00247	2.39	369	288			
B	Crescent Flue Radiator.	9	36½	8	60.8	3.81	223	73.6	149	0.245	0.00136	1.30	248	280			
b'	Do. do. do.	1	36½	8	6.23	4.0	225	68.8	156	0.360	0.00231	2.24	350	296			
C	Plain Bundy, single row.	14	39½	2½	40.25	3.94	224	65.7	158	0.345	0.00243	2.33	335	312			
c'	Do. do. do.	1	39½	2½	2.83	4.1	226	66.2	159	0.375	0.00237	2.26	365	312			
D	Princess flue radiator.	9	38	8	63.1	3.96	225	71.5	153	2.21	0.00145	1.39	214	285			
d	Do. do. do.	1	38	8	7.18	4.1	226	70.5	155	0.301	0.00194	1.9	292	294			
D'	Same as D with extended surface removed	9	38	8	41.2	3.97	225	71.7	153	0.292	0.00191	1.85	284	285			
d'		1	38	8	4.50	4.0	222	66.2	159	0.365	0.00231	2.24	355	312			

TEST OF RADIATOR SUPPLIED WITH SUPERHEATED STEAM, SIBLEY COLLEGE, 1902.

Number of Test.	1.	3.	5.	6.	7.	8.
Barometer, inches.	29.59	29.32	29.9	29.52	29.09	29.10
Temperature (degrees Fahr.)						
(a) Adjacent air.	86.75	87.60	91.46	91.80	87.90	96.0
(b) Entering steam.	216.3	248.4	277.4	307.7	326.0	346.2
(c) Condensed water.	216.3	218.8	221.4	219.8	221.1	221.9
(d) Inside radiator.	211.1	213.2	213.2	217.0	218.6	219.1
(e) Outside radiator.	207.5	208.3	209.6	213.6	213.7	213.2
Steam-pressure, absolute, lbs.	16.01	16.8	17.65	17.14	17.56	17.85
Degree of superheat (degrees F.)	0	20.6	56.0	87.9	104.9	124.3
Total heat per lb. steam, B.T.U.	1119.1	1162.8	1176.3	1191.0	1199.5	1209.1
Total heat per lb. condensed water, B.T.U.	184.9	187.5	190.1	188.5	189.8	190.7
Total heat per lb. radiated, B.T.U.	934.2	975.3	986.2	1002.5	1009.7	1018.4
Total heat radiated, B.T.U.	5390	5580	5585	5295	5760	5432
Total heat radiated per hr. per deg., B.T.U.	41.55	34.74	30.0	24.5	24.22	21.7
Total heat radiated, per sq. ft., B.T.U.	1.405	1.173	1.014	0.827	0.819	0.734

The above table shows the results of a series of carefully conducted tests made by the author, giving the results of sup-

* Test by Denton and Jacobus, July, 1894.

plying steam of different degrees of superheat to a cast-iron radiator containing 29.6 square feet of surface. The entering steam was superheated by a gas-furnace as desired. By comparison of the degree of superheat with the final results it will be noted that the heat transmitted per degree difference of temperature fell off materially with increase of the degree of superheat. Temperature readings taken from a thermometer inserted immediately inside the radiator (*d*) indicated no superheat, although the small condensation warrants the opinion that the steam in the central portion of the radiator was superheated. A thermometer (*e*) was fastened in contact with the outer surface of the radiator and protected as much as possible from loss of heat by hair felt. This thermometer read about 3.5 to 5.5 degrees less than the inside one, thus indicating an error in that method of taking temperatures of a radiator surface, as it is probable that the metal was almost at the same temperature both inside and outside.

The following tests made by the author on cast-iron steam-radiators of different dimensions are interesting as showing that the heat transmission is lessened by increasing the height or the thickness of the radiator, and increased by diminishing the distance between the sections or parts.

TESTS OF CAST-IRON STEAM-RADIATORS WITH DIFFERENT DIMENSIONS.

Number of columns.....	1	2	3	6	2	3
Thickness of radiator, inches...	5.12	7.25	9	10.75	7.25	6.5
Height of radiator, inches....	35	35	35	14	36	36
Distance between sections, ins.	$\frac{1}{8}$	$\frac{1}{8}$	3.4	3.8	1.2	$\frac{1}{4}$
Actual surface, square feet....	29.60	39.82	51.73	36.59	49.9	49.1
Rated surface, square feet....	30.00	42.50	55.00	50.00	52.00	49.5
Barometer, inches.....	29.59	29.37	28.94	29.93	28.94	28.94
<i>Temperature, degrees Fahr.</i>						
(a) Adjacent air, degrees.....	86.75	86.27	89.53	81.77	79.6	79.3
(b) Entering steam, degrees...	216.3	221.20	222.28	224.59	223.7	223.8
(c) Condensed water, degrees...	216.3	221.20	222.28	224.59	180.3	184.1
(d) Difference between steam and air, degrees.....	129.5	134.9	132.74	132.82	144.1	144.6
Steam-pressure, absolute lbs....	16.01	17.60	17.97	18.79	18.4	18.5
Quality of steam, per cent.....	97	99	98.5	99	97.9	96.7
Steam condensed per hr., lbs....	5.77	9.81	12.54	7.92	10.5	12.4
Ditto and per sq. ft., lbs.....	.195	.245	.242	.217	.21	.253
Total heat radiated per hr., B.T.U.....	5390	9320	11,840	7515	10,308	12,282
Ditto and per square foot.....	182	232	229	207	207	250
Ditto and per degree (actual) B.T.U.....	1.405	1.733	1.725	1.549	1.43	1.72
Ditto and per degree (rated) B.T.U.....	1.385	1.624	1.622	1.132	1.38	1.71

TESTS OF SEVERAL STYLES OF RADIATORS BY THE AUTHOR.

Radiator Number	I.	II.	III.	IV.	V.	VI.
Average steam-pressure above atmosphere.....	4.37	4.41	4.35	4.33	6.00	4.365
Absolute steam-pressure, pounds.....	18.59	18.52	18.56	18.55	20.4	18.58
Average temperature of surrounding air, degrees Fahr.....	84.28	84.31	84.80	83.87	78.50	84.31
Temperature of steam entering radiator.....	224.08	224.3	224.3	223.97	230.00	224.16
Quality of steam.....	96.61	98.26	98.31	97.88	100.00	97.76
Difference in temperature of steam and surrounding air, degrees.....	140.23	139.87	139.22	140.00	150.40	139.84
Total heat per pound of steam per hour, B.T.U.....	1124.4	1148.8	1134.5	1128.9	1152.0	1134.1
Total heat per pound of condensing water, B.T.U.....	141.1	162.7	148.2	129.2	196.6	145.3
Heat radiated per pound of steam, B.T.U.....	993.8	956.9	988.8	996.9	954.8	984.1
Total heat radiated per hour, B.T.U.....	11912.8	11616.2	10774.7	9235.8	9963.8	10885
Total heat radiated per hour, per degree difference of temperature steam and air, B.T.U.....	85.0	82.9	77.5	65.9	67.1	77.8
Ditto as above per square foot of actual surface, B.T.U.....	1.732	1.705	1.643	1.319	2.325	1.601
Ditto as above, rated surface, B.T.U.....	1.712	1.594	1.668	1.266	2.40	1.545
Total weight of steam condensed per hour, lbs.....	11.77	11.75	10.94	9.03	10.56	10.87
Ditto per square foot actual surface.....	0.236	0.239	0.219	0.182	0.351	0.219
Ditto per square foot rated surface.....	0.233	0.234	0.214	0.181	0.370	0.219

EXPLANATION.—DESCRIPTION OF RADIATORS TESTED.

- I. A three-column, cast-iron, loop radiator, containing 49.12 square feet actual surface and 50 square feet of rated surface.
 II. A cast-iron radiator, having loops attached to a base, containing 48.63 square feet actual surface and 50 square feet of rated surface.
 III. A pipe radiator, three rows wide, in a cast-iron base, containing 46.94 square feet actual surface and 48 square feet of rated surface.
 IV. A two-column, cast-iron loop radiator, containing 49.51 square feet actual surface and 50 square feet of rated surface.
 V. A cast-iron, horizontal wall radiator, containing 30 square feet actual surface and 28 square feet of surface as per manufacturers' rating.
 VI. Average results of tests Nos. I, II, III, and IV.

HEAT GIVEN OFF FROM RADIATING SURFACES. 103

The wall radiator, which gives the highest results in the above series of tests, was placed about four inches from a wall and was about 21 inches in height by 54 inches in length. Its efficiency is about the same as horizontal pipe surface.

The following table is of value as showing the relation between coal consumption and temperatures of water and air in a hot-water heating system.

CONDITIONS OF TEMPERATURE, CIRCULATION, AND COST OF WARMING WITH A DIRECT WATER-HEATING APPARATUS AT DRAPER HALL, ABBOT ACADEMY, ANDOVER, MASS., 1890, BY J. H. MILLS.

Date 1890.	Average Temperatures Fahrenheit for 24 Hours.							Cost of Coal for 24 Hours, at \$6 per ton of 2000 lbs.		
	Outside.	Inside.	Flow Water.	Return Water.	Mean.	Loss.	Diff. Air and Water.	Lbs. Coal per Day.	Per 1000 Cu. Ft.	
Feb. 24	36°	71°	187°	150°	168°	37°	97°	1600	\$4.80	8.6 mills
" 25	39	71	196	162	179	34	108	1250	3.75	6.8 "
" 26	39	70	183	136	159	47	89	1550	4.65	8.4 "
" 27	40	71	183	145	164	38	93	1450	4.35	7.9 "
" 28	39	69	172	124	148	48	79	1100	3.30	6.0 "
Mar. 1	39	70	175	153	164	42	94	1150	3.45	6.2 "
" 2	26	64	169	131	150	38	86	1100	3.30	6.0 "
" 3	20	69	188	153	170	35	101	1650	4.95	9.0 "
" 4	21	68	178	141	159	37	91	1500	4.50	8.1 "
" 5	37	69	181	147	164	34	95	1400	4.20	7.6 "
" 6	20	66	187	150	168	37	102	1650	4.95	9.0 "
" 7	11	63	191	159	170	41	107	1900	5.70	1 cent
" 8	18	65	183	145	164	38	99	1850	5.55	1 "
" 9	22	57	157	138	147	19	90	1050	3.15	5.7 mills
" 10	24	67	172	135	163	37	96	1400	4.20	7.6 "
" 11	39	70	182	144	163	38	93	1300	3.90	7.0 "
" 12	40	70	157	127	142	30	72	900	2.70	5.0 "
" 13	42	63	157	120	138	37	75	750	2.25	4.0 "
" 14	40	65	161	131	145	28	80	750	2.25	4.0 "
" 15	37	57	155	125	140	30	83	650	1.95	3.5 "
" 16	34	60	150	114	132	36	72	700	2.10	3.8 "
" 17	19	61	172	141	156	31	95	1050	3.15	5.7 "
" 18	35	61	156	123	139	33	78	1200	3.60	6.5 "
" 19	25	63	168	128	148	40	87	1400	4.20	7.0 "
" 20	28	63	160	127	143	33	80	1200	3.60	6.5 "
" 21	34	69	157	127	142	30	73	900	2.70	5.0 "
" 22	37	67	155	125	140	30	73	900	2.70	5.0 "
" 23	35	67	155	130	132	25	65	600	1.80	3.2 "
" 24	24	60	156	129	137	37	77	1200	3.60	6.5 "
Average	31°	65°	170°	136°	153°	34°	87°	1210	\$3.74	6.8 mills

The building is of brick, four stories above the basement, and contains 96 sleeping- and study-rooms, 12 music- and 24 public-rooms; total, 132, besides basement. Contains 553,000 cubic feet space; exposed wall, 17,478 square feet, and 5236 feet glass.

The heating apparatus consists of two Mills 14-section No. 5 boilers set in battery. Combined fire-surface, 936 square feet, with 25 square feet of grate. Third boiler runs dynamo. Heating surface to boiler, 1 to 7½. Distance from boiler to last radiator, 385 feet. Main supply-pipe, 7 in.; vertical supply-pipes, 1½ in.; connections to radiators, ¾ in.

Radiating surfaces—one hundred and forty Royal Union radiators = 5000 square feet; indirect Golds' pin, 450; pipe surface, 1550; total 7000. Radiating surface to space warmed, 1 to 79.

RESULTS OF RADIATOR TEST WITH SUPERHEATED STEAM.

RADIATOR No. 1.

Height, 18". Measured surface, 38.6 sq. ft. Least distance between sections, $\frac{1}{4}$ inch.

No. of Test.	Pressure. Lbs.	Temperature Air. Degrees.	Temperature Steam. Degrees.	Degree Superheat.	B. T. U. per Hour per Sq. Ft. per Degree.	Pounds of Steam Condensed per Hour.
6	2	71.3	217.0	0	1.48	6.25
5	2	77.1	217.1	.13	1.50	8.13
4	2	74.0	252.8	35.83	1.16	7.88
7	5	70.2	239.0	13.10	1.41	9.18
3	5	75.5	252.7	24.10	1.23	8.38
2	10	72.5	264.7	26.70	1.24	9.18
8	10	75.8	238.4	.30	1.50	9.25
1	30	74.1	274.5	1.10	1.83	14.07

RADIATOR No. 2.

Height, 38". Measured surface, 49.1 sq. ft. Least distance between sections, $\frac{3}{8}$ inch.

6	2	73.5	217.0	0	1.88	13.00
5	2	80.3	217.1	.13	1.92	12.75
4	2	77.0	252.8	35.83	1.41	12.75
7	5	73.5	239.0	13.10	1.74	14.16
3	5	76.7	252.7	24.10	1.45	13.12
2	10	74.2	264.7	26.70	1.62	15.00
8	10	77.3	238.4	.30	1.91	15.16
1	30	76.8	274.5	1.10	1.97	18.94

54. **Tests of Indirect Heating Surfaces.**—The tests which have been made on indirect heating surfaces show very great differences in results, varying from those given by Péclet for the loss due to convection alone, to results which are 8 or 10 times as great. This difference in result is no doubt due in each case to the velocity of air which comes in contact with the surface. When the indirect radiators are not freely supplied with air, or the velocity is low, the amount of heat which is discharged is small; when the velocity of the air is high, the amount of heat taken up is proportionally greater. According to experiments made by the writer, the coefficient of heat transmission increases as the square root of the velocity of the air.

The amount of air passing over a given surface of the radiator can be estimated quite accurately by the amount of heat given off, which we can reasonably suppose in this case to be all utilized in warming the air. At a temperature of about 60 degrees, 1 heat-unit will warm 55 cubic feet of air 1 degree (see Table X), so that the number of cubic feet of air warmed is equal to 55 times the total number of heat-units given off from 1 square foot of heating surface per hour, divided by the difference of temperature of entering and discharge air.

NOTE.—Let T = temperature discharge air, t' = that of entering air, H = total number of heat-units given off by surface, a = the number of square feet of surface. Then,

$$\text{Cubic feet of air per square foot heating surface} = \frac{55H}{(T-t')a}$$

Prof. John R. Allen gives the following table in his "Notes on Heating and Ventilation,"* derived from the results of tests:

HEAT LOSSES FROM INDIRECT RADIATORS.

Cubic Feet of Air Passing per Sq. Ft. of Radiation.	Increase in Temperature of the Air Passing.		Pounds of Steam Condensed per Sq. Ft.		B.T.U. Transmitted per Sq. Ft. per Degree Difference in Temperature of Air Passing Through Radiator and the Steam.	
	Standard Pin.	Long Pin.	Standard Pin.	Long Pin.	Standard Pin.	Long Pin.
50	147	140	.125	.15	.80	.95
75	143	137	.17	.21	1.17	1.27
100	140	135	.24	.26	1.51	1.60
125	138	132	.295	.31	1.85	1.90
150	135	129	.355	.36	2.22	2.20
175	132	126	.41	.405	2.57	2.47
200	130	123	.47	.45	2.90	2.72
225	127	120	.53	.49	3.25	3.00
250	123	118	.585	.53	3.60	3.20
275	121	115	.645	.57	3.90	3.40
300	119	112	.700	.61	4.22	3.60

* Published by the "Domestic Engineering Co."

EXPERIMENTS ON INDIRECT RADIATORS.*

Number.	Names of Radiators, Engineers' and Dates of Experiments.	Square Feet Surface.	Gauge-pressure, Steam.	Tempera- tures.			Diff. Temp.		Oz. Water Con- densed per Foot per Hour.	Air, Cubic Ft. per Ft. per Hour.	Units of Heat.				
				Steam.	Entering Air.	Exit Air.	Enter and Exit Air.	Steam and Enter Air.			Per Ft. per Hour.	Diff. Temp. Stm. & Air. Per Deg.			
1	C.B. Richards, 1873-4.		1	215	0	160	160	215	5.44	111	340	1.53			
2				Novelty	1	215	0	156	156	215	5.09	102	318	1.48	
3				G. Whittier	1	215	0	135	135	215	4.40	106	275	1.28	
4	W.J. Baldwin, 1885.	60	10	215	0	147	147	215	4.88	108	305	1.42			
5				Gold's pin	10	239	71	168	97	168	3.83	128	239	1.42	
6				Compound coil	60	10	239	71	170	98	167	3.84	126	240	1.43
7	W. Warner, 1880,	70	3	222	42	145	103	180	4.60	145	288	1.60			
8	J. H. Mills, 1879.	40	5	227	33	142	109	194	5.00	149	313	1.61			
9				Walworth	5	227	78	162	84	139	4.08	158	255	1.71	
100 Cubic Feet of Air per Foot per Hour, Average.										126	286	1.50			
10	Dr. Gray, 1875,	90	20	259	33	125	92	226	6.54	231	409	1.81			
11	J. R. Reed, 1875,	68	3	222	45	129	84	177	5.09	197	318	1.80			
12	C.B. Richards, 1873-4.		1	215	0	139	139	215	9.15	214	572	2.66			
13				Novelty	1	215	0	132	132	215	8.70	214	544	2.53	
14				G. Whittier	1	215	0	102	102	215	6.66	212	416	1.94	
15	Pipe coil	1	215	0	106	106	215	6.98	214	436	2.03				
200 Cubic Feet of Air per Foot per Hour, Average.										214	449	2.13			
16	J. R. Reed, 1875.	68	3	222	52	110	58	170	5.50	308	344	2.02			
17				Whittier	3	222	52	114	62	170	5.86	307	366	2.15	
18				Gold's pin	58	3	222	52	127	75	170	7.92	343	495	2.91
19	C.B. Richards, 1873-4.		1	215	0	129	129	215	12.65	319	791	3.68			
20				Novelty	1	215	0	121	121	215	11.90	320	744	3.46	
21				G. Whittier	1	215	0	87	87	215	8.53	319	533	2.48	
22	Pipe coil	1	215	0	89	89	215	8.64	323	540	2.51				
23	J. H. Mills, 1876,	76½	10	239	81	159	78	158	8.49	354	531	3.36			
24	Nov., 1885.	60	5	227	82	150	68	145	8.16	390	510	3.52			
25	Compound coil	60	5	227	82	152	70	145	8.16	379	510	3.52			
300 Cubic Feet of Air per Foot per Hour, Average.										336	536	2.96			
26	J. H. Mills, 1876,	76½	10	239	90	158	67	148	8.91	433	557	3.76			
27	W.J. Baldwin, 1885.	60	5	227	70	137	67	158	8.93	433	558	3.55			
28				Gold's pin	60	5	227	70	135	65	158	8.40	420	525	3.34
29				Compound coil	1	215	0	121	121	215	15.92	428	995	4.63	
30	C.B. Richards, 1873-4.		1	215	0	113	113	215	14.86	428	929	4.32			
31				Novelty	1	215	0	77	77	215	10.14	428	634	2.95	
32				G. Whittier	1	215	0	76	76	215	10.02	428	626	2.91	
400 Cubic Feet of Air per Foot per Hour, Average.										428	689	3.64			
33	J. H. Mills, 1876,	77	6	230	88	158	70	142	10.04	467	628	4.42			
34	Walworth	67½	6	230	88	142	54	142	8.88	534	555	3.91			
500 Cubic Feet of Air per Foot per Hour, Average.										501	592	4.17			
35	J. H. Mills, 1876,	85	20	259	90	160	70	169	13.60	636	856	5.06			
36	Walworth	76½	20	259	90	166	76	169	15.16	649	948	5.61			
600 Cubic Feet of Air per Foot per Hour, Average.										643	902	5.34			
37	J. H. Mills, 1876,	85	3	222	90	142	52	132	11.61	726	726	5.50			
38	Walworth	76½	3	222	90	145	55	132	12.54	741	784	5.94			
700 Cubic Feet of Air per Foot per Hour, Average.										734	755	5.72			
39	J. H. Mills, 1876,	77	5	227	94	145	51	133	13.43	855	839	6.31			
40	Nason	85	7½	233	79	135	56	154	15.30	888	956	6.21			
800 Cubic Feet of Air per Foot per Hour, Average.										872	898	6.26			

* From John H. Mills' Work on Heat, by permission.

COMPARISONS OF WATER AND STEAM CIRCULATION, WITH INDIRECT RADIATORS, NATURAL AND FORCED AIR SUPPLY. By J. H. MILLS

No. for Reference.	Radiators boxed in Stacks, open below, and with Outlet above for heated Air, the duty of Radiator being determined by the Volume and Temperatures of the heated Air.	Square Feet of Surface.		Temperatures.		Difference of Temperature.		Cubic Feet of Air.		Units of Heat per Sq. Ft. per Hour.		
		Sq. Feet of Outlet.	Sq. Feet of Surface.	Water or Steam.	Air to be Warmed.	Water or Steam.	Warm and Cold Air.	Velocity of Hot Air, per Sec.	Per Sq. Ft. per Hour.	Per Sq. Ft. per Hour.	Per Deg. Dif. Steam or Water & Air.	Total.
Engineers, Radiators, and Dates.												
1	W. J. Baldwin, { Box coil, nat. draught, water.....	74	192	176	85	134	90	49	1.97	106	90	1.00
2	1886, { Compound coil, nat. draught, water.....	48	195	185	85	143	105	58		117	131	1.25
3	J. H. Mills, { Albany cast, nat. draught, water.....	60	78	172	38	128	149	90	4.5	123	213	1.43
4	1885, { Box coil, nat. draught, water.....	55	82	205	45	135	138	90	4.7	145	251	1.82
5	W. J. Baldwin, { Box coil.....	74	144	186	78	150	118	72	3.8	149	206	1.75
6	1886, { Compound coil.....	48	144	206	144	178	166	122	2.5	148	250	2.05
7	J. H. Mills, { Gold's pin.....	100	144	214	28	143	168	115	5.3	146	323	1.92
8	1885, { Mills' indirect.....	100	144	181	28	138	160	110	5.3	157	332	1.96
9	Staggered Tube Coil Radiator, Shakelton's, water.....	55	50	198	34	116	144	82	7.8	158	249	1.73
10	J. H. Mills, { Mills' indirect, Shakelton's, water.....	100	144	196	40	111	135	71	6.6	204	270	2.07
11	1885, { Gold's pin, Shakelton's, water.....	100	144	196	40	114	133	74	7.	211	300	2.22
	Averages.....		202	173	53	134	135	82	4.6	151	239	1.75
Comparison of Steam and Water under similar Conditions and Temperatures.												
12	J. H. Mills, 1884, { Box coil, nat. draught { water.	55	50	163	50	146	137	96	5.8	107	198	1.45
13	C. B. Richards, 1874, { steam.		215			147	215	147		106	305	1.42
14	J. H. Mills, 1884, { Mills' indirect..... { water.	100	144	180	28	136	172	108	4.9	146	303	1.76
15	W. J. Baldwin, 1875, { steam.		227			162	149	84		151	255	1.71
16	W. J. Baldwin, { Compound coil..... { water.	48	144	194	78	166	122	88	2.5	148	250	2.05
17	W. J. Baldwin, { steam.	60	144	220	62	170	158	108		146	303	1.92
18	J. H. Mills, 1884, { water.	100	144	240	26	157	194	128	5.7	163	401	2.07
19	W. J. Baldwin, 1885, { Gold's pin..... { steam.	60	144	220	62	157	158	95		161	295	1.87
	Averages.....		219	184	46	157	156	105		141	288	1.83
			221		51	159	170	109		141	289	1.73
20	J. H. Mills, Walworth 10-ft. flue { steam.	66	217	231	84	138	147	54	6.7	461	1077	3.26
21	" " forced draught { In-	66	217	180	94	135	134	41	22.1	1360	4077	8.04
22	June 16, 1876, Gold's pin, 10-ft. flue { direct	"	76	217	231	184	155	147	6.3	360	492	3.35
23	" " forced dr't { Radia-	"	76	217	228	150	94	145	19.7	1143	1121	8.36
24	Nason, 10-foot flue { tor.	85	217	178	83	133	145	50	10.1	534	513	3.54

NOTE.—For Nos. 5, 15, 17, and 19 the heat recorded is that due to the amount of steam condensed (see Table XII).

The two preceding tables contain an extensive summary of tests of indirect radiators, abstracted from Mill's work on Heating and Ventilation, and are of especial interest as showing the close agreement in results, whether water or steam is used. The higher results in this table agree fairly well with the rule stated; those for natural draft are much smaller, and approximately equal to the square root of the velocity in feet per second.

Chapter XV on hot blast heating contains the formulas, tests and charts for the convection of heat from indirect heating surfaces with air at high velocities and with forced draft.

55. Conclusions from Radiator Tests.—The general results of radiator tests can be summed up as follows: First, that the values for heat transmission in recent tests of direct radiators vary greatly and differ more from an average result than from those given by Péclet, and consequently his results can be used with confidence as applying to modern radiators. Second, the results of the test show greater differences in favor of low radiators as compared with high ones than was shown in the experiments of Péclet. Third, the experiments do not show any sensible difference for different materials used in radiators or for hot water or steam, provided the difference in temperature between the air in the room and that of the fluid in the radiator is the same. Fourth, the internal volume of radiators is of value only in lessening the friction of the fluid. It has no special influence on the results. Fifth, the extended surface radiators, or radiators in which the cast iron projects from the surface into the air, show large results when estimated on the basis of projected or plain surface, but show very small results when estimated on the basis of measured surface. Sixth, thin radiators, or those with a few rows of tubes, always show a higher efficiency than deep ones or those with numerous rows of tubes. Seventh, comparative tests of radiators should only be made between radiators of similar forms, or at least those which have about the same amount of surface.

Prof. J. H. Kinealy in his work translated from the German, "Formulas and Tables of Heating," gives the total value of the heat in B. T. U. per square foot per hour from Rietschel as follows:

Heating-surface.	Low Pressure. Below 7.5 Pounds.		High Pressure. Above 7.5 Pounds.	
	Total B. T. U. per Hour.	Pounds of Steam Condensed per Hour.	Total B. T. U. per Hour.	Pounds of Steam Condensed per Hour.
STEAM: DIRECT RADIATION.				
Smooth pipes, vertical.....	260 to 275	0.25 to 0.26	315 to 330	0.30 to 0.31
" " " horizontal.....	275 to 295	0.26 to 0.28	330 to 350	0.31 to 0.33
Pipe coiled.....	240 to 260	0.23 to 0.25	295 to 315	0.27 to 0.29
*Cast-iron ribbed radiators.....	150 to 185	0.15 to 0.18	185 to 220	0.17 to 0.21
STEAM: INDIRECT RADIATION.				
Pipe coiled lower, than 3 feet 3 inches..	405	0.39	450	0.425
" " " higher than 3 feet 3 inches	370	0.35	430	0.415
*Cast-iron ribbed heater lower than 3 feet 3 inches.....	295	0.28	325	0.306
*Cast-iron ribbed heater higher than 3 feet 3 inches.....	280	0.27	315	0.298
HOT WATER: DIRECT RADIATION.				
Vertical pipe radiator: one row.....	150 to 165	185 to 205
" " " two rows.....	140 to 155	175 to 195
" " " over two rows.....	130 to 145	165 to 185
Smooth pipe under 13 feet long, verti- cal.....	165 to 185	205 to 220
Smooth pipe under 13 feet long, hori- zontal.....	185 to 205	220 to 240
Pipe coiled.....	150 to 165	185 to 205
*Cast-iron ribbed radiators.....	85 to 110	110 to 140
HOT WATER: INDIRECT RADIATION.				
Pipe coiled, under 3 ft. 3 in. high ...	245	305
" " " over	235	295
*Cast-iron ribbed heater under 3 ft. 3 in high.....	185	235
*Cast-iron ribbed heater over 3 ft. 3 in high.....	175	220

* These cast-iron radiators have only about two-thirds the capacity of the American radiators.

The amount of steam condensed in pounds per hour per square foot can be calculated when the heat transmission per degree difference of temperature per square foot is given, by multiplying this last quantity by the difference in temperature between the steam and the room and dividing this result by the latent heat of one pound of steam at the given pressure. Thus if the steam is supplied at a gauge pressure of 1.3 pounds (16 absolute), we find by consulting the steam-table, No. XIII in the Appendix, that its temperature is $216^{\circ}.29$, and that it contains 962.65 B. T. U. per pound as latent heat. With room 70° , difference of temperature 146° , and coefficient of heat transmission 1.75, the total heat transmitted per square foot per hour becomes 255 B. T. U. This divided by 962.62

gives the condensed steam as 0.265 pound, which is about an average case for a cast-iron radiator.

COEFFICIENTS OF HEAT TRANSMISSION*

BY JOHN R. ALLEN,

Professor Mechanical Engineering, University of Michigan.

HEAT TRANSMISSION FROM DIRECT RADIATORS

Type of Radiator Cast Iron.	No. of Square Feet.	No. of Lbs. Con- densed per Hr. per Sq. Ft.	Coefficient of Transmission.
1 column.....	48	.212	1.82
2 column.....	48	.265	1.65
3 column.....	45.3	.204	1.45
6 column.....	36	.217	1.35
WROUGHT IRON			
1 column.....	12	.446	3.27
2 column.....	42	.286	2.00
3 column.....	48	.294	1.77
4 column.....	48	.202	1.27
1-IN. PIPE COIL			
1 pipe high.....41	2.8
4 pipes high.....425	2.48
WALL COIL (C. I.)			
Section vertical.....	5	1.92
Section horizontal.....	5	2.11
Section vertical.....	7	1.70
Section horizontal.....	7	1.92
Section vertical.....	9	1.77
Section horizontal.....	9	1.98

HEAT TRANSMISSION THROUGH CAST-IRON RADIATOR UNDER VARYING CONDITIONS OF TEMPERATURE.

Difference in Temperature.	Coefficient of Transmission.
80	1.56
100	1.58
120	1.615
140	1.645
150	1.65
160	1.675
170	1.69
180	1.705
190	1.72

* Read at the third annual convention of the National District Heating Association, June 6-8, 1911.

EFFECT OF HUMIDITY ON THE TRANSMISSION OF HEAT THROUGH CAST-IRON RADIATOR.

Percentage of Moisture Saturation	Coefficient of Transmission.
20	1.79
30	1.77
40	1.73
50	1.72
60	1.69
70	1.66
80	1.63
90	1.61
100	1.59

56. **Temperature Produced in a Room by a given Amount of Surface when Outside Temperature is High.**—Guarantees are often made respecting heating apparatus that it shall be sufficient to maintain a temperature of 70 degrees when the external air is at some fixed point, as zero, or 10 below. As under the exact conditions of the guarantee the trial can only be made when the external temperature corresponds with that specified, it becomes of some importance to establish an equivalent temperature which would indicate the efficiency of the heating apparatus for any specified condition. The following method is applicable for such computations and is expressed in the shape of a formula:

Let T equal temperature of radiator, t' that of room, and t that of outside air for the conditions corresponding to the guarantee. Let B equal loss from room for 1 degree difference of temperature; let c equal the heat-units from 1 square foot of radiator per 1 degree difference of temperature for conditions corresponding to the guarantee; let c' denote the same values for other conditions; let x equal resulting temperature of room, t'' outside air for the actual conditions, R equal square feet of radiation.

For guaranteed conditions,

$$(t' - t)B = c(T - t')R. \dots \dots \dots (1)$$

For actual conditions,

$$(x-t'')B=c'(T-x)R. \quad \dots \quad (2)$$

Dividing (1) by (2),

$$\frac{t'-t}{x-t''}=\frac{c(T-t')}{c'(T-x)}, \quad \dots \quad (3)$$

When $t'=70$, $T=220$, $t=0$, and $c=1.8$, we have

$$c'\left(\frac{T-x}{x-t''}\right)=3.86.$$

The coefficient of heat transmission c' grows less as the temperature in the room becomes higher, as already shown in Art. 48; so the equations can only be solved in an approximate manner. The following table gives the temperatures in column

TABLE *

Temperature Outside Air.	Coefficient. † Heat per Square Foot per Hour per Degree.	Total Heat per Square Foot per Hour.	Resulting Temperature of Room.	Difference Temperature Radiator and Room.
10	1.85	288	64.7	155.3
0	1.8	270	70	150
10	1.75	253	75.1	144.9
20	1.7	236	81	139
30	1.65	218	86.5	133.5
40	1.6	203	93.1	128.0
50	1.55	188	98.7	122.5
60	1.5	172	104.7	116.5
70	1.45	158	110.5	109.5
80	1.4	142	117.1	102.9
90	1.35	130.5	123.5	96.5
100	1.3	117	130.3	89.7

Example Showing Application of Table.—To determine by a test of the apparatus, when weather is 60° , whether a guarantee to heat to 70° in zero weather is maintained, operate the apparatus as though in regular use and note the average temperature of the room. If the room has a temperature equal to or in excess of 104.7° F., it would have a temperature of 70° in zero weather, all other conditions, such as wind, position of windows, etc., being the same as on the day of the test.

* This table, although calculated for steam with radiator at temperature of 220° F., is practically correct for hot-water radiation or for steam at any pressure and temperature.

† Value of c' in formulæ.

4, which a room would have for various temperatures outside, provided there was sufficient radiating surface to heat the room to 70 degrees in zero weather. The temperature of the radiator in all cases is assumed to be that due to 3 pounds pressure of steam by gauge, or 220 degrees.

57. Correcting for the Wind Velocity.—W. H. Whitten in a paper read before the American Society of Heating and Ventilating Engineers, gives the following rule for correcting the outside temperature used for the effect of the velocity of the wind. "From 40 to 15 degrees above zero, 1 mile of wind movement per hour is equal to 1 degree drop in temperature; from 15 degrees plus to 20 degrees minus, 1 mile of wind movement per hour is equal to 1.15 degrees drop in temperature. This is for buildings constructed in the ordinary manner, that is, without protected windows.

"This not only applies to the sides having the so-called greatest exposure, but, owing to the suction or nonpressure existing on the sheltered sides, should be applied to all sides of the building.

Where the windows are equipped with efficient weather strips the loss of heat caused by the wind is much less.

58. Protection of Main Pipe from Loss of Heat.—The loss of heat which takes place from an uncovered main steam or hot-water pipe is, because of its isolated position, considerably greater than that which takes place from an equal amount of radiating surface. Unless this heat is actually required it will cause an expenditure of fuel the cost of which is likely to be in a few seasons many times that of a good covering.

The heat lost per square foot of surface from a small uncovered pipe is from 375 to 400 heat-units per square foot per hour in steam-heating, or an amount equal to that required for the evaporation of 0.4 pound of steam. Computing this loss for 100 square feet for a day of 20 hours and for a season of 150 days, it will be found equivalent to the coal required to evaporate 120,000 pounds of steam; this would not be less than 12,000 pounds of coal, which at \$5.00 per ton would cost \$30.00. The cost per square foot per annum will be found on

the above basis to be 30 cents, of which 75 to 80 per cent would have been saved by using the best covering. The loss from hot-water pipes would be about two-thirds of the above.

The best insulating substance known is air confined in minute particles or cells, so that heat cannot be removed by convection. No covering can equal or surpass that of perfectly still and stagnant air; and the value of most insulating substances depends upon the power of holding minute quantities in such a manner that circulation cannot take place. The best known insulating substance is a covering of hair felt, wool, or eider-down, each of which, however, is open to the objection that, if kept a long time in a confined atmosphere and at a temperature of 150 degrees or above, it becomes brittle and partly loses its insulating power.

A covering made by wrapping three or more layers of asbestos paper, each about $\frac{1}{16}$ inch thick, on the pipe, covering with a layer of hair felt $\frac{3}{4}$ inch in thickness, and wrapping the whole with canvas or paper, is much used. This covering has an effective life of about 5 years on high-pressure steam-pipes and 10 to 15 years on low-temperature pipes. There are a large number of coverings regularly manufactured for use, in such a form that they can be easily applied or removed if desired. There is a very great difference in the value of these coverings; some of them are very heavy and contain a large amount of mineral matter with little confined air, and are very poor insulators. Some are composed entirely of incombustible matter and are nearly as good insulators as hair felt. In general the value of a covering is inversely proportional to its weight—the lighter the covering the better its insulating properties; other things being equal, the incombustible mineral substances are to be preferred to combustible material. The following table gives the results of some actual tests of different coverings, which were conducted with great care and on a sufficiently large scale to eliminate slight errors of observation. In general the thickness of the coverings tested was 1 inch. Some tests were made with coverings of different thicknesses, from which it would appear that the gain in

insulating power obtained by increasing the thickness is very slight compared with the increase in cost. If the material is a good conductor its heat-insulating power is lessened rather than diminished by increasing the thickness beyond a certain point.

PERCENTAGE OF HEAT TRANSMITTED BY VARIOUS PIPE-COVERINGS, FROM TESTS MADE AT SIBLEY COLLEGE, CORNELL UNIVERSITY, AND AT MICHIGAN UNIVERSITY.*

Kind of Covering.	Relative Amount of Heat Transmitted.
Naked pipe.....	100.
Two layers asbestos paper, 1 in. hair felt, and canvas cover.....	15.2
Two layers asbestos paper, 1 in. hair felt, canvas cover, wrapped with manilla paper.....	15.
Two layers asbestos paper, 1 in. hair felt.....	17.
Hair felt sectional covering, asbestos lined.....	18.6
One thickness asbestos board.....	59.4
Four thicknesses asbestos paper.....	50.3
Two layers asbestos paper.....	77.7
Wool felt, asbestos lined.....	23.1
Wool felt with air spaces, asbestos lined.....	19.7
Wool felt, plaster paris lined.....	25.9
Asbestos molded, mixed with plaster paris.....	31.8
Asbestos felted, pure long fibre.....	20.1
Asbestos and sponge.....	18.8
Asbestos and wool felt.....	20.8
Magnesia, moulded, applied in plastic condition.....	22.4
Magnesia, sectional.....	18.8
Mineral wool, sectional.....	19.3
Rock wool, fibrous.....	20.3
Rock wool, felted.....	20.9
Fossil meal, moulded, $\frac{3}{8}$ inch thick.....	29.7
Pipe painted with black asphaltum.....	105.5
Pipe painted with light drab lead paint.....	108.7
Glossy white paint.....	95.0
Two layers wood ($\frac{3}{8}$ "") separated by paper, lined with bright tin, and coated outside with asphaltum.....	16 to 18

* These tests agree remarkably well with a series made by Prof. M. E. Cooley of Michigan University, and also with some made by G. M. Brill, Syracuse, N. Y., and reported in Transactions of the American Society of Mechanical Engineers, vol. xvi.

TESTS OF PIPE COVERING MADE IN SIBLEY COLLEGE LABORATORY

TESTS OF ULTRO AND MAGNESIA COVERINGS

Size of pipe, 6 inches. Length, 50 feet in the case of bare pipe and Magnesia covered pipe, and 41 feet in case of Ultro covered pipe. The Ultro covering was composed principally of infusorial earth.

Tests made in the open with the same pipe on different days, weather conditions as nearly identical as could be judged. Temperatures were observed by nine thermometers located at equal intervals on either side of the pipe. Over magnesia covering were placed one thickness of building paper and one thickness of 10 ounce canvas. Over the Ultro covering were placed three thicknesses of building paper and one thickness of 10 oz. canvas.

TABLE OF RESULTS.

	Bare Pipe.	Magnesia.	Ultro.
Length of pipe, feet.....	49.3	49.3	40.1
Radiating surface.....	88.01	88.01	71.91
Thickness of covering, inches, over all.....	0.0	1.2	2.7
Wt. of covering per ft., lbs.	3.38	9.36
Steam pressure, absolute, lbs....	75.14	75.14	82.57
Steam quality.....	99.4	99.7	99.0
Temp. steam, deg. F. ave.....	307.0	307.65	313.3
Temp. air around pipe.....	83.7	87.28	76.31
Temp. air, external.....	79.0	78.0
Temp. difference, air and steam	223.3	229.37	236.99
Temp. exterior of covering.....	139.4	122.8
Wt. cond. steam, dry, per hr., lbs.	63.78	9.57	6.11
B.T.U. radiated per lb. steam, dry.....	898.6	898.02	894.0
B.T.U. radiated per hour.....	57312.7	8594.05	5462.34
B.T.U. radiated per deg. diff., of temp., air and steam, per hour by collector.....	1.6	1.6	1.6
B.T.U. radiated per deg. diff. of temp. air and steam, per hr., net.....	255.0	35.9	21.5
B.T.U. radiated per deg. diff. of temp. air and steam per hour per square foot.....	2.9	.408	.299
Relative amount of heat transfer, per cent.....	100.0	14.1	10.3

The following table translated from Péclet's *Traité de la Chaleur* gives in a general way the amount of heat transmitted through coverings of various kinds and of different thicknesses; the loss from a naked pipe is taken as 100:

LOSS OF HEAT THROUGH VARIOUS PIPE-COVERINGS.

Relative conductivity.	Thickness, in inches.							Kind of Covering.
	0.4	0.8	1.0	1.6	2.0	4.0	6.0	
	Relative Loss of Heat.							
0.04	29	20	18	13	11	7	6	Eider down, loose wool, hair felt, etc.
0.08	43	32	29	23	20	13	11	Powdered charcoal.
0.16	56	48	45	38	35	25	22	Wood across fibres.
0.32	66	63	62	58	55	44	41	Sand.
0.64	73	73	73	72	71	70	68	Clayey earth.
1.28	77	83	85	92	96	102	109	Stone, rock.
2.56	78	87	91	103	110	130	150	White marble.
5.12	79	90	95	109	118	149	180	Solid gas carbon.
10.00	100	100	100	100	100	100	100	Naked, or unprotected surface, iron.

59. Pipe Coverings.—For the insulation of the pipe many methods have been adopted, of which we may mention first the wooden tube and concentric air-space surrounding the pipe, Fig. 38. The tube is usually made by sawing out the interior portion of a log, leaving a shell or wall about two inches thick. Each length is provided with a mortise and tenon joint, and the different lengths are joined together by driving. These wooden tubes are slipped over the steam-pipe as it is laid, the pipe being held in a central position by collars, so as to leave an air-space about one inch thick surrounding the pipe. This pipe is usually strongly banded with hoop-iron, and the joints can be made water-tight when laid, but checks soon form in the wood-pipe and make crevices through which the soil-water can reach the steam-pipe. Recently a form of tube made of two layers of inch board separated by tarred felting has come into use and is in general to be preferred to the solid

tube as having superior insulating qualities. A view of such tubing partly in section is shown in Fig. 39.

The wooden-tube system of insulation is objectionable, principally because it does not protect the pipe from ground-

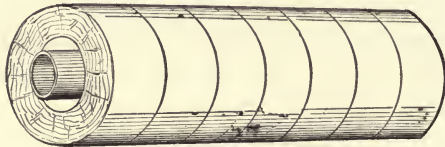

FIG. 38.—Pipe with Wooden-tube Insulation.

water, its durability, as proved by experience, is not great, and leaks in the steam-pipe are very difficult to locate and repair. A modified plan of the construction described has been employed, in which both steam- and return-pipes were covered with asbestos and hair felt and placed in a box made of 2-inch plank; the box was laid on a concrete bottom three inches thick, and after the pipes were laid it was completely surrounded with concrete. This was arranged so that the steam-pipes would not be disturbed by decay of the wood. The concrete would in that event support the steam-pipes and constitute a protecting tube. The heat insulation proved on trial to be much superior to that of the solid wooden tube, while its cost was somewhat less.

Similar constructions in which the wooden tube has been replaced by sewer-pipe are in use and are of superior durability. In one case familiar to the writer a wooden tube lined with sewer-pipe was laid outside the steam-pipe, the whole being covered with earth;

such a construction replaced one shown in Fig. 38, but in practice its heat-insulation properties have not proved to be better.

The best system of transmitting steam long distances, but probably also the most expensive, is to be obtained by building a conduit lined with brick or masonry laid in cement and sufficiently large for inspection and repairs. The pipe should

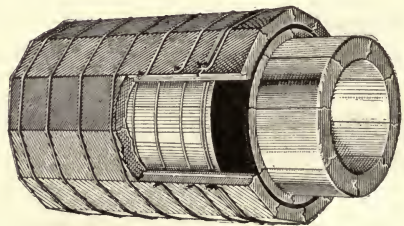

FIG. 39.—Wyckoff Built-up Wood Tubing.

be carried in it on proper hangers and thoroughly wrapped with insulating material.

60. Tests of Pipe Coverings.

TESTS OF WYCKOFF WOOD PIPE COVERING

Made in Sibley College Laboratories.

Duration of run, $2\frac{1}{2}$ hrs. Barom., 29.37 in. Size of pipe, $1\frac{1}{2}$ in. Length of Pipe, 100 ft. Radiating Surface, 56.2 sq. ft.

	Bare Pipe.	Covered Pipe.
Steam pressure, absolute.....	63.3	63.3
Quality of steam.....	100.0	100.0
Temperature of steam, deg. F.....	296.0	296.0
Temperature of air, deg. F.....	87.0	84.0
Temperature difference, air and steam.....	209.0	212.0
Temperature, exterior of pipe covering.....	288.0	193.0
Weight of condensed steam, actual, lbs.....	95.8	16.8
Weight of condensed steam, per hour, dry, lbs.....	95.8	16.8
B.T.U. radiated per lb. steam.....	906.7	906.7
B.T.U. radiated per hour.....	34745	6093
B.T.U. radiated by pipe, net.....	34411	5754
B.T.U. per deg. diff. temp., air and steam, per hour.....	164.6	27.1
B.T.U. per deg. diff. temp., air and steam, per hour, per sq.ft.....	2.93	.48
Relative amount of heat transmitted.....	100.0	16.4

Professor Allen gives costs on piping tunnels of \$7.00 and \$9.00 per foot. One pipe covering catalogue gives prices of \$1.00 per foot for 4-inch pipe and \$2.00 per foot for a 12-inch pipe, for high pressure steam, and 20 per cent less cost for low pressure steam or hot water.

61. Transmission of Steam Long Distances.—The loss of heat from systems protected by a simple wooden tube is considerable, rising in many cases to from 30 to 40 per cent of that from the bare pipe. This is, however, due to the poor system of insulation used, since it should not exceed in any case 20 per cent of that from naked pipe. The loss from the underground system of piping at Cornell University, which is somewhat over one-half mile in length, and in which the steam-pipes are laid inside of sewer-pipe, with a wooden tube outside the sewer pipe, the whole covered with about 4 feet of earth,

causes the consumption of about two and one-half tons of coal per day, which is about 10 per cent of the total coal consumption when the plant is working at normal capacity. This heat loss is very nearly a constant amount and cannot be expressed as a fixed percentage of the total steam used, for the reason that when the steam consumption is large this percentage of loss is small and *vice versa*.

High-pressure steam for power purposes is also sometimes transmitted in this manner and engines operated at a great distance from the boiler-plant. The losses from such a system of transmission are often serious, especially if a long pipe-line has to be kept hot, and if the engine is operated only a part of the time or only at partial capacity. Where the engine is worked to its full capacity, the loss is not usually large in proportion to the total transmitted. The following paragraph gives a careful estimate, based on actual experiment, of the loss experienced in transmitting constant power by various methods a distance of 1000 feet.

The loss in transmitting power by any system is principally constant, and hence when the power is greatly increased the percentage is correspondingly reduced. The following estimate is based on the transmission of 100 horse-power 1000 feet:

Method of Transmission.	Percentage of Loss.
Line shafting:	
Loss by friction.....(average 32)	25 to 40
Electricity:	
Loss in transforming from mechanical to electrical, and <i>vice versa</i>	20 to 30
Line loss.....	2 to 5
Total loss, electrical transmission.....	22 to 35
Conveying steam:	
Naked steam-pipe (still air).....	37 to 45
Pipe covered with solid wood and earth.....	11 to 13

For operating machinery which is required occasionally or at intervals electricity is no doubt the most economical medium, since when the demand for power ceases the expenditure on

account of transmission also becomes nothing, which is rarely the case either with line-shafting or steam.

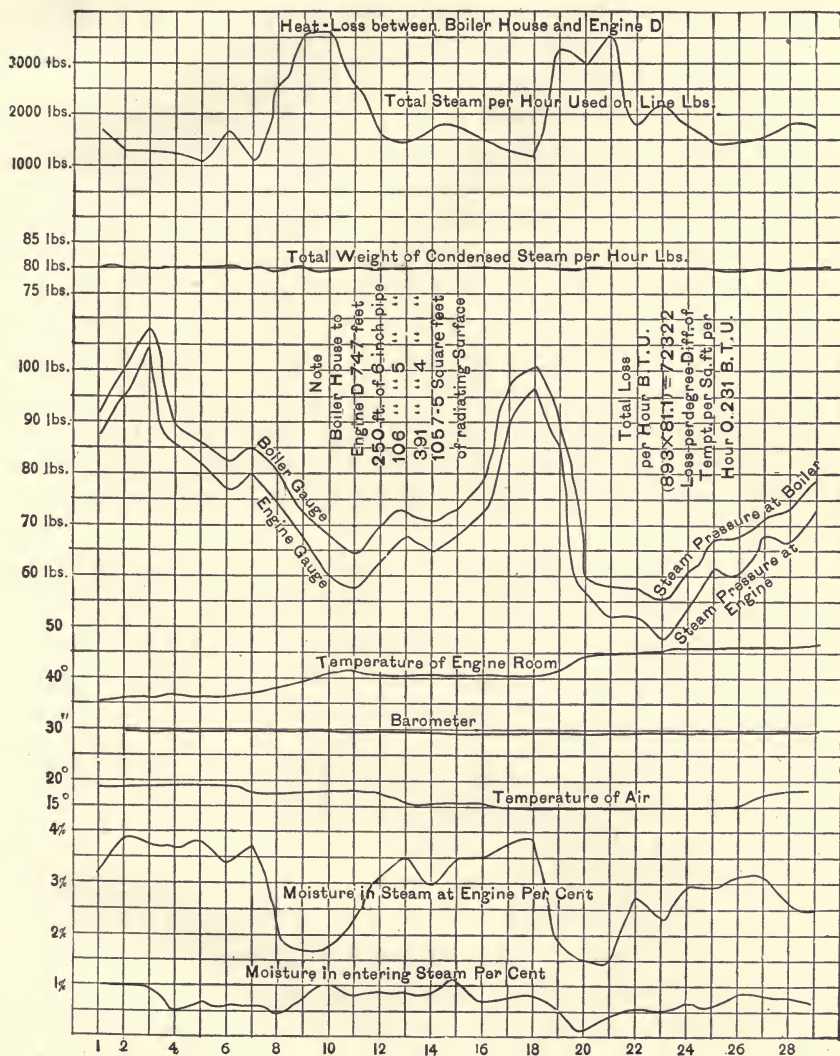

FIG. 40.—Diagram Showing Results of Test to Determine Heat-loss in Under-ground Pipe.

The diagram, Fig. 40, gives the summary of the results of a test of the Lehigh Coal-storage Plant, South Plainfield, N. J.,

made by the writer to determine the heat lost in supplying an engine situated 740 feet from a boiler-house, the connecting pipe-line consisting of 250 feet of 6-inch, 106 feet of 5-inch, and 391 feet of 4-inch pipe, having a total radiating surface of 1057.5 square feet.

The engine was 12-inch diameter, 16-inch stroke, running with a piston speed of about 600 feet a minute, thus producing, when cutting off at one-third stroke, a velocity of steam of about 60 feet per second in the 4-inch supply-pipe.

The general method of testing gave the total amount of steam used, and the fall in pressure between the boilers and engine. The amount of water in the steam was determined by a throttling calorimeter at both ends, the sample of steam being drawn in each case from a vertical pipe located close to a bend from a horizontal, and collected by a half-inch nipple extending past the centre of the vertical pipe. The drip was caught at places which had been provided in the pipe, and was weighed from time to time.

The barometer readings were taken with an aneroid which had been compared with a mercurial barometer. The corrected readings are given in the summary as well as in the diagram. Simultaneous observations were taken every ten minutes. A study of the summary shows that the loss was sensibly constant during the run. This is clearly shown by noting the fact that any increase in the amount of steam flowing through the line had the effect of decreasing the percentage of moisture at the engine.

The total heat loss per hour was 72,322 B.T.U. The average steam-pressure was 70.1 pounds by gauge, its temperature 313.6° F., and the average outside temperature 16.6° F. The loss for each degree difference of temperature between that of outside air and that of steam was 243.7 B.T.U. per hour. The loss in B.T.U. per square foot per hour was 0.229 per degree difference of temperature.

This for a difference of temperature of 150 degrees corresponds to an amount about 10 per cent of that which would have been given off from a naked pipe.

The loss by condensation varied from 3 to 8 per cent, the loss of pressure and consequent ability to do work about 6 per cent. The total loss was not far from 10 per cent from both these causes; if this had been proportional to length, it would have been 13.5 per cent for a line 1000 feet in length.

The diagram shows variations in the observed quantities as they occurred from time to time. It is to be noted that as the demand for steam at the engine was large the moisture in the steam delivered was correspondingly reduced.

CHAPTER V.

FLOW OF WATER, STEAM AND AIR.

62. Flow of Water and Steam.—It seems necessary to say a few words respecting the general laws which apply before considering the practical application. The velocity with which water flows in a pipe is computed from the same general laws as those applying to the fall of bodies. The velocity is produced, however, not by actually falling through a given distance, but by a difference of pressure, which must be expressed, not in pounds per square inch, but in feet of head. This head is in every case to be found by multiplying the difference of pressure by the height required for the given fluid to make one pound of pressure. If we denote by h the difference of head as described, by g the force of gravity = 32.16, by v the velocity in feet per second, we would have in case of no friction

$$v = \sqrt{2gh}.$$

The quantity discharged per second would be found in every case by multiplying the velocity by the area of the orifice in square feet.

In the flow of water in pipes there is considerable friction, which acts to reduce the velocity and the amount discharged; this increases with the length and decreases with the diameter of the pipe.

The friction caused by bends and by passing through valves and into entrance of pipes is of considerable amount, and often requires consideration. It can be considered as producing the same resistance to flow as though the pipe had been increased in length certain distances as follows: 90-degree elbow is equivalent to increase in length of the pipe $\frac{1}{2}$ diam-

eters, globe-valve 70 diameters, entrance of a pipe in tee or elbow 60 diameters, entrance in straight coupling 20 diameters.

The flow of steam in pipes presents some problems slightly different from that of flow of air, but in many respects the two cases are similar. There is a tendency for the steam to condense, which changes the volume flowing and affects the results greatly. The effect of condensation and friction is to reduce the pressure in the pipe an amount proportional to the velocity and also to the distance, and these losses are greater as the pipe is smaller. There are at the present time exact data regarding the steady flow of steam in pipes, yet it has been customary for writers to assume that the same laws which apply to the flow of water hold true for steam also, and that the same methods can be used in computing quantities. These results are certainly safe, although no doubt giving sizes somewhat larger than strictly necessary for the purposes required.

In estimating the size of steam-pipe for power purposes it is customary to figure the area of cross-section, such as giving a velocity of flow not exceeding 100 feet per second. This velocity is generally accompanied by a reduction of pressure in a straight pipe of about one pound in 100 feet. For steam-heating purposes the general practice is to use a much larger pipe and lower velocity, so that the total reduction in pressure on the whole system is much less; the effect of a drop in pressure of one pound will cause the water to stand in the return-pipe in a gravity system 2.4 feet above the water-level in the boiler.

63. Gravity Hot Water.—The velocity of water and steam in a gravity system of heating is due to a different cause from that in the case just considered, for the reason that the pressure upon the heater acts uniformly in all directions, and exerts the same force to prevent the flow into the boiler from the return, as to produce the flow into the main. For such cases the sole cause of circulation must be the difference in weight of the heated bodies, hot water, or steam, in the ascending column and the cooler and heavier body in the descending column. The velocity induced by a given force will be reduced in propor-

tion as the acting force is less. In the case of steam-heating the difference between the weight in the ascending and descending column is so great that the velocity will not be essentially different from that of free fall, provided correction is made for loss of head due to friction, etc., as explained, but in case of hot water the theoretical velocity produced will be found very small.

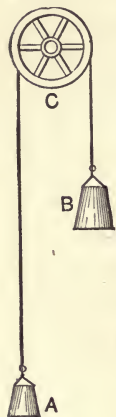

FIG. 41.

The case is analogous to the well-known problem in mechanics in which two bodies *A* and *B* of unequal weights are connected by a cord passing over the frictionless pulley *C* (Fig. 41).

The heavier body *B* in its descent draws up the lighter body *A*. In this case the moving force is to the force of gravity as the difference in the weights is to the sum of the weights, and the velocity is the square root of twice the force into the height.

In other words, if *f* equals the moving force, we have by proportion

$$f : g :: B - A : B + A,$$

from which

$$f = g \frac{B - A}{B + A},$$

which, substituted in place of *f* in formula $v = \sqrt{2fh}$, gives the following as the velocity:

$$v = \sqrt{\frac{2g(B - A)h}{B + A}},$$

h being the height fallen through.

In applying this to the case of hot-water heating we have, instead of the descent and ascent of two solids of different weights, the descent and ascent of columns of water connected as shown in Fig. 42, the heated water rising in the branch *AF* and the cooler water descending in the branch *BC*. The force which produces the motion is the difference in weight of water in the two columns; the quantity moved is the sum of the weight of water in both columns.

This is equal to the difference in weight of 1 cubic foot of the heated and cooled water divided by the sum, multiplied by the total height of

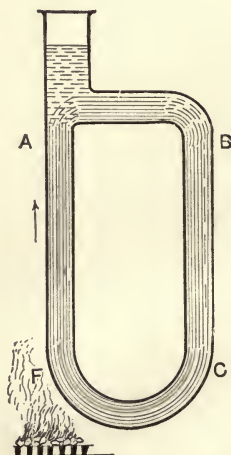

FIG. 42.—Circulation in Hot-water Pipe.

water in the system, so that if W_1 represents the weight of 1 cubic foot in the column BC , and W represents the weight of 1 cubic foot in the column AF , and h represents the total height of the system, then the velocity of circulation will be, in feet per second,

$$v = \sqrt{\frac{2gh(W_1 - W)}{(W_1 + W)}}.$$

In this formula no allowance whatever is made for friction, consequently the results obtained by its use will be much in excess of that actually found in pipes. The amount of friction will depend upon the length of pipe and its diameter. As result of experiment the writer found considerable variation in different measurements of velocity, but in no case did he find a velocity greater than that indicated by the formula. The following table is calculated from the formula without allowance for loss by friction. The computation is made with the colder water at 160 degrees F., although little difference would be found in calculations at other temperatures.

VELOCITY IN FEET PER SECOND IN HOT-WATER PIPES.

Height or Head in Feet.	Free Fall in Air.	Difference of Temperature.						
		1°	5°	10°	15°	20°	30°	40°
1	8.03	0.107	0.242	0.335	0.412	0.478	0.593	0.672
5	17.9	0.232	0.541	0.750	0.922	1.09	1.33	1.51
10	25.4	0.328	0.765	1.06	1.32	1.55	1.88	2.14
20	35.9	0.463	1.085	1.5	1.85	2.19	2.66	3.01
30	43.9	0.567	1.33	1.83	2.26	2.68	3.26	3.71
40	50.7	0.656	1.53	2.12	2.61	3.08	3.76	4.26
50	56.7	0.732	1.71	2.37	2.82	3.47	4.22	4.77
60	62.1	0.802	1.88	2.59	3.20	3.79	4.62	5.22
70	67.1	0.866	2.02	2.80	3.45	4.08	4.97	5.65
80	71.8	0.925	2.16	3.0	3.69	4.37	5.32	6.03
90	76.1	0.932	2.29	3.18	3.91	4.64	5.64	6.41
100	80.3	1.037	2.42	3.35	4.13	4.78	5.93	6.72

Experiments referred to in an article by Professor J. R. Allen, of the University of Michigan, in *Domestic Engineering*, December 22, 1906, indicate that the actual velocity in hot-water circulating pipes is about 25 to 50 per cent of the the-

oretical as given in the above table. The method usually employed in computing this velocity has been to consider the denser and lighter fluids occupying the relative positions shown in Fig. 43, the lighter fluid being in one branch of the U-tube, the heavier in the other.* If the cock be opened, equilibrium will be established, and the lighter liquid will stand in the branch higher than the heavier a distance sufficient to balance the difference in weight. If we suppose (1) the cock closed



FIG. 43.

and enough of the heavier material added to the shorter column, so that the heights in each are the same; (2) the cock opened, then the heavier liquid will move downward and drive the lighter liquid upward with a velocity said to be equal to that which a body would acquire in falling through the distance equal to the difference in heights when the columns were in equilibrium. This gives too great results, because it neglects the effect of the mass of the bodies moved. If friction be considered, we should have as a probable expression of velocity, using the same notation,

$$v = 50 \sqrt{\frac{(W_1 - W) h D}{(W_1 + W) l}}$$

64. Flow of Water Through Pipes.—As water is heated it expands and its density grows less. At 70 degrees F., a cubic foot of water weighs 62.3 lbs. while at 200 degrees F. a cubic foot weighs 60.12 lbs. On the other hand, heated water flows with less friction. The pipe friction formulas are based on experiments with water at ordinary room temperatures, and if the results are figured in pounds of water without any allowance for temperature, the results can be applied to hot water without sensible error since the effects of the decreased

* See Hood's work on "Warming Buildings," page 27. So far as the writer knows, this theory has not before been questioned.

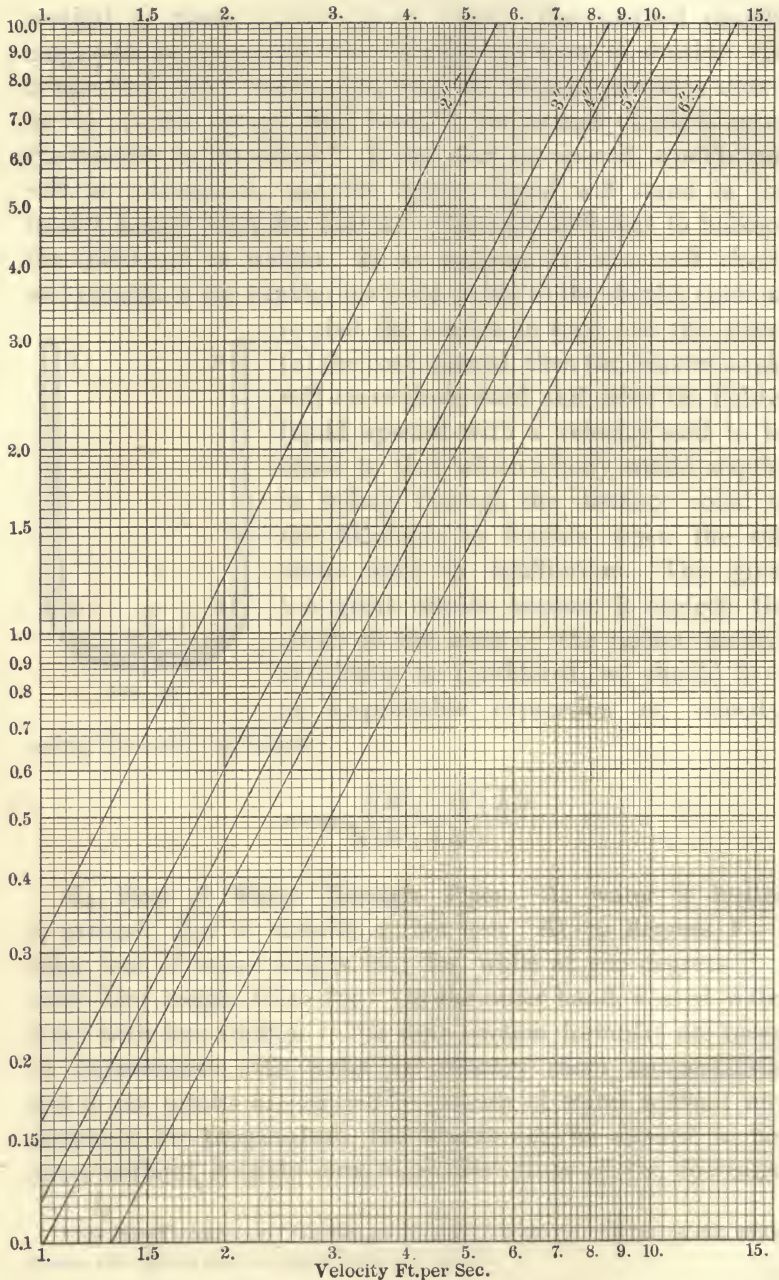

FRICITION HEAD PER 100 FT. OF PIPE—
 OLD WROUGHT IRON PIPE—RUSTED—UNCOATED—

friction and the decreased density of the water will then practically cancel. In other words, the weight of water flowing will remain practically the same regardless of the temperature but the volume will be affected by temperature changes.

The generally accepted formulas for the flow of water through pipes are as follows when v =velocity in feet per second, d =diameter and l =length and h =head, all in feet:

$$\text{(Eytelwein)} \quad v = 50 \sqrt{\frac{dh}{l + 50d}};$$

when d is very small with reference to l this becomes

$$v = 50 \sqrt{\frac{dh}{l}}.$$

$$\text{(Hawksley)} \quad v = 48 \sqrt{\frac{dh}{l + 54d}};$$

when d is small with reference to l this becomes

$$v = 48 \sqrt{\frac{dh}{l}}.$$

d becomes less than 1 per cent when l is 10 feet for 1-inch pipe and 50 feet for a 6-inch pipe.

Other formulas as the Chezy where

$$h_f = f \frac{LV^2}{D2g}$$

have a coefficient of friction which varies with the size of the pipe and with the velocity.

Williams and Hazen's Hydraulic Tables have complete sets of pipe friction values for all ordinary conditions.

Resistance of Pipe Fittings: Tests by F. E. Giesecke † with new 90-degree elbows give resistances of from 25 diameters for

* The preceding chart was drawn from Schoder & Gehring values for pipe friction on page 320 of Hughes and Safford's "Hydraulics."

† Professor of Architecture, University of Texas.

1½-inch pipe to 52 diameters with 7-inch pipe. Other fittings had the following equivalent values:

1—45-degree elbow equals.....	½—90 degree elbow.
1—open return bend equals.....	1—90 degree elbow.
1—gate-valve equals.....	½—90 degree elbow.
1—globe-valve equals.....	12—90 degree elbows.
1—tee equals.....	2—90 degree elbows.
1—sleeve (negligible) equals.....	16—90 degree elbow.
1—radiator with valve and union elbow equals.....	7—90 degree elbows.

65. The Flow of Air and Gases.—The flow of air obeys the same general laws as those which apply to liquids. The gases are, however, compressible, and the volume is affected very much by change of temperature, so that the actual results differ considerably from those obtained for liquids. These laws can only be expressed in mathematical formulas, from which, however, practical tables are derived.

The flow of air from an orifice takes place under the same general conditions as those of liquids, and we have the general formula $v = \sqrt{2gh}$ as applicable. In this case h is the head which is equal to the height of a column of air of sufficient weight to produce the pressure. Air under a barometric pressure of 30 inches and at 50 degrees in temperature is 801 times lighter than water. The pressure of air is usually measured by its capacity of balancing a column of water in a U-shaped tube, which may be expressed in inches of water. One inch of water-pressure is equivalent to 67.9 feet of air at 60°, and increases $\frac{1}{5}$ part for each degree of increase in temperature. The above formula is [only approximate, and does not account for the [change in temperatures and of pressures due to expansion, nor for friction head, contraction of discharge, etc.; its results are always high. Professor Unwin gives in the article "Hydromechanics," Encyc. [Brit., the following formula for computing the velocity of flow of air from an orifice:

$$\frac{v^2}{2g} = 183.6T \left\{ 1 - \left(\frac{p_2}{p_1} \right)^{0.29} \right\}.$$

T = absolute temperature;

p_1 = absolute pressure in vessel from which flow takes place;

p_2 = absolute pressure in surrounding space.

To find the volume discharged the velocity must be multiplied by the area, and that result by a coefficient which Prof. Unwin gives as follows:

Conoidal mouthpieces of the form of the contracted vein,	$c =$
with effective pressures of .23 to 1.1 atmosphere.....	.097 to 0.99.
Circular sharp-edged orifices.....	0.563 “ 0.788
Short cylindrical mouthpieces.....	0.81 “ 0.84
The same, rounded at the inner end.....	0.92 “ 0.93
Conical converging mouthpieces.....	0.90 “ 0.99

Weisbach gives as a formula for efflux of air under small pressure

$$Q = \mu F \sqrt{2g \frac{ph}{\gamma b}},$$

in which

F = area of discharge orifice;

γ = the weight per unit of volume;

p = initial absolute pressure in vessel from which flow takes place;

h = absolute pressure into which flow takes place;

b = the atmospheric pressure;

μ = the coefficient of discharge having the following values for pressure less than $\frac{1}{6}$ that of the atmosphere:

(1) for an orifice in a thin plate; $\mu = 0.56$;

(2) for a short cylindrical pipe; $\mu = 0.75$;

(3) for a well-rounded-off conical mouthpiece; $\mu = 0.98$;

(4) for a conical pipe whose angle of convergence is about 6° ; $\mu = 0.62$.

If we denote by τ the absolute temperature in degrees centigrade, the last formula may be written, for dimensions in feet,

$$Q = 1299 \mu F \sqrt{(1 + 0.004\tau) \frac{h}{b}} \text{ cubic feet per second.}$$

The *flow of air* in a pipe is retarded by friction and eddy currents the same as water, and is also affected by the change in volume and density dependent upon change in temperature and pressure. The formulas generally employed for computing the flow of air through pipes are obtained from Weisbach's "Mechanics of Engineering"; they are based on carefully conducted experiments, and are as a rule sufficiently correct for practical purposes. Prof. W. C. Unwin* has modified some of the Weisbach formulas by comparison with recent experiments, and has deduced in this manner other formulas which are probably somewhat more accurate than those of Weisbach, although usually giving essentially the same results. *Loss of head or pressure* in pipes through which air is flowing may be due to friction, transformation of pressure head into velocity head, changes due to gravity dependent upon difference of elevation. Neglecting the latter, the loss of head is due to friction and velocity. The velocity head is that portion of the total head transformed into velocity and is expressed by the formula

$$h_1 = \frac{v^2}{2g}.$$

The friction head is that required to overcome the friction, and is given by Unwin, for a circular pipe,

$$h_2 = 4\zeta \frac{l}{d} \frac{v^2}{2g}.$$

Weisbach's formula is slightly different in form, but gives exactly the same results.

In the above formulas

l = length in feet,

d = diameter in feet,

v = velocity in feet per second,

ζ = the coefficient of friction.

The total loss of head is equal to the sum of the two expressions. Unwin gives the following values for the coefficient of friction ζ :

* Article "Hydromechanics," Encyclopedia Britannica, Vol. XII.

$$\text{For ordinary pipes } \zeta = 0.005 \left(1 + \frac{3}{10d} \right), \quad 4\zeta = 0.02 \left(1 + \frac{3}{10d} \right).$$

$$\text{For smooth pipes } \zeta = 0.0028 \left(1 + \frac{3}{10d} \right), \quad 4\zeta = 0.0112 \left(1 + \frac{3}{10d} \right).$$

Weisbach gives as a value for 4ζ :

$$4\zeta = 0.026 \text{ to } 0.015 \text{ for pipes of different kinds.}$$

$$4\zeta = 1.61 \text{ to } 1.41 \text{ for } 90^\circ \text{ elbows.}$$

$$4\zeta = 0.47 \text{ to } 0.48 \text{ for long bends of } 90^\circ.$$

M. Ledoux obtained the following formula for the flow of air in pipes from the results of some very extended experiments * on the flow of air and steam through long pipes:

$$\text{The loss of head } h_2 = \frac{k \delta l v^2}{d}.$$

δ = the weight per unit of volume.

k = a coefficient which, for metric measure and a straight horizontal conduit, equals 0.00091 (this corresponds to a value of $0.0172 = 4\delta$ as used by Weisbach, which is intermediate in amount to those given).

Other symbols as before.

Taking into account all these conditions, Prof. Unwin gives as a formula for the flow of air in a circular pipe

$$u_0 = \sqrt{\left\{ \frac{gctd}{4\zeta l} \frac{p_0^2 - p_1^2}{p_0^2} \right\}},$$

in which u_0 = velocity in feet per second;

$$c = 53.15;$$

$$t = \text{absolute temperature};$$

$$g = 32.16;$$

$$d = \text{diameter in feet};$$

$$l = \text{length in feet};$$

$$\zeta = \text{coefficient of friction} = 0.005 \left(1 + \frac{3}{10d} \right);$$

$$p_0 = \text{greatest absolute pressure};$$

$$p_1 = \text{least absolute pressure.}$$

* Annales des Mines, Vol. II. Paris, 1892.

For a velocity of 100 feet per second ζ varies from 0.00484 to 0.01212 for a diameter varying from 1.64 ft. to 0.164 ft.

For a temperature of 60° F. and for a pipe one foot in diameter and 100 feet long $\zeta=0.006$. For barometer reading of 30 inches, pressure being expressed in inches of water, $p_0=407$, we have

$$u_0 = 1.512 \sqrt{(p_0 - p_1)(p_0 + p_1)}.$$

From the above formula the third column in Table XXVI of Appendix is computed. It is noted from the general formula for velocity, that the velocity varies as the square root of the diameter in feet divided by the length; from this it follows that to obtain the velocity for lengths and diameters other than given, the results in column (3) must be multiplied by $10\sqrt{d/l}$.

The fourth column of Table XXVI gives 0.7 of the theoretical velocity $v = \sqrt{2gh}$ under the conditions named above. It is to be noted that for velocities less than 40 feet per second the results by the latter method of calculation would not be greatly in error.

M. Ledoux states that the formula giving the pressure p at the extremity of a straight horizontal conduit which is supplied with a volume Q_0 cubic meters of air per second at the pressure p_0 and the temperature T_0 is as follows:

$$p^2 = p_0^2 \left(1 - 0.0001012 \frac{Q_0^2 T l}{T_0^2 d^5} \right) \text{ in metric units, centigrade degrees.}$$

From this the diameter of the pipe in meters is

$$d = 0.1589 \sqrt{\frac{Q_0^2 T l}{T_0^2 \left(1 - \frac{p^2}{p_0^2} \right)}} \text{ in metric units, centigrade degrees.}$$

Diameter in feet equals for a given flow of Q cubic feet per minute, English measures (feet) and Fahr. degrees,

$$d' = 0.0217 \sqrt{\frac{Q_0^2 T l}{T_0^2 \left(1 - \frac{p^2}{p_0^2} \right)}}.$$

This formula agrees closely with that of Prof. Unwin, given above.

66. Experiments on the Flow of Steam Through Pipes.—*

Where steam flows in a given pipe there are several factors which tend to dissipate or change the form of energy possessed by the steam. These may be classified as follows: (a) condensation, (b) friction, (c) expansion with changes of external energy, (d) the effect of gravity.

(a) The condensation may be divided into two parts, one the static condensation, that which occurs when there is no flow of steam; the other the dynamic condensation which occurs when there is a flow of steam. The latter should be less than the former on account of fall of pressure and temperature at the delivery part of the pipe, which tends to raise the quality of the steam, but the fall in pressure also involves a change in kinetic energy, and this, with other influences, seems to have made the amount of condensation very nearly the same for both cases.

(b) The friction in the pipe would cause a loss of pressure and require work to be done. If the pipe were a non-conductor and the expansion adiabatic, then there would be no loss of energy, but there would be a transformation of initial potential energy into external and kinetic. This change of energy between two points could be equated to a form involving the coefficient of friction, and its value thus derived. In practical work the adiabatic condition is seldom or never realized, for a pipe may be covered ever so well and still there is a loss of heat.

(c) The expansion would cause change in external latent energy which is accounted for by the steam table under different absolute pressures.

(d) The effect of gravity may be considered as *nil* in this series of experiments, as the pipe was horizontal. If the pipe were inclined any perceptible amount from the horizontal, the work could be computed, due to the delivery, and the height through which the steam raised or fell. We shall consider only the case of a straight, horizontal pipe.

* By E. C. Sickles and the Author. Presented at the New York meeting (1898) of the American Society of Mechanical Engineers, and forming part of Volume XX. of the *Transactions*.

TABLE 1.—FLOW OF

CALCULATED BY

LENGTH OF PIPE, ONE THOUSAND FEET.

DISCHARGE IN POUNDS PER MINUTE.

Corresponding to Drop in Pressure on Right, for Pipe Diameters in Inches in Top Line.

Diameter	24"	22"	20"	18"	16"	15"	14"	13"	12"	11"	10"
Discharge	14,000	11,188	8772	6678	4923	4163	3481	2871	2328	1853	1443
"	13,000	10,392	8144	6203	4573	3867	3233	2667	2165	1721	1341
"	12,000	9,593	7517	5724	4220	3569	2983	2461	1906	1589	1237
"	11,000	8,804	6891	5247	3868	3271	2736	2256	1830	1456	1134
"	10,000	7,992	6265	4770	3517	2974	2486	2051	1663	1324	1031
"	9,500	7,705	5947	4532	3341	2825	2362	1940	1580	1258	979
"	9,000	7,205	5638	4293	3165	2676	2237	1846	1497	1192	928
"	8,500	6,905	5321	4054	2989	2527	2113	1743	1414	1125	876
"	8,000	6,506	5012	3816	2814	2379	1989	1640	1331	1059	825
"	7,500	6,106	4695	3577	2638	2230	1865	1538	1248	993	873
"	7,000	5,707	4385	3339	2462	2082	1740	1435	1164	927	722
"	6,500	5,307	4069	3100	2286	1933	1616	1333	1081	860	670
"	6,000	4,908	3758	2862	2110	1784	1492	1230	998	794	619
"	5,500	4,508	3443	2623	1934	1635	1368	1128	915	728	567
"	5,000	4,108	3132	2385	1758	1487	1243	1025	832	662	516
"	4,500	3,709	2817	2147	1583	1339	1119	922	748	596	464
"	4,000	3,309	2505	1908	1407	1191	994	820	665	530	412
"	3,500	2,910	2191	1670	1231	1043	870	717	582	463	361
"	3,000	2,510	1779	1431	1055	895	746	615	499	397	309
"	2,500	2,110	1565	1193	879	747	622	592	416	331	258
"	2,000	1,711	1252	954	703	599	497	490	333	265	206
"	1,500	1,311	939	716	528	451	373	307	250	198	155
"	1,000	912	626	477	352	303	249	205	166	132	103
"	500	512	312	239	176	155	124	103	83.2	66.0	51.6

Diameter	9"	8"	7"	6"	5"	4"	3½"	3"	2½"	2"	1½"	1"
Discharge	1093	799	560	371	227	123	71.6	55.9	28.8	18.1	6.81	2.52
"	1015	742	521	344	210	114.6	68.6	51.9	27.6	16.8	6.52	2.34
"	937	685	481	318	194	106	65.6	47.9	26.4	15.5	6.24	2.16
"	859	628	441	292	178	97.0	62.7	43.9	25.2	14.2	5.95	1.98
"	781	571	401	265	162	88.2	59.7	39.9	24.0	12.9	5.67	1.80
"	742	542	381	252	154	83.8	56.5	37.9	22.8	12.3	5.29	1.71
"	703	514	361	239	146	79.4	53.5	35.9	21.6	11.6	5.00	1.62
"	664	485	341	226	138	75.0	50.5	33.9	20.4	10.9	4.72	1.53
"	625	457	321	212	130	70.6	47.56	31.9	19.2	10.3	4.43	1.44
"	586	428	301	199	122	66.2	44.5	29.9	18.0	9.68	4.15	1.35
"	547	400	281	186	113	61.7	41.6	27.9	16.8	9.03	3.86	1.26
"	508	371	261	172	105	57.3	38.6	25.9	15.6	8.38	3.68	1.17
"	469	343	241	159	97.2	52.9	35.6	23.9	14.4	7.74	3.40	1.08
"	430	314	221	146	89.1	48.5	32.6	21.91	13.2	7.10	3.11	0.99
"	390	286	200	132	81.0	44.1	29.6	20.0	12.0	6.45	2.83	0.90
"	351	257	180	119	72.9	39.7	26.6	18.0	10.8	5.81	2.55	0.81
"	312	228	160	106	64.8	35.3	23.7	16.0	9.60	5.16	2.26	0.72
"	274	200	140	92.8	56.7	30.9	20.7	14.0	8.4	4.52	1.98	0.63
"	234	171	120	79.5	48.6	26.5	17.71	12.0	7.2	3.87	1.70	0.54
"	195	143	100	66.3	40.5	22.1	14.7	10.0	6.0	3.23	1.42	0.45
"	159	114	80.2	53.0	32.4	17.6	11.7	7.98	4.80	2.58	1.13	0.36
"	117	85.7	60.2	39.8	24.3	13.2	8.75	5.98	3.6	1.93	0.85	0.27
"	78.1	57.1	40.1	26.5	16.2	8.82	5.97	3.99	2.40	1.29	0.56	0.18
"	39.0	28.6	20	13.2	8.10	4.41	2.98	2.00	1.20	0.645	0.29	0.09

STEAM IN PIPES.

E. C. SICKLES, M.E.

LENGTH OF PIPE, ONE THOUSAND FEET.

DROP IN PRESSURE IN POUNDS PER SQUARE INCH.

Corresponding to Discharge on Left; Densities and Corresponding Absolute Pressures per Square Inch in First Two Lines.

Density. Pressure	.208 90	.215 93	.222 96	.230 100	.239 104	.248 108	.256 112	.265 116	.273 120	.284 125	.295 130	.306 135	.316 140
Drop ...	18.10	17.5	16.9	16.4	15.8	15.2	14.7	14.2	13.8	13.3	12.8	12.30	11.9
"	15.60	15.1	14.6	14.1	13.6	13.0	12.7	12.2	11.9	11.4	11.0	10.66	10.3
"	13.3	12.8	12.4	12.0	11.6	11.2	10.8	10.4	10.1	9.74	9.38	9.04	8.75
"	11.1	10.7	10.4	10.0	9.66	9.21	9.02	8.71	8.46	8.13	7.83	7.54	7.31
"	9.25	8.94	8.66	8.36	8.05	7.75	7.52	7.26	7.5	6.78	6.52	6.29	6.09
"	8.33	8.05	7.80	7.53	7.25	6.99	6.77	6.54	6.35	6.10	5.87	5.66	5.48
"	7.48	7.23	7.01	6.76	6.51	6.27	6.08	5.87	5.70	5.48	5.27	5.09	4.92
"	6.67	6.45	6.25	6.03	5.80	5.59	5.42	5.24	5.08	4.88	4.70	4.53	4.39
"	5.91	5.71	5.54	5.35	5.14	4.96	4.80	4.64	4.50	4.33	4.17	4.02	3.89
"	5.19	5.02	4.86	4.69	4.52	4.35	4.22	4.07	3.95	3.80	3.66	3.53	3.42
"	4.52	4.37	4.24	4.09	3.93	3.79	3.67	3.55	3.44	3.31	3.19	3.07	2.98
"	3.90	3.77	3.65	3.53	3.39	3.27	3.17	3.06	2.97	2.86	2.75	2.65	2.57
"	3.32	3.21	3.11	3.00	2.89	2.78	2.70	2.61	2.53	2.43	2.34	2.26	2.19
"	2.79	2.69	2.61	2.52	2.43	2.34	2.27	2.19	2.13	2.04	1.97	1.90	1.84
"	2.31	2.23	2.16	2.09	2.01	1.94	1.88	1.81	1.76	1.69	1.63	1.57	1.52
"	1.87	1.81	1.75	1.69	1.63	1.57	1.52	1.47	1.42	1.37	1.32	1.27	1.23
"	1.47	1.42	1.38	1.33	1.28	1.23	1.19	1.15	1.12	1.08	1.04	1.06	.968
"	1.13	1.09	1.06	1.02	.983	.948	.918	.887	.861	.828	.797	.768	.744
"	.831	.804	.779	.752	.723	.697	.675	.652	.633	.609	.586	.565	.547
"	.577	.558	.541	.520	.502	.484	.469	.453	.440	.423	.407	.392	.380
"	.369	.356	.346	.334	.321	.309	.300	.290	.281	.270	.260	.251	.243
"	.208	.201	.195	.188	.181	.174	.169	.163	.158	.152	.147	.141	.137
"	.0923	.089	.086	.0835	.0803	.0774	.0751	.0725	.0703	.0676	.0651	.0627	.0608
"	.0231	.0223	.0216	.0209	.0201	.0194	.0188	.0182	.0176	.0169	.0163	.0157	.0152

Density. Pressure	.327 145	.338 150	.359 160	.380 170	.401 180	.422 190	.443 200	.464 210	.485 220	.506 230	.527 240	.548 250
Drop ...	11.5	11.1	10.5	9.91	9.39	8.92	8.50	8.11	7.76	7.44	7.14	6.87
"	9.92	9.60	9.04	8.54	8.09	7.69	7.33	6.99	6.69	6.41	6.16	5.92
"	8.46	8.18	7.70	7.28	6.90	6.55	6.24	5.96	5.70	5.47	5.25	5.05
"	7.06	6.83	6.43	6.08	5.76	5.47	5.21	4.97	4.76	4.56	4.38	4.21
"	5.88	5.69	5.36	5.06	4.80	4.56	4.34	4.15	3.97	3.80	3.65	3.51
"	5.30	5.13	4.83	4.56	4.32	4.11	3.91	3.73	3.57	3.42	3.29	3.16
"	4.76	4.60	4.33	4.09	3.88	3.69	3.51	3.35	3.21	3.07	2.95	2.84
"	4.24	4.10	3.86	3.65	3.46	3.29	3.13	2.99	2.86	2.74	2.63	2.53
"	3.76	3.64	3.42	3.23	3.07	2.91	2.78	2.65	2.53	2.43	2.33	2.24
"	3.30	3.19	3.01	2.84	2.69	2.56	2.44	2.33	2.23	2.13	2.05	1.97
"	2.87	2.78	2.62	2.47	2.34	2.23	2.12	2.02	1.94	1.86	1.78	1.72
"	2.48	2.40	2.26	2.13	2.02	1.92	1.83	1.75	1.67	1.60	1.54	1.48
"	2.11	2.04	1.92	1.82	1.72	1.64	1.56	1.49	1.42	1.36	1.31	1.26
"	1.77	1.72	1.62	1.53	1.45	1.38	1.31	1.25	1.20	1.15	1.10	1.06
"	1.47	1.42	1.34	1.26	1.20	1.14	1.08	1.04	.991	.949	.912	.877
"	1.19	1.15	1.08	1.02	.970	.922	.878	.838	.802	.760	.738	.710
"	.935	.905	.852	.805	.762	.724	.690	.659	.630	.604	.580	.558
"	.719	.695	.655	.619	.586	.557	.531	.507	.485	.465	.446	.429
"	.528	.511	.481	.455	.431	.410	.390	.373	.356	.342	.328	.315
"	.367	.355	.334	.316	.299	.284	.271	.259	.247	.237	.228	.219
"	.235	.227	.214	.202	.191	.182	.173	.165	.158	.152	.146	.140
"	.132	.128	.120	.114	.108	.102	.0977	.932	.0892	.0855	.0821	.0789
"	.0587	.0568	.0535	.0505	.0479	.0455	.0433	.0414	.0396	.0379	.0364	.0350
"	.0147	.0142	.0134	.0126	.0120	.0114	.0108	.0104	.0099	.0091	.0091	.00877

General Equations.

If P be any pipe of uniform diameter, d , and E_1 the energy of the steam entering a section, as A , in one second, and E_2 the energy leaving a section B , at the distance of L feet from A , then

$$E_1 - E_2 = E_c + E_f + E_e + E_g \quad \dots \quad (1)$$

where E_c = dynamic condensation energy;

E_f = friction energy;

E_e = expansion energy;

E_g = gravitation energy.

Now, since in steam tables the energy E_e of the latent external energy is included in the total energy of steam at any pressure, it need not be considered for our present purpose; also E_g is negligible because our pipe is horizontal.

Writing E_1' and E_2' for the new form of (1), we have:

$$E_1' - E_2' = E_c + E_f \quad \dots \quad (2)$$

This is an indeterminate equation for certain values of E_c and E_f , but if E_c can be determined by direct measurement, or if the pipe can be so protected that the condensation loss is negligible, the equation becomes determinate. It is also possible to make the velocity of steam so much that the heat developed by friction shall make the loss by condensation zero, in which case the equation is also determinate. Let the total loss of energy be denoted by E , then we have that

$$E = E_1' - E_2' = E_c + E_f \quad \dots \quad (3)$$

from which

$$E - E_c = E_f \quad \dots \quad (4)$$

Various expressions for the value of E_f , the loss by friction, have been given by various writers, and an excellent discussion of the results obtained by use of different formulæ is given in *Engineering*, March 19, 1897, by Mr. Arthur J. Martin.

It seemed desirable, after obtaining unsatisfactory results with other formulæ, to reduce all experimental results by the formula given by Unwin in article "Hydro-Mechanics," page 484 (*Encyclopædia Britannica*), which is reduced from Weisbach. In accordance with this formula the frictional work is for the length of pipe L .

$$E_f = f \frac{V^2}{2g} \frac{4}{d} WL = f \frac{V^2}{g} \frac{2}{d} WL \dots \dots \dots (5)$$

In which f = coefficient of friction, V = velocity in feet per second, d = diameter in feet, W = weight of fluid per second. This substituted for E_f in equation (4) gives

$$E - E_c = f \frac{V^2}{g} \frac{2}{d} WL \dots \dots \dots (6)$$

The value of E_c was found by experiment to average 1,700 foot-pounds per second for the pipe, protected as well as possible by covering.

The loss of head

$$h = f \frac{V^2}{g} \frac{2}{d} L.$$

Let p equal loss of pressure in pounds per square inch, and D density of the fluid or weight per cubic foot, then will

$$p = \frac{hD}{144}.$$

The values of the coefficient obtained in these experiments do not differ materially from those obtained by the experiments cited in vol. xii., *Encyclopædia Britannica*, article "Hydro-Mechanics." Professor Unwin gives formulæ for the coefficient of friction for flow of *water* through pipes, as follows: $f = 0.005 \left(1 + \frac{1}{12d}\right)$, and for a slightly incrustated pipe, $f = 0.01 \left(1 + \frac{1}{12d}\right)$. For the flow of *air*, by experiments at St. Gothard tunnel:

$$f = 0.0028 \left(1 + \frac{3}{10d}\right) \text{ for air.}$$

By experiments by M. Arson on pipes which were probably rougher,

$$f = 0.005 \left(1 + \frac{3}{10d} \right) \text{ for air.}$$

The experiments at Sibley College, which have been cited, indicate a value of the coefficient of friction for steam flowing in pipes, as follows:

$$f = 0.00223 \left(1 + \frac{3}{10d} \right) \text{ for steam.}$$

The experiments at Oriskany indicated the coefficient of friction:

$$f = 0.0026 \left(1 + \frac{3}{10d} \right) \text{ for steam.}$$

The tables were calculated for a coefficient of friction,

$$f = 0.0027 \left(1 + \frac{3}{10d} \right) \text{ for steam.}$$

In the last five formulæ, d , the diameter, is to be taken in feet.

The complete expression for loss of head in pounds, p , is obtained by substituting the value 0.0127 for K in equation (11), in which case

$$p = 0.000131 \left(1 + \frac{3.6}{d'} \right) \frac{w'^2 L}{D d'^5},$$

in which d' = diameter in inches, L = length in feet, D = density. The discharge in pounds per minute

$$w = 87.45 \sqrt{\frac{p \delta d^5}{\left(1 + \frac{3.6}{d} \right) l}}$$

The diameter in inches

$$d = 0.167 \sqrt[5]{\frac{w^2 l}{p \delta} \left(1 + \frac{3.6}{d} \right)}.$$

These formulæ also agree closely with experiments made by Ledoux.

From the above table, it is seen that the loss of water by evaporation is not very small, and that the loss of water by leakage is not very small.



Diagram illustrating the water wear and loss at the bottom of a dam. The vertical axis represents the vertical distance from the top of the dam to the bottom, and the horizontal axis represents the horizontal distance from the left side of the dam to the right side. The diagram shows the profile of the dam and the water flow, with the loss of water by evaporation and leakage indicated by the shaded areas.

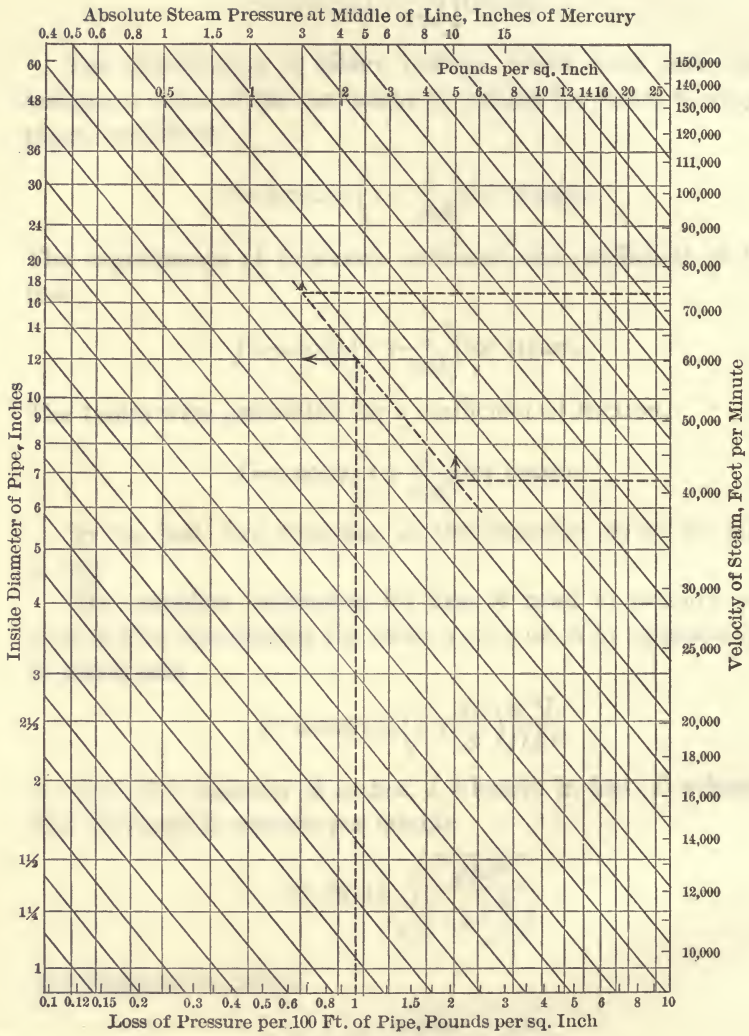

Friction of Pipe, Fittings.—For steam, the length of pipe in inches equivalent to one elbow is

$$L' = 52d' - \left(1 + \frac{3.6}{d'}\right),$$

and to one globe-valve

$$L' = 70d' - \left(1 + \frac{3.6}{d'}\right),$$

where d' and L' are both in inches.

The loss through gate-valves was found to be negligible.

67. Charts for Flow of Steam in Pipes.—The following charts, taken from *Power* and prepared by Prof. H. V. Carpenter, of Washington University, present a ready means of obtaining the velocity of steam in feet per minute and also the steam delivered in pounds per minute. The charts were developed from experiments made by Mr. Sickles and the author and are extended over a somewhat wider field, but the results seem to check quite well with practice so they can perhaps be accepted as representing the truth as closely as is possible at present.

The method of reading the charts is shown by the heavy dotted lines; for example, following the dotted lines on the velocity chart, it is found that if the loss of pressure is assumed to be 1 lb. per 100 feet of pipe, in a 12-inch pipe, and the absolute pressure is 5 lb. per sq.in. at the middle of the pipe line, then the velocity of the steam will be a little over 41,000 feet per minute; or, if the pressure is 3 inches of mercury the velocity will be nearly 74,000 feet per minute.

In a similar way the quantity chart shows that, with a drop of 1 lb. per 100 feet, in a 12-inch pipe, and an average pressure of 5 lb. per sq.in., the quantity of steam delivered will be 440 lb. per minute; or if the pressure is 3 inches of mercury, 250 lb. per minute will be delivered; or if the pressure is 1 inch of mercury, 150 lb. will be delivered.

The charts may, of course, be worked in any direction so that if any three of the quantities are known or assumed the fourth may be determined.

It will be noted that by using both charts for the same

case the velocity required to deliver a given quantity of steam per minute may be determined; for example, in the first case given above it follows from the results obtained with both charts that to deliver 440 lb. of steam per minute through a 12-inch pipe at an average pressure of 5 lbs. absolute, a velocity of 41,000 ft. per minute will be required.

All of the charts are calculated for saturated steam. There should be little error, however, in their use for superheated steam provided that instead of the actual pressure of the superheated steam we use the pressure at which saturated steam has the same weight per cubic foot.

In the calculation of the charts it has been assumed that the nominal diameter of the pipe is its actual diameter. The error due to this will not be noticeable, except, perhaps, for piping over 12 inches in diameter, which is rated by its outside diameter. In these larger sizes the actual inside diameter should be used in applying the charts.

If it should be desired to apply the charts to pipes which are not circular in cross-section, it would be necessary to calculate the hydraulic radius (cross-section divided by perimeter) of the conductor. This multiplied by four would be the equivalent diameter.

The enormous velocities which the velocity chart shows to be permissible at low pressures emphasize the need of avoiding sudden bends or offsets in condenser piping.

68. Dimensions of Registers and Flues.—The approximate dimensions of registers and flues can be computed from consideration of the limiting velocity of entering air.

For residence heating the velocity in flues is likely to be as follows, in feet per second:

	Warm-air Duct.	Ventilating Duct.	Entering Air at Register.	Discharge Air, at Register.
First story.....	2.5 to 4	6	3	4
Second story.....	5	5	3	4
Third story.....	6	4	3	3
Attic floor.....	7	3	3	2½

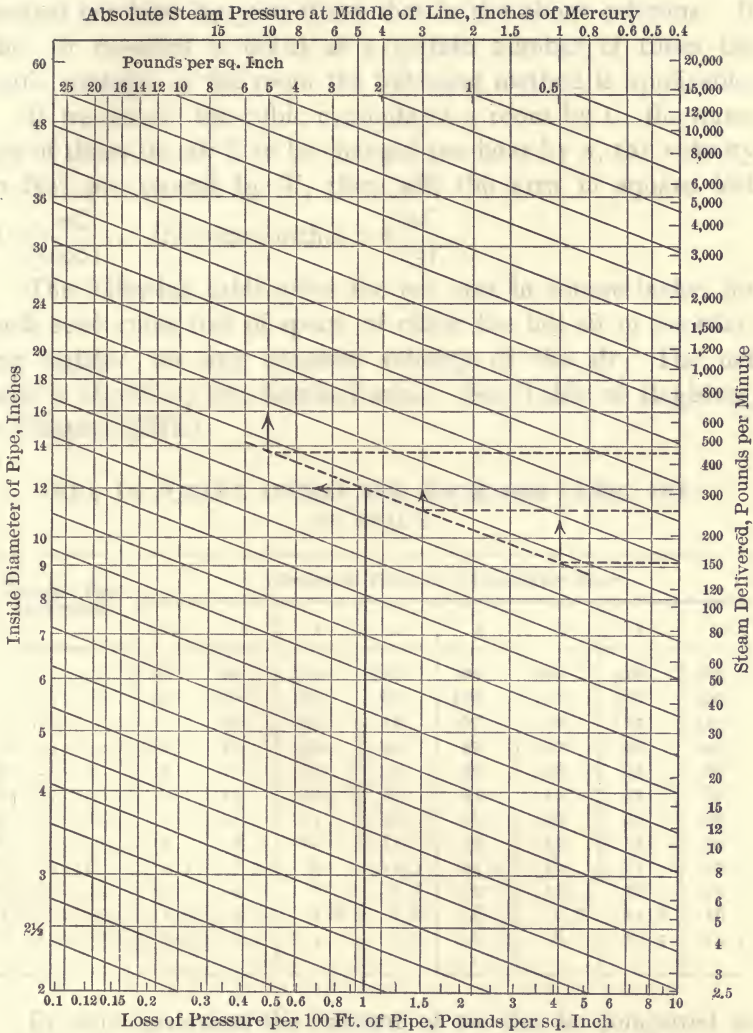

A variation of the size, contents of the room, quantity of steam required by appliances, etc. For ventilation purposes the pressure of superheating the steam is selected simply by comparison with the steam required on the basis of the cubic feet per hour for each room which will occupy the room; second,

The following is a list of the names of the officers and crew of the aircraft which were shot down or crashed during the operations mentioned above.

No.	Name	Rank	Service No.	Regiment	Notes
1
2
3
4
5
6
7
8
9
10
11
12
13
14
15
16
17
18
19
20
21
22
23
24
25
26
27
28
29
30
31
32
33
34
35
36
37
38
39
40
41
42
43
44
45
46
47
48
49
50
51
52
53
54
55
56
57
58
59
60
61
62
63
64
65
66
67
68
69
70
71
72
73
74
75
76
77
78
79
80
81
82
83
84
85
86
87
88
89
90
91
92
93
94
95
96
97
98
99
100

Continued on page 149

No.	Name	Rank	Service No.	Regiment	Notes
101
102
103
104
105
106
107
108
109
110
111
112
113
114
115
116
117
118
119
120
121
122
123
124
125
126
127
128
129
130
131
132
133
134
135
136
137
138
139
140
141
142
143
144
145
146
147
148
149
150

The velocity per hour being 3600 times that per second, the area of the duct can be found by dividing the cubic feet of air needed per hour by 3600 times that in the above columns. If the air required is taken as a certain number of times the cubic contents of the room the following method is applicable:

If we denote the cubic contents of a room by C , the number of times the air is to be changed per hour by n , the velocity in feet per second by V , then will the area in square feet

$$A = \frac{nC}{3600V}. \text{ In square inches } a = \frac{nC}{25V}.$$

The following table gives the net area in square inches for each 1000 cubic feet of space, of either the hot-air or ventilating register, for any required velocity of the air. The net area is about 0.7 the nominal area. (See Table of Registers, in Chapter XIII.)

AREA IN SQUARE INCHES FOR EACH 1000 CUBIC FEET OF SPACE

Velocity, Feet per Second.	Number of Times Air Changed per Hour.							
	1	2	3	4	5	6	8	10
1.....	40	80	120	160	200	240	320	400
2.....	20	40	60	80	100	120	160	200
3.....	13.3	26	40	53	67	80	107	133
4.....	10	20	30	40	50	60	80	100
5.....	8	16	24	34	40	48	64	80
6.....	6.7	13	20	27	33	40	53	67
8.....	5	11	15	20	25	30	40	50
10.....	4	8	12	17	20	24	32	40
15.....	2.7	5.3	8	11.3	13.3	16	21	26.6
20.....	2	4	6	8.5	10	12	16	20
25.....	1.6	3.4	4.8	6.8	8	9.6	12.8	16
30.....	1.3	2.7	4	5.7	6.7	8	10.5	13.3

In some instances the amount of air can be computed as a function of the cubic contents of the room, especially when required for ventilation alone. For ventilation purposes the problem of proportioning the air-passages is solved simply by computing, first, the air required, on the basis of 1800 cubic feet per hour for each person who will occupy the room; second,

the number of times the air will be changed per hour, by dividing this result by the volume of the room.

In applying this method to practical problems, it is best to proportion the ducts so that in no case will the required velocity of the air in the flue exceed 12 feet per second or 43,200 feet per hour, an amount not likely to be reached without a fan or blower, and one which corresponds to a pressure of nearly 0.1 inch of water.

69. Dimensions of Registers.—The registers should be so proportioned that the velocity of the entering air will not be sufficient to produce a sensible draft; that is, the area must be such that the velocity shall not exceed 3 to 5 feet per second or 10,800 to 18,000 lineal feet per hour. The writer thinks that very excellent results are obtained by proportioning the registers for first floor so as to give velocity of $2\frac{1}{2}$ feet per second, and those of higher floors and at entrance to ventilating-shafts 3 feet per second. The results above, except for entrances to ventilating-shafts on the top floor, are less than is usually produced by natural draft, so that the area computed by dividing the total amount of air required by the number which expresses the velocity gives satisfactory results.

The above rules are for effective or clear opening, and this will be found in each case to be about two-thirds of the nominal or rated size of the register as shown in the table given in Chapter XIII.

By computing, from the data given, the number of changes of air per hour in room, the table on the preceding page can be used as explained to determine the effective area in square inches required for each 1000 cubic feet of space.

70. Size of Ducts for Indirect Heating.—An approximate method of computing the sizes of air-flues would evidently be that of dividing the total amount of air which is required in a given time by that delivered or discharged through a flue one square foot in area. A table is given for capacity of ventilating-pipes, see Appendix, Table XXV.

As an illustration, consider that of a room with 48 square feet of glass surface and 320 square feet of exposed wall surface,

and from which the heat loss per degree difference of temperature is 128. Supposing air in room to be 70° F. and that supplied by flue to be 100° F., we see by table page 265 that for every heat-unit as above there will be required 135 cubic feet of air per hour, and for this case we will require $135 \times 128 = 17,280$ cubic feet per hour. If excess of temperature of air in flue over that outside be considered as 50°, and height of flue as 10 feet, the discharge per square foot of flue (see table in Appendix) will be 242 feet per minute or 14,520 per hour. Hence the required area of the flue will be 17,280 divided by 14,520 = 1.19 square feet = 171 square inches. Areas of flues may be computed by the following table, making suitable allowance for friction.

THEORETICAL AREA OF FLUE IN SQUARE INCHES REQUIRED TO SUPPLY A GIVEN AMOUNT OF HEAT.

(Excess of temperature is 30°; allowance for friction, 0.)

Total Building Loss per Hour.	Building Loss per Deg. Dif. of Temp. per Hour. †	Height or Head of Flue in Feet.												
		5	10	15	20	30	40	50	60	80	100			
		Area of Flue in Square Feet.												
B.T.U.	B.T.U.													
700	10	12	8.5	7	5.5	4.6	4.1	3.5	3.3	3	2.7			
1,400	20	24	17.5	14	11	9.2	8.2	7.1	6.6	6.1	5.5			
2,100	30	36	26	21	16.5	14	12.5	10.5	9.7	9.1	8.1			
2,800	40	48	35	28	22	18.4	16.4	14	13.2	12.2	10.9			
3,500	50	60	43	35	27	23	21	18	16.3	15.2	13.6			
5,250	75	90	64	58	41	35	31	27	24	23	21			
7,000	100	120	87	71	55	46	41	35	33	31	27			
8,750	125	150	108	88	68	57	51	44	41	38	34			
10,500	150	180	129	116	82	69	61	53	48	46	41			
12,225	175	210	151	123	95	81	72	62	57	53	48			
14,000	200	240	173	141	109	93	82	71	66	61	55			
17,500	250	300	216	157	136	115	102	87	81	76	68			
21,000	300	360	258	212	164	138	122	105	98	152	82			
28,000	400	480	346	244	218	184	163	141	130	124	109			
35,000	500	600	432	315	273	231	204	175	163	153	136			
52,500	750	900	645	530	412	347	306	263	243	229	204			
70,000	1000	1200	865	715	545	462	408	352	326	306	273			
105,000	1500	1800	1290	1060	825	693	612	527	457	458	408			
140,000	2000	2400	1730	1410	1090	925	818	705	655	612	545			
175,000	2500	3000	2160	1760	1360	1150	1018	870	820	765	681			
210,000	3000	3600	2580	2120	1640	1380	1218	1055	980	915	817			

Table is computed by finding air required to supply heat when outside air is 0°, inside air 70°, and heated air 100°, and dividing this by the air supplied by a flue one square foot in area for the given height and a difference of temperature of 30°, as obtained in Table XVI. Actual flues should be taken 1 inch larger in each dimension to allow for friction. Ventilating-flues for a given height should be taken one-quarter larger than the values given in the table. It should be noted that this table gives the area of flue without allowance for loss due to friction, and in practice the results must be increased to give satisfactory service.

† Approximately equal to area of glass plus one-fourth the exposed wall-surface.

As the velocity of flow increases with difference of temperature between outside air and that in the flue, and is lessened when this difference is small, it is better to assume a mean difference of temperature so low that the computation will certainly afford plenty of air for ventilation.

The preceding table is computed by the method explained for different heights of flue and for a difference of temperature of the air in the flue over that in the space into which it discharges of 30° F.

For difference of temperature other than 30° multiply results in the table by the following factors to obtain the area of the flue:

Difference Temperature, Degrees.	Factor.	Difference Temperature, Degrees.	Factor.
10	1.74	50	0.775
20	1.22	60	0.71
40	0.87	70	0.655

For usual conditions of residence heating in which the air in the supply-flue is 30° above the temperature of the air in the room, and that in the ventilating-flue 20°, we may compute the approximate area in square inches of the supply- and ventilating-duct, by multiplying each heat-unit per degree difference of temperature lost from the walls by a series of simple factors which are easily memorized.

TABLE OF FACTORS FOR AREA OF AIR-FLUES.

Story of Building.	Supply-duct.			Ventilating-duct.		
	Approximate Head in Feet.	Velocity in Feet per Sec.	Factor for Area, Sq. In.	Approximate Distance to Roof.	Velocity in Feet per Sec.	Factor for Area, Sq. In.
	(1)	(2)	(3)	(4)	(5)	(6)
First Floor	5	2.8	2.40	47	5.5	0.93
Second Floor . . .	28	6.8	0.95	32	4.2	1.27
Third Floor	40	8.1	0.82	20	3.6	1.33
Fourth Floor . . .	50	9.0	0.71	10	2.6	2.17

As an example, find the required area of heat- and ventilating-ducts for a room with 200 square feet of exposed wall-surface and 30 square feet of glass; 30 plus one-fourth of 200 is 80, the approximate building loss per degree. This quantity multiplied by factors in columns (3) and (6) gives respective areas of flues in square inches with sufficient exactness for ordinary requirements.

71. Roof Ventilators.—There are a number of roof ventilators of different designs on the market. Some have wire glass tops so as to light the vent flue, and are equipped with automatic dampers controlled by a fusible link which closes it in case of fire. They are made in two general types, one with a rotating cowl with the opening on the leeward side, the other with a stationary top and hood. A roof ventilator tested by the author, showed good ventilating action when placed in a horizontal air current.

72. Power for Moving Air Through Ventilating System.—Air is moved through a building and its ventilating system only by some form of power expenditure. When unconfined air is warmed, approximately one-third of the heat imparted to it has no effect in raising its temperature, and is expended in the work of expanding the air. That work put into and stored in the air is, in part at least available for ventilating purposes. It is that which makes ventilation by gravity methods possible, and, under conditions designed with reference to that end, wholly inexpensive so far as the mechanical side of the problem is concerned. The working pressure which is due to differences in temperature and in weight between the air inside and the air outside of a building varies through a wide range. Even where that pressure is greatest it is yet so small that a close and dust-filled cobweb can resist it and arrest air-flow.

CHAPTER VI.

PIPE AND FITTINGS USED IN STEAM AND HOT-WATER HEATING.

56. General Remarks.—In this chapter will be found a concise description of pipe and fittings to be had regularly of most dealers. Such a description is entirely unnecessary to those familiar with current practice in the industry of steam and hot-water heating; but as the writer has found by experience detailed knowledge on this subject is often required, the following descriptions are deemed necessary.

It may be remarked in a general way, that for conveying heated air, galvanized or tin pipe or brick flues are usually provided, but for the purposes of conveying steam or hot water wrought-iron pipe is used almost exclusively.

57. Cast-iron Pipes and Fittings.—Cast-iron pipe was used very largely at one time for both supply-pipe and radiating surface in hot-water heating, but at present it is used only to a limited extent in greenhouse heating. For this purpose one size of pipe only is used, and this is $4\frac{1}{2}$ " outside diameter. The pipe weighs about 12 lbs. to the foot, and has a capacity of $\frac{1}{2}$ gal. per foot. The pipes are usually joined by socket-joints, for which purpose a socket is cast on one end of each pipe. The joints are formed by inserting one end of one pipe into the socket of another and filling the interspace either with melted lead, iron filings and sal-ammoniac, sulphur, iron cement, or red lead. The lead joint, which is ordinarily used, is formed by making a mould, by wrapping a hemp rope covered with clay around the joint, with a pouring-place on top into which the melted lead is run. After the joint cools the lead is driven into place with a calking-iron. The rust-

joint is a very excellent joint, and often used. It is made with a cement formed by saturating for ten or twelve hours iron

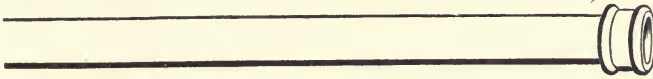

FIG. 44.—Cast-iron Pipe with Socket.

turnings or filings with sal-ammoniac. This cement is pressed into the socket, and then pounded tightly into place with a calking-iron. Joints made with Portland cement are sometimes used, but they are likely to crack from the heat, and cannot be recommended.



FIG. 45.—
Elbow for Cast-
iron Pipe.

The regular form of pipe and some of the principal fittings are shown in Figs. 44 to 48.

Special brackets are usually used where two or more lengths of pipe are run in parallel lines with a slight descent in the direction of the flow, and thus serve both for radiating surface and circulating pipes. For greenhouse heating, where the air is to be kept moist, a special pan to be filled with water, as shown in Fig. 47, supported by the pipes, is used at intervals.

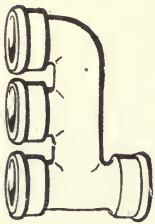

FIG. 46.—
Round Tee for
Cast-iron Pipes.

For the purpose of checking or stopping the flow a stop consisting of a flat plate, which can be set at any angle with the pipe, and of a form as in Fig. 48, is used. Each length of cast-iron pipe is sometimes pro-

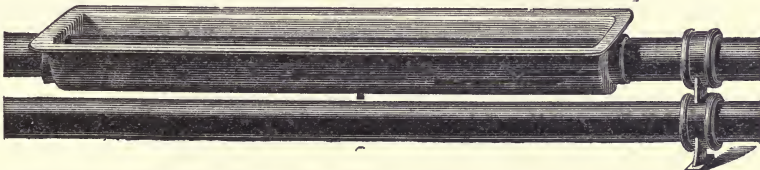

FIG. 47.—Radiating Surface and Pan for Holding Water to Moisten Air.

vided with flanges, and joints are made by bolting the pipes together, packing being inserted to prevent leaks. These are inferior to the calked joints.

58. Wrought-iron and Steel Pipe.—Pipe made of wrought iron or mild steel is generally used for the purpose of conveying steam or hot water in heating systems. This pipe is made in a number of factories and of standard sizes, so that the pipe obtained from one is reasonably certain to fit that from another. Wrought-iron or steel pipe is made from metal of the proper thickness, which is rolled into pipe shape, and raised to a welding heat, after which the edges are welded by drawing through a die. The smaller sizes, $1\frac{1}{4}$ inch and under, are butt-welded; the larger sizes are in all cases lap-welded.

Lap-weld Process.—The following description is taken from the National Tube Company's Handbook for 1913.—“The skelp used in making lap-welded tubes is rolled to the necessary width and gauge for the size tubes to be made, the edges being scarfed and overlapped when the skelp is bent into shape, thus giving a comparatively large welding surface, compared with the thickness of the plate. As a result of the work done in forging down the metal at the weld, tubes made in this way will probably be stronger at the weld than at any other place.

The skelp is first heated to redness in a “bending furnace,” and then drawn from the front of the furnace through a die, the inside of which gradually assumes a circular shape, so that the skelp when drawn through is bent into the form of a tube with the edges overlapping.

In the next operation the skelp so formed is heated evenly to the welding temperature in a regenerative furnace. When the proper temperature is obtained, the skelp is pushed through an opening in the front of this furnace into the welding rolls, passing between two rolls set one above the other, each having

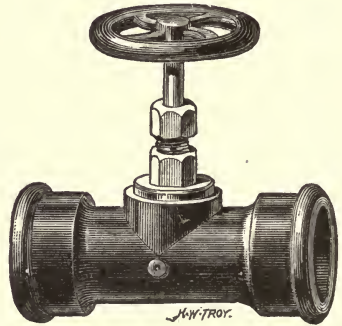

FIG. 48.—Valve or Stop for Cast-iron Pipe.

a semicircular groove, so that the two together form a circular pass. Between these rolls a mandrel is held in position inside the tube, the lapped edges of the skelp being firmly pressed together at a welding heat between the mandrel and the rolls. The tube then enters a similarly shaped pass to correct any irregularities and to give the outside diameter required. It will be noted that the outside diameter is fixed by these rolls; any variation in gauge, therefore, makes a proportional variation in the internal diameter. This also applies to butt-weld pipe. Finally, the tube is passed to the straightening, or cross rolls, consisting of two rolls set with their axes askew. The surfaces of these rolls are so curved that the tube is in contact with each for nearly the whole length of the roll, and is passed forward and rapidly rotated when the rolls are revolved. The tube is made practically straight by the cross rolls, and is also given a clean finish with a thin, firmly adhering scale.

After this last operation the tube is rolled up an inclined cooling table, so that the metal will cool off slowly and uniformly without internal strain. When cool enough the rough ends are removed by cold saws or in a cutting-off machine, after which the tube is ready for inspection and testing."

This pipe is put on the market in three different grades of thickness: first the *standard grade*, which is used principally for heating purposes; this is tested to a pressure of 250 lbs. per sq. in. and has the dimensions given in Table XVIII; it is manufactured in sizes from $\frac{1}{8}$ in. to 15 in. in diameter. Thicker pipe, called *extra strong*, and still heavier pipe called *double-extra strong*, is manufactured, and can be obtained if required. The thick piping has the same distinguishing name as pipe of standard weight, having the same external diameter, which is in all cases that of the external diameter of the standard pipe. The extra-strong and double-extra strong have smaller internal diameters than would be implied by the name; thus, for instance, inch pipe, standard size, has an inside diameter of about one inch, an outside diameter of 1.315 inches, while the extra-strong pipe of the same nominal size has the

same outside diameter and an inside diameter approximately 0.951 inch, while the double-extra strong has the same outside diameter and an inside diameter of 0.587 inch.

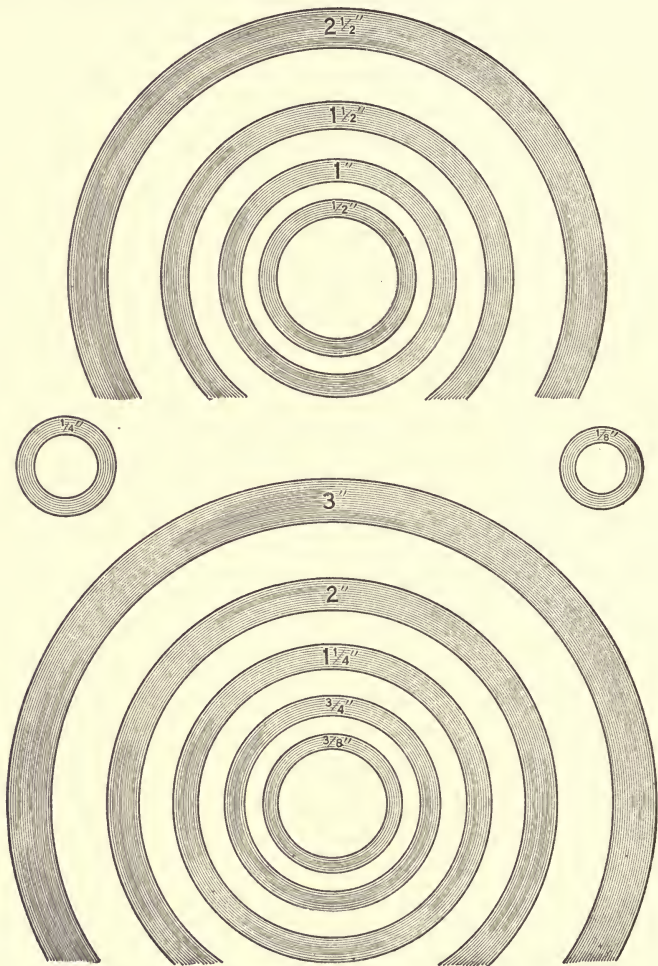

Fig. 49.—Section of Standard Pipes $\frac{1}{4}$ to 3 inches Nominal Size.

The following table gives the diameters, external and internal, and weights per foot, of the various kinds of pipe. In the table* the normal inside diameter is the actual diameter,

* See more extended table in Appendix.

or nearly so, for the standard pipe; sizes to $1\frac{1}{4}$ inch are butt-welded, larger sizes lap-welded:

Nominal Diameter (name), Inches.	Actual Outside Diameter, Inches.	Actual Inside Diam., In.		Thickness of Iron, Inches.			Weight per Foot, Pounds.			Threads per Inch.
		Extra Strong.	Double Extra Strong.	Standard.	Extra Strong.	Double Extra Strong.	Standard.	Extra Strong.	Double Extra Strong.	
$\frac{1}{8}$	0.405	0.215	0.068	0.095	0.24	0.31	27
$\frac{1}{4}$	0.54	0.302	0.088	0.119	0.42	0.54	18
$\frac{3}{8}$	0.675	0.423	0.091	0.126	0.56	0.74	18
$\frac{1}{2}$	0.84	0.546	0.252	0.109	0.147	0.294	0.85	1.09	1.71	14
$\frac{3}{4}$	0.105	0.742	0.434	0.113	0.154	0.308	1.13	1.47	2.44	14
1	1.315	0.957	0.599	0.133	0.179	0.358	1.68	2.17	3.66	$11\frac{1}{2}$
$1\frac{1}{4}$	1.66	1.278	0.896	0.140	0.191	0.382	2.28	3.00	5.21	$11\frac{1}{2}$
$1\frac{1}{2}$	1.9	1.500	1.100	0.145	0.200	0.400	2.73	3.63	6.40	$11\frac{1}{2}$
2	2.375	1.939	1.503	0.154	0.218	0.436	3.67	5.02	9.03	$11\frac{1}{2}$
$2\frac{1}{2}$	2.875	2.323	1.771	0.203	0.276	0.552	5.81	7.66	13.69	8
3	3.5	2.900	2.300	0.216	0.300	0.600	7.61	10.25	18.58	8
$3\frac{1}{2}$	4.	3.364	2.728	0.226	0.318	0.636	9.20	12.50	22.85	8
4	4.5	3.826	3.152	0.237	0.337	0.674	10.88	14.98	27.54	8
$4\frac{1}{2}$	5.	4.290	3.580	0.247	0.355	0.710	12.64	17.61	32.53	8
5	5.563	4.813	4.063	0.258	0.375	0.750	14.81	20.78	38.55	8
6	6.625	5.761	4.897	0.280	0.432	0.864	19.18	28.57	53.16	8

Each length of pipe as sold is provided with a collar or coupling screwed on to one end and has a thread cut on the other end. Connections are made by screwing the threaded end of one pipe into the coupling on the other. There is no standard length of pipes, the range usually being from 16 to 24 feet, with occasional short pieces. It can be ordered in lengths cut as desired for slightly extra prices; but it can be readily cut any length, and right- or left-handed threads may be cut as desired. It is quite malleable, and when heated may be bent into almost any shape by a skillful workman without materially changing the form of its cross-section.

59. Pipe Fittings.—Fittings for connecting pipes and for giving them any required direction with respect to each other are regularly on the market. These fittings are mostly made of cast and malleable iron, the prominent exception being straight couplings with right-handed threads in both ends, which are usually of wrought iron.

Cast-iron fittings are generally preferred to those of malleable iron in any system of piping for heating, for the reason that, being harder than the pipe and less elastic, they are not likely to stretch and yield sufficiently to permit leakage when the pipes are connected; if broken, a fracture can readily be detected and a new fitting supplied. Malleable-iron fittings frequently stretch if pipes are screwed somewhat too hard, so that future expansion and contraction is quite certain to cause a leak. If it is necessary to take down a long line of pipe in which no removable joints occur, a cast-iron fitting can be easily broken, thus often saving more time than the cost of the fitting, while the malleable fitting cannot be so disposed of. It is quite true that malleable fittings are stronger than cast-iron when of equal weight, but those on the market are much lighter than the cast-iron ones; and, moreover, the standard fittings are abundantly strong for any pressures likely to be sustained in ordinary systems of heating.

The standard pipes are considerably stronger than the standard fittings, and if extra heavy pressures are required, say 100 to 150 pounds per square inch, it is advisable to use special fittings, which differ from the ordinary ones principally in weight.

The fittings which are on the market can be divided into various classes, depending upon their use.

For high pressure superheated steam, considerable trouble has been experienced with cast-iron fittings. If cast-iron fittings are used for such purposes consideration should be given to this fact and precautions taken to prevent accidents from this cause.

Pipe Connections.—For joining pipes in the same line there is provided, first, the *wrought-iron coupling* shown in Figs. 50 to 52.

The coupling, usually with plain exterior, has right-hand threads cut in both ends, and is used principally in erecting a pipe line where the construction is continuous from one end to the other. A reducing coupling, Fig. 52, is frequently used for uniting pipes of different sizes. In cases where it is neces-

sary to "make up" or unite lines of piping which come together from different directions, a left-hand thread can be cut on the end of one of the pipes and the junction formed by using a coupling similar to the above, but with a right-hand thread cut in one end and a left-hand thread cut in the other, such a coupling being known as a *right-and-left coupling*. To use this coupling room is required for end motion of one of the pipes sufficient to insert it.



FIG. 50.
Coupling.



FIG. 51.
Right-and-left Coupling.



FIG. 52.
Reducing Coupling.

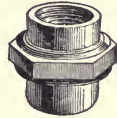

FIG. 53.
The Union.

In making up right-and-left couplings care must be taken that both threads on the pipe engage with those in the coupling at about the same instant. This can be done by screwing the coupling by hand on the end of each pipe, and counting the number of turns that can be made, noting the number of threads in sight after the joint is made up. This coupling, while sometimes difficult to use, forms the most certain method of uniting two pipe lines so that they will not leak. For join-

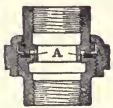

FIG. 54.
Section of Union.



FIG. 55.
Flange Union.



FIG. 56.
Long-threaded Nipple and Lock-nut.

ing pipes a coupling which separates into three pieces, termed a *union*, is often employed. The parts of the union are screwed onto the ends of the pipe, and are drawn together by a revolving collar which engages with the thread on one of the pieces. The joint is formed either by drawing flat faces in the union against some elastic and soft material, as packing, or else by producing contact of ground and fitted metallic surfaces. Pipes are also held together by screwing flanges to the

pipes, and drawing these flanges either in contact or against a ring of packing by bolts (Fig. 55). Such a joint is called a *flange union*.

Lengths of pipe are frequently made up by a short piece of pipe with a long screw-thread cut on one end, onto which is screwed a very short collar or lock-nut, Fig. 56. The junction is made between two ordinary pipe couplings by first screwing the long thread into one pipe coupling until the piece is short enough to be slipped into position, then it is screwed into the other coupling by unscrewing from the first. When screwed home, the collar or lock-nut is turned tightly against the first coupling, forming a steam-tight joint either by metallic contact or by use of packing.

Pipe Bends and Elbows.—For changing the direction of

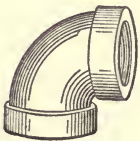

FIG. 57.—90°
Cast-iron Elbow.

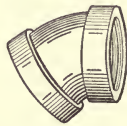

FIG. 58.—45°
Cast-iron Elbow.

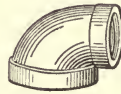

FIG. 59.—90°
Reducing Elbow.

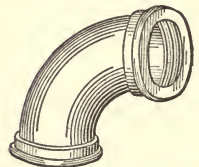

FIG. 60.—Long-
radius Elbow.

pipe lines there can be purchased elbows with bends of 45 or 90 degrees, also reducing elbows in which one opening is for smaller size of pipe than that of the other. The 90-degree elbow can be had either with right threads in both ends or with right and left threads, as required. The right-and-left threaded elbow can be used for making up two pipe lines in a manner similar to that described for a right-and-left coupling.

The internal diameter of elbows is somewhat in excess of that of the external diameter of the pipe, and the radius of the bend is, according to Briggs' table (Van Nostrand Science Series, No. 68), equal in nearly every case to the diameter of the pipe plus a constant which varies from $\frac{3}{8}$ inch for the smallest size of pipe to $\frac{1}{2}$ inch for the largest size. For the sizes of pipes used in heating the radius of curvature is practically equal to that of the diameter of the pipe plus $\frac{1}{2}$ inch.

Where the friction caused by a standard elbow is detrimental, special fittings (Fig. 60) can be obtained in which the radius of curvature is from two to three times that given.

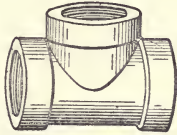

FIG. 61.
Plain Tee—Openings all Same
Size, Threads Right-handed.

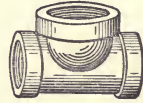

FIG. 62.
Reducing Tee—Openings Various
Sizes. (In describing state diam-
eter of branch last.)

Such fittings are especially desirable in heating by hot-water circulation, and often permit the use of smaller pipes than would be possible with standard fittings.

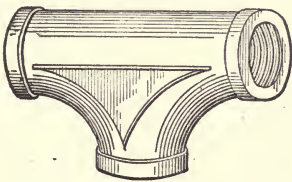

FIG. 63.
Long-radius Tee.

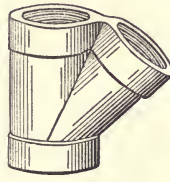

FIG. 64.
Y Fitting.

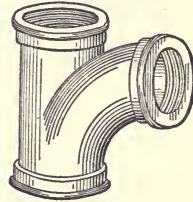

FIG. 65.
Long-radius Y.

Pipe Junctions, Tees, Y's, etc.—For the purpose of taking off one pipe line from another special fittings can be had, which are designated, according to their shape, as *tee*, *cross*,

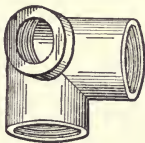

FIG. 66.
Side-opening Elbow.



FIG. 67.
Cross.

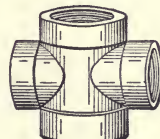

FIG. 68.
Reducing Cross.

side-outlet elbow, and *Y-branch*, all of which can be bought with the openings for the same or different sized pipes in any combination required.

These various fittings are shown in the annexed engravings.

Miscellaneous Fittings.—For reducing the size of opening in a fitting, bushings of cast (Fig. 69) or malleable iron can be used; for closing up the end of fittings a screwed plug (Fig. 70) can be employed; and for closing the end of a pipe a screwed cap (Fig. 71) can be used. Where a coil of pipe is desirable, it



FIG. 69.—Bushing.



FIG. 70.—Plug.



FIG. 71.—Cap.



FIG. 72.

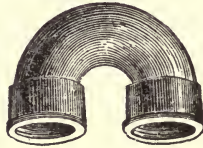
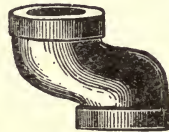

FIG. 73.

Return Bends.

FIG. 74.
Offset.FIG. 75.
Lock-nut.

can be formed by screwing pipes into U-shaped fittings, called return bends. These can be had with either right threads or right-and-left threads, and in close (Fig. 72) or open pattern (Fig. 73), and with the threads tapped so as to give nearly any pitch or rake of the pipe. For slightly changing the position of a pipe an offset (Fig. 74) can be used. To prevent leaking where a long-threaded nipple has been used, a lock-nut can be screwed on against a grummet, or ring of packing.

Fittings can also be had for erecting parallel lines of pipe,



FIG. 76.—Branch Tee, Plain.

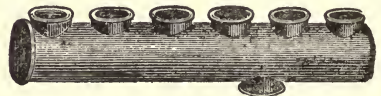

FIG. 77.—Branch Tee, with Back Outlet.

as shown in Figs. 76 and 77; they are termed *branch tees*, and can be had for almost any number of pipes, and for sizes varying from three-quarter to three inches. The distance between centres of branches is varied somewhat, but is usually 2 inches for three-quarter-inch pipe, $2\frac{1}{2}$ inches for one-inch

pipe, 3 inches for one-and-a-quarter-inch pipe, and $3\frac{1}{2}$ inches for one-and-a-half-inch pipe. The branch tees are fitted with opening for supply-pipe and discharge-pipe either in end or side as specified. In those made for circulation the holes are tapped with right-hand threads; those made for box-coils are tapped for left-hand thread on branches.



FIG. 78.
Shoulder
Nipple.

Short pieces of pipe called *nipples* can be had of any length required, provided with right-hand threads cut on both ends, or with right thread on one end and left thread on the other. Short pieces of pipe called quarter or eight-bends (Fig. 110) may be used in place of elbows when a long-radius turn is required.



FIG. 79.
Close
Nipple.

In addition to the fittings mentioned there can be had, for supporting the pipes to side walls, hooks and hook-plates with curved or straight arms, ringed plate, and coil-stand, as desired.

There can also be had hangers of various patterns for supporting and holding pipes from ceilings. These are of great variety of pattern, and are made so that, if desired, they can be put on after the piping is in place.



FIG. 80.—Hook-plate.



FIG. 81.—Expansion-plate.

The principal standard fittings as above described are also made of brass.

Ceiling and Floor Plates are collars used to hold the pipes in place, and to prevent overheating of wood-work by the steam or hot water. These are often made in halves, which may

be slipped on over the pipes, and are fastened to the woodwork by screws, thus holding the pipe in position and keeping it from contact with wood.

60. Valves and Cocks.—The fittings used for the purpose of stopping the passages in pipes are operated by moving

a disk across the pipe with or without rotation, or by simply turning through an angle. The first class have been generally called *valves*, the second *cocks*.

Valves are of two classes: the globe valve (Fig. 85), which closes an opening in a diaphragm parallel to the direction of flow, and the gate valve (Fig. 84), which closes an opening at right angles to the pipe.

The globe valve forms a serious obstruction, since any fluid in passing through

it must make two turns, each nearly a right angle; while the gate valve when open presents little or no resistance.

The globe valve is much more simple in construction than the gate valve, is cheaper, and often will answer all require-

ments for steam-heating, but will seldom do for hot-water heating. It should be set so that the valve closes against the flow; when set in the opposite way accidents might happen—for instance, if the valve should be detached from the stem it could not be opened, although the stem would move apparently all right. It will be noted that the diaphragm of the globe valve forms an obstruction in the pipe, which extends to the centre, and if the stem of this valve be set vertical when used for a horizontal pipe it is likely to cause the pipe to stand half full of water. Whenever used in steam-heating, on a horizontal pipe, the stem should be placed

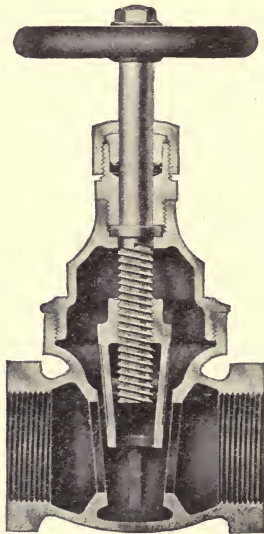

FIG. 84.—Gate Valve.

in a horizontal position, so that it will not interfere with the drainage of water of condensation from the pipe.



FIG. 82.—Ring-plate.



FIG. 83.—Coil-stands.

The construction of the gate valve varies in detail as made by different manufacturers, but it in general consists of a gate which is moved across the opening in the pipe by turning the stem. When the gate reaches the bottom of the pipe it moves laterally sufficient to bring a strong pressure on the seat.

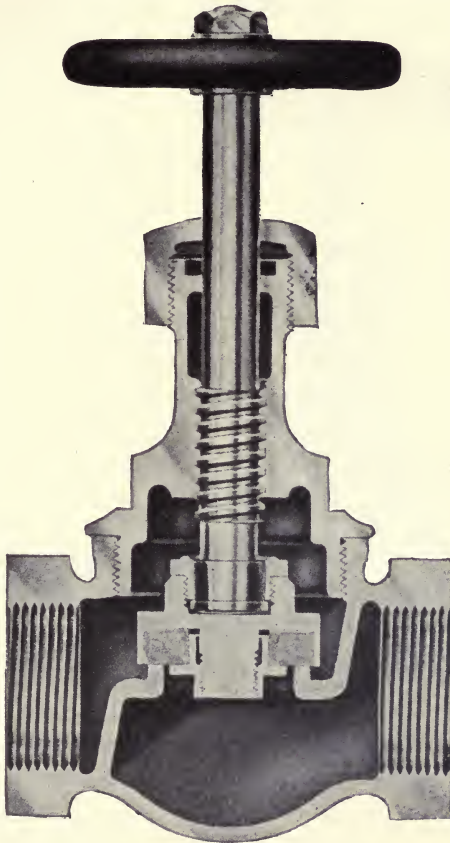

FIG. 85.—Globe Valve with Disk Seat.

These valves are made with a stem which rises with the gate or with one which remains in one position, the gate travelling up the stem (Fig. 84). This latter form is objectionable, as one cannot tell, by looking, whether the valve is open or closed.

Globe valves are made with a solid metallic seat, or with a seat made of soft metal or packing, as in Fig. 85, of such

a form that it can be replaced whenever the valve begins to leak.

Angle Valves (Fig. 86) are made in the same general way as globe valves, except that the openings are at right angles to each other. They cause a slightly greater resistance to motion than the ordinary elbow, but not sufficient to prevent their

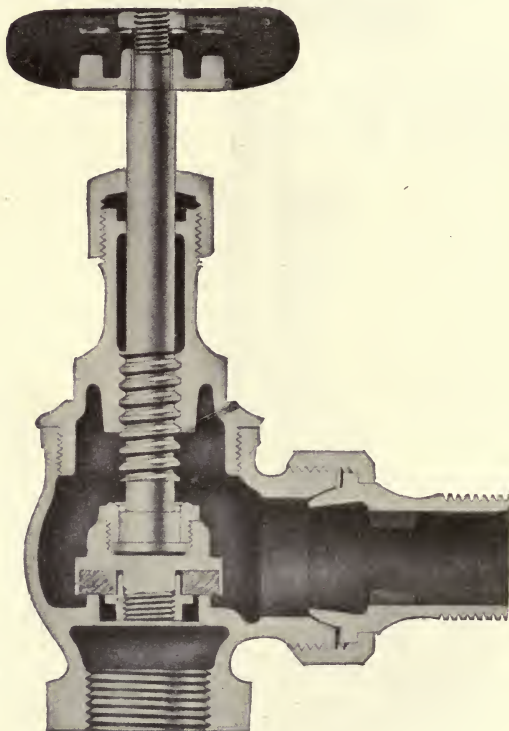

FIG. 86.—Angle Valve.

use for any system of heating. The seats are either metallic or of soft material, which can be removed.

Stuffing-boxes.—In all classes of valves a cavity is left around the stem, which must be filled with some packing material by turning back a cap-screw. Hemp, lamp-wicking, asbestos fibre, well oiled and, if possible, covered with plumbago, will make satisfactory packing for this purpose. Patent ring packing

can be purchased, usually made of asbestos fibre soaked in oil, and serves an excellent purpose.

Radiator Valves.—These are forms of angle valves with fittings making them especially convenient for radiator connections, being plain as shown in Fig. 87 or with an attached union as in Fig. 88. These are often nickel-plated.

Radiator valves for hot water, when closed, have a small opening left to allow for the expansion and contraction of the water.

The various kinds of valves which have been described are made with sockets for screwed connections to the pipes, or with flanges which are to be bolted to similar flanges screwed on the pipes as desired. They can also be had, especially for the larger sizes, with either brass or iron bodies.

Cross Valves.—A form of angle valve with one supply and two opposite discharge openings is sometimes convenient, and is termed a *cross valve*. (See Fig. 99.)

Corner Valves, in which the openings are at the same level but at right angles, can be purchased if desired (Fig. 89).

Cocks.—A plug, slightly conical, provided with one or more ports or holes through it, and arranged so that it can be turned in any direction, is termed a *cock*. When there is but a single hole it is called a plain cock. When two or more holes at angles to each other, it is called a two-way or three-way cock, since water can be directed in two or more directions by varying the angle through which the plug is turned. Cocks are very little used in steam-heating; as ordinarily made they are apt to leak, and, besides, do not provide a full opening for the fluid (Fig. 95).

Improved cocks with larger openings and with packed ends are now much used on the blow-off pipes from boilers, and are for this purpose superior to valves.

Quick-opening valves (Fig. 91) for use on hot-water pipes are often made on the same plan as cocks, and do excellent service in these places.



FIG. 87.
Radiator Valve.



FIG. 88.—Radiator Gate Valve.

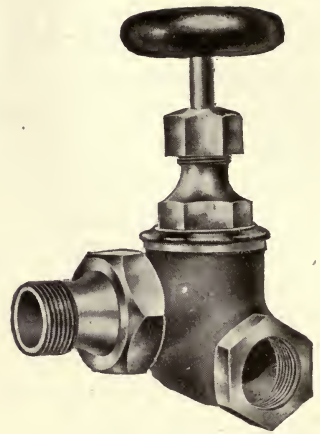

FIG. 89.—Corner Radiator Valve.

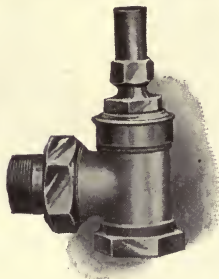

FIG. 90.—Lock and Shield for Radiator Valves.

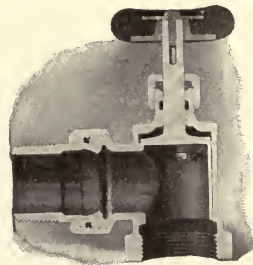

FIG. 91.—Bonnetless Water Radiator Valve.

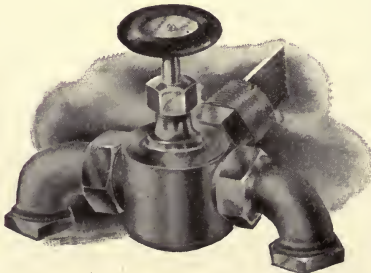

FIG. 92.—Single Pipe Water Radiator Valve.

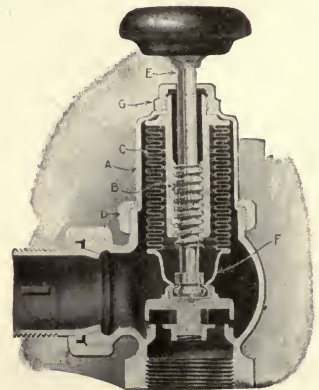

FIG. 93.—Syphon Packless Radiator Valve.

Check Valves.—Where it is necessary that the flow should always take place in the same direction and there is danger of a reverse flow, check valves are employed. These are usually of a similar pattern to the globe valve, the seat being at right angles to the direction of flow, with either a flat or ball valve (Figs. 96, 97). In this class the valve is held in place by its own weight or by the weight of the fluid in case of reverse flow. They are made for horizontal pipes, vertical pipes, or angles. One known as the swinging-check valve, in which the seat is at an angle of about 45 degrees to the direction of flow (Fig. 98), offers less resistance to the fluid, and is generally to be preferred.

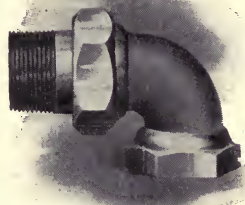

FIG. 94.—Union Elbow.

61. Air-valves.—It is necessary to provide means for allowing the air to escape in systems of steam and hot-water heating.

Air is heavier than steam, and although it will mix with it to a great extent, it will finally settle at or near the bottom of a radiator or pipe filled with steam. Air is, however, much lighter than water, and it will gather in any bends that are convex upward and in the upper part of radiators filled with water, and unless removed it will prevent circulation.

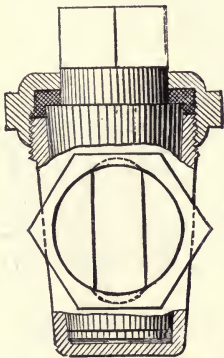

FIG. 95.—Packed Plug-cock.

For removal of the air several forms of valves and cocks have been especially manufactured. These are usually made of $\frac{1}{4}$ - or $\frac{1}{8}$ -inch pipe size, and vary in quality and design from the simplest valve

to be opened by hand to a complicated automatic pattern, which permits the escape of air, but not of water or steam.

One of the simplest patterns of air-valves is shown in Fig. 100. This can be had with a bibb if desired, also with various forms of handles or keys, and with nickel or brass finish.

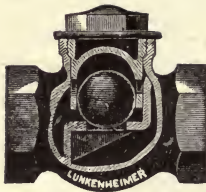

FIG. 96.—Horizontal Check with Ball Clack.



FIG. 97.—Horizontal Check Valve.

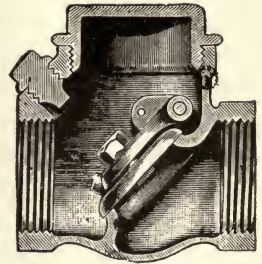
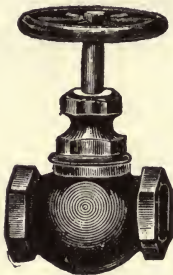

FIG. 98.—Swinging Check.



Globe Valve.



Angle Valve.

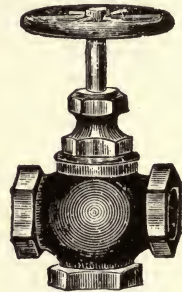

Cross Valve.



Horizontal Check Angle Valve.



Check Valve.



Vertical Check.

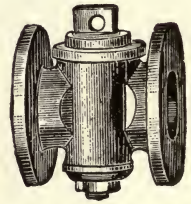

Steam Cock Flanged Ends.

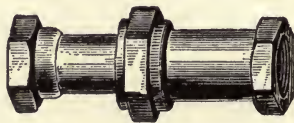

Expansion or Slip Joint.

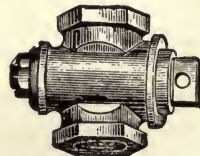

Steam Cock, Screwed Ends.

FIG. 99.—Principal Valves and Stops used in Heating.

Automatic air-valves are made of a great variety of patterns. Those for steam-radiators are all closed by the expansion of some material. Fig. 101 shows an expansion air-valve, in which the valve is closed by the expansion of a curved metallic strip. The valve will remain open until this curved strip becomes nearly equal in its temperature to that of the steam; the heat then increases its length and it bends out

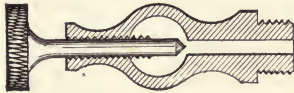

FIG. 100.—Simplest Pattern Air-valve.

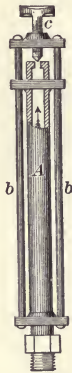

FIG. 102.—Automatic Air-valve.

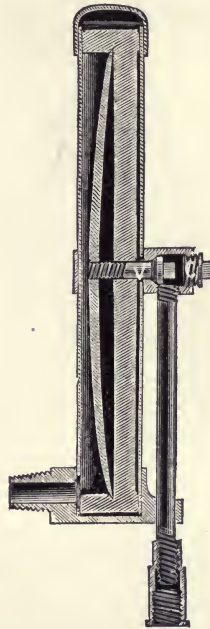

FIG. 101.—Breckenridge Automatic Air-valve.

sufficiently to close the valve. A drip-pipe is provided for removing any water of condensation escaping from the air-valve.

Another form, which has in the past been extensively used, is shown in Fig. 102. In this case the interior tube *A* is heated more than the frame *bb*; this serves to press the valve *c* against the end of the tube when it is heated, thus closing the orifice. This is best adapted for use in a vertical position.

A form of air-valve now in extensive use is shown in Fig.

103. In this a composite material which expands rapidly when heated is used instead of metal. It is claimed for some of these valves that with suitable adjustment of the inside screw the temperature of the radiator will be automatically maintained at any desired point—a mixture in any required proportion of air and steam being maintained in the radiator by this action.

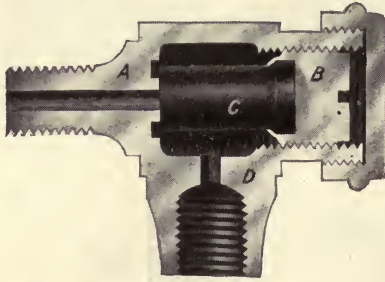

FIG. 103.—Composition Automatic Valve.

A—Inlet; B—Adjusting Screw; C—Expandible Plug; D—Outlet, Tapped to Connect Drip Cup or Drip Pipe.

To prevent escape of water and injury to furniture a radiator-valve with a float attachment is often used, as shown in Fig. 104. The valve is closed when heated, as in Fig. 103, by the expansion of a composite substance; it is connected to a

float, so that if water passes into the air-valve the float will rise and close the orifice regardless of the temperature.

An automatic air-valve for hot-water radiators is shown in

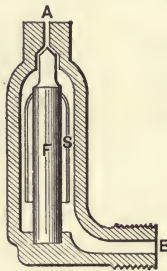

FIG. 104.—Radiator Air-valve with Float.

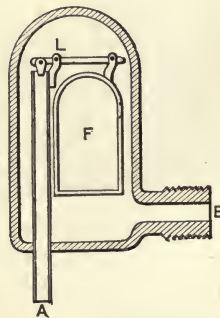

FIG. 105.—Hot-water Air-valve.

the sketch, Fig. 105. The air escapes at A, the orifice being closed by the float *F* acting on the lever *L*. So long as only air surrounds the float it sinks and keeps the orifice open, but as soon as water surrounds it it rises and closes the orifice.

Fig 106 shows a modern pattern of float air-valve. The floating element of this valve has such a short vertical travel that it will expand and close the valve tight when heated by contact with steam. These valves close and prevent the escape of both steam and water. A float valve with a siphon to return the excess water to the radiator and prevent the drowning out of the float is shown in Fig. 107.

62. **Expansion-joints.**—In the erection of any system of piping means must be provided so that the elongation of the

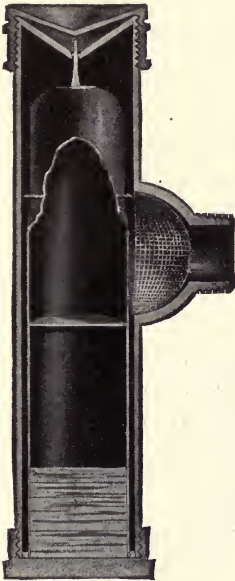

FIG. 106.



FIG. 107.

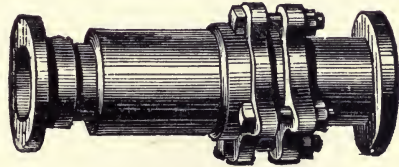

FIG. 108.—Flanged Expansion-joint.

pipe due to expansion will not cause a leak. For all ordinary purposes of heating the expansion can be provided for by the use of elbows and right-angled offsets, of such length that the expansion will simply cause one pipe to unscrew slightly in one or more joints. This requires the use of two or three elbows, and so causes a slight increase of resistance to flow due to friction; but it is a very satisfactory arrangement, and will stand for years without developing leaks, even with high-pressure steam, if properly erected.

The expansion of wrought iron is one part in 149,000 of length per degree F. The expansion of cast iron is somewhat less and varies between one part in 168,000 and one part in 180,000 of length per degree F., depending upon its composition. The expansion of steel is intermediate between that of wrought iron and that of cast iron; it varies between one part in 149,000 and one part in 162,000. The greatest expansion, that of wrought iron, is equivalent to about 1.45 inches per 100 feet length in changing from temperature of freezing to boiling, or nearly $1\frac{1}{2}$ inches per 100 feet of length.

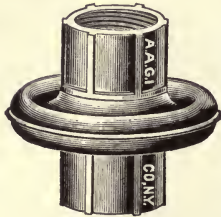

FIG. 109.—Bundy Elastic Coupling.

As it is impossible to confine this expansion without buckling the pipe or breaking the fittings, the piping has to be erected with bends, offsets, or expansion-joints, so situated as to provide enough flexibility to take up the expansion. Where there



FIG. 110.—Right Angle and Offset Bends.

They are much superior to cast fittings in steam piping as they provide largely for expansion, and by avoiding sharp corners give an easy flow to the steam.



FIG. 111.—Expansion Bend.

For use in long lines of steam pipe to allow for expansion.

is sufficient room, pipe bends provide adequate means of taking up the expansion. Bends can be made or obtained to nearly any radius not less than six times the pipe radius and for any number of degrees.

Pipe bends increase the resistance to the flow of water or

steam but little more than straight pipe, and the saving in friction head would often warrant their use without consideration of the effectiveness in taking up expansion. The use cuts down the number of joints, over all the other devices. For exposed piping in heating and ventilating their use is often awkward from an architectural standpoint, as piping usually run with or near the lines of the room, that is either vertically or horizontally.

Long lengths of pipe should be supported on rollers or swinging hangers so as to freely transmit the expansion to the bends, expansion-joints or offsets, which should be provided to take up the expansion.

Expansion-joints are often used constructed of copper pipe in form of a U-shaped bend; also of one or more diaphragms connected to each other at the edges and to the pipes near the centre (Fig. 109). The copper bend is always satisfactory. The last-named device works very well if means can be adopted to thoroughly drain off any water lodging against the diaphragm. If used in a horizontal position, and on large pipes it is likely to gather sufficient moisture to form a water-hammer that may produce rupture when steam is turned on.

CHAPTER VII.

RADIATORS AND HEATING SURFACES.

63. Qualities of an Efficient Steam Radiator.—The efficiency of a steam radiator is primarily dependent upon the temperature of the surface and upon the facility for utilization or abstraction of the heat which passes through its walls. In order to produce uniform temperature internally, it is necessary to abstract the air from the steam, which is facilitated by a positive and rapid circulation of the steam in all parts of the radiator. The water of condensation should also be removed since its temperature is likely to fall below that of the steam and it also produces pounding or water hammer. The presence of air, a condition known as "air binding," is the principal reason for uneven or partial heating of the radiator. The removal of the air is greatly facilitated by circulation of the steam.

The absorption of the heat transmitted through the walls of a radiator requires favorable conditions for radiation and convection. The construction should be such as to intercept as little as possible the radiant heat and induce as far as possible air-currents over the radiator which should absorb the heat from the surfaces, the absorption by convection being a function of the velocity. The amount of heat which will pass through various kinds of radiating surface is determined largely by experiment, and has been fully discussed in Chapter IV. In this chapter we will consider briefly the methods of construction.

64. Radiating Surface of Pipe.—Very efficient radiating surfaces can be made of coils of piping arranged as shown. The return-bend coil shown in Fig. 112 is made by connecting

return-bends with lines of straight pipe. The pipe mostly used is one inch in diameter, although, when the bends are numerous, $1\frac{1}{2}$ - or 2-inch pipe should be used to reduce the friction. In use the flow is continuous, the fluid entering at the top and thence with a gradual descent flowing to the right and left alternately, finally discharging at the bottom. There is a great deal of friction in coils of this class, and air is likely to gather in the bends and stop circulation. The writer would, therefore, recommend that they be employed only when other forms will not answer.

The branch-tee or manifold coil is constructed by connecting branch-tees with parallel lines of pipe. In each pipe-line

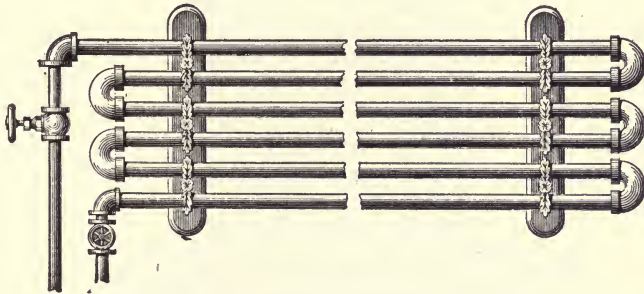

FIG. 112.—Return-bend Coil.

one or more elbows must be placed to counteract the effect of unequal expansion.

The coil may be arranged on a flat wall-surface so as to form a *mitre* branch-tee coil as in Fig. 113, lower part, or with both branch-tees at one end and elbows and nipples at the opposite end; the fittings at ends being connected by pipes having the proper pitch. Such a construction is called a *return* branch-tee coil, see upper part Fig. 113. The coil may be arranged on two sides of a room with the elbows placed in the intervening corner, in which case it is called a *corner coil*.

The various types of branch-tee or manifold coils as described present small frictional resistance to the flow of steam or water and give satisfactory service for either steam or hot-water heating.

If two connections are used the steam should be supplied at the highest point of the coil, and the return taken off at the lowest; if one connection, steam is to be supplied at the

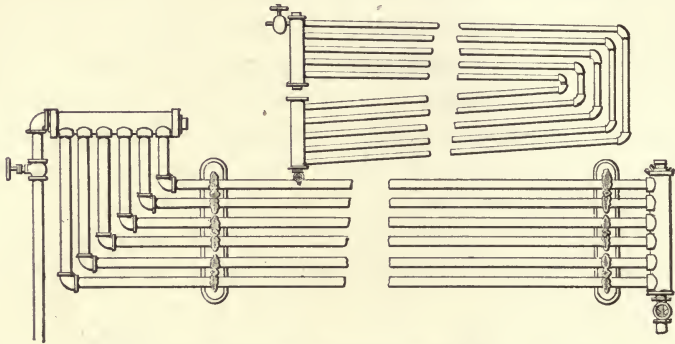

FIG. 113.—Branch-tee Mitre Coil and Return-coil.

lowest point. The horizontal portion should be given a pitch of one inch in ten or twelve feet, and an air valve or cock should be connected to each coil. When several return-bend coils

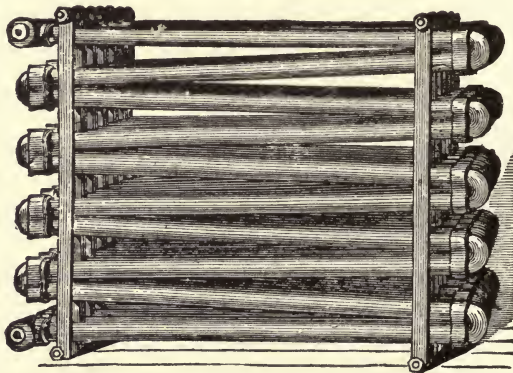

FIG. 114.—The Box Coil.

are grouped together, as in Fig. 114, the construction is termed a *box coil*. This has all the faults in an aggravated manner that were ascribed to the return-bend coil, and in addition causes a loss of efficiency due to close grouping of surface.

65. **Vertical Pipe Steam-radiators.**—These were at one time used extensively, and were made by screwing short pieces of vertical pipe into a cast-iron base and connecting the pipes in pairs at the top with return-bends. One form was made by screwing pipes, having the upper end closed and provided with an internal diaphragm, into a cast-iron base, the diaphragm being so placed as to produce the same circulation in one pipe that was obtained in two pipes with the other form.

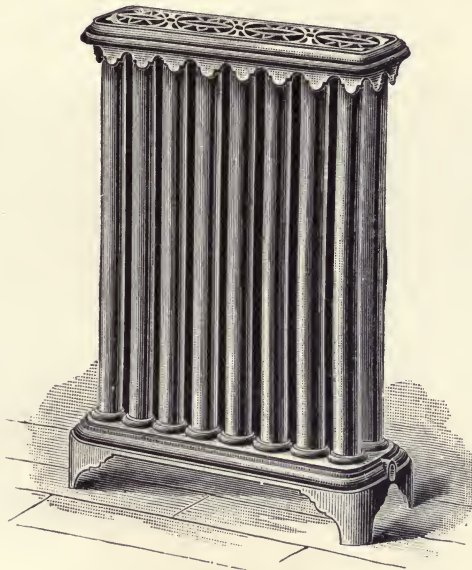

FIG. 115.—Pipe Radiator.

The pipes are arranged in two or more rows as necessary to secure the desired radiating surface. An air-valve must always be provided with these radiators, the best location for which is at about one-third the height of the radiator, and on the end opposite the admission.

The wrought-iron radiator is constructed in nearly every case of one-inch pipe, taken of such length that there is one square foot of exposed radiating surface for each pipe in the radiator. The form being quite regular its surface can be accurately measured.

66. **Cast-iron Steam-radiators.**—Cast-iron sectional radiators are now mostly used in direct heating.

Those principally used have vertical radiating surfaces, and are made by connecting a series of parallel vertical sections by nipples screwed from the outside or inside of the base. The sectional radiators can be increased or diminished in length by adding or taking off sections. The greater portion of those of recent design have a plain surface depending on their form alone for any esthetic effect. The following illustrations give a very fair idea of the appearance of those in use. They are painted

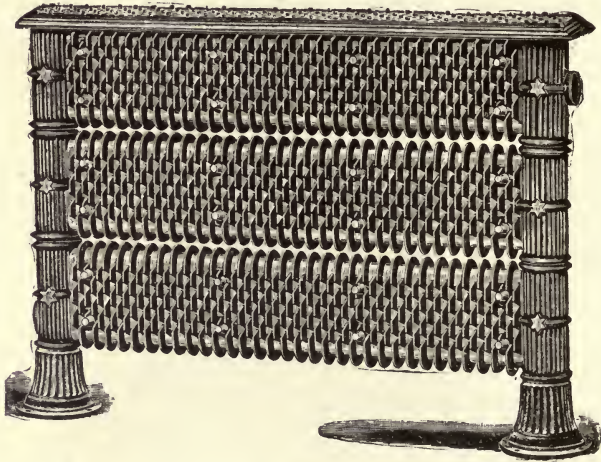

FIG. 116.—Whittier Extended Surface Radiator.

in various colors, enamelled or bronzed, as may be required by the house owners or architects.

The efficiency of direct radiation is somewhat increased by painting or bronzing, but is lessened by varnishing or enamelling; but that of indirect is not so affected.

These radiators are made in great variety of forms, and can be had of such shape as to surround columns, or fit in corners; and of almost any height desired. Some of the radiators are fitted with warming closets.

The sectional radiators are in many cases built in such a manner as to form flues for the passage of air from the bottom

to the top of the radiator for the purpose of increasing the air-heating capacity. Such radiators are termed *flue radiators*.

Radiators are sometimes built with projecting fins or ornaments of cast iron for the purpose of greatly extending the surface in contact with the air. Such a radiator is termed an *extended surface radiator*, and is now little used for direct heating (Fig. 116).

The radiators in principal use are constructed as described,

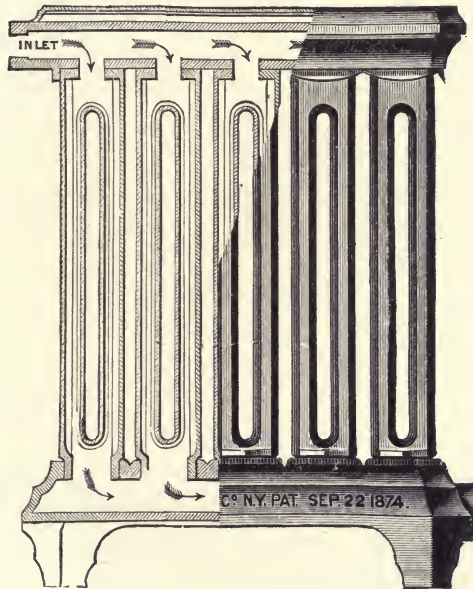

FIG. 117.—Section of Hot-water Radiator.

but radiators have been built by many other methods and in many other shapes. They have been constructed of one solid casting, and by uniting sections of various forms by bolts and packed joints.

67. Hot-water Radiators.—Hot-water radiators differ essentially from the steam-radiators in having a horizontal passage at the top as well as at the bottom. This construction is necessary in order to draw off the air which gathers at the top of each loop or section. Aside from this the construction may

be the same in every particular as that for steam-radiators; in general the hot-water radiator will be found well adapted for steam circulation, being in some respects superior to the ordinary form.

Many of the hot-water radiators, as shown in Fig. 117, are made with an opening at the top for the entrance of water and at the bottom for its discharge, thus insuring a supply of hot water at the top and of colder water at the bottom.

Some of the hot-water radiators are constructed with a cross-partition so that all water entering passes at once to the top, from which it may take any passage toward the outlet.

The hot-water radiator, is, however, usually made with continuous passages at top and bottom, and the warm water is supplied at one side and drawn off on the other. The action of gravity is depended on for making the hot and lighter water pass to the top and the cold water to sink to the bottom and flow off in the return.

Wall Radiators.—Cast-iron wall radiators are extensively used. Several different designs of these wall radiators and their installation are shown by the following illustrations. A space of about two inches should be left between the radiator and the wall from which it is supported. As the thickness of the wall radiators rarely exceeds three inches, the total distance from the wall is usually not over five inches, with a maximum, seldom exceeded, of six inches, their saving of space is considerable. They can be hung from any unoccupied wall or even ceiling space, without sacrificing either their efficiency or their appearance.

The units are furnished in rectangular shapes and tapped to be used with the longest dimension either horizontal or vertical and for any system of piping. The units usually contain 5, 7 or 9 square feet of heating surface although several other sized units can be obtained. By a proper grouping of the units the desired radiating surface can be obtained in a manner more economical, more convenient, and more effective than with pipe coils.

One type of wall radiator has two sets of intermediate cross

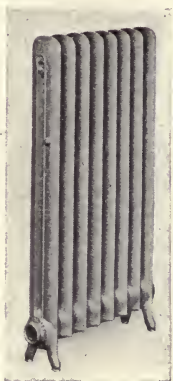

FIG. 118.—One-column Radiator.

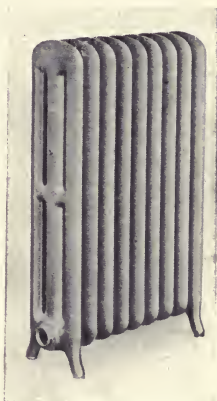

FIG. 120.—Three-column Radiator.

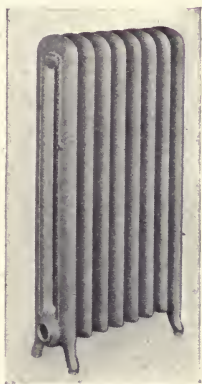

FIG. 119.—Two-column Radiator.

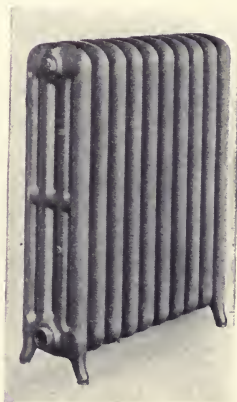

FIG. 121.—Four-column Radiator.

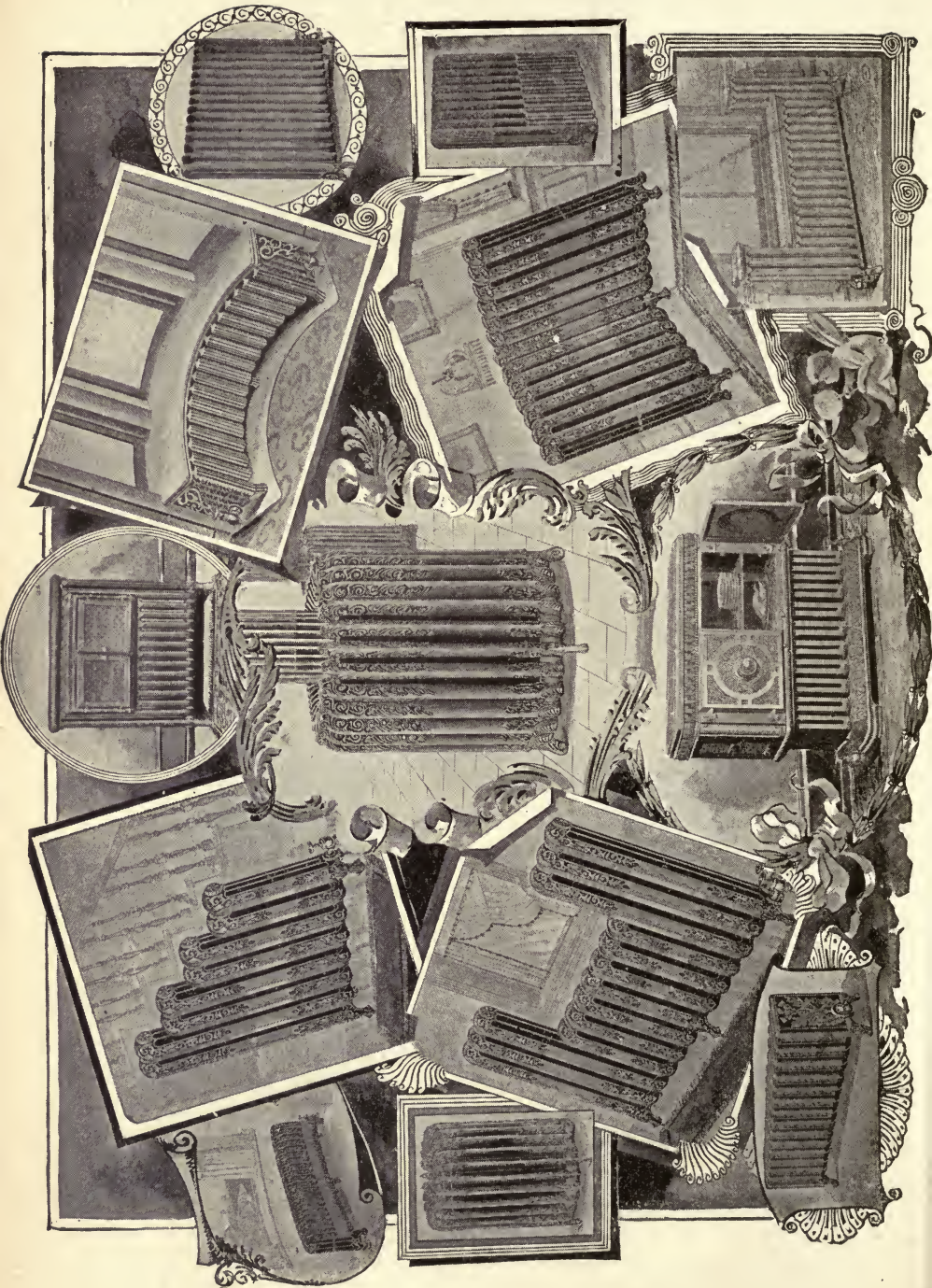

FIG. 122.—Types of Radiators.

tubes running at right angles to each other so that when installed either in a horizontal or in a vertical position, it provides for the direct passage of the wet steam and the water of condensation to the lowest tube, from which it is readily drained.

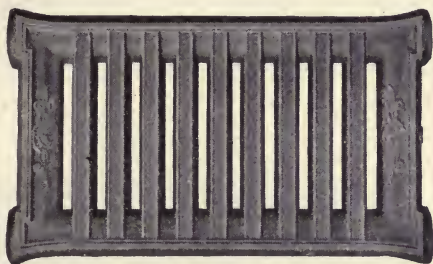

FIG. 123.—Wall Radiator.

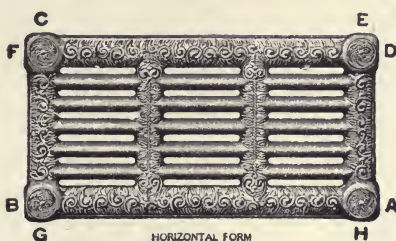

FIG. 124.—Wall Radiator

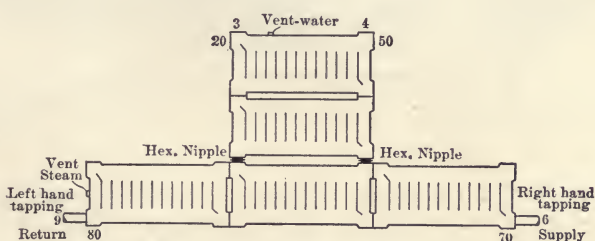

FIG. 125.—Diagram Showing Wall Radiator Units Assembled.

It is claimed for this type (Fowler and Wolfe) that four square feet of heating surface can be installed on one square foot of wall surface. Special requirements such as for use in plate warmers, corner radiators, and bay window radiators can be met by tapping the radiator units at the necessary angles.

Pressed Radiators.—Radiators made of thin pressed steel are sold to a limited extent on the market. These radiators come already assembled. Their durability as compared with cast-iron radiators, has not as yet been fully established.

68. Direct-indirect Radiators.—Radiators arranged with a damper under the base and located so that air from the outside will pass over the heating surface before entering the room are often used to improve the ventilation. The surface of these

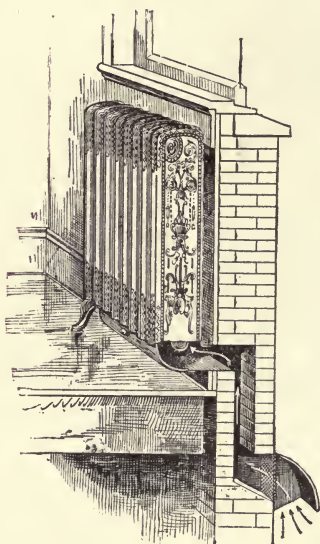

FIG. 126.—Direct-indirect Radiator in Position.

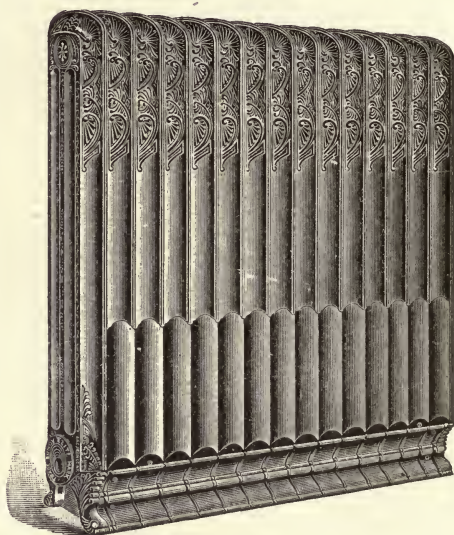

FIG. 127.—Direct-indirect Radiator.

radiators should be about 25 per cent greater than that of a direct radiator for heating the same space. The styles and kinds either for steam or hot water are the same as the direct.

69. Indirect Heaters.—Radiators which are employed to heat the air of a room in a passage or flue which supplies air are termed indirect. These heaters are made in various forms, either of pipe arranged in return bend or in manifold coils, as in Fig. 113, or of cast-iron sections of various forms united in different ways. When cast-iron surfaces are used, they are

generally covered with projections like the extended surface radiator. The sections, or, as they are sometimes called, the *stacks* for indirect heating, are usually held together by bolts. The joints being formed by inserting packing between faced surfaces. The sections are sometimes united by nipples screwed into branch-tees above and below, as shown in Fig. 128, which is an excellent form for hot-water circulation.

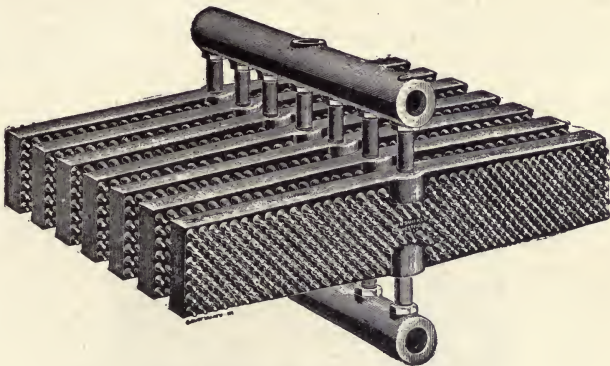

FIG. 128.—Indirect Heating Surface.

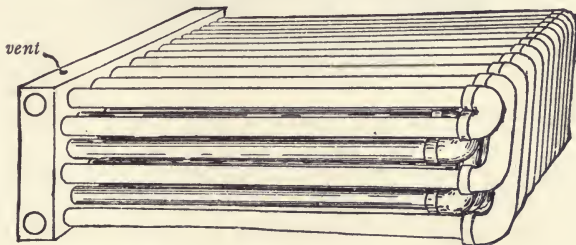

FIG. 129.—Indirect Pipe Coil.

Indirect radiators should be placed in a chamber or box as nearly as possible at the foot of a vertical flue leading to the room to be heated.

Air is admitted through a passage from the outside provided with suitable dampers to a point beneath the indirect stacks. It is taken off generally on the opposite side, and directly into the flue leading into the room to be heated.

The chamber surrounding the indirect radiator is usually

built of a casing of matched wood, as in Fig. 130 and Fig. 131, suspended from the ceiling of the basement, and lined inside with bright tin; but a small chamber of masonry at the bottom of a flue is a better and more durable construction. The flue leading from the chamber is of masonry or galvanized iron; that supplying the cold air, of matched wood and sheet iron. There should be a door in the chamber so that the indirect heater can be examined and cleaned when required. It is often of advantage to have a passage and deflecting damper so arranged that air can be drawn into the room for ventilation without passing over the heater.

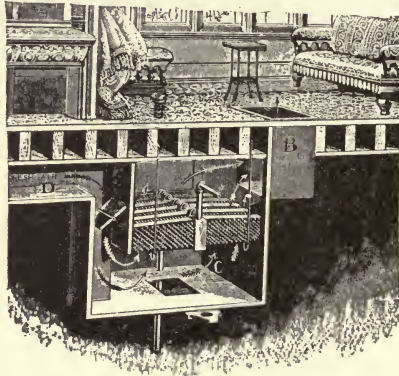

FIG. 130.—Arrangement of Indirect Heater.

The registers for admitting the heated air into the rooms can be located as desired, either in the walls or the floor; for ventilation purposes it is preferable to admit the air near the ceiling, and as shown in Fig. 132. Registers in the floor should be protected from the falling dirt.

Setting of Indirect Heaters.—The indirect heating-surface is supported usually by bars of iron or pieces of pipe held in place by hangers fastened at the ceiling (Fig. 130). This heater should be set so as to give room for the freest possible circulation of air, and so that all parts will be at least ten inches from top or bottom of casing, and arranged so that no air can pass into rooms without being warmed. An automatic air-valve should be used to remove the air from the sections of the heater.

If the sections are of proper form, one connection will be sufficient for steam; but in nearly every case two connections, one for the supply and one for the discharge, will be required for water circulation.

70. Proportions of Parts of Radiators.—There is great difference regarding the relative volume of radiators of differ-

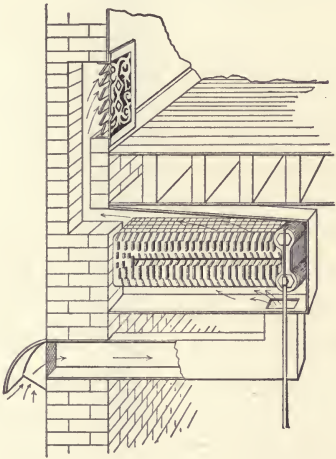

FIG. 131.—Arrangement of Indirect Heating Surface.

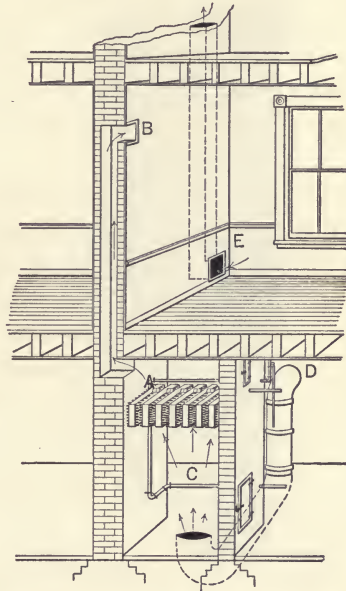

FIG. 132.—Indirect Heater Arranged for Ventilation.

ent make as compared with the surface; but the practice is quite uniform as regards the sizes of supply-pipes for either steam or hot water. Because of the high efficiency of a radiating surface formed of one-inch horizontal pipe, it has been argued that this should form a standard for relation of contents to surface. It is seen, however, by consulting the tests given in Chapter IV, that inch-pipe vertical radiators are not more efficient than cast-iron radiators with larger volume; so that it is doubtful if the relative ratio of volume to surface is of importance.

It is of importance that the steam or water should circulate through the radiators with the least possible friction, and that in the case of steam-radiators the base should be of such a form as to perfectly drain; otherwise the water which remains in will be certain to cause the disagreeable noise and pounding known as water-hammer.



FIG. 133.

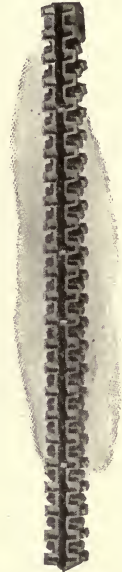

FIG. 134.

Hot Blast Radiator.

The following table gives the standards which are almost universally adopted by the different makers for the size of inlet and outlet to the direct radiators; those for indirects are to be taken one size larger:

Size of Radiator, Sq. Ft.	Diameter of Openings.	
	Two Openings.	One Opening.
0 to 50	1 inch	1 $\frac{1}{4}$ inches
50 to 125	1 $\frac{1}{4}$ inches	1 $\frac{1}{2}$ "
125 to 200	1 $\frac{1}{2}$ "	2 "
200 to 300	2 "	2 $\frac{1}{2}$ "

CHAPTER VIII.

STEAM-HEATING BOILERS AND HOT-WATER HEATERS.

71. General Properties of Steam—Explanation of Steam-tables.—Steam has certain definite properties which always pertain to it and distinguish it from the vapor of other liquids than water.

Steam, at any given pressure above a vacuum, possesses a definite temperature. The atmospheric pressure is different at different localities and for different conditions of the weather, thus causing slight changes in temperature of the boiling-point. The pressure which is read by any steam-gauge is that in excess of the atmosphere; *the pressure which is given in the steam-tables is that which is reckoned from a perfect vacuum*, and is usually called *absolute*; hence, in order to use the steam-table which is given in the back of the book, the pressure as determined by a steam-gauge reading must be increased by the atmospheric pressure. The atmospheric pressure is given accurately by a barometer, but it will be sufficiently accurate, for most cases, to consider it as 14.7 pounds. To use the table add this quantity to the gauge-reading and the result will be the absolute pressure. For approximate purposes the atmospheric pressure may be considered as 15 pounds. The steam-tables referred to give, in the first column, the pressure above a vacuum; in the second column, the temperature Fahrenheit; in the third, the heat, expressed in heat-units, required to raise one pound of water from zero Fahrenheit to the required temperature. If the specific heat of water were unity at all temperatures, the heat contained in one pound of water would be numerically the same as the temperature. The difference is not great in any case.

The fourth column gives the value in heat-units of the latent heat of evaporation for each pound of steam. This quantity expresses the amount of heat which is stored, without change of temperature or pressure, during the physical change of condition from water to steam; and it has been termed *latent* because it cannot be measured by a thermometer (see Chap. I). It will be noted that this quantity is relatively large as compared with the sensible heat. It is of importance, since it expresses the amount of heat which is contained in one pound of steam in excess of that in one pound of water at the same temperature.

The fifth column gives the total heat contained in one pound of steam; this is the sum of the sensible and latent heat.

The sixth column gives the weight in pounds of one cubic foot of steam for various pressures. The steam-tables are arranged so as to give the heat in one pound of steam above 32° Fahr., the freezing-point of water, instead of above zero.

It should be noted that the temperature of steam corresponding to different pressures, as given in column (2), is also the boiling-point of water corresponding to the same pressure.

As the temperature and absolute pressure of steam always bear definite relation to each other, it is quite evident that a steam-table could be arranged giving the properties of steam from measurements of temperature. This is generally not so convenient as the present arrangement. If temperatures are known, the corresponding pressure can be determined by inspection and interpolation in the present table.

72. General Requisites of Steam-boilers.—The steam-boiler is a closed vessel, which must possess sufficient strength to withstand the pressure to which it may be subjected in use; but it may have almost any form, and may be constructed of various materials.

It is used in connection with a furnace, from which the heat required for evaporation is obtained by combustion of fuel. The heat is received on the surface of the boiler, and passes by conduction through the metallic walls to the water or

steam. The surface which receives this heat is called *heating surface*, and is partly situated so as to receive the direct or radiant heat and partly located so as to receive the convected or indirect heat from the gases only. The heating surface in most modern boilers is made relatively great, as compared with the cubic contents, by the use of tubes containing water or heated gases, or by subdividing the boiler so as to make the surface large with respect to the cubic contents and weight. The steam generated rises in the shape of bubbles through the water in the lower part of the boiler, and is liberated from the surface of the water at the water-line.

The power of the boiler depends upon the amount and form of heating surface, upon its capacity for holding water and steam, and upon the extent of fire-grate surface. Its economy depends upon the relative proportions of these, and the character and amount of fuel burned. Its ability to produce dry steam depends upon the circulation of its liquid contents, and also upon the extent of surface at the water-line.

For safety, the boiler must be provided with a safety-valve, and pressure and water gauges. For convenience automatic damper-regulators, water-feeding apparatus, etc., are desirable.

73. Boiler Horse-power.—As a boiler performs no actual work, but simply provides steam for such purposes, a boiler horse-power is entirely an arbitrary quantity, and may be transformed into a lesser or greater amount of work, as the character of the engine which uses the steam varies.

The standard established by the Committee of Judges at the Centennial Exhibition in 1876 as a boiler horse-power has been universally adopted, and would, no doubt, in absence of other stipulations, constitute a legal standard of capacity. This committee defined a boiler horse-power as the evaporation of 30 pounds of water from feed-water at 100° Fahr. into steam at 70 pounds pressure; this is equivalent to the evaporation of 34.5 pounds of water from a temperature of 212° Fahr. into steam at atmospheric pressure.* Engines require

* The condition of evaporating from water at 212° into steam at the same temperature will be referred to hereafter as *evaporation*, without other qualification.

from 12 to 40 pounds of steam per horse-power per hour, depending upon the grade or class to which they belong; hence the steam required to perform one horse-power of work in an engine bears no definite relation to a boiler horse-power.

Since the evaporation of one pound of water from and at 212° Fahr. requires 966 heat-units, one boiler horse-power is equivalent to 33,327 heat-units.

For heating purposes a more convenient standard of power is the square foot of radiating surface. Each square foot of direct steam-radiating surface gives off 220 to 280 heat-units per hour when the difference of temperature is 150 degrees which is that usually existing in low-pressure steam-heating. About two-thirds as much is given off by one square foot of hot-water radiating surface. As the evaporation of one pound of water requires 966 heat-units, there is needed about one-third of a pound of steam for each square foot of steam-radiating surface per hour, hence one boiler horse-power will be sufficient to supply somewhat more than 100 square feet of direct radiating surface; that is, we can consider the boiler horse-power as equivalent to 100 square feet of direct steam radiation, with sufficient allowance to meet ordinary losses.

74. Relative Proportions of Heating to Grate Surface.—The relative amount of grate surface and heating surface required in a steam-boiler depends, to a large extent, upon the nature and amount of coal burned per unit of time. That part of the heating surface which is close to the fire and receives directly the radiant heat is much more effective than that which is heated by contact with hot gases only; but it will be found that considerable indirect heating surface will in every case be required, in order to prevent excessive waste of heat in the chimney. Power-boilers have been rated for a long time not on their actual capacity, but on the amount of heating surface; and this quantity as well as grate surface is an important consideration for heating-boilers. It is the general practice to consider 10 square feet of heating surface in water-tube boilers or 15 square feet in plain tubular boilers as equivalent to one horse-power.

The actual power of the boiler depends more upon the method and management of the fires than upon the size; and either of the above classes of boilers can be made to develop under favorable circumstances from two to three times the capacity for which they are rated.

A rating of 15 sq. ft. of heating surface to one horse-power requires an evaporation of 2.3 lbs. of water per square foot of heating surface per hour, and a rating of 11.5 sq. ft. per horse-power requires an evaporation of 3 lbs. Experience for a number of years with power-boilers—20 horse-power and larger—indicates these proportions to be safe ones and to result in durable construction. With the small boilers often used in house-heating the waste due to loss of heat from the heating surfaces, imperfect combustion, and bad management generally are much greater, so that it is necessary to use boilers somewhat larger than would be required by the data given.

The house-heating boiler, however, under best condition of management and draft will give, as shown by actual test, results approximating very closely to those obtained with the power-boiler under best conditions. In the ordinary management of heating-boilers the principal loss is due to operating with an insufficient supply of air, hence to secure best results the draft should be so arranged that whenever the air supply below the grate is reduced an amount sufficient to prevent perfect combustion, air should be admitted above the fire.

With perfect combustion and no waste of heat, one pound of pure carbon would evaporate about 15 pounds of water, but as all coal contains considerable ash and refuse, and furthermore as an amount scarcely ever less than 25 per cent of the total heat must escape into the chimney, the results obtained in practice are much less and seldom exceed an actual evaporation of 9 pounds of water for each pound of coal.

The amount of coal burned per square foot of grate per hour varies in large power plants with varying conditions of the fuel and the draft from 15 to 30 pounds, but under usual conditions of house-heating boilers it varies from 4 to 8 pounds per hour.

The amount of heat absorbed by the boiler heating surface depends upon the circulation of the heated gases, the circulation of the water and the difference in temperature between the gases and the water. The average absorption in power boilers varies between 2000 and 3000 B.T.U. per square foot per hour and the ratio of grate to heating surface varies between 1 to 40 and 1 to 60. With house-heating boilers either for water or steam it is probably not desirable in the interests of economy to require a heat absorption exceeding 1800 to 2400 B.T.U. per square foot per hour. As each square foot of steam radiating surface requires about 250 B.T.U. per hour for steam, and 150 B.T.U. for hot water, one square foot of heating surface would under these conditions supply from 7.2 to 9.6 square feet of radiating surface for steam and 12 to 16 square feet for hot-water heating.

If we consider that one pound of coal will in its combustion give 8,000 to 10,000 heat-units to the steam or water, and that if we burn on one square foot of grate 4 pounds of coal per hour we shall have from 32,000 to 40,000 B.T.U. per hour. We find this on the basis stated above would supply from 115 to 140 square feet of steam radiating surface per hour, and about two-thirds more of hot water. It is evident that if twice as much coal be burned per square foot of grate, that twice as much radiating surface could be supplied with steam; increasing the rate of combustion would produce, however, a large chimney waste and a loss in efficiency of the boiler unless there was a corresponding increase in heating surface; for this reason the lower rate of combustion is usually preferable.

The table on page 193 gives an abstract of the results of tests of two house-heating boilers made by the author under the usual conditions of operation.

The ratio of grate surface to radiating surface gives a fair check when comparing two or more boilers for the same installation, but the amount of heating surface does not, as the heating surfaces of cast-iron boilers and heaters vary greatly in their efficiency. Too much heating surface may be as undesirable as too little due to excessive cooling of the furnace gases.

TESTS OF HOUSE-HEATING BOILERS.

Kind of Boiler.	Wrought-iron Water-tube.	Cast-iron Sectional.
Area of grate, square feet.....	2.28	3.21
Water-heating surface, square feet.....	100.06	41.17
Steam-gauge pressure, pounds.....	7.35	3.26
Temperature of air, degrees Fahr.....	35	89
Temperature of feed-water, degrees Fahr.....	40	83
Dry coal consumed per hour, pounds.....	12.26	17.3
Total ashes and refuse per hour, pounds.....	2.89	3.2
Dry coal per square foot of grate per hour, pounds ..	5.98	5.4
Quality of steam, per cent.....	98.2	97
Total weight of water evaporated per hour, pounds..	316	135
Actual evaporation per pound of fuel.....	6.82	7.8
Actual evaporation per pound of combustible.....	8.40	9.6
Equivalent evaporation per pound of combustible from and at 212° Fahr.....	10	10.6
Efficiency, per cent (about).....	69	75

The example considered on the preceding page would give 160 sq. ft. of radiating surface to one sq. ft. of grate surface for steam, and 280 for hot water, for burning 4 pounds of coal per hour on one square foot of grate surface.

75. Water Surface—Steam and Water Space.—The surface on the water-line from which ebullition takes place should be so large that the velocity of steam will not be great enough to project particles of water into the main steam-pipes. Practice is variable in this respect; in successful plants it will be found that from one-third to one square foot of surface is provided per horse-power or per 100 square feet of radiating surface. The greater this surface the less water will be carried out of the boiler with the steam, other things being equal.

There is much variation in the amount of water and steam space provided in various kinds of boilers: in the fire-tube and shell boilers there is much more space than in water-tube and sectional boilers. A large amount of water and steam absorb the heat slowly, but on the other hand they require less frequent attention and are more regular in operation. The following rules have been given:

Tredgold * states that the volume of steam space should

* Thurston's Steam-boilers.

be sufficient to prevent variations in pressure exceeding 1 in 30, by irregular use.

In the ordinary tubular boilers to-day there will be found about 2.0 cubic feet of water and 1.0 cubic foot of steam per horse-power, and about one-third the above amounts for the water-tube boilers.

76. Requisites of a Perfect Steam-boiler.—The late Mr. George H. Babcock of Plainfield, N. J., gave as the results of his experience the following requisites for a perfect steam-boiler for power purposes:

1st. The best materials sanctioned by use, simple in construction, perfect in workmanship, durable in use, and not liable to require early repairs.

2d. A mud-drum to receive all impurities deposited from the water in a place removed from the action of the fire.

3d. A steam and water capacity sufficient to prevent any fluctuation in pressure or water-level.

4th. A large water surface for the disengagement of the steam from the water in order to prevent foaming.

5th. A constant and thorough circulation of water throughout the boiler, so as to maintain all parts at one temperature.

6th. The water space divided into sections, so arranged that should any section give out, no general explosion can occur, and the destructive effects will be confined to the simple escape of the contents; with large and free passages between the different sections to equalize the water line and pressure in all.

7th. A great excess of strength over any legitimate strain; so constructed as not to be liable to be strained by unequal expansion, and, if possible, no joints exposed to the direct action of the fire.

8th. A combustion-chamber, so arranged that the combustion of gases commenced in the furnace may be completed before they escape to the chimney.

9th. The heating surface as nearly as possible at right angles to the currents of heated gases, so as to break up the currents and extract the entire available heat therefrom.

10th. All parts readily accessible for cleaning and repairs. This is a point of the greatest importance as regards safety and economy.

11th. Proportioned for the work to be done, and capable of working to its full rated capacity with the highest economy.

12th. The very best gauges, safety-valves, and other fixtures.

The same requirements apply equally well to a boiler for heating, but the relative importance of the various requirements might be different, and some might be omitted as unimportant; thus, for instance, the mud-drum, which is of importance in a boiler for power, because it is receiving constant accessions of water with more or less impurities, is seldom on heating boilers when they are supplied with water of condensation. The importance of provisions for cleaning is less in heating than in power boilers, but should not be neglected.

77. General Types of Boilers.—*Power-boilers.*—It seems necessary to consider boilers built for high-pressure steam and of large sizes as a separate class from those used principally in heating small buildings, although boilers of similar structure may be constructed for heating. These boilers will be spoken of as *power-boilers*, and are required to fulfill conditions as to strength and capacity not needed in heating-boilers.

The principal boilers of this type now in use can be grouped into two classes, viz., *fire-tube* and *water-tube* boilers, and one or the other of this type must be used for heating purposes, with the present condition of the market, whenever high-pressure steam is required.

The fire-tube or common tubular boiler consists of a cylindrical boiler with plain heads, connected by a large number of tubes which serve as passages for the smoke or heated gases. The fire is built underneath, and the smoke passes horizontally either twice or thrice the length of the boiler. The general form of this boiler is shown in Fig. 135. This boiler is also used sometimes in a vertical position with the fire beneath one head, in which case it is called a vertical tubular. The water-tube boilers have the water in small tubes, and the heated

gases pass out between the tubes. In this class of boilers the steam is contained in drums or horizontal cylinders, which are located above the heating surface. The tubular boilers are made in small sizes, 10 horse-power and larger, while the water-tube boiler for power is seldom less than 60 horse-power capacity.

Heating-boilers.—The boilers which are used for steam heating are designed in a multiplicity of forms, and present examples of nearly every possible method of producing extended surfaces, both of the water-tube and fire-tube types. They are generally built for low-pressure steam, and are expected to be used mainly in buildings where the condensed water is

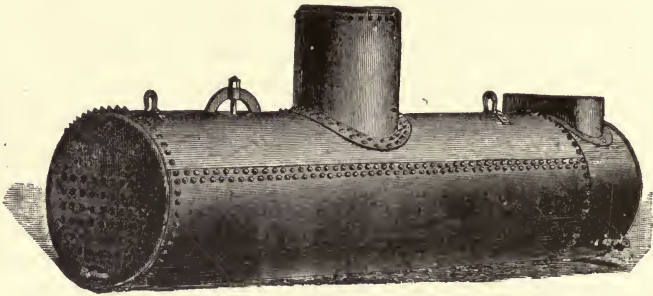

FIG. 135.—Horizontal Tubular Boiler.

returned by gravity to the boiler without pumps or traps. They are usually built in small sizes having a capacity of 250 to 2000 ft. of radiating surface ($2\frac{1}{2}$ to 20 H.P.), and are fitted with safety-valves, water and steam gauges and damper regulators.

The limits of this book prevent a detailed description of any make of heating-boiler, but the leading general types are described. Several types of the power-boiler are described quite in detail, and much that is said with respect to them will apply in a general way to heating-boilers.

The following classification of steam-heating boilers was suggested by one presented by Mr. A. C. Walworth in a paper before the New York Convention of Master Steam and Hot-water Fitters, June, 1894:

CLASSIFICATION OF HEATING-BOILERS.

Boiler	Plain Surface	{	Spherical	{	Vertical			
			Cylindrical		Horizontal			
	Extended Surface	{	Wrought Iron, Projecting Tubes					
			Cast Iron, Irregular Surface					
	Divided Surface	{	Tubular	{	Fire-tube	{	Vertical	
						Horizontal		
Water-tube			{	Straight tubes	{	Curved	{	Locomotive
				Spiral		Coil of		Drop
Sectional	{	Horizontal	{	Packed joints	{	Screwed		
				Faced		Faced		
		Vertical	{	Packed joints	{	Screwed	{	Faced
				Faced		Faced		

78. The Horizontal Tubular Boiler.—This boiler is manufactured in many places, so that in many respects it is a standard article of commerce, and it can be purchased in nearly every market for a slight advance over the cost of materials and labor used in its construction. In the construction of this boiler the shell is now almost invariably made of soft steel of a thickness depending upon the pressure which the boiler is expected to sustain. The heads of the boiler are made of flange steel, and are generally $\frac{1}{8}$ inch thicker than the material in the shell. Lap-welded steel tubes are almost invariably used, the standard sizes are based on outer diameters. The tubes are expanded into the heads of the boiler and may or may not be beaded, and are generally arranged in parallel vertical rows in the lower two-thirds part of the boiler. In some instances the middle row of tubes is omitted with good results. It is not a good plan to stagger the tubes, since in that case they are difficult to clean, and also act to impede the circulation of the water. The boiler should be provided with manholes, with

strongly reinforced edges, so that a person can enter for cleaning. The heads of the boiler above the tubes should be thoroughly braced in order to sustain safely any pressure from the inside of the boiler.

Domes are often placed above the horizontal part of the boiler, and serve to increase the capacity for the storage of steam and also provide ready means of drawing off dry steam. The dome is always an element of weakness, and if used it should be stayed and reinforced in the strongest possible manner. The dome is frequently omitted, and steam taken directly from the top of the shell or drawn through a long pipe with numerous perforations, termed a *petticoat pipe*.

In construction this boiler must be strongly braced wherever any flat surfaces are exposed to pressure, and the girth and longitudinal seams must be riveted in such a manner as to secure the maximum strength.

The following table gives principal dimensions for a series of horizontal tubular boilers designed for a working pressure of 80 to 100 pounds per square inch:

Radiating surface.....	1000	1200	1600	2000	2500	3000	4000	5000	6000	8000	10000
Horse-power.....	10	12	16	20	25	30	40	50	60	80	100
Diameter of boiler, inches....	32	32	36	36	42	42	48	54	54	60	66
Length of boiler, feet.....	6	7½	8	10	10	12	12	12	14	16	16
Thickness of shell, inches....	1/4	1/4	1/4	1/4	9/32	9/32	9/32	5/16	5/16	11/32	3/8
Thickness of heads, inches....	5/16	5/16	5/16	3/8	3/8	3/8	3/8	3/8	3/8	1/2	1/2
Length of flues, feet.....	6	7½	8	10	10	12	12	12	14	16	16
Number of flues.....	32	32	30	32	40	40	52	70	70	83	104
Diameter of flues, inches....	2½	2½	3	3	3	3	3	3	3	3	3
Square feet of heating surface.	155	192	239	310	385	462	600	765	901	1206	1504
Proper diam. of smoke-pipe (20' chimney) inches.....	13	14	15	17	18	20	24	26	28	32	37
Approximate weight, lbs.....	1800	2000	2700	3100	4000	4600	5600	7000	8000	10500	12500
Wt. of grate and fixtures, lbs..	1200	1400	1600	1800	2100	2200	2800	5200	5400	7200	7500

Fifteen square feet of surface to each horse-power.

79. Locomotive and Marine Boilers.—Boilers of the horizontal tubular type with a fire-box entirely enclosed and surrounded by heating surface are usually termed locomotive boilers from the fact that such construction is common on locomotives. Boilers of this style are sometimes used for stationary power purposes, and possess the advantage over the plain tubular

boiler of requiring no brick setting. They are not, however, as strong in form as the plain tubular, since large flat surfaces have to be used over the fire-box.

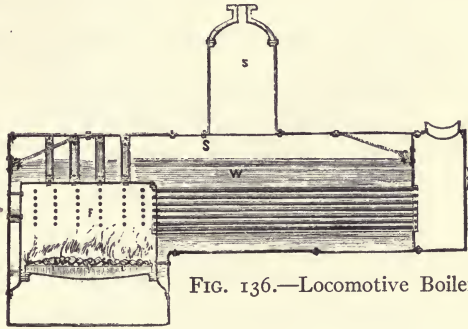

FIG. 136.—Locomotive Boiler.

Marine Boilers.—A cylindrical boiler with an internal cylindrical fire-box is principally used on large boats. The fire-box is often corrugated. This form of boiler is very strong and efficient, but because of cost of construction has been little used for stationary purposes.

Vertical Boilers.—Vertical boilers of large size are made in every respect like the horizontal tubular boiler, but are set so that the flame plays directly on one head and the heated gases pass up through tubes. These boilers are generally provided with a water-leg which extends below the lower crown sheet and is intended to receive deposits of mud, etc., from the boiler. They are usually made so that the heat passes directly out of the top of the flue, but in some cases the heat is made to pass down a portion of the length of the external shell before being discharged.

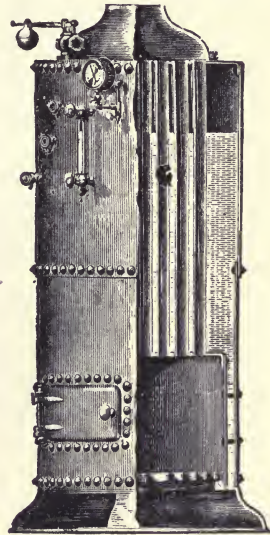

FIG. 137.—Upright Tubular Boiler.

They are economical in the use of fuel and occupy very small amount of floor-space; they require, however, a great deal

of head-room, are very easily choked up with deposits and sediment, very difficult to clean, and very likely to leak around the tubes in the lower crown-sheet, and consequently have a short life.

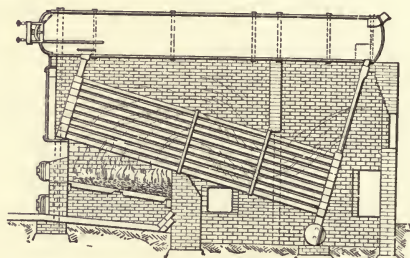

FIG. 138.—Babcock & Wilcox Boiler.

Vertical boilers with horizontal radial tubes projecting outward with ends closed, known as porcupine boilers, and vertical boilers of the water-tube type are on the market.

80. Water-tube Boilers.—The water-tube boilers, which are used for power purposes, are designed to withstand great

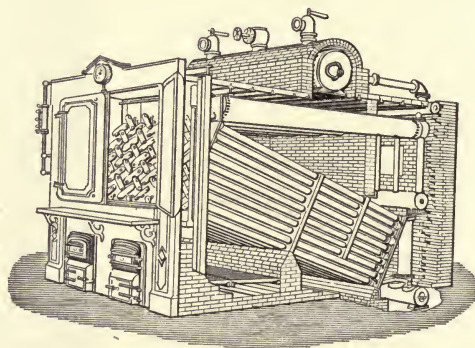

FIG. 139.—Root Boiler.

pressures, and can be purchased in sizes ranging from 60 to 500 horse-power per boiler. The general construction of these boilers is such as to have the water on the inside of the tubes, and the fire without. There are two general forms: first, those with straight tubes, and second, those with curved tubes.

In all cases they have large steam-drums at the top, which are connected to the heating surface by headers filled with water. In the Babcock & Wilcox, Heine, and Root boilers the tubes are inclined and parallel, and are connected at the end with headers, the fire being applied in each case under the elevated portion of the inclined tube, so as to insure circulation uniformly in one direction.

In the Babcock & Wilcox boiler, forged zigzag headers are used; in the Root boiler, the tubes are connected together

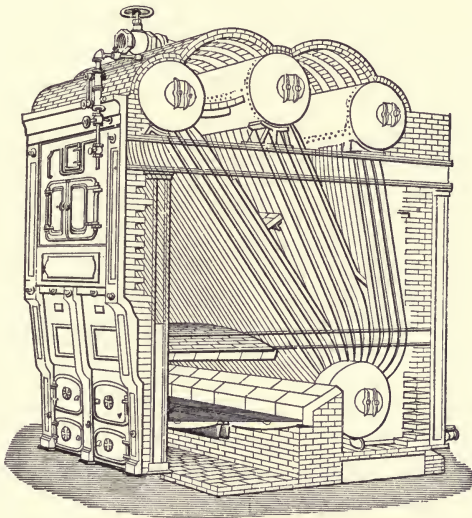

FIG. 140.—Stirling Boiler.

by external U-shaped bends; in the Heine boiler (Fig. 141), the tubes are connected to large, flat-stayed surfaces. In the Babcock & Wilcox and Heine boilers, feed-water is supplied at the lower part of the top drums; while in the Root boiler, it is supplied to a special drum in the down-circulation tubes at the back end of the boiler. The Stirling boiler has three horizontal drums at the top connected by curved tubes to a single lower drum at the back end of the boiler; the Hogan has one drum at top and two at bottom, which are parallel and connected by curved tubes, and also a series of down-circulating

tubes connecting the same drums, but not exposed to the heat of the fire. In the Stirling boiler, the feed-water is introduced in the top drums; in the Hogan boiler, into a special heater and purifier arranged as a part of the downward circulation.

The Harrison boiler consists of an aggregation of spheres of cast iron or steel connected by necks, forming what is to be considered rather as a sectional than a water-tube boiler. These spheres are held in place by bolts, which will stretch and act as safety-valves in case of excessive pressure.

In addition to the water-tube boilers for power purposes which have been mentioned here, there are many others which cannot be described in the space at our command, but of which

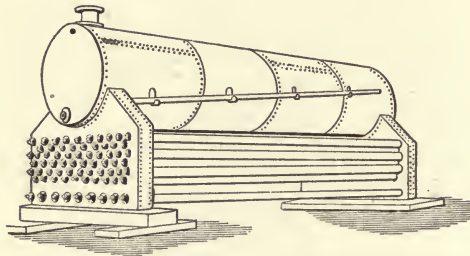

FIG. 141.—Heine Boiler.

we may name the National, Campbell & Zell, and the Caldwell as worthy of notice.

All the water-tube boilers are provided with mud-drums, which are frequently cylinders removed from the circulation and intended to receive any deposits of scale or material which is loosened in the process of circulation.

81. Hot-water Heaters.—Hot-water heaters differ essentially from steam-boilers, principally in the omission of a reservoir or space for steam above the heating surface. The steam-boiler might answer as a heater for hot water, but the large capacity left for the steam would tend to make its operation slow and quite unsatisfactory.

The passages in a hot-water heater need not extend so directly from bottom to top as in a steam-heater, since the

problem of providing for the early liberation of the steam-bubbles does not have to be considered. In general, the heat from the furnace should strike the surfaces in such a manner as to increase the natural circulation, and not act to produce a backward circulation. This may be accomplished in a certain measure by arranging the heating surface so that a large proportion of the direct heat will be absorbed near the top of the heater.

There is a great difference of opinion as to the relative merits of horizontal and vertical heating surfaces for this purpose, but the writer cannot find that any experiments have been made which satisfactorily decide this question. Where the surface is very much divided, and the fire is maintained at a high temperature, considerable steam is likely to be formed, and this always acts in a certain measure to increase circulation in the circulating-pipes and in the heater; it is likely also to produce a disagreeable crackling noise.

Practically, the boilers for low-pressure steam and for hot water differ from each other very little as to the character of the heating surface, and in describing the general classes which are in use no attempt will be made to make any distinction as to whether the apparatus will be used for hot-water or steam heating. If designed for steam heating, a reservoir or chamber connected with the circulating system is in every case provided, containing water in its lower part and considerable steam capacity above the water-line, also sufficient area of water-surface to permit the separation of the steam from the water without noise and violent ebullition.

82. Classes of Heating-boilers and Hot-water Heaters.—*Plain-surface Boilers.*—There are probably no boilers or heaters

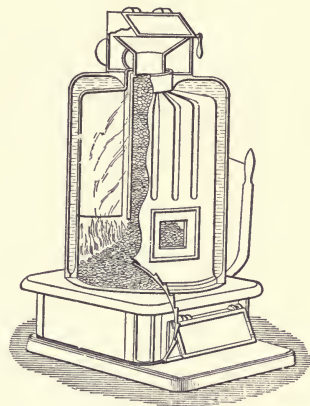

FIG. 142.—Vertical Magazine Hot-water Heater.

built at the present time with a plain surface, either spherical or cylindrical, since the expense of a given amount of surface in that form would practically preclude its use.

Extended-surface Heaters (Figs. 143 and 144).—Heaters of

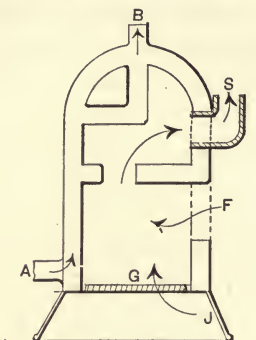

FIG. 143.—Extended-surface Heater.

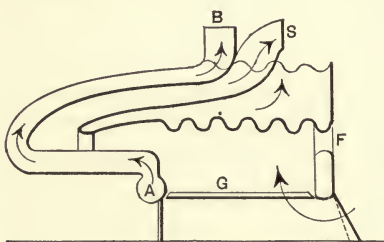

FIG. 144.—Extended-surface Heater.

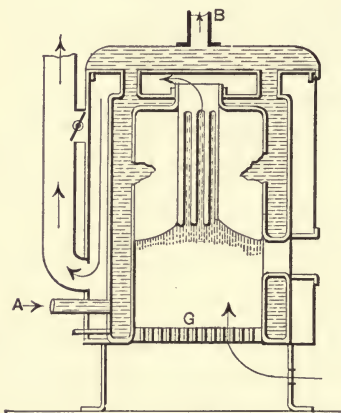

FIG. 145.—Extended Surface, Vertical Prisms.

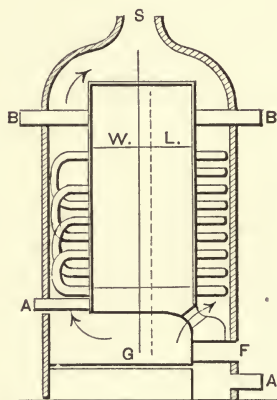

FIG. 146.—Radial and Curved with Extended Surface.

this class with extended and irregular surface, are used quite extensively in hot-water heating, and with the addition of domes are used to some extent in steam-heating. In these heaters the water is received at the lowest point, as at *A*, and is heated as it gradually rises, receiving the effect of the fire at various projections, and is finally discharged at *B*. The

grate is at *G*, the smoke being discharged at *S*. The smoke and heated gases move in nearly a direct line in Fig. 143, and in a sinuous course in Fig. 144.

A form which is in extensive use, and in which water and smoke are each grouped in one body, is shown in Fig. 145. In this case the extended surface is produced by the wedge-shaped hollow prisms extending over the fire-space. The heated gases have a return circulation around the lower portion of the heater, and also come in contact with a top dome from which the heated water is drawn off.

Heaters belonging to the extended-surface class made with vertical cylinders, into which are connected either straight horizontal tubes with closed end, as shown on the right-hand side of Fig. 146, or U-shaped projections of pipe either horizontal or slightly inclined, are in use for both water- and steam-heating. In case they are used for steam-heating the water-line is carried at sufficient distance from the top of the cylinder to give the required steam-space, and the heater is supplied with both pressure- and water-gauges. The heated gases pass around the cylindrical part of the boiler and may be made to circulate among the projections by means of baffle-plates.

Tubular Boilers.—Heating-boilers with fire-tubes and with a steel shell similar in construction to Fig. 135 for both horizontal and vertical tubular boilers are in use for heating to considerable extent in the forms already described. Modifications of these, with return flues arranged so that the heat passes both upward and downward, and also with two or more short cylindrical shells connected together by tubes filled with water, are in extensive use. Very few horizontal tubular boilers, or boilers of the locomotive type, are used for the heating of small buildings.

Water-tube Boilers.—Water-tube boilers of all classes and various modifications are in extensive use for heating. The tubes are made of either cast-iron or wrought-iron pipe. The pipe-boilers which are in the market are arranged with nearly every form of heating surface; some are built with heating surface in the form of the pipe-coil and others in the form of

a manifold coil. Still other boilers have the pipe arranged in the form of a spiral connecting with a receiving-drum below and a steam-drum above. The heated gases are arranged to move in some cases parallel with the surfaces, and in other cases at right angles.

The Field tube is used extensively for the purpose of increasing the heating surface; in its original form it consisted of a tube with a closed end projecting downward and expanded into the boiler-shell; into this extended another tube which did not reach quite to the bottom, and was held in position by an internal perforated support, as shown in Fig. 147. This is

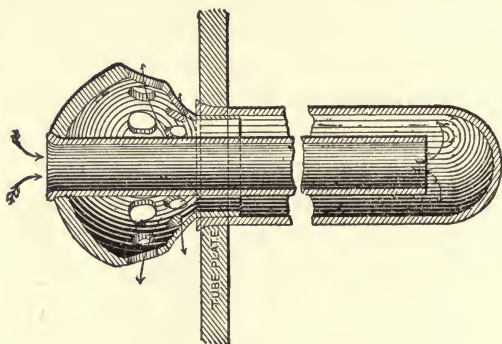

FIG. 147.—FIELD TUBE.

used in heating-boilers with various modifications both projecting downward and horizontally. When used projecting downward, it is termed a drop-tube, and is supplied either with an internal tube, as shown, or a partition; when used horizontally the internal tube is frequently supplied from a compartment separated from that to which the external tube is attached. Fig. 148 illustrates a type of heating-boiler which is quite extensively used for both hot water and steam, and is built by different manufacturers, either of steel or cast iron. The heater consists of a cylindrical drum, the lower surface of which is covered with tubes of the type described which project downward. The tubes directly over the fire and over the fire door are short, while those around the fire are sufficiently

long to form the external walls of the heater. The return water is received in one of the long pipes near the bottom of the heater, and the steam or heated water is taken off at the top. The drum in one of these heaters is provided with a baffle-plate connected to the diaphragm in the drop-tube, so that the circulation must take place in a vertical direction in the tube.

Fig. 149 shows a heater in which the surface is made up partly of pipe-coils and partly of drop-tubes. The return water is received in a drum surrounding the grate, and as it is warmed passes to the top drum of the heater, from which it

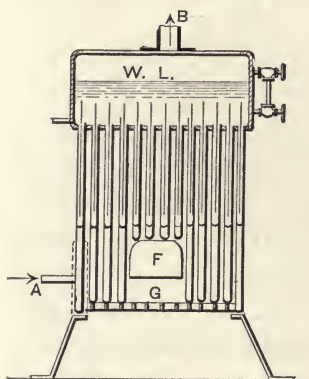

FIG. 148.—Drop-tube Surface.

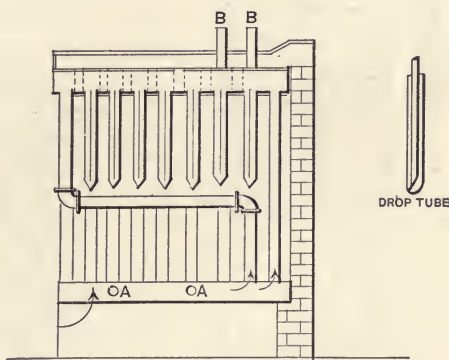

FIG. 149.—Drop-tube and Coil-heater.

flows to the building; a type of heater in many respects similar is made without drop-tubes, the whole surface being obtained by use of pipe-coils, made either with return bends or with branch tees.

Sectional Boilers.—The greater number of cast-iron boilers are made by joining either horizontal or vertical sections. These sections are joined in some instances by a screwed nipple, in other cases by a packed or faced joint, and are held in place with bolts. The sections generally contain water and steam, and the heated gases circulate around the sections in flues provided for that purpose. The joints in the flues are usually made tight enough to prevent the escape of smoke by the use

of an asbestos cement or a stove putty. This type of boiler has been largely adopted on account of the ease with which they can be shipped and delivered into the cellars of buildings; also on account of their lower cost due to the combining of three or four different castings to make up a full line of boiler sizes.

Horizontal Sections.—Fig. 150 represents a type of heater in which the various sections are horizontal, the surface being

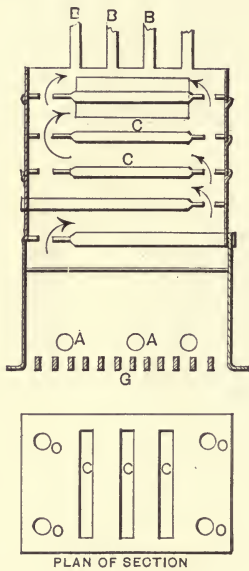

FIG. 150.

Boiler with Horizontal Sections.

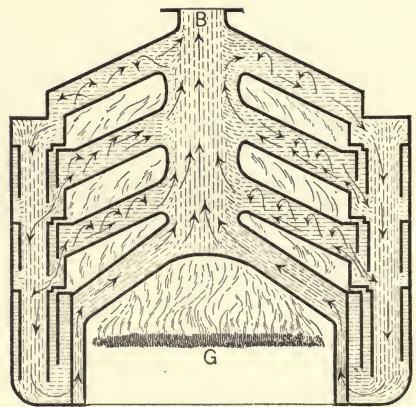

FIG. 151

Boiler with Horizontal Sections.

increased to any amount by adding sections. This form is used extensively in a number of hot-water heaters. Fig. 151 shows another form of boiler made in a similar manner, but with the sections of such form as to produce both an up and down circulation within the heater. The up circulation takes place over the hottest portion of the fire, the down circulation in special external passages which are not heated.

Vertical Sections.—Boilers with vertical sections are made in the same manner in many respects, the sections being united by internal or external connections. When united by external

connections, screwed nipples connecting the sections to outside drums, of the general form as shown in Fig. 152, are usually employed. In this case the return-water is received into horizontal drums, *AA*, which extend the full length of the heater, and flows into the lower part of each section. The steam or hot water is drawn off from a similar drum, *B*, which extends over the top of the heater and is connected with each section by a screwed nipple. Fig. 152 shows methods of attaching steam- and water-gauges. This form is used quite extensively in steam-heating and to some extent for hot-water heating.

83. Heating-boilers with Magazines.

—Many of the heating-boilers are manufactured as required with or without a magazine to hold a supply of coal. The magazine in most cases consists of a cylindrical tube opening at or near the top of the heater and ending eight to twelve inches above the grate. The magazine is filled with coal, which descends as combustion takes place at the lower end, and provides fuel for further combustion (see Fig. 142). The magazine works successfully with anthracite coal, which is that ordinarily employed in domestic

heating, but it takes up useful space in the heater, decreases the effective heating surface for a given size, and in that respect is objectionable. The writer's own experience would lead him to believe that the magazine heater, except in very small sizes, requires as much attention as the surface burner, and consequently has no special advantage.*

84. Heating-boilers for Soft Coal.—It is quite probable that no furnace, either for power- or heating-boilers, has yet

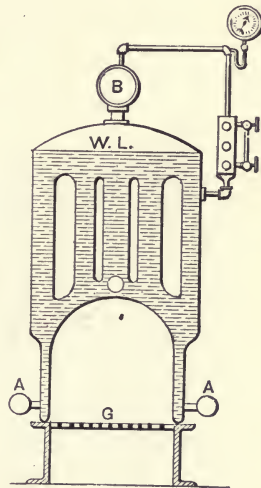

FIG. 152.

* Magazine heaters have been constructed with a magazine set obliquely above and to the side of the grate, and in that position are not open to all the objections stated.

been produced which will consume soft coal without more or less black smoke. This smoke is due principally to the imperfect combustion of the hydrocarbons contained in the coal. The hydrogen burning out after the gases have left the fire leaves solid carbon in the form of small particles, which float with and discolors the products of combustion. The amount of loss as found by experiment in Sibley College, even when dense black smoke is produced, seldom reaches one per cent, and is of no economical importance. The sooty matter produced in the combustion of this coal is likely to adhere to the water-heating surfaces, and if these are minutely divided it will be certain to choke the passages for the gases of combustion. For the combustion of soft coal those heaters have been the most successful which have a grate with small openings, and with an area 50 to 70 per cent as large as that needed for anthracite coal, also with the heating-surface of comparatively simple form and arranged so as to be easily cleaned. It is considered important that the air-flues be so arranged as to keep the products of combustion as hot as possible. This coal is likely to swell when first heated, and cannot be fed successfully by a magazine.

85. Boilers in Batteries.—Two or more boilers or heaters are sometimes used as a battery for heating on account of limited headroom, insurance against breakdown, etc. A single unit will generally give a higher efficiency on the coal burned, due mostly to more efficient combustion of the coal and the smaller amount of heat wasted in heating the gases going up the chimney. If two units are used they should be installed with separate dampers which can be closed off tight, preventing the leakage of air into the chimney through the unused unit.

CHAPTER IX.

SETTINGS AND APPLIANCES—METHODS OF OPERATING BOILERS AND HEATERS.

86. **Brick Settings for Boilers.**—Horizontal tubular boilers and a few heating-boilers require to be set in brickwork, of which the general arrangement is shown in Fig. 153. The

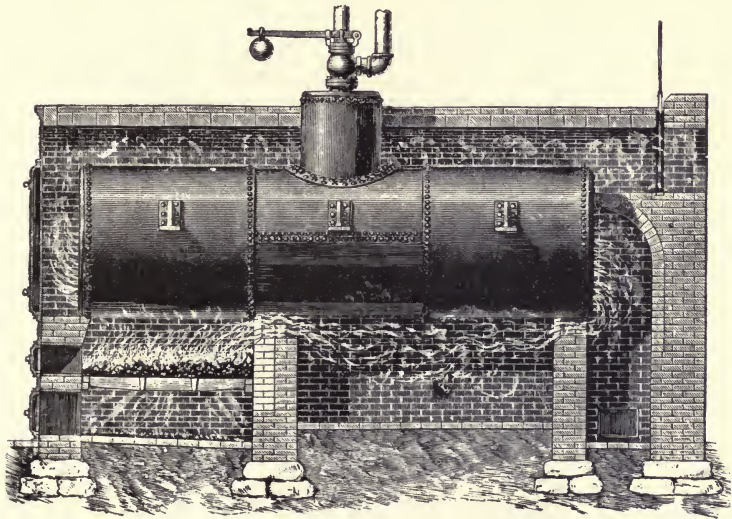

FIG. 153.—Perspective View of Tubular Boiler Set in Brickwork.

horizontal tubular boiler is usually supported from cast-iron flanges which are riveted to the sides of the shell, and which rest directly on the walls of brickwork, or are supported by suspension-rods from above. In some instances the boiler-lugs rest on cast-iron columns embedded within the brickwork, and of such a length that all the brickwork above the grates can be removed without affecting the setting. In setting the boiler the back end should be slightly lower than the front,

in order that the entire bottom of the boiler may be drained at the blow-off pipe. One of the lugs of the boiler on each side should be anchored in the brickwork; the others should rest on rollers, which in turn rest on an iron plate embedded in the

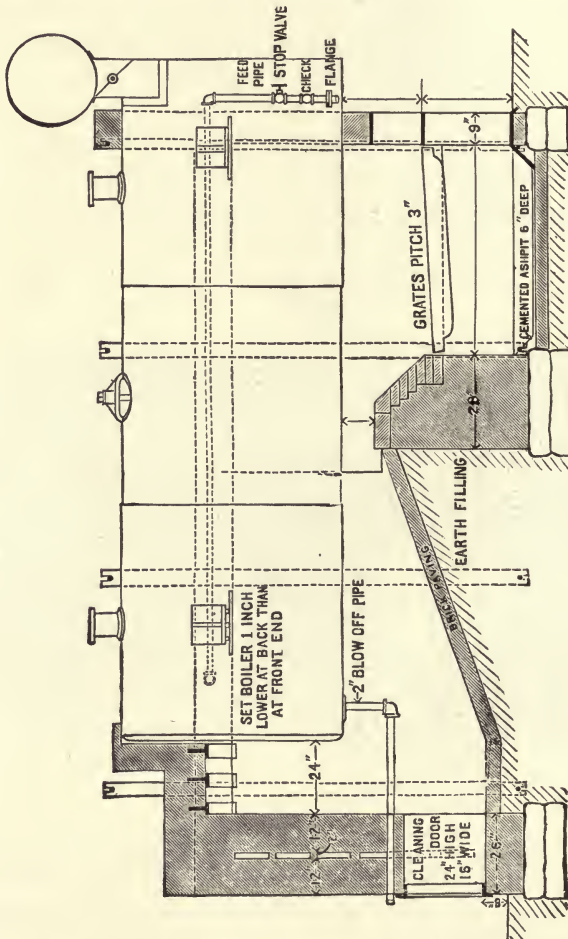

FIG. 154.—Boiler-setting.

brick walls. This permits expansion due to heating and cooling to take place without straining the boiler. If the boiler is not over 14 feet in length, two lugs on a side will be sufficient to sustain it, but if it is of greater length, more lugs will need to be supplied. This brickwork surrounding the boiler is

more durable if built with an air-space, as shown in Fig. 155. It must be thoroughly stayed, by means of iron braces, connected with tie-rods of wrought iron at top and bottom to prevent transverse or longitudinal motion. The top may be arched over so as to leave a passage for the hot gases directly over the shell, as in Fig. 153, or made to rest directly on the boiler, and the hot gases taken away at the front end by means of a flue, usually termed a *breeching*, which extends to the chimney. The practice of taking the heated gases from the front

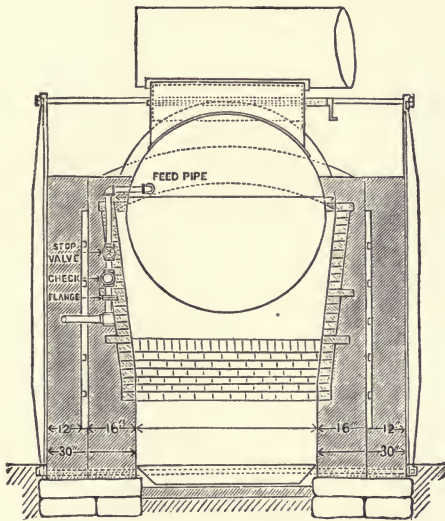

FIG. 155.—Sectional View of Boiler-setting.

end of the boiler is rather more common than that of returning them to the back end over the top, and there are many engineers who believe that the hot gases injure the boiler when coming in contact with the shell above the water-line. Figs. 154, 155, and 156 show longitudinal and transverse sections of a boiler-setting, with smoke-pipe or breeching in front, which can be highly commended as representing the best practice.

The depth of foundation to be used in boiler-setting will depend upon the character of the soil and the weight of the boiler. For large tubular and water-tube boilers it should

generally be not less than 3 feet. Fire-brick of the best quality should be used to line the brick walls where exposed to the fire from the grate to the water-line of the boiler, and these should be arranged so that if necessary they can be renewed without

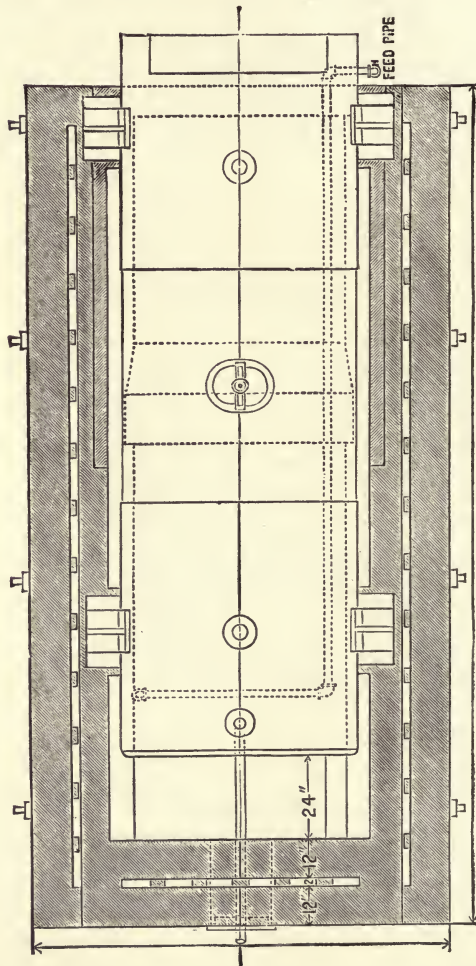

FIG. 156.—Top View of Boiler-setting.

disturbing the outer brickwork. In the setting shown in Figs. 154-155 the top of the boiler is covered with a coating of some good, non-conducting material, for which magnesia and asbestos may be recommended, put on while in a plastic condition to the

depth of 2 inches. Mineral wool is also used for this purpose. Brickwork is often used; but it is heavier, and quite liable to crack from the effects of heat.

87. Setting of Heating-boilers.—If heating-boilers are to be set in brickwork, the special directions which have already been given can be applied, with such modifications as may be needed for the boiler in question. Nearly all heating-boilers are now set in what is called a *portable setting*, in which no brick whatever is used. Some of the heaters are constructed in such a manner that no outside casing is required, as in Fig. 159; others require thin casing of galvanized or black iron which is lined with some non-conducting material, as magnesia, asbestos fibre, or rock wool, which is placed outside the heater and arranged so as to enclose a dead-air space, as in Fig. 158. These coverings are nearly as efficient in preventing the loss of heat as brickwork, and they form a more cleanly and neater appearing job.

The slight amount of heat which escapes from such a setting is seldom more than that required to warm up the basement or room in which the heater is located.

The boiler must in all cases be provided with a steam-gauge, safety-valve, and damper regulator, all of which are specially described later. The steam-gauge should be either connected below the water-level or else provided with a siphon to prevent dry steam entering the interior tube. A safety-valve of the single-weighted type is preferable and should be connected at the top of the heater. Fig. 158 represents a boiler with portable setting with external iron casing and equipped with all appliances, and Fig. 159 represents a portable setting without enclosing case.

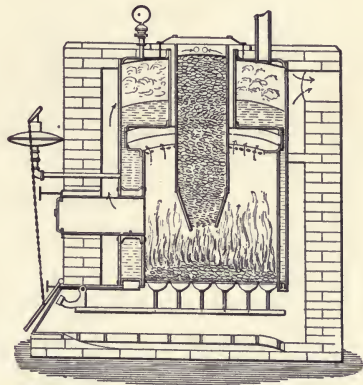

FIG. 157.—Brick-set Magazine Boiler.

Hot-water heaters are set in the same general manner as steam-boilers. Each should be provided with thermometers showing both the temperature of the flow and the return water, and with a pressure-gauge graduated to show pressure of water in feet and sufficiently large to show any variation in height in the open expansion tank. The dampers to a hot-water heater cannot be opened and closed by variation in pressure, but reliable thermostats are now on the market which will operate

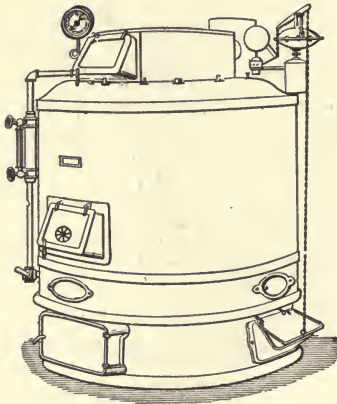

FIG. 158.—Heating-boiler with Portable Setting.

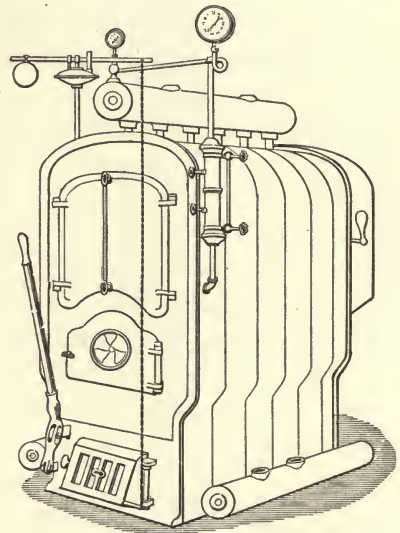

FIG. 159.—Heating-boiler with Portable Setting.

the dampers by change of temperature in the various rooms of the building.

88. The Safety-valve.—The safety-valve has been used since the earliest days of boiler construction for reducing the pressure when it reached or exceeded a certain limit. It has been built in various forms, but in every case has consisted essentially of a valve opening outward and held in place by a weight or a spring. One form in common use consists of a valve held in place by a weight on the end of a lever, shown in Fig. 160. In this form of safety-valve the force required to

lift the valve can be regulated by sliding the weight to different positions on the lever. The form shown in Fig. 161 consists of a single weight suspended from the valve and hanging in the upper part of the boiler. This form is to be commended, since it cannot be adjusted without opening the boiler.

A form used very extensively for low-pressure heating-boilers consists of a single weight resting on a valve, as shown in Fig. 162; its principle of operation is the same as

that of the other valves. A form much used on power-boilers, and frequently called, from the suddenness with which it opens, a *pop-valve*,

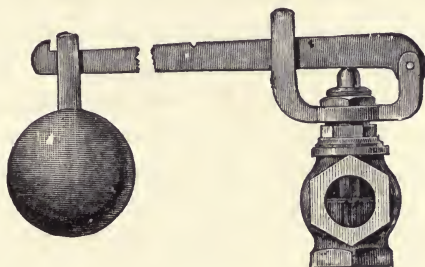

FIG. 160.—Lever Safety-valve, Modern Form.

consists of a very quick-opening valve held in place with a spring, one form of which is shown in Fig. 163.

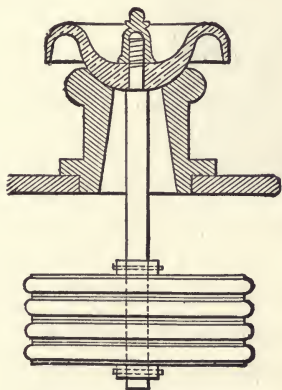

FIG. 161.—Dead-weight Safety-valve. Weight inside of boiler.

It is desirable that the safety-valve be made in such a manner that the engineer or attendant to the boiler cannot manipulate it at pleasure so as to maintain a higher pressure on the boiler than prescribed.

Serious accidents have been caused by excessive weighting of the safety-valve through ignorance or carelessness on the part of the attendants, and for this reason a class of valves should be selected which cannot be

tampered with. Some of the safety-valves are provided with an external case which can be locked, and others are provided with internal weights, as already described. The lever safety-valve offers the greatest temptation for extra weighting and should rarely be used.

Safety-valves should be fastened directly to the boiler without any intervening valves or piping.

88. Safety-valve Area.—This must be sufficiently large to reduce the boiler pressure effectually when the valve is open and when a brisk fire is burning on the grate. It may be computed from the following considerations:

The steam which will flow through one square inch of opening in one hour of time was found by Napier to equal in pounds nearly 50 times the absolute pressure of the steam; further, it has been found by experiment that the safety-valves in ordinary use open only to such an extent as to make $\frac{1}{5}$ of

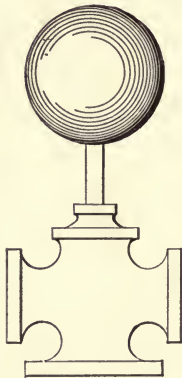

FIG. 162.—Externally Weighted Safety-valve.

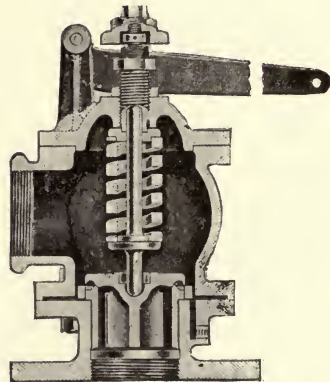

FIG. 163.—Section of Spring or Pop Safety-valve.

the total area of the valve effective in reducing the pressure. From these considerations it will be seen that the area of the safety-valve in inches should be $\frac{1}{50}$ the weight of steam generated per hour, divided by the absolute pressure. Considering that 100 lbs. of steam can be generated from each square foot of grate per hour, this would be equivalent to the following rule: The area in square inches is equal to 18 times the grate surface in square feet, divided by the absolute pressure.

The following table gives the areas of grate surfaces, in square feet, for direct spring-loaded safety-valves, required by the Massachusetts Board of Boiler Rules:

	$W = \frac{75}{3600}$ $P = .40$ $A = .401$	$W = \frac{100}{3600}$ $P = .65$ $A = .329$	$W = \frac{160}{3600}$ $P = 115$ $A = .297$	$W = \frac{160}{3600}$ $P = 140$ $A = .244$	$W = \frac{200}{3600}$ $P = 190$ $A = .224$	$W = \frac{240}{3600}$ $P = 240$ $A = .213$
Maximum Pressure allowed per Square Inch on the Boiler.	Zero to 25 Pounds.	Over 25 to 50 Pounds.	Over 50 to 100 Pounds.	Over 100 to 150 Pounds.	Over 150 to 200 Pounds.	Over 200 Pounds.

Diameter of Valve, in Inches.	Area of Valve, in Square Inches.	Area of Grate, in Square Feet.					
1	.7854	2.00	2.50	2.75	3.25	3.5	3.75
1 $\frac{1}{4}$	1.2272	3.25	4.00	4.25	5.00	5.5	5.75
1 $\frac{1}{2}$	1.7671	4.50	5.50	6.00	7.25	8.0	8.50
2	3.1416	8.00	9.75	10.75	13.00	14.0	15.00
2 $\frac{1}{2}$	4.9087	12.50	15.00	16.50	20.00	22.0	23.00
3	7.0686	17.75	21.50	24.00	29.00	31.5	33.25
3 $\frac{1}{2}$	9.6211	24.00	29.50	32.50	39.50	43.0	45.25
4	12.5660	31.50	38.25	42.50	51.50	56.0	59.00
4 $\frac{1}{2}$	15.9040	40.00	48.50	53.50	65.00	71.0	74.25
5	19.6350	49.00	60.00	66.00	80.00	88.0	92.25

When the conditions exceed those on which the table is based, the following formula shall be used:

$$A = \frac{W70}{P} \times 11.$$

A = area of direct spring-loaded safety-valve in square inches per square foot of grate surface.

W = weight of water in pounds evaporated per square foot of grate surface per second.

P = pressure (absolute) at which the safety valve is set to blow.

A table of areas of grate surfaces, in square feet; for other than direct spring-loaded safety-valves, will be found on p. 220.

Various rules quite different from those in the tables are given in treatises on boiler construction, but it is believed that these two tables represent the best practice of to-day and form a safe guide for estimating the size of safety-valves.

Safety-valves are liable to stick fast to the seat, through corrosion, in which case they fail to raise with excess of pressure; for that reason they should be periodically lifted from their seats and otherwise inspected.

Maximum Pressure Allowed per Square Inch on the Boiler.		Zero to 25 Pounds.	Over 25 to 50 Pounds.	Over 50 to 100 Pounds.
Diameter of Valve, in Inches.	Area of Valve, in Square Inches.	Area of Grate, in Square Feet.		
1	.7854	1.50	1.75	2.00
1 $\frac{1}{4}$	1.2272	2.25	2.50	3.00
1 $\frac{1}{2}$	1.7671	3.00	3.75	4.00
2	3.1416	5.50	6.50	7.25
2 $\frac{1}{2}$	4.9087	8.25	10.00	11.00
3	7.0686	11.75	14.25	16.00
3 $\frac{1}{2}$	9.6211	16.00	19.50	21.75
4	12.5660	21.00	25.50	28.25
4 $\frac{1}{2}$	15.9040	26.75	32.50	36.00
5	19.6350	32.75	40.00	44.00

In case the area of the valve required is greater than 4 inches in diameter, two or more safety-valves should be provided.



FIG. 164.
Water Gauge.

89. Appliances for showing Level of Water in the Boiler.—In the first boilers constructed floats were used, and such appliances are still common on European boilers. In this country water-gauge glasses and try-cocks are now used, to the exclusion of all other devices. The water-gauge (see Fig. 164), consists of two angle-valves, one of which is screwed into the boiler above the water-line; the other is screwed about an equal distance below, and these are connected by means of a glass tube usually $\frac{3}{8}$ to $\frac{5}{8}$ inch external diameter and strong enough to withstand the steam-pressure. When both angle-valves are open the water will stand in the gauge-glass the same height as in the boiler, but if either valve is closed the water-level shown in the glass will not accord with that in the boiler. Three try-cocks are usually put on a boiler in addition to the water-gauge.

The try-cocks are made in various forms, one kind being shown in Fig. 165, and are located so that one is above,

the other below, and the third at about the mean position of the water-line. When the top one is opened, it should show steam; when the bottom one is opened, it should show

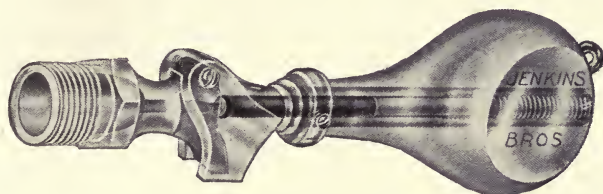

FIG. 165.—Try-cock.

water. Both try-cocks and gauge-glasses should usually be put on boilers, so that the reading as shown in the water-gauge glass can be checked from time to time. This is necessary, because if dirt should get in the angle-valves or passages leading to the gauge-glass the determination would be inaccurate.

Water-columns attached to the boiler by large pipes, both above and below the water-line, and fitted with try-cocks and water-gauge as shown in Fig. 166, are often provided. These

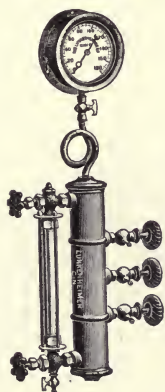

FIG. 166.—Water-column.

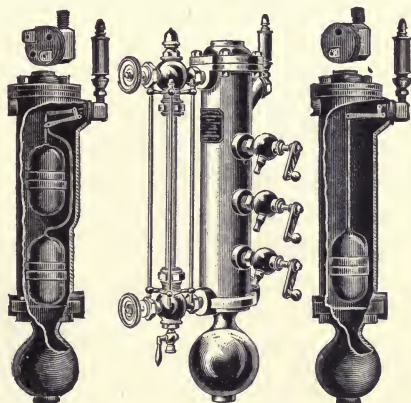

FIG. 167.—Reliance Alarm Water-column.

columns frequently contain floats (Fig. 167), so arranged that steam is admitted into a small whistle if the water falls below or rises above the required limits, and thus gives an alarm.

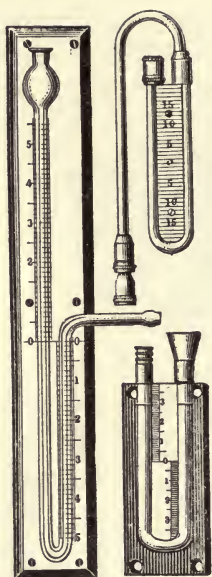

FIG. 168.—U-shaped Manometer Tubes.

90. Methods of Measuring Pressure.—The excess of pressure above that of the atmosphere is measured by some form of manometer or pressure-gauge. Where the pressure is small in amount, a siphon, or U-shaped tube filled with some liquid is a very convenient means of measuring pressure.

If water, mercury, or other liquid be placed in the U-shaped tube it will be forced down on the side of the greater pressure and upward on the side of the less, a distance proportional to the pressure. The height of the fluid in one side in excess of that on the other will be a measure of the difference of pressure between that of the atmosphere and that in the vessel.

Various forms of manometers are used, of which several are shown in Fig. 168. For very low pressures water is the liquid generally employed; for moderate pressures up to 15 or 25 pounds mercury is very convenient, and often used; while for high pressures a pressure-gauge (Fig. 169) is commonly employed.

91. The Bourdon Pressure-gauge is ordinarily used. This consists of a tube of elliptical cross-section bent into a circular form. The free end of the tube is attached by gearing to a hand which moves over a dial. Pressure on the interior of the tube tends to straighten it, and moves the hand an amount proportional to the pressure.



FIG. 169.—Bourdon Gauge.

Fig. 169 shows the interior of a pressure-gauge of this character, the dial being removed. In place of the tube a corrugated diaphragm is sometimes employed. A section of such a gauge is shown in Fig. 170. In the use of gauges of the character just described it is necessary to protect them from extreme heat. For this purpose when they are connected to a steam-boiler a siphon or U-shaped form of pipe is to be used in the connection, so that water and not steam will be forced into the interior of the gauge.

The manometers and gauges described in every case measure the pressure above or below that of the atmosphere. If they measure a pressure lower than that of the atmosphere they are commonly called vacuum-gauges, but the principle of construction is the same as described.

The relations of various units used in measuring pressure can be readily determined from the following table of equivalents:

1 inch of mercury	= 13.58
inches of water	= 1.131
feet of water	= 0.490
lbs. per sq. in.	= 920
feet of air at 60 degrees Fahrenheit and barometer pressure 30 inches.	

The pressures are usually taken as acting on one square inch of a body.

In any hot-water heating system it is quite important to know the temperature of the water leaving the heater, and in many cases also that of the return. This information, while not so vital to the safety of the heater as that given by a pressure-gauge on a steam-heating system, is of the same character, and will prove to be equally valuable in indicating

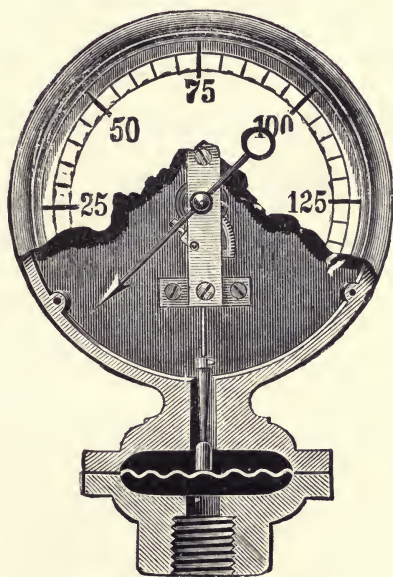

FIG. 170.—Diaphragm Gauge.

the work done by the heater, and the heat absorbed by the system.

Any of the suitable forms of thermometers described in Chapter I can be used, but special forms in which the thermometer-bulb sets in a cup of mercury are often used, the cup being screwed into the pipe whose temperature is required. These thermometers should be set so as to extend deep into the current of flowing water, and there should be no opportunity for air to gather around the bulb; otherwise the readings will not be the true temperature.

92. Damper-regulators.—Nearly all steam-boilers are provided with an apparatus for opening or closing the dampers and draft-doors to the boiler as may be required to maintain

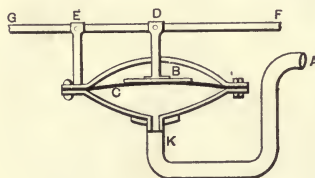

FIG. 171.—Diaphragm Damper-regulator.

a constant steam-pressure. For low-pressure steam-heating plants the regulator consists in nearly every case of a rubber diaphragm (Fig. 171), which receives the steam-pressure on one side, and acts against a counter-weight resting on a plate on the oppo-

site side. The plate is connected by a rod to a lever pivoted to the external case, which in turn is connected to the various drafts by means of chains, and so arranged that if the pressure rises the lever is lifted and the dampers closed, while if the pressure falls the lever also falls, and the dampers are opened. By means of weights on the lever the regulator can be set to operate at any pressure. The regulator should be connected to the boiler below the water-line, or by means of a U-shaped pipe, arranged so that the part of the vessel below the diaphragm will remain full of water; otherwise the heat in the steam will cause the rubber to deteriorate rapidly. The form shown in Fig. 171 is so arranged that the diaphragm must in every case be in contact with water.

While rubber diaphragms are usually durable for low-pressure steam-regulators, still they occasionally are ruptured. In order to prevent accident from such a cause, the Nason Manu-

facturing Co. have devised a form of such a character that the draft-doors will close, instead of open, in case of rupture. This is done by using a link in the connecting-chain to the draft-doors of some metal that will be fused at a temperature below that of boiling water, and arranged so that in case of rupture the escaping steam and hot water will impinge upon and melt it; the damper will be closed by its own weight when the link breaks.

Damper-regulators for high-pressure steam are constructed so as to operate on the same principle as those described, but instead of a rubber diaphragm, either a metallic diaphragm or a piston working in a cylinder, and operated by water-pressure, is employed.

The following cut shows the external appearance of one of the many forms in use:

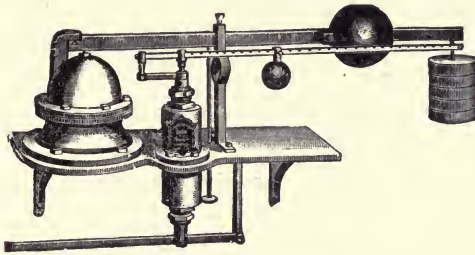

FIG. 172.—Piston Damper-regulator.

93. Blow-off Cocks or Valves.—Every steam-boiler should be provided with an appliance for emptying all of the water when desired. This may be done by leading a pipe from the lowest part of the boiler and providing a cock or valve so that it can be discharged at pleasure. The pipe leading from the boiler should have a visible outlet, so in case there is any leak it can be seen and stopped. The writer prefers a cock to a valve for use on the blow-off pipe, since it is less likely to be stopped by scale or sediment from the boiler.

In case the water of condensation from the heating coils is not returned to the boiler it is necessary to blow off some of the water very frequently in order to lessen the deposition of scale or dirt on the bottom of the boiler.

94. Form of Chimneys.—The form and size of the chimney is of great importance in connection with the satisfactory operation of a heating plant, and it should in every case receive the closest inspection before guarantees of capacity are made.

It will be found that for a specified area a round chimney will have the greatest capacity, but in ordinary building construction such a chimney is difficult to construct and is not ordinarily built. A square chimney of the same area has somewhat more friction, and one with a rectangular narrow flue very much more, so that an increase in area proportional to excess of perimeter should be made for such cases. The chimney should be as smooth as possible on the inside in order to prevent loss of velocity by friction, and, if of brick, the flue should in every case be plastered. In the construction of chimneys it is better that the inside be made with a thin wall not connected in any way with the outside, both in order to permit free expansion of the inner layer of the chimney with the heat and also to secure the advantage of the non-conducting power of an air space between the inside and outside walls. Such a construction is common for chimneys for power purposes, but is not ordinarily applied to those used in buildings.

95. Sizes of Chimneys.—The area of cross-section required for a given chimney will depend upon its height and also upon the amount of coal to be burned. The conditions which affect chimney draft are so numerous, and so difficult to consider in any theoretical discussion, that empirical or practical formulæ derived from the study of actually existing plants are probably more satisfactory than those obtained from purely theoretical computations. Of the various formulæ which have been given for the capacity of chimneys the writer prefers that of William Kent, from which the accompanying table is computed.

Kent's formula is computed on the assumption that the chimney shall have a diameter two inches greater than that required for passage of the air, in order to compensate for friction. The following is his formula:

$$E = \frac{0.3H}{\sqrt{h}} = A - 0.6\sqrt{A};$$

$$H = 3.33E\sqrt{h};$$

$$S = 12\sqrt{E} + 4;$$

$$h = \left(\frac{0.3H}{E}\right)^2;$$

in which A = actual area of the chimney in square feet, E = effective area, h = height in feet, S = side of the square in inches, H = horse-power of plant.

If we let R = number of square feet of radiating surface to be supplied, then, Article 73, page 190,

$$H = \frac{R}{100};$$

from which $E = \frac{0.003R}{\sqrt{h}}$.

The table gives the diameter of round or side of square chimneys in inches for various heights computed from the above formulæ, with the diameter increased by 2, to allow for friction. A square chimney is considered the equivalent of the inscribed round one.

DIAMETER OR SIDE OF CHIMNEY IN INCHES REQUIRED FOR VARYING AMOUNTS OF DIRECT STEAM-RADIATING SURFACE.

Height of Chimney in Feet.		20	30	40	50	60	80	100	120
Square Feet of Steam Radiation.	Horse-power.								
250	2.5	7.4	7.0	6.7	6.4	6.2	6.0	6.0	6.0
500	5.0	9.6	9.2	8.8	8.2	8.0	6.6	7.3	7.0
750	7.5	11.3	10.8	10.2	9.6	9.3	8.8	8.5	8.2
1,000	10.0	12.8	12.0	11.4	10.8	10.5	10.0	9.5	9.2
1,500	15.0	15.2	14.4	13.4	12.8	12.4	11.5	11.2	10.8
2,000	20.0	17.2	16.3	15.2	14.5	14.0	13.2	12.6	12.1
3,000	30.0	20.6	18.5	18.2	17.2	16.6	15.8	15.0	14.4
4,000	40.0	23.6	22.2	20.8	19.6	19.0	17.8	17.0	16.3
5,000	50.0	26.0	24.6	23.0	21.6	21.0	19.4	18.6	18.0
6,000	60.0	28.4	26.8	25.0	23.4	22.8	21.2	20.2	19.5
7,000	70.0	30.4	28.8	27.0	25.5	24.4	23.0	21.6	20.8
8,000	80.0	32.4	30.6	28.6	26.8	26.0	24.2	23.4	22.2
9,000	90.0	34.0	32.4	30.4	28.4	27.4	25.6	24.4	23.4
10,000	100.0	37.0	34.0	32.0	30.0	28.6	27.0	25.4	24.6
15,000	150.0	38.4	36.2	35.0	33.0	31.0	29.2
20,000	200.0	43.0	42.0	41.0	37.0	35.0	34.0
30,000	300.0	50.0	48.0	46.0	43.0	41.0

For other kinds of heating multiply the radiating surface by the following factors: Hot-water heating 1.5, indirect steam 0.7, hot-blast heating 0.2.

96. Chimney-tops.—The draft of a chimney is influenced to a great extent by the conditions of the surrounding space. If other buildings exist in the vicinity of such a form as to deflect the currents of air down the chimney, the draft will be impaired and may be entirely destroyed. The objects which tend to produce downward air-currents may sometimes be situated a considerable distance from the chimney and thus render the specific cause of poor draft very difficult to determine. The remedy for a smoky chimney is sometimes difficult to apply, but usually the draft will be improved, first, by increasing the height of the chimney; second, by adopting some form of chimney-top which utilizes the force of horizontal currents to aid by induction in increasing the draft.

The writer found that curved trumpet-shaped tubes located with the small ends projecting into the chimney in an upward direction increased the draft materially when the wind was blowing into the openings, and there is little reason to doubt but that a chimney-top may be constructed in such a manner as to materially increase the draft.

97. Grates.—For supporting the fuel during its combustion in such a manner as to allow a free passage of air, a perforated metallic construction of some sort is required. For burning very fine coal the perforations must be small and close together; for burning larger sized coal the perforations may be larger and further apart. The area of the air-spaces compared with the total area of the grate should be about 50 per cent in order to secure best results, but they will more generally be found to be 30 to 40 per cent. The grates are usually constructed of cast iron and in a great variety of forms, as shown in Figs. 173 and 174. In some instances a series of parallel bars is used; in others the grates are made in one solid casting. This latter practice is never one to be recommended. The solid grate is likely to break from expansion strains due to heating unless made in such form that the various parts are free to expand independently.

Nearly all heating-boilers, hot-water heaters, and furnaces are supplied with some form of shaking- and dumping-grate.

Many of these grates are known from experience of the writer to give most excellent satisfaction, and doubtless all present points of merit. The various shaking-grates operate in nearly every way, and it is hard to conceive either a form of grate-bar or a method of shaking which is not exemplified in some of these grates. Some of the bars are flat or rectangular in shape, and are operated by shaking backward and forward; others are triangular and are occasionally rotated so as to present successively new surfaces to the fire each time they are shaken. The shaking-grate will, in general, be found much superior to the fixed one, and a furnace fitted with such grates is more easily managed and more cleanly than one with a fixed grate of any description.

Hard coal, stove or egg size, is the standard fuel upon which

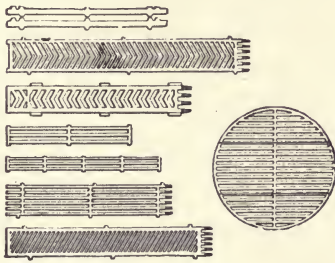

FIG. 173.

Different Forms of Grates.

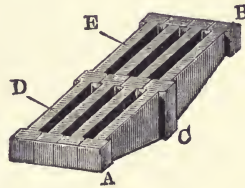

FIG. 174.

boiler capacities are usually based. For pea or buckwheat coal, a larger grate is necessary, as the smaller sizes pack closer, choking the draft and burning coal slower. For anthracite coal, the heating value falls off approximately proportional as the percentage of the ash increases, so that an excellent check on the quality of the coal and the efficiency of the grate is the relative amount of ashes produced.

The smaller sizes of coal are cheaper but require more care in firing and the saving in price may be easily offset by coal dumped through with the ashes. The small coal is hard to force in severe weather, but holds the fire better in mild weather. Soft coals are objectionable on account of the smoke and soot

produced and are not much used for household heating except where anthracite is commercially unobtainable.

98. Traps.—In all systems of gravity steam-heating, the water of condensation returns directly to the boiler, and no appliance either for maintaining a water-line in the building or returning the condensed steam to the boiler is required. But there are cases in which it is necessary to maintain the water-line at a certain definite height, and also to prevent the escape of steam without interfering with the discharge of condensing water. For this purpose a steam-trap is required. One form

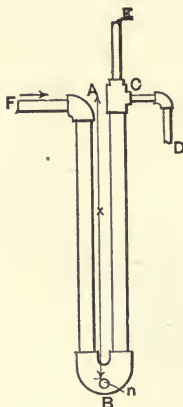

FIG. 175.
Siphon-trap.

of a steam-trap which has always been used to a greater or less extent for this purpose is a siphon made in the shape of a U bend, or its equivalent of pipe and fittings, as shown in Fig. 175. It consists of two legs, *AB* and *BC*, which may be close together or any distance apart, but the length of which must be sufficiently great to prevent pressure acting through the pipe *FA* forcing the water out of *BC*. *CE* is a vent-pipe extending to the air; *D* is the discharge for the condensed water. In ordinary operation the leg *CB* is filled with water which is constantly overflowing, and *AB* with steam and water, the total pressure in both legs being in each case equal.

The siphon-trap may be open to the objection that it will require a great deal of vertical room if the pressure is great; for this reason traps with mechanical movements of some kind are usually preferred. The simplest of these traps contains a float (Fig. 176) which rises and falls with change of level of the water in the vessel. Rising above a certain point, it opens a discharge-valve; falling below, it closes it. Traps of this class are made of a great many designs. In some instances traps are made as in Fig. 177, in which a weight *W* is used instead of a float and is nearly counter-balanced by the weight *D*. As the water rises in the trap it tends to lift the weight *W* with a force equal to weight of water displaced, thus opening a discharge-

valve at *B*. When the water falls, the valve is closed. It is noted that the counter-weight *D* is always above the water-line.

A large number of traps are made with a hollow metallic float or bucket, so arranged as to open a valve when the bucket

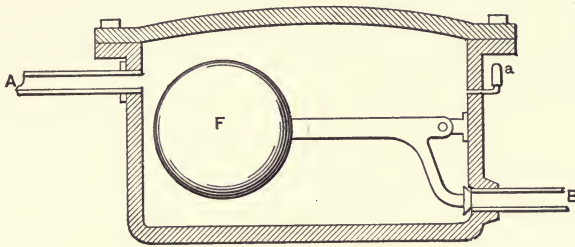

FIG. 176.—Float-trap.

is full of water. One form is shown in Fig. 178, in which the water enters the trap at *A*, filling the space *S* between the bucket and the walls of the trap. This causes the bucket to float, and thus to close an orifice in the discharge-pipe *V*. When the water rises above the edges of the bucket it flows into it and causes it to sink, which opens the discharge-valve at *V*. The

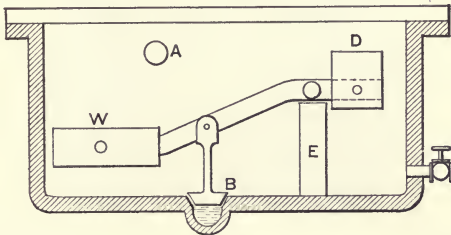

FIG. 177.—Counter-weighted Trap.

water is forced out through the pipe *B* by the steam pressure acting on the surface *SS*.

The bucket traps are made in great variety, both as to form of valve, guides for bucket, etc. Fig. 179, shows one of the traps which is in common use, with all details of construction.

Another extensive class of traps are made so as to be closed by the expansion due to increase in temperature. These traps

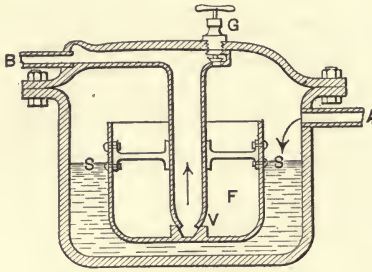

FIG. 178.—Bucket Trap.

which closes the orifice in the discharge-pipe *B*. When the water in the trap cools the valve opens. The materials used for traps of this class can be metallic or some compo-

differ from each other very much in form; the principle, however, is in all cases the same. Thus in the diagram, Fig. 180, steam is supplied at *A* and discharged at *B*. The bent springs *S* are prevented by guides from moving laterally, so that the expansion due to heat causes a motion

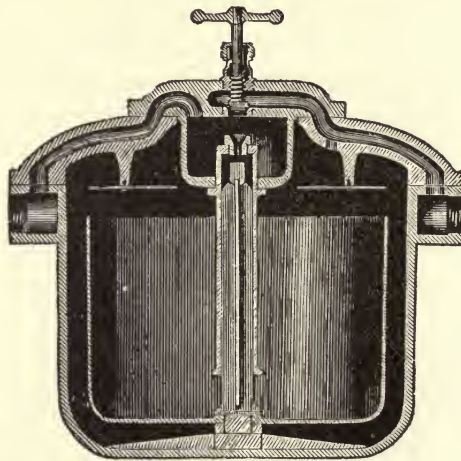

FIG. 179.—Bucket Trap.

sition of material like that employed for air-valves. The discharge can be arranged to take place from the bottom or, as shown in the diagram, from the side.

Traps which combine one or more of the principles of operation as described are on the market. Thus Fig. 181 represents a

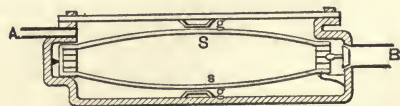

FIG. 180.—Expansion-trap.

trap with two valves in which one valve is opened by expansion, the other by a float.

The bucket traps have generally proved the most reliable and less likely to be injured by use. The float-traps have been liable to failure because of leakage of the float, but recent improvements in manufacture render this accident quite improbable. All traps need periodical inspection, as the valves are likely to become more or less choked up, in which case the trap may fail to operate. All of the traps described will discharge the water to a height which corresponds to the steam-pressure in use, and hence when used with high-pressure steam will lift water to a considerable distance; but in no case will they

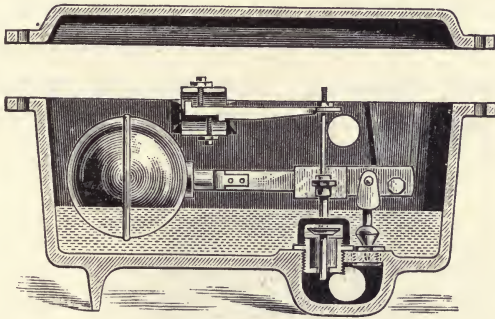

FIG. 181.—Combined Float- and Expansion-trap.

return the water into the boiler from which the steam was received. For this purpose a trap of considerable more complexity, known as a return-steam trap, must be used.

99. Return-traps.—Traps which receive the water of condensation and return it to a boiler having considerably higher-pressure steam than that acting on the returns, are known as *return-traps*. They are made in quite a variety of forms, but the general principle of operation is shown by the diagram Fig. 182. In this figure *D* represents the boiler and *AB* the trap, which is located above the boiler and is supplied with steam from the boiler at *A*. It is connected with the return system by a pipe leading from the tank or drum *P*, and pipe discharging into the trap at *E*. A pipe leads from the bottom of the trap

B and connects below the water-line with the boiler. Check-valves are located at *C'* and *C*, which permit the flow to take

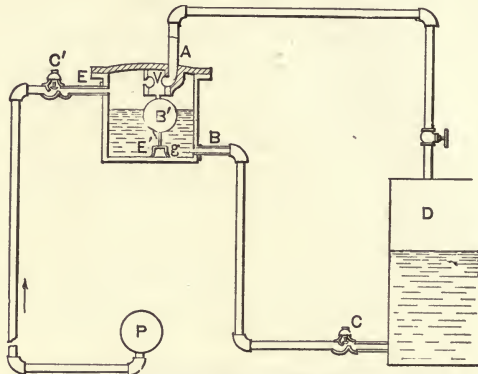

FIG. 182.—Diagram Showing Action of Return-trap.

place toward the boiler only. The essential method of operation of the trap is as follows: First, water flows into the trap

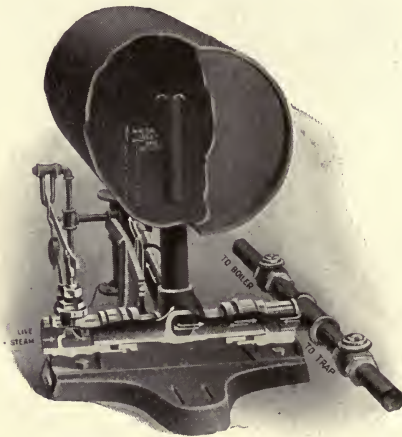

FIG. 183.—The accompanying engraving shows a cross-sectional view of the Morehead Tilting Return Trap with parts removed and broken away to disclose the water inlet and discharge openings, and also the manner of delivering live steam from boiler to a point above the line of condensation in trap. The arrows indicate the direction taken by the condensation on entering and leaving and the steam on entering the trap.

from the return *P*, until it reaches a certain level, when it acts on the float *B* so as to open a balanced steam-valve, called an

equalizing-valve, connected to the main pipe *A*. This permits steam from the boiler to enter the trap, which equalizes the pressure of steam in the trap and boiler. The water in the trap,

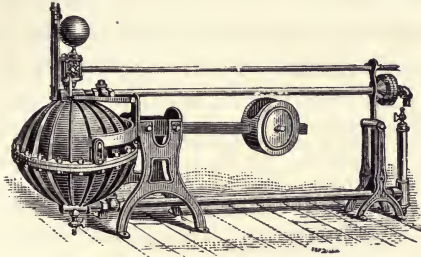

FIG. 184.—Gravitating Return-trap.

because of its greater density, then commences to flow out through the pipe *B*, and need only cease when the level becomes nearly the same as in the boiler. The discharge of the water

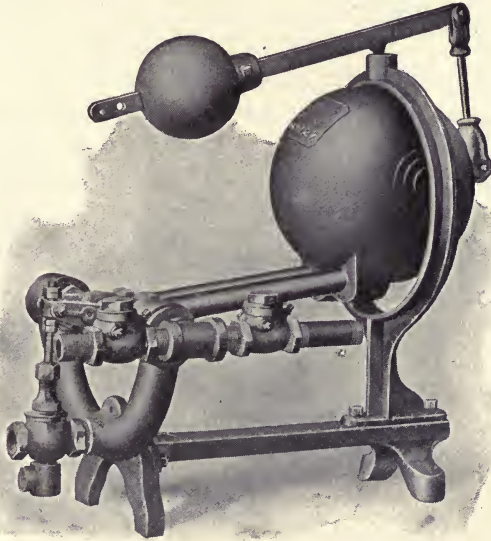

FIG. 185.—Bundy Return Trap.

causes the float *B* to fall, which closes the equalizing-valve, and the operation as described is again repeated.

The accompanying engraving shows a cross-sectional view

of the Morehead Tilting Return Trap with parts removed and broken away to disclose the water inlet and discharge openings, and also the manner of delivering live steam from boiler to a point above the line of condensation in trap. The arrows indicate the direction taken by the condensation on entering and leaving and the steam on entering the trap.

Instead of a float a bucket may be used to operate the equalizing-valve, acting in a manner similar to that described for the ordinary bucket trap.

The bucket is probably superior to the float for this purpose, since it is less likely to be affected in its operation by change in density or pressure of the steam.

Various other systems for opening and closing the equalizing-valve have been adopted, of which one, shown in Fig. 184, consists in mounting the trap so that it will move into one position when empty and into another when full, the motion so obtained being used to open and close the equalizing-valve.

A different construction for accomplishing the same purpose is shown in Figs. 183 and 185.

100. General Directions for the Care of Steam-heating Boilers.—Special directions will be no doubt supplied by the maker for each kind of boiler, or for those which are to be managed in a peculiar way. The following directions are general and should always be observed, regardless of the kind of boiler employed:

1. Before starting the fire see that the boiler contains water. Its surface should stand a distance of from one-third to one-half the height of the gauge-glass.

2. See that the smoke-pipe and chimney-flue are clean and that the draft is good.

3. Build the fire in the usual way, using a quality of coal which is adapted to the heater.

4. In operating the fire keep the fire-pot full of coal and shake down and remove all ashes and cinders as often as the state of the fire requires it. If a magazine heater is used it must be kept full of coal.

5. Hot ashes or cinders must not be allowed to remain in

the ash-pit under the grate-bars, but must be removed at stated intervals to prevent burning out of the grate.

6. To control the fire, see that the damper regulator is properly attached to draft-doors and damper; then regulate the draft by weighting automatic draft-lever as required, lightly or not at all in mild weather, but increasing as the weather becomes colder.

7. Should the water in the boiler escape, by means of a broken gauge-glass or other mishap, it will be safer to dump the fire and let the boiler cool before letting in cold water.

In no case should an empty boiler be filled when hot. If the water gets low, but not out of sight in the gauge-glass, extra water may be added at any time by the means provided for that purpose.

8. Occasionally lift the safety-valve from its seat to see that it is in good condition.

9. Clean the boiler, if used in a gravity system of circulation, once each year by filling with pure water and emptying through the blow-off pipe. If the steam is used largely for power, the boiler must be cleaned at frequent intervals. In case the boiler should become foul or dirty it can be thoroughly cleaned by adding a few pounds of caustic soda and allowing it to stand one day, then emptying and thoroughly rinsing. Kerosene oil will loosen boiler scale and not injure the boiler, but its odor will be quite likely to penetrate the whole building in which the heating system is located.

10. During the summer months the writer would recommend that all the water be drawn off from the system and that air-valves and safety-valves be opened, to permit the heater to dry out and remain so. Good results are, however, obtained by filling the heater full of water, driving off the air by boiling slowly, and allowing it to remain in this condition until needed in the fall. The water should then all be drawn off and fresh water added.

11. Keep the fire surfaces of the boiler clean and free from soot. For this purpose a brush is provided with most heaters.

12. In case any of the rooms are not heated, look out for

the steam-valves at the radiators. If a two-pipe system, both valves at each radiator must be opened or closed at the same time, as required. See that the air-valves are in proper condition. If a one-pipe system, one valve only has to be opened or closed.

13. If the building is left unoccupied in cold weather, draw all the water out of the system, which can only be done by opening blow-off pipe, all radiators, and air-valves.

101. Care of Hot-water Heaters.—The general directions for the care of steam-heating boilers, apply in a general way to hot-water heaters as to the methods of caring for the fires and for cleaning and filling the heater. The special points of difference only need to be considered. All the pipes and radiators must be full of water and the expansion-tank should contain some water, as shown by the gauge-glass or by the pressure-gauge; and this condition should be determined before building a fire and whenever visiting the heater for the purpose of replenishing the fuel. Should any of the radiators not circulate, see that the radiator valve is open, then open air-valve until the water runs out, after which it must be closed tight. Water must always be added at the expansion-tank when for any reason it is drawn from the system.

102. Boiler Explosions.—Boiler explosions sometimes occur with disastrous results. They are not limited to boilers in which high-pressure steam is employed, but also occur in some instances with low-pressure boilers employed in heating.

The cause of a steam-boiler explosion is in every case an excess of pressure above that of the strength of the boiler. The effect of this is primarily to rupture a part or portion of the boiler, relieving the pressure on the side of the rupture. This leaves unbalanced all the pressure acting on the opposite side of the boiler, which may be sufficient to project the boiler into the air with considerable velocity. As showing the amount of force which exists even with small pressures we would have for each square foot of the boiler with 10 pounds pressure above the atmosphere a force of 1440 pounds per square foot of surface, applied to move it as a projectile. If the pressure

were ten times as great the force would be ten times greater, and the effect many times worse. The disaster caused by the explosion would depend largely upon the suddenness with which this force was applied; if it were applied gradually no bad results might follow; if applied instantly the results might equal the explosion of a large amount of dynamite. Boilers sometimes explode because of defective material, poor construction, or overheating of parts; they also sometimes explode because of defects in the safety-valve or in the appliances for showing the true level of the water; but in all cases the immediate cause of the explosion is over-pressure. The causes which lead to the formation of steam with a pressure in excess of that of the strength of the boiler are various; one of them is the practice of permitting the water in the boiler to get low and then supplying feed-water, which because of the highly heated condition of the surfaces is rapidly converted into steam, causing the pressure to become excessively high.

It is not necessary to suppose that boiler explosions are caused by any mysterious force which is suddenly developed in the boiler. On the other hand, the amount of force which is stored in the hot water and steam is sufficient to produce at any time a terrific explosion, provided the necessary opportunity is presented. Dr. R. H. Thurston has computed the energy stored in various classes of boilers under the ordinary conditions of working, and the table on p. 240 shows some of the principal results of that calculation and will give some idea of the enormous force stored in heated water and steam.

Considering the total number of heating-boilers in use in the United States the number of explosions is very small, so that if we suppose no improvement in construction over the ordinary methods, the risk which any person would run is very slight; and it seems quite probable that if one were to use a heating-boiler as safe as the average boiler, the chances would be that if he did not die until killed from this cause he would live to be 10,000 years old; that is, estimating from the total number of boilers in use for heating, as compared with the

number of explosions of such boilers, the chances are that one per year in ten thousand would explode.

Some disastrous explosions of heating-boilers have, however, occurred in the United States, of which may be mentioned that at the Central Park Hotel, Hartford, Feb. 17, 1889, in which fifteen people were killed and the hotel entirely destroyed; also the boiler explosion at St. Mary's Church, Fort

STORED ENERGY OF STEAM-BOILERS.*

Type.	Pressure, Lbs. per Sq. In.	Rated Power, H.P.	Total Stored Energy Available.	Energy per Lb. of Boiler. Foot-lbs.	Maximum Ht. of Proj't'n of Boiler. Feet.	Initial Velocity. Total.
1. Plain Cylinder...	100	10	47,281,898	18,913	18,913	606
2. Cornish cylinder..	30	60	58,260,060	3,431	3,431	290
3. Two-flue cylinder.	150	35	82,949,407	12,243	12,243	625
4. Plain tubular.....	75	60	51,031,521	5,372	5,372	430
5. Locomotive.....	125	525	54,044,971	2,786	2,786	375
6. ".....	125	650	71,284,592	2,851	2,851	379
7. ".....	125	600	66,218,717	3,219	3,219	397
8. ".....	125	425	65,555,591	4,677	4,677	455
9. Scotch marine....	75	300	72,734,800	2,687	2,687	348
10. ".....	75	350	109,724,732	2,889	2,889	356
11. Flue and return...	30	200	92,101,987	1,644	1,644	245
12. " " ".....	30	180	104,272,264	1,862	1,862	253
13. Water-tube.....	100	250	174,563,380	5,067	5,067	445
14. " ".....	100	250	230,879,830	5,130	5,130	450
15. " ".....	100	250	109,624,283	2,030	2,030	323

* "Steam-boiler Explosions, in Theory and Practice," by R. H. Thurston.

Wayne, Ind., in which the church and priest's house were nearly torn down, which occurred Jan. 13, 1886; another at Dell Brown's Hotel, Eagle Bridge, N. Y., Dec. 20, 1888, in which several people were injured and the building badly wrecked; also various other explosions doing less damage.

It would seem, from a study of the boilers which are injured by explosions, that no boiler is entirely free from the disastrous effects of an explosion when it is badly managed; but on the other hand it also appears that the sectional boilers, or boilers in which the water occurs in small quantities, are subject to injuries which are comparatively slight and generally easily

repaired. So far as the writer can find from a study of all the explosions recorded in the United States, the water-tube boilers, or those with small masses of water, are singularly exempt from disastrous explosion. They are, however, quite likely to have some part broken away, in which case the pressure on the boiler is relieved quickly enough to avert a serious explosion. The worst accidents which usually happen to the sectional boilers are those due to the burning out of a tube or some easily replaceable part. This results ordinarily in a very severe leak, which can, however, be repaired.

The total number of boiler explosions for the United States for all classes of boilers average about 255 per year, and as reported by the *Locomotive*, they were as follows for the ten years preceding 1894:

BOILER EXPLOSIONS IN THE UNITED STATES.

Year.	Total No. Explosions.	Stationary, etc.	Portable.	Saw-mills.	Railway Locomotives.	Steam-boats.	Total Killed.	Total Injured.
1884	152	48	18	56	15	15	254	261
1885	155	80	16	33	10	16	220	288
1886	185	88	16	45	22	14	254	314
1887	198	67	20	73	14	14	264	388
1888	246	104	30	69	23	20	331	505
1889	180	85	21	56	15	13	304	433
1890	226	94	16	75	25	16	244	351
1891	257	115	35	68	22	17	263	371
1892	269	122	24	79	33	11	298	442
1893			245				220	151

The following table gives the total number in Great Britain for about the same time:

BOILER EXPLOSIONS IN GREAT BRITAIN.

Years.	Explosions.	Killed.	Years.	Explosions.	Killed.
1882-83	45	35	1889-90	77	21
1883-84	41	18	1890-91	72	32
1884-85	43	40	1891-92	88	23
1885-86	57	33	1892-93	72	20
1886-87	37	24			
1887-88	61	31	Total.....	660.....	313
1888-89	67	33	Ratio.....		482

This table would seem to indicate that the explosions in this country were more disastrous, so far as taking life is concerned,



FIG. 186.
The Boiler before Explosion.

as in this country two people were killed for about every three explosions, whereas in Germany and Great Britain we have about twice as many explosions as deaths. This is probably due to the fact that the statistics in this country classify as boiler explosions only those which are markedly disastrous, whereas in France and Germany every leak or break which appears from this cause is recorded as an explosion.

As showing the disastrous effects often produced by a boiler explosion, the following is abstracted from Thurston's "Manual of Steam-boilers." Fig. 186 shows the boiler-room before the explosion. The boiler was made of $\frac{5}{16}$ iron,



FIG. 187.—Path taken by the Boiler.

was 3 feet in diameter, and was 7 feet high; the upper tube-head was flush with the top of the shell, the lower forming

the crown of the furnace, which was about 2 feet above the grates and the base of the shell, and was flanged upon the inner surface of the furnace. There was a safety-plug in the lower tube-head which was not melted out. The working pressure was 60 pounds per square inch, and the explosion probably took place at or a little below this pressure, throwing the boiler through the roof and high over a group of buildings and a tall tree close by, finally burying itself half its diameter in the frozen ground. There had been a leak in the lower head which had reduced by erosion the thickness of the tubes and the lower head, so that the pressure was sufficient to force the lower head down away from the tubes, opening fifty or more holes 2 inches in diameter from which the fluid contents of the boiler issued at a high velocity, relieving the pressure below and converting the whole boiler into a great rocket weighing about 2000 pounds.

103. Explosions of Hot-water Heaters.

—While hot-water heaters provided with an open expansion-tank are to a great extent free from the dangers of explosions, still it is quite possible that extreme carelessness in erection, the freezing up of connections to expansion-tank, or other mishaps, might render the apparatus fully as dangerous as the steam-boiler under its most unfavorable conditions. Some very disastrous explosions have occurred of hot-water heating plants when operated under the Perkins or high-pressure system, and it seems quite probable that such a system, even under the most favorable conditions, is more dangerous than the steam-heating system. The hot-water heating system should be so constructed that the connection between the expansion-tank and heater cannot by any possible means be closed. The placing of a valve in this connection was the cause of a very disastrous explosion in a residence in New York City several years ago, and emphasizes the necessity for caution in this respect.

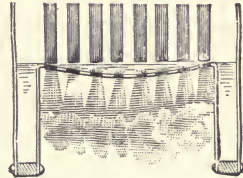

FIG. 188.
Showing Beginning of
Process of Rupturing.

104. Prevention of Boiler Explosions.—Boiler explosions are probably preventable in every single case by using, first, boilers properly designed, and constructed of excellent material and with good workmanship; and second, by seeing that all appliances, as safety-valves, blow-off cocks, feeding apparatus, etc., are in excellent order; and third, by providing skilled and intelligent attendance.

Disastrous results are usually almost entirely prevented by the use of sectional boilers, and for heating purposes there are at the present time comparatively few of any other kind in use.

As a rule heating-boilers, especially those of small sizes, are not under close supervision, but are attended to and visited only at comparatively long intervals. For this reason automatic appliances for feeding the boiler and for regulating the pressure, opening and closing the dampers, are usually supplied; hence the person erecting the plant should exercise the utmost care to see that such appliances are in excellent order and of such character as are likely to prove durable and reliable. While it is quite certain from our statistics that not one boiler out of ten thousand is likely to explode per year, yet nevertheless the contractor should always bear in mind that a steam-boiler is in every case a magazine of stored energy, and if badly constructed, poorly erected, or carelessly managed may do an immense amount of damage.

To insure safety it is better to specify that, "All steam-heating boilers and hot-water heaters and their appurtenances, which are not provided with an effective device limiting the pressure carried to fifteen pounds to the square inch, shall conform to the Rules formulated by the Massachusetts Board of Boiler Rules. Steam-heating boilers and hot-water heaters and their appurtenances, not carrying a pressure in excess of fifteen pounds to the square inch, shall be provided with such appliances to insure safety as to conform to the Rules formulated by the Massachusetts Board of Boiler Rules."

CHAPTER X.

GRAVITY STEAM-HEATING SYSTEMS.

105. **Systems Employed in Steam-heating.**—There are in general two systems of heating, known as the *gravity return*, and the *pump return heating systems*. In the first of these, the gravity system, the water of condensation from the radiators flows by its own weight into the boiler at a point below the water line, either with or without traps or separate drips; in the second the water of condensation does not flow directly into the boiler, but is returned by some special machinery or else wasted. The second class of steam-heating systems includes most of the *high-pressure steam-heating* systems and many of the various systems of *vacuum, vapor, or atmospheric* steam heating.

In the high-pressure systems steam of any pressure can be produced in the boiler, of which a portion may be employed in operating engines, elevators, etc. High-pressure steam is seldom used in the radiators, low-pressure steam being obtained either directly from the boiler or by throttling or passing through a reducing valve, or, in some instances, by using the exhaust steam from engines or pumps. In general the different types of vapor, vacuum, or atmospheric steam-heating systems regulate the amount of heat delivered by the radiator by changing the absolute steam pressure, or by varying the amount of air present inside the radiator by special traps, air-valves, or other special devices in the air (or water) discharge line from the radiator.

In this chapter we shall discuss the amount of heat and radiating surface required for the gravity circulating system of steam heating in detail, reserving the next chapter for the other systems of steam heating.

The preceding classification is independent of the pressure carried in the heating system, and a vacuum heating system will fall into the first or second of these classes depending upon whether the condensed steam returns to the boiler by its own weight or not. The vacuum system, in which the condensate is pumped back or wasted, will be treated in the next chapter.

106. Definitions of Terms Used.—Certain terms have been adopted which are always used to describe definite parts in a system of piping, as follows:

The *main or distributing pipe* is the pipe leaving the boiler or heater and conveying the heated products to the radiating surfaces. In steam-heating this is termed the *main steam-pipe*, and in hot-water heating the *main flow-pipe*. It may be carried from the boiler without branches to the top of the building (Fig. 189), where the distributing pipes are taken off, or it may run in a horizontal or vertical direction from the heater, and branch pipes taken off as required. The pipes in which the flow takes place from the radiating surface toward the boiler are called return-pipes. The pipes which extend in a vertical direction are termed *risers*; when the flow in these pipes is downward they are called *return-risers*.

A *relief or drip* is a small pipe run from a steam-main, so as to convey any water of condensation to the return; it must be employed at all points where water is likely to gather. For illustration of use see Fig. 192.

Pitch is the inclination given to any pipe when running in nearly a horizontal direction. In general the inclination or pitch of a supply-pipe should, in steam-heating, be downward from the boiler, and arranged so that the water of condensation will move in the same direction as the current of steam. In hot-water heating the pitch should be upward from the boiler. In all return-pipes the inclination should be downward, toward the heater or boiler.

A *relay* is a term sometimes used to describe a sudden change of alignment, or "jumping up," of a horizontal pipe. This is often necessary in a long line of piping to keep the pipe near the ceiling and preserve the necessary pitch. At such

points a drip or relief must permit water of condensation to flow into the return.

Water-line is a term used to denote the height at which the water will stand in the return-pipes. It is usually very nearly the same as the level of the water in the boiler, being higher only in case there is considerable reduction in pressure due to friction. In heating with high-pressure steam it is desirable to have all the relief-pipes discharge into a return filled with water, so that circulation of steam shall be continuously in one direction; this is of less importance with low-pressure steam, provided the water which gathers in returns can move freely and quickly to the boiler.

The term *siphon* is applied to a bend below the horizontal; it is sometimes used in the main return to hold water at a different level from that in the boiler. This is done by admitting steam to the top part of the bend on the boiler side by a relief from the main steam-pipe. It is similar to the siphon-trap. If the relief were not connected to the top of the bend the water would pass over by suction into the boiler.

Steam-traps are vessels designed with valves which open automatically so as to preserve the water-level in the returns at any desired point. Various kinds are described in Chap. IX.

Water-hammer is a term applied to a very severe concussion which often occurs in steam-heating pipes. It is caused by water accumulating to such an extent as to condense some of the steam in the pipe, thus forming a vacuum which is filled by a very violent rush of steam and water. The water strikes the side of the radiators or pipes with great force, and often so as to produce considerable damage. In general a water-hammer may be prevented by arranging the piping in such a manner that the water of condensation will immediately drain out of the radiator or pipes.

A bend in the return of a steam- or water-heating system, when convex upward, will frequently accumulate air to such an extent as to prevent circulation in the system. This is designated as an *air-trap*. When bends of this character must be used a small pipe for the escape of the air should be con-

nected with the highest portion of the bend and led to some pipe which will freely discharge the entrapped air.

An air-valve is not ordinarily to be recommended for such situations.

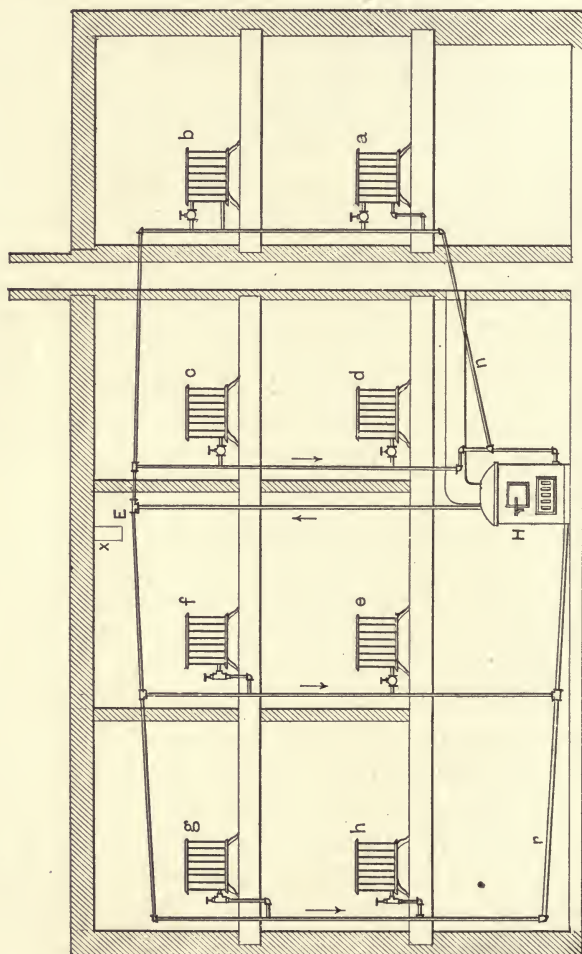

FIG. 189.—Direct-circuit System of Piping—Radiators to the Right Arranged as for Hot-water Heating.

107. Systems of Piping.—The systems of piping ordinarily employed provide for either a complete or a partial circulating system, each consisting of main and distributing pipes and returns. Several systems of piping are in common use, of which we may mention:

First, the complete-circuit system, often called the one-pipe system, in which the main pipe is led directly to the highest part of the building; from thence distributing pipes are run to the various return-risers, which in turn connect with the radiating surface and discharge in the main return. The supply for the radiating surface is all taken from the return-risers, and in some cases the entire downward circulation passes through the radiating system.

This system was employed by Perkins in his method of high-pressure hot-water heating, and is mentioned by Péclet as in use in France in 1830. In this country it seems to have been introduced into use by J. H. Mills, and is often spoken of as the Mills system of piping. The system is equally well adapted for either steam or hot-water heating, and on the score of positiveness of circulation and ease of construction is no doubt to be commended as superior to all others. It is principally objectionable because the horizontal distribution pipes have to be run in the top story of the building instead of the basement, which may or may not be of serious importance.

Second, a partial-circuit system, in which the main flow-pipe rises to the highest part of the basement by one or more branches, from whence the distributing pipes run at a slight incline, often nearly around the basement, and finally connect with the boiler below the water-line. The radiators are connected by risers which carry both flow and return from and to the distributing pipes, as shown in elevation in Fig. 190 and in plan in Fig. 191. This method of piping is employed extensively for steam-heating, and is perhaps less open to objection than any other.

Third, a system of circulation in which each radiator is provided with separate flow- and return-pipes (Fig. 192). In this case the riser and distributing pipes are run as before, but are connected to the return by a *drip-pipe*; the return is located below the water-line of the boiler. The supply-riser from each radiator is taken from the main flow-pipe, and the return-riser is connected to the main return below the water-level. In case two connections are made to a radiator, one for supply

and the other for the return, it is quite important that the connection of the return-riser to the main return be made below the water-level of the boiler, in order to prevent steam flowing from two directions to the radiator. Such a condition is certain

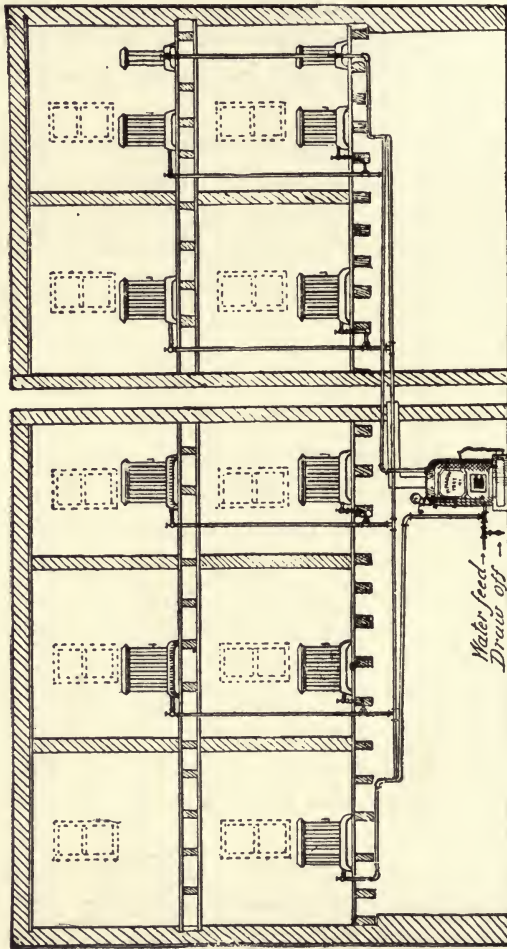

FIG. 190.—Elevation of Pipe System Usually Employed in Steam-heating.

to cause water-hammer, as the radiator will retain water of condensation.

Various modifications of this third system have been used from time to time with greater or less success. For instance, each radiator has in some cases been connected to a separate

flow and return riser, and in other cases simply to a separate return riser. These modifications are unimportant and hardly worthy of notice.

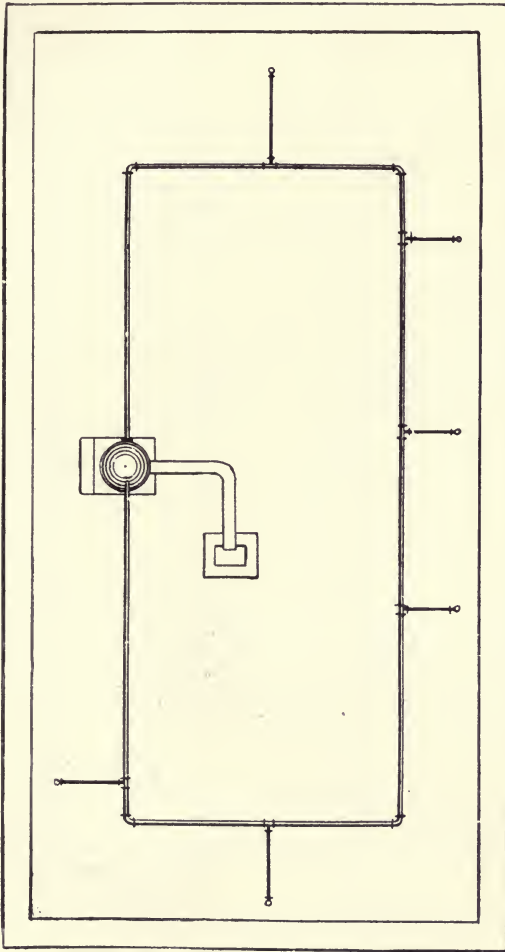

FIG. 191.—Plan of Distributing-pipe to be Placed in Basement.

108. Pipe Connections, Steam-heating Systems.—The manner in which branches are taken off may have great effect on the results obtained in any heating system, since any increase in friction in any part of the system will cause the flow to be sluggish in that portion, and require more pres-

sure to induce circulation. The size of pipes required in order that resistances may not exceed a certain amount are given in the next chapter; but it should be noted that bad workman-

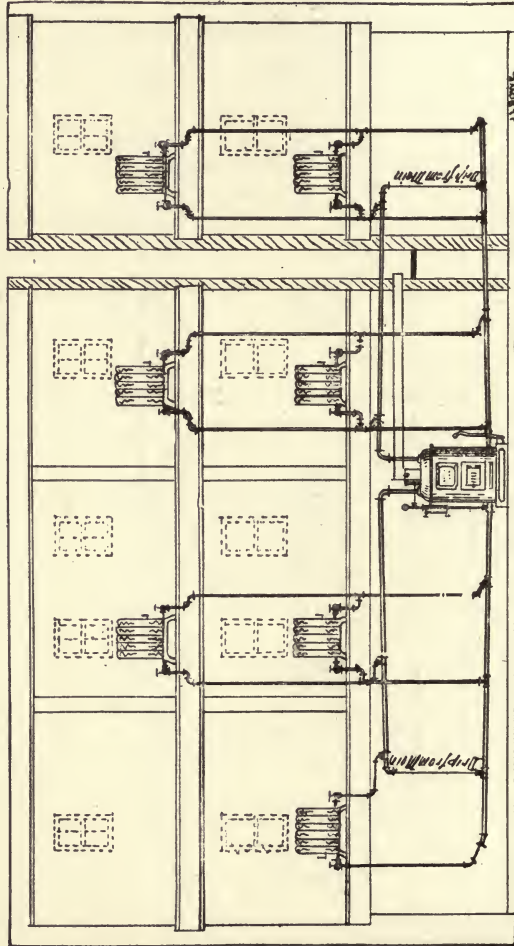

FIG. 192.—Two-pipe System of Steam-heating.

ship may defeat the operation of a steam-heating plant having the best proportions possible, and that great care is needed, (1) to secure the alignment of every part, (2) the absence of air-traps or any obstructions whatever which would reduce the circulation or make it irregular or uncertain. Some details

which are to be considered rather as suggestions than as formal directions are given.

In general, pipe connections should be made so as to afford as little resistance as possible to the flow of steam, and in such a manner as not to interfere with the expansion of the main pipes. The line of piping should present the freest possible channels of circulation for the steam as it leaves the boiler and for the water of condensation as it returns.

The expansion, which is not essentially different from $1\frac{3}{8}$ inches for each 100 feet in length, can usually be well provided for by the use of two or more right-angled elbows substantially as shown in Fig. 193. No general rule can be laid down for all circumstances and conditions. The following examples and illustrations from *Heating and Ventilation* show the methods of piping commonly employed in setting steam-radiators with one-pipe connections. Fig. 193 illustrates the method where the radiator is set close to the main and no special drip is required.

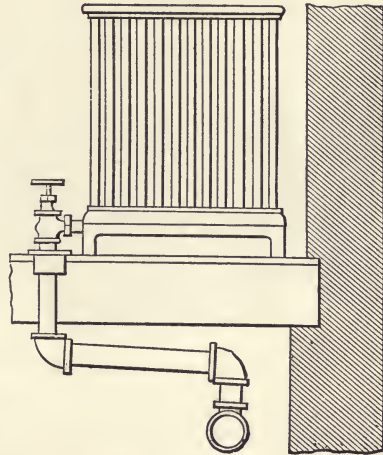

FIG. 193.—Connection of Radiator from Steam Main.

The method often employed in connecting a riser to a horizontal steam main and running a special drip-pipe for condensed water to the return main is shown in Fig. 194.

The method often employed in connecting radiators to risers is shown in the upper portion of Fig. 219. The lower portion illustrates an essentially different method from that shown in Fig. 194 of connecting the riser to the main, and the drip-pipe to the return. This method, however, does not allow for expansion of the steam main; hence this must be provided for in some other portion of its length.

The area of the main pipe must in every case be equivalent in carrying capacity to that of all the branches taken off; it consequently may be reduced as the distance from the heater becomes greater and as more branches are supplied. Table XXII, Appendix, gives the equivalent capacity of pipes of different diameters, and can be used in determining the relative number of branches of a given size, and also the reduction in pipe area which may be made after a certain number of branches have been connected. It will, however, in general

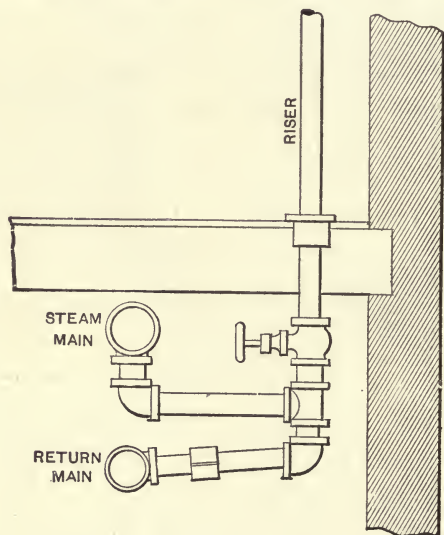

FIG. 194.—Connection to Riser from Main and Return.

be found, except when large pipes are used, less expensive to run the main full size than to use reducing fittings.

109. Piping for Indirect Heaters.—Indirect radiators have been described and methods of setting them illustrated in Chapter VII. These radiators are generally set in a case or box which is suspended from the basement ceiling and made of matched boards lined with tin. The sides of the casing should be removable for repair of the radiator. The system of pipes which supply the indirect radiators are generally most conveniently erected, like those shown in Fig. 191 or 214 for steam-heating, and like that shown in Fig. 224 for hot-water heating.

The heater should be located above the water-line of the boiler a sufficient distance to afford ready means of draining off the water of condensation. In case this is impossible, a style of radiator should be adopted which can be heated by water circulation. An automatic air-valve should be connected to the heater, and every means should be taken to obtain perfect circulation to and from the boiler. The chamber which surrounds the indirect surface is to be supplied with air from the outside by a properly constructed flue. The air passes up through or over the heater and into the rooms by means of special flues, the sizes of which are given in Chapter V.

110. Vacuum Circulating Systems.—If the air could be removed and kept from flowing back in any closed system of steam-heating, as, for instance, the usual one- or two-pipe system of steam circulation, in which the return-water

flows directly to the boiler, we should have conditions which would permit a circulation of steam with a pressure above or below the atmosphere as desired, and consequently with a pressure and temperature dependent upon the amount of fire maintained in the heater. Thus, for instance, if so much air were removed as to produce an absolute pressure of 2 pounds corresponding to a vacuum of about 26 inches, the boiling temperature, at which steam would be produced, would be 126 degrees Fahr., and if just sufficient fire were maintained to produce that pressure, the temperature would be as stated. If more fire were maintained, so as to produce greater quantities of steam, the pressure in the system would rise with a corresponding increase in temperature. By simple regulation of the fire any temperature from 100° to 300° F. could be maintained under

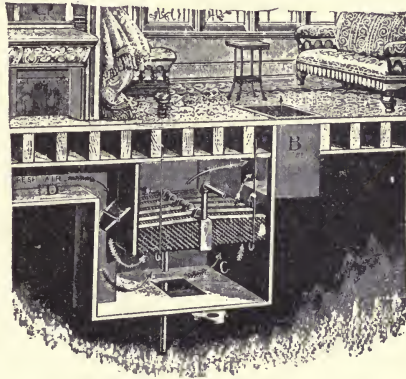

FIG. 195.—Indirect Surface.

these conditions. Such a system would give all the advantages pertaining to low temperatures and regulation of temperatures possessed by the hot-water system of heating, and all the advantages relating to high temperatures, small radiators, and cost of installation pertaining to the steam system.

Several plans have been devised to produce the results described.

The *Morgan system* accomplishes the desired result simply by the use of an automatic air-valve so constructed that it will permit the air to flow out when the steam is at a higher pressure than atmospheric in the radiator, but will not permit it to return when the pressure is reduced. The air-valve is attached in the usual manner to a radiator, a small screen being inserted in the connection to prevent dirt passing into the valve. The automatic features for permitting the escape of air when the pressure is above that of the atmosphere, and preventing the escape of steam, consist of a hollow float, one end of which is open and submerged in water so as to keep the float nearly filled with air. The air thus sealed constitutes a thermostatic substance that when expanded by heat causes the float to rise closing the opening and thus preventing the escape of steam from the radiator; when the temperature falls this air contracts and allows the float to fall, thus permitting the escape of the air. It is thus seen that the air is expelled from the radiator as in the automatic air-valves previously described. To prevent the return of the air to the radiator after it has been allowed to cool and a vacuum has been formed by condensation, a soft rubber ball resting on a rubber seat is employed, which is situated near the top of each air-valve and constitutes a check-valve opening outward.

A modified form of the Morgan system, as designed by James A. Trane* of Milwaukee, connects the discharge of all the air-valves by pipe-lines to a mercury trap or seal located near the heater. The air from the system can be expelled by pressure through the mercury seal, which, however, acts to

* The Trane system works equally well if the air-valves at the radiators are omitted.

prevent its return to the system when the pressure falls, thus maintaining any vacuum produced by condensation.

In the operation of the systems which have been described for circulating steam at less than atmospheric pressure, the valves or checks which prevent the return of the air must in all cases be so constructed as not to leak; since any leakage of air into the system at any point would destroy the vacuum. The problem of constructing every valve or fitting of an entire system so as to remain perfectly tight, especially when below atmospheric pressure, is a difficult one, consequently all the above systems are likely to become inoperative for these reasons.

As in normal operation the fire is forced in the early morning to heat the rooms to 70° , and most of the air is forced out of the radiators each day. Consequently, several slight leaks which may be plainly visible or audible will not materially affect the working of the Trane or similar vacuum systems.

III. General Principles.—The general problem of design includes the proportioning of, first, the amount of radiating surface which will be located directly in the rooms to be heated in all systems of direct heating, and in the air-passages or flues leading to the rooms in all cases of indirect heating; second, the size of the pipes which are to convey the heated fluids to the radiating surfaces; and third, the proper size of boiler or heater.

The question of the system or method of heating which is to be adopted will usually depend upon considerations of cost or of personal preference on the part of the proprietor. The various systems of heating, whether by steam, hot water, or hot air, as commonly practised in this country, do not often come in direct competition. Hot-air heating, where the air is moved by natural draft, is adapted only to the smaller sizes of dwelling houses, and where heat does not need to be carried any considerable distance horizontally. It is generally found that if the horizontal distance exceeds 15 or 20 feet the supply of heat becomes uncertain in amount. With steam and hot-water heating there is no such limitation as to distance; the first cost is, however, considerably greater than that of hot air,

but heat can be supplied with certainty to all parts of the system under all atmospheric conditions. Regarding the relative merits of systems of steam and hot-water heating, little can be said. It will generally be found that the first expense of steam-heating is considerably less, and that there is considerable difference of opinion regarding the relative economy of operation of steam and hot-water heating plants. The tests which have been made have generally shown somewhat in favor of water.* The difference, however, is not great, and may be due to local conditions, but is probably due to the fact that the temperature of the discharged gases may be somewhat lower for the hot-water heater than for the steam-boiler, and also to the fact that in comparatively mild weather the fire in the hot-water heater may be regulated somewhat closer, to meet the demand for heat. The hot-water system in general requires rather better workmanship in the erection of pipe lines than steam-heating, and more care must be taken in proportioning the various pipes and fittings. The heat from hot-water radiators is somewhat less in intensity and more pleasant than that from steam-radiators, and the temperature can be regulated by simply throttling the supply-pipe of the radiators, which is not the case with steam.

Whether direct or indirect heating shall be used will depend also on circumstances. It will be found that in general the surface required for indirect heating is one-third to one-half greater than that for direct, and it will give off 50 per cent more heat per square foot, so that the operating expense is practically twice that of direct heating.

112. Amount of Heat and Radiating Surface Required for Warming.—The amount of heat required for buildings of various constructions has been considered quite fully in Chapter III, from which it may be seen that in ordinary building construction the amount required in heat-units, for each degree difference between inside and outside temperature, is approximately equal to the area of the glass surface plus one-fourth

* See Transactions American Society Mechanical Engineers, vol. x, paper by the author. See also report Massachusetts Experimental Station No. 8, 1890.

the area of the exposed wall surface plus one fifty-fifth of the number of cubic feet of air due to ventilation and leakage.

When results of extreme accuracy are desired the heat loss from any room under consideration may be computed by multiplying the area by the loss per square foot as given in Chapter III by the difference of temperature and taking the sum of the results. I have given in the following pages a diagram completed by the late Alfred R. Wolff, for facilitating such computation. The approximate method of computation in which the assumption is made that a definite area of wall surface is equivalent to one foot of glass surface, with the coefficients as stated, is usually of sufficient accuracy to meet all practical requirements. It should be noted that because of varying conditions of weather and variations in building construction, and ignorance of the exact laws of heat transmission a certain allowance in calculation is necessary. This allowance corresponds very closely to the "factor of safety" used in computing structural construction and serves the same purpose. In nearly every case the approximate computation of building losses as stated in the following rule will result in providing radiation correct within the limits of error of the coefficients on which the apparently more accurate calculation must be based. The approximate rule can therefore be generally used with confidence.

Our knowledge of the coefficient of air *leakage* through the walls of buildings is far from exact yet it is well known that leakage of air into a room often has as much to do with the requirements for heat as conduction of heat. Until more exact data relating to air leakage is obtained it is somewhat absurd to expect to compute the heat requirements of a room from an exact computation of the heat conducting ability of the walls and windows.

The leakage or infiltration of air into a room through the walls and windows is undoubtedly a function of wind velocities, difference of pressure inside and out, difference of temperature and quality of construction, rather than the volume of the room. The data which we have on this subject is obtained by a

comparison of radiation actually needed with that computed from building loss only. This data is expressed in volume or number of changes of air per hour rather than as a function of the exposed area. It is probably fairly accurate for ordinary dwellings and small buildings but is to be used with caution for other classes of buildings. The air entering by *leakage* will vary with conditions as noted but in direct heating of residences it approximately equals to three changes per hour in halls, two in rooms on the first floor and one in rooms on upper floors.

The amount of heat given off by one square foot of radiating surface, as determined by a great number of experiments, is given in Chapter IV, from which it is seen that for the ordinary radiating surface, with a temperature of 150 degrees above the surrounding air, 1.8 heat-units will be given off per square foot of surface per degree difference of temperature per hour, and when the temperature is 110 above the surrounding air about 1.7 heat-units are emitted.

113. Wolfe's Diagram.—The total heat emitted from radiating surfaces of different characters, corresponding to the average results of experiments as stated in Chapter III is shown on the diagram, Fig. 196. In this diagram the horizontal distances correspond to the mean difference of temperature between the air in the room and the radiator, while vertical distances, the value of which is read on the scale at the left, correspond to the total heat-units transmitted per square foot per hour.

To use the diagram assume the difference of temperature between the air of the room and the radiator, then look on vertical line until intersection with the line representing the desired condition is found, thence read results on the left. Thus, for instance, if the difference of temperature is 150 degrees the intersection of the line from this point with that representing direct ordinary radiation corresponds to 275 heat-units, and with that representing 1-inch horizontal pipe, 375 heat-units, as read on the scale at the left. The dotted lines in the diagram give the heat transmitted from various indirect surfaces for different velocities of the moving air. The results are to be found as for direct radiation, but the difference of

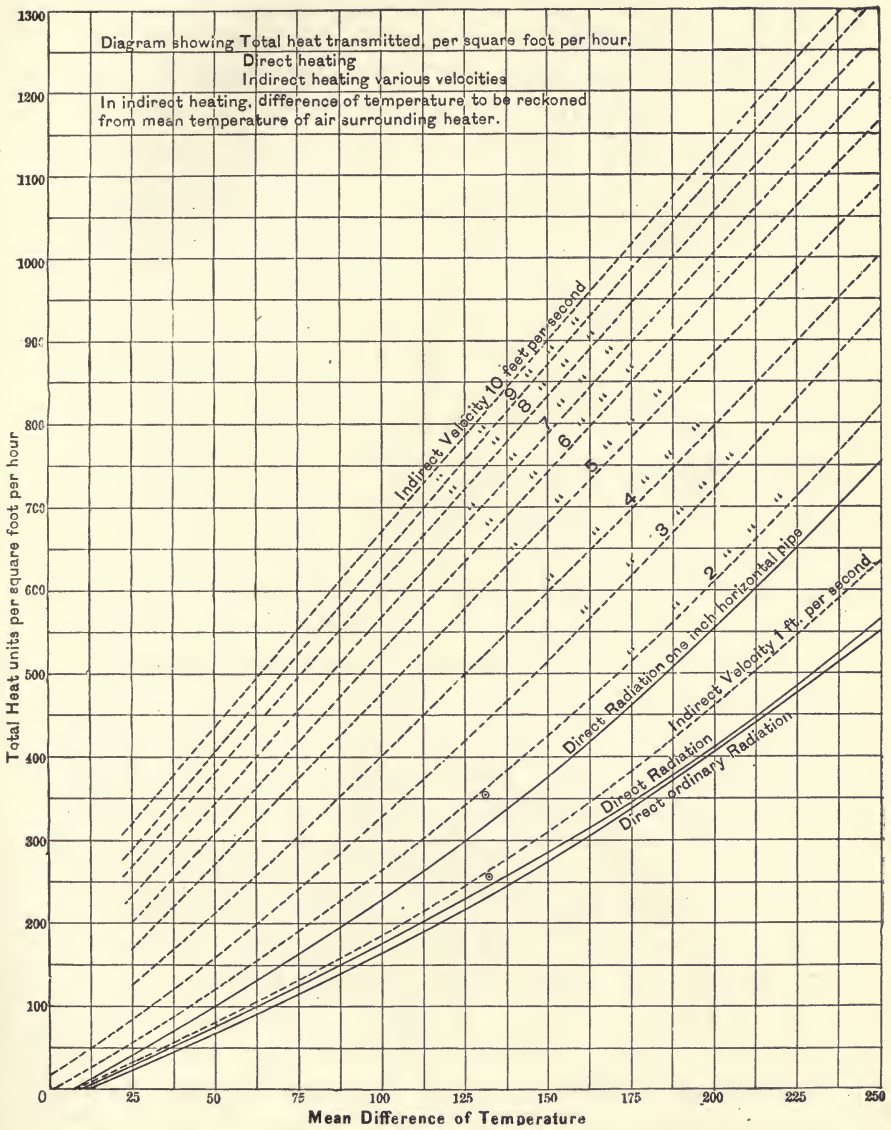

Fig. 106.—Diagram of Heat from Radiating Surfaces.

temperature is that estimated from the mean of the surrounding air and the radiator.

Knowing the total heat required for warming and that which is given off from one square foot of radiating surface, it is quite evident that the surface required may be computed by the process of dividing the former by the latter.

Many designers of heating apparatus compute the amount of radiating surface required by approximate "rules-of-thumb" which are in current use in their localities. These rules differ in many cases very greatly from each other, and often have to be modified materially in order to give satisfactory results. In the application of the more scientific rules which have been given there will still always be an opportunity for applying judgment and the results of experience and practice, since it is quite impossible that any table of coefficients, no matter how extensive, could be given which would apply to all cases of building construction and to all exposures. Allowance for unusual conditions are given by Rietschell, Chapter III.

Certain allowances for unusual construction of buildings are often required and must depend upon judgment.

114. The Amount of Surface Required for Indirect Heating.—For this case the heat received by the rooms is all supplied by air which passes over the radiating surfaces and is heated by convection. A large number of tests have been quoted of these heaters, both with natural and mechanical draft. From these experiments it is seen that the amount of heat given off by one square foot of surface varies with the velocity of the air, as shown by the diagram Fig. 196, the use of which has been explained. From Table XVI in Appendix it will be noticed that with natural circulation the velocity in feet per second will vary from 2.97 for a height of 5 feet to 8.4 for a height of 50 feet, and the corresponding convection expressed in heat-units per degree difference of temperature per square foot per hour, which in the preceding table is termed the *coefficient*, varies from 1.7 to 2.8.

In indirect systems of heating the warm air enters at a temperature 30 to 60 degrees above that in the room and

passes out either through the vent-flues or by other means of egress at a temperature practically that of the room. In cooling to the temperature of the room it must surrender sufficient heat to balance that lost through the walls and windows. Neglecting the slight change in volume due to change in temperature, the amount required can be readily computed; thus if the entering air be about 100 degrees F., one heat-unit (B.T.U.) will raise 59 cubic feet one degree; hence one cubic foot in cooling thirty degrees will surrender $30/59$ parts of a heat-unit. Since we require approximately to balance the building loss, heat-units equal to the product of the difference of the temperature of the room and the outside air, multiplied by the glass surface, plus one fourth that of the exposed wall, we can find the volume of air required by dividing the result by $30/59$ for the above case.

The extent of heating surface in square feet in the radiator can be obtained by dividing the total number of cubic feet of air as obtained above by the number of cubic feet which may be heated the required amount by one square foot of heating surface.

These results are better expressed in shape of formulæ from which tables suited for practical application may be computed. Let t equal the temperature of the room, t' that of the outside air, t'' that of the mean temperature of the air surrounding the heating surface, T' that of the heated air, T that of the radiating surface, H the heat required per hour per degree difference of temperature to supply loss from the room, a the heat given off from 1 sq. ft. radiating surface per degree difference of temperature. We have the following formula:

$$\text{Loss from the room per hour } (t-t')H = (t-t')(G + \frac{1}{4}W) \text{ nearly; } \dots (1)$$

$$\text{Heat brought in by 1 cu. ft. of air } 1/58(T'-t); \dots (2)$$

$$\text{Heat given off from 1 sq. ft. of radiating surface per hour} = a(T-t''); (3)$$

$$\text{Cubic feet of air required per hour} = \frac{(t-t')H}{1/58(T'-t)}; \dots (4)$$

$$\begin{aligned} \text{Cubic feet of air heated by 1 sq. ft. of radiating surface per hour} \\ = \frac{a(T-t'')}{1/58(T'-t''); \dots (5) \end{aligned}$$

$$\text{Radiating surface} = \frac{(t-t')(T'-t)H}{a(T'-t)(T-t'')} \dots (6)$$

TABLE OF FACTORS TO OBTAIN INDIRECT HEATING SURFACE AND OF CUBIC FEET OF AIR HEATED PER SQUARE FOOT OF SURFACE PER HOUR.

Temperatures.			B. T. U.—Total Heat per Sq. Ft. Heater.				Factors for Heater Surface.*				Cu. Ft. Air per Sq. Ft. Heat. Surf. per Hour.			
Air Entering Room.	Mean of Air Surrounding Heater.	Mean Difference Air and Radiator.	Coefficient 1.	Coefficient 2.	Coefficient 3.	Coefficient 4.	Coefficient 1.	Coefficient 2.	Coefficient 3.	Coefficient 4.	Coefficient 1.	Coefficient 2.	Coefficient 3.	Coefficient 4.
T'	t''	$T' - t''$	(1)	(2)	(3)	(4)	(5)	(6)	(7)	(8)	(9)	(10)	(11)	(12)

ROOM 70° FAHR., OUTSIDE AIR 0° FAHR., STEAM PRESSURE 0 LBS., STEAM TEMPERATURE 212° FAHR.

90	45	167	167	334	501	668	1.92	0.96	0.64	0.48	108	216	324	432
100	50	162	162	324	486	648	1.47	0.73	0.49	0.36	94	188	292	376
110	55	157	157	314	471	628	1.24	0.62	0.41	0.31	88	176	264	352
120	60	152	152	304	456	608	1.10	0.55	0.37	0.28	73	147	220	394

ROOM 70° FAHR., OUTSIDE AIR 0° FAHR., STEAM PRESSURE 5 LBS., STEAM TEMPERATURE 210° FAHR.

90	45	174	174	348	522	696	1.72	0.86	0.51	0.43	112	224	336	448
100	50	169	169	338	507	676	1.38	0.69	0.46	0.34	98	196	294	392
110	55	164	164	328	492	656	1.18	0.59	0.39	0.29	86	173	260	346
120	60	159	159	318	477	636	1.16	0.53	0.35	0.27	77	154	231	308

ROOM 60° FAHR., OUTSIDE AIR 0° FAHR., STEAM PRESSURE 0 LBS., STEAM TEMPERATURE 212° FAHR.

80	40	172	172	344	516	688	1.66	0.83	0.55	0.41	125	250	375	500
90	45	167	167	334	501	668	1.16	0.58	0.29	0.29	108	216	324	332
100	50	162	162	326	486	652	0.93	0.46	0.31	0.23	94	188	282	376
110	55	157	157	314	461	628	0.89	0.42	0.28	0.21	83	166	249	332

ROOM 70° FAHR., OUTSIDE AIR 0° FAHR., HOT WATER AT TEMPERATURE 160° FAHR.

90	45	115	115	230	345	460	2.8	1.4	0.93	0.7	74	148	222	296
100	50	110	110	220	330	440	2.12	1.06	0.70	0.53	64	128	192	256
110	55	105	105	210	315	420	1.86	0.93	0.62	0.46	55	110	165	220
120	60	100	100	200	300	400	1.68	0.83	0.56	0.42	48.5	97	145	194

ROOM 70° FAHR., OUTSIDE AIR 0° FAHR., HOT WATER AT TEMPERATURE 180° FAHR.

90	45	135	135	270	405	540	2.36	1.18	0.78	0.57	87	174	261	348
100	50	130	130	260	390	520	1.78	0.89	0.59	0.54	75	150	225	300
110	55	125	125	250	375	500	1.55	0.72	0.52	0.39	66	132	198	264
120	60	120	120	240	360	480	1.4	0.7	0.47	0.35	58	116	174	232

* To find surface of heater multiply loss from room for one degree difference of temperature by the factor for the given condition. Results computed by formula (6).

The table on page 264, computed from the above formulæ for various conditions gives a series of factors which, multiplied into the building loss H per degree difference of temperature, will give the radiating surface required; it also gives the number of cubic feet of air heated the required amount per square foot of radiating surface per hour. In the table the term coefficient is used for the heat transmitted per degree difference of temperature per square foot per hour.

To use the table, we need simply to know, in addition to temperatures, the probable coefficient of heat transmission, all other conditions being given. For ordinary indirect heating first floor, the velocity of air can be considered as 2 to 4 feet per second, and the corresponding value of this coefficient as 2. For higher floors the velocity is higher, and coefficients may be taken as 3. As an example, assume outside temperature zero, inside temperature 70° , and the air leaving the indirect radiator at 100° , the factor with which to multiply the building loss to obtain radiating surface is 0.69. This is practically 3.00 times that for direct heating.

CUBIC FEET OF AIR PER HEAT-UNIT FROM WALL PER DEGREE DIFFERENCE.

$T-t$.	t .		$T-t$.	t .	
	60°	70°		60°	70°
10	337	400	60	61	73
20	172	204	70	53	63
30	116	138	80	48	57
40	84	106	90	43	51
50	72	86	100	39	47

T = temp. of entering air. t = temp. of room.

The above table gives the number of cubic feet of air required per hour in indirect heating to maintain the proper temperature, as computed by formulæ (4), for each heat-unit lost from walls and windows of room for a temperature of 60° or 70° above outside air. The total air required will be found by multiplying the values, as given in the table, by the total heat lost per degree difference of temperature from the room.

This loss is designated by H in formulæ (4), and is approximately equal to the glass plus $\frac{1}{4}$ the exposed wall surface expressed in square feet.

Thus to find the number of cubic feet of air required to warm a room to 70° in zero weather, for $G + \frac{1}{4}w = 128$ and $T - t = 30$; multiply 138 from table by 128.

For indirect heating, 50 per cent more surface is usually allowed than for direct, although some engineers add only 25 per cent.

The heat given off from indirect heating surfaces would seem from experiments to depend largely upon construction. If surfaces are crowded the heat transfer will be small. If the entire surface of extended surface radiators is figured as effective the coefficient should be reduced about 10 per cent. For forced draft the coefficient may be taken as 4 to 6 or about 100 per cent greater than natural circulation.

115. Summary of Approximate Rules for Estimating Radiating Surface.—Some very simple rules may be given for heating to 70° in zero weather:

First. The amount of heat required to supply that lost from the room per degree difference of temperature *is approximately equal to the area of the glass in square feet plus $\frac{1}{4}$ the exposed wall surface.*

Second. The heat necessary to supply loss from ventilation for dwelling houses, first floor, is 0.04 of the cubic contents per hour for living-rooms;

0.06 of the cubic contents for halls;

0.02 of the cubic contents for upper stories.

For churches, auditoriums, the loss to supply ventilation should be taken as 0.005 to 0.01 of the cubic contents; for offices, banks, etc., 0.02 to 0.04 of the cubic contents, depending upon circumstances.

NOTE.— $1/50 = 0.02$ is substituted here for $1/55$ used in previous calculations. The error thus made in result is less than one-tenth of one per cent and is negligible.

Third. To find the radiating surface for direct steam-heating, multiply the sum of the numbers as given by rules First and Second by $\frac{1}{4}$.

Fourth. To obtain the radiating surface for direct hot-water heating, multiply the sum of the numbers as given by rules First and Second by 0.4 to 0.42. It should be noted that from 60 to 67 per cent more radiating surface is required for hot-water than for steam-heating, consequently it becomes possible to compute radiating surface for both methods of heating by one rule, viz., that for steam-heating, by multiplying for hot-water heating by the proper factor.

When the minimum temperature is 10 degrees below zero Fahr., the radiating surface should be increased by 5 per cent, when 20 degrees below zero by 10 per cent, etc.

For indirect heating the following rules will give quite satisfactory results when the temperature of the room is to be maintained at 70° with outside air at zero and the heated air brought in at a temperature 30° above that in the room. In this calculation the surface of the steam radiator is supposed to be 212°, that of the hot-water radiator 170° Fahr. The coefficients are taken from the preceding table.

RULE.—The radiating surface for indirect heating is equal to the glass surface plus one-fourth the exposed wall surface in square feet multiplied by the following factors:

	Steam-heating.	Hot-water Heating.
1st story.....	0.7	1.15
2d “	0.6	1.0
3d “	0.5	0.8

The total amount of air supplied will be given by the following:

RULE.—The air in cubic feet per hour is found by multiplying the radiating surface, computed as in above rule, by the following factors:

	Steam-heating.	Hot-water Heating.
1st story.....	200	150
2d “	170	130
3d “	150	115

If this is insufficient for ventilating purposes more air must be introduced, which must be heated to 70° F., and this will require an additional foot of surface for each additional 300 cubic feet of air heated by steam, and for each additional 200 cubic feet heated by hot water.

Rule for area of hot-air duct in indirect heating:

The cross-sectional area of the hot-air duct leading from the indirect heating surface or radiator to the room to be warmed should be as follows for each square foot of surface in the radiator:

	Steam-heating.	Hot-water Heating.
For the first story, square inches....	1.5	1.8
“ second story “	1.0	1.25
“ third story “	0.9	1.1

Make area cold-air flue 75 to 80 per cent of that of the hot-air flue.

116. Computation of Steam-piping.—An approximate method of computing the size of pipes required for steam-heating would be as follows: First find the amount of steam by dividing the total number of heat-units given out by 1 square foot of radiating surface by the latent heat in 1 pound of steam, this will give the weight of steam required per square foot; this multiplied by the number of cubic feet in 1 pound of steam will give the volume which will be required for each square foot of radiating surface. Knowing this quantity the size of pipe may be computed from the considerations already given, either by formulæ or by assuming the velocity of flow as equal that due to the head, corrected for friction; 25 to 50 feet per second can in nearly every case be realized. As an illustration; compute the size of main steam-pipe required to supply 1000 feet of radiating surface with steam at a temperature of 212 degrees when the surrounding temperature of the air is 70: For this case 1 square foot of radiating surface can be assumed ordinarily as giving off (1.8 times 142) 255 heat-units. To supply 1000 feet of surface 255,000 heat-units per hour would be required; as each pound of steam during condensation will give up 966 heat-units, we will need for this purpose 264 pounds per hour; and as each pound of steam at this temperature makes 26.4 cubic feet, we will require 6970 cubic feet of steam per hour, or 1.94 cubic feet per second.

If we proportion the pipes so that the velocity shall not exceed 25 feet per second; the area of the pipe must be 0.077 square foot, which equals 11.1 square inches. For this we

would require a pipe 4 inches in diameter. If we had assumed the velocity to be 50 feet per second, the area would have been 5.6 square inches and the diameter 3 inches; if we had assumed a velocity of 100 feet per second, the area required would have been 2.8 square inches and the diameter of the pipe required would have been somewhat less than 2 inches. The friction in a pipe when steam is moving at a velocity of 100 feet per second causes a reduction in pressure of about $1\frac{1}{2}$ pounds in 100 feet, a velocity of 50 feet per second causes about $\frac{1}{4}$ as much, and a velocity of 25 feet about $\frac{1}{16}$ as much. Indirect surfaces of the same extent usually require twice as much steam and a pipe with area twice as great as that needed for direct radiation.

For the *single-pipe system of heating* an additional amount of space must be provided in the steam main to permit the return of the water of condensation. The actual space occupied by the water is small compared with that taken by the steam, but in order to afford room for the free flow of the currents of water and steam in opposite directions, experience indicates that about 50 per cent more area should be provided than is required in the separate return or double pipe system of heating.

By similar computations we obtain the following factors, which are to be multiplied by the radiating surface to obtain areas and diameters of steam-heating mains in inches:

APPROXIMATE AREA AND DIAMETER OF STEAM-MAIN.

Velocity of Steam, Ft. per Sec.	Multiply each 100 Sq. Ft. Radiating Surface for Area Steam Main by		Multiply Sq. Root Radiating Surface for Diameter by		Probable Frictional Resistance per 100 Ft., Ins. Water.	Required Steam Pressures. Lbs.
(1)	(2)		(3)		(4)	(5)
	Double-pipe system.	Single-pipe system.	Double-pipe system.	Single-pipe system.		
25	.90	1.35	.107	.131	2.0	0 to 1
37.5	.675	1.01	.092	.113	6.0	2 to 3
50	.45	0.67	.075	.092	8.0	3 to 4
62.5	.375	0.56	.069	.090	12.6	4 to 5
75	.30	0.45	.062	.075	18.0	5 to 6
100	.225	0.34	.054	.066	32.0	6 to 40

In all cases if the mains are not covered, its surface is to be estimated as a part of the radiating surface.

The preceding table gives in the first column the velocity of steam, in the second column the corresponding area of pipe in square inches required for each 100 square feet of radiating surface for the double and single pipe systems of heating, in the third column the diameter of pipe for each square foot of radiating surface for both systems of heating, which latter is to be multiplied by the square root of the given radiating surface, to obtain the diameter required. Column 4 gives the approximate back pressure in inches of water per 100 feet in length of the main for steam having the same velocity as in column 1. Column 5 suggests steam-pressures which will render any of these values satisfactory in practice.

117. Rules for Steam-pipe Sizes.—Most of the rules which have been given for determining sizes of steam-pipe when the radiating surface only is given will be found included in the tabulated values. Thus Mr. George H. Babcock gives a rule for gravity heating-systems with separate returns as follows:* “The diameter of the mains leading from the boiler to the radiating surface should be equal in inches to one-tenth the square root of radiating surface, mains included, in square feet.” By consulting the table already given, column 3, this factor would correspond to a velocity of steam slightly exceeding 25 feet per second, and would be adapted for low-pressure steam-heating in small plants.

One authority † gives the following rules for determining the cross-sections of area of pipes: “For steam-mains and returns it will be ample to allow a constant of 0.375 of a square inch for each 100 square feet of heating surface in coils and radiators, 0.375 of a square inch when exhaust steam is used, 0.19 of a square inch when live steam is used, and 0.09 of a square inch for the return. Steam-mains should never be less than $1\frac{1}{2}$ inches, nor the returns less than three-fourths of an inch, in diameter.” Mr. Alfred R. Wolff uses a table for obtaining the capacity of steam-mains of a given diameter, the capacity being expressed both in heat-units delivered and in radiating

* Transactions American Society Mechanical Engineers, May, 1885.

† Van Nostrand's Science Series, No. 68.

surface. This table is given on the next page and will be found convenient and accurate.

The size of main steam-pipe depends on the consideration already given; the smaller the size the greater the resistance of the steam and the more friction and consequent back pressure on the system; the larger the pipes that are used the less the resistance, and, in general, the more satisfactory the results, but economy, of course, forbids the use of pipes beyond a certain size, and that size should be selected by considerations relating to pressure, velocity of steam, and friction, as explained.

TABLE FOR THE CAPACITY OF STEAM-PIPES 100 FEET IN LENGTH WITH SEPARATE RETURNS.

By A. R. WOLFF.

Diameter of Supply. Inches.	Diameter of Return. Inches.	2 Lbs. Pressure.		5 Lbs. Pressure.	
		Total Heat Transmitted. B.T.U.	Radiating Surface. Square Feet.	Total Heat Transmitted. B.T.U.	Radiating Surface. Square Feet.
1	1	9,000	36	15,000	60
1 $\frac{1}{4}$	1	18,000	72	30,000	120
1 $\frac{1}{2}$	1 $\frac{1}{4}$	30,000	120	50,000	200
2	1 $\frac{1}{2}$	70,000	280	120,000	480
2 $\frac{1}{2}$	2	132,000	528	220,000	880
3	2 $\frac{1}{2}$	225,000	900	375,000	1,500
3 $\frac{1}{2}$	2 $\frac{1}{2}$	330,000	1,320	550,000	2,200
4	3	480,000	1,920	800,000	3,200
4 $\frac{1}{2}$	3	690,000	2,760	1,150,000	4,600
5	3 $\frac{1}{2}$	930,000	3,720	1,550,000	6,200
6	3 $\frac{1}{2}$	1,500,000	6,000	2,500,000	10,000
7	4	2,250,000	9,000	3,750,000	15,000
8	4	3,200,000	12,800	5,400,000	21,600
9	4 $\frac{1}{2}$	4,450,000	17,800	7,500,000	30,000
10	5	5,800,000	23,200	9,750,000	39,000
12	6	9,250,000	37,000	15,500,000	62,000
14	7	13,500,000	54,000	23,000,000	92,000
16	8	19,000,000	76,000	32,500,000	130,000

In above table each square foot of radiating surface is assumed to transmit 250 heat-units per hour, a safe and conservative estimate, as will be seen by consulting Chapter IV.

For pipes of greater length than 100 feet multiply results

in the above table by the square root of 100 divided by the length. In all cases the length is to be taken as the equivalent length in straight pipe of the pipe, elbows, and valves.* For other lengths multiply above results by following factors:

Length of pipe in feet	200	300	400	500	600	700	800	900	1000
Factor	0.71	0.58	0.5	0.45	0.41	0.38	0.35	0.33	0.32

For example, the capacity of a pipe 8 inches in diameter and 800 feet long would be 0.35 of 12,800 sq. ft. of radiating surface = 4480 sq. ft. It will be noted that the size of return specified by Mr. Wolff is about one pipe-size greater than believed to be necessary by the author.

Unless otherwise impracticable the author would always advise the use of the table of commercial sizes of steam-mains in proportioning pipe sizes. In using the table, first find the size of the branch pipes from single radiators, and then the size of the mains which will be increased with amount of radiation carried, as shown in the table.

118. Size of Return-pipes, Steam-heating.—The size of return-pipes, if figured from the actual volume of water to be carried back, would be smaller than is safe to use, largely because of air which is contained in the steam-pipes, and which does not change in volume when the steam is condensed. For this reason it is necessary to use dimensions which have been proved by practical experience to be satisfactory. When the steam-main is large, the diameter of the return-pipe will prove satisfactory if taken one size less than one-half that of the steam-pipe; but if the steam-main is small, for instance, 5 inches or less, the return-pipe should be but one or two sizes smaller. The return-pipe should never be less than 1 inch, in order to give satisfactory results. The following table suggests

* NOTE.—In case there are bends or obstructions consider the length of pipe increased as follows: Right-angle elbow 40 diameters; globe-valve 125 diameters; entrance to tee 60 diameters.

For obtaining the diameter of steam-main to be used in case there is a separate return multiply the above results by 0.82.

For indirect heating without separate return multiply above results by 1.4, with separate return use the results in the form given.

sizes of returns which will prove satisfactory for sizes of main steam-pipes as given:

Diameter Steam-pipe.	Diameter Return-pipe.	Diameter Steam-pipe.	Diameter Return-pipe.
inches.	inches.	inches.	inches.
1½	1¼	5	3
2	1½	6	3½
2½	1½	8	4
3	2	9	4½
3½	2½	10	4½
4	2½	12	5

The size of return-pipes, if computed on basis of reduction in volume due to condensation of the steam, supposing the steam to have a gauge-pressure of 40 pounds and that one-half its volume is air, would be, neglecting friction, about one-sixth of that of the main steam-pipe, which is much smaller than would be considered safe in practice.

Main and Return-pipes for Indirect Heating Surfaces.—The indirect heating surfaces require about twice as much heat as the same quantity of direct radiating surface, and hence, for same resistance in the pipe, the area should be twice that required in direct heating. It will usually be sufficiently accurate to use a pipe whose diameter is 1.4 times greater than that for direct heating.

Reliefs and Drip-pipes.—The size of drip-pipes necessary to convey the water of condensation from a steam main to a return cannot be obtained by computation, as there is much uncertainty regarding the amount of water that will flow through, under the conditions which exist.

As the flow through the relief tends to increase the pressure in the return, it may also serve to lessen the velocity of flow beyond the point of junction, provided the size is greater than necessary to carry off the water of condensation from the steam-main. Drip-pipes should be united to the return in such a manner as to re-enforce rather than impede the circulation, which result can usually be attained by joining the pipes with 60 or 45 degree fittings.

The writer would recommend the employment of the following sizes of drip-pipes as ample for usual conditions:

DIAMETER OF DRIP-PIPE FOR STEAM-MAINS OF VARIOUS LENGTHS.

Diameter of Steam-main, Inches.	Length of Steam-main in Feet.			
	0 to 100.	100 to 200.	200 to 400.	400 to 600.
	Diameter of Drip-pipe in Inches.			
0 to 2	$\frac{1}{2}$	$\frac{1}{2}$	$\frac{1}{2}$	$\frac{3}{4}$
3	$\frac{1}{2}$	$\frac{3}{4}$	$\frac{3}{4}$	1
4	$\frac{3}{4}$	$\frac{3}{4}$	1	$1\frac{1}{4}$
5	$\frac{3}{4}$	1	$1\frac{1}{4}$	$1\frac{1}{2}$
6	1	$1\frac{1}{4}$	$1\frac{1}{2}$	$1\frac{1}{2}$

119. Summary of Various Methods of Computing Quantities Required for Heating.—The following table gives the required size of steam-pipes and of steam-boiler or hot-water heater, for various amounts of radiating surface. The proportions given will apply to residence heating or where the length of main pipe is not over 200 feet. The value given for the steam-main is that for the single-pipe system when no return is needed. For the system of separate steam- and return-pipes the diameter of the steam-main should be taken $\frac{3}{4}$ of that given. The cubic space heated is given if the ratio to radiating surface be known; this is an approximation only, although it may often serve a useful purpose when experience has been gained of heat required in constructions of similar nature in the same locality.

About two-thirds as much air is warmed by hot-water as by steam radiators, and flues should be about two-thirds as large as given in the table on page 276.

REQUIRED PROPORTION OF PARTS; DIRECT STEAM-HEATING

Radiating surface, sq. ft. *	100	250	500	750	1,000	1,500	2,000	3,000	4,000	5,000	7,500	10,000
Diameter steam-mains ins. *	1.5	2	2.5	2.5	3	3.5	4	4.5	5	5.5	6	7
Heating surface boiler, sq. ft. *	25	55	98	138	178	250	322	447	580	710	833	1,110
Grate-area boiler, sq. ft. *	0.9	1.9	3.0	5.4	6.4	8.9	11.2	15.5	19.5	23.2	32.5	42
Diameter smoke-flue, ins. *	5	7	9	10	12	13	15	18	20	23	27	30
Cubic feet heated, 40 to 100	10,000	20,000	30,000	40,000	50,000	60,000	80,000	120,000	160,000	200,000	300,000	400,000
" " " " 50 to 100	12,500	25,000	37,500	50,000	75,000	100,000	100,000	150,000	200,000	250,000	375,000	500,000
" " " " 75 to 100	18,750	37,500	56,250	75,000	112,500	150,000	150,000	225,000	300,000	375,000	562,500	750,000

DIRECT HOT-WATER HEATING

Radiating surface, sq. ft. *	100	250	500	750	1,000	1,500	2,000	3,000	4,000	5,000	7,500	10,000
Diameter pipe, ins., 1st story*	1.5	2	2.5	3.5	4.0	4.5	5.0	5.5	6.0	6.5	7.5	9.5
" " " " 2d story*	1.5	2	3.0	3.5	4.0	4.5	5.0	5.5	6.0	6.5	7.5	10
" " " " 3d story*	1.25	1.5	2.5	3.0	3.5	4.0	4.5	5.0	5.5	6.0	7.5	9
Heating surface, heater sq. ft. *	16	36.5	65	92	118	160	215	290	385	470	703	950
Grate-area, heater sq. ft. *	0.5	1.25	2.6	3.6	4.3	5.9	7.1	10.3	13.0	15.3	21.5	27.5
Diameter smoke-flue, ins. *	5	7	9	10	12	13	15	18	20	23	27	39
Cubic feet heated, 20 to 100	5,000	10,000	15,000	20,000	30,000	40,000	40,000	60,000	80,000	100,000	150,000	200,000
" " " " 30 to 100	7,500	15,000	22,500	30,000	45,000	60,000	60,000	90,000	105,000	150,000	225,000	300,000
" " " " 40 to 100	10,000	20,000	30,000	40,000	60,000	80,000	80,000	120,000	160,000	200,000	300,000	400,000

INDIRECT STEAM-HEATING

Square feet radiation	100	250	500	750	1,000	1,500	2,000	3,000	4,000	5,000	7,500	10,000
Cu. ft. air heated per minute	480	1,200	2,400	3,600	4,800	7,200	9,600	14,400	19,100	24,000	36,000	48,000
Diameter main steam-pipe*	5.0	11.0	19.6	27.0	35.0	50.0	64.4	89.4	116.0	142.0	212.0	280.0
Heating surface, boiler, sq. ft. *	1.8	3.8	7.8	10.8	12.8	17.8	22.4	31.0	40.0	50.0	70.0	90.0
Grate-area boiler, sq. ft. *	7	10	12	14	17	20	21	25	30	32	38	44
Diameter smoke-flue, ins. *	2000	5,000	10,000	15,000	20,000	30,000	40,000	60,000	80,000	100,000	150,000	200,000
Cubic feet heated, 20 to 100	3000	7,500	15,000	22,500	30,000	45,000	60,000	90,000	120,000	160,000	240,000	320,000
" " " " 30 to 100	4000	10,000	20,000	30,000	40,000	60,000	80,000	120,000	160,000	200,000	300,000	400,000

INDIRECT HOT-WATER HEATING

Square feet radiation	100	250	500	750	1,000	1,500	2,000	3,000	4,000	5,000	7,500	10,000
Cu. ft. air heated per minute	374	925	1,850	2,770	3,740	4,600	7,480	11,200	15,000	18,800	28,200	37,000
Diam. supply-and return-pipe*	3.2	7.2	13.0	18.4	22.8	33.2	43.0	59.2	73.0	94.0	130.0	170.0
Heating surface in boiler sq. ft. *	1.0	2.5	5.2	7.2	8.6	11.8	14.2	20.6	26.0	32.0	42.0	55.0
Grate-area in boiler sq. ft. *	7	10	12	14	17	20	21	25	32	38	48	62
Diam. smoke flue, ins. *	1500	3,750	7,500	11,250	15,000	22,500	30,000	45,000	60,000	75,000	112,500	150,000
Cubic feet heated, 15 to 100	2500	6,250	12,500	18,750	25,000	37,500	50,000	75,000	100,000	125,000	187,500	250,000
" " " " 25 to 100	3500	8,750	17,500	26,250	35,000	52,500	70,000	105,000	140,000	175,000	262,500	350,000

DATA FOR COMPUTATION.—Temperature outside air 0, room 70, entering air 100, temperature steam surface 220, hot water 180.
* Pipe assumed 100 feet in length. Diameter of main in steam-heating for single-pipe system.

HOT-AIR AND VENTILATING FLUES.

INDIRECT RADIATION STEAM CIRCULATION.

Square feet radiation.....	.25	50	75	100	125	150	175	200	250
Cubic feet air per minute.....	122	244	362	486	602	729	846	972	1220
Area hot-air flue, square feet:									
1st story.....	0.72	1.45	2.16	2.87	3.57	4.3	5.0	5.7	7.3
2d story.....	0.29	0.59	0.88	1.9	1.47	1.78	2.06	2.35	2.95
3d story.....	0.24	0.49	0.73	0.97	1.22	1.46	1.7	1.95	2.45
Area ventilating flue, square feet:									
1st story.....	0.37	0.74	1.1	1.46	1.81	2.2	2.57	2.95	3.7
2d story.....	0.48	0.87	1.44	1.92	2.37	2.8	3.35	3.84	4.8
3d story.....	0.55	1.1	1.64	2.2	2.71	3.3	3.85	4.4	5.4
Actual area register, square feet:									
1st story.....	1.22	2.4	3.6	4.9	6	7.3	8.4	9.7	12.2
2d and above.....	1.0	2	3	4	5	6	7	8.0	10.0
Ventilating register, square feet...	0.6	1.2	1.8	2.4	3	3.6	4.2	4.8	6.1

120. **Short Method of Computing Radiation**, published by A. C. Rogers in the *Heating and Ventilating Magazine*. Tables for the radiating surface for hot water and for steam are given on the following pages. It will readily be seen that by taking off from the drawings the quantities for each of wall, glass and cubic contents, the radiation for which is readily found from the tables, and by adding these values, the radiation sought is the result of this sum. First, get the value of radiating surface needed for each item for the room and then their sum equals the radiating surface required for that room. For instance, if a room had 100 square feet of wall surface it would require 10 square feet of radiating surface, with 10 square feet of window surface would require 4 square feet of radiating surface, and with a cubic content of 2000 cubic feet, and 2 changes of air per hour would require 32 square feet of radiating surface; or a total of 46 square feet of radiating surface for the room.

The table for hot water is computed for the formula,

$$R = 0.4 \left(\frac{W}{4} + G + 0.02 NC \right),$$

where R = the radiating surface in square feet,

W = " wall " "

G = " glass " "

C = " contents of the room in cubic feet,

N = " number of times per hour the air is changed.

The table for steam is computed from the formula,

$$R = 0.25 \left(\frac{W}{4} + G + 0.02 NC \right).$$

Time may be saved by properly tabulating the values of the items taken from the drawings and by the use of an adding machine.

SQUARE FEET OF RADIATION FOR HOT WATER.

Quantity.	Square Feet Surface.		Cubic Feet of Air Contents.			
	Wall.	Glass.	N = 1.	N = 2.	N = 3.	N = 4.
1	.1	.4	.008	.016	.024	.032
2	.2	.8	.016	.032	.048	.064
3	.3	1.2	.024	.048	.072	.096
4	.4	1.6	.032	.064	.096	.128
5	.5	2.0	.040	.080	.120	.160
6	.6	2.4	.048	.096	.144	.192
7	.7	2.8	.056	.112	.168	.224
8	.8	3.2	.064	.128	.192	.256
9	.9	3.6	.072	.144	.216	.288
10	1.0	4.0	.080	.160	.240	.320
20	2.0	8.0	.160	.320	.480	.640
30	3.0	12.0	.240	.480	.720	.960
40	4.0	16.0	.320	.640	.960	1.280
50	5.0	20.0	.400	.800	1.200	1.600
60	6.0	24.0	.480	.960	1.440	1.920
70	7.0	28.0	.560	1.120	1.680	2.240
80	8.0	32.0	.640	1.280	1.920	2.560
90	9.0	36.0	.720	1.440	2.160	2.880
100	10.0	40.0	.800	1.600	2.400	3.200
200	20.0	80.0	1.600	3.200	4.800	6.400
300	30.0	120.0	2.400	4.800	7.200	9.600
400	40.0	160.0	3.200	6.400	9.600	12.800
500	50.0	200.0	4.000	8.000	12.000	16.000
600	60.0	240.0	4.800	9.600	14.400	19.200
700	70.0	280.0	5.600	11.200	16.800	22.000
800	80.0	320.0	6.400	12.800	19.200	25.600
900	90.0	360.0	7.200	14.400	21.600	28.800
1,000	100.0	400.0	8.000	16.000	24.000	32.000
2,000	200.0	800.0	16.000	32.000	48.000	64.000
3,000	300.0	1,200.0	24.000	48.000	72.000	96.000
4,000	400.0	1,600.0	32.000	64.000	96.000	128.000
5,000	500.0	2,000.0	40.000	80.000	120.000	160.000
6,000	600.0	2,400.0	48.000	96.000	144.000	192.000
7,000	700.0	2,800.0	56.000	112.000	168.000	224.000
8,000	800.0	3,200.0	64.000	128.000	192.000	256.000
9,000	900.0	3,600.0	72.000	144.000	216.000	288.000
10,000	1000.0	4,000.0	80.000	160.000	240.000	320.000
20,000	2000.0	8,000.0	160.000	320.000	480.000	640.000
30,000	3000.0	12,000.0	240.000	480.000	720.000	960.000
40,000	4000.0	16,000.0	320.000	640.000	960.000	1280.000
50,000	5000.0	20,000.0	400.000	800.000	1220.000	1600.000
60,000	6000.0	24,000.0	480.000	960.000	1444.000	1920.000
70,000	7000.0	28,000.0	560.000	1120.000	1680.000	2240.000
80,000	8000.0	32,000.0	640.000	1280.000	1920.000	2560.000
90,000	9000.0	36,000.0	720.000	1440.000	2160.000	2880.000
100,000	10000.0	40,000.0	800.000	1600.000	2400.000	3200.000

SQUARE FEET OF RADIATION FOR STEAM.

Quantity.	Square Feet Surface.		Cubic Feet of Air Contents.			
	Wall.	Glass.	N = 1.	N = 2.	N = 3.	N = 4.
1	0.0625	.25	0.005	0.010	0.015	0.020
2	.1250	.50	0.010	0.020	0.030	0.040
3	.1875	.75	0.015	0.030	0.045	0.060
4	.2500	1.00	0.020	0.040	0.060	0.080
5	.3125	1.25	0.025	0.050	0.075	0.100
6	.3750	1.50	0.030	0.060	0.090	0.120
7	.4375	1.75	0.035	0.070	0.105	0.140
8	.5000	2.00	0.040	0.080	0.120	0.160
9	.5625	2.25	0.045	0.090	0.135	0.180
10	0.625	2.50	0.05	0.10	0.15	0.20
20	1.250	5.00	0.10	0.20	0.30	0.40
30	1.875	7.50	0.15	0.30	0.45	0.60
40	2.500	10.00	0.20	0.40	0.60	0.80
50	3.125	12.50	0.25	0.50	0.75	1.00
60	3.750	15.00	0.30	0.60	0.90	1.20
70	4.375	17.50	0.35	0.70	1.05	1.40
80	5.000	20.00	0.40	0.80	1.20	1.60
90	5.625	22.50	0.45	0.90	1.35	1.80
100	6.25	25.0	0.5	1.0	1.5	2.0
200	12.50	50.0	1.0	2.0	3.0	4.0
300	18.75	75.0	1.5	3.0	4.5	6.0
400	25.00	100.0	2.0	4.0	6.0	8.0
500	31.25	125.0	2.5	5.0	7.5	10.0
600	37.50	150.0	3.0	6.0	9.0	12.0
700	43.75	175.0	3.5	7.0	10.5	14.0
800	50.00	200.0	4.0	8.0	12.0	16.0
900	56.25	225.0	4.5	9.0	13.5	18.0
1,000	62.5	250.0	5.0	10.0	15.0	20.0
2,000	125.0	500.0	10.0	20.0	30.0	40.0
3,000	187.5	750.0	15.0	30.0	45.0	60.0
4,000	250.0	1,000.0	20.0	40.0	60.0	80.0
5,000	312.5	1,250.0	25.0	50.0	75.0	100.0
6,000	375.0	1,500.0	30.0	60.0	90.0	120.0
7,000	437.5	1,750.0	35.0	70.0	105.0	140.0
8,000	500.0	2,000.0	40.0	80.0	120.0	160.0
9,000	562.5	2,250.0	45.0	90.0	135.0	180.0
10,000	625.0	2,500.0	50.0	100.0	150.0	200.0
20,000	1250.0	5,000.0	100.0	200.0	300.0	400.0
30,000	1875.0	7,500.0	150.0	300.0	450.0	600.0
40,000	2500.0	10,000.0	200.0	400.0	600.0	800.0
50,000	3125.0	12,500.0	250.0	500.0	750.0	1000.0
60,000	3750.0	15,000.0	300.0	600.0	900.0	1200.0
70,000	4375.0	17,500.0	350.0	700.0	1050.0	1400.0
80,000	5000.0	20,000.0	400.0	800.0	1200.0	1600.0
90,000	5625.0	22,500.0	450.0	900.0	1350.0	1800.0
100,000	6250.0	25,000.0	500.0	1000.0	1500.0	2000.0

CHAPTER XI.

PUMP RETURN STEAM HEATING SYSTEMS.

130. **General Remarks.**—Under this heading will be taken up, under their various trade names, the different systems of Vacuum, Vapor or Atmospheric steam heating, in which the water is returned to the boiler by a pump or injector, etc., or else wasted; as well as high pressure steam heating, whether the steam is furnished directly from the boiler or indirectly by using the exhaust steam of engines, turbines, pumps, etc. Steam after being employed in an engine contains the greater portion of its heat, and if not condensed or utilized for other purposes it can usually be employed for heating without materially affecting the power of the engine. The systems of steam-heating which have been described are those in which the water of condensation flows directly into the boiler by gravity. In other systems in use high-pressure steam is carried in the boilers, high- or low-pressure steam in the heating-mains and radiators, and the return-water of condensation is received by a trap and delivered either into a tank from which it is pumped into the boiler or in some instances wasted. The exhaust steam may need to be supplemented by live steam taken directly from the boiler, which may be reduced in pressure either by passing through a valve partly open or a reducing-valve.

It will often be found that little attempt is made to utilize the heat escaping in the exhaust steam from non-condensing engines, and consequently a good opportunity exists for construction of systems which will save annually many times their first cost.

131. Systems of Exhaust Heating.—The exhaust steam discharged from non-condensing engines contains from 20 to 30 per cent of water, and considerable oil or greasy matter which has been employed in lubricating. When the engine is freely exhausting into the air, the pressure in the exhaust-pipe is, or should be, but slightly in excess of that due to the atmosphere. The effect of passing exhaust steam through heating-pipes is likely to increase the resistance and cause back pressure which will reduce the effective work of the engine. The engine delivers steam discontinuously, but at regular intervals at the end of each stroke. The amount is likely to vary with the work done by the engine, since the engine-governor is always adjusted to admit steam in such amount as is required to preserve uniform speed; if the work is light very little steam will be admitted to the engine. For this reason the supply available for heating varies within wide limits.

The general requirements for a successful system of exhaust-steam heating must be, first, the arrangement of a system of piping having such proportions as will make little or no increase in back pressure on the engine and will provide for using an intermittent supply of steam; second, provision for removing the oil from the exhaust, since this will interfere materially with the heating capacity of the radiating surfaces; third, provision against accidents by use of a safety or *back-pressure valve* so arranged as to prevent damage to the engine by sudden increase in back pressure.

These requirements can be met in various ways. To prevent sudden change in back pressure due to irregular supply of steam the exhaust-pipe from the engine should be carried directly to a closed tank whose cubic contents should be at least 30 times that of the engine and as much larger as practicable. This tank can be provided with diaphragms or baffle-plates arranged so as to throw all or nearly all the grease and oil in the steam into a drip-pipe, from which it is removed by means of a steam-trap. These requirements are fully met by modern types of open feed-water heaters. To this tank may be connected a relief-pipe leading to the back-pressure valve,

and also a supplementary pipe for supplying live steam. The supply of steam for heating should be drawn from the top of the tank.

Small sized steam turbine units usually require more steam than high grade steam engines of the same capacities when operated non-condensing or exhausting against a back pressure. However, the exhaust steam from turbines is free from oil or grease. Unless the demand for power is relatively high as compared with the heating load, a highly efficient steam engine may not show any saving at the coal pile over an engine which requires more steam per horse-power hour, since more live steam would have to be supplied to the heating system through a reducing valve. So each installation is a separate problem, its most economical solution depending upon the average amount and distribution of the power and heating loads as well as other commercial conditions.

Any system of piping may be adopted, but extreme care should be taken that as little resistance as possible is introduced at bends or fittings. The radiating surface employed should be such as will give the freest possible circulation. In general, that system will be preferable in which the main steam-pipe is carried directly to the top of the building, the distributing-pipes run from that point, and the radiating surface is supplied by the down-flowing current of steam. It is desirable to have a closed tank at the highest point of the system, from which the distributing-pipes are taken, and provided with drips leading to a trap so as to remove, before it can reach the radiating surface, any water of condensation or oil which has been carried to the top of the building.

132. Proportions of Radiating Surface and Main Pipes Required in Exhaust Heating.—The size of exhaust pipe required for an engine of given power, in order that the back pressure shall not exceed a certain amount, may be computed, the only data required in addition to that already given for heating with live steam being that relating to the steam required by engines. The amount of steam used by engines will depend upon the workmanship and class to which they

belong, but we can assume with little error that non-condensing engines will require the following weights of steam per horse-power per hour: simple with throttling-governor 40 pounds, with automatic governor 35 pounds, with Corliss valves 30 pounds, compound using high-pressure steam 25 pounds. In order that the pipes may be sufficiently large it is better to proportion the systems for the more uneconomical type.

TABLE OF DATA FOR COMPUTATION.

Steam-pressure from Atmosphere.....	0	1	2	3	10	-2	-5	
Absolute.....	14.7	15.7	16.7	18.7	24.7	12.7	9.7	
Temperature of steam, F.....	212	216	219	222	239	204	192	
Temperature of air.....	70	70	70	70	70	70	70	
Difference.....	142	146	149	152	169	134	122	
Heat per min. from 100 sq. ft. radiation in B.T.U. equal 3 times difference	426	438	447	456	507	402	366	
Total heat of steam above 212°.....	966	967	967	967	973	962	958	
Latent heat steam, B.T.U.....	966	963	960	957	946	970	978	
Cubic feet steam per lb.....	26.4	24.6	23.3	21.0	16.2	30.3	30.0	
Cubic feet steam to weigh $\frac{1}{2}$ lb.....	17.6	16.4	15.5	14.0	10.8	20.2	26.0	
Cubic feet steam required each min. to supply 100 ft. rad. sur., air 70°.....	11.6	11.25	10.85	10.1	8.8	12.6	11.5	
Weight of 1 cubic foot steam..... lbs.	0.0379	.0403	.0427	.0475	.0640	.0326	.0257	
Radiating surface per	H.P.....	Throttling	152	146	143	139	126	162
		Automatic	134	129	127	122	112	146
		Corliss.....	114	110	107	104	95	122
		Compound	95	91	90	87	79	102
Head of steam in feet equal 1 foot water of water column.....	1669	1585	1455	1317	1010	1902	2440	

In the following discussion the dimensions of piping are computed for an engine using 40 pounds of steam per horse-power per hour ($\frac{2}{3}$ pound per minute), and exhausting against a back pressure above or below atmosphere as stated.* The preceding table gives properties of steam, also radiating surface supplied per horse-power by engines of various classes.

The computation of the size of exhaust-pipes can be made by the following algebraic process:

Let v equal velocity of the steam in feet per second; V , velocity in feet per minute; l , length of pipe in feet; D , diameter of pipe in feet; d , diameter in inches; A , area of pipe in square feet; Q , cubic feet of steam discharged per minute; h , back pressure above atmosphere expressed in feet of steam; p , back pressure expressed in pounds per square inch; HP , horse-power of engine; c , number of cubic feet in one pound of steam.

* Radiating surface 25 per cent less.

From the following formulæ (see Chapter V), we have, for velocity in feet per second

$$v = 48\sqrt{\frac{hD}{l+48D}} = \text{nearly } 50\sqrt{\frac{h}{l}}D; \quad \dots \dots \dots (1)$$

from which by reduction the velocity in feet per minute

$$V = 3000\sqrt{\frac{h}{l}}D = 866\sqrt{\frac{h}{l}}d. \quad \dots \dots \dots (2)$$

The discharge in cubic feet per minute

$$Q = AV = 3000A\sqrt{\frac{h}{l}}D = 4.723\sqrt{\frac{h}{l}}d^3. \quad \dots \dots \dots (3)$$

Since $\frac{2}{3}$ pound of steam is used per horse-power per minute,

$$Q = \frac{2}{3}cHP \quad \dots \dots \dots (4)$$

From above by reduction

$$d = 0.537\sqrt[5]{\frac{Q^2l}{h}} = 0.457\sqrt[5]{\frac{c^2l}{h}HP^2}; \quad \dots \dots \dots (5)$$

$$HP = 7.135\sqrt{\frac{d^5h}{c^2l}} \quad \dots \dots \dots (6)$$

In case the back pressure is equal to one foot of water column (0.433 pound per square inch) above atmosphere, $h = 1598$, $c = 25.7$, and we have

$$HP = 1.11\sqrt{d^5}.$$

For one pound back pressure

$$HP = 1.18\sqrt{d^5}.$$

It is advisable to make the diameter one inch greater to overcome additional resistances. (See table.)

RADIATING SURFACE AND HORSE-POWER OF ENGINE FOR A GIVEN DIAMETER OF EXHAUST-PIPE.

Diam. Exhaust-steam Pipe 100 Ft. Long. Back Pressure not to Exceed 0.4 Lb.	Corresponding H.P. of Engine.	Radiating Surface in Sq.ft. Supplied by Automatic Type of Engine.	Diam. Exhaust-steam Pipe 100 Ft. Long. Back Pressure not to Exceed 0.4 Lb.	Corresponding H.P. of Engine.	Radiating Surface in Sq.ft. Supplied by Automatic Type of Engine.
Inches.			Inches.		
2	1.12	110	6	63	6,200
2½	3.1	300	7	99.3	9,500
3	6.4	605	9	304	19,500
3½	11.1	1,050	12	356	34,000
4	17.5	1,650	14	562	54,000
4½	22.9	2,200	16	825	89,000
5	36.6	3,400	18	1,150	110,000

The foregoing table is computed for steam having a pressure of 0.43 pound above the atmosphere. For other pressures of exhaust multiply the results given in the table by the following factors (for other distances multiply by $0.1\sqrt{l}$):

Pressure.	Factor.
Atmospheric.....	1.05
2 pounds below.....	1.125
5 pounds below.....	1.27
2 pounds above.....	0.98
3 pounds above.....	0.895
10 pounds above.....	0.79

As an example, find the size of exhaust-pipe and amount of radiating surface supplied by the exhaust of a 50 horse-power engine of the automatic type, working against a back pressure of 0.43 pound. For this condition, the exhaust from one horse-power will supply 25 per cent less than 131 square feet of radiation (see above table), or 4900 square feet. From the table at top of page we see that a 6-inch pipe will be somewhat larger than required, but should be used. The amount of radiating surface needed to warm a given building will depend on pressure of the steam, exposure, and class of building, as previously explained.

133. District Heating.—The power generated may be all used in the building or factory that is heated by the exhaust steam; or the exhaust steam may be furnished from a separate establishment, usually an electric power company or a district heating company.

A good commercial arrangement in a thickly settled city is to install a non-condensing steam turbine power station in or near the centre of the heating district to be served. Then the turbo-alternators are run in parallel with other power stations whose generating units can be run under a high vacuum, the load on the non-condensing turbines in the heating station being so regulated that just the necessary amount of exhaust steam is furnished to the heating system. A good combination for a smaller city is a combination electric lighting and power station, selling exhaust steam in the winter, and using the exhaust steam in the manufacture of ice in the summer.

The local conditions to be met very largely govern the installation and operation of district heating plants. Where the distances to be transmitted are great and where the buildings to be heated are scattered, heating by high pressure steam from a central station is generally used. These conditions are met in some educational and state institutions. Superheated steam, being a poor conductor of heat, is desirable in the supply mains but not in the radiating surfaces. A moderate superheat of 50 or 100° F. at the boilers will cut down the heat transmission losses in the first one or two thousand feet of mains.

134. Systems of Exhaust-heating with Less than Atmospheric Pressure.—If a system of exhaust-heating discharge its steam and condensation directly into the atmosphere, the pressure must be slightly above atmospheric; but systems have been used with success in which the back-pressure was less than atmospheric, and in the table of proportions which has been given such cases are considered.

Such a system can be constructed by connecting the discharge from the system to an air-pump which will remove the water of condensation and to a great extent the atmospheric

pressure; the heating surface will act as a condenser for the engine, and in case it is insufficient for this purpose a jet or surface-condenser supplied with cold water may be used to supplement it. Instead of an air-pump and condenser, a siphon condenser, Fig. 197, may be used. This latter instrument is regularly on the market, and consists of a chamber above a convergent tube which receives the exhaust steam and a jet of water. This condenser depends for its action upon the fact that a column of water 34 feet in height will balance and overcome the atmospheric pressure. For its successful use it must be set so that the top of the condenser is at least 34 feet higher than the end of the discharge-tube, the bottom of which is to be submerged.

In a system of exhaust heating, by-pass connections to the outside air or condenser should be provided, so that the heating surface need not be used in warm weather.

Besides the general system which has been described, other systems of great merit have been devised and put on the market with many special and patented features. Of these we may mention first the Willames system, which is shown in Fig. 198, with details of construction. It will be seen that the exhaust from the engine is received into a large upright stand-pipe with back-pressure valve at top, and that the steam

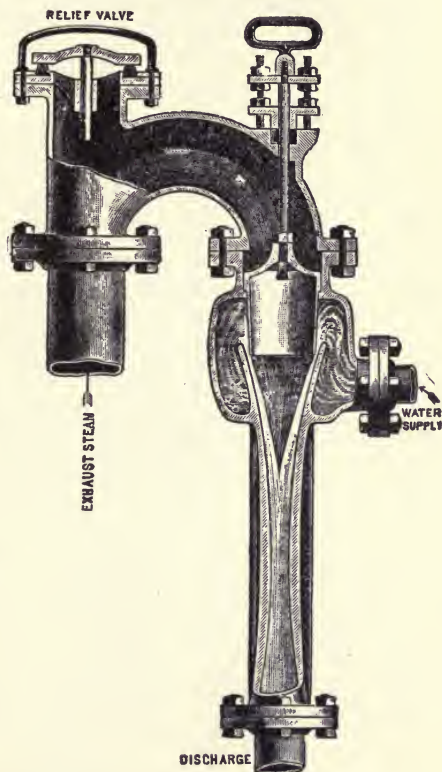

FIG. 197.—Siphon Condenser.

is drawn from near the top, and after passing through the radiating system, is received into a large branch-tee, which is supplied with injection-water and serves as a condenser. The suction-pipe of the air-pump is connected to the branch-tee and acts to remove the atmospheric pressure from the entire

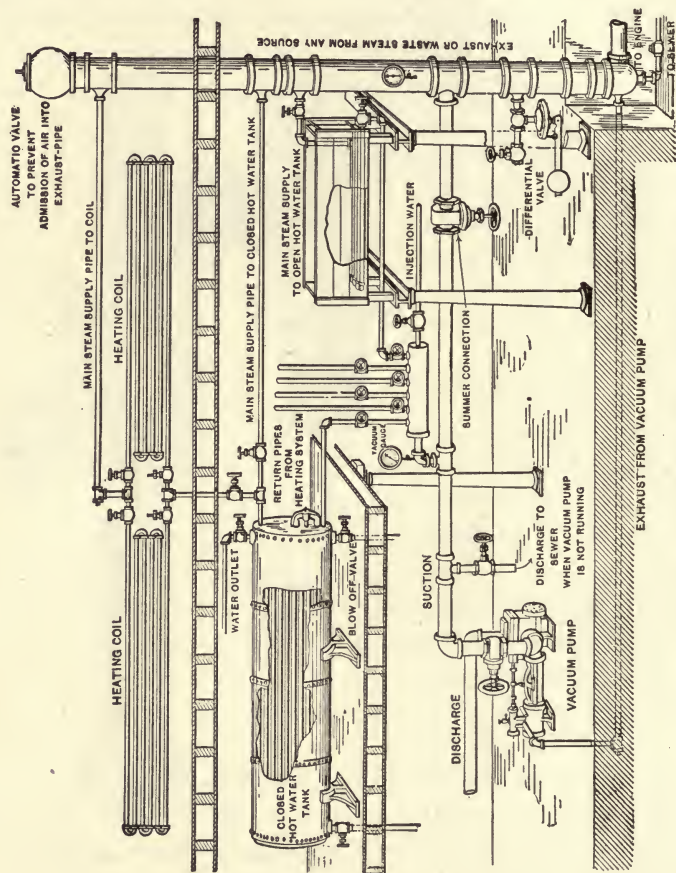

FIG. 198.—Williamses System of Exhaust-steam Heating.

system. A by-pass for summer use is shown. Water is heated in the closed hot-water tank by a portion of the return and may be used for any purpose needed, as, for instance, feed-water for boilers, heating by hot-water circulation, etc.

The cut illustrates an automatic valve at the upper or discharge end of the exhaust-pipe, technically known as a *back-*

pressure valve, which in construction is like a check-valve opening outward, but is provided with removable or adjustable weights for the purpose of balancing any desired pressure inside. It is adjusted to open and discharge the steam when the pressure exceeds any desired amount, and to close when the pressure falls; it is almost universally employed to discharge the excess of steam in connection with any system of exhaust-heating, as already noted. When the steam supplied is not greater than can be condensed and removed in the form of water or steam by the vacuum-pump or exhausting device, a vacuum will be produced throughout the entire system and even extend to the engine; the temperature in the radiators will be less than the boiling-point of water and dependent upon the amount of vacuum. When the steam supplied is in excess of that which can be condensed, the back-pressure valve will open intermittently for a short period of time; the pressure in the main exhaust will be above that of the atmosphere and the temperature above 212° F. The exhausting device will, however, for this condition, draw the steam and water of condensation and the entrained air through the radiators and coils and may produce considerable vacuum throughout the entire heating system, which may begin at a point near the exhaust-pipe or position of restricted supply.

The Williames system was patented by N. P. Williames, April 4, 1882. It is interesting as being the fundamental patent granted in the United States for circulating steam positively without material condensation through a heating system by means of a suction device or exhauster connected to the return-pipe.

135. The Webster System, Fig. 199, was the immediate successor commercially to the Williames system and is now in extensive use. It differs from the Williames system principally in the use of a thermostatic valve located in the return pipe from each radiator or heating coil. This valve, Fig. 200, is constructed on the same principle, as the automatic valve shown in Fig. 87, or as the expansion trap shown in Fig. 164, and so as to open when the temperature falls below a certain

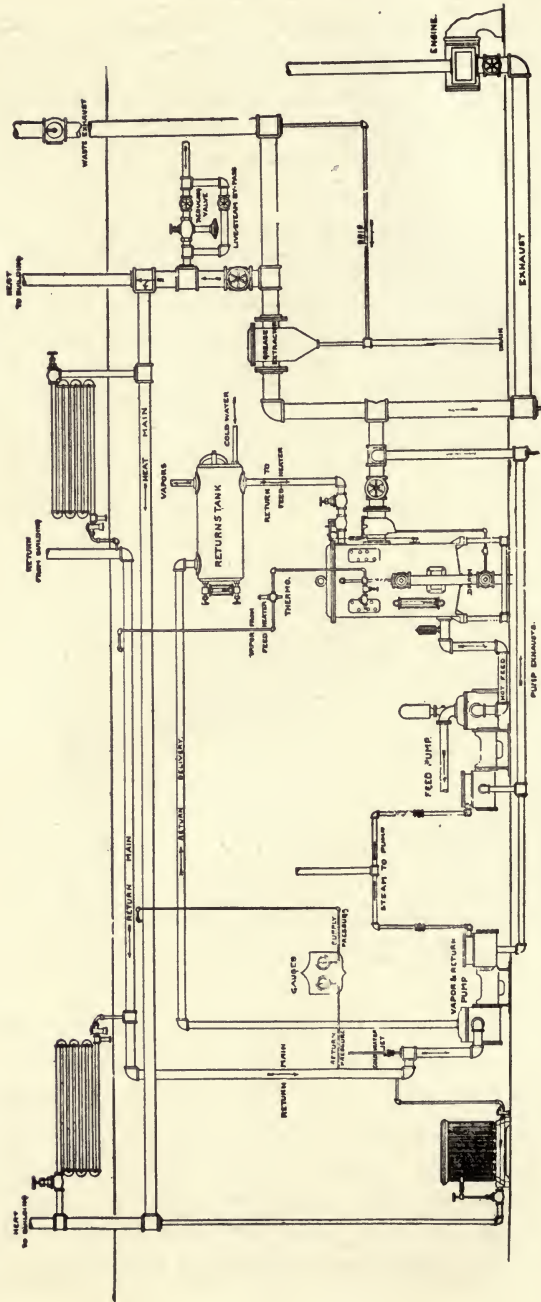

FIG. 199.—The Webster System of Heating.

prearranged amount less than that of the steam, or to close when the temperature rises to that of the steam. The action of the valve in this manner causes complete condensation to take place in the radiator, so that the vacuum-pump removes only the water of condensation and air. It should be noted that separate steam supply- and return-pipes are required in both the Willames and Webster systems.

At the present time, Warren Webster & Co., sell systems of vacuum and modulation steam heating. On the following page are shown three different radiator traps used by them. These radiator traps are in principle, miniature steam traps, allowing the water and air to leave the radiator and closing against the steam. Several styles of their traps are shown. The application of the various types of traps is determined by the conditions, varying according to the temperature of the apparatus which is to be drained and the quantity of condensation which will be thrown down, and whether the return lines are under a vacuum or atmospheric pressure.

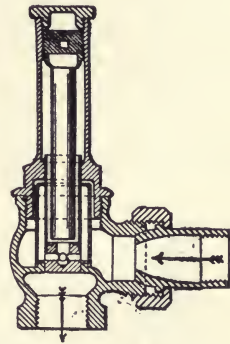

FIG. 200.—Webster Thermostatic Valve. (Old Form.)

The *Webster Thermostatic or Thermo Valve*, Fig. 201, is used principally on small units of radiation, is adjustable and automatic, permitting water and air to pass, but expanding when the plug is surrounded by steam, causing it to seat and preventing waste of steam to the return. This valve is intended for fairly constant low pressures.

The valve shown in Fig. 202 is all metallic, automatic, non-adjustable and works on the float principle. Air passes out around the screw thread spindle. Water surrounding the float causes it to rise, opening the port and allowing the water to pass to the return pipe. This valve is intended for low pressure service. Any vapors which may pass to the returns are readily condensed in these bare pipes.

The illustration Fig. 203 shows an automatic thermostatic

valve for the return end of steam radiators, which can be used for widely varying pressures, permitting water and air to pass while tight against steam-leakage.

136. **Diagrams with Cochrane Steam Stack Heaters.**—A number of cross-section cuts of a few representative radiator traps operating on either the float or the thermostatic principle are shown in Chapter IX. Lack of space prevents the description of the various systems manufactured but the "Exhaust Steam Heating Encyclopedia" * contains diagrams of all of the following heating systems when used with the Cochrane exhaust-outlet valves and feed-water heaters:

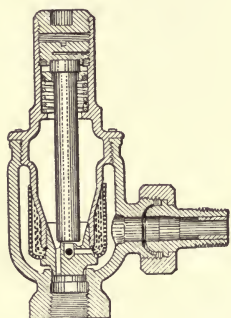

FIG. 201.—Webster Thermostatic Valve.

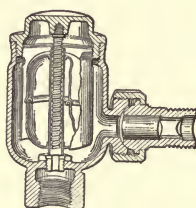

FIG. 202.—Webster Water Seal Motor.

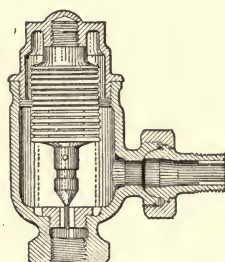

FIG. 203.—Webster Syphon Thermotor.

Armak, Broomell, Crescent, Cryer, Dexter, Dunham, Eddy, Haines, Illinois Engineering Co., Kieley, Kinealy, Kriebel, Moline, Monash, Morehead, Morgan-Clark, Paul, Positive Differential, Reliable (Bishop-Babcock-Becker), Rochester, Simonds, Sparks, Sure-Seal, Thermograde, Trane, Van Auken, Webster.

Three of these diagrams of the Kinealy, Monash, and Positive Differential systems are reproduced at a reduced size on the following pages.

Fig. 204. *Kinealy Vacuum Heating System.*—Exhaust steam is admitted to the system, from the stack of the open feed-water

* Published by the Harrison Safety Boiler Works, Philadelphia, Pa.

system, or live steam is admitted directly through the live steam regulating valve. Each radiator is equipped with a hand control inlet valve and an impulse check outlet valve. The differential controlling valves in the vacuum lines are for close regulation. The vacuum pump discharges the water of

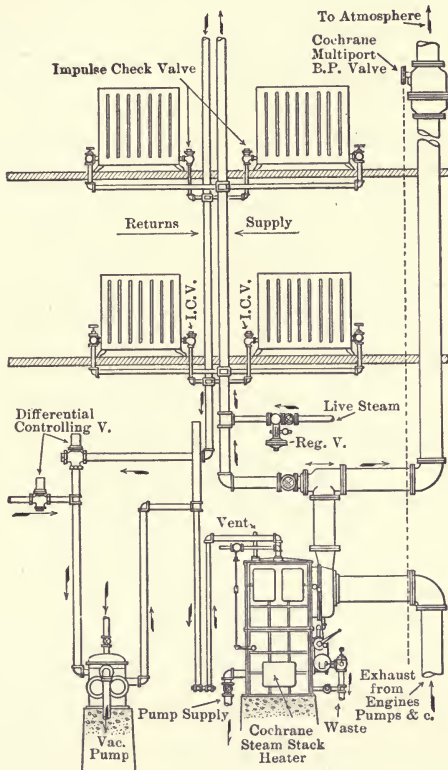

FIG. 204.—Kinealy Vacuum Heating System.

condensation through a water siphon seal to the feed-water heater. This discharge is vented to allow the air to escape.

Fig. 205. *Monash Vacuum Heating System*.—Hand control inlet valves and Monash noiseless vacuum valves are used on the radiators. A vacuum pump equipped with pump governor returns the water of condensation to the heater and the air to the atmosphere.

Fig. 206. *Positive Differential Heating System*.—Live steam is admitted through a regulating valve to either or both halves of the system. Radiators equipped with thermograde graduating control valves and radiator trap valves, allow the water

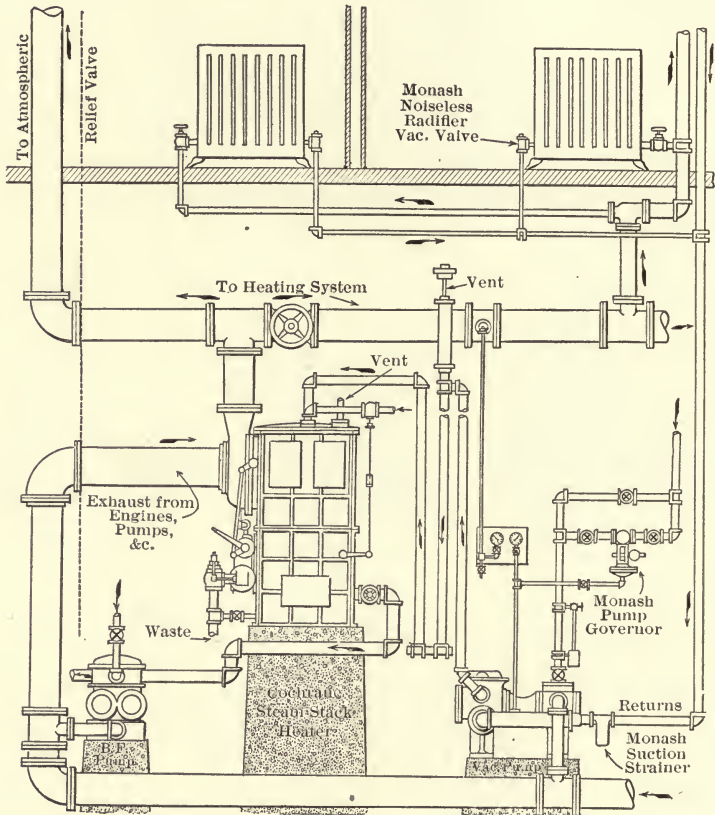

FIG. 205.—Monash Vacuum Heating System.

and air to flow into the return pipes which drain into the feed-water heater, while the air is vented to the atmosphere.

137. **The Paul System**, which is now in extensive use for heating large buildings, differs in construction and in principle of operation from those described, in that, instead of using a large air or vacuum pump which is connected to the return

of all the radiators so as to cause circulation of steam through the radiator, it employs a small jet-pump called an *exhauster*, which can be operated either by water or steam under pressure, and which is connected to a pipe-fitting in communication with a series of exhaust- or air-pipes, each leading to a

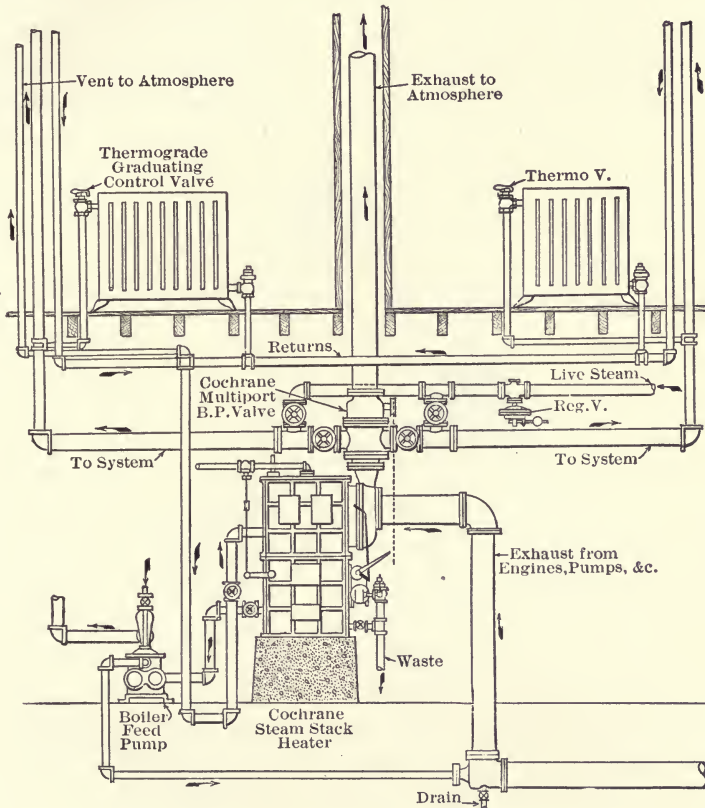

FIG. 206.—Thermograde Positive Differential Heating System.

thermostatic air-valve attached to each radiator. The thermostatic air-valve is constructed on the same principle as that shown in Fig. 87, and will close at the temperature of the steam so that it will discharge air only. A simple diagram showing the essential elements of the Paul system is shown in Fig. 207, opposite, as applied to heating with

exhaust-steam taken from an open exhaust-pipe. In the lower right-hand corner is shown an elevation of the engine cylinder and its exhaust-pipe, which may or may not be provided with a back-pressure valve near the point of discharge into the air. From the exhaust-pipe branches lead off for supplying each radiator with steam in the usual manner. The lower radiator, being supplied with a separate return, illustrates the application of the system to a two-pipe job, while the upper radiator illustrates the application to a one-pipe system of heating. Returns from all the radiators and drips from

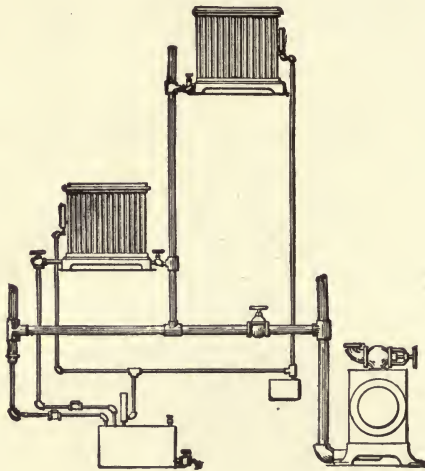

FIG. 207.—Paul System.

the pipe-lines connect with a tank or receiver shown in the lower centre part of the diagram. This receiver serves as a receptacle for hot water, which may be pumped out for further use or wasted as may be desired, and is usually connected to the atmosphere by a pipe-line provided with a check-valve opening inward so as to prevent a vacuum. In the diagram, however, the receiver is a closed tank from which the air may be removed by the exhauster. The *exhauster* is indicated in the diagram by a small rectangle near the engine cylinder, and is connected to the pipes leading to the discharge side of the thermostatic air-valves which are located

on each radiator and on the receiver. These valves open when the temperature is less than that of the steam and permit the flow of air from the radiator into the exhauster, whence it is discharged. Under ordinary conditions the vacuum produced by the exhauster would extend only to the discharge orifice of the thermostatic valve; but if the supply of steam is restricted and the discharge from the returns sealed, the vacuum may extend into the radiators and through the entire heating system to the engine.

In the practical erection of the Paul system for large buildings the arrangement of pipe is generally similar to that shown for the Williames system, except that it is applicable to either a one- or two-pipe system of heating and is usually such that the exhaust steam first passes through a feed-water heater so constructed that the water to be warmed flows through a coil of pipes surrounded by the exhaust-steam. This is for the purpose of warming the boiler feed-water without contaminating it with grease and oil. The exhaust-steam, after separation of the water of condensation and oil, flows to the top of the building, from whence it is conveyed to the various radiators and heating-coils as in the system described. The system is so arranged that live steam can be used if desired.

The advantages of the Paul system depend principally upon the quick removal of air from the various radiators and pipes, which constitutes the principal obstruction to circulation.

138. The Johnson System of Hermetic Heating, designed by W. S. Johnson of Milwaukee, consists of an air-valve attached to a radiator which is constructed in such a manner that when the air is once forced out it cannot return. In this case the air-valve and also the supply-valve are operated by pneumatic pressure controlled by a thermostat located at any convenient point in the room, as in the Johnson system of temperature regulation. It is intended to be used in connection with the Johnson system of heat regulation, and is arranged to produce any desired vacuum, by condensation, and consequently any desired temperature in the radiator to which it is attached.

The Van Auken system of circulation is similar to the

Paul system as already described, in that it has an exhausting device attached to a thermostatic air-valve in essentially the same manner. The thermostatic movement, however, is regulated by change of temperature in the room and operates both admission- and air-valve for each radiator, as in the Johnson system. The air-valve is so constructed that it admits air to the radiator when the temperature of the room is too high and discharges it through the exhauster when the temperature is too low, thus controlling the temperature by varying the amount of air in the radiator.

139. Combined High- and Low-pressure Heating-systems.—In nearly all systems of heating with exhaust steam it is necessary to arrange the piping so that at times live steam may be admitted in any amount required.

In some instances high-pressure steam is carried in the boiler and may possibly be used in a few radiators, while the principal part of the building is heated with low-pressure steam which is drawn directly from the boiler, and is reduced in pressure by passing through a reducing-valve. In this case the return-water of condensation passes to a tank or chamber at the lowest portion of the system, and is fed into the boiler by means of a return-trap or steam-pump. The principal elements of such a system are shown in Fig. 208, as designed by the Albany Steam Trap Company, and forms a useful illustration of the method of piping essential. To start the pump automatically and to keep it moving at the proper speed a pump-governor is used.

140. Pump-governors.—In non-gravity systems of heating the water of condensation is returned to the boiler by return traps, as described in Chapter IX, or by steam-pumps. The trap is automatic, and when in good order will operate without attention, but the ordinary steam-pump needs to be started and stopped, as required. To render the pump automatic a device termed a *pump-governor* is often employed. Many forms are used, but they consist in nearly every case of a tank containing a float or equivalent device, connecting with levers to the valve which admits steam for

operating the pump. The tank is connected to the suction and located above the pump. When the tank is full of water, the steam-pump is put in operation by the rising of the float,

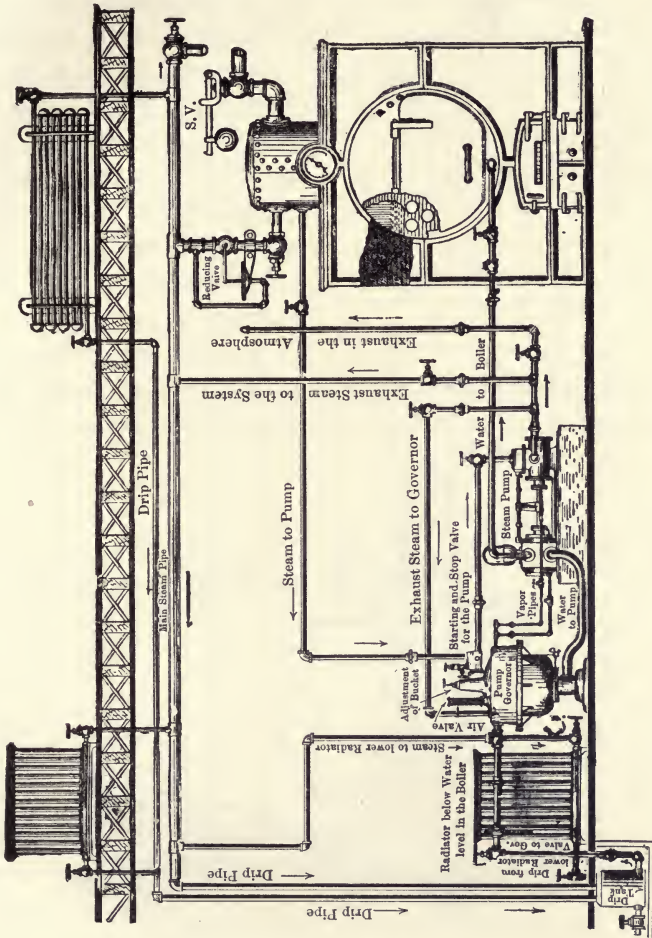

FIG. 208.—Combined High- and Low-pressure Heating-system.

which opens the steam-valve. When the tank is empty, the float falls, closing the steam-valve and thus stopping the pump.

A pump-governor consisting of a float-trap with outside connections to a steam-valve, as described by F. Barron,* is shown in Fig. 209.

* *Heating and Ventilation*, March, 1894.

A steam-pump with attached governor is shown partly in section, Fig. 210. In this case the float is of the bucket form,

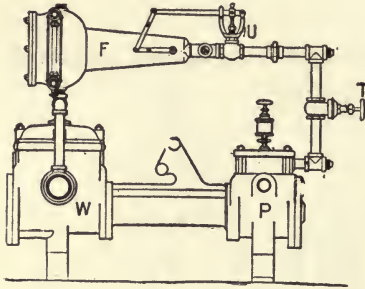

FIG. 209.—Pump-governor with Outside Levers.

the valve for supplying steam to the pump is flat with a single port, and is connected by an internal lever to the bucket in such a manner that when the tank is filled the valve will be opened and the pump will operate, and when the tank is empty the valve will be closed, and the pump will stop.

The pump-governors are frequently set some little distance from the pump, but attached in every case so as to produce the results described.

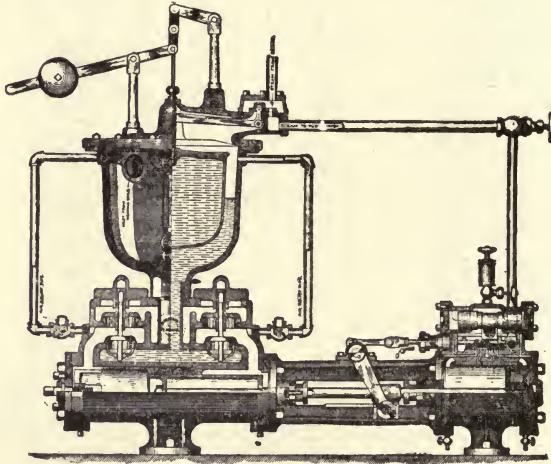

FIG. 210.—Internal Connected Pump-governor.

141. The Steam-loop.—A device which has been used quite extensively for returning water of condensation to the boiler when the pressure has been reduced only a few pounds is called a steam-loop, the construction and principle of operation of which, as described by Walter C. Kerr, is as follows:

The figure shows the loop returning the water from a separator, attached to an engine-main, to a boiler above the separator level. "From the separator drain leads the pipe called the 'riser,' which at a suitable height empties into the horizontal. This runs back to the drop-leg, connecting to the boiler anywhere under the water-line. The riser, horizontal, and drop-leg, form the loop, and usually consist of pipes varying in size from three-quarters of an inch to two inches, and are wholly free from valves, the loop being simply an open pipe, giving free communication from separator to boiler. (Stop and check-valves are inserted for convenience, but take no part in the loop's action.)" Supposing, for example, the boiler-

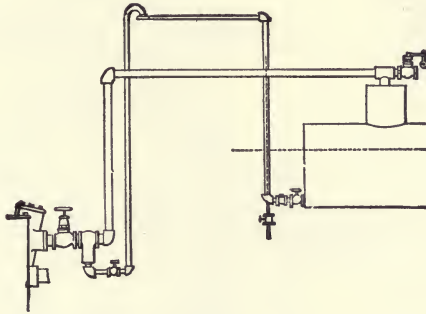

FIG. 211.—The Steam Loop.

pressure to be 100 pounds and the pressure at the separator reduced to 95. "The pressure of 95 pounds at the separator extends (with even further reduction) back through the loop, but in the drop-leg meets a column of water (indicated by the broken line) which has risen from the boiler, where the pressure is 100 pounds, to a height of about 11 feet, that is, to the hydrostatic head equivalent to the 5 pounds difference in pressure. Thus the system is placed in equilibrium. Now the steam in the horizontal condenses, lowering slightly the pressure to 94 pounds, and the column in the drop-leg rises 2.3 feet to balance it; but meanwhile the riser contains a column of mixed vapor, spray, and water, which also tends to rise to supply the horizontal, as its steam condenses, and being lighter than the

solid water of the drop-leg it rises much faster. By this process the riser will empty its contents into the horizontal, whence there is a free run to the drop-leg and thence to the boiler."

142. Reducing-valves.—The reducing-valve is a throttling-valve arranged to be operated automatically so as to reduce the pressure and also to maintain a constant pressure on the steam-mains. A great many forms of these valves are in

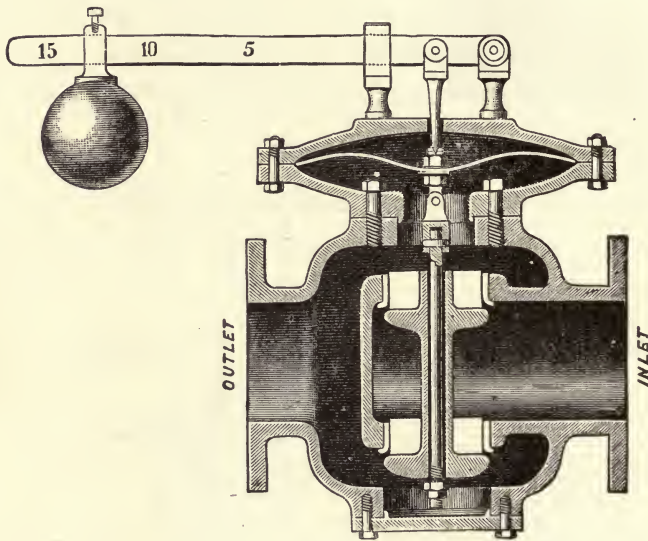

FIG. 212.—Holt's Reducing-valve.

common use. In one a diaphragm of metal or rubber is employed, as in Fig. 212. The low-pressure steam acts on one side of the diaphragm, a weight or spring which may be set at any desired pressure on the other side. This diaphragm is connected with a balanced valve which is moved to or from its seat as less or more steam is required to preserve constant pressure. Since the pressure in the main steam-pipe does not effect the motion of the valve, its position will depend upon the pressure on the two sides of the diaphragm. The pressure on one side is that due to the steam which has passed through

the valve, and that on the other to a weight or spring which can be set at any desired point.

Another form of reducing-valve with differential piston and diaphragm is shown in Fig. 213, and is described as follows:

Steam from the boiler enters at side "steam inlet" and, passing through the auxiliary valve *K*, which is held open by the tension of the spring *S*, passes down the port marked "from auxiliary to cylinder," underneath the differential piston *D*. By raising this piston *D* the valve *C* is opened against the initial pressure, since the area of *C* is only one-half of that of *D*. Steam is thus admitted to the low-pressure side, and also passes up the port *XX* underneath the phosphor-bronze diaphragm *OO*. When the low pressure in the system has risen to the required point, which is determined by the tension of the spring *S*, the diaphragm is forced upward by the steam in the chamber, the valve *K* closes, no more steam is admitted under the piston *D*. The valve *C* is forced onto its seat by the initial pressure, thus shutting off steam from the low-pressure side. This action is repeated as often as the low pressure drops below the required amount. The piston *D* is fitted with a dash-pot *E*, which prevents chattering or pounding. In another style of construction a piston acted on by the low-pressure steam serves to open or close a balanced valve an amount sufficient to maintain the steam-pressure constant.

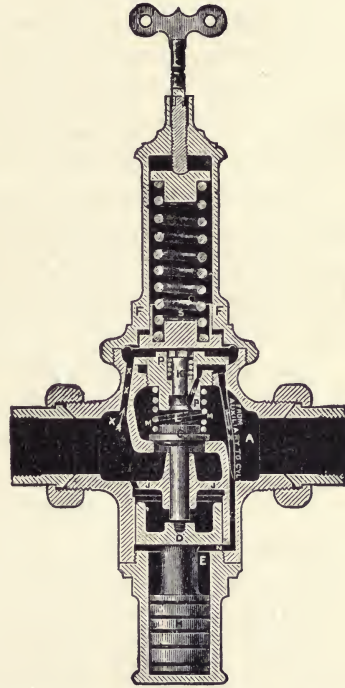

FIG. 213.—Mason's Reducing-valve.

143. Transmission of Steam Long Distances.—It is frequently necessary to transmit steam long distances under-

ground, and in many cases this method gives better financial returns than the construction and operation of a large number of small and isolated plants. A number of plants, in which steam has been conveyed long distances in pipes laid underground, have been constructed for the purpose of heating portions of cities, and also various buildings belonging to the same public institution.

In the heating of various buildings which belong to the same public institution this system of heating has proved a great improvement in many respects over that of separate heating-plants, although it is doubtful if in a single case it has ever resulted in the lessening of expense for fuel.

The three important requisites in the construction of such plants are, first, a removal of all surface-water so that it cannot possibly come in contact with the steam-pipe; second, provision for taking up expansion of pipe and keeping it in proper alignment; and, third, insulation of the pipe from heat losses.

The first condition, which is the most important of all, is also the most likely to be overlooked, and many failures to secure economic transmission have been caused by allowing the surface-water to come in contact with the heated pipes. This water can be removed by the construction of a drain beneath or by the side of the pipe-system, provided with proper outlets. A perfect drainage-system for the soil is in every case an essential requisite for success.

Provision for expansion may be made by the use of expansion-joints, or by the use of elbows and right-angled offsets arranged to partly turn as the line expands. The writer has had experience with various forms of these joints, and found nothing equal to the straight expansion-joint, Fig. 108, which should, however, be constructed so that it cannot by any possible accident be pulled apart; this may be done either by use of an internal lug or external brace. These joints should be thoroughly anchored, so that they will stay in position, and should be placed sufficiently close together to take up all expansion without strain on the pipe-line. If the ordinary slip-joints are used, they will need to be placed at distances of about 120 feet apart.

The pipe between the joints should rest on rollers or connecting hangers which permit its free motion. If elbows and offsets are employed to take up expansion, there will be an abrupt change in grade, and if any part dips below the main steam-line it should be drained by a pipe connecting to a trap or to the return. If bends convex upward are necessary, means must be provided for removing the air.

In general, in systems where the steam is transmitted long distances the best results will be possible only when the boiler-plant can be located on lower ground than the buildings to be heated, so that the water of condensation may be returned by gravity. This cannot always be done, and in many cases it will only be possible to return the water of condensation by a pump located in one of the buildings to be heated, and regulated by a pump-governor. This in some cases may involve more expense than will be warranted by the saving due to returning the water of condensation.

144. Pipe Sizes for Vacuum Steam Heating Systems.—

Since the amount of radiating surface is usually based on the heat required for zero weather out of doors, radiators for either vacuum or atmospheric steam heating system should be at least as large as required for gravity steam heating.

The main supply pipes for vacuum pipes are the same as those for the equivalent gravity steam heating installations. The branch supply pipes are practically one-half the diameter of those for the ordinary two-pipe steam system. The branch and the main return pipes are about $\frac{3}{4}$ the diameter of the return pipes of the two-pipe steam system.

All the supply pipes for the modulation atmospheric steam heating systems should be sized liberally to prevent sensible loss of pressure except at the hand or automatic regulating valves at the radiator inlets.

CHAPTER XII.

HOT WATER HEATING SYSTEMS.

145. In the *gravity circulating system*, the water is caused to flow by the difference in density of the heated water from the boiler and the return water from the radiators. In the *forced circulating systems*, the circulation is assisted by pumps, steam jets or air lifts, etc., which are sometimes only used in severe weather or used in a part of the heating system where difficult conditions are to be overcome.

In Chapter X, the general question of the amount of heat and radiating surface required for hot-water heating is taken up as being inseparable from that for steam heating.

146. Methods of Piping Used in Hot-water Heating.—

A system of hot-water heating should present a perfect system of circulation from the heater to the radiating surface and thence back to the heater through the returns, an expansion-tank being provided, as explained, to prevent excessive pressure due to the heating and the consequent expansion of the water. The direct-circuit system, as described for steam-heating, Fig. 189, is well adapted for hot-water heating, and has been used to a limited extent. When this system is employed for hot-water heating two connections are usually taken off from the return riser at different levels for each radiator, as shown in Fig. 223, although in some cases a single connection is made and a radiator of ordinary form employed, otherwise the method of piping is exactly similar to that described for steam-heating.

The system of piping ordinarily employed for hot-water heating is illustrated in Fig. 214. In this system the mains and distributing pipe have an inclination upward from the heater; the returns are parallel to the main and have an inclina-

tion downward toward the heater, connecting at its lowest part. The flow-pipes are taken from the top of the main and supply one or more radiators. The return-risers are connected

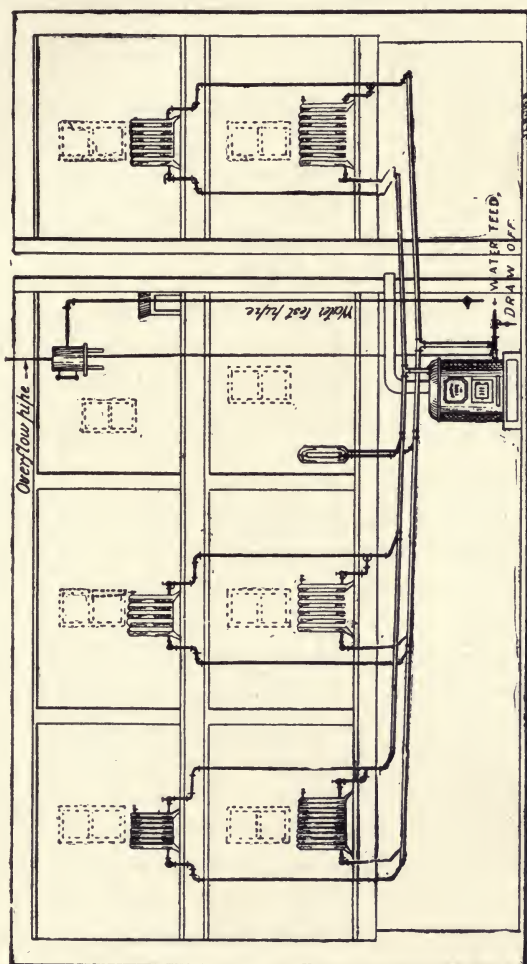

FIG. 214.—System of Piping for Hot-water Heating—Main Flow- and Return-pipes in the Basement.

with the return-pipe in a similar manner. In this system great care must be taken to produce nearly equal resistance to flow in all the branches leading to the different radiators. It will be found that invariably the principal current of heated water will take the path of least resistance, and that a small obstruc-

tion, any irregularity in piping, etc., is sufficient to make very great differences in the amount of heat received in different parts of the same system. For instance, two branch pipes connected at opposite ends of a tee, which itself is connected by a centre opening to a riser, are almost certain to have an irregular and uncertain circulation.

The method of piping generally adopted for the closed or high-pressure system is that of the complete-circuit or one-pipe system, as illustrated in Fig. 189. This system when now employed is used only for moderately low pressures, and a safety-valve is provided on the expansion-tank to prevent excessive pressure. In this system, or, in fact, in any of the systems for hot-water heating, the level of the return-pipe can be carried below that of the heater without bad results. The method of applying this system is shown in Fig. 215, which is similar in many respects to that used in the Baker system of car-heating.

The expansion-tank must in every case be connected to a line of piping which cannot by any possible means be shut off from the boiler. It does not seem to be a matter of importance whether it is connected with the main flow or with the return.

Single-pipe systems for hot-water heating have been used to some extent. In this case there is a gradual flow of the heated water to the top, and the consequent settlement of the colder water to the bottom. The form of piping would be essentially the same as that shown in Fig. 189 or 190. Separate flow and return risers are used. The flow risers are connected to the top of the mains and the return risers to the bottom of the mains. Where the supply and return water have to flow in opposite directions in the same pipe, the horizontal length of the main cannot exceed about 12 feet. Usually, return mains are connected to the end of the flow mains so that the water currents are not opposed.

The writer erected such a system at one time as an experiment, and found that it worked well after the water had once become heated. Where there is no objection to a system which heats

slowly, this would probably do well on a small scale, but could not be recommended for an extensive job.

147. **Expansion-tank.**—An expansion-tank will be needed in hot-water heating systems. With increase of temperature

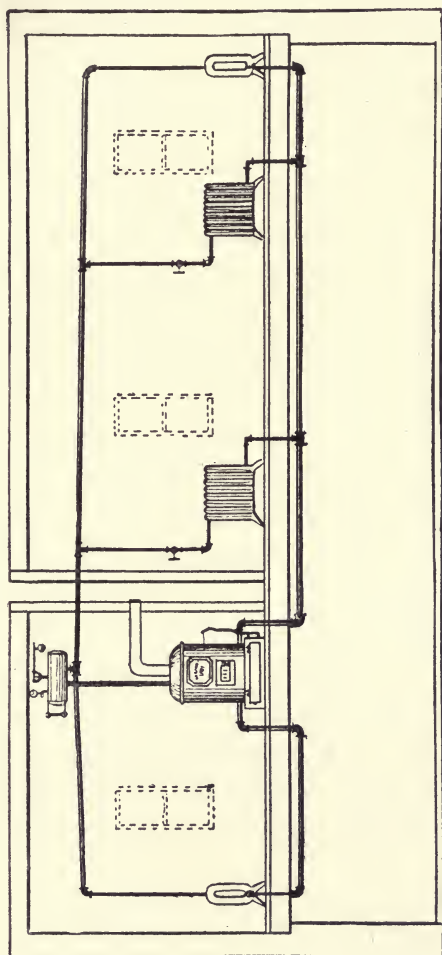

FIG. 215.—A Closed, or High Temperature, Hot-water Heating Apparatus, with Heater and Radiators on one Floor.

from 40° F. to the boiling-point, water expands 4.33 parts in 100, or over 4 per cent. The force of expansion is nearly irresistible, and the increase in volume due to it must be provided for, so as not to produce a dangerous pressure.

The method ordinarily adopted consists in the use of a vessel called an *expansion-tank*, whose cubical contents must be somewhat greater than one twentieth of the total cubical contents of heater, pipes, and radiators. It must be connected to the heating system in such a way as to receive the increase in volume, and should be placed on a level somewhat above that of the highest radiating surface.

If there is to be no sensible increase in pressure due to expansion the tank is connected with the outside air by a vent-pipe, and in this case the pressure inside will be atmospheric; the pressure on the heating system will depend on the distance from the water-level in the tank, each foot corresponding to 0.415 pound per square inch (2.41 feet being equivalent to one pound of pressure at 212° F.).

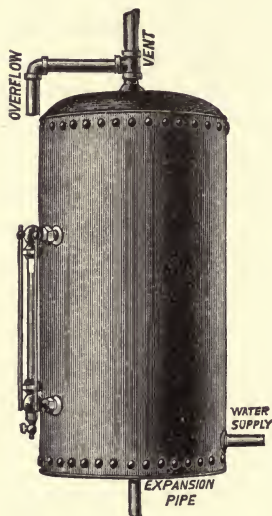

FIG. 216.—Expansion-tank.

148. **Closed Systems.**—In case a pressure in excess of the atmosphere is required, the vent pipe is closed and a safety-valve attached which will open when the pressure reaches the desired point. By increasing the pressure on the system the boiling temperature of the water will be much increased, and hence it will be possible to maintain a higher temperature throughout the system. As showing the increase in temperature of the boiling-point with excess of pressure, the following table is inserted.

Pressure systems of hot-water heating were used at one time to a considerable extent in England, under what was known as the Perkins * system, in which small pipes and exceedingly high pressures and temperatures were used. It has also been used to some extent in this country in the Baker system of car-heating.

* Hood's "Heating and Ventilating of Buildings."

The advantages of the pressure system are those which are due simply to the use of higher temperatures and smaller radiating surfaces; the disadvantages are the danger of an explosion which would be likely to happen were the safety-valve inoperative, or did any part of the apparatus give way. The sudden liberation of a considerable body of water having a temperature above the boiling-point would result in the instantaneous production of a large amount of steam, which might produce disastrous results.

Pressure.		Temperature of Boiling-point (degrees F.).
Pounds per Sq. In. above Atmosphere.	Equivalent Head, in Feet.	
0	0	212
5	12	228
10	24	240
15	37	250
20	49	259
25	61	267
30	74	274
35	87	280
40	100	287
45	113	292
50	125	297
55	137	302
60	151	307
70	177	316
80	205	324
90	230	332
100	257	338
125	324	352
150	393	365
175	463	378
200	534	388

With the open expansion-tank it seems hardly possible that any serious accidents could result even from the most careless management, since the escape of steam from the top of the expansion-tank would prevent the accumulation of pressure. To prevent accident the expansion-tank should be connected to the heater by a pipe protected from frost and without stop

or valve, so as to render it impossible to increase the pressure on the system by stoppage of the connection.

It is desirable to provide the expansion-tank with a glass water-gauge showing the depth of water, and a connection to the supply-pipe for adding water to the system. In case the expansion-tank occupies a cold location where it might freeze in extreme weather, a small pipe connected with the circulating system, in addition to those described, should be run to the tank and connected at a higher level than the expansion-pipe, so as to insure circulation of warm water.

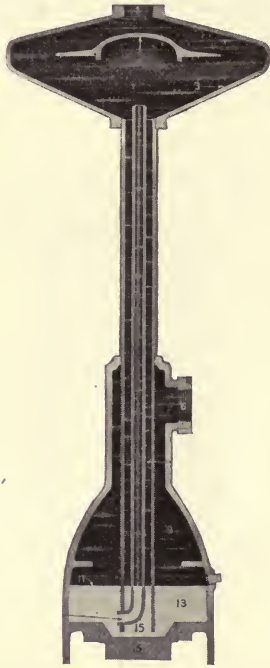

FIG. 217. — Illustrating position of Mercury and Water when Generator is Producing no Pressure.

149. The Honeywell Pressure System.—By the use of a mercury safety valve called a “Heat Generator,” located in the pipe connecting the expansion-tank with the rest of the hot-water heating system, they are enabled to use a hot-water pressure system, without any sacrifice of safety. The “Heat Generator” is essentially a safety-valve preventing any flow of water to the expansion-tank until a pressure of about ten pounds above atmospheric is reached, when any excess of pressure is relieved by forcing water through the mercury seal into the expansion-tank, which is open to the atmosphere. As the

mercury seal is provided with a large mercury chamber at the bottom of the escape tube, a drop in pressure of only one-half pound is sufficient to draw in water from the expansion-tank, thus preventing the formation of a vacuum in the system, which would cause the infiltration of air into the heating system. The device is so made as to prevent the mercury being either forced out into the expansion pipe or sucked back into

the heating system. The accompanying cut shows the "Generator" in cross-section.

150. Accelerated Hot-water Systems are those in which the water in the risers is superheated, causing the liberation of steam bubbles as the water ascends and the head or pressure on the water is lessened. If injectors, pulsometers, or air lifts etc., are used, they fall under the head of pumped hot-water systems, only using another kind of pump.

Forced or pumped hot-water systems in which the circulation of the water is accelerated by pumping allow the use of smaller pipes. In an installation of this character the relative cost of the piping and the cost and upkeep of the pump are the commercial determining features. This system is especially adapted to installations where exhaust steam at less than atmospheric pressure is available for heating purposes. The heating water is circulated through the tubes of a surface condenser or a closed heater and a partial vacuum maintained except in severe weather.

Centrifugal or rotary pumps are usually employed. The centrifugal pumps will not build up an excessive pressure in case the mains should be shut off, and will have a fair efficiency under these conditions.

Compute the pipe sizes from either the amount of radiating surface or the heat required, by computing the volume of water for each main for the assumed temperature drop (30 degrees). Then assume some velocity of flow and check the total friction heads for each path of the water all of which should be nearly equal. Allow for the difference in densities in the risers.

All mains should have gate valves for close adjustment of the relative flow.

151. Hot-water Circulation Systems.—There are several systems in use in which hot water after being heated by exhaust-steam is circulated by pumps or otherwise through the various radiators and heating-coils. Of these systems that of Evans & Almirall is in most extensive use, of which one form is shown in the diagram, Fig. 218. As illustrated, the exhaust-steam from the engines *CC* and pump *B* passes through the heater

shown at *A*, where it is in part condensed and the remainder discharged through the open exhaust-pipe *B*. The exhaust-

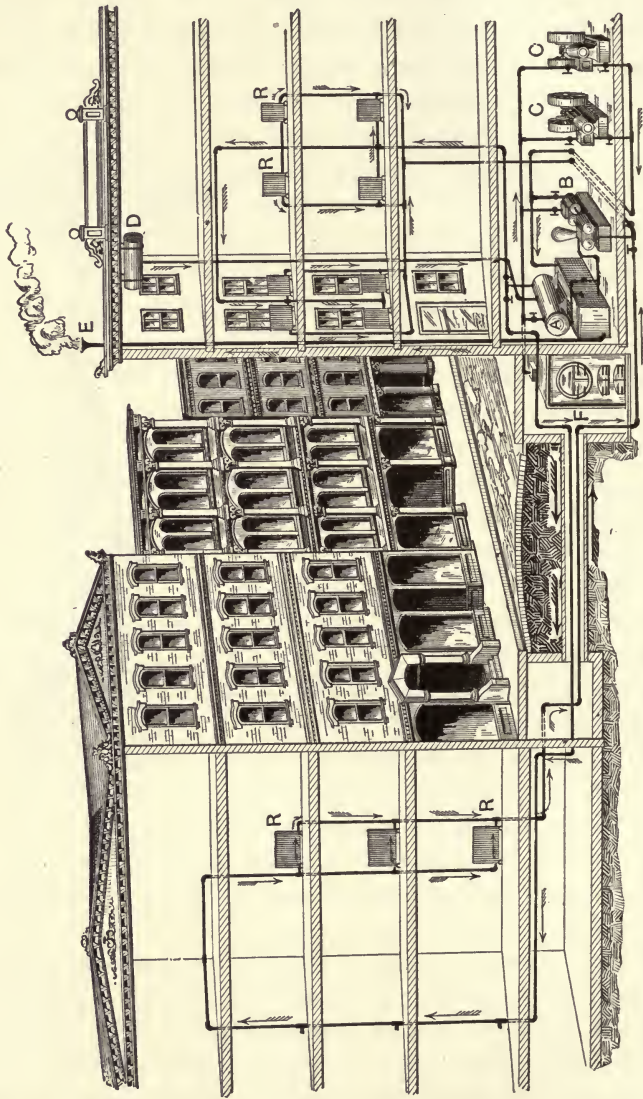

FIG. 218.—Evans & Almirall System.

steam in this heater surrounds brass or copper coils through which the water flows, thereby taking up heat from the steam.

The water after being warmed in the heater *A* is circulated by the pump *B* (which is represented here as a piston-pump, but is usually of the centrifugal or rotary type) through the various pipes and radiators *RR* constituting the heating system. The pump simply performs the work of circulating the water at the required velocity and overcoming the friction, as the pressure on both suction and delivery sides is otherwise the same. By means of the pump any desired velocity can be attained with a corresponding regulation of the temperature.

An auxiliary live-steam heater is shown at *D*, which is provided with a coil through which the live steam can pass, and is arranged so that the water can be circulated through it as needed to supplement the exhaust-steam heater. In some instances an *economizer* or heater in the smoke-flue is employed alone or in connection with the other heaters. This system is particularly well adapted for the warming of buildings without causing excessive back-pressure on the engines, although they may be situated some distance from the supply of exhaust steam; it has been extensively employed for utilizing the exhaust steam of electric-light plants for warming buildings in connection with large institutions and in cities and villages.

The Yaryan system is essentially the same as the Evans & Almirall system. It seems to differ only in minor details of construction.

The Osborne system differs in that the exhaust steam is circulated to a heater located in the building to be warmed; no pump for circulating water is used; the transfer of heat from the exhaust steam causes a circulation of water through the heater and the heating system in much the same manner as in the ordinary systems of hot-water heating.

152. Pipe Connections, Hot-water Heating Systems.—The general arrangement of hot-water radiator piping is to have the supply and return pipes on opposite ends of the radiators. The supply may be either top or bottom, but the return is at the bottom. Both pipes may be at the same end, and provided the radiator is tapped large enough, both connections can be made at the same place by using a special valve or fitting.

If the system of circulation adopted is the complete-circuit system, as in Fig. 189, in which the heating main is first taken directly to the top of the building and thence run horizontally to the various lines of return risers, the system of construction would be essentially the same as that described for a steam-

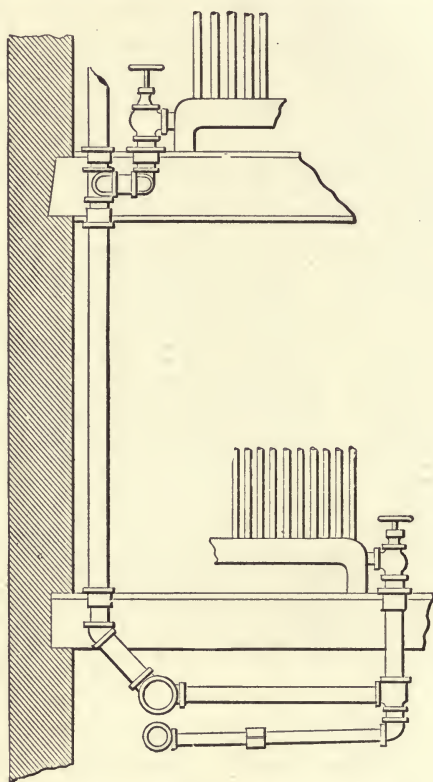

FIG. 219.—Connection of Radiator to Riser.

heating plant. The main riser should connect into a drum, from the top of which the distributing pipes leading to the return risers are taken. The size of the distributing pipes should be proportional to the amount of radiating surface, and the various distributing pipes should be arranged so that the resistance in each will be substantially equal. The flow connection for each radiator should be taken off at a point

about level with the top of the radiator, as in Fig. 223, and the return should enter the same pipe at a point below the radiator. A valve affording as little resistance as possible is to be put in each connection. Hot-water heating systems have been erected in which the radiators are joined to the riser by one connection only; and while this system seems to be somewhat slower in heating than that with two connections, it is otherwise quite satisfactory.

In the system commonly employed the main and distributing pipes are erected in the basement, as shown in Fig. 214. An offset from the main to the foot of the riser has usually to be made, which should be done as from the steam main in Fig. 193, and in such a manner as to take the flow from the upper

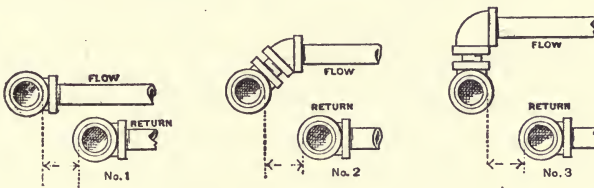

FIG. 220.—Connections to Mains, Hot-water Heating.

part of the pipe; such a connection is also shown in No. 3, Fig. 220. The connection to the main return may be made on the side or at the top, as convenient. In some instances a tee turned at an angle and a 45-degree elbow can be used with good results, as shown at No. 2, Fig. 220. The method of connecting shown at No. 1 should only be employed in case the room is not sufficiently high for connections, as shown at No. 3, as its use is attended with doubtful success in many cases.

In taking off branches from the top of a riser a tee should seldom or never be employed, since it will be found that if for any reason the current becomes established in one direction it will be very difficult to induce it to flow in the other. When branches running in opposite directions have to be taken from the main riser, long-radius tees, as shown in Fig. 63, should be employed; but unless the riser is long it will in gen-

eral be better to erect a separate line for each branch. Precautions should be taken in every case that the junction of two currents shall not exert an opposing force which will impede the circulation.

The connections to radiators for this system need to be made in such a way that the horizontal branches which are taken off from the risers will receive a strong current of water. There is a tendency for water to flow directly in the line of motion, and to the highest radiators in the system. This renders it necessary to increase the resistance in the riser beyond the branch a greater or less amount in order to induce circulation into the side connections. This may be done in

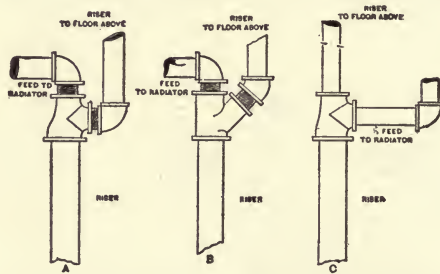

FIG. 221.—Connection to Radiators, Hot-water Heating.

several ways, as shown below: (1) by connecting the radiator to an elbow placed on the main pipe and continuing the main pipe from the side opening of a tee or Y, as shown at *A* and *B*; or (2) by using a reducing fitting, as shown at *C*, and continuing the riser with a reduced diameter. The return connections can be made in a similar manner, but they will in every case work well if the return riser be run in a direct line and the connection be made into the side opening of a Y.

153. Position of Valves in Pipes.—If a valve has to be used on a horizontal pipe it should be located so as to afford the least possible obstruction to the flow of water in the required direction. If a globe valve be used with the stem set vertically, Fig. 222, it will form an obstruction sufficient to fill the pipe nearly full of water; if the stem be placed in a horizontal

direction the flow of water will be less impeded. Globe valves form a great obstruction to the flow in water-heating pipes, and under no circumstances should they be used for that work. In the case of steam-heating they are less objectionable, provided

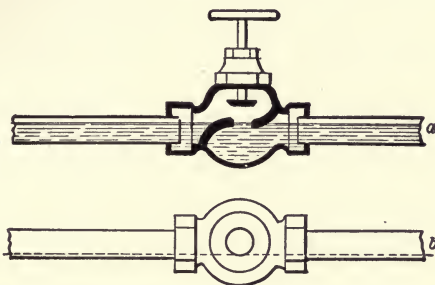

FIG. 222.—Illustration of Water Held by Globe Valve.

they are located in such a manner as to permit free drainage of the pipes. In general, angle or gate valves can be used, however, in every place with better satisfaction.

For hot-water heating special valves have been designed, which when open offer no special impediment to the flow, and which close sufficiently tight to prevent circulation, although not sufficient to prevent leaks.

154. Size of Pipes for Hot-water Radiators.—Method of computation of the velocity with which circulation will take place in a hot-water heating system without friction has been considered in Chapter IV. In some instances this velocity is increased by bubbles or particles of steam which pass up the main risers and reduce the specific gravity of the water in the ascending pipes to such an extent that the actual velocity produced is much in excess of what would have been possible had no steam formed. This condition is usually undesirable, as it is often accompanied with more or less noise, but several rapid-circulating systems have

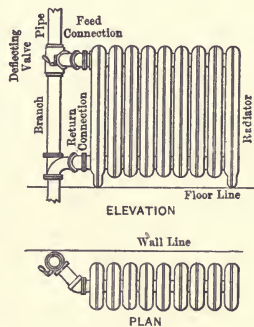

FIG. 223.—Radiators with Top and Bottom Connections.

recently been designed to allow the generation of a small quantity of steam. It should not be recommended that heaters be run in such manner as to produce steam in any part unless so designed.

The heat which is given off from radiating surfaces of various kinds has already been considered and as each thermal unit given off by the surface is obtained by the cooling of one pound of water one degree in temperature, it is easy to compute from the data given (1) the weight of water required, and (2) the number of cubic feet needed to heat each square foot of radiating surface.

The following table gives the data necessary for computing the volume of water required to supply radiating surface for various conditions likely to occur in heating:

HOT-WATER HEATING.

DATA USED IN COMPUTATION OF TABLES.

Temperature outside air.....	0	0	0	0	0
Temperature water in radiator.....	140	160	180	200	220
Heat-units per degree diff. temperature per square foot per hour.....	1.4	1.45	1.5	1.6	1.8
Weight of cu. ft. water, pounds.....	61.37	60.98	60.55	60.07	59.64
Total heat-units per square foot per hour:					
Room 60°.....	113	145	180	224	288
" 70°.....	98	130	165	208	270
<i>Cubic feet of water required to supply one square foot per hour.</i>					
Radiator cooled 5°—Room 70°.....	0.316	0.426	0.546	0.686	0.902
" " " 60°.....	0.396	0.472	0.592	0.740	0.970
Radiator cooled 10°— " 70°.....	0.158	0.213	0.273	0.343	0.451
" " " 60°.....	0.183	0.236	0.296	0.37	0.483
Radiator cooled 15°— " 70°.....	0.138	0.142	0.182	0.228	0.339
" " " 60°.....	0.132	0.157	0.131	0.247	0.361
Radiator cooled 20°— " 70°.....	0.079	0.107	0.137	0.172	0.226
" " " 60°.....	0.091	0.118	0.148	0.175	0.241

By dividing the number of cubic feet to be supplied per hour by the velocity with which the water moves per hour we obtain the area of the pipe in square feet.

The general case from which practical tables may be computed can best be considered by the use of formulæ, as follows:

Let w equal the weight of water per cubic foot, let H equal total heat per square foot per hour from radiator, R total radiating surface, Q number of cubic feet of water per hour, A area of pipe in square feet, a area of pipe in square inches, v velocity in feet per second as given in table, page 127, V equal velocity in feet per hour, T loss of temperature of water in radiator. We have the following formulæ:

$$(1) \quad a = 144A.$$

$$(2) \quad V = 3600v$$

$$(3) \quad \frac{HR}{wT} = Q \left\{ \begin{array}{l} \text{Total heat divided by heat given off by 1} \\ \text{cu.ft. equals total number of cubic feet.} \end{array} \right.$$

$$(4) \quad \frac{Q}{V} = \frac{Q}{3600v} = A = \frac{a}{144}. \quad \text{From which}$$

$$(5) \quad Q = 25av. \quad \text{Equate (3) and (5), and}$$

$$(6) \quad R = \frac{25avwT}{H}$$

$$(7) \quad a = \frac{HR}{25wvT}$$

By taking special values corresponding to temperatures of water and of surrounding air we can reduce these formulæ to simple forms. Thus, if the temperature of the radiator is 180° and of the room 70° , the total heat-units given off per hour, H , will be 165. If we further assume that the water in the radiator cools during the circulation a certain amount, say 10 degrees, T will equal 10, weight of water w will equal 60.5 pounds and we shall have formulæ 8 and 9:

$$(8) \quad R = 92av$$

$$(9) \quad a = \frac{R}{92v}$$

For the above condition the radiating surface is equal to 92 times the area of the main pipe in square inches times the velocity of the water in feet per second; and further, the area in square inches is equal to the radiating surface divided by 92 times the velocity. The velocity in feet per second will depend upon the height, the difference of temperature, and amount of friction.

The following table gives relations of radiating surfaces to areas of main pipes, friction neglected. For distances less than 200 ft. sufficient allowance for friction will be made by making the main one size larger than required by table:

AREA AND DIAMETER OF HOT-WATER HEATING-MAIN, DIRECT RADIATION.*

DIFFERENCE OF TEMPERATURE, 10 DEGREES.

(1) Height, Feet.	(2) Velocity Water Feet per Second.	(3) Multiply each 100 Square Feet Radiating Surface for Area Main by	(4) Multiply Square Root Radiating Surface for Diameter by	(5) Equivalent Head in Feet.
1	0.335	3.26	0.205	0.0015
5	0.750	1.45	0.133	0.0081
10	1.06	1.03	0.113	0.017
15	1.28	0.85	0.104	0.025
20	1.5	0.723	0.095	0.035
25	1.67	0.65	0.091	0.044
30	1.83	0.595	0.087	0.052
40	2.12	0.513	0.081	0.072
50	2.37	0.46	0.076	0.088
60	2.59	0.42	0.072	0.105
80	3.00	0.362	0.068	0.142
100	3.35	0.324	0.064	0.176

* As illustrating the use of the table, compute the area of main pipe needed to supply 350 square feet of direct radiation situated 25 feet above the heater. The area is obtained by multiplying 3.5 by 0.65, which will equal 2.28 square inches. The diameter can be found from this, or it may be obtained from column (4), by multiplying the square root of 350 by 0.091. The square root of 350 is 18.7, the product is 1.7. The pipe used, if the distance is about 200 feet, should be 2½ inches in diameter.

In the above table column (1) gives the height in feet; column (2) the velocity corresponding to the head for a reduction in temperature of 10° F.; column (3) is the area in square inches, neglecting friction, for each 100 square feet of radiating surface; column (4) is the corresponding diameter of pipe required for each square foot of surface, and is to be multiplied by the number of square feet of radiating surface to give the diameter for any given case; the actual diameter should be one

pipe size greater; column (5) is the equivalent head which would produce the same velocity if falling freely in the air.

The preceding table is in the same form as that given for diameters of steam-main. If we consider 10 feet as the average height or head producing circulation for the first floor, it will be seen that we shall need, neglecting friction, one square inch in area in our main pipe for each 100 square feet of radiation, or the diameter of our pipe would be found for this case as equal approximately to $\frac{1}{3}$ of the square root of the radiating surface in square feet.

If the temperature of the water be supposed to change 20° in passing through the radiators, the required area of the main would be one-half of that given by the table; if 15° , two-thirds, etc.

In hot-water heating the *return-pipe must have the same diameter as the supply-pipe*, since there is no sensible change in bulk between the hot and cold water.

We may take as a practical rule, applicable when less than 200 feet in length: *The diameter of main supply- or return-pipe in a system of direct hot-water heating should be one pipe-size greater than the square root of the number of square feet of radiating surface divided by 9 for the first story, by 10 for the second story, and by 11 for the third story of a building; for indirect hot-water heating multiply above results by 1.5.*

The table given for commercial sizes of steam-mains in a single-pipe system of heating applies with accuracy to systems of hot-water heating and is easily and quickly applied. The table is to be used as explained for steam-heating.

155. Combination Systems of Heating.—Several methods have been devised for using the same system of piping alternately for steam or hot water as the demand for higher or lower temperature might change. The object of this is to secure the advantages which pertain to the hot-water system of heating for moderate temperature and to steam-heating for extremely cold weather. As less radiating surface is required for steam-heating, there is the advantage due to reduction in first cost.

The combination system of hot-water and steam heating must require, first, a heater or boiler which will answer for either purpose; second, the construction of a system of piping which will permit the circulation of either steam or hot water; third, the use of radiators which are adapted to both kinds of heating.

These requirements will be met in the best manner by using a steam-boiler provided with all the fittings required for steam-heating, but the addition of an expansion-tank is required, which must be arranged so that it can be closed off when the system is required for steam-heating.

Of the different systems of piping, that designated as the complete-circuit or one-pipe system (Fig. 189) is the only one which is equally well adapted for both hot water and steam. In case that system cannot be conveniently installed, the one shown in Fig. 214 for hot water will be found to give fairly good results, it being objectionable in steam-heating only because of the fact that the condensation in the main pipe flows against the current. The radiators and connecting pipes should be of the form required for hot-water heating, but the proportions and dimensions the same as for steam-heating.

While this system has many advantages in the way of cost over the complete hot-water system, yet the labor of changing from steam to hot water will in some cases be troublesome, and should the connections to the expansion-tank not be opened, serious results would certainly follow.

A combination hot-air furnace and hot-water system has been employed to considerable extent. In such a case the water-heating surface is obtained by inserting a coil of pipe or suitable vessel into the hot-air furnace, and certain rooms and portions of the house are warmed by the heated air directly from the furnace, while other parts are heated by the circulation of hot water.

This system is an admirable one from every point of consideration, theoretically; but practically it is a very difficult one to design and construct in such a manner that the supply of heat to the different rooms shall be positive and well dis-

tributed. Fig. 224 shows the arrangement of such a system. In this case the hot-air furnace supplies heat to the lower floor and the hot-water circulating system to the upper floor.

Any system of piping suitable for hot-water heating can be employed for this purpose: the one shown is that of the complete-circuit or one-pipe system, the heated water being taken directly to the top of the building and all radiating surface supplied by the descending current. As the writer knows from experience, it is very difficult indeed to proportion the

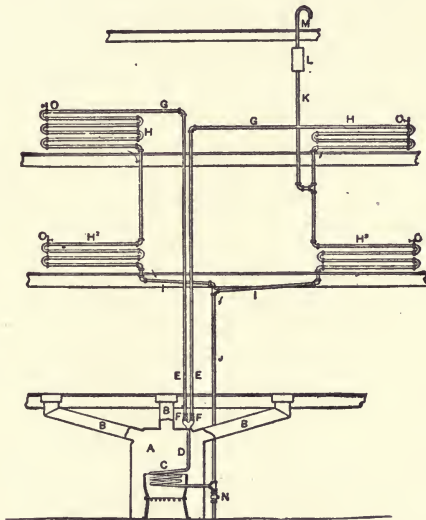

FIG. 224.—Combination System, Hot-air Furnace and Hot Water.

heating surface in the furnace and the radiating surface in the room so as to give in all cases satisfactory results without an irregular and uncertain distribution of heat. It will generally be found that the fire maintained in a hot-air furnace is much more intense than that in a steam or hot-water heater; and further, the heating surface which is usually employed is subjected to the full heat of the fire, consequently a smaller amount of heating in proportion to radiating surface must be employed. Whereas in the ordinary hot-water heater one foot of heating surface supplies from 8 to 10 of radiating surface,

in this system 1 foot of heating surface will supply 25 to 35 feet of radiating surface in coal-burning furnaces and 50 to 75 in wood-burning furnaces.

Similar combination systems of hot air and steam are also used, but in such cases the heater must be very much like a steam-boiler, and possess all its appliances and also storage capacity for steam. In the case of the hot-water and hot-air system the heater is substantially a hot-air furnace, to which is added a coil of pipe or vessel of suitable form, which serves as the heating surface for the hot water, so that the change in construction is very slight; but for steam-heating the change of construction must be more marked, and is likely to be more expensive and complicated.

CHAPTER XIII.

HEATING WITH HOT AIR.

156. General Principles.—The general laws which apply to hot-air heating have previously been considered in the articles relating to “Ventilation” and to the “Methods of Indirect Heating with Steam or Hot Water.” The method of heating with hot air, as usually practised, consists in first enclosing a suitable heater, termed a *furnace*, in a small chamber with brick or metallic walls, which is connected to the external air by a flue leading to its lower portion and to the various rooms to be heated by smaller flues leading from the upper part. In operation the cold air is drawn from the outside, is warmed by coming in contact with the heated surfaces of the furnace, and is discharged through the proper flues or pipes to the various rooms. The rapidity of circulation depends entirely upon the temperature to which the air is heated and the height of the flue through which it passes. In order that a system of circulation may be complete flues must be provided for the escape of the cooler air from the room to be heated, otherwise the *circulation* will be very uncertain and the heating quite unsatisfactory. Registers and flues for the escape of the air from the room are often neglected, although fully equal in importance to those leading to the furnace.

Regarding the relative merits of hot-air heating by furnace as described and of the various systems of steam or hot-water heating, little can be said in a general way, since so much depends on circumstances and local conditions. It is rarely that these systems come in direct competition. The force which causes the circulation of the heated air is a comparatively feeble one and may be entirely overcome by a heavy wind;

consequently it is generally found that the horizontal distance to which heated air will travel under all conditions is short; hence the system is in general not well adapted for large buildings. When properly erected and well proportioned, this system gives, in buildings of moderate size, very satisfactory results.

It may be said, however, that, in erecting a hot-air system of heating, competition has been in many cases so sharp as to induce cheap, rather than good, construction. Small furnaces have been used in which the temperature of the exterior shell had to be kept so high, in order to meet the demands for heat, that the heated air absorbed noxious gases from the furnace and entered the room in such condition as to impair, rather than to improve, the ventilation. Ventilation-ducts for removing the air from the rooms have often been neglected, and hence the results obtained have been far from satisfactory. Such faults are to be considered, however, as those of design and construction rather than as pertaining to the system itself.

In order that the hot-air system should be satisfactory in every respect, the furnace should be sufficiently large, and the ratio of heating surface to grate such that a large quantity of air may be heated a comparatively small amount rather than that a small quantity shall be heated a great amount. As air takes up heat very much more slowly than steam or water, it would seem that the relative ratio of heating surface to grate surface should be more than that commonly employed in steam-heating. By studying the proportions which have previously been given for steam-heating boilers it will be seen that the ratio of heating surface to grate surface for the steam-boiler varies between 20 and 45, averaging about 32. From a study of the results in catalogues of manufacturers of furnaces the ratio of air-heating surface to grate surface in hot-air furnaces seems to vary from 20 to 50 as extremes. These proportions are essentially the same as used in steam-heating and are much too small for the best results in hot-air heating. It is quite evident that since air cannot be heated by radiation,

and is warmed only by the contact of its particles against the heated surface, that the exterior form of the furnace should be such as will induce a current of air to impinge in some portion of its course directly against the surface.

Regarding the economy of this or any other system of indirect heating, it is simply a question of perfect combustion and relative wastes of heat. If the fuel is perfectly burned and all the heat which is given off is usefully applied, the system is perfect. The waste of heat in any system of combustion is that due to loss in the ashes, to radiation, and to escape of hot gases into the chimney. If the furnace is properly encased and if the hot-air pipes are well covered, there is no reason why losses from imperfect combustion and from radiation should not be a minimum. The chimney loss depends largely upon the temperature of the surface of the heater; if this is high, the loss will be large. In general, it may be said that the larger the heating surface provided the lower may be its temperature, and the greater the economy. It should be noted, however, that this or any system of indirect heating requires the consumption of more fuel than when the heating surfaces are placed directly in the room, and for that reason the operating expense must be considerably greater than that of direct systems of hot-water and steam heating.

Furnaces, or in fact heating-boilers of any kind, are uneconomical if operated with a deficient supply of air. In this case the product of combustion will contain carbon monoxide, an extremely poisonous and inflammable gas, which is quite likely to take fire and burn, on coming in contact with air, at the base or top of the chimney.

157. General Form of a Furnace.—The principles which apply in furnace construction are not essentially different from those given in Chapter VIII for steam and hot-water boilers. In the case of a hot-air furnace the fire and heated products of combustion are on one side of the shell and the air to be warmed on the other. In the case of steam or hot-water boilers the water and steam occupy the same relative positions as the air in the case of the hot-air furnaces. The

types and forms of furnaces which are in use may be classified exactly the same as heating-boilers, as having plain or extended surface, and as being horizontal or vertical, tubular or sectional; it may be said that the forms which are in use are fully as numerous as those described for steam-heating and hot-water heating.

The material which is employed in construction is usually cast iron or steel, and there is a very great difference of opinion as to the relative merits of the two. It seems quite probable that cast iron, because of its rough surface, may be a better medium for giving off heat than wrought iron or steel, but it is quite certain that at a very high temperature, some carbon from the cast iron will unite with the oxygen from the air forming carbonic acid. When very hot it may be slightly permeable to the furnace gases. Such objections are, however, of little practical importance, since the temperature of a furnace never should, and never does if properly proportioned, exceed 300 or 400 degrees Fahr., and for this condition the difference in heating power of cast iron and steel is very slight. It is of great importance that the shell of the furnace be tight, so that smoke and the products of combustion cannot enter the air-passages.

Furnaces can be purchased with or without magazine feed, but the demand of late years is principally for those without the magazine, since it has not been proved to present any special advantages.

Furnaces are often set in a chamber surrounded with brick walls, as explained for steam-boilers, but they are more frequently set inside a metallic casing, this latter being termed a portable setting; this casing varies somewhat as constructed by different makers, but usually consists of two sheets of metal, the outer of galvanized iron, with intervening air-space empty or filled with asbestos. The casing is placed at such a distance from the furnace as to provide ample room for the passage of air.

Some form of dumping or shaking grate which can be readily and quickly cleaned is almost invariably employed.

The draft-doors which admit air below the grate and check-dampers in the stovepipe are usually arranged so they can be opened or closed from some convenient place on the first floor of the house by means of chains passing over guide-pulleys.

A pan in which water may be kept is added to every furnace for the purpose of increasing the moisture in the air; this is of importance, since the heated air requires more moisture than cold to maintain a comfortable degree of saturation.

158. Proportions Required for Furnace Heating.—The proportion of the area of heating surface in the furnace to that of the grate cannot be computed from any data accessible to the writer, and the proportions given are assumed to be twice those which have been found to give best results in steam-heating; these apparently agree well with the best practice.* The tables which are given are computed for a maximum temperature of 120° F. for the air leaving the furnace, which is 50 degrees in excess of the ordinary temperature in the house. No doubt better practice might require the introduction of more air at a lower temperature, but considering the fact that this high temperature only has to be maintained when the outside weather is extremely cold, it seems quite doubtful if the expense of a furnace large enough for this additional duty, would be warranted.

The ratio which the grate surface of the furnace should bear to the glass and exposed wall surface of the room can be computed with sufficient accuracy from known data relating to the heat contained in coal and to the probable efficiency of combustion. The heat given off from the walls of a room for each degree difference of temperature between the inside and outside is approximately equal to the area of the glass plus one-quarter the area of the exposed wall surface, which we will in this place denominate as the *equivalent glass surface*. One pound of good anthracite coal will give off about 13,000 heat-

*The Federal Furnace League find average values of 1 sq. ft. of direct heating surface and 1.5 sq. ft. of indirect heating surface or a total of 2.5 sq. ft. of heating surface per square foot of grate surface.

units in combustion. One pound of soft or bituminous coal will give off in combustion from 10,000 to 15,000 heat-units, depending on the kind and quality. Of this amount a good furnace should utilize 70 per cent.* The amount of coal which is burned per square foot of grate surface per hour will depend very much upon the character of attendance; in ordinary furnaces used in house heating, and where it is expected to replenish the fires only two or three times per day, this amount is low, being not greatly in excess of 3 pounds. If the air is 120 degrees in temperature, nearly 60 cubic feet will be required, when heated one degree, to absorb one heat-unit (see Table X), and if such air is delivered 50 degrees above that of the air in the room, each cubic foot will bring in $\frac{1}{5}$ of one heat-unit.

The velocity of air in feet per minute with ample allowance for friction is given in Appendix, Table XVI, from which it is seen that it will be safe to assume velocities of 4, 5, and 6 feet respectively, per second in the flues or stacks leading to the various floors. The velocity of the air passing the register may be assumed as 3 feet per second in every case; this lower velocity is obtained by making the area of the register somewhat larger than that of the pipe leading to it.

The following mathematical discussion gives these various considerations in general and algebraic terms, as follows:

Let F =square feet in grate, C =weight of coal burned per square foot of grate per hour, r =heat-units per pound of coal, E =efficiency of furnace, h =heat-units per hour, T =temperature of air leaving furnace, t' =temperature outside air, t =temperature of room, G =area of glass in room, W =area of exposed wall surface, H =heat lost by room for one degree difference of temperature, K =cubic feet of air heated by furnace per hour, K' =cubic feet air required to warm room.

We have, as explained,

$$h = CFEr = \text{total heat given off by furnace, equal to that required for all the rooms} \dots \dots \dots (1)$$

* It is quite probable that the efficiency of combustion in an ordinary furnace is much less than the above, often as low as 50 per cent.

$$K = \frac{60CFEr}{T-t'} = \text{cubic feet of air heated per hour by furnace.} \quad \dots \quad (2)$$

$$h' = (G + \frac{1}{4}W)(t-t') = \text{total heat-units to warm the room.} \quad \dots \quad (3)$$

$$K' = \frac{60(G + \frac{1}{4}W)(t-t')}{T-t} = \text{cubic feet of air to warm the room.} \quad \dots \quad (4)$$

For average conditions substitute in above, as explained, $T = 120$, $t = 70$, $t' = 0$, $C = .70$, $r = 13,000$, $Cr = 9100$, and we have

$$h = 9100CF = 2K. \quad \dots \quad (5)$$

$$K = 4550CF = 0.5h. \quad \dots \quad (6)$$

$$K' = 84(G + \frac{1}{4}W). \quad \dots \quad (7)$$

When $K = K'$, $CF = \frac{G + \frac{1}{4}W}{54.2}$; when $C = 3$, $F = \frac{G + \frac{1}{4}W}{162.6}$. $\dots \quad (8)$

$$h' = 70(G + \frac{1}{4}W). \quad \dots \quad (9)$$

For computing areas of leader-pipes and stacks, for residence heating, assume velocities which can safely be taken as follows: First floor, 4 feet per second or 240 per minute; second floor, 5 feet per second or 300 per minute; third floor, 6 feet per second or 360 per minute.

Through a cross-section of the flue equal to one square inch 100 cubic feet will pass in one hour when the velocity is 4 feet per second, 125' when the velocity is 5 feet per second, 150 when the velocity is 6 feet per second, 25v when the velocity in feet per second is represented by v.

Denote area of flue in square inches by L; then from equation (7)

$$L = \frac{K'}{25v} = \frac{84(G + \frac{1}{4}W)}{25v} = \frac{3.36(G + \frac{1}{4}W)}{v} \quad \dots \quad (10)$$

From this, by transposition, we have

$$(G + \frac{1}{4}W) = \frac{vL}{3.36} \quad \dots \quad (11)$$

If for first-floor rooms $v=4$

$$G + \frac{1}{4}W = 1.19L.$$

If for second-floor rooms $v=5$

$$G + \frac{1}{4}W = 1.53L.$$

If for third-floor rooms $v=6$

$$G + \frac{1}{4}W = 1.78L.$$

The following table gives the relative values of these various quantities, computed for the conditions as explained:

PROPORTIONS REQUIRED IN FURNACE HEATING.

Equivalent glass surface	25	50	75	100	125	150	200	250	500	750	1000
Cu. ft. air to be heated per hour.....	2100	4200	6300	8400	10500	12600	16800	21000	42000	63000	84000
Grate area, square inches	22	43	64	85	107	127	170	212	425	640	850
Equivalent diameter round grate, inches...	7.5	8.5	9.5	11.5	12.5	13.5	15	17	24	29	33
Heating surface, sq.ft. . .	4	6	8	10	12	15	22	27	53	80	100
Diam. smoke-pipe, ins. . .							7	7	8	10	11
Approximate cubic feet space	420	840	1260	1680	2100	2520	336	420	840	12600	16800
Area stack:	525	1050	1570	2100	2625	3150	4200	5250	2100	15750	21000
1st floor (vel. 4) sq.in.	21	42	63	84	105	126	168	210	420	630	840
2d " (vel. 5) sq.in.	17	33	51	68	85	102	135	170	345	500	670
3d " (vel. 6) sq.in.	14	28	42	55	70	84	112	140	280	420	560
Diameter leader pipe: *											
1st floor.....	7	7.5	9	10.5	11.6	12.7	14.7	16.5	19	23.2	26.7
2d ".....	7	7	8.2	9.5	10.5	11.5	13.2	14.7	21	25.2	29.2
3d ".....	7	7	7.5	8.5	9.5	10.4	12	13.4	19	23.2	26.7
Net area, register, sq.in.											
1st floor (vel. 3).....	28	56	84	110	140	168	224	280	560	840	1120
2d floor and above....	21	42	63	84	105	126	168	210	420	630	840
Area ventilating flue....	21	42	63	84	105	126	168	210	420	630	840
Net area ventilating register.....	17	33	51	68	85	102	135	170	345	500	670

* For pitch of one inch per foot. Use larger pipe for less pitch.

NOTE.—The proportions in the above table agree very well with those given by the Excelsior Steel Furnace Co. for the condition of changing the air in each room four times per hour, which can be taken as representing the average amount required to bring in the heat.

The grate surface is computed for combustion of 3 pounds per square foot per hour, with an efficiency of 70 per cent or a greater amount at less efficiency. The heating surface given in above table is much larger than ordinarily found in furnaces, but not too large for best results.

159. Air-supply for the Furnace.—The air-supply for the furnace is usually obtained by the construction of a passage-way or duct of wood, metal, or masonry leading from a point beneath the furnace casing or near its bottom to the outside air, essentially as shown in section Fig. 225. This duct or pipe is usually termed the *cold-air* box and is often constructed of wood. In all cases there should be a screen over the outer end to keep out vegetable matter or vermin, and doors should be arranged so that it can be cleaned periodically. A damper is usually desirable, arranged so that it can be partly or entirely opened to regulate the admission of the cold air. The cold-air box should be made perfectly tight and in a workmanlike

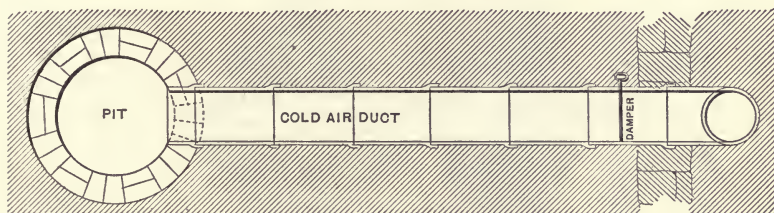

FIG. 225.—Hot-air Furnace with Cold-air Box below Cellar Bottom.

manner, so that air cannot escape into or be drawn from the cellar or basement. This should join onto the furnace casing at as low a point as the character of the cellar bottom will permit. In some instances it is desirable to erect two cold-air boxes, opening to the air on opposite sides of the house, so that the supply may be drawn from either direction as required to obtain the help of wind-pressure, to aid in the circulation of the air over the furnace.

The cross-sectional area of the cold-air box is proportioned, by different authorities, from 66 to 100 per cent of the sum of the areas of all pipes taken from the furnace. If this were proportioned so that its area should be in ratio to the respective volume of cold and heated air, the sectional area of the cold-air box should be about 80 per cent of the sum of the areas of the various stacks. To avoid frictional resistances it would

seem to be advisable when practicable to make its area equal to that of the sum of the areas of the stacks.

160. Pipes for Heated Air.—The pipes for heated air are of two classes: first, those which are nearly horizontal and are taken from near the top of the furnace casing—these are usually round and made of a single thickness of bright tin, and if possible erected with an ascending pitch of one inch to one foot, and are termed *leader-pipes*; second, rectangular vertical pipes or risers, termed *stacks*, made in such dimensions as will fit in the partitions of a building and to which the leader-pipe connects. The bottom of the stack is enlarged into a

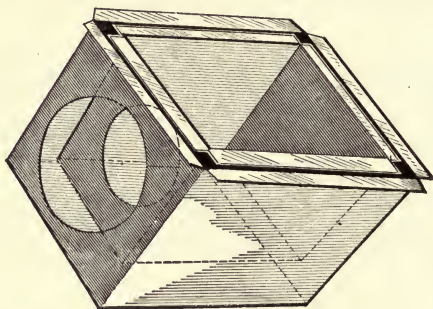

FIG. 226.—Register Boxes Shown in Position.

chamber termed a *boot*, which is made in various forms and provided with a round collar for connection to the leader-pipe. The top part of the stack may be provided with a similar boot from which horizontal rectangular stacks are taken, or it may be connected to a rectangular chamber into which the register may be fitted and which is known as the *register box*. The stacks usually pass up or near the woodwork of partitions, and for lessening the fire risk as well as preventing loss of heat should be made with double walls separated by an intervening air-space. The register boxes should also in every case have double walls. The general form of a stack in position in a partition, with boot attached at bottom for leader-pipe and with round connection for register box, is shown in the accompanying figure.

The leader-pipes and stacks, boots, and register boxes are now a standard article of manufacture by several firms.

It will be found profitable in nearly every case to wrap the leader-pipes with two or more thicknesses of asbestos paper and mineral wool in order to prevent loss of heat. It is desirable to locate the stacks in the inside partition-walls of the building, or where they will be protected as much as possible from loss of heat, since any loss affects the rapidity of circulation. It is generally necessary to have the leader-pipes not over 15 feet in length, otherwise the circulation will be uncertain in amount and character.

In a test at the Underwriters Laboratories, Chicago,* W. C. Robinson, Chief Engineer, shows that the outer wall of the double wall stacks gets only about 75 to 80 per cent as hot as the wall of the single stack. The asbestos cover on the single wall stack affords very little protection.

“One of the vital points involved in these tests has been to demonstrate the greater efficiency of double wall pipe of smaller area in comparison with single wall pipe of larger area, the single pipe installed in the wall in question being $3\frac{5}{8} \times 12\frac{5}{8}$, whereas the double pipe had a cross area of only 3×12 inches. Notwithstanding an increased area of more than 25 per cent in favor of single pipe the latter showed much less efficiency than double wall pipe, due to the very great loss of heat into partitions with single pipe. The area of the double pipe tested was 36 square inches, and of the single pipe $45\frac{3}{4}$ square inches.”

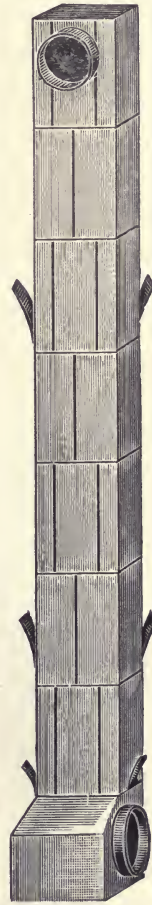

FIG. 227.—Regular Stack with Collar at Top and Flat Back Boot at Bottom.

* From the *Engineering Review*, August, 1911.

The inclined or baseboard register, see Fig. 228, for use on the first story of a house is not a receptacle for dust like the flat floor register.

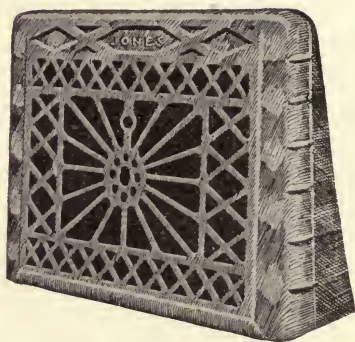

FIG. 228.—Baseboard Register.

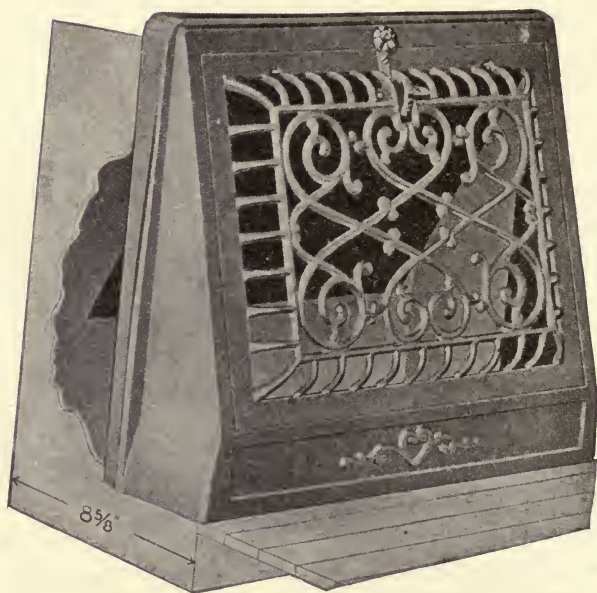

FIG. 228 (a).—Baseboard Register with Deflecting Damper.

161. The Areas of Registers or Openings into Various Rooms.—

Registers are made regularly in various forms, square or round, and arranged for use either in the floor or side walls as required.

TABLE OF SIZES AND DIMENSIONS OF SAFETY DOUBLE HOT-AIR STACKS *

Size of Stack as Listed. (In Inches.)	Actual Size of Outside Stack.	Actual Size of Inside Stack.	Area of Inside Stack in Inches.	Capacity as Compared with that of Hot-air Pipe with Pitch of 1 Inch to 1 Foot.	Equivalent in Round Pipe with Pitch of 1 Inch to 1 Foot.	Sizes of Round Pipe Which Should be Used with Each Stack.	Area of Said Round Pipes in Inches.	Sizes of Registers and Register Boxes Which Should be Used with Each Stack.	Cubic Feet of Space (Approximate) That Can be Heated with Each Stack with Pipe and Registers of Size Given.	Equivalent of Said Space on Floor of Rooms 10 Ft. High.	Area in Inches of Registers with Space Occupied by Bars Deducted.
4 X 8	3 X 7	3 X 7	23	35	6	7	38	6 X 8	500	6 X 8	35
4 X 10	3 X 9	3 X 9	29	43	8	8	50	8 X 10	850	8 X 10	45
4 X 12	3 X 11	3 X 11	35	48	10	10	63	10 X 12	1000	10 X 12	55
4 X 14	3 X 13	3 X 13	41	53	12	12	78	12 X 14	1250	10 X 12½	60
6 X 10	5 X 9	5 X 9	47	63	10	10	100	10 X 12	1650	12 X 14	70
6 X 12	5 X 11	5 X 11	58	71	12	12	113	12 X 14	2000	12 X 17	80
6 X 14	5 X 13	5 X 13	68	87	11	12	133	12 X 15	2300	14 X 17	115
8 X 10	7 X 9	7 X 9	68	102	12	12	153	12 X 17	2600	15 X 18	120
8 X 12	7 X 11	7 X 11	79	119	12½	14	154	14 X 20	3000	15 X 20	156
8 X 14	7 X 13	7 X 13	124	186	16	16	201	16 X 24	4000	20 X 20	210
10 X 12	9 X 11	9 X 11	176	264	18	18	254	20 X 24	5400	20 X 27	270
10 X 14	9 X 13	9 X 13	213	330	20½	20	314	21 X 29	7000	20 X 35	340

Stacks for 4-inch studs carried in stock. Other sizes made to order.

* This table is copyrighted by Excelsior Steel Furnace Co.

These registers are usually supplied with a series of valves which may be readily opened or closed. The space taken by the screen and valves is usually about $\frac{1}{3}$ of that of the register, so that the effective or net area is about $\frac{2}{3}$ of the nominal size of opening. These registers may be obtained finished in black or white japan, or electroplated with nickel, brass, bronze, or copper. The table on page 340 gives the various sizes of registers which are regularly on the market, their effective area in square inches, and diameters of round pipe having the same capacity.

The areas of stacks may be considerably less than those of the registers, since it is generally required that the velocity of air entering the room shall not exceed 3 or 4 feet per second, while that passing through pipes and stacks may have the

highest velocity possible, which for the different floors will not differ greatly from 4 to 6 feet per second, as already explained.

TABLE OF REGISTERS.

Size of Opening. Inches.	Effective Area. Square Inches.	Diameter Round Pipe. Inches.	Size of Opening. Inches.	Effective Area. Square Inches.	Diameter Round Pipe. Inches.
4½ × 6½	20	5.1	10 × 20	132	13.0
4 × 8	21	5.2	12 × 12	96	11.1
4 × 10	26	5.8	12 × 14	112	11.9
4 × 13	34	6.6	12 × 15	120	12.4
4 × 15	40	7.2	12 × 16	128	12.8
4 × 18	48	7.8	12 × 17	136	13.2
6 × 6	24	5.6	12 × 18	144	13.5
6 × 8	32	6.4	12 × 19	152	13.9
6 × 9	36	6.7	12 × 20	160	14.3
6 × 10	40	7.2	12 × 24	192	15.6
6 × 14	56	8.5	14 × 14	130	12.8
6 × 16	64	9.1	14 × 16	149	14.8
6 × 18	72	9.6	14 × 18	168	14.7
6 × 24	96	11.1	14 × 20	186	15.5
7 × 7	32	6.4	14 × 22	205	16.2
7 × 10	52	8.2	15 × 25	250	17.8
8 × 8	42	7.4	16 × 16	170	14.7
8 × 10	53	8.2	16 × 20	213	16.5
8 × 12	64	9.6	16 × 24	256	18.1
8 × 15	80	10.1	18 × 24	288	19.2
8 × 18	96	11.2	20 × 20	267	18.5
9 × 9	54	8.2	20 × 24	320	20.2
9 × 12	72	9.6	20 × 26	347	21.0
9 × 13	78	10.0	21 × 29	406	22.7
9 × 14	84	10.3	24 × 24	384	22.1
10 × 10	66	9.2	24 × 32	512	25.5
10 × 12	80	9.1	27 × 27	486	25.0
10 × 14	93	10.9	27 × 38	684	29.5
10 × 16	107	11.7	30 × 30	600	27.7
10 × 18	120	12.4			

Considerable difference of opinion exists as to the relative merit of floor and wall registers for heating purposes. It is the common practice to use floor registers for most rooms on the first floor, and wall registers for rooms on the second and higher floors. The floor register, from its general form and position, can be supplied with hot air somewhat more readily than the wall register, and for that reason may induce somewhat stronger circulation, but it is a receptacle for dust and

sweepings of the room and in a position to materially interfere with the carpets. It will be found that the experiments made by Briggs as to diffusion of air hold in the case of furnace heating the same as in that of any other system. From these experiments it would seem that the highest efficiency would be attained when the inlet for the heated air was at the side near the top of the room and the outlet for ventilation near the floor. This distribution is one that, so far as the writer knows, has never been practised in furnace heating of residences, although it is the commonly accepted method in school-house heating, whether with a furnace or an indirect system of steam or hot-water heating.

162. Circulating Systems of Hot Air.—By connecting the cold-air box with the hall floor or the lower portion of a passage communicating with all rooms of the building and closing outside connections a downward current of air will pass from the rooms to the furnace, which, being warmer than the outside air, will aid materially in heating. Such a connection if properly made and used with judgment may be of great service in reducing the cost of operation without seriously affecting the ventilation. Such a system if erected, however, should be supplied with devices to prevent overheating and arranged so that cold air can be drawn from outside of the building whenever desired. There is so much danger that ventilation will be poor with this system that it is not recommended.

163. Heating with Stoves and Fireplaces.—The manufacture of stoves for heating purposes is a very great industry in the United States and they are extensively used in the cheaper classes of dwellings. In every case the stove is located directly in the room to be heated and is connected with a chimney by means of several lengths of sheet-iron pipe. Stoves are built in many forms, some of which are very elaborate and highly ornamented, and in many cases they are provided with magazines from which the coal feeds itself automatically as required. The heat given off from a stove is generally nearly all utilized in warming, perhaps not over 10 or 15 per cent being

carried off by the chimney. Stoves do not, however, present an economical mode of heating, largely because the wastes which occur from the operation of small fires are very great and cannot be avoided. It is doubtful if the efficiency averages much above 25 per cent. In addition, the stove occupies useful room, is the source of very much dirt and litter, and requires a great deal of attention.

Open fireplaces which were used at one time extensively are very wasteful, as little more than the direct radiant heat from the fire is absorbed in warming. They are also subject to all the wastes which pertain to stoves, and their probable efficiency cannot be considered as over 15 or 20 per cent. They are, however, valuable adjuncts of a system of ventilation, since large quantities of air are drawn from the room and discharged into the chimney. In the use of a stove called a fireplace heater, the heated gases from an open fire pass through a drum or radiating surface in the room above, and the heat which otherwise would be discharged from the chimney and wasted is partly utilized in heating.

164. General Directions for Operating a Furnace.—The general directions for operating a furnace so far as regards the care of the fire are the same as those which have been previously given for the operation of steam-heating furnaces; there are, however, no steam-gauges or safety appliances needed. In regulating the temperature of the house the drafts of the furnace should be operated rather than the valves of registers leading to various rooms. In some instances, if the circulation is strong in certain directions and weak in others so that certain rooms cannot be heated, it may be a good plan to shut all registers except the one to the room where heat is required until circulation is established, after which circulation will usually continue without further attention. In the operation of a furnace great care should be taken that the metal never becomes red hot or even cherry-red. If it will not warm the building without being excessively hot, the furnace is too small, or else has too little radiating surface in proportion to the fire-pot. The water-pan should be kept filled with water.

Thermostats arranged to open or close the drafts when desired are in use in many systems of furnace heating with success.

For protection of the furnace during summer months some makers recommend that the fire-pot be filled with lime. For burning soft coal, furnaces of special construction only should be employed.

165. Practical Arrangement of Furnaces.—Furnaces are usually arranged in an approximately central position with reference to the rooms to be heated, although the location must in a large measure depend upon the position of the chimney. The cold-air flue or box is arranged as convenient and

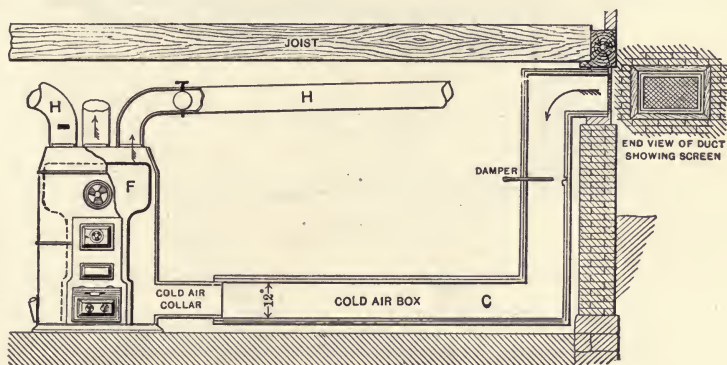

FIG. 229.—Elevation of Furnace.

so as to enter the furnace either below or above the level of the floor, and to secure best results this box should open on the windward side of the house so that the force of the wind may be utilized as far as possible in producing circulation. In localities where the winds often vary in direction it is advisable to erect, when possible, two cold-air flues, so arranged that the one which produces the better results can be used and the other closed off by a damper.

The hot-air pipes are almost universally taken off from the top part of the hot-air chamber and at the same level, and erected without branches, so that we find as many pipes in use as there are rooms to be heated.

The usual arrangement of cold- and hot-air piping is shown in the accompanying figure. In this particular case the cold-air box is upon the floor, the furnace has a portable setting, and the hot-air pipes are taken from the top of the hot-air chamber. In a few instances partitions or pipes in the hot-air chamber are arranged so that a definite area of the furnace surface is used to warm the air for each hot-air pipe, it being expected to produce by such a construction a more positive flow of air to the remote rooms. It is doubtful, however, if the heating is more reliable than that which can be obtained

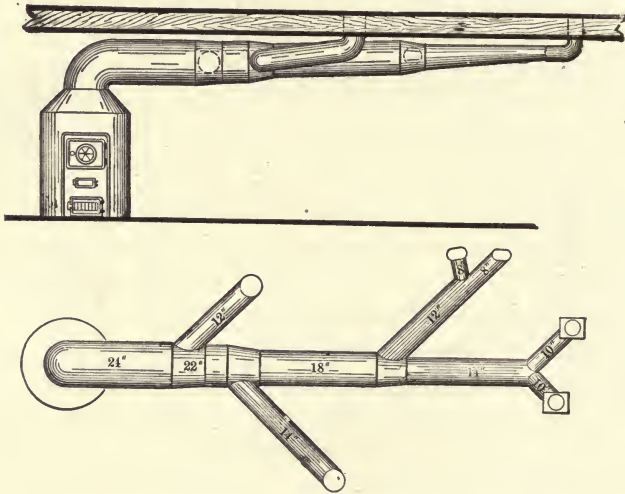

FIG. 230.—Plan and Elevation of Furnace with Main Pipe and Branches.

with good proportions of parts when arranged in the usual manner.

In the opinion of the author the hot air could be distributed with much less friction were a system of main pipes and branches employed as suggested in the diagram Fig. 230. If the friction in the distributing pipes could be entirely eliminated, the trouble which is now experienced in securing the circulation of hot air to remote rooms would cease almost entirely. Incidentally, this system of piping has the advantage of taking less room in the cellar and is doubtless cheaper to construct.

The figure shows the pipe-line extending only in one direction, but it is evident it could be equally as well extended in two directions. In proportioning such a pipe-line, first find the area of branches, then of submain, and lastly of the main.

The hot-air furnace is rarely used for ventilation purposes during that portion of the year when little or no heat is required. It is possible, however, to arrange the furnace so as to deliver a constant volume of air during the entire period of its use,

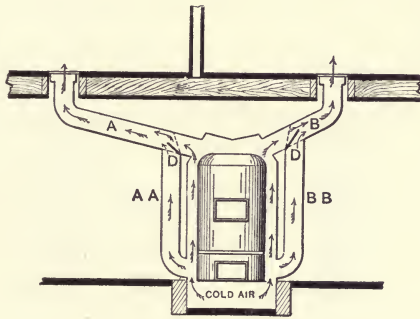

FIG. 231.—Ventilating-pipes used at Furnace.

as suggested in the sketch Fig. 232. In this case a by-pass pipe connects the cold-air box with each hot-air pipe; at the point of junction, as at *D*, a damper is placed, which is so constructed that as one pipe is closed the other will be opened an equal amount, thus delivering a constant volume of air into the room, which may thus be had hot or cold or at any desired temperature, as required by the occupants.

Vent-pipes having 80 per cent of the area of the hot-air pipe, and provided with registers, should be built in the partitions, and should connect each room at a point near the floor with the attic or outside air, in order to permit the escape of a volume of air equal to that brought in by the furnace with as little resistance as possible.

Approved methods of setting floor- and wall-registers are shown in detail in Fig. 232, the same letters being used as far as possible to denote the same object in each view. The

end of the vertical pipe above the wall-register should be curved so as to direct the entering air through the register.

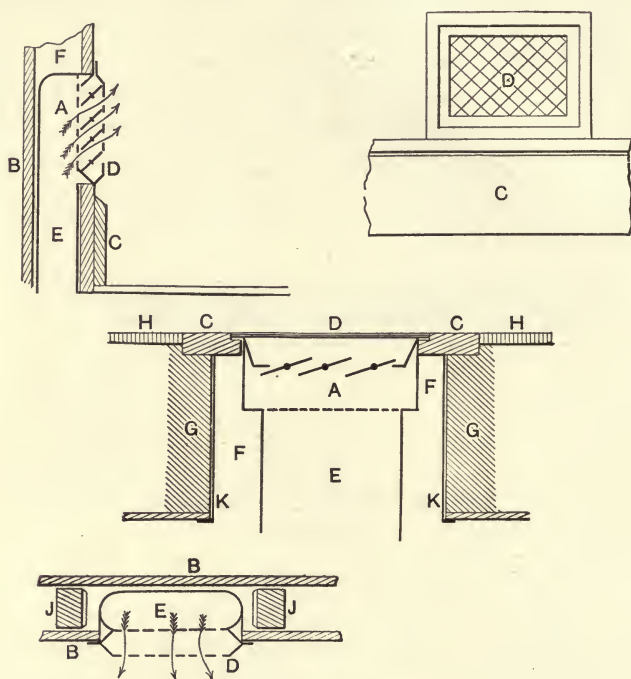

FIG. 232.—Details of Floor- and Wall-registers.

166. The Federal Furnace League rates hot-air furnaces as to capacity only by actual testing in square feet of equivalent glass surface by the use of the following rules.*

To find heating requirements for each room: Compute the number of square feet of glass exposure, and

For north north-west and west glass exposure, add.....	20%
For north-east glass exposure, add.....	10%
For east and south-west glass exposure, add.....	nothing
For south glass exposure, deduct.....	20%
For south-east glass exposure, deduct.....	10%

* Copyrighted by the Federal Furnace League.

To the total allowance for glass exposure as figured by foregoing method: Add one-sixth of the number of square feet of net wall exposure.

To be counted as regular single glass exposure:

- Outside doors (not vestibuled).
- Ordinary single windows.
- Skylights (single).

To be counted as 50 per cent (50%) of regular single glass exposure:

- Outside door (vestibuled).
- Double windows.
- Windows fitted with storm sash.
- Double skylights.

The percentage additions to and subtraction from glass exposure, are based on the following maximum wind velocities:

North wind blowing 25 miles per hour, add	20%
West wind blowing 25 miles per hour, add	20%
East wind blowing 15 miles per hour, add	nothing
South wind blowing 5 miles per hour, deduct	20%

In some localities where extraordinary wind velocities are quite common, the following percentages may be added to glass exposures:

Wind blowing 35 miles per hour, add	40%
Wind blowing 45 miles per hour, add	60%

To be counted as net wall exposure:

- Actual number of square feet of outside wall surface.
- Floor and ceiling of overhanging bay windows.

To be counted as 50 per cent (50%) of net wall exposure:

- Party walls.
- Partitions (including doors) between heated and cold rooms.

When the walls of a building are of concrete add one-fourth ($\frac{1}{4}$) of the number of square feet of net exposed wall surface [instead of one-sixth ($\frac{1}{6}$)].

Building Heated.	Grate Surface.	Heating Surface.	Type of Furnace.	Coal Burned per Season.	Space Heated.	Outside Dimensions and Character of Building.	Wall Surface.	Number and Size of Windows.	Glass Surface.
	Dia. Ar.	Sq. ft.		Tons.	Cu. ft.		Sq. ft.		Sq. ft.
Reported by W. J. Woodall, Cornellsville, Pa. Store and residence. Stands in a block.	21 X 41 = 861"	90	All steel; buck-lined; shallow fire-pot.		57,000	2-story brick; ceiling 16 X 10	3020		930
Reported by W. J. Woodall, Cornellsville, Pa. Church. Isolated in country	21 X 3 = 756"	75	Do.		21,000	1-story brick, 28 X 42 X 18	$\begin{array}{r} 2520 \\ 420 \\ \hline 4)2100 \\ \hline 525 \end{array}$	$\begin{array}{r} 9-3 \times 9\frac{1}{2} \\ 1-2 \times 8 \\ 2-6 \times 14 \\ 1-8 \times 8 \\ \hline 420 \end{array}$	420
Reported by W. J. Woodall, Connellsville, Pa. Dwelling. Isolated in town	21 X 26 = 546"	50	Do.		12,000	2-story frame	$\begin{array}{r} 2000 \\ 200 \\ \hline 4)1800 \\ \hline 450 \end{array}$	$\begin{array}{r} 13-2\frac{1}{2} \\ \times 5 \\ \hline 2-4 \times 5 \end{array}$	200
Reported by M. L. Kaiser, Wilkes-Barre, Pa. Residence. 72 to 74 deg.	18" 254	135	Cast iron; vertical flue; return-flue jacket.	From Oct. 1 to April 1 5	10,657	2-story balloon-frame; sheathed, 9, 8, and 6	$\begin{array}{r} 4)1675 \\ \hline 419 \end{array}$		212
Reported by M. L. Kaiser, Wilkesbarre, Pa. Church. Adjoining a Sunday-school at one end.	30" 706	191	Do.	Less than one-half formerly used.	68,816	Auditorium and balcony	$\begin{array}{r} 4)3700 \\ \hline 925 \end{array}$	$\begin{array}{r} 10 \\ 4 \times 11 \end{array}$	440
Reported by R. C. Carpenter, Ithaca, N. Y.	20" 400	Unknown	All cast iron; indirect draft. Inside casting; 287 Carton.	9.5	16,004	2-story wooden house, ceilings 9 ft., 8 ft.	Exposed 1850	11	616

ACTUAL FURNACE WORK.

Equivalent Glass Surface. The E. C. S. equals the Glass Surface, plus One Quarter of the Difference between the Wall Surface and the Glass Surface.		Number and Size of Hot-air Pipes.		Area of Hot-air Pipes.	Size and Area of Cold-air Supply.	Proportion of Hot-air Pipe Area to Space Heated.	Proportion of Hot-air Pipe Area to Equivalent Glass Surface.	Proportion of Grate Area to Space Heated.	Proportion of Grate Area to Equivalent Glass Surface.	Proportion of Grate Area to Heating Surface.	Proportion of Heating Surface to Space Heated.	Proportion of Heating Surface to Equivalent Glass Surface.	Temperature at Register.	Deg. Fahr.	Temperature of Air Outside.
Sq. ft.						Sq.in. to Cu.ft.	Sq.in. to Sq.ft.	Sq.in. to Cu.ft.	Sq.in. to Sq.ft.	Sq.ft. to Sq.ft.	Sq.ft. to Cu.ft.	Sq.ft. to Sq.ft.			
1685	5-10-78 2-4-154 1-16-201	390 308 201		899	Inside: 2 X 15 X 30 = 900	1-63	1-1.9	1-66	1-2	1-15	1-633	1-18	140	0	
942	2-18-254	508			Inside Outside 14 X 18 12 X 18 250 200	1-42	1-1.9	1-30	1-1½	1-14	1-280	1-12	140	0	
450 201 650	3-10-78 4-8-50	234 200		434	Outside: 14 X 25 = 350	1-30	1-1	1-24	1-1½	1-13	1-240	1-13	140	0	
212 419 631	7 1-12 1-8 2-11 3-10	113 56 190 234		593	16 X 36 16 X 36 594	1-18	1-1.06	1-42	1-2.5	1-75	1-79	1-4.7	120	0	
440 925 1365	5 16"	105			27 X 27 729 30" 737	1-68	1-1.4	1-97	1-1.9	1-40	1-360	1-7			
462 616 1078	5-8-50 2-10-78	406			Inside: 1 X 2 ft.	1-28.6	1-2.65	1-45	1-2.18	Furnace heating surface not known			120 to 160		Zero F.

Furnace capacities to be increased by one-quarter for bituminous coals from western Kentucky or from west of the Ohio river and by one-third for lignites and bituminous coals from the Rocky Mountain Region.

167. Rules for Furnace Heating.—From the formulas given the following rules can be deduced, it being understood that the equivalent glass surface is equal to the area of windows and doors plus one-fourth that of the exposed wall expressed in square feet:

First. To find area of grate in square inches: *Divide equivalent glass surface in square feet by 1.25 or multiply by 0.8.*

Second. To find area of flue for any room in square inches: *Divide equivalent glass surface in square feet by 1.2 for first floor, by 1.5 for second floor, by 1.8 for third floor.*

Third. Make area of vent-flues 0.8 of hot-air flues.

Fourth. Make area of cold-air box 0.8 of given areas of hot-air flues.

Fifth. Take area of chimney smoke flue in square inches as one-twelfth that of the grate, with one inch added to each dimension.

168. Abstract for Furnace Specifications.—The following suggestions are given for the purpose of calling attention to points of construction, which should be fully considered in the complete specifications furnished a contractor.

The *location* of furnace, hot- and cold-air pipes, vent-pipes, smoke-pipe, and registers should be shown on accompanying drawings.

The *furnace* should be gas tight and built of cast iron (or steel) in such manner as to be free from expansion strains and from danger of warping or cracking in use. Grate should be of shaking pattern, containing 50 per cent air-space and adapted to burn the coal needed. The heating surface should be of form best adapted to transmit heat to the surrounding air. Furnace should be provided with all necessary fire and clean-out doors, vapor-pan, and a complete set of fire-tools. Complete drawings and specifications should be submitted. Draft for fire-doors should be arranged to be operated from above.

The furnace may be either *brick-set* or *portable-set* as desired. If brick-set, the wall should be well laid, of good, hard merchantable brick, in such manner as to leave an air-space between the inner and outer walls. If portable-set, the casing outside the air-chamber should be made of two thicknesses of No. 24 galvanized iron, $\frac{1}{2}$ inch apart, and with the space between filled with asbestos. The casing should in all events be provided with doors for cleaning out dust from the air-pipes and the air-chamber, also with collars for the hot-air pipes.

The *smoke-pipe* should be of size noted in specifications, and should be provided with check-draft for admitting air into the flue, which can be operated from the rooms above if desired.

The hot-air pipe should be made of IX bright tin-plate, and should be covered with two thicknesses of asbestos paper to reduce radiation. The hot-air pipes in the partitions should be made double, with $\frac{1}{2}$ -inch air-space. In case this cannot be done the pipe should be covered with asbestos paper. All hot-air pipes should be at least one inch from woodwork, and if the pipes are not double the woodwork should be protected by a covering of asbestos paper firmly secured in place. Hot-air pipes passing through wooden partitions should be guarded by a double-collar of metal giving at least 2 inches of air-space. Disk dampers should be located in all hot-air pipes excepting one.

The *cold-air box* should be made of masonry or of matched wood lined with tin or zinc, and provided with regulating-damper, and with a screen for removing dust; also with doors for cleaning.

Hot-air pipes for wall-registers should have rounded end above register-box.

Registers to be of sizes shown on plans and finished as required. The register-boxes to be of shape shown in drawings and to be finished in the best manner.

Automatic draft-regulators of good quality, operated by change of temperature, are always desirable.

CHAPTER XIV.

MECHANICAL VENTILATORS.

169. General Conditions.—Attention has been called to the fact that air will not flow unless a difference of head tends to urge the particles from a higher to a lower region of pressure. This difference of head may be produced, as already shown, by heat or by mechanical action, and in every case produces a velocity which, if friction and other resistances be neglected, may be expressed by the formula $v = \sqrt{2gh}$, in which h is the

difference of head in feet of air and is equivalent to the difference of pressure. If the resultant pressure is less than that of the surrounding atmosphere, a partial vacuum is formed and the flow is said to be caused by *suction*; if, on the other hand, the pressure is greater, a plenum is formed and the flow is said to be due to *pressure*. In the case of a heated chimney or flue the pressure is less than atmospheric and the flow of air is caused principally by suction, as would also be the

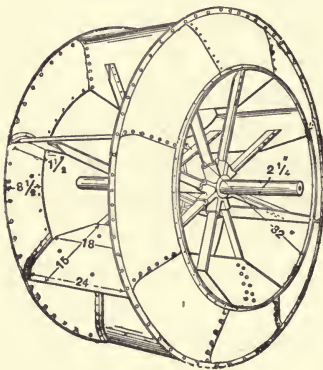

FIG. 233.—Wheel for Centrifugal Blower.

case with an exhaust-fan; with a blowing-fan, however, the flow would be principally caused by increase of pressure.

The principal machines used for moving air for ventilating purposes, either by pressure or suction, are the centrifugal fans or blowers, the positive-volume blowers of the piston or

rotary type, and the jet-pumps from which are discharged jets of steam or compressed air. The requirements for good ventilation demand that large volumes of air must be moved at a comparatively low velocity and pressure, which is not a favorable condition for high efficiency, and can in general be better satisfied by the centrifugal fan or blower than by any other machine; it may also be stated that the fan is comparatively cheap to install, is simple in construction, and possesses a fair efficiency.

170. Steel Plate Fans or Blowers consist of a wheel provided with several blades or vanes approximately radial and either plain or curved; this wheel is set in a casing or housing arranged to prevent the return of the air from the delivery side to the suction side and direct it to the point desired, and is constructed so that it may be rotated by some external motive force. A fan used for ventilating buildings is shown on the preceding page, as it appears when removed from its casing. In this particular type of wheel the blades are radial and plane nearest the center, but are curved backward and narrowed at the outer circumference. The proportions of the wheel are varied to suit different conditions, but do not usually differ materially from those which Mr. W. Buckle* found to give the best results and which are given in the following table. In addition are given the proportions in ordinary use in parts of the diameter of the wheel, D .

	Buckle's Proportions.	Proportions in Common Practice.
Diameter of fan-wheel.....	D	D
Diameter of inlet (single).....	$0.5D$	0.6 to $0.7D$
Diameter of inlet (double).....	0.4 to $0.5D$
Width of wheel at outer circumference...	$0.25D$	$0.3D$
Width of wheel at inlet circumference...	$0.5D$	0.5 to $0.5D$
Length of blade radially.....	$0.25D$	0.2 to $0.3D$

The air enters the fan-wheel through the opening in the casing adjacent to and surrounding the axis; it is then thrown outward and compressed by the centrifugal force produced by the rapidly revolving blades; this causes a difference of pres-

* Proceedings of Institute of Mechanical Engineers in 1847.

sure between the centre and circumference of the wheel, which in turn produces a continuous flow of air from the centre outward. If the chamber leading to the inlet is restricted and the delivery opening unrestricted, the pressure at the centre may be less than that of the atmosphere, in which case the fan is said to act by suction or as an *exhaust* fan; if the outlet passage in the casing is restricted, more or less pressure will be produced, in which case the fan will be considered to act as a *pressure* fan. It should be noted that the blades or vanes in the wheels of the centrifugal blowers vary greatly in shape as made for different purposes and by different designers, and

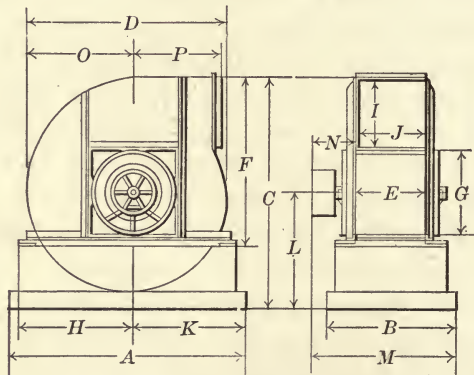

FIG. 234.—Casing for Ventilating-fan.

that, although the centrifugal fan has been used practically for more than two centuries, engineers have not as yet agreed as to the best proportions and best forms of the working parts. A number of examples of different design will be shown later in the chapter.

The casing or framework surrounding the fan-wheel should be constructed so as to first permit or direct the flow of air to the centre of the fan-wheel, and second to receive the discharge of the fan and direct it as desired; from which it is evident that the form of the casing may be varied greatly to suit different conditions. The forms of casing usual in centrifugal ventilators for buildings are those with plain sides,

having a periphery or scroll which is spiral in form and which contains considerable room or clearance in excess of that required for the fan-wheel. The clearance space in the casing is essential for noiseless operation and efficient results, as will appear later. The following clearances or distances between wheel and casing, expressed in proportional parts of the diameter of the fan-wheel, D , are common in the best practice of fan construction:

Least radial distance from wheel to casing. . . . $0.08D$ to $0.16D$.

Maximum radial distance from wheel to casing. $0.50D$ to $1.00D$.

Least side distance from wheel to casing. . . . $0.05D$ to $0.08D$.

The *inlet* opening, G , Fig. 234, to the fan-casing is usually circular in form, concentric with the axis of the fan-wheel, located in either or both sides of the casing as circumstances may permit, and with dimensions as given in a preceding table.

The *outlet* or discharge opening in the fan-casing often extends for exhaust-fans completely around the periphery, but in case of pressure-fans delivering into conduits or pipes the periphery is closed except at the opening for discharge, which should be constructed so as to permit delivery with the least possible shock. As will be shown later, the exhaust-fan is more efficient when discharging into an expanding conduit or chimney of proper shape than when delivering freely into the air.

The ordinary forms of *casing* differ from each other principally in the position of the discharge opening, as shown in Figs. 235 to 237; thus in Fig. 235 the discharge is horizontal and at the bottom, in Fig. 236 it is horizontal and at the top, and in Fig. 237 it is vertical and at the top. The casings are made with discharge at any angle or position desired, and single or double as required. There is usually only one inlet provided for fans to be used as exhausters and it is generally located in the side of the casing opposite the motor or driving-wheel and is always concentric with the axis of the wheel.

The centrifugal fans described above and shown in Figs. 233 to 237 have a small number of nearly radial vanes around the

shaft and from the material generally used in their construction are usually called Steel Plate fans. They operate almost equally well as blowers or exhausters and are very extensively used in the ventilation of buildings.

These fans are a standard article upon the market, being sold by several manufacturers in sizes ranging from 30 to 350 inches. The size usually designates the approximate height of the casing in inches. The large sizes are more efficient than the small ones, but the height of basements, etc., do not as a rule permit them to be used for ventilating buildings.

A form of setting known as "three-quarter housed," in which the lower part of the casing is constructed of masonry

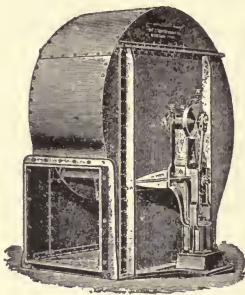

FIG. 235.—Bottom Horizontal Discharge.

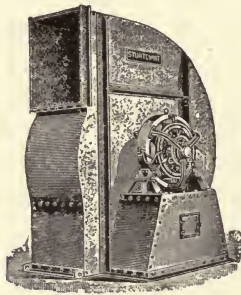

FIG. 236.—Top Horizontal Discharge.

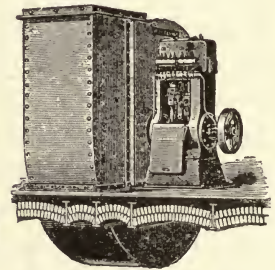

FIG. 237.—Top Vertical Discharge.

or concrete and the lower part of the wheel placed below the floor line, is used for large fans. (See Fig. 237.)

The centrifugal fan may be driven by any convenient type of motor, and several types are suggested in the various figures referred to; in Figs. 235 and 237 are shown fans driven by direct connection to a steam-engine; while in Fig. 236 is shown a fan driven by direct connection to an electric motor.

171. The Guibal Chimney or discharge-tube, invented about fifty years ago by M. Guibal, is extensively used in connection with fans for mine ventilation, and would doubtless prove equally beneficial for ventilating work; it is in effect a continuation of the casing at the point of delivery, so as to form a trumpet-shaped or expanding tube through which the air is discharged

without shock and with a gradual reduction of velocity. It has been found that an expanding discharge-tube with gradual curves in the general form of the *vena contracta* adds greatly to the efficiency, for the reason that the reaction due to shock at delivery is largely overcome, and the full momentum is utilized in moving the air.

The Guibal fan is constructed in such a variety of forms by different designers that no special description is possible, the

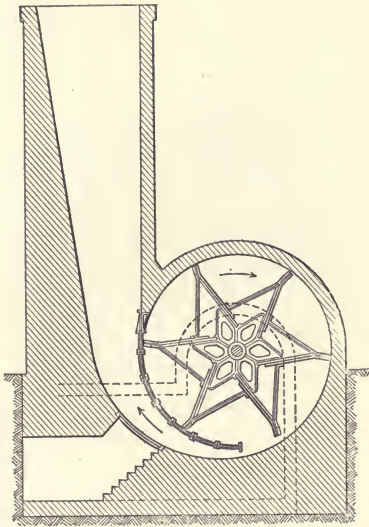

FIG. 238.—The Guibal Fan and Chimney.

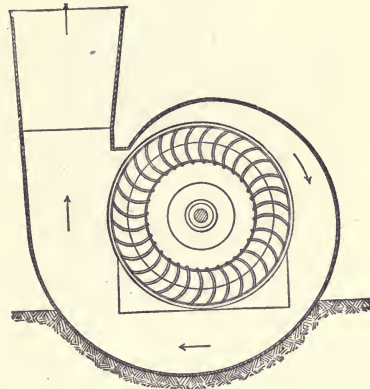

FIG. 239.—Elevation of the Ser Ventilator.

only essential characteristic being the expanding chimney. One form of this fan is here shown.

172. Multivane Fans.—To meet the demand for a fan to occupy less space than the Steel Plate fan, a type, known as the Multivane, having a large number of vanes usually curved forward and operated at a high rotary speed, was designed. A fan designed by Professor Ser of Paris is a good example of an early form of this type. The impeller of this fan consists of a circular plate fixed on a shaft and carrying on each side thirty-two curved vanes, each of which is a portion of a cylindrical

surface whose generatrices are parallel to the shaft and whose transverse section is circular; the width of the vanes is constant, and they are so arranged that inflow takes place without shock and that the air is discharged from the fan in the direction of 45° with the tangent to the outer periphery. The air enters the fan on both sides, and after passing through it enters a volute which conducts it to an expanding chimney, from which it escapes into the atmosphere. The volute is so designed that there is as little loss of energy as possible at entry from the fan and while passing through it; the sides of the

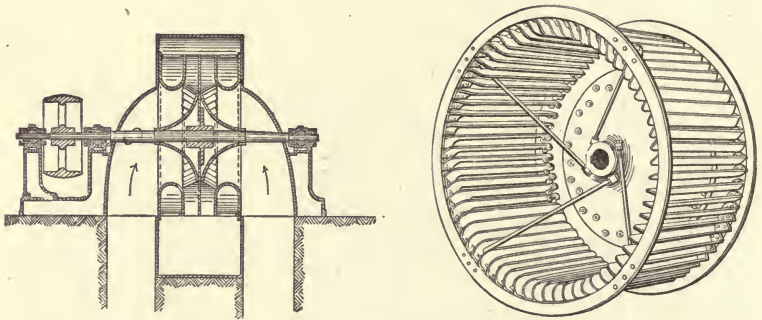

FIG. 240.—Section Through Ser Ventilator. FIG. 241.—Impeller of Sirocco Fan.

chimney are inclined at not more than 1 to 8 in order to avoid the loss due to the sudden enlargement of passage.

The "Sirocco" fan which was designed by Mr. Davidson in Ireland is a well known example of the Multivane type. This fan is shown in Figs. 241 and 242 and is also constructed with two inlets. The characteristics in its design are: 64 vanes having a depth radially of $\frac{1}{16}$ diameter of impeller and a length equal to one-half the diameter of the impeller.

The vanes are curved forward to meet a tangent to the periphery at an angle of 22.5° and an angle of about 62° with a tangent to inside circle.

These fans are constructed in sizes from 1 to 12, corresponding to heights of casing of $10\frac{5}{8}$ to $126\frac{1}{4}$ inches and diameters of impeller of 6 to 72 inches. The manufacturers claim capacities

of 280 to 38,400 cubic feet of air per minute against one inch of water column at 1080 to 175 R.P.M.

In addition to the fans shown numerous forms have been designed which have not proved to be of great practical importance and which, for want of space, cannot be considered more in detail.

A form of centrifugal fan or blower, shown mounted in a brick casing in Fig. 243, is often used where the conditions are not favorable for the form shown in Fig. 233. It is known as the *cone* blower, for the reason that a cone-shaped guide is used

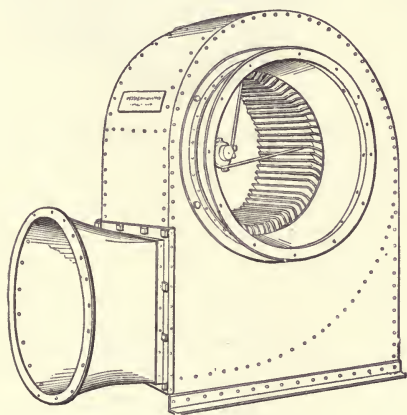

FIG. 242.—The Sirocco Fan.

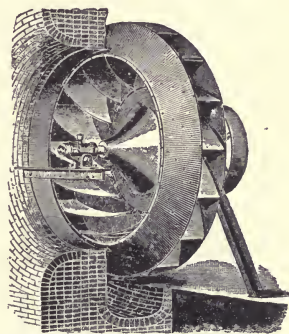

FIG. 243.—The Cone Fan or Blower.

to direct the entering air from the center toward the circumference. In construction it consists of a plate mounted on a shaft to which are connected the cone guides and the various vanes required to give the centrifugal motion to the air; its principle of operation is identically the same as that of other forms of centrifugal blowers.

173. Propeller or Disk Fans.—The name is applied to a class of fans which move the air forward by impact as well as by centrifugal force. In general these fans are mounted in a cylindrical casing and have a number of vanes or blades which are arranged with a diminishing pitch from the centre to the circumference somewhat similar to the blades of a propeller.



FIG. 244.—Sturdevant Multivane Runner.



FIG. 245.—Conoidal Fan Runner.

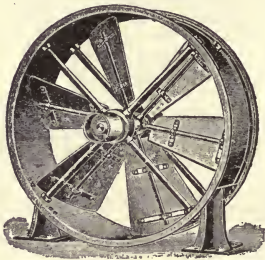

FIG. 246.—Propeller Fan with Plane Blades.

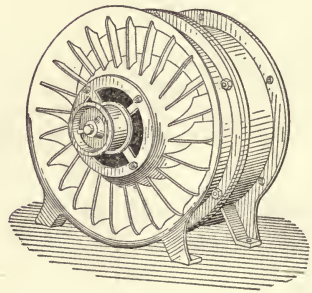

FIG. 247.—Propeller Fan with Curved Blades.

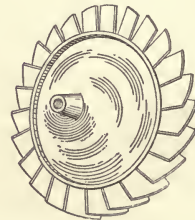

FIG. 248.—Rateau Screw Fan and Wheel.

Three forms are shown, one with plane blades, Fig. 246, one with curved blades driven by a motor, Fig. 247, and one with helix-shaped or screw blades, Fig. 248, into which the air is guided by fixed vanes.

The fans in this class are useful for moving large volumes of air with comparatively low pressures and velocities. They are as a rule not adapted for use where there is any great resistance to be overcome.

174. Volume or Positive Blowers.—This name is applicable to that class of blowers which deliver a fixed volume of air at each revolution and which are positive in their action

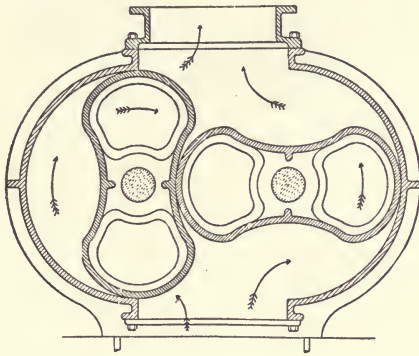

FIG. 249.—Section of the Root Positive Blower.

and prevent the return of compressed air, not by uniform action of centrifugal force, but by use of valves or by contact of the rotating parts. A great variety of blowers have been constructed that could be put in the above classification, but the only ones at present in extensive use are piston blowers and two forms of rotary blowers shown in Figs. 249 and 250. Blowers in this class are well adapted to move small volumes of air at high pressures and are extensively used for blast-furnaces and similar work. They are not well adapted for ventilators or for any other purposes requiring large quantities of air at comparatively low pressures.

175. The Theoretical Work of Moving Air.—The work performed by the fan is made up of the resistance due to moving

and compressing a definite amount of air, and can always be considered as equivalent to moving a given weight of air through a height or head which is equivalent to the sum of the velocity and pressure heads expressed in feet of air at the density corresponding to the air after being compressed.

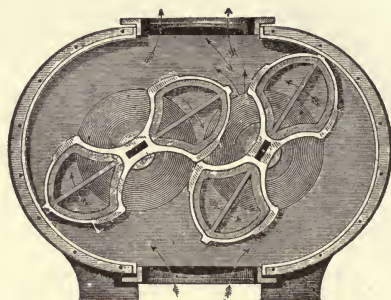

FIG. 250.—Section of the Connessville Positive Blower.

For the low pressure required for the ventilation of buildings the work of compression is only a small part of one per cent of the total work and is neglected in the following formulas:

Let Q = volume of air in cubic feet per minute,
 d = weight of air, in lbs. per cubic foot,
 d' = weight of water, in lbs. per cubic foot,
 h = pressure head in feet of air against which air is moved,
 h' = pressure head in inches of water against which air is moved.

Work = force \times distance = weight \times height = $Qd \times h$.

$$\text{H.P.} = \frac{\text{work in ft.-lbs. per minute}}{33,000} = \frac{Qd \times h}{33,000} = \frac{Qd \times \frac{h'}{12} \times \frac{d'}{d}}{33,000}.$$

d' may usually be taken as 62.4 without appreciable error, which gives

$$\text{H.P.} = \frac{Qh'}{6347} = 0.0001575Qh'.$$

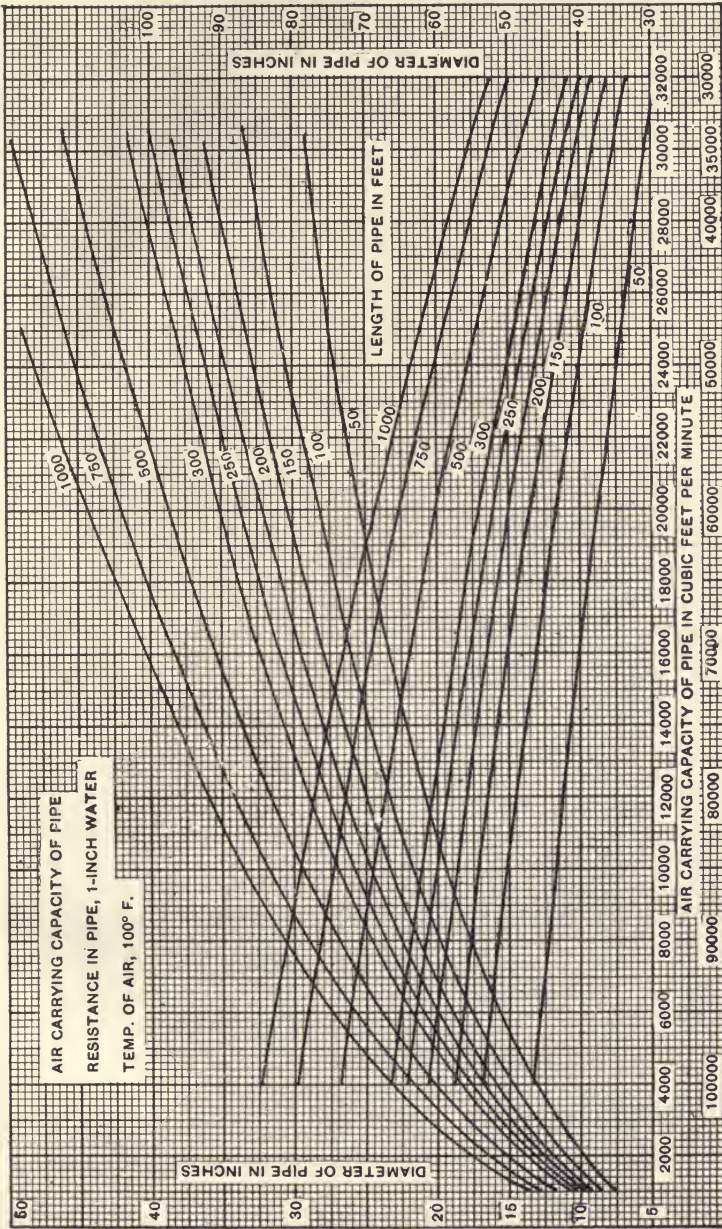

FIG. 251.—Diagram Showing Discharge of a Circular Pipe.

This equation shows that the work done in moving air is independent of the density, but this is not exactly true in

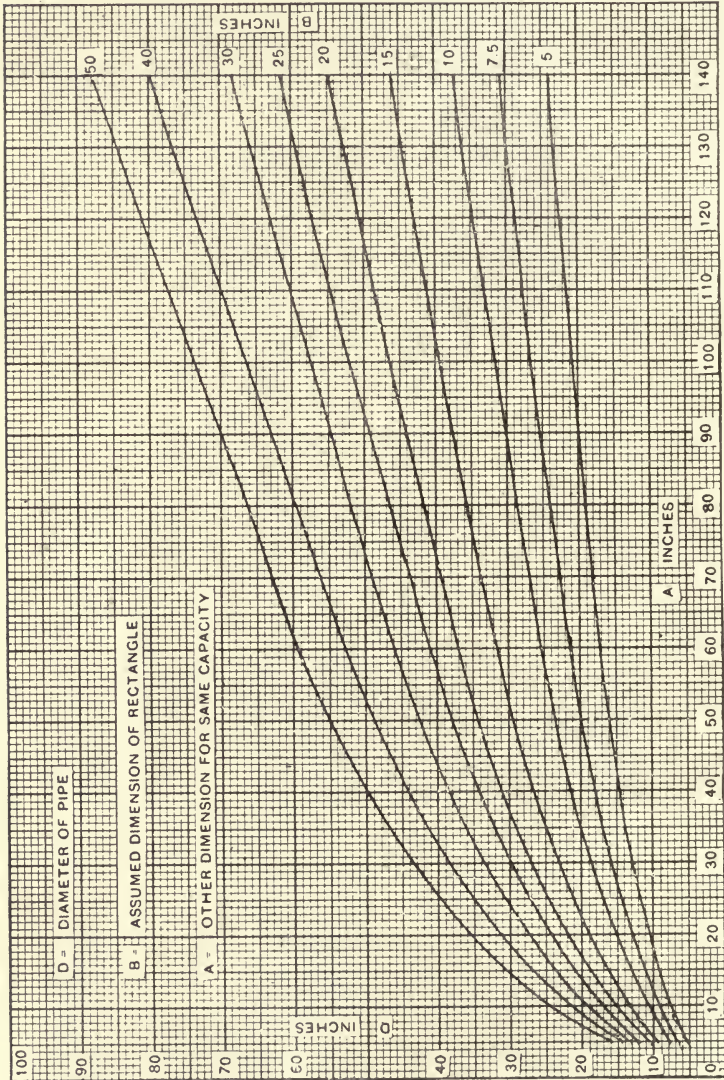

FIG. 252.—Diagram showing Dimensions of Rectangular Pipe with Capacity Equivalent to that of a Given Circular Pipe.

practice as the speed of the fan must be increased as the density of the air decreases, and a little more is lost in friction.

176. **Work of Moving Air through Pipes.**—To the work needed for moving the required volume of air at the desired velocity must be added that which is necessary to overcome the resistance in the fan and in the various pipes or flues. As previously explained, the loss of head due to friction in a circular pipe can be expressed by the formula

$$h = 4\xi \frac{l}{d} \frac{v^2}{2g}$$

in which h = loss of head in feet of air, d = diameter in feet, l = length in feet, v = velocity in feet per second.

Let p = loss of head expressed in ounces per square inch; d' = diameter in inches; $2g = 64.32$; $4\xi = 0.025$. We have

$$h = 115p \text{ at } 50^\circ \text{ F.};$$

$$p = \frac{lv^2}{(2573 \times 115) \frac{d'}{12}} = \frac{lv^2}{24646d'} = \frac{lv^2}{25000d'}, \text{ nearly,}$$

which is the formula representing the loss of pressure in a pipe of galvanized iron carefully made and erected, with all internal laps extending in the direction of the air movement, assumed in the work on "Mechanical Draft," published by the B. F. Sturtevant Co., Boston.

The work done in overcoming friction, expressed in foot-pounds per second, is equivalent to the resistance, expressed in pounds, multiplied by the space passed through in one second of time. If F denote the area of cross-section, p the resistance per square inch in ounces, then $\frac{Fp}{16}$ will equal the total resistance in pounds; if v denote the velocity in feet per second, it will equal space passed through in one second. Hence the work done in one second will equal $\frac{Fpv}{16}$; this result divided by 550 will equal the horse-power, P :

$$P = \frac{Fpv}{8800}$$

From these two formulas can be calculated the drop or loss in pressure in ounces in a given pipe-line, and also the horse-power required to overcome the resistance of moving air at the given velocity through the given pipe.

Table No. XXIII in the Appendix gives such values for the principal pipe sizes and for a length of pipe equal to 100 feet. For any other length multiply the results in the table by $\sqrt[3]{\frac{L}{100}}$ the square root of the given length in feet, for the reason that the work required varies as the square root of the length.

177. Dimensions of Pipe-lines for Air.—Formulas for computing the flow of air through a pipe under various conditions have been fully discussed. For practical use Table No. XXV in Appendix has been computed, which gives the diameter of circular pipe, also the corresponding side of a square pipe, for a given discharge in cubic feet per minute and a given length, with a drop in pressure equal to an inch of water-column (0.58 ounces per square inch) and a temperature of 100° F. The relation of the discharge to the diameter of a circular pipe is also shown in the diagram Fig. 251, in which the ordinates give the diameter of pipe corresponding to a given discharge represented as abscissa, the varying lengths of pipe-lines being distinguished by different lines. The scale on the left corresponds to the lines inclined upward to the right and to the upper scale at the bottom, that on the right to the lines inclined upward to the left and to the lower scale at the bottom. To use the diagram, suppose it be required to find the diameter of a circular pipe whose length is 500 feet and whose capacity must be 20,000 cubic feet of air per minute; find intersection of vertical line from 20,000 with *upper* line marked 500, thence horizontally to the scale at the left, which is intersected at a point corresponding to the required diameter, which by interpolation is found to be 38.5 inches. If the capacity is to be 90,000 cubic feet per minute and length 100 feet, find the intersection of vertical from 90,000 with lower line marked 100, and read diameter on right, which will be found to be 52 inches.

The flow of air through other than circular pipes has not

been discussed in this work; it is known, however, that for any pipe the resistance to the flow varies as the mean hydraulic radius, a quantity equal in every case to the area of cross-section divided by the perimeter which is subjected to friction; for a circular pipe this becomes one-fourth part of the diameter, for other cases it must be computed.

From this relation we have constructed a diagram or chart, Fig. 252, which enables a designer to select a rectangular pipe having dimensions which give a carrying capacity equal to a known circular pipe, it being supposed that one of the required dimensions of the rectangular pipe is known.

In the diagram Fig. 252 the diameter of the known circular pipe is given as ordinate, corresponding to the scale at the left; one of the dimensions of the equivalent rectangular pipe is given as abscissa, the other is denoted by a series of lines corresponding to the scale at the right. Thus to find a rectangular pipe with the same carrying capacity as a 30-inch circular pipe, one dimension of which shall be 40 inches, we find the intersection of the horizontal line from 30 on the scale at the left with the line marked 40 on the scale at the right; the result read on the bottom scale is 19, which indicates that a rectangular pipe with dimensions of 19×40 inches is equivalent in capacity to a circular pipe with a diameter of 30 inches.

The results of a series of tests carried out at the Government Testing Plant at Washington under the supervision of Naval Constructor D. W. Taylor to determine the head lost in friction of air moving through pipes gave the following results:

Coefficient of friction, f , constant for different sizes and velocities and having values for galvanized iron pipe from 0.00008 to 0.0001 depending upon the alignment and surface of duct, which are to be substituted in the following standard formula:

$$H_r = 4f \frac{l}{d} v^2 \text{ for square and round pipes,}$$

$$H_r = 4 \frac{1+n}{n} f \frac{l}{h} v^2 \text{ for rectangular pipes having sides } h \text{ and } nh.$$

161. Formulas for the Approximate Dimensions and Capacities of Fans.—There are formulas in more or less general use which give the relations of capacity to proportions with sufficient accuracy for ordinary use.

D = outside diameter of impeller, in feet,
 W = width of impeller at periphery, in feet,
 D_1 = diameter of inlet, feet,
 Q = capacity, cubic feet of air per minute,
 h = effective head in feet of air,
 h' = effective head in inches of water,
 V = velocity of air corresponding to h ,
 V' = peripheral velocity in feet per minute,
 v = peripheral velocity in feet per second,
 A = blast area in square feet.

In any centrifugal fan the effective static pressure produced when the outlet is closed should be equal to $v^2 \div 2g$, which is the pressure due to the centrifugal force. This would be exactly true in every case regardless of the shape of vanes if there were no leaks and the air had a uniform angular velocity of rotation entirely to centre of impeller. If the outlet be slowly opened while fan is running, the pressure due to centrifugal force, as given above, will be partially utilized in overcoming friction in fan and in giving the radial component of the velocity of the air passing through impeller, but at the same time a new source of pressure comes into existence, since the head corresponding to the velocity at which the particles are discharged from impeller may be converted into pressure. For radial vanes, the maximum value for the pressure due to the tangential component of the velocity of the particles leaving vanes is also equal to $v^2 \div 2g$. The sum of the maximum values of these two pressures is $v^2 \div g$, which is often termed the theoretical head, but it is apparent that this value is not obtainable from any radial vane fan because the two conditions necessary cannot exist at the same time.

For fans of the steel plate type having vanes approximately radial, the effective pressure may be safely taken as

$$h = \frac{v^2}{2g}, \quad \dots \dots \dots (1)$$

which for air weighing 0.075 and water 62.4 lbs. per cubic foot gives

$$v = 4000\sqrt{h'} \text{ (nearly)}, \quad \dots \dots \dots (2)$$

$$\pi DN = 4000\sqrt{h'},$$

$$h' = \frac{\pi^2 D^2 N^2}{(4000)^2} = 0.000000616 D^2 N^2. \quad \dots \dots \dots (3)$$

A well known fan of the multivane type having vanes curved forward, making an angle of $22\frac{1}{2}^\circ$ with the tangent at periphery, gives 48% greater pressure for the same peripheral speed or may be operated 17.5% slower to give the same pressure as a radial vane fan.

The efficiency of the steel plate fan decreases as the diameter of the inlet increases, and it has been found that fans having inlets proportioned according to the following formula give good results,

$$D_1 = n\sqrt{\frac{Q}{N}}. \quad \dots \dots \dots (4)$$

For steel plate fans make $n = 0.93$ for single inlet,
 $n = 0.74$ for double inlet.

The blast area is the ratio of the capacity to the velocity in feet per minute corresponding to the effective pressure, and is a term of the same general nature as the equivalent orifice used by Murgue.

$$\text{Blast area } A = \frac{Q}{V}.$$

This ratio bears a definite relation to the dimension of a fan which is constant for all fans of the same relative proportions

$$\frac{Q}{V} = \frac{DW}{m} \dots \dots \dots (5)$$

For steel plate fans, $m = 3$, and for $V = V' = \pi DN$.

$$Q = \frac{\pi D^2 NW}{3} = 1.047 D^2 NW \dots \dots (6)$$

For the multivane fan mentioned above,

$$m = 1.87 \text{ and } V = 1.215 V' = 1.215 \pi DN,$$

which gives

$$Q = \frac{1.215 \pi D^2 NW}{1.87} = 2.04 \pi D^2 NW.$$

Experiments show that well constructed fans of the steel plate type having inlet proportioned as in (4) will have efficiencies bearing approximately the following relation to the ratio $\frac{D_1}{D}$ as shown by experiments.

$\frac{D_1}{D}$	Efficiency. Per cent.
0.40	62
0.50	57
0.60	51
0.70	44
0.80	36

The power required to operate a fan may be determined by dividing the power required to move air as computed from a formula given in Art. 171 by the efficiency of fan, which for steel plate fans may be taken as 45% for the average size of fan used in the ventilation of buildings.

$$v = e.u \dots \dots \dots (6)$$

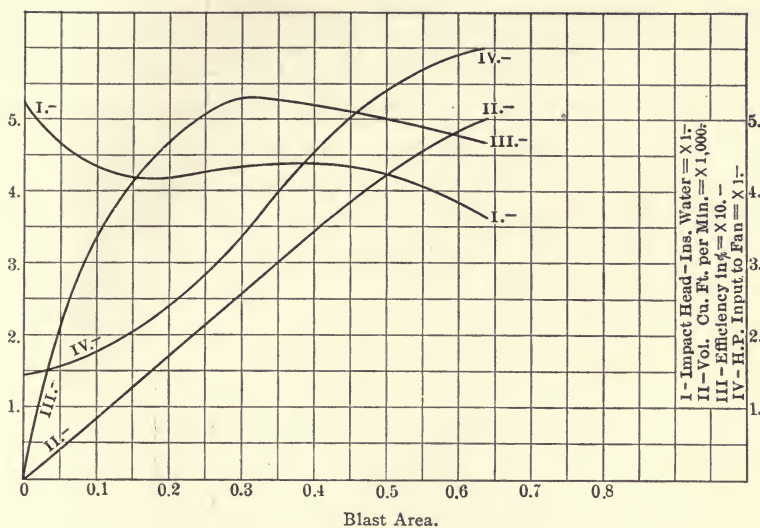

FIG. 253.—Test of Sirocco Fan No. 2 1/2.—(Square outlet 10" X 10".)

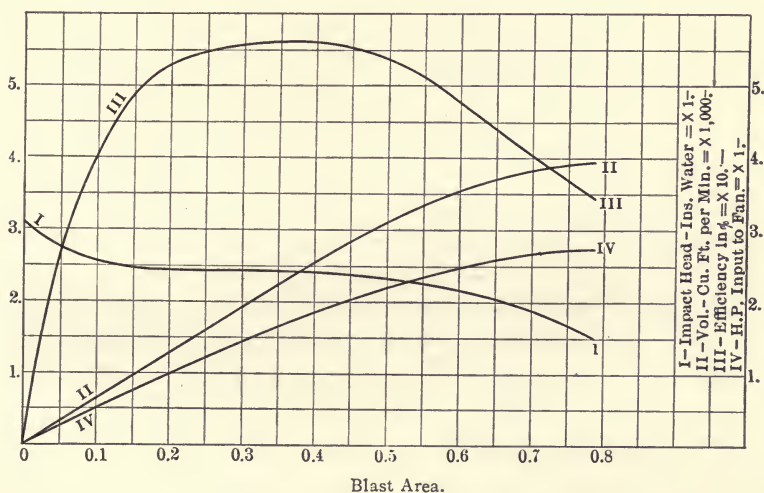

FIG. 254.—Test of Sturdevant Multivane Fan.—(Circular outlet 12 1/2" diameter.)

178. **Characteristic Curves of Multivane Fans.**—The characteristic curves for the Sirocco Fan No. 2 1/2 and the Sturdevant multivane fan were obtained from tests made at

Sibley College under the author's direction by Prof. W. M. Sawdon and Mr. T. B. Hyde. The results are here plotted against the equivalent orifice or the blast area, which is the volume of air delivered divided by the velocity corresponding to the total or the impact head. By using this method the characteristic curves of the blower are put on an equal basis for comparison with other blower tests, under different conditions as to blower sizes and piping conditions.

The scales used in plotting these curves are multiplied by 1000 to get the volume of air and by 10 to get the efficiency

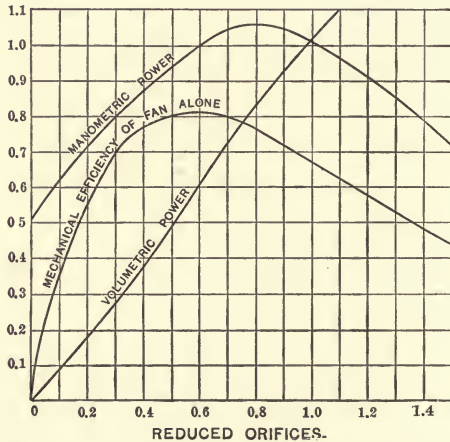

FIG. 255.—Characteristic Curves of Rateau Fans.

in per cent. For instance with the Sirocco fan, taking a blast area of 0.5, then Curve I reads directly as $4\frac{1}{4}$ inches of water impact head, and Curve II reads 4.25×1000 or 4250 cubic feet of air per minute, and Curve III reads 5×10 or 50% efficiency of the fan, while Curve IV reads directly as 5.85 horse-power input to drive the fan.

Professor Rateau has modified the Murgue theory by substituting Q/\sqrt{gh} for the value of the equivalent orifice $Q/0.65\sqrt{2gh}$, this being done in order to simplify the intermediate computations, the results except for the value of the coefficients being otherwise the same. Rateau also used a

“reduced orifice” (b) as equal to the equivalent orifice divided by the square of the external radius, r , of the fan inlet; that is, $b = \frac{Q}{r\sqrt{gh}}$. He uses the term “manometric power,” M , as equal to gh/u^2 , in which u is the peripheral velocity of the fan. In accordance with Rateau’s notation a fan may be represented by an equation of the following form, where s , t , and u are constants depending upon the construction

$$\frac{1}{M} + \frac{so}{\sqrt{M}} + to^2 + u = 0.$$

In a series of tests made by Mr. Brian Donkin the following values of these constants were found:

Number of Fan.	Value of Constants.		
	s	t	u
VIII	0.136	14.18	1.690
VI	0.192	5.85	1.666
X	2.43	13.55	1.755
XI	10.05	126.4	3.51

The characteristic curve of the Rateau fan, Fig. 248, is shown in Fig. 255, which gives the manometric power and various efficiencies for a series of reduced orifices.

179. Maximum Pressure Produced by a Fan or Blower.—

This quantity corresponds to the initial depression in Murgue’s theory and is obtained only at the time when the work imparted to the fan is all utilized in overcoming resistances, as, for instance, in a pressure fan when the discharge opening is entirely closed. For this case, if there is no loss of energy due to eddies or other resistances, we shall find, since the work done is equal to the weight moved or the pressure H overcome in one second multiplied by the space, that

$$H\left(\frac{1}{2}u\right) = W\frac{u^2}{2g},$$

from which

$$H = W \frac{u}{g}$$

But $W = cFu$, hence

$$H = cF \frac{u^2}{g}$$

and we have for unity of volume and area, since Q and F each = 1,

$$H = \frac{u^2}{g} \dots \dots \dots (7)$$

From the last equation it is noted that the maximum pressure produced may be equal to twice that due to the head producing the same velocity which is the same result as obtained by Murgue.

MAXIMUM PRESSURE DUE TO SPEED OF FAN.

Speed of Periphery of Fan, Ft. per Sec.	Difference of Pressure, Inches of Water.	Speed of Periphery of Fan, Ft. per Sec.	Difference of Pressure, Inches of Water.	Speed of Periphery of Fan, Ft. per Sec.	Difference of Pressure, Inches of Water.
49.21	1.08	77.10	2.66	98.75	4.36
50.19	1.13	78.41	2.75	100.08	4.48
52.82	1.25	80.05	2.87	101.71	4.63
55.12	1.36	82.02	3.00	103.02	4.75
58.07	1.51	83.01	3.08	104.33	4.87
60.04	1.61	85.30	3.26	105.30	5.05
62.67	1.76	86.62	3.36	107.28	5.15
64.96	1.89	88.58	3.51	108.27	5.24
66.93	2.00	90.55	3.66	109.58	5.37
70.21	2.20	91.86	3.77	110.89	5.50
72.50	2.35	94.49	3.99	112.53	5.63
74.80	2.50	96.13	4.13	113.85	5.76
75.79	2.57	97.77	4.27	114.50	5.87

In general the increase in pressure produced will always be less than the theoretical, if we denote the coefficient indicating this ratio by K . Then for the case when velocity of discharge is zero, we have

$$H' = \frac{Ku^2}{g} \dots \dots \dots (8)$$

The actual increase of pressure produced will be lessened by increasing the velocity of discharge, as indicated by the formula,

$$h = \frac{Ku^2}{g} - \frac{v^2}{g} \dots \dots \dots (9)$$

For dimensions of outlet, F , less than or equal to those of the inlet, F_0 , we have as nearly true

$$v^2 = Ku^2 \left(1 - \frac{F}{F_0} \right)^2.$$

Substituting this value in the preceding equation, we have for the resultant pressure-head in feet of air

$$h = \frac{Ku^2}{g} \left(1 - \frac{F}{F_0} \right)^2.$$

For the pressure expressed in any other units the results must be divided by the ratio of the weight of the unit desired to that of one foot of air. Call this ratio δ ; then we will have for maximum pressure in the desired unit

$$H = \frac{Ku^2}{\delta g} \dots \dots \dots (10)$$

The table on page 376 gives values of relative density δ expressed in feet and inches of water, the barometer being 29.92 inches. The value of the coefficient K will depend upon the construction of the fan, the casing, and chimney; but, as shown by Murgue, its value for an uncovered exhaust fan cannot exceed 50 per cent. Its value varies greatly with different fans and with the area of discharge opening; it was found by experiments by Buckle to have an average value, for ventilating-fans, of 0.617, in which case the equation (8) becomes

$$H = 0.617 \frac{u^2}{g} \dots \dots \dots (8')$$

RELATIVE WEIGHT OF WATER AND AIR.

Temperature.		Weight per Cubic Foot.		δ in the Formula.	
				Feet of Air Balanced by Water-column of	
Degrees. Fahrenheit.	Degrees. Centigrade.	Water.	Air.	1 Foot.	1 Inch.
32	0	62.42	0.0864	722.4	60.2
41	5	62.42	0.0793	789.3	65.8
50	10	62.41	0.0771	801.2	66.7
59	15	62.38	0.0765	815.5	67.9
68	20	62.33	0.0752	828.8	69.1
77	25	62.26	0.0740	841.3	70.1
86	30	62.17	0.0728	854.0	71.2
95	35	62.08	0.0717	865.8	72.2
104	40	61.97	0.0704	880.2	73.3
113	45	61.85	0.0693	894.2	74.5
122	50	61.70	0.0682	904.7	75.4
131	55	61.54	0.0672	975.8	81.3

Considering the weight of one cubic foot of air as .08 pound, the following equations will show the relation of the velocity of the tips of the blades to the pressure in Buckle's formula:

$$\text{When } p = \text{pounds per square inch, } u = 310\sqrt{p}.$$

$$\text{When } p_1 = \text{ounces per square inch, } u = 80\sqrt{p_1}.$$

$$\text{When } h_1 = \text{inches of mercury, } u = 220\sqrt{h_1}.$$

$$\text{When } h_2 = \text{inches of water, } u = 60\sqrt{h_2}.$$

The table on page 378 shows the relation of the peripheral velocity of the fan to the pressure produced, computed from the formulas as given above. The table will be found to give lower pressures than the maximum actually produced with most fans when the outlet is closed, hence it can be considered a safe one to use. It is to be noted that this table gives the pressures only when the fan is operating to deliver a small volume of air. To determine the pressure when the outlet has an area F , and the inlet an area F_1 , multiply the tabular results by $1.62\left(1 - \frac{F}{F_1}\right)^2$.

The effect of varying the area of discharge outlet is shown in the diagram Fig. 256, which shows the pressure in inches of water produced by a speed of 500 revolutions per minute in three different fans, each having a fan-wheel 4 feet in diameter and an inlet 22 inches in diameter. In one case the blades were radial, in another case bent forward, and in a third case bent backward. It will be noted that the highest readings obtained when the outlet was closed agreed very closely with

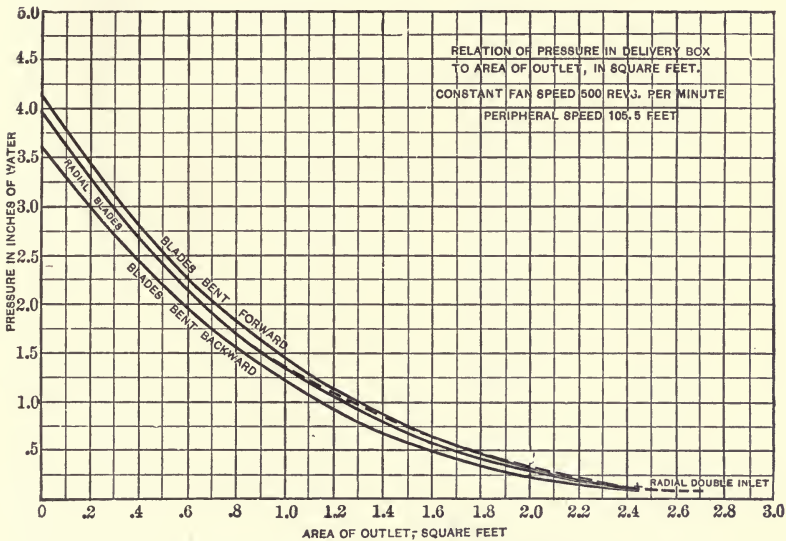

FIG. 256.—Relation of Pressure to Area of Outlet.

the results given in the table by Murgue, $H = \frac{\mu^2}{\delta g}$, and are considerably greater than in Buckle's table given above.

180. **The Velocity and Volume.**—The velocity of air in feet per second discharged from fan will be, in accordance with the notation used,

$$v = eu = 2\pi eRn = \pi Den,$$

and that entering

$$v' = iv = eiu = 2\pi Rein = \pi Dein. \quad \dots \quad (11)$$

PRESSURE CORRESPONDING TO VARIOUS PERIPHERAL VELOCITIES
OF FAN. (BUCKLE'S FORMULA.)

Allowance made for Increased Density of Air.

Peripheral Velocity.		Pressure Produced.	
Feet per Second.	Feet per Minute.	Ounces per Square Inch.	Inches of Water.
1	60	0.000156	0.000269
5	300	0.0039	0.0068
10	600	0.0156	0.0269
15	900	0.035	0.061
20	1,200	0.062	0.107
25	1,500	0.098	0.167
30	1,800	0.140	0.281
40	2,400	0.250	0.430
50	3,000	0.38	0.65
60	3,600	0.52	0.89
70	4,200	0.73	1.26
80	4,800	0.96	1.65
90	5,400	1.21	2.08
100	6,000	1.49	2.57
110	6,600	1.78	3.07
120	7,200	2.11	3.63
130	7,800	2.46	4.24
140	8,400	2.83	4.87
150	9,000	3.23	5.57
160	9,600	3.67	6.32
170	10,200	4.16	7.14
180	10,800	4.70	8.09
190	11,400	5.29	9.15
200	12,000	5.93	10.20
210	12,600	6.59	11.34
220	13,200	7.27	12.51
230	13,800	7.97	13.78
240	14,400	8.69	14.97
250	15,000	9.41	16.19
260	15,600	10.17	17.49
270	16,200	10.95	18.84
280	17,000	11.75	20.25
290	17,600	12.56	21.61
300	18,000	13.39	23.04

The cubic feet of air supplied per second will equal circumferential inlet velocity multiplied by area of cross-section of fan inside of the vanes:

$$\begin{aligned}
 Q &= v'b'\pi d = ivb'\pi d = eiub'\pi d = ei\pi Db'\pi dn \\
 &= (\pi^2 ei)(Ddb')n. \quad (12)
 \end{aligned}$$

181. Work Required to Run a Fan.—The work is equal to the square of the velocity as expressed in (11) multiplied by the mass moved, which in turn is equal to the weight divided by twice the force of gravity ($2g$). That is.

$$\left. \begin{array}{l} \text{Useful work in foot-} \\ \text{pounds per second} \end{array} \right\} T = \frac{1}{2} Mv^2 = \frac{W}{2g} v^2 = \frac{cQv^2}{2g} = \frac{cQe^2u^2}{2g}.$$

Substituting in above $Q = e i u b' \pi d$,

$$T = \frac{c i \pi}{2g} b' d e^3 u^3. \quad (13)$$

Substituting in above $u = \pi D n$, we have

$$T = \frac{c i \pi^4}{2g} b' d D^3 e^3 n^3, \quad (14)$$

from which it would appear that the work to drive a fan will increase with the cube of the number of revolutions.

182. Application of Theory.—The equations which have been given are general ones applying to all centrifugal fans regardless of form of blade or of entrance and admission passages. From equation (11) it is noted that the velocity of the discharge-air varies with the velocity of the tips of the blades. The value of the coefficient e depends on the pressure which opposes the delivery of the air, the velocity of the fan, and probably also on the form of blades. For fans working against a pressure of about 1 ounce per square inch or about 1.73 inches of water this coefficient seems from practical data to be about 0.32, increasing to 0.4 or 0.5 with free delivery.

In the ordinary construction of ventilating-fans the width b' and inlet diameter d are usually taken in a fixed proportion to the external diameter of the fan-wheel D , as noted in the table of proportions, and so that the product of $b'd$ will equal 0.2 to 0.25 D^2 .

Substituting in equation (12) the following values for the coefficients:

$$\pi^2 = 9.94 = \text{nearly } 10;$$

$e = 0.4$, average velocity of discharge air to periphery velocity;

$i = 0.6$ coefficient of supply to inlet;

$$db' = 0.2D^2, —$$

$$Q = .48D^3. \dots \dots \dots (15)$$

By actual experiment this coefficient is found to vary with change in resistance, as explained later, from 0.3 to 0.6.

If we substitute the value of the above coefficients in equation (14), and also the value of $c = 0.8$, and divide by 550, we have, as a value of work performed reduced to horse-power,

$$T = 0.000012(D^5n^3) \text{ very nearly.} \dots \dots (16)$$

The above results are for a fan working with a moderate resistance, and in practice the last coefficient will vary, being less as the resistance is greater; it is approximately correct when the delivery pressure is one ounce per square inch, and decreases for higher pressures and increases for lower pressures, being in both cases essentially as expressed in the following rules:

183. Practical Rule for Capacity.—By referring to formula (12) it is noted that the capacity is equal to the product of the constants multiplied by width of wheel, diameter of inlet, and by diameter of fan-wheel into the number of revolutions. Since, in accordance with common practice, the last three proportions are varied together, we shall have as a practical rule for determining the capacity of fans with proportions similar to above the following:

RULE.—*The capacity of fans, expressed in cubic feet of air delivered per minute, is equal to the cube of the diameter of the fan-wheel in feet multiplied by the number of revolutions, multiplied by a coefficient having the following approximate value:*

For fan with single inlet delivering air without pressure, 0.6; delivering air with pressure of 1 inch, 0.5; delivering air with pressure of 1 ounce, 0.4. For fans with double inlets the

coefficient should be increased about 50 per cent. For practical purposes of ventilation the capacity of a fan in cubic feet per revolution will equal 0.4 the cube of the diameter in feet.

184. Practical Rule for Power.—*The delivered horse-power required for a given fan or blower is equal to the fifth power of the diameter in feet, multiplied by the cube of the number of revolutions per second, divided by one million, and multiplied by one of the following coefficients: For free delivery 30, for delivery against one ounce of pressure 20, for delivery against two ounces of pressure 10.*

As an example showing application of rules, find the capacity in air delivered and horse-power required for a blower working against a pressure of 1 ounce and provided with a wheel 5 feet in diameter and of usual proportions, running at 300 revolutions per minute, or $300/60 = 5$ per second.

The capacity equals $(5 \times 5 \times 5)(0.4)(300) = 15,000$ cubic feet per minute.

The horse-power equals

$$\frac{(5 \times 5 \times 5 \times 5 \times 5)(20)}{1,000,000} \frac{(300 \times 300 \times 300)}{60 \times 60 \times 60} = 7.81.$$

If the speed should be doubled, the horse-power needed would be increased eight times, provided the relative resistance remained the same. It should be noted that the horse-power as given by the above rule is that delivered to the fan, and in reckoning the amount to be supplied, it should be increased an amount sufficient to cover any loss by friction in the motor and transmission mechanism.

185. Tests Which Verify the Rules.—This extremely simple rule for capacity agrees very closely with an extensive series of experiments made on different fans, with proportions approximately those given. Thus, for instance, in a test made of a fan-wheel 5 feet diameter, running at 300 revolutions per minute at Wheeling, W. Va., the air discharged was 16,446 cubic feet per minute against a pressure of about 1.0 inch. By the rule just stated the discharge would be $0.4 \times$

$125 \times 300 = 15,000$, an amount 10 per cent less but still within the limits of error of measurement of air. In another test a fan of 4 feet 6 inches diameter when running at 310 revolutions gave a discharge of 11,651 cubic feet per minute under working conditions. The rules as stated above would give a delivery of 11,284 cubic feet per minute.

In another case the test of an American blower-fan 18 inches diameter, working against a pressure of 1.1 inches of water, delivered 1368 cubic feet per minute; by the rule given it should deliver 1394 cubic feet per minute.

The simple rule stated for capacity, while approximate and applying only to fans of essentially the same proportions as those mentioned and when working under the conditions described, will still be found very useful. For fans of materially different proportions working under higher pressures the rule will not apply even approximately.

Experiments by the author with a fan 4 feet in diameter give the following coefficients for capacity and horse-power:

Pressure above Atmosphere per Square Inch.		Coefficient for Capacity.	Coefficient for Horse-power.
Inches of Water.	Ounces.	(a)	(b)
0	0	0.60	0.30
0.5	0.29	.56	.27
1.0	0.59	.50	.25
1.72	1.0	.40	.20
2.0	1.18	.35	.16
3.74	2.0	.30	.10

The table on page 383 gives results of tests of two fans used in heating the Veterinary Building at Cornell University.

186. Relative Efficiency of Fans or Blowers and of Heated Flues.—Fans or blowers are usually driven by steam-engines of a medium or poor grade, and as they must be considered in connection with the motive power for a fair comparison, they do not present the most efficient method of transforming heat into mechanical work. The very best engine constructed would develop about a horse-power for a consump-

	Large Fan.	Small Fan.
Diameter of wheel, inches		
Width at centre, inches	36	18
Diameter inlet, inches	54	28
Discharge opening, inches	40×42	22×22
Diameter engine cylinder, inches	19	6
Length of stroke, inches	8	8
Heating surface; lineal feet, total	4,770	1,980
“ “ “ “ heater	3,816	1,584
“ “ “ “ tempering coil	954	396
Lineal feet per cubic foot heated	12.7	28.02
Cubic feet of air per minute	21,000	5,180
Lineal feet of pipe in heater, per cubic foot of air	4.5	3.28
Pressure in ounces	0.875	0.034
Revolutions engine per minute	220	201
Revolution of fan	200	402
Indicated horse-power	8.6	2.5
Delivered horse-power, actually found	5.5	1.51
Steam pressure, pounds	22	22
Temperature outside air	34	34
Temperature of room	70	70
Temperature of warm air	80	136
Heat supplied per minute B.T.U.	4,560	5,180
Heat per lineal foot of pipe, B.T.U. per hour	58.8	195.6
Pounds of steam, per square foot of heating surface per hour	0.17	0.61
Cubic feet of space heated	121,724	56,732
Changes of air per hour	10.1	5.5

tion of 1.25 pounds of coal per hour under the boiler, which would correspond to an efficiency of transformation of heat into work of about 12 per cent. The engine ordinarily employed for driving blowers is of the simple non-condensing type, using about 40 pounds of steam per horse-power hour and requiring per horse-power from 5 to 8 pounds of coal to be burned under the boiler per hour; its thermal efficiency is from 2 to 4 per cent, perhaps averaging not far from 3 per cent.

Quite an extensive series of experiments on different fans and blowers have been conducted by the author in Sibley College, Cornell University. These have shown that the efficiency of fans under usual conditions may vary between 10 and 40 per cent, and under best conditions may rise to 50 per cent.

A blower with an efficiency of 10 per cent, operated by

an engine having an efficiency of 3 per cent, would constitute a plant with a joint efficiency of 0.3 of 1 per cent; this may be considered as the poorest case likely to be found in practice. The joint efficiency of engine and blower would probably be about 1.2 per cent in average practice, and about 2.5 per cent in the best cases likely to be found. In many cases all the steam exhausted from the engine may be used for heating or other useful purposes, which would make the joint efficiency from twenty to thirty times that mentioned above.

The following mathematical principles may be applied: Thus let r equal that percentage of heat in the coal burned under the boiler which is converted into mechanical work by the engine, f that percentage of the indicated horse-power of an engine which is utilized in moving the air, R the total available heat in B.T.U., T and T' the absolute temperature, inside and outside the chimney.

The total useful work performed by a fan or blower will then be

$$W_f = 778rfR, \dots \dots \dots (1)$$

in which the efficiency of the engine and blower combined is denoted by rf .

The ratio of the useful work done by the same coal in operating an engine and a fan to that done by heating a chimney for discharging air at the top will be found by dividing the above equation by the mechanical work done in a chimney (see equation (c), page 55, in which $c = .238$):

$$W_a = \frac{Rh}{cT} \dots \dots \dots (2)$$

$$R_f = \frac{W_f}{W_a} = \frac{778cTrf}{h} = \frac{185.2Trf}{h} \dots \dots \dots (3)$$

1st. Consider $rf = 0.003 =$ the assumed lowest value, the outside temperature = 60° , so that $T = 60 + 460 = 520$ in all cases; then

$$R_f = \frac{288}{h} \dots \dots \dots (4)$$

2d. Take $rf=0.012$, the average value; then

$$R_f = \frac{1155}{h} \dots \dots \dots (5)$$

3d. Take $rf=0.025$ per cent, the highest value when the exhaust steam is not used; then

$$R_f = \frac{2400}{h} \dots \dots \dots (6)$$

4th. For the case when the exhaust steam may be utilized or the fan can be driven by shafting, r may equal 80 per cent, $f=35$ per cent, and $rf=28$ per cent, for which case

$$R_f = \frac{27,000}{h} \dots \dots \dots (7)$$

From the above formulas it is noted that the relative efficiencies of fan and blower would be about equal for the case of the most inefficient fan and engine were the chimney 288 feet high; for the average case they would be equal when the chimney was 1155 feet high, and for the best case when the chimney was 2400 feet high. From this it appears that the fan and engine under average conditions are from three to twenty-four times as efficient as a chimney 100 feet high. In all the above cases the delivery of air from the top of the chimney is considered.

A fan is frequently used to draw air by suction as well as to deliver it by increase of pressure; and as the air entering the fan is seldom heated to any great extent, the work of a fan under usual conditions is fairly comparable with that of delivering cold air into a chimney. For this case the ratios of efficiencies will be found by dividing formula (1) by formula (e), page 56, for supply of air to a chimney, $W_e = \frac{RhT}{cT'^2}$:

$$R_c = \frac{W_f}{W_e} = \frac{778crfT'^2}{hT} = \frac{185.2rfT'^2}{hT} \dots \dots \dots (8)$$

When the outside temperature is 60° , T equals 520° , which will be used in all cases.

Substituting $rf = 0.003$, we have for the most inefficient fan and engine

$$R_e = \frac{0.001065T^2}{h} \dots \dots \dots (9)$$

Substituting other values of rf as before, values may be found for the average and best quality of fan and engine. For these last conditions the relative efficiency depends upon the square of the absolute temperature directly and on the height of the chimney inversely.

Attention has been called to the extremely wasteful results which characterize the movement of air by heat, as in a chimney. From this it may be deduced at once that any mechanical appliance, even with a moderate efficiency, would be many times more economical for moving air than a chimney. This is rather more remarkable since mechanical appliances for moving air at low pressures, as is usually required in ventilation, have a comparatively low efficiency and seldom make use of more than 25 per cent of the power applied. Even, however, considering the case when the efficiency is very low, we shall still find the mechanical appliance usually much less wasteful for moving air than when heat is applied directly in a chimney. Thus considering the case when the total efficiency of the heat applied to drive a steam-engine and all the intermediate machinery for mechanically moving the air to be .6 of 1 per cent, we shall have the mechanical method of ventilation as many times more economical than the chimney as shown in the table on page 387.

The foregoing discussion shows that mechanical ventilation as usually conducted is much more efficient than that which may be obtained with heat applied directly to a chimney; consequently the cost of obtaining ventilation by mechanical means is many times less than by use of a heated chimney.

While the truth of the conclusions regarding the relative efficiency of ventilation by mechanical means or by a chimney

cannot be questioned when fuel has to be burned for this special purpose, yet it should be noted that in many cases a heated chimney is available without extra cost or, from the character of the building, is the only kind of ventilation permissible; for such cases it is to be adopted as preferable to mechanical ventilation.

TABLE SHOWING NUMBER OF TIMES MECHANICAL VENTILATORS ARE MORE EFFICIENT UNDER AVERAGE CONDITION THAN A CHIMNEY DISCHARGING AIR FROM A ROOM.

Temperature of Chimney, Fahr.	80°	100°	150°	200°	250°	300°	400°	450°
Height of Chimney, Ft.	Ratio of Efficiency.							
10	68.4	73.4	87.3	102	118	135	173	194
20	34.2	36.7	43.6	51	59	67	86	97
30	22.8	24.5	29.1	34	39	45	57	65
40	17.1	18.3	21.8	24	29	34	44	48
50	13.7	14.7	15.4	20	24	27	35	39
60	11.4	12.2	14.5	17	19	22	28	32
70	9.8	10.5	12.8	15	17	19	25	28
80	8.5	9.2	10.9	12	15	17	22	24
90	7.6	8.1	9.7	11	13	15	17	21
100	6.8	7.3	8.7	10	12	13.5	15.3	19.4
125	5.4	5.9	7.0	8.1	9.5	10	13.9	15.5
150	4.6	6.1	5.1	6.7	8.0	9.0	11.7	13
175	3.9	4.2	5.0	5.8	6.7	7.7	9.9	11.1
200	3.4	3.6	4.4	5.1	6.0	6.7	8.6	9.7
250	2.7	2.9	3.1	4.1	4.7	5.4	6.9	7.8
300	2.3	2.4	2.9	3.4	3.9	4.5	5.7	6.5

187. **Disk and Propeller Fans.**—The same general formulae which have been quoted for centrifugal fans also apply to the disk or propeller fans. In this case the air is delivered from the entire edge of the blade and with a velocity proportional to the velocity of the blade at that point. An extensive series of tests of fans of this character were made by W. G. Walker of London, Eng., and published in *Engineering*, August, 1897. The results of the test show that the efficiencies under the best conditions are essentially the same as those for pressure-blowers as quoted. These fans developed, according to the

experiments made, a volumetric efficiency in some cases greater than unity; this can only be explained by the fact that the velocity of the air-particles must under some conditions have been greater than that of the blade, a condition sometimes found true in tests of propellers for steam-boats.

The rule for capacity as given for blowers of the radial-flow type would seem by the tests to also apply closely to propeller fans, while that quoted for horse-power required does not apply. The capacity would be expressed by the following formula, in which α = a constant varying from .06 to .50 per cent, dependent upon the resistance,

$$Q = \alpha D^3 n.$$

The horse-power would be expressed by a formula, in which b = a constant to be determined,

$$\text{H.P.} = b D^5 n^3.$$

188. Measurement of Air Supplied a Room.—Specifications for ventilating apparatus generally require as a condition of acceptance the delivery of a specified amount of air into a room, and it is important that accurate measurements of such air be made.

Air is generally delivered into a room through the grill of a register, and it will be found in nearly every case that there is considerable variation in velocity in the air delivered from different portions of the register. The results would also vary considerably with the position of the anemometer, which is the best instrument for such measurements. An approved method of measuring the air discharged from a register requires the use of a temporary pipe or tube of the size of the register frame, which is extended into the room for a distance of about two feet, and is subdivided into small sections, each from 4 to 8 inches in size, by fine wires. The average velocity if taken in each section with the anemometer will represent accurately the velocity of the entering air, and this quantity multiplied by the area of cross-section of the temporary tube will give the volume supplied.

If the anemometer is held close to the face of the register, there may be considerable error in obtaining the average velocity and also the actual area of cross-section of the incoming air, both of which quantities are essential.

189. Introduction of Air into Rooms.—The principal difficulties experienced in mechanical ventilation are those relating to an equable distribution of air in the rooms to be ventilated. It is a comparatively easy matter to force any required amount of air through a given duct into a room provided there be suitable discharge-flues or openings leading to the air, but it is a very difficult matter to supply this air in such a manner that it will be thoroughly and perfectly distributed. In all cases of mechanical ventilation there must be erected ducts or pipes for conveying the air to the room, and also suitable ducts or passages for removing the air from the room, and these may be arranged in various ways with reference to each other.

Air may be introduced into rooms through registers either in the floor or ceiling or in the side walls at various heights, and each system has certain advantages and disadvantages. In introducing the air through floor-registers, any sweepings, dirt, or contamination falling to the floor is likely to be carried by the entering air into a position where it might be respired and thus become a medium for spreading or communicating disease. Where warm air is introduced for ventilation, as is likely to be the case during the cold months, there is a tendency for this air to rise, thus causing a natural circulation, which assists the artificial one due to pressure. On the other hand natural circulation tends to increase the air-currents in local positions, and especially in the lines between the supply- and discharge-registers, and this prevents that equable distribution which might otherwise be obtained. This system, which we may term the up-draft system, has been extensively used in the past, and is at the present time frequently employed for the ventilation of large auditoriums, as, for instance, the House of Parliament in London, Eng., the Senate Chamber at Washington, D. C., and various theatres and opera-houses. In the House of Parliament, London, Eng., the air is introduced through-

out the whole floor-area through small perforations covered with matting, and is removed through registers in the ceiling. Professor S. H. Woodbridge constructed a system of ventilation, in 1896, for the Senate Chamber at Washington, in which the air is introduced through perforations located in the fixed furniture, and discharged in the ceiling.

The introduction of the fresh air through registers or perforations in the ceiling and its discharge from the floor-line would seem to be supported by the best theoretical reasons, since it naturally presents the best methods for an equable distribution, provided the air-currents are not of sufficient intensity to cause a sensible draft. This system has not, however, been as extensively used as that with the up-draft currents, but has been applied successfully to a few large auditoriums.

The introduction of air from the side walls is perhaps more extensively practised for the ventilation of rooms of moderate height and extent than any other, and is doubtless the best suited for the ventilation of such rooms as are usually found in school buildings. For such cases the best results are obtained by locating the supply-register on an inner wall of the room and about three or four feet from the ceiling, and the discharge- or vent-register in the same wall and near the floor-line diagonally opposite the supply-register. This arrangement of registers is found to give a fairly equable distribution of the air with rooms from 12 to 14 feet in height when not exceeding 30 to 40 feet in floor dimensions. The introduction of air at two or more registers under similar conditions is likely to cause cross-currents and eddies, thus producing irregular ventilation. In all systems of ventilation, as previously mentioned, the fresh air should be introduced in such a manner as not to produce sensible drafts; where it enters in such a position as to impinge directly on the people, the velocity should, for best results, not exceed 3 feet per second; but where it is delivered in the upper portion of the room and into a larger body of nearly still air the velocity may be 6 to 10 feet per second without producing serious inconvenience to the occupants.

Mechanical ventilation may be performed by forcing the

required amount of air into a room and allowing it to discharge through suitable flues; or by exhausting the air from a room, fresh air being supplied by suitable connections to the outside; or it may be performed by a combination of forcing and exhausting methods. The system of forcing the required amount of air into a room is as a rule more positive than that of exhausting the air from a room, since in the first case leaks in the flues or conduits have less influence on the results than in the other; this system is also generally more cheaply constructed. The exhaust system would necessarily be used in cases where noxious gases need to be removed from a room without the possibility of spreading into adjacent rooms. The combination of the two systems is frequently employed; in which case the air is delivered into the room by force or under a slight pressure and is removed from the room by action of an exhaust-fan placed in the discharge-flue. In this latter case the exhaust fan is virtually used as a substitute for a chimney.

CHAPTER XV.

HOT-BLAST HEATING.

190. General Remarks.—In the systems of hot-air heating which have been described the circulation of air caused by expansion due to heating, which is a feeble force and is likely to be overcome by adverse wind currents, by badly proportioned pipes, or by friction; by employing a fan or blower of some character for moving the air the circulation will be rendered positive and strong enough to overcome these difficulties.

This system can be employed where power is available, and in many cases will be found to present an economical and satisfactory system of heating, comparing well with any that has been devised, especially when the amount of ventilation provided is considered. The cost of heating a large quantity of air is, however, in every case one of considerable amount, so that it is quite probable that in expense of operation no system of indirect heating, whether by furnace or steam-pipes, can compare with that of direct hot-water or steam radiation. The system of mechanical ventilation is in almost every case employed in connection with steam-heated surfaces, but in some instances the system has been applied successfully with furnace-heated surfaces.

191. Various Forms of Mechanical Ventilating and Heating Systems.—A mechanical system of ventilation is much more economical than one which depends upon the use of a heated flue for the reasons already given, and in connection with a method of warming it may also form a convenient and

economical system of heating. In general it will be necessary to warm the air which enters for ventilation purposes in cold weather in order to prevent uncomfortable sensations of chilliness; this may be done to a sufficient extent to provide all the heat needed for warming or to an amount sufficient only to prevent a sensation of chilliness, which may be perhaps to 72° to 75° . A mechanical system of circulation can be employed for the purpose of heating only, by driving air over heated surfaces and thence into the rooms to be warmed, and many successful plants of this kind have been erected for heating shops or other places where direct radiation was objectionable; it is most successfully used, however, in buildings where ventilation is necessary by introducing a constant volume of air which is heated more or less as may be necessary to provide a uniform temperature in the room.

Systems of mechanical ventilation and heating have been used in the art for more than a century, but until within the last decade they have not been extensively or systematically installed.

As erected at present we have the following general methods of installation in use. First, systems which supply a constant volume of air which is warmed sufficiently to provide all the heat required; the air may be warmed (A) by concentrating the heating surface near the fan and providing a flue or passage over it for hot air and another around it for cool air; these two flues or pipes are kept separate for some distance, but join at the bottom of a vertical flue leading to the room to be heated, where they are controlled by a regulating damper, which is arranged to open one flue as it closes the other; this system is generally known as the double duct system, and has been extensively used. All the air before reaching the fan is usually warmed to 70° or 75° by a coil of steam-pipe, termed the tempering-coil. The air is warmed in the second way (B) by separate radiating surfaces arranged as for indirect heating with steam; at the base of the vertical flues leading to the various rooms to be warmed, a by-pass pipe around the heater permits the cool or tempered air to enter a room in any

desired amount, being regulated by a damper. In this latter system the heating surface is subdivided, but only one air-pipe has to be erected from the fan to each heater.

A third system (C) has been recently used to a considerable extent, in which the air driven into the room by the fan is warmed only to a temperature of 72° to 75° , or sufficient to prevent a sensation of chilliness, and the remaining heat needed is supplied by direct radiation. For this latter case sufficient direct radiation must be used to balance the loss from the walls and windows, or in other words, the steam-radiating surface for each room in square feet must equal

$$R = \frac{1}{4}(G + \frac{1}{4}W);$$

in which G = area of the glass in square feet, W equals the area of the exposed surface of the wall.

The system employed for heating and not for ventilation would need the same amount of radiating surface and piping or ducts for supplying hot air, but would not need the pipes for supplying cool or tempered air.

In all these systems a fan or blower, as described in the previous chapter, is located in a convenient place, but usually in the basement; it can be arranged to draw by suction or to force the air over the heating surface as desired, but for the ventilating systems with double ducts or heaters at the base of the flues, it is in general more convenient to force the air over the main heater or heaters and draw the air by suction through a steam-coil situated between the fan and the outside air, known as a tempering coil and of sufficient extent to warm the entering air to 70° in the coldest weather.

The usual arrangement of fan and heating surface, when the heater is concentrated at one place, is shown in Fig. 257. The entering air is first drawn through a filter to remove any dust, if necessary, thence through a tempering coil, which is not shown in the drawing. It then passes through the fan and is thence in part forced through the heater and then into a

hot-air chamber, from which hot-air pipes lead to vertical flues leading to the various rooms; a part flows into the passage

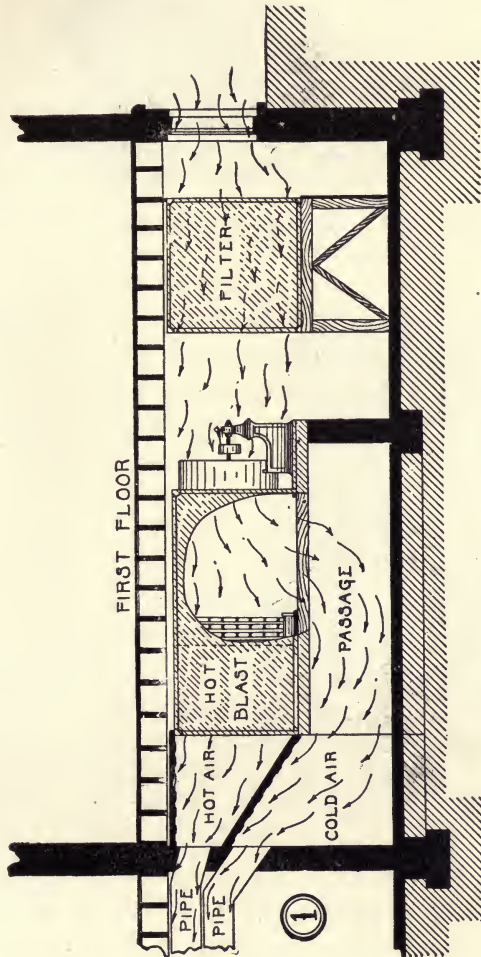

FIG. 257.—Arrangement of Blower and Heater.

beneath the fan and thence into the cold or tempered air-pipe, which in the system shown is directly below the hot-air pipe, although in other systems the position may be reversed. In

Fig. 258 is shown another style of blower and heater in which the cold-air flue is located above the hot-air flue.

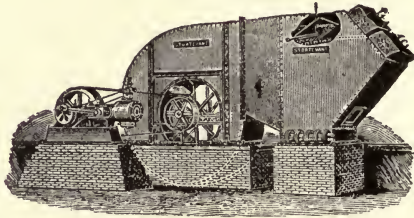

FIG. 258.—Arrangement of Blower and Heater.

192. Volume- or Regulating-dampers.—These dampers are used at the place where the horizontal flues for hot and cold air join a vertical flue leading to the room to be warmed. These dampers are made in a variety of ways, but in

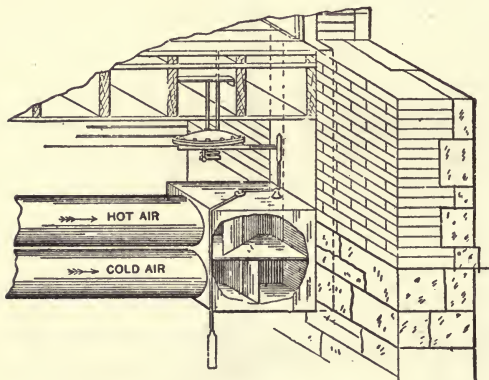

FIG. 259.—Regulating-dampers.

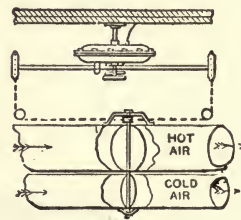

FIG. 260.—Volume-dampers.

such a manner that one flue will be opened as the other is closed, so as to provide the discharge of a constant volume of air.

One form of damper is shown below consisting of two planes,

or disks mounted at right angles on the same shaft and so connected that the hot-air pipe will be closed as the cold-air pipe is opened and *vice versa*. The damper in the figure is shown as operated by a thermostat, but it could readily be arranged to be operated by hand from the room to be warmed.

Another form of volume damper is also shown of the same general character, and operated in the same manner and so as to secure the same results.

193. Form of Steam-heated Surface.—The heating surface is generally built of inch pipe, set vertically into a square cast-iron base, connected at top with return-bends, although the box coil, or any form of indirect radiating surface could be used.

The three following illustrations show forms of heating surface built up of one-inch pipe in use in the blower system of heating. The heaters are especially designed to afford free circulation of the steam and to permit a ready removal of the water of condensation and air.

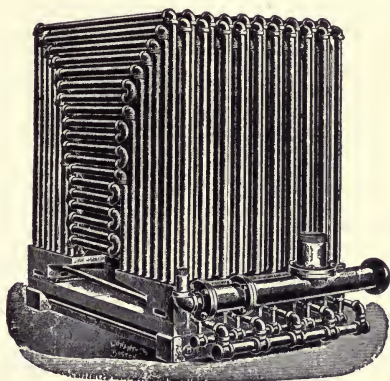

FIG. 261.—Heater for Mechanical System.

The heating surface will emit 600 to 1000 B.T.U. per square foot per hour and should average 1 square foot for every 13 to 15 cubic feet of air heated from 0° to 120° F. per minute. To account for inefficiency of heating surface there should be about 10 per cent excess or one square foot of heating surface for 12 cubic feet of air heated. This heating surface for convenience is usually estimated in lineal feet of one-inch pipe, and on this basis there should be 1 foot in length of one-inch pipe for 4 cubic feet of air heated per minute, which agrees well with the average practice; the increase in tem-

perature of air is as shown in the following diagram, Fig. 264, as the results of tests previously referred to.

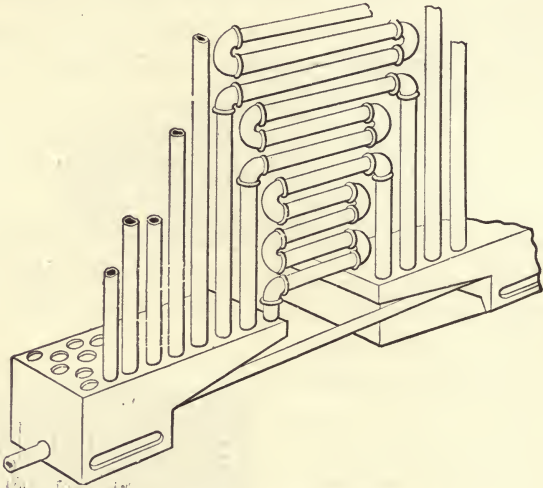

FIG. 262.—Details of Heater Shown in Fig. 261.

Cast-iron Heaters.—Formerly, nearly all the heaters used to warm or heat air for mechanical ventilating and heating systems were constructed of one-inch wrought-iron pipe. Heaters constructed of cast-iron sections are now used and give good results both as to efficiency and capacity. Cast iron possesses the advantage over steel or wrought iron of being more durable and less expensive, and will doubtless be employed extensively in future installations.

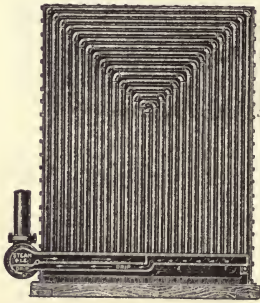

FIG. 263.—Heater for Mechanical Systems of Heating.

194. Ducts or Flues — Registers.—

The dimensions of the ducts or flues leading from the heater should be such that the required amount of air may be delivered with a low pressure and velocity, so as to avoid excessive resistances due to friction. The velocity which will be produced by various pressures in excess of that of the atmosphere is given in Table XXVI, from

which it is seen that a drop in pressure sufficient to balance $\frac{1}{2}$ inch of water (0.29 ounce per square inch) will produce a velocity of 30 feet per second in a pipe 100 feet long and 1 foot in diameter; this is generally considered to be the maximum velocity which should be permitted in any of the pipes or passages. In proportioning apparatus in this system of heating it is generally required that sufficient air shall be brought in to change the cubic contents of the room four times per hour.

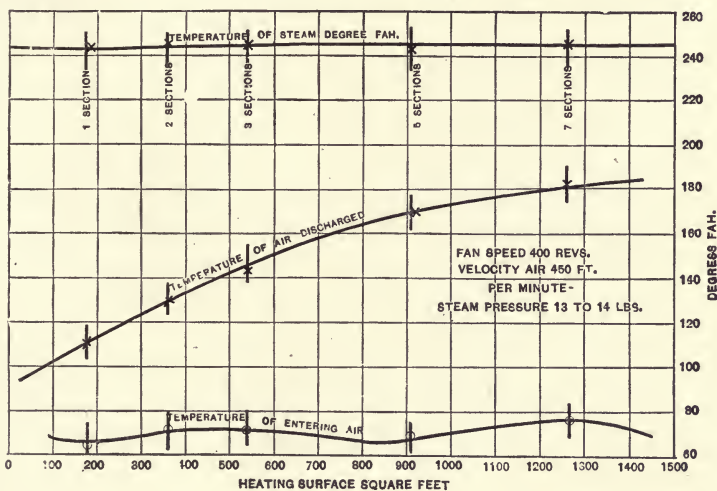

FIG. 264.—Diagram showing Relation between Temperature of Discharged Air and Heating Surface.

A more accurate method of proportioning area of ducts is by use of Table XXV, which gives the diameter of a round pipe or side of a square pipe required to discharge a given volume of air at a known distance and with a drop in pressure of one inch of water. The author would advise the use of this table in proportioning ducts for supply of air, and in its use it is first necessary to determine the air required for each room, and the length of the pipe-line. This method will insure equal resistance in the various pipe lines and an equable distribution.

The pipes are usually made of galvanized iron or bright tin and should have tight joints and be protected from loss of heat

by some good covering. Flues of brick or masonry cause more friction than those of galvanized iron, and if used should generally be about two inches larger in diameter than provided for by this table. As branch pipes for various apartments are taken off, the main pipe can be reduced in size; this should never be done abruptly, but only by the use of tapering tubes, the angle of whose sides measured from the line of the main pipe should rarely be greater than 15 degrees. In a double-duct system of heating the area of the hot-air duct should be sufficient to carry 90 per cent of the total air; that of the cold-air duct sufficient to carry 40 to 50 per cent.

The area of the cold-air duct or passageway leading to the fan should be as great as possible in order to keep the velocity of entering air low; if the area of cross-section is equal to the sum of the areas of all the ducts leading from the heating surface, the velocity will probably be about three-quarters of that in the hot-air pipes, and may draw in considerable dust and dirt from outside. Except in very large rooms the flues which convey air should discharge near the upper part of the room. The friction in small pipes is greater than in large ones, being relatively proportional to the circumference or perimeter; hence the sum of the areas of the branch pipes should be considerably greater than that of the main.*

The table on opposite page gives the number of small pipes which provide an area equivalent to that of one large pipe of

* The velocity of flow of air is given in formulæ in Chapter V; the amount discharged is equal to the area of the pipe multiplied by the velocity and will be equal in every case to the square root of the fifth power of a constant multiplied by the diameter of the pipe. If we denote diameter of larger pipe by D , of smaller pipe by d , and the number of smaller pipes required to make one of area equivalent to that of larger by n ,

$$n = \left(\frac{D}{d} \right)^{\frac{5}{2}}.$$

To find diameter of round pipe, d , which shall be equivalent in carrying capacity to a rectangular pipe with dimensions a and b , we would have

$$d = \sqrt[5]{\frac{32a^2b^3}{\pi^2(a+b)}}.$$

TABLE FOR EQUALIZING THE DIAMETER OF PIPES.

Diameter of Main Blast-pipe in Inches.	1	2	3	4	5	6	7	8	9	10	11	12	13	14	15	16	17	18	19	20	21	22	24	26	28	30	36	42	48	54	60			
1	5.7																																	
2	16	2.7																																
3	32	5.7	2.																															
4	50	9.8	3.6	1.8																														
5	88	16	5.7	2.8	1.6																													
6	120	23	8.3	4.1	2.3	1.5																												
7	180	32	12	5.7	3.2	2.1	1.4																											
8	244	42	16	7.6	4.3	2.8	1.9	1.3																										
9	317	56	20	9.9	5.7	3.6	2.4	1.7	1.3	10																								
10	402	71	26	12	7.1	4.5	3.1	2.2	1.7	1.3	11																							
11	501	88	32	16	9	5.7	3.8	2.8	2.0	1.6	1.2	12																						
12	613	107	39	19	11	6.9	4.7	3.4	2.5	1.9	1.5	1.2	13																					
13	737	120	47	23	13	8.3	5.7	4.1	3.0	2.3	1.8	1.5	1.2	14																				
14	876	152	56	27	16	9.9	6.7	4.8	3.6	2.8	2.2	1.8	1.4	1.2	15																			
15	1020	180	65	32	18	11	7.9	5.7	4.2	3.2	2.6	2.1	1.7	1.4	1.2	16																		
16	1197	208	76	37	21	13	9.2	6.6	4.9	3.8	2.9	2.4	2.0	1.6	1.4	1.2	17																	
17	1375	239	88	43	24	16	10	7.7	5.7	4.3	3.4	2.8	2.3	1.9	1.6	1.3	1.2	18																
18	1580	275	100	49	28	18	12	8.8	6.5	5.0	3.9	3.2	2.6	2.2	1.8	1.5	1.3	1.2	19															
19	1797	313	114	56	32	20	14	9.9	7.4	5.7	4.5	3.6	2.9	2.5	2.1	1.7	1.5	1.3	1.2	20														
20	2284	398	145	71	41	26	18	13	9.3	7.2	5.4	4.3	3.6	2.9	2.4	2.1	1.7	1.4	1.3	22														
21	2834	493	180	88	50	32	22	16	12.8	9.7	7.6	5.7	4.6	3.8	3.2	2.9	2.4	2.1	1.8	1.6	1.2	24												
22	3474	605	210	108	62	39	27	19	14	11.8	6.9	5.7	4.7	4.0	3.4	2.9	2.5	2.2	1.9	1.5	1.2	26												
23	4105	725	265	129	74	48	32	23	17	13	10.8	3.6	5.7	4.8	4.1	3.5	3.0	2.6	2.3	1.8	1.5	1.2	28											
24	4963	864	315	154	88	56	38	28	20	16	12	9.8	6.7	5.7	4.7	4.1	3.6	3.0	2.6	2.2	1.7	1.4	1.2	30										
25	7818	1361	497	243	139	88	00	43	32	25	19	16	13	11.8	9.7	6.6	5.7	5.0	4.3	3.4	2.7	2.2	1.9	1.6	1.2	36								
26	11488	2000	730	358	205	129	88	63	47	36	29	23	19	16	13	11	9.6	8.5	7.3	6.4	5.0	4.3	3.4	2.7	2.2	1.9	1.6	1.2	42					
27	14888	2702	1081	492	282	180	133	88	66	50	39	32	26	22	18	16	13	12	10.8	9.7	8.0	7.3	6.4	5.0	4.3	3.4	2.7	2.2	1.9	1.4	1.1	48		
28	19580	3753	1368	671	384	244	166	119	88	68	53	43	35	29	24	21	18	16	15	12.9	10.4	9.6	8.5	7.3	6.4	5.0	4.3	3.4	2.8	2.1	1.4	54		
29	27913	4879	1781	872	499	314	215	154	115	88	69	56	46	38	32	27	23	20	18	16	12	9.9	8.1	6.7	5.7	4.3	3.6	2.4	1.8	1.3	60			

The large figures at the top of each column give the diameters in inches of the branch pipes. The figures in any horizontal line give the number of pipes, of the diameter given at the top of the column, that will be equal in capacity for conveying air to the one given opposite in the first column. Thus one 10-inch pipe is equivalent in carrying capacity, friction included, to 3.6, 6-inch pipes.

similar cross-section; in case no table is at hand the same results may be obtained by dividing the larger diameter by the smaller one and taking the square root of the fifth power of the quotient.

The following table gives the actual amount discharged with constant resistance, and with loss of pressure equal to one-half inch of water column in round pipes, as computed from Unwin's formulæ. (Also see Table XXV, Appendix.)

VELOCITY AND QUANTITY OF AIR DELIVERED IN PIPES OF DIFFERENT DIAMETERS, EACH 100 FEET LONG, WITH AN AIR-PRESSURE EQUAL TO $\frac{1}{2}$ INCH OF WATER COLUMN.

Diameter of Pipe. In.	Velocity of Air. Ft. per Sec.	Cubic Feet of Air per Min.	Diameter of Pipe. In.	Velocity of Air. Ft. per Sec.	Cubic Feet of Air per Min.
1	8.7	2.6	16	35.6	3,024
2	12.4	16	18	36.8	4,032
3	15.0	45	20	38.8	5,184
4	17.3	90	22	40.6	6,480
5	19.4	160	24	42.4	8,208
6	21.3	253	26	44.2	9,936
7	23.0	380	28	46.0	11,952
8	24.5	515	30	47.4	14,256
9	26.1	720	36	52.0	23,040
10	27.4	900	42	56.1	33,120
11	28.6	1100	48	61.0	46,080
12	30.5	1440	54	63.6	61,920
13	31.3	1620	60	67.0	80,640
14	32.4	2160			

Air which is drawn in from outside at high velocity is often loaded with dust, and for this reason filters made of some textile material, or baffle-plates which discharge the dust into vessels of water, are sometimes required in the passageway leading to the fan.

The net areas of registers should be sufficiently great to prevent the velocity in the entering air becoming so great as to produce a sensible draft. Taking this limiting value at 5 feet per second, the area of the register can be computed. If the air is to be changed four times per hour, there should be 34 square inches in the register for each 1000 cubic feet of space.

The nominal area of the register should be about 50 per cent greater than given by this computation; the actual areas of commercial registers is given in table, page 340.

195. Blowers or Fans.—The principles relating to the operation and construction of fans and blowers have been quite fully given in the preceding chapter, together with a description of the more important types, so that it is only necessary in this place to refer to such features of construction or operation as are peculiar or of special importance in connection with systems of mechanical ventilation and heating.

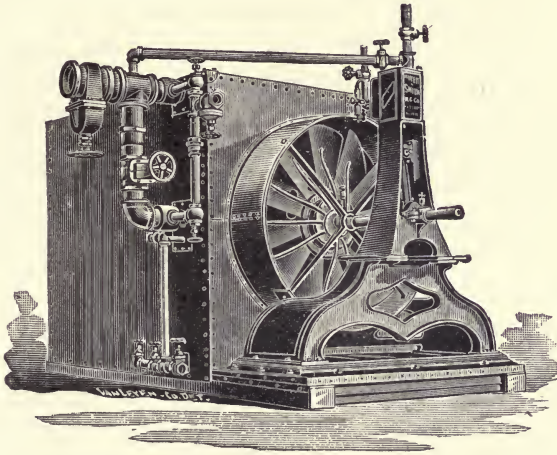

FIG. 265.—Blower Connected to Engine.

The motive power employed to drive fans may be obtained from a running countershaft, from an engine either directly connected or belted, or from an electric or water motor. Where the fan is to be used only at intervals, the electric motor will be found more desirable and fully as economical as the engine.

Where fans are used in connection with heating systems they can usually be driven most economically by a steam-engine, arranged so that the steam after passing through and driving the engine will exhaust into the heating coil. For this condition the cost of motive power will be scarcely appre-

chable, since the loss of heating capacity by the steam in passing through the engine will not usually exceed ten to thirty per cent.

The fan should be located in a position where the noise caused by its operation is likely to be of little importance, and it should be arranged so that a portion or all of the blast can be deflected from the heating surface and sent to the rooms without being warmed if so required. This can be done by proper construction of ducts and dampers.

An exhaust fan in the ventilating shaft has been used, in some instances with good results, for removing air from a building and producing circulation over the heater, but there is liability of leakage or infiltration of air into the flues from the outside. In case air enters this without passing over the heating surface, it is likely to reduce its efficiency, so that in practice it has not proved as satisfactory as the pressure-system. For purposes of ventilation only, or for the removal of foul and noxious gases where the ventilating ducts are tight, or as an accessory to the pressure-system, the exhaust fan is very efficient and often invaluable.

196. Heating Surface Required.—The methods of proportioning the heating surface will be the same in every particular as those previously described for indirect heaters, and for hot-air furnaces. In this case, however, as the air passes over the heating surfaces with considerable velocity, the amount of heat which is given off is many times more than that from ordinary radiating surfaces in direct heating. Experiments show that the number of heat-units given off per degree difference of temperature per square foot of surface per hour is dependent on a function of the square root of the velocity of the air in feet per second; for a velocity of 36 feet per second this might amount to 6 heat-units. For very cold weather the difference of temperature between heating surface and air will be from 160 to 170 degrees, and in this case the total heat given off per square foot will be about 1000 heat-units, or the equivalent of that given off in the condensation of somewhat more than 1 pound of steam.

The following general formula will apply to this case:

Let T = temperature of heating surface, t that of the air of the room, t' that of outside air, t'' that of air leaving heating surface, t_1 the mean temperature of air surrounding heating surface = $\frac{1}{2}(t'' - t')$, n = number of times air is to be changed per hour in the room, C cubic contents of room, a = coefficient giving number of heat-units per degree difference of temperature per square foot per hour from heating surface. We have, since one heat-unit is capable of heating 56 cubic feet of air one degree:*

$$\text{Cubic feet of air heated per hour} = nC;$$

$$\text{Heat-units required for warming this air} = \frac{nC}{56}(t'' - t');$$

$$\text{Square feet of heating surface} = \frac{nC(t'' - t')}{56a(T - t_1)};$$

Substituting in the last equation

$$a(T - t_1) = 1000; \quad t'' - t' = 70,$$

and multiplying by 60 to reduce to minutes, we have

$$\frac{nC(t'' - t')60}{56a(T - t')} = \frac{(nC)(70)(60)}{56 \times 1000} = \frac{nC}{13.3}.$$

From this computation it would appear that one square foot of heating surface would warm 13.3 cubic feet of air 70° per minute. In designing it is considered safe to reduce this to 12 cubic feet, as 3 lineal feet of one-inch pipe are practically equivalent to one square foot of heating surface; we note from the above that *one foot of one-inch pipe in the heater will warm 4 cubic feet of air per minute.*

197. Size of Boiler Required.—From the preceding statement it is seen that one square foot of heating surface in mechanical heating will condense from 0.5 to 0.8 the amount of steam that can be produced by one square foot of heating surface in the boiler. Hence there should be from 0.5 to 0.9 as much area of heating surface in the boiler as in the indirect heater, or, in other words, there should be one boiler horse-

* See Table X, temp. at 70° F.

power for every 20 to 30 square feet in the heater. The proportions of grate surface, chimney, etc., will be found by consulting Chapter VIII.

198. Practical Construction of the Hot-blast System of Heating.—The following matter regarding the construction of mechanical heating plants has been kindly furnished for this book by Mr. F. R. Still of Detroit, who has had an extensive engineering experience in this particular kind of work:

Air Required.—The following is intended to give the basis of calculation for different parts of a plant of a mechanical heating system. The first thing to consider with this system usually is the amount of air to be delivered and warmed per minute. Experience has proved that the delivery of an amount of air at 120° into a building or apartment equal to its cubic contents every 15 minutes, will warm it under average conditions of construction of 70° F. when the outside temperature is zero. This amount of air will accomplish like results in some buildings when the outside temperature is 10 or even 20 degrees below zero, and in other cases this amount will be found insufficient, the variation being due to construction, glass surface, and other conditions. In some classes of buildings, for instance churches, school-houses, theatres, and hospitals, a change of air may be required every 10 minutes.

Amount of Heating Surface.—Having determined the amount of air required, the next consideration is the amount of heating surface to be used in the indirect heater. This can be treated better by taking a specific example; for instance, suppose that 20,000 cubic feet of air to be delivered into the building every minute (1,200,000 cubic feet per hour) at a temperature of 120 degrees, when air outside is zero, that the steam-pressure on the coils or heating surface is 10 pounds per square inch, and that the temperature of the water of condensation is 213 degrees. In one pound of steam at a pressure of 10 pounds above the atmosphere there is 1186.5 units of heat, while in one pound of water of condensation there is 213 units, leaving 973.5 units, which is given off by the heating surface. By consulting Table X it will be seen that at tem-

perature of 70° F. one heat-unit will warm 56 cubic feet of air one degree, and hence to heat one cubic foot 120 degrees will require 2.15 heat-units; each pound of steam gives off 973.5 heat-units and will heat 452 cubic feet of air from zero to 120 degrees. To heat 1,200,000 cubic feet of air to 120 degrees will require 2660 pounds of steam. The indirect heater provided with blower will condense under average conditions 1 pound of water per square foot of surface per hour, and hence we should require as many square feet of surface as the quotient of 2660 divided by 1, or 2660 square feet.

Size of Boiler.—To find the size of boiler needed, divide the total steam required per hour, in the example 2660, by that required for one boiler horse-power; this, when water of condensation is all returned to boiler, is 34.5 pounds, and we obtain 77 horse-power. This computation gives a larger boiler than would generally be installed for work of this magnitude. The rated horse-power of a boiler is capable of considerable increase in times of necessity and for short periods. It can hardly be considered good practice to overwork a boiler, but as extremely severe weather is usually of very short duration and the balance of the season mild, there is good reason, on the score of economy in first cost, for this practice. The boiler is usually rated on the supposition that it will need to supply 1.5 pounds of steam for each square foot of surface in the radiator per hour, in which case 23 square feet of surface would be supplied by one boiler horse-power. This estimate would require the normal rating of the boiler to be developed during the average stress of weather; this method would require a boiler of about 60 horse-power for the plant considered in the example. Such a method of proportioning has proved quite satisfactory in actual practice, although greater economy could, no doubt, be obtained by using a larger boiler.

Size of Blower.—We are next to determine the size of blower required to deliver 20,000 cubic feet of air per minute under a pressure of one inch of water, which is about the pressure ordinarily used for such a case. This pressure corresponds

to a peripheral velocity of 4000 feet per minute. Then for a steel plate blower

$$4000 = \pi DN,$$

$$DN = 1274.$$

199. Description of Mechanical Ventilating Plant.—The plant erected in the New York State Veterinary College in 1896 is described, not because it has any peculiar points of merit or is to be regarded as a model of its kind, but principally for the reason that the author has in his possession data regarding details of construction, and has had careful tests made of the efficiency of the plant.

The buildings are arranged as follows: A main building three stories in height, in which are located the offices, lecture-rooms, museum, laboratories, and, in the basement, the heating and ventilating plant; the north wing to this building, one story in height, containing the anatomical theatre, laboratory, preparation room, locker, and lavatory; a mortuary building located in the rectangle formed by the main building and north wing at two sides; an operating shed east of the mortuary; and the stables and the isolated wards for contagious diseases, which are located to the east and south, and not heated from the main plant. The operating shed is built of wood; all other buildings are of buff brick and of slow-burning construction, viz., all the inner walls are finished in brick and painted, the timbers are all extra heavy and exposed to view, the flooring and sheeting on the roof is laid over plank, the ceilings are of narrow pine, and in general no enclosed spaces are left. The roofs are all covered with tin and the trimmings in the interior of the main building are of oak. The building is lighted, except in the north wing and operating shed, through side windows; in the former the principal light comes through skylights in the roof. Except on the three stories of the main building, all floors are of concrete. A vault in the rear of this building and on a level with the basement contains the boilers, crematory, and cold storage.

The exposure of walls and windows to the weather is about as follows:

<i>Main Building.</i>	Brick Wall.	Glass.
On the north about.....	3366 sq.ft.....	644 sq.ft.
“ south.....	3366 “.....	644 “
“ east.....	9339 “.....	1546 “
“ west.....	9504 “.....	1572 “
Surfaces covered by tin roof.....	6074 “	

<i>North Wing.</i>	Brick Wall.
Total exposed wall surface.....	6069 sq.ft.
“ roof surface.....	4875 “
Skylight surface.....	552 “
Window surface.....	170 “

The essential dimensions are as given in the annexed table:

DIMENSIONS OF PRINCIPAL ROOMS AND FLUES.

Room.	Cubic Contents Cu. Ft.	Number of Persons.	Air-flue. Dimensions Inches.	Air- register, Inches.	Vent. register, Inches.	Direct Radi- ating, Sq. Ft.
<i>First Floor.</i>						
No. 1 *.....	4,920	10	$\left\{ \begin{array}{l} 8 \times 7\frac{1}{2} \text{H} \\ 6 \times 7\frac{1}{2} \text{T} \end{array} \right\}$	10 X 15	8 X 15	40
No. 2 *.....	3,600	10	“	10 X 15	8 X 15	40
No. 3 *.....	4,920	10	“	10 X 15	8 X 15	40
No. 4.....	3,600	12	“	10 X 15	8 X 15	40
Museum.....	39,366	10	0	240
South Hall.....	7,200	0	110
North Hall.....	7,200	0	100
No. 5.....	20,800	135	$\left\{ \begin{array}{l} 3(8 \times 24) \text{H} \\ 3(6 \times 24) \text{T} \end{array} \right\}$	4(21 X 29)	$\left\{ \begin{array}{l} 2(24 \times 24) \\ 2(24 \times 16) \end{array} \right\}$	80
<i>Second Floor.</i>						
No. 8.....	5,904	12	$\left\{ \begin{array}{l} 8 \times 7\frac{1}{2} \text{H} \\ 6 \times 7\frac{1}{2} \text{T} \end{array} \right\}$	12 X 10	10 X 20	40
No. 9 *.....	5,904	10	“	14 X 20	10 X 20	40
No. 11 *.....	5,904	10	“	12 X 20	10 X 20	40
No. 12 *.....	5,904	10	“	14 X 20	10 X 20	40
Museum and Temp. Lecture-Room.....	34,992	10	0	0	240
South Hall.....	3,600	0	0	0
North Hall.....	3,600	0	0	0
<i>Third Floor.</i>						
No. 13 *.....	5,904	10	$\left\{ \begin{array}{l} 8 \times 7\frac{1}{2} \\ 6 \times 7\frac{1}{2} \end{array} \right\}$	14 X 20	10 X 20	40
No. 14 *.....	5,904	10	“	14 X 20	12 X 20	40
No. 15.....	20,892	40	$\left\{ \begin{array}{l} 2(8 \times 8) \\ 2(8 \times 6) \end{array} \right\}$	2(20 X 24)	2(18 X 21)	100
No. 16.....	13,488	40	$\left\{ \begin{array}{l} 2(8 \times 8) \\ 2(8 \times 8) \end{array} \right\}$	2(18 X 24)	$\left\{ \begin{array}{l} 18 \times 20 \\ 18 \times 21 \end{array} \right\}$	100
No. 17 *.....	5,904	10	$\left\{ \begin{array}{l} 8 \times 7\frac{1}{2} \\ 6 \times 7\frac{1}{2} \end{array} \right\}$	12 X 24	12 X 20	40
No. 18.....	5,904	10	“	14 X 20	12 X 20	40
North wing, first floor.....	3(16 X 24)	3(16 X 24)	3(16 X 20)	400
No. 6.....	39,600	40	3(16 X 20)	3(16 X 20)	3(20 X 24)
Closets, and lockers, No. 7.....	10	2(10 X 16)	10 X 16	80

* Offices and studies assumed as containing 10 people.

Description of Plant.—The ventilating plant is located in the basement, and as shown on plan and sectional views, consists of two independent heating and ventilating plants con-

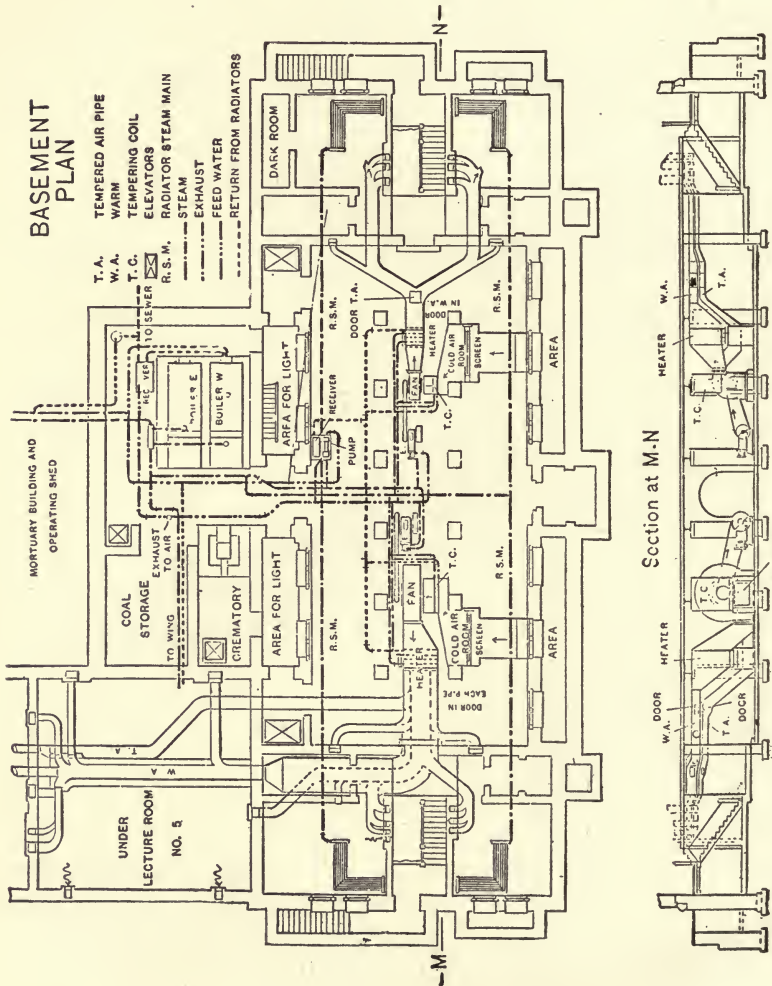
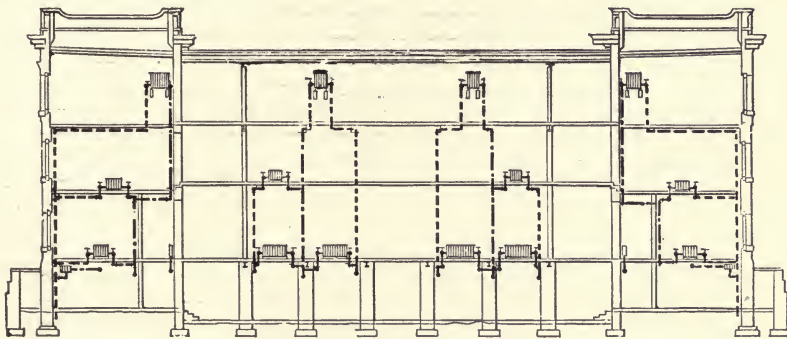

FIG. 266.—Basement Plan and Elevation.

nected to different portions of the building. These plants were installed so that if one portion of the building only was in use, the other portion need not be ventilated. A system of

direct heating was put in for the halls and museum and some rooms when no ventilation was required for supplying heat. It was also put into a number of other rooms to be used after school hours, when the ventilating system would not be in operation. This system, although shown on the drawings, is of no especial interest and was only erected because of the peculiar conditions which existed.

The cold air enters the building through two windows; from these it is carried to the cold-air rooms shown on basement plan, and before entering which it is passed through fine



LONGITUDINAL ELEVATION

Looking at Front Wall

FIG. 267.—Elevation Showing Direct Radiation.

wire screens to remove any large particles of dust which might be drawn in. Air from the museum, which is usually unoccupied, can also, when desired, by the opening of certain registers, be drawn into each cold-air room and mixed with air from the outside. From the cold-air rooms it is drawn into the fans through a coil of steam-piping known as the "tempering coil," the office of which is to warm or temper all the air entering the building to between 65° and 70° ; in case the entering air is already near this temperature, the damper is so adjusted that the entering air passes underneath the tempering coil and through the by-pass.

The air-pipe from each fan, and through which the air is

forced, is separated into two pipes, one above the other. The upper and larger one contains a chamber in which is placed a number of steam-coils similar to the tempering coil. This is called the heater, its duty being to raise the temperature of the air passing through the warm-air pipe from 65° or 70° to 100° or 150° .

The general arrangement of the system is shown in Fig. 266, from which it is seen that air is taken in from the outside,

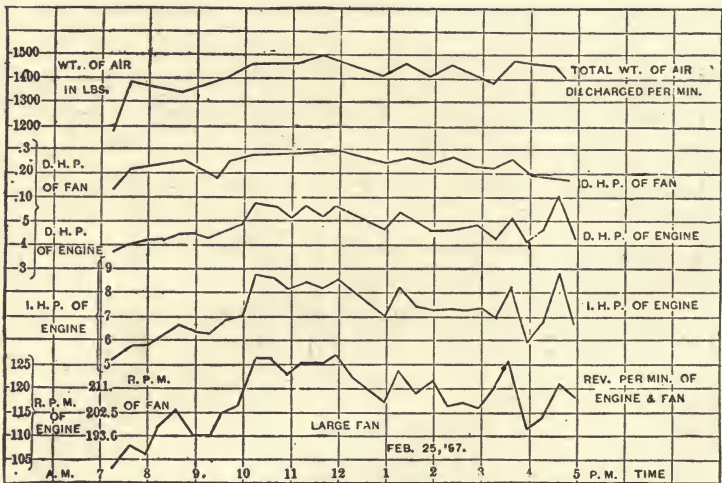

FIG. 268.—Speed, Horse-power, and Weight of Air, Large Fan, Feb. 25, 1897.

is passed through or under the tempering coil *T*, depending on the position of the damper. This damper may be regulated as desired, either by a thermostat or by hand. The blower is placed as shown, and serves to draw in the air from the outside, also to force it over the heating surface and into the warm-air chamber, also through an opening in front of the heater and into the cool-air chamber. From the warm-air chamber and also from the cool-air chamber pipes are led to a vertical flue (which we will term the mixing flue), connecting with the rooms to be heated. These pipes are controlled

by a single damper, operated by a thermostat which is so adjusted that either the warm-air pipe or the cold-air pipe can be opened as desired, but the total supply of air cannot be changed by any motion of the damper.

A complete test of this plant was described by the author in Vol. IV. of the "Trans. American Society Heating and Ventilating Engineers," from which the following data and results are taken:

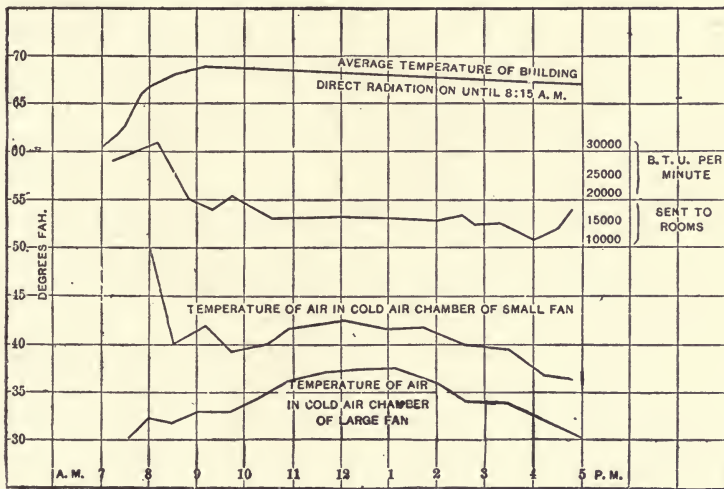

FIG. 269.

The heating surface consisted of inch pipe screwed into cast-iron bases or manifolds, arranged in five sections for each fan. Each section had four tiers of pipe, and contained for the large fan 954 feet of inch pipe and for the small fan 396 feet. One of these sections was arranged as a tempering coil, to warm the air when required before reaching the fan, the other four sections were set in the heater coil. The total heating surface expressed in lineal feet of one-inch pipe, 4770 for the large fan and 1980 for the small fan.

The following table gives the principal dimensions of machinery:

	Large Fan.	Small Fan.
Diameter of wheel, inches.....	84	44
Width at centre, inches.....	36	18
Diameter of inlet, inches.....	54	28
Discharge opening, inches.....	40×42	22×22
Diameter engine cylinder, inches.....	19	6
Length of stroke, inches.....	8	8
Heating surface, lineal feet.....	4770	1980
“ “ heater, lineal feet.....	3816	1584
“ “ tempering coil, lineal feet.....	954	396
Lineal feet of pipe per cubic foot.....	12.7	28.2
Dimensions of flues from fan:		
Tempered air, inches.....	40×20	42×10.5
Warm air, inches.....	72×28	42×14.25
Area of flue in square feet:		
Tempered air.....	5.56	3.06
Warm air.....	11.66	4.04
Velocity of air, feet per minute, by measurement:		
Feb. 13.....	888	1186
Tempered air.....	1400	1073
Feb. 13.....	1000	601
Warm air.....	1218	411
Temperature outside air 32°, Feb. 13, 1897:		
Tempered air.....	60	63
Warm air.....	91.5	100

The graphical results of the test on February 25 are shown in the two diagrams.

The results of a test were as follows:

	Large Fan.	Small Fan.
Cubic feet of air per minute.....	21,000	5,180
Lineal feet of pipe per cubic foot per minute.....	4.5	3.28
Pressure in ounces.....	7/8	1/32
Revolutions per minute.....	220	201
Delivered engine horse-power.....	5.5	1.01
Indicated engine horse-power.....	8.6	1.5
Steam pressure, pounds.....	22	22
Temperature outside air, degrees.....	34	34
“ entering air, degrees.....	80	136
“ of rooms supplied, degrees.....	70	70
Heat supplied per minute.....	4560	5180
Heat per foot lineal pipe, B.T.U. per minute.....	0.98	3.26
Pounds of steam condensed per square foot heating surface per hour.....	0.17	0.61
Cubic feet of space heated.....	121,724	56,732
Changes of air per hour.....	10.1	5.5

COMPARISON OF RESULTS WITH CAPACITY AND POWER RULES.

Cube of diameter of fan in feet.....	343	49.2
Coefficient for capacity rule.....	0.3	0.5
Capacity by rule.....	22,028	5,250
Fifth power of diameter in feet.....	16,807	663
D ⁵ N ³ ÷ 1,000,000.....	0.179	0.053
Factor for horse-power by rule.....	30	20
Horse-power by rule.....	5.37	1.16

It will be noted that the heating surface for the large fan is apparently less efficient than for the small fan; this is explained by the action of the thermostat, which regulated the relative amount of hot and tempered air to maintain a uniform temperature, and merely indicates that only a portion was utilized at the time of the test. It will also be noted that the temperature of the air delivered by the small fan was higher and the pressure less than was the case with the large fan; this in large part was due to the fact that the small fan was only run at about two-thirds its rated speed. The necessity for ventilation was also less in that portion of the building heated by the small fan. The practical operation and use of the building has proved that better results would have been produced had one fan and heating system been employed instead of two.

200. Tests of Blower Systems of Heating.—The heat given off from an indirect radiator over which the air is forced by a blower or fan varies with the difference in temperature between the steam in the pipe and the surrounding air, with the velocity of air, and with the number of rows of pipes over which the air passes. A series of tests were made under supervision of the author by blowing air over an indirect heater, consisting of eight sections, each section containing four rows of one-inch pipe and 180.85 square feet of heating surface, and arranged so that one or more sections could be employed as desired. During each test air was drawn by suction through the heater or radiator by an exhaust-fan having a wheel 4 feet in diameter, driven by an engine. The principal portion of the test was made with the fan revolving 400 turns per minute, and so as to give a peripheral speed to the tips of the fan-wheel of 5026 feet per minute. The speed of the air approaching the heater was for the most part 473 feet per minute, but between the coils its speed was about 1250 feet and in the discharge-duct 2900 feet per minute; its temperature on entering was about 70° Fahr. The tables following give the data and results of the various tests expressed in B.T.U. per square foot per hour per degree difference of temperature between the

Results.	Number of Run.								
	1	2	3	4	5	6	7	8	9
a	4	4	4	8	8	8	12	12	9
b	180.85	180.85	180.85	361.7	361.7	361.7	542.6	542.6	542.6
1	12.62	35.5	54	13.1	35.5	57	14	34.5	56.5
2	241.1	280.5	302	240.3	281	302.7	245	280	303.7
3	203	294	320	458	405	511	575	591	647
4	1.45	1.64	1.77	1.27	1.28	1.42	1.05	1.09	1.19
5	1340	1413	1582	1108.5	1107	1267	986	993	1053
6	65	65	65.9	71.2	72.7	73.8	74	73	70.2
7	82.5	83	84.2	102.7	106	106	112	111	111
8	73.2	74	75	86.7	90.6	90	93	92	90.6
9	17.5	18	20.3	31.5	35.3	32.2	38.2	38	41
10	1250	1250	1260	1250	1250	1260	1250	1260	1250
11	473	473	477	473.	473	477	473	477	473
12	400	400	404	400	400	404	400	404	400
13	5026	5026	5070	5026	5026	5070	5026	5040	5040
14	179.1	215.5	236.1	175.1	218.3	248.9	171	207	233.5
15	168.9	206.5	227.0	159.6	191.0	212.7	152	188	213.1
16	7.5	6.6	6.8	6.34	5.34	5.07	5.78	4.8	4.48
17	7.92	6.83	7.00	7.00	6.10	6.00	6.50	5.27	4.95
18	1615	1655	1835	1380	1410	1510	1258	1475	1608
19	1.67	1.72	1.90	1.43	1.46	1.56	1.35	1.53	1.67
20	13,500	13,500	13,650	13,500	13,500	13,650	13,500	13,650	13,500
21	2,900	2,905	2,950	2,900	2,910	2,930	2,900	2,940	2,900
22	.576	.578	.582	.576	.576	.582	.576	.582	.575

Area discharge-duct, 4.7 square feet. Area entrance-duct, 28.5 square feet.

Results.	Number of Run.								
	10	11	12	13	14	15	16	17	18
a	20	20	20	28	28	28	16	16	16
b	904.4	904.4	904.4	1266	1266	1266	723.4	723.4	723.4
1	13	34	53.2	13.2	58.3	53.6	13	12.5	12.7
2	245	279	300.7	246.3	201	310	245	244	246.5
3	764	937	1014	970	1088	1231	769	518	405
4	0.84	1.04	1.12	0.76	0.865	0.97	1.06	0.72	0.56
5	800.6	931.8	991.0	703.3	759	852	1003.6	673.3	529.8
6	66	70.6	74.9	77	78	75.7	73.2	73.3	73.5
7	137	130	139.2	132.4	146.3	153.2	115.7	107.3	143.0
8	94	100	107	109.7	112.1	120.0	95	90.3	108.2
9	59.5	59.5	64.3	57.2	68.3	77.5	37.5	34	69.5
10	1250	1260	1255	1250	1255	1255	1550	1260	640
11	473	477	470	473	475	470	585	477	240
12	400	404	402	400	402	403	552	404	204
13	5026	5050	5050	5026	5040	5065	6440	5070	2568
14	179	208.4	225.8	149.3	213	234.3	172.8	159.7	143
15	151	179	193.4	137.6	178.9	190.0	150.0	143.7	138.3
16	4.5	4.5	4.42	4.7	3.65	3.65	5.83	4.18	3.71
17	5.32	5.22	5.15	5.11	4.3	4.50	6.70	4.70	3.83
18	1007	1140	1220	937	987	1055	12275	815	683
19	1.05	1.19	1.27	0.965	1.02	1.09	1.33	.845	.705
20	13,500	13,650	13,565	13,500	13,560	13,600	18,647	13,650	6,817
21	2,900	2,950	2,925	2,900	2,920	2,925	3,560	2,950	1,400
22	.576	.578	.58	.576	.58	.578	.555	.582	.568

Area discharge-duct, 4.7 square feet. Area entrance-duct, 28.5 square feet.

steam and the entering air and between the steam and the mean temperature of the air. The tables also give the probable B.T.U. per square foot per hour for the entering air at 0° Fahr., this amount being calculated from the results of the test by application of the well-known physical law that the heat transmitted varies almost exactly with the mean difference of temperature. By dividing this latter quantity by the number of heat-units latent in one pound of steam, as shown in a steam-table for the required pressure, the weight of steam that would be condensed per square foot of heating surface per hour is obtained as given in the tables which follow.

A general table given is computed from the average results of the tests by application of well-established physical laws.

GENERAL TABLE FOR BLOWER SYSTEMS OF HEATING.

Number of Rows of Pipes.	Lbs. of Steam Condensed per Hr. per Sq.ft. H. S.		B.T.U. per Square Foot H. S. per Hour.		Velocity of Air 1250 Ft. per Minute.	
	Entering Air 70°.	Entering Air 0°.	Total Entering Air 70°.	Per Degree Difference Steam and Entering Air.	Increase in Temperature of Air, Deg. Fahr.	Cu.Ft. Air per Sq.Ft. H. S. per Minute.
4	1.57	1.67	1480	7.4	20	72
8	1.32	1.37	1240	6.2	33	36
12	1.11	1.16	1050	5.3	42	24
16	0.98	1.02	930	4.7	49	18
20	0.90	0.93	850	4.3	56	14.4
24	0.85	0.88	800	4.0	63	12
28	0.83	0.85	780	3.9	72	10.3
30	0.81	0.83	775	3.85	76.5	9.6

The temperature of discharge would be increased by driving over the radiator smaller quantities of air, and diminished by increasing the amount of air, the rise of absolute temperature being inversely proportional to the volume.

It will be noted from the above table that the amount of heat given to the air increases very slowly after it has passed through or between 16 rows of pipes, and that the economic limit of the number of rows of pipes must approximate between 16 and 24.

The tests indicate that the total heat transmitted in B.T.U. per square foot for a heater with varying rows of

pipes can be expressed very nearly by an equation in which H equals the number of heat-units per square foot per hour, the subscript gives the number of rows of pipes over which the air has passed and V equals velocity of air in feet per minute between the rows. We shall have for entering air 70° F.,

For one pipe.....	$H_1 = 250 + 45\sqrt{V}$.
For four pipes.....	$H_4 = 250 + 35\sqrt{V}$.
For eight pipes.....	$H_8 = 250 + 27\sqrt{V}$.
For twelve pipes.....	$H_{12} = 250 + 23\sqrt{V}$.
For sixteen pipes.....	$H_{16} = 250 + 20\sqrt{V}$.
For twenty pipes.....	$H_{20} = 250 + 17\sqrt{V}$.
For twenty-four pipes.....	$H_{24} = 250 + 16\sqrt{V}$.
For twenty-eight pipes.....	$H_{28} = 250 + 15\sqrt{V}$.
For thirty pipes.....	$H_{30} = 250 + 14.7\sqrt{V}$.

It will be noted in the above equations that when $V=0$, H in all cases $= 250$, which approximates the transmission of heat in B.T.U. per square foot per hour in still air. The amount of heat transmitted for entering air 0° F. will be about 3 per cent greater than given by the above equations.

The heat transmitted per square foot of heating-surface per degree difference of temperature of the steam and entering air can also be expressed by an equation similar to that given for the total heat per square foot per hour. The calculation for this case will be rendered easier by using the velocity in feet per second, instead of in feet per minute as in the preceding case. If we denote the velocity of the air over the pipes in feet per second by v , the heat transmitted per degree difference of temperature per hour by r , with a subscript denoting the number of pipes over which the air passes, we shall have:

For n pipe.....	$r_n = 1.25 + (220/5n - n/220)\sqrt{v}$.
For four pipes.....	$r_4 = 1.25 + 1.35\sqrt{v}$.
For eight pipes.....	$r_8 = 1.25 + 1.08\sqrt{v}$.
For twelve pipes.....	$r_{12} = 1.25 + .91\sqrt{v}$.
For sixteen pipes.....	$r_{16} = 1.25 + .75\sqrt{v}$.
For twenty pipes.....	$r_{20} = 1.25 + .67\sqrt{v}$.
For twenty-four pipes.....	$r_{24} = 1.25 + .60\sqrt{v}$.
For twenty-eight pipes.....	$r_{28} = 1.25 + .58\sqrt{v}$.
For thirty pipes.....	$r_{30} = 1.25 + .57\sqrt{v}$.

It will be noted in the above equations that for $v=0$, $r=1.25$ in all cases.

In many cases the entering air ordinarily passes first through a heater of sufficient extent to warm it to 70° F, in zero weather, which is termed a tempering coil; from thence

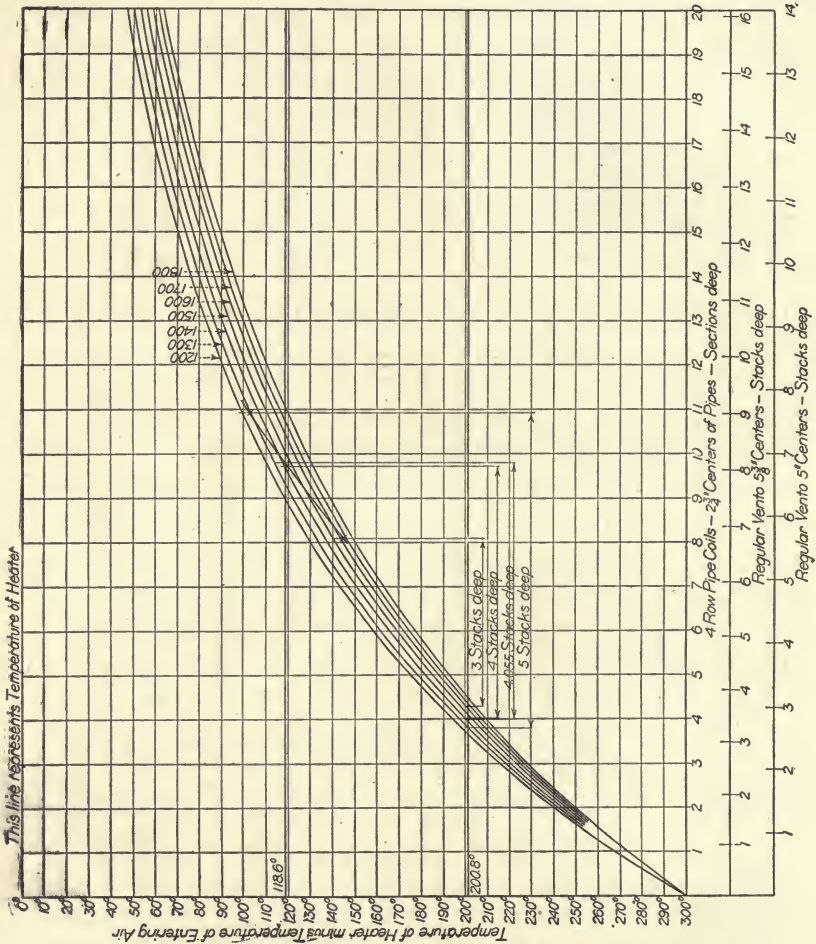

FIG. 270.—Temperature Chart.
NOTE: The figures on the curves are the equivalent velocities (in ft. per min.) of the air through the free area of the heater, if the air is measured at 70 deg. F., Barometer at 29.97 in. dry air.

it passes either through the main radiator or heater or directly to the room, as may be necessary to maintain the proper temperature without changing the volume of air supplied.

201. Charts for Vento Heaters, from paper by L. C. Soule, before the A. S. H. & V. E., 1913.

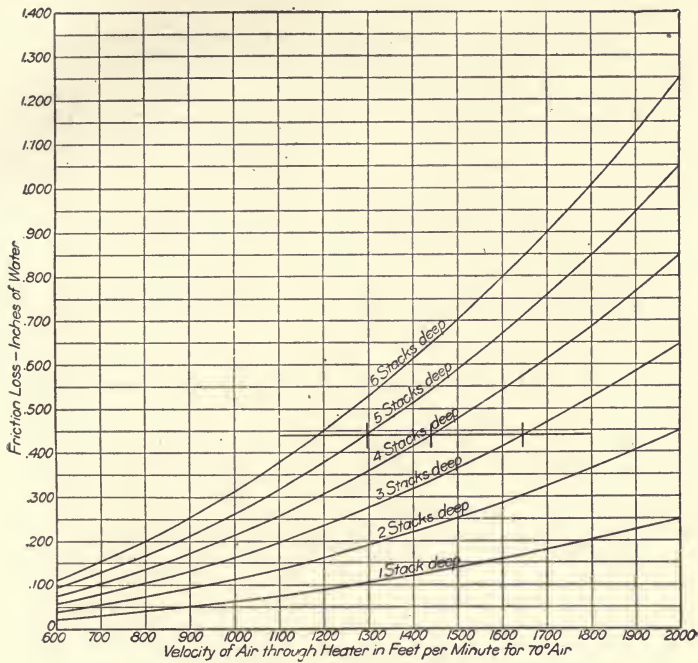

FIG. 271.—Chart Showing Friction Losses. Vento.

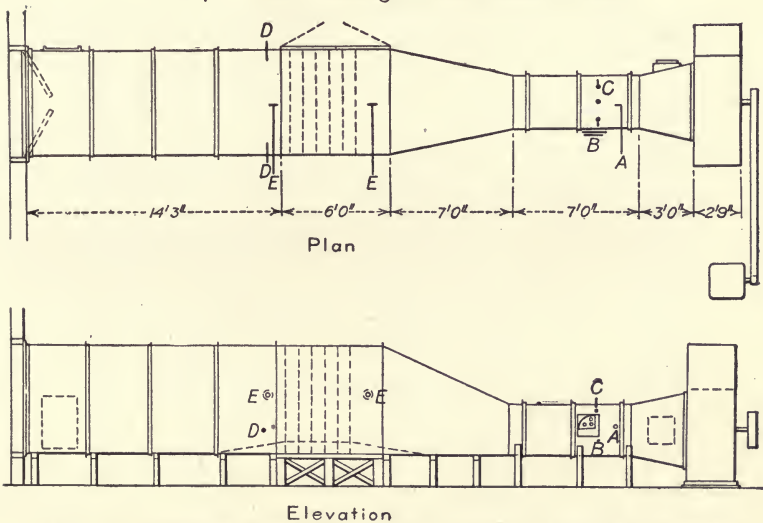

FIG. 272.—Plan and Elevation Showing Location of Testing Apparatus.

202. Table for Wrought-iron Pipe Heaters, by Frank L. Busey, before the A. S. H. & V. E., 1912:

TEMPERATURE OBTAINED WITH BUFFALO STANDARD HEATERS, 1" W. I. PIPE.

Gauge Pressure, 5 Lbs., Steam Temp. 227° F.

Velocity of Air in Feet per Minute, Measured at 70° F. and 29.92" Baro.

Temp. of Entering Air.	No. of Heater Sections.	200		400		600		800		1000		1200		1400	
		Final Temp. Lin. Ft. per Hr.	B.T.U. per Lin. Ft. per Hr.	Final Temp.	B.T.U. per Lin. Ft. per Hr.	Final Temp.	B.T.U. per Lin. Ft. per Hr.	Final Temp.	B.T.U. per Lin. Ft. per Hr.	Final Temp.	B.T.U. per Lin. Ft. per Hr.	Final Temp.	B.T.U. per Lin. Ft. per Hr.	Final Temp.	B.T.U. per Lin. Ft. per Hr.
-20°	1	23.0	261	17.9	459	14.1	620	11.1	754	8.9	876	6.9	976	5.1	1065
	2	58.0	236	49.5	421	43.1	574	38.0	703	34.1	820	30.2	913	27.2	1001
	3	87.1	210	76.5	590	68.4	536	61.5	659	56.1	769	51.1	862	46.9	946
	4	111.0	168	99.3	362	90.0	599	82.1	619	75.5	724	69.8	817	64.4	898
	5	131.2	183	118.4	336	108.5	497	100.0	582	92.7	683	86.1	772	80.6	854
	6	147.9	169	135.2	314	124.6	438	115.6	548	108.0	647	100.8	732	94.9	813
	7	161.5	157	149.0	293	138.5	412	129.3	517	121.3	612	114.0	696	107.8	775
	8	172.7	140	166.7	274	150.3	387	141.0	488	133.0	580	125.7	662	119.1	738
-10°	1	31.1	249	26.0	436	22.5	591	20.0	728	17.7	839	15.3	918	13.8	1010
	2	64.0	226	56.3	402	50.3	553	45.5	673	41.5	781	37.8	869	34.9	953
	3	92.0	207	82.4	374	74.8	514	68.1	631	62.8	736	57.8	822	53.9	904
	4	115.4	190	104.0	346	95.4	479	87.8	593	81.4	693	75.5	778	70.9	858
	5	135.0	176	122.7	322	113.0	447	105.0	558	97.9	654	91.4	738	86.1	816
	6	151.0	163	138.9	301	128.6	420	120.1	526	112.4	618	105.7	701	99.9	777
	7	164.0	151	152.0	281	141.9	395	133.0	495	125.2	585	118.3	667	112.3	741
	8	174.7	140	163.2	262	153.3	371	144.4	468	136.4	555	129.5	634	123.0	705

0°	1	39.5	239	34.5	418	31.1	566	28.5	691	26.4	800	24.2	378	22.6	959
	2	71.5	217	63.5	385	58.0	527	53.0	643	49.3	747	45.6	788	42.9	910
	3	98.2	198	88.4	337	81.0	491	74.6	603	69.5	702	65.0	744	61.0	863
	4	120.2	182	109.2	331	100.8	458	93.5	567	87.2	661	81.8	706	77.2	819
	5	138.9	168	127.3	309	117.9	429	110.0	534	103.0	624	97.0	670	91.9	780
	6	154.1	156	142.4	288	132.7	402	124.3	502	117.0	591	110.6	637	105.0	743
	7	166.6	144	155.0	268	145.4	378	136.8	474	129.2	559	122.6	617	116.7	708
	8	177.0	134	166.0	251	156.3	355	147.7	448	149.0	605	133.2	605	127.1	674
10°	1	47.6	228	43.0	400	39.5	537	37.1	637	35.0	758	33.1	838	31.5	913
	2	78.3	207	71.0	370	65.3	503	60.8	616	56.8	710	53.5	791	50.9	868
	3	103.7	189	94.5	342	87.4	469	81.2	576	76.2	669	71.9	751	68.0	821
	4	124.8	174	114.4	317	106.3	438	99.2	541	93.1	630	88.0	710	83.7	782
	5	143.7	161	131.7	295	122.7	410	115.0	509	108.3	596	102.6	674	97.7	745
	6	157.3	149	146.1	275	136.7	384	128.8	480	121.6	564	115.6	640	110.1	708
	7	169.2	138	158.8	258	148.9	361	140.5	452	133.2	534	127.0	608	121.2	674
	8	179.1	128	168.7	241	159.3	340	151.6	428	143.8	507	137.0	578	131.1	643
20°	1	55.6	216	51.5	382	48.3	515	45.8	626	43.6	716	41.9	795	40.4	866
	2	85.1	197	78.0	352	72.7	479	68.3	586	64.4	673	61.5	755	58.8	823
	3	109.4	181	100.5	326	94.0	449	88.0	550	82.8	635	79.0	710	75.3	783
	4	129.6	166	119.6	302	111.6	417	104.9	515	99.1	600	94.1	674	90.0	748
	5	146.7	154	135.6	280	127.4	391	120.0	485	113.4	566	108.1	641	103.4	708
	6	160.3	142	149.8	262	140.8	366	133.0	457	126.0	536	120.5	610	115.2	674
	7	171.8	132	161.2	245	152.4	344	144.4	431	137.3	508	131.4	579	125.9	642
	8	181.2	122	171.3	229	162.3	324	154.5	408	147.1	482	141.0	550	135.4	612
60°	1	88.6	173	85.4	368	82.9	417	80.5	497	79.0	576	77.6	639	76.3	692
	2	112.2	158	106.8	284	102.3	385	98.7	469	95.5	538	93.0	600	91.0	658
	3	132.2	146	125.0	263	119.0	358	114.4	440	110.4	509	107.0	570	104.2	625
	4	148.6	134	130.5	244	128.2	335	128.2	414	123.4	481	119.4	540	116.0	594
	5	162.0	124	153.2	226	146.1	313	140.1	389	134.8	454	130.4	512	126.4	564
	6	173.1	114	164.4	211	157.0	294	150.6	366	145.2	430	140.1	486	135.9	537
	7	182.4	106	174.0	198	166.5	277	160.0	347	154.2	408	149.0	463	144.6	513
	8	190.0	99	182.0	185	174.7	261	168.0	327	162.2	387	157.2	442	152.7	492

203. Carrier's Theory of Convection with Forced Circulation.*

From experimental investigation they conclude that the exterior of the conducting wall is covered with a surface film into which heat passes directly from the conducting wall, and whose resistance to the passage of heat is independent of the velocity of the convecting medium; but it is a direct function of the density and specific heat of that medium.

The total resistance of the surface film of the steam, of the conducting wall, and of the surface film of the conducting medium, may therefore be represented by a constant R , which is independent of the temperature difference between the steam and the convecting medium, and of the velocity of the latter.

Experimental investigation also indicates that heat is transferred from the surface film to the main body of the convecting medium, that is to the air, entirely by displacement. Particles of air in the surface film are displaced by impact, due to the velocity of the air over the surface, and are thus mixed with the main body of the air. This displacement may be shown to be in direct proportion to the velocity. The rate of heat transfer to the air is therefore directly proportional to the product of the velocity and temperature difference between the film and air.

Let θ_s represent the steam temperature, C_p the specific heat of the air, and B is a constant to be determined.

Let W_0 and V_0 be the corresponding densities and velocities of the air at an absolute base temperature θ_0 and let θ be the absolute temperature of the air corresponding to W and V then

$$WV = \left(\frac{W_0\theta_0}{\theta}\right)\left(\frac{V_0\theta}{\theta_0}\right) = W_0V_0.$$

Let K be the rate of transmission in B.T.U. per square foot per hour per degree difference in temperature between the steam and air. Then

$$K = \frac{1}{R + \frac{B}{C_p W_0 V_0}}.$$

* From paper by Willis H. Carrier and Frank L. Busey before the A. S. M. E., December, 1911.

Let H_s be the total heat transferred per hour from a surface S .

$$H_s = K(\theta_s - \theta)S$$

G = weight of air per hour passing over the surface S .

$$KS = C_p G \log_e \left(\frac{\theta_s - \theta_1}{\theta_s - \theta_2} \right)$$

where

A = clear area through heater having surface S ;

V = velocity in ft. per min. through clear area;

W = density of air in lb. per cu.ft.

$$G = 60AVV = 60AW_0V_0$$

Hence

$$\log_e \left(\frac{\theta_s - \theta_1}{\theta_s - \theta_2} \right) = \frac{KS}{60C_pAW_0V_0}$$

Changing this to common logarithms

$$\log \left(\frac{\theta_s - \theta_1}{\theta_s - \theta_2} \right) = \frac{KS}{(2.3026 \times 60)C_pAW_0V_0}$$

$$K = \frac{1}{R + \frac{B}{C_pW_0V_0}}$$

$$\begin{aligned} \log \left(\frac{\theta_s - \theta_1}{\theta_s - \theta_2} \right) &= \frac{S}{(2.3026 \times 60)AC_pW_0 \left(RV_0 + \frac{B}{C_pW_0} \right)} \\ &= \frac{S}{(2.3026 \times 60)(RC_pQ + BA)} \end{aligned}$$

where Q = cu.ft. of air per minute at standard temperature.
Will also reduce to

$$\log \left(\frac{\theta_s - \theta_1}{\theta_s - \theta_2} \right) = \frac{f}{mV + n}$$

$f = \frac{S}{A}$, n is a constant, and m is substantially a constant except as varied by change in the absolute temperature of the surface film.

HEATING AND VENTILATING.

COMPARISON OF THE VALUES OF θ , m , R , K AND K_0 .

Velocit.	Buffalo Standard W. I. Pipe Heaters.						Vento Regular C. I. Heaters, 5 In. Centres. Steam Press. 5 Lbs.						
	Steam Press. 5 Lbs.			Steam Press. 50 Lbs.			Velocity.	Mean Absolute Film Temperature θ m	Film Resistance R.	Coefficient of Transmission K.	Coef. of Trans. Corrected to Stand. Film Temp. of 625 Deg. Ab. K ₀		
200	669.9	.0479	3.316	3.354	733.5	.0525	3.322	3.413	200	672.6	.0511	2.795	2.819
300	662.4	.0474	4.674	4.735	723.3	.0517	4.549	4.700	300	666.1	.0507	3.948	3.990
400	655.7	.0469	5.788	5.858	714.0	.0510	5.026	5.838	400	660.4	.0503	4.017	4.990
500	649.4	.0465	6.743	6.841	705.7	.0505	6.565	6.839	500	654.8	.0497	5.837	5.922
600	643.2	.0460	7.614	7.718	697.8	.0449	7.461	7.784	600	649.8	.0494	6.738	6.825
700	638.3	.0456	8.412	8.476	691.5	.0495	8.064	8.403	700	646.6	.0480	8.051	8.145
800	633.5	.0454	9.146	9.204	684.2	.0489	8.829	9.190	800	632.6	.0480	9.191	9.255
900	629.0	.0450	9.823	9.850	678.4	.0485	9.472	9.846	900	626.0	.0476	10.160	10.200
1000	624.7	.0447	10.465	10.455	672.1	.0481	10.063	10.440	1000	619.8	.0471	11.030	11.050
1100	620.1	.0444	11.040	11.000	666.7	.0477	10.640	11.020	1100	614.3	.0467	11.780	11.700
1200	616.3	.0441	11.610	11.490					1200	609.0	.0463	12.505	12.350
Total Variation	8.00%	7.93%			9.17%	9.14%				9.46%	9.39%		

CHAPTER XVI.

HEATING WITH ELECTRICITY.

204. Equivalents of Electrical and Heat Energy.—Electrical energy can all be transformed into heat, and as there are certain advantages pertaining to its ready distribution, it may come into more extended use for heating, especially where the cost is not of prime importance. Electricity is usually sold on the basis of 1000 watt-hours called a kilowatt hour, the watts being the product obtained by multiplying the amount of current in amperes by the pressure in volts; on this basis one kilowatt hour is the equivalent of 3410 heat-units. Either direct or alternating current may be used as they have equal heating value per kilowatt. The voltage should not be higher than that ordinarily used for incandescent lighting.

205. Expense of Heating by Electricity.—The expense of electric heating must in every case be very great, unless the electricity can be supplied at an exceedingly low price. Much data exists regarding the cost of electrical energy when it is obtained from steam-power. Estimated* on the basis of present practice, the average transformation into electricity does not account for more than 4 per cent of the energy in the fuel which is burned in the furnace; although under best

* The mechanical energy in one horse-power is equivalent to 0.707 B.T.U. per second or 2545 per hour. One pound of pure carbon will give off 14,500 heat-units by combustion, which if all utilized would produce 5.7 horse-power for one hour, in which case one horse-power could be produced by the combustion of 0.175 lb. of carbon. The best authenticated actual performance is one horse-power for 1.2 lb., corresponding to 14.6 per cent efficiency. The usual consumption is not less than 4 to 6 pounds per indicated horse-power, or from 3 to 5 times the above. A *kilowatt* is very nearly $1\frac{1}{2}$ horse-power, but because of friction and other losses requires an engine of 1.5 indicated horse-power.

conditions 15 per cent has been realized, it would not be safe to assume that in commercial enterprises more than 5 per cent could be transformed into electrical energy. In transmitting this to a point where it could be applied losses will take place amounting to from 10 to 20 per cent, so that the amount of electrical energy which can be usefully applied for heating would probably not average over 4 per cent of that in the fuel. In heating with steam or hot water or hot air the average amount utilized will probably be about 60 per cent, so that the expense of electrical heating is approximately as much greater than that of heating with coal as 60 is greater than 4, or about 15 times. If the electrical current can be furnished by water-power which otherwise would not be usefully applied, these figures can be very much reduced. The above figures, are made on the basis of fuel cost of the electrical current, and do not provide for operating, profit, interest, etc., which aggregate many times that of the fuel. With coal at \$3.30 per ton this cost on above basis is about .97 cent per thousand watt-hours. The lowest commercial price quoted, known to the writer, for the electric current was 3 cents per thousand watt-hours; the ordinary price for lighting current varies from 10 to 20 cents. It may be said that for lighting purposes 10 cents per thousand watt-hours is considered approximately the equivalent of gas at \$1.25 per thousand cubic feet.

It may be a matter of some interest to consider the method of computation employed for some of these quantities. The ordinary steam-engine requires about 4 pounds of coal for each horse-power developed; on account of friction and other losses about 1.5 horse-power are required per kilowatt, or in other words 6 pounds of coal are required for each thousand watts of electrical energy. In the very best plants where the output is large and steady this amount is frequently reduced 20 to 30 per cent from the above figures in cost. The cost of 6 pounds of coal at \$3.33 per ton is one cent. To this we must add transmission loss about 10 per cent, attendance and interest 20 per cent, making the actual cost per kilowatt 1.3 cents per hour. As one pound of coal represents from 13,000 to 15,000

heat-units, depending upon its quality, and one kilowatt-hour is equivalent to 3415 heat-units, if there were no loss whatever in connection with transformation of heat into electricity, one pound of coal should produce 4 to 5 kilowatts per hour of electrical energy. This discussion is sufficient to show that at cost prices electrical heating obtained from coal will amount under ordinary conditions to 15 to 20 times that of heating with steam or hot water, and at commercial prices which are likely to be charged for current its cost will be from 2 to 10 times this amount.

The following table gives the cost of a given amount of heat, if obtained from the electric current, furnished at different prices. Thus 30,000 heat-units if obtained from electric current furnished at 8 cents per *kilowatt* hour would cost 70.28 cents per hour. The amount of heat needed for various buildings can be determined by methods stated in Chapter III.

COST OF HEAT OBTAINED FROM ELECTRICITY.

Heat-units, B.T.U.	Cost per kilowatt hour, cents.									
	1	2	3	4	5	6	7	8	9	10
	Cost of heat obtained, cents.									
10,000	2.93	5.86	8.78	11.71	14.64	17.57	20.50	23.42	26.35	29.28
20,000	5.85	11.68	17.57	23.42	29.28	35.13	40.99	46.84	52.70	58.56
30,000	8.78	17.57	26.35	35.14	43.92	52.70	61.49	70.28	79.06	87.84
40,000	11.71	22.42	33.14	43.84	54.56	65.28	76.00	86.72	97.44	108.16
50,000	14.64	29.28	43.92	58.56	73.20	87.84	102.48	117.12	131.76	146.40
60,000	17.57	35.14	52.70	70.28	87.84	105.40	122.98	140.56	158.12	175.68
70,000	20.50	40.99	61.49	81.98	102.48	122.98	143.47	163.96	184.46	204.96
80,000	23.42	46.84	70.28	93.68	117.12	140.56	163.97	187.36	210.80	234.24
90,000	26.35	52.70	79.06	105.42	131.76	158.10	184.46	210.84	237.17	263.52
100,000	29.28	58.56	87.84	117.12	146.40	175.68	204.96	234.24	263.52	292.80

NOTE.—10,000 heat-units is equal to two-thirds the heat contained in one pound of the best coal, and is very near the average amount that can be realized per pound in steam or hot-water heating, hence the table can also be considered as showing the relative price of electricity and coal for the same amount of heating. For instance, if 5 cents per kilowatt hour is charged for electric current, the expense would be the same as that of good coal at 14.64 cents per pound, which is at rate of \$392.80 per ton.

There are some conditions where the cost is not of moment and where other advantages are such as to make its use desirable. In such cases electricity will be extensively used for heating.

For the purposes of cooking it will be found in many cases that electrical heat, despite its great first cost, is more economical than that obtained directly from coal. This is due to the fact that of the total amount of heat, which is given off from the fuel burned in a cook stove very little, perhaps less than one per cent, is applied usefully in cooking; the principal part is radiated into the room and diffused, being of no use whatever for cooking, while the heat from the electric current can be utilized with scarcely any loss.

206. Formulæ and General Considerations.—The following formulæ express the fundamental conditions relating to the transformation of the electric current into heat:

$$C = \frac{E}{R} \quad \dots \dots \dots (1)$$

$$W = CE = C^2R. \quad \dots \dots \dots (2)$$

$$R = \frac{kl}{w} \quad \dots \dots \dots (3)$$

$$H = 0.24C^2R. \quad \dots \dots \dots (4)$$

$$h_1 = .000000095C^2R. \quad \dots \dots \dots (5)$$

$$h_2 = 3.415W = 3.415C^2R = 3.415CE. \quad \dots \dots (6)$$

In which the symbols represent the following quantities: *E*, electromotive force in *volts*; *C*, intensity of current in *amperes*; *R*, resistance of conductor in *ohms*; *l*, the length in metres; *w*, the area of cross-section in square centimetres; *k*, coefficient of specific resistance; *W*, kilowatts; *H*, the heat in minor calories, and *h*₁ in B.T.U. per second, *h*₂ the heat in B.T.U. per hour.

The amount of heat given off per hour is given in equation (6), and is seen to be dependent upon both the resistance and

the current, and apparently would be increased by increase in either of these quantities. The effect, however, of increasing the resistance as seen by equation (1) will be to reduce the amount of current flowing, so that the total heat supplied would be reduced by this change. On the other hand, if there were no resistance no heat would be given off, for to make $R=0$ in equation (6) would result in making $h_2=0$. From these considerations it is seen that in order to obtain the maximum amount of heat, the resistance must have a certain mean value dependent upon the character of material used for the conductor in the heater, its length and diameter.

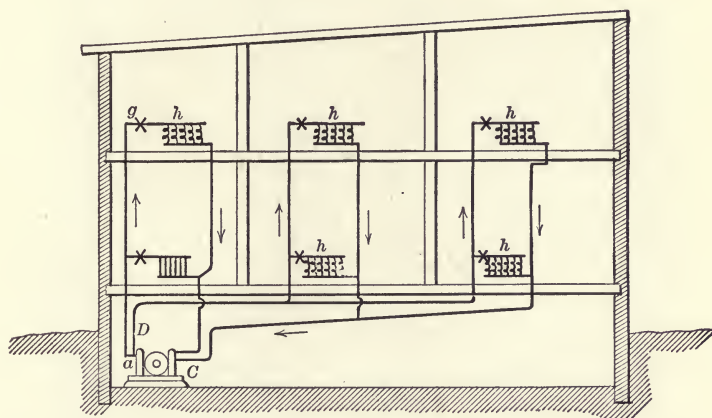

FIG. 273.—Diagram of Electric Heating.

The principle of electric heating is much the same as that involved in the non-gravity return system of steam-heating. In that system the pressure on the main steam-pipes is essentially that at the boiler, that on the return is much less, the reduction of pressure occurring in the passage of the steam through the radiators; the water of condensation is received into a tank and returned to the boiler by a steam-pump. In a system of electric heating the main wires must be sufficiently large to prevent a sensible reduction in *voltage* or pressure between the dynamo and the heater, so that the pressure in them shall be substantially that in the dynamo. The pressure

or voltage in the main return wire is also constant but very low, and the dynamo has an office similar to that of the steam-pump in the system described, viz., that of raising the pressure

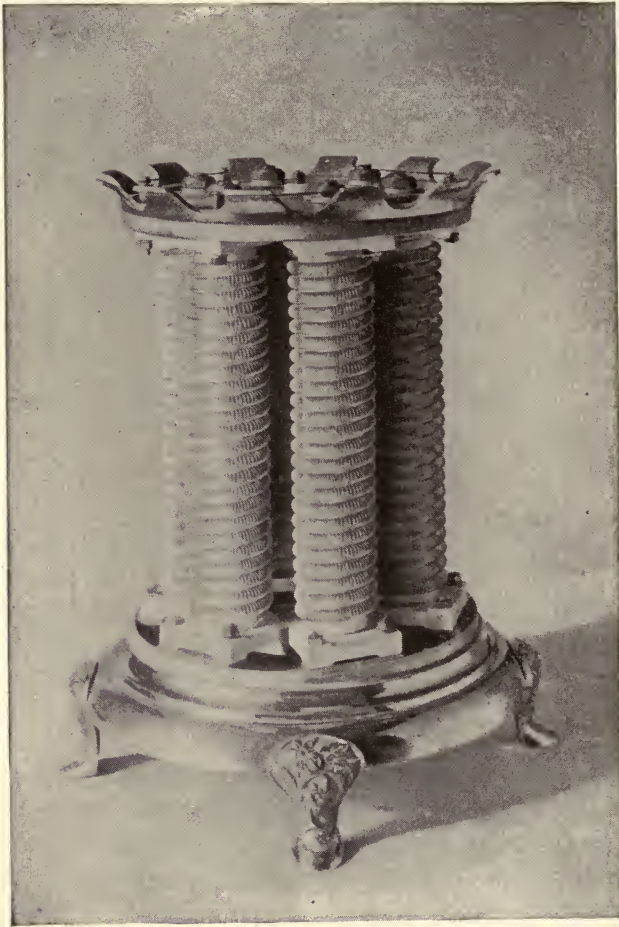

FIG. 274.—Office or House Heater.

of the return current up to that in the main. The power which drives the dynamo can be considered synonymous with the boiler in the other case. All the current which passes from the main to the return current must flow through the heater,

and in so doing its pressure or voltage falls from that of the main to that of the return.

Thus in the diagram, a generator is located at *D*, from which main and return wires are run, much as in the two-pipe system of heating, and these are so proportioned as to carry the required current without sensible drop or loss of pressure. Between these wires are placed the various heaters; these are arranged so that when electric connection is made, they draw current from the main and discharge into the return wire.

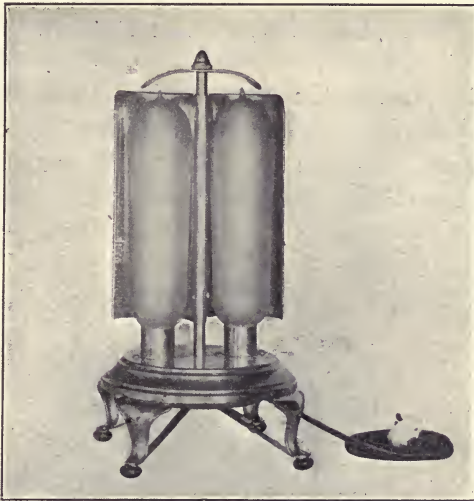

FIG. 275.—Twin Glow Electric Radiator.

Connections which are made and broken by switches take the place of valves in steam-heating, no current flowing when the switches are open.

The heating effect is proportional to the current flowing, and this in turn is affected by the length, cross-section, and relative resistance of the material in the heater. The resistance is generally proportioned such as to maintain a constant temperature with the electromotive force available, and the amount of heat is regulated by increasing the number of conductors in the heater.

207. **Construction of Electrical Heaters.**—Various forms of heaters have been employed. Some of the simplest consist merely of coils or loops of iron wire arranged in parallel rows so that the current can be passed through as many wires as



FIG. 276.—Car Heater of Consolidated Co.

are needed to provide the heat required. In other forms of these heaters the heating material has been surrounded with fire-clay, enamel, or some relatively poor conductor, and in other cases the material itself has been such as to give consid-

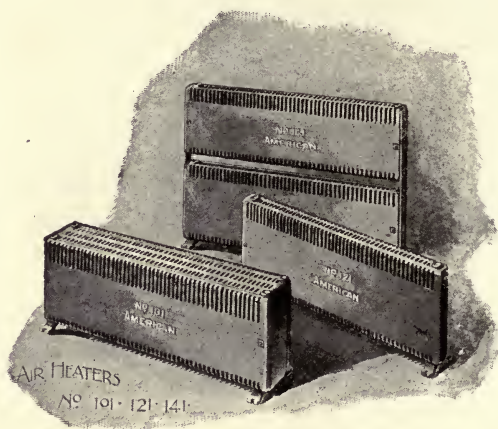

FIG. 277.—American Car Heater.

erable resistance to the current. It is generally conceded that the most satisfactory results are obtained with electrical as with other heaters by regulating the resistance, by change of length and cross-section of the conductor, to such an extent as to keep

the heating coils at a moderately low temperature. Some of the various forms which have been used are shown in the cuts. The electrical heating surface is made in the latter by a coil of wire wound spirally about an incombustible clay core. The casing is like that for an ordinary stove, and is built so that air will draw in at the bottom and pass out at the top.

The electrical heaters at the present time are used almost exclusively in heating electrical cars, where current is available and room is of considerable value. These heaters are generally located in an inconspicuous place beneath the seats, their general form being shown by the illustrations.

208. Connections for Electrical Heaters.—The method of wiring for electrical heaters must be essentially the same as for lights which require the same amount of current. The details of this work pertain rather to the province of the electrician than to that of the steam-fitter or mechanic usually employed for installing heating apparatus. These wires must be run in accordance with the underwriters' specifications, so as not, under any conditions, to endanger the safety of the building from fire.

CHAPTER XVII.

TEMPERATURE REGULATORS.

209. General Remarks.—A temperature regulator is an automatic device which will open or close, as required to produce a uniform temperature, the valves which control the supply of heat to the various rooms. Although these regulators are often constructed so as to operate the dampers of the heater, they differ from damper-regulators for steam-boilers, by the fact that the latter are unaffected by the temperature of the surrounding air, although acting to maintain a uniform pressure and temperature within the boiler, while the former are put in operation by changes of temperature in the rooms heated.

The temperature regulator, in general, consists of three parts, as follows: First, a *thermostat* which is so constructed that some of its parts will move because of change of temperature in the surrounding air, the motion so produced being used either directly or indirectly to open dampers or valves, and thus to control the supply of heat. Second, means of transmitting and often of multiplying the slight motion of the parts of the thermostat produced by change of temperature in the room, to the valves or dampers controlling the supply of heat. Third, a motor or mechanism for opening the valves or dampers, which may or may not be independent from the thermostat.

In some systems the thermostat is directly connected to the valves or dampers, and no independent motor or mechanism is employed; in this case the power which is used to open or close the valves regulating the heat-supply is generated within the thermostat, and is obtained either from the expansion or contraction of metallic bodies, or by the change in pressure caused by the vaporizing of some liquid which boils at a low

temperature. The force generated by slight changes in temperature is comparatively feeble, and the motion produced is generally very slight, so that when no auxiliary motor is employed it is necessary to have the regulating valves constructed so as to move very easily and not be liable to stick or get out of order. In most systems, however, a motor operated by clockwork, water, electricity or compressed air is employed, and the thermostat is required simply to furnish power sufficient to start or stop this motor. The limits of this work do not permit an extended historical sketch of many of the forms which have been tried. The reader is referred to Knight's Mechanical Dictionary, article "Thermostats," and to Péclet's "Traité du la Chaleur," Vol. II, for a description of many of the early forms used. Those which are in use may be classified either according to the general character of the thermostat or the construction of the motor employed to operate the heat-regulating valves as follows:

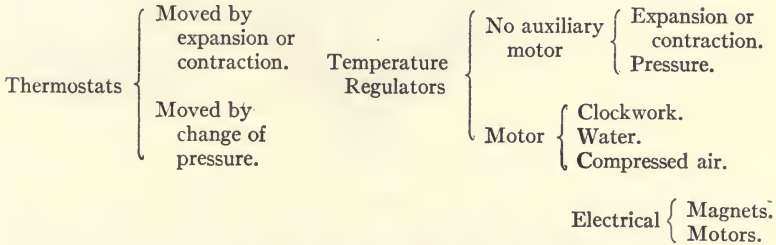

210. Regulators Acting by Change of Pressure.—A change of temperature acting on any liquid or gaseous body causes a change in volume, which in some instances has been utilized to move the heat-regulating valves so as to maintain a constant temperature. Fig. 278 represents a regulator in which the expansion or contraction of a body of confined air is utilized to control the motion of the dampers to a hot-water heater.

It consists of a vessel containing in its lower portion a jacketed chamber connected to the hot-water heater at points of different elevation so as to secure a circulation from the heater through the lower portion or jacket of the vessel from 2 to 3. Above this is a second chamber which is covered on

top with a rubber diaphragm, and which contains a funnel-shaped corrugated-brass cup. The opening to the cup is in the lower portion of the chamber, the top and larger surface resting against the rubber diaphragm. Enough water or alcohol is poured into the upper chamber through the opening marked 1 to seal the orifice in the inverted cup and confine the air it contains. The regulator acts as follows: The warm water from the heater moving through the lower chamber communicates heat to the water or alcohol in the upper chamber, which in turn warms the air in the inverted cup, causing it to expand. This moves the

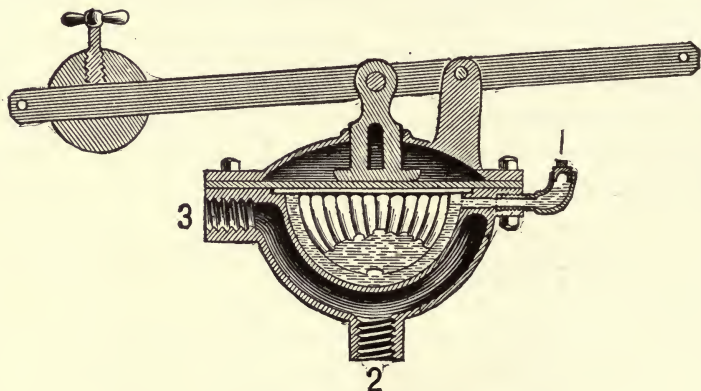

FIG. 278.—Lawler Hot-water Damper-regulator.

rubber diaphragm and connected levers leading to the dampers substantially as in the damper-regulator for steam-heaters, already described.

211. The Powers Regulator for hot-water heaters (see Fig. 279) is somewhat similar in construction to the one described, but acts on a different principle. A liquid which will vaporize at a lower temperature than that of the water in the heater is placed in the vessel communicating with the diaphragm, in which case considerable pressure is generated before the water in the heater reaches the boiling-point. As the water in the heater is usually under a pressure of 5 to 10 pounds per square inch, its boiling temperature is from 225 to 240 degrees, water of atmospheric pressure which boils at 212° can be used in the

closed vessel, and will generate considerable pressure before that in the heater boils.

The method of construction is shown at the right, in Fig. 279, as applied to a hot-water heater. The diaphragm employed consists of two layers of elastic material with compartments between and beneath; the lower one is connected to the chamber *A*, which is filled with water at atmospheric pressure and is surrounded by the hot water flowing from the heater. The water in chamber *A*, being under less pressure, will boil before that in the heater, and will produce sufficient pressure to move the diaphragm and levers so as to close the dampers, before the water in the heater reaches the boiling-point. The compart-

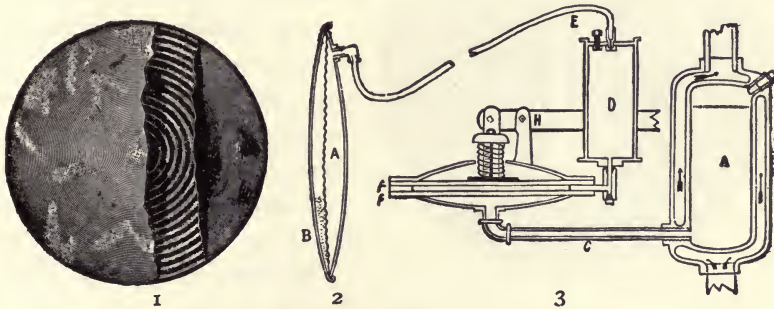

FIG. 279.—The Powers Thermostat for Hot-water Heaters.

ment between the two diaphragms, *ff*, is in communication with a vessel *D*, which in turn is connected by a closed pipe *E* with a thermostat, which may be placed at any point in the house and so arranged that if the temperature becomes too high in that room, the dampers of the heater will be closed. With this apparatus the dampers are closed either by excessive temperature of water at the heater or too great a heat in any room. The intermediate compartment is only required when the dampers are to be operated by change of temperature in the rooms.

The thermostat employed in this apparatus consists of a vessel 2, Fig. 279, separated into two chambers by a diaphragm; one of these chambers, *B*, is filled with a liquid which will boil at a temperature below that at which the room is to be maintained; the other chamber, *A*, is filled with a liquid which

does not boil, and is connected by a tube to a diaphragm damper-regulator which moves the dampers through the medium of a series of levers.

Fig. 279, 2, shows a transverse section of a thermostat, 1 an elevation with parts broken away, and Fig. 280 an elevation with attached thermometer. The vapor of the liquid in the chamber *B* produces considerable pressure at the normal temperature of the room, and a slight increase of heat crowds the diaphragm over and forces the liquid in the chamber *A* outward through a connecting tube which leads to the damper-regulator, one form of which has been described.



FIG. 280.—Elevation of Thermostat.

The damper-regulator as applied to a steam-heater is provided with a single rubber diaphragm with the parts arranged as shown in the sectional view Fig. 281. In this case the liquid pressure is applied above the diaphragm, its weight being

counterbalanced by springs and weights, attached to the levers.

The liquid used in the thermostat may be any which has a boiling temperature somewhat below that at which the room is to be kept. Many liquids are known which fulfil this condition, of which we may mention etheline, bromine, various petroleum distillates, alcohol, anhydrous ammonia, SO_3 , and liquid carbonic acid. The

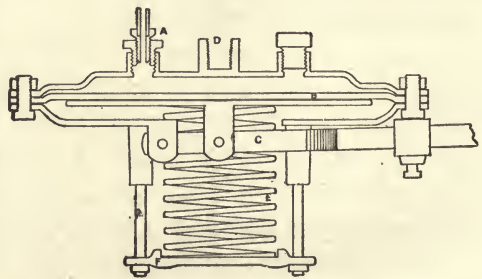

FIG. 281.—Diaphragm Damper-regulator.

liquids employed in the Powers thermostat are said to give pressures as follows at the given temperatures:

At	60°	1	1	pound to the square inch.
“	65°	2	$\frac{1}{2}$	“ “ “
“	70°	4	“	“ “
“	75°	5	$\frac{1}{2}$	“ “ “
“	80°	7	“	“ “
“	90°	10	“	“ “
“	100°	13	“	“ “

212. Regulators Operated by Direct Expansion.—Metals of various kinds expand when heated and contract when cooled, and this fact has often been utilized in the construction of temperature regulators.

A single bar of metal expands so small an amount that it is of little value for this purpose unless very long, or unless its expansion is multiplied by a series of levers. Several forms have been used, of which may be mentioned: a bent rod with its ends confined so that expansion tends to change its curvature; a series of bent rods of oval form resting on each other with the ends confined between two fixed bars; two metallic bars having different rates of expansion arranged parallel and the variation in length multiplied by a series of connecting levers an amount sufficient to be available in moving dampers; two strips of metal of different kinds bent into the form of an arc and fastened together so as to form a curved bar, with the metal which expands at the greater rate on the inside, so that expansion tends to straighten it when heated; the difference in expansion between an iron rod which is not heated and the flow-pipe of a hot-water heater multiplied by means of a series of levers. The constructions described above have all been tried for the purpose of moving the dampers of heaters or for opening and closing valves. In general, however, they have not proved satisfactory, because of the slight motion caused by expansion, and the uncertainty of operation obtained with multiplying devices.

Temperature regulators with time clock attachments are made by attaching a small alarm clock which will shift the adjustment of the thermostat back to the normal of 70 degrees, at any predetermined hour, thus allowing the house to be kept

at a lower temperature during the night by shifting the adjustment of the thermostat each night. They are more commonly used with the type of electrical thermostats in which the metal expansive element makes one electrical contact to raise the temperature and another in the opposite direction to lower the temperature. The electrical contact is made by actuating a magnet or a motor which in turn moves the dampers, either directly or by means of some clockwork mechanism.

The direct expansion of a liquid or of a gas in a confined vessel has also been utilized to move a diaphragm or piston which is connected by levers to the dampers of heaters, in a manner similar to that described in the preceding article. The writer at one time constructed a regulator for a hot-water system in which the expansion of water in a closed vessel surrounding the return-pipe was employed to operate a damper-regulator similar to those used in steam-heating. Péclet describes regulators in which the expansion of air was employed to move a piston connected by cords and pulleys to the dampers.

213. Relative Rates of Expansion.—By vaporizing a liquid an expansion of many thousand times that obtained by simply heating that liquid is obtained. The following example is computed from the steam tables to show the enormous increase in the expansion obtained by the vaporizing of a liquid over that due to the direct expansion only of the same liquid, which is water in this case. One pound of water expands from 0.01663 cubic foot to 0.01670 cubic foot when heated from 200° to 210° F., or 0.000007 cubic foot increase in volume per one degree rise in temperature. Water at 212 degrees when heated and turned into steam at 212 degrees expands from 0.01671 cubic foot to 2.167 cubic feet, or 2.15029 cubic feet for one degree. The relative rates of expansion equal $2.15029 \div 0.000007$ or 307,000. Thus water expands about three hundred thousand times more by being vaporized than by being heated one degree. Other liquids have similiar characteristics.

214. Regulators Operated with Motor—General Types.—The regulators which have been described in the preceding articles

operate the regulating valves with a feeble force acting through a considerable range, or with a considerable force acting through a short distance. They are consequently liable to be rendered inoperative by any accident to the levers or connecting tubes, or by any cause which renders the valves difficult to operate. To overcome such difficulties several systems have been devised in which the power for operating the dampers should be obtained from an independent source, and in which the work required of the thermostat would be simply that of starting and stopping an auxiliary motor. In the first systems of this kind the motor employed was a system of clockwork which had to be wound at stated intervals in order to supply the force required for moving the dampers. In recent systems electricity, water, or compressed air is employed to generate the power required, and in some instances regulators are arranged to operate not only the valves which supply heat to the rooms, but also the various dampers for supplying hot or cold air in the ventilating system.

In all of the early forms of this kind of regulator the thermostat consisted of a tube of mercury or a curved strip, made of two metals of different kinds soldered together and arranged so that a given change of temperature would produce sufficient motion to make or break electric contact. A current was obtained from a battery, and connecting wires led to the motor and to the various terminals. When electric contact was made at a position corresponding to the highest temperature, the current would flow in a certain direction and cause a magnet to release a pawl which would start a motor revolving in the proper direction for closing the valves. When the temperature fell below a certain point, the thermostat would make electric connections so that the current would flow in the opposite direction and cause the motor to reverse its motion, thus opening the valve. If the motor was operated by water, the electric current would open and close a valve in the supply-pipe; if the motor was operated by electricity, the current from the battery would move a switch on the wires leading to the motor.

The valves for regulating the heat-supply are made in a great variety of ways. Dampers for regulating the flow in chimneys or flues are generally plain disks, balanced and mounted on a pivot, so that they may be turned very easily; globe- or gate-valves are usually employed in steam-pipes and must, to give satisfactory service, either be closed tight or opened wide. A system in which steam-valves are operated requires much more power than one in which dampers only are moved.

Many systems of heat-regulation employing motors are in use and are doubtless worthy an extended notice, but space will only permit a short description of the one in most extensive use in the larger buildings of this country, namely, the Johnson system of temperature regulation.

215. Pneumatic Motor System.—In the Johnson system of heat-regulation the motive force for opening or closing the valves which regulate the heat-supply is obtained from compressed air which is stored in a reservoir by the action of an automatic motor. The thermostat acts with change of temperature to turn off or on the supply of compressed air. When the air-pressure is on, the valves supplying heat are closed; when off, they are opened by strong springs. The detailed construction of the parts are as follows:

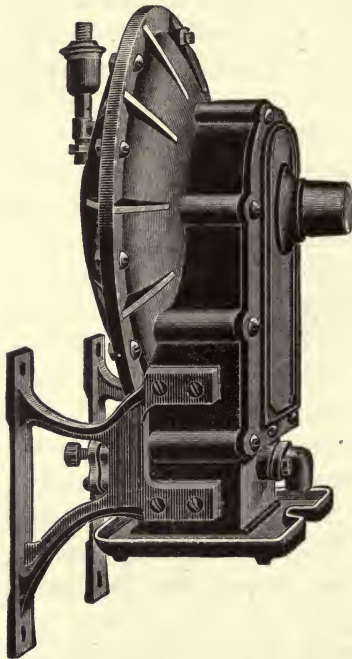

FIG. 282.—External View of Small Air-compressor.

below the limit of pressure.

The compressed air is supplied by an automatic air-compressor which is operated in small plants by water-pressure and acts only when the supply of compressed air has fallen. The external form of the air-

compressor is shown in Fig. 282. It consists of a vessel divided into two chambers by a diaphragm; one chamber is connected to the water-supply, the other to the atmosphere. The water entering on one side crowds the diaphragm over until a certain position is reached when the supply-valve is closed and a discharge-valve is opened, after which the diaphragm returns to its original place. The motion of the diaphragm backward and

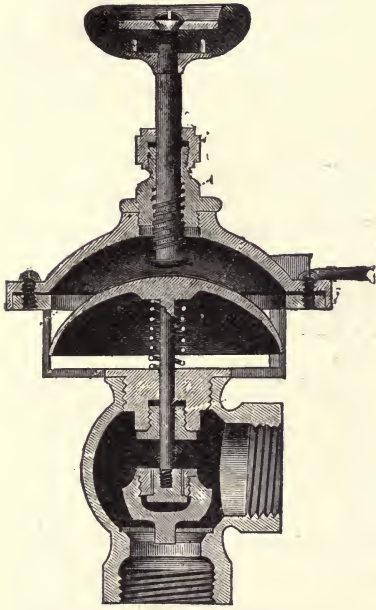

FIG. 283.—Sectional View of Diaphragm-valve.

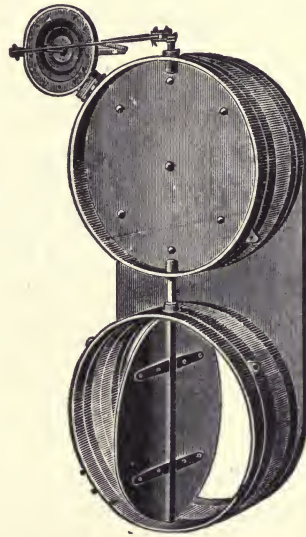

FIG. 284.—Damper for Hot- and Cold-air Flue.

forward serves to draw in and discharge air from the other chamber in a manner similar to the operation of a piston-pump, valves being provided on both inlet- and discharge-pipes. When the air-pressure reaches a certain amount, the pump ceases its operation.

An air-pipe leads from the air-compressor to the thermostat, and another from the thermostat to the diaphragms in connection with valves or dampers. The action of the thermostat, as already explained, is simply to operate a minute valve

for supplying or wasting, as necessary, compressed air in the pipe leading from the thermostat to the diaphragm-valves.

Fig. 283 is a sectional view of the diaphragm-valve, the compressed air being admitted above the valve and acting merely to close it. It can also be closed if necessary by hand. The compressed air can also be made to operate dampers of which various styles are used, and these may be placed in ventilating flues, hot-air pipes, or smoke-flues, and so arranged as to admit either warm or cold air alternately to a room, as may be required to maintain a uniform temperature. Fig. 284 shows a damper for two round flues, one for cold air, the other

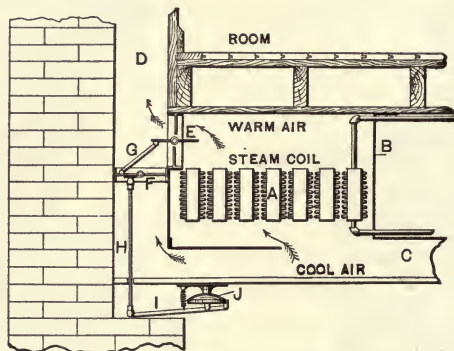

FIG. 285.—Double Damper in Brick Duct.

for hot, connected to a diaphragm and arranged so that when one is open the other will be closed.

This system of heat-regulation has been brought to a very high degree of perfection, and if sufficient heat is supplied the temperature of a room is maintained with certainty within one degree of any required point. Farther than that, the system is so arranged that after all the rooms of the house reach the desired temperature the heat-regulator then acts to close the furnace-dampers. The apparatus is in extensive use for regulating temperature in the hot-blast system of heating. Fig. 285 shows the method adopted of applying a damper-regulator to a stack for indirect heating which is so arranged as to admit either warm or cool air as necessary to maintain a uniform temperature.

216. **Construction of Pneumatic Thermostat.**—The following diagram and explanation will render the principle of action of the pneumatic thermostat as employed in the Johnson system of heat regulation intelligible.

Fig. 286 shows to different scales the reservoir for compressed air, a diagram of the thermostat and of a diaphragm for operating dampers. The thermostat is drawn relatively to

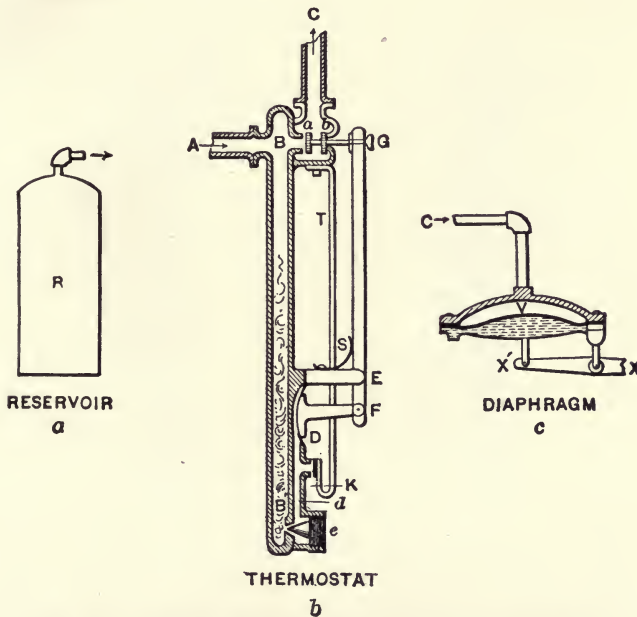

FIG. 286.—Diagram Illustrating the Pneumatic Thermostat.

a very large scale. The temperature regulator as a whole consists first of an air compressor, as shown in Fig. 282, or one of similar construction, and so arranged as to maintain a constant pressure in air reservoir *R* or in the pipes of the building.

The principle of operation of the thermostat is illustrated by the diagram, although the details of construction of the actual instrument are quite different. Compressed air from the reservoir or air-pump passes through the pipe *A* to the chamber *B*, thence, if the double valve *ab* is open, it will pass out

through the pipe *C* to the chamber *V* above the diaphragm. Its pressure then causes the end *X'* of the lever *X'X* to move downward. This lever is connected to the damper in such a manner as to close off the supply of heat when in the lowest position. If the room becomes too cold, mechanism to be hereafter described moves the valve *ab* into such a position as to close the communication to the compressed air in the chamber *B* and open communication with the atmosphere at *b*. This permits the air to escape from the chamber *V*, through the pipe *C* and opening *b*, into the air, the diaphragm in the lower part of the chamber *V* being moved upward by a spring or weight not shown in the sketch. Thus it is seen that by moving the double valve *ab* the chamber *V* is put in communication with the compressed air and the damper moved to close off the heat, or with the outside air, in which case the pressure in the chamber *V* is lessened and the damper is moved by action of a weight or a spring so as to admit the warm air.

The mechanism for moving the valve *ab* consists of a thermostat *T*, which may be made of any two materials having a different rate of expansion, as rubber and brass, zinc and brass, etc. Connected to the thermostatic strip is a small valve *K*, so adjusted that when the room is too warm the valve will be opened and when too cold it will be closed by the expansion and contraction of the thermostatic strip. Suppose the room too warm and the valve *K* open, air then flows through the chamber *B*, through the filtering cotton in the lower part of *B'*, thence through the small tube *d* and the valve *K* to the air. The small tube *d* connects with an expansible chamber *D* and opens back of a small diaphragm. When the valve *K* is open the spring *S* forces the diaphragm into the contracted or collapsed position, causing the lever *GF* to move the valve *ab* so as to put the chamber *B* in communication with chamber *V* and permit the air-pressure to close the damper connected to the lever *X'X*. If, however, the room becomes too cold, the thermostat *T* moves so as to close the valve *K*; this stops the escape of air from the pipe *d* and causes sufficient pressure to accumulate under the diaphragm at *D* to move the

lever *FG*, so as to move *ab* to the left, thus cutting off the supply of compressed air from the chamber *V* and permitting the air to escape at *b*. It will be noted that air is continually escaping at *K* during the time the room is too hot, but this is a very short interval as compared with the entire time, and moreover the orifice at *K* is exceedingly small, so that the loss of air is quite insignificant. It will also be noted that with this apparatus the damper is quickly moved from a position fully

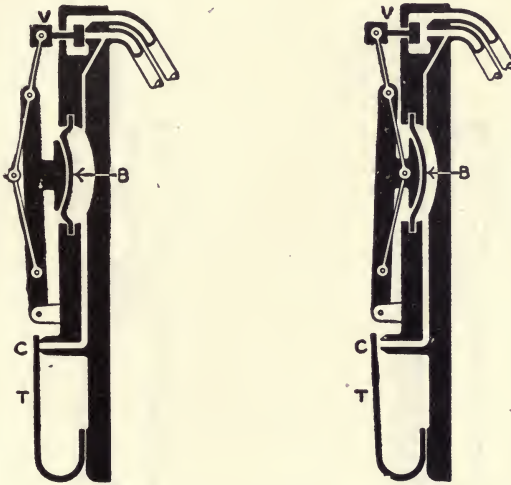

FIG. 287.—Johnson Positive Thermostat.

open to shut, or vice versa, and that it will not stand in an intermediate position.

The manufacturers of the Johnson thermostat have quite recently designed an instrument which will move the adjusting damper connected to the line *XX'* slowly and will hold it in any intermediate position as desired. This is considered an advantage for systems of ventilation in which it is always desired to admit the same volume of air, but in which the relative amounts of hot and cold air are varied to maintain the desired temperature.

The Johnson Positive Thermostat.—In the accompanying cuts, the curved metal strip *T* is the element affected by

the room temperature. A slight change in temperature immediately affects the strip and the movement causes it to either open or close the small air port *C*. When this port *C* is open, a small amount of air escapes, but when the strip closes the port, it causes a pressure to collect on the diaphragm *B*. This pressure forces out the knuckle movement, which, when it passes the center position, instantly pushes in the valve *V*. This movement of valve *V* immediately releases

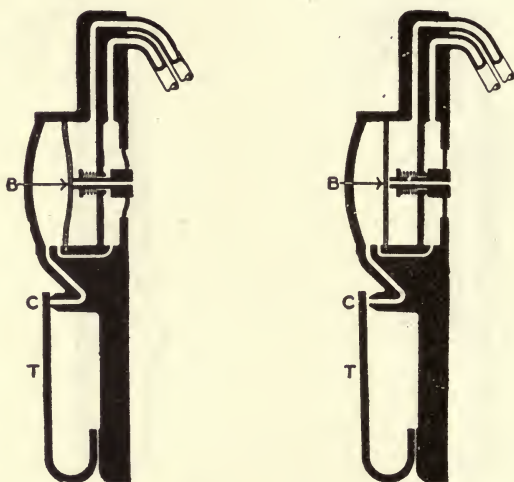

FIG. 288.—Johnson Intermediate Thermostat.

the air pressure in the branch line, permitting the radiator valve to open.

When *T* expands outward, the air pressure on *B* is relieved, the valve *V* is instantly thrown outward, and the full air pressure is at once turned into the branch line to close the radiator valve.

The Johnson Intermediate Thermostat.—The thermostatic strip *T* moving inward or outward, as affected by the room temperature, varies the amount of air which can escape through the small port *C*. When the port *C* is completely closed the full air pressure collects on the diaphragm *B*,

which forces down the main valve, letting the compressed air from the main pass through the chamber *D* into chamber *E*, as the valve is forced off its seat. The air from chamber *E* passes into the branch to operate the damper.

When port *C* is fully open, the air pressure on diaphragm *B* is relieved, the back pressure in *E* lifts up the diaphragm and the air from the branch escapes out through the hollow stem of the main valve. The thermostat thus operates on a reducing valve principle which insures various pressures as required in the branch line to operate the damper.

217. Humidity Regulators.—Automatic devices have recently been perfected for varying the moisture content of the air automatically so as to maintain it at any desired percentage of humidity. This apparatus works on the principle of a double, differential thermostat, one part of which is moved by the temperature of the wet bulb thermometer and the other by the temperature of the dry bulb thermometer in such a way as to give a differential action arranged to supply or cut off the supply of moisture as desired to maintain a constant percentage of humidity corresponding to a constant temperature difference between a dry and wet bulb thermometer for a given temperature. One type is described in Chapter XX on Air Conditioning.

218. Saving Due to Temperature Regulation.—The expense of constructing a perfect system of heat-regulation is met in a short time by the saving in fuel bills. The writer recently examined the records of the fuel consumed in a building when heated for a series of years without, and afterwards with, the heat-regulating system. He also examined the records showing the coal consumed in two buildings of exactly the same size and class, in the same city, and as nearly as possible with the same exposure. In both these cases the saving was somewhat over 35 per cent annually of the cost of the regulating apparatus.

The saving in any given case must, of course, depend upon conditions and how carefully the drafts are regulated under ordinary systems of operation. Usually, when the temperature

is regulated by hand, the rooms are allowed to become alternately hot and cool, but a greater portion of the time they are much warmer than is necessary, and frequently windows are opened for the escape of the extra heat. The maintenance of a uniform temperature for such cases means a saving of fuel by utilizing the heat better, and usually, also, by a more perfect combustion of fuel. It would seem from these considerations that a reasonable estimate of the saving obtained by the use of a perfect temperature regulator, as compared with ordinary regulation, would run from 15 to 35 per cent of the fuel bills per year.

CHAPTER XVIII.

SCHOOLHOUSES, SHOPS AND GREENHOUSES.

219. Schoolhouse Warming and Ventilation.—The warming and ventilation of school buildings constitutes one of the most important applications of the art and involves a practical exposition of all the scientific principles relating to the subject. The best general discussion of the application of this science is to be found in a treatise written by Professor S. H. Woodbridge of the Massachusetts Institute of Technology for the Connecticut State Board of Education in 1898 and from which extracts are here reprinted by permission.

220. Complex Character of the Problem.—What the respiratory system is to an animal the ventilating system is to a building. As the habits of an animal determine the type of respiratory system most appropriate to it, so the type and use of a building are the principal factors in determining the characteristic features of the ventilating system best adapted to it. The large and modern high school building presents a complex type far removed from the simpler patterns, found in the dwelling-house, the office building, the audience-hall, the church, or even the theatre. It presents an involved combination of rooms designed for widely different purposes, each room requiring an equipment adapted to its special use, and the building as a whole demanding a treatment with proper reference to its periodic use and its peculiarities of arrangement and exposure. Between the complex problem peculiar to such a building and the simple one presented by the one-room schoolhouse at a country cross-road there exists a range of type completely filling the interval, each step of the gradation necessitat-

ing a corresponding modification in the method of, and means for, ventilation.

221. Relation of Pure Air to Vitality.—Air is as essential to the products of physical and dependent mental energy as it is to the intensity and brilliancy of a candle-flame. The breathing of impoverished air results of necessity in the dulling of the vital fires of the body and of the keen edge of the intellect. It means a weakened body and a dulled mind. A lowered vitality of the body, besides exposing it to an increased liability to communicated, contracted, or constitutional disease, also impairs its effectiveness as a vital mechanism. The aggregate of physical and mental vitality lost through ignorant or indifferent regard, and even culpable disregard, of the exact and delicate dependence of the activities of body and mind on the maintenance of a normal, including atmospheric, environment, surpasses all common conception or belief. That air quality is fully as important as food quality in the production of vital energy is a conception which has yet to be borne in upon the public, if not the professional, belief and conscience.

222. Limitations to the Supply of Pure Air.—A rule which may be safely insisted upon for general adoption and application is that pure air should be supplied to enclosures in the maximum rather than in the minimum quantity tolerable. Only two considerations should be allowed to limit the quantity of air-supply: air-draughts and bank-drafts.

Draughtiness in air-currents is more dangerous to health than the ordinary vitiation of air in badly ventilated enclosures. On the other hand, the warming and, under some circumstances, the moving of air in large quantities for ventilating work is far from costless. Both draughtiness in air movement and costliness in the warming of air put, therefore, a deterring limit on air quantities to be used in practical ventilating work.

223. Draughtiness in Large Halls.—With a given hourly per capita air-supply, the danger from draughtiness within an enclosure increases, approximately, inversely as the per capita space. Fortunately, however, the necessity and importance of ventilation are not the same for crowded as for sparsely

occupied rooms, being of least account in rooms intermittently occupied, and of greatest account in those most continuously used. The length of time for which a person is exposed to the confined air of an enclosure is, therefore, an essential factor in determining the proper rate of its ventilation. The harmful effects of short exposure to impure air once a week are small when compared with those incurred by frequent and protracted exposure to such air. In effect, the time of actual occupancy varies with the provided per capita space; and, for equal hygienic results, the per hour and per capita air-supply required also vary in the same manner. Considering only permanent effects on health, and individual air-supply of 1000 cubic feet per hour furnished to a crowded audience-hall having but 100 cubic feet space per capita, may, therefore, be regarded as equally good ventilation with 3000 cubic feet per capita supply of air per hour furnished to a schoolroom having 300 cubic feet per capita space. For the ventilation of crowded rooms the air-volumes usable are limited by draught dangers; and for ventilating less and the least crowded rooms the quantities are limited by the cost. It is the office of the architect and the engineer to provide for the rooms of the first class a maximum air-supply with a minimum of draught; and for rooms of the second class the freest ventilation consistent with reasonable expense.

224. Means for Reducing Draughtiness.—The audience-halls and larger lecture-rooms of schoolhouses cannot generally be provided for as perfectly as can similar rooms having fixed seats or desks, the usual or specially provided surface of which may be utilized for a diffusive entrance of large quantities of air. The floors of these large rooms must at times be cleared for drill, dancing, and social occasions. Danger from draughts must, therefore, be reduced by dividing the inflow into as many and small and slow-moving currents as practicable, and by giving to the inlets such positions and formations as shall deliver the air in directions least liable to produce sensible draughtiness. The animal heat yielded by a crowded audience is frequently more than that lost through walls, windows, and other means.

The effect of that heat is to raise the temperature of the auditorium air and to necessitate a temperature of air-supply lower than the temperature of the room. Because of the need of this low temperature, it is desirable to give to the entering currents of air a direction which shall as much as possible prevent their dropping floorward, at least in concentrated form. If the air-supply must be admitted through wall apertures, they should be elevated, unless they are made so large as to reduce the rate of inflow to or below a linear rate of 30 feet per minute. Even when the wall openings are elevated, the currents should be given an initial upward direction. They will thus take a longer path before reaching the floor, and will, therefore, mix more thoroughly with the warm air of the room by being longer in contact with it, and by flowing more diffusively through it. If the air-inlets to a room of this character can be placed in the floor and protected from infalling dirt, that position is preferable to a wall location. In general it may be said that wall inlets through which air issues with rapid or even moderate movement and at temperatures from 100° downward should be elevated well above the head plane for the purpose of giving the currents a location in the unoccupied parts of a room. By means of chutes of solid or open material, the entering air may be given a slight or sharp upward course. By completely covering the inlet with a semi-cylindrical surface of fine wire gauze or other impervious material, of any size desired, the entering air may be made to move radially from the inlet in a more or less horizontal plane, and with a velocity varying with the extent of the diffusing surface, and with the volume of air issuing through it. By deflecting plates or blades set to separate the current and to throw the entering air in divergent directions, the inflow may be given a radial direction from the inlet, both laterally and vertically if desired. Blades are preferable to gauze, as the meshes of the latter fill, and, even when clean, offer sensible resistance to air-flow. Blades are as effective in breaking up the larger current into a number of divergent ones, and produce a quicker and more thorough diffusion of air throughout a

room. The form of diffuser must be chosen with reference to the location and surroundings of the inlet. Properly made and used, diffusers make impossible a processional of air from inlet to outlet that does no effective ventilating work.

The rapidity of air-flow through supply-flues has obviously no necessary effect upon draughtiness within rooms. By the use of suitable diffusing means, air, although brought to the diffusers with a relatively high velocity, may yet by them be given such reduced velocity and dispersed movement as to remove all danger from this cause.

225. Little Draughtiness in Outflowing Currents.—For the protection against draught due to outward movement of air from rooms less precaution is needed. The movement of escaping air is slowly accelerated toward the location of the discharge, the velocity of the movement toward that point decreasing inversely as the square of the distance from it. The air-movement, therefore, being convergent for a wide range, is the reverse of the divergent inflow produced by the use of deflecting plates or diffusing surfaces, and is wholly unlike the concentrated and continuous current projected from a supply-register. It is necessary only that the area of the outlets should not be too large, the volume of air-movement too great, the final velocity of air-approach too rapid, and that permanent sittings should not be placed too near the outlets.

226. Air-supply for Schoolroom.—In the case of a school-room, the per capita floor and cubic space is generally from two to three times that common in well-filled audience halls. To such a room, having a cubic space of from 11,000 to 12,000 feet, and seating from forty-five to fifty scholars, it is practicable to supply without draughtiness and without the use of exceptional precautionary means for preventing it, from 2000 to 2500 cubic feet of air per hour to each occupant, or a total hourly quantity of from 100,000 to 125,000 cubic feet, the larger quantity being more than one-sixth of the contents of the room per minute. When special means are provided for a draughtless entrance and removal of air these quantities

may be largely increased. Between 90 and 100 cubic feet per minute for each sitting have been passed through the classrooms of a schoolhouse equipped in accordance with modern methods, and there was no complaint of draughts. Usually, however, the limit of immunity from draughts is reached when the rate of air-supply is brought up to an equivalent of ten changes per hour.

227. Cost.—The expense of ventilation properly includes the cost of all special building arrangements and construction provided; of all special equipment for heat production and air warming; of power for moving, distributing, and removing the air; of fuel for warming; and of specially skilled attendance required above that called for in ordinary heating work.

228. Methods of Saving Heat.—It is now intended to set forth in detail various opportunities for economy in methods as illustrated by the special characteristics of schoolhouses. The several means for special economy in the warming and ventilating of schoolhouses will accordingly be discussed under the following heads: successive ventilation; quick preparatory warming; warming by rotation; heat commonly wasted; solar heat; automatic control of temperature; double glazing; double sashing; waste of heat at night; plenum and vacuum methods; location of inlets and outlets.

229. Successive Ventilation.—The first suggestion made in the interest of economy relates to a method for the successive use of one and the same volume of air, first for the free ventilation of the least occupied parts of a school building, and then for the ventilation of those rooms in which the vitiation of air is either excessive or else of obnoxious quality. The parts of buildings, especially in those designed for use as high or normal schools, which are not closely occupied, frequently aggregate as much in space as the classrooms themselves. Such parts of a building are generally continuously ventilated, though perhaps infrequently occupied. No amount of instruction or training of janitors and engineers is likely to result in a continued practice of opening and closing dampers or registers, according to the occupied or unoccupied condition of rooms.

However carefully such precautions may be taken at first, they are likely to be eventually abandoned, and the ventilation of the entire building to become continuous during school sessions. It is this continuous ventilation of large parts of the building outside of classrooms which greatly increases the apparent cost of classroom ventilation, and which justifies the use of economic methods for the ventilation of rooms not continuously occupied. Besides the provision to be made in school buildings of higher grade for such rooms as audience halls, lecture rooms, recitation and classrooms, gymnasiums, and laboratories—all of which, when in use, require, in the order given, increasingly large per capita supplies of air—are the coat, lunch, bath, lavatory, and sanitary rooms, and the private and retiring rooms, each requiring its own appropriate treatment. Unquestionably, a generous and continuous flushing of all these apartments with the purest air would prove hygienically advantageous and financially disastrous. In every case there is at some point of ventilating work a balance between hygienic gain and financial loss.

Only in cases of special impurities or of abnormal or disease-producing contents given to, and carried in, the air of an enclosure, or in cases of prostrated vitality requiring the utmost opportunity for recovery, is there commensurate gain in providing more than 50 cubic feet of air per capita per minute for breathing purposes, provided, of course, that such air is effectively used. For ordinary schoolroom work even that quantity cannot be safely urged unless assurance is given of the purpose and ability of its users to make ventilation draughtless.

230. Supply of Air for Rooms not Frequently Occupied.—

The quantities of air which should be furnished by ventilating means cannot be safely based solely on the number of those to occupy the rooms to be provided for. The most active and dangerous impurity in the air of occupied enclosures is the matter of organic nature, called effluvia, thrown off by the body through its pores. That matter rapidly changes in character, passing through a fermenting and decomposing to a putrescent condition. The longer it is retained within a room,

the worse its odor becomes and the more morbid its condition. The aims of ventilation should be, as far as practicable, to limit atmospheric impurities to the location of their origin, and to reduce the quantity and the time of retention of such impurities within an enclosure to a minimum. In proportion as the per capita space of an enclosure is greater, the quantity of such matter contained in it is large, the time of its retention longer, and its character more offensive and harmful. It follows, therefore, that the more sparsely occupied rooms of a building are those to which the largest per capita supply should be furnished. Laboratories in which gas is burned and in which vapors, fumes, and gases are generated in any considerable amount outside of hoods also belong to the class of rooms needing more air per occupant than do classrooms. The same is true of gymnasiums, physical-training rooms, and playrooms, for vigorous physical exercise produces a condition of the body calling for a larger air-supply than the condition of repose demands.

231. Course of the Air-supply.—The ventilation of corridors should be sufficiently free to fill them with air suitable for passage to, and use in, class or other rooms. The continuously or frequently opened doors or transoms between corridors and rooms make the continuous or occasional mingling of corridor air with that of rooms probable and almost inevitable. The passage from such an accidental to an intentional use of hallways for fresh-air reservoirs and channels is both legitimate and proper. Playrooms, lunch rooms, gymnasiums, and other rooms of their general type, though intermittently occupied and sometimes crowded, belong, because of their average condition, to the sparsely occupied class of rooms. Continuously and separately to ventilate them on the basis of the largest or the ordinary numbers occasionally occupying them would require great volumes of air. Such rooms and parts of buildings may, however, be ventilated in series, or by a successive method, which will meet the requirements of their shifting groups of occupants, and yet require the use of relatively small volumes of air. Coat, bath, lavatory, and sanitary rooms

need no independent supply of purest air. Air pure enough for breathing purposes in schoolrooms is certainly suitable for airing wraps hung in coat rooms. The air which passes out from schoolrooms through discharge-flues is, generally speaking, as pure as that surrounding the occupants of the rooms. Stigmatized as foul only as a matter of convenience to distinguish it from the air-supply, it is popularly supposed to become so by virtue of its entrance into the way of the outcast. Lavatory, bath, and sanitary rooms are, from a hygienic point of view, most suitably treated when they are atmospherically isolated from other parts of a building, as when ventilated by strong aspirating currents which cause air to move toward and into them from adjacent apartments, and prevent air-movement from such rooms to those apartments. Classrooms may be vented, in part at least, through their coat rooms. Lavatory, bath, and sanitary rooms may take their air from the supply which has done its partial ventilating work in the hallways, playrooms, and other permanently or periodically occupied rooms. For that purpose air may be continuously supplied in generous quantities to playrooms, lunch rooms, physical-training rooms, or gymnasiums, which are in the basement, and which are occupied but a small fraction of the time. From these rooms the air may be sent to ventilate the corridors of the building, rather than being immediately thrown away. The corridors are by this means flushed with fresh air which should find egress, not through the roof nor through outlets or windows on the upper floor, but rather through the lavatories and sanitariums. If the air-supply is generous enough, as it may be made to be, it may be sent from the corridors to the classrooms, and thence to the coat rooms. Thus in successive ventilation the movement of air must be from locations of lesser to those of greater vitiation, as from playrooms to corridors, from classrooms to coat rooms, or as from the corridors through playrooms to sanitary rooms.

When at recess scholars leave classrooms for play or lunch rooms the conditions described above are in part temporarily reversed. The crowds are then in the basement, and the

corridor air contains impurities brought from the crowded basement rooms. 'Meanwhile, however, the vacated classrooms are being flushed by their independent and uninterrupted air-supply, and at the same time the large volume of corridor air is so diluting the impurities carried upward from the basement that they become imperceptible, if, indeed, they are at all noticeable even in the basement rooms themselves. In this successive method, then, basement rooms and corridors, sanitary rooms, and coat rooms, may be effectively ventilated by moderate quantities of air as compared with the volume that would be required if each part were as effectively and continuously ventilated by independent means.

232. Quick Preparatory Warming.—The heat quantity necessary for the preparatory warming of a building varies greatly with the methods used. In the first place, the heat expenditure is approximately proportional to the time given to the warming process. The quicker the process, the less the fuel required. During the process of warming, heat is lost by its transmission through walls and by air-leakage. For rapid heating the production and distribution of heat must be large and quick. A heating apparatus of low power, although economical in its first cost, is, in the end, expensive, because it is unequal to such a demand. A heating system successfully planned with reference to maintaining both an internal temperature of 70° against an outside temperature of zero, and also a generous ventilation at such times, is equal to the demands of such work.

233. Warming by Rotation.—Relatively little heat and time are required to warm the air of a building as compared with the heat and time needed for warming walls, floors, ceilings, and contents. The warmer the air entering the heating battery, the higher its temperature is on leaving it, and the amount of heat required to bring that air to a given temperature is correspondingly less. A considerable gain is, therefore, made when, for the purpose of warming a building, air is taken from the building itself, rather than from the colder outside supply. The method of warming a building in this way is one of rota-

tion: the air is taken from the building, heated, distributed to the rooms, and, after yielding considerable of its heat to the room surfaces, is brought back to the heating battery either by means of a special arrangement of flues, or by the use of the corridor-ways and stairwells. Warming by rotation should, of course, cease and ventilation should begin before a building is occupied.

234. Heat Commonly Wasted.—Heat usually wasted is the spare heat of boiler-gases escaping through the smoke-pipe. This may be used for strengthening draughts through vent-stacks, and thus the making of heat especially for that purpose is rendered unnecessary. This spare heat may also be made available for strong ventilation of sanitary rooms or any other equally important work. For this purpose the chimney and the ventilating stack about it should be designed with reference to the transfer of the needed amount of heat from the combustion gases to the vent-flue air. In all such work care should be taken not to reduce the temperature of the combustion gases so as to jeopardize the chimney-draught. Still another form of heat usually wasted is that of fires banked for the night, this heat being generally expended in useless steam-making in closed boilers. Such steam may be used in limited and subordinate parts of the heating system, as in the foot-warmers, hallway coils, heaters in sanitary rooms for the protection of fixtures against freezing, and for other like work. Provision for these uses may be made in any steam system through suitable supply- and return-pipe connections with the boiler.

235. Solar Heat.—Solar heat is a factor to be regarded in the planning of a warming and ventilating system. It may be demonstrated by a properly protected thermometer that the average day temperature of air is higher on the south than on the north side of a building. The difference often reaches 10° . An average of 5° would make it highly advantageous to take the air for ventilating work from the south rather than from the north side of a building. If an average rise of 35° is needed in the air temperature in ventilating work, then one-

seventh of the heat required for that rise could be gained by choosing a south as against a north location for the inlet. Such a location is possible only when mechanical ventilation is used, for in gravity work it is necessary to place the inlet on the side of the building toward the prevailing winds of winter.

236. Automatic Control of Temperature.—From a hygienic point of view the close regulations of the temperature of a building is important; and from an economic point of view it is even more important, when the air-volumes used are large. Such regulation cannot be safely entrusted to teachers who, absorbed in their work, fail to note a change in temperature until it becomes sufficiently extreme to extort notice. A radical and speedy change being then called for, windows and doors are resorted to until rooms become chilly. The inevitable results of such methods of regulating the temperature are wasteful escape of heat and disastrous catching of colds. The quantity of heat may be closely regulated by automatic means which control either the flow of steam or hot water into the heaters, or the proportions in which cold and hot air are mixed to produce the temperatures required. Such control is as essential to the evenness of temperatures furnished by a heating system and to the economy of its working as is a governor to the steadiness and the economy of the working of an engine. The importance and reliability of the control in these essential particulars are fully established. That reliable results are obtainable with the best forms of apparatus properly installed, cared for, and used, has been abundantly demonstrated. Aside from the undoubted value of a reliable system for control of temperature in protecting health and in sustaining vigor, its service in economizing fuel is important.

237. Double Glazing.—As heat loss through the glass of windows is generally about four times that through equal areas of walls, a double glazing in windows is advantageous. The two panes, thoroughly clean, can be puttied in, one on the outside and one on the inside of a sash, with a space between them of from one-fourth to one-half of an inch. If the work

is reasonably well done, the inside surfaces of the panes will remain clean indefinitely. Double glazing stands between cold temperature on the outside of a building and the desired temperature on the inside, and so is as effective upon one side of a building as another. If day and night are included, the differences in temperature between the north and south side are not great. The saving in heat by double glazing can be made to approximate 33 per cent of the heat escaping through single-glazed windows; the saving in fuel approximates 2 pounds per hour for every 1000 square feet of windows.

238. Double Sashing.—Double windows are more effective than double glazing in preventing heat waste. They protect against both inside and outside differences of temperature, and also against the inward leakage of cold air resulting from pressure due either to inside and outside temperature differences or to wind action. They are, therefore, doubly serviceable. They are more effective on the prevailing windward side of a building than on its leeward side.

239. Waste of Heat at Night.—To carry over from one day to another as much as possible of the heat of a building some of which is stored in its air and much more in its walls, the building should be closed as tightly as practicable when not in use. The in-leakage of air through walls and windows is far more rapid than is usually supposed. Recent experiments made in a building of ordinary schoolhouse construction indicate that in mildly cold and quiet weather such leakage equals the cubic contents of a room or building approximately once in each ninety minutes. In sharply cold weather it is greater, and still more so in windy weather. Air-leakage is the unknown and most disturbing factor in estimating the required power of heating-plants. Unless such leakage is to be relied upon as a factor in ventilation, it should be made as small as possible. To reduce loss of heat at night, and whenever the building is closed, the vent flues or shafts should be closed by dampers at their tops.

240. Plenum and Vacuum Methods.—For the same reason discharge ventilation should not be made in excess of the

supply. The supply should, on the other hand, be in sufficient excess of the discharge to produce a slight pressure or plenum condition, particularly within the lower rooms of a building. A vacuum condition within rooms augments the inward movement of cold air through walls and windows, and tends to cold floors and chilly rooms. No system of ventilation should be installed which prevents the windows being opened.

241. Location of Inlets.—The efficiency of a ventilating system has an important bearing on the cost of obtaining the results for which it is provided. The air quantity used does not determine the thoroughness of the ventilating work it effects. As the Gulf Stream goes through the Atlantic, so air often goes through schoolrooms, its ventilating effectiveness ranging as low as from 36 per cent to 40 per cent out of a possible 100 per cent. The location of outlets and the concentrated or diffused movement of air through rooms are the chief determining factors in the problem.

242. Local Ventilation.—Strong local exhaust is required in certain parts of schoolhouse ventilation. Where ventilation can be effected by the immediate removal of atmospheric impurities, a great gain is made by doing so. To remove completely the smoke of an open fire burned in a brazier placed in the middle of a room would require a hundred or a thousand times more air than if that fuel were burned in a fireplace. The air of a chemical laboratory may be kept as clear as that of a classroom and with no greater per capita supply, if all fuming work is done under hoods. If such work is generally done in the open rooms, ten times that volume of air passed through them might not clear the air. The discharge from such rooms should be largely, if not chiefly, through the hoods; and the airways through and from the hoods should be designed and furnished with reference to that purpose. So also the general ventilation of sanitary rooms should be largely by means of strong local discharge through the fixtures of both closets and urinals. If the discharge ventilation is not effected by mechanical means, the vent-flues of lavatories, sanitary rooms, and hoods of lunch-room ranges should be made warmer than

the flues of other rooms. In this way a movement of air toward and into the rooms which are to be locally ventilated is produced, counteracting and overcoming any conflicting pull of flues which discharge air from other parts of the building. The location of chemical laboratories, of kitchen schoolrooms, and of other rooms of similar character should be on the top floor, since the trend of air, especially in cold weather, is upward through a building. When such rooms are thus situated, fumes, gases, and odors generated within them are more completely confined to the place of their origin than was ever possible when these rooms were placed, as was formerly the custom, in the basement.

243. Air Filtration.—The importance of filtering (or washing) the air supplied to school buildings varies with local conditions. In dusty or smoky localities such filtering may be essential to the cleanliness of a building and to the protection of its contents.

244. Heating of Greenhouses.—Greenhouses and conservatories are heated in some cases by steam and in other cases by hot water, and there is quite a difference of opinion held by florists respecting the relative merits of these two methods of heating. The fact, however, that either system when properly proportioned and well constructed gives satisfactory results indicates that the difference is not great, and that the relative value may depend entirely on local conditions.

The methods of piping employed may in a general way be like those described, and the pipes may be located so as to run underneath the beds of growing plants, or in the air above, as bottom or top heat is preferred. In many cases large cast-iron pipes, the method of erection of which is described in Chapter VI, are used in hot-water heating of greenhouses. These are generally located beneath the beds of growing plants; the main flow- and return-pipes are laid in parallel lines, with an upward pitch from the boiler to the farthest extremity of the house. Recently small wrought-iron pipes have been used extensively for greenhouse heating. In this case the main pipe has generally been run near the upper part of the greenhouse and to the farthest extremity in one or more branches, with a

pitch upward from the heater for hot-water heating and with a pitch downward for steam-heating. The principal radiating surface is made of parallel lines of $1\frac{1}{2}$ -inch, or larger, pipe, placed under the benches and supplied by the return current; this has in all cases a pitch toward the heater. An illustration

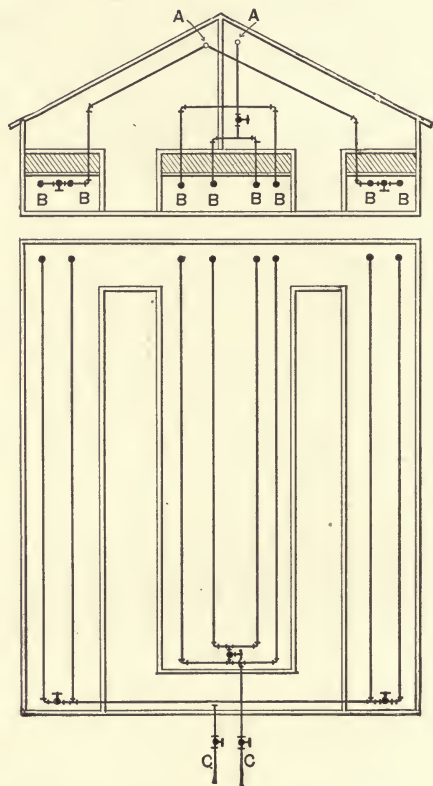

FIG. 288.—Plan and Elevation of Piping.

of the method of piping as designed by A. H. Dudley of the Herendeen Mfg. Co. is shown in the three following figures so clearly as to require no special explanation.

Any system of piping which gives free circulation and which is adapted to the local conditions will give satisfactory results. The directions for erecting and taking off branches are the same as in residence heating.

Proportioning Radiating Surface.—The loss of heat from a greenhouse or conservatory is due principally to the extent of glass surface; hence the amount of radiating surface is to be taken proportional to the equivalent glass surface, which in

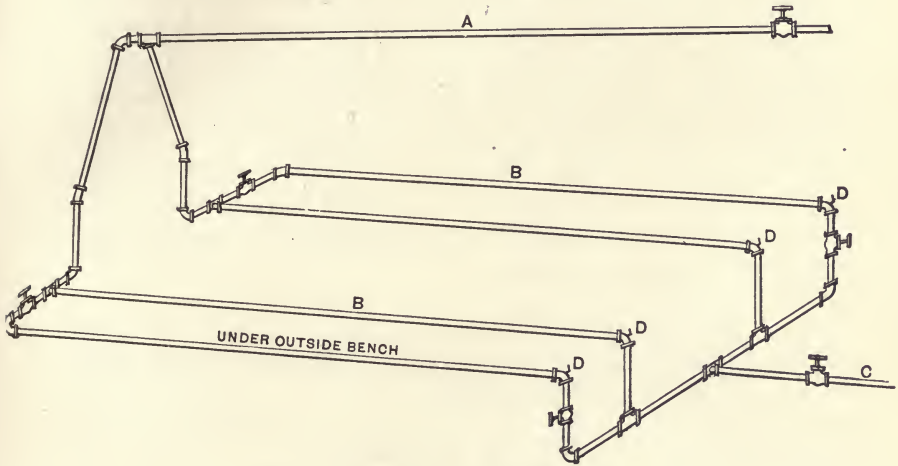

FIG. 289.—Piping for Outside Bench.

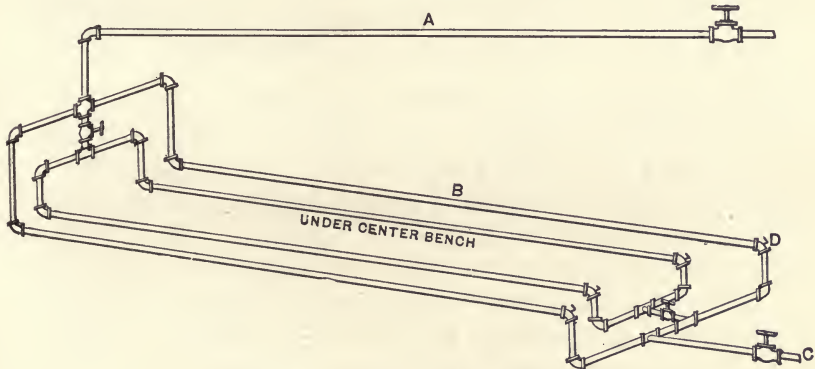

FIG. 290.—Piping for Inside Bench.

every case is to be considered as the actual glass surface plus $\frac{1}{4}$ the exposed wall surface. From this surface about 1 heat-unit will be transmitted from each square foot for each degree difference of temperature between that inside and outside per hour; that is, if the difference of temperature is 70 degrees,

each square foot of glass surface would transmit 70 heat-units per hour. The radiating surface usually employed for this purpose is horizontal pipe, and hence is of the most efficient kind. From a surface of this nature we can consider without sensible error that 2.2 heat-units are given off from each square foot for each degree difference of temperature between the radiator and the air of the room per hour. From this data a table can be computed which gives the ratio of equivalent glass surface to radiating surface, in which the results will be found to agree well with average practice; the results are to be increased or diminished 10 to 20 per cent, according as the circumstances of exposure or the quality of the building vary more or less from the average condition.

TABLE SHOWING AMOUNT OF GLASS SURFACE OR ITS EQUIVALENT WHICH MAY BE HEATED BY ONE SQUARE FOOT OF RADIATING SURFACE IN GOOD BUILDINGS.

Temp. of Radiating Surface, Deg. F.	Hot Water.			Steam.	
	160°	180°	200°	5 lbs. 227°	10 lbs. 240°
	Square Feet of Glass for 1 Square Foot of Radiating Surface.				
Temp. of surrounding air, 90° F...	1.9	2.3	2.8	3.3	3.8
“ “ “ “ 80° F..	2.3	2.9	3.5	4.0	4.6
“ “ “ “ 70° F...	3.0	3.6	4.2	5.0	5.7
“ “ “ “ 60° F...	4.0	4.6	5.25	6.0	7.0
“ “ “ “ 50° F...	5.0	6.0	6.8	8.0	9.0
“ “ “ “ 40° F...	6.9	8.0	8.2	10.0	11.5

From the data above the following table is computed, which gives the radiation in square feet required for greenhouses or conservatories with different amounts of glass surfaces. It also gives divisors from which the heating surfaces or grate surfaces in the boilers may be computed by dividing the given amount of radiation. Thus for a greenhouse with 1000 feet of glass surface, which is to be kept at 70 degrees in the coldest weather, we note in the table that 200 square feet of radiation will be required; the heating surface in the boiler

will be 200 divided by 5.6(=36) square feet, and the area of grate will be (200 divided by 156=)1.28 square feet.

GREENHOUSE HEATING WITH STEAM.

Square feet of glass.....	100	250	500	750	1000	1500	2000	2500	3000	4000	5000	10,000
Radiation required, sq. ft., tempt. 40.....	10	25	50	75	100	150	200	250	300	400	500	1,000
Radiation required, sq. ft., tempt. 50.....	13	33	62	82	125	188	250	313	375	500	625	1,250
Radiation required, sq. ft., tempt. 60.....	16	43	84	125	167	250	333	416	500	660	830	1,660
Radiation required, sq. ft., tempt. 70.....	20	50	100	150	200	300	400	500	600	800	1000	2,000
Radiation required, sq. ft., tempt. 80.....	25	64	125	188	250	350	500	625	750	1000	1250	2,500
<i>Divisor of Radiation</i>												
For heating surface in boiler.....	4	4.5	5.1	5.4	5.6	6.0	6.2	6.5	6.7	6.9	7.0	7
For area of grate.....	125	132	138	144	150	160	180	190	192	204	216	240

GREENHOUSE HEATING WITH HOT WATER.

Square feet of glass.....	100	250	500	750	1000	1500	2000	2500	3000	4000	5000	10,000
<i>Water 160°</i>												
Radiation sq.ft. tempt. 40...	15	37	73	110	145	218	290	360	435	580	730	1,450
“ “ “ 50...	20	50	100	150	200	300	400	500	600	800	1000	2,000
“ “ “ 60...	25	62	125	187	250	375	500	625	750	1000	1250	2,500
“ “ “ 70...	33	83	166	250	333	500	666	833	1000	1330	1660	3,333
“ “ “ 80...	37	91	183	333	441	666	888	1000	1330	1660	2100	4,450
<i>Divisors of Radiation</i>												
For heating surface.....	6.5	6.8	7.6	8.1	8.4	9.0	9.3	10.0	10.4	10.5	10.5	12.0
For grate surface.....	190	193	207	216	232	252	270	288	306	324	342	360

The sizes of main pipes should be the same as those which are used for direct heating.

Relative Tests of Hot-water and Steam Heating Plants.—

Several tests have been made to determine the relative efficiency and economy of steam and hot-water heating plants. The first test so recorded was made at the Massachusetts Agricultural College by Professor S. T. Maynard, the results of which are given in Bulletins 4, 6, and 8, issued by the Mass. Exp. Station, 1889 and 1890. In this test two houses were used which were located as nearly as possible with equal exposure, and the tests were made with great care and by entirely disinterested observers. The following is a summary of the results and conclusions as taken from the bulletins:

STEAM-HEAT VERSUS HOT-WATER.

[From *Bulletin No. 4.*]

In order to get at some facts in regard to this subject, so important to the grower of plants under glass, and gain some positive knowledge as to the relative value of the two systems, two houses were constructed during the summer of 1888, 75×18 feet, as nearly alike as possible in every particular. Two boilers of the same pattern and make were put in, one fitted for steam and one for hot water; the steam for heating the east house, and the hot water for the west and most exposed one. The boilers were completed and ready for work in November and were used until January 9, 1889, when these experiments began.

Records of temperature of each house were made at 7.30 and 9 A.M., and 3, 6, and 9 P.M. Sufficient coal was weighed out each morning for the day's consumption and the balance not consumed deducted the next morning. "The two boilers and fittings were put in so as to cost the same sum and were warranted to heat the rooms satisfactorily in the coldest weather."

These experiments were repeated during the months of January and February, 1889, and in summarizing the results it was found that the steam-boiler consumed during the two months referred to 6582 lbs. of coal while the hot-water boiler consumed in the same time only 5174 lbs., a saving in favor of the latter of nearly 20 per cent. At the same time the temperature of the room heated by hot water averaged 1.7° higher than that heated by steam.

The temperature was more even where heated by hot water, and consequently there was less danger from sudden cold weather. This was strikingly shown on the night of February 22.

The average outside temperature for the day was 34°.

At 9 P.M. it was above 32°, and proper precautions not having been taken for so sudden a change as followed (the average temperature during the 23d of February was 2°), at 6 o'clock on the morning of the 23d the temperature of the room heated by steam was 29°, while in that heated by hot water it was 35° . . .

[From *Bulletin No. 6.*]

The boilers used were built of cast-iron sections. In the hot-water boiler five sections are used, the area of heating surface exposed to the fire being 74.5 feet.

The steam-boiler consists of eight sections, the total heating surface of which is 85.12 feet.

The experiments reported in the April Bulletin were continued during the two following months of March and April, and from the tables showing the comparative results the following summary is appended:

SUMMARY FOR HOT-WATER BOILER.

Total coal consumed by hot-water boiler from December 23, 1888, to April 24, 1889, 4 tons 1155 lbs. Average daily temperature for the four months, 53.5°.

SUMMARY FOR STEAM-BOILER.

Total coal consumed by steam-boiler from December 23, 1888, to April 24, 1889, 5 tons 1261 lbs. Average daily temperature for the four months, 51.2°.

It will be seen by the above that the average temperature of the house heated by hot water was 2.3° higher than that heated by steam, and that the amount of coal consumed was 2106 lbs. less in the former than in the latter.

[From Bulletin No. 8, April, 1890.]

Much discussion having been provoked relative to the accuracy of the results of experiments with steam and hot water for heating greenhouses, reported in Bulletins No. 4 and 6, we have the past winter made a careful repetition of the experiments to correct any errors that might be found and to verify previous results.

The boilers having been run with the greatest care possible from December 1, 1889, to the present date, March 18, 1890, and every precaution having been taken that no error should occur, we give the results in the following table:

Month.	HOT WATER.					STEAM.				
	Lettuce and Carnation Room.					Lettuce and Carnation Room.				
	Outdoor Average Daily Temperature.	Indoor Minimum Temperature.	Indoor Maximum Temperature.	Indoor Average Daily Temperature.	Lbs. Coal Consumed.	Indoor Minimum Temperature.	Indoor Maximum Temperature.	Indoor Average Daily Temperature.	Lbs. Coal Consumed.	
December . . .	34.99°	41.52°	57°	47.59°	1505	40.21°	51.69°	46.39°	2350	
January	33.27	44.35	62.48	51.41	2304	42.72	61	49.45	3202	
February	32.04	43.67	65.96	52.54	1704	42.42	66.32	51.01	2540	
March, 17 days	29.75	39.94	58.83	47.44	1085	39.16	58.11	46.73	1692	
Averages	32.51°	42.37°	61.06°	49.74°	Total 6598	41.12°	59.28°	48.39°	Total 9784	

SUMMARY FOR HOT-WATER BOILER.

Total coal consumed from December 1, 1889, to March 18, 1890, 6598 lbs. Average daily temperature for the time, 49.74°.

SUMMARY FOR STEAM-BOILER.

Total coal consumed from December 1, 1889, to March 18, 1890, 9784 lbs. Average daily temperature for the time, 48.39°.

A saving of fuel in favor of hot water of about 33 per cent.

Similar tests were made under the general direction of the author for the Michigan Experiment Station and are to be found reported in full in a paper by the writer, read before the American Society of Mechanical Engineers, Volume XI. For this test two houses were used, each of the same size and of the same grade of construction. The houses were equally exposed to the heat of the sun, but the hot-water house was rather more exposed to the wind. The general method of testing was essentially the same as that described, and the results show substantially the same difference. The heaters used were cast-iron of the drop-tube form, quite different from those used in Massachusetts, but well adapted for the work.

The following table gives a summary of the results:

SUMMARY OF RESULTS OF TEST OF HOT WATER AND STEAM.

Year.	1889				1890					
	December.		January.		February.		March.		April.	
	10		31		28		20		30	
Months.										
Days of Experiment.										
	Steam.	H. W.	Steam.	H. W.	Steam.	H. W.	Steam.	H. W.	Steam.	H. W.
Total coal	1025	825	3475	2799	3400	2775	2714	2288	1800	1800
Average coal per day	93.2	75	112.1	90.3	121.4	99.1	114.4	135.7	60	60
Average outside temperature, 6 A.M.	31.8	31.8	27.7	27.7	22	22	19.2	19.2	36.2	36.2
Average outside temperature, 4 P.M.	38.5	38.5	38	38	33.8	33.8	29.2	29.2	42	42
Average outside temperature, 9 P.M.	35.1	35.1	27.2	27.2	27	27	22.0	22.0	38	38
Average inside temperature, 6 A.M.	53.9	54.9	52.5	54.1	54.1	54.4	53.3	54.3	51.8	53.4
Average inside temperature, 9 P.M.	54.9	60.3	53.8	54.8	53.5	56	55.7	57	54.9	60.2
Extreme variation	13	4.4	4	4.3	4.2	5.9	4.3

During the month of April, 1890, the same amount of coal was burned in both heaters in order to see what the effect would be on the resulting temperature of the two houses. The results gave a temperature which averaged 8.5 degrees higher in the hot-water-heated house than in the steam-heated house.

Experiments were made by Prof. L. H. Bailey, of Cornell University, in 1891 with houses which were not similar either as to exposure or methods of piping, the results of which were in general somewhat more favorable to steam than to hot water. In 1892 Prof. Bailey arranged the same room so that it could be alternately heated with steam and hot water. The results of this last test so far as economy is concerned were also somewhat in favor of the steam heat. The general conclusions which Prof. Bailey drew from this test were as follows:

CONCLUSIONS.

Under the present conditions the following results can be deduced. It will be observed that they confirm several of the conclusions of last year.

1. Hot water maintained a slightly greater average difference between the minimum inside and outside night temperature than steam.
2. There was practically no difference in the coal consumption under the two systems.
3. With a small plant like this the fluctuations under both systems are much greater than in larger ones, and neither proved very satisfactory.
4. The utility of slight pressure in enabling steam to overcome unfavorable conditions is fully demonstrated.
5. The addition of crooks and angles is decidedly disadvantageous to the circulation of hot water and of steam without pressure, but the effect is scarcely perceptible with steam under low pressure.
6. In starting a new fire with cold water, circulation commences with hot water sooner than with steam, but it requires a much longer time for the water to reach a point where the temperature of the house will be materially affected.
7. The length of pipe to be traversed is a much more important consideration with water than with steam.
8. A satisfactory fall toward the boiler is of much greater importance with steam than the manner of placing the pipes.

245. Heating of Workshops and Factories.—Workshops or factories where counter-shafts and belting are running which

keeps the air in agitation can be heated satisfactorily by erecting coils of pipe for radiating surface near the ceiling of the room. Coils made with branch-tees, as described in Chapter VI, may be used, with the pipes placed in a horizontal plane and parallel to each other. In such a position the radiating surface is very efficient, and the heat given off as shown by experiment is a maximum. In a coil located near the ceiling the temperature of the room in the upper portion will become very high and will not be evenly distributed unless the air is mechanically agitated, so that the overhead system of piping is only satisfactory in shops and places where there are moving belts or other means for agitating the air. The method of proportioning supply-pipes and radiating surface for this case has already been considered. Mr. C. J. H. Woodbury gives, in Vol. VI, page 861, "Transactions of American Society Mechanical Engineers," considerable useful data relating to this method of heating. It is the favorite method for heating cotton-mills, about one foot in length of $1\frac{1}{4}$ -inch pipe being used for 90 cubic feet of space.

246. Summary of Approved Methods for Design of Steam and Hot-water Systems of Heating.—For convenience of application the following concise summary of approved methods of computation for radiating surface, dimensions of pipes and grate surface are here given:

A. Compute area of windows and outside doors, G , and one-fourth the exposed wall surface, $\frac{1}{4}W$, for each room. In computing exposed surface estimate ceilings and partitions adjacent to unheated rooms as 30 to 50 per cent exposed. Denote this result by A .

B. For direct radiation. Compute 2 per cent of the cubic contents of each room. For residence heating take once this quantity for second- and third-floor rooms, twice this quantity for first-floor rooms, three times this quantity for halls; for office, store, or bank rooms, twice this quantity; for large assembly rooms, lecture halls, churches, etc., one-half this quantity under usual conditions. Denote this result by B .

C. For *radiating surface, direct heating*, multiply the sum of the results *A* and *B* by one-fourth for steam-heating; multiply this last quantity by five-thirds for direct hot-water heating.

D. For *dimensions of piping, direct heating*, use the tables given. The table computed for one-pipe systems of steam-heating, commercial sizes of pipes, will apply with accuracy for dimensions of pipes for hot-water heating, both return- and flow-pipe being of dimensions shown in the table. For two-pipe systems of steam-heating use the special table for steam- and return-pipes, or use the table referred to above for steam-pipes less than 3 inches, taking the main one pipe-size smaller than tabulated when above 3 inches in diameter. Take in all cases the diameter of return from the special table.

In applying tables, in all cases, find first the diameter of branches to each radiator; second, the diameter of sub-main; and third, the diameter of main and return, corresponding in each case to total area of radiator and the equivalent length of pipe. The equivalent length of pipe is the actual length increased by allowance for elbows and bends as explained.

E. For *radiating surface, indirect heating*, multiply the result $A = G + \frac{1}{4}W$ by the following factors for steam-heating: for the first floor, by 0.7; for the second floor, by 0.6; for the third floor, by 0.5. For hot-water heating multiply each result as above by five-thirds.

F. For *dimensions of piping, indirect heating*, use the table given for one-pipe system of steam-heating, for finding the diameter of the steam-pipe in steam-heating and for the diameter of flow- and return-pipes in hot-water heating. Take the diameter of return-pipe for steam-heating from special table. Tables to be used as explained.

G. Size of *air-flues, indirect heating*, should be computed on the basis of a cross-sectional area for each square foot of surface in the radiator as follows; steam-heating, 1.5 to 2.0 square inches for the first floor, 1.0 to 1.25 square inches for the second floor, and 0.9 to 1.0 square inch for the third and higher floors. The cold-air flue supplying any radiator should have 0.8 the area of cross-section of that of the hot-air flues.

The vent-flues from the room should have an area equal to that of the hot-air flues on the first floor, and 10 to 20 per cent greater for the higher floors. For hot-water indirect heating area of flue may be two-thirds as great, reckoned from area of radiating surface.

H. *Dimensions of register for supplying air* should be such as to give a net area not less than one and two-thirds to twice that of the section of the hot-air flue; for ventilation purposes the net area should be 50 per cent greater than cross-sectional area of hot-air flue.

I. To compute *heating surface* in boiler or heater, divide total radiating surface, in which is included the surface of all uncovered pipe, by 6 to 8 for the area of heating surface in a steam-heater, and by 10 to 12 for area of heating surface in a hot-water heater.

To compute *area of grate* divide total radiating surface obtained as before by 120 to 200 for steam-heating, and by 200 to 300 for hot-water heating.

J. To compute *area of smoke-flue* first find total radiating surface as explained; if for steam, obtain diameter of flue as explained in Article 95; if for a hot-water heating system, multiply by 0.6 to reduce to equivalent steam-radiation, then proceed as before.

CHAPTER XIX.

SPECIFICATION PROPOSALS AND BUSINESS SUGGESTIONS.

247. General Business Methods.—Nearly all heating-plants are constructed by contractors, who agree for a specified sum to install a heating-plant in accordance with certain specifications, or, in absence of specifications, one which is guaranteed to fulfil certain stipulations as to warming and ventilating in any stress of weather. Specifications are prepared either by a disinterested third party who is thoroughly familiar with the subject, or by the party submitting the proposal. The first method, although not common except in the case of large buildings, is, when the specifications are properly drawn, satisfactory both to the owner and the contractor. With proper specifications estimates can be obtained from different bidders on work of the same class and quantity, and this is likely to result in a better quality of work, and often in lower prices. Where each contractor bids on his own specifications and arranges for apparatus in accordance with his own judgment, there will be a very great difference in the quality and method of construction proposed, which is likely to result to the advantage of an unscrupulous bidder, who would, if possible, use cheap material and the least possible quantity of heating and radiating surface. It is for these reasons to the advantage of all concerned that full and complete specifications should be provided which will show, accurately, the character, amount and quality of the required work.

The specifications may be written as a part of the tender for the work, or as an independent document to which reference is made in the proposals.

The specifications are often accompanied with drawings

which show the location of all the principal parts of the heating apparatus and frequently many details of construction; the drawings are considered in every case a portion of the specifications and are equally binding on the contractor.

After the bid has been accepted a contract is drawn which should contain a full statement of the agreement between contractor and owner, and of all conditions relating to the method of payment, penalties, time of completion of work, etc.

J. J. Blackmore and J. G. Dudley, New York, acting as a committee appointed by the National Association of Manufacturers of Heating Apparatus, have given the matter relating to uniform specifications much study, and we are indebted to them for the following discussion, and also for the copy of the uniform proposals here submitted.

248. General Requirements.*—"It is not within the scope of a work such as this, nor have the trade conditions in the heating business advanced to such a point, that all the details of any or every system can be provided for. The following proposed form for uniform standard specifications, however, covers the ground as fully as can be done at this time, as is shown by the recommendation by the National Association of Manufacturers of Heating Apparatus, and if generally accepted by heating contractors, manufacturers, architects, investors, and the laymen installing steam or hot-water heating apparatus, would result in a higher standard of excellence. Much trouble now exists in securing best results, due to ignorance on part of owner, architect, or contractor, as well as to unfair competition or unauthorized substitutions of 'cheap' materials.

"Any specification should set forth unequivocally and in detail (as far as feasible) all that the contractor is to furnish and exactly what is to be accomplished by his guarantee, which should embody a standard of economy as well as one of efficiency. The function of the owner or architect is to stipulate what results must be accomplished according to standards in accepted use, and to give the consulting engineer (when char-

* Written for this work by J. J. Blackmore and J. G. Dudley.

acter of heating-plant demands one) or the contractor proper latitude as to *methods* to be pursued. Further than this, it is the office of owner or architect, in justice to himself and to competing bidders, as well as to the successful contractor, to see that the provisions of the specifications are carried out, and that the quantity and character of material agreed upon are actually furnished and used. Certificates to that end should be demanded and given, if it is deemed necessary, since much injury is done to a legitimate and beneficial calling by what is termed 'skinning the job,' that is, agreeing to furnish certain things and then by taking advantage of 'lay' ignorance substituting inferior goods or omitting them outright.

"As already shown, the attainment of certain results follows from, and is accomplished by, scientific and mathematical processes, whether actually figured and reasoned out, or arrived at by 'rule of thumb,' as many really excellent contractors are known to do.

"In illustration, imagine a country residence in course of erection after plans by, and under supervision of, a competent architect, and note how a proper heating-plant is installed. To begin with, the owner should learn from his architect or from any other properly informed person that the desired efficiency, sufficiency, and results to be procured by the heating system depends more on amount of investment than on anything else. For instance, the same results can be achieved by employing either steam or water. The first cost, however, is less with steam, while, it is contended by many, the running and ultimate cost is less with water. The reason for this is that with the hot-water system as usually installed, with an open tank for expansion of water, the temperature of the heating medium ranges from 150° to 200° F., while with steam it ranges from 212° to 240° F.; as a consequence more radiating surface is needed for the former than for the latter.

"To continue the illustration, let the owner select steam, and also suppose that he elects to have indirect heating on ground-floor, to obtain extra ventilation (for be it understood that some ventilation, accidental or otherwise, is absolutely

necessary to obtain right heating results), while on the upper floors he chooses direct heating. This done, it then devolves on the engineer, contractor, or architect to determine the respective amounts of heating surfaces required to warm the several rooms to the indicated temperature according to an accepted standard. Much harm at present results from demanding and permitting the several bidders to estimate on different amounts of heating-surface for exactly the same work. The minimum amount should be determined by some one individual, who should be recompensed for this service, and he alone held responsible for this estimate. The owner or architect should indicate on the building plans where surfaces shall be placed, bearing in mind always the room required in the allotted spaces and also the requirements of the system. This is necessary for the contractor to know, since on it depend the number of his riser-lines and the amount of piping in his boiler-room.

“When feasible, the owner or architect should indicate all the ‘specialties’ desired in the apparatus, and each bidder should be compelled to figure as nearly as possible on exactly the same set of specifications. This method is just to those who estimate in good faith, and usually closer and lower figures will be obtained by the owner. The contractor, with these data before him, takes dimensions either from the architect’s plans or from the measurements of the building itself; he then computes the quantity and cost of all materials which will be used in the completed apparatus; the method of computation varying from that of pure guesswork or shrewd ‘estimating’ to that of painstaking measurement and actual figuring out of the exact amount of stock required together with its purchasable cost from the trade catalogues and price-lists.

“To the net cost for material, including boiler, radiators, pipe, fittings, valves, vents, floor- and ceiling-plates, registers, ducts, covering, painting, bronzing, smoke-pipe, freight and cartage, board, car-fares, labor, and incidentals, is added such a margin of profit as the contractor considers his experience, reputation, and workmanship are entitled to.

“In justice to the bidders the conditions of the award should be clearly set forth beforehand, and it should be stated whether this work will go to the lowest bidder, or whether a ‘preference’ (often justified) is to be given a certain contractor. When it is known that the preparation of a set of specifications and of an estimate of cost is an expense, and often not a small one, to each and every bidder, the injustice of requiring all to bear this instead of having it done once and for all is too evident for argument. It is for this reason that a uniform standard specification is recommended by the National Association of Manufacturers of Heating Apparatus.

“Suppose now the award be made to the lowest bidder, bids having been made on the same set of specifications which embody full statements in regard to requirements of the completed plant. The owner (or architect) and the contractor are then to execute a proper contract for the performance of the work and for the payments therefor. Then each should be required to fulfil the conditions of said contract. The National Association of Master Steam and Hot-water Fitters has adopted a uniform standard contract which seems to meet the requirements and is quite generally accepted in such cases.

249. Form of Uniform Contract.—

UNIFORM CONTRACT FOR THE CONSTRUCTION OF HEATING APPARATUS (TO BE) ADOPTED FOR USE BY THE MASTER STEAM AND HOT-WATER FITTERS' ASSOCIATION OF THE UNITED STATES.*

Copyright, 1895, by the Master Steam and Hot-water Fitter's Association of the United States.)

THIS AGREEMENT, made and concluded at *Kalamazoo*, State of *Michigan*, the *first* day of *January*, in the year one thousand eight hundred and ninety-five, by and between *Jones & Brown*, of *Chicago*, State of *Illinois*, for themselves and their legal representatives, parties of the first part (hereinafter designated the Contractor), and *R. I. Peters*, of *Kalamazoo*, State of *Michigan*, for himself and his legal representatives, party of the second part (hereinafter designated the Owner).

* Printed words in italics to be supplied in each contract.

WITNESSETH, That the Contractor, in consideration of the fulfilment of the agreements herein made by the Owner, agrees with the said Owner, as follows:

ARTICLE I. The Contractor, for the consideration hereinafter provided, covenants and agrees, with the Owner, that the Contractor shall and will, within the space of *three* months next, after the date hereof, in a good and workmanlike manner, and at his own proper charge and expense, well and substantially build, furnish, and erect a certain *Steam Heating Apparatus*, at *444 4th Avenue, City of Kalamazoo*, according to the Specifications, Drawings, and Plans designed by *Thomas Robinson, Architect*, which Specifications, Drawings, and Plans are made a part of this Contract and are identified by the signatures of the parties hereto.

ARTICLE II. No alterations shall be made in the work shown or described by the drawings and specifications, except upon a written order of the *Architects*, and when so made, the value of the work added or omitted shall be computed by the *Architects*, and the amount so ascertained shall be added to or deducted from the contract price. In the case of dissent from such award by either party hereto, the valuation of the work added or omitted shall be referred to three (3) disinterested arbitrators, one to be appointed by each of the parties to this Contract, and the third by the two thus chosen; the decision of any two of whom shall be final and binding, and each of the parties hereto shall pay one-half of the expenses of such reference.

ARTICLE III. Should any difference arise in interpreting the Plans or Specifications, involving or assuming additional compensation, the Contractor shall, upon written notice from the Owner, immediately execute such interpretation, the question of compensation to be determined on completion by arbitrators, as provided in Article II.

ARTICLE IV. All of the materials and workmanship of the apparatus to be of the quality as expressed in said Specifications, Drawings, and Plans; said Owner to reserve the right to reject, through himself or his authorized agent, all material or

workmanship of an inferior quality, which said Contractor may attempt to use in the erection of said Heating Apparatus, and if the said Contractor, after being notified, neglects or refuses to do the work, or furnish the materials as called for in the Specifications, Drawings, and Plans, then, and in that case, said Owner shall give notice in writing to the Contractor, which notice is to set forth in full the cause or causes of complaint. If the Contractor demurs and refuses to do the work or furnish the materials as directed in the notice of complaint, within three days from the date of said notice, resort to arbitration shall be had as provided in Article II.

ARTICLE V. The Owner shall not, in any manner, be answerable or accountable for any loss or damage that shall or may happen to the said works, or any parts thereof respectively, or for any of the materials or other things used and employed in finishing and completing the same; loss or damage by fire excepted. The Contractor shall be responsible for all damage to the building and adjoining premises, and to individuals, caused by himself or his employees in the course of their employment.

ARTICLE VI. It is hereby mutually agreed between the parties hereto, that the sum to be paid by the Owner to the Contractor for said work and materials shall be *Seven Thousand Dollars* (\$7,000), subject to additions and deductions as hereinbefore provided, and that such sum shall be paid in current funds by the Owner to the Contractor, in monthly payments, to the amount of 90 per cent of the value of materials delivered to and labor performed in the said building during the preceding month; and the remaining 10 per cent shall be paid as a final payment within 30 days after this contract is fulfilled.

All payments shall be made upon written certificates of the *Architects* to the effect that such payments have become due.

ARTICLE VII. It is mutually agreed that payments for all additional work shall be made at the same time and in the same manner as contract payments, Article VI.

ARTICLE VIII. It is mutually agreed that should default be made in any of the payments as herein provided, the Con-

tractor shall have the right to stop work and withdraw all unused materials until such payment is properly made, or may at his option cancel the contract.

ARTICLE IX. It is further mutually agreed that the essence of this Agreement is that the Owner purchasing this apparatus and paying therefor will receive full value to the extent that it will warm the subdivisions of the building indicated on the plans to 70 degrees Fahrenheit in the coldest weather; but nothing herein contained, or in the Specification accompanying the same, shall prevent the Contractor from receiving from the Owner a final payment for the work herein and at the time stipulated.

ARTICLE X. The Contractor guarantees his workmanship and materials, the capacity of the boiler, the circulation of the system and the efficiency of the heating surfaces, all as called for in the Specifications hereto attached, and should any defects or deficiencies occur, other than from neglect on the part of the Owner or his employees, within the term of one year from the above date, the Contractor agrees to make good the same upon a written notice from the Owner at the Contractor's expense.

ARTICLE XI. If at any time there shall be evidence of any lien or claim for which, if established, the Owner of the said premises might become liable, and which is chargeable to the Contractor, the Owner shall have the right to retain out of any payment then due, or thereafter to become due, an amount sufficient to completely indemnify himself against such lien or claim. Should there prove to be any such claim after all payments are made, the Contractor shall refund to the Owner all moneys that the latter may be compelled to pay in discharging any lien on said premises made obligatory in consequence of the Contractor's default.

ARTICLE XII. It is further mutually agreed, between the parties hereto, that no certificate given or payment made under this Contract, except the final certificate or final payment, shall be conclusive evidence of the performance of this Contract, either wholly or in part, and that no partial payment shall be

construed to be an acceptance of defective work or improper materials.

ARTICLE XIII. The said parties for themselves, their heirs, executors, administrators, and assigns, do hereby agree to the full performance of the covenants herein contained.

IN WITNESS WHEREOF, the parties to these presents have hereunto set their hands and seals, the day and year first above written.

In presence of

J. B. Saxe

Jones & Brown

(SEAL)

R. J. Peters

(SEAL)

(SEAL)

(SEAL)

ALTERNATE FOR ARTICLE VI.

It is hereby mutually agreed, between the parties hereto, that the sum to be paid by the Owner to the Contractor for said work and materials shall be *Seven Thousand Dollars (\$7,000)* subject to additions and deductions as hereinbefore provided, and that such sum shall be paid in current funds by the Owner to the Contractor in installments, as follows:

When <i>The Boilers are delivered and set,</i>	\$1,500
When <i>Steam Mains and Risers are in place,</i>	\$1,500
When <i>The Radiators are delivered,</i>	\$1,500
When <i>The Radiators are connected,</i>	\$1,500

And the balance of \$1,000 as a final payment to be made within 30 days after this contract is fulfilled.

All payments shall be made upon written certificates of the *Architects* to the effect that such payments have become due.

250. Duty of the Architect.—The heating system is an essential part of the building in this latitude, and it should be the duty of the architect to provide building designs of such character that it can be readily and economically installed. The architect's specifications for the buildings should provide for the construction of ventilating, heating, and smoke-flues, and his

plans should show the location, including pipe-lines, of every essential part of the heating apparatus. All responsibility regarding flues and the general adaptability of the heating system to the building should be assumed by the architect, and not shifted to the contractor. If the heating system is designed at the same time as the building, slight changes can be made in arrangement of details, partitions, doors, etc., that will tend to cheapen construction, and will add to the efficiency of operation and the general appearance of the heating apparatus. If steam- or water-pipes are required to be erected out of sight, conduits should be provided, so that they will be readily accessible for inspection and repairs.

251. Methods of Estimating Cost of Construction.—In estimating the cost of construction of any system of heating apparatus the contractor must depend largely upon his own experience and knowledge. No general directions can be given, but a few suggestions are offered which may aid in adopting a systematic method of proceeding. Determine first the amount and character of radiation to be placed in each room by the methods which have already been given fully in Chapters X, XI, and XII. Second, determine the position and sizes of pipes leading from the heater to the various radiating surfaces by methods given in Chapters X, XI, and XII.

To facilitate the above work, a set of floor drawings of each story should be obtained, and on these there should be carefully laid out the position of all radiators, flues, pipe-lines, etc. After determining the amount required, a schedule of material should be made and the cost should be computed.

The manufacturers have adopted a price, which is changed very rarely, for all standard fittings, pipes, etc., and from which a discount is given which varies with the condition of the market, cost of material, labor, etc. The discount is usually large upon cast-iron fittings and brass goods, being seldom less than 70 per cent, and sometimes 80 per cent and even greater. The discount on piping, especially the smaller sizes, is much less, ordinarily ranging from 40 to 70 per cent.

The cost of labor will vary greatly in different localities, so

that no general method of estimating can be given. It must be determined largely by experience in each locality and with a given set of men. The cost of heaters of any given type, with fittings, etc., can only be determined accurately by correspondence with manufacturers.

The list price of the principal standard fittings, together with the discount allowed, can be obtained by correspondence with wholesale dealers.

252. Suggestions for Pipe-fitting.—Certain suggestions are here made relating to the actual work of pipe-construction which may be useful to those not having an extended experience.

In the actual construction of steam-heating or hot-water heating systems it is usually customary to send a supply of pipe and fittings to the building somewhat greater than is required, and the workman, after receiving plans of construction which show the location and sizes of the various pipes to be erected, makes his own measurements, cuts the pipes to the proper length in the building, threads them, and proceeds to screw them into place. In some rare instances all lengths of pipe are purchased the proper length, and the workman has merely to put them in the proper position. The skill required for pipe-fitting may seem to the novice to be easily acquired; this is not true, as it is a trade requiring as much training and experience as any with which the writer is familiar.

The tools belonging to this trade consist of tongs or wrenches for screwing the pipe together, cutters for cutting, taps and dies for threading the pipe, and vises for holding it in position while cutting or threading. A very great variety of tongs and wrenches is to be found on the market, some of which are adjustable to various sizes of pipe, and others are suited for only one size. For rapid work no tool is perhaps superior to the plain tongs, and one or more sets especially for the smaller sizes of pipes should always be available. For large pipes, chain tongs of some pattern will be found strong and convenient, and can be used with little danger of crushing the pipe. A form of adjustable wrench known from the inventor as the Stilson wrench has proved a very excellent and durable tool, and is

well worthy a place in the chest of any fitter. Other wrenches of value are also on the market, one with a triangular head and projecting teeth being especially valuable for small pipes. The wrenches or tongs which are used for turning the pipe in most cases exert more or less lateral pressure, and if too great strength is applied at the handles there is a tendency to split the pipe. It is an advantage to have the tongs or wrenches catch on the outer circumference of the pipe with as little lateral pressure as possible, and to this end the projecting edges should be kept sharp and clean.

The cutter ordinarily employed for small pipe consists of one or more sharp-edged steel wheels, which are held in an adjustable frame, the cutting being performed by applying pressure and revolving it around the pipe. With this instrument the cutting is accomplished by simply crowding the metal to one side, and hence burrs of considerable magnitude will be formed both on the outside and inside of the pipe. The outside burr must usually be removed by filing before the pipe can be threaded. The inside burr forms a great obstruction to the flow of steam or water, and should in every case be removed by the use of a reamer. Workmen quite often neglect to remove the inside burr. A cutter consisting of a cape chisel set in a frame is more difficult to use and keep in order, although it makes cleaner cuts; it can be had in connection with some of the adjustable die-stocks, but is rarely used. Pipes, especially the larger sizes, are sometimes cut by expert workmen with *diamond-pointed* or *cape chisels*, but this process requires too much time to be applicable to small pipes.

The *hack-saw* is coming into use to some extent for cutting pipes, and is an excellent instrument for this purpose, as it does not tend to burr or crush the pipe, and is quite as rapid as the wheel-cutter.

The dies for threading the pipes are of a solid form, each die fitting into a stock or holder with handles; or of an adjustable form, the dies being made of chasers, which are held where wanted and can be set in various positions by a cam. The adjustable dies can be run over the pipes several times, and

hence work easier than solid ones; but in their use great care should be taken that the exterior diameter of the pipe is not made less than the standard size. The cutting edges of the dies should be kept very sharp and clean, otherwise perfect threads cannot be cut. In the use of the dies some lubricant, as oil or grease, kept on the iron will be found to add materially to the ease with which the work can be done, and will tend to prevent heating and crumbling of the pipe and injury to the threads.

Taps are required for cutting threads in opening or couplings into which pipes must be screwed—an operation which the pipe-fitter seldom has to perform, unless a thread has been injured. The vises for holding the pipe should be such as will prevent it from turning without crushing it under any circumstances. Adjustable vises with triangular-shaped jaws on which teeth are cut are usually employed.

In the erection of pipe great care should be taken to preserve the proper pitch and alignment, and the pipes should, to appear well, be screwed together until no threads are in sight. Every joint should be screwed six to eight complete turns for the smaller sizes, 2" and under, and eight to twelve turns for the larger sizes, otherwise there will be danger of leakage. It is a good plan to test the threads on all pipes before erection by unscrewing the coupling and screwing it back with the ends reversed. It is also advisable to look through each length of pipe and see if it is clear before erecting in place; serious trouble has been caused by dirt or waste in pipes, which would have been removed had this precaution been taken.

In screwing pipes together, red or white lead is often used; the writer believes this practice to be generally objectionable, and to be of no especial benefit in preventing leaks. The lead acts as a lubricant, and consequently aids by reducing the force required to turn the pipe. It will generally be found, however, that linseed or some good lubricating oil will be equally valuable in that respect, and will have the advantage of not discoloring the work.

If possible, arrange the work so that it can "be made up" with right and left elbows, or right and left couplings. Packed joints, especially *unions*, are objectionable, and likely to leak after use. Flange-unions, packed with copper gaskets, should be used on heavy work.

Good workmanship in pipe-fitting is shown by the perfection with which small details are executed, and it should be remembered that bad workmanship in any of the particulars mentioned may defeat the perfect operation of the best-designed plant.

253. Protection from Fire. Hot-air and Steam-heating.—

Where hot-air stacks or steam-pipes pass up through partitions near woodwork there is considerable danger of fire, and for this reason certain requirements have been made both as to the position of hot-air pipes in furnace-heating and steam-pipes in steam-heating. The following digest, compiled by H. A. Phillips, of the municipal laws relating to hot pipes in buildings, in force in some of the principal cities of the United States, appeared in the *American Architect and Building News*, Feb., 1893, and is useful in preparing specifications. They are as follows:

Boston.—1. Hot-air pipes shall be at least 1 inch from woodwork.

(This may be modified by inspector in first-class buildings.)

2. Any metal pipe conveying heated air or steam shall be kept 1 inch from any woodwork, unless pipe is protected by soapstone or earthen tube or ring, or metal casing.

Baltimore.—1. Metal flue for hot air may be of one thickness of metal, if built into stone or brick wall.

2. Otherwise it must be double, the two pipes separated by 1 inch air-space.

3. No woodwork shall be placed against any flue or metal pipe used for conveying hot air.

Chicago.—1. Hot-air conductors placed within 10 inches of woodwork shall be made double, one within the other, with at least $\frac{1}{2}$ inch air-space between the two.

2. All hot-air flues and appendages shall be made of IC or IX bright tin.

3. Steam-pipes shall be kept at least 2 inches from woodwork, unless protected by soapstone, earthen ring or tube, or rest on iron supports.

Cincinnati.—No pipes conveying heated air or steam shall be placed nearer than 6 inches to any unprotected combustible material. All subject to approval of inspector.

Cleveland.—1. Hot-air conductors placed within 10 inches of woodwork

shall be made double, one within the other, with at least $\frac{1}{2}$ inch air-space between the two.

2. No pipes conveying heated air or steam shall be placed nearer than 6 inches to any unprotected combustible material.

Denver.—Metal flue for hot air may be of one thickness of metal, if built into stone or brick wall; otherwise it shall be made double or wrapped in incombustible material.

Detroit.—No metal pipe for conveying hot air shall be placed nearer than 3 inches to any woodwork. Such pipes over 15 feet long shall be safely stayed by wire or metal rods.

District of Columbia.—1. Hot-air pipes shall be at least 1 inch from woodwork.

2. Pipes passing through stud or wooden partitions shall be guarded by double collar of metal, "giving at least 2 inches air-space, having holes for ventilation, or other device equally secure, to be approved by inspector."

3. Metal pipe double, with the space filled with 1 inch of non-combustible, non-conducting material, or a single pipe surrounded by 1 inch of plaster of Paris or other non-conducting material between pipe and timber.

Kansas City.—1. Any metal pipe conveying heated air or steam shall be kept 1 inch from any woodwork, unless pipe is protected by soapstone or earthen tube or ring, or metal casing, or otherwise protected to satisfaction of superintendent.

2. No wooden flue or air-duct for heating or ventilation shall be placed in any building.

Memphis.—1. All stone or brick hot-air flues and shafts shall be lined with tin pipes.

2. No wooden casing, furring, or lath shall be placed against or over any smoke-flue or metal pipe used to convey hot air or steam.

3. No metal flues or pipes to convey heated air shall be allowed unless inclosed with 4 inches thickness of hard, incombustible material, except horizontal pipes in stud partitions, which shall be built in the following manner: The pipes shall be double, one inside the other, and $\frac{1}{2}$ inch apart, and with 3 inches space between pipe and stud on each side; the inside faces of said stud well lined with tin plate, and the outside face with iron lath or slate. Where hot-air pipe passes through partition shall be at least 8 feet from furnace.

4. Horizontal hot-air pipes shall be kept 6 inches below floor-beams or ceiling. If floor-beams or ceiling are plastered or protected by metal shield, then distance shall not be less than 3 inches.

5. Where hot-air pipes pass through wooden or stud partition, they shall be guarded by double collar of metal with 2-inch air-space and holes for ventilation, or by 4 inches of brickwork.

6. No hot-air flues or pipes shall be allowed between any combustible floor or ceiling.

7. Steam-pipe shall not be placed less than 2 inches from woodwork unless wood is protected by metal shield, and then distance shall not be less than 1 inch.

8. Steam-pipes passing through floors and ceilings or lath-and-plaster partitions shall be protected by metal tube 2 inches larger in diameter than pipe.

9. Wooden boxes or casings inclosing steam-pipes and all covers to recesses shall be lined with iron or tin plate.

Milwaukee.—1. Hot-air conductors placed within 10 inches of woodwork shall be made double, one within the other, with at least $\frac{1}{2}$ inch air-space between them.

2. All hot-air flues and appendages shall be made of IC or IX bright tin.

Nashville.—1. Sheet-iron flue running through floor or roof shall have a sheet-iron or terra-cotta guard at least 2 inches larger than flue.

2. Steam-pipes shall be kept at least 2 inches from woodwork.

3. All steam and hot-air flues and pipes must be suspended by iron brackets.

Newark.—1. Hot-air pipes shall be set at least 2 inches from woodwork and the woodwork protected with tin.

2. Such pipes placed in lath-and-plaster partitions must be covered with iron, tin, or other fire-proof material.

New York.—(Same regulations as noted under heading of "Memphis.")

No hot-air flue or pipe allowed between combustible floor or ceiling.

Omaha.—1. Steam-pipe shall not be placed less than 2 inches from woodwork unless wood is protected by metal shield; and then distance shall not be less than 1 inch.

2. Steam-pipes passing through floors and ceilings, or lath-and-plaster partitions, shall be protected by metal tube 2 inches larger in diameter than pipe.

3. Wooden boxes or casings inclosing steam-pipes and all covers to recesses shall be lined with iron or tin plate.

4. Stud partitions in which hot-air pipes are placed to be at least 5 inches wide, and the space between studs at least 14 inches.

5. Hot-air pipes shall not be placed between floor-joists unless same are doubled and the joists 14 inches apart.

6. Bright tin shall be used in construction of all hot-air flues and appendages.

Providence.—1. Hot-air pipes shall be at least 1 inch from woodwork, unless protected by soapstone or earthen ring, or metal casing permitting circulation of air around pipe.

2. Steam-pipes must be kept at least 1 inch from woodwork, or supported by incombustible tubes or rest on iron supports.

St. Louis.—1. Hot-air pipes shall be at least 1 inch from woodwork, unless protected by soapstone or earthen ring or metal casing permitting circulation of air around pipe.

2. Steam- or hot-water pipes carried through wooden partition or between joists, or in other close proximity to woodwork, shall be inclosed in clay pipe or covered with felting or other non-conducting material.

San Francisco.—1. Metal flue for hot air may be of one thickness of metal, if built into stone or brick wall; otherwise double, one pipe within the other, $\frac{1}{2}$ inch apart, and space filled with fire-proof materials.

2. No woodwork shall be placed against any flue or metal pipe used for conveying hot air.

3. Steam-pipes shall be placed at least 3 inches from woodwork, or protected by ring of soapstone or earthenware.

Wilmington.—Metal pipes to carry hot air shall be double, one inside the other, $\frac{1}{2}$ inch apart; or, if single, have a thickness of 2 inches of plaster of Paris between pipe and woodwork adjoining same.

254. Heating and Ventilating Laws.—Abstracts of the laws relating to the heating and ventilating of schoolhouses and public buildings of some of the States, are given here. In a few cases regulations by the State board of health are given:

CONNECTICUT.

In Revision of the General Statute 1902, Paragraph 2505, under the caption, "Duties of the State Board," it is stated that "said Board shall take cognizance of the interests of health and life among the people of this State; shall make sanitary investigations and inquire respecting the causes of disease." "Cause to be made by the Secretary or by a Committee of the Board of Inspection at such times as it may deem best and wherever directed by the Governor or the general assembly of all public hospitals, prisons, asylums or other public institutions in regard to the location, drainage, water supply, disposal of excreta, heating and ventilation and other circumstances in any way affecting the health of the inmates."

INDIANA VENTILATION OF SCHOOLHOUSES.

Approved March 3d, 1911.

SECTION 1. That all schoolhouses which shall be constructed or remodeled shall be constructed in accordance and conform to the following sanitary principles, to wit:

(B) BUILDING. School buildings, if of brick, shall have a stone foundation, or the foundation may be of brick or concrete; provided a layer of slate, stone or other impervious material be interposed above the ground line, or the foundation may be of vitrified brick and the layer of impervious material will not be required.

Every two-story schoolhouse shall have a dry, well-lighted basement under the entire building, said basement to have cement or concrete floor, and ceiling to be not less than 10 feet above the floor level. The ground floor of all schoolhouses shall be raised at least 3 feet above the ground level, and have, when possible, dry, well-lighted basement under the entire building; and shall have a solid foundation of brick, tile, stone or concrete, and the area between the ground and the floor shall be thoroughly ventilated. Each pupil shall be provided with not less than 225 cubic feet of space, and the interior walls and ceilings shall be either painted, or tinted some neutral color as gray, slate, buff or green.

(C) LIGHTING AND HEATING. All schoolrooms where pupils are seated for study shall be lighted from one side only, and the glass area shall not be less than one-sixth of the floor area, and the windows shall extend not less than 4 feet from the floor to at least 1 foot from the ceiling, all windows to be provided with roller or adjustable shades of neutral color as blue, gray, slate, buff or green. Desks and desk seats shall preferably be adjustable, and at least 20 per cent of all desks and seats in each room shall be so placed that the light shall fall over the left shoulders of the pupils. For left-handed pupils, desks and seats may be placed so as to permit the light to fall over the right shoulder.

(D) BLACKBOARDS AND CLOAKROOMS. Blackboards shall be preferably of slate, but of whatever material, the color shall be a dead black. Cloakrooms well lighted, warmed and ventilated, or sanitary lockers, shall be provided for each study schoolroom.

(F) HEATING AND VENTILATING. Ventilating heating stoves, furnaces, and heaters of all kinds shall be capable of maintaining a temperature of 70° F., in zero weather and of maintaining a relative humidity of at least 40 per cent; and said heaters of all kinds shall take air from outside the building and after heating introduce it into the schoolroom at a point not less than 5 nor more than 7 feet from the floor, at a minimum rate of 30 cubic feet per minute per pupil, regardless of outside atmospheric conditions; Provided, That when direct-indirect steam heating is adopted this provision as to height of entrance of hot air shall not apply. Halls, office rooms, laboratories and manual training rooms may have direct-steam radiators, but direct-steam heating is forbidden for study schoolrooms, and direct-indirect steam heating is permitted.

All schoolrooms shall be provided with ventilating ducts of ample size to withdraw the air at least four times every hour, and said ducts and their openings shall be on the same side of the room with the hot-air ducts.

SEC. 2. Whenever, from any cause, the temperature of a schoolroom falls to 60° F., or below, without the immediate prospect of the proper temperature, namely, not less than 70° F., being attained, the teacher shall dismiss the school until the fault is corrected.

ILLINOIS NEW FACTORY VENTILATION LAW.

Senate Bill No. 385 became a law July 1, 1909.

SEC. 2. In every factory, mercantile establishment, mill or workshop, where one or more persons are employed, adequate means shall be taken for securing and maintaining a reasonable and, as far as possible, equable temperature consistent with the requirements of the manufacturing process. No unnecessary humidity which would jeopardize the health of employees shall be permitted.

NEW VENTILATION LAW IN KANSAS.

SEC. 4. VENTILATION OF THEATRES AND PICTURE SHOWS. It shall be unlawful for the owner, proprietors or lessee to operate any theatre, picture show or place of amusement in any structure, room or place in the State of Kansas which structure, room or place is capable of containing fifty or more persons unless the system of ventilation is capable of supplying at least 30 cubic feet of fresh air per minute for each person therein.

SEC. 5. VENTILATOR FANS—BOOTHES FOR PICTURE MACHINES—ELECTRIC WIRING. All such structures, rooms or places used for the purpose mentioned in Section 4 of this act having less than 500 cubic feet of air space for each person, and all rooms having less than 2000 cubic feet of air space for each person in which the outside window and door area used for ventilation is less than one-eighth of the floor area, shall be provided with a draught fan, or other artificial means of ventilation installed so as to force the stagnant air outward from said structure, room or place. In the end of the room opposite said fan an inlet ventilator shall

be provided of sufficient size to admit the required amount of fresh air as provided in Section 4 of this act. All booths used for moving picture machines shall be made of galvanized sheet iron of not less than 20 B. W. gauge, or $\frac{1}{4}$ -inch hard asbestos board, securely riveted or bolted to angle iron frame (of not less than $1 \times 1 \times \frac{1}{4}$ inch angle iron, properly braced), or equivalent fire-resisting material. A not less than 6-inch diameter ventilating-pipe shall be used as an exhaust for the hot air generated in operating the machine. All electric wiring shall be in accordance with the National Electrical Code.

Inspection is to be made at least once every six months, and failure to comply with the law makes the proprietor, lessee or manager subject to a fine of \$10 per day for such failure.

Set of rules by the State Superintendent of Building Inspection W. L. A. Johnson, to assist those concerned in fulfilling the requirements of the law, as follows:

" 1. With natural ventilation by doors and windows, under normal conditions and at normal temperature, the velocity of air travel is estimated to be from 30 to 60 feet per minute, where the exhaust equals the intake in area.

" 2. With natural ventilation by ventilating flues and chimneys under normal conditions, the velocity of air travel is estimated at 200 to 300 feet per minute. The velocity of air travel through ventilators in ceilings will range about 100 to 150 feet per minute.

" 3. Small power fans, placed in windows or openings in walls, will give a force velocity of air travel from 800 to 900 feet per minute, where the fans compare reasonably well with the size of the openings.

" 4. The velocity in number of feet of air travel per minute multiplied by the number of square feet of area of openings used for ventilation will give the volume of air in cubic feet that will pass through the opening per minute.

" 5. To determine the required amount of artificial ventilation, multiply the number of seating capacity by thirty and from this amount subtract the number of cubic feet of air obtained per minute from natural ventilation as per rules 1 and 2. The remainder will be the amount of air in cubic feet to be supplied by fans or otherwise."

One of the things cautioned against in ventilating is the "short circuiting" of air.

"Baffle" boards for the breakage of drafts also are demanded by the law.

For correct ventilation, the inlet openings should be near the top of the room and the outlet near the bottom, and in the opposite end of the room. No intake should be placed less than 8 feet above the floor. Where fans are used, it is recommended that they should all be placed in the outlet, so as to draw the foul air from the room.

The placing of chairs or stools in aisles also is to be tabooed under the new law.

A semi-annual report is required of the fire chief, whose duty it is to inspect the buildings to compel whatever change he may desire made.

ABSTRACT OF THE HEALTH LAWS OF STATE OF MAINE, COMPILED BY STATE BOARD OF HEALTH, 1909.

An Act relative to School Buildings. Chapter 88, Laws of 1909.

SECTION 1. It shall be the duty of the State Superintendent of Public Schools to procure architects' plans and specifications for not to exceed four-room school buildings, and full detail working plans therefor. Said plans and specifications shall be loaned to any superintending school committee or school building committee desiring to erect a new school building. For the use of the State Superintendent in procuring such plans and specifications the sum of two hundred dollars is hereby appropriated for the year nineteen hundred and nine, and a like sum for the year nineteen hundred and ten.

SEC. 2. Where the plans and specifications prepared by the State Superintendent are not used all superintending school committees of towns in which new schoolhouses are to be erected shall make suitable provision for the heating, lighting and ventilating and hygienic conditions of such buildings, and all plans and specifications for any such proposed school building shall be submitted to and approved by the State Superintendent of Public Schools and the State Board of Health before the same shall be accepted by the superintending school committee or school building committee of the town in which it is proposed to erect such building.

CIRCULAR NO. 65—STATE BOARD OF HEALTH OF MAINE ON BUILDING SCHOOLHOUSES.

SCHOOLROOMS.—The best shape for schoolrooms is that of an oblong, the width being to the length about as three to four. The teacher's platform should be placed at one end.

The ceiling should be at least 12 feet high, and if the room is of considerable width, especially if unilateral lighting is employed, it may be necessary to have the ceiling somewhat higher.

In rooms for study it is desirable for each pupil to have 20 square feet of floor space, and 240 cubic feet of air space; for example, a room for 35 pupils should have 700 square feet of floor surface inclusive of aisles, and should include within its walls an aggregate of 8400 cubic feet of air space. A room 30 feet long, 23 feet 4 inches wide and 12 feet high will fill these requirements.

LIGHTING.—The glass surface of the windows should equal at least one-fifth of the floor space of the room.

It is advisable in all school buildings to have double windows. The increased cost of construction will be paid by them over and over again in the saving of fuel and they facilitate very much that window ventilation which must be the main reliance in mild weather. Both sets of sashes should be hung with weights and pulleys.

HEATING AND VENTILATION.—The warming of schoolrooms may be accomplished by using stoves, furnaces, or steam heating.

Direct radiation from stoves or steam-coils should never be used.

It is practicable to supply 2000 cubic feet of air per hour for each scholar and the plans for ventilation should admit of furnishing this amount at least ordinarily.

Stoves should invariably be jacketed and connected with fresh-air inlets for the purpose of supplying fresh air to the room.

Furnaces should be a kind capable of supplying 2000 cubic feet of air for each scholar hourly, and a capacious fresh-air inlet should never be omitted.

When steam heating is used the coils should be placed in boxes or fresh-air rooms in the basement or elsewhere for the purpose of warming the air before it enters the schoolroom.

School buildings should be so planned as to permit the ducts for fresh air and for foul air to be as direct and as free from horizontal extension as possible.

Inlets and outlets should be of ample size. Their cross-section should equal from 16 to 20 square inches at least for each scholar.

In ordinary schoolrooms it is preferable to place both inlets and outlets on the same side of the room, namely, upon the inner or warm side. When so placed, the warm air should be admitted 7 feet or more above the floor, and the foul air should pass out close to the floor.

Inlets and outlets should not be constructed with registers which occupy much space, but the opening should be covered with stout wire network.

To insure successful ventilation in all kinds of weather when mechanical means are not employed to move the air it is necessary to have means for artificially heating the foul-air flue. This may be done by means of an open fire, by a small stove set into the base of the shaft, or by steam coils. In small buildings warmed with stoves or furnaces, the smoke-pipe of the heater will usually furnish sufficient heat for this purpose. When thus heated the foul-air flue should contain an iron pipe passing up its center, or, in the case of double flues, set in the division wall, and into this the smoke-pipe should enter.

Instead of ventilating by heated flues, the air may be moved by mechanical means; that is, by fans run by any available motor.

Each furnace or steam-heating apparatus should be supplied with a mixing valve or other arrangement by means of which warm air and cold air can be mixed in such proportions as is required.

MASSACHUSETTS.

The following is the Massachusetts State law in regard to the ventilation of school and public buildings:

LAWS ENFORCED BY THE DEPARTMENT OF INSPECTION OF THE DISTRICT POLICE, BOSTON, MASS.

Acts of 1909, Chapter 354.

An Act to define the powers and duties of the Inspectors of Factories and Public Buildings.

SECTION 1. The Chief of the District Police, the Deputy Chief of the Inspection Department of the District Police, and the Inspectors of Factories and Public Buildings may, in the performance of their duty in enforcing the laws of the Commonwealth, enter any building, structure or enclosure, or any part thereof, and

examine the methods of prevention of fire, means of exit and means of protection against accident, and may make investigations as to the employment of children, young persons and women, except concerning health and the influence of occupation upon health.

They may, except in the city of Boston, enter any public building, public or private institution, schoolhouse, church, theatre, public hall, place of assemblage or place of public resort, and make such investigations and order such structural or other changes in said buildings as are necessary relative to the construction, occupation, heating, ventilating and the sanitary condition and appliances of the same.

Acts of 1909, Chapter 514.

Sanitary, Ventilating and Heating Provisions for Public Buildings and Schoolhouses.

Sec. 105. Every public building and every schoolhouse shall be kept clean and free from effluvia arising from any drain, privy or nuisance, shall be provided with a sufficient number of proper water closets, earth closets, or privies, and shall be ventilated in such manner that the air shall not become so impure as to be injurious to health. If it appears to an inspector of Factories and Public Buildings that further or different sanitation, ventilating or heating provisions are required in any public building or schoolhouse, in order to conform to the requirements of this section, and that such requirements can be provided without unreasonable expense, he may issue a written order to the proper person or authority directing such sanitary, ventilating or heating provisions to be provided. A school committee, public officer or person who has charge of, or owns, or leases any such public building or schoolhouse, who neglects for four weeks to comply with the order of such inspector shall be punished by a fine of not more than one hundred dollars. Whoever is aggrieved by the order of an inspector, issued as herein provided and relating to a public building or schoolhouse, may appeal to a judge of the Superior Court, as provided in chapter four hundred and eighty-seven of the acts of the year nineteen hundred and eight. The State Inspectors of Health or such other officers as the State Board of Health may from time to time appoint shall make such examinations of school buildings as in the opinion of said Board the protection of the pupils may require. The provisions of this section may be enforced by the State Inspectors of Factories and Public Buildings.

FORM NO. 83A. COMMONWEALTH OF MASSACHUSETTS. DISTRICT
POLICE—INSPECTION DEPARTMENT.

In the ventilation of school buildings the many hundred examinations made by the inspectors of this department have shown that the following requirements can be easily complied with:

1. That the apparatus will, with proper management, heat all the rooms, including the corridors, to 70° F., in any weather.

That, with the rooms at 70 degrees and a difference of not less than 40 degrees between the temperature of the outside air and that of the air entering the room at the warm-air inlet, the apparatus will supply at least 30 cubic feet of air per minute for each scholar accommodated in the rooms.

3. That such supply of air will so circulate in the rooms that no uncomfortable draught will be felt, and that the difference in temperature between any two points on the breathing plane in the occupied portion of a room will not exceed 3 degrees.

4. That vitiated air in amount equal to the supply from the inlets will be removed through the ventiducts.

5. That the sanitary appliances will be so ventilated that no odors therefrom will be perceived in any portion of the building.

To secure the approval of this department of plans showing methods or systems of heating and ventilation, the above requirements must be guaranteed in the specifications accompanying the plans.

The law requires that a copy of the plans of every public building and every schoolhouse (except in the city of Boston) shall be deposited with the Inspector of Factories and Public Buildings of the district in which such building is located, before the erection of the building is begun, which plans shall also include the system or method of ventilation to be provided, together with such portion of the specification as the inspector may require.

The plans usually required are a plan of each floor, including the basement and the attic, if the attic is occupied, and a front and a side elevation, and also plans and sectional detail drawings of the system of ventilation. Further plans may be required by the inspector if deemed by him to be necessary.

The size of standard classrooms, as generally used in Massachusetts, is $28 \times 32 \times 12$ feet, and generally seat 48 or 49 pupils.

MINNESOTA.

The requirements of the Minnesota State Board of Health, relating to the construction, etc., of school buildings.

146. No schoolroom or classroom, except an assembly room, shall have a seating capacity that will provide less than 18 square feet of floor space and 216 cubic feet of air-space per pupil, and no ceiling in buildings hereafter to be erected shall be less than 12 feet from the floor.

147. A system of ventilation, in order to be approved by the Minnesota State Board of Health, shall furnish not less than 30 cubic feet of air per minute for each person that the room will accommodate when the difference of the temperature between the outside air and the air in the schoolroom shall be 30° F. or more.

148. In a gravity system of ventilation in connection with a furnace or steam-plant the flues for admitting fresh air to the room, as well as the vent-flues, shall have a horizontal area of not less than 1 square foot for every nine persons that the room will accommodate.

149. The flues for a plenum or vacuum system of ventilation shall have a horizontal area of not less than 1 square foot for every fifteen persons that the room will accommodate.

150. The window space shall equal one-fifth of the floor space of the school-room.

151. In all rooms not exceeding 25 feet in width all the light shall be admitted to the left of the pupils.

152. In rooms exceeding 25 feet in width, light shall be admitted to the left and rear of the pupils.

153. Translucent instead of opaque shades shall be used in the windows for controlling the light.

154. The top of the windows shall be as near the ceiling as the mechanical construction of the building will allow.

155. No cloakroom shall be less than 6 feet wide, nor shall it have less than one window.

156. The so-called "sanitary wardrobe," which allows the foul air of the room to pass through the clothing of the children before passing into the vent duct, shall be condemned as unsanitary.

PUBLIC HEALTH LAWS OF THE STATE OF MONTANA.

PART III, TITLE VII, CHAPTER I, ARTICLE I, REVISED CODES OF MONTANA, 1907.

SECTION 1482. INSPECTION AND REGULATION OF SCHOOLHOUSES, CHURCHES AND PLACES OF PUBLIC RESORT: The State Board of Health shall prepare and issue to the local and county Boards of Health regulations for the lighting, heating and ventilating of schoolhouses, and shall cause sanitary inspection to be made of schoolhouses, churches and all places of public resort in towns or cities of 1000 or more inhabitants, and make such regulations concerning the same as it may deem necessary for the safety of the persons who may attend school or services therein or resort thereto.

And all schoolhouses, churches or public buildings hereafter erected in such towns or cities shall conform to the regulations of the State Board of Health in respect to all sanitary conditions; and all persons, corporations or committees intending to erect any public building hereinbefore named, in towns or cities of 1000 or more inhabitants, shall submit plans thereof, so far as to show the method of heating, ventilating, plumbing and sanitary arrangements to the secretary of the State Board of Health and secure his approval thereof, or the approval of the State Board of Health on appeal from the decision of its secretary, before erecting said building, and shall conform strictly to all the requirements of the said Board in the respects aforesaid, and any person, corporation or committee that shall erect any such building without such approval, and without complying with such requirements, shall be guilty of a misdemeanor, and shall also make such building conform to the requirements of said Board before the same shall be used for any of the purposes above mentioned; and any such use of said building until such requirements have been complied with shall be a misdemeanor.

SEC. 1483. PUBLIC BUILDINGS FOUND IN INSANITARY CONDITION MAY BE DECLARED A PUBLIC NUISANCE. When any schoolhouse, church, theatre or other public building in the State shall, on inspection by a local, county or State health officer, be found to be in such an insanitary condition as to endanger the health of those who may frequent the same, such health officer shall give to the owner, or those in charge of such building, notice to place the same in proper sanitary condition in such a manner as he shall direct and within a reasonable time, and should the owner, agent or other person in charge of such building fail, neglect

or refuse to place the said building in proper sanitary condition, in such a manner as shall be directed and within the time specified in said notice, then such building shall be deemed a public nuisance, and the local or county health officer or the secretary of the State Board of Health shall institute action against the same in the manner now provided by law for the abating of a public nuisance.

The State Board of Health of Montana adopted the following regulations for the protection of school children, April 1, 1909:

REGULATION 29. SANITARY REQUIREMENTS FOR SCHOOLHOUSES. All schoolhouses in towns or cities of 1000 or more inhabitants in the State must conform to the following requirements, and it is earnestly recommended that all schoolhouses conform to these requirements:

HEATING. The heating plant must be of such character that the temperature of the room or rooms can easily be kept at 70 degrees during the most severe weather.

LIGHTING. The windows must come to within 1 foot of the ceiling and the area of glass in the windows must be not less than one-sixth of the floor area. All windows must be on one side and the rear of the room. No blackboards shall be placed between windows.

VENTILATION. The number of pupils seated in a room must be regulated so that each child shall have not less than 250 cubic feet of air space. The ventilating system must be such that each child will be supplied with not less than 1250 cubic feet of fresh air per hour. When the amount of air space provided for each child does not exceed 250 cubic feet, the air in the room must be changed not less than five times per hour. In buildings of more than four rooms some form of forced ventilation must be provided.

REGULATION 41. HEALTH OFFICER MUST INSPECT PUBLIC BUILDINGS. Each local or county health officer shall inspect all schoolhouses, churches, theatres and other public buildings within his district in towns of 1000 or more inhabitants once in each year, and if any such building is found to be in an insanitary condition so as to endanger the health or lives of those who frequent the same, or if such building shall fall short of the requirements prescribed by the State Board of Health, hereafter to be printed, then such health officer shall take such action as is prescribed by law and shall be designated in the regulations of the State Board of Health relative to public buildings.

THE NEW JERSEY LAW CONCERNING PUBLIC SCHOOL BUILDINGS —RULES FOR THE APPROVAL OF SCHOOLHOUSE PLANS, 1909.

Plans of schoolhouses supervised by the business manager.

All plans and specifications for the erection, improvement or repair of public schoolhouses shall be drawn by or under the supervision of the business manager, if there be one, and shall be approved by the Board of Education. Said business manager, if there be one, shall supervise the construction and repair of all school buildings and shall report monthly to the Board of Education the progress of the work; provided, that repairs not exceeding the sum of \$100 may be ordered by the committee of the Board having charge of the repair of school property, without the previous order of the Board and without advertisement. The business manager, if there be one, shall superintend all advertisements for bids

and letting of all contracts. He shall inspect all work done and materials or supplies furnished under contract, and shall, subject to the approval of the Board of Education, condemn any work and reject any materials or supplies which, in his judgment, do not conform to the specifications contained in the contract therefor, and shall perform such other duties as may be required by the Board of Education.

APPROVAL OF PLANS BY STATE BOARD. In order that due care may be exercised in the heating, lighting, ventilating and other hygienic conditions of public school buildings hereafter to be erected, all plans and specification for any such proposed school buildings shall be submitted to the State Board of Education for suggestion and criticism before the same shall be accepted by the Board of Education of the district in which it is proposed to erect such building.

REQUIREMENTS IN ERECTING SCHOOLHOUSES. In order that the health, sight and comfort of the pupils may be properly protected, all schoolhouses hereafter erected shall comply with the following conditions:

LIGHT. Light shall be admitted from the left, or from the left and rear of classrooms, and the total light area must, unless strengthened by the use of reflecting lenses, equal at least 20 per centum of floor space.

VENTILATION. Schoolhouses shall have in each classroom at least 18 square feet of floor space and not less than 200 cubic feet of air space per pupil. All school buildings shall have an approved system of ventilation, by means of which each classroom shall be supplied with fresh air at the rate of not less than 30 cubic feet per minute for each pupil.

HEIGHT OF CEILINGS. All ceilings shall be at least 12 feet in height.

VENTILATION LAW FOR NORTH DAKOTA.

ACT APPROVED MARCH 6, 1911.

“SECTION 1. No building which is designed to be used, in whole or in part, as a public-school building, shall be erected until a copy of the plans thereof has been submitted to the State Superintendent of Public Instruction, who for the purposes of carrying out the provisions of this act is hereby designated as inspector of said public-school building plans and specifications, by the person causing its erection by the architect thereof; such plans shall include the method of ventilation provided therefor, and a copy of the specifications therefor.

“SEC. 2. Such plans and specifications shall show in detail the ventilation, heating and lighting of such building. The State Superintendent of Public Instruction shall not approve any plans for the erection of any school building or addition thereto unless the same shall provide at least 12 square feet of floor space and 200 cubic feet of air space for each pupil to be accommodated in each study or recitation room therein.

“1. Light shall be admitted from the left or from the left and rear of classrooms and the total light area must, unless strengthened by the use of reflecting lenses, be equal to at least 20 per cent of the floor space.

“2. All ceilings shall be at least 12 feet in height.

“3. No such plans shall be approved by him unless provision is made therein for assuring at least 30 cubic feet of pure air every minute per pupil and warmed

to maintain an average temperature of 70° F. during the coldest weather, and the facilities for exhausting the foul or vitiated air therein shall be positive and independent of atmospheric changes. All schoolhouses for which plans and detailed specifications shall be filed and approved, as required by this act, shall have all halls, doors, stairways, seats, passageways and aisles and all lighting and heating appliances and apparatus arranged to facilitate egress in case of fire or accident and to afford the requisite and proper accommodations for public protection in such cases. All exit doors shall open outwardly, and shall, if double doors be used, fasten with movable bolts operated simultaneously by one handle from the inner face of the door. No staircase shall be constructed with wider steps in lieu of a platform, but shall be constructed with straight runs, changes in direction being made by platform. No doors shall open immediately upon a flight of stairs, but a landing at least the width of the door shall be provided between such stairs and such doorway.

"Sec. 3. No toilet room shall be constructed in any public-school building unless same has outside ventilation and windows permitting free access of air and light. The provisions of this act shall be enforced by the State Superintendent of Public Instruction or some person designated by him for that purpose.

"SEC. 5. No wooden flue or air duct for heating or ventilating purposes shall be placed in any building which is subject to the provisions of this act, and no pipe for conveying hot air or steam in such building shall be placed or remain within 1 inch of any woodwork, unless protected by suitable guards or casings of incombustible material.

"SEC. 6. To secure the approval of plans showing methods or systems of heating and ventilation as provided for in Section 2 the foregoing requirements must be guaranteed in the specifications accompanying the plans. Hereafter erections or constructions of public-school buildings by architect or other person who draws plans of specifications or superintends the erection of a public-school building, in violation of the provisions of this act, shall be punished by a fine of not less than \$100 nor more than \$1000."

NEW YORK STATE VENTILATION LAW.

An Act to amend the consolidated school law, relative to proper sanitation, ventilation and protection from fire of schoolhouses.

SECTION 1. No schoolhouse shall hereafter be erected in any city of the third class or in any incorporated village or school district of this State, and no addition to a school building in any such place shall hereafter be erected the cost of which shall exceed \$500, until the plans and specifications for the same shall have been submitted to the Commissioner of Education and his approval endorsed thereon. Such plans and specifications shall show in detail the ventilation, heating and lighting of such buildings. Such Commissioner of Education shall not approve any plans for the erection of any school building or addition thereto unless the same shall provide at least 15 square feet of floor space and 200 cubic feet of air space for each pupil to be accommodated in each study or recitation room therein, and no such plans shall be approved by him unless provision is made therein for assuring at least 30 cubic feet of air every minute per pupil, and the facilities for exhausting the foul or vitiated air therein shall be positive and independent of

atmospheric changes. No tax voted by a district meeting or other competent authority in any such city, village or school district exceeding the sum of \$500 shall be levied by the trustees until the Commissioner of Education shall certify that the plans and specifications for the same comply with the provisions of this act. All schoolhouses for which plans and detailed statements shall be filed and approved, as required by this act, shall have all halls, stairways, seats, passageways and aisles and all lighting and heating appliances and apparatus arranged to facilitate egress in cases of fire or accident and to afford the requisite and proper accommodations for public protection in such cases. All exit doors shall open outwardly, and shall, if double doors be used, fasten with movable bolts operated simultaneously by one handle from the inner face of the door. No staircase shall be constructed with wider steps in lieu of a platform, but shall be constructed with straight runs, changes in directions being made by platforms. No doors shall open immediately upon a flight of stairs, but a landing at least the width of the door shall be provided between such stairs and such doorway.

SEC. 2. This act shall take effect immediately.

In a circular issued by the New York State Education Department calling attention to the law the following interesting information is found:

NEW YORK STATE EDUCATION DEPARTMENT, INSPECTIONS DIVISION.

It should be noted that the act has been so amended as to require the submission of plans for repairing or remodeling school buildings where the cost is in excess of \$500.

The following points should be specially observed:

The plans and specifications must be submitted in duplicate, the original set to be returned after the indorsement of approval, the duplicate to be retained on file at this Department. The original set is the property of the district and in a union free school district should be filed with the clerk of the Board of Education; in a common school district, with the district clerk.

The plans must show in detail the ventilation, heating and lighting of the building. The specifications must contain a statement requiring the contractor to guarantee that the system of heat and ventilation described will heat the rooms to a temperature of 70 degrees in zero weather and provide at least 30 cubic feet of pure air every minute for each pupil to be accommodated in each study or classroom.

At least 15 square feet of floor space and 200 cubic feet of air space for each pupil to be accommodated in each study or recitation room must be provided. In this connection, it will be necessary not only to state the size of the rooms (length, breadth and height) but also to give the number of individual desks to be placed in the room.

Ample cloakrooms should be provided. These should be thoroughly heated and ventilated.

If the closets are located in the basement, the closet for each sex must be approached by a separate stairway. The rooms must be well lighted, heated and thoroughly ventilated. The ventilation must be entirely independent of the ventilation of the schoolrooms. One seat should be provided for every 25

boys and one for every 15 girls. One urinal should be allowed for every 15 boys. Both seats and urinals should be separated into compartments. Absorbent or corrosive materials cannot be approved for use in the construction of urinals.

PENNSYLVANIA.

The State of Pennsylvania has the following laws in reference to school buildings:

SANITARY LAWS RELATING TO SCHOOLS AND SCHOOL HOUSES IN PENNSYLVANIA.

5. Public school buildings to be so constructed that the health, sight and comfort of all pupils may be properly protected. Plans for heating, lighting and ventilation to be submitted.

No schoolhouse shall be erected by any board of education or school district in this State, the cost of which shall exceed four thousand (\$4,000) dollars, until the plans and specifications for the same shall show in detail the proper heating, lighting and ventilating of such building.

6. Light shall be admitted from the left, or from the left and rear of class rooms, and the total light area must, unless strengthened by the use of reflecting lenses, equal at least 25 per centum of floor space.

7. Schoolhouses shall have in each classroom at least 15 square feet of floor space, and not less than 200 cubic feet of air space per pupil, and for an approved system of indirect heating and ventilation, by means of which each classroom shall be supplied with fresh air at the rate of not less than 30 cubic feet per minute for each pupil, and warmed to maintain an average temperature of 70° F. during the coldest weather.

14. On and after the first day of December, 1907, that it shall be unlawful for any board of school directors within this Commonwealth to use a common heating stove for the purpose of heating any schoolroom, unless every such stove shall be in part enclosed within a shield or jacket, made of galvanized iron or other suitable material, and of sufficient height and so placed as to protect all pupils, while seated at their desks, from direct rays of heat.

15. Ventilation: Every schoolroom in this Commonwealth shall be provided with ample means of ventilation, and that, when windows are the only means in use, they shall be so constructed as to admit of ready adjustment, both at the top and bottom, and some device shall be provided to protect pupils from currents of cold air.

16. A thermometer shall be placed in every schoolroom in this Commonwealth by the directors in charge, and this provision shall be complied with even when standard systems of heating and ventilation are in use.

17. Penalty: Any school board neglecting or refusing to comply with the provisions of this act, may, by proper course of law, be dismissed from office: Provided, That when one or more members shall vote to comply with the provisions of this act, such member or members shall not be subject to dismissal.

OHIO STATE BUILDING CODE.

WHICH BECAME A LAW AUGUST 14, 1911.

TITLE I.

THEATRES AND ASSEMBLY HALLS.

SECTION 8. HEATER ROOM. Furnaces, hot-water heating boilers and low-pressure steam boilers may be located in the buildings, providing the heating apparatus, breeching, fuel room and firing room are inclosed in a standard fire-proof heater room and all openings into the same are covered by standard self-closing fire-doors.

No boiler or furnace shall be located under the auditorium, stage, lobby, passageways, stairways, or exits of a theatre; or, under any exit, passageway or lobby of an assembly hall. No cast-iron boiler carrying more than 10 pounds pressure or steel boiler carrying more than 35 pounds pressure shall be located within the main walls of any theatre or assembly hall.

SEC. 16. AUTOMATIC VENTILATION. The stage, if containing movable scenery, shall be provided with one or more ventilators placed near the centre and above the highest point of the stage, extending at least six feet above the stage roof, of a combined area equal to at least one-eighth the area of the stage floor.

The openings in such ventilator shall be closed by valves, louvers or dampers, so counterbalanced as to open automatically, and so constructed that ice or snow will not interfere with their operation; or, the roof of these ventilators may be made in the form of sliding doors providing all tracks, wheels and working apparatus are so placed as to be protected from snow and ice.

All valves, louvers, dampers or doors shall be held closed by hemp or cotton cords, running to and connecting with the stage floor close to each stage exit door. Fusible links shall be inserted in these cords close to each ventilator, ten feet above the stage floor and midway between these two points.

If glass is placed in the ventilator a wire screen of $\frac{1}{2}$ -inch mesh shall be suspended under the ventilator and be placed not less than 3 feet below the soffit of the roof.

SEC. 30. HEATING AND VENTILATION. A heating system shall be installed which will uniformly heat all parts of the building to a temperature of sixty-five degrees in zero weather.

All parlors, retiring, toilet and check rooms, and all assembly halls used in connection with and a necessary adjunct to a church, school building, lodge building, club house, hospital or hotel shall be heated by an indirect system combined with a system of ventilation which will change the air not less than six times per hour. All other assembly halls and theatre auditoriums shall be heated and ventilated by a system which will supply to each auditor not less than 1200 cubic feet of air.

The system to be installed where a change of air is required shall be either a gravity or mechanical furnace system, gravity indirect-steam or hot-water or a mechanical indirect steam or hot-water system.

No stove or open grate shall be used in any theatre or assembly hall except water heaters, furnaces and boilers.

No stove pipe shall be more than 5 feet long, measuring horizontally, unless the same be enclosed in a standard fireproof heater room, nor shall any stove pipe come closer to any combustible material or ceiling than 3 feet.

The fresh-air supply shall be taken from outside the building and no vitiated air shall be reheated. The vitiated air shall be conducted through flues or ducts to and be discharged above the roof of the building.

No floor register for heating or ventilating shall be placed in any aisle or passageway.

No coil or radiator shall be placed in any aisle or passageway used as an exit, but said coils and radiators may be placed in recesses formed in the wall or partitions providing no part of the radiator or coil projects beyond the wall line.

PART II. TITLE III.

SCHOOL BUILDINGS.

SECTION 5. HEATER ROOM. Furnaces, hot-water heating boilers and low-pressure steam boilers may be located in the buildings, providing the heating apparatus, breeching, fuel room and firing room are enclosed in a standard fireproof heater room and all openings into the same are covered by standard self-closing fire doors.

No boiler or furnace shall be located under any lobby, exit, stairway or corridor.

No cast-iron boiler carrying more than 10 pounds pressure or steel boiler carrying more than 35 pounds pressure shall be located within the main walls of any school building.

SEC. 7. DIMENSIONS OF SCHOOL AND CLASS ROOMS. *Floor Space.* The minimum floor space to be allowed per person in school and class rooms shall not be less than the following, viz.:

Primary grades, 16 square feet per person.

Grammar grades, 18 square feet per person.

High schools, 20 square feet per person.

All other schools and class rooms, 24 square feet per person.

Cubical Contents. The gross cubical contents of each school and class room shall be of such a size as to provide for each pupil or person not less than the following cubic feet of air space, viz.:

Primary grades, 200 cubic feet; grammar grades, 225 cubic feet; high schools, 250 cubic feet, and in grade B buildings, 300 cubic feet.

Height of Stories. Toilet, play and recreation rooms shall be not less than 8 feet high in the clear, measuring from the floor to the ceiling line.

The height of all rooms, except toilet, play and recreation rooms, shall be not less than one-half the average width of the rooms, and in no case less than 10 feet high.

SEC. 21. HEATING AND VENTILATION. A heating system shall be installed which will uniformly heat all corridors, hallways, play rooms, toilet rooms, recreation rooms, assembly rooms, gymnasiums and manual training rooms to a uniform temperature of 65 degrees in zero weather; and will uniformly heat all other parts of the building to 70 degrees in zero weather.

Exceptions. Rooms with one or more open sides used for open air or outdoor treatment.

The heating system shall be combined with a system of ventilation which will change the air in all parts of the building except the corridors, halls and storage closets not less than six times per hour.

The heating system to be installed where a change of air is required shall be either standard ventilating stoves, gravity or mechanical furnaces, gravity indirect-steam or hot-water; or a mechanical indirect-steam or hot-water system.

Where wardrobes are not separated from the class room they shall be considered as part of the class room and the vent register shall be placed in the wardrobe.

If these wardrobes are separated from the class rooms they shall be separately heated and ventilated the same as the class rooms.

The bottom of warm-air registers shall be placed not less than 8 feet above the floor line, excepting foot warmers, which may be placed in the floors of the main corridors or lobbies.

Vent registers shall be placed not more than 2 inches above the floor line.

The fresh-air supply shall be taken from the outside of the building, and no vitiated air shall be reheated. The vitiated air shall be conducted through flues or ducts and be discharged above the roof of the building.

A hood shall be placed over each and every stove in the domestic science room, over each and every compartment desk or demonstration table in the chemical laboratories and chemical laboratory lecture rooms, of such size as to receive and carry off all offensive odors, fumes and gases.

These ducts shall be connected to ventilating flues placed in the walls and shall be independent of the room ventilation previously provided for.

Where electric current is available electric exhaust fans shall be placed in the ducts or flues from the stove fixtures in domestic science rooms and chemical laboratories, and where electric current is not available and a steam or hot-water system is used the main vertical flues from the above ducts shall be provided with accelerating coils of proper size to create sufficient draft to carry away all fumes and offensive odors.

TITLE X.

STANDARD VENTILATING STOVES.

SECTION 1. STOVE. A standard ventilating stove may be any style or design of heating stove placed within the room to be warmed and ventilated, and shall be enclosed in a jacket made of galvanized or black iron. Jacket shall extend from the stove tray to a point 4 inches above the top of the stove.

SEC. 2. FRESH-AIR SUPPLY. Fresh-air supply shall be taken from outside the building, be carried to the stove below the floor line either in vitrified sewer pipe, masonry ducts or ducts made of wrought iron or steel, of not less than $\frac{3}{16}$ inch in thickness, riveted together with tight joints.

Ducts shall be turned up and discharge under the centre of the stove, from which point the air shall ascend between the radiating surface of the stove and jacket and enter the room from the top of the stove.

SEC. 3. TRAY. Stove shall be placed on a cast-iron tray raised 3 inches above the floor line, of the same size as the enclosing jacket, provided with an opening of proper size to receive the fresh-air duct and projecting beyond the stove door

1 foot in all directions. Stove door shall be provided with a metal collar extending from the face of the stove to the face of the jacket.

SEC. 4. SMOKE PIPE. No smoke pipe connection between the stove and the smoke flue shall be more than 5 feet long, measured horizontally.

SEC. 5. VENTILATION. Each room in which a standard ventilating stove is installed shall be provided with a ventilating flue placed close to the stove.

The vent flue shall be of the same area as the fresh-air supply and run through and above the roof. Vent flues of not over 150 square inches of area shall be enclosed with walls of brick or concrete not less than 4 inches thick, and vent flues of a larger area shall be made of brick walls not less than 8 inches thick, brick walls 4 inches thick lined with tile flue lining, or monolithic concrete walls not less than 4 inches thick.

Openings to vent flues shall be placed at the floor line, and if vent registers are used the same shall be 50 per cent larger than the area of the flue.

SOUTH DAKOTA SCHOOLHOUSE PLANS.

THE LEGISLATURE OF 1907 PASSED THE FOLLOWING LAW:

ARTICLE XV. SEC. 237. Plans for school buildings approved by State Superintendent.

In order that due care may be exercised in the heating, lighting and ventilating of public school buildings hereafter erected, no schoolhouse shall be erected by any board of education or school district board in this State until the plans and specifications for the same, showing in detail the proper heating, lighting and ventilating of such building shall have been approved by the Superintendent of Public Instruction.

Schoolhouses shall have in each class room at least 15 square feet of floor space, and not less than 200 cubic feet of air space per pupil, and shall provide for an approved system of heating and ventilation by means of which each class room shall be supplied with fresh air at the rate of not less than 30 cubic feet per minute for each pupil, and have a system of heating capable of maintaining an average temperature of 70° F., during the coldest weather.

LAWS OF UTAH, 1909.

SECTION 1. That Section 1823, Compiled Laws of Utah, 1907, be, and the same is amended to read as follows:

1823: PLANS OF NEW BUILDINGS TO BE SUBMITTED TO COMMISSION.

Provided that no schoolhouse shall hereafter be erected in any school district of this State not included in cities of the first and second class, and no addition to a school building in any such place, the cost of which schoolhouse or addition thereto shall exceed \$1,000, shall hereafter be erected until the plans and specifications for the same shall have been submitted to a commission consisting of the State Superintendent of Public Instruction, the Secretary of the State Board of Health, and an architect to be appointed by the Governor, and their approval endorsed thereon. Such plans and specifications shall show in detail the ventila-

tion, heating and lighting of such buildings. The commission herein provided shall not approve any plans for the erection of any school building or addition thereto unless the same shall provide at least 125 square feet of floor space and 200 cubic feet of air space for each pupil to be accommodated in each study or recitation room therein, and no such plans shall be approved by them unless provision is made therein for assuring at least 30 cubic feet of pure air per minute for each pupil and the facilities for exhausting the foul or vitiated air therein shall be positive and independent of atmospheric changes. No tax voted by a district meeting or other competent authority in any such school district shall be levied by the trustees until the commission shall certify that the plans and specifications for the same comply with the provisions of this act. All schoolhouses for which plans and detailed statements shall be filed and approved, as required by this act, shall have all halls, doors, stairways, seats, passageways and aisles, all lighting and heating appliances and apparatus arranged to facilitate egress in cases of fire or accident and to afford the requisite and proper accommodations for public protection in such cases.

No schoolhouse shall hereafter be built with the furnace or heating apparatus in the basement, or immediately under such building.

VERMONT VENTILATION LAW.

REGULATIONS PROMULGATED BY THE STATE BOARD OF HEALTH, VERMONT— EXTRACTS FROM PUBLIC STATUTES OF VERMONT.

REGULATIONS. The following regulations are intended for architects, corporations, committees or other persons intending to erect any public building:

1. Plans of each floor, including basement and attic, if the attic is to be occupied, and front and side elevations, also plans and sectional detail drawings of the proposed system of ventilation, plumbing and heating, shall be submitted to the local health officer, or State Board of Health.

The heating and ventilation plans of schoolhouses, hospitals and other public buildings shall meet the following requirements:

(a) The heating apparatus must be of sufficient capacity to warm all rooms to 70° F., in any weather.

(b) With the rooms at 70 degrees, and a difference of not less than 40 degrees between the temperature of outside air and that of the air entering the room at the warm-air inlet, the apparatus must supply at least thirty cubic feet of air per minute for each person accommodated in the rooms.

(c) Such supply of air should so circulate in the rooms that no uncomfortable draft will be felt and that the difference in temperature between any two points on the breathing plane in the occupied portion of the room will not exceed 3 degrees.

(d) Vitiated air in amount equal to the supply from the inlets should be removed through the ventiducts.

(e) The closets and fixtures must be so arranged and ventilated that no odors therefrom will be perceived in any portion of the building.

To secure the approval of the state or local health officials of plans showing methods or systems of heating and ventilation, the above requirements must

be guaranteed in the specifications accompanying the plans. In schoolhouses, hospitals and other institutions, the number of occupants intended for each room should be given, and in places of assemblage the arrangement of seats and aisles should be shown on plans.

Schoolhouses shall conform to the following detail requirements:

- (a) The site shall be a slight elevation with soil dry and well drained.
- (b) If in a village, it shall be at a point free from noises and unsavory odors.
- (c) If in the rural portion of a town, at a point free from violent winds.
- (d) As near the centre of school population as possible.
- (e) Playgrounds shall be provided for exercise and amusement.
- (f) In villages, or where there is a basement, play rooms can be arranged.

In rural houses, without basements, a shed should be provided for exercise in inclement weather.

(g) There shall be plenty of pure water supplied for drinking purposes.

(h) Buildings shall be so located as to secure the best light. Particular attention must be given to this in villages where the schoolhouse is likely to be surrounded by other buildings.

(i) Care must be taken when the building is of wood to make it warm. This can be done either by using thick building paper under the clapboards, or by filling the space between the outside boarding and the lath with clean, dry sawdust.

(j) The walls of the room shall be light grey or buff color.

(k) All doors shall be hung to swing out, and on large school buildings proper fire escapes shall be provided.

(l) As forty pupils are as large a number as one teacher can well instruct, the rooms shall be $32 \times 28 \times 12$ feet high, giving from 200 to 300 cubic feet of air space and 20 square feet of surface area for each pupil.

(m) The windows must be numerous, large enough, and so arranged as to give ample light to every part (and corner) of the room. The window space should be one-fourth of the floor space, and must be not less than one-fifth. There must be no more space between the top of the window and the ceiling than is required to finish the building, and the window-sill must be 4 feet from the floor. The light must be arranged so as to fall upon the pupil from the left or left and back, never from the front. There must be curtains of a grey or buff color for all windows—two to each window—hung in the centre of the window so that either the upper or lower half, or both, can be shaded.

(n) If there is no cellar under the building, there shall be a space of at least 2 feet from the floor to the ground, and there shall be windows or openings in the underpinning so that there can be a free circulation of air.

(o) If the corridors are used as coat-rooms they shall be well lighted and ventilated.

WARMING AND VENTILATING SCHOOLHOUSES. The heating apparatus must be of sufficient capacity to warm all rooms to 70° F. in any weather.

Not less than 30 cubic feet per minute of pure air for each pupil should be supplied, and it should be so introduced that there shall be no uncomfortable drafts. The difference in temperature between any two points on the breathing plane shall not exceed 3 degrees. The ventilating flues shall be of sufficient size to readily introduce and remove the requisite amount of air from the room.

In rural houses of one room where a furnace is impracticable, the above con-

ditions can most economically and satisfactorily be met by the use of the "jacketed stove," as shown. The ordinary wood-burner box stove may be surrounded by a casing, or jacket, of galvanized iron, with proper air space of 6 to 9 inches between jacket and stove. Fresh air should be conveyed from the outside of building through tin tube to space under stove.

The vent or foul air pipe (also of tin) should be set on legs with an opening at the bottom, 12 inches from the floor, to run straight up through the roof as high as the chimney. The stove-pipe should enter this at not more than 6 feet from the floor, passing up as far as possible before it leaves the vent pipe for chimney. There should be a door in the jacket at the rear end of the stove which can be opened for pupils to warm their feet.

STATE BOARD OF HEALTH.

September 20, 1909.

VIRGINIA.

CHAPTER 187: AN ACT FOR THE PURPOSE OF REGULATING THE CONSTRUCTION OF PUBLIC SCHOOL BUILDINGS IN ORDER THAT THE HEALTH, SIGHT AND COMFORT OF ALL PUPILS MAY BE PROPERLY PROTECTED.

APPROVED MARCH 11, 1908.

1. Be it enacted by the General Assembly of Virginia, that the State Board of Inspectors for public school buildings shall not approve any plans for the erection of any school building or room in addition thereto unless the same shall provide at least 15 square feet of floor space and 200 cubic feet of air space for each pupil to be accommodated in each study or recitation room therein, and no such plans shall be approved by said board unless provision is made therein for assuring at least 30 cubic feet of pure air every minute per pupil, and the facilities for exhausting the foul and vitiated air therein shall be positive and independent of atmospheric changes. All ceilings shall be at least 12 feet in height.

2. All schoolhouses for which plans and detailed statements shall be filed and approved by said board, as required by law, shall have all halls, doors, stairways, seats, passageways and aisles, and all lighting and heating appliances and apparatus arranged to facilitate egress in cases of fire or accidents, and to afford the requisite and proper accommodations for public protection in such cases. All exit doors in any school house of two or more stories in height shall open outwardly. No staircase shall be constructed except with straight runs, changes in direction being made by platforms. No doors shall open immediately upon a flight of stairs, but a landing at least the width of the doors shall be provided between such stairs and such doorways.

3. All schoolhouses, as aforesaid, shall provide for the admission of light from the left, or from the left and rear of the pupils and the total light area must be at least 25 per centum of the floor space.

CHAPTER XX

AIR CONDITIONING

255. Air Conditioning is the art of positively producing and controlling any desired atmospheric conditions within an enclosure with respect to moisture content, temperature and purity. The purity has reference to the dust carried by the air as well as poisonous and noxious gases. The principle object, however, is the regulation of moisture or the humidity.

256. Useful Results of Air Conditioning.—In many industries, such as the manufacture of textiles, food products, high explosives, photographic films, tobacco, etc., the artificial regulation of atmospheric moisture or humidity and the removal of the dust and some of the gaseous impurities of the air is of the greatest importance.

When applied to the blast furnace, it has increased the net profit in the production of pig iron from \$0.50 to \$0.70 per ton, and in the textile mill it has increased the output from 5 to 15 per cent, at the same time greatly improving the quality of the product and also the hygienic conditions surrounding the operatives. In many other industries, such as lithographing, the manufacture of candy, bread, high explosives and photographic films, and the drying and preparing of delicate hygroscopic materials such as macaroni and tobacco, the question of humidity is equally important.

257. Percentage of Humidity Desirable.—From a physiological standpoint this subject is of importance. Messrs. H. W. Clarke and Stephen De M. Gage in a paper read before the Health Association, Washington, D. C., 1912, say,* “The feeling of depression felt in badly ventilated rooms is largely

* American Journal of Public Health, Nov. 1913.

caused, not by excess of carbonic acid or depletion of the air of oxygen or by toxic substances emitted from the occupants, but from the fact that the temperature and humidity have increased, and normal evaporation from the skin has been reduced, thereby affecting the temperature regulating mechanism of the body and the entire nervous and circulating systems. According to Haldane and others, it is the sensible temperature, or that indicated by the wet bulb thermometer, which the body feels, and the actual or dry bulb temperature and the real humidity, are of minor importance under ordinary conditions. With a wet bulb temperature above 88° F. in still air, heat stroke is likely to occur even with persons wearing little or no clothing and doing no work, while in the case of persons dressed in ordinary clothing and doing muscular work, serious effects may follow at very much less sensible temperature. On the other hand, eminent physicians assert that excessively dry air is harmful, causing a thickening of the mucous membranes and aggravation of catarrhal conditions. What degree of humidity is most conducive to the comfort of indoor workers is an open question and undoubtedly depends somewhat upon the nature of the employment. There is little question, however, that the comfort, and probably the health, of persons employed in the majority of textile processes is affected to a greater or less extent, as the wet bulb temperature of the air measures above 70° to 75° F."

As a result of a thorough test of three months duration in the Oliver Wendell Holmes School in Boston by Charles F. Eocleth and Dr. T. W. Harrington, the following conclusions were deduced:

First. To secure the greatest comfort, the relative humidity should not exceed 55 per cent; somewhere between 45 and 50 per cent is probably the best range.

Second. With the humidity at 55 per cent, the temperature of the room should never rise above 65° F. A temperature of from 61° to 62° F. will give better results.

Third. Moistening the air up to 40 per cent or above should not be attempted, unless both the heating system and

the humidifying apparatus can be kept under close control. With a room temperature of from 70° to 75° and a relative humidity of 50 per cent, there is a very pronounced feeling of oppression and physical discomfort as well as a perceptibly disagreeable odor. If temperature rises above 75° , the relative humidity should not rise above 35 per cent.

258. Humidity and its Determination.*—The conditions of the atmosphere as regards moisture involves two distinct elements: (1) The amount or weight of vapor present, which is called absolute humidity, and (2) the ratio of this to the amount which would produce saturation at the existing temperature, which is called relative humidity. The sensation of relative dryness or moisture depends chiefly upon the second of these elements.

Water has the property of emitting vapor in a confined space at a definite pressure or tension, depending upon its temperature whether the space is filled with air or not. If the vapor is sufficient to fill a given space, the space is *saturated* and the maximum vapor tension is produced; with insufficient vapor a less vapor tension is produced. The amount or weight of moisture present would be the same whether the space is a vacuum or whether it is filled with air or any other gas. Contrary to the usual opinion, air has no capacity for absorbing moisture. By lowering the temperature sufficiently, the vapor contained in a confined space may be condensed and may appear as dew. The exact temperature at which the formation of dew ceases, with rising temperature, is called the *dew point*. The *relative humidity*, scientifically, is the ratio of vapor tensions at the dew point and at the actual temperatures. It may be calculated from the values given in standard vapor or steam tables. An abbreviated table of the properties of saturated vapor in a confined space follows. This table gives the tension and weight per cubic foot for the dew point temperature, found as explained later. Thus, supposing that the actual temperature is 60° F., and the dew point temperature is 50°

* For definitions of humidity, dew-point, etc., see Sec. 28, p. 36.

F., the weight of vapor would be given in column 4 corresponding to 50°, which is 0.00059 pound per cubic foot. This vapor weight or absolute humidity would remain constant if the temperature in the confined space were increased, but the relative humidity would be diminished, because the vapor present is not sufficient to produce saturation or dew point at a higher temperature. The table shows that at 60° F. the weight of vapor at saturation is 0.00083 pound per cubic foot. The *relative humidity* is the ratio of the tensions at the dew point and at the observed temperatures, or, for the example selected, the tension at 50 degrees, 0.363, divided by the tension at 60 degrees, 0.522, is 0.696. The tension due to the vapor is always the same at the same temperature whether the confined space is occupied by air or not, but the total pressure in the confined space is the sum of the vapor

TABLE OF VAPOR TENSIONS, DENSITY AND LATENT HEAT AT SATURATION OR DEW-POINT

1 Temp. Fahr.	2 Pressure or Tension.	3	4 Density or Weight.	5 Latent Heat.
Degrees.	Lbs. per Sq.in.	Inches of Hg.	Lbs. per Cu.ft.	B. T. U. per Lb. Vapor.
32	0.089	0.180	0.00030	1073
35	1.100	0.203	0.00034	1072
40	0.122	0.248	0.0041	1069
45	0.148	0.300	0.00049	1066
50	0.178	0.363	0.00059	1063
55	0.214	0.436	0.00070	1061
60	0.256	0.522	0.00083	1058
65	0.305	0.622	0.00098	1055
70	0.362	0.739	0.00115	1052
75	0.429	0.873	0.00135	1050
80	0.505	1.029	0.00157	1047
85	0.594	1.209	0.00183	1044
90	0.696	1.417	0.00213	1041
95	0.813	1.655	0.00247	1038
100	0.946	1.926	0.00285	1036
105	1.098	2.236	0.00328	1033
110	1.271	2.589	0.00377	1045
115	1.467	2.438	0.00431	1027
120	1.689	3.987	0.00492	1024

pressure and that already existing in the space. Thus, if the air in a confined space were at a pressure of 29.18 inches of mercury and the temperature at dew point were 70 degrees, there would be an additional vapor pressure at dew point of about 0.74 inches, making a total pressure of 29.92 inches Hg.

Column No. 5 in the table gives the heat required to vaporize one pound of water, or condense one pound of vapor at the given temperature. Thus to condense one pound of vapor at 60° F. there must be absorbed 1058 B. T. U.; conversely, to evaporate one pound of water from and at 60° F., there will be required an expenditure in heat of 1058 B. T. U. If a change of temperature occurred without any evaporation or condensation, the heat interchange would be calculated by multiplying the range of temperature by the weights and specific heat of each constituent element and finding the sum of the products.

Dew-point Determination.—One of the most common and best known instruments for determining the dew-point is Daniell's hygrometer, which consists of a bent tube with a hollow globe or bulb at each end and partly filled with ether. The lower bulb is of black glass and contains a thermometer, while the upper bulb is wrapped with muslin. The instrument is supported by a stand which carries a thermometer for giving the atmospheric temperature. It is used by passing the liquid to the lower bulb and then moistening the upper or covered bulb with ether. The evaporation on the surface of the covered bulb causes a drop in temperature and consequently condenses part of the vapor within it. This produces an evaporation in the lower bulb and a lowering of the temperature. When moisture first appears on the lower bulb the temperature is noted, then the instrument is allowed to stand until the moisture disappears, when the temperature is again read. The mean of these temperature readings is the dew-point. The dew-point hygrometer is inconvenient for the determination of the relative humidity and is not used as extensively as the *wet and dry bulb* thermometer or sling

psychrometer described on page 37, which involves a different principle and does not give the dew-point. The wet and dry bulb instrument with proper handling and the use of accurate tables or charts gives the relative humidity as accurately as desired for practical purposes.

259. Dust.—Ordinary air always contains a greater or less amount of both dead and living matters in suspension, which may have an important influence upon the health. The dead matter of the dust consists of particles of mineral matter from the streets and pavements and from vehicles and machinery, and the organic matter from the floors and walls, from clothing, and from the emanations of men and animals. Dust, when present in excessive amounts, irritates the mucous membranes of the lungs and respiratory passages and renders them more susceptible to invasion by the germs of disease. The living matter consists of bacteria, yeasts and molds which are always present in greater or less numbers, and which have found their way into the air from the emanations from animal and vegetable life. So far as is known the yeasts and molds have little pathological significance, but it is well recognized that the germs of tuberculosis, pneumonia, influenza and perhaps other diseases are frequently transmitted through the air.

The presence of dust in the atmosphere allows the condensation to take place whenever the air is cooled to the saturation point, whereas if there were no dust, condensation would require a much lower temperature. Many of the dust particles in the air are extremely minute; each one serves, however, as a nucleus for water-vapor to condense on, and is rendered visible by placing the air under examination in an air-tight receiver saturated with water vapor. The particles may be counted on a micrometer by expanding the air with an air pump and producing condensation if the number of particles are less than 500 per cubic centimeter. If the number of particles exceed that amount, the air is diluted with known volumes of air free from dust until the number is less than 500 per cubic centimeter. The number of dilutions

multiplied by the number counted serves to give the number of dust particles.

The weight of dust is sometimes obtained by forcing known volumes through a filter or body of water and determining the dust by finding the increase of weight.

The dust particles are greatly reduced by increasing the relative humidity, thus when the wet bulb depression is 2° to 4° , the number of particles are less than one-half those found when the wet bulb depression is 7° . They are almost entirely removed by washing.

It is rare to find any air containing less than 100 particles of dust per cubic centimeter, and in cities the numbers may be as high as 100,000 to 150,000 per cubic centimeter. Even over the ocean the number usually exceeds 300 per cubic centimeter.

260. Solubility of Gases.—The water employed in air washing not only absorbs the solid dust particles but it absorbs many of the gaseous impurities, so that such water is likely to be charged with dangerous impurities.*

The following table gives the number of volumes of certain gases that one volume of water will dissolve at 68° F. temperature and a pressure of 29.98 inches of mercury.

Ammonia, NH_3	710.00
Carbon dioxide, CO_2	0.00072
Carbon monoxide, CO	0.023
Chlorine, Cl	0.226
Hydrogen, H	0.017
Hydrogen sulphuric, H_2S	2.91
Nitrogen, N	0.0158
Oxygen, O	0.03
Nitrous oxide, N_2O	0.67
Methane, CH_4	0.035
Ethylene, C_2H_4	0.15
Acetylene, C_2H_2	103.0
Sulphur dioxide, SO_2	0.384

* Paper by Prof. G. C. Whipple, Am. Public Health Association, 1913.

261. Combustibility of Gases.—Smells and fumes are often composed largely of complex hydrocarbons which are practically insoluble in water, but are combustible when passed through fire, where they are decomposed into water and carbon dioxide, etc. This can often be done by installing exhaust fans and ducts to take the contaminated air to the ash pits of boiler or of other furnaces. Wherever practical, any industrial process producing noxious fumes should be equipped with an adequate system of hoods, discharging into chimneys, or induced draft fans conveying them to places where they are rendered harmless by proper treatment.

Poisonous gases, such as carbon monoxide, which are heavier than air, should be prevented from settling into unventilated cellars or pits in which such gases may collect.

262. Regulation of Relative Humidity.*—This operation will require the addition of vapor, or humidifying, when humidity is to be increased, and the reduction of vapor, or dehumidifying, when it is to be decreased. As has been pointed out, an increase in temperature will decrease the relative humidity, and a decrease in temperature will increase the relative humidity.

In some industries, such as textile mill work, the necessity for some means of increasing the relative humidity has long been realized and met by crude means without much regard to the health or comfort of the operatives.

Old methods of humidifying:

- (a) Sprinkling the floor, or "degging" as it is called;
- (b) the use of shallow channels in the floor or shallow pans for water;
- (c) Introductions of steam into the room usually through deep cans to prevent dirty water and oil from injuring the goods.

Modern methods of humidifying:

Humidifiers may be classified into Spray and Evaporative types, and the latter again divided into direct and indirect.

* See papers by W. H. Carrier and Frank L. Busey, read before the A. S. M. E. in 1911, and entitled "Rational Psychrometric Formulæ" and "Air Conditioning Apparatus."

The relative humidity of air may also be increased by the direct introduction of steam into the air supply, or into the room. This method raises the temperature perceptibly and is therefore intolerable in most cases. It is also objectionable because it introduces a noticeable odor so that its use is of little engineering interest.

For ventilation purposes both the spray and the evaporative types of humidifier have an additional value, due to the cooling effect, which is in direct proportion to the moistening effect. The direct spray type is distinguished from the evaporative type in that it introduces a finely divided or atomized spray directly into the room in constant volume, while the evaporative type introduces only a water vapor.

There is also a mixed type which discharges both moist air and free moisture into the room.

In what may be termed the indirect evaporative humidifier the air is partly or entirely taken from the outside and humidified and conditioned before it is introduced into the room. This system is also called the central system. In the direct evaporative type the water vapor passes directly into the air of the room. The direct spray type of humidifier introduces a fixed quantity of moisture into the room regardless of the condition of the room until it is closed off by hand, or by an automatic control.

In the automatic type there is an inherent self-regulating feature, owing to the fact that the rate of evaporation is in direct proportion to the deficiency in moisture in the air. This is especially true in the indirect evaporative type, which, with all conditions of outside air, may be made to maintain an absolutely uniform relative humidity, other conditions remaining constant.

The essential features of a modern humidifier are as follows:

a. A diffuser which serves as an eliminator to prevent water from being carried outward against the air current.

b. A system of atomizing sprays so arranged as to fill the air completely with water particles uniformly distributed over the chamber area.

c. A centrifugal pump for maintaining the proper pressure on the spray nozzles.

d. A settling chamber provided with proper strainers for the removal of dirt from the spray water.

e. An eliminator for washing the air by impact and centrifugal force and for the removal of all free moisture.

f. An automatic water heater for supplying heat and moisture to the air through the water spray. This may be either of the closed type or of the open, ejector type.

g. A dew-point thermostat subject to the temperature of saturation and connected to motor valves controlling the supply of heat to the spray water.

Air is drawn through this humidifier at a velocity of about 500 feet per minute. The temperature of the air is raised immediately in the humidifier from out-door temperature, to that necessary to hold the desired amount of moisture.

263. Automatic Humidity Control.—There are three different methods by which such control can be secured: (*a*) by two separate thermostats, one of which is placed at the humidifier just beyond the eliminator plates. This controls the temperature of the dew-point by an automatically operating valve or damper governing the means of operating the temperature of the spray water, of the entering air or of both in conjunction. The other thermostat placed in the room maintains a constant room temperature, either by controlling the temperature of the air entering the room or by controlling some source of heat within the room. With these two temperatures maintained constant the percentage of humidity in the room will remain constant and will depend upon the difference between the dew-point temperature maintained at the humidifier and the temperature maintained in the room.

(*b*) By a differential thermostat: This type of dew-point control is required wherever it is impracticable to maintain either a constant dew-point or a constant room temperature. In this method there are two elements, one of which is exposed to the dew-point temperature, while the other is exposed to the room temperature. They are so connected that they act

conjointly upon a single thermostatic valve connected with operating motors arranged to control the dew-point temperature in relation to a variable room temperature, or to control the room temperature with respect to a variable dew-point temperature.

(c) By means of some form of differential hygostat which controls the wet bulb temperature with respect to the dry bulb temperature so as to maintain a constant relative humidity with regard to the dew-point for variation in room temperature.

264. Relative Humidity, Variation.*—The degree of saturation of the air leaving any type of air washer depends upon the intimacy of the contact of the air and water, and upon the relation of the water temperature to the wet bulb temperature of the entering air. It also depends to some degree upon the length of the spray chamber as well as upon the velocity of the air passing through it. With the centrifugal type of spray nozzles the water pressure is a most important element affecting the degree of saturation.

Tests made on a standard humidifier having four $\frac{3}{16}$ -inch orifice centrifugal spray nozzles per square foot, and the wet bulb depression of the entering air maintained constant at 16° F., showed that an increase of 2½ pounds (from 25 to 27.5 pounds) per square inch permitted an increase in the air velocity up to 670 feet per minute through the spray chamber with perfect saturation of the air, while with 25 pounds pressure and a velocity of 500 feet per minute the air was not perfectly saturated. This effect was undoubtedly due to the increase in fineness of the spray rather than to the increase in the amount of water discharged. The water was discharged in the opposite direction from the air flow.

When the spray water is recirculated without heating as in warm weather, it remains at all times substantially at the wet-bulb temperature of the entering air, while the wet-bulb temperature of the air leaving the washer or humidifier is unchanged. Therefore it follows, in conformance with the theory that when the air is completely saturated as in the

* See articles by Carrier and Bussey, Transactions A. S. M. E., 1911.

humidifier the air is cooled to the wet-bulb temperature of the incoming air. This cooling effect is due to the transformation of sensible heat into latent heat of evaporation and is therefore in direct proportion to the moisture added to the air. The wet-bulb depression in atmospheric air averages from 12 to 15 degrees in summer, while occasionally a depression of 20 to 30 degrees is found in extremely hot and dry weather. In every case the humidifier will cool the incoming air a corresponding number of degrees.

When saturation is incomplete, as in the ordinary air washer, the wet-bulb depression of the air leaving the washer is found to be a constant percentage of the initial wet-bulb depression, when the air velocity remains constant.

It also follows that the cooling effect is a constant percentage of the initial wet-bulb depression. This may be expressed by the formulæ

$$\frac{t_2 - t'}{t_1 - t'} = R, \quad (1)$$

$$\frac{t_1 - t_2}{t_1 - t'} = 1 - R = E, \quad (2)$$

where

t' = constant wet-bulb temperature;

t_1 = temperature of air entering washer;

t_2 = temperature of air leaving washer;

R = constant ratio depending upon intimacy of contact, air velocity, etc.;

$1 - R = E$ = efficiency of saturation.

265. Power Required for Operating Humidifiers.—The following table * gives the power required to saturate 1000 cubic feet of air per minute at various velocity conditions, based on overcoming the resistance of the humidifier, using a fan with a static efficiency of 45 per cent, which is a fair value.

* See paper by Carrier and Bussey, A. S. M. E. Transactions, 1911.

TABLE II. RESISTANCE OF HUMIDIFIERS AND HORSE-POWER REQUIRED TO HUMIDIFY 1000 CUBIC FEET OF AIR.

Velocity through Spray Chamber in Ft. per Min.	Assumed Resistance in Inches of Water.	Resistance in Oz. per Square Inch.	Horse-power to Move 1000 Cu. Ft. Air per Min. at 45 Per Cent Fan Efficiency.	Horsepower for Spray per 1000 Cu. Ft. of Air (½ Orifice Nozzle).	Total Horse-power Required per 1000 Cu. Ft. of Air.
350	0.112	0.0647	0.0391	0.1408	0.1799
400	0.147	0.0850	0.0513	0.1231	0.1744
450	0.186	0.1075	0.0652	0.1095	0.1747
500	0.229	0.1322	0.0800	0.0985	0.1785
550	0.277	0.1600	0.0968	0.0897	0.1865
600	0.330	0.1906	0.1150	0.0822	0.1972
650	0.387	0.2240	0.1350	0.0758	0.2108
700	0.450	0.2600	0.1570	0.0704	0.2274
750	0.516	0.2990	0.1810	0.0658	0.2468

This does not include the power required to overcome the resistance of the ducts, which varies considerably, but should not exceed that required for the humidifier. The resistance of the heating coils is not considered, because in summer when the largest supply of air is usually required the air is by-passed around the heaters while in winter the requirements are so much smaller that the total horsepower is greatly reduced and the total resistance is but slightly increased. The power required to pump the water is based on the use of centrifugal pumps having an efficiency of 55 per cent and using $\frac{1}{16}$ -inch orifice nozzle with rotary self-cleaning strainers.

266. The Relation of Cooling Effect to Percentage of Relative Humidity.*—In the moist air system of humidifying it is essential that the difference between the dew-point temperature of the incoming air and the room temperature shall not exceed a predetermined value, depending upon the percentage of humidity to be maintained. The minimum temperature at which air can be introduced is the dew-point or saturation temperature at the apparatus. This permissible temperature rise limits the possible cooling effect to be obtained from each cubic foot of air. The proper relationship of these factors is of primary importance in the design of humidifying systems.

In the majority of industrial applications the problem during warm weather, and in some instances throughout the

* See paper by Carrier and Bussey, A.S.M.E. Transactions, 1911.

entire year, is as much a question of cooling as of humidifying. In the moist air system one is dependant upon the other. In every air conditioning plant there are four sources of heat which must be taken into account in the design of the system.

a. Radiation from the outside owing to the maintainence of a lower temperature inside. At ordinary humidities this is negligible, but at high humidities and in dehumidifying plants it is an important factor, owing to the increased temperature difference. This may be calculated from the usual constants of radiation.

b. The heating effect of direct sunlight. This is especially noticeable from window shades and exposed windows and skylights where the entire heat energy of the sunlight is admitted to the room, and from the roof, which constitutes the greater amount of sunlight exposure, and which in the ordinary construction transmits heat much more readily than the walls. Precautions should be taken where high humidities are desired to shade exposed windows and to insulate the roof thoroughly. Ventilators in the roof are of great advantage in removing the hot layer of air next it and those of ample capacity should always be provided.

c. The radiation of heat from the bodies of the operatives. This amounts to about 400 to 500 B. T. U. per operative, about one-half of which is sensible heat, the other half being transformed into latent heat through evaporation.

d. The heat developed by power consumed in driving the machinery and in the manufacturing processes in general. According to the laws of conservation of energy, all power used in manufacturing is ultimately converted entirely into its heat equivalent. Each horsepower of energy therefore creates $42\frac{1}{2}$ B. T. U. of heat per minute which must be cared for by ventilation. In high-powered mills this is the chief source of heating and is frequently sufficient to overheat the building even in zero weather, thus requiring cooling by ventilation the year round.

Relation of room temperature to outside wet-bulb temperature: During cold weather the dew-point or saturation

temperature at the apparatus is secured and controlled artificially at whatever point required. During warm weather, however, it is impossible, during the greater part of the time, to obtain as low a dew-point as desired without refrigeration. The lowest saturation temperature that can be obtained (where the water is refrigerated) is the same as the outside wet-bulb temperature; therefore the dew-point in the room will always be the same as the outside wet-bulb temperature. The difference between the dew-point and room temperatures is dependent upon the relative humidity maintained so that the higher the humidity the lower the room temperature may be kept.

267. Dehumidifier.—May be of the spray type or of the surface type. A knowledge of the relation of water temperature to the discharge air temperature in either type is essential. In the spray type of one stage having two banks of opposed nozzles, the air temperature leaving is practically identical with the temperature of the leaving water; the difference never exceeds one degree in properly designed apparatus. The air will always be saturated when leaving, and under some conditions there is a slight tendency to entrainment even after thorough elimination.

The degree of entrainment will depend upon the range of temperature of both the air and the water. In general, the smaller the temperature range the greater the tendency is to moisture entrainment or supersaturation. This may be reduced, where a considerable lowering of air temperature is required, by passing the air successfully through two or more humidifiers in series. When the system is properly designed the entrainment should not be sufficient to raise the true dew-point temperature more than one degree.

The spray type dehumidifier is able to bring the air to substantially the same temperature as the spray water, while in the surface type there is usually from 15 to 25 degrees difference in the temperature of the air leaving the humidifier and the cooling water. This permits of a much increased efficiency in cooling with the spray type where artesian well water is used. By artificial refrigeration using the compression sys-

tem, this higher water temperature permits a much increased ammonia pressure in the water cooler, often doubling the absolute pressure. As shown in the following table, this increases the capacity of the ammonia pressure correspondingly and accordingly reduces the horse-power required per ton of refrigeration. The ammonia condenser of course remains unchanged.

TABLE III. B.T.U. REFRIGERATION REQUIRED TO COOL 1000 CUBIC FEET OF AIR (MEASURED AT 70 DEGREES) FROM A GIVEN WET-BULB TEMPERATURE TO A GIVEN DEW-POINT.

Leaving Dew-point.	Ammonia Temperature.	Suction Pressure (Gage).	Per Cent Compressor Ratings at 15 Lbs.	Per Cent Horsepower Compared with Horsepower Required at Rated Suction Pressure of 15 Lbs. Gage.	Entering Wet-bulb Temperature.							
					50	55	60	65	70	75	80	85
					65	45	65.96	270	41.5
60	40	58.29	244	45.5	259.0	553	865	1220	1609
55	35	51.22	220	49.5	221.5	480.5	777	1086	1440	1840
50	30	44.72	199	54.5	...	203	425.0	683.0	980	1290	1570	2030
45	25	38.73	182	59.5	185	388	611.0	869.0	1165	1474	1830	2220
40	20	33.25	164	66.0	359	569	791.0	1050.0	1345	1656	2010	2400

268. Refrigeration Required for Dehumidifying. — The heat to be removed in cooling a known weight of air from a given temperature and moisture content to a given dew-point temperature is evidently the difference of the total heat quantities contained in the air under these respective conditions. The total of the latent and specific heats in one pound of pure air is dependent upon the wet-bulb temperature only. Table 3 shows the amount of refrigeration required to cool and dehumidify 1000 cubic feet of air between various given wet-bulb temperatures and final dew-points. The amount of water required to cool air in a one-stage spray system dehumidifier may be calculated from the foregoing data as follows.

$$W(t_w - t_2) = N(H_1 - H_2) = N(t_1' - t_2) \frac{\Delta H}{\Delta t'}, \dots (1)$$

$$W = N \left(\frac{H_1 - H_2}{t_w - t_2} \right) = N \left(\frac{t_1 - t_2}{t_1 - t_2} \right) \frac{\Delta H}{\Delta t'}, \dots (2)$$

whence

W = weight of water in pounds;

N = weight of air in pounds;

t_w = initial water temperature;

t_1' = initial wet-bulb temperature of air;

t_2 = final dew-point temperature of air;

H_1 = initial total heat in 1 pound of air at wet-bulb temperature, t_1' ;

H_2 = total heat in 1 pound of air at final dew-point, t_2 ;

$\frac{\Delta H}{\Delta t'}$ = approximate rate of total heat change at the given temperature per degree change in wet-bulb temperature, t' ;

To find the final temperature possible with a given weight of water and of air at temperature, t_w and t_1' , respectively, we have from (1)

$$Wt_w - Wt_2 = Nt_1' \frac{\Delta H}{\Delta t'} - Nt_2 \frac{\Delta H}{\Delta t'}. \quad \dots \quad (3)$$

Hence

$$t_2 = \frac{Nt_1' \frac{\Delta H}{\Delta t'} - Wt_w}{N \frac{\Delta t}{\Delta t'} - W}. \quad \dots \quad (4)$$

269. Air Washers.—Air washers differ from humidifiers principally in the object to be accomplished. In the humidifiers the main object is to bring the air to the proper relative humidity and temperature. In the air washer the chief aim is to obtain pure air free from all foreign substances such as poisonous gases, noxious odors, dust and bacteria. In the open country nature provides for purifying the air through the agency of rain. Alfred E. Stacy, Jr., in a paper before the A. S. H. & V. Engineers, states that “a heavy rain acts as an air washer and removes from the air all but traces of dust. This has been proven conclusively by daily readings taken on the roof of the Chicago City Hall.” In cities, however, dust from the streets, smoke, germs and impurities from the bodies of the

inhabitants, are in such abundance as to require further attention than nature can provide. With natural ventilation all the dust is carried into the buildings through the open windows and this is especially true of the lower stories of the buildings. With artificial ventilation the supply of air is usually taken near the ground, and unless some means of purification is employed the dust from the streets is forced into the rooms of the building to be breathed by the occupants and to settle upon the furniture and decorations, causing rapid deterioration. The essential parts of a modern air washer are: a spray chamber, an eliminator and a sump or tank. Other accessories necessary to the operation, where the washing water is re-circulated, are: a pump, a strainer, and some motive power for driving the pump. The spray in the spray chamber does not need to be so finely divided as in the case of a humidifier for industrial purposes, where the air must be completely saturated, and the spray may be directed with the current of air. A coarser spray also probably has a better washing effect than the very fine spray, and the power required to produce the very fine spray is greater. In cold weather, tempering coils are also necessary, since the temperature of the spray water would become too cold and the relative humidity in the building would become abnormally low. In warm weather the washer will have but slight cooling effect, which will be proportional to the increase in relative humidity, except where cooling coils are used or where fresh cold water is supplied for the spray.

In cases where the amount of air required for heating is substantially in excess of that required for ventilation, as is probably the case with a large class of buildings, the practice of re-circulating part of the air through the air washer would result in a considerable saving of heat. However, the use of direct radiation to supply the heat in excess of that carried by the air necessary for ventilation would be more economical and would obviate the danger of re-circulating too much of the air and thereby impairing the ventilation.

APPENDIX

CONTAINING

REFERENCES AND TABLES.

LITERATURE AND REFERENCES.

THE literature devoted to the subject of warming and ventilation is quite extensive, dating back to a treatise on the economy of fuel and management of heat by Buchanan in 1815. A most-excellent compilation of this literature was made by Hugh J. Barron of New York, in a paper presented to the American Society of Heating and Ventilating Engineers at its first meeting in January, 1895, from which the following list of books has been copied:

A Treatise on the Economy of Fuel and Management of Heat. Robertson Buchanan, C.E. Glasgow, 1815.

Conducting of Air by Forced Ventilation. Marquis de Chabannes. London, 1818.

The Principles of Warming and Ventilating Public Buildings, Dwelling-houses, etc. Thos. Tredgold, C.E. London, 1824.

Warming, Ventilation, and Sound. W. S. Inman. London, 1836.

The Principles of Warming and Ventilating, by Thos. Tredgold, with an appendix. T. Bramah, C.E. London, 1836.

Heating by the Perkins System. C. J. Richardson. London, 1840.

Illustrations of the Theory and Practice of Ventilation, with Remarks on Warming. David Boswell Reid, M.D. London, 1844.

A Practical Treatise on Warming by Hot Water. Chas. Hood, F.R.S. London, 1844.

History and Art of Warming and Ventilating. Walter Bernan, C.E. London, 1845.

Warming and Ventilation. Chas. Tomlinson. London, 1844.

Walker's Hints on Ventilation. London, 1845.

Practical Treatise on Ventilation. Morrill Wyman. Boston, 1846.

Traité de la Chaleur. E. Pécelet. Paris. First edition, 1848; second edition, 3 vols, 1859.

Practical Method of Ventilating Buildings, with an appendix on Heating by Steam and Water. Dr. Luther V. Bell. Boston, 1848.

Warming and Ventilation. Chas. Tomlinson. London, 1850.

Practical Ventilation. Robert Scott Burns. Edinburgh, 1850.

Ventilation and Warming. Henry Ruttan. New York, 1862.

A Treatise on Ventilation. Robert Richey. London, 1862.

American edition of Dr. Reid's Ventilation as Applied to American Houses, edited by Dr. Harris. New York, 1864.

A Treatise on Ventilation. Lewis W. Leeds. Philadelphia, 1868; New York, 1871.

Observations on the Construction of Healthy Dwellings. Capt. Douglas Galton. Oxford, 1875.

Practical Ventilating and Warming. Jos. Constantine. London, 1875.

Warming and Ventilation. Chas. Tomlinson. London, 1876. Sixth edition.

Mechanics of Ventilating. Geo. W. Rafter, C.E. New York, 1878.

Ventilation. H. A. Gouge. New York, 1881.

Ventilation. R. S. Burns. Edinburgh, 1882.

American Practice in Warming Buildings by Steam. Robert Briggs. Edited by A. R. Wolf, with additions. New York, 1882.

Steam-heating for Buildings. W. J. Baldwin. New York, 1883.

Thirteenth edition published in 1893.

The Principles of Ventilation and Heating. John S. Billings, M.D. New York, 1884.

Heating by Hot Water. Walter Jones. London, 1884.

A Manual of Heating and Ventilation. F. Schuman. New York, 1886.

Ventilation. W. Butler. Edited by Greenleaf. New York, 1888.

Steam-heating Problems from the Sanitary Engineer. New York, 1888.

Metal Worker Essays on House Heating. New York, 1890.

Heat—Its Application to the Warming and Ventilation of Buildings. John H. Mills. Boston, 1890.

Ventilation and Heating. T. Edwards. London, 1890.

Ventilation—A Text-book to the Art of Ventilating Buildings. Wm. Paton Buchan. London, 1891.

The Ventilating and Warming of School Buildings. Gilbert B. Morrison. New York, 1892.

Hot-water Heating. Wm. J. Baldwin. New York, 1893.

Ventilation and Heating. John S. Billings, M.D. New York, 1893.

Warming by Hot Water, Chas. Hood, C.E. Edited by F. Dye. London, 1894.

Heating and Ventilating. R. C. Carpenter. New York, 1895. First edition.

- Furnace Heating. Wm. G. Snow. New York, 1902.
 Schoolhouse Heating and Ventilating. Joseph A. Moon. Boston, 1905.
 Ventilation and Heating of Dwellings. J. W. Thomas. London, 1906.
 Heating and Ventilating Notes. John R. Allen. Chicago, 1911.
 Third edition.
 Principles of Heating. Wm. G. Snow. New York, 1912.
 Mechanics of Heating and Ventilation. Konrad Meier. New York, 1912.
 Handbook of Heating and Ventilation. J. D. Hoffman. New York, 1912. Second edition.
 Heating and Ventilating. R. C. Carpenter. New York, 1915. Sixth edition.

CURRENT LITERATURE OF THE DAY

The current literature relating to this subject is extensive, and consists mainly of magazines and papers published weekly or monthly. In these journals are to be found from time to time descriptions of new apparatus and complete drawings of plants recently constructed which will prove invaluable in the study of this art.

The American Society of Heating and Ventilating Engineers, formed soon after the publication of the first edition of this book, has contributed greatly to advance the scientific and practical knowledge of the art of heating and ventilating. Much information for the sixth edition of the work has been obtained from the Transactions of the Society, which are the most valuable books of reference yet published for heating and ventilating engineers.

EXPLANATION OF TABLES

Of the tables which have been given a few only need special explanation in order to fully understand their use. These are as follows: Table No. VII, Logarithms of Numbers. This table will be found of very great convenience in facilitating any operation involving multiplication and division. Thus it will be found in every case that the sum of two logarithms is the logarithm of a number equal to the product of the two numbers whose sum was taken, and the difference of two logarithms

is the logarithm of the quotient obtained by dividing one by the other. Every logarithm consists of two parts: a decimal part, which is given in the table, and an index or characteristic, which must be prefixed. The index or characteristic is a whole number and is one less than the number of integral places; for a decimal number it is negative and one more than the number of ciphers between the decimal point and the first significant figure. Thus, to find the logarithm of 254, a number containing 3 integral places, the index is 2, the decimal part of this logarithm found opposite 25 and under 4 in the table is 4048, making the full logarithm 2.4048. If the number had been 25.4 the index would have been 1, the decimal part as before. If the number had been 0.0254, the index would have been minus 2, the decimal part the same as before.

As an illustration showing how to multiply by logarithms, multiply 254 by 2.48. We have:

$$\begin{array}{r}
 \text{The logarithm of } 254 = 2.4048 \\
 \text{“ “ “ } 2.48 = 0.3945 \\
 \hline
 \text{Log. of product} = 2.7993
 \end{array}$$

The sum of these two logarithms, which is the logarithm of the product, is equal to 2.7993. The index, or number 2, is of use in showing that there are three figures or integral places in the result. To find the logarithm, look in the table for the number next smaller than 7993; in this case the result is exact and is found opposite 63 in the column marked zero, indicating that the product is 630; the actual product of these numbers is slightly less than this, the difference, however, being scarcely ever of any practical importance. Had our number been 7994, it would have been one greater than 7993 and 6 less than the logarithm of the next number. In that case our number would have been $630\frac{1}{7}$, which, reduced to a decimal, would have been the number to consider as the product. The logarithm of a power can be found by multiplying the logarithm by the number which represents the power and the logarithm of a root by dividing by the index of the root.

Thus, to raise 368 to the fifth power, we have:

$$\begin{aligned} \text{Log. } 368 &= 2.5658 \\ \text{Multiply by } &\quad \underline{\quad 5} \\ \text{Log. 5th power} &= 12.8290 \\ \text{No.} = 674\frac{1}{2} \text{ expanded to } 13 \text{ places} &= 674500000000. \\ \text{To extract the 5th root of } 368: - & \\ \text{Log. } 368 &= 2.5658 \\ \text{Divide by } 5 &= 0.51316 = \text{log. of root} \\ \text{Root} &= 3.259 \end{aligned}$$

In general the table will be found to afford an easy method of dividing or multiplying, and it will be well worth while to become master of its use.

The table which is printed in the book is correct for 4 places of figures only, but tables of 7 and even 13 places have been printed.

The four-place table can be used with confidence for all operations, not requiring extreme accuracy. It will in almost every case be found sufficiently accurate for all practical problems of designing.

The method of using Table No. XII to determine the amount of moisture in the air has been quite fully explained in Chapter II. The method of using Table No. XIII (properties of saturated steam) has been fully explained in Chapter VIII. The reader should note that the steam-pressure tabulated is that above a vacuum, and not the reading of a pressure-gauge. The pressure-gauge reads from the atmosphere, which is generally 14.7 pounds above zero; hence, in order to use the table add 14.7 pounds to the steam-gauge reading for the pressure above zero. The other quantities will be quite readily understood.

The table for equalization of pipe areas has been quite fully explained in Chapter XV. The number of pipes of the size, as shown in the side column, required to give an equivalent area to the one in the top column is given by the numbers. Thus 14.7 pipes 1 inch in diameter have a carrying capacity equivalent to that of one pipe 3 inches in diameter.

TABLE I.—UNITED STATES STANDARD WEIGHTS AND MEASURES.
By T. C. MENDENHALL, Superintendent, U. S. Coast Survey.

LINEAR.			SQUARE.				CUBIC.				
Inches to Millimetres.	Feet to Metres.	Yards to Metres.	Miles to Kilometres.	Sq. Ins. to Sq. Centimetres.	Sq. Ft. to Sq. Decimetres.	Sq. Yds. to Sq. Square Metres.	Acres to Hectares.	Cu. Ins. to Cubic Centimetres.	Cu. Ft. to Cubic Metres.	Cu. Yds. to Cubic Metres.	Bushels to Hectolitres.
1 = 25.4000	0.304801	0.914402	1.609335	6.452	9.290	0.836	0.4047	16.387	0.02832	0.765	0.35242
2 = 50.8001	0.609601	1.828804	3.218669	12.903	18.581	1.672	0.8094	32.774	0.05663	1.529	0.70484
3 = 76.2001	0.914402	2.743205	4.82804	19.355	27.871	2.508	1.2141	49.161	0.08495	2.294	1.05727
4 = 101.6002	1.219202	3.657607	6.43739	25.807	37.101	3.344	1.6187	65.549	0.11327	3.058	1.40909
5 = 127.0002	1.524003	4.572009	8.4074	32.258	46.452	4.181	2.0234	81.936	0.14158	3.823	1.76211
6 = 152.4003	1.828804	5.486411	9.65608	38.710	55.742	5.017	2.4281	98.323	0.16990	4.587	2.11434
7 = 177.8003	2.133604	6.400813	11.26543	45.161	65.032	5.853	2.8328	114.710	0.19822	5.352	2.46969
8 = 203.2004	2.438405	7.315215	12.87478	51.613	74.323	6.689	3.2375	131.097	0.22654	6.116	2.81938
9 = 228.6004	2.743205	8.229616	14.48412	58.065	83.013	7.525	3.6422	147.484	0.25485	6.881	3.17181

CAPACITY.			WEIGHT.		
Fluid Drams to Millilitres or Cu. Centimetres.	Fluid Ounces to Millilitres.	Gallons to Litres.	Grains to Milligrammes.	Avoirdupois Ounces to Grammes.	Troy Ounces to Grammes.
1 = 3.70	29.57	0.94636	64.7989	28.3495	31.10348
2 = 7.39	59.15	1.89272	129.5978	56.6991	62.20696
3 = 11.09	88.72	2.83908	194.3968	85.0486	93.31044
4 = 14.79	118.30	3.78544	259.1957	113.3981	124.41392
5 = 18.48	147.87	4.73180	323.9946	141.7476	155.51740
6 = 22.18	177.44	5.67816	388.7935	170.0972	186.62089
7 = 25.88	207.02	6.62452	453.5924	198.4467	217.72437
8 = 29.57	236.59	7.57088	518.3914	226.7962	248.82785
9 = 33.28	266.16	8.51724	583.1903	255.1457	279.93133

1 = 16.387	0.02832	0.765	0.35242
2 = 32.774	0.05663	1.529	0.70484
3 = 49.161	0.08495	2.294	1.05727
4 = 65.549	0.11327	3.058	1.40909
5 = 81.936	0.14158	3.823	1.76211
6 = 98.323	0.16990	4.587	2.11434
7 = 114.710	0.19822	5.352	2.46969
8 = 131.097	0.22654	6.116	2.81938
9 = 147.484	0.25485	6.881	3.17181

1 = 16.387	0.02832	0.765	0.35242
2 = 32.774	0.05663	1.529	0.70484
3 = 49.161	0.08495	2.294	1.05727
4 = 65.549	0.11327	3.058	1.40909
5 = 81.936	0.14158	3.823	1.76211
6 = 98.323	0.16990	4.587	2.11434
7 = 114.710	0.19822	5.352	2.46969
8 = 131.097	0.22654	6.116	2.81938
9 = 147.484	0.25485	6.881	3.17181

The only authorized material standard of customary length is the Troughton scale belonging to the Coast Survey office, whose length at 59.62° Fahr. conforms to the British standard. The yard in use in the United States is therefore equal to the British yard.

The only authorized material standard of customary weight is the Troy pound of the Mint. It is of brass of unknown density, and therefore not suitable for a standard of mass. It was derived from the British standard Troy pound of 1758 by direct comparison. The British Avoirdupois pound was also derived from the latter, and contains 7000 grains Troy.

The grain Troy is therefore the same as the grain Avoirdupois, and the pound Avoirdupois in use in the United States is equal to the British pound Avoirdupois. The British gallon = 4.54346 litres. The British bushel = 36.3477 litres.

TABLE I.—Continued.

LINEAR.			SQUARE.				CUBIC.			
Metres to Inches.	Metres to Feet.	Kilometres to Miles.	Sq. Centi-metres to Sq. Inches.	Square Metres to Square Feet.	Square Metres to Square Yards.	Hectares to Acres.	Cu. Centi-metres to Cubic Inches.	Cubic Decim. to Cu. Ins.	Cubic Metres to Cubic Feet.	Cubic Metres to Cubic Yards.
1 =	39.3700	3.28083	1.003611	0.62137	1.196	2.471	1 =	0.0610	35.314	1.308
2 =	78.7400	6.56167	2.187222	1.24274	2.392	4.942	2 =	0.1220	70.629	2.616
3 =	118.1100	9.84250	3.280833	1.86411	3.588	7.413	3 =	0.1831	105.943	3.924
4 =	157.4800	13.12333	4.374444	2.48548	4.784	9.884	4 =	0.2441	141.258	5.232
5 =	196.8500	16.40417	5.468056	3.10685	6.065	12.355	5 =	0.3051	176.572	6.540
6 =	236.2200	19.68500	6.561667	3.72822	7.346	14.826	6 =	0.3661	211.887	7.848
7 =	275.5900	22.96583	7.655278	4.34959	8.627	17.297	7 =	0.4272	247.201	9.156
8 =	314.9600	26.24667	8.748889	4.97099	9.908	19.768	8 =	0.4882	282.516	10.464
9 =	354.3300	29.52750	9.842500	5.59233	11.194	22.239	9 =	0.5492	317.830	11.771

WEIGHT.

CAPACITY.			WEIGHT.								
Millilitres or Cu. Centi-litres to Fl. Drams.	Centilitres to Fluid Ounces.	Litres to Quarts.	Deca-litres to Gallons.	Hekto-litres to Bushels.	Milli-grams to Grains.	Kilo-grams to Grains.	Hecto-grams (100 grams) to Ounces Av.	Kilo-grams to Pounds Av.	Quintals to Pounds Av.	Milliers or Tonnes to Pounds Av.	Grams to Ounces Troy.
1 =	0.27	0.338	1.0597	2.6417	2.8375	15432.36	3.5274	2.20462	220.46	2204.6	0.03215
2 =	0.54	0.676	2.1134	5.2834	5.6750	30864.71	7.0548	4.40924	440.92	4409.2	0.06430
3 =	0.81	1.014	3.1700	7.9251	8.5125	46297.07	10.5822	6.61386	661.38	6613.8	0.09645
4 =	1.08	1.352	4.2267	10.5668	11.3500	61729.43	14.1096	8.81849	881.84	8818.4	0.12860
5 =	1.35	1.691	5.2834	13.2085	14.1875	77161.78	17.6370	11.02311	1102.30	11023.0	0.16075
6 =	1.62	2.029	6.3401	15.8502	17.0250	92594.14	21.1644	13.22773	1322.77	13227.7	0.19290
7 =	1.89	2.368	7.3968	18.4919	19.8625	108026.40	24.6918	15.43235	1543.22	15432.2	0.22503
8 =	2.16	2.706	8.4534	21.1336	22.7000	123458.85	28.2192	17.63697	1763.68	17636.8	0.25721
9 =	2.43	3.043	9.5101	23.7733	25.5375	138891.21	31.7466	19.84159	1984.14	19841.4	0.28936

By the concurrent action of the principal governments of the world, an International Bureau of Weights and Measures has been established near Paris. Under the direction of the International Committee, two ingots were cast of pure platinum-iridium in the proportion of 9 parts of the former to 1 of the latter metal. From one of these a certain number of kilogrammes were prepared, from the other a definite number of metre bars. These standards of weight and length were intercompared, without preference, and certain ones were selected as International prototype standards. The others were distributed by lot to the different governments, and are called national prototype standards. Those apportioned to the United States are in the keeping of this office.

The metric system was legalized in the United States in 1866. The International Standard Metre is derived from the Metre des Archives, and its length is defined by the distance between two lines at 0° Centigrade, on a platinum-iridium bar deposited at the International Bureau of Weights and Measures. The International Standard Kilogram is a mass of platinum-iridium deposited at the same place, and its weight in vacuo is the same as that of the Kilogram des Archives. The litre is equal to a cubic decimetre of water, and it is measured by the quantity of distilled water which, at its maximum density, will counterpoise the standard kilogram in a vacuum, the volume of such a quantity of water being, as nearly as has been ascertained, equal to a cubic decimetre.

TABLE NO. II.

EQUIVALENT VALUE OF UNITS IN BRITISH AND METRIC SYSTEMS.

One foot = 12 inches = 30.48 centimetres = 0.3048 metre.

One metre = 100 centimetres = 3.2808 ft. = 1.094 yd.

One mile = 5280 ft. = 1760 yd. = 1609.3 metres.

One foot = 144 sq. in. = $1/9$ sq. yd. = 929 sq. centimetres = .0929 sq. metre.

One sq. metre = 10000 sq. centimetres = 1.1960 sq. yds. = 10.764 sq. ft.

One cubic foot = 1728 sq. in. = 2832 cu. centimetres = 0.02832 cu. metres.

One cubic metre = 35.314 cu. ft. = 1.3079 cu. yds.

One pound adv. = 7000 grains = 16 oz. = 453.59 grains = 0.45359 kilograms.

One kilogram = 1000 grams = 2.2046 lbs. = 15432 grains = 35.27 oz. adv.

COMPOUND UNITS.

One foot-pound = 0.13826 kg.-mt. = 1,3826 gr.-c. = $1/778$ B.T.U.

One horse-power = 33000 ft.-pound per minute = 746 Watts.

One kilogram -metre = 7.233 ft.-lb = 100,000 gr.-c. = $1/426$ calorie.

One gram-centimetre = $1/100000$ kg.-mt. = .00007233 ft.-lb.

One calorie = 426.10 kg.-mt. = 3.9672 B.T.U. = 42000 million ergs per second = 42 Watts.

One B. T. U. = 778 ft.-lbs. = 0.2521 cal. = 10820 mil. ergs. = 107.37 kg.-m.

One calorie per sq. metre = 0.3686 B.T.U. per sq. ft.

C. G. S. SYSTEM.

One dyne = one gram / 981 = 0.00215 lb.

One erg. = 1 dyne \times 1 cent. = 0.0000707 ft.-lb.

One Watt = 10 mil. ergs. per sec. = 0738 ft.-lbs. per sec. = h. p. / 746.

One h. p. = 756 Watts.

TABLE III.—REDUCTION TABLE.

HEIGHT OF WATER-COLUMN IN INCHES TO CORRESPOND TO VARIOUS PRESSURES IN OUNCES PER SQUARE INCH. TEMPERATURE 50° FAHR.

Pressure in Oz. per Sq. In.	Decimal Parts of an Ounce.									
	.0	.1	.2	.3	.4	.5	.6	.7	.8	.9
0	0.17	0.35	0.52	0.69	0.87	1.04	1.21	1.38	1.56
1	1.73	1.90	2.08	2.25	2.42	2.60	2.77	2.94	3.11	3.29
2	3.46	3.63	3.81	3.98	4.15	4.33	4.50	4.67	4.84	5.01
3	5.19	5.36	5.54	5.71	5.88	6.06	6.23	6.40	6.57	6.75
4	6.92	7.09	7.27	7.44	7.61	7.79	7.96	8.13	8.30	8.48
5	8.65	8.82	9.00	9.17	9.34	9.52	9.69	9.86	10.03	10.21
6	10.38	10.55	10.73	10.90	11.07	11.26	11.43	11.60	11.77	11.95
7	12.11	12.28	12.46	12.63	12.80	12.97	13.15	13.32	13.49	13.67
8	13.84	14.01	14.19	14.36	14.53	14.71	14.88	15.05	15.22	15.40
9	15.57	15.74	15.92	16.09	16.26	16.45	16.62	16.79	16.96	17.14

PRESSURES IN OUNCES PER SQUARE INCH CORRESPONDING TO VARIOUS HEADS OF WATER IN INCHES.

Head in Inches.	Decimal Parts of an Inch.									
	.0	.1	.2	.3	.4	.5	.6	.7	.8	.9
0	0.06	0.12	0.17	0.23	0.29	0.35	0.40	0.46	0.52
1	0.58	0.63	0.69	0.75	0.81	0.87	0.93	0.98	1.04	1.09
2	1.16	1.21	1.27	1.33	1.39	1.44	1.50	1.56	1.62	1.67
3	1.73	1.79	1.85	1.91	1.96	2.02	2.08	2.14	2.19	2.25
4	2.31	2.37	2.42	2.48	2.54	2.60	2.66	2.72	2.77	2.83
5	2.89	2.94	3.00	3.06	3.12	3.18	3.24	3.29	3.35	3.41
6	3.47	3.52	3.58	3.64	3.70	3.75	3.81	3.87	3.92	3.98
7	4.04	4.10	4.16	4.22	4.28	4.33	4.39	4.45	4.50	4.56
8	4.62	4.67	4.73	4.79	4.85	4.91	4.97	5.03	5.08	5.14
9	5.20	5.26	5.31	5.37	5.42	5.48	5.54	5.60	5.66	5.72

TABLE IV.—TABLE OF PROPERTIES OF GASES.

Element or Compound.	Symbol by Volume.	Atomic Weights.	Cubic Feet per Lb. at 62°.	Weight per Cu. Ft. at 62°, Lbs.	Specific Gravity at 62°. Water = 1.	Relative Density.
Oxygen.....	O	16	11.88	0.0814	0.001350	1.10563
Nitrogen.....	N	14	13.54	0.0738	0.001185	0.97137
Hydrogen.....	H	1	189.7	0.00527	0.0000846	0.06926
Argon.....		19	0.001607	1.3118
Carbon.....	C	12	15.84	0.63131	0.001013	0.82323
Phosphorus.....	P	31	6.119	0.16337	0.0026221	2.1877
Sulphur.....	S	32	5.932	0.16861	0.002705	2.2150
Silicon.....	Si	14	13.55	0.07378	0.001184	1.01032
Air.....	79N+21O	13.14*	0.0761	0.001221	1.0000
Water-vapor.....	H ₂ O	18	21.07	0.04745	0.0007613	0.6253
Ammonia.....	NH ₃	17	22.3	0.0448	0.00118	0.5892
Carbon monoxide.....	CO	28	13.6	0.07364	0.002369	0.9674
(Carbonic oxide)						
Carbon dioxide.....	CO ₂	44	8.64	0.11631	0.00187	1.52901
(Carbonic acid)						
Olefiant gas.....	CH ₂	14	13.587	0.0736	0.001181	0.967104
Marsh gas.....	CH ₄	16	23.757	0.04209	0.000675	0.55306
Sulphurous acid.....	SO ₂	64	6.463	0.15536	0.002493	1.54143
Sulphuretted hydrogen	SH ₂	34	5.582	0.17918	0.002877	2.3943
Bisulphuret of carbon.	S ₂ C	76	2.487	0.40052	0.00643	5.3007
Ozone.....	O ₃	24	7.97	0.12648	0.00203	1.64656

* By this table there would be 12.75 cubic feet of air at 32° per pound.

TABLE V.—TABLE OF CIRCLES, SQUARES, AND CUBES.

n Diam.	$n\pi$ Circumf.	$\frac{n^2\pi}{4}$ Area.	n^2 Square.	n^3 Cube.	\sqrt{n} Sq. Root.	$\sqrt[3]{n}$ Cub. Rt.
1.0	3.142	0.7854	1.000	1.000	1.0000	1.0000
1.1	3.456	0.9503	1.210	1.331	1.0488	1.0323
1.2	3.770	1.1310	1.440	1.728	1.0955	1.0627
1.3	4.084	1.3273	1.690	2.197	1.1402	1.0914
1.4	4.398	1.5394	1.960	2.744	1.1832	1.1187
1.5	4.712	1.7672	2.250	3.375	1.2247	1.1447
1.6	5.027	2.0106	2.560	4.096	1.2649	1.1696
1.7	5.341	2.2698	2.890	4.913	1.3038	1.1935
1.8	5.655	2.5447	3.240	5.832	1.3416	1.2164
1.9	5.969	2.8353	3.610	6.859	1.3784	1.2386
2.0	6.283	3.1416	4.000	8.000	1.4142	1.2599
2.1	6.597	3.4636	4.410	9.261	1.4491	1.2806
2.2	6.912	3.8013	4.840	10.648	1.4832	1.3006
2.3	7.226	4.1548	5.290	12.167	1.5166	1.3200
2.4	7.540	4.5239	5.760	13.824	1.5492	1.3389
2.5	7.854	4.9087	6.250	15.625	1.5811	1.3572
2.6	8.168	5.3093	6.760	17.576	1.6125	1.3751
2.7	8.482	5.7256	7.290	19.683	1.6432	1.3925
2.8	8.797	6.1575	7.840	21.952	1.6733	1.4095
2.9	9.111	6.6052	8.410	24.389	1.7029	1.4260
3.0	9.425	7.0686	9.00	27.000	1.7321	1.4422
3.1	9.739	7.5477	9.61	29.791	1.7607	1.4581
3.2	10.053	8.0425	10.24	32.768	1.7889	1.4736
3.3	10.367	8.5530	10.89	35.937	1.8166	1.4888
3.4	10.681	9.0792	11.56	39.304	1.8439	1.5037
3.5	10.996	9.6211	12.25	42.875	1.8708	1.5183
3.6	11.310	10.179	12.96	46.656	1.8974	1.5326
3.7	11.624	10.752	13.69	50.653	1.9235	1.5467
3.8	11.938	11.341	14.44	54.872	1.9494	1.5605
3.9	12.252	11.946	15.21	59.319	1.9748	1.5741
4.0	12.566	12.566	16.00	64.000	2.0000	1.5874
4.1	12.881	13.203	16.81	68.921	2.0249	1.6005
4.2	13.195	13.854	17.64	74.088	2.0494	1.6134
4.3	13.509	14.522	18.49	79.507	2.0736	1.6261
4.4	13.823	15.205	19.36	85.184	2.0976	1.6386
4.5	14.137	15.904	20.25	91.125	2.1213	1.6510
4.6	14.451	16.619	21.16	97.336	2.1448	1.6631
4.7	14.765	17.349	22.09	103.823	2.1680	1.6751
4.8	15.080	18.096	23.04	110.592	2.1909	1.6869
4.9	15.394	18.857	24.01	117.649	2.2136	1.6985

TABLE V.—Continued.

n Diam.	$n\pi$ Circumf.	$n^2 \frac{\pi}{4}$ Area.	n^2 Square.	n^3 Cube.	\sqrt{n} Sq. Root.	$\sqrt[3]{n}$ Cub. Rt.
5.0	15.708	19.635	25.00	125.000	2.2361	1.7100
5.1	16.022	20.428	26.01	132.651	2.2583	1.7213
5.2	16.336	21.237	27.04	140.608	2.2804	1.7325
5.3	16.650	22.062	28.09	148.877	2.3022	1.7435
5.4	16.965	22.902	29.16	157.464	2.3238	1.7544
5.5	17.279	23.758	30.25	166.375	2.3452	1.7652
5.6	17.593	24.630	31.36	175.616	2.3664	1.7758
5.7	17.907	25.518	32.49	185.193	2.3875	1.7863
5.8	18.221	26.421	33.64	195.112	2.4083	1.7967
5.9	18.535	27.340	34.81	205.379	2.4290	1.8070
6.0	18.850	28.274	36.00	216.000	2.4495	1.8171
6.1	19.164	29.225	37.21	226.981	2.4698	1.8272
6.2	19.478	30.191	38.44	238.328	2.4900	1.8371
6.3	19.792	31.173	39.69	250.047	2.5100	1.8469
6.4	20.106	32.170	40.96	262.144	2.5298	1.8566
6.5	20.420	33.183	42.25	274.625	2.5495	1.8663
6.6	20.735	34.212	43.56	287.496	2.5691	1.8758
6.7	21.049	35.257	44.89	300.763	2.5884	1.8852
6.8	21.363	36.317	46.24	314.432	2.6077	1.8945
6.9	21.677	37.393	47.61	328.509	2.6268	1.9038
7.0	21.991	38.485	49.00	343.000	2.6458	1.9129
7.1	22.305	39.592	50.41	357.911	2.6646	1.9220
7.2	22.619	40.715	51.84	373.248	2.6833	1.9310
7.3	22.934	41.854	53.29	389.017	2.7019	1.9399
7.4	23.248	43.008	54.76	405.224	2.7203	1.9487
7.5	23.562	44.179	56.25	421.875	2.7386	1.9574
7.6	23.876	45.365	57.76	438.976	2.7568	1.9661
7.7	24.190	46.566	59.29	456.533	2.7749	1.9747
7.8	24.504	47.784	60.84	474.552	2.7929	1.9832
7.9	24.819	49.017	62.41	493.039	2.8107	1.9916
8.0	25.133	50.266	64.00	512.000	2.8284	2.0000
8.1	25.447	51.530	65.61	531.441	2.8461	2.0083
8.2	25.761	52.810	67.24	551.468	2.8636	2.0165
8.3	26.075	54.106	68.89	571.787	2.8810	2.0247
8.4	26.389	55.418	70.56	592.704	2.8983	3.0328
8.5	26.704	56.745	72.25	614.125	2.9155	2.0408
8.6	27.018	58.088	73.96	636.056	2.9326	2.0488
8.7	27.332	59.447	75.69	658.503	2.9496	2.0567
8.8	27.646	60.821	77.44	681.473	2.9665	2.0646
8.9	27.960	62.211	79.21	704.969	2.9833	2.0724
9.0	28.274	63.617	81.00	729.000	3.0000	2.0801
9.1	28.588	65.039	82.81	753.571	3.0166	2.0878
9.2	28.903	66.476	84.64	778.688	3.0332	2.0954
9.3	29.217	67.929	86.49	804.357	3.0496	2.1029
9.4	29.531	69.398	88.36	830.584	3.0659	2.1105

TABLE V.—Continued.

n Diam.	$n\pi$ Circumf.	$\frac{n^2\pi}{4}$ Area.	n^2 Square.	n^3 Cube.	\sqrt{n} Sq. Root.	$\sqrt[3]{n}$ Cub. Rt.
9.5	29.845	70.882	90.25	857.375	3.0822	2.1179
9.6	30.159	72.382	92.16	884.736	3.0984	2.1253
9.7	30.473	73.898	94.09	912.673	3.1145	2.1327
9.8	30.788	75.430	96.04	941.192	3.1305	2.1400
9.9	31.102	76.977	98.01	970.299	3.1464	2.1472
10.0	31.416	78.540	100.00	1000.000	3.1623	2.1544
10.1	31.730	80.119	102.01	1030.301	3.1780	2.1616
10.2	32.044	81.713	104.04	1061.208	3.1937	2.1687
10.3	32.358	83.323	106.09	1092.727	3.2094	2.1757
10.4	32.673	84.949	108.16	1124.863	3.2249	2.1828
10.5	32.987	86.590	110.25	1157.625	3.2404	2.1897
10.6	33.301	88.247	112.36	1191.016	3.2558	2.1967
10.7	33.615	89.920	114.49	1225.043	3.2711	2.2036
10.8	33.929	91.609	116.64	1259.712	3.2863	2.2104
10.9	34.243	93.313	118.81	1295.029	3.3015	2.2172
11.0	34.558	95.033	121.00	1331.000	3.3166	2.2239
11.1	34.872	96.769	123.21	1367.631	3.3317	2.2307
11.2	35.186	98.520	125.44	1404.928	3.3466	2.2374
11.3	35.500	100.29	127.69	1442.897	3.3615	2.2441
11.4	35.814	102.07	129.96	1481.544	3.3764	2.2506
11.5	36.128	103.87	132.25	1520.875	3.3912	2.2572
11.6	36.442	105.68	134.56	1560.896	3.4059	2.2637
11.7	36.757	107.51	136.89	1601.613	3.4205	2.2702
11.8	37.071	109.36	139.24	1643.032	3.4351	2.2766
11.9	37.385	111.22	141.61	1685.159	3.4496	2.2831
12.0	37.699	113.10	144.00	1728.000	3.4641	2.2894
12.1	38.013	114.99	146.41	1771.561	3.4785	2.2957
12.2	38.327	116.90	148.84	1815.848	3.4928	2.3021
12.3	38.642	118.82	151.29	1860.867	3.5071	2.3084
12.4	38.956	120.76	153.76	1906.624	3.5214	2.3146
12.5	39.270	122.72	156.25	1953.125	3.5355	2.3208
12.6	39.584	124.60	158.76	2000.376	3.5496	2.3270
12.7	39.898	126.68	161.29	2048.383	3.5637	2.3331
12.8	40.212	128.68	163.84	2097.152	3.5777	2.3392
12.9	40.527	130.70	166.41	2146.689	3.5917	2.3453
13.0	40.841	132.73	169.00	2197.000	3.6056	2.3513
13.1	41.155	134.78	171.61	2248.091	3.6194	2.3573
13.2	41.469	136.85	174.24	2299.968	3.6332	2.3633
13.3	41.783	138.93	176.89	2352.637	3.6469	2.3693
13.4	42.097	141.03	179.56	2406.104	3.6606	2.3752
13.5	42.412	143.14	182.25	2460.375	3.6742	2.3811
13.6	42.726	145.27	184.96	2515.456	3.6878	2.3870
13.7	43.040	147.41	187.69	2571.353	3.7013	2.3928
13.8	43.354	149.57	190.44	2628.072	3.7148	2.3986
13.9	43.668	151.75	193.21	2685.619	3.7283	2.4044

TABLE V.—Continued.

n	$n\pi$	$\frac{n^2\pi}{4}$	n^2	n^3	\sqrt{n}	$\sqrt[3]{n}$
Diam.	Circumf.	Area.	Square.	Cube.	Sq. Root.	Cub. Rt.
14.0	43.982	153.94	196.00	2744.000	3.7417	2.4101
14.1	44.296	156.15	198.81	2803.221	3.7550	2.4159
14.2	44.611	158.37	201.64	2863.288	3.7683	2.4216
14.3	44.925	160.61	204.49	2924.207	3.7815	2.4272
14.4	45.239	162.86	207.36	2985.984	3.7947	2.4329
14.5	45.553	165.13	210.25	3048.625	3.8079	2.4385
14.6	45.867	167.42	213.16	3112.136	3.8210	2.4441
14.7	46.181	169.72	216.09	3176.523	3.8341	2.4497
14.8	46.496	172.03	219.04	3241.792	3.8471	2.4552
14.9	46.810	174.37	222.01	3307.949	3.8600	2.4607
15.0	47.124	176.72	225.00	3375.000	3.8730	2.4662
15.1	47.438	179.08	228.01	3442.951	3.8859	2.4717
15.2	47.752	181.46	231.04	3511.808	3.8987	2.4772
15.3	48.066	183.85	234.09	3581.577	3.9115	2.4825
15.4	48.381	186.27	237.16	3652.204	3.9243	2.4879
15.5	48.695	188.69	240.25	3723.875	3.9370	2.4933
15.6	49.009	191.13	243.36	3796.416	3.9497	2.4986
15.7	49.323	193.59	246.49	3869.893	3.9623	2.5039
15.8	49.637	196.07	249.64	3944.312	3.9749	2.5092
15.9	49.951	198.56	252.81	4019.679	3.9875	2.5146
16.0	50.265	201.06	256.00	4096.000	4.0000	2.5198
16.1	50.580	203.58	259.21	4173.281	4.0125	2.5251
16.2	50.894	206.12	262.44	4251.528	4.0249	2.5303
16.3	51.208	208.67	265.69	4330.747	4.0373	2.5355
16.4	51.522	211.24	268.96	4410.944	4.0497	2.5406
16.5	51.836	213.83	272.25	4492.125	4.0620	2.5458
16.6	52.150	216.42	275.56	4574.296	4.0743	2.5509
16.7	52.465	219.04	278.89	4657.463	4.0866	2.5561
16.8	52.779	221.67	282.24	4741.632	4.0988	2.5612
16.9	53.093	224.32	285.61	4826.809	4.1110	2.5663
17.0	53.407	226.98	289.00	4913.000	4.1231	2.5713
17.1	53.721	229.66	292.41	5000.211	4.1352	2.5763
17.2	54.035	232.35	295.84	5088.448	4.1473	2.5813
17.3	54.350	235.06	299.29	5177.717	4.1593	2.5863
17.4	54.664	237.79	302.76	5268.024	4.1713	2.5913
17.5	54.978	240.53	306.25	5359.375	4.1833	2.5963
17.6	55.292	243.29	309.76	5451.776	4.1952	2.6012
17.7	55.606	246.06	313.29	5545.233	4.2071	2.6061
17.8	55.920	248.85	316.84	5639.752	4.2190	2.6109
17.9	56.235	251.65	320.41	5735.339	4.2308	2.6158
18.0	56.549	254.47	324.00	5832.000	4.2426	2.6207
18.1	56.863	257.30	327.61	5929.741	4.2544	2.6256
18.2	57.177	260.16	331.24	6028.568	4.2661	2.6304
18.3	57.491	263.02	334.89	6128.487	4.2778	2.6352
18.4	57.805	265.90	338.56	6229.504	4.2895	2.6401

TABLE V.—Continued.

n Diam.	$n\pi$ Circumf.	$n^2 \frac{\pi}{4}$ Area.	n^2 Square.	n^3 Cube.	\sqrt{n} Sq. Root.	$\sqrt[3]{n}$ Cub. Rt.
18.5	58.119	268.80	342.25	6331.625	4.3012	2.6448
18.6	58.434	271.72	345.96	6434.856	4.3128	2.6495
18.7	58.748	274.65	349.69	6539.203	4.3243	2.6543
18.8	59.062	277.59	353.44	6644.672	4.3359	2.6590
18.9	59.376	280.55	357.21	6751.269	4.3474	2.6637
19.0	59.690	283.53	361.00	6859.000	4.3589	2.6684
19.1	60.004	286.52	364.81	6967.871	4.3703	2.6731
19.2	60.319	289.53	368.64	7077.888	4.3818	2.6777
19.3	60.633	292.55	372.49	7189.057	4.3932	2.6824
19.4	60.947	295.59	376.36	7301.384	4.4045	2.6869
19.5	61.261	298.65	380.25	7414.875	4.4159	2.6916
19.6	61.575	301.72	384.16	7529.536	4.4272	2.6962
19.7	61.889	304.81	388.09	7645.373	4.4385	2.7008
19.8	62.204	307.91	392.04	7762.392	4.4497	2.7053
19.9	62.518	311.03	396.01	7880.599	4.4609	2.7098
20.0	62.832	314.16	400.00	8000.000	4.4721	2.7144
20.1	63.146	317.31	404.01	8120.601	4.4833	2.7189
20.2	63.460	320.47	408.04	8242.408	4.4944	2.7234
20.3	63.774	323.66	412.09	8365.427	4.5055	2.7279
20.4	64.088	326.85	416.16	8489.664	4.5166	2.7324
20.5	64.403	330.06	420.25	8615.125	4.5277	2.7368
20.6	64.717	333.29	424.36	8741.816	4.5387	2.7413
20.7	65.031	336.54	428.49	8869.743	4.5497	2.7457
20.8	65.345	339.80	432.64	8998.912	4.5607	2.7502
20.9	65.659	343.07	436.81	9129.329	4.5716	2.7545
21.0	65.973	346.36	441.00	9261.000	4.5826	2.7589
21.1	66.288	349.67	445.21	9393.931	4.5935	2.7633
21.2	66.602	352.99	449.44	9528.128	4.6043	2.7676
21.3	66.916	356.33	453.69	9663.597	4.6152	2.7720
21.4	67.230	359.68	457.96	9800.344	4.6260	2.7763
21.5	67.544	363.05	462.25	9938.375	4.6368	2.7806
21.6	67.858	366.44	466.56	10077.696	4.6476	2.7849
21.7	68.173	369.84	470.89	10218.313	4.6583	2.7893
21.8	68.487	373.25	475.24	10360.232	4.6690	2.7935
21.9	68.801	376.69	479.61	10503.459	4.6797	2.7978
22.0	69.115	380.13	484.00	10648.000	4.6904	2.8021
22.1	69.429	383.60	488.41	10793.861	4.7011	2.8063
22.2	69.743	387.08	492.84	10941.048	4.7117	2.8105
22.3	70.058	390.57	497.29	11089.567	4.7223	2.8147
22.4	70.372	394.08	501.76	11239.424	4.7329	2.8189
22.5	70.686	397.61	506.25	11390.625	4.7434	2.8231
22.6	71.000	401.15	510.76	11543.176	4.7539	2.8273
22.7	71.314	404.71	515.29	11697.083	4.7644	2.8314
22.8	71.628	408.28	519.84	11852.352	4.7749	2.8356
22.9	71.942	411.87	524.41	12008.989	4.7854	2.8397

TABLE V.—Continued.

n Diam.	$n\pi$ Circumf.	$n^2 \frac{\pi}{4}$ Area.	n^2 Square.	n^3 Cube.	\sqrt{n} Sq. Root.	$\sqrt[3]{n}$ Cub. Rt.
23.0	72.257	415.48	529.00	12167.000	4.7958	2.8438
23.1	72.571	419.10	533.61	12326.391	4.8062	2.8479
23.3	72.885	422.73	538.24	12487.168	4.8166	2.8521
23.3	73.199	426.39	542.89	12649.337	4.8270	2.8562
23.4	73.513	430.05	547.56	12812.904	4.8373	2.8603
23.5	73.827	433.74	552.25	12977.875	4.8477	2.8643
23.6	74.142	437.44	556.96	13144.256	4.8580	2.8684
23.7	74.456	441.15	561.69	13312.053	4.8683	2.8724
23.8	74.770	444.88	566.44	13481.272	4.8785	2.8765
23.9	75.084	448.63	571.21	13651.919	4.8888	2.8805
24.0	75.398	452.39	576.00	13824.000	4.8990	2.8845
24.1	75.712	456.17	580.81	13997.521	4.9092	2.8885
24.2	76.027	459.96	585.64	14172.488	4.9193	2.8925
24.3	76.341	463.77	590.49	14348.907	4.9295	2.8965
24.4	76.655	467.60	595.36	14526.784	4.9396	2.9004
24.5	76.969	471.44	600.25	14706.125	4.9497	2.9044
24.6	77.283	475.29	605.16	14886.936	4.9598	2.9083
24.7	77.597	479.16	610.09	15069.223	4.9699	2.9123
24.8	77.911	483.05	615.04	15252.992	4.9799	2.9162
24.9	78.226	486.96	620.01	15438.249	4.9899	2.9201
25.0	78.540	490.87	625.00	15625.000	5.0000	2.9241
25.1	78.854	494.81	630.01	15813.251	5.0099	2.9279
25.2	79.168	498.76	635.04	16003.008	5.0199	2.9318
25.3	79.482	502.73	640.09	16194.277	5.0299	2.9356
25.4	79.796	506.71	645.16	16387.064	5.0398	2.9395
25.5	80.111	510.71	650.25	16581.375	5.0497	2.9434
25.6	80.425	514.72	655.36	16777.216	5.0596	2.9472
25.7	80.739	518.75	660.49	16974.593	5.0695	2.9510
25.8	81.053	522.79	665.64	17173.512	5.0793	2.9549
25.9	81.367	526.85	670.81	17373.979	5.0892	2.9586
26.0	81.681	530.93	676.00	17576.000	5.0990	2.9624
26.1	81.996	535.02	681.21	17779.581	5.1088	2.9662
26.2	82.310	539.13	686.44	17984.728	5.1185	2.9701
26.3	82.624	543.25	691.69	18191.447	5.1283	2.9738
26.4	82.938	547.39	696.96	18399.744	5.1380	2.9776
26.5	83.252	551.55	702.25	18609.625	5.1478	2.9814
26.6	83.566	555.72	707.56	18821.096	5.1575	2.9851
26.7	83.881	559.90	712.89	19034.163	5.1672	2.9888
26.8	84.195	564.10	718.24	19248.832	5.1768	2.9926
26.9	84.509	568.32	723.61	19465.109	5.1865	2.9963
27.0	84.823	572.56	729.00	19683.000	5.1962	3.0000
27.1	85.137	576.80	734.41	19902.511	5.2057	3.0037
27.2	85.451	581.07	739.84	20123.648	5.2153	3.0074
27.3	85.765	585.35	745.29	20346.417	5.2249	3.0111
27.4	86.080	589.65	750.76	20570.824	5.2345	3.0147

TABLE V.—Continued.

n Diam.	$n\pi$ Circumf.	$\frac{n^2\pi}{4}$ Area.	n^2 Square.	n^3 Cube.	\sqrt{n} Sq. Root.	$\sqrt[3]{n}$ Cub. Rt.
27.5	86.394	593.96	756.25	20796.875	5.2440	3.0184
27.6	86.708	598.29	761.76	21024.576	5.2535	3.0221
27.7	87.022	602.63	767.29	21253.933	5.2630	3.0257
27.8	87.336	606.99	772.84	21484.952	5.2725	3.0293
27.9	87.650	611.36	778.41	21717.639	5.2820	3.0330
28.0	87.965	615.75	784.00	21952.000	5.2915	3.0366
28.1	88.279	620.16	789.61	22188.041	5.3009	3.0402
28.2	88.593	624.58	795.24	22425.768	5.3103	3.0438
28.3	88.907	629.02	800.89	22665.187	5.3197	3.0474
28.4	89.221	633.47	806.56	22906.304	5.3291	3.0510
28.5	89.535	637.94	812.25	23149.125	5.3385	3.0546
28.6	89.850	642.42	817.96	23393.656	5.3478	3.0581
28.7	90.164	646.93	823.69	23639.903	5.3572	3.0617
28.8	90.478	651.44	829.44	23887.872	5.3665	3.0652
28.9	90.792	655.97	835.21	24137.569	5.3758	3.0688
29.0	91.106	660.52	841.00	24389.000	5.3852	3.0723
29.1	91.420	665.08	846.81	24642.171	5.3944	3.0758
29.2	91.735	669.66	852.64	24897.088	5.4037	3.0794
29.3	92.049	674.26	858.49	25153.757	5.4129	3.0829
29.4	92.363	678.87	864.36	25412.184	5.4221	3.0864
29.5	92.677	683.49	870.25	25672.375	5.4313	3.0899
29.6	92.991	688.13	876.16	25934.336	5.4405	3.0934
29.7	93.305	692.79	882.09	26198.073	5.4497	3.0968
29.8	93.619	697.47	888.04	26463.592	5.4589	3.1003
29.9	93.934	702.15	894.01	26730.899	5.4680	3.1038
30.0	94.248	706.86	900.00	27000.000	5.4772	3.1072
30.1	94.562	711.58	906.01	27270.901	5.4863	3.1107
30.2	94.876	716.32	912.04	27543.608	5.4954	3.1141
30.3	95.190	721.07	918.09	27818.127	5.5045	3.1176
30.4	95.505	725.83	924.16	28094.464	5.5136	3.1210
30.5	95.819	730.62	930.25	28372.625	5.5226	3.1244
30.6	96.133	735.42	936.36	28652.616	5.5317	3.1278
30.7	96.447	740.23	942.49	28934.443	5.5407	3.1312
30.8	96.761	745.06	948.64	29218.112	5.5497	3.1346
30.9	97.075	749.91	954.81	29503.629	5.5587	3.1380
31.0	97.389	754.77	961.00	29791.000	5.5678	3.1414
31.1	97.704	759.65	967.21	30080.231	5.5767	3.1448
31.2	98.018	764.54	973.44	30371.328	5.5857	3.1481
31.2	98.332	769.45	979.69	30664.297	5.5946	3.1515
31.4	98.646	774.37	985.96	30959.144	5.6035	3.1548
31.5	98.960	779.31	992.25	31255.875	5.6124	3.1582
31.6	99.274	784.27	998.56	31554.496	5.6213	3.1615
31.7	99.588	789.24	1004.89	31855.013	5.6302	3.1648
31.8	99.903	794.23	1011.24	32157.432	5.6391	3.1681
31.9	100.22	799.23	1017.61	32461.759	5.6480	3.1715

TABLE V.—Continued.

<i>n</i> Diam.	$n\pi$ Circumf.	$\frac{n^2\pi}{4}$ Area.	n^2 Square.	n^3 Cube.	\sqrt{n} Sq. Root.	$\sqrt[3]{n}$ Cub. Rt.
32.0	100.53	804.25	1024.00	32768.000	5.6569	3.1748
32.1	100.85	809.28	1030.41	33076.161	5.6656	3.1781
32.2	101.16	814.33	1036.84	33386.248	5.6745	3.1814
32.3	101.47	819.40	1043.29	33698.267	5.6833	3.1847
32.4	101.79	824.48	1049.76	34012.224	5.6921	3.1880
32.5	102.10	829.58	1056.25	34328.125	5.7008	3.1913
32.6	102.42	834.69	1062.76	34645.976	5.7096	3.1945
32.7	102.73	839.82	1069.29	34965.783	5.7183	3.1978
32.8	103.04	844.96	1075.84	35287.552	5.7271	3.2010
32.9	103.36	850.12	1082.41	35611.289	5.7358	3.2043
33.0	103.67	855.30	1089.00	35937.000	5.7446	3.2075
33.1	103.99	860.49	1095.61	36264.691	5.7532	3.2108
33.2	104.30	865.70	1102.24	36594.368	5.7619	3.2140
33.3	104.62	870.92	1108.89	36926.037	5.7706	3.2172
33.4	104.93	876.16	1115.56	37259.704	5.7792	3.2204
33.5	105.24	881.41	1122.25	37595.375	5.7879	3.2237
33.6	105.56	886.68	1128.96	37933.056	5.7965	3.2269
33.7	105.87	891.97	1135.69	38272.753	5.8051	3.2301
33.8	106.19	897.27	1142.44	38614.472	5.8137	3.2332
33.9	106.50	902.59	1149.21	38958.219	5.8223	3.2364
34.0	106.81	907.92	1156.00	39304.000	5.8310	3.2396
34.1	107.13	913.27	1162.81	39651.821	5.8395	3.2428
34.2	107.44	918.63	1169.64	40001.688	5.8480	3.2460
34.3	107.76	924.01	1176.49	40353.607	5.8566	3.2491
34.4	108.07	929.41	1183.36	40707.584	5.8651	3.2522
34.5	108.38	934.82	1190.25	41063.625	5.8736	3.2554
34.6	108.70	940.25	1197.16	41421.736	5.8821	3.2586
34.7	109.01	945.69	1204.09	41781.923	5.8906	3.2617
34.8	109.33	951.15	1211.04	42144.192	5.8991	3.2648
34.9	109.64	956.62	1218.01	42508.549	5.9076	3.2679
35.0	109.96	962.11	1225.00	42875.000	5.9161	3.2710
35.1	110.27	967.62	1232.01	43243.551	5.9245	3.2742
35.2	110.58	973.14	1239.04	43614.208	5.9329	3.2773
35.3	110.90	978.68	1246.09	43986.977	5.9413	3.2804
35.4	111.21	984.23	1253.16	44361.864	5.9497	3.2835
35.5	111.53	989.80	1260.25	44738.875	5.9581	3.2866
35.6	111.84	995.38	1267.36	45118.016	5.9665	3.2897
35.7	112.15	1000.98	1274.49	45499.293	5.9749	3.2927
35.8	112.47	1006.60	1281.64	45882.712	5.9833	3.2958
35.9	112.78	1012.23	1288.81	46268.279	5.9916	3.2989
36.0	113.10	1017.88	1296.00	46656.000	6.0000	3.3019
36.1	113.41	1023.54	1303.21	47045.881	6.0083	3.3050
36.2	113.73	1029.22	1310.44	47437.928	6.0166	3.3080
36.3	114.04	1034.91	1317.69	47832.147	6.0249	3.3111
36.4	114.35	1040.62	1324.96	48228.544	6.0332	3.3141

TABLE V.—Continued.

n Diam.	$n\pi$ Circumf.	$\frac{n^2\pi}{4}$ Area.	n^2 Square.	n^3 Cube.	\sqrt{n} Sq. Root.	$\sqrt[3]{n}$ Cub. Rt.
36.5	114.67	1046.35	1332.25	48627.125	6.0415	3.3171
36.6	114.98	1052.09	1339.56	49027.896	6.0497	3.3202
36.7	115.30	1057.84	1346.89	49430.863	6.0580	3.3232
36.8	115.61	1063.62	1354.24	49836.032	6.0663	3.3262
36.9	115.92	1069.41	1361.61	50243.409	6.0745	3.3292
37.0	116.24	1075.21	1369.00	50653.000	6.0827	3.3322
37.1	116.55	1081.03	1376.41	51064.811	6.0909	3.3352
37.2	116.87	1086.87	1383.84	51478.848	6.0991	3.3382
37.3	117.18	1092.72	1391.29	51895.117	6.1073	3.3412
37.4	117.50	1098.58	1398.76	52313.624	6.1155	3.3442
37.5	117.81	1104.47	1406.25	52734.375	6.1237	3.3472
37.6	118.12	1110.36	1413.76	53157.376	6.1318	3.3501
37.7	118.44	1116.28	1421.29	53582.633	6.1400	3.3531
37.8	118.75	1122.21	1428.84	54010.152	6.1481	3.3561
37.9	119.07	1128.15	1436.41	54439.939	6.1563	3.3590
38.0	119.38	1134.11	1444.00	54872.000	6.1644	3.3620
38.1	119.69	1140.09	1451.61	55306.341	6.1725	3.3649
38.2	120.01	1146.08	1459.24	55742.968	6.1806	3.3679
38.3	120.32	1152.09	1466.89	56181.887	6.1887	3.3708
38.4	120.64	1158.12	1474.56	56623.104	6.1967	3.3737
38.5	120.95	1164.16	1482.25	57066.625	6.2048	3.3767
38.6	121.27	1170.21	1489.96	57512.456	6.2129	3.3796
38.7	121.58	1176.28	1497.69	57960.603	6.2209	3.3825
38.8	121.89	1182.37	1505.44	58411.072	6.2289	3.3854
38.9	122.21	1188.47	1513.21	58863.869	6.2370	3.3883
39.0	122.52	1194.59	1521.00	59319.000	6.2450	3.3912
39.1	122.84	1200.72	1528.81	59776.471	6.2530	3.3941
39.2	123.15	1206.87	1536.64	60236.288	6.2610	3.3970
39.3	123.46	1213.04	1544.49	60698.457	6.2689	3.3999
39.4	123.78	1219.22	1552.36	61162.984	6.2769	3.4028
39.5	124.09	1225.42	1560.25	61629.875	6.2849	3.4056
39.6	124.41	1231.63	1568.16	62099.136	6.2928	3.4085
39.7	124.72	1237.86	1576.09	62570.773	6.3008	3.4114
39.8	125.04	1244.10	1584.04	63044.792	6.3087	3.4142
39.9	125.35	1250.36	1592.01	63521.199	6.3166	3.4171
40.0	125.66	1256.64	1600.00	64000.000	6.3245	3.4200
40.1	125.98	1262.93	1608.01	64481.201	6.3325	3.4228
40.2	126.29	1269.23	1616.04	64964.808	6.3404	3.4256
40.3	126.61	1275.56	1624.09	65450.827	6.3482	3.4285
40.4	126.92	1281.90	1632.16	65939.264	6.3561	3.4313
40.5	127.23	1288.25	1640.25	66430.125	6.3639	3.4341
40.6	127.55	1294.62	1648.36	66923.416	6.3718	3.4370
40.7	127.86	1301.00	1656.49	67419.143	6.3796	3.4398
40.8	128.18	1307.41	1664.64	67917.312	6.3875	3.4426
40.9	128.49	1313.82	1672.81	68417.929	6.3953	3.4454

TABLE V.—Continued.

n	$n\pi$	$n^2 \frac{\pi}{4}$	n^2	n^3	\sqrt{n}	$\sqrt[3]{n}$
Diam.	Circumf.	Area.	Square.	Cube.	Sq. Root.	Cub. Rt.
41.0	128.81	1320.25	1681.00	68921.000	6.4031	3.4482
41.1	129.12	1326.70	1689.21	69426.531	6.4109	3.4510
41.2	129.43	1333.17	1697.44	69934.528	6.4187	3.4538
41.3	129.75	1339.65	1705.69	70444.997	6.4265	3.4566
41.4	130.06	1346.14	1713.96	70957.944	6.4343	3.4594
41.5	130.38	1352.65	1722.25	71473.375	6.4421	3.4622
41.6	130.69	1359.18	1730.56	71991.296	6.4498	3.4650
41.7	131.00	1365.72	1738.89	72511.713	6.4575	3.4677
41.8	131.32	1372.28	1747.24	73034.632	6.4653	3.4705
41.9	131.63	1378.85	1755.61	73560.059	6.4730	3.4733
42.0	131.95	1385.44	1764.00	74088.000	6.4807	3.4760
42.1	132.26	1392.05	1772.41	74618.461	6.4884	3.4788
42.2	132.58	1398.67	1780.84	75151.448	6.4961	3.4815
42.3	132.89	1405.31	1789.29	75686.967	6.5038	3.4843
42.4	133.20	1411.96	1797.76	76225.024	6.5115	3.4870
42.5	133.52	1418.63	1806.25	76765.625	6.5192	3.4898
42.6	133.83	1425.31	1814.76	77308.776	6.5268	3.4925
42.7	134.15	1432.01	1823.29	77854.483	6.5345	3.4952
42.8	134.46	1438.72	1831.84	78402.752	6.5422	3.4980
42.9	134.77	1445.45	1840.41	78953.589	6.5498	3.5007
43.0	135.09	1452.20	1849.00	79507.000	6.5574	3.5034
43.1	135.40	1458.96	1857.61	80062.991	6.5651	3.5061
43.2	135.72	1465.74	1866.24	80621.568	6.5727	3.5088
43.3	136.03	1472.54	1874.89	81182.737	6.5803	3.5115
43.4	136.35	1479.34	1883.56	81746.504	6.5879	3.5142
43.5	136.66	1486.17	1892.25	82312.875	6.5954	3.5169
43.6	136.97	1493.01	1900.96	82881.856	6.6030	3.5196
43.7	137.29	1499.87	1909.69	83453.453	6.6106	3.5223
43.8	137.60	1506.74	1918.44	84027.672	6.6182	3.5250
43.9	137.92	1513.63	1927.21	84604.519	6.6257	3.5277
44.0	138.23	1520.53	1936.00	85184.000	6.6333	3.5303
44.1	138.54	1527.45	1944.81	85766.121	6.6408	3.5330
44.2	138.86	1534.39	1953.64	86350.888	6.6483	3.5357
44.3	139.17	1541.34	1962.49	86938.307	6.6558	3.5384
44.4	139.49	1548.30	1971.36	87528.384	6.6633	3.5410
44.5	139.80	1555.28	1980.25	88121.125	6.6708	3.5437
44.6	140.12	1562.28	1989.16	88716.536	6.6783	3.5463
44.7	140.43	1569.30	1998.09	89314.623	6.6858	3.5490
44.8	140.74	1576.33	2007.04	89915.392	6.6933	3.5516
44.9	141.06	1583.37	2016.01	90518.849	6.7007	3.5543
45.0	141.37	1590.43	2025.00	91125.000	6.7082	3.5569
45.1	141.69	1597.51	2034.01	91733.851	6.7156	3.5595
45.2	142.00	1604.60	2043.04	92345.408	6.7231	3.5621
45.3	142.31	1611.71	2052.09	92959.677	6.7305	3.5648
45.4	142.63	1618.83	2061.16	93576.664	6.7379	3.5674

TABLE V.—Continued.

n Diam.	$n\pi$ Circumf.	$n^2\frac{\pi}{4}$ Area.	n^2 Square.	n^3 Cube.	\sqrt{n} Sq. Root.	$\sqrt[3]{n}$ Cub. Rt.
45.5	142.94	1625.97	2070.25	94196.375	6.7454	3.5700
45.6	143.26	1633.13	2079.36	94818.816	6.7528	3.5726
45.7	143.57	1640.30	2088.49	95443.993	6.7602	3.5752
45.8	143.88	1647.48	2097.64	96071.912	6.7676	3.5778
45.9	144.20	1654.68	2106.81	96702.579	6.7749	3.5805
46.0	144.51	1661.90	2116.00	97336.000	6.7823	3.5830
46.1	144.83	1669.14	2125.21	97972.181	6.7897	3.5856
46.2	145.14	1676.39	2134.44	98611.128	6.7971	3.5882
46.3	145.46	1683.65	2143.69	99252.847	6.8044	3.5908
46.4	145.77	1690.93	2152.96	99897.344	6.8117	3.5934
46.5	146.08	1698.23	2162.25	100544.625	6.8191	3.5960
46.6	146.40	1705.54	2171.56	101194.696	6.8264	3.5986
46.7	146.71	1712.87	2180.89	101847.563	6.8337	3.6011
46.8	147.03	1720.21	2190.24	102503.232	6.8410	3.6037
46.9	147.34	1727.57	2199.61	103161.709	6.8484	3.6063
47.0	147.65	1734.94	2209.00	103823.000	6.8556	3.6088
47.1	147.97	1742.34	2218.41	104487.111	6.8629	3.6114
47.2	148.28	1749.74	2227.84	105154.048	6.8702	3.6139
47.3	148.60	1757.16	2237.29	105823.817	6.8775	3.6165
47.4	148.91	1764.60	2246.76	106496.424	6.8847	3.6190
47.5	149.23	1772.05	2256.25	107171.875	6.8920	3.6216
47.6	149.54	1779.52	2265.76	107850.176	6.8993	3.6241
47.7	149.85	1787.01	2275.29	108531.333	6.9065	3.6267
47.8	150.17	1794.51	2284.84	109215.352	6.9137	3.6292
47.9	150.48	1802.03	2294.41	109902.239	6.9209	3.6317
48.0	150.80	1809.56	2304.00	110592.000	6.9282	3.6342
48.1	151.11	1817.11	2313.61	111284.641	6.9354	3.6368
48.2	151.42	1824.67	2323.24	111980.168	6.9426	3.6393
48.3	151.74	1832.25	2332.89	112678.587	6.9498	3.6418
48.4	152.05	1839.84	2342.56	113379.904	6.9570	3.6443
48.5	152.37	1847.45	2352.25	114084.125	6.9642	3.6468
48.6	152.68	1855.08	2361.96	114791.256	6.9714	3.6493
48.7	153.00	1862.72	2371.69	115501.303	6.9785	3.6518
48.8	153.31	1870.38	2381.44	116214.272	6.9857	3.6543
48.9	153.62	1878.05	2391.21	116930.169	6.9928	3.6568
49.0	153.94	1885.74	2401.00	117649.000	7.0000	3.6593
49.1	154.25	1893.45	2410.81	118370.771	7.0071	3.6618
49.2	154.57	1901.17	2420.64	119095.488	7.0143	3.6643
49.3	154.88	1908.90	2430.49	119823.157	7.0214	3.6668
49.4	155.19	1916.65	2440.36	120553.784	7.0285	3.6692
49.5	155.51	1924.42	2450.25	121287.375	7.0356	3.6717
49.6	155.82	1932.21	2460.16	122023.936	7.0427	3.6742
49.7	156.14	1940.00	2470.09	122763.473	7.0498	3.6767
49.8	156.45	1947.82	2480.04	123505.992	7.0569	3.6791
49.9	156.77	1955.65	2490.01	124251.499	7.0640	3.6816

TABLE V.—Continued.

n Diam.	$n\pi$ Circumf.	$n^2 \frac{\pi}{4}$ Area.	n^2 Square.	n^3 Cube.	\sqrt{n} Sq. Root.	$\sqrt[3]{n}$ Cub. Rt.
50.0	157.08	1963.50	2500.00	125000.000	7.0711	3.6840
51.0	160.22	2042.82	2601.00	132651.000	7.1414	3.7084
52.0	163.36	2123.72	2704.00	140608.000	7.2111	3.7325
53.0	166.50	2206.19	2809.00	148877.000	7.2801	3.7563
54.0	169.64	2290.22	2916.00	157464.000	7.3485	3.7798
55.0	172.78	2375.83	3025.00	166375.000	7.4162	3.8030
56.0	175.93	2463.01	3136.00	175616.000	7.4833	3.8259
57.0	179.07	2551.76	3249.00	185193.000	7.5498	3.8485
58.0	182.21	2642.08	3364.00	195112.000	7.6158	3.8709
59.0	185.35	2733.98	3481.00	205379.000	7.6811	3.8930
60.0	188.49	2827.44	3600.00	216000.000	7.7460	3.9149
61.0	191.63	2922.47	3721.00	226981.000	7.8102	3.9365
62.0	194.77	3019.07	3844.00	238328.000	7.8740	3.9579
63.0	197.92	3117.25	3969.00	250047.000	7.9373	3.9791
64.0	201.06	3216.99	4096.00	262144.000	8.0000	4.0000
65.0	204.20	3318.31	4225.00	274625.000	8.0623	4.0207
66.0	207.34	3421.20	4356.00	287496.000	8.1240	4.0412
67.0	210.48	3525.66	4489.00	300763.000	8.1854	4.0615
68.0	213.63	3631.69	4624.00	314432.000	8.2462	4.0817
69.0	216.77	3739.29	4761.00	328509.000	8.3066	4.1016
70.0	219.91	3848.46	4900.00	343000.000	8.3666	4.1213
71.0	223.05	3959.20	5041.00	357911.000	8.4261	4.1408
72.0	226.19	4071.51	5184.00	373248.000	8.4853	4.1602
73.0	229.33	4185.39	5329.00	389017.000	8.5440	4.1793
74.0	232.47	4300.85	5476.00	405224.000	8.6023	4.1983
75.0	235.62	4417.87	5625.00	421875.000	8.6603	4.2172
76.0	238.76	4536.47	5776.00	438976.000	8.7178	4.2358
77.0	241.90	4656.63	5929.00	456533.000	8.7750	4.2543
78.0	245.04	4778.37	6084.00	474552.000	8.8318	4.2727
79.0	248.18	4901.68	6241.00	493039.000	8.8882	4.2908
80.0	251.32	5026.56	6400.00	512000.000	8.9443	4.3089
81.0	254.47	5153.01	6561.00	531441.000	9.0000	4.3267
82.0	257.61	5281.03	6724.00	551368.000	9.0554	4.3445
83.0	260.75	5410.62	6889.00	571787.000	9.1104	4.3621
84.0	263.89	5541.78	7056.00	592704.000	9.1652	4.3795
85.0	267.03	5674.50	7225.00	614125.000	9.2195	4.3968
86.0	270.17	5808.81	7396.00	636056.000	9.2736	4.4140
87.0	273.32	5944.69	7569.00	658503.000	9.3274	4.4310
88.0	276.46	6082.13	7744.00	681472.000	9.3808	4.4480
89.0	279.60	6221.13	7921.00	704969.000	9.4340	4.4647
90.0	282.74	6361.74	8100.00	729000.000	9.4868	4.4814
91.0	285.88	6503.89	8281.00	753571.000	9.5394	4.4979
92.0	289.02	6647.62	8464.00	778688.000	9.5917	4.5144
93.0	292.17	6792.92	8649.00	804357.000	9.6437	4.5307
94.0	295.31	6939.78	8836.00	830584.000	9.6954	4.5468
95.0	298.45	7088.23	9025.00	857375.000	9.7468	4.5629
96.0	301.59	7238.24	9216.00	884736.000	9.7980	4.5789
97.0	304.73	7389.83	9409.00	912673.000	9.8489	4.5947
98.0	307.87	7542.98	9604.00	941192.000	9.8995	4.6104
99.0	311.02	7697.68	9801.00	970299.000	9.9499	4.6261
100.0	314.16	7854.00	10000.00	1000000.000	10.0000	4.6416

TABLE VI.—CIRCUMFERENCES AND AREAS OF CIRCLES.*

Diam	Circum.	Area.	Diam	Circum.	Area.	Diam	Circum.	Area.
1	3.1416	0.7854	65	204.20	3318.31	129	405.27	13069.81
2	6.2832	3.1416	66	207.34	3421.19	130	408.41	13273.23
3	9.4248	7.0686	67	210.49	3525.65	131	411.55	13478.22
4	12.5664	12.5664	68	213.63	3631.68	132	414.69	13684.78
5	15.7080	19.635	69	216.77	3739.28	133	417.83	13892.91
6	18.850	28.274	70	219.91	3848.45	134	420.97	14102.61
7	21.991	38.485	71	223.05	3959.19	135	424.12	14313.88
8	25.133	50.260	72	226.19	4071.50	136	427.26	14526.72
9	28.274	63.617	73	229.34	4185.39	137	430.40	14741.14
10	31.416	78.540	74	232.48	4300.84	138	433.54	14957.12
11	34.558	95.033	75	235.62	4417.86	139	436.68	15174.68
12	37.699	113.10	76	238.76	4536.46	140	439.82	15393.80
13	40.841	132.73	77	241.90	4656.63	141	442.96	15614.50
14	43.982	153.94	78	245.04	4778.36	142	446.11	15836.77
15	47.124	176.71	79	248.19	4901.67	143	449.25	16060.61
16	50.265	201.06	80	251.33	5026.55	144	452.39	16286.02
17	53.407	226.98	81	254.47	5153.00	145	455.53	16513.00
18	56.549	254.47	82	257.61	5281.02	146	458.67	16741.55
19	59.690	283.53	83	260.75	5410.61	147	461.81	16971.67
20	62.832	314.16	84	263.89	5541.77	148	464.96	17203.36
21	65.973	346.36	85	267.04	5674.50	149	468.10	17436.62
22	69.115	380.13	86	270.18	5808.80	150	471.24	17671.44
23	72.257	415.48	87	273.32	5944.68	151	474.38	17907.86
24	75.398	452.39	88	276.46	6082.12	152	477.52	18145.84
25	78.540	490.87	89	279.60	6221.14	153	480.66	18385.39
26	81.681	530.93	90	282.74	6361.73	154	483.81	18626.50
27	84.823	572.56	91	285.88	6503.88	155	486.95	18869.19
28	87.965	615.75	92	289.03	6647.61	156	490.09	19113.45
29	91.106	660.52	93	292.17	6792.91	157	493.23	19359.28
30	94.248	706.86	94	295.31	6939.78	158	496.37	19606.68
31	97.389	754.77	95	298.45	7088.22	159	499.51	19855.65
32	100.53	804.25	96	301.59	7238.23	160	502.65	20106.19
33	103.67	855.30	97	304.73	7389.81	161	505.80	20358.31
34	106.81	907.92	98	307.88	7542.96	162	508.94	20611.99
35	109.96	962.11	99	311.02	7697.69	163	512.08	20867.24
36	113.10	1017.88	100	314.16	7853.98	164	515.22	21124.07
37	116.24	1075.21	101	317.30	8011.85	165	518.36	21382.46
38	119.38	1134.11	102	320.44	8171.28	166	521.50	21642.43
39	122.52	1194.59	103	323.58	8332.29	167	524.65	21903.97
40	125.66	1256.64	104	326.73	8494.87	168	527.79	22166.08
41	128.81	1320.25	105	329.87	8659.01	169	530.93	22431.76
42	131.95	1385.44	106	333.01	8824.73	170	534.07	22698.01
43	135.09	1452.20	107	336.15	8992.02	171	537.21	22965.83
44	138.23	1520.53	108	339.29	9160.88	172	540.35	23235.22
45	141.37	1590.43	109	342.43	9331.32	173	543.50	23506.18
46	144.51	1661.90	110	345.58	9503.32	174	546.64	23778.71
47	147.65	1734.94	111	348.72	9676.89	175	549.78	24052.82
48	150.80	1809.56	112	351.86	9852.03	176	552.92	24328.49
49	153.94	1885.74	113	355.00	10028.75	177	556.06	24605.74
50	157.08	1963.50	114	358.14	10207.03	178	559.20	24884.56
51	160.22	2042.82	115	361.28	10386.89	179	562.35	25164.94
52	163.36	2123.72	116	364.42	10568.32	180	565.49	25446.90
53	166.50	2206.18	117	367.57	10751.32	181	568.63	25730.43
54	169.65	2290.22	118	370.71	10935.88	182	571.77	26015.53
55	172.79	2375.83	119	373.85	11122.02	183	574.91	26302.20
56	175.93	2463.01	120	376.99	11309.73	184	578.05	26590.44
57	179.07	2551.76	121	380.13	11499.01	185	581.19	26880.25
58	182.21	2642.08	122	383.27	11689.87	186	584.34	27171.63
59	185.35	2733.97	123	386.42	11882.29	187	587.48	27464.59
60	188.50	2827.43	124	389.56	12076.28	188	590.62	27759.11
61	191.64	2922.47	125	392.70	12271.85	189	593.76	28055.21
62	194.78	3019.07	126	395.84	12468.98	190	596.90	28352.87
63	197.92	3117.25	127	398.98	12667.69	191	600.04	28652.11
64	201.06	3216.99	128	402.12	12867.96	192	603.19	28952.92

* From Kent's Pocket-book for Mechanical Engineers.

TABLE VII.—LOGARITHMS OF NUMBERS.

No.	0	1	2	3	4	5	6	7	8	9
10	0000	0043	0086	0128	0170	0212	0253	0294	0334	0374
11	0414	0453	0492	0531	0569	0607	0645	0682	0719	0755
12	0792	0828	0864	0899	0934	0969	1004	1038	1072	1106
13	1139	1173	1206	1239	1271	1303	1335	1367	1399	1430
14	1461	1492	1523	1553	1584	1614	1644	1673	1703	1732
15	1761	1790	1818	1847	1875	1903	1931	1959	1987	2014
16	2041	2068	2095	2122	2148	2175	2201	2227	2253	2279
17	2304	2330	2355	2380	2405	2430	2455	2480	2504	2529
18	2553	2577	2601	2625	2648	2672	2695	2718	2742	2765
19	2788	2810	2833	2856	2878	2900	2923	2945	2967	2989
20	3010	3032	3054	3075	3096	3118	3139	3160	3181	3201
21	3222	3243	3263	3284	3304	3324	3345	3365	3385	3404
22	3424	3444	3464	3483	3502	3522	3541	3560	3579	3598
23	3617	3636	3655	3674	3692	3711	3729	3747	3766	3784
24	3802	3820	3838	3856	3874	3892	3909	3927	3945	3962
25	3979	3997	4014	4031	4048	4065	4082	4099	4116	4133
26	4150	4166	4183	4200	4216	4232	4249	4265	4281	4298
27	4314	4330	4346	4362	4378	4393	4409	4425	4440	4456
28	4472	4487	4502	4518	4533	4548	4564	4579	4594	4609
29	4624	4639	4654	4669	4683	4698	4713	4728	4742	4757
30	4771	4786	4800	4814	4829	4843	4857	4871	4886	4900
31	4914	4928	4942	4955	4969	4983	4997	5011	5024	5038
32	5051	5065	5079	5092	5105	5119	5132	5145	5159	5172
33	5185	5198	5211	5224	5237	5250	5263	5276	5289	5302
34	5315	5328	5340	5353	5366	5378	5391	5403	5416	5428
35	5441	5453	5465	5478	5490	5502	5514	5527	5539	5551
36	5563	5575	5587	5599	5611	5623	5635	5647	5658	5670
37	5682	5694	5705	5717	5729	5740	5752	5763	5775	5786
38	5798	5809	5821	5832	5843	5855	5866	5877	5888	5899
39	5911	5922	5933	5944	5955	5966	5977	5988	5999	6010
40	6021	6031	6042	6053	6064	6075	6085	6096	6107	6117
41	6128	6138	6149	6160	6170	6180	6191	6201	6212	6222
42	6232	6243	6253	6263	6274	6284	6294	6304	6314	6325
43	6335	6345	6355	6365	6375	6385	6395	6405	6415	6425
44	6435	6444	6454	6464	6474	6484	6493	6503	6513	6522
45	6532	6542	6551	6561	6571	6580	6590	6599	6609	6618
46	6628	6637	6646	6656	6665	6675	6684	6693	6702	6712
47	6721	6730	6739	6749	6758	6767	6776	6785	6794	6803
48	6812	6821	6830	6839	6848	6857	6866	6875	6884	6893
49	6902	6911	6920	6928	6937	6946	6955	6964	6972	6981
50	6990	6998	7007	7016	7024	7033	7042	7050	7059	7067
51	7076	7084	7093	7101	7110	7118	7126	7135	7143	7152
52	7160	7168	7177	7185	7193	7202	7210	7218	7226	7235
53	7243	7251	7259	7267	7275	7284	7292	7300	7308	7316
54	7324	7332	7340	7348	7356	7364	7372	7380	7388	7396
No.	0	1	2	3	4	5	6	7	8	9

TABLE VII.—Continued.

No.	0	1	2	3	4	5	6	7	8	9
55	7404	7412	7419	7427	7435	7443	7451	7459	7466	7474
56	7482	7490	7497	7505	7513	7520	7528	7536	7543	7551
57	7559	7566	7574	7582	7589	7597	7604	7612	7619	7627
58	7634	7642	7649	7657	7664	7672	7679	7686	7694	7701
59	7709	7716	7723	7731	7738	7745	7752	7760	7767	7774
60	7782	7789	7796	7803	7810	7818	7825	7832	7839	7846
61	7853	7860	7868	7875	7882	7889	7896	7903	7910	7917
62	7924	7931	7938	7945	7952	7959	7966	7973	7980	7987
63	7993	8000	8007	8014	8021	8028	8035	8041	8048	8055
64	8062	8069	8075	8082	8089	8096	8102	8109	8116	8122
65	8129	8136	8142	8149	8156	8162	8169	8176	8182	8189
66	8195	8202	8209	8215	8222	8228	8235	8241	8248	8254
67	8261	8267	8274	8280	8287	8293	8299	8306	8312	8319
68	8325	8331	8338	8344	8351	8357	8363	8370	8376	8382
69	8388	8395	8401	8407	8414	8420	8426	8432	8439	8445
70	8451	8457	8463	8470	8476	8482	8488	8494	8500	8506
71	8513	8519	8525	8531	8537	8543	8549	8555	8561	8567
72	8573	8579	8585	8591	8597	8603	8609	8615	8621	8627
73	8633	8639	8645	8651	8657	8663	8669	8675	8681	8686
74	8692	8698	8704	8710	8716	8722	8727	8733	8739	8745
75	8751	8756	8762	8768	8774	8779	8785	8791	8797	8802
76	8808	8814	8820	8825	8831	8837	8842	8848	8854	8859
77	8865	8871	8876	8882	8887	8893	8899	8904	8910	8915
78	8921	8927	8932	8938	8943	8949	8954	8960	8965	8971
79	8976	8982	8987	8993	8998	9004	9009	9015	9020	9025
80	9031	9036	9042	9047	9053	9058	9063	9069	9074	9079
81	9085	9090	9096	9101	9106	9112	9117	9122	9128	9133
82	9138	9143	9149	9154	9159	9165	9170	9175	9180	9186
83	9191	9196	9201	9206	9212	9217	9222	9227	9232	9238
84	9243	9248	9253	9258	9263	9269	9274	9279	9284	9289
85	9294	9299	9304	9309	9315	9320	9325	9330	9335	9340
86	9345	9350	9355	9360	9365	9370	9375	9380	9385	9390
87	9395	9400	9405	9410	9415	9420	9425	9430	9435	9440
88	9445	9450	9455	9460	9465	9469	9474	9479	9484	9489
89	9494	9499	9504	9509	9513	9518	9523	9528	9533	9538
90	9542	9547	9552	9557	9562	9566	9571	9576	9581	9586
91	9590	9595	9600	9605	9609	9614	9619	9624	9628	9633
92	9638	9643	9647	9652	9657	9661	9666	9671	9675	9680
93	9685	9689	9694	9699	9703	9708	9713	9717	9722	9727
94	9731	9736	9741	9745	9750	9754	9759	9763	9768	9773
95	9777	9782	9786	9791	9795	9800	9805	9809	9814	9818
96	9823	9827	9832	9836	9841	9845	9850	9854	9859	9863
97	9868	9872	9877	9881	9886	9890	9894	9899	9903	9908
98	9912	9917	9921	9926	9930	9934	9939	9943	9948	9952
99	9956	9961	9965	9969	9974	9978	9983	9987	9991	9996
No.	0	1	2	3	4	5	6	7	8	9

TABLE VIII.—IMPORTANT PROPERTIES OF FAMILIAR SUBSTANCES.

	Specific Gravity. Water, 1.	Specific Heat. Water, 1.	Absorbing and Radiating Power of Bodies in Units of Heat per Square Foot for Difference of 1°.	Conducting Power in Units of Heat per Square Foot of Surface with Difference of 1°.	Weight in Pounds.	Melting Points Deg.F.
Metals from 32 to 212°:						
					Per cu. in.	
Aluminium.....	2.61-2.65	.212	0.0956	1200
Antimony.....	6.712	.0508	0.2428	1150
Bismuth.....	9.823	.0308	0.3533	500
Brass.....	8.1	.0939	.049	0.2930	1092
Copper.....	8.788	.092	.0327	515.0	0.3179	1940
Iron, cast.....	7.5	.1298	.648	103.0	0.2707	2300
Iron, wrought.....	7.744	.1138	.566	103.0	0.2801	2900
Gold.....	19.258	.0324	0.6965	1930
Lead.....	11.352	.0314	.1329	50.0	0.4106	620
Mercury at 32°.....	13.598	.0333	0.4918	-39
Nickel.....	8.800	.1086	0.3183	2600
Platinum.....	16.000	.0324	0.5787	3200
Silver.....	10.474	.056	.0265	0.3788	1740
Steel.....	7.834	.1165	0.2916	2500
Tin.....	7.291	.0562	.0439	0.2637	446
Zinc.....	7.191	.0953	.049	102.0	0.26	785
Stones:						
					Per cu. ft.	
Chalk.....	2.784	.2149	.6786	174.0	
Limestone.....	3.156	.2174	.735	197.0	
Masonry.....	2.240	.2	.735	140.0	
Marble, gray.....	2.686	.2694	.735	5.6	168.0	
Marble, white.....	2.650	.2158	.735	4.4	165.0	
Woods:						
Oak.....	.86	.57	.73	0.4	54.0	
Pine, white.....	.55	.65	.73	.17	34.6	
Mineral substances:						
Charcoal, pine.....	.44	.2415	27.5	
Coal, anthracite.....	1.43	.2411	88.7	
Coke.....	1.00	.203	62.5	
Glass, white.....	2.89	.1977	.5948	1.5	180.7	
Sulphur.....	2.03	.2026	127.0	
Liquids:						
Alcohol, mean.....	.9	.6588	57.5	
Oil, petroleum.....	.88	.31	1.480	55.0	
Steam at 212°.....	.0006	.847050	
Turpentine.....	.87	.416	54.37	
Water at 62°.....	1.000	1.000	1.0853	62.35	
Solid:						
Ice at 32°.....	.922	.504	57.5	
Gases:						
Air at 32°.....	.00122	.2380807	
Oxygen.....	.00127	.24120892	
Hydrogen.....	.000089	3.293600559	
Carbonic acid.....	.00198	.22101234	

TABLE IX.—COEFFICIENTS, STRENGTH OF MATERIALS.

	Ultimate Strength. Tons per Square Inch.			Moduli. Tons per Sq. In.		
	Tension.	Com- pression.	Shearing.	Elasticity.	Rig.	
	<i>T</i>	<i>C</i>	<i>S</i>	<i>E</i>	<i>E_s</i>	
Cast-iron.....	5½-10½	25-65	9-13	} 5000 to 6000	} 1300 to 2500	
Average.....	7	42	11			
American ordnance.....	14	36-58				
Repeatedly melted.....	15-20	60-75				
Wrought-iron:						
Finest Low- moor plates: { with grain. 27-29			} 18-22	} 12,000 to 13,000	} 5000	
{ across " .. 24						
Bridge-iron: { with " .. 22						
{ across " .. 19						
Bars, finest.....	27-29					
Bars, ordinary.....	25	20				
Bars, soft Swedish.....	19-24					
Wire.....	25-50					
Steel:						
Mild-steel plates.....	26-32		} % of Tension	} 12,000 to 13,000	} 5000 to 5200	
Axle and rail steel.....	30-45					
Crucible tool-steel.....	40-65					
Chrome steel.....	80					
Tungsten steel.....	72					
Steel wire.....	70					
Piano-wire.....	150				13,000	
Copper:						
Cast.....	10-14			7000		
Rolled.....	15-16	35	10-14			
Wire, hard drawn.....	28			8000	2800	
Brass.....	8-13	5		5500	1500	
Wire.....	22			6400	2200	
Gun-metal.....	11-23			4500-6000	1700	
Phosphor bronze.....	15-26			6000	2400	
Zinc, cast.....	2-3					
Zinc, rolled.....	7-10			5500		
Tin.....	2					
Lead.....	0.9	3		1000		
Timber:						
Oak.....	3-7	4	1	800		
White pine.....	1½-3½	2½		600		
Pitch-pine.....	4			950		
Ash.....	4-7	2-4	½	750		
Beech.....	4-6	4				
Mahogany.....	4-7	3½		650		
Stone:						
Granite.....		2½-5				
Sandstone.....		1½-2½				
Limestone.....		1½-3				
Brick.....		¼-6				

TABLE X.—PROPERTIES OF AIR.

OF THE WEIGHTS OF AIR, VAPOR OF WATER, AND SATURATED MIXTURES OF AIR AND VAPOR OF DIFFERENT TEMPERATURES, UNDER THE ORDINARY ATMOSPHERIC PRESSURE OF 29.921 INCHES OF MERCURY.

Temperature Fahr.	Volume of Dry Air at Different Temperatures, the Volume at 32° being 1000.	Weight of a Cubic Foot of Dry Air at Different Temperatures in Pounds.	Elastic Force of Vapor in Inches of Mercury (Regnault).	Mixtures of Air Saturated with Vapor.			
				Elastic Force of the Air in the Mixture of Air and Vapor in Inches of Mercury.	Weight of a Cubic Foot of the Mixture.		
					Weight of the Air in Pounds.	Weight of the Vapor in Pounds.	Total Weight of Mixture in Pounds.
1	2	3	4	5	6	7	8
0°	.935	.0864	.044	29.877	.0863	.000079	.086379
12	.960	.0842	.074	29.849	.0840	.000130	.084130
22	.980	.0824	.118	29.803	.0821	.000202	.082302
32	1.000	.0807	.181	29.740	.0802	.000304	.080504
42	1.020	.0791	.267	29.654	.0784	.000440	.078840
52	1.041	.0776	.388	29.533	.0766	.000627	.077227
60	1.057	.0764	.522	29.399	.0751	.000830	.075252
62	1.061	.0761	.556	29.365	.0747	.000881	.075581
70	1.078	.0750	.754	29.182	.0731	.001153	.073509
72	1.082	.0747	.785	29.136	.0727	.001221	.073921
82	1.102	.0733	1.092	28.829	.0706	.001667	.072267
92	1.122	.0720	1.501	28.420	.0684	.002250	.070717
100	1.139	.0710	1.929	27.992	.0664	.002848	.069261
102	1.143	.0707	2.036	27.885	.0659	.002997	.068897
112	1.163	.0694	2.731	27.190	.0631	.003946	.067042
122	1.184	.0682	3.621	26.300	.0599	.005142	.065046
132	1.204	.0671	4.752	25.169	.0564	.006639	.063039
142	1.224	.0660	6.165	23.756	.0524	.008473	.060873
152	1.245	.0649	7.930	21.991	.0477	.010716	.058416
162	1.265	.0638	10.099	19.822	.0423	.013415	.055715
172	1.285	.0628	12.758	17.163	.0360	.016682	.052682
182	1.306	.0618	15.960	13.961	.0288	.020536	.049336
192	1.326	.0609	19.828	10.093	.0205	.025142	.045642
202	1.347	.0600	24.450	5.471	.0109	.030545	.041445
212	1.367	.0591	29.921	0.000	.0000	.036820	.036820

For vapor tensions and latent heat, see table on page 518.

TABLE X.—Continued.

Temperature Fahr.	Mixture of Air Saturated with Vapor.		Cubic Feet of Vapor from one Pound of Water at Pressure as in Column 4.	B. T. U. Absorbed by one Cubic Foot of Dry Air per Degree F.	B. T. U. Absorbed by one Cubic Foot Saturated Air per Degree F.	Cubic Feet Dry Air Warmed One Degree per B. T. U.	Cubic Feet Saturated Air Warmed One Degree per B. T. U.
	Ratio of Water to Dry Air.	Ratio of Dry Air to Water Vapor.					
1	9	10	11	12	13	14	15
0°	.00092	1092.402056	.02054	48.5	48.7
12	.00115	646.102004	.02006	50.1	50.0
22	.00245	406.401961	.01963	51.1	51.0
32	.00379	263.81	3289	.01921	.01924	52.0	51.8
42	.00501	178.18	2252	.01882	.01884	53.2	52.8
52	.00819	122.17	1595	.01847	.01848	54.0	53.8
60	.01251	92.27	1227	.01818	.01822	55.0	54.9
62	.01179	84.79	1135	.01811	.01812	56.2	55.7
70	.01780	64.59	882	.01777	.01794	57.3	56.5
72	.01680	59.54	819	.01777	.01790	58.5	56.8
82	.02361	42.35	600	.01744	.01770	57.2	56.5
92	.03289	30.40	444	.01710	.01751	58.5	57.1
100	.04495	23.66	356	.01690	.01735	59.1	57.8
102	.04547	21.98	334	.01682	.01731	59.5	57.8
112	.06253	15.99	253	.01651	.01711	60.6	58.5
122	.08584	11.65	194	.01623	.01691	61.7	59.1
132	.11771	8.49	151	.01596	.01670	62.5	59.9
142	.16170	6.18	118	.01571	.01652	63.7	60.6
152	.22465	4.45	93.3	.01544	.01634	65.0	60.5
162	.31713	3.15	74.5	.01518	.01616	62.2	60.4
172	.46338	2.16	59.2	.01494	.01608	67.1	60.3
182	.71300	1.402	48.6	.01471	.01687	68.0	59.5
192	1.22643	.815	39.8	.01449	68.9	
202	2.80230	.357	32.7	.01466	68.5	
212	Infinite	.000	27.1	.01406	71.4	

TABLE XI.—RELATIVE WEIGHTS OF WATER AND AIR.

Temperature.		Relative Weight.	Temperature.		Relative Weights.
Degrees F.	Degrees C.		Degrees F.	Degrees C.	
32	0	722.4	86	30	854.0
41	5	789.3	95	35	865.8
50	10	801.2	104	40	880.2
59	15	815.5	113	45	894.2
68	20	828.8	122	50	904.7
77	25	841.3	131	55	915.8

TABLE XII.—RELATIVE HUMIDITY, PER CENT—FAHRENHEIT TEMPERATURES.
Pressure = 30.0 inches.

Air Temp. t	Depression of Wet-bulb Thermometer ($t - t'$).																			
	.2	.4	.6	.8	1.0	1.2	1.4	1.6	1.8	2.0	2.2	2.4	2.6	2.8	3.0	3.2	3.4	3.6	3.8	4.0
-40	46																			
-39	48																			
-38	50	2																		
-37	53	6																		
-36	56	10																		
-35	59	15																		
-34	61	20																		
-33	63	24																		
-32	64	28																		
-31	66	32	0																	
-30	68	36	4																	
-29	70	41	9																	
-28	72	45	15																	
-27	74	48	19																	
-26	75	51	24	0																
-25	76	53	29	5																
-24	77	55	32	10																
-23	78	57	36	15																
-22	80	59	39	20	0															
-21	81	61	43	24	5															
-20	82	63	45	28	10															
-19	83	65	48	32	15															
-18	84	67	51	35	19	2														
-17	85	69	53	39	23	7														
-16	86	70	56	42	27	12														
-15	86	72	58	45	31	17	4													
-14	87	74	61	48	34	21	8													
-13	88	75	63	50	38	25	13	0												
-12	88	76	64	52	41	29	17	6												
-11	89	77	66	55	44	32	21	10												
-10	90	78	68	57	46	36	25	14	4											
-9	90	79	70	59	49	39	29	18	9											
-8	90	81	71	61	51	42	32	22	13	3										
-7	91	82	72	63	54	44	35	26	17	8										
-6	91	82	73	64	56	47	38	29	20	12	3									
-5	91	83	75	66	58	49	41	32	24	16	7									
-4	92	84	76	68	60	52	44	36	28	20	12	4								
-3	92	85	77	69	61	54	46	39	31	23	16	8								
-2	92	85	78	71	63	56	49	42	34	27	19	12	5							
-1	93	86	79	72	65	58	51	44	37	30	23	16	10	3						
0	93	87	80	73	67	60	53	47	40	33	27	20	14	7	1					
+1	93	87	81	75	68	62	56	49	43	36	30	24	18	11	5					
2	94	88	82	76	70	64	58	52	46	39	33	27	21	15	9	3				
3	94	88	82	77	71	65	59	54	48	42	36	30	25	19	13	7	2			
4	94	89	83	78	72	66	61	55	50	44	39	33	28	22	17	11	6	0		
5	95	89	84	78	73	68	65	57	52	46	41	36	31	25	20	15	10	4		
6	95	90	84	79	74	69	64	59	54	49	43	38	33	28	23	18	13	8	3	
7	95	90	85	80	75	70	65	60	55	51	46	41	36	31	26	21	17	12	7	2
8	95	90	86	81	76	71	67	62	57	53	48	43	38	34	29	24	20	15	11	6
9	95	91	86	82	77	72	68	63	59	55	50	46	41	36	32	27	23	18	14	10
10	96	91	87	82	78	73	69	65	60	56	52	47	43	39	34	30	26	22	17	13
11	96	91	87	83	79	74	70	66	62	58	53	49	45	41	37	33	28	25	20	16
12	96	92	88	84	80	75	71	67	63	59	55	51	47	43	39	35	31	27	23	19
13	96	92	88	84	80	76	73	69	65	61	57	53	49	45	41	38	34	30	26	23
14	96	92	89	85	81	77	74	70	66	62	59	55	51	48	44	40	37	33	29	26
15	96	93	89	86	82	78	75	71	67	64	60	57	53	50	46	42	39	35	32	29
16	96	93	90	86	82	79	76	72	69	65	62	58	55	51	48	45	41	38	34	31
17	97	93	90	86	83	80	77	73	70	66	63	60	57	53	50	47	43	40	37	34
18	97	93	90	87	84	80	77	74	71	68	65	61	58	55	52	49	45	42	39	36
19	97	94	90	87	84	81	78	75	72	69	66	63	60	56	53	50	47	44	41	38
20	97	94	91	88	85	82	79	76	73	70	67	64	61	58	55	52	49	46	43	40

t'	$(t - t')$									
	4.2	4.4	4.6	4.8	5.0	5.2	5.4	5.6	5.8	6.0
8	1									
9	5									
10	9	5	0							
11	12	8	4	0						
12	16	12	8	4	0					
13	19	15	11	7	4	0				
14	22	18	15	11	8	4	0			
15	25	21	18	14	11	7	4	0		
16	28	24	21	18	14	11	8	4	1	
17	30	27	24	21	17	14	11	8	5	1
18	33	30	27	24	20	17	14	11	8	5
19	35	32	29	26	23	20	17	14	11	8
20	37	34	32	29	26	23	20	17	14	12

t'	$(t - t')$				
	0.1	0.2	0.3	0.4	0.5
-50	50				
-49	54	5			
-48	57	12			
-47	60	17			
-46	63	22			
-45	66	28			
-44	68	32			
-43	70	36	3		
-42	71	40	9		
-41	72	43	14		
-40	73	46	18		
-39	74	48	22		
-38	75	50	25	2	
-37	76	53	28	6	
-36	77	56	33	10	
-35	78	59	37	15	0
-34	80	61	41	20	5
-33	81	63	44	24	10
-32	82	64	46	28	15
-31	83	66	49	32	20
-30	84	68	52	36	25

TABLE XII.—Continued.

Air Temp. t	Depression of Wet-bulb Thermometer ($t - t'$).																				
	0.5	1.0	1.5	2.0	2.5	3.0	3.5	4.0	4.5	5.0	5.5	6.0	6.5	7.0	7.5	8.0	8.5	9.0	9.5	10.0	10.5
20	92	85	77	70	62	55	48	40	33	26	19	12	5								
21	92	85	78	71	63	56	49	42	35	28	21	15	8	1							
22	93	85	78	71	65	58	51	44	37	31	24	17	11	4							
23	93	86	79	72	66	59	52	46	39	33	26	20	14	7							
24	93	87	80	73	67	60	54	47	41	35	29	22	16	10	1						
25	94	87	81	74	68	62	55	49	43	37	31	25	19	13	7						
26	94	87	81	75	69	63	57	51	45	39	33	27	21	16	10						
27	94	88	82	76	70	64	58	52	47	41	35	29	24	18	13						
28	94	88	82	76	71	65	59	54	48	43	37	32	26	21	15						
29	94	88	83	77	72	66	60	55	50	44	39	34	28	23	18						
30	94	89	83	78	73	67	62	56	51	46	41	36	31	26	21	16					
31	94	89	84	78	73	68	63	58	52	47	42	37	33	28	23	18					
32	95	89	84	79	74	69	64	59	54	49	44	39	35	30	25	20					
33	95	90	85	80	75	70	65	60	56	51	46	41	37	32	27	23					
34	95	90	86	81	76	71	66	62	57	52	48	43	38	34	29	25					
35	95	91	86	81	77	72	67	63	58	54	49	45	40	36	32	27					
36	95	91	86	82	77	73	68	64	60	55	51	46	42	38	34	29					
37	95	91	87	83	78	74	69	65	61	57	53	48	44	40	36	31					
38	96	91	87	83	79	75	70	66	62	58	54	50	46	42	37	33					
39	96	92	87	83	79	75	71	67	63	59	55	51	47	43	39	35					
40	96	92	87	83	79	75	71	68	64	60	56	52	48	45	41	37					
41	96	92	88	84	80	76	72	69	65	61	57	54	50	46	42	39					
42	96	92	88	85	81	77	73	69	65	62	58	55	51	47	44	40					
43	96	92	88	85	81	77	73	70	66	63	59	55	52	48	45	42					
44	96	93	89	85	81	78	74	71	67	63	60	56	53	49	46	43					
45	96	93	89	86	82	78	74	71	67	64	61	57	54	51	47	44					
46	96	93	89	86	82	79	75	72	68	65	61	58	55	52	48	45					
47	96	93	90	86	82	79	75	72	69	66	62	59	56	53	49	46					
48	96	93	90	86	83	79	76	73	69	66	63	60	57	54	50	47					
49	96	93	90	86	83	80	76	73	70	67	64	61	57	54	51	48					
50	96	93	90	87	83	80	77	74	71	67	64	61	58	55	52	49					
51	97	94	90	87	84	81	78	75	71	68	65	62	59	56	53	50					
52	97	94	90	87	84	81	78	75	72	69	66	63	60	57	54	51					
53	97	94	90	87	84	81	78	75	72	69	66	63	61	58	55	52					
54	97	94	91	88	85	82	79	76	73	70	67	64	61	59	56	53					
55	97	94	91	88	85	82	79	76	73	70	68	65	62	59	57	54					
56	97	94	91	88	85	82	79	76	73	71	68	65	63	60	57	55					
57	97	94	91	88	85	82	80	77	74	71	69	66	63	61	58	55					
58	97	94	91	88	85	83	80	77	74	72	69	66	64	61	59	56					
59	97	94	91	89	86	83	80	78	75	72	70	67	65	62	59	57					
60	97	94	91	89	86	83	81	78	75	73	70	68	65	63	60	58					
61	97	94	92	89	86	84	81	78	76	73	71	68	65	63	61	58					
62	97	94	92	89	86	84	81	79	76	74	71	69	66	64	61	59					
63	97	95	92	89	87	84	82	79	77	74	71	69	67	64	62	60					
64	97	95	92	90	87	84	82	79	77	74	72	70	67	65	63	60					
65	97	95	92	90	87	85	82	80	77	75	72	70	68	66	63	61					
66	97	95	92	90	87	85	82	80	78	75	73	71	68	66	64	61					
67	97	95	92	90	87	85	83	80	78	75	73	71	69	66	64	62					
68	97	95	92	90	88	85	83	80	78	76	74	71	69	67	65	62					
69	97	95	93	90	88	85	83	81	79	76	74	72	70	67	65	63					
70	98	95	93	90	88	86	83	81	79	77	74	72	70	68	66	64					
71	98	95	93	90	88	86	84	81	79	77	75	72	70	68	66	64					
72	98	95	93	91	88	86	84	82	79	77	75	73	71	69	67	65					
73	98	95	93	91	88	86	84	82	80	78	75	73	71	69	67	65					
74	98	95	93	91	89	86	84	82	80	78	76	74	71	69	67	65					
75	98	96	93	91	89	86	84	82	80	78	76	74	72	70	68	66					
76	98	96	93	91	89	87	85	83	81	79	77	75	73	71	69	67					
77	98	96	93	91	89	87	85	83	81	79	77	74	72	71	69	67					
78	98	96	93	91	89	87	85	83	81	79	77	75	73	71	69	67					
79	98	96	93	91	89	87	85	83	81	79	77	75	73	71	69	68					
80	98	96	94	91	89	87	85	83	81	79	77	75	74	72	70	68					

TABLE XII.—Continued.

Air Temp. <i>t</i>	Depression of Wet-bulb Thermometer (<i>t - t'</i>).																				
	11.0	11.5	12.0	12.5	13.0	13.5	14.0	14.5	15.0	15.5	16.0	16.5	17.0	17.5	18.0	18.5	19.0	19.5	20.0	20.5	21.0
35	2																				
36	5	I																			
37	7	3																			
38	10	6	2																		
39	12	8	5	I																	
40	15	11	7	4	0																
41	17	13	10	6	3																
42	19	16	12	9	5		2														
43	21	18	14	11	8		4	I													
44	23	20	16	13	10		7	4													
45	25	22	18	15	12		9	6	3												
46	26	23	20	17	14		11	8	5	2											
47	28	25	22	19	16		13	10	7	5	2										
48	29	26	23	21	18		15	12	9	7	4										
49	31	28	25	22	19		17	14	11	9	6		I								
50	32	29	27	24	21		18	16	13	10	8		5	3							
51	34	31	28	26	23		20	17	15	12	9		7	4							
52	35	32	29	27	24		22	19	17	14	11		9	6		I					
53	36	33	31	28	26		23	20	18	16	13		10	8		6	3				
54	37	35	32	29	27		24	22	20	17	15		12	10		8	5		I		
55	38	36	33	31	28		26	23	21	19	16		14	12		9	7		2		
56	39	37	34	32	30		27	25	22	20	18		16	13		11	9		5		
57	40	38	35	33	31		28	26	24	22	19		17	15		13	10		6		
58	41	39	37	34	32		30	27	25	23	21		18	16		14	12		8		
59	42	40	38	35	33		31	29	26	24	22		20	18		16	13		9		
60	43	41	39	37	34		32	30	28	26	23		21	19		17	15		11		
61	44	42	40	38	35		33	31	29	27	25		22	20		18	16		12		
62	45	43	41	39	36		34	32	30	28	26		24	22		20	18		14		
63	46	44	42	40	37		35	33	31	29	27		25	23		21	19		15		
64	47	45	43	41	38		36	34	32	30	28		26	24		22	20		17		
65	48	46	44	41	39		37	35	33	31	29		27	25		24	22		18		
66	48	46	44	42	40		38	36	34	32	30		29	27		25	23		19		
67	49	47	45	43	41		39	37	35	33	31		30	28		26	24		20		
68	50	48	46	44	42		40	38	36	34	32		31	29		27	25		21		
69	51	49	47	45	43		41	39	37	35	33		32	30		28	26		23		
70	51	49	48	46	44		42	40	38	36	34		33	31		29	27		24		
71	52	50	48	46	45		43	41	39	37	35		34	32		30	28		25		
72	53	51	49	47	45		44	42	40	38	36		35	33		31	29		26		
73	53	51	50	48	46		44	42	40	39	37		35	34		32	30		27		
74	54	52	50	48	47		45	43	41	39	38		36	34		33	31		28		
75	54	53	51	49	47		45	44	42	40	39		37	35		34	32		29		
76	55	53	51	50	48		46	44	43	41	39		38	36		35	33		30		
77	56	54	52	50	48		47	45	43	42	40		39	37		36	34		31		
78	56	54	53	51	49		47	46	44	43	41		39	38		36	34		31		
79	57	55	53	51	50		48	46	45	43	42		40	38		37	35		32		
80	57	55	54	52	50		49	47	45	44	42		41	39		38	36		33		

<i>t</i>	<i>(t - t')</i>														
	21.5	22.0	22.5	23.0	23.5	24.0	24.5	25.0	25.5	26.0	26.5	27.0	27.5	28.0	28.5
61	I														
62	2	I													
63	4	2		0											
64	6	4	2	0											
65	7	5	4	2	0										
66	9	7	5	3	2	0									
67	10	8	7	5	3	2	0								
68	11	10	8	6	5	3	2								
69	13	11	9	8	6	5	3	I							
70	14	12	11	9	8	6	4	3	I						
71	15	13	12	10	9	7	6	4	3	I					
72	16	15	13	12	10	9	7	6	4	3	I				
73	17	16	14	13	11	10	8	7	5	4	I				
74	18	17	15	14	13	11	10	8	7	5	I				
75	20	18	17	15	14	12	11	9	8	7	5	I			
76	21	19	18	16	15	13	12	11	9	8	7	5	I		
77	22	20	19	17	16	14	13	12	10	9	8	7	5	I	
78	23	21	20	18	17	16	14	13	11	10	9	8	7	5	I
79	23	22	21	19	18	17	15	14	13	11	10	9	7	6	5
80	24	23	22	20	19	18	16	15	14	12	11	10	9	7	6

TABLE XII.—Continued.

Air Temp. <i>t</i>	Depression of Wet-bulb Thermometer ($t - t'$).														
	1	2	3	4	5	6	7	8	9	10	11	12	13	14	15
80	96	91	87	83	79	75	72	68	64	61	57	54	50	47	44
82	96	92	88	84	80	76	72	69	65	61	58	55	51	48	45
84	96	92	88	84	80	76	73	69	66	62	59	56	52	49	46
86	96	92	88	84	81	77	73	70	66	63	60	57	53	50	47
88	96	92	88	85	81	77	74	70	67	64	61	57	54	51	48
90	96	92	89	85	81	78	74	71	68	65	61	58	55	52	49
92	96	92	89	85	82	78	75	72	68	65	62	59	56	53	50
94	96	93	89	85	82	79	75	72	69	66	63	60	57	54	51
96	96	93	89	86	82	79	76	73	69	66	63	61	58	55	52
98	96	93	89	86	83	79	76	73	70	67	64	61	58	56	53
100	96	93	89	86	83	80	77	73	70	68	65	62	59	56	54
102	96	93	90	86	83	80	77	74	71	68	65	62	60	57	55
104	97	93	90	87	83	80	77	74	71	69	66	63	60	58	55
106	97	93	90	87	84	81	78	75	72	70	66	64	61	58	56
108	97	93	90	87	84	81	78	75	72	70	67	64	62	59	57
110	97	93	90	87	84	81	78	75	73	70	67	65	62	60	57
112	97	94	90	87	84	81	79	76	73	70	68	65	63	60	58
114	97	94	91	88	85	82	79	76	74	71	68	66	63	61	58
116	97	94	91	88	85	82	79	76	74	71	69	66	64	61	59
118	97	94	91	88	85	82	79	77	74	72	69	67	64	62	59
120	97	94	91	88	85	82	80	77	74	72	69	67	65	62	60
122	97	94	91	88	85	83	80	77	75	72	70	67	65	63	60
124	97	94	91	88	85	83	80	78	75	73	70	68	65	63	61
126	97	94	91	88	86	83	80	78	75	73	70	68	66	64	61
128	97	94	91	89	86	83	81	78	76	73	71	68	66	64	62
130	97	94	91	89	86	83	81	78	76	73	71	69	67	64	62
132	97	94	92	89	86	84	81	79	76	74	71	69	67	65	63
134	97	94	92	89	86	84	81	79	76	74	72	69	67	65	63
136	97	94	92	89	86	84	81	79	77	74	72	70	68	65	63
138	97	94	92	89	87	84	82	79	77	75	72	70	68	66	64
140	97	95	92	89	87	84	82	79	77	75	73	70	68	66	64

<i>t</i>	Depression of Wet-bulb Thermometer ($t - t'$).														
	16	17	18	19	20	21	22	23	24	25	26	27	28	29	30
80	41	38	35	32	29	26	23	20	18	15	12	10	7	5	3
82	42	39	36	33	30	28	25	22	20	17	14	12	10	7	5
84	43	40	37	35	32	29	26	24	21	19	16	14	12	9	7
86	44	42	39	36	33	31	28	26	23	21	18	16	14	11	9
88	46	43	40	37	35	32	30	27	25	22	20	18	15	13	11
90	47	44	41	39	36	34	31	29	26	24	22	19	17	15	13
92	48	45	42	40	37	35	32	30	28	25	23	21	19	17	15
94	49	46	43	41	38	36	33	31	29	27	24	22	20	18	16
96	50	47	44	42	39	37	35	32	30	28	26	24	22	20	18
98	50	48	45	43	40	38	36	34	32	29	27	25	23	21	19
100	51	49	46	44	41	39	37	35	33	30	28	26	24	22	21
102	52	49	47	45	42	40	38	36	34	32	30	28	26	24	22
104	53	50	48	46	43	41	39	37	35	33	31	29	27	25	23
106	53	51	49	46	44	42	40	38	36	34	32	30	28	26	24
108	54	52	49	47	45	43	41	39	37	35	33	31	29	27	25
110	55	52	50	48	46	44	42	40	38	36	34	32	30	28	26
112	55	53	51	49	47	44	42	40	38	36	35	33	31	29	27
114	56	54	52	49	47	45	43	41	39	37	35	34	32	30	28
116	57	54	52	50	48	46	44	42	40	38	36	34	33	31	29
118	57	55	53	51	49	47	45	43	41	39	37	35	34	32	30
120	58	55	53	51	49	47	45	43	41	40	38	36	34	33	31
122	58	56	54	52	50	48	46	44	42	40	39	37	35	34	32
124	59	57	54	52	50	48	47	45	43	41	39	38	36	34	33
126	59	57	55	53	51	49	47	45	44	42	40	38	37	35	33
128	60	58	56	54	52	50	48	46	44	42	41	39	37	36	34
130	60	58	56	54	52	50	48	47	45	43	41	40	38	37	35
132	61	58	56	55	53	51	49	47	45	44	42	40	39	37	36
134	61	59	57	55	53	51	49	48	46	44	43	41	39	38	36
136	61	59	57	55	54	52	50	48	46	45	43	41	40	38	37
138	62	60	58	56	54	52	50	49	47	45	44	42	40	39	37
140	62	60	58	56	54	53	51	49	47	46	44	43	41	40	38

TABLE XII.—*Concluded.*

Air Temp. <i>t</i>	Depression of Wet-bulb Thermometer (<i>t</i> - <i>t'</i>).														
	31	32	33	34	35	36	37	38	39	40	41	42	43	44	45
80	0														
82	2	0													
84	5	3	0												
86	7	5	3	1											
88	9	7	5	3	1										
90	11	9	7	5	3	1									
92	13	11	9	7	5	3	1								
94	14	12	10	9	7	5	3	1							
96	16	14	12	10	8	7	5	3	2	0					
98	17	15	14	12	10	8	7	5	3	2	0				
100	19	17	15	13	12	10	8	7	5	4	2	1			
102	20	18	16	15	13	11	10	8	7	5	4	2	1		
104	21	20	18	16	14	13	11	10	8	7	5	4	2	1	
106	23	21	19	17	16	14	13	11	10	8	7	5	4	3	1
108	24	22	20	19	17	16	14	12	11	10	8	7	5	4	3
110	25	23	21	20	18	17	15	14	12	11	10	8	7	6	4
112	26	24	23	21	19	18	16	15	14	12	11	9	8	7	6
114	27	25	24	22	20	19	18	16	15	13	12	11	9	8	7
116	28	26	25	23	22	20	19	17	16	14	13	12	11	9	8
118	29	27	25	24	23	21	20	18	17	16	14	13	12	11	9
120	29	28	26	25	23	22	21	19	18	17	15	14	13	12	10
122	30	29	27	26	24	23	22	20	19	18	16	15	14	13	11
124	31	30	28	27	25	24	22	21	20	18	17	16	15	14	12
126	32	30	29	27	26	25	23	22	21	20	18	17	16	15	13
128	33	31	30	28	27	25	24	23	22	20	19	18	17	16	14
130	33	32	30	29	28	26	25	24	22	21	20	19	18	16	15
132	34	33	31	30	28	27	26	24	23	22	21	20	18	17	16
134	35	33	32	30	29	28	26	25	24	23	21	20	19	18	17
136	35	34	33	31	30	28	27	26	25	23	22	21	20	19	18
138	36	35	33	32	30	29	28	27	25	24	23	22	21	20	19
140	37	35	34	32	31	30	29	27	26	25	24	23	21	20	19

<i>t</i>	Depression of Wet-bulb Thermometer (<i>t</i> - <i>t'</i>).														
	46	47	48	49	50	51	52	53	54	55	56	57	58	59	60
106	0														
108	2	0													
110	3	2	1												
112	4	3	2	1											
114	6	5	3	2	1										
116	7	6	5	4	2	1									
118	8	7	6	5	4	3	2	1							
120	9	8	7	6	5	4	3	2	1						
122	10	9	8	7	6	5	4	3	2	1	0				
124	11	10	9	8	7	6	5	4	3	2	1	0			
126	12	11	10	9	8	7	6	5	4	3	2	2	1		
128	13	12	11	10	9	8	7	6	5	4	3	2	1	1	0
130	14	13	12	11	10	9	8	7	6	5	4	3	2	2	1
132	15	14	13	12	11	10	9	8	7	6	5	4	3	3	2
134	16	15	14	13	12	11	10	9	8	7	6	5	4	4	3
136	17	16	15	14	13	12	11	10	9	8	7	6	5	5	4
138	17	16	15	14	13	12	11	10	9	8	7	6	5	6	5
140	18	17	16	15	14	13	12	11	10	9	8	7	7	7	6

TABLE XIII.—PROPERTIES OF SATURATED STEAM.

Press. lbs.	Temp. Deg. F.	Press. Atmos.*	Sp. Vol., cu. ft. per lb.	Density, lbs. per cu. ft.	Heat of the Liquid	Latent Heat of Evap.	Total Heat of Steam.	Internal Energy. B.t.u.		Entropy.			Press. lbs.
								Evap.	Steam.	Water.	Evap. L/T or r/T	Steam. N or ϕ	
<i>p</i>	<i>t</i>	—	<i>v</i> or <i>s</i>	<i>1/v</i>	<i>h</i> or <i>q</i>	<i>L</i> or <i>r</i>	<i>H</i>	<i>I</i> or <i>\rho</i>	<i>E</i>	<i>n</i> or <i>\theta</i>	<i>L/T</i> or <i>r/T</i>	<i>N</i> or <i>\phi</i>	<i>p</i>
1	101.83	0.068	333.0	0.00300	69.8	1034.6	1104.4	972.9	1042.7	0.1327	1.8427	1.0754	1
2	126.15	0.136	173.5	0.00576	94.0	1021.0	1113.0	956.7	1050.7	0.1749	1.7431	1.0180	2
3	141.52	0.204	118.5	0.00845	109.4	1012.3	1121.6	946.4	1055.8	0.2006	1.6840	1.8848	3
4	153.01	0.272	90.5	0.01107	120.9	1005.7	1126.5	938.6	1059.5	0.2198	1.6416	1.8614	4
5	162.28	0.340	73.33	0.01364	130.1	1000.3	1130.5	932.4	1062.5	0.2348	1.6084	1.8432	5
6	170.06	0.408	61.89	0.01616	137.9	995.8	1133.7	927.0	1064.9	0.2471	1.5814	1.8285	6
7	176.85	0.476	53.56	0.01867	144.7	991.8	1136.5	922.4	1067.1	0.2579	1.5582	1.8161	7
8	182.86	0.544	47.27	0.02115	150.8	988.2	1139.0	918.2	1069.0	0.2673	1.5380	1.8053	8
9	188.27	0.612	42.36	0.02361	156.2	985.0	1141.1	914.4	1070.5	0.2756	1.5202	1.7958	9
10	193.22	0.680	38.38	0.02606	161.1	982.0	1143.1	910.9	1072.0	0.2832	1.5042	1.7874	10
11	197.75	0.748	35.10	0.02849	165.7	979.2	1144.9	907.8	1073.4	0.2902	1.4895	1.7797	11
12	201.96	0.816	32.36	0.03090	169.9	976.6	1146.5	904.8	1074.7	0.2967	1.4766	1.7727	12
13	205.87	0.885	30.03	0.03330	173.8	974.2	1148.0	902.0	1075.8	0.3025	1.4639	1.7664	13
14	209.55	0.953	28.02	0.03569	177.5	971.9	1149.4	899.3	1076.8	0.3081	1.4523	1.7604	14
15	213.0	1.021	26.27	0.03806	181.0	969.7	1150.7	896.8	1077.8	0.3133	1.4416	1.7549	15
16	216.3	1.089	24.79	0.04042	184.4	967.6	1152.0	894.4	1078.7	0.3183	1.4311	1.7494	16
17	219.4	1.157	23.38	0.04277	187.5	965.6	1153.1	892.1	1079.6	0.3229	1.4215	1.7447	17
18	222.4	1.225	22.16	0.04512	190.5	963.7	1154.2	889.9	1080.4	0.3273	1.4127	1.7400	18
19	225.2	1.293	21.07	0.04748	193.4	961.8	1155.2	887.8	1081.1	0.3315	1.4045	1.7360	19
20	228.0	1.361	20.08	0.04980	196.1	960.0	1156.2	885.8	1081.9	0.3355	1.3965	1.7320	20
21	230.6	1.429	19.18	0.05213	198.8	958.3	1157.1	883.9	1082.6	0.3393	1.3887	1.7280	21
22	233.1	1.497	18.37	0.05445	201.3	956.7	1158.0	882.0	1083.2	0.3430	1.3811	1.7241	22
23	235.5	1.565	17.62	0.05676	203.8	955.1	1158.8	880.2	1083.9	0.3465	1.3739	1.7203	23
24	237.8	1.633	16.93	0.05907	206.1	953.5	1159.6	878.5	1084.5	0.3499	1.3670	1.7169	24
25	240.1	1.701	16.30	0.0614	208.4	952.0	1160.4	876.8	1085.1	0.3532	1.3604	1.7136	25
26	242.2	1.769	15.72	0.0636	210.6	950.6	1161.2	875.1	1085.6	0.3564	1.3542	1.7106	26
27	244.4	1.837	15.18	0.0659	212.7	949.2	1161.9	873.5	1086.2	0.3594	1.3483	1.7077	27
28	246.4	1.905	14.67	0.0682	214.8	947.8	1162.6	872.0	1086.7	0.3623	1.3425	1.7048	28
29	248.4	1.973	14.19	0.0705	216.8	946.4	1163.2	870.5	1087.2	0.3652	1.3367	1.7019	29
30	250.3	2.041	13.74	0.0728	218.8	945.1	1163.9	869.0	1087.7	0.3680	1.3311	1.6991	30
31	252.2	2.109	13.32	0.0751	220.7	943.8	1164.5	867.6	1088.2	0.3707	1.3257	1.6964	31
32	254.1	2.178	12.93	0.0773	222.6	942.5	1165.1	866.2	1088.6	0.3733	1.3205	1.6938	32
33	255.8	2.246	12.57	0.0795	224.4	941.3	1165.7	864.8	1089.1	0.3759	1.3155	1.6914	33
34	257.6	2.314	12.22	0.0818	226.2	940.1	1166.3	863.4	1089.5	0.3784	1.3107	1.6891	34
35	259.3	2.382	11.89	0.0841	227.9	938.9	1166.8	862.1	1089.9	0.3808	1.3060	1.6868	35
36	261.0	2.450	11.58	0.0863	229.6	937.7	1167.3	860.8	1090.3	0.3832	1.3014	1.6846	36
37	262.6	2.518	11.29	0.0886	231.3	936.6	1167.8	859.5	1090.7	0.3855	1.2969	1.6824	37
38	264.2	2.586	11.01	0.0908	232.9	935.5	1168.4	858.3	1091.0	0.3877	1.2925	1.6802	38
39	265.8	2.654	10.74	0.0931	234.5	934.4	1168.9	857.1	1091.4	0.3899	1.2882	1.6781	39
40	267.3	2.722	10.49	0.0953	236.1	933.3	1169.4	855.9	1091.8	0.3920	1.2841	1.6761	40
41	268.7	2.790	10.25	0.0976	237.6	932.2	1169.8	854.7	1092.2	0.3941	1.2800	1.6741	41
42	270.2	2.858	10.02	0.0998	239.1	931.2	1170.3	853.6	1092.5	0.3962	1.2759	1.6721	42
43	271.7	2.926	9.80	0.1020	240.5	930.2	1170.7	852.4	1092.8	0.3982	1.2720	1.6702	43
44	273.1	2.994	9.59	0.1043	242.0	929.2	1171.2	851.3	1093.2	0.4002	1.2681	1.6683	44
45	274.5	3.062	9.39	0.1065	243.4	928.2	1171.6	850.3	1093.5	0.4021	1.2644	1.6665	45
46	275.8	3.130	9.20	0.1087	244.8	927.2	1172.0	849.2	1093.8	0.4040	1.2607	1.6647	46
47	277.2	3.198	9.02	0.1109	246.1	926.3	1172.4	848.1	1094.1	0.4059	1.2571	1.6630	47
48	278.5	3.266	8.84	0.1131	247.5	925.3	1172.8	847.1	1094.4	0.4077	1.2536	1.6613	48
49	279.8	3.334	8.67	0.1153	248.8	924.4	1173.2	846.1	1094.7	0.4095	1.2502	1.6597	49

* 1 atmo. (standard atmosphere) = 760 mms. of Hg. by def. = 29.921 ins. of Hg. = 14.696 lbs. per sq. in.
 $T^{\circ} = t^{\circ} + 459.6$; $J = 777.5$ ft.-lbs. per B.t.u. [$\log = 2.89071$]; $A = 1/J = 1.286 \times 10^{-3}$; $144 A = 0.1852$ [$\log = 1.26764$].

For water, at 15 lbs., sp. vol., v' or $\sigma = 0.0167$ cu. ft. per lb.; $1/v' = 59.8$ lbs. per cu. ft.; $144 A p v' = 0.05$ B.t.u.

For water, at 40 lbs., sp. vol., v' or $\sigma = 0.0171$ cu. ft. per lb.; $1/v' = 58.3$ lbs. per cu. ft.; $144 A p v' = 0.13$ B.t.u.

TABLE XIII.—PROPERTIES OF SATURATED STEAM.—Continued.

Press. lbs.	Temp. Deg. F.	Press. Atmos.*	Sp. Vol., cu. ft. per lb.	Density, lbs. per cu. ft.	Heat of the Liquid	Latent Heat of Evap.	Total Heat of Steam.	Internal Energy. B.t.u.		Entropy.			Press. lbs.
								Evap.	Steam.	Water.	Evap. L/T	Steam.	
p	t	—	r or s	I/v	h or q	L or r	H	I or p	E	n or θ	N or φ	p	
50	281.0	3.402	8.51	0.1175	250.1	923.5	1173.6	845.0	1095.0	0.4113	1.2468	1.6581	50
51	282.3	3.470	8.35	0.1107	251.4	922.6	1174.0	844.0	1095.3	0.4130	1.2435	1.6565	51
52	283.5	3.538	8.20	0.1210	252.6	921.7	1174.3	843.1	1095.5	0.4147	1.2402	1.6549	52
53	284.7	3.606	8.05	0.1241	253.9	920.8	1174.7	842.1	1095.8	0.4164	1.2370	1.6534	53
54	285.9	3.674	7.91	0.1263	255.1	919.9	1175.0	841.1	1096.1	0.4180	1.2339	1.6519	54
55	287.1	3.742	7.78	0.1285	256.3	919.0	1175.4	840.2	1096.3	0.4196	1.2309	1.6505	55
56	288.2	3.810	7.65	0.1307	257.5	918.2	1175.7	839.3	1096.6	0.4212	1.2278	1.6490	56
57	289.4	3.878	7.52	0.1329	258.7	917.4	1176.0	838.3	1096.8	0.4227	1.2248	1.6475	57
58	290.5	3.947	7.40	0.1350	259.8	916.5	1176.4	837.4	1097.1	0.4242	1.2218	1.6460	58
59	291.6	4.015	7.28	0.1372	261.0	915.7	1176.7	836.5	1097.3	0.4257	1.2189	1.6446	59
60	292.7	4.083	7.17	0.1394	262.1	914.9	1177.0	835.6	1097.6	0.4272	1.2160	1.6432	60
61	293.8	4.151	7.05	0.1416	263.2	914.1	1177.3	834.8	1097.8	0.4287	1.2132	1.6419	61
62	294.9	4.219	6.95	0.1438	264.3	913.3	1177.6	833.9	1098.0	0.4302	1.2104	1.6406	62
63	295.9	4.287	6.85	0.1460	265.4	912.5	1177.9	833.1	1098.2	0.4316	1.2077	1.6393	63
64	297.0	4.355	6.75	0.1482	266.4	911.8	1178.2	832.2	1098.4	0.4330	1.2050	1.6380	64
65	298.0	4.423	6.65	0.1503	267.5	911.0	1178.5	831.4	1098.7	0.4344	1.2034	1.6368	65
66	299.0	4.491	6.56	0.1525	268.5	910.2	1178.8	830.5	1098.9	0.4358	1.2007	1.6355	66
67	300.0	4.559	6.47	0.1547	269.6	909.5	1179.0	829.7	1099.1	0.4371	1.1972	1.6343	67
68	301.0	4.627	6.38	0.1569	270.6	908.7	1179.3	828.9	1099.3	0.4385	1.1946	1.6331	68
69	302.0	4.695	6.29	0.1590	271.6	908.0	1179.6	828.1	1099.5	0.4398	1.1921	1.6319	69
70	302.9	4.763	6.20	0.1612	272.6	907.2	1179.8	827.3	1099.7	0.4411	1.1896	1.6307	70
71	303.9	4.831	6.12	0.1634	273.6	906.5	1180.1	826.5	1099.9	0.4424	1.1872	1.6296	71
72	304.8	4.899	6.04	0.1656	274.5	905.8	1180.4	825.8	1100.1	0.4437	1.1848	1.6285	72
73	305.8	4.967	5.96	0.1678	275.5	905.1	1180.6	825.0	1100.3	0.4449	1.1825	1.6274	73
74	306.7	5.035	5.89	0.1699	276.5	904.4	1180.9	824.2	1100.5	0.4462	1.1801	1.6263	74
75	307.6	5.103	5.81	0.1721	277.4	903.7	1181.1	823.5	1100.6	0.4474	1.1778	1.6252	75
76	308.5	5.171	5.74	0.1743	278.3	903.0	1181.4	822.7	1100.8	0.4487	1.1755	1.6242	76
77	309.4	5.239	5.67	0.1765	279.3	902.3	1181.6	822.0	1101.0	0.4499	1.1732	1.6231	77
78	310.3	5.307	5.60	0.1787	280.2	901.7	1181.8	821.3	1101.2	0.4511	1.1710	1.6221	78
79	311.2	5.375	5.54	0.1808	281.1	901.0	1182.1	820.6	1101.4	0.4523	1.1687	1.6210	79
80	312.0	5.444	5.47	0.1829	282.0	900.3	1182.3	819.8	1101.6	0.4535	1.1665	1.6200	80
81	312.9	5.512	5.41	0.1851	282.9	899.7	1182.5	819.1	1101.7	0.4546	1.1644	1.6190	81
82	313.8	5.580	5.34	0.1873	283.8	899.0	1182.8	818.4	1101.9	0.4557	1.1623	1.6180	82
83	314.6	5.648	5.28	0.1894	284.6	898.4	1183.0	817.7	1102.1	0.4568	1.1602	1.6170	83
84	315.4	5.716	5.22	0.1915	285.5	897.7	1183.2	817.0	1102.2	0.4579	1.1581	1.6160	84
85	316.3	5.784	5.16	0.1937	286.3	897.1	1183.4	816.3	1102.4	0.4590	1.1561	1.6151	85
86	317.1	5.852	5.10	0.1959	287.2	896.4	1183.6	815.6	1102.6	0.4601	1.1540	1.6141	86
87	317.9	5.920	5.05	0.1980	288.0	895.8	1183.8	815.0	1102.7	0.4612	1.1520	1.6132	87
88	318.7	5.988	5.00	0.2001	288.9	895.2	1184.0	814.3	1102.9	0.4623	1.1500	1.6123	88
89	319.5	6.056	4.94	0.2023	289.7	894.6	1184.2	813.6	1103.0	0.4633	1.1481	1.6114	89
90	320.3	6.124	4.89	0.2044	290.5	893.9	1184.4	813.0	1103.2	0.4644	1.1461	1.6105	90
91	321.1	6.192	4.84	0.2065	291.3	893.3	1184.6	812.3	1103.3	0.4654	1.1442	1.6096	91
92	321.8	6.260	4.79	0.2087	292.1	892.7	1184.8	811.7	1103.5	0.4664	1.1423	1.6087	92
93	322.6	6.328	4.74	0.2109	292.9	892.1	1185.0	811.0	1103.6	0.4674	1.1404	1.6078	93
94	323.4	6.396	4.69	0.2130	293.7	891.5	1185.2	810.4	1103.8	0.4684	1.1385	1.6069	94
95	324.1	6.464	4.65	0.2151	294.5	890.9	1185.4	809.7	1103.9	0.4694	1.1367	1.6061	95
96	324.9	6.532	4.60	0.2172	295.3	890.3	1185.6	809.1	1104.1	0.4704	1.1348	1.6052	96
97	325.6	6.600	4.56	0.2193	296.1	889.7	1185.8	808.5	1104.2	0.4714	1.1330	1.6044	97
98	326.4	6.668	4.51	0.2215	296.8	889.0	1186.0	807.9	1104.4	0.4724	1.1312	1.6036	98
99	327.1	6.736	4.47	0.2237	297.6	888.6	1186.2	807.2	1104.5	0.4733	1.1295	1.6028	99

* 1 atm. (standard atmosphere) = 760 mms. of Hg. by def. = 29.921 ins. of Hg. = 14.696 lbs. per sq. in.
 $T^{\circ} = t^{\circ} + 459.6$; $J = 777.5$ ft.-lbs. per B.t.u. [$\log = 2.8907$]; $A = 1/J = 1.286 \times 10^{-3}$; $144 A = 0.1852$ [$\log = 1.26764$].
 For water, at 65 lbs., sp. vol., v' or $\sigma = 0.0174$ cu. ft. per lb.; $1/v' = 57.4$ lbs. per cu. ft.; $144 A p v' = 0.21$ B.t.u.
 For water, at 90 lbs., sp. vol., v' or $\sigma = 0.0175$ cu. ft. per lb.; $1/v' = 56.8$ lbs. per cu. ft.; $144 A p v' = 0.30$ B.t.u.

TABLE XIII.—PROPERTIES OF SATURATED STEAM.—Continued.

Press. lbs.	Temp. Deg. F.	Press. Atmos.*	Sp. Vol., cu. ft. per lb.	Density, lbs. per cu. ft.	Heat of the Liquid	Latent Heat of Evap.	Total Heat of Steam.	Internal Energy. B.t.u.		Entropy.			Press. lbs.
								Evap.	Steam.	Water. # or θ	Evap. L/T or r/T	Steam. N or φ	
100	327.8	6.80	4.420	0.2258	208.3	888.0	1186.3	806.6	1104.6	0.4743	1.1277	1.6020	100
101	328.6	6.87	4.388	0.2279	209.1	887.4	1186.5	806.0	1104.8	0.4752	1.1260	1.6012	101
102	329.3	6.94	4.347	0.2300	209.8	886.9	1186.7	805.4	1104.9	0.4762	1.1242	1.6004	102
103	330.0	7.01	4.307	0.2322	300.6	886.3	1186.9	804.8	1105.0	0.4771	1.1225	1.5996	103
104	330.7	7.08	4.268	0.2343	301.3	885.8	1187.0	804.2	1105.1	0.4780	1.1208	1.5988	104
105	331.4	7.14	4.230	0.2365	302.0	885.2	1187.2	803.6	1105.3	0.4789	1.1191	1.5980	105
106	332.0	7.21	4.192	0.2386	302.7	884.7	1187.4	803.0	1105.4	0.4798	1.1174	1.5972	106
107	332.7	7.28	4.155	0.2408	303.4	884.1	1187.5	802.5	1105.5	0.4807	1.1158	1.5965	107
108	333.4	7.35	4.118	0.2429	304.1	883.6	1187.7	801.9	1105.7	0.4816	1.1141	1.5957	108
109	334.1	7.42	4.082	0.2450	304.8	883.0	1187.9	801.3	1105.8	0.4825	1.1125	1.5950	109
110	334.8	7.49	4.047	0.2472	305.5	882.5	1188.0	800.7	1105.9	0.4834	1.1108	1.5942	110
111	335.4	7.55	4.012	0.2493	306.2	881.9	1188.2	800.2	1106.0	0.4843	1.1092	1.5935	111
112	336.1	7.62	3.978	0.2514	306.9	881.4	1188.4	799.6	1106.2	0.4852	1.1076	1.5928	112
113	336.8	7.69	3.945	0.2535	307.6	880.9	1188.5	799.0	1106.3	0.4860	1.1061	1.5921	113
114	337.4	7.76	3.912	0.2556	308.3	880.4	1188.7	798.5	1106.4	0.4869	1.1045	1.5914	114
115	338.1	7.83	3.880	0.2577	309.0	879.8	1188.8	797.9	1106.5	0.4877	1.1030	1.5907	115
116	338.7	7.89	3.848	0.2599	309.6	879.3	1189.0	797.4	1106.6	0.4886	1.1014	1.5900	116
117	339.4	7.96	3.817	0.2620	310.3	878.8	1189.1	796.8	1106.8	0.4894	1.1000	1.5893	117
118	340.0	8.03	3.786	0.2641	311.0	878.3	1189.3	796.3	1106.9	0.4903	1.0984	1.5887	118
119	340.6	8.10	3.756	0.2662	311.6	877.8	1189.4	795.7	1107.0	0.4911	1.0969	1.5880	119
120	341.3	8.17	3.726	0.2683	312.3	877.2	1189.6	795.2	1107.1	0.4919	1.0954	1.5873	120
121	341.9	8.23	3.697	0.2705	313.0	876.7	1189.7	794.7	1107.2	0.4927	1.0939	1.5866	121
122	342.5	8.30	3.668	0.2726	313.6	876.2	1189.8	794.2	1107.3	0.4935	1.0924	1.5859	122
123	343.2	8.37	3.639	0.2748	314.3	875.7	1190.0	793.6	1107.4	0.4943	1.0910	1.5853	123
124	343.8	8.44	3.611	0.2769	314.9	875.2	1190.1	793.1	1107.6	0.4951	1.0895	1.5846	124
125	344.4	8.50	3.583	0.2791	315.5	874.7	1190.3	792.6	1107.7	0.4959	1.0880	1.5839	125
126	345.0	8.57	3.556	0.2812	316.2	874.2	1190.4	792.0	1107.8	0.4967	1.0865	1.5832	126
127	345.6	8.64	3.530	0.2833	316.8	873.8	1190.5	791.5	1107.9	0.4974	1.0851	1.5825	127
128	346.2	8.71	3.504	0.2854	317.4	873.3	1190.7	791.0	1108.0	0.4982	1.0837	1.5818	128
129	346.8	8.78	3.478	0.2875	318.0	872.8	1190.8	790.5	1108.1	0.4990	1.0823	1.5813	129
130	347.4	8.85	3.452	0.2897	318.6	872.3	1191.0	790.0	1108.2	0.4998	1.0809	1.5807	130
131	348.0	8.91	3.427	0.2918	319.3	871.8	1191.1	789.5	1108.3	0.5005	1.0795	1.5801	131
132	348.5	8.98	3.402	0.2939	319.9	871.3	1191.2	789.0	1108.4	0.5013	1.0782	1.5795	132
133	349.1	9.05	3.378	0.2960	320.5	870.9	1191.3	788.5	1108.5	0.5020	1.0768	1.5789	133
134	349.7	9.12	3.354	0.2981	321.1	870.4	1191.5	788.0	1108.6	0.5028	1.0755	1.5783	134
135	350.3	9.19	3.331	0.3002	321.7	869.9	1191.6	787.5	1108.7	0.5035	1.0742	1.5777	135
136	350.8	9.25	3.308	0.3023	322.3	869.4	1191.7	787.0	1108.8	0.5043	1.0728	1.5771	136
137	351.4	9.32	3.285	0.3044	322.8	869.0	1191.8	786.5	1108.9	0.5050	1.0715	1.5765	137
138	352.0	9.39	3.263	0.3065	323.4	868.5	1192.0	786.0	1109.0	0.5057	1.0702	1.5759	138
139	352.5	9.46	3.241	0.3086	324.0	868.1	1192.1	785.5	1109.1	0.5064	1.0688	1.5753	139
140	353.1	9.53	3.219	0.3107	324.6	867.6	1192.2	785.0	1109.2	0.5072	1.0675	1.5747	140
141	353.6	9.59	3.197	0.3129	325.2	867.2	1192.3	784.5	1109.3	0.5079	1.0662	1.5741	141
142	354.2	9.66	3.175	0.3150	325.8	866.7	1192.5	784.1	1109.4	0.5086	1.0649	1.5735	142
143	354.7	9.73	3.154	0.3171	326.3	866.3	1192.6	783.6	1109.5	0.5093	1.0637	1.5730	143
144	355.3	9.80	3.133	0.3192	326.9	865.8	1192.7	783.2	1109.6	0.5100	1.0624	1.5724	144
145	355.8	9.87	3.112	0.3213	327.4	865.4	1192.8	782.7	1109.6	0.5107	1.0612	1.5719	145
146	356.3	9.93	3.092	0.3234	328.0	865.0	1192.9	782.2	1109.7	0.5114	1.0599	1.5713	146
147	356.9	10.00	3.072	0.3255	328.6	864.5	1193.0	781.7	1109.8	0.5121	1.0587	1.5708	147
148	357.4	10.07	3.052	0.3276	329.1	864.0	1193.2	781.3	1109.9	0.5128	1.0574	1.5702	148
149	357.9	10.14	3.033	0.3297	329.7	863.6	1193.3	780.8	1110.0	0.5135	1.0562	1.5697	149

* 1 atmo. (standard atmosphere) = 760 mms. of Hg. by def. = 29.921 ins. of Hg. = 14.696 lbs. per sq. in.
 $T^{\circ} = t^{\circ} + 459.6$; $J = 777.5$ ft.-lbs. per B.t.u. [log = 2.89071]; $A = 1/J = 1.286 \times 10^{-3}$; $144 A = 0.1852$ [log = 1.26764].
 For water, at 115 lbs., sp. vol., v' or $\sigma = 0.0178$ cu. ft. per lb.; $1/v' = 56.0$ lbs. per cu. ft.; $144 A v' = 0.38$ B.t.u.
 For water, at 140 lbs., sp. vol., v' or $\sigma = 0.0180$ cu. ft. per lb.; $1/v' = 55.4$ lbs. per cu. ft.; $144 A v' = 0.47$ B.t.u.

TABLE XIII.—PROPERTIES OF SATURATED STEAM.—Concluded.

Press. lbs.	Temp. Deg. F.	Press. Atmos.*	Sp. Vol., cu. ft. per lb.	Density, lbs. per cu. ft.	Heat of the Liquid	Latent Heat of Evap.	Total Heat of Steam.	Internal Energy, B.t.u.		Entropy.			Press. lbs.
								Evap.	Steam.	Water	Evap. L/T	Steam.	
150	358.5	10.21	3.012	0.3320	330.2	863.2	1193.4	780.4	1110.1	0.5142	1.0550	1.5602	150
152	359.5	10.34	2.974	0.3362	331.4	862.3	1193.6	779.4	1110.3	0.5155	1.0525	1.5680	152
154	360.5	10.48	2.938	0.3404	332.4	861.4	1193.8	778.3	1110.4	0.5169	1.0501	1.5670	154
156	361.6	10.61	2.902	0.3446	333.5	860.6	1194.1	777.6	1110.6	0.5182	1.0477	1.5659	156
158	362.6	10.75	2.868	0.3488	334.6	859.7	1194.3	776.7	1110.8	0.5195	1.0454	1.5649	158
160	363.6	10.89	2.834	0.3529	335.6	858.8	1194.5	775.8	1110.9	0.5208	1.0431	1.5639	160
162	364.6	11.02	2.801	0.3570	336.7	858.0	1194.7	775.0	1111.1	0.5220	1.0409	1.5629	162
164	365.6	11.16	2.769	0.3612	337.7	857.2	1194.9	774.1	1111.2	0.5233	1.0387	1.5620	164
166	366.5	11.30	2.737	0.3654	338.7	856.4	1195.1	773.2	1111.4	0.5245	1.0365	1.5610	166
168	367.5	11.43	2.706	0.3696	339.7	855.5	1195.3	772.4	1111.5	0.5257	1.0343	1.5600	168
170	368.5	11.57	2.675	0.3738	340.7	854.7	1195.4	771.5	1111.7	0.5269	1.0321	1.5590	170
172	369.4	11.70	2.645	0.3780	341.7	853.9	1195.6	770.7	1111.8	0.5281	1.0300	1.5581	172
174	370.4	11.84	2.616	0.3822	342.7	853.1	1195.8	769.8	1112.0	0.5293	1.0278	1.5571	174
176	371.3	11.97	2.588	0.3864	343.7	852.3	1196.0	769.0	1112.1	0.5305	1.0257	1.5562	176
178	372.2	12.11	2.560	0.3906	344.7	851.5	1196.2	768.2	1112.3	0.5317	1.0235	1.5552	178
180	373.1	12.25	2.533	0.3948	345.6	850.8	1196.4	767.4	1112.4	0.5328	1.0215	1.5543	180
182	374.0	12.38	2.507	0.3989	346.6	850.0	1196.6	766.6	1112.6	0.5339	1.0195	1.5534	182
184	374.9	12.51	2.481	0.4031	347.6	849.2	1196.8	765.8	1112.7	0.5351	1.0174	1.5525	184
186	375.8	12.66	2.455	0.4073	348.5	848.4	1196.9	765.0	1112.8	0.5362	1.0154	1.5516	186
188	376.7	12.79	2.430	0.4115	349.4	847.7	1197.1	764.2	1113.0	0.5373	1.0134	1.5507	188
190	377.6	12.93	2.406	0.4157	350.4	846.9	1197.3	763.4	1113.1	0.5384	1.0114	1.5498	190
192	378.5	13.06	2.381	0.4199	351.3	846.1	1197.4	762.6	1113.2	0.5395	1.0095	1.5490	192
194	379.3	13.20	2.358	0.4241	352.2	845.4	1197.6	761.8	1113.4	0.5405	1.0076	1.5481	194
196	380.2	13.34	2.335	0.4283	353.1	844.7	1197.8	761.1	1113.5	0.5416	1.0056	1.5472	196
198	381.0	13.47	2.312	0.4325	354.0	843.9	1197.9	760.3	1113.6	0.5426	1.0038	1.5464	198
200	381.9	13.61	2.290	0.437	354.9	843.2	1198.1	759.5	1113.7	0.5437	1.0019	1.5456	200
205	384.0	13.95	2.237	0.447	357.1	841.4	1198.5	757.6	1114.0	0.5463	0.9973	1.5436	205
210	386.0	14.29	2.187	0.457	359.2	839.6	1198.8	755.8	1114.4	0.5488	0.9928	1.5416	210
215	388.0	14.63	2.138	0.468	361.4	837.9	1199.2	754.0	1114.6	0.5513	0.9885	1.5398	215
220	389.9	14.97	2.091	0.478	363.4	836.2	1199.6	752.3	1114.9	0.5538	0.9841	1.5379	220
225	391.9	15.31	2.046	0.489	365.5	834.4	1199.9	750.5	1115.2	0.5562	0.9799	1.5361	225
230	393.8	15.65	2.004	0.499	367.5	832.8	1200.2	748.8	1115.4	0.5586	0.9758	1.5344	230
235	395.6	15.99	1.964	0.509	369.4	831.1	1200.6	747.0	1115.7	0.5610	0.9717	1.5327	235
240	397.4	16.33	1.924	0.520	371.4	829.5	1200.9	745.4	1115.9	0.5633	0.9676	1.5309	240
245	399.3	16.67	1.887	0.530	373.3	827.9	1201.2	743.7	1116.2	0.5655	0.9638	1.5293	245
250	401.1	17.01	1.850	0.541	375.2	826.3	1201.5	742.0	1116.4	0.5676	0.9600	1.5276	250
260	404.5	17.66	1.782	0.561	378.9	823.1	1202.1	738.9	1116.9	0.5719	0.9525	1.5244	260
270	407.9	18.37	1.718	0.582	382.5	820.1	1202.6	735.8	1117.3	0.5760	0.9454	1.5214	270
280	411.2	19.05	1.658	0.603	386.0	817.1	1203.1	732.7	1117.7	0.5800	0.9385	1.5185	280
290	414.4	19.73	1.602	0.624	389.4	814.2	1203.6	729.7	1118.1	0.5840	0.9316	1.5156	290
300	417.5	20.41	1.551	0.645	392.7	811.3	1204.1	726.8	1118.5	0.5878	0.9251	1.5129	300
350	431.9	23.82	1.334	0.750	408.2	797.8	1206.1	713.3	1120.2	0.6053	0.8949	1.5002	350
400	444.8	27.22	1.17	0.86	422.	786.	1208.	701.	1122.	0.621	0.868	1.489	400
450	456.5	30.62	1.04	0.96	435.	774.	1209.	690.	1123.	0.635	0.844	1.479	450
500	467.3	34.02	0.93	1.08	448.	762.	1210.	678.	1124.	0.648	0.822	1.470	500

* 1 atm. (standard atmosphere) = 760 mms. of Hg. by def. = 29.921 ins. of Hg. = 14.696 lbs. per sq. in.

$T^{\circ} = t^{\circ} + 459.6$; $J = 777.5$ ft.-lbs. per B.t.u. [$\log = 2.89071$]; $A = 1/J = 1.286 \times 10^{-6}$; $144 A = 0.1852$ [$\log = 1.26764$].

For water, at 215 lbs., sp. vol., v' or $\sigma = 0.0185$ cu. ft. per lb.; $1/v' = 54.0$ lbs. per cu. ft.; $144 Av' = 0.74$ B.t.u.

For water, at 240 lbs., sp. vol., v' or $\sigma = 0.0186$ cu. ft. per lb.; $1/v' = 53.6$ lbs. per cu. ft.; $144 Av' = 0.83$ B.t.u.

TABLE XIV.—APPROXIMATE COMPOSITION AND CALORIFIC VALUE OF SOME OF THE EASTERN AMERICAN COALS.*

State.	County.	Field, Bed or Vein.	Mine.	Moisture.	Air Drying Loss.	Proximate Analysis, Dry Coal Basis.			B.T.U.
						Vol.	Fixed C.	Ash.	
Pa.	Lackawanna	ANTHRACITES	Scranton	5.41	3.4	7.42	75.90	16.68	12737
Pa.	Schuykill	Diamond	Phoenix Park	2.76	1.6	2.55	84.40	13.05	12933
Pa.	Schuykill	Mammoth	St. Nicholas	2.80	1.5	1.19	90.75	8.06	13682
Pa.	Schuykill	Lykens	West Brookside	3.33	2.6	3.38	87.19	9.43	13810
R. I.	Newport	500-foot level	Potsmouth	16.80	14.0	2.76	77.44	19.80	11093
R. I.	Providence		Cranston	2.41	2.0	5.04	75.43	19.53	11268
Ark.	Johnson	SEMI-ANTHRACITES	Needmore	2.15	1.4	11.05	78.56	10.39	13091
Ark.	Pope	Spadra	Southern	2.07	1.4	10.02	86.48	9.50	13617
Pa.	Sullivan	" B	Connell	3.38	2.6	8.77	79.33	11.90	13324
Pa.	Sullivan	O'Boyle and Fay	Big Vein	3.66	3.0	9.51	76.90	13.50	13324
Va.	Montgomery		Poverty	2.05	1.6	6.72	59.44	33.84	8901
Va.	Montgomery	Big Seam		4.80	4.1	10.63	70.43	18.94	12564
Ark.	Franklin	SEMI-BITUMINOUS	No. 2	0.84	...	16.60	75.96	7.44	14769
Ark.	Sebastian	Denning	No. 26	1.90	1.7	16.22	76.58	7.20	14373
Geor.	Chattoga	Hartshorne	Lookout	2.85	2.3	17.64	74.20	8.07	14614
Md.	Allegany	Little River	Ocean No. 7	3.42	2.7	18.27	78.39	7.34	14665
Md.	Garrett	Big Vein or Pitsburg	" 6-foot "	2.33	1.4	16.40	79.07	13.44	13572
Okla.	Haskell	Washington, No. 3	San Bois No. 2	2.37	1.9	10.73	71.23	9.04	14177
Okla.	La Flore	Hartshorne	Panama	5.11	4.3	14.10	77.15	8.40	14398
Pa.	Cambria	Miller	No. 3	3.40	2.8	16.50	77.38	5.92	13641
Pa.	Cambria	Upper Kittanning	Vintyde	3.60	3.1	14.87	75.87	10.60	14074
Pa.	Cambria	Upper Kittanning	Sunnyside	2.03	1.6	18.83	71.8	8.37	14416
Pa.	Huntingdon	Barnett	Barrett or " B "	2.09	1.6	18.59	75.93	6.38	14722
Pa.	Indiana	B or Miller	Lackawanna No. 4	2.57	2.1	18.57	70.93	10.00	14074
Pa.	Somerset	Upper Kittanning	Jenner No. 2	3.99	3.2	10.32	77.14	6.54	14722
Pa.	Somerset	Lower Kittanning	Kimmelton	3.69	2.0	16.84	70.47	11.60	13853
Pa.	Somerset	" B " Freeport	Staufers	2.18	...	18.18	73.63	8.19	14428
Pa.	Somerset	Pittsburg	Pen Mar No. 3	2.71	...	10.41	74.02	9.57	14193
Pa.	Somerset	Lower Kittanning	Elk Lick No. 1	2.71	2.0	19.88	73.27	6.85	14992
Pa.	Westmoreland	Lower Kittanning	Sureka No. 31	1.10	...	15.98	76.53	9.49	14959
W. Va.	Fayette	Fire Creek	Seward	4.00	3.0	10.55	72.47	10.98	13903
W. Va.	M'Dowell	Fire Creek	Alaska	3.07	2.2	17.30	77.63	5.01	14680
W. Va.	M'Dowell	Sewell	Big Sandy	1.72	1.1	18.10	74.85	6.99	14827
W. Va.	M'Dowell	No. 6	Fremer Pocahontas	2.10	...	18.00	76.00	6.00	14830
W. Va.	Mercer	Pocahontas	Fremer Pocahontas	4.07	3.3	17.03	71.38	11.59	14081
W. Va.	Mercer	Pocahontas	Zemth	3.40	2.9	10.73	79.70	3.57	15214
W. Va.	Mineral	Upper Freeport	Pinnacle	3.40	2.9	10.73	79.70	3.57	15214
W. Va.	Mineral	Upper Freeport	Kittanning No. 14	2.03	...	15.05	78.01	6.94	14695

* Bulletin No. 22, Bureau of Mines, 1913.

APPENDIX.

TABLE XIV.—APPROXIMATE COMPOSITION AND CALORIFIC VALUE OF SOME OF THE EASTERN AMERICAN COALS.—*Con.*

State.	County.	Field, Bed or Vein.	Mine.	Moisture.	Air Drying Loss.	Proximate Analysis, Dry Coal Basis.			B. T. U.
						Vol.	Fixed C.	Ash.	
Ala.	Bibb.	Youngblood.	Cane Creek No. 2.	6.43	5.5	30.52	55.67	13.81	13247
Ala.	Jefferson.	Pratt.	No. 2.	3.23	2.4	27.03	66.04	6.93	14544
Ala.	Franklin.	No. 6.	Benton.	8.31	4.6	34.52	54.05	11.43	12780
Ky.	Bell.	Straight Creek.	Straight Creek No. 2.	3.10	1.2	37.38	58.19	4.53	14602
Mich.	Saginaw.	Saginaw.	Bernard.	11.91	7.9	35.76	56.48	7.76	13474
Mo.	Adair.	No. 1.	Rombauer No. 2.	16.36	14.15	34.82	41.85	23.33	10769
Mo.	Lafayette.	Lexington.	Black Diamond.	12.34	7.7	39.20	47.87	12.93	12546
Ohio.	Belmont.	No. 8.	Empire No. 1.	4.14	2.6	41.00	49.21	9.70	13330
Ohio.	Guernsey.	No. 7.	Empire No. 1.	6.65	2.6	36.36	52.34	11.30	13046
Okla.	Pittsburg.	Lower Hartshorne.	No. 8.	4.45	2.8	37.83	50.60	11.51	13404
Pa.	Allegheny.	Pittsburg.	Bertha.	3.67	1.8	35.32	59.01	5.67	14402
Pa.	Allegheny.	Upper Freeport.	Creighton.	2.53	1.0	33.87	58.92	9.21	13703
Pa.	Cambla.	Upper Freeport.	Peerless No. 4.	3.30	2.7	38.64	58.25	9.11	14590
Pa.	Clarion.	Brookville.	Sligo.	2.35	1.1	38.77	59.19	11.44	13435
Pa.	Fayette.	Pittsburg.	Leisening No. 1.	5.73	4.2	29.58	61.44	9.18	14689
Pa.	Greene.	Waynesburg.	Crabapple.	2.79	1.2	37.08	49.74	13.18	14089
Pa.	Indiana.	Lower Freeport.	Lucerne No. 1.	3.31	2.7	27.13	64.47	8.40	14241
Pa.	Jefferson.	Pittsburg.	Florence.	2.53	1.1	28.54	65.01	5.85	14070
Pa.	Washington.	Pittsburg.	Blanche.	1.70	37.84	56.80	5.36	14584
Pa.	Washington.	Pittsburg.	Ellsworth No. 1.	1.22	36.73	56.93	6.34	14423
Pa.	Westmoreland.	Pittsburg.	Keystone No. 1.	3.98	3.1	29.30	60.12	10.58	13864
Tenn.	Anderson.	Dean.	Windrock.	6.39	4.7	34.53	55.29	10.18	13441
Tenn.	Cumberland.	Lower Swanee(?)	Yellow Creek No. 1.	3.53	2.3	21.51	49.60	28.89	10640
Tenn.	Putnam.	Wildcat.	Fentress.	3.89	2.9	28.73	56.26	15.01	13021
Tenn.	Putnam.	Grundy.	White B.	3.03	1.7	30.00	50.75	13.25	12996
Tenn.	Putnam.	Sewanee.	Sewanee.	5.68	4.7	20.89	53.44	19.67	12172
Tenn.	White.	Sewanee.	Clifty No. 1.	3.01	1.9	35.78	53.13	11.09	13511
Va.	Lee.	Darby.	Darby.	3.35	2.0	38.57	58.50	4.53	14573
Va.	Fazewell.	No. 4.	Richlands.	5.62	5.0	24.44	65.18	10.38	14053
W. Va.	Fayette.	Ansted.	Gauley Mountain.	4.16	2.6	32.64	59.88	7.48	14384
W. Va.	Harrison.	Pittsburg.	Pitcairn.	1.95	0.5	40.73	51.25	8.02	14083
W. Va.	Kanawha.	No. 2 Gas.	Keystone.	2.82	2.1	33.13	58.01	8.26	14166
W. Va.	Monongalia.	Upper Freeport.	Richard.	2.29	1.3	30.56	58.07	10.47	13876
W. Va.	Tucker.	Lower Kittanning.	Coketon.	2.21	24.82	66.90	8.10	14330

ANALYSES OF ASH

	Specific Grav.	Color of Ash.	Silica.	Alumina.	Oxide Iron.	Lime.	Magnesia.	Loss.	Acids S. & P.
Penna. Anthracite.	1.559	Reddish Buff.	45.6	42.75	9.43	1.41	0.33	0.48	
Penna. Bituminous	1.372	Gray.	76.0	21.00	2.60	0.40	
Welsh Anthracite..	1.32	40.0	44.8	...	12.0	trace	...	2.97
Scotch Bituminous.	1.26	37.6	52.0	...	3.7	1.1	...	5.02
Lignite.....	1.27	19.3	11.6	5.8	23.7	2.6	...	33.8

TABLE XV.—FOR REDUCING BAROMETRIC OBSERVATIONS TO THE FREEZING-POINT.

Reading of Barometer. Inches.	Correction at 10° Fahr. Inches.	Correction at 40° Fahr. Inches.	Correction at 70° Fahr. Inches.	Correction at 90° Fahr. Inches.
	+	—	—	—
27	0.045	0.028	0.100	0.148
27.5	0.046	0.028	0.102	0.151
28.0	0.047	0.029	0.104	0.153
28.5	0.048	0.029	0.106	0.156
29	0.049	0.030	0.108	0.159
29.5	0.050	0.030	0.109	0.162
30.0	0.051	0.031	0.111	0.164
30.5	0.052	0.032	0.113	0.167
31.0	0.053	0.032	0.115	0.170

TABLE XVI.—THEORETICAL VELOCITY OF AIR IN FEET PER SECOND DUE TO NATURAL DRAFT.

Height Flue in Feet.	Excess of Temperature in Flue above External Air.								
	5°	10°	15°	20°	25°	30°	50°	100°	150°
1	0.8	1.1	1.4	1.6	1.8	2.0	2.5	3.6	4.4
5	1.8	2.5	3.1	3.6	4.0	4.5	5.6	8.1	9.9
10	2.6	3.6	4.4	5.1	5.7	6.6	8.1	11.4	14.0
15	3.1	4.4	5.4	6.3	7.0	7.7	9.9	14.0	17.1
20	3.6	5.1	6.3	7.2	8.1	8.8	11.4	16.1	19.8
25	4.0	5.7	7.1	8.1	9.0	9.9	12.8	18.0	22.1
30	4.4	6.3	7.8	8.8	9.9	10.8	14.0	19.8	24.2
35	4.8	6.8	8.4	9.5	10.7	11.7	15.1	22.3	26.1
40	5.1	7.3	8.9	10.2	11.4	12.5	16.1	22.8	27.9
45	5.4	7.7	9.4	10.8	12.1	13.3	17.1	24.2	29.6
50	5.7	8.1	9.9	11.4	12.8	14.0	18.0	25.5	31.1
60	6.3	8.8	10.8	12.6	14.0	15.3	19.8	27.8	33.3
70	6.8	9.5	11.7	13.6	15.2	16.5	21.4	30.0	36.1
80	7.3	10.2	12.5	14.4	16.2	17.7	22.9	32.2	38.9
90	7.7	10.8	13.3	15.3	17.2	18.8	24.3	34.2	41.6
100	8.1	11.4	14.0	16.2	17.8	19.8	25.6	36.0	44.2
125	9.1	12.8	15.6	18.1	20.1	22.1	28.7	40.3	49.3
150	9.9	14.0	17.2	19.8	22.2	24.3	31.4	44.3	54.3

TABLE FOR NATURAL CIRCULATION.

Height in Feet.	Temperature of Entering Air above Room.	Velocity in Feet per Second.	Units of Heat per Degree Difference of Temperature, Average per Square Foot per Hour.	Corresponding Story of Building.
5	50	2.97	1.72	1
10	50	4.17	2.02	1
17	47	5.3	2.3	2
20	45	5.6	2.36	2
25	45	6.3	2.52	2
30	42	6.6	2.58	3
35	42	7.2	2.68	3
40	40	7.5	2.72	4
50	40	8.4	2.81	5

TABLE XVII.—THERMAL CONDUCTIVITIES.

Per Degree Difference of the Substance.

Substances.	Thickness one Meter. Calories per Sq. Meter.	Thickness, one Foot. B.T.U. per Sq. Foot per Hr.	Authority.
Copper.....	326	594	
Iron.....	57.5	104	
Zinc.....	56	102	
Lead.....	28	50.5	
Air, Oxygen, Nitrogen, Carbonic oxide, }	0.0177	0.323	Clausius and Maxwell, accord- ing to kinetic theory
Carbonic acid.....	0.0137	0.0249	Do. do. do.
Hydrogen.....	0.0125	0.0227	Do. do. do.
Glass.....	0.82	1.49	Péclet
Porphyritic trachyte.....	2.12	3.86	Aryton & Perry, Phil. Mag., 1878, first half year, p. 241.
Marble.....	3.13	5.67	Péclet
Underground strata.....	1.8	3.29	Forbes and Wm. Thomson
Limestone.....	1.82	3.31	
Sandstone of Craigleith Quarry.....	3.84	7.0	Do. do. do.
Trap-rock of Calton Hill	1.5	2.73	Do. do. do.
Sand of experimental garden.....	0.94	1.72	Do. do. do.
Water.....	0.72	1.82	J. P. Bottomley
Fir across fibers.....	0.093	0.169	Péclet in Everett's Units and Physical Constants
Fir along fibers.....	0.169	0.308	Do. do. do.
Walnut across fibers.....	0.105	0.192	Do. do. do.
Walnut along fibers.....	0.173	0.315	Do. do. do.
Oak across fibers.....	0.212	0.387	Do. do. do.
Cork.....	0.105	0.192	Do. do. do.
Hempen cloth, new.....	0.052	0.095	Do. do. do.
Hempen cloth, old.....	0.043	0.078	Do. do. do.
Writing paper, white.....	0.043	0.078	Do. do. do.
Gray paper, unsized.....	0.0337	0.0515	Do. do. do.
Calico, new of all densities.	0.05	0.091	Do. do. do.
Wool, carded, of all densities.....	0.044	0.08	Do. do. do.
Finely carded cotton-wool	0.04	0.073	Do. do. do.
Eider-down.....	0.039	0.017	Do. do. do.
Indian rubber.....	0.17	0.308	
Brick dust.....	0.15	0.272	
Wood ashes.....	0.06	0.109	
Coke.....	4.96	9.01	

TABLE XVIII.—WROUGHT-IRON WELDED STEAM-, GAS-, AND WATER-PIPE.
Table of Standard Dimensions.

Nominal Internal Inches.	Diameter.		Thick-ness. Inches.	Circumference.		Transverse Areas.				Length of Pipe per Square Foot of		Length of Pipe Containing One Cubic Foot. Feet.	Nominal Weight per Foot. Pounds.	Number of Threads per inch of Screw.
	Actual Internal Inches.	Actual External Inches.		External Inches.	Internal Inches.	External Sq. In.	Internal Sq. In.	Metal Sq. In.	External Surface Feet.	Internal Surface Feet.				
1	.405	.27	.068	1.272	.848	1.129	.0573	.0717	9.431	14.199	2513	.445	27	
1	.54	.304	.088	1.696	1.144	1.229	.1041	.1249	7.073	10.493	1383.3	.425	18	
1	.675	.493	.091	2.121	1.358	1.672	.1908	.1672	5.658	7.47	751.2	.568	18	
1	.84	.622	.109	2.639	1.954	.554	.3038	.2592	4.547	6.141	472.4	.852	14	
1	1.03	.824	.113	3.299	2.589	.866	.5333	.3327	3.637	4.635	279.0	1.134	14	
1	1.315	1.049	.133	4.131	3.290	1.338	.8643	.4937	2.904	3.641	166.9	1.684	11	
1	1.66	1.380	.14	5.215	4.335	2.104	1.496	.668	2.301	2.372	96.25	2.281	11	
1	1.9	1.610	.145	5.969	5.058	2.835	2.036	.799	2.01	1.847	70.66	2.731	11	
2	2.375	2.067	.154	7.461	6.494	4.43	3.356	1.074	1.668	1.547	42.91	3.678	11	
2	2.875	2.469	.203	9.032	7.757	6.492	4.788	1.704	1.328	1.547	30.1	5.819	8	
3	3.5	3.068	.216	10.996	9.639	9.621	7.393	2.228	1.991	1.245	19.5	7.616	8	
3	4.0	3.548	.226	12.566	11.146	12.566	9.887	2.679	.954	1.076	14.57	9.202	8	
4	4.5	4.026	.237	14.137	12.648	15.904	12.73	3.174	.848	.948	11.31	10.889	8	
4	5.0	4.506	.247	15.708	14.156	19.635	15.947	3.688	.763	.847	9.02	12.642	8	
5	5.593	5.047	.258	17.477	15.856	24.306	20.006	4.316	.686	.756	7.2	14.810	8	
6	6.625	6.065	.28	20.813	19.054	34.472	28.888	5.584	.576	.659	4.98	19.185	8	
7	7.625	7.023	.301	23.955	22.063	45.664	38.738	6.926	.500	.543	3.72	23.769	8	
8*	8.625	7.981	.322	27.096	25.073	58.426	50.027	8.399	.442	.478	2.88	28.809	8	
9	9.625	8.941	.342	30.238	28.089	72.76	62.786	9.974	.396	.438	2.29	34.188	8	
10*	10.75	10.020	.365	33.772	31.479	90.763	78.854	11.909	.355	.381	1.82	41.132	8	
11*	12.75	12.0	.375	36.914	34.558	108.434	95.033	13.401	.325	.347	1.51	46.247	8	
12*	14.0	13.25	.375	40.055	37.699	127.677	113.997	14.580	.299	.318	1.27	50.766	8	
13	15.0	14.25	.375	43.982	41.620	153.938	137.887	16.051	.272	.288	1.04	55.824	8	
14	15.0	14.25	.375	47.124	44.768	176.715	159.485	17.23	.254	.268	.903	60.375	8	
15	16.0	15.25	.375	50.26	47.909	201.00	182.65	18.41	.238	.259	.77	69.600	8	

* 8, 10, and 12-inch pipe are also made with thinner walls.

TABLE XIX.—WEIGHT OF WATER PER CUBIC FOOT FOR VARIOUS TEMPERATURES.*

Weight of Water per Cubic Foot, from 32° to 212° F., and Heat-units per Pound, Reckoned Above 32° F.

Temperature Deg. F.	Weight, Lbs. per Cubic Foot.	Heat-units.	Temperature, Deg. F.	Weight, Lbs. per Cubic Foot.	Heat-units.	Temperature, Deg. F.	Weight, Lbs. per Cubic Foot.	Heat-units.	Temperature, Deg. F.	Weight, Lbs. per Cubic Foot.	Heat-units.
32	62.42	0.	78	62.25	46.03	123	61.68	91.16	168	60.81	136.44
33	62.42	1.	79	62.24	47.03	124	61.67	92.17	169	60.79	137.45
34	62.42	2.	80	62.23	48.04	125	61.65	93.17	170	60.77	138.45
35	62.42	3.	81	62.22	49.04	126	61.63	94.17	171	60.75	139.46
36	62.42	4.	82	62.21	50.04	127	61.61	95.18	172	60.73	140.47
37	62.42	5.	83	62.20	51.04	128	61.60	96.18	173	60.70	141.48
38	62.42	6.	84	62.19	52.04	129	61.58	97.19	174	60.68	142.49
39	62.42	7.	85	62.18	53.05	130	61.56	98.19	175	60.66	143.50
40	62.42	8.	86	62.17	54.05	131	61.54	99.20	176	60.64	144.51
41	62.42	9.	87	62.16	55.05	132	61.52	100.20	177	60.62	145.52
42	62.42	10.	88	62.15	56.05	133	61.51	101.21	178	60.59	146.52
43	62.42	11.	89	62.14	57.05	134	61.49	102.21	179	60.57	147.53
44	62.42	12.	90	62.13	58.06	135	61.47	103.22	180	60.55	148.54
45	62.42	13.	91	62.12	59.06	136	61.45	104.22	181	60.53	149.55
46	62.42	14.	92	62.11	60.06	137	61.43	105.23	182	60.50	150.56
47	62.42	15.	93	62.10	61.06	138	61.41	106.23	183	60.48	151.57
48	62.41	16.	94	62.09	62.06	139	61.39	107.24	184	60.46	152.58
49	62.41	17.	95	62.08	63.07	140	61.37	108.25	185	60.44	153.59
50	62.41	18.	96	62.07	64.07	141	61.36	109.25	186	60.41	154.60
51	62.41	19.	97	62.06	65.07	142	61.34	110.26	187	60.39	155.61
52	62.40	20.	98	62.05	66.07	143	61.32	111.26	188	60.37	156.62
53	62.40	21.01	99	62.03	67.08	144	61.30	112.27	189	60.34	157.63
54	62.40	22.01	100	62.02	68.08	145	61.28	113.28	190	60.32	158.64
55	62.39	23.01	101	62.01	69.08	146	61.26	114.28	191	60.29	159.65
56	62.39	24.01	102	62.00	70.09	147	61.24	115.29	192	60.27	160.67
57	62.39	25.01	103	61.99	71.09	148	61.22	116.29	193	60.25	161.68
58	62.38	26.01	104	61.97	72.09	149	61.20	117.30	194	60.22	162.69
59	62.38	27.01	105	61.96	73.10	150	61.18	118.31	195	60.20	163.70
60	62.37	28.01	106	61.95	74.10	151	61.16	119.31	196	60.17	164.71
61	62.37	29.01	107	61.93	75.10	152	61.14	120.32	197	60.15	165.72
62	62.36	30.01	108	61.92	76.10	153	61.12	121.33	198	60.12	166.73
63	62.36	31.01	109	61.91	77.11	154	61.10	122.33	199	60.10	167.74
64	62.35	32.01	110	61.89	78.11	155	61.08	123.34	200	60.07	168.75
65	62.34	33.01	111	61.88	79.11	156	61.04	124.35	201	60.05	169.77
66	62.34	34.02	112	61.86	80.12	157	61.06	125.35	202	60.02	170.78
67	62.33	35.02	113	61.85	81.12	158	61.02	126.36	203	60.00	171.79
68	62.33	36.02	114	61.83	82.13	159	61.00	127.37	204	59.97	172.80
69	62.32	37.02	115	61.82	83.13	160	60.98	128.37	205	59.95	173.81
70	62.31	38.02	116	61.80	84.13	161	60.96	129.38	206	59.92	174.83
71	62.31	39.02	117	61.78	85.14	162	60.94	130.39	207	59.89	175.84
72	62.30	40.02	118	61.77	86.14	163	60.92	131.40	208	59.87	176.85
73	62.29	41.02	119	61.75	87.15	164	60.90	132.41	209	59.84	177.86
74	62.28	42.03	120	61.74	88.15	165	60.87	133.41	210	59.82	178.87
75	62.28	43.03	121	61.72	89.15	166	60.85	134.42	211	59.79	179.89
76	62.27	44.03	122	61.70	90.16	167	60.83	135.43	212	59.76	180.90
77	62.26	45.03									

WEIGHT OF WATER AT TEMPERATURES ABOVE 212° F.

Porter (Richards' "Steam-engine Indicator", p. 52) says that nothing is known about the expansion of water above 212° F. Applying formulae derived from experiments made at temperatures below 212° F., however, the weight and volume above 212° F. may be calculated, but in the absence of experimental data we are not certain that the formulae hold good at higher temperatures.

* Kent's "Pocket-book for Mechanical Engineers."

TABLE XIX.—Continued.

Thurston, in his "Engine and Boiler Trials," gives a table from which we take the following (neglecting the third decimal place given by him):

Temperature, Deg. F.	Weight, Lbs. per Cubic Foot.	Temperature, Deg. F.	Weight, Lbs. per Cubic Foot.	Temperature, Deg. F.	Weight, Lbs. per Cubic Foot.	Temperature, Deg. F.	Weight, Lbs. per Cubic Foot.	Temperature, Deg. F.	Weight, Lbs. per Cubic Foot.
212	59.71	280	57.90	350	55.52	420	52.86	490	50.03
220	59.64	290	57.59	360	55.16	430	52.47	500	49.61
230	59.37	300	57.26	370	54.79	440	52.07	510	49.20
240	59.10	310	56.93	380	54.41	450	51.66	520	48.78
250	58.81	320	56.58	390	54.03	460	51.26	530	48.36
260	58.52	330	56.24	400	53.64	470	50.85	540	47.94
270	58.21	340	55.88	410	53.26	480	50.44	550	47.52

Box on Heat gives the following:

Temperature F.	212°	250°	300°	350°	400°	450°	500°	600°
Lbs. per cubic foot.	59.82	58.85	57.42	55.94	54.34	52.70	51.02	47.64

TABLE XX.—PRESSURE OF WATER PER SQUARE INCH FOR DIFFERENT HEIGHTS IN FEET.*

At 60° F. 1 foot head = 0.433 lb. per square inch, .433 × 144 = 62.352 lbs. per cubic foot.

Head Feet.	0	1	2	3	4	5	6	7	8	9
0		0.433	0.866	1.299	1.732	2.165	2.598	3.031	3.404	3.897
10	4.330	4.763	5.196	5.629	6.062	6.495	6.928	7.361	7.794	8.227
20	8.660	9.093	9.526	9.959	10.392	10.825	11.258	11.691	12.124	12.557
30	12.990	13.423	13.856	14.289	14.722	15.155	15.588	16.021	16.454	16.887
40	17.320	17.753	18.186	18.619	19.052	19.485	19.918	20.351	20.784	21.217
50	21.650	22.083	22.516	22.949	23.382	23.815	24.248	24.681	25.114	25.577
60	25.980	26.413	26.846	27.279	27.712	28.145	28.578	29.011	29.444	29.877
70	30.310	30.743	31.176	31.609	32.042	32.475	32.908	33.341	33.774	34.207
80	34.640	35.073	35.506	35.939	36.372	36.805	37.238	37.671	38.104	38.577
90	38.970	39.403	39.836	40.269	40.702	41.135	41.568	42.001	42.436	42.867

HEAD IN FEET OF WATER, CORRESPONDING TO PRESSURES IN POUNDS PER SQUARE INCH.

1 lb. per square inch = 2.30947 feet head, 1 atmosphere = 14.7 lbs. per square inch = 33.95 feet head.

Pressure	0	1	2	3	4	5	6	7	8	9
0		2.309	4.619	6.928	9.238	11.547	13.857	16.166	18.476	20.785
10	23.0947	25.404	27.714	30.023	32.333	34.642	36.952	39.261	41.570	43.880
20	46.1894	48.499	50.808	53.118	55.427	57.737	60.046	62.356	64.665	66.975
30	69.2841	71.594	73.903	76.213	78.522	80.831	83.141	85.450	87.760	90.069
40	92.3788	94.688	96.998	99.307	101.616	103.925	106.234	108.543	110.852	113.161
50	115.4735	117.783	120.092	122.401	124.710	127.019	129.328	131.637	133.946	136.255
60	138.5682	140.877	143.186	145.495	147.804	150.113	152.422	154.731	157.040	159.349
70	161.6629	163.971	166.280	168.589	170.898	173.207	175.516	177.825	180.134	182.443
80	184.7576	187.066	189.375	191.684	193.993	196.302	198.611	200.920	203.229	205.538
90	207.8523	210.161	212.470	214.779	217.088	219.397	221.706	224.015	226.324	228.633

* Kent's "Pocket-book."

TABLE XXI.—CONTENTS IN CUBIC FEET AND U. S. GALLONS OF PIPES AND CYLINDERS OF VARIOUS DIAMETERS AND 1 FOOT IN LENGTH.*

1 gallon = 231 cubic inches. 1 cubic foot = 7.4805 gallons.

Diameter in Inches.	For 1 Foot in Length.		Diameter in Inches.	For 1 Foot in Length.		Diameter in Inches.	For 1 Foot in Length.	
	Cu. Ft.; also Area in Sq. Ft.	U. S. Gals., 231 Cu. In.		Cu. Ft.; also Area in Sq. Ft.	U. S. Gals., 231 Cu. In.		Cu. Ft.; also Area in Sq. Ft.	U. S. Gals., 231 Cu. In.
1/8	.0003	.0025	6 1/2	.2485	1.859	19	1.969	14.73
1/4	.0005	.004	7	.2673	1.999	19 1/2	2.074	15.51
3/8	.0008	.0057	7 1/2	.2867	2.145	20	2.182	16.32
1/2	.001	.0078	7 3/4	.3068	2.295	20 1/2	2.292	17.15
5/8	.0014	.0102	7 3/4	.3276	2.45	21	2.405	17.99
3/4	.0017	.0129	8	.3491	2.611	21 1/2	2.521	18.86
7/8	.0021	.0159	8 1/2	.3712	2.777	22	2.640	19.75
1	.0026	.0193	8 1/2	.3941	2.948	22 1/2	2.761	20.66
1 1/8	.0031	.0230	8 3/4	.4176	3.125	23	2.885	21.58
1 1/4	.0036	.0269	9	.4418	3.305	23 1/2	3.012	22.53
1 1/2	.0042	.0312	9 1/2	.4667	3.491	24	3.142	23.50
1 3/4	.0048	.0359	9 1/2	.4922	3.682	25	3.409	25.50
2	.0055	.0408	9 3/4	.5185	3.879	26	3.687	27.58
2 1/8	.00685	.0638	10	.5454	4.08	27	3.976	29.74
2 1/4	.0123	.0918	10 1/2	.5730	4.286	28	4.276	31.99
2 1/2	.0167	.1249	10 1/2	.6013	4.498	29	4.587	34.31
2 3/4	.0218	.1632	10 3/4	.6303	4.715	30	4.909	36.72
3	.0276	.2066	11	.66	4.937	31	5.241	39.21
3 1/8	.0341	.2550	11 1/4	.6903	5.164	32	5.585	41.78
3 1/4	.0412	.3085	11 1/4	.7213	5.396	33	5.940	44.43
3 1/2	.0491	.3672	11 3/4	.7530	5.633	34	6.305	47.16
3 3/4	.0576	.4309	12	.7854	5.875	35	6.681	49.98
4	.0668	.4998	12 1/2	.8522	6.375	36	7.069	52.88
4 1/8	.0767	.5738	13	.9218	6.895	37	7.467	55.86
4 1/4	.0873	.6528	13 1/2	.994	7.430	38	7.876	58.92
4 1/2	.0985	.7369	14	1.069	7.997	39	8.296	62.06
4 3/4	.1134	.8263	14 1/2	1.147	8.578	40	8.727	65.28
5	.1231	.9206	15	1.227	9.180	41	9.168	68.58
5 1/8	.1364	1.020	15 1/2	1.310	9.801	42	9.621	71.97
5 1/4	.1503	1.125	16	1.396	10.44	43	10.085	75.44
5 1/2	.1650	1.234	16 1/2	1.485	11.11	44	10.559	78.99
5 3/4	.1803	1.349	17	1.576	11.79	45	11.045	82.62
6	.1963	1.469	17 1/2	1.670	12.49	46	11.541	86.33
6 1/8	.2131	1.594	18	1.768	13.22	47	12.048	90.13
6 1/4	.2304	1.724	18 1/2	1.867	13.96	48	12.566	94.00

To find the capacity of pipes greater than the largest given in the table look in the table for a pipe of one-half the given size, and multiply its capacity by 4; or one of one-third its size, and multiply its capacity by 9, etc.

To find the weight of water in any of the given sizes multiply the capacity in cubic feet by 62 1/2 or the gallons by 8 1/8, or, if a closer approximation is required, by the weight of a cubic foot of water at the actual temperature in the pipe.

Given the dimensions of a cylinder in inches to find its capacity in U. S. gallons: square the diameter, multiply by the length and by .0034. If *d* = diam, *l* = length,

$$\text{gallons} = \frac{d^2 \times .7854 \times l}{231} = .0034d^2l.$$

* Kent's "Pocket-book."

TABLE XXII.—EQUALIZATION OF PIPE AREAS.*

Sizes of Pipe, Inches.	Number of Small Pipes Required to Make Area Equivalent to One Larger Pipe, with Allowance for Friction.														
	$\frac{1}{2}$ In.	$\frac{3}{4}$ In.	1 In.	1 $\frac{1}{4}$ In.	1 $\frac{1}{2}$ In.	2 In.	2 $\frac{1}{2}$ In.	3 In.	3 $\frac{1}{2}$ In.	4 In.	4 $\frac{1}{2}$ In.	5 In.	6 In.	7 In.	8 In.
$\frac{1}{2}$	1	2.0	3.7	7.6	11.3	19	37	55	80	108	146	188	290	427	595
1	1	1.8	3.7	5.4	9.2	16.7	25.5	39	53	70	90	117	143	210	295
1 $\frac{1}{4}$	1	1.5	3.1	5.1	9.3	14.7	27	30	39	53	70	90	117	165	80
1 $\frac{1}{2}$	1	1	2.0	3.1	5.1	9.3	14.7	27	30	39	53	70	90	117	165
2	1	1	1.5	2.6	4.5	7.3	10.6	14.7	19.5	25	39	57	80	117	165
2 $\frac{1}{2}$	1	1	1.5	2.6	4.5	7.3	10.6	14.7	19.5	25	39	57	80	117	165
3	1	1	1.5	2.6	4.5	7.3	10.6	14.7	19.5	25	39	57	80	117	165
3 $\frac{1}{2}$	1	1	1.5	2.6	4.5	7.3	10.6	14.7	19.5	25	39	57	80	117	165
4	1	1	1.5	2.6	4.5	7.3	10.6	14.7	19.5	25	39	57	80	117	165
4 $\frac{1}{2}$	1	1	1.5	2.6	4.5	7.3	10.6	14.7	19.5	25	39	57	80	117	165
5	1	1	1.5	2.6	4.5	7.3	10.6	14.7	19.5	25	39	57	80	117	165
6	1	1	1.5	2.6	4.5	7.3	10.6	14.7	19.5	25	39	57	80	117	165
7	1	1	1.5	2.6	4.5	7.3	10.6	14.7	19.5	25	39	57	80	117	165
8	1	1	1.5	2.6	4.5	7.3	10.6	14.7	19.5	25	39	57	80	117	165

* Especially computed.

TABLE XXIII.—HORSE-POWER LOST IN FRICTION OF AIR PER 100 FEET OF PIPE. 50° F.

Diameter of Pipe, Inches.	Velocity of Air, Feet per Second.									
	5	10	15	20	25	30	40	50	75	100
	Horse-power Lost in Friction.									
3	.0001	.0011	.0036	.0086	.0167	.0289	.0685	.1339	.4518	1.0710
6	.0003	.0021	.0072	.0171	.0335	.0578	.1371	.2677	.9036	2.1416
9	.0004	.0032	.0108	.0256	.0502	.0867	.2056	.4016	1.3554	3.2125
12	.0005	.0043	.0145	.0343	.0669	.1156	.2741	.5354	1.8072	4.2833
15	.0007	.0053	.0182	.0430	.0835	.1445	.3425	.6695	2.2590	4.3590
18	.0008	.0064	.0217	.0512	.1004	.1735	.4112	.8031	2.7158	6.4249
21	.0008	.0075	.0253	.0602	.1169	.2023	.4795	.9373	3.1626	7.4970
24	.0011	.0086	.0289	.0685	.1339	.2313	.5483	1.0708	3.6144	8.5666
30	.0014	.0107	.0361	.0857	.1673	.2891	.6855	1.3388	4.5180	10.7100
36	.0016	.0128	.0434	.1024	.2008	.3469	.8224	1.6062	5.4216	12.8498
42	.0019	.0150	.0484	.1224	.2338	.4046	.9590	1.8746	6.5252	14.9900
48	.0021	.0171	.0578	.1371	.2677	.4626	1.0905	2.1416	7.2288	17.1331
54	.0024	.0193	.0648	.1548	.3006	.5202	1.2330	2.4102	8.1324	19.2780
60	.0027	.0214	.0723	.1713	.3346	.5782	1.3706	2.6771	9.0360	21.4164
Pressure Lost, Ounces per Square Inch.										
3	.033	.133	.300	.533	.833	1.200	2.133	3.333	7.500	13.333
6	.017	.067	.150	.267	.417	.600	1.067	1.667	3.750	6.667
9	.011	.044	.100	.178	.278	.400	.711	1.111	2.500	4.444
12	.008	.033	.075	.133	.208	.300	.533	.833	1.875	3.333
15	.007	.027	.060	.106	.166	.240	.427	.667	1.505	2.666
18	.006	.022	.050	.089	.139	.200	.356	.556	1.250	2.222
21	.005	.019	.043	.076	.119	.172	.305	.476	1.071	1.905
24	.004	.017	.037	.067	.104	.150	.267	.417	.937	1.667
30	.003	.013	.030	.053	.083	.120	.213	.333	.750	1.333
36	.003	.011	.025	.044	.069	.100	.178	.278	.625	1.111
42	.002	.009	.022	.038	.060	.086	.152	.238	.536	.952
48	.002	.008	.019	.033	.052	.075	.133	.208	.460	.833
54	.002	.007	.016	.030	.046	.066	.118	.185	.417	.741
60	.002	.007	.015	.027	.042	.060	.107	.167	.375	.667

For other lengths of pipe divide by 10 and multiply by square root of length.

TABLE XXIV.—THEORETICAL HORSE-POWER REQUIRED TO MOVE A GIVEN VOLUME OF AIR, AT 70° F., AT A GIVEN VELOCITY.

Cu. Ft. of Air per Min., Temp. 70° F.	Velocity of Air, Feet per Second.									
	5	10	15	20	25	30	40	50	75	100
	Theoretical Horse-power.									
1,000	.0009	.0035	.0080	.0141	.0221	.0318	.0566	.0884	.1987	.3535
2,000	.0018	.0071	.0159	.0283	.0442	.0636	.1131	.1768	.3973	.7070
3,000	.0026	.0106	.0239	.0424	.0663	.0955	.1697	.2651	.5960	1.0665
4,000	.0035	.0141	.0318	.0566	.0884	.1273	.2262	.3535	.7946	1.4140
5,000	.0044	.0177	.0398	.0707	.1105	.1591	.2828	.4419	.9933	1.7675
10,000	.0088	.0353	.0795	.1414	.2209	.3182	.5656	.8838	1.9866	3.5350
20,000	.0176	.0706	.1590	.2828	.4418	.6364	1.1312	1.7676	3.9732	7.0700
30,000	.0264	.1059	.2385	.4242	.6627	.9546	1.6968	2.6514	5.9598	10.6050
40,000	.0352	.1412	.3180	.5656	.8836	1.2728	2.2624	3.5352	7.9464	14.1400
50,000	.0440	.1765	.3975	.7070	1.1045	1.5910	2.8280	4.4190	9.9330	17.6750
75,000	.0660	.2647	.5962	1.0605	1.6567	2.3865	4.2420	6.6285	14.7990	26.5120
100,000	.0880	.3530	.7950	1.4140	2.2090	3.1820	5.6560	8.8380	19.8660	35.3500
125,000	.1100	.4412	.9937	1.7675	2.7612	3.9775	7.0700	11.0475	24.7320	44.1870
150,000	.1320	.5294	1.1924	2.1210	3.3134	4.7730	8.4840	13.2570	29.5980	53.0240
175,000	.1540	.6177	1.3912	2.4745	3.8657	5.5685	9.8980	14.4665	34.6650	61.8620
200,000	.1760	.7060	1.5900	2.8280	4.4180	6.3640	11.3120	17.6760	39.7320	70.7000

For any other temperature, t , multiply by $\frac{530}{492}(t-32)$.

TABLE XXV.—DIMENSIONS OF A PIPE FOR A GIVEN DISCHARGE WITH LOSS OF PRESSURE OF ONE INCH OF WATER, TEMPERATURE 100° FAHRENHEIT.

Cubic Feet of Air per Minute.	Length of Pipe in Feet.																	
	50		100		150		200		250		300		500		750		1000	
	D	A	D	A	D	A	D	A	D	A	D	A	D	A	D	A	D	A
1,000	7.25	6.6	8.50	7.7	9.25	8.4	9.75	8.9	10.25	9.3	10.50	9.5	11.75	10.7	12.75	11.6	13.50	12.3
2,000	9.75	8.9	11.25	10.2	12.25	11.1	13.00	11.8	13.25	12.3	14.00	12.7	15.50	14.1	16.75	15.2	17.75	16.1
3,000	11.50	10.4	13.25	12.0	14.25	12.9	15.00	13.6	15.75	14.3	16.50	15.0	18.00	16.3	19.50	17.7	20.75	18.8
4,000	12.75	11.6	14.75	13.4	16.00	14.5	17.00	15.4	17.75	16.1	18.50	16.8	20.25	18.4	22.00	20.0	23.25	21.1
5,000	14.00	12.7	16.25	14.7	17.50	15.9	18.50	16.8	19.25	17.5	20.00	19.2	22.25	20.2	24.00	21.8	25.50	23.1
10,000	18.50	16.8	21.25	19.3	23.00	20.9	24.50	22.2	25.50	23.1	26.25	23.8	29.25	26.6	31.75	28.8	33.75	30.6
20,000	25.50	23.1	28.00	25.4	30.50	27.6	32.25	29.2	33.75	30.6	35.00	31.8	38.75	35.2	42.00	38.1	44.50	40.4
30,000	28.75	25.0	33.00	30.0	35.75	32.5	38.00	34.5	39.50	35.9	41.00	37.2	45.50	41.4	49.25	44.7	52.25	47.3
40,000	32.50	29.5	37.00	33.6	40.00	35.3	42.50	38.6	44.50	40.4	46.00	41.8	51.00	46.3	55.25	50.2	58.50	53.1
50,000	35.25	32.0	40.50	36.7	43.75	39.7	46.50	42.3	48.50	44.1	50.25	45.7	55.75	50.7	60.25	55.0	64.50	58.2
75,000	41.25	37.6	47.50	43.2	51.50	46.8	54.50	49.6	57.00	51.8	59.25	53.8	65.50	59.6	71.00	64.5	75.25	68.3
100,000	46.50	42.2	53.25	48.3	57.75	52.3	61.25	55.7	64.00	58.1	66.50	60.3	73.50	66.7	79.75	72.3	84.50	76.7
125,000	50.75	46.0	58.25	52.8	63.25	57.3	67.00	60.8	70.00	63.5	72.50	65.8	80.50	73.0	87.25	79.1	92.50	83.9
150,000	54.50	49.4	63.75	56.9	68.00	61.7	72.00	65.3	75.25	68.3	78.00	70.8	86.50	78.5	93.75	85.0	99.25	90.0
175,000	58.00	52.0	66.75	60.7	72.25	65.5	76.50	69.4	80.00	72.0	83.00	75.3	92.00	83.5	99.75	90.5	105.75	96.0
200,000	61.25	55.6	70.25	63.7	76.25	69.1	80.75	73.2	84.25	76.7	87.25	79.4	96.75	87.7	105.25	95.6	111.50	101.2

A = side of square pipe, inches.

D = diameters in inches.

TABLE XXVI.—VELOCITY OF AIR DISCHARGED AT VARIOUS PRESSURES THROUGH PIPE ONE FOOT IN DIAMETER, 100 FEET LONG, AT 60° F.

Difference of Pressure.		Velocity in Feet per Second.	
Inches of Water.	Ounces per Square Inch.	By Unwin's Formula. Pipe 1 Ft. in Diam., 100 Ft. long.	By Approximate Formula. $v = .7\sqrt{2gh}$.
0.01	0.006	4.3	4.6
0.05	0.030	9.6	9.5
0.1	0.058	14.5	14.5
0.2	0.116	19.4	20.5
0.3	0.174	23.6	25.1
0.4	0.232	27.4	29.1
0.5	0.289	30.5	32.5
0.6	0.347	34.0	35.2
0.7	0.405	36.0	38.3
0.8	0.463	39.2	40.7
0.9	0.512	41.0	43.7
1.0	0.579	43.0	45.7
2.0	1.158	61.1	65.2
3.0	1.303	78.0	78.2
4.0	2.316	85.3	91.1
5.0	2.895	86.2	103.3
6.0	3.474	104.0	113.3
7.0	4.053	114.0	122.1
8.0	4.622	121.0	130.6
9.0	5.221	128.0	138.8
10.0	5.790	136.0	145.7
11.0	6.369	142.0	153.0
12.0	6.948	148.0	159.6

For pipes of different diameters, d' , and lengths, l' , multiply results in the above table by $10\sqrt{\frac{d'}{l'}}$.

For different temperatures, t' , multiply results in table by $\sqrt{\frac{460+t'}{520}}$.

TABLE XXVII.—TEMPERATURES OF VARIOUS LOCALITIES.

Compiled from Observations of the Signal Service, U. S. A., and Blodgett's "Climatology of the United States."

NOTE.—In the United States the comfortable temperature of the air in occupied rooms is generally 70 degrees when walls have the same temperature.

Station.	No. of Months Fire is Required.	Mean temp. of Cold Months.	Av. No. of Deg. Temp. to be Raised.	Max. No. Deg. Temp. to be Raised.	Minimum Temperature F°.
Albany, N. Y.	7	35	35	87	-17
Baltimore, Md.	6	39	31	72	- 2
Boston, Mass.	7	37	33	81	-11
Buffalo, N. Y.	8	35	35	83	-13
Burlington, Vt.	7	32	38	90	-20
Chicago, Ill.	7	35	35	90	-20
Charleston, S. C.	3	52	18	47	+23
Cincinnati, O.	7	42	28	77	- 7
Cleveland, O.	7	38	32	83	-13
Detroit, Mich.	7	35	35	90	-20
Duluth, Minn.	8	28	42	108	-38
Indianapolis, Ind.	7	41	29	88	-18
Key West, Fla.	0	0	0	26	+44
Leavenworth, Kan.	6	37	33	90	-20
Louisville, Ky.	6	42	28	80	-10
Memphis, Tenn.	5	39	31	68	+ 2
Milwaukee, Wis.	8	37	33	95	-25
New Orleans, La.	0	0	0	44	+26
New York, N. Y.	7	40	30	76	- 6
Philadelphia, Pa.	7	40	30	75	- 5
Pittsburg, Pa.	7	39	31	82	-12
Portland, Me.	8	33	37	82	-12
Portland, Ore.	6	43	27	67	+ 3
San Francisco, Cal.	4	53	17	34	+36
St. Louis, Mo.	5	37	33	86	-16
St. Paul, Minn.	7	25	45	102	-32
Washington, D. C.	5	40	30	73	+ 3
Wilmington, N. C.	4	50	20	55	+15

INDEX.

- Absolute Zero, 6.
Accelerated Hot-water Systems, 313.
Air, Amount Required per Person, 41.
Air, Analysis of, 31, 572.
Air, Bacteria in, 26.
Air, Carrying Capacity of Pipes, 363.
Air, Changes per Hour, 63, 72.
Air Conditioning, 515.
Air, Density, 25.
Air, Dimensions of Pipe Lines for, 366, 581.
Air, Discharged from Fan, 378.
Air, Distribution of, 56.
Air, Draughtiness of, 57, 454, 457.
Air-Ducts, Area of, 268.
Air, Effect of Heat on, 45, 53.
Air-filter, 402.
Air, Filtration in School-houses, 467.
Air, Flow through Pipes, 130, 361, 365, 579, 581.
Air-flues, Indirect Heating, 276, 477.
Air, Force Required for Moving, 45.
Air, Horse-power Loss by Friction, Table, 579.
Air, H.P. required to Move, 580.
Air, Humidity of, 36, 561.
Air, Impurities in, 26.
Air-Inlet, Location for, 58, 466.
Air, Introduction into Rooms, 61, 389.
Air, Limitations to Supply in School-houses, 454.
Air, Measurement of Velocity, 46.
Air, Moisture Absorbed by, 36, (Ap. Table), 561.
Air, Motion Produced by Heat, 53.
Air, Natural Circulation of, Table, 573.
Air-outlet, Location for, 58.
Air, Power for Moving, 147, 361, 365, Table, 580.
Air, Properties of, Table, 559.
Air, Relation between Velocity and Force, 57.
Air, Relation to Vitality, 454.
Air, Relative Weight of Water and Table, 560.
Air-space, in Grates, 228.
Air, Standard for Ventilation, 41.
Air-supply, Course of in School-house Ventilation, 460.
Air-supply for Hot-air Furnace, 335.
Air-supply for Rooms not Frequently Occupied, 459.
Air-supply for School-rooms, 457.
Air-supply, Limitations, 454.
Air-supply, Measurement of, 39, 388.
Air Thermometer, 10.
Air-trap, 247.
Air-valves, 165.
Air-valves, Webster Thermostatic, 291.
Air, Velocity Due to Natural Draft, Table, 573.
Air, Velocity Due to Pressures, 582.
Air, Velocity Measurement, 46.
Air, Velocity in Pipe, Ledoux' Formula, 133.
Air, Velocity in Pipe, Unwin's Formula, 130.
Air, Velocity of Entering, 57.
Air, Velocity on Different Floors, 62.
Air, Velocity Produced by Heating, 53.
Air Washers, 531.
Air, Work in Heating, 55.
Air, Work of Moving through Pipes, 361, 365.
Anemometer, 47.
Anemometer Calibration, 50.
Angle Valves, 162.
Architect, Duty of, 487.
Argon in Atmosphere, 30.
Artificial Heat, Demand for, 1.

- Ash, Analysis of, Table, 572.
 Atmosphere, Composition and Pressure, 24, 26.
 Atmosphere, Impurities in, 26.
 Automatic Air-valves, 167.

 Back-pressure Valve, 281.
 Bacteria in Air, 26.
 Barometer, Correction for Temperature, 572.
 Blower and Heater Arrangement, 395.
 Blowers for Mechanical Heating Systems, 403, 407.
 Blowers or Fans, Maximum Pressure Produced, 373.
 Blowers, Relative Efficiency Compared to Heated Flues, 382.
 Blowers, Size of, 407.
 Blowers, Steel Plate, 353.
 Blowers, Volume of Positive, 361, 362.
 Blower Systems of Heating, Tests, 415.
 Blow-off Cocks and Valves, 221, 225.
 Boiler Dimensions, Table, 198.
 Boiler Domes, 198.
 Boiler Explosions, 238.
 Boiler Explosions, Prevention of, 244.
 Boiler Foundations, 213.
 Boiler Horse-power, 189.
 Boilers, Babcock & Wilcox, 200, 201.
 Boilers, Computation of Heating Surface, 478.
 Boilers, Fire-tube, 195.
 Boilers for Heating Purposes, 196, 197.
 Boilers for Power Purposes, 195.
 Boilers, General Directions for Care of, 236.
 Boilers, General Types, 195.
 Boilers, Harrison, 202.
 Boilers, Heine, 201, 202.
 Boilers, Hogan, 202.
 Boilers, Horizontal Tubular, 197, 205.
 Boilers in Batteries, 210.
 Boiler Size Required for Mechanical Heating Systems, 405, 407.
 Boilers, Locomotive and Marine, 198.
 Boilers, Plain Surface, 203.
 Boilers, Rating of, 190.
 Boilers, Root, 200.
 Boilers, Sectional, 207.
 Boilers, Steam, General Requisites of, 188.
 Boilers, Stirling, 201.
 Boilers, Stored Energy of, 240.
 Boilers, Vertical, 199.

 Boilers, Water-tube, 200, 205.
 Boiler Tests, House-heating Type, 193.
 Boiling-point of Water, 25.
 Books on Heating and Ventilation, List of, 533-534.
 Bourdon Gauge, 222.
 Box Coil, 174.
 Branch Tees, 158.
 Branch Pipes, Areas of, 400.
 Breckenridge Automatic Air-valve, 167.
 Breeching, 213.
 Brick Setting for Furnace, 351.
 Brick Settings for Boilers, 211.
 British Thermal Unit, Definition, 3, 4.
 Bucket Trap, 232.
 Buckle's Proportions for Centrifugal Ventilators, 378.
 Buildings, Heat Loss from, 64, 73.
 Bundy Return Trap, 235.

 Calorie, Definition, 4.
 Calorimetric Pyrometers, 14.
 Capacity of Fans, Practical Rule for, 380.
 Carbocidometer of Professor Wolpert, 33.
 Carbonic Acid, Amount in Air, 24, 28, 29, 31, 33.
 Carbonic Acid Determination, 33, 35.
 Carbonic Oxide, 30.
 Care of Hot-water Heaters, 238.
 Care of Steam-heating Boilers, 236.
 Carrier's Theory of Convection with Forced Circulation, 424.
 Casing for Indirect Heaters, 184, 185.
 Casings for Fans, 354.
 Cast-iron Pipes and Fittings, 148.
 Ceiling and Floor-Plates, 159.
 Celsius Thermometer, 8.
 Centigrade Thermometer, 8.
 Centrifugal Ventilators. (*See Fans.*)
 Changes of Air per Hour, 63, 72.
 Characteristic Curves of Multivane Fans, 371.
 Check Valves, 165.
 Chimney Draft, 573.
 Chimneys, Form of, 226.
 Chimneys, Guibal, 356.
 Chimneys, Sizes of, 226.
 Chimney Tops, 228.
 Circles, Squares, and Cubes, Table, 542.
 Circulating Systems for Hot-air, 341.
 Circulating Systems of Hot-water Heating, 310.

- Circulation Affecting Heat Transmission, 89.
 Circulation in Gravity Systems, 125.
 Circulation in Hot-water Pipes, 126.
 Circumference and Area of Circles, Table, 554.
 Class Rooms, Ventilation of, 461.
 Closed Systems of Hot-water Heating, 310.
 Coal per Square Foot of Grate, 191.
 Coals, Analysis of, 570.
 Coat Rooms, Ventilation of, 461.
 Cochran's Steam Stack Heaters, 292.
 Cocks and Valves, 159, 163, 221, 225.
 Cold-air Box or Duct, 335.
 Cold-air Duct, Area, 268, 400.
 Combination Systems of Heating, 323.
 Combustion of Fuel, Economy, 191, 332.
 Complete-circuit System of Piping, 249.
 Condenser, Siphon, 287.
 Conduction of Heat, 20, 79.
 Conductivity Table, 79, 574.
 Conductors, Thermal, Table, 574.
 Cone Fan or Blower, 359.
 Connecticut Ventilation Laws, 495.
 Connersville Positive Blower, 362.
 Contract, Form for Construction of Heating Apparatus, 483.
 Convection, Heat Removed by, 84, 86.
 Convection of Heat, 22.
 Convection with Forced Circulation, Carrier's Theory, 424.
 Corner Coil, 173.
 Corner Valves, 163.
 Corridors, Ventilation of, 460.
 Cost of Construction of Heating Apparatus, Methods of Estimating, 488.
 Cost of Electric Heating, 427.
 Cost of Ventilating School Buildings, 458.
 Couplings, 154, 155.
 Cross-valves, 163.
 Cubic Space and Changes of Air, 63.
 Cylinders, Contents of, Table, 578.

 Damper Regulator for Hot-water, Lawler, 438.
 Damper Regulators, 224, 436, 438, 440.
 Dampers for Air Flues, 445, 446.
 Dampers, Volume or Regulating, 396.
 Dehumidifiers, 529.
 Dehumidifying, Refrigeration for, 530.
 Design of Heating Systems, Summary of Approved Methods, 476.

 Dew-point, 36, 519.
 Diaphragm Gauge, 223.
 Diaphragm Valve, 445.
 Diathermancy, Definition, 19.
 Diathermanous Value of Substances, 19.
 Diffusion of Gases, Definition, 27.
 Diffusion of Heat, 20.
 Diffusion, Relation to Ventilation, 27.
 Dimensions of Pipe, 153, 581.
 Direct Heating, 81, 87.
 Direct-indirect Radiators, 182.
 Direct Radiation, 81, 87.
 Disk Fans, 359, 387.
 Distributing Pipe, 246.
 District Heating, 286.
 Double Glazing, 464.
 Double Sashing, 465.
 Draughtiness of Air in Ventilation, 57, 454, 457.
 Drip-pipe, Diameter for Steam-mains, 274.
 Ducts for Indirect Heating, Sizes of, 144.
 Ducts or Flues for Mechanical Heating Systems, 398.
 DuLong's Law, 83.
 Dust, 520.
 Duty of the Architect, 487.

 Economizer or Heater in Smoke-flue, 315.
 Economy in Heating Systems, 329.
 Efficiency of Combustion of Fuel, 191, 332.
 Efficiency of Fans or Blowers Compared to Heated Flues, 382.
 Elbows and Bends, 156.
 Electrical Heater Connections, 435.
 Electrical Heaters, 434.
 Electrical Heating, Expense of, 427.
 Electrical Heating, Formulae and General Considerations, 430.
 Electrical Resistance Thermometer, 11.
 Electrical Units, Relation to Heat, 4, 427.
 Electricity, Heating with, 427.
 Equalizing Circular and Rectangular Pipes, 364.
 Equalizing Pipe Areas, Table, 579.
 Equalizing Pipe Diameters, Table, 579.
 Equalizing Valve, 235.
 Equivalent Glass Surface, 329.

- Equivalents of Electrical and Heat Energy, 4, 427.
 Evans and Almirall System of Hot-water Circulation, 314.
 Exhauster, Paul System, 295.
 Exhaust Fan, 354.
 Exhaust Heating, Proportions of Radiating Surface and Main Pipes, 282.
 Exhaust Heating, Systems of, 281.
 Exhaust Heating with Vacuum, 286.
 Exhaust-steam Heating, Paul System, 294.
 Exhaust-steam Heating, Webster System, 289.
 Exhaust-steam Heating, Williames System, 288.
 Expansion Joints, 169.
 Expansion of Pipe, 170.
 Expansion Plate, 159.
 Expansion, Relative Rates of, 442.
 Expansion Tank, 309.
 Expansion Trap, 232.
 Explosions, Boiler, 238.
 Explosions, Hot-water Heaters, 243.
 Explosions, Prevention of, 244.
 Extended Surface Heaters, 204.
 Extended Surface Radiator, 177.

 Factory Heating, 475.
 Fahrenheit Thermometer, 8.
 Fan and Heating Surface, Arrangement of, 395.
 Fan Casings, 354.
 Fan Efficiency, 382.
 Fans, Application of Theory, 379.
 Fans, Characteristic Curves of Multivane Type, 371.
 Fans, Dimensions and Capacity, 368.
 Fans for Mechanical Heating Systems, 403, 407.
 Fans, Formulae for Dimensions and Capacity, 368.
 Fans, Guibal, 357.
 Fans, Multivane, 357.
 Fans or Blowers, Maximum Pressure Produced, 373.
 Fans, Practical Rule for Capacity, 380.
 Fans, Practical Rule for Power, 381.
 Fans, Pressure and Exhaust, 354.
 Fans, Pressure Corresponding to Peripheral Velocity, 378.
 Fans, Propeller or Disk, 359, 387.
 Fans, Relative Efficiency Compared to Heated Flues, 382.
 Fans, Steel Plate, 353.
 Fans, Tests which Verify the Results, 381.
 Fans, Velocity and Volume of Air Discharged, 377.
 Fans, Work Required to Run, 379.
 Field Tube, 206.
 Filtration of Air, 467.
 Fire-places, Heating with, 341.
 Fire, Protection from, 492.
 Fire-tube Boiler, 195.
 Fittings, Cast-iron and Malleable Iron, 148.
 Flange Unions, 155.
 Float Trap, 231.
 Flow of Air, Ledoux, 133, 134.
 Flow of Air through Pipes, 130, 362, 365.
 Flow of Air, Unwin, 130, 132, 133.
 Flow of Steam through Pipes, 135, 141.
 Flow of Water and Steam, 124.
 Flow of Water through Pipes, 128.
 Flue Radiators, 177.
 Flues and Registers, Dimensions of, 142, 144.
 Flues for Indirect Heating, 268, 276, 477.
 Flues, Heated—Relative Efficiency of, 382.
 Flues or Ducts for Mechanical Heating Systems, 398.
 Flues, Theoretical Area, 145.
 Foot-pound, Definition, 4.
 Forced Circulation, Carrier's Theory of Convection, 424.
 Friction in Pipes and Bends, 124, 579, 581.
 Friction of Air through Orifice, Unwin, 130.
 Fuels, Composition of, 570.
 Furnace Heating, Air Supply, 335.
 Furnace Heating, Proportions Required, 329.
 Furnace Heating, Rules for, 350.
 Furnace Heating, Specifications, 350.
 Furnace Operation, General Directions, 342.
 Furnace Proportions, 348, 349.
 Furnace Rating, Federal Furnace League, 346.
 Furnaces, Brick Settings for, 351.
 Furnaces, General Form, 329.
 Furnaces, Portable Settings for, 351.
 Furnaces, Practical Arrangement, 343.

- Gas-burners, Allowance for in Ventilation, 41.
- Gases, Combustibility of, 522.
- Gases, Diffusion of, 27.
- Gases, Properties of, Table, 541.
- Gases, Solubility of, Table, 521.
- Gate-valve, 160.
- Gauge, Pressure, Bourdon and Diaphragm, 222.
- Gauge, Water, 220.
- Glazing, Double, 464.
- Globe-valve, 161.
- Governor for Pump, 298.
- Grate Area, 478.
- Grates, 228.
- Grate Surface, Relative Proportions to Heating Surface, 190.
- Gravitating Return Trap, 235.
- Gravity Steam Heating Systems, 245.
- Gravity Steam Heating, Terms Used in, 246.
- Greenhouse Heating, 467.
- Greenhouse Heating, Proportioning Radiating Surface, 469.
- Greenhouse Heating, Relative Tests of Hot-water and Steam, 471.
- Guibal Chimney and Fan, 356.
- Hair Hygrometer, 38.
- Head, Loss in Pipes, 124, 130.
- Head of Water Corresponding to Various Pressures, 541, 577.
- Heat Absorbed by Heating Surfaces, 192.
- Heat Absorption in Boilers, 192.
- Heat, Amount Required for Warming, 258.
- Heat, Artificial, Demand for, 1.
- Heat, Conduction of, 20.
- Heat, Conductivity of Substances, 79.
- Heat Contained in Water at Various Temperatures, 576.
- Heat, Convection of, 22, 84.
- Heat, Diffusion of, 20.
- Heated Flues, Relative Efficiency Compared to Fans and Blowers, 382.
- Heat, Effect in Producing Motion of Air, 45, 53.
- Heat Emitted by Radiation, 82, 86, 87.
- Heat Emitted from Different Surfaces, 87.
- Heater and Blower Arrangement, 395.
- Heaters, Care of, 238.
- Heaters, Electric, 434.
- Heaters, Extended Surface, 204.
- Heaters for Mechanical Heating Systems, Cast-iron, 398.
- Heaters, Hot-water, 202.
- Heaters, Indirect, 182.
- Heaters, Plain Surface, 203.
- Heaters, Tubular, 205.
- Heaters, Vento Charts, 420.
- Heaters, Vertical Magazine, 203.
- Heaters, Water Tube Boilers, 205.
- Heaters, Wrought-iron Pipe Table, 422.
- Heat from Radiating Surfaces, 87, 261.
- Heating and Grate Surface, Relative Proportions, 190.
- Heating and Ventilating, Current Literature, 535.
- Heating and Ventilating, Form of Uniform Contract, 483.
- Heating and Ventilating, General Business Methods, 479.
- Heating and Ventilating, General Requirements, 480.
- Heating and Ventilating Laws, 495.
- Heating and Ventilating Systems, Methods of Installation, 393.
- Heating Apparatus, Magnitude of Industry of Manufacture, 1.
- Heating Boilers, 196, 197.
- Heating Boilers for Soft Coal, 209.
- Heating Boilers, Setting of, 215.
- Heating Boilers with Magazines, 209.
- Heating by Contact—Convection, 22.
- Heating, Combination Systems, 323.
- Heating, Hermetic—Johnson System, 297.
- Heating, Hot-blast System, 392.
- Heating, Mechanical Systems, 392.
- Heating of Greenhouses, 467.
- Heating of Schoolhouses, 453.
- Heating of Schools, Automatic Control of Temperature, 464.
- Heating of Schools, Heat Commonly Wasted, 463.
- Heating of Schools, Heat Waste at Night, 465.
- Heating of Schools, Methods of Saving, 458.
- Heating of Schools, Quick Preparatory Warming, 462.
- Heating of Schools, Solar Heat, 463.
- Heating of Schools, Warming by Rotation, 462.
- Heating of Workshops and Factories, 475.

- Heating, Relation to Ventilation, 24.
 Heating Requirements, Hot-air Furnaces, 346.
 Heating, Rules for Estimating Radiating Surface, 266.
 Heating, Summary of Computations, 274.
 Heating Surface, 189.
 Heating Surface in Boiler, Computation, 478.
 Heating Surface, Relative Proportions to Grate Surface, 190.
 Heating Surface Required in Mechanical Heating Systems, 404, 406.
 Heating System, Evans and Admirall, 314.
 Heating System, Morgan, 256.
 Heating System, Osborne, 315.
 Heating System, Van Auken, 297.
 Heating System, Yarian, 315.
 Heating Systems, Combination, 323.
 Heating Systems, Combined High- and Low-pressure, 298.
 Heating Systems, Comparison, 257.
 Heating Systems, Design of, 476.
 Heating Systems, Electrical, 427.
 Heating Systems, High-pressure Steam, 245.
 Heating Systems, Hot-blast, 392.
 Heating Systems, Hot-water, 306.
 Heating Systems of Exhaust Heating, 281.
 Heating Systems of Steam Heating, 245.
 Heating Systems, Proportions of Parts, 275.
 Heating Systems, Tests of Blower Systems, 415.
 Heating Systems, Vacuum, Vapor, or Atmospheric, 245.
 Heating Systems, Various Forms, 392.
 Heating, Tests of Blower Systems, 415.
 Heating with Electricity, Expense of, 427.
 Heating with Electricity, Formulæ and General Considerations, 430.
 Heating with Exhaust Steam, 281.
 Heating with Exhaust Steam under Vacuum, 286.
 Heating with Hot-air, General Principles, 327.
 Heating with Stoves and Fire-places, 341.
 Heat, Intensity of, 3.
 Heat, Latent, Definition, 17.
 Heat Loss from Buildings, 64, 73.
 Heat Loss from Indirect Radiators, 105.
 Heat Loss from Pipe Coverings, 115, 116, 117.
 Heat Loss from Walls, 66, 73.
 Heat Loss from Windows, 64, 78.
 Heat Loss in Underground Pipes, 119.
 Heat Loss, Peclet's Computation, 73.
 Heat Loss, Protection of Main Pipes from, 113.
 Heat Loss through Stone Walls, 67.
 Heat, Measure of, 4.
 Heat, Nature of, 2.
 Heat, Per cent Transmitted through Substances, 20.
 Heat, Quantity of, 3.
 Heat, Radiant—Transmission and Reflection, 19.
 Heat, Relation to Electrical Units, 4.
 Heat, Relation to Mechanical Work, 4.
 Heat Removed by Convection, Indirect Heating, 84.
 Heat Required for Ventilation, 69.
 Heat Saved by Double Glazing, 464.
 Heat, Solar, Effect of, 463.
 Heat, Specific, Definition, 16.
 Heat Supplied by Radiating Surfaces, 81, 86.
 Heat, Total Emitted, Peclet's Tables, 85.
 Heat, Total in a Body, 17.
 Heat, Total Required, 70.
 Heat Transfer by Radiation, 18.
 Heat Transmission Coefficients, 110.
 Heat Transmission from Direct Radiators, 110.
 Heat Transmission from Steam to Water, 89.
 Heat Transmission through Corrugated Iron, 73.
 Heat Transmission through Glass, 64, 65, 68, 78.
 Heat Transmission through Stone Walls, 67.
 Heat Transmission, Variation with Circulation, 89.
 Heat Transmission, Variation with Humidity, 111.
 Heat Transmission, Variation, with Temperature, 110.
 Heat Unit, B.T.U., 4.
 Heat Unit, Calorie, 4.
 Heat Waste at Night in Schoolhouses, 465.

- Hermetic Heating, Johnson System, 297.
 Holt's Reducing Valve, 302.
 Honeywell Pressure System, 312.
 Horizontal Tubular Boilers, 197, 205.
 Horse-power, 5.
 Horse-power lost in Friction in Pipes, 579.
 Horse-power of Boiler, 189.
 Horse-power Required to Move Air, 580.
 Hot-air Circulating Systems, 341.
 Hot-air Duct, Indirect Heating, 268, 276, 477.
 Hot-air Furnace Heating, Rules for, 350.
 Hot-air Furnace Heating, Specifications, 350.
 Hot-air Furnace Proportions, 348, 349.
 Hot-air Furnace Rating, 346.
 Hot-air Furnaces, Practical Arrangement of, 343.
 Hot-air Heating, Directions for Furnace Operation, 342.
 Hot-air Heating, General Form of Furnace, 329.
 Hot-air Heating, General Principles, 327.
 Hot-air Pipes, 336, 339, 344.
 Hot-blast Heating Systems (*See* "Mechanical Heating Systems"), 392.
 Hot-water Damper Regulator, Lawler, 438.
 Hot-water Heaters, 202.
 Hot-water Heaters, Care of, 238.
 Hot-water Heaters, Explosion of, 243.
 Hot-water Heating, Accelerated Systems, 313.
 Hot-Water Heating, Area and Diameter of Main for Direct Radiation, 322.
 Hot-water Heating, Circulating Systems Utilizing Exhaust Steam, 313.
 Hot-water Heating, Circulation in Pipes, 126.
 Hot-water Heating, Closed Systems, 310.
 Hot-water Heating, Connections to Mains, 317.
 Hot-water Heating Connections to Radiators, 318.
 Hot-water Heating, Expansion Tank, 309.
 Hot-water Heating, Honeywell Pressure System, 312.
 Hot-water Heating, Methods of Piping, 306.
 Hot-water Heating, Perkins' System, 310.
 Hot-water Heating, Pipe Connections, 315.
 Hot-water Heating, Position of Valves in Pipes, 318.
 Hot-water Heating, Proportions of Parts, 275.
 Hot-water Heating, Square Feet of Radiation, 278.
 Hot-water Heating Systems, 306.
 Hot-water Heating Systems, Design of, 476.
 Hot-water Radiators, Sizes of Pipes for, 319, 322, 323.
 Hot-water Radiators, Types, 177.
 Hot Water, Velocity in Pipes, 127.
 Humidifiers, Power Required for Operating, 526.
 Humidity, Automatic Control of, 524.
 Humidity, Desirable Percentage of, 515.
 Humidity, Determination of, 517.
 Humidity of Air, 36, 561.
 Humidity, Regulation of Cooling Effect to, 527.
 Humidity Regulators, 451, 522, 525.
 Humidity, Relation to Ventilation, 39.
 Hygrodeik, 38.
 Hygrometer, 38.
 Illinois Factory Ventilation Law, 496.
 Impurities in Air, 26.
 Indiana Ventilation of Schoolhouses, 495.
 Indirect Heaters, 182.
 Indirect Heaters, Comparison of Water and Steam Circulation, 107.
 Indirect Heaters, Losses from, 105.
 Indirect Heaters, Methods of Testing, 92.
 Indirect Heaters, Piping for, 254.
 Indirect Heaters, Results of Tests, 106.
 Indirect Heaters, Setting of, 184.
 Indirect Heating, 84.
 Indirect Heating, Amount of Surface Required, 262.
 Indirect Heating, Size of Air Flue, 268, 276, 477.
 Indirect Heating Surface, Main and Return Pipes for, 272.
 Indirect Heating Surfaces, Results of Tests, 104.

- Inlet for Air, Location, 57, 466.
 Introduction of Air into Rooms, 61, 389.
- Johnson System of Hermetic Heating, 297.
 Johnson System of Temperature Regulation, 444, 449, 450.
 Joule, 4.
- Kansas Ventilation Law, 496.
 Kinealy Vacuum Heating System, 292.
- Lap-weld Process, 150.
 Latent Heat, 17.
 Lavatory, Ventilation of, 461.
 Lawler Hot-water Damper Regulator, 438.
 Laws for Heating and Ventilating, 495.
 Leader Pipes, 336.
 Leakage of Air, Rapidity of, 465.
 Ledoux's Formula for Velocity of Air in Pipes, 133.
 Local Ventilation, 466.
 Location of Inlet for Air, 57, 466.
 Location of Outlet for Air, 58.
 Lock-nut and Nipple, 155.
 Locomotive and Marine Boilers, 198.
 Logarithmic Tables, 555.
 Loss in Transmitting Power by Various Methods, 120.
 Loss of Head in Pipes, 124, 130.
 Loss of Heat from Buildings, 64, 73
 Loss of Heat from Indirect Radiators, 105.
 Loss of Heat from Main Pipe, Protection from, 113.
 Loss of Heat from Pipe Coverings, 115, 116, 117.
 Loss of Heat from Walls, 66, 73.
 Loss of Heat from Windows, 64, 78.
 Loss of Heat, Pecllet's Computation, 73.
 Loss of Heat through Stone Walls, 67.
 Lunge-Zeckendorf Method of CO₂ Determination, 35.
- Main and Return Pipes for Indirect Heating Surface, 272.
 Main Connections, Hot-water Heating, 317.
 Maine Building Code for Schoolhouses, 498.
 Maine Health Laws, 498.
 Main Flow Pipe, Hot-water Heating, 246.
- Main Steam Pipe, Steam Heating, 246.
 Manifold Coil, 173.
 Manometer, 47, 222.
 Marine and Locomotive Boilers, 198.
 Mason's Reducing Valve, 303.
 Massachusetts Ventilation Law, 499.
 Materials, Strength of, 558.
 Maxima and Minima Thermometers, 15.
 Measurement of Air Supplied, 39, 338.
 Measurement of Radiating Surface, 94.
 Mechanical Heating Systems, Blowers or Fans, 403, 407.
 Mechanical Heating Systems, Flues or Ducts, 398.
 Mechanical Heating Systems, Heating Surface Required, 404, 406.
 Mechanical Heating Systems, Practical Construction, 406.
 Mechanical Heating Systems, Registers, 402.
 Mechanical Heating Systems, Size of Boiler, 405, 407.
 Mechanical Heating Systems, Tests, 415.
 Mechanical Ventilation, 46.
 Mechanical Ventilation and Heating Systems, 392.
 Mechanical Ventilation, Cost of, 458.
 Mechanical Ventilation Plant, Description, 408.
 Mechanical Ventilators, 352.
 Mechanical Work Relation to Heat, 4.
 Mercurial Thermometer, 9.
 Metallic Pyrometers, 13.
 Metric Units, Equivalent in British, 540.
 Mills System of Piping, 249.
 Miter Branch Tee Coil, 173.
 Minnesota Building Code, 501.
 Mixing Dampers, 396.
 Moisture in Air, 36, (Ap.) 561.
 Monash Vacuum Heating System, 293.
 Montana Public Health Laws, 502.
 Morgan System, 256.
 Moving of Air, Force Required, 45.
 Morehead Tilting Return Trap, 234.
 Multivane Fans, 357.
 Multivane Fans, Characteristic Curves, 371.
- Natural Circulation of Air, 573.
 Nature of Heat, 2.
 New Jersey Building Code, 503.

- New York State Education Department
 Laws, 506.
 New York State Ventilation Law, 505.
 Nitrogen in Air, 30, 31.
 Noel Pyrometer, 14.
 North Dakota Ventilation Law, 504.
 Offset, 158.
 Offset Bend, 170.
 Ohio State Building Code, 507.
 One-pipe System, 249.
 One-pipe System, Hot-water Heating,
 308.
 One-pipe System, Steam Heating, 269.
 Osborne System of Hot-water Cir-
 culation, 315.
 Outlet for Air, Location, 58.
 Oxygen in Atmosphere, 28, 31.
 Ozone, 24, 26, 28.
 Painting Radiating Surface, Effect of,
 95.
 Partial Circuit System of Piping, 249.
 Paul System, Exhaust Steam Heating,
 294.
 Peclet's Computation of Loss of Heat,
 73.
 Pennsylvania Sanitary School Laws,
 507.
 Perkins' System of Hot-water Heating,
 310.
 Petticoat Pipe, 198.
 Pipe, Air Carrying Capacity of, 363.
 Pipe Areas, Equalization of, Table, 579.
 Pipe Bends and Elbows, 156.
 Pipe Boot, 336.
 Pipe Connections, 154.
 Pipe Connections, Hot-water Heating,
 315.
 Pipe Connections, Steam-heating Sys-
 tems, 251.
 Pipe, Contents in Gallons and Cubic
 Feet, 578.
 Pipe Coverings, 114, 117.
 Pipe Coverings, Tests of, 115, 116, 119.
 Pipe, Diagram Showing Discharge, 363.
 Pipe Dimensions, 153, 575.
 Pipe, Dimensions for Given Discharge,
 581.
 Pipe, Equalization of Areas, 579.
 Pipe, Expansion of, 170.
 Pipe Fittings, 153, 158.
 Pipe Fittings, Resistance of, 129.
 Pipe Fitting, Suggestions for, 489.
 Pipe Insulation, 114, 117.
 Pipe Insulation, Wooden Tube, 118.
 Pipe Junctions, Tees, Y's, etc., 157.
 Pipe Line Dimensions, 366.
 Pipe, Radiating Surface of, 172.
 Pipe Radiators, 175.
 Pipe, Rectangular Equivalent of Cir-
 cular, 364.
 Pipe, Relief and Drip, 273, 274.
 Pipes and Fittings, Cast-iron, 148.
 Pipes for Heated Air, 336.
 Pipe Sizes, 153.
 Pipe Sizes for Given Discharge, 581.
 Pipe Sizes for Vacuum Steam-heating
 Systems, 305.
 Pipes, Pitch of, 246.
 Pipe, Table of Standard Dimensions,
 575.
 Pipe, Wrought Iron and Steel, 150.
 Piping, Complete Circuit System, 249.
 Piping, Computations for Steam Piping,
 268, 270.
 Piping for Greenhouses, 468, 469.
 Piping for Hot-water, One-pipe System,
 308.
 Piping for Indirect Heaters, 254.
 Piping for Indirect Heating, 477.
 Piping for Steam, One-pipe System, 269.
 Piping, Exhaust Heating, 282, 285.
 Piping, Hot-air Heating, 344.
 Piping, Hot-water Heating, 306.
 Piping, Mills' System, 249.
 Piping, One-pipe System, 249.
 Piping, Partial-circuit System, 249.
 Piping Systems, 248.
 Piping, Two-pipe System, 249.
 Pitch of Pipes, 246.
 Pitot-tube, 48, 52.
 Plates, Ceiling and Floor, 159.
 Plates, Hook-, Expansion-, and Ring-
 plates, 159.
 Plenum and Vacuum Methods of
 Ventilation, 465.
 Pneumatic Motor System of Tempera-
 ture Regulation, 444.
 Pneumatic Thermostat Construction,
 446.
 Pop-valve, 217.
 Portable Setting for Furnace, 351.
 Portable Setting for Heating Boilers,
 215.
 Positive Differential Vacuum Heating
 System, 294.
 Power Boilers, 195.

- Power Boilers, Rating of, 190.
 Power for Moving Air, 147, 361, 365, 580.
 Power of Fans, Rule for, 381.
 Powers Temperature Regulator, 438.
 Preparatory Warming, 462.
 Pressure and Head Reduction, 541, 577.
 Pressure Fan, 354.
 Pressure Gauge, Bourdon, 222.
 Pressure Gauge, Diaphragm, 223.
 Pressure Head, 47.
 Pressure, Methods of Measuring, 222.
 Pressure of Water for Different Heights, 541.
 Pressure Produced by Fans, 373, 378.
 Pressure Systems of Hot-water Heating, 312.
 Propeller or Disk Fans, 359, 387.
 Properties of Air, 559.
 Properties of Familiar Substances, 557.
 Properties of Gases, Table, 541.
 Properties of Steam, General, 187.
 Protection from Fire, 492.
 Pump Governors, 298.
 Pump-return Steam Heating Systems, 280.
 Pyrometer, Noel, 14.
 Pyrometers, 13.
 Pyrometers, Calorimetric, 14.
 Pyrometers, Metallic, 13.
- Radiant Heat, Defined, 18.
 Radiant Heat, Reflection and Transmission, 19.
 Radiating Surface, Amount Required for Warming, 258.
 Radiating Surface, Effect of Painting, 95.
 Radiating Surface, Exhaust Heating, 282.
 Radiating Surface, Greenhouse Heating, 469.
 Radiating Surface, Heat from, Diagram, 261.
 Radiating Surface, Heat Supplied by, 81, 86.
 Radiating Surface, Indirect Heating, 262.
 Radiating Surface, Measurement of, 94.
 Radiating Surface, Pipe, 172.
 Radiating Surface, Results of Tests, 96.
 Radiating Surface Required for Warming, 258.
- Radiating Surface, Rules for Estimating, 266.
 Radiation, 18.
 Radiation, Area for Hot-water, 278.
 Radiation, Area for Steam, 279.
 Radiation, Direct, 81, 87.
 Radiation, Heat Emitted by, 82, 86.
 Radiation, Heat Loss from Various Surfaces, 86.
 Radiation, Indirect, 81.
 Radiation, Short Method of Computing, 276.
 Radiator Connections, Hot-water, 316.
 Radiator Connections, Steam, 253.
 Radiators, Cast-iron, 176.
 Radiators, Direct-indirect, 182.
 Radiators, Extended Surface, 177.
 Radiators, Flue Type, 177.
 Radiators, Height of, 98.
 Radiators, Hot-water, 177.
 Radiators, Illustrated, 180.
 Radiators, Indirect, 182.
 Radiators, Methods of Testing, 90.
 Radiators, Pressed Steel, 182.
 Radiators, Proportions of Parts, 185.
 Radiators, Qualities for Efficiency, 172.
 Radiators, Sizes of Pipes in Hot-water Heating, 319.
 Radiators, Vertical Pipe, 175.
 Radiators, Wall Type, 178.
 Radiator Tests, Conclusions from, 108.
 Radiator Valves, 163.
 Rateau Screw Fan, 360.
 Réaumur Thermometer, 8.
 Rectangular Pipes, Capacity of, 364.
 Reducing Valves, 302.
 Reflecting Power of Metals, 19.
 Reflection and Transmission of Radiant Heat, 19.
 Refrigeration to Cool Air, Table, 530.
 Register Area, 339, 402.
 Register Box, 336.
 Register Details, 346.
 Registers and Flues, Dimensions of, 142, 144.
 Registers for Hot-air, 338, 340, 346.
 Registers for Mechanical Heating Systems, 402.
 Registers, Merits of Floor and Wall Types, 340.
 Regulating Dampers, 396.
 Regulators, Diaphragm, 440.
 Regulators, Lawler, 438.

- Regulators Operated by Change of Pressure, 437.
- Regulators Operated by Direct Expansion, 441.
- Regulators Operated by Motor, 442.
- Regulators, Powers, 438.
- Regulators, Temperature, 436.
- Relation of Air to Vitality, 454.
- Relation of Ventilation to Heating, 24.
- Relative Weights of Water and Air, 560.
- Relay, 246.
- Relief and Drip Pipes, Size of, 273, 274.
- Relief Pipe, 246.
- Return Bend, 158.
- Return-pipes, Hot-water Heating, 323.
- Return Pipe, Sizes of, 272.
- Return Pipes, Steam Heating, 272, 273.
- Return Riser, 246.
- Return Trap, Bundy, 235.
- Return Trap, Diagram Showing Action, 234.
- Return Trap, Gravitating, 235.
- Return Trap, Morehead Tilting, 234, 236.
- Return Traps, 233.
- Riser, 246.
- Roof Ventilators, 147.
- Root Positive Blower, 361.
- Rules for Estimating Radiating Surface, 266.
- Rules for Fan Capacity and Power, 380, 381.
- Rules for Furnace Heating, 350.
- Rust Joint, 149.
- Safety-valve, 458.
- Safety-valve Area, 218.
- Sanitary Rooms, Ventilation of, 461.
- Sashing, Effect of Double, 465.
- Saturated Steam, Tables, 566
- Saving in Schoolhouse Heating, 458.
- Schoolhouse Warming and Ventilation, Air Filtration, 467.
- Schoolhouse Warming and Ventilation, Air Supply, 454, 457, 459, 460.
- Schoolhouse Warming and Ventilation, Character of Problem, 453.
- Schoolhouse Warming and Ventilation, Cost, 458.
- Schoolhouse Warming and Ventilation, Draughtiness, 454, 457.
- Schoolhouse Warming and Ventilation, Local Ventilation, 466.
- Schoolhouse Warming and Ventilation, Plenum and Vacuum Methods, 465.
- Schoolhouse Warming and Ventilation, Quick Preparatory Warming, 462.
- Schoolhouse Warming and Ventilation, Relation of Pure Air to Vitality, 454.
- Schoolhouse Warming and Ventilation, Saving of Heat, 458, 463, 464, 465.
- Schoolhouse Warming and Ventilation, Successive Ventilation, 458.
- Schoolhouse Warming and Ventilation, Temperature Control, 464.
- Schoolhouse Warming and Ventilation, Warming by Rotation, 462.
- Sectional Boilers, Horizontal and Vertical, 208.
- Settings for Boilers, 211.
- Settings for Indirect Heaters, 184.
- Siphon, 247.
- Siphon Condenser, 287.
- Siphon Trap, 230.
- Sirocco Fan, 358, 359.
- Sling Psychrometer, 37.
- Smith Method of CO₂ Determination, 35.
- Smoke-flue Area, 478.
- Solar Heat, Effect of, 463.
- South Dakota Schoolhouse Plans, 511.
- Specification Proposals, 479.
- Specifications for Furnace Heating, 350.
- Specifications for Heating Apparatus, 483.
- Specifications, Form of Contract, 483.
- Specifications, General Business Methods, 479.
- Specifications, General Requirements 480.
- Specific Heat, Definition of, 16.
- Stack Area, Hot-air Heating, 339.
- Stacks, Hot-air Heating, 336.
- Stacks, Indirect Heating, 183.
- Steam Boilers, General Requisites of, 188.
- Steam Boilers, Proportions of Heating to Grate Surface, 190.
- Steam Boilers, Requisites of, 194.
- Steam Boilers, Stored Energy of, 240.
- Steam Boilers, Water Surface, 193.
- Steam Boiler Tests, House-heating Type, 193.
- Steam Condensed in Heating, 109.
- Steam, Flow through Pipes, 135, 141.
- Steam-gauge, Connection for, 215.
- Steam, General Properties of, 187.

- Steam-heated Surface, Form of, 397.
 Steam Heating, Amount of Heat and Radiating Surface Required, 258, 262.
 Steam-heating Boilers, Care of, 236.
 Steam Heating, Exhaust Heating Systems, 281.
 Steam Heating, General Principles of Design, 257.
 Steam Heating, Gravity Circulating System, 245.
 Steam Heating, Greenhouses, 471.
 Steam Heating, High Pressure System, 245.
 Steam Heating, Pipe Connections, 251.
 Steam Heating, Piping for Indirect Heaters, 254.
 Steam Heating, Piping Systems, 248.
 Steam Heating, Proportions of Parts, 275.
 Steam Heating, Pump-return System, 280.
 Steam Heating, Sizes of Return Pipes, 272.
 Steam Heating, Square Feet of Radiation, 279.
 Steam Heating, Summary of Approved Methods of Design, 476.
 Steam-loop, 300.
 Steam Main, Approximate Area and Diameter, 269.
 Steam Pipes, Capacity Tables, 271.
 Steam Pipes, Size of Return Pipes, 272.
 Steam Piping, Computations, 268.
 Steam Piping, Rules for Sizes, 270.
 Steam Piping, Sizes for Vacuum Heating, 305.
 Steam, Properties of, Table, 566.
 Steam Radiators, Cast-iron, 176.
 Steam Radiators, Vertical, 175.
 Steam Space in Boilers, 193.
 Steam Tables, Explanation of, 187.
 Steam, Transmission Long Distances, 119.
 Steam Trap, 230, 247.
 Steel-plate Fans or Blowers, 353.
 Stefan's Law, 83.
 Stuffing-boxes, 162.
 Stone Walls, Heat Loss through, 67.
 Stoves, Heating with, 341.
 Strength of Materials, Coefficients, 558.
 Substances, Properties of Various, 557.
 Successive Ventilation in Schoolhouses, 458.
 Summary of Approved Methods of Design for Heating Systems, 476.
 Systems of Piping in Gravity Steam Heating 248.
 Systems of Warming, 23.
 Tables in Appendix, Explanation of, 535.
 Temperature, 3, 5.
 Temperature by Color of Incandescent Bodies 14.
 Temperature by Melting-points, 14.
 Temperature Control in Schoolhouses, 464.
 Temperature Corrections for Barometer, 572.
 Temperature of Various Localities, 583.
 Temperature Produced when Outside Temperature is High, 111.
 Temperature Regulation, Johnson System, 444.
 Temperature Regulation, Pneumatic Motor System, 444.
 Temperature, Regulation, Saving by, 451.
 Temperature Regulator, Powers, 438.
 Temperature Regulators, 436.
 Temperature Regulators Acting by Change of Pressure, 437.
 Temperature Regulators Operated by Direct Expansion, 441.
 Temperature Regulators Operated by Motor, 442, 444.
 Temperature Regulators, Relative Rates of Expansion, 442.
 Temperatures at Various Localities, 583.
 Ten-point Method, 49.
 Tests of Blower Systems of Heating, 415.
 Tests of Hot-water and Steam Heating of Greenhouses, 471.
 Tests of House-heating Boilers, 193.
 Tests of Radiating Surface, 96.
 Thermal Conductivities, 574.
 Thermograde Positive Differential Vacuum Heating System, 294.
 Thermometer, Air, 10.
 Thermometer Cup, 15, 17.
 Thermometer, Centigrade, 8.
 Thermometer, Construction and Forms of, 5.
 Thermometer, Electrical Resistance, 11.
 Thermometer, Fahrenheit, 8.
 Thermometer, Maxima and Minima, 15.

- Thermometer, Mercurial, 9.
 Thermometer Scales, 7, 8.
 Thermometer, Thermo-electric, 11.
 Thermometer, Use of, 15.
 Thermometer, Wet and Dry Bulb, 37.
 Thermostat, 436.
 Thermostatic Valve, Webster, 291.
 Thermostat, Johnson Intermediate, 450.
 Thermostat, Johnson Positive, 449.
 Thermostat, Pneumatic, 446.
 Trane System, 256.
 Transmission of Heat, Coefficients, 110.
 Transmission of Heat from Direct Radiators, 110.
 Transmission of Heat from Steam to Water, 89.
 Transmission of Heat through Corrugated Iron, 73.
 Transmission of Heat through Glass, 64, 65, 68, 78.
 Transmission of Heat through Stone Walls, 67.
 Transmission of Heat, Variation with Circulation, 89.
 Transmission of Heat, Variation with Humidity, 111.
 Transmission of Heat, Variation with Temperature, 110.
 Transmission of Power, Losses by Various Methods, 120.
 Transmission of Steam Long Distances, 119.
 Trap, Bucket, 232.
 Trap, Bundy Return, 235.
 Trap, Combined Float and Expansion, 233.
 Trap, Counter-weighted, 231.
 Trap, Expansion, 232.
 Trap, Float, 231.
 Trap, Gravitating Return, 235.
 Trap, Morehead Tilting Return, 234.
 Trap, Return, 233.
 Traps, 230, 247.
 Trap, Siphon, 230.
 Try-cocks, 221.
 Two-pipe System, 249.

 Underground Pipes, Heat Loss in, 119.
 Unions, 155.
 U. S. Standard Weights and Measures, 538.
 Utah Building Code, 511.

 Vacuum Circulating Systems, 255.
 Vacuum Gauge, 223.
 Vacuum Heating Systems, Kinealy, 292.
 Vacuum Heating Systems, Monash, 293.
 Vacuum Heating Systems, Paul, 294.
 Vacuum Heating Systems, Positive Differential, 294.
 Vacuum Steam Heating, Pipe Sizes, 305.
 Vacuum Systems, Exhaust Heating, 286.
 Valve, Air, 165, 167.
 Valve, Angle, 162.
 Valve, Automatic Air, 167.
 Valve, Back-pressure, 281.
 Valve, Check, 165.
 Valve, Corner, 163.
 Valve, Cross, 163.
 Valve, Diaphragm, 445.
 Valve, Equalizing, 235.
 Valve, Gate, 160.
 Valve, Globe, 161.
 Valve, Reducing, 302.
 Valves and Cocks, 159.
 Valves, Position in Pipes in Hot-water Heating, 318.
 Van Auken System of Circulation, 297.
 Vapor, Table of Properties, 518.
 Velocity and Volume of Air Discharged from Fans, 377.
 Velocity Head, 47.
 Velocity in Hot-water Pipes, 127.
 Velocity of Air Entering, 57.
 Velocity of Air, Ledoux's Formulæ, 133.
 Velocity of Air, Measurements of, 46.
 Velocity of Air, Natural Draft, 573.
 Velocity of Air on Different Floors, 62.
 Velocity of Air Produced by Heating, 53.
 Velocity of Air under Pressure, 582.
 Velocity of Air, Unwin's Formula, 130.
 Ventilating Systems, Power for Moving Air through, 147.
 Ventilation, Air Required per Person, 41.
 Ventilation by Heating of Air, 53.
 Ventilation by Mechanical Means, 46, 352.
 Ventilation, Coat, Bath, Lavatory and Sanitary Rooms, 461.
 Ventilation, Cost of, 458.
 Ventilation, Classrooms, 462.
 Ventilation Flues, 61, 268, 276, 477.
 Ventilation, Heat Required for, 60.
 Ventilation, Influence of Humidity, 39.

- Ventilation, Influence of Size of Room, 43.
- Ventilation, Introduction of Air into Rooms, 61, 389.
- Ventilation, Local, 466.
- Ventilation, Location of Inlets in Schoolrooms, 466.
- Ventilation, Measurement of Air Supplied, 388.
- Ventilation, Measurement of Relative Air Supply, 39.
- Ventilation, Mechanical, 46, 352, 389.
- Ventilation, Movement of Air, 45.
- Ventilation, Plenum and Vacuum Methods, 465.
- Ventilation, Relation to Heating, 24.
- Ventilation, Successive, 458.
- Ventilation, Summary of Problems, 62.
- Ventilation, Vacuum Methods, 465.
- Ventilators, Mechanical, 352, 389.
- Ventilators, Roof, 147.
- Vento Heaters, Charts, 420.
- Vent Pipes, 345.
- Vermont Ventilation Law, 512.
- Vertical Boilers, 199.
- Virginia Building Code, 514.
- Volume or Positive Blowers, 361, 362.
- Wall Radiators, 103, 178.
- Walls, Heat Loss from, 66, 73.
- Warming, Quick Preparatory, 462.
- Warming, Rotation, 462.
- Warming, Schoolhouse, 453.
- Warming, Systems of, 23.
- Waste of Heat at Night in Schoolhouses, 465.
- Water, Boiling Temperatures, 25.
- Water Column, 221.
- Water Column Reduced to Ozs. per Sq.in., Table, 541.
- Water, Flow of, 124.
- Water, Flow through Pipes, 128.
- Water-gauge, 220.
- Water-hammer, 247.
- Water, Heat Content at Various Temperatures, 576.
- Water Heaters, Care of, 238.
- Water, Hot, Velocity in Pipes, 127.
- Water-leg, 199.
- Water, Pressure for Different Heads, 577.
- Water-line, Steam Heating, 247.
- Water, Relative Weight of Air and, 560.
- Water-space in Boilers, 193.
- Water-surface in Boilers, 193.
- Water-tube Boilers, 200, 205.
- Water Vapor in Atmosphere, 31.
- Water, Weight per Cubic Foot at Various Temperatures, Table, 576.
- Webster System of Exhaust Steam Heating, 289.
- Webster Thermostatic Valve, 291.
- Weight of Water per Cubic Foot at Various Temperatures, Table, 576.
- Weights and Measures, U. S. Standard, 538.
- Wet and Dry Bulb Thermometers, 37.
- William's System, Exhaust Steam Heating, 288.
- Windows, Double, 464.
- Windows, Heat Loss from, 64, 78.
- Wind Velocity, Correction for, 113.
- Wolfe's Diagram for Heat Emitted, 261.
- Wolff's Diagram for Loss of Heat, 68.
- Wood Tubing for Pipe Insulation, 119.
- Work, Defined, 4.
- Work Done in Heating Air, 55.
- Work of Moving Air through Pipes, 361, 365.
- Work Required to Run Fan, 379.
- Workshop Heating, 475.
- Wrought-iron and Steel Pipe, 150.
- Wrought-iron Pipe Heaters, Table, 422.
- Wyckoff Built-up Wood Tubing, 119.
- Yaryan System of Hot-water Circulation, 315.

20
a a s
u. E u s

UNIVERSITY OF CALIFORNIA LIBRARY
BERKELEY

Return to desk from which borrowed.

This book is DUE on the last date stamped below.

ENGINEERING LIBRARY

OCT 24 1948 *L*

NOV 8 1948 *L*

APR 28 1950 *R*

INTERLIBRARY LOAN

MAR 29 1983

UNIV. OF CALIF., BERK.

JUN 19 1992
AUTO DISC.

MAR 23 1992

CIRCULATION

YC 33226

U.C. BERKELEY LIBRARIES



039578387

302970

Computer

Engineering
Library

UNIVERSITY OF CALIFORNIA LIBRARY

