

US SOUTHERN REGIONAL LIBRARY FACILITY

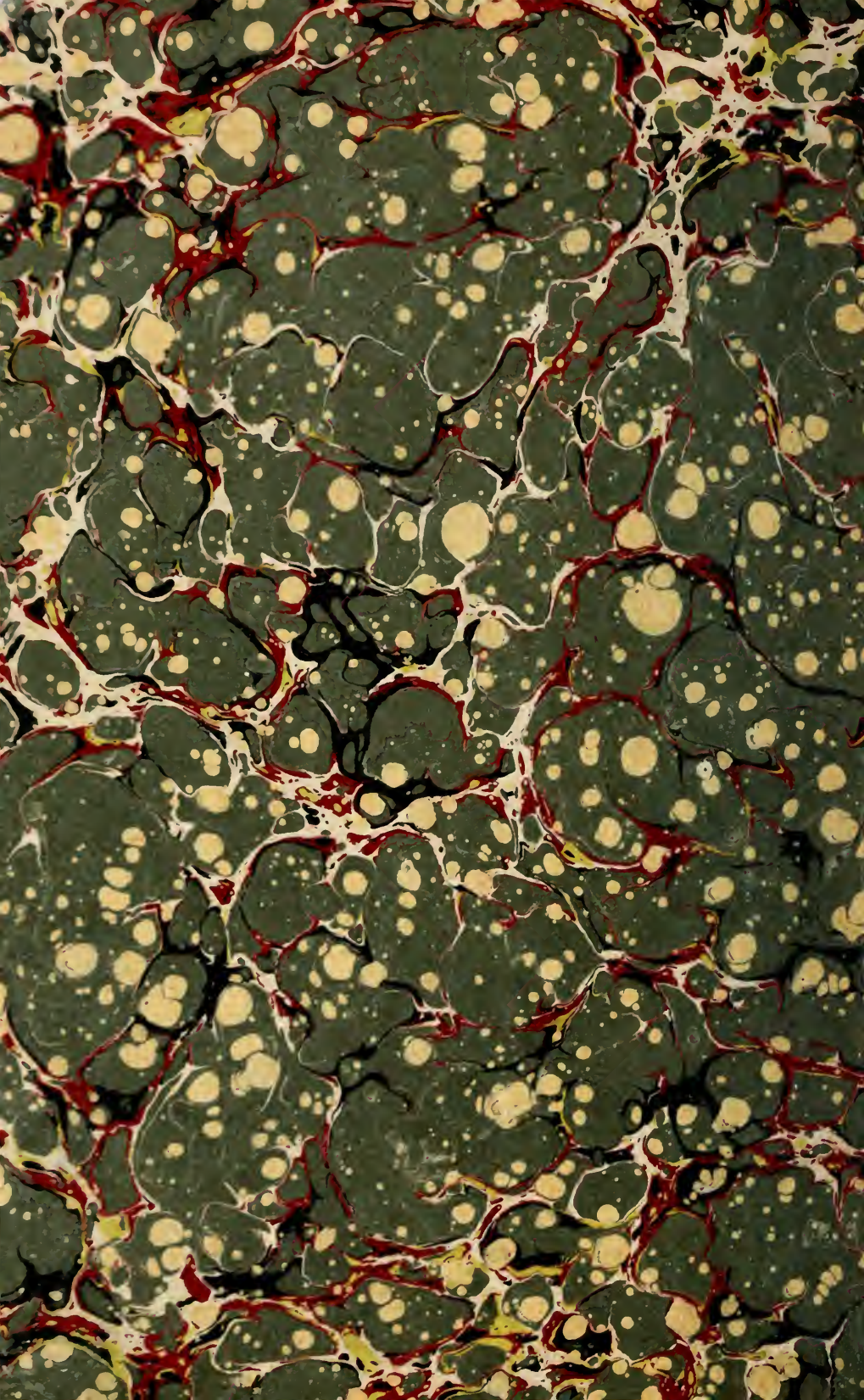

A
0
0
6
0
7
2
1
9
3

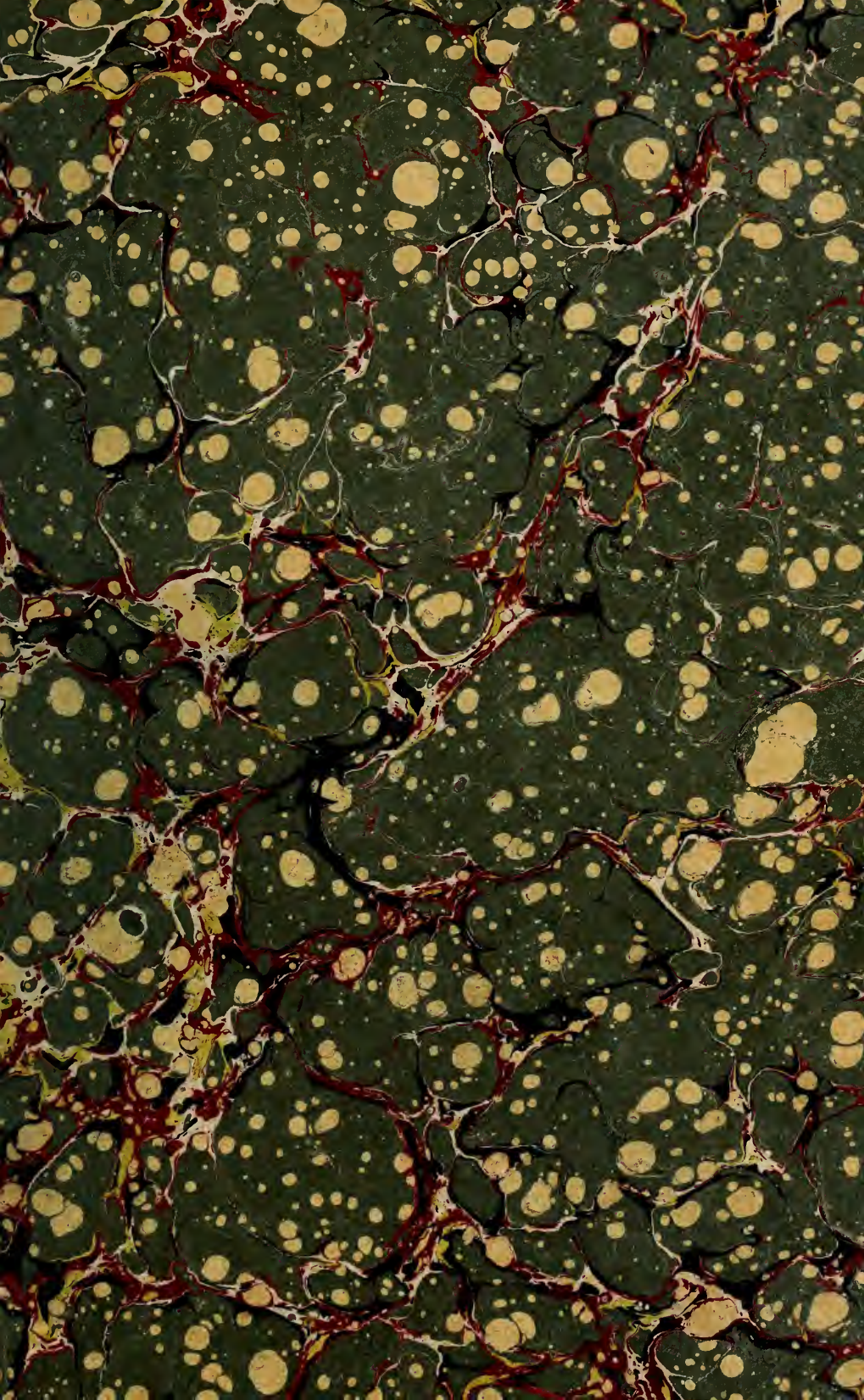



UCSB LIBRARY

Z-63001

FS

1.50

HEATING AND VENTILATION.

PART I.

INSTRUCTION PAPER



AMERICAN SCHOOL OF CORRESPONDENCE

[CHARTERED BY THE COMMONWEALTH OF MASSACHUSETTS]

BOSTON, MASSACHUSETTS

U. S. A.

PREPARED BY
CHARLES L. HUBBARD, M.E.,
OF
S. HOMER WOODBRIDGE COMPANY,
HEATING, VENTILATION AND SANITARY ENGINEERS.

*Copyright 1902, by
American School of Correspondence
• Boston, Mass.*

HEATING AND VENTILATION.

SYSTEMS OF WARMING.

Any system of warming must include, *first*, the combustion of fuel which may take place in a fireplace, stove, steam or hot-water boiler; *second*, a system of transmission, by means of which the heat may be carried, with as little loss as possible, to the place where it is to be used for warming, and *third*, a system of diffusion, which will convey the heat to the air in a room and to its walls, floors, etc., in the most economical way.

Stoves. The simplest and cheapest form of heating is the stove. The heat is diffused by radiation and convection directly to the objects and air in the room, and no special system of transmission is required. The stove is used largely in the country and is especially adapted to the warming of small dwelling houses and isolated rooms.

Furnaces. Next in cost of installation and simplicity of operation is the hot-air furnace. In this method, the air is drawn over heated surfaces and then transmitted through pipes, while at a high temperature, to the rooms where heat is required. Furnaces are used largely for warming dwelling houses, also churches, halls and schoolhouses of small size. They are more costly than stoves, but have some advantages over that form of heating. They require less care, as several rooms may be warmed from a single furnace; and, being placed in the basement all dust from coal and ashes is kept from the rooms above.

In construction a furnace is a large stove with a combustion chamber of ample size over the fire; the whole being enclosed in a casing of sheet iron or brick. The bottom of the casing is provided with a cold-air inlet, and at the top are pipes which connect with registers placed in the various rooms to be heated. Cold fresh air is brought from out of doors through a pipe or duct called the "cold-air box;" this air enters the space between the casing and the furnace near the bottom and in passing over the

hot surfaces of the fire pot and combustion chamber, becomes heated. It then rises through the warm-air pipes at the top of the casing and is discharged through the registers into the rooms above.

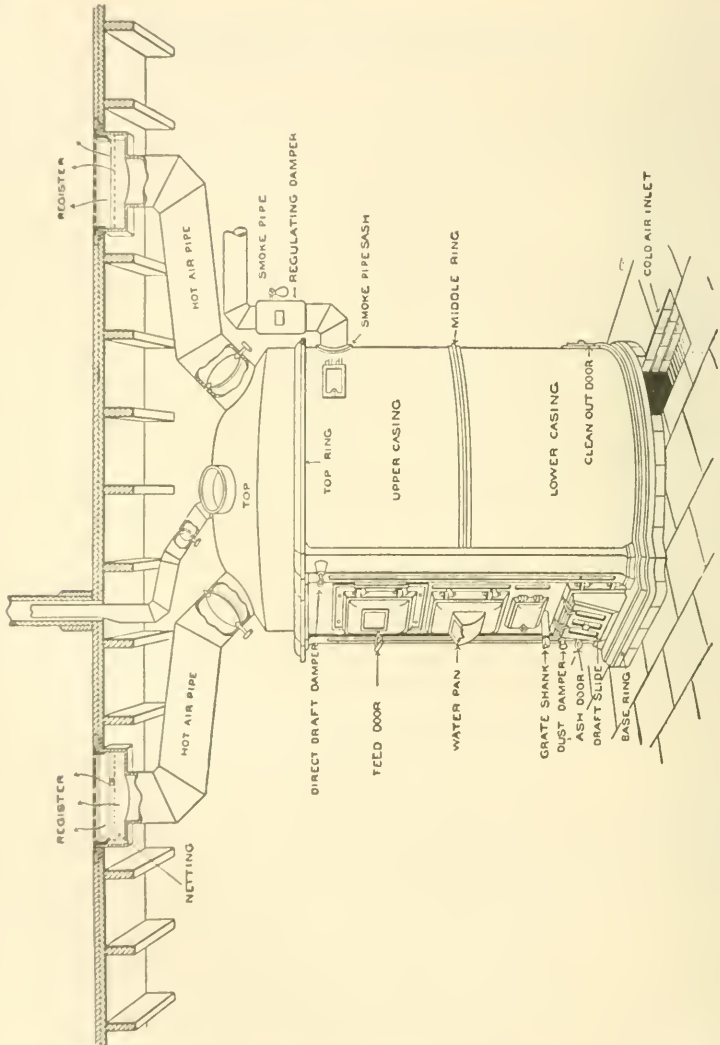

Fig. 1.

As the warm air is taken from the top of the furnace, cold air flows in through the cold-air box to take its place. The air for heating the rooms does not enter the combustion chamber.

Fig. 1 shows the general arrangement of a furnace with its connecting pipes. The cold-air inlet is seen at the bottom and the hot-air pipes at the top; these are all provided with dampers for shutting off or regulating the amount of air flowing through them. The feed or fire door is shown at the front and the ash door beneath it; a water pan is placed inside the casing and furnishes moisture to the warm air before passing into the rooms; water is either poured into the pan through an opening in the front, provided for this purpose, or is supplied automatically through a pipe.

The fire is regulated by means of a draft slide in the ash door and a cold-air or regulating damper placed in the smoke-pipe. Clean-out doors are placed at different points in the casing for the removal of ashes and soot. Furnaces are made either of cast iron, or of wrought iron plates riveted together and provided with brick-lined fire pots.

One great advantage in this method of warming comes from the constant supply of fresh air which is required to bring the heat into the rooms. While this is greatly to be desired from a sanitary standpoint it requires a

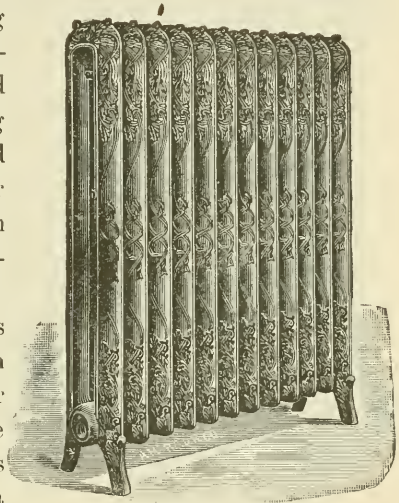

Fig. 2.

larger amount of fuel than would otherwise be necessary, for heat is required to warm the fresh air from out of doors up to the temperature of the rooms, in addition to that lost by leakage through walls and windows.

A more even temperature may be maintained in this way than by the use of stoves, owing to the greater depth and size of the fire, which causes it to be more easily controlled. When a building is placed in an exposed location, difficulty may be experienced at times in warming certain rooms, depending upon the direction of the wind; this may be overcome to a large extent by a proper location of the furnace and the exercise of suitable care

in running the connecting pipes. This will be taken up later in the design of heating systems.

Direct Steam Heating. Direct steam heating is used in all classes of buildings, both by itself and in combination with other systems. The first cost of installation is greater than for furnace heating but the amount of fuel required is less, as no outside air-supply is necessary. If used for warming hospitals, schoolhouses or other buildings where ventilation is desired, it must be supplemented by some other means for providing warm fresh air. A

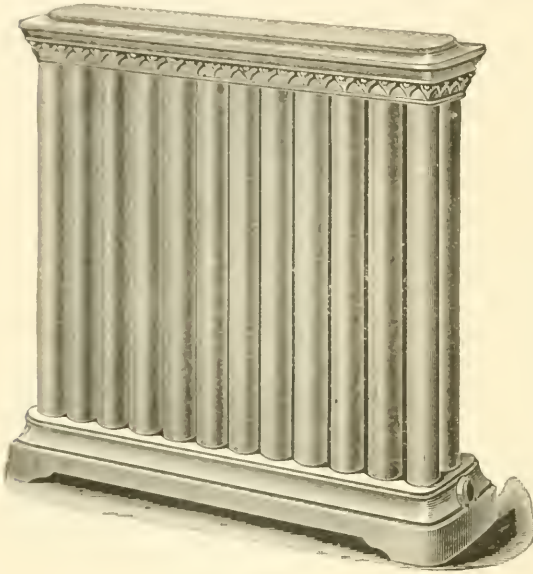

Fig. 3.

system of direct steam heating consists of a furnace and boiler for the combustion of fuel and the generation of steam: a system of pipes for conveying the steam to the radiators and for returning the water of condensation to the boiler; and radiators or coils placed in the rooms for diffusing the heat.

Various types of boilers are used, depending upon the size and kind of building to be warmed. Some form of cast iron sectional boiler is commonly used for dwelling houses, while the tubular or water-tube boiler is more usually employed in larger buildings. Where the boiler is used for heating purposes only, a low steam pressure of from 2 to 10 pounds is carried and the condensation flows back by gravity to the boiler which is placed below the lowest radiator. When, for any reason, a higher pressure is required, the steam for the heating system is made to pass through a reducing valve and the condensation is returned to the boiler by means of a pump or return trap. The methods of

making the pipe connections between the boiler and radiators vary for different conditions and in different systems of heating. These will be taken up later under the head of design.

Direct radiating surface is made up in different ways: Fig 2 shows a common form of cast iron sectional radiator; these can be made up in any size depending upon the height and number of sections used. Fig. 3 is made up of vertical wrought iron pipes serewed into a cast iron base and is a very efficient form. Fig. 4 shows a type of cast iron wall radiator which is often used where it is desired to keep the floor free from obstruction. Fig. 5 is a special form of dining-room radiator provided with a warming closet. Wall and ceiling coils of wrought iron pipe are often used

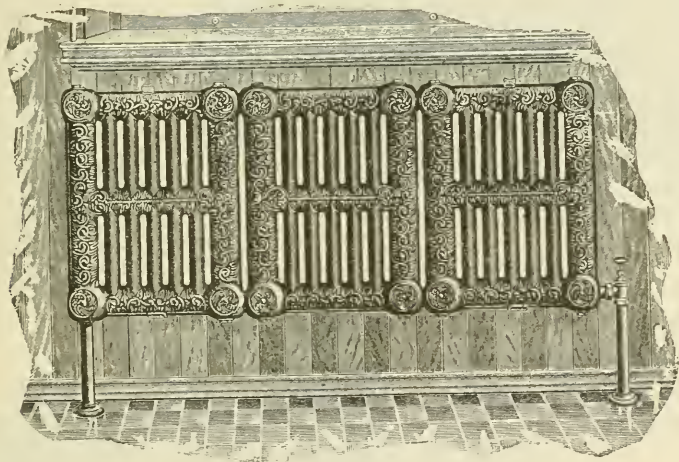

Fig. 4.

in school rooms, halls and shops or where the appearance is not objectionable.

Indirect Steam. This system of heating combines the advantages of both the furnace and direct steam but is more expensive to install. The amount of fuel required is about the same as in the case of furnace heating. Instead of placing the radiators in the rooms, a special form of heater is placed beneath the floor and encased in galvanized iron or brickwork. A cold-air box is connected with the space beneath the heater and warm-air pipes at the top are connected with registers in the floors or walls as

already described for furnaces. A separate heater may be provided for each register if the rooms are large, or two or more registers may be connected with the same heater if the horizontal runs of pipe are short. Fig. 6 shows a section through a heater arranged for introducing hot air into a room through a floor register and Fig. 7 shows the same type of heater connected with a wall register. The cold-air box is seen at the bottom of the casing, and the air in passing through the spaces between the sections of the heater, becomes warmed and rises to the rooms above.

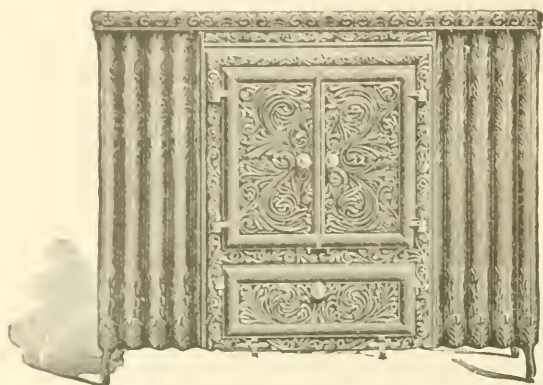

Fig. 5.

8 and 9. Several sections connected in a single group are called a "Stack." Sometimes the stacks are encased in brickwork built up from the basement floor instead of galvanized iron as shown in the cuts. This method of heating provides fresh air for ventilation, and for this reason is especially adapted for school-houses, hospitals, churches, etc. As compared with furnace heating it has the advantage

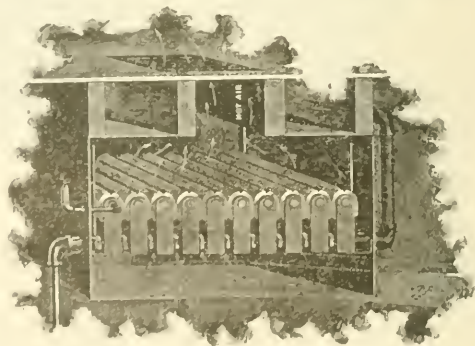

Fig. 6.

of being less affected by outside wind pressure, as long runs of horizontal pipe are avoided and the heaters can be placed near the registers. In a large building where several furnaces would be required, a single boiler can be used and the number of stacks increased to suit the existing conditions, thus

making it necessary to run but a single fire. Another advantage is the large ratio between the heating and grate surface as compared with a furnace, and as a result a large quantity of air is warmed to a moderate temperature in place of a smaller quantity heated to a much higher temperature. This gives a more agreeable quality to the air and renders it less dry. Direct and indirect systems are often combined, thus providing the living rooms with ventilation while the hallways, corridors, etc., have only direct radiators for warming.

Direct-Indirect Radiators.

A direct-indirect radiator is similar in form to a direct radiator and is placed in a room in the same manner. Fig. 10 shows the general form of this type of radiator and Fig. 11 shows a section through the same.

The shape of the sections is such, that when in place, small flues are formed between them. Air is admitted through an opening in the outside wall and in passing upward

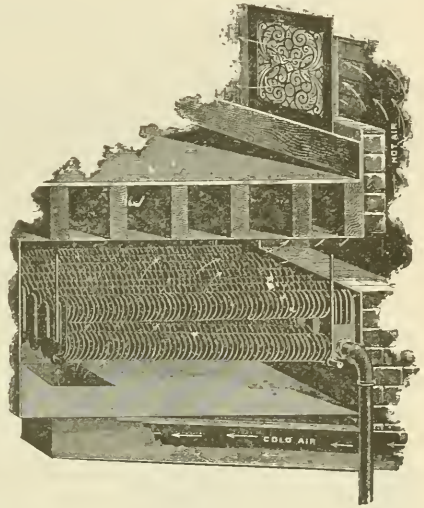

Fig. 7.

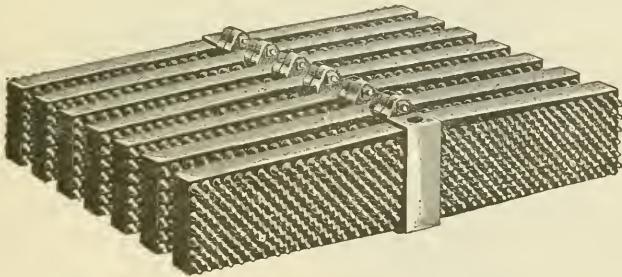

Fig. 8.

through these flues becomes heated before entering the room. A switch damper is placed in the duct at the base of the radiator so that the air may be taken from the room itself instead of from out of doors if so desired.

Direct Hot Water. This system is similar in construction to one for direct steam, except that hot water flows through the pipes and radiators instead of steam. It is largely used for the warming of dwelling houses to which it is especially adapted

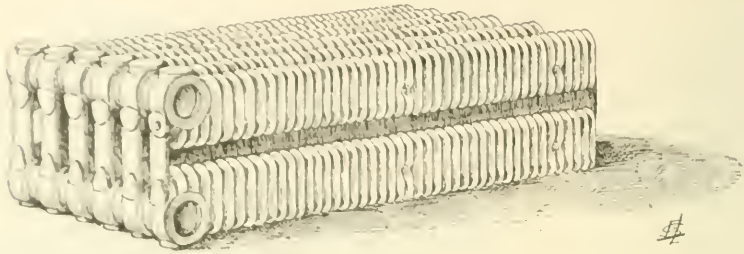

Fig. 9.

owing to the ease with which the temperature of the water can be regulated.

Where steam is used the radiators are always at practically the same temperature, and regulation must be secured by shutting off steam and turning it on at intervals depending on the outside temperature; while with hot water, the radiators can be kept turned on all the time, and regulation secured by varying the temperature of the water flowing through them.

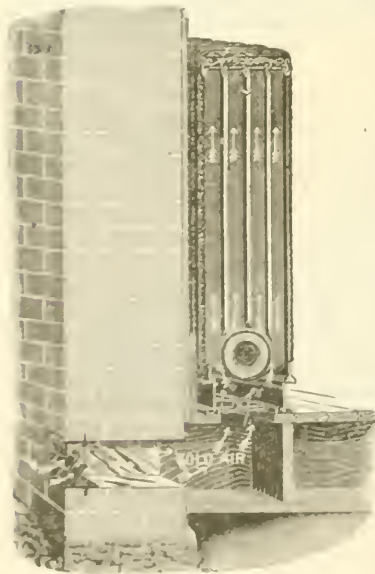

Fig. 11.

There are two distinct systems of circulation employed; one depending on the difference in temperature of the water in the supply and return pipes, called "gravity circulation;" and another where a pump is used to force the water through the mains, called "forced circulation." The former is used for dwellings and other buildings of ordinary size, and the latter for large

buildings, and especially where there are long horizontal runs of pipe.

For gravity circulation some form of sectional cast iron boiler is commonly used although wrought iron tubular boilers may be employed if desired. In the case of forced circulation a heater designed to warm the water by means of live or exhaust steam is often used. A centrifugal or rotary pump of the type shown in

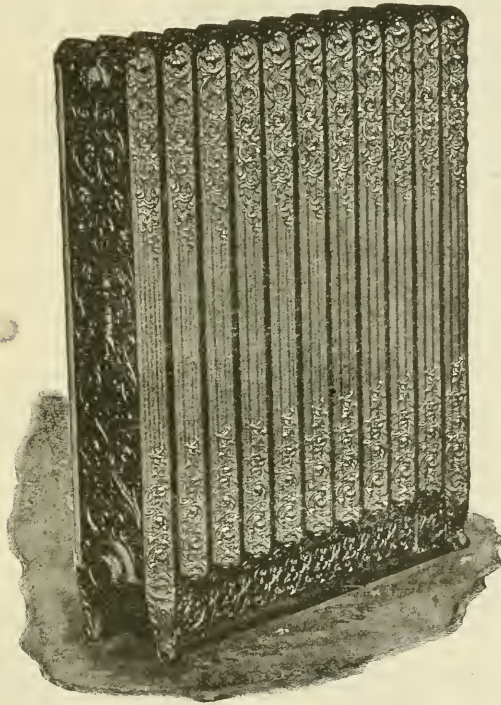

Fig. 10.

Fig. 12 is best adapted to this purpose; this pump may be driven by an electric motor, or a steam engine, as most convenient. Fig. 13 shows the general form of a hot-water radiator, which is similar to those used for steam, except the sections are connected at the top as well as at the bottom; this is shown by the cap over the opening at the top of the end section, which does not appear on the steam radiator shown in Fig. 2. A system for hot-water heating costs more to install than one for steam as the radiators

have to be larger and the piping of larger size and more carefully graded.

Indirect Hot Water. This is used under the same conditions as indirect steam, and the heaters used are similar to those already described. Special attention is given to the form of the

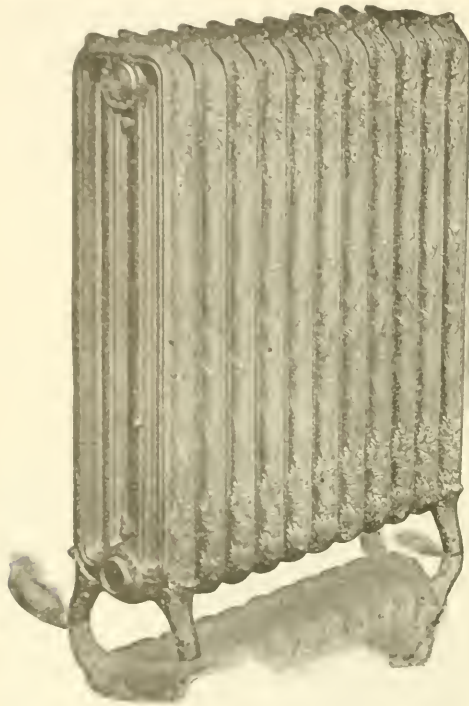

Fig. 13.

sections in order that there may be an even distribution of water through all parts of them. Figs. 14 and 15 show typical hot-water radiators for indirect work. As the stacks are placed in the basement of a building, and only a short distance above the boiler, extra large pipes must be used to secure a proper circulation, for the "head" producing flow is small. The stack casings, cold and warm-air pipes and registers are the same as in steam heating.

Exhaust Steam. Exhaust steam is used for heating in connection with power plants, as in factories and shops or in office buildings which have their own lighting plants. There are two methods of using exhaust steam for heating purposes. One is to carry a back pressure on the engines of from 5 to 10 pounds, depending on the length and size of the pipe mains, and the other is to use some form of "vacuum system" which consists of a pump or ejector attached to the returns from the radiators; this draws the steam through the radiators and tends to reduce the back pressure on the engines rather than to increase it.

Where the first method is used, and a back pressure carried,

either the boiler pressure or the cut-off of the engines must be increased to keep the "mean effective pressure" the same and not reduce the horse-power delivered. In general it is more economical to utilize the exhaust steam for heating. There are instances, however, where the relation between the quantities of steam required for heating and for power are such, especially if the engines are run condensing, that it is better to throw the exhaust away and heat with live steam. Where the vacuum method is used these difficulties are avoided, and for this reason it is coming into more common use. If the condensation from the exhaust steam is returned to the boilers the oil must first be removed; this is usually accomplished by passing the steam through some form of grease extractor as it leaves the engine. The water of condensation is

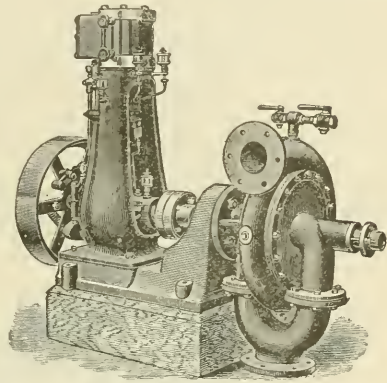

Fig. 12.

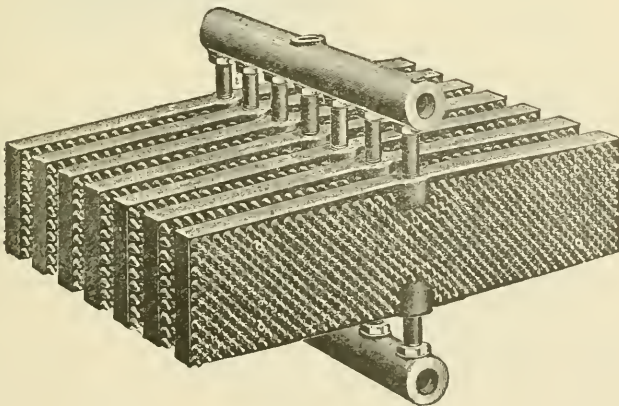

Fig. 14.

then passed through a separating tank before it is delivered to the return pumps. It is better to remove a portion of the oil before the steam enters the pipes and radiators, else a coating

will be formed on their inner surfaces which will reduce their heating efficiency.

Forced Blast. This method of heating, in different forms, is used for the warming of factories, schools, churches, theatres, halls or any large building where good ventilation is desired. The air for warming is drawn or forced through a heater of special design, and discharged by a fan or blower into ducts which lead to registers placed in the rooms to be warmed. The heater is usually made up in sections so that steam may be admitted to or shut off from any section independently of the others, and the temperature of the air regulated in this manner. Sometimes a by-pass

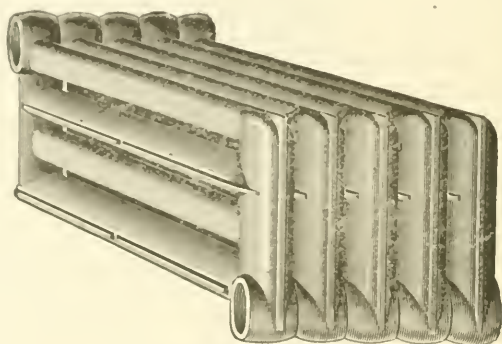

Fig. 15.

damper is attached, so that part of the air will pass through the heater and part around or over it; in this way the proportions of cold and heated air may be so adjusted as to give the desired temperature to the air entering the rooms. These forms of regulation are common where a blower is used for warming a single room as in the case of a church or hall; but where several rooms are warmed, as in a schoolhouse, it is customary to use the main or primary heater at the blower for warming the air to a given temperature, (somewhat below that which is actually required) and to supplement this by placing secondary coils or heaters at the bottoms of the flues leading to the different rooms. By means of this arrangement the temperature of each room can be regulated independently of the others. The so-called double duct system is sometimes employed. In this case two ducts are

carried to each register, one supplying hot air and the other cold or tempered air, and a damper for mixing these in the right propor-

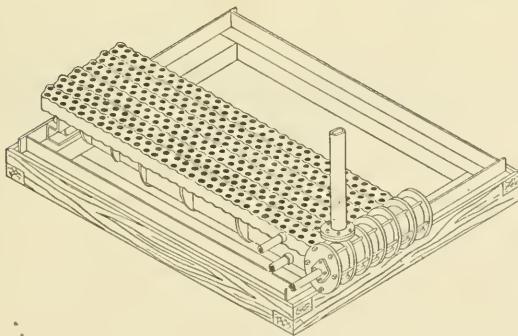
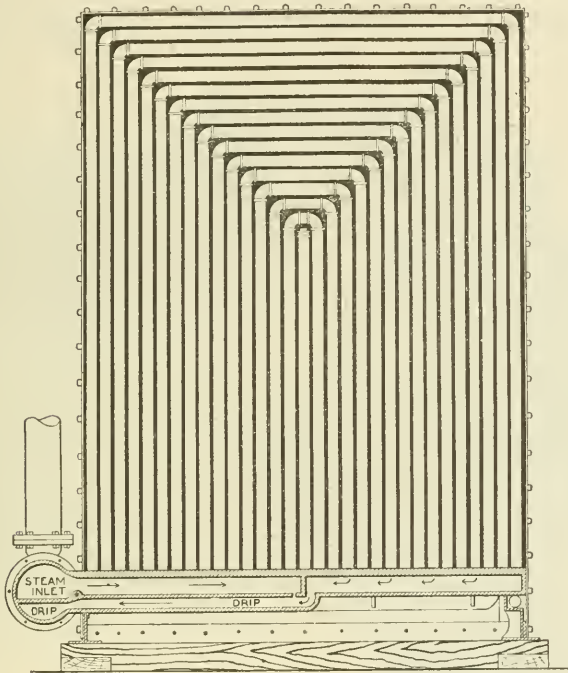

Fig 16.

tions is placed in the flue below the register. Fig. 16 shows a common form of the heater used in connection with a fan ; this is en-

cased in heavy sheet iron or brickwork, and is so connected with the fan that the air is drawn or forced through the spaces between the hot pipes and thus becomes heated. Fig. 17 represents the usual form of fan wheel used for heating and ventilating work; this is enclosed in a steel plate casing with inlet openings at the sides and a discharge outlet at the outer edge of the fan. A common arrangement of fan and heater is shown in Fig. 18. The arrows indicate the cold air entering the heater and the discharge from the fan is through the circular opening at the top of the casing. This fan is shown as being driven by a direct connected engine.

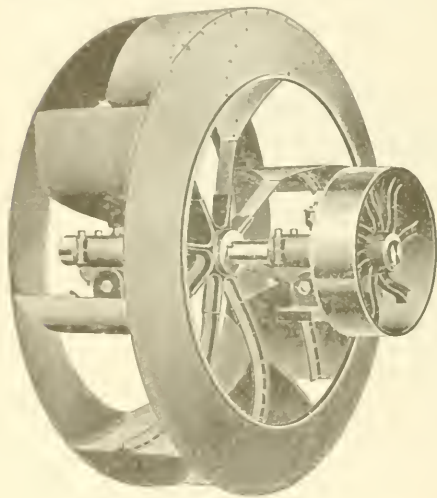

Fig. 17.

Electric motors and steam engines are both used for this purpose and may be either belted or direct connected.

Fig. 19 shows a fan and heater arranged for a double duct system. A portion of the air passes through the heater, the top of which can be seen where the casing is broken away; the remainder of the air passes partly through, and partly over the heater, depending upon the position of the by-pass damper above. The temperature

of the air in the upper duct is therefore less than that in the lower, and the two can be mixed at the registers as required. In Fig. 20 is shown a type of fan called the "cone fan." This is usually placed in an opening in a brick wall and discharges air from its entire perimeter into a room called a "plenum" chamber, with which the various distributing ducts connect.

Electricity. Unless electricity is produced at a very low cost, its use for heating residences or large buildings is not practicable. It has however quite a field of usefulness in the heating of small offices, bath rooms, cold corners of rooms, electric cars, etc., and is often used in rooms which cannot be reached by steam or warm-air pipes.

It has the special advantage of being instantly available, and the amount of heat may be regulated at will.

The heaters are perfectly clean, do not vitiate the air and are portable. They are usually arranged in sections so that the amount of heat can be regulated as desired. They are made up

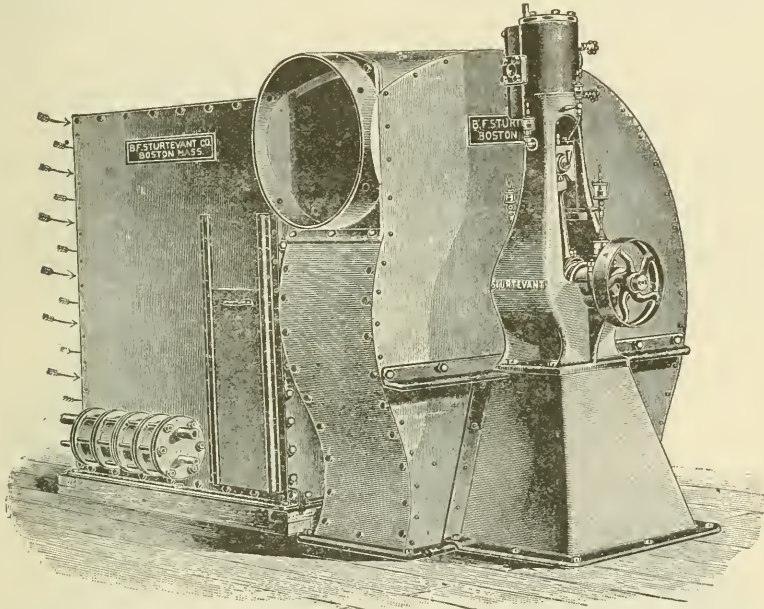

Fig. 18.

of resistance coils embedded in asbestos or some other form of non-conducting material.

Figs. 21, 22 and 23 show different forms of electric radiators; Fig. 22 is designed especially for car heating.

PRINCIPLES OF VENTILATION.

Closely connected with the subject of heating is the problem of maintaining air of a certain standard of purity in the various buildings occupied.

The introduction of pure air can only be done properly in connection with some system of heating, and no system of heating is complete without a supply of pure air, depending in amount upon the kind of building and the purpose for which it is used.

Composition of the Atmosphere. It has already been stated

in the instruction paper on Chemistry that atmospheric air is not a simple substance but a mechanical mixture. Oxygen and nitrogen, the principal constituents, are present in very nearly the proportion of one part of oxygen to four parts of nitrogen by weight. Carbonic acid gas, the product of all combustion, exists in the proportion of 3 to 5 parts in 10,000 in the open country. Water in the form of vapor, varies greatly with the temperature, and the exposure of the air to open bodies of water. In addition to the above, there are generally present, in variable but exceedingly small quantities, ammonia, sulphuretted hydrogen, sulphuric, sulphurous, nitric and nitrous acids, floating organic and inorganic matter and local impurities. Air also contains ozone which is a peculiarly active form of oxygen, and lately a new constituent called argon has been discovered.

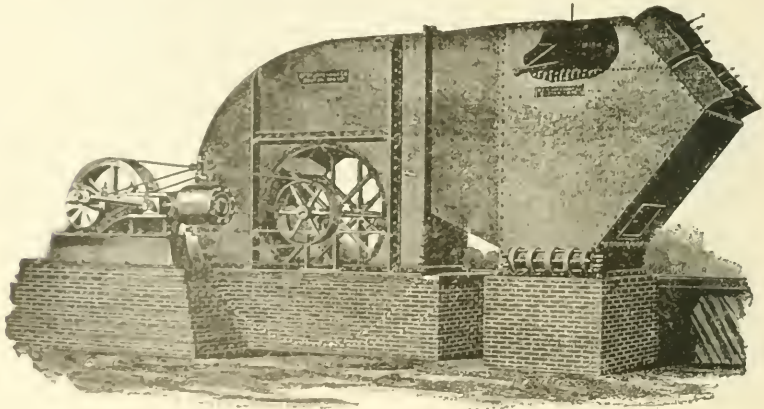

Fig. 19.

Oxygen is one of the most important elements of the air, so far as both heating and ventilation are concerned. It is the active element in the chemical process of combustion and also of a somewhat similar process which takes place in the respiration of human beings. Taken into the lungs it acts upon the excess of carbon in the blood, and possibly upon other ingredients, forming chemical compounds which are thrown off in the act of respiration or breathing.

Nitrogen. The principal bulk of the atmosphere is nitrogen, which exists uniformly diffused with oxygen and carbonic acid

gas. This element is practically inert in all processes of combustion or respiration. It is not affected in composition, either by passing through a furnace during combustion or through the lungs in the process of respiration. Its action is to render the oxygen less active and to absorb some part of the heat produced by the process of oxidation.

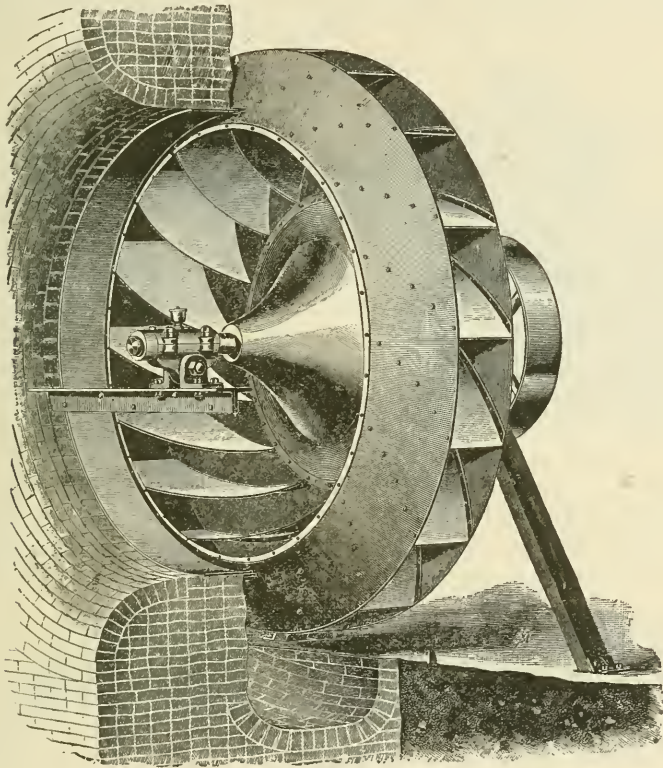

Fig. 20.

Carbonic Acid Gas is of itself only a neutral constituent of the atmosphere, like nitrogen, and contrary to the general impression its presence in moderately large quantities (if uncombined with other substances) is neither disagreeable nor especially harmful. Its presence in the air, however, provided for respiration, decreases the readiness with which the carbon of the blood unites with the oxygen of the air, and therefore, when present in sufficient quantity may cause indirectly, not only serious, but fatal results.

The real harm of a vitiated atmosphere is caused by its other constituent gases and by the minute organisms which are produced in the process of respiration. It is known, however, that these other impurities exist in fixed proportion to the amount of carbonic acid present in an atmosphere vitiated by respiration. Therefore, as the relative proportion of carbonic acid may be easily determined by experiment, the fixing of a standard limit of the amount

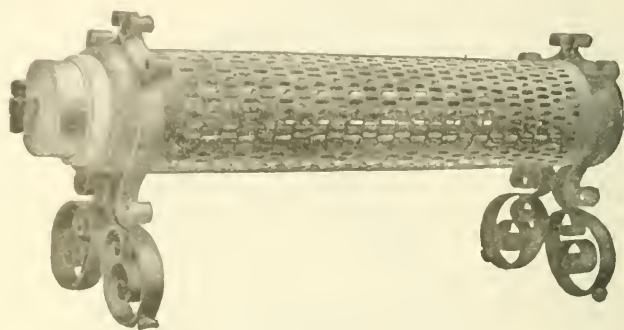

Fig. 21.

in which it may be allowed, also limits the amounts of other impurities which are found in combination with it.

When carbonic acid is present in excess of 10 parts in 10,000



Fig. 22.

parts of air, a feeling of weariness and stuffiness, generally accompanied by a headache, will be experienced; while with even 8 parts in 10,000 parts a room would be considered close. For general considerations of ventilation the limit should be placed at 6 to 7 parts in 10,000 thus allowing an increase of 2 to 3 parts over that present in outdoor air which may be considered to contain four parts in 10,000 under ordinary conditions.

Analysis of Air. The amount of carbonic acid present in

the air may be readily determined, with sufficient accuracy for practical purposes, in the following manner :

Six clean, dry and tightly corked bottles, containing respectively 100, 200, 250, 300, 350 and 400 cubic centimeters, a glass tube containing exactly 15 cubic centimeters to a given mark, and a bottle of perfectly clear, fresh lime-water make up the apparatus required. The bottles should be filled with the air to be examined by means of a hand-ball syringe. Add to the smallest bottle 15 cubic centimeters of the lime-water, put in the cork and shake well. If the lime-water has a milky appearance the amount of carbonic acid will be at least 16 parts in 10,000. If the contents of the bottle remains clear, treat the bottle of 200 cubic centimeters in the same manner; a milky appearance or turbidity in this would indicate 12 parts in 10,000. In a similar manner, turbidity in the 250 cubic centimeter bottle indicates 10 parts in 10,000; in the 300, 8 parts; in the 350, 7 parts and in the 400,

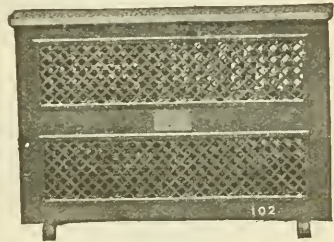

Fig. 23.

less than 6 parts. The ability to conduct more accurate analyses can only be attained by special study and a knowledge of chemical properties and methods of investigation.

Air Required for Ventilation. The amount of air required to maintain the standard of purity can be very easily determined provided we know the amount of carbonic acid given off in the process of respiration. It has been found by experiment that the average production of carbonic acid by an adult at rest is about .6 cubic feet per hour. If we assume the proportion of this gas as 4 parts in 10,000 in the external air, and are to allow 6 parts in 10,000 in an occupied room, the gain will be 2 parts in 10,000, or in other words there will be $\frac{2}{10,000} = .0002$ cubic feet of carbonic acid mixed with each cubic foot of fresh air entering the room.

Therefore, if one person gives off .6 cubic feet of carbonic acid per hour it will require $.6 \div .0002 = 3000$ cubic feet of air per person to keep the air in the room at the standard of purity assumed, that is, 6 parts of carbonic acid in 10,000 of air.

The following table has been computed in this manner and shows the amount of air which must be introduced for each person in order to maintain various standards of purity:

TABLE I.

STANDARD PARTS OF CARBONIC ACID IN 10,000 OF AIR IN ROOM.	CUBIC FEET OF AIR REQUIRED PER PERSON.	
	PER MINUTE.	PER HOUR.
5	133	8,000
6	67	4,000
7	44	2,667
8	33	2,000
9	27	1,600
10	22	1,333
11	19	1,151
12	17	1,000

While this table gives the theoretical quantities of air required for different standards of purity, and may be used as a guide, it will be better in actual practice to use quantities which experience has shown to give good results in different types of buildings. Authorities differ somewhat in their recommendations on this point and the present tendency is toward an increase of air.

The following table represents good modern practice and may be used with satisfactory results:

TABLE II.

AIR SUPPLY PER OCCUPANT FOR	CUBIC FEET PER MINUTE.	CUBIC FEET PER HOUR.
Hospitals	50 to 80	3,000 to 4,800
High Schools	50	3,000
Grammar Schools	40	2,400
Theatres and Assembly Halls	25	1,500
Churches	20	1,200

Force for Moving Air. Air is moved for ventilating purposes in two ways: first, by expansion due to heating; and second

by mechanical means. The effect of heat on the air is to increase its volume and therefore lessen its density or weight, so that it tends to rise and is replaced by the colder air below. The available force for moving air obtained in this way is very small and is quite likely to be overcome by wind or external causes. It will be found in general that the heat used for producing velocity in this manner, when transformed into work in the steam engine, is greatly in excess of that required to produce the same effect by the use of a fan. Ventilation by mechanical means is performed either by pressure or suction. The former is used for delivering fresh air into a building and the latter for removing the foul air from it. By both processes the air is moved without change in temperature, and the force for moving must be sufficient to overcome the effects of wind or changes in outside temperature. Some form of fan is used for this purpose.

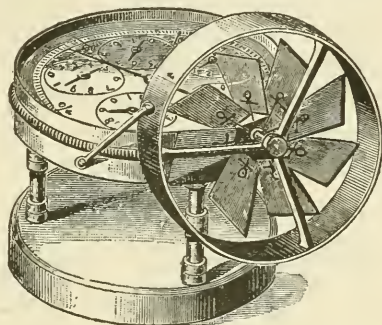

Fig. 24.

Measurements of Velocity.

The velocity of air in ventilating ducts and flues is measured directly by an instrument called an anemometer. A common form of this instrument is shown in Fig. 24. It consists of a series of flat vanes attached to an axis, and a series of dials. The revolution of the axis causes motion of the hands in proportion to the velocity of the air, and the result can be read directly from the dials for any given period.

AIR DISTRIBUTION.

The location of the air inlet to a room depends upon the size of the room and the purpose for which it is used. In the case of living rooms in dwelling houses, the registers are placed either in the floor or in the wall near the floor; this brings the warm air in at the coldest part of the room and gives an opportunity for warming or drying the feet if desired. In the case of school rooms where large volumes of warm air at moderate temperatures are required, it is best to discharge it through openings in the wall at

a height of 7 or 8 feet from the floor: this gives a more even distribution as the warmer air tends to rise and hence spreads uniformly under the ceiling: it then gradually displaces other air and the room becomes filled with pure air without sensible currents or drifts. The cooler air sinks to the bottom of the room and can be taken off through ventilating registers placed near the floor. The relative positions of the inlet and outlet are often governed to some extent by the building construction, but if possible they should both be located in the same side of the room. Figs. 25, 26 and 27 show common arrangements.

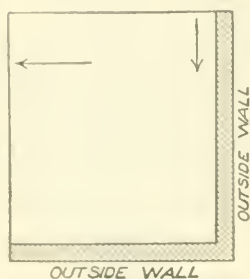

Fig. 25.

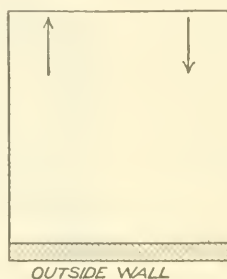

Fig. 26.

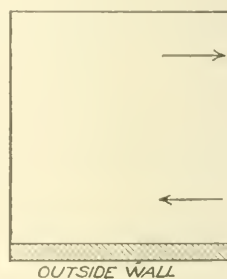

Fig. 27.

The vent outlet should always if possible be placed in an inside wall else it will become chilled and the air-flow through it will become sluggish. In theatres or halls which are closely packed, the air should enter at, or near, the floor in finely-divided streams, and the discharge ventilation should be through openings in the ceiling. The reason for this is the large amount of animal heat given off from the bodies of the audience, which causes the air to become still further heated after entering the room, and the tendency is to rise continuously from floor to ceiling thus carrying away all impurities from respiration as fast as they are given off.

The matter of air velocities, size of flues, etc., will be taken up under the head of design.

HEAT LOSS FROM BUILDINGS.

A British Thermal Unit, or B. T. U., has been defined as the amount of heat required to raise the temperature of one pound of water one degree F. This measure of heat enters into many of

the calculations involved in the solving of problems in heating and ventilation, and one should familiarize himself with the exact meaning of the term.

Causes of Heat Loss. The heat loss from a building is due to the following causes; *first*, radiation and conduction of heat through walls and windows; *second*, leakage of warm air around doors and windows and through the walls themselves; and *third*, heat required to warm the air for ventilation.

Loss Through Walls and Windows. The loss of heat through the walls of a building depends upon the material used, the thickness, the number of layers and the difference between the inside and outside temperatures. The exact amount of heat lost in this way is very difficult to determine theoretically, hence we depend principally on the results of experiments.

Loss by Air Leakage. The leakage of air from a room varies from one to two or more changes of the entire contents per hour, depending upon the construction, opening of doors, etc. It is common practice to allow for one change per hour in well-constructed buildings where two walls of the room have an outside exposure. As the amount of leakage depends upon the extent of exposed wall and window surface it seems best to allow for this loss by increasing that due to conduction and radiation. The following table gives the heat losses through different thickness of walls, doors, windows, etc., in B. T. U., per square foot of surface per hour for varying differences in inside and outside temperatures.

Authorities differ considerably in the factors given for heat losses, and there are various methods for computing the same. The following figures and methods have been used extensively in actual practice and have been found to give good results when used with judgment.

TABLE III.

Material.	Difference between inside and outside temperatures.									
	10°	20°	30°	40°	50°	60°	70°	80°	90°	100°
8" Brick Wall	5	9	13	18	22	27	31	36	40	45
12" Brick Wall	4	7	10	13	16	20	23	26	30	33
16" Brick Wall	3	5	8	10	13	16	19	22	24	27
20" Brick Wall	2.8	4.5	7	9	11	14	16	18	20	23
24" Brick Wall	2.5	4	6	8	10	12	14	16	18	20
28" Brick Wall	2	3.5	4.5	7	9	11	13	14	16	18
32" Brick Wall	1.5	3	5	6	8	10	11	13	15	16
Single Window	12	24	36	49	60	73	85	93	105	
Double Window	8	16	24	32	40	48	56	62	70	
Single Skylight	11	21	31	42	52	63	73	84	94	
Double Skylight	7	14	20	28	35	42	48	56	62	
1" Wooden Door	4	8	12	16	20	24	28	32	36	40
2" Wooden Door	3	5	8	11	14	17	20	23	25	28
Concrete Floor on Brick Arch	2	4	6.5	9	11	13	15	18	20	22
Wood Floor on Brick Arch	1.5	3	4.5	6	7	9	10	12	13	15
Double Wood Floor	1	2	3	4	5	6	7	8	9	10
Walls of Ordinary Wooden Dwellings	3	5	8	10	13	16	19	22	24	27

For solid stone walls multiply the figures for brick of the same thickness by 1.7. Where rooms have a cold attic above or cellar beneath, multiply the heat loss through walls and windows by 1.1. The figures given in table III. are for a southern exposure; for other exposures multiply the heat loss given in table III. by the factors given in table IV.

TABLE IV.

EXPOSURE.	FACTOR.
N.	1.32
E.	1.12
S.	1.0
W.	1.20
N. E.	1.22
N. W.	1.26
S. E.	1.06
S. W.	1.10
N. E. S. W. or total exposure.	1.16

In order to make the use of the table clear we will give a number of examples illustrating its use.

Assuming an inside temperature of 70°, what will be the heat loss from a room having an exposed wall surface of 200 square

feet and a glass surface of 50 square feet, when the outside temperature is zero. The wall is of brick, 16 inches in thickness and has a southern exposure; the windows are single.

We find from table III. that the factor for a 16" brick wall with a difference in temperature of 70° is 19, and that for glass (single window) under the same condition is 85; therefore

$$\begin{aligned} \text{Loss through walls} &= 200 \times 19 = 3800 \\ \text{Loss through windows} &= 50 \times 85 = 4250 \end{aligned}$$

$$\text{Total loss per hour} = 8050 \text{ B. T. U.}$$

In computing the heat loss through walls, only those exposed to the outside air are considered.

A room 15 ft. square and 10 ft. high has two exposed walls; one toward the north and the other toward the east. There are 4 windows, each 3' \times 6' in size. The two in the north wall are double while the other two are single. The walls are of brick, 20 inches in thickness; with an inside temperature of 70° what will be the heat loss per hour when it is 10° below zero.

$$\text{Total surface} = 15 \times 10 \times 2 = 300$$

$$\text{Glass surface} = 3 \times 6 \times 4 = 72$$

$$\text{Net wall surface} = \underline{228}$$

Difference between inside and outside temperature 80°.

Factor for 20" brick wall is 18.

Factor for single window is 93.

Factor for double window is 62.

The heat losses are as follows:

$$\text{Wall,} \quad 228 \times 18 = 4104$$

$$\text{Single windows,} \quad 36 \times 93 = 3348$$

$$\text{Double windows,} \quad 36 \times 62 = 2232$$

$$\underline{9684 \text{ B. T. U.}}$$

As one side is toward the north and the other toward the west the actual exposure is N. W. Looking in table IV. we find the correction factor for this exposure to be 1.26; therefore the total heat loss is

$$9684 \times 1.26 = 12,201.84 \text{ B. T. U.}$$

A dwelling house of wooden construction measures 160 ft.

around the outside: it has 2 stories, each 8 ft. in height; the windows are single and the glass surface amounts to $\frac{1}{5}$ the total exposure; the attic and cellar are unwarmed. If 8000 B. T. U. are utilized from each pound of coal burned in the furnace, how many pounds will be required per hour to maintain a temperature of 70° when it is 20° above zero outside.

$$\begin{array}{r} \text{Total exposure} = 160 \times 16 = 2560 \\ \text{Glass surface} = 2560 \div 5 = 512 \\ \hline \text{Net wall} = 2048 \\ \text{Temperature difference} = 70 - 20 = 50^{\circ} \\ \text{Wall} \quad 2048 \times 13 = 26624 \\ \text{Glass} \quad 512 \times 60 = 30720 \\ \hline 57344 \text{ B. T. U.} \end{array}$$

As the building is exposed on all sides the factor for exposure will be the average of those for N, E, S, and W, or

$$1.32 + 1.12 + 1.0 + 1.20 \div 4 = 1.16$$

The house has a cold cellar and attic so we must increase the heat loss 10% for each or 20% for both. Making these corrections we shall have

$$57344 \times 1.16 \times 1.20 = 79822 \text{ B. T. U.}$$

One pound of coal furnishes 8000 B. T. U. then $79822 \div 8000 = 9.97$; or about 10 pounds of coal per hour will be required to warm the building to 70° under the conditions stated.

Approximate Method. For dwelling houses of usual construction the following simple method may be used. Multiply the total exposed surface by 38, which will give the heat loss in B. T. U. per hour for an inside temperature of 70° in zero weather.

This factor is obtained in the following manner. Assume the glass surface to be $\frac{1}{6}$ the total exposure, which is an average proportion.

Then each square foot of exposed surface consists of $\frac{1}{6}$ glass and $\frac{5}{6}$ wall and the heat loss for 70° difference in temperature would be as follows:

$$\text{Wall } \frac{5}{6} \times 19 = 15.8$$

$$\text{Glass } \frac{1}{6} \times 85 = \frac{14.1}{29.9}$$

Increasing this by 16% for total exposure and 10% for loss through ceilings we have $29.9 \times 1.16 \times 1.10 = 38.1$. The loss through floors is considered as being offset by including the kitchen walls of a dwelling house, which are warmed by the range and would not otherwise be included if computing the size of a furnace or boiler for heating.

If the heat loss is required for outside temperatures other than zero, corrections must be made as follows: Multiply by 50 for 20° below zero, by 44 for 10° below, by 33 for 10° above.

This method is convenient for approximations in the case of dwelling houses but the more exact method should be used for other types of buildings, and in all cases for computing the heating surface for separate rooms. When calculating the heat loss from isolated rooms, the cold inside walls as well as the outside must be considered.

The loss through a wall next to a cold attic or other unwarmed space may in general be taken as about two-thirds that of an outside wall.

Heat Loss by Ventilation. One B. T. U. will raise the temperature of 1 cubic foot of air 55 degrees at average temperatures and pressures or will raise 55 cubic feet 1 degree, so that the heat required for the ventilation of any room may be found by the following formula:

$$\frac{\text{cu. ft. of air per hour} \times \text{number of degrees rise}}{55} = \text{B. T. U. required.}$$

To compute the heat loss for any given room which is to be ventilated, first find the loss through walls and windows, and correct for exposure, then compute the amount required for ventilation as above and take the sum of the two. An inside temperature of 70° is always assumed unless otherwise stated.

Example — What quantity of heat will be required to warm 100,000 cubic feet of air to 70° for ventilating purposes when the outside temperature is 10 below zero?

$$100,000 \times 80 \div 55 = 145,454 \text{ B. T. U. } \text{Ans.}$$

How many B. T. U. will be required per hour for the ventilation of a church seating 500 people, in zero weather?

Referring to table II, we find that the total air required per hour is $1200 \times 500 = 600,000$ cu. ft.; therefore $600,000 \times 70 \div 55 = 763,636$ B. T. U.

EXAMPLES FOR PRACTICE.

1. A room in a grammar school $28' \times 32'$ and $12'$ high is to accommodate 50 pupils. The walls are of brick $16''$ in thickness and there are 6 single windows in the room, each $3' \times 6'$; there are warm rooms above and below; the exposure is S. E. How many B. T. U. will be required per hour for warming the room and how many for ventilation, in zero weather?

Ans. 22,056 + for warming, 152,727 + for ventilation.

2. A stone church seating 400 people has walls $20''$ in thickness. It has a wall exposure of 5,000 square feet, a glass exposure (single windows) of 600 square feet, and a roof exposure of 7,000 square feet; the roof is of $2''$ pine plank and the factor for heat loss may be taken the same as for a $2''$ wooden door. The floor is of wood on brick arches and has an area of 4,000 square feet. The building is exposed on all sides. What will be the heat required per hour for both warming and ventilation when the outside temperature is 20° above zero?

Ans. 296,380 for warming; 436,363 + for ventilation.

3. A dwelling house of wooden construction measures 200 feet around the outside and has 3 stories, each 9 feet high: compute the heat loss by the approximate method when the temperature is 20° below zero.

Ans. 270,000 B. T. U. per hour.

FURNACE HEATING.

Types of Furnaces. Furnaces may be divided into two general types known as direct and indirect draft. Fig. 28 shows a common form of **direct draft** furnace with a brick setting; the better class have a radiator, generally placed at the top, through which the gases pass before reaching the smoke pipe. They have but one damper usually combined with a cold-air check. Many of the cheaper direct draft furnaces have no radiator at all; the

gases passing directly into the smoke pipe and carrying away much heat that should be utilized.

The furnace shown in Fig. 28 is made of cast iron and has a large radiator at the top ; the smoke connection is shown at the rear.

Fig. 29 represents another form of direct draft furnace. In this case the radiator is made of sheet steel plates riveted together,

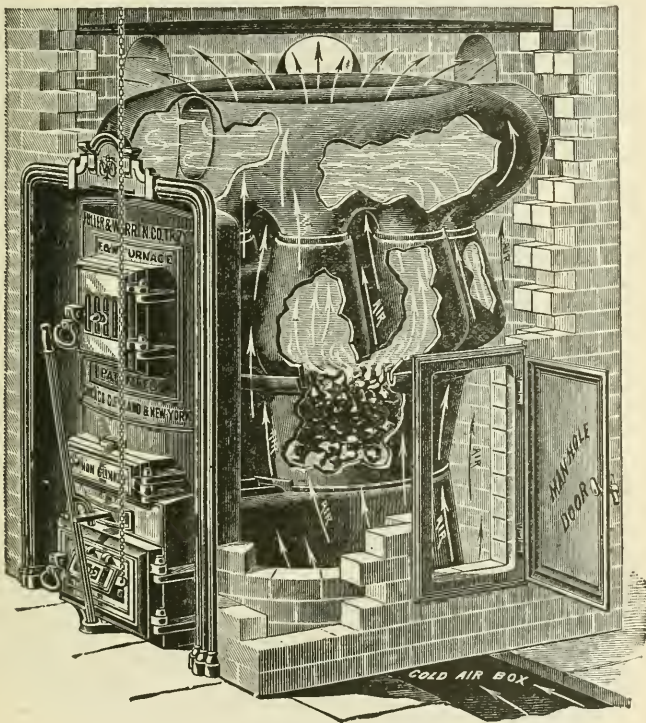

Fig. 28.

and the outer casing is of heavy galvanized iron instead of brick.

In the ordinary **indirect draft** type of furnace (see Fig. 30) the gases pass downward through flues to a radiator located near the base, thence upward, through another flue to the smoke pipe. In addition to the damper in the smoke pipe, a direct draft damper is required to give direct connection with the funnel when coal is first put on, to facilitate the escape of gas to the chimney. When

the chimney draft is weak, trouble from gas is more likely to be experienced with furnaces of this type than with those having a direct draft.

Grates. No part of a furnace is of more importance than the grates. The plain grate rotating about a center pin was for a long time the one most commonly used. These grates were usually

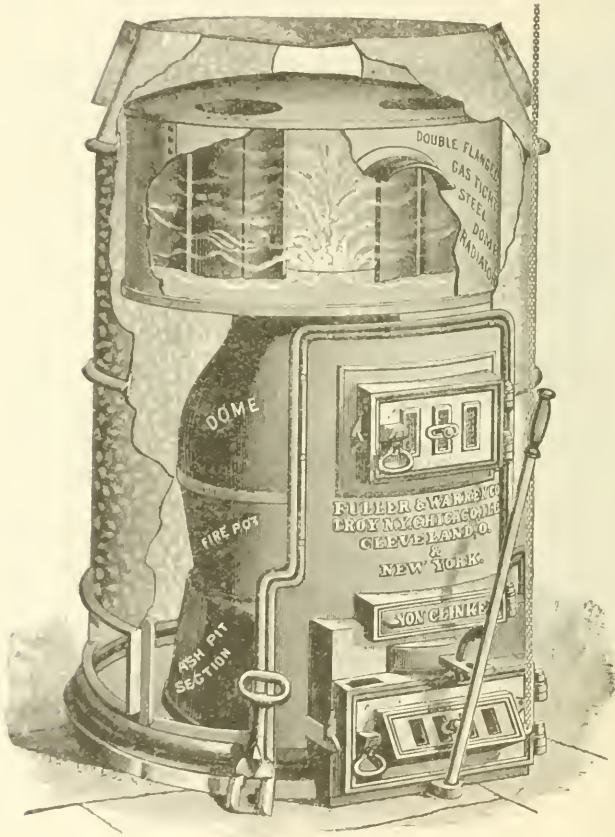

Fig. 29.

provided with a clinker door for removing any refuse too large to pass between the grate bars. The action of such grates tends to leave a cone of ashes in the center of the fire causing it to burn more freely around the edges. A better form of grate is the revolving triangular pattern which is now used in many of the lead-

ing furnaces. It consists of a series of triangular bars having teeth. The bars are connected by gears and are turned by means of a detachable lever. If properly used this grate will cut a slice of ashes and clinkers from under the entire fire with little, if any loss of unconsumed coal.

The Fire Pot. Fire pots are generally made of cast iron or of steel plate lined with fire brick. The depth ranges from about

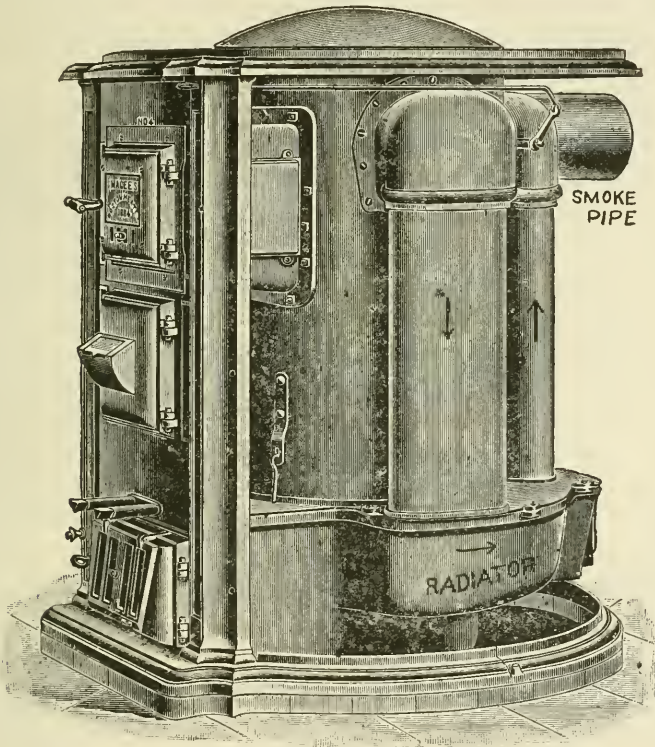

Fig. 30.

12 to 18 inches. In cast iron furnaces of the better class the fire pot is made very heavy to insure durability and to render it less likely to become red hot. The fire pot is sometimes made in two pieces to reduce the liability of cracking. The heating surface is sometimes increased by corrugations, pins or ribs.

A fire brick lining is necessary in a wrought iron or steel furnace to protect the thin shell from the intense heat of the fire.

Since brick lined fire pots are much less effective than cast iron in transmitting heat, such furnaces depend to a great extent for their efficiency on the heating surface in the dome and radiator, and this as a rule is much greater than in those of cast iron.

Cast iron furnaces have the advantage when coal is first put on, (and the drop flues and radiator are cut out by the direct damper) of still giving off heat from the fire pot, while in the case of brick linings very little heat is given off in this way and the rooms are likely to become somewhat cooled before the fresh coal becomes thoroughly ignited.

Combustion Chamber. The body of the furnace above the fire pot, commonly called the dome or feed section, provides a combustion chamber. This chamber should be of sufficient size to permit the gases to become thoroughly mixed with the air passing up through the fire or entering through openings provided for the purpose in the feed door. In a well-designed furnace this space should be somewhat larger than the fire pot.

Radiator. The radiator, so called, with which all furnaces of the better class are provided, acts as a sort of reservoir in which the gases are kept in contact with the air passing over the furnace until they have parted with a considerable portion of their heat. Radiators are built of cast iron, of steel plate or of a combination of the two. The former is more durable and can be made with fewer joints, but owing to the difficulty of casting radiators of large size, steel plate is commonly used for the sides.

The effectiveness of a radiator depends on its form, its heating surface and the difference between the temperature of the gases and the surrounding air. Owing to the accumulation of soot, the bottom surface becomes practically worthless after the furnace has been in use a short time; surfaces to be effective must therefore be self-cleaning.

If the radiator is placed near the bottom of the furnace the gases are surrounded by air at the lowest temperature, which renders the radiator more effective for a given size than if placed near the top and surrounded by warm air. On the other hand, the cold air has a tendency to condense the gases, and the acids thus formed are likely to corrode the iron.

Heating Surface. The different heating surfaces may be

described as follows: Fire pot surface; surfaces acted upon by direct rays of heat from the fire, such as the dome or combustion chamber; gas or smoke heated surfaces, such as flues or radiators and extended surfaces, such as pins or ribs. Surfaces unlike in character and location, vary greatly in heating power, so that in making comparisons of different furnaces we must know the kind, form and location of the heating surfaces as well as the area.

In some furnaces having an unusually large amount of surface, it will be found on inspection that a large part would soon become practically useless from the accumulation of soot. In others a large portion of the surface is lined with fire brick, or is so situated that the air currents are not likely to strike it.

The ratio of grate to heating surface varies somewhat according to the size of furnace. It may be taken as varying from 1 to 2.5 in the smaller sizes and 1 to 1.5 in the larger.

Efficiency. One of the first items to be determined in estimating the heating capacity of a furnace is its efficiency, that is, the proportion of the heat in the coal that may be utilized for warming. The efficiency depends chiefly on the area of the heating surface as compared with the grate, on its character and arrangement, and on the rate of combustion. The usual proportions between grate and heating surface have been stated. The rate of combustion required to maintain a temperature of 70° in the house depends of course on the outside temperature. In very cold weather a rate of 4 to 5 pounds of coal per square foot of grate per hour must be maintained.

One pound of good anthracite coal will give off about 13000 B. T. U. and a good furnace should utilize 70 per cent. of this heat. The efficiency of an ordinary furnace is often much less, sometimes as low as 50 per cent.

In estimating the required size of a first-class furnace with good chimney draft we may safely count upon a maximum combustion of 5 pounds of coal per square foot of grate per hour, and may assume that 8000 B. T. U. will be utilized for warming purposes from each pound burned. This quantity corresponds to an efficiency of 60 per cent.

Heating Capacity. Having determined the heat loss from a building by the methods given, it is a simple matter to compute

the size of grate necessary to burn a sufficient quantity of coal to furnish the amount of heat required for warming.

As a matter of illustration we may consider the heat delivered to the rooms as made up of two parts: first, that required to warm the outside air up to 70° (the temperature of the rooms) and second, the quantity which must be added to this to offset the loss through walls and windows. Air is usually delivered at the registers at about 140 degrees under zero conditions outside; this air leaves the rooms by leakage at a temperature of 70 degrees, (the normal inside temperature) having lost one-half its heat by conduction, radiation, etc., so that the heat given to the entering air must be twice that which we have computed for loss through walls, etc.

Example. — The loss through the walls and windows of a building is found to be 80000 B. T. U. per hour in zero weather, what will be the size of furnace required to maintain an inside temperature of 70 degrees?

From the above we have the total heat required, equal to $80000 \times 2 = 160000$ B. T. U. per hour. If we assume that 8000 B. T. U. are utilized per pound of coal, then $160000 \div 8000 = 20$ pounds of coal required per hour, and if 5 pounds can be burned on each square foot of grate per hour, then $\frac{20}{5} = 4$ square feet required. A fire pot 28 inches in diameter has an area of 4.27 square feet and is the size we should use.

The following table will be found useful in determining the diameter of fire pot required:

TABLE V.

AVERAGE DIAMETER OF FIRE POT IN INCHES.	AREA IN SQUARE FEET.
18	1.77
20	2.18
22	2.64
24	3.14
26	3.69
28	4.27
30	4.91
32	5.58

If the outside temperature is below zero the method of computation becomes slightly different. We have seen that in zero weather a certain quantity of heat is required to raise the temperature of the entering air from zero to 70° , the temperature of the room, and that a second quantity must then be added to raise the temperature of the air to 140° , which is the usual temperature of delivery at the registers. This last quantity is to offset that lost by radiation and conduction, and must equal the heat loss from the building as computed by the factors given in tables III. and IV. The air has been raised through 140 degrees and $\frac{70}{140}$ of the heat supplied has been used to raise it to the temperature of the room and has been lost by leakage; while the remaining $\frac{70}{140}$, an equal amount, has been given up by radiation and conduction. In this case we have only to compute the heat loss for radiation and conduction by the rules given and multiply this result by 2 to obtain the total amount of heat to be supplied by the furnace.

Now take a case where it is 10 degrees below zero. If the air is delivered to the rooms at 140 degrees as before, it must be warmed through 150 degrees. Of the heat supplied $\frac{80}{150}$ has been used to raise the temperature of the outside air to that of the room, and only $\frac{70}{150}$ for loss by radiation and conduction. As in the preceding example, this latter quantity must equal the computed heat loss through walls and windows; and as it is only $\frac{70}{150}$ or .466 of the total amount of heat required we must multiply it by $1 \div .466 = 2.14$ instead of by 2 as in the first case where the outside temperature is zero.

In the same manner multiply by 2.28 for 20 degrees below zero and by 2.42 for 30 degrees.

EXAMPLES FOR PRACTICE.

1. A brick apartment house is 20 feet wide, and has 4 stories, each being 10 feet in height. The house is one of a block and is exposed only at the front and rear. The walls are 16 inches thick and the block is so sheltered that no correction need be made for exposure. Single windows make up $\frac{1}{3}$ the total exposed surface. Figure for cold attic but warm basement. What area of grate surface will be required for a furnace to keep

the house at a temperature of 70° when it is 10° below zero outside? Ans. 2.9 square feet.

2. A house having a furnace with a fire pot 30 inches in diameter is not sufficiently warmed and it is decided to add a second furnace to be used in connection with the one already in. The heat loss from the building is found by computation to be 133,600 B. T. U. per hour, in zero weather. What diameter of fire pot will be required for the extra furnace?

Ans. 18 inches.

Location of Furnace. A furnace should be so placed that the warm-air pipes will be of nearly the same length. The air travels most readily through pipes leading toward the sheltered side of the house and to the upper rooms. Therefore pipes leading toward the north or west or to rooms on the first floor should be favored in regard to length and size. The furnace should be placed somewhat to the north or west of the center of the house or toward the points of compass from which the prevailing winds blow.

Smoke Pipes. Furnace smoke pipes range in size from about 6 inches in the smaller sizes to 8 or 9 inches in the larger ones. They are generally made of galvanized iron of No. 24 gauge or heavier. The pipe should be carried to the chimney as directly as possible, avoiding bends which increase the resistance and diminish the draft. Where a smoke pipe passes through a partition it should be protected by a soapstone or double perforated metal collar having a diameter at least 8 inches greater than that of the pipe. The top of the smoke pipe should not be placed within 8 inches of unprotected beams nor less than 6 inches under beams protected by asbestos or plaster with a metal shield beneath. A collar to make tight connection with the chimney should be riveted to the pipe about 5 inches from the end to prevent its being pushed too far into the flue. Where the pipe is of unusual length it is well to cover it to prevent loss of heat and the condensation of smoke.

Chimney Flues. Chimney flues if built of brick should have walls 8 inches in thickness, unless terra cotta linings are used, when only 4 inches of brick work is required. Except in small houses where an 8 \times 8 flue may be used, the nominal size of the

smoke flue should be at least 8×12 to allow for contractions or offsets. A clean-out door should be placed at the bottom of the flue for removing ashes and soot. A square flue cannot be reckoned at its full area as the corners are of little value. To avoid down drafts the top of the chimney must be carried above the highest point of the roof unless provided with a suitable hood or top.

Cold-Air Box. The cold-air box should be large enough to supply a volume of air sufficient to fill all the hot-air pipes at the same time. If the supply is too small, the distribution is sure to be unequal and the cellar will become overheated from lack of air to carry away the heat generated.

If a box is made too small or is throttled down so that the volume of air entering the furnace is not large enough to fill all the pipes it will be found that those leading to the less exposed side of the house or to the upper rooms will take the entire supply, and that additional air to supply the deficiency will be drawn down through registers in rooms less favorably situated. It is common practice to make the area of the cold-air box three-fourths the combined area of the hot-air pipes. The inlet should be placed where the prevailing cold winds will blow into it; this is commonly on the north or west side of the house. If it is placed on the side away from the wind, warm air from the furnace is likely to be drawn out through the cold-air box.

Whatever may be the location of the entrance to the cold-air box, changes in the direction of the wind may take place which will bring the inlet on the wrong side of the house. To prevent the possibility of such changes affecting the action of the furnace the cold-air box is sometimes extended through the house and left open at both ends, with check-dampers arranged to prevent back drafts. These checks should be placed some distance from the entrance to prevent their becoming clogged with snow or sleet. The cold-air box is generally made of matched boards, but galvanized iron is much better; it costs more than wood but is well worth the extra expense on account of tightness which keeps the dust and ashes from being drawn into the furnace casing to be discharged through the registers into the rooms above.

The cold-air inlet should be covered with galvanized wire

netting with a mesh of at least three-eighths of an inch. The frame to which it is attached should not be smaller than the inside dimensions of the cold-air box. A door to admit air from the cellar to the cold-air box is generally provided. As a rule air should be taken from this source only when the house is temporarily unoccupied or during high winds.

Return Duct. In some cases it is desirable to return air to the furnace from the rooms above, to be reheated. Ducts for this purpose are common in places where the winter temperature is

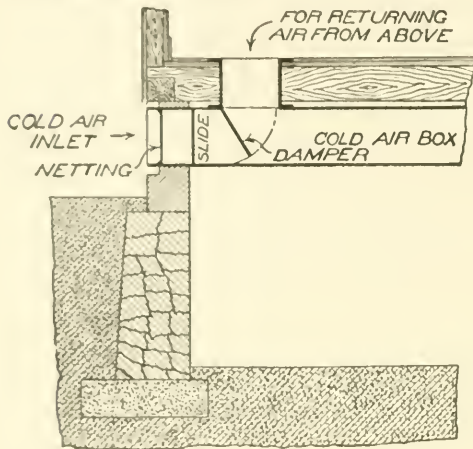

Fig. 31.

frequently below zero. Return ducts when used, should be in addition to the regular cold-air box. Fig. 31 shows a common method of making the connection between the two. By proper adjustment of the swinging damper the air can be taken either from out of doors or through the register from the room above. The return register is often placed

in the hallway of a house so that it will take the cold air which rushes in when the door is opened and also that which may leak in around it while closed. Check valves or flaps of light gossamer or woolen cloth should be placed between the cold-air box and the registers to prevent back drafts during winds.

The return duct should not be used too freely at the expense of outdoor air, and its use is not recommended except during the night when air is admitted to the sleeping rooms through open windows.

Warm-Air Pipes. The required size of the warm-air pipe to any given room depends upon the heat loss from the room and the volume of warm air required to offset this loss. Each cubic foot of air warmed from zero to 140 degrees brings into a room 2.2 B. T. U. We have already seen that in zero weather with the air

entering the registers at 140 degrees, only one-half of the heat contained in the air is available for offsetting the losses by radiation and conduction, so that only 1.1 B. T. U. in each cubic foot of entering air, can be utilized for warming purposes. Therefore if we divide the computed heat loss in B. T. U. from a room, by 1.1 it will give the number of cubic feet of air at 140 degrees necessary to warm the room in zero weather.

As the outside temperature becomes colder the quantity of heat brought in per cubic foot of air increases, but the proportion available for warming purposes becomes less at nearly the same rate, so that for all practical purposes we may use the figure 1.1 for all usual conditions. In calculating the size of pipe required, we may assume maximum velocities of 280 and 400 feet per minute for rooms on the first and second floors respectively. Knowing the number of cubic feet of air per minute to be delivered, we can divide it by the velocity, which will give us the required area of the pipe in square feet.

Round pipes of tin or galvanized iron are used for this purpose. The following table will be found useful in determining the required diameters of pipe in inches.

TABLE VI.

DIA. OF PIPE IN INCHES.	AREA IN SQ. INCHES.	AREA IN SQUARE FEET.
6	28	.196
7	38	.267
8	50	.349
9	64	.442
10	79	.545
11	95	.660
12	113	.785
13	133	.922
14	154	1.07
15	177	1.23
16	201	1.40

Example. — The heat loss from a room on the second floor is 22,000 B. T. U., per hour. What diameter of warm air pipe will be required?

$22,000 \div 1.1 = 20,000 =$ cubic feet of air required per hour.
 $20,000 \div 60 = 333$ per minute. Assuming a velocity of 400 feet per minute we have $333 \div 400 = .832$ square feet, which is the area of pipe required. Referring to table VI, we find this comes between a 12 and 13-inch pipe and the larger size would probably be chosen.

EXAMPLES FOR PRACTICE.

1. A first floor room has a computed loss of 33000 B. T. U. per hour when it is 10° below zero. The air for warming is to enter through two pipes of equal size, and at a temperature of 140 degrees. What will be the required diameter of the pipes?

Ans. 13 inches.

2. If in the above example the room had been on the second floor and the air was to be delivered through a single pipe; what diameter would be required?

Ans. 15 inches.

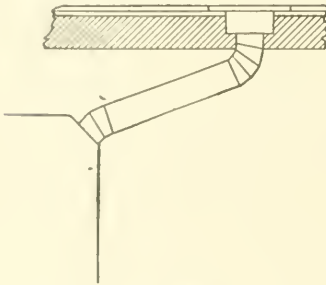

Fig. 32

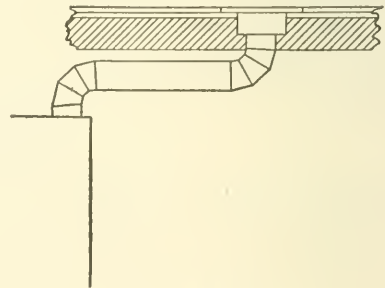

Fig. 33.

Since long horizontal runs of pipe increase the resistance and loss of heat, they should not in general be over 15 feet in length. This applies especially to pipes leading to rooms on the first floor or to those on the cold side of the house. Pipes of excessive length should be increased in size because of the added resistance.

Figs. 32 and 33 show common methods of running the pipes in the basement. The first gives the best results and should be used where the basement is of sufficient height to allow it. A damper should be placed in each pipe near the furnace for regulating the flow of air to the different rooms or for shutting them off entirely when desired.

While round pipe risers give the best results, it is not always possible to provide a sufficient space for them, and flat or oval pipes are substituted. When vertical pipes must be placed in single partitions, much better results will be obtained if the studding can be made 5 or 6 inches deep instead of 4 as is usually done. Flues should never in any case be made less than $3\frac{1}{2}$ inches in depth. Each room should be heated by a separate pipe. In some cases however, it is allowable to run a single riser to heat two unimportant rooms on an upper floor. A clear space of at least $\frac{1}{2}$ inch should be left between the risers and studs and the latter should be carefully tinned, and the space between them on both sides covered with tin, asbestos or wire lath.

The following table gives the capacity of oval pipes. A 6-inch pipe oveled to 5 means that a 6-inch pipe has been flattened out to a thickness of 5 inches and column 2 gives the resulting area.

TABLE VII.

DIMENSION OF PIPE.	AREA IN SQUARE INCHES.
6 oveled to 5	27
7 " " 4	31
7 " " $3\frac{1}{2}$	29
7 " " 6	38
8 " " 5	43
9 " " 4	45
10 " " $3\frac{1}{2}$	46
9 " " 6	57
9 " " 5	51
11 " " 4	58
12 " " $3\frac{1}{2}$	55
10 " " 6	67
11 " " 5	67
14 " " 4	76
15 " " $3\frac{1}{2}$	73
12 " " 6	85
12 " " 5	75
19 " " 4	96
20 " " $3\frac{1}{2}$	100

Having determined the size of round pipe required, an equiva-

lent oval pipe can be selected from the table to suit the space available.

Registers. The registers which control the supply of warm air to the rooms, generally have a net area equal to two-thirds of their gross area. The net area should be from 10 to 20 per cent greater than the area of the pipe connected with it. It is common practice to use registers having the short dimension equal to, and the long dimension about one-half greater than the diameter of the pipe. This would give the following standard sizes for different diameters of pipe.

TABLE VIII.

DIAMETER OF PIPE.	SIZE OF REGISTER.
6	6 × 10
7	7 × 10
8	8 × 12
9	9 × 14
10	10 × 15
11	11 × 16
12	12 × 17
13	14 × 20
14	14 × 22
15	15 × 22
16	16 × 24

Combination Systems. A combination system for heating by hot air and hot water consists of an ordinary furnace with some form of surface for heating water, placed either in contact with the fire or suspended above it. Fig. 34 shows a common arrangement where part of the heating surface forms a portion of the lining to the fire pot and the remainder is above the fire.

Care must be taken to properly proportion the work to be done by the air and the water, else one will operate at the expense of the other. One square foot of heating surface in contact with the fire is capable of supplying from 40 to 50 square feet of radiating surface, and one square foot suspended over the fire will supply from 15 to 25 square feet of radiation.

Care and Management. The following general rules apply to the management of all hard coal furnaces.

The fire should be thoroughly shaken once or twice daily in cold weather. It is well to keep the fire pot heaping full at all times. In this way a more even temperature may be maintained, less attention required and no more coal burned than when the

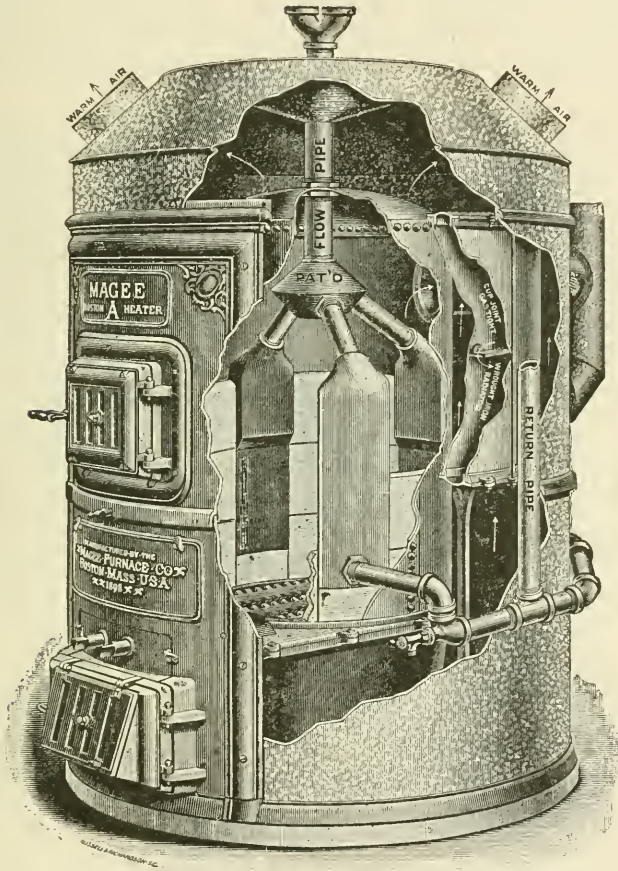

Fig. 34.

pot is only partly filled. In mild weather the mistake is frequently made of carrying a thin fire, which requires frequent attention and is likely to die out. Instead, to diminish the temperature in the house, keep the fire pot full and allow ashes to accumulate on the grate (not under it) by shaking less frequently

or less vigorously. The ashes will hold the heat and render it an easy matter to maintain and control the fire. When feeding coal on a low fire, open the drafts and neither rake nor shake the fire till the fresh coal becomes ignited. The air supply to the fire is of the greatest importance. An insufficient amount results in incomplete combustion and a great loss of heat. To secure proper combustion the fire should be controlled principally by means of the ash pit, through the ash pit door or slide.

The smoke pipe damper should be opened only enough to carry off the gas or smoke and to give the necessary draft. The openings in the feed door act as a check on the fire and should be kept closed during cold weather, except just after firing, when with a good draft they may be partly opened to increase the air supply and promote the proper combustion of the gases.

Keep the ash pit clear to avoid warping or melting the grate. The cold-air box should be kept wide open except during winds or when the fire is low. At such times it may be partly, but never completely closed. Too much stress cannot be laid on the importance of a sufficient air supply to the furnace. It costs little if any more to maintain a comfortable temperature in the house night and day than to allow the rooms to become so cold during the night that the fire must be forced in the morning to warm them up to a comfortable temperature.

In case the warm air fails at times to reach certain rooms it may be forced into them by temporarily closing the registers in other rooms. The current once established will generally continue after the other registers have been opened.

It is best to burn as hard coal as the draft will warrant. Egg size is better than larger coal, since for a given weight small lumps expose more surface and ignite more quickly than larger ones. The furnace and smoke pipe should be thoroughly cleaned once a year. This should be done just after the fire has been allowed to go out in the spring.

STEAM BOILERS.

Types. The boilers used for heating are the same as have already been described for power work. In addition there is the

cast-iron sectional boiler, which is almost exclusively used for dwelling houses.

Sectional Boilers. Fig. 35 shows a common form of cast-iron boiler. It is made up of slabs or sections, each one of which is connected by nipples with headers at the sides and top. The top header acts as a steam drum and the lower ones act as mud drums; they also receive the water of condensation from the radiators. The gases from the fire pass backward and forward

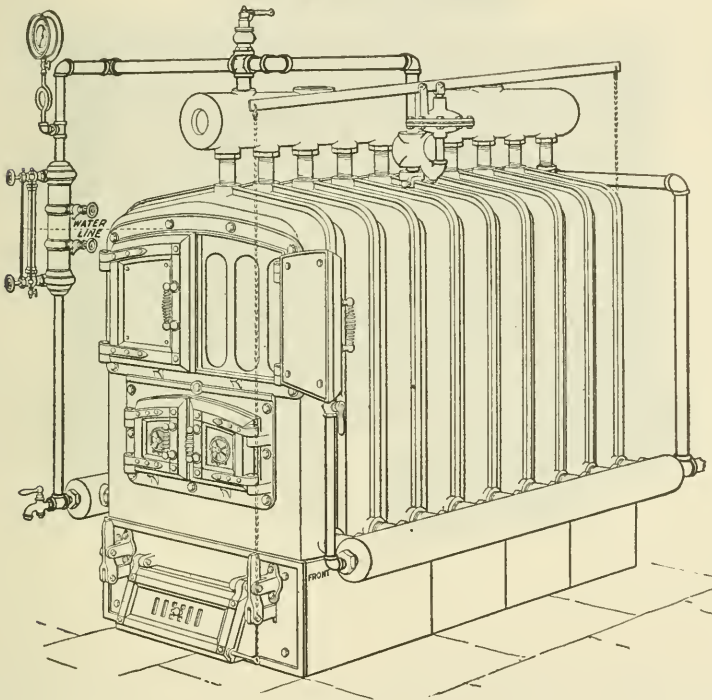

Fig. 35.

through flues and are finally taken off at the rear of the boiler. The ratio of heating to grate surface in this type of boiler ranges from 15 to 25 in the best makes. They are provided with the usual attachments, such as pressure gage, water glass, gage cocks and safety valve; a low-pressure damper regulator is furnished for operating the draft doors, thus keeping the steam pressure practically constant. A pressure of from 1 to 5 pounds is usually

carried on these boilers depending upon the outside temperature. The usual setting is simply a covering of some kind of non-conducting material like plastic magnesia or asbestos, although some forms are enclosed in light brickwork. Fig. 36 shows one of this kind with part of the setting removed. In computing the required size we may proceed in the same manner as in the case

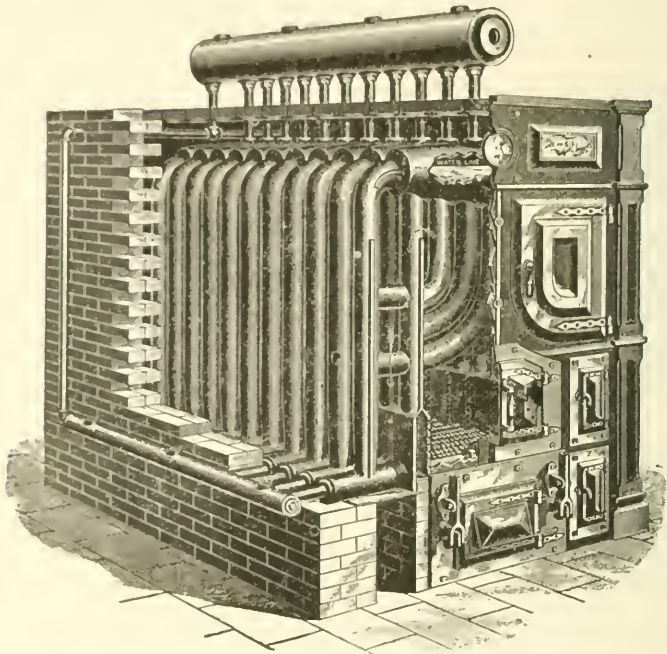

Fig. 36.

of a furnace. For the best types we may assume a combustion of 5 pounds of coal per square foot of grate per hour, and an average efficiency of 60 per cent, which corresponds to 8,000 B. T. U. per pound of coal, available for useful work.

In the case of direct steam heating we have only to supply heat to offset that lost by radiation and conduction, so the grate area may be found by dividing the computed heat loss per hour by 8,000 which gives the number of pounds of coal, and this in turn divided by 5 will give the area of grate required. The most efficient rate of combustion will depend somewhat upon the ratio between the grate and heating surface. It has been found by

experiment that about $\frac{1}{4}$ of a pound of coal per hour for each square foot of heating surface gives the best results, so that by knowing the ratio of heating surface to grate area for any make of heater we may easily compute the most efficient rate of combustion and from it determine the necessary grate area.

For example — The heat loss from a building is 480,000 B. T. U. per hour; we wish to use a heater in which the ratio of heating surface to grate area is 24, what will be the most efficient rate of combustion and the required grate area? $480,000 \div 8,000 = 60$ pounds of coal per hour, and $24 \div 4 = 6$, which is the best rate of combustion to employ, therefore $60 \div 6 = 10$, the grate area required.

EXAMPLES FOR PRACTICE.

1. The heat loss from a building is 240,000 B. T. U. per hour and the ratio of heating to grate area in the heater to be used is 20, what will be the required grate area? Ans. 6 sq. ft.

2. The heat loss from a building is 168,000 B. T. U. per hour and the chimney draft is such that not over 3 pounds of coal per hour can be burned per square foot of grate. What ratio of heating to grate area will be necessary and what will be the required grate area? Ans. Ratio 12. Grate area 7 sq. ft.

Cast iron sectional boilers are used for dwelling houses, small schoolhouses, churches, etc., where low pressures are carried. They are increased in size by adding more slabs or sections. After a certain length is reached the rear sections become less and less efficient, thus limiting the size and power.

Tubular Boilers. Tubular boilers are largely used for heating purposes, and are adapted to all classes of buildings except dwelling houses and the special cases mentioned for which sectional boilers are preferable. The capacity of this type of boiler is usually stated as so many horse-power, and the method of determining the size is different from that just described. A boiler horse-power has been defined as the evaporation of $34\frac{1}{2}$ pounds of water from and at a temperature of 212 degrees, and in doing this 33,317 B. T. U. are absorbed, which are again given out when the steam is condensed in the radiators. Hence to find the boiler H. P. required for warming any given building we have only to

compute the heat loss per hour by the methods already given and divide the result by 33,330. It is more common to divide by the number 33,000, which gives a slightly larger boiler and is on the side of safety. The ratio of heating to grate surface in this type of boiler ranges from 30 to 40 and therefore allows a combustion of from 8 to 10 pounds of coal per square foot of grate. This is easily obtained with a good chimney draft and careful firing. The larger the boiler, the more important the plant usually, and the greater the care bestowed upon it so that we may generally count on a higher rate of combustion and a greater efficiency as the size of the boiler increases. The following table will be found useful in determining the size of boiler required under different conditions. The grate area is computed for an evaporation of 8 pounds of water per pound of coal, which corresponds to an efficiency of about 60 per cent and is about the average obtained in practice for heating boilers.

The areas of uptake and smoke pipe are figured on a basis of 1 square foot to 7 square feet of grate surface and the results given in round numbers. In the smaller sizes the relative size of smoke pipe is greater. The rate of combustion runs from 6 pounds in the smaller sizes to $11\frac{1}{2}$ in the larger. Boilers of the proportions given in the table, correspond well with those used in actual practice and may be relied upon to give good results under all ordinary conditions.

Water-tube boilers are often used for heating purposes but more especially in connection with power plants. The method of computing the required H. P. is the same as for tubular boilers.

Horse Power for Ventilation. We already know that one B. T. U. will raise the temperature of 1 cubic foot of air $5\bar{5}$ degrees, or it will raise 100 cubic feet $\frac{1}{100}$ of $5\bar{5}$ or $\frac{5\bar{5}}{100}$ of 1 degree, therefore to raise 100 cubic feet 1 degree it will take $1 \div \frac{5\bar{5}}{100}$ or $\frac{100}{5\bar{5}}$ B. T. U., and to raise 100 cubic feet through 100 degrees it would take $\frac{100}{5\bar{5}} \times 100$ B. T. U. In other words, the B. T. U. required to raise any given volume of air through any number of degrees in temperature is equal to

$$\frac{\text{Volume of air in cubic ft.} \times \text{Degrees raised}}{5\bar{5}}$$

TABLE IX.

Diameter of Shell in Inches.	Number of Tubes.	Diameter of Tubes in Inches.	Length of Tubes in Feet.	Horse Power.	Size of Grate in Inches.	Size of Uptake in Inches.	Size of smokepipe in sq. in.	
30	28	2½	6	8.5	24 x 36	10 x 14	140	
			7	9.9	24 x 36	10 x 14	140	
			8	11.2	24 x 36	10 x 14	140	
			9	12.6	24 x 42	10 x 14	140	
			10	14.0	24 x 42	10 x 14	140	
36	34	2½	8	13.6	30 x 36	10 x 16	160	
			9	15.3	30 x 42	10 x 18	180	
			10	16.9	30 x 42	10 x 18	180	
			11	18.6	30 x 48	10 x 20	200	
			12	20.9	30 x 48	10 x 20	200	
42	34	3	9	18.5	36 x 42	10 x 20	200	
			10	20.5	36 x 42	10 x 20	200	
			11	22.5	36 x 48	10 x 25	250	
			12	24.5	36 x 48	10 x 25	250	
			13	26.5	36 x 48	10 x 28	280	
			14	28.5	36 x 54	10 x 28	280	
48	44	3	10	30.4	42 x 48	10 x 28	280	
			11	33.2	42 x 48	10 x 28	280	
			12	35.7	42 x 54	10 x 32	320	
			13	38.3	42 x 54	10 x 32	320	
			14	40.8	42 x 60	10 x 36	360	
			15	43.4	42 x 60	10 x 36	360	
			16	45.9	42 x 60	10 x 36	360	
54	54	3	11	34.6	48 x 54	10 x 38	380	
			12	37.7	48 x 54	10 x 38	380	
			13	40.8	48 x 54	10 x 38	380	
			14	43.9	48 x 54	10 x 38	380	
			15	47.0	48 x 60	10 x 40	400	
	16	50.1	48 x 60	10 x 40	400			
	46	3½	17	53.0	48 x 60	10 x 40	400	
60	72	3	12	48.4	54 x 60	12 x 40	460	
			13	52.4	54 x 60	12 x 40	460	
			14	56.4	54 x 60	12 x 40	460	
			15	60.4	54 x 66	12 x 42	500	
			16	64.4	54 x 66	12 x 42	500	
	64	3½	17	71.4	54 x 72	12 x 48	550	
			18	75.6	54 x 72	12 x 48	550	
66	90	3	14	70.1	60 x 66	12 x 48	500	
			15	75.0	60 x 72	12 x 52	620	
			16	80.0	60 x 72	12 x 52	620	
	78	3½	17	86.0	60 x 78	12 x 56	670	
			18	91.1	60 x 78	12 x 56	670	
			19	96.2	60 x 78	12 x 56	670	
	62	4	20	93.1	60 x 78	12 x 56	670	
	72	114	3	14	87.4	66 x 72	12 x 56	670
				15	93.6	66 x 72	12 x 56	670
16				99.7	66 x 78	12 x 62	740	
17				106.4	66 x 78	12 x 62	740	
98		3½	18	112.6	66 x 84	12 x 66	790	
			19	118.8	66 x 84	12 x 66	790	
			20	125.0	66 x 84	12 x 66	790	
			21	131.2	66 x 84	12 x 66	790	

Example — How many B. T. U. are required to raise 100,000 cubic feet of air 70 degrees?

$$\frac{100,000 \times 70}{55} = 127,272 +$$

To compute the H. P. required for the ventilation of a building we multiply the total air supply in cubic feet per hour by the number of degrees through which it is to be raised, and divide the result by 55. This gives the B. T. U. per hour, which divided by 33,000 will give the H. P. required. In using this rule always take the air supply in cubic feet per *hour*.

EXAMPLES FOR PRACTICE.

1. The heat loss from a building is 1,650,000 B. T. U. per hour. There is to be an air supply of 1,500,000 cubic feet per hour, raised through 70 degrees.

What is the total boiler H. P. required? Ans. 108.

2. A high school has 10 class rooms, each occupied by 50 pupils. Air is to be delivered to the rooms at a temperature of 70 degrees. What will be the total H. P. required to heat and ventilate the building when it is 10 degrees below zero if the heat loss through walls and windows is 1,320,000 B. T. U. per hour?

Ans. 106 +.

DIRECT STEAM HEATING.

Types of Radiating Surface. The radiation used in direct steam heating is made up of cast iron radiators of various forms, pipe radiators and circulation coils.

Cast Iron Radiators. The general form of cast iron sectional radiators has been shown in Fig. 2. They are made up of sections, the number depending upon the amount of heating surface required. Fig. 37 shows an intermediate section of a radiator of this type. It is simply a loop with inlet and outlet at the bottom. The end sections are the same, except they have legs as shown in Fig. 38. These sections are connected at the bottom by special nipples so that steam entering at the end fills the bottom of the radiator, and being lighter than the air rises through the loops and forces the air downward and toward the farther end, where it is discharged through an air-valve placed about midway

of the last section. There are many different designs varying in height and width, to suit all conditions. The wall pattern shown in Fig. 4 is very convenient when it is desired to place the radiator above the floor, as in bath rooms, etc.; it is also a convenient form to place under the windows of halls and churches to counteract the effect of cold down drafts. It is adapted to nearly every place where the ordinary direct radiator can be used and may be connected up in different ways to meet the various requirements.

Pipe Radiators. This type of radiator (see Fig. 3) is made up of wrought iron pipes screwed into a cast iron base. The pipes are either connected in pairs at the top by return bends or each separate tube has a thin metal diaphragm passing up the center nearly to the top. It is necessary that a loop be formed else a "dead end" would occur. This would become filled with air and prevent steam from entering, thus causing portions of the radiator to remain cold. For a given surface the average pipe radiator is more efficient than the cast iron sectional radiator.



Fig. 37.

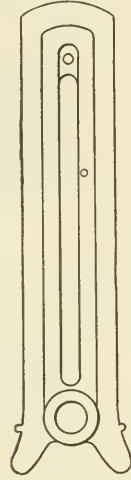

Fig. 38.

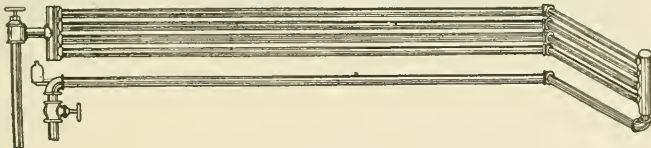

Fig. 39.

Circulation Coils. These are usually made up of 1 or 1½-inch wrought iron pipe, and may be hung on the walls of a room by means of hook plates or suspended overhead on hangers and rolls.

Fig. 39 shows a common form for schoolhouse and similar

work; this coil is usually made of $1\frac{1}{4}$ -inch pipe screwed into "headers" or "branch tees" at the ends, and is hung on the wall just below the windows. This is known as a "branch coil." Fig. 40 shows a "trombone coil," which is commonly used when the pipes cannot turn a corner, and where the entire coil must be placed upon one side of the room. Fig. 41 is called a "miter coil," and is used under the same conditions as a trombone coil if

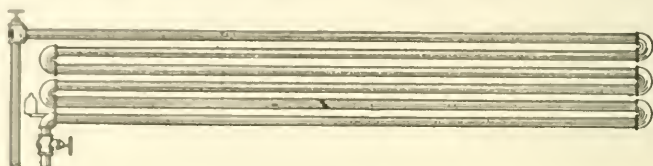

Fig. 40.

there is room for the vertical portion. This form is not as pleasing in appearance as either of the other two and is only found in factories or shops where looks are of minor importance.

Overhead coils are usually of the "miter" form laid on the side and suspended about a foot from the ceiling; they are less efficient than when placed nearer the floor, as the warm air stays at the ceiling and the lower part of the room is likely to remain cold. They are only used when wall coils or radiators would be in the way of fixtures or when they would come below the water

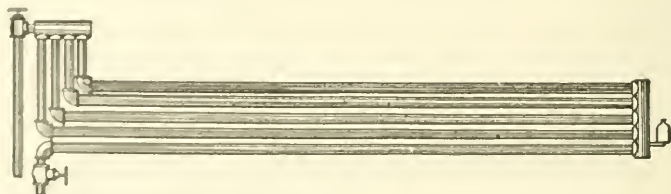

Fig. 41.

line of the boiler if placed near the floor. A coil should never be made up as shown in Fig. 42, as unequal expansion of the pipes would cause strains which would soon result in leaky joints. When steam is first turned on a coil it usually passes through a portion of the pipes first and heats them while the others remain cold and full of air. Therefore the coil must always be made up in such a way that each pipe shall have a certain amount of spring and may expand independently without bringing undue strains upon

the others. Circulation coils should incline about 1 inch in 20 feet toward the return end in order to secure proper drainage and quietness of operation.

Efficiency of Radiators. The efficiency of a radiator, that is, the B. T. U. which it gives off per square foot of surface per hour, depends upon the difference in temperature between the steam in the radiator and the surrounding air, the velocity of the air over the radiator, and the quality of the surface, whether smooth or rough. In ordinary low-pressure heating the first condition is practically constant, but the second varies somewhat with the pattern of the radiator. An open design which allows the air to circulate freely over the radiating surfaces is more efficient than a close pattern and for this reason a pipe coil is more efficient than a radiator.

In a large number of tests of cast iron radiators, working

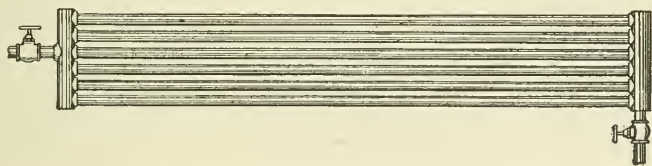

Fig. 42.

under usual conditions, the heat given off per square foot of surface per hour, for each degree difference in temperature between the steam and surrounding air, was found to vary from about 1.3 to 1.7 B. T. U. The temperature of steam at 3 pounds pressure is 220 degrees, and $220 - 70 = 150$, which may be taken as the average difference between the temperature of the steam and the air of the room, in ordinary low-pressure work. If we take the mean of the above results, that is, 1.5 we shall have $150 \times 1.5 = 225$ B. T. U. as the efficiency of an average cast iron radiator. A circulation coil made up of pipes from 1 to 2 inches in diameter will easily give off 300 B. T. U. under the same conditions, and a shallow pipe radiator of standard height may be safely counted upon to give 260. These efficiencies are lower than are given by some engineers, but if the sizes are taken from trade catalogues it is not safe to go much above these figures. If the radiator is to be used for warming rooms which are to be kept at a temperature

above or below 70 degrees, the radiating surface may be changed in the same proportion as the difference in temperature between the steam and the air.

For example — if a room is to be kept at a temperature of 60° the efficiency of the radiator becomes $\frac{150}{140} \times 225 = 241$; that is the efficiency varies directly as the difference in temperature between the steam and the air of the room. It is not customary to consider this unless the steam pressure should be raised to 10 or 15 pounds or the temperature of the rooms changed 15 or 20 degrees from the normal.

From the above it is easy to compute the size of radiator for any given room. First compute the heat loss per hour by radiation and conduction, in the coldest weather, then divide the result by 225 for cast iron radiators, 260 for pipe radiators and 300 for pipe coils. It is customary to make the radiators of such size, that they will warm the rooms to 70 degrees in the coldest weather. This varies a good deal in different localities, even in the same state, and the lowest temperature for which we wish to provide must be settled upon before any calculations are made. In New England and through the Middle and Western States it is usual to figure on warming a building to 70 degrees when the outside temperature is from zero to 10 degrees below.

The makers of radiators publish in their catalogues, tables giving the square feet of heating surface for different styles and heights, and these can be used in determining the number of sections required for all special cases.

If pipe coils are to be used, it becomes necessary to reduce square feet of heating surface to linear feet of pipe; this can be done by means of the factors given below.

$$\text{Square feet of heating surface} \times \begin{cases} 3 & = \text{linear ft. of } 1'' \text{ pipe} \\ 2.3 & = \text{ " " } 1\frac{1}{4}'' \text{ " } \\ 2 & = \text{ " " } 1\frac{1}{2}'' \text{ " } \\ 1.6 & = \text{ " " } 2'' \text{ " } \end{cases}$$

The size of radiator is only made sufficient to keep the room warm after it is once heated, and no allowance is made for "warming up," that is, the heat given off by the radiator is just equal to that lost through walls and windows. This condition is offset in two ways — first, when the room is cold, the difference

in temperature between the steam and air of the room is greater and the radiator is more efficient, and second the radiator is proportioned for the coldest weather so that for a greater part of the time it is larger than necessary. This last condition is one of the disadvantages of direct steam heating; if steam is on the radiator

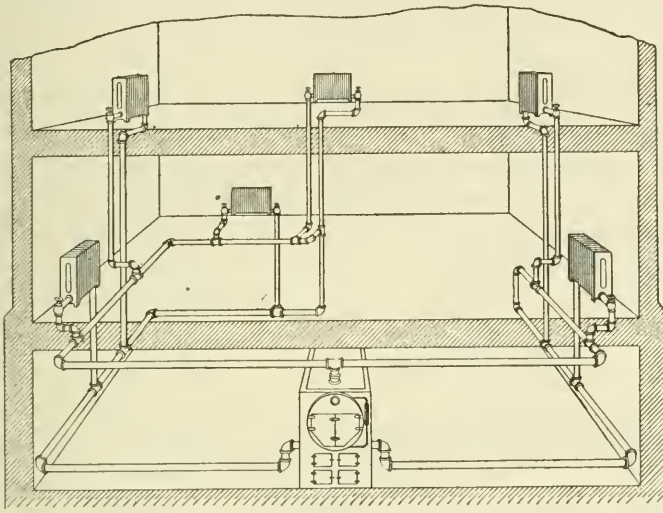

Fig. 43.

at all it will give off the same amount of heat regardless of the outside temperature.

EXAMPLES FOR PRACTICE.

1. The heat loss from a room is 22,500 B. T. U. per hour in the coldest weather; what size of direct radiator will be required?

Ans. 100 square feet.

2. A schoolroom is to be warmed with circulation coils of $1\frac{1}{4}$ -inch pipe. The heat loss is 30,000 B. T. U. per hour; what length of pipe will be required?

Ans. 230 linear feet.

Location. Radiators should be placed in the coldest part of the room if possible, as under windows or near outside doors. In living rooms it is often desirable to keep the windows free, in which case the radiators may be placed at one side. Circulation coils are run along the outside walls of a room under the

windows. Sometimes the position of the radiators is decided by the necessary location of the pipe risers, so that a certain amount of judgment must be used in each special case as to the best arrangement to suit all requirements.

Systems of Piping. There are three distinct systems of piping, known as the "two-pipe system," the "one-pipe relief system," and the "one-pipe circuit system," with various modifications of each.

Fig. 43 shows the arrangement of piping and radiators in the two-pipe system. The steam main leads from the top of the boiler and the branches are carried along near the basement ceiling; risers are taken off from the supply branches and carried up to the

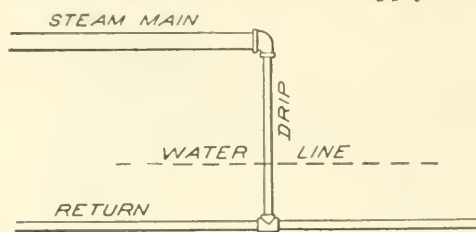

Fig. 44.

radiators on the different floors, and return pipes are brought down to the return mains, which should be placed near the basement floor below the water line of the boiler. Where the building is more than two stories high, radiators in similar positions on different floors are connected with the same riser, which may run to the highest floor, and a corresponding return drop connecting with each radiator is carried down beside the riser to the basement. A system in which the main horizontal returns are below the water line of the boiler is said to have a "wet" or "sealed" return. If the returns are overhead and above the water line, it is called a "dry" return. Where the steam is exposed to extended surfaces of water, as in overhead returns, where the condensation partially fills the pipes, there is likely to be cracking or "water hammer" due to the sudden condensation of the steam as it comes in contact with the cooler water. This is especially noticeable when steam is first turned into cold pipes and radiators, and the condensation is excessive. When dry returns are used the pipes should be large, and have a good pitch toward the boiler.

In the case of sealed returns the only contact between the steam and standing water is in the vertical returns where the

exposed surfaces are very small (being equal to the sectional area of the pipes) and trouble from water hammer is practically done away with. Dry returns should be given an incline of at least 1 inch in 10 feet, while for wet returns 1 inch in 20 or even 40 feet is ample. The ends of all steam mains and branches should be dripped into the returns. If the return is sealed, the drip may be directly

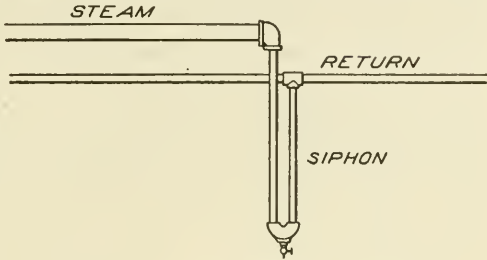

Fig. 45.

connected as shown in Fig. 44, but if it is dry, the connection should be provided with a siphon loop as indicated in Fig. 45. The loop becomes filled with water and prevents steam from

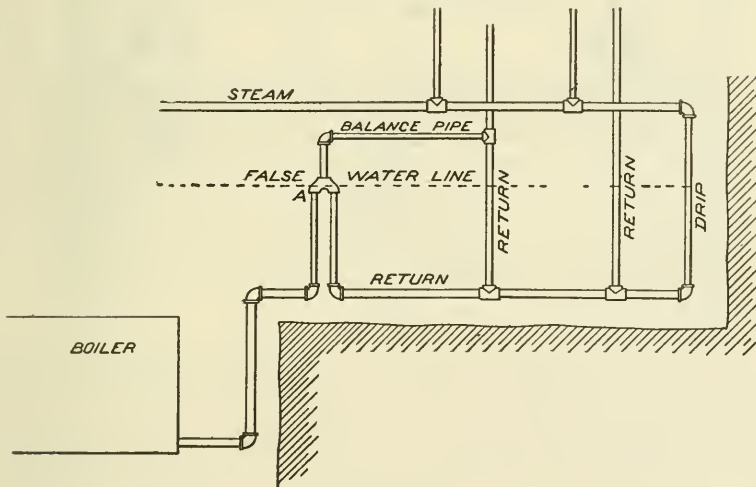

Fig. 46.

flowing directly into the return. As the condensation collects in the loop it overflows into the return pipe and is carried away. The return pipes in this case are of course filled with steam above the water, but it is steam which has passed through the radiators and their return connections, and is therefore at a slightly lower pressure, so that if steam were admitted directly from the

main it would tend to hold back the water in more distant returns and cause surging and cracking in the pipes. Sometimes the boiler is at a lower level than the basement in which the returns are run and it then becomes necessary to establish a "false" water line. This is done by making connections as shown in Fig. 46.

It is readily seen that the return water in order to reach the boiler must flow over the loop "A" which raises the water line, or seal, to the level shown by the dotted line. The balance pipe is to break the seal as the water flows over the loop, and prevent

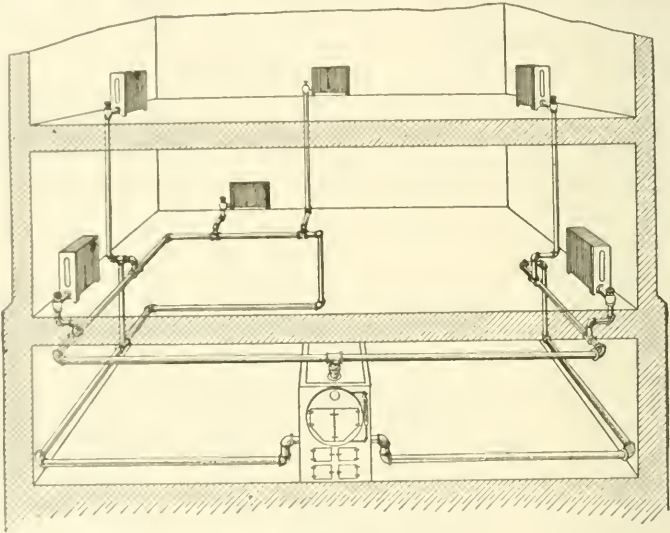

Fig. 47.

any siphon action which would tend to drain the water out of the return mains after a flow was once started.

One-Pipe Relief System. In this system of piping the radiators have but a single connection, the steam flowing in and the condensation draining out through the same pipe. Fig. 47 shows the method of running the pipes for this system. The steam main, as before, leads from the top of the boiler and is carried to as high a point as the basement ceiling will allow; it then slopes downward with a grade of about 1 inch in 10 feet and makes a circuit of the building or a portion of it.

Risers are taken off from the top and carried to the radiators above as in the two-pipe system, but in this case, the condensation

flows back through the same pipe and drains into the return main near the floor through drip connections which are made at frequent intervals. In a two-story building the bottom of each riser to the second floor is dripped, and in larger buildings it is customary to drip each riser that has more than one radiator connected with it. If the radiators are large and at a considerable distance from the next riser, it is better to make a drip connection for each radiator. When the return main is overhead, the risers should be dripped through siphon loops, but the ends of the branches should make direct connection with the returns. This is the reverse of the two-pipe system. In this case the lowest

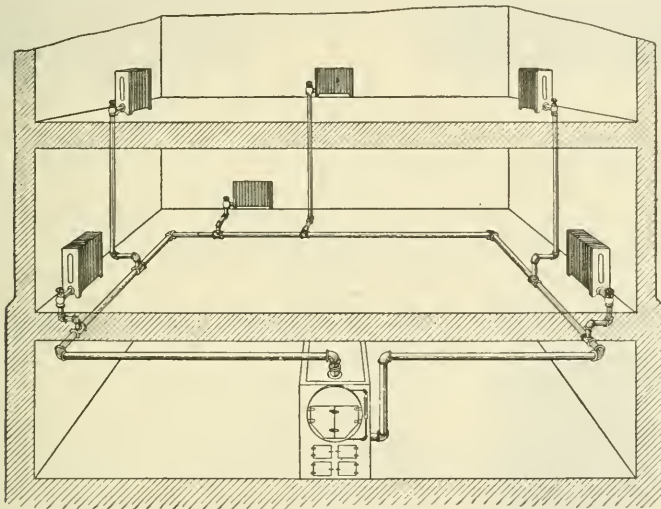

Fig. 48.

pressure is at the ends of the mains so that steam introduced into the returns at these points will cause no trouble in the pipes connecting between these and the boiler.

If no steam is allowed to enter the returns, a vacuum will be formed, and there will be no pressure to force the water back to the boiler. A check valve should always be placed in the main return near the boiler to prevent the water from flowing out in case of a vacuum being formed suddenly in the pipes.

One-Pipe Circuit System. (See Fig. 48.) In this case the steam main rises to the highest point of the basement as before,

and then with a considerable pitch makes an entire circuit of the building and again connects with the boiler below the water line. Single risers are taken from the top and the condensation drains back through the same pipes and is carried along with the flow of steam to the extreme end of the main, where it is returned to

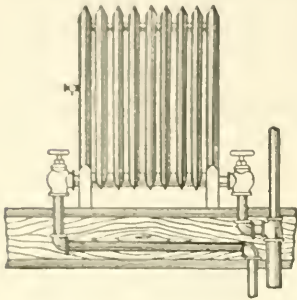

Fig. 49.

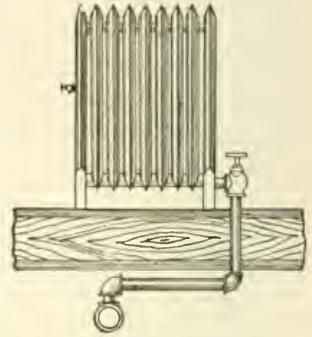

Fig. 50.

the boiler. The main is made large and of the same size throughout its entire length: it must be given a good pitch to insure satisfactory results.

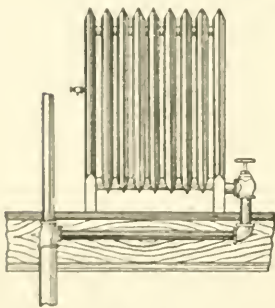

Fig. 51.

One objection to a single-pipe system is that the steam and return water are flowing in opposite directions, and the risers must be made of extra large size to prevent any interference. This is overcome in large buildings by carrying a single riser to the attic, large enough to supply the entire building; then branching and running "drops" to the basement. In this system the flow of steam is downward as well as that of water. This method of piping may be used with good results in two-pipe systems as well. Care must always be taken that no pockets or low points occur in any of the lines of pipe, but if for any reason they cannot be avoided they should be carefully drained.

Pipe Connections. Figs. 49, 50 and 51 show the common methods of making the connections between the supply pipes and

the radiators. Fig. 49 shows a two-pipe connection with a riser; the return is carried down to the main below. Fig. 50 shows a single pipe connection with a basement main and Fig. 51 a single connection with a riser.

Care must always be taken to make the horizontal part of the piping between the radiator and riser as short as possible and to give it a good pitch toward the riser. There are various ways of making these connections especially suited to different conditions,

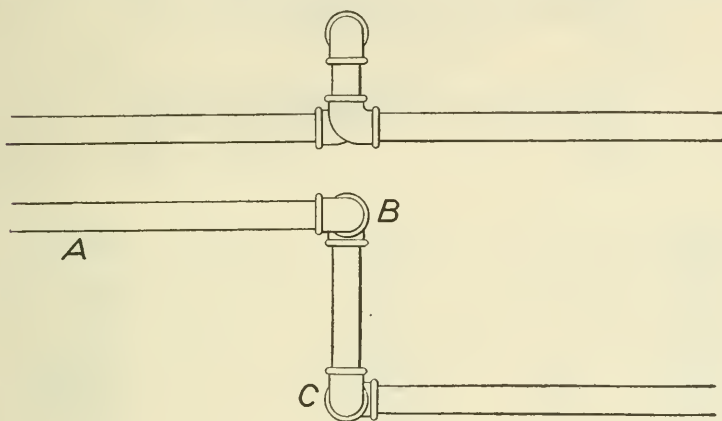

Fig. 52.

but the examples given serve to show the general principle to be followed.

Figs. 39, 40 and 41 show the common methods of making steam and return connections with circulation coils. The position of the air valve is shown in each case.

Expansion of Pipes. Cold steam pipes expand approximately 1 inch in each 100 feet in length when low pressure steam is turned into them, so that in laying out a system of piping we must arrange it in such a manner that there will be sufficient "spring" or "give" to the pipes to prevent injurious strains. This is done by means of offsets and bends. In the case of larger pipes this simple method will not be sufficient, and swivel or slip joints must be used, to take up the expansion. The method of making up a swivel joint is shown in Fig. 52.

Any lengthening of the pipe A will be taken up by slight turning or swivel movements at the points B and C. A slip joint

is shown in Fig. 53. The part *c* slides inside the shell *d* and is made steam tight by a stuffing box as shown. The pipes are connected at the flanges A and B.

When pipes pass through floors or partitions, the woodwork should be protected by galvanized iron sleeves having a diameter from $\frac{3}{4}$ to 1 inch greater than the pipe. Fig. 54 shows a form of

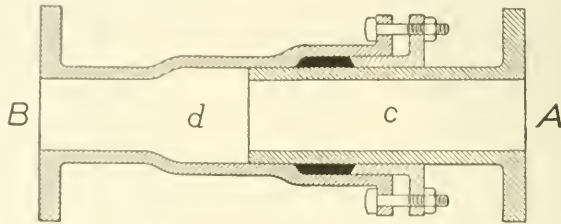

Fig. 53.

adjustable floor sleeve which may be lengthened or shortened to conform to the thickness of floor or partition. If plain sleeves are used, a plate should be placed around the pipe where it passes through the floor or partition. These are made in two parts so

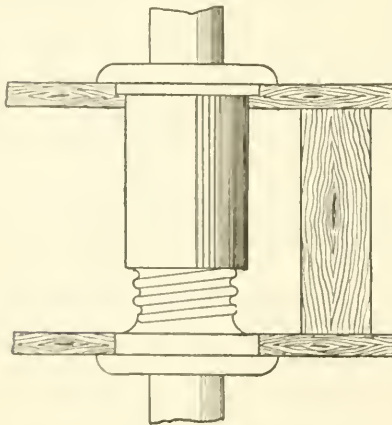

Fig. 54.

that they may be put in place after the pipe is hung. A plate of this kind is shown in Fig. 55.

Valves. The different styles commonly used for radiator connections are shown in Figs. 56, 57 and 58, and are known as "angle," "offset" and "corner" valves respectively. The first is used when the radiator is at the top of a riser or when the connections are like those shown in Figs. 49, 50 and 51; the second is

used when the connection between the riser and radiator is above the floor, and the third when the radiator has to be set close in the corner of a room and there is not space for the usual connection. A *globe* valve should never be used in a horizontal steam supply or dry return; the reason for this is plainly shown in

Fig. 59. In order for water to flow through the valve it must rise to a height shown by the dotted line, which would half fill the pipes, and cause serious trouble from water hammer. The gate valve shown in Fig. 60 does not have this undesirable feature, as the opening is on a level with the bottom of the pipe.

Air Valves. Valves of various kinds are used for freeing the radiators from air when steam is turned on. Fig. 61 shows simplest form, which is operated by hand.

Fig. 62 is a type of automatic valve; it consists of a shell, which is attached to the radiator. B is a small opening which may be closed by the spindle C which is provided with a conical end. D is a strip composed of a layer of iron or steel

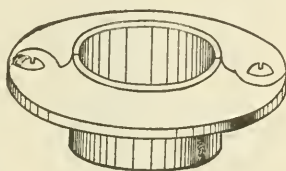

Fig. 55.



Fig. 56.



Fig. 57.



Fig. 58.

and one of brass soldered or brazed together. The action of the valve is as follows; when the radiator is cold and filled with air the valve stands as shown in the cut. When steam is turned on, the air is driven out through the opening B. As soon as this is expelled and steam strikes the strip D, the two prongs spring

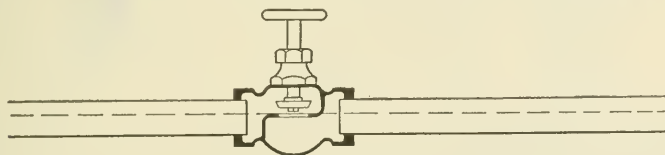

Fig 59.

apart owing to the unequal expansion of the two metals due to the heat of the steam. This raises the spindle C and closes the opening so that no steam can escape. If air should collect in the valve and the metal strip become cool it would contract and the spindle would drop and allow the air to escape through B as be-

fore. E is an adjusting nut and F is a float attached to the spindle, and is supposed in case of a sudden rush of water with the air to rise and close the opening; this action is somewhat uncertain, especially if the pressure of water continues for some time.

There are other types of valves acting on the same principle. The valve shown in Fig. 63 is closed by the expansion of a piece of vulcanite instead of a metal strip, and has no water float.

The valve shown in Fig. 64 acts on a somewhat different principle. The float C is made of thin brass, closed at top and bottom, and is partially filled with wood alcohol. When steam strikes the float the alcohol is vaporized, and creates a pressure sufficient to bulge out the ends slightly which raises the spindle and closes the opening B. Fig. 65 shows a form of so-called "vacuum valve."

It acts in a similar manner to those already described, but has in addition a ball check which prevents the air from being drawn into the radiator, should the steam go down and a vacuum be formed. If a partial vacuum exists in the

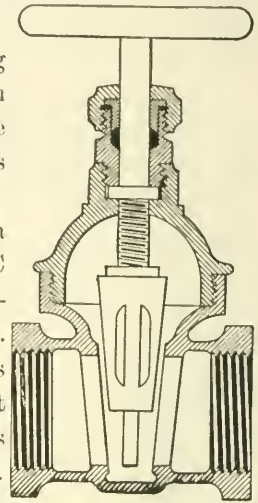

Fig. 60.

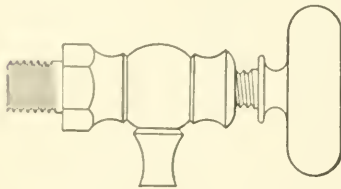

Fig. 61.

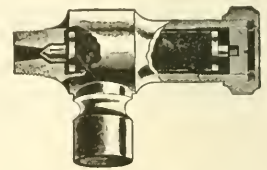

Fig. 63.

boiler and radiators, the boiling point, and consequently the temperature of the steam are lowered, and less heat is given off by the radiators. This method of operating a heating plant is sometimes advocated for spring and fall when less heat is required, and steam under pressure would overheat the rooms.

Pipe Sizes. The proportioning of the steam pipes in a heating plant is of the greatest importance, and should be carefully worked out by methods which experience has proved to be correct.

There are several ways of doing this, but for ordinary conditions the following tables have given excellent results in actual practice. They have been computed from what is known as

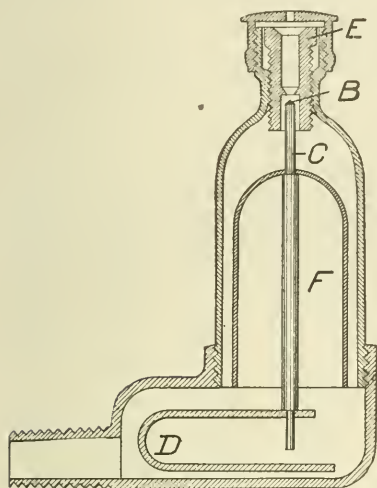

Fig. 62.

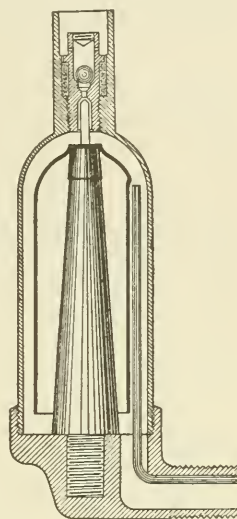

Fig. 65.

D'Arey's formula, with suitable corrections made for actual working conditions. As the computations are somewhat complicated, only the results will be given here, with full directions for their proper use. The following table gives the flow of steam in pounds per minute for pipes of different diameters, and with varying drops in pressure between the supply and discharge ends of the pipe. These quantities are for pipes 100 feet in length; for other lengths the results must be corrected by the factors given in table XII. As the length of the pipe increases, the friction becomes greater, and the quantity of steam discharged in a given time is diminished.

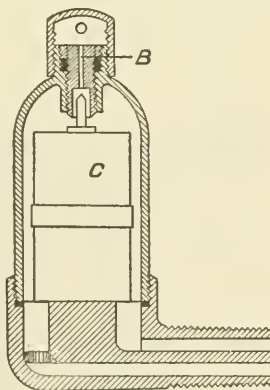

Fig. 64.

Table X is computed on the assumption that the drop in pressure between the two ends of the pipe equals the initial pressure. If the drop in pressure is less than the initial pressure the

actual discharge will be slightly greater than the quantities given in the table, but this difference will be small for pressures up to 5 pounds, and can be neglected as it is on the side of safety. For higher initial pressures, table XI has been prepared. This is to

TABLE X.

Diam. of Pipe.	Drop in Pressure (Pounds.)								
	$\frac{1}{4}$	$\frac{1}{2}$	$\frac{3}{4}$	1	$1\frac{1}{2}$	2	3	4	5
1	.44	.63	.78	.91	1.13	1.31	1.66	1.97	2.26
1 $\frac{1}{4}$.81	1.16	1.43	1.66	2.05	2.39	3.02	3.59	4.12
1 $\frac{1}{2}$	1.06	1.89	2.34	2.71	3.36	3.92	4.94	5.88	6.75
2	2.93	4.17	5.16	5.99	7.43	8.65	10.9	13.0	14.9
2 $\frac{1}{2}$	5.29	7.52	9.32	10.8	13.4	15.6	19.7	23.4	26.9
3	8.61	12.3	15.2	17.6	21.8	25.4	32	31.8	43.7
3 $\frac{1}{2}$	12.9	18.3	22.6	26.3	32.5	37.9	47.8	56.9	65.3
4	18.1	25.7	31.8	36.9	45.8	53.3	67.2	80.1	91.9
5	32.2	45.7	56.6	65.7	81.3	94.7	120	142	163
6	51.7	73.3	90.9	106	131	152	192	229	262
7	76.7	109	135	157	194	226	285	339	390
8	108	154	190	222	274	319	402	478	549
9	147	209	258	299	371	432	545	649	745
10	192	273	339	393	487	567	715	852	977
12	305	434	537	623	771	899	1130	1350	1550
15	535	761	942	1090	1350	1580	1990	2370	2720

be used in connection with table X as follows. First find from table X the quantity of steam which will be discharged through the given diameter of pipe with the assumed drop in pressure;

TABLE XI.

Drop in Pressure in Pounds.	Initial Pressure.					
	10	20	30	40	60	80
$\frac{1}{4}$	1.27	1.49	1.68	1.84	2.13	2.38
$\frac{1}{2}$	1.26	1.48	1.66	1.83	2.11	2.36
$\frac{3}{4}$	1.24	1.46	1.64	1.80	2.08	2.32
1	1.21	1.41	1.59	1.75	2.02	2.26
2	1.17	1.37	1.55	1.70	1.97	2.20
3	1.14	1.34	1.51	1.66	1.92	2.14
4	1.12	1.31	1.47	1.62	1.87	2.09

then look in table XI for the factor corresponding with the assumed drop and the higher initial pressure to be used. The quantity given in table X multiplied by this factor will give the actual capacity of the pipe under the given conditions.

Example—What weight of steam will be discharged through a 3" pipe, 100 feet long, with an initial pressure of 60 pounds and a drop of 2 pounds?

Looking in table X we find that a 3" pipe will discharge 25.4 pounds of steam per minute with a 2-pound drop. Then looking in table XI we find the factor corresponding to 60 pounds initial pressure and a drop of 2 pounds to be 2.02. Then according to the rule given, $25.4 \times 2.02 = 51.3$ pounds which is the capacity of a 3" pipe under the assumed conditions.

Sometimes the problem will be presented in the following way: What size of pipe will be required to deliver 80 pounds of steam a distance of 100 feet with an initial pressure of 40 pounds and a drop of 3 pounds?

TABLE XII.

Feet.	Factor.	Feet.	Factor.	Feet.	Factor.	Feet	Factor.
10	3.16	120	.91	275	.60	600	.40
20	2.24	130	.87	300	.57	650	.39
30	1.82	140	.84	325	.55	700	.37
40	1.58	150	.81	350	.53	750	.36
50	1.41	160	.79	375	.51	800	.35
60	1.29	170	.76	400	.50	850	.34
70	1.20	180	.74	425	.48	900	.33
80	1.12	190	.72	450	.47	950	.32
90	1.05	200	.70	475	.46	1,000	.31
100	1.00	225	.66	500	.45		
110	.95	250	.63	550	.42		

We have seen that the higher the initial pressure with a given drop, the greater will be the quantity of steam discharged; therefore a smaller pipe will be required to deliver 80 pounds of steam at 40 pounds than at 3 pounds initial pressure. From table XI we find that a given pipe will discharge 1.7 times as much steam per minute with a pressure of 40 pounds, and a drop of 3 pounds, as it would with a pressure of 3 pounds, dropping to zero. From this it is evident that if we divide 80 by 1.7 and look in table X under "3 pounds drop" for the result thus obtained, the size of pipe corresponding will be that required.

$$80 \div 1.7 = 47.$$

The nearest number in the table marked "3 pounds drop" is 47.8 which corresponds to a $3\frac{1}{2}$ " pipe and is the size required.

These conditions will seldom be met with in low-pressure heating, but apply more particularly to combination power and heating plants, and will be taken up more fully under that head. For lengths of pipe other than 100 feet, multiply the quantities given in table X by the factors found in table XII.

Example — What weight of steam will be discharged per minute through a $3\frac{1}{2}$ " pipe, 450 feet long with a pressure of 5 pounds and a drop of $\frac{1}{2}$ pound?

Table X, which may be used for all pressures below 10 pounds, gives for a $3\frac{1}{2}$ " pipe, 100 feet long, a capacity of 18.3 pounds for the above conditions. Looking in table XII, we find the correction factor for 450 feet to be .47. Then $18.3 \times .47 = 8.6$ pounds, the quantity of steam which will be discharged if the pipe is 450 feet long.

Examples involving the use of tables X, XI and XII in combination are quite common in practice. The following shows the method of calculation:

What size of pipe will be required to deliver 90 pounds of steam per minute a distance of 800 feet, with an initial pressure of 80 pounds and a drop of 5 pounds? Table XII gives the factor for 800 feet as .35 and table XI that for 80 pounds pressure and 5 pounds drop as 2.09. Then $\frac{90}{.35 \times 2.09} = 123$; which

is the equivalent quantity, we must look for in table X. We find that a 4" pipe will discharge 91.9 pounds, and a 5" pipe 163 pounds. A $4\frac{1}{2}$ " pipe is not commonly carried in stock and we should probably use a 5" in this case, unless it was decided to use a 4" and allow a slightly greater drop in pressure. In ordinary heating work with pressures varying from 2 to 5 pounds, a drop of $\frac{1}{4}$ pound in 100 feet has been found to give satisfactory results.

In computing the pipe sizes for a heating system by the above methods it would be a long process to work out the size of each branch separately so the following table has been prepared for ready use in low-pressure work.

As most direct heating systems, and especially those in schoolhouses, are made up of both radiators and circulation coils,

an efficiency of 300 B. T. U. has been taken for direct radiation of whatever variety, no distinction being made between the different kinds. This gives a slightly larger pipe than is necessary for cast iron radiators, but it is probably offset by bends in the pipes, and in any case gives a slight factor of safety. We find from a steam table that the "latent heat" of steam at 20 pounds above a vacuum, (which corresponds to 5 pounds gage-pressure) is $954 +$ B. T. U., which means that for every pound of steam condensed in a radiator 954 B. T. U. are given off for warming the air of the room. If a radiator has an efficiency of 300 B. T. U., then each square foot of surface will condense $300 \div 954 = 314$ pounds of steam per hour, so that we may assume in round numbers a condensation of $\frac{1}{3}$ of a pound of steam per hour for each square foot of direct radiation, when computing the sizes of steam pipes in low-pressure heating. Table XIII has been calculated on this assumption, and gives the square feet of heating surface

TABLE XIII.
LENGTH OF PIPE 100 FEET.

Size of Pipe.	Square Feet of Heating Surface.	
	$\frac{1}{4}$ Pound Drop.	$\frac{1}{2}$ Pound Drop.
1	80	114
$1\frac{1}{4}$	145	210
$1\frac{1}{2}$	190	310
2	525	750
$2\frac{1}{2}$	950	1350
3	1550	2210
$3\frac{1}{2}$	2320	3290
4	3250	4620
5	5800	8220
6	9320	13200
7	13800	19620
8	19440	27720

which different sizes of pipe will supply, with drops in pressure of $\frac{1}{4}$ and $\frac{1}{2}$ pounds, in each 100 feet of pipe. The former should be used for pressures from 1 to 5 pounds, and the latter may be used for pressures over 5 pounds, under ordinary conditions. The

sizes of long mains and special pipes of large size should be proportioned directly from tables X, XI and XII.

Where the two-pipe system is used and the radiators have separate supply and return pipes, the risers or vertical pipes may be taken from table XIII, but if the single pipe system is used, the risers must be increased in size as the steam and water are flowing in opposite directions and must have plenty of room to pass each other. It is customary in this case to base the computation on the velocity of the steam in the pipes rather than on the drop in pressure. Assuming as before, a condensation of one-third of a pound of steam per hour per square foot of radiation, the following tables have been prepared for velocities of 10 and 15 feet per second. The sizes given in table XV have been found sufficient in most cases, but the larger sizes, based on a flow of 10 feet per second, give greater safety and should be more generally used. The size of the largest riser should usually be limited to $2\frac{1}{2}$ " in school and dwelling house work unless it is a special pipe carried up in a concealed position. If the length of riser is short between the lowest radiator and the main, a higher velocity of 20 feet or more may be allowed through this portion rather than make the pipe excessively large.

TABLE XIV.

10 Feet Per Second Velocity.	
Size of Pipe.	Sq. Feet of Radiation.
1	30
$1\frac{1}{4}$	60
$1\frac{1}{2}$	80
2	130
$2\frac{1}{2}$	190
3	290
$3\frac{1}{2}$	390

TABLE XV.

15 Feet Per Second Velocity.	
Size of Pipe.	Sq. Feet of Radiation.
1	50
$1\frac{1}{4}$	90
$1\frac{1}{2}$	120
2	200
$2\frac{1}{2}$	290
3	340
$3\frac{1}{2}$	590

EXAMPLES FOR PRACTICE.

- How many pounds of steam will be delivered per minute, through a $3\frac{1}{2}$ " pipe 600 feet long with an initial pressure of 5 pounds and a drop of $\frac{1}{2}$ pound. Ans. 7.32 pounds.
- What size pipe will be required to deliver 25.52 pounds

of steam per minute with an initial pressure of 3 pounds and a drop of $\frac{1}{4}$ pound; the length of the pipe being 50 feet. Ans. 4".

3. Compute the size of pipe required to supply 10,000 square feet of direct radiation, (assume $\frac{1}{3}$ of a pound of steam per square foot per hour) where the distance to the boiler house is 300 feet and the pressure carried is 10 pounds; allowing a drop in pressure of 4 pounds.

Ans. 5". (This is slightly larger than is required, while a 4" is much too small.)

TABLE XVI.

Dia. of Steam Pipe.	Dia. of Dry Return.	Dia. of Sealed Return.
1	1	$3\frac{3}{4}$
$1\frac{1}{4}$	1	1
$1\frac{1}{2}$	$1\frac{1}{4}$	1
2	$1\frac{1}{2}$	$1\frac{1}{4}$
$2\frac{1}{2}$	2	$1\frac{1}{3}$
3	$2\frac{1}{2}$	2
$3\frac{1}{2}$	$2\frac{1}{2}$	2
4	3	$2\frac{1}{3}$
5	3	$2\frac{1}{2}$
6	$3\frac{1}{2}$	3
7	$3\frac{1}{2}$	3
8	4	$3\frac{1}{3}$
9	5	$3\frac{1}{2}$
10	5	4
12	6	5

Returns. The size of return pipes is usually a matter of custom and judgment rather than computation. It is a common rule among steam fitters to make the returns one size smaller than the corresponding steam pipes. This is a good rule for the smaller sizes, but gives a larger return than is necessary for the larger sizes of pipe. Table XVI gives different sizes of steam pipes with the corresponding diameters for dry and sealed returns.

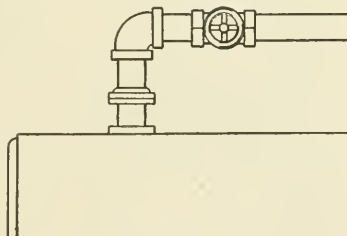

Fig. 66.

The length of run and number of turns in a return pipe should be noted and any unusual conditions provided for. Where the condensation is discharged through a trap into a lower pressure the sizes given may be slightly reduced, especially among the larger sizes, depending upon the difference in pressures.

Radiators are usually tapped for pipe connections as follows, and these sizes may be used for the connections with the mains or risers.

TWO-PIPE CONNECTION.

Square Feet of Radiation.	Steam.	Return.
10 to 30	$\frac{3}{4}$ "	$\frac{3}{4}$ "
30 to 48	1 "	$\frac{3}{4}$ "
48 to 96	$1\frac{1}{4}$ "	1 "
96 to 150	$1\frac{1}{2}$ "	$1\frac{1}{4}$ "

SINGLE PIPE CONNECTION.

10 to 24	1 "
24 to 60	$1\frac{1}{4}$ "
60 to 80	$1\frac{1}{2}$ "
80 to 130	2 "

Boiler Connections. The steam main should be connected to the rear nozzle, if a tubular boiler is used, as the boiling of the water is less violent at this point and dryer steam will be obtained. The shut-off valve should be placed in such a position that pockets for the accumulation of condensation will be avoided. Fig. 66 shows a good position for the valve.

The return connection is made through the blow-off pipe and should be arranged so that the boiler can be blown off without draining the returns. A check valve should be placed in the main return and a plug cock in the blow-off pipe. Fig. 67 shows in plan a good arrangement for these connections.

Blow-Off Tank. Where the blow-off pipe connects with a sewer some means must be provided for cooling the water or the expansion and contraction caused by the hot water flowing through the drain pipes will start the joints and cause leaks. For this reason it is customary to pass the water through a blow-off tank. A form of wrought iron tank is shown in Fig. 68. It

consists of a receiver supported on cast-iron cradles. The tank ordinarily stands nearly full of cold water.

The pipe from the boiler enters above the water line, and the sewer connection leads from near the bottom as shown. A vapor pipe is carried from the top of the tank above the roof of the building. When water from the boiler is blown into the tank

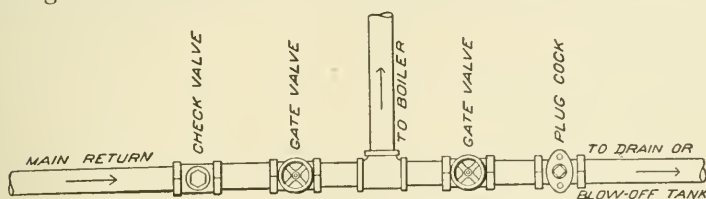

Fig. 67.

cold water from the bottom flows into the sewer and the steam is carried off through the vapor pipe. The equalizing pipe is to prevent any siphon action which might draw the water out of the tank after a flow was once started. As only a part of the water is blown out of a boiler at one time the blow-off tank can be of a comparatively small size. A tank 24" \times 48" should be large

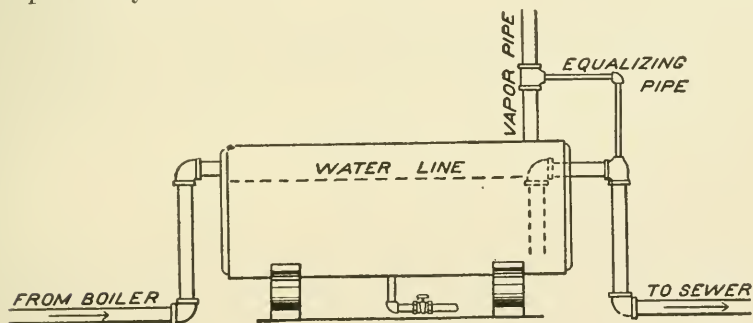

Fig. 68.

enough for boilers up to 48 inches in diameter and one 36" \times 72" should care for a boiler 72 inches in diameter. If smaller quantities of water are blown off at a time smaller tanks can be used. The sizes given above are sufficient for batteries of 2 or more boilers, as one boiler can be blown off and the water allowed to cool before a second one is blown off. Cast iron tanks are often used in place of wrought iron and these may be sunken in the ground if desired.

EXAMINATION PAPER.

HEATING AND VENTILATION

PART I.

HEATING AND VENTILATION.

Instructions to the Student. Place your name and full address at the head of the paper. Avoid crowding your work as it leads to errors and shows bad taste. Mark your answers plainly "Ans." Any cheap, light paper like the sample previously sent you may be used. After completing the work add and sign the following statement.

I hereby certify that the above work is entirely my own.

(Signed)

1. What advantage does indirect steam heating have over direct heating? What advantages over furnace heating?
2. What are the causes of heat loss from a building?
3. Why is hot water especially adapted to the warming of dwellings?
4. What proportion of carbonic acid gas is found in outdoor air under ordinary conditions?
5. A room in the N. E. corner of a building is 18' square and 10' high; there are 5 single windows, each 3' \times 10' in size. The walls are of brick 12" in thickness. With an inside temperature of 70 degrees what will be the heat loss per hour in zero weather? Ans. 21,447 B. T. U.
6. State four important points to be noted in the care of a furnace?
7. A grammar school building has 4 rooms, one in each corner, each being 30' \times 30' and 14' high and seating 50 pupils. The walls are of wooden construction and the windows make up $\frac{1}{3}$ of the total exposed surface. The basement and attic are warm. How many pounds of coal will be required per hour for both heating and ventilation in zero weather if 8000 B. T. U. are utilized from each pound of coal? Ans. 96.3 lbs.
8. What two distinct types of furnaces are used? What are the distinguishing features?
9. What is meant by the efficiency of a furnace? What efficiencies are obtained in ordinary practice?
10. What are the principal parts of a furnace? State briefly the use of each.
11. A brick house 20' \times 40' has 3 stories, each 10' high.

The walls are 12" in thickness and $\frac{1}{4}$ the total exposed wall is taken up by windows, which are double. The basement is warm, but the attic is cold. The house is to be warmed to 70 degrees when it is ten degrees below zero outside. How many square feet of grate surface will be required, assuming usual efficiencies of coal and furnace? Ans. 8.5 square feet.

12. A high school is to be provided with tubular boilers. What H. P. will be required for warming and ventilation in zero weather if there are 600 occupants, and the heat loss through walls and windows is 1,500,000 B. T. U. per hour?

Ans. 114.8

13. What are the three essential parts of any heating system?

14. Is direct steam heating adapted to the warming of schoolhouses and hospitals? Give the reasons for your answer.

15. The heat loss from a dwelling house is 280,000 B. T. U. per hour. It is to be heated with direct steam by a type of boiler in which the ratio of heating surface to grate surface is 28. What will be the most efficient rate of combustion, and how many square feet of grate surface will be required?

Ans. 7 pounds. 5 sq. feet.

16. What is the use of a blow-off tank? Show by a sketch how the connections are made.

17. How are the sizes of single pipe risers computed?

18. What weight of steam will be discharged per hour through a 6" pipe 300' long with an initial pressure of 10 pounds and a drop of $\frac{3}{4}$ pound in its entire length? Ans. 65.6 pounds.

19. What is an air valve? Upon what principles does it work?

20. What size of steam pipe will be required to discharge 2400 pounds of steam per hour a distance of 900', with an initial pressure of sixty pounds and a drop in pressure of 5 pounds?

Ans. $3\frac{1}{2}$ dia.

21. What objection is there to a single pipe riser system? How is this sometimes overcome in large buildings?

22. What patterns of valves should be used for radiators? What conditions of construction must be observed in making the connections between the radiator and riser?

23. The heat loss from a shop is 36,000 B.T.U. per hour; how many linear feet of 2" pipe will be required to warm it, using low pressure steam? Ans. 192 feet.

24. What are meant by "wet" and "dry" returns? Which is the better, and why?

25. How many linear feet of 1½" pipe are required to give off the same amount of heat as a cast iron radiator having 125 square feet of surface? Ans. 215 feet.

26. What three systems of piping are commonly used in direct steam heating? Describe each briefly.

27. What is a "branch coil?" What is a "trombone coil?" In what cases would you use a trombone coil instead of a branch coil?

28. What is meant by the efficiency of a radiator? Give average efficiencies of cast iron and pipe radiators, also circulation coil.

29. The heat loss from a room is 22,500 B.T.U. in zero weather. What size of cast iron radiator would be required to warm the room when it is twenty degrees below zero?

Ans. 128 square feet.

30. Where would you place the direct radiation in a school-room?

HEATING AND VENTILATION

PART II

INSTRUCTION PAPER



AMERICAN SCHOOL OF CORRESPONDENCE

[CHARTERED BY THE COMMONWEALTH OF MASSACHUSETTS]

BOSTON, MASSACHUSETTS

U. S. A.

PREPARED BY
CHARLES L. HUBBARD, M.E.,
OF
S. HOMER WOODBRIDGE COMPANY,
HEATING, VENTILATION AND SANITARY ENGINEERS.

*Copyright 1902, by
American School of Correspondence
Boston, Mass.*

HEATING AND VENTILATION.

INDIRECT STEAM HEATING.

Types of Heaters. Various forms of indirect radiators have been shown in Figs. 8, 9, 14 and 15 of Part I. A hot-water radiator may be used for steam but a steam radiator cannot always be used for hot water as it must be especially designed to produce a continuous flow of water through it from top to bottom. Figs. 1 and

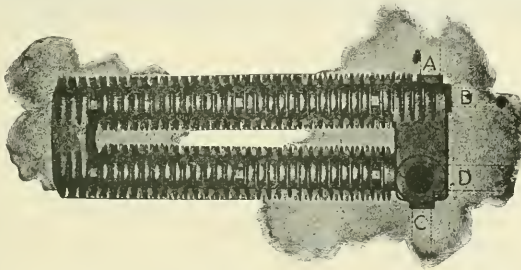

Fig. 1.

2 show the outside and the interior construction of a common pattern of indirect radiator designed especially for steam. The arrows in Fig. 2 indicate the path of the steam through the

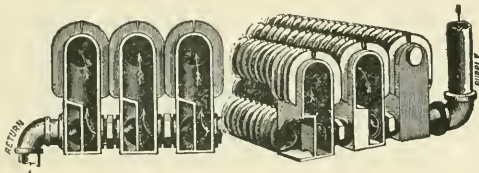

Fig. 2.

radiator which is supplied at the right while the return connection is at the left. The air valve in this case should be connected in the end of the last section near the return.

A very efficient form of radiator and one that is especially adapted to the warming of large volumes of air as in schoolhouse

work, is shown in Fig. 3, and is known as the "School pin" radiator. This can be used for either steam or hot water as there is a continuous passage downward from the supply connection at the top to the return at the bottom. These sections or slabs are made up in stacks after the manner shown in Fig. 4 which repre-

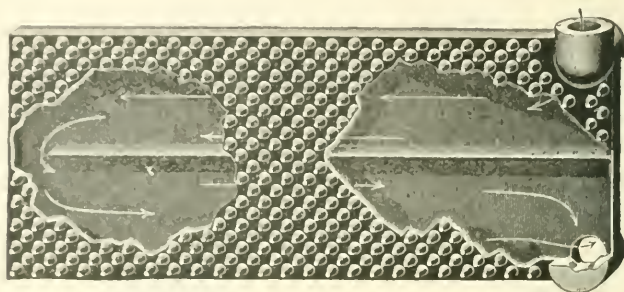

Fig. 3.

sents an end view of several sections connected together with special nipples.

A very efficient form of indirect heater may be made up of wrought iron pipe joined together with branch tees and return bends. A heater like that shown in Fig. 5 is known as a "box coil." Its efficiency is increased if the pipes are "staggered," that is, if the pipes in alternate rows are placed over the spaces between those in the row below.

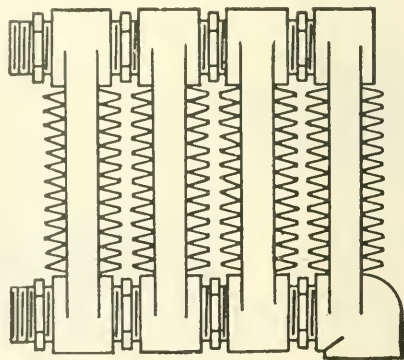

Fig. 4.

Stacks and Casings. It has already been stated that a group of sections connected together is called a stack, and examples of these with their casings are shown in Figs. 6 and 7 of Part I. The casings are usually made of galvanized iron and are made up in sections by means of small bolts so that they may be taken apart in case it is necessary to make repairs. Large stacks are often enclosed in brick work; the sides consisting of 8-inch walls and the top being covered over with a layer of brick and mortar

supported on light wrought iron tee bars. Where a single stack supplies several flues or registers the connections between these and the warm-air chamber are made in the same manner as already described for furnace heating. When galvanized iron casings are used the heater is supported by hangers from the floor above. Fig. 6 shows the method of hanging a heater from a wooden

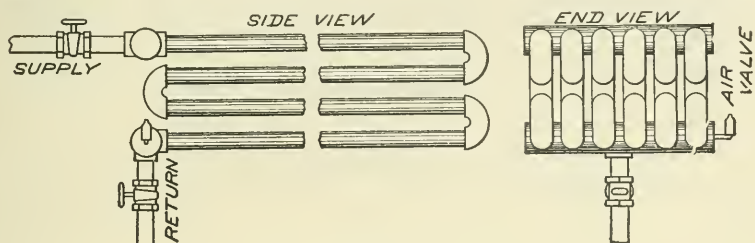

Fig. 5.

floor. If the floor is of fireproof construction the hangers may pass up through the brickwork and the ends be provided with nuts and large washers or plates; or they can be clamped to the iron beams which carry the floor. Where brick casings are used, the heaters are supported upon pieces of pipe or light I-beams built into the walls.

Dampers. The general arrangement of a galvanized iron casing and mixing damper is

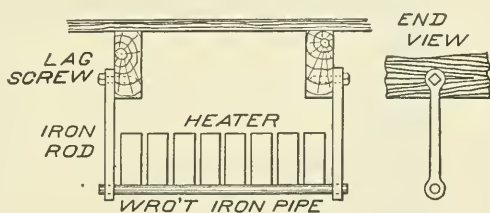

Fig. 6.

shown in Fig. 7. The cold-air duct is brought along the basement ceiling from the inlet window and connects with the cold-air chamber beneath the heater. The entering air passes up between the sections and rises through the register above, as shown by the arrows. When the mixing damper is in its lowest position all air reaching the register must pass through the heater, but if the damper is raised to the position shown, part of the air will pass by without going through the heater and the mixture entering through the register will be at a lower temperature than before. By changing the position of the damper the proportions of warm and cold air delivered to the

room can be varied, thus regulating the temperature without diminishing, to any great extent, the quantity of air delivered. The objection to this form of damper is that there is a tendency

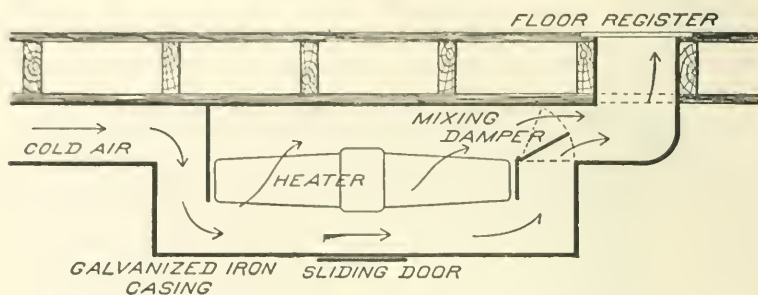

Fig. 7.

for the air to enter the room before it is thoroughly mixed, that is, a stream of warm air will rise through one half of the register while cold air enters through the other. This is especially true if

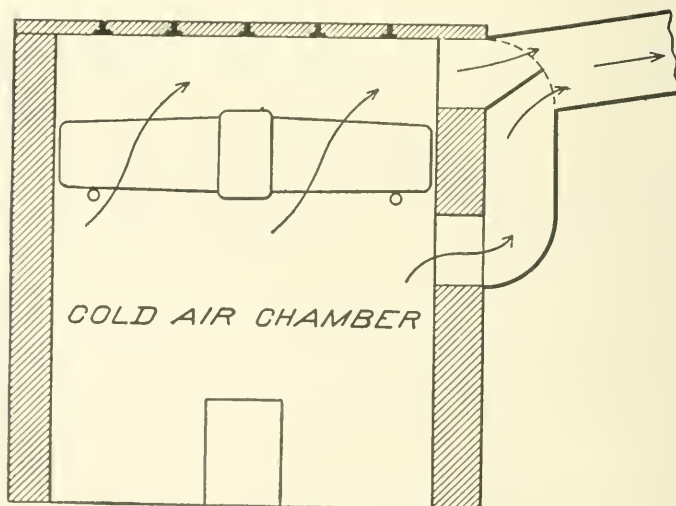

Fig. 8.

the connection between the damper and register is short. Fig. 8 shows a similar heater and mixing damper, with brick casing. Cold air is admitted to the large chamber below the heater and

rises through the sections to the register as before. The action of the mixing damper is the same as already described. Several flues or registers may be connected with a stack of this form, each connection having its own mixing damper.

The arrangement shown in Fig. 9 is somewhat different and overcomes the objection noted in connection with Fig. 7 by sub-

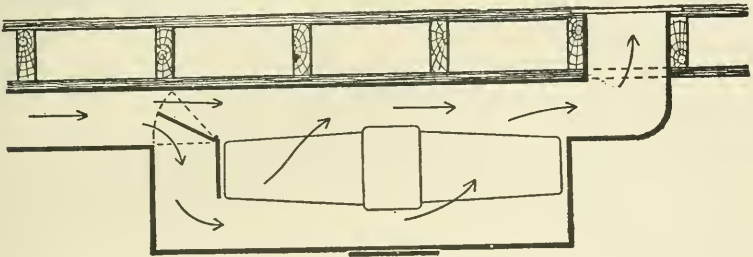

Fig. 9.

stituting another. The mixing damper in this case is placed at the other end of the heater. When it is in its highest position all of the air must pass through the heater before reaching the register, but when partially lowered a part of the air passes over the heater and the result is a mixture of cold and warm air, in proportions depending upon the position of the damper. As the layer of warm air in this case is below the cold air, it tends to rise through it, and a more thorough mixture is obtained than is possible with the damper shown in Fig. 8. One quite serious objection however to this form of damper is illustrated in Fig. 10. When the damper is nearly closed

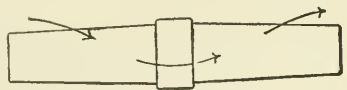

Fig. 10.

so that the greater part of the air enters above the heater, it has a tendency to fall between the sections, as shown by the arrows, and becoming heated rises again, so that it is impossible to deliver air to a room below a certain temperature. This peculiar action increases as the quantity of air admitted below the heater is diminished. When the inlet register is placed in the wall at some distance above the floor, as in schoolhouse work, a thorough mixture of air can be obtained by placing the heater so that the current of warm air will pass up the front of the flue and be discharged into the room through the

lower part of the register. This is shown quite clearly in Fig. 11 where the current of warm air is represented by crooked arrows and the cold air by straight arrows. The two currents pass up the flue separately, but as soon as they are discharged through the register the warm air tends to rise, and the cold air to fall, with the result of a more or less complete mixture as shown.

It is often desirable to warm a room at times when ventilation

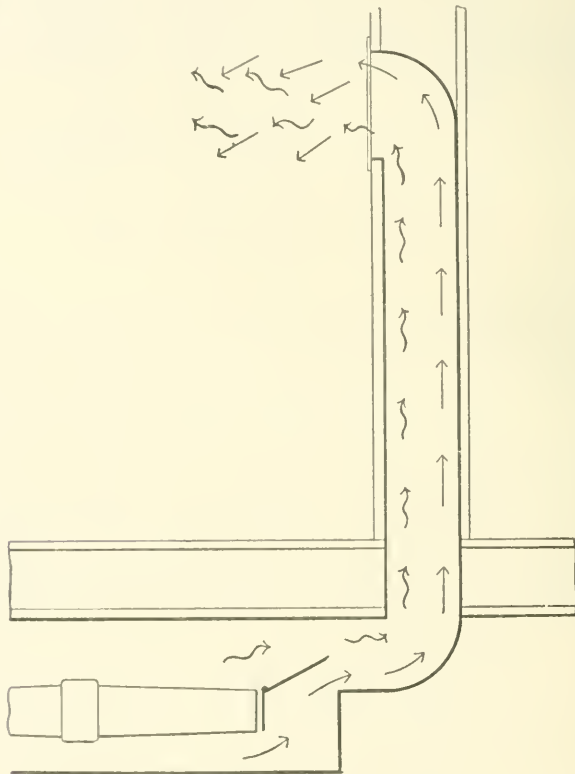

Fig. 11.

is not necessary, as in the case of living rooms during the night, or for quick warming in the morning. A register and damper for air rotation should be provided in this case. Fig. 12 shows an arrangement for this purpose. When the damper is in the position shown, air will be taken from the room above and be warmed over and over, but by raising the damper, the supply will be taken

from outside. Special care should be taken to make all mixing dampers tight against air leakage, else their advantages will be lost. They should work easily and close tightly against flanges covered with felt. They may be operated from the rooms above by means of chains passing over guide pulleys; special attachments should be provided for holding in any desired position.

Size of Heaters. The efficiency of an indirect heater depends upon its form, the difference in temperature between the steam and the surrounding air, and the velocity with which the air passes over the heater. Under ordinary conditions in dwelling-house work, a good form of indirect radiator will give off about 2 B. T. U. per square foot per hour for each degree difference in temperature. Assuming a steam pressure of 2 pounds and an outside temperature of zero we should have a difference in tem-

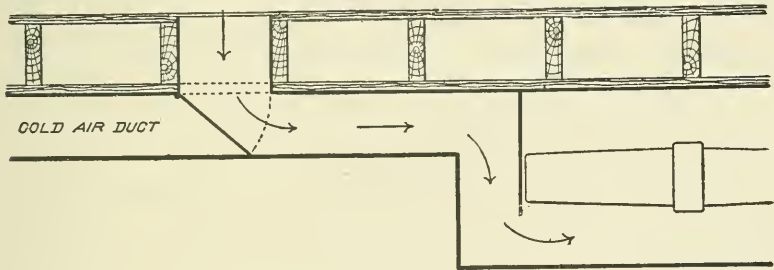

Fig. 12.

perature of about 220 degrees, which under the conditions stated would give an efficiency of $220 \times 2 = 440$ B. T. U. per hour for each square foot of radiation. By making a similar computation for 10 degrees below zero we find the efficiency to be 460. In the same manner we may calculate the efficiency for varying conditions of steam pressure and outside temperature. In the case of schoolhouses and similar buildings where large volumes of air are warmed to a moderate temperature, a somewhat higher efficiency is obtained due to the increased velocity of the air over the heaters. Where efficiencies of 440 and 460 are used for dwellings, we may substitute 600 and 620 for school-houses. This corresponds approximately to 2.7 B. T. U. per square foot per hour for a difference of 1 degree between the air and steam.

The principles involved in indirect steam heating are similar

to those already described in furnace heating. Part of the heat given off by the radiator must be used in warming up the air supply to the temperature of the room, and part for offsetting the loss by conduction through walls and windows. The method of computing the heating surface required, depends upon the volume of air to be supplied to the room. In the case of a schoolroom or hall, where the air quantity is large as compared with the exposed wall and window surface we should proceed as follows:

First compute the B. T. U. required for loss by conduction through walls and windows, and to this add the B. T. U. required for the necessary ventilation, and divide the sum by the efficiency of the radiators. An example will make this clear.

How many square feet of indirect radiation will be required to warm and ventilate a schoolroom in zero weather, where the heat loss by conduction through walls and windows is 36000 B. T. U. and the air supply is 100,000 cubic feet per hour? By the methods given under "Heat for Ventilation" we have

$$\frac{100,000 \times 70}{55} = 127,272 =$$

B. T. U. required for ventilation.

$36,000 + 127,272 = 163,272$ B. T. U. = the total heat required, and this in turn divided by 600 (the efficiency of indirect radiators under these conditions) gives 272 square feet of surface required.

In the case of a dwelling-house the conditions are somewhat changed, for a room having a comparatively large exposure will perhaps have only 2 or 3 occupants, so that if the small air quantity necessary in this case was used to convey the required amount of heat to the room, it would have to be raised to an excessively high temperature. It has been found by experience that the radiating surface necessary for indirect heating is about 50 per cent greater than that required for direct heating. So for this work we may compute the surface required for direct radiation and multiply the result by 1.5.

Buildings like hospitals are in a class between dwellings and school houses. The air supply is based on the number of occupants, as in schools, but other conditions conform more nearly to dwelling houses.

To obtain the radiating surface for buildings of this class, we compute the total heat required for warming and ventilation as in the case of schoolhouses, and divide this sum by the efficiencies given for dwellings, that is 440 for zero weather and 460 for 10 degrees below.

Example. A hospital ward requires 50,000 cubic feet of air per hour for ventilation, and the heat loss by conduction through walls, etc. is 100,000 B. T. U. per hour. How many square feet of indirect radiation will be required to warm the ward in zero weather.

$$(50,000 \times 70) \div 55 = 63,636 \text{ B. T. U. for ventilation; then,}$$

$$\frac{63,636 + 100,000}{440} = 372 \text{ + square feet.}$$

EXAMPLES FOR PRACTICE.

1. A school room having 40 pupils is to be warmed and ventilated when it is 10 degrees below zero. If the heat loss by conduction is 30,000 B. T. U. per hour and the air supply is to be 40 cubic feet per minute per pupil, how many square feet of indirect radiation will be required? Ans. 273.

2. A contagious ward in a hospital has 10 beds, requiring 6,000 cubic feet of air each, per hour. The heat loss by conduction in zero weather is 80,000 B. T. U. How many square feet of indirect radiation will be required? Ans. 355.

3. The heat loss from a sitting room is 11,250 B. T. U. per hour in zero weather. How many square feet of indirect radiation will be required to warm it? Ans. 75.

Warm-Air Flues. The required size of the warm-air flue between the heater and the register, depends first upon the difference in temperature between the air in the flue and that of the room, and second, upon the height of the flue. In dwellings, hospitals, etc., where the conditions are practically constant, it is customary to allow 2 square inches area for each square foot of radiation when the room is on the first floor, and $1\frac{1}{2}$ square inches when it is on the second floor.

In schoolhouse work it is more usual to calculate the size of flue from an assumed velocity of air flow through it. This will vary greatly according to the outside temperature and the prevailing

wind conditions. The following figures may be taken as average velocities obtained in practice, and may be used as a basis for calculating the required flue areas for the different stories of a school building.

1st floor	280	feet	per	minute.
2nd "	340	"	"	"
3rd "	400	"	"	"

These velocities will be increased somewhat in windy weather and will be reduced when the atmosphere is damp.

Having assumed these velocities, and knowing the number of cubic feet of air to be delivered to the room per minute, we have only to divide this quantity by the assumed velocity, to obtain the required flue area in square feet.

Example — A schoolroom on the second floor is to have an air supply of 2,000 cubic feet per minute; what will be the required flue area?

$$2000 \div 340 = 5.8 + \text{sq. feet Ans.}$$

The velocities would be higher in the coldest weather and dampers should be placed in the flues for throttling the air supply when necessary.

Cold-Air Ducts. The cold-air ducts supplying heaters should be planned in a similar manner to that described for furnace heating. The air inlet should be on the north or west side of the building, but this of course is not always possible. The method of having a large trunk line or duct with inlets on two or more sides of the building should be carried out when possible. A cold-air room with large inlet windows, and ducts connecting with the heaters make a good arrangement for schoolhouse work. The inlet windows in this case should be provided with check valves to prevent any outward flow of air. A detail of this arrangement is shown in Fig. 13.

This consists of a boxing around the window, extending from the floor to the ceiling. The front is sloped as shown and is closed from the ceiling to a point below the bottom of the window. The remainder is open and covered with a wire netting of about $\frac{1}{2}$ inch mesh; to this are fastened flaps or cheeks of gossamer cloth about 6 inches in width. These are hemmed on both edges and a stout wire is run through the upper hem which is fastened

to the netting by means of small copper or soft iron wire. The checks allow the air to flow inward but close when there is any tendency for the current to reverse.

The area of the cold-air duct for any heater should be about three-fourths the total area of the warm air ducts leading from it.

A common rule for dwelling houses and similar work is to allow $1\frac{1}{2}$ square inches of area for each square foot of radiating surface. The inlet windows should be provided with some form of damper or slide, outside of which should be placed a wire grating, backed by a netting of about $\frac{3}{8}$ inch mesh.

Vent Flues. In dwelling houses vent flues are often omitted and the frequent opening of doors and leakage are depended upon to carry away the impure air. A well designed system of warming should provide some means

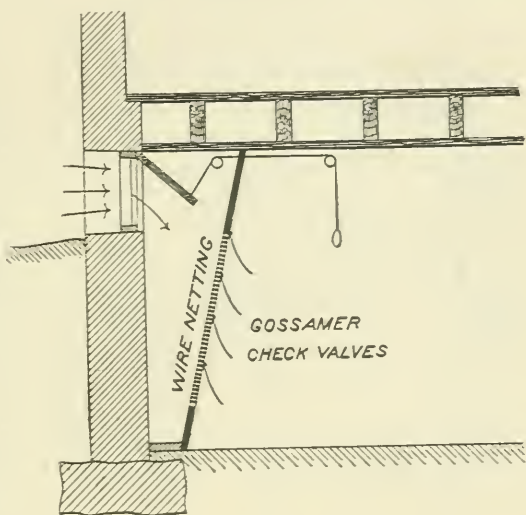

Fig. 13.

for discharge ventilation, especially for bath and toilet rooms, and also for living rooms where lights are burned in the evening. The sizes of flues may be made the reverse of the warm-air flues, that is, $1\frac{1}{2}$ square inches area per square foot of indirect radiation for rooms on the first floor and 2 square inches for those on the second. This is because the velocity of flow will depend upon the height of flue and will therefore be greater from the first floor. The flues should be joined together in the attic and then carried through the roof where a ventilating hood should be provided, especially designed to keep out the rain and snow. A good form is shown in Fig. 14.

Very good results may be obtained by simply letting the flues open into an unfinished attic and depending upon leakage through

the roof to carry away the foul air. The flow of air through the vents will be slow at best unless some means is provided for warming the air in the flue to a temperature above that of the room with which it connects. This may be done by carrying up a loop of steam pipe inside of the flue. It should be connected for drainage and air venting as shown in Fig. 15.

For schoolhouse work we may assume average velocities through the vent flues as follows :

1st floor	340	feet	per	min.
2nd "	280	"	"	"
3rd "	220	"	"	"

Where flue sizes are based on these velocities it is well to guard against down drafts by placing an aspirating coil in the flue. A single row of pipes across the flue as shown in Fig. 16 is usually sufficient for this purpose. The slant height of the heater should be about twice the depth of the flue so that the area between the pipes shall equal the free area of the flue.

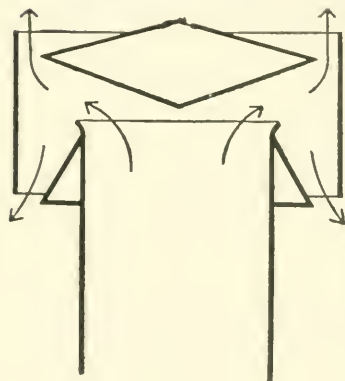

Fig. 14.

Large vent flues of this kind should always be provided with dampers for closing at night and for regulation during strong winds.

Sometimes it is desired to move a given quantity of air through a flue which is already in place.

Table I shows what velocities may be obtained through flues of different heights for varying differences in temperature between the outside air and that in the flue.

Example. — It is desired to discharge 1300 cubic feet of air per minute through a flue having an area of 4 square feet and a height of 30 feet. If the efficiency of an aspirating coil is 400 B. T. U. how many square feet of surface will be required to move this amount of air when the temperature of the room is 70° and the outside temperature is 60° ?

$1300 \div 4 = 325$ feet per minute = velocity through the flue. Looking in table I and following along the line oppo-

site a 30-foot flue we find that to obtain this velocity there must be a difference of 30 degrees between the air in the flue and the external air. If the outside temperature is 60 degrees then the air in the flue must be raised to $60 + 30 = 90$ degrees. The air

TABLE I.

Height of Flue in Feet.	Excess of Temperature of Air in Flue above that of External Air.					
	5°	10°	15°	20°	30°	50°
5	55	76	94	109	134	167
10	77	108	133	153	188	242
15	94	133	162	188	230	297
20	108	153	188	217	265	342
25	121	171	210	242	297	383
30	133	188	230	265	325	419
35	143	203	248	286	351	453
40	153	217	265	306	375	484
45	162	230	282	325	398	514
50	171	242	297	342	419	541
60	188	264	325	373	461	594

of the room being at 70 degrees, a rise of 20 degrees is necessary, so the problem resolves itself into the following — What amount of heating surface, having an efficiency of 400 B. T. U. is neces-

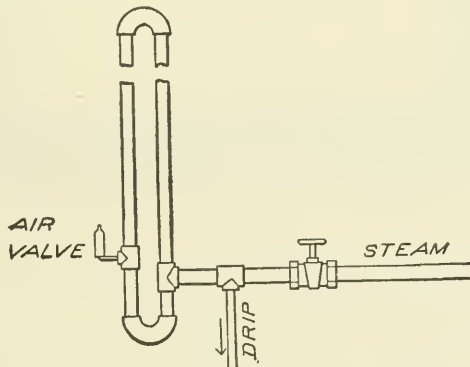

Fig. 15.

sary to raise 1300 cubic feet of air per minute through 20 degrees?
 1300 cubic feet per minute = $1300 \times 60 = 78,000$ per hour,

and making use of our formula for "heat for ventilation," we have

$$\frac{78,000 \times 20}{55} = 28,363 \text{ B. T. U.},$$

and this divided by 400 = 71 square feet of heating surface required.

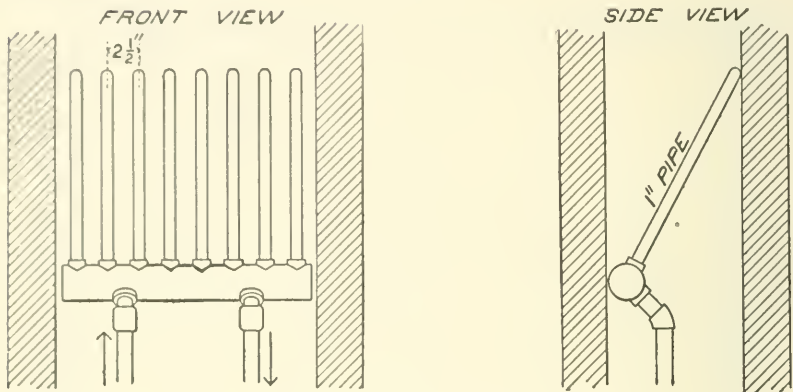

Fig. 16.

EXAMPLES FOR PRACTICE.

1. A school room on the 3d floor has 50 pupils which are to be furnished with 30 cubic feet of air per minute each. What will be the required areas in square feet of the supply and vent flues?
 Ans. Supply 3.7 +. Vent 6.8 +.

2. What size of heater will be required in a vent flue 40 feet high and with an area of 5 square feet, to enable it to discharge 1530 cubic feet per minute, when the outside temperature is 60°? (Assume an efficiency of 400 B. T. U. for the heater.)
 Ans. 41.7 square feet.

Registers. Registers are made of cast iron and bronze, in a great variety of sizes and patterns. The universal finish for cast iron is black "Japan"; they are also finished in colors and electroplated with copper and nickel. Fig. 17 shows a section through a floor register in which "A" represents the valves, which may be turned in a vertical or horizontal position, thus opening or closing the register; "B" is the iron border, "C" the register box of tin or galvanized iron and "D" the warm-air pipe. Floor registers

are usually set in cast iron borders, one of which is shown in Fig. 18, while wall registers may be screwed directly to wooden borders or frames to correspond with the finish of the room. Wall registers should be provided with pull cords for opening and closing from the floor; these are shown in Fig. 19. The plain lattice pattern shown in Fig. 20 is the best for schoolhouse work as it has a comparatively free opening for air flow and is pleasing and simple in design. More elaborate patterns are used for fine dwelling-house work. Registers with shut-off valves are used for air inlets while the plain register faces without the valves are placed in the vent openings. The vent flues are usually

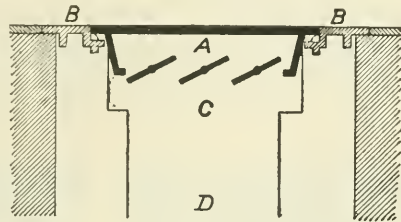

Fig. 17.

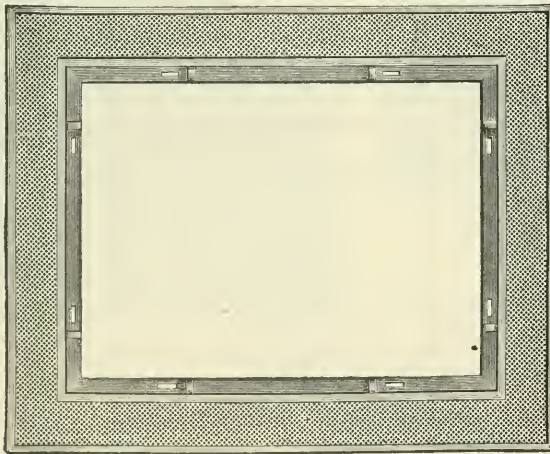

Fig. 18.

gathered together in the attic and a single damper may be used to shut off the whole number at once. Flat or round wire gratings of open pattern are often used in place of register faces. The grill or solid part of a register face usually takes up about $\frac{1}{3}$ of the area, hence in computing the size we must allow for this by multiplying the required "net area" by 1.5 to obtain the "total" or "over all" area.

For example, suppose we have a flue 10 inches in width and

wish to use a register having a free area of 200 square inches, what will be the required height of the register? $200 \times 1.5 = 300$ square inches which is the total area required, then $300 \div 10 = 30$, which is the required height and we should use a $10'' \times 30''$ register. When a register is spoken of as a $10'' \times 30''$ or $10'' \times 20''$, etc. the dimensions of the latticed opening is meant, and not the outside dimensions of the whole register. The free opening should have the same area as the flue with which it

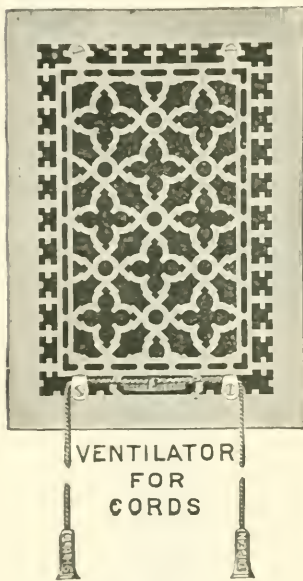

Fig. 19.

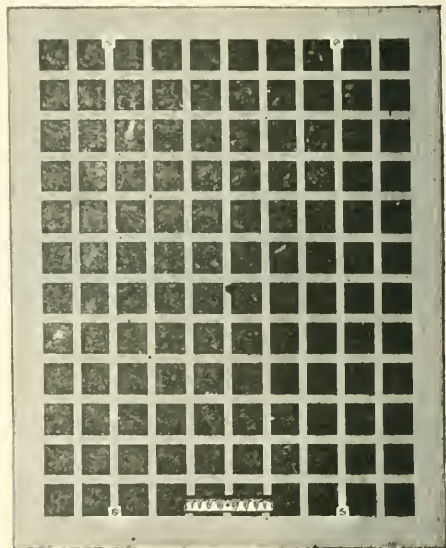

Fig. 20.

connects. In designing new work one should provide himself with a trade catalogue, and use only standard sizes as special patterns and sizes are costly. Fig. 21 shows the method of placing gossamer check valves back of the vent register faces to prevent down drafts, the same as described for fresh-air inlets.

Pipe Connections. The two-pipe system with dry or sealed returns is used in indirect heating. The conditions to be met are practically the same as in direct heating, the only difference being that the radiators are at the basement ceiling instead of on the floors above. The exact method of making the pipe connections will depend somewhat upon existing conditions, but the

general method shown in Fig. 22 may be used as a guide with modifications to suit any special case. The ends of all supply mains should be dripped, and the horizontal returns should be sealed if possible.

Pipe Sizes. The tables already given for the proportioning of pipe sizes can be used for indirect systems. The following table has been computed for an efficiency of 640 B. T. U. per square foot of surface per hour, which corresponds to a condensa-

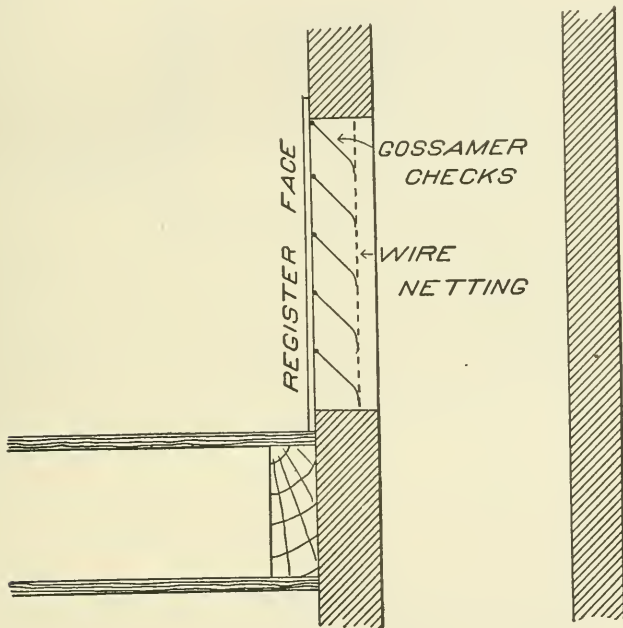

Fig. 21.

tion of $\frac{2}{3}$ of a pound of steam. This is twice that allowed for direct radiation in table XIII. of Part I., so that we can consider 1 square foot of indirect surface as equal to 2 of direct in computing pipe sizes.

As the indirect heaters are placed in the basement, care must be taken that the bottom of the radiator does not come too near the water line of the boiler, or the condensation will not flow back properly; this distance should not be less than 2 feet under ordinary conditions. If much less than this, the pipes should be made extra large so there may be little or no drop in pressure

between the boiler and the heater. A drop in pressure of 1 pound would raise the water line at the heater 2.4 feet.

Direct-Indirect Heating. The general form of a direct-indirect radiator has been shown in Figs. 10 and 11 of Part I. Another form where the air is admitted to the radiator through the wall instead of the floor is shown in Fig. 23. Fig. 24 shows the wall

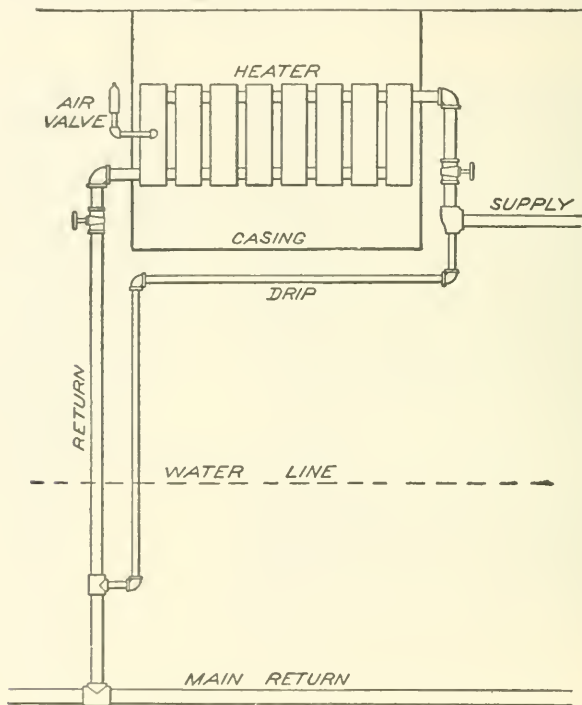

Fig. 22.

box with louvre slats, and netting, through which the air is drawn. A damper door is placed at either end of the radiator base, and if desired, when the cold air supply is shut off by means of the register in the air duct, the radiator can be converted into the ordinary type by opening both damper doors, thus taking the air from the room instead of from the outside. It is customary to increase the size of a direct-indirect radiator 30 per cent. above that called for in the case of direct heating.

TABLE II.

Size of Pipe.	Square Feet of Indirect Radiation which will be Supplied with		
	$\frac{3}{4}$ Pound Drop in 200 Feet.	$\frac{1}{2}$ Pound Drop in 100 Feet.	$\frac{3}{4}$ Pound Drop in 100 Feet.
1	28	40	57
1 $\frac{1}{4}$	51	72	105
1 $\frac{1}{2}$	67	95	170
2	185	262	375
2 $\frac{1}{2}$	335	475	675
3	540	775	1105
3 $\frac{1}{2}$	812	1160	1645
4	1140	1625	2310
5	2030	2900	4110
6	3260	4660	6600
7	4830	6900	9810
8	6800	9720	13860

CARE AND MANAGEMENT OF STEAM HEATING BOILERS.

Special directions are usually supplied by the maker for each kind of boiler, or for those which are to be managed in any peculiar way. The following general directions apply to all makes, and may be used regardless of the type of boiler employed.

Before starting the fire see that the boiler contains sufficient water. The water line should be at about the center of the gage glass.

The smoke pipe and chimney flue should be clean and the draft good.

Build the fire in the usual way, using a quality of coal which is best adapted to the heater. In operating the fire keep the fire-pot full of coal and shake down and remove all ashes and cinders as often as the state of the fire requires it.

Hot ashes or cinders must not be allowed to remain in the ash pit under the grate bars but must be removed at regular intervals to prevent burning out the grate.

To control the fire see that the damper regulator is properly attached to the draft doors, and the damper; then regulate the draft by weighting the automatic lever as may be required to

obtain the necessary steam pressure for warming. Should the water in the boiler escape by means of a broken gage glass, or from any other cause, the fire should be dumped, and the boiler allowed to cool before adding cold water.

An empty boiler should never be filled when hot. If the water gets low at any time, but still shows in the gage glass, more water should be added by the means provided for this purpose.

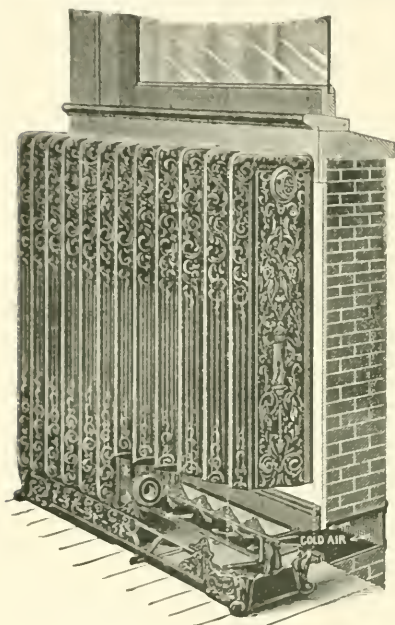

Fig. 23.

The safety valve should be lifted occasionally to see that it is in working order.

If the boiler is used in connection with a gravity system it should be cleaned each year by filling with pure water and emptying through the blow-off. If it should become foul or dirty it can be thoroughly cleansed by adding a few pounds of caustic soda and allowing it to stand for a day and then emptying and thoroughly rinsing.

During the summer months it is recommended that the water be drawn off from the system, and that air valves and safety valves be opened to permit the heater to dry out and to remain so.

Good results are however obtained by filling the heater full of water, driving off the air by boiling slowly, and allowing it to remain in this condition until needed in the fall. The water should then be drawn off and fresh water added.

The heating surface of the boiler should be kept clean and free from ashes and soot by means of a brush made especially for this purpose.

Should any of the rooms fail to heat, examine the steam valves at the radiators. If a two-pipe system both valves at

each radiator must be opened or closed at the same time as required. See that the air valves are in working condition.

If the building is to be unoccupied in cold weather draw all the water out of the system by opening the blow-off pipe at the boiler and all steam and air valves at the radiators.

HOT WATER HEATERS.

Types. Hot water heaters differ from steam boilers principally in the omission of the reservoir or space for steam above the heating surface. The steam boiler might answer as a heater for hot water, but the large capacity left for the steam would tend to make its operation slow and rather unsatisfactory, although the

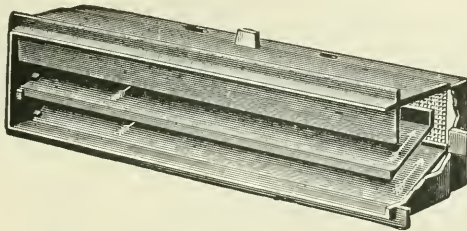

Fig. 24.

same type of boiler is sometimes used for both steam and hot water. The passages in a hot water heater need not extend so directly from bottom to top as in a steam boiler, since the problem of providing for the free liberation of the steam bubbles does not have to be considered. In general, the heat from the furnace should strike the surfaces in such a manner as to increase the natural circulation; this may be accomplished to a certain extent by arranging the heating surface so that a large proportion of the direct heat will be absorbed near the top of the heater. Practically the boilers for low-pressure steam and for hot water differ from each other very little as to the character of the heating-surface, so that the methods already given for computing the size of grate surface, horsepower, etc., under the head of steam boilers can be used with satisfactory results in the case of hot water heaters. It is sometimes stated that owing to the greater difference in temperature between the furnace gases and the water in a hot water heater, as compared with steam, that the heating surface will be more efficient and that a smaller heater can be used;

while this is true to a certain extent different authorities agree that this advantage is so small that no account should be taken of it, and the general proportions of the heater should be calculated in the same manner as for steam. Fig. 25 shows a form of hot-water heater made up of slabs or sections similar to the sectional steam boiler shown in Part I; the size can be increased in the same way by adding more slabs. A different form is shown in Fig. 26. This is made of cast iron but is not a sectional boiler.

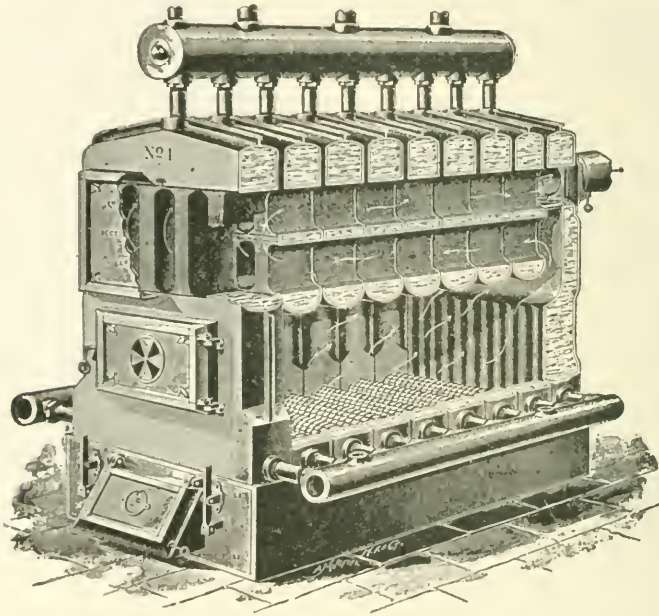

Fig. 25.

It has no horizontal flues for the ashes and soot to collect in and a greater part of the heating surface is directly exposed to the hottest part of the fire. Fig. 27 shows another form of heater similar in principle to the one just described. The space between the outer and inner shells surrounding the furnace is filled with water and also the cross pipes directly over the fire and the drum at the top. The supply to the radiators is taken off from the top of the heater and the return connects at the lowest point.

The ordinary horizontal and vertical tubular boilers with various modifications are used to quite an extent for hot water

heating and are well adapted to this class of work, especially in the case of large buildings.

Automatic regulators are often used for the purpose of main-

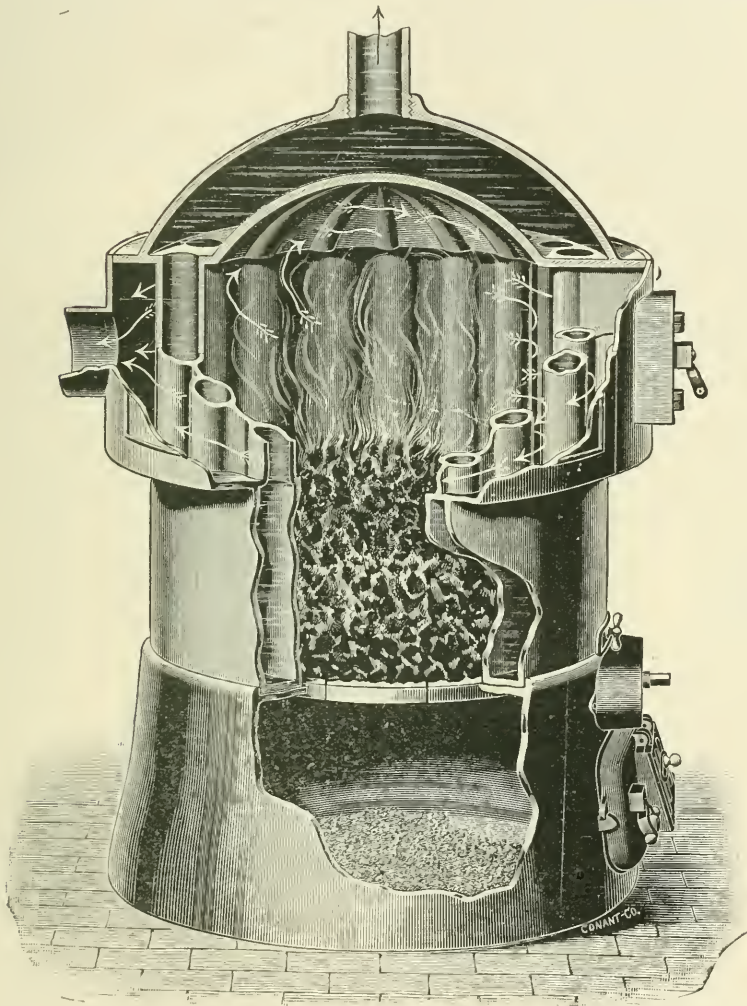

Fig. 26.

taining a constant temperature of the water. They are constructed in different ways — some depend upon the expansion of a metal pipe or rod at different temperatures, and others upon the vapor-

ization and consequent pressure of certain volatile liquids. These means are usually employed to open small valves which admit water pressure under rubber diaphragms, and these in turn are connected by means of chains with the draft doors of the furnace, and so regulate the draft as required to maintain an even temperature of the water in the heater. Fig. 28 shows one of the first kind. "A" is a metal rod placed in the flow pipe from the heater, and is so connected with the valve "B" that when the water

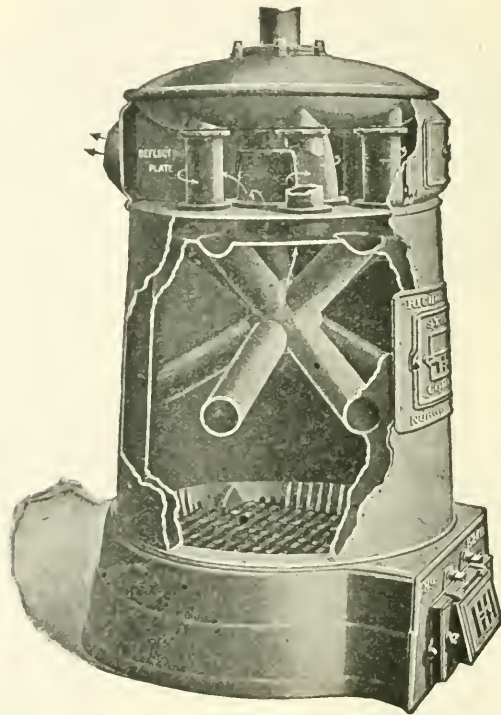

Fig. 27.

reaches a certain temperature the expansion of the rod opens the valve and admits water from the street pressure through the pipes "C" and "D" into the chamber "E." The bottom of "E" consists of a rubber diaphragm which is forced down by the water pressure and carries with it the lever which operates the dampers as shown, and checks the fire. When the temperature of the water drops, the rod contracts and valve "B" closes, shutting off the

pressure from the chamber "E." A spring is provided to throw the lever back to its original position and the water above the diaphragm is forced out through the pet cock "G" which is kept slightly open all of the time.

DIRECT HOT WATER HEATING.

A hot water system is similar in construction and operation to one designed for steam, except the *hot water* flows through the pipes, giving up its heat by conduction to the coils and radiators, which in turn transfer it to the air of the room by conduction and radiation.

The flow through the system is produced solely by the difference in weight of the water in the supply and return pipes, due to the difference in temperature. When water is heated it expands, and thus a given volume becomes lighter and tends to rise, and the cooler water flows in to take its place; if the application of heat is kept up the circulation thus produced is continuous. The velocity of flow depends upon the difference in temperature between the supply and return, and the height of radiator above the boiler. The horizontal distance of the radiator from the boiler is also an important factor.

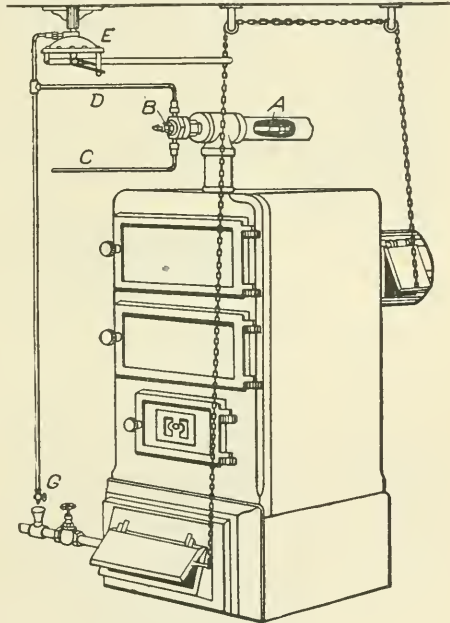

Fig. 28.

Types of Radiating Surface. Cast iron radiators and circulation coils are used for hot water as well as for steam. Hot water radiators differ from steam radiators principally in having a horizontal passage at the top as well as at the bottom. This construction is necessary in order to draw off the air which

gathers at the top of each loop or section. Otherwise they are the same as steam radiators, and are well adapted for the circulation of steam, and in some respects are superior to the ordinary pattern.

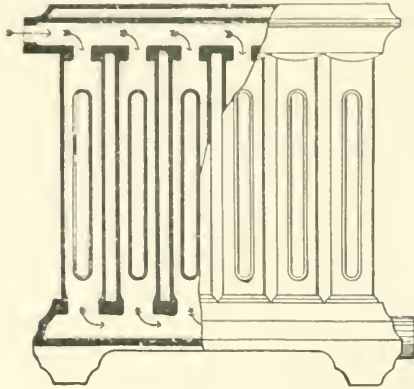

Fig. 29.

The form shown in Fig. 29 is made with an opening at the top for the entrance of water and at the bottom for its discharge, thus insuring a supply of hot water at the top and of colder water at the bottom.

Some hot water radiators are made with a cross-partition so arranged that all water entering passes at once to the top, from which it may take any passage toward the outlet. Fig. 30 is the more common form of radiator, and is made with continuous

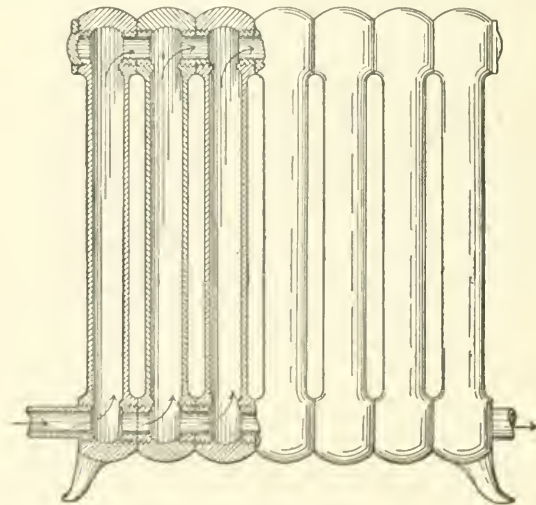

Fig. 30.

passages at top and bottom; the hot water is supplied at one side and drawn off at the other. The action of gravity is depended upon for making the hot and lighter water pass to the

top, and the colder water sink to the bottom and flow off through the return. Hot water radiators are usually tapped and plugged so that the pipe connections can be made either at the top or at the bottom. This is shown in Fig. 31.

Efficiency of Radiators. The efficiency of a hot water radiator depends entirely upon the temperature at which the water is circulated. The best practical results are obtained with the water leaving the boiler at a maximum temperature of about 180 degrees in zero weather and returning at about 160 degrees; this gives an average temperature of 170 in the radiators. Variations may be made however to suit the existing conditions of outside temperature. We have seen that an average cast iron radiator gives off about 1.5 B. T. U. per hour per square foot of surface per degree difference in temperature between the surrounding air and the radiator, when working under ordinary conditions, and this holds true whether filled with steam or water.



Fig. 31.

If we assume an average temperature of 170 degrees for the radiators then the difference will be $170 - 70 = 100$ degrees, and this multiplied by $1.5 = 150$ which may be taken as the efficiency of a hot water radiator under the above conditions, which represent good average practice.

This calls for a water radiator about 1.5 times as large as a steam radiator to heat a given room under the same conditions. This is common practice although some engineers multiply by the factor 1.6 which allows for a lower temperature of the water. Water leaving the boiler at 170 degrees should return at about 150; the drop in temperature should not ordinarily exceed 20 degrees.

System of Piping. A system of hot water heating should produce a perfect circulation of water from the heater to the radiating surface, and thence back to the heater through the returns. The system of piping usually employed for hot water heating is shown in Fig. 32. In this arrangement the main and branches have an inclination upward from the heater; the returns are

parallel to the mains and have an inclination downward toward the heater, and connect with it at the lowest point. The flow pipes or risers are taken from the tops of the mains and may supply one or more radiators as required. The return risers or drops are connected with the return mains in a similar manner. In this system great care must be taken to produce a nearly equal resistance to flow in all of the branches so that each radiator may receive its full supply of water. It will always be found that the principal current of heated water will take the path of least resistance, and that a small obstruction or irregularity in the piping is

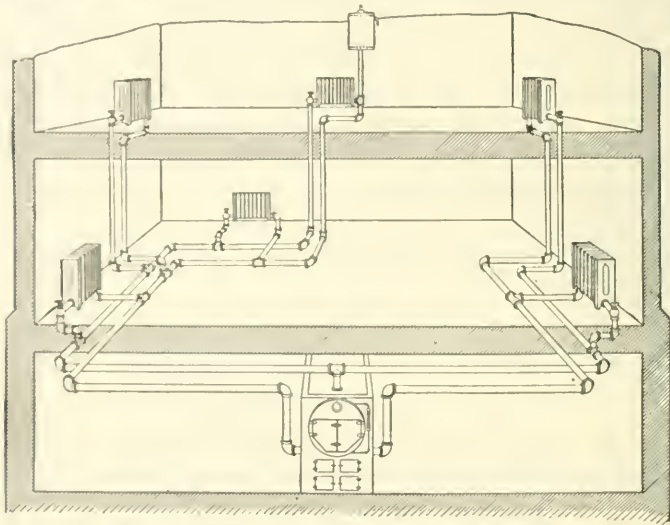

Fig. 32.

sufficient to interfere greatly with the amount of heat received in the different parts of the same system.

Expansion Tank. Every system for hot water heating should be connected with an expansion tank placed at a point somewhat above the highest radiator. The tank must in every case be connected to a line of piping which cannot by any possible means be shut off from the boiler. When water is heated, it expands a certain amount, depending upon the temperature to which it is raised and a tank or reservoir should always be provided to care for this increase in volume.

Expansion tanks are usually made of heavy galvanized iron

of one of the forms shown in Figs. 33 and 34, the latter being used where the head room is limited. The connection from the heating system enters the bottom of the tank and an open vent pipe is taken from the top.

An overflow connected with a sink or drain pipe should be provided. Connections should be made with the water supply both at the boiler and at the expansion tank, the former to be used when first filling the system, as by this means all air is driven from the bottom upward and is discharged through the vent at the expansion tank.

Water that is added afterward may be supplied directly to the expansion tank where the water line can be noted in the gage glass. A ball cock is often arranged to keep the water line in the tank at a constant level.

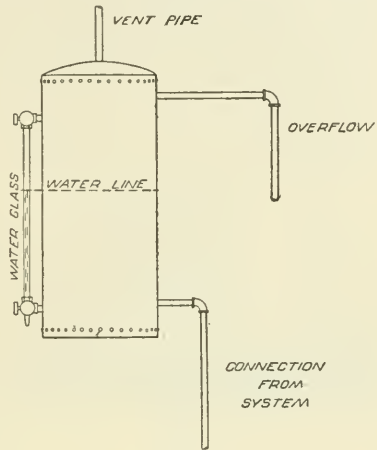

Fig. 33.

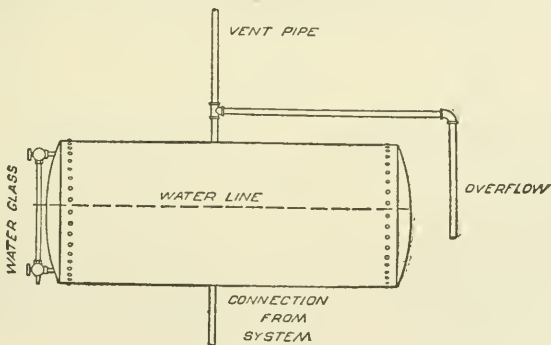

Fig. 34.

The size of the expansion tank depends upon the volume of water contained in the system, and the temperature to which it is heated. The following rule for computing the capacity of the tank may be used with satisfactory results.

The square feet of radiation divided by 40 equals the required capacity of the tank in gallons.

Overhead Distribution. This system of piping is shown in Fig. 35. A single riser is carried directly to the expansion tank, from which branches are taken to supply the various drops to which the radiators are connected. An important advantage in connection with this system is that the air rises at once to the expansion tank and escapes through the vent, so that air valves are not required on the radiators.

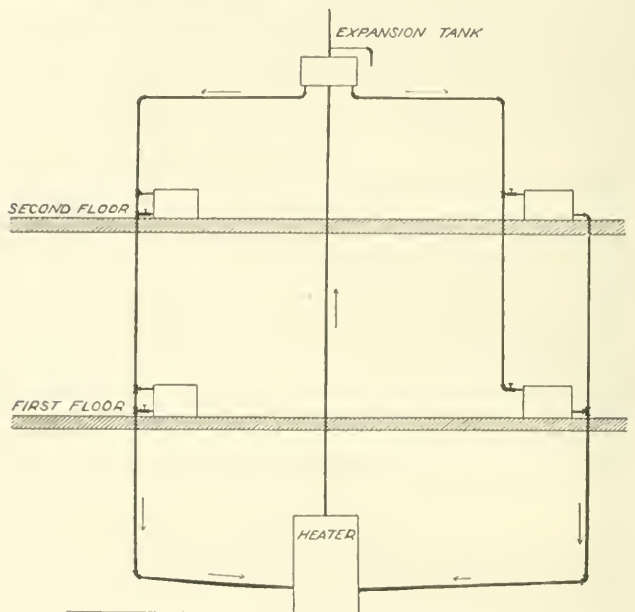

Fig. 35.

Pipe Connections. There are various methods of connecting the radiators with the mains and risers. Fig. 36 shows a radiator connected with the horizontal flow and return mains which are located below the floor. The manner of connecting with a vertical riser and return drop is shown in Fig. 37. As the water tends to flow to the highest point, the radiators on the lower floors should be favored by making the connection at the top of the riser and taking the pipe for the upper floors from the side as shown. Fig. 38 illustrates the manner of connecting with a radiator on an upper floor where the supply is connected at the top of the radiator.

The connections shown in Figs. 39 and 40 are used with the overhead system shown in Fig. 35.

Where the connection is of the form shown at the left in Fig. 35, the cooler water from the radiators is discharged into the supply pipe again so that the water furnished to the radiators on

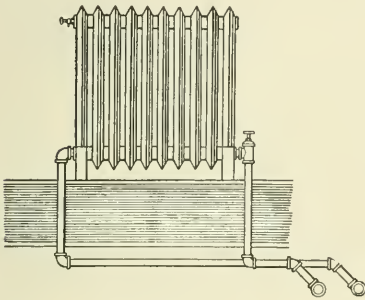

Fig. 36.

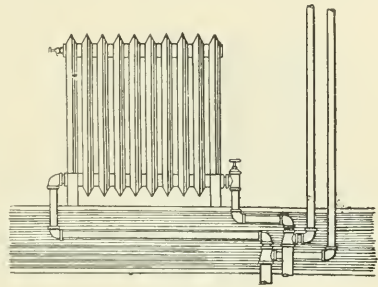

Fig. 37.

the lower floors is at a lower temperature, and the amount of heating surface must be correspondingly increased to make up for this loss.

For example.—If in the case of Fig. 35 we assume the water to leave the heater at 180 degrees and return at 160 we

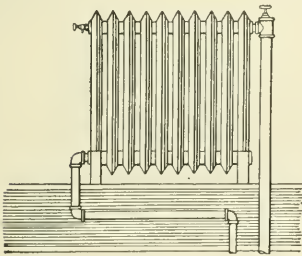

Fig. 38.

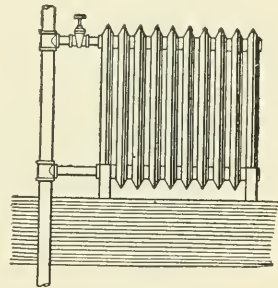

Fig. 39.

shall have a drop in temperature of 10 degrees on each floor, that is, the water will enter the radiator on the second floor at 180 degrees and leave it at 170 and will enter the radiator on the first floor at 170 and leave it at 160. The average temperatures will be 175 and 165 respectively. The efficiency in the first

case will be $175 - 70 = 105$ and $105 \times 1.5 = 157$. In the second case $165 - 70 = 95$ and $95 \times 1.5 = 142$, so that the radiator on the first floor will have to be larger than that on the second floor in the ratio of 157 to 142, in order to do the same work.

Where the radiators discharge into a separate return as in the case of Fig. 32 or those at the right in Fig. 35, we may assume

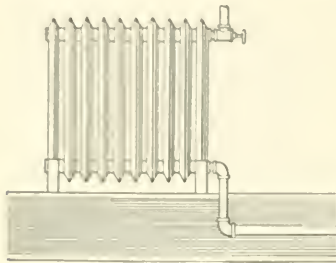

Fig. 40.

the temperature of the water to be the same on all floors and give the radiators an equal efficiency.

In a dwelling house of two stories no difference would be made in the sizes of radiators on the two floors, but in the case of a tall office building corrections would necessarily be made as described.

Where circulation coils are used they should be of a form which will tend to produce a flow of water through them. Figs. 41, 42 and 43 show different ways of making up and connecting these coils. In Figs. 41 and 43 the supply pipes may be either drops or risers, and in the latter

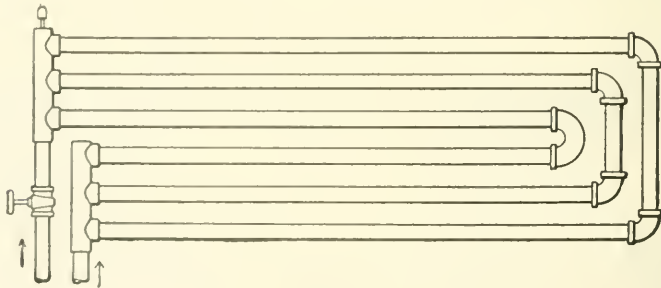

Fig. 41.

case the return in Fig. 43 may be carried back if desired into the supply drop as shown by the dotted lines.

Combination Systems. Sometimes the boiler and piping are arranged for either steam or hot water, since the demand for a higher or lower temperature of the radiators might change.

The object of this arrangement is to secure the advantages

of a hot water system for moderate temperatures, and of steam heating for extremely cold weather.

As less radiating surface is required for steam heating, there is an advantage due to the reduction in first cost. This is of con-

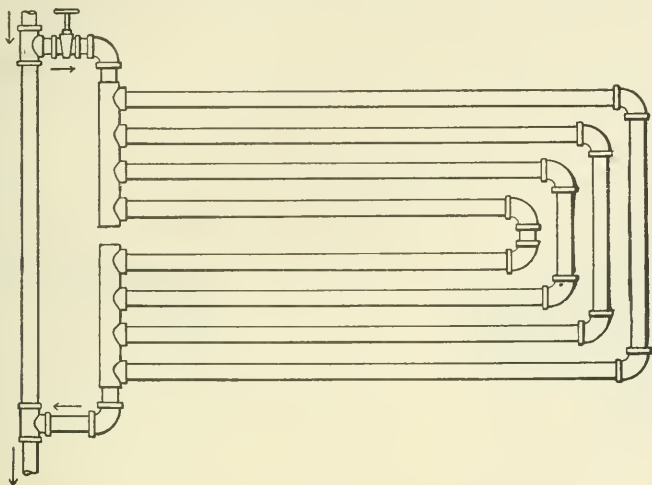

Fig. 42.

siderable importance, as a heating system must be designed of such dimensions as to be capable of warming a building in the

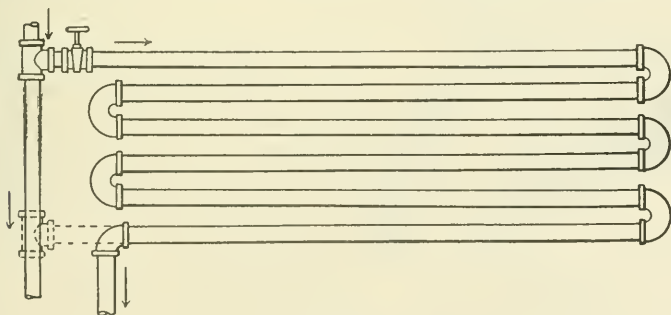

Fig. 43.

coldest weather, and this involves the expenditure of a considerable amount for radiating surfaces, which are needed only at rare intervals. A combination system of hot water and steam heating requires, first, a heater or boiler which will answer for either pur-

pose; second, a system of piping which will permit the circulation of either steam or hot water; and third, the use of radiators which are adapted to both kinds of heating. These requirements will be met by using a steam boiler provided with all the fittings required for steam heating, but so arranged that the damper regulator may

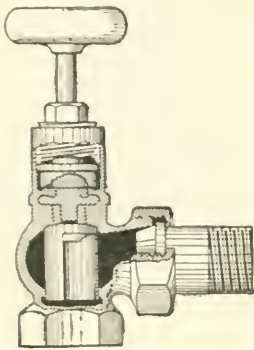

Fig. 44.

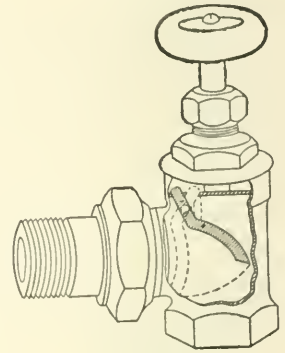

Fig. 45.

be closed by means of valves when the system is to be used for hot water heating. The addition of an expansion tank is required, which must be so arranged that it can be shut off when the system is used for steam heating. The system of piping

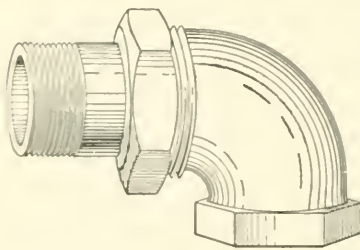

Fig. 46.

shown in Fig. 32 is best adapted for a combination system, although an overhead distribution as shown in Fig. 35 may be used, by shutting off the vent and overflow pipes, and placing air valves on the radiators.

While this system has many advantages in the way of cost over the complete hot water system, yet the labor of changing from steam to hot water will in some cases be troublesome, and should the connections to the expansion tank not be opened, serious results would follow.

Valves and Fittings. Gate valves should always be used in connection with hot water piping, although angle valves may

be used at the radiators. There are several patterns of radiator valves made especially for hot water work; their chief advantage lies in a device for quick closing, usually a quarter or half turn being sufficient to open or close the valve. Two different designs are shown in Figs. 44 and 45.

It is customary to place a valve in only one connection as that is sufficient to stop the flow of water through the radiator; a fitting known as a "union elbow" is often employed in place of the second valve. (See Fig. 46.)

Air Valves. The ordinary pet-cock air valve is the most reliable for hot-water radiators, although there are several forms of automatic valves which are claimed to give satisfaction. One of these is shown in Fig. 47. This is similar in construction to a steam trap. As air collects in the chamber, and the water line is lowered, the float drops, and in so doing opens a small valve at the top of the chamber which allows the air to escape. As the water flows in to take its place the float is forced upward and the valve is closed.

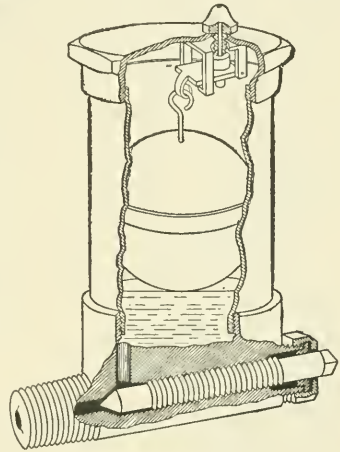

Fig. 47.

All radiators which are supplied by risers from below should be provided with air valves placed in the top of the last section at the return end. If they are supplied by drops from an overhead system the air will be discharged at the expansion tank and air valves will not be necessary at the radiators.

Fittings. All fittings, such as elbows, tees, etc., should be of the "long turn" pattern. If the common form is used, they should be a size larger than the pipe, bushed down to the proper size. The long turn fittings, however, are preferable.

Pipe Sizes. The size of pipe required to supply any given radiator depends upon four conditions; *first* the size of the radiator, *second* its elevation above the boiler, *third* the length of pipe required to connect it with the boiler, and *fourth* the difference in

temperature between the supply and return. The following illustration will serve to make these points clear.

If we should take a glass tube of the form shown in Fig. 48, fill it with water and hold it in a vertical position, we would notice that the water remained perfectly quiet : now if the flame of a lamp were held near the tube A and a few drops of coloring matter were poured into the tube, we would find that the water was in motion, and the current would be in the direction shown by the arrows. While the water in both tubes was at the same temperature, the two columns were of the same weight and remained in equilibrium. If, however, the water in column A is heated, it expands and becomes

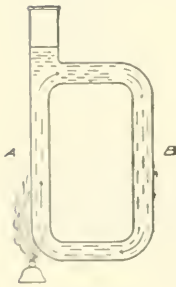

Fig. 48.

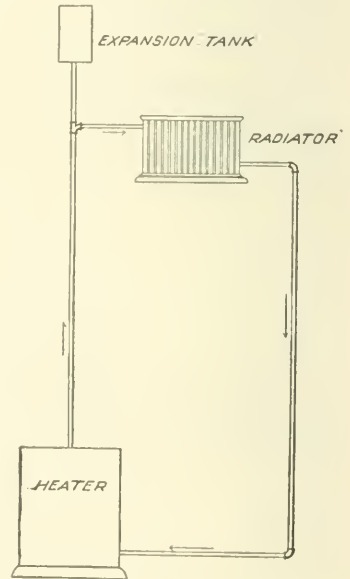

Fig. 49.

lighter than column B, and is forced upward by the heavier water falling toward the bottom of the tube. The heated water flows across the top and into B where it takes the place of the cooler water which is settling to the bottom. As long as there is a difference in the temperature of the two columns this action will continue. If now we replace the lamp by a furnace, and connect the two columns A and B at the top by inserting a radiator, we

shall have the same illustration in practical form as utilized in hot water heating. (See Fig. 49).

The heat given off by the radiator always insures a difference in temperature between the columns of water in the supply and return pipes, so that as long as heat is supplied by the furnace the flow of water will continue. The greater the difference in temperature of the water in the two pipes, the greater the difference in weight, and consequently the faster the flow. The greater the height of the radiator above the heater the more rapid the flow, for the difference in weight between two columns 1 foot high and two columns 10 feet high is ten times as great and if there were no friction in the pipes the flow would be directly proportional to the elevation of the radiator above the heater. The quantity of water discharged by a given pipe under constant pressure varies inversely as the length of pipe; that is, if a pipe 100 feet long will discharge 10 gallons per minute under a given pressure, it will discharge only half as many gallons if the length is increased to 200 feet, the pressure remaining the same.

As it would be a long process to work out the required size of each pipe for a heating system, the following tables have been prepared, covering the usual conditions to be met with in practice.

Table III gives the number of square feet of direct radiation which different sizes of mains will supply for varying lengths of run.

TABLE III.

Size of Pipe.	Square Feet of Radiating Surface.								
	100 ft. Run.	200 ft. Run.	300 ft. Run.	400 ft. Run.	500 ft. Run.	600 ft. Run.	700 ft. Run.	800 ft. Run.	1000 ft. Run.
1	30								
1¼	60	50							
1½	100	75	50						
2	200	150	125	100	75				
2½	350	250	200	175	150	125			
3	550	400	300	275	250	225	200	175	150
3½	850	600	450	400	350	325	300	250	225
4	1200	850	700	600	525	475	450	400	350
5		1400	1150	1000	700	850	775	725	650
6				1600	1400	1300	1200	1150	1000
7							1706	1600	1500

These quantities have been calculated on a basis of 10 feet difference in elevation between the center of the heater and the radiators, and a difference in temperature of 17 degrees between the supply and return.

This table may be used for all horizontal mains. For the vertical risers or drops, table IV may be used. This has been computed for the same difference in temperature, and gives the square feet of surface which different sizes of pipe will supply on the different floors of a building, assuming the height of the stories to be 10 feet. Where a single riser is carried to the top of a building to supply the radiators on the floors below, by drop pipes, we must first get what is called the "average elevation of the system" before taking its size from the table. This may be illustrated by the following diagram, (see Fig. 50).

In A we have a riser carried to the third story and from there a drop brought down to supply a radiator on the first floor. The elevation available for producing a flow in the riser is only 10 feet, the same as though it extended only to the radiator. The water in the two pipes above the radiator is practically at the same temperature and therefore in equilibrium, and has no effect on the flow of the water in the riser. (Actually there would be some radiation from the pipes, and the return, above the radiator, would be slightly cooler, but for purposes of illustration this may be neglected). If the radiator was on the second floor the elevation of the system would be 20 feet (see B), and on the third floor 30 feet, and so on. The distance which the pipe is carried above the first radiator which it supplies has but little effect in producing a flow, especially if covered, as it should be in practice. Having seen that the flow in the main riser depends upon the elevation of the radiators, it is easy to see that the way in which it is distributed on the different floors must be considered. For example, in B, Fig. 50, there will be a more rapid flow through the riser with the radiators as shown than there would be if they were reversed and the larger one were placed upon the first floor.

We get the average elevation of the system by multiplying the square feet of radiation on each floor by the elevation above the heater, then adding these products together and dividing the same

by the total radiation in the whole system. In the case shown in B the average elevation of the system would be

$$\frac{(100 \times 30) + (50 \times 20) + (10 \times 25)}{100 + 50 + 10} = 26 \text{ feet,}$$

and we must proportion the main riser the same as though the

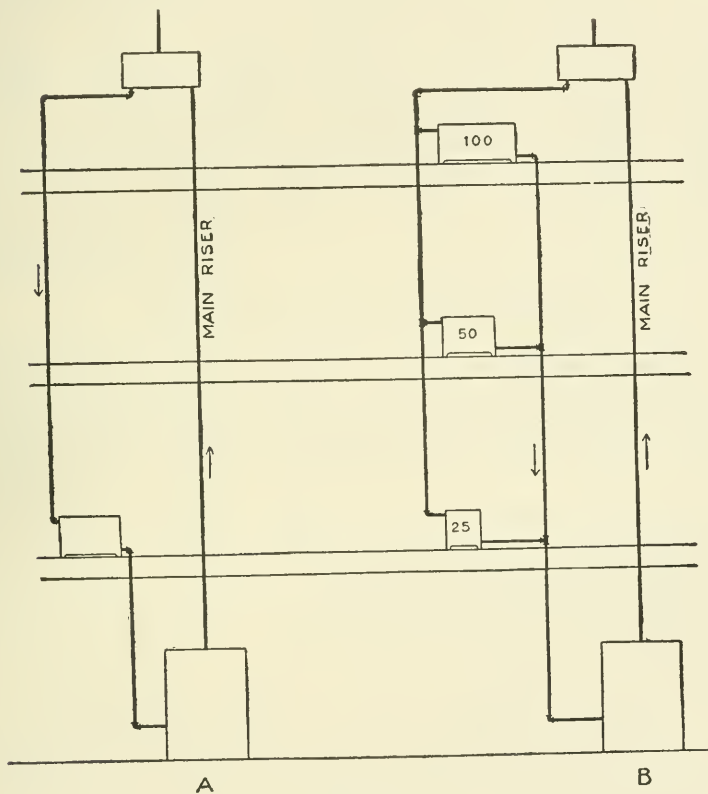

Fig. 50.

whole radiation were on the second floor. Looking in table IV we find for the second story that a $1\frac{1}{2}$ inch pipe will supply 140 square feet and a 2 inch pipe 275. Probably a $1\frac{1}{2}$ inch pipe would be sufficient.

Although the height of the stories varies in different buildings,

10 feet will be found sufficiently accurate for ordinary practice.

TABLE IV.

Size of Riser.	Square Feet of Radiating Surface.					
	1st Story	2d Story	3d Story	4th Story	5th Story	6th Story
1	30	55	65	75	85	95
1 $\frac{1}{4}$	60	90	110	125	140	160
1 $\frac{1}{2}$	100	140	165	185	210	240
2	200	275	375	425	500	
2 $\frac{1}{4}$	350	475				
3	550					
3 $\frac{1}{2}$	850					

INDIRECT HOT WATER HEATING.

Types of Heaters. The heaters for indirect hot water heating are of the same general form as those used for steam. The heaters shown in Figs. 9, 14 and 15 of Part I, are common patterns. The "drum pin," Fig. 14, is an excellent form, as the

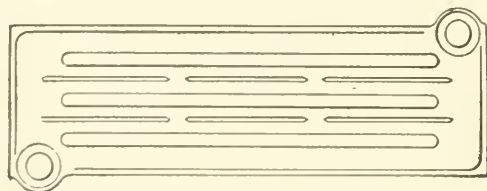

Fig. 51.

method of making the connections insures a uniform distribution of water through the stack.

Fig. 51 shows a section of good form for water circulation, and

also of good depth, which is a necessary point in the design of hot water heaters. They should not be less than 10 or 12 inches for good results. Box coils of the form given for steam may also be used, provided the connections for supply and return are made of good size.

Size of Heaters. As indirect hot water heaters are used principally in the warming of dwelling houses, and in combination with direct radiation, the easiest method is to compute the surfaces required for direct radiation and multiply these results by 1.5 for pin radiators of good depth. For other forms the factor should

vary from 1.5 to 2, depending upon the depth and proportion of free area for air flow between the sections.

If it is desired to calculate the required surface directly by the thermal unit method, we may allow an efficiency of from 360 to 380 for good types in zero weather.

Flues and Casings. For cleanliness, as well as for obtaining the best results, indirect stacks should be hung at one side of the register or flue receiving the warm air, and the cold-air duct should enter beneath the heater at the other side. A space of 10 inches, and preferably 12, should be allowed for the warm air above the stack. The top of the casing should pitch upward toward the warm-air outlet at least an inch in its length. A space of from 6 to 8 inches should be allowed for cold air below the stack.

As the amount of air warmed per square foot of heating surface is less than in the case of steam, we may make the flues somewhat smaller as compared with the size of heater. The following proportions may be used under usual conditions: $1\frac{1}{2}$ square inches per square foot of radiation for the first floor, and $1\frac{1}{4}$ square inches for the second floor, and $1\frac{1}{4}$ square inches for the cold-air duct.

Pipe Connections. In hot water indirect work it is not desirable to supply more than 80 to 100 square feet of radiation from a single connection. When the requirements call for larger stacks they should be divided into two or more groups according to the size.

The branches supplying the stacks should pitch upward from the boiler to a point directly over the stack, then drop and make connection with the heater at such a point as the special form in use requires. An air valve should be placed in the highest point of the pipe just before it drops to the heater. The return should be taken from the bottom of the stack and carried at a lower level back to the boiler or heater.

Conditions may make it necessary to bring back several separate returns to the heater, but it is better practice to use one large flow main and a single return of the same size, branching to the different stacks as necessary.

Pipe Sizes. As the difference in elevation between the

stacks and the heater is necessarily small, the pipes should be of ample size to offset the slow velocity of flow through them. The following sizes for runs up to 100 feet will be found ample for ordinary conditions. Some engineers make a practice of using somewhat smaller pipes, but the larger sizes will in general be found more satisfactory.

TABLE V.

Size of Pipe.	Square feet of Indirect Radiation.
1	15
1 $\frac{1}{4}$	30
1 $\frac{1}{2}$	50
2	100
2 $\frac{1}{2}$	200
3	300
3 $\frac{1}{2}$	400
4	600
5	1000

CARE AND MANAGEMENT OF HOT WATER HEATERS.

The directions given for the care of steam heating boilers apply in a general way to hot water heaters as to the methods of caring for the fires and for cleaning and filling the heater. Only the special points of difference need be considered. Before building the fire all the pipes and radiators must be full of water and the expansion tank should be partially filled as indicated by the gage glass. Should the water in any of the radiators fail to circulate, see that the valves are wide open and that the radiator is free from air. Water must always be added at the expansion tank when for any reason it is drawn from the system.

The required temperature of the water will depend upon the outside conditions and only enough fire should be carried to keep the rooms comfortably warm. Thermometers should be placed in the flow and return pipes near the heater as a guide. Special forms are made for this purpose in which the bulb is immersed in a bath of oil or mercury. See Fig. 52.

EXHAUST STEAM HEATING.

Steam after being used in an engine contains the greater part of its heat, and if not condensed or used for other purposes it can

usually be employed for heating without affecting to any great extent the power of the engine.

The systems of steam heating which have been described are those in which the water of condensation flows back into the boiler by gravity; where exhaust steam is used the pressure is much below that of the boiler and it must be returned either by a pump or return trap. The exhaust steam is often insufficient to supply the entire heating system and must be supplemented by live steam taken directly from the boiler. This must first pass through a reducing valve in order to reduce the pressure to correspond with that carried in the heating system.

The exhaust steam discharged from non-condensing engines contains from 20 to 30 per cent of water, and considerable oil or greasy matter which has been employed for lubrication. When the engine is exhausting into the air, the pressure in the exhaust pipe is but slightly above that due to the atmosphere. The effect of passing exhaust steam through the pipes and radiators of a heating system is likely to increase the back pressure on the engine and reduce its effective work; this must be offset by raising the boiler pressure or increasing the cut-off of the engine.

An engine does not deliver steam continuously but at regular intervals at the end of each stroke and the amount is likely to vary with the work done since the governor is adjusted to admit steam in such a quantity as is required to maintain a uniform speed. If the work is light, very little steam will be admitted to the engine and for this reason the supply available for heating may

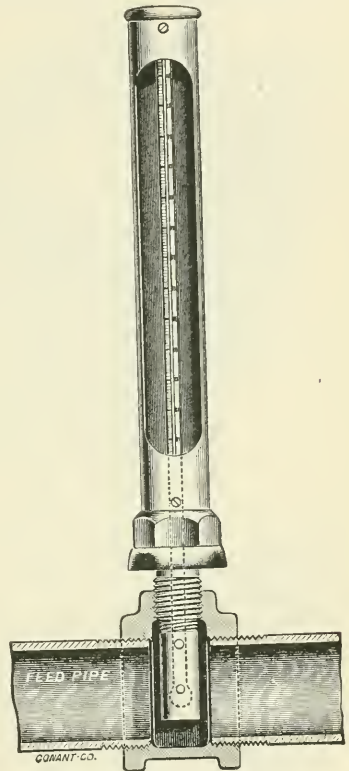

Fig. 52.

vary somewhat depending upon the use made of the power delivered by the engine. In mills the amount of exhaust steam is practically constant; in office buildings where power is used for lighting, the variation is greater, especially if power is also required for the running of elevators.

The general requirements for a successful system of exhaust steam heating include a system of piping of such proportions that only a slight increase in back pressure will be thrown upon the engine; a connection which shall automatically supply live steam at a reduced pressure as needed; provision for removing the oil from the exhaust steam; a relief or back pressure valve

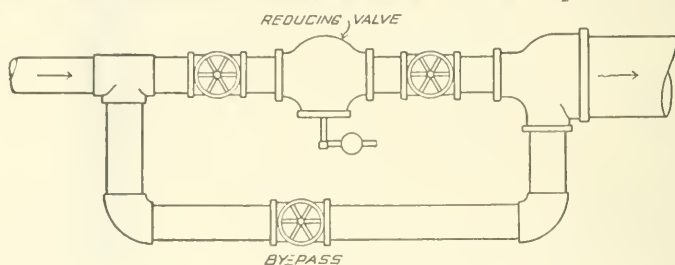

Fig. 53.

arranged to prevent any sudden increase in back pressure on the engine, and a return system of some kind for returning the water of condensation back to the boiler against a higher pressure. These requirements may be met in various ways depending upon actual conditions found in different cases.

To prevent sudden changes in the back pressure due to irregular supply of steam, the exhaust pipe from the engine is often carried to a closed tank having a capacity from 30 to 40 times that of the engine cylinder. This tank may be provided with baffle plates or other arrangements and serve as a separator for removing the oil from the steam as it passes through.

Any system of piping may be used but great care should be taken that as little resistance as possible is introduced at bends and fittings; and the mains and branches should be of ample size. Usually the best results are obtained from the system in which the main steam pipe is carried directly to the top of the building, the distributing pipes run from that point, and the radiating surfaces supplied by a down-flowing current of steam.

Before taking up the matter of piping in detail a few of the more important pieces of apparatus will be described in a brief way.

Reducing Valves. The action of pressure reducing valves has been taken up quite fully in "Boiler Accessories," and need not be repeated here. When the reduction in pressure is large, as in the case of a combined power and heating plant, the valve may be one or two sizes smaller than the low pressure main into which it discharges. For example—a 5-inch valve will supply an 8-inch main, a 4-inch a 6-inch main, a 3-inch a 5-inch main, a 2½-inch a 4-inch main, etc.

For the smaller sizes the difference should not be more than one size. All reducing valves should be provided with a valved by-pass for cutting out the valve in case of repairs. The connection is usually made as shown in plan by Fig. 53.

Grease Extractor. As already stated, when exhaust steam is used for heating purposes, it must first be passed through some form of separator for removing the oil. This is usually effected by introducing a series of baffling plates in the path of the steam; the particles of oil striking these are stopped and thus separated from the steam. The oil drops into a receiver provided for this purpose and is discharged through a trap to the sewer.

In the separator, or extractor, shown in Fig. 54, the separa-

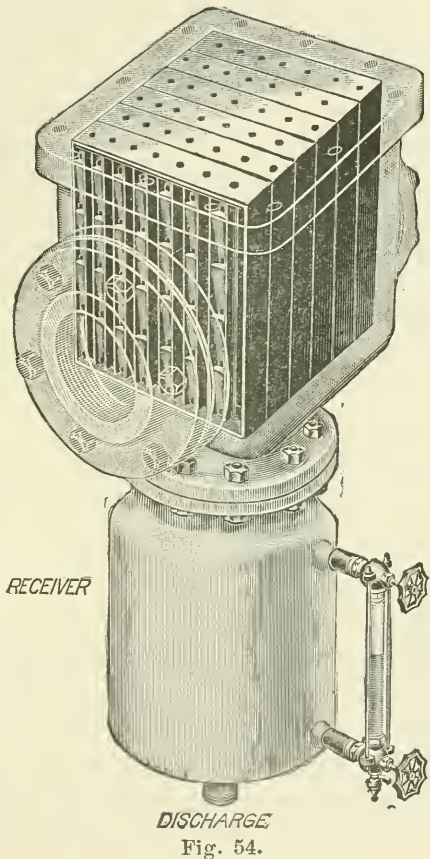

DISCHARGE
Fig. 54.

tion is accomplished by a series of plates placed in a vertical position in the body of the separator through which the steam must pass. These plates consist of upright hollow columns, with openings at regular intervals for the admission of water and oil, which drains downward to the receiver below. The steam takes a zig-zag course and all of it comes in contact with the intercepting plates, which insures a thorough separation of the oil and other solid matter from the steam. Another form, shown in Fig. 55, gives excellent results and has the advantage of providing an equalizing chamber for overcoming, to some extent, the unequal pressure due to the varying load on the engine. It consists of a

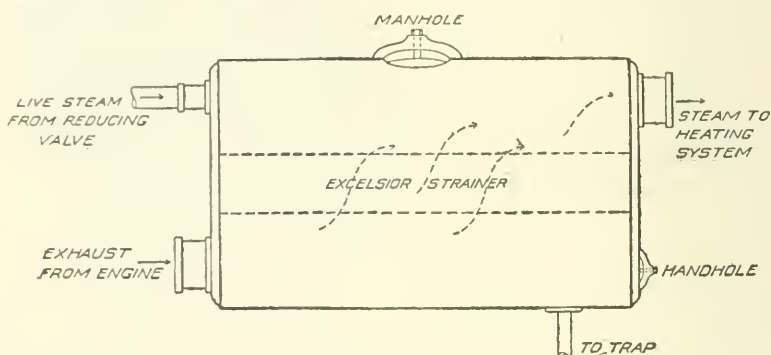

Fig. 55.

tank or receiver about 4 feet in diameter, with heavy boiler iron heads slightly crowned to give stiffness. Through the center is a layer of excelsior (wooden shavings of long fibre) about 12 inches in thickness, supported on an iron grating, with a similar grating laid over the top to hold it in place. The steam enters the space below the excelsior and passes upward, as shown by the arrows. The oil is caught by the excelsior which can be renewed from time to time as it becomes saturated. The oil and water which fall to the bottom of the receiver are carried off through a trap. Live steam may be admitted through a reducing valve for supplementing the exhaust when necessary.

Back Pressure Valve. This is a form of relief valve which is placed in the outboard exhaust pipe to prevent the pressure in the heating system from rising above a given point. Its office is the reverse of the reducing valve which supplies more steam when

the pressure becomes too low. The form shown in Fig. 56 is designed for a vertical pipe. The valve proper consists of two discs of unequal area, the combined area of which equals that of the pipe. The force tending to open the valve is that due to the steam pressure acting on an area equal to the difference in area between the two discs; it is clear from the cut that the pressure acting on the larger disc tends to open the valve while the pressure on the smaller acts in the opposite direction. The valve stem is connected by a link and crank arm with a spindle upon which is a lever and weight outside.

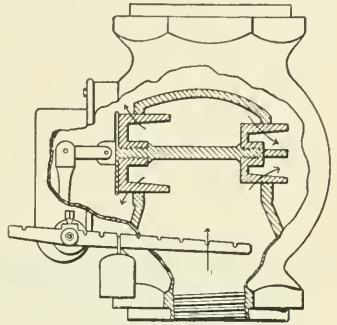

Fig. 56.

As the valve opens the weight is raised so that by placing it in different positions on the lever arm the valve will open at any desired pressure.

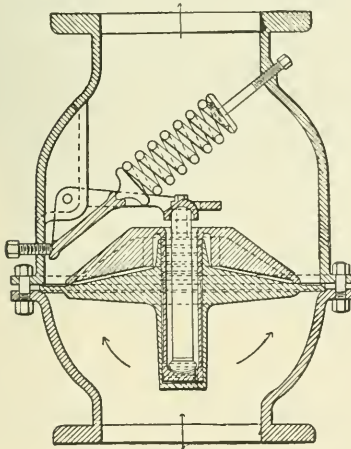

Fig. 57.

Fig. 57 shows a different type in which a spring is used instead of a weight. This valve has a single disc moving in a vertical direction. The valve stem is in the form of a piston or dash-pot which prevents a too sudden movement and makes it more quiet in its action. The disc is held on its seat against the steam pressure by a lever attached to the spring as shown. When the pressure of the steam on the underside becomes

greater than the tension of the spring, the valve lifts and allows the steam to escape. The tension of the spring can be varied by means of the adjusting screw at its upper end.

A back pressure valve is simply a low pressure safety valve designed with a specially large opening for the passage of steam through it. They are also made for horizontal pipes as well as vertical.

Exhaust Head. This is a form of separator placed at the top of an outboard exhaust pipe to prevent the water carried up in the steam from falling upon the roofs of buildings or in the street below. Fig. 58 is known as a centrifugal exhaust head. The steam on entering at the bottom is given a whirling or rotary motion by the spiral deflectors and the water is thrown outward by centrifugal force against the sides of the chamber from which it flows into the shallow trough at the base and is carried away through the drip pipe which is brought down and connected with a drain pipe inside the building. The passage of the steam outboard is shown by the arrows. Other forms are used in which the water is separated from the steam by deflectors which change the direction of the currents.

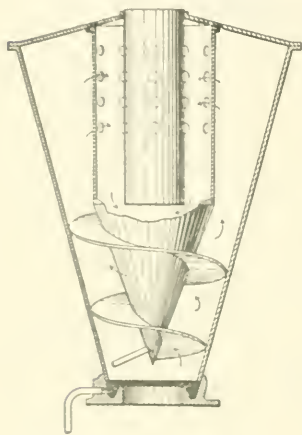

Fig. 58.

Automatic Return Pumps. In exhaust heating plants the condensation is returned to the boilers by means of some form of return pump. A combined pump and receiver of the form illustrated in Fig. 59 is generally used. This consists of a cast or wrought iron tank mounted on a base in connection with a boiler feed pump. Inside of the

tank is a ball float connected by means of levers with a valve in the steam pipe which is connected with the pump. When the water line in the tank rises above a certain level, the float is raised and opens the steam valve which starts the pump. When the water is lowered to its normal level the valve closes and the pump stops. By this arrangement a constant water line is maintained in the receiver and the pump runs only as needed to care for the condensation as it returns from the heating system. If dry returns are used they may be brought together and connected with the top of the receiver. If it is desired to seal the horizontal runs, as is usually the case, the receiver may be raised to a height sufficient to give the required elevation and the returns connected near the bottom below the water line.

A "balance pipe," so called should connect the heating main

with the top of the tank for equalizing the pressure, otherwise the steam above the water would condense and the vacuum thus formed would draw all the water into the tank leaving the returns practically empty and thus destroying the condition sought. Sometimes an independent regulator or pump governor is used in place of a receiver. One type is shown in Fig. 60. The return

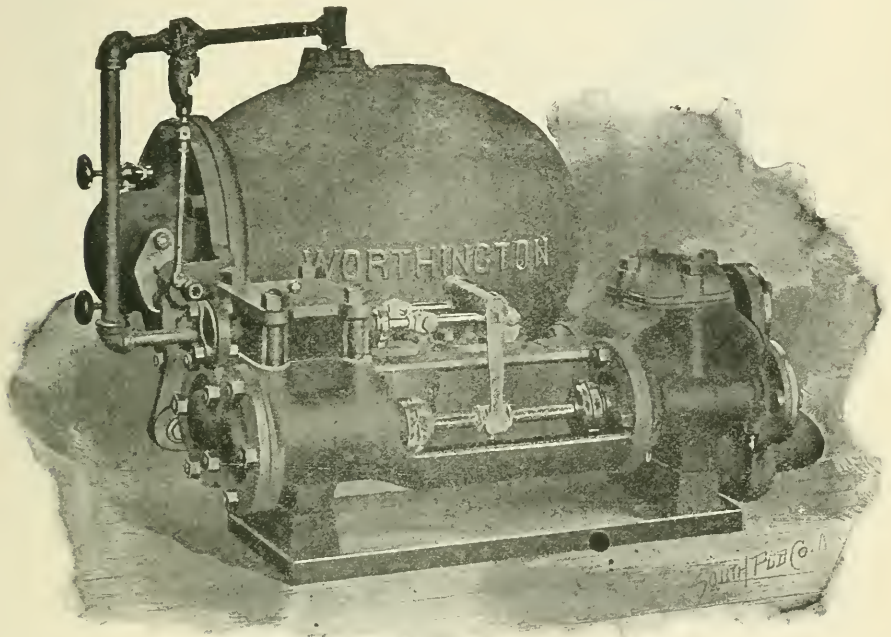

Fig. 59.

main is connected at the upper opening and the pump suction with the lower. A float inside the chamber operates the steam valve shown at the top and the pump works automatically as in the case just described.

If it is desired to raise the water line the regulator may be elevated to the desired height and connections made as shown in Fig. 61.

Return Traps. The principle of the return trap has been described in "Boiler Accessories" but its practical form and application will be taken up here. The type shown in Fig. 62 has all

of its working parts outside of the trap. It consists of a cast iron bowl pivoted at G and H.

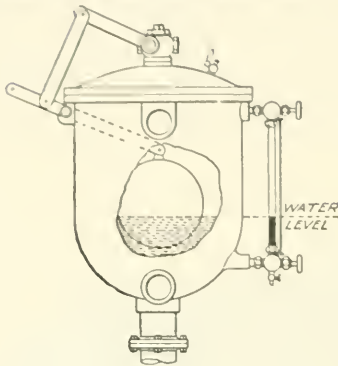

Fig. 60.

There is an opening through G connecting with the inside of the bowl. The pipe K connects through C with an interior pipe opening near the top (see Fig. 63.) The pipe D connects with a receiver into which all of the returns are brought. A is a check valve allowing water to pass through in the direction shown by the arrow. E is a pipe connecting with the boiler below the water line. B is a check opening toward the boiler and K a pipe connected with the steam main or drum.

The action of the trap is as follows. As the bowl fills with water from the receiver it overbalances the weighted lever and

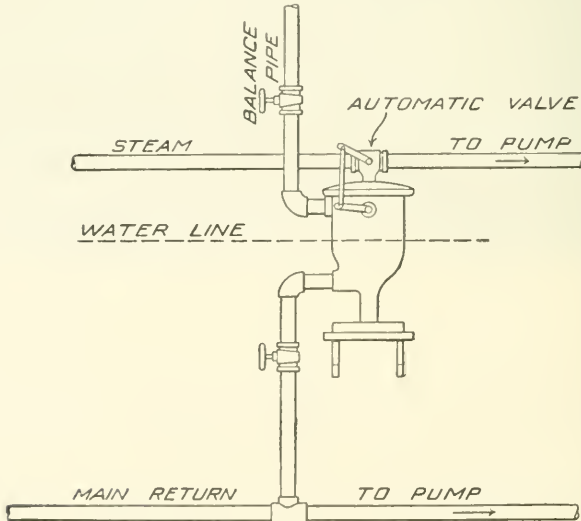

Fig. 61.

drops to the bottom of the ring. This opens the valve C and admits steam at boiler pressure to the top of the trap. Being at a higher level the water flows by gravity into the boiler, through

the pipe E. Water and steam are kept from passing out through D by the check A.

When the trap has emptied itself the weight of the ball raises it to the original position, which movement closes the valve C and opens the small vent F. The pressure in the bowl being relieved, water flows in from the receiver through D until the trap is filled, when the process is repeated. In order to work satisfactorily the trap should be placed at least 3 feet above the water level in the boiler and the pressure in the returns must always be sufficient to raise the water from the receiver to the trap against atmospheric pressure which is theoretically about 1 pound for every 2 feet in height. In practice there will be more or less friction to overcome, and suitable adjustments must be made for each particular case. Fig. 64 shows another form acting upon the same

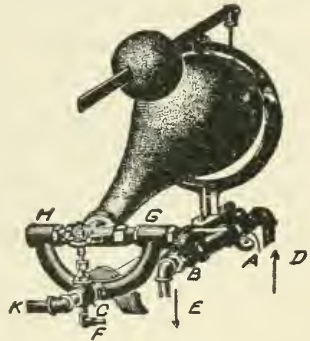

Fig. 62.

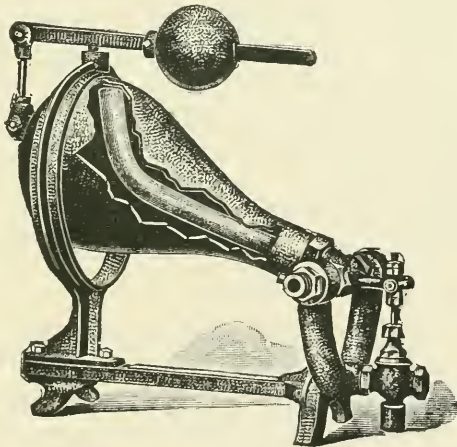

Fig. 63.

principle except in this case the steam valve is operated by a bucket or float inside of the trap. The pipe connections are practically the same as with the trap just described.

Return traps are more commonly used in smaller plants where it is desired to avoid the expense and care of a pump.

Damper Regulators. Every heating and every power plant should be provided with automatic means for closing the dampers when the steam pressure reaches a certain point, and for opening them again when the pressure drops. There are various regulators

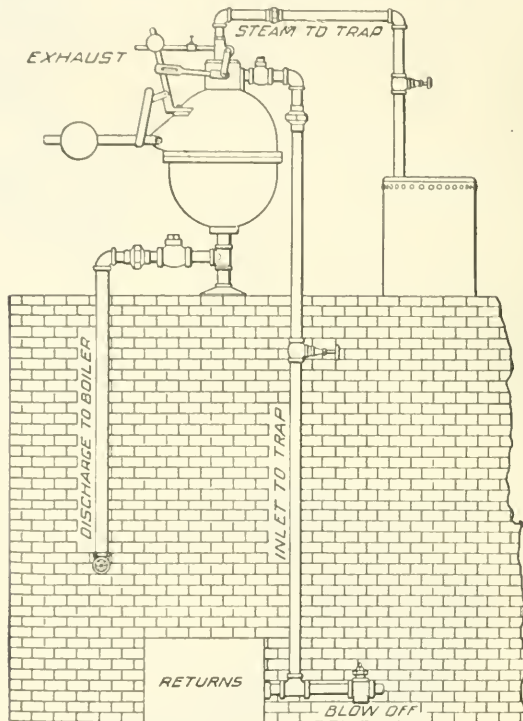

Fig. 64.

designed for this purpose, a simple form of which is shown in Fig. 65.

Steam at boiler pressure is admitted beneath a diaphragm which is balanced by a weighted lever. When the pressure rises to a certain point it raises the lever slightly and opens a valve which admits water under pressure above a diaphragm located near the smokepipe. This action forces down a lever connected by chains with the damper and closes it. When the steam pressure drops, the water valve is closed, and the different parts of the

apparatus take their original positions. Another form similar in principle is shown in Fig. 66. In this case a piston is operated by the water pressure instead of a diaphragm. In both types the pressures at which the damper shall open and close are regulated by suitable adjustments of the weights upon the levers.

Pipe Connections. The method of making the pipe connections in any particular case will depend upon the general arrange-

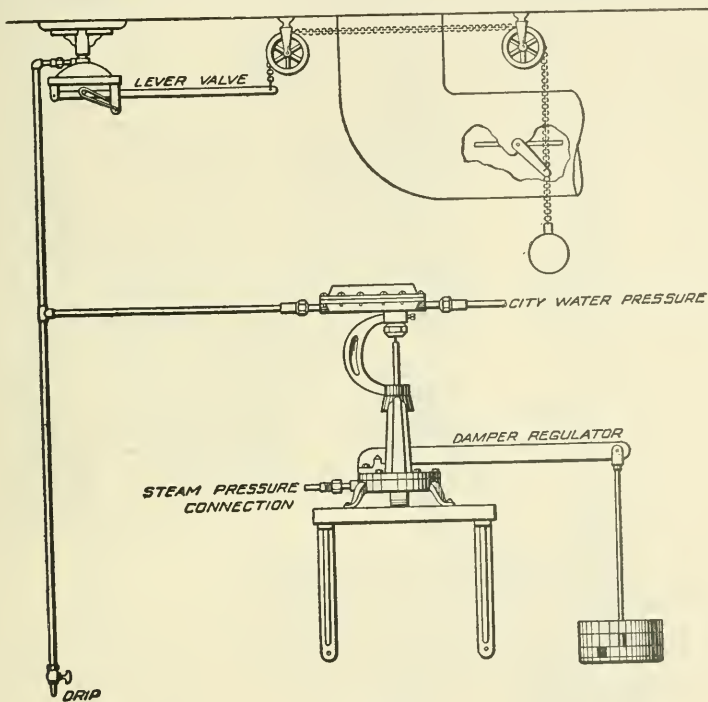

Fig. 65.

ment of the apparatus and the various conditions. Fig. 67 illustrates the general principles to be followed, and by suitable changes may be used as a guide in the design of new systems.

Steam first passes from the boilers into a large drum or header; from this a main, provided with a shut-off valve, is taken as shown; one branch is carried to the engines while another is connected with the heating system through a reducing valve having a by-pass and cut-out valves. The exhaust from the engines connects with the large main over the boilers at a point just above

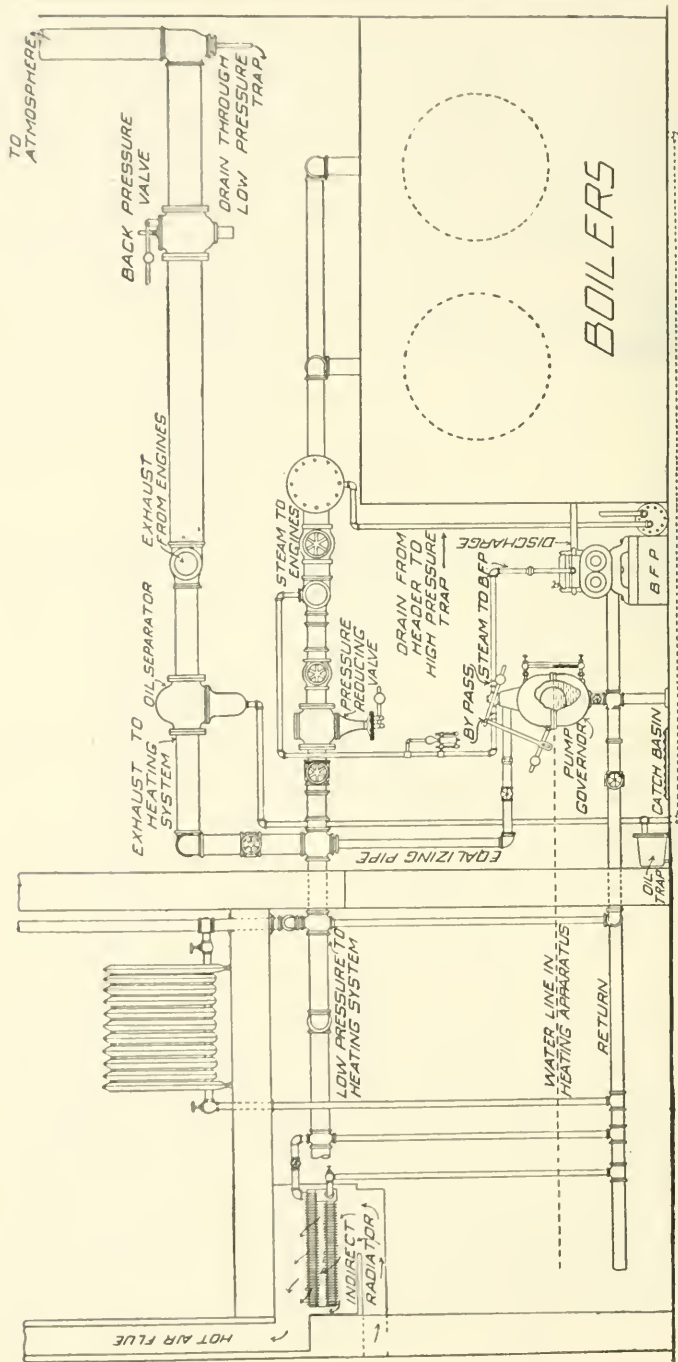

Fig. 67.

the steam drum. The branch at the right is carried outboard through a back pressure valve which may be set to carry any desired pressure on the system. The other branch at the left passes through an oil separator into the heating system. The connections between the mains and radiators are made in the usual way and the main return is carried back to the return pump near the floor. A false water line or seal is obtained by elevating

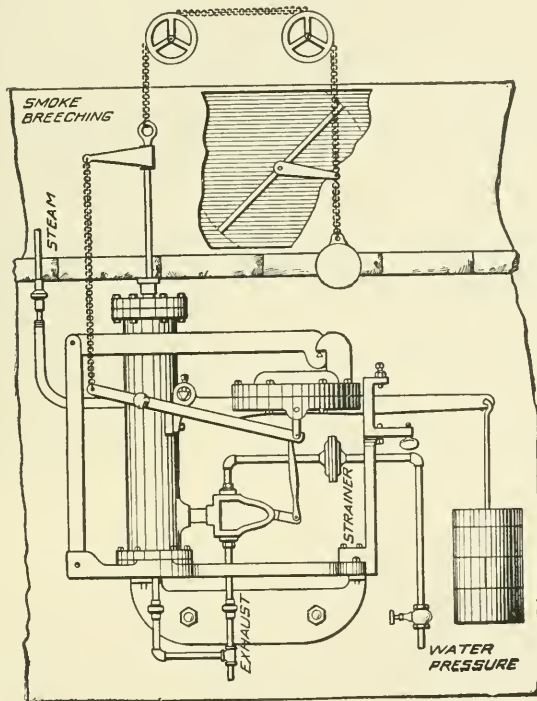

Fig. 66.

the pump regulator as already described. An equalizing or balance pipe connects the top of the regulator with the low pressure heating main and high pressure is supplied to the pump as shown.

A sight feed lubricator should be placed in this pipe above the automatic valve, and a valved by-pass should be placed around the regulator for running the pump in case of accident or repairs. The oil separator should be drained through a special oil trap to a

catch basin or to the sewer, and the steam drum or any other low points or pockets in the high pressure piping dripped to the main return through suitable traps.

Means should be provided for draining all parts of the system to the sewer and all traps and special apparatus should be bypassed. The return pump should always be duplicated in a plant of any size as a safeguard against accident and the two pumps run alternately to make sure that one is always in working order. One piece of apparatus not shown in Fig. 67 is the feed water heater. If all of the exhaust steam can be utilized for heating purposes, this is not necessary as the cold water for feeding the boilers may be discharged into the return pipe and be pumped in with the condensation. In summer time, however, when the heating plant is not in use, a feedwater heater is necessary, as a large amount of heat which would otherwise be wasted may be saved in this way. The connections will depend somewhat upon the form of heater used, but in general a single connection with the heating main inside the back pressure valve is all that is necessary. The condensation from the heater should be trapped to the sewer.

EXAMINATION PAPER.

HEATING AND VENTILATION PART II.

HEATING AND VENTILATION.

Instructions to the Student. Place your name and full address at the head of the paper. Work out in full the examples and problems, showing each step in the work. Mark your answers plainly "Ans." Avoid crowding your work as it leads to errors and shows bad taste. Any cheap, light paper like the sample previously sent you may be used. After completing the work add and sign the following statement.

I hereby certify that the above work is entirely my own.
(Signed)

1. How would you obtain the sizes of the cold and warm-air pipes connecting with indirect heaters in dwelling house work?

2. What is an aspirating coil and what is its use?

3. What efficiencies may be allowed for indirect heaters in school house work? How would you compute the size of an indirect heater for a room in a dwelling house?

4. How is the size of a direct-indirect radiator computed?

5. A school room on the fourth floor is to be supplied with 2400 cubic feet of air per minute. What should be the area of the warm-air supply flue?

Ans. 6 square feet.

6. What is the chief objection to a mixing damper, and how may this be overcome?

7. How many square feet of indirect radiation will be required to warm and ventilate a school room when it is 10 degrees below zero, if the heat loss through walls and windows is 42,000 B. T. U., and the air supply 120,000 cubic feet per hour?

Ans. 349 square feet.

8. What is the difference in construction between a steam radiator and one designed for hot water? Can the steam radiator be used for hot water? State reasons for answer.

9. How may the piping in a hot water system be arranged so that no air valves will be required on the radiators?

10. What efficiency is commonly obtained from a direct hot water radiator? How is this computed?

11. How should the pipes be graded in making the connections with indirect hot water heaters? Where should the air valve be placed?

12. Describe briefly one form of grease extractor.

13. What is the office of a pressure reducing valve in an exhaust steam heating system?

14. Upon what principle does a pump governor operate?

15. What type of pipe fittings should always be used in hot water work?

16. How is the water of condensation returned to the boilers in exhaust steam heating?

17. How many cubic feet of air per hour will be discharged through a flue 2 feet by 3 feet and 60 feet high, if the air in the flue has a temperature of 80 degrees and the outside air 60 degrees?

Ans. 134,280 cubic feet.

18. In a hot water heating system what causes the water to flow through the pipes and radiators? How does the height of the radiator above the boiler effect the flow?

19. What precaution should always be taken before starting a fire under a steam boiler?

20. What is the free opening in square feet through a register 24 inches by 48 inches? Ans. 5.3 square feet.

21. Why are return pumps or return traps necessary in exhaust steam heating plants?

22. What efficiency may be obtained from indirect hot water radiators under usual conditions? What is the common method of computing indirect hot water surface for dwelling house work?

23. State briefly how a return trap operates.

24. What is the use of an expansion tank, and what should be its capacity?

25. Describe the action of one form of damper regulator.

26. What is the principal difference between a hot water heater and a steam boiler? What type of heater is best adapted to the warming of dwelling houses?

27. Upon what four conditions does the size of a pipe to supply any given radiator depend?

28. What is the use of an exhaust head?

29. A hospital ward requires 60,000 cubic feet of air per hour for ventilation, and the heat loss through walls and windows is 140,000 B. T. U. per hour. How many square feet of indirect radiation will be required in zero weather?

Ans. 491 sq. ft.

30. For what purpose is a back-pressure valve used?

31. A hospital ward is warmed by direct heat and it is desired to add ventilation by using indirect radiators for warming the air supply. The ward has 20 occupants. How many square feet of indirect surface will be required when it is 10 degrees below zero, allowing an efficiency of 660?

Ans. 220 sq. ft.

32. A first floor class-room in a high school had 40 pupils, how many square feet area should the vent flue have?

Ans. 5.8 sq. ft.

33. A private grammar school room having 15 pupils is heated by direct hot water. It is decided to increase the size of boiler and introduce ventilation by means of indirect hot water radiation. How many more square feet of grate surface will be required in the new boiler for zero weather?

Ans. 1.4 sq. ft.

HEATING AND VENTILATION

PART III.

INSTRUCTION PAPER



AMERICAN SCHOOL OF CORRESPONDENCE

[CHARTERED BY THE COMMONWEALTH OF MASSACHUSETTS]

BOSTON, MASSACHUSETTS

U. S. A.

PREPARED BY
CHARLES L. HUBBARD, M.E.,
OF
S. HOMER WOODBRIDGE COMPANY,
HEATING, VENTILATION AND SANITARY ENGINEERS.

*Copyright 1906, by
American School of Correspondence*

HEATING AND VENTILATION.

VACUUM SYSTEMS.

Low Pressure or Vacuum Systems. In the systems of steam heating which have been described up to this point the pressure carried has always been above that of the atmosphere, and the action of gravity has been depended upon to carry the water of condensation back to the boiler or receiver; the air in the radiators has been forced out through air valves by the pressure of steam back of it. Methods will now be taken up in which the pressure in the heating system is less than the atmosphere and where the circulation through the radiators is produced by suction rather than by pressure.

Systems of this kind have several advantages over the ordinary methods of circulation under pressure. First — no back pressure is produced at the engines when used in connection with exhaust steam, but rather there will be a reduction of pressure due to the partial vacuum existing in the radiators; second — a complete removal of air from the coils and radiators so that all portions are steam filled and available for heating purposes; third — complete drainage through the returns, especially those having long horizontal runs, and the absence of water hammer; and fourth the smaller size of return pipes necessary.

The two systems of this kind in most common use are known as the Webster and Paul systems.

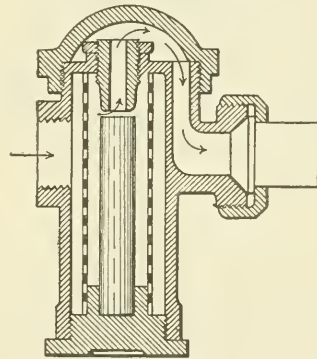

Fig. 1.

Webster System. This consists primarily of an automatic outlet valve on each coil and radiator connected with some form of suction apparatus such as a pump or ejector. The valve used is shown in section in Fig. 1 and replaces the usual hand valve at

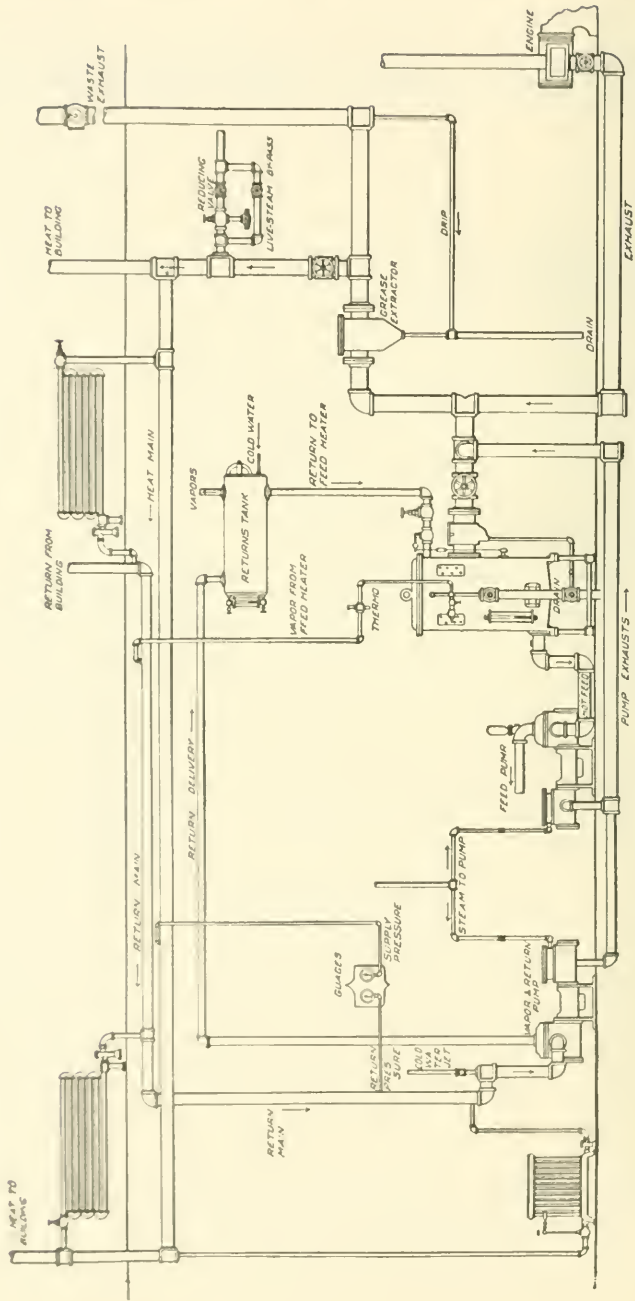

Fig. 4.

the return end of the radiator. It is similar in construction to some of the air valves already described, consisting of a rubber or vulcanite stem closing against a valve opening when made to expand by the presence of steam. When water or air fills the valve the stem contracts and allows them to be sucked out as shown by the arrows. A perforated metal strainer surrounds the stem or expansion piece to prevent dirt and sediment from clogging the valve.

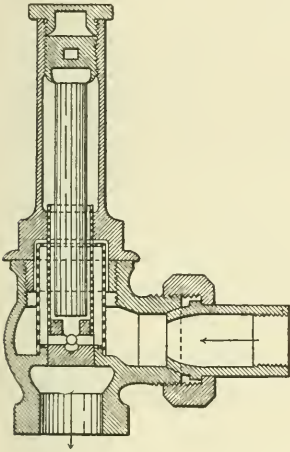

Fig. 2.

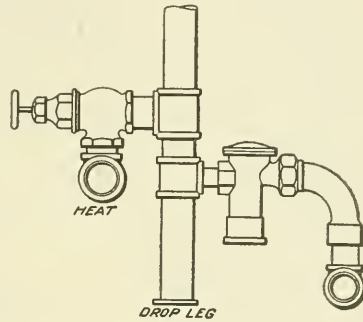

Fig. 3.

Fig. 2 shows the valve, or thermostat as it is called, attached to an ordinary angle valve with the top removed, and Fig. 3 indicates the method of draining the bottoms of risers or the ends of mains.

One special advantage claimed for this system is that the amount of steam admitted to the radiators may be regulated to suit the requirements of outside temperature, and this may be done without water logging or hammering, a result impossible to obtain with any other combination of steam heating apparatus. This may be done at will by closing down on the inlet supply to the desired degree. The result is the admission of a smaller amount of steam to the radiator than it is calculated to condense normally. The condensation is removed as fast as formed by the opening of the thermostatic valve.

The general application of this system to exhaust heating is shown in Fig. 4. Exhaust steam is brought from the engine as shown: one branch is connected with a feed-water heater while the other is carried upward and through a grease extractor where it branches again, one line leading outbound through a back-pressure valve and the other connecting with the heating main. A live steam connection is made through a reducing valve as in the ordinary system. Valved connections are made with the coils and radiators in the usual manner but the return valves are replaced by the special thermostatic valves described above.

The main return is brought down to a vacuum pump which discharges into a "returns tank" where the air is separated from the water and passes off through the vapor pipe at the top. The condensation then flows into the feed water heater from which it is automatically pumped back into the boilers. The cold-water feed supply is connected with the returns tank and a small cold-water jet is connected into the suction at the vacuum pump for increasing the vacuum in the heating system by the condensation of steam at this point.

Paul System. In this system the suction is connected with the air valves instead of the returns and the vacuum is produced by means of a steam ejector instead of a pump. The returns are carried back to a receiving tank and pumped back to the boiler in the usual manner. The ejector in this case is called the "exhauster."

Fig. 5 shows the general method of making the pipe connections with radiators in this system and Fig. 6 the details of connection at the exhauster.

A A are the returns from the air valves and connect with the exhausters as shown. Live steam is admitted in small quantities through the valves B B and the mixture of air and steam is discharged outbound through the pipe C. D D are gages showing the pressure in the system and E E are check valves. The advantage of this system depends principally upon the quick removal of air from the various radiators and pipes which constitutes the principal obstruction to circulation; the inductive action in many cases is sufficient to cause the system to operate somewhat below atmospheric pressure.

Where exhaust steam is used for heating, the radiators should be somewhat increased in size owing to the lower temperature of

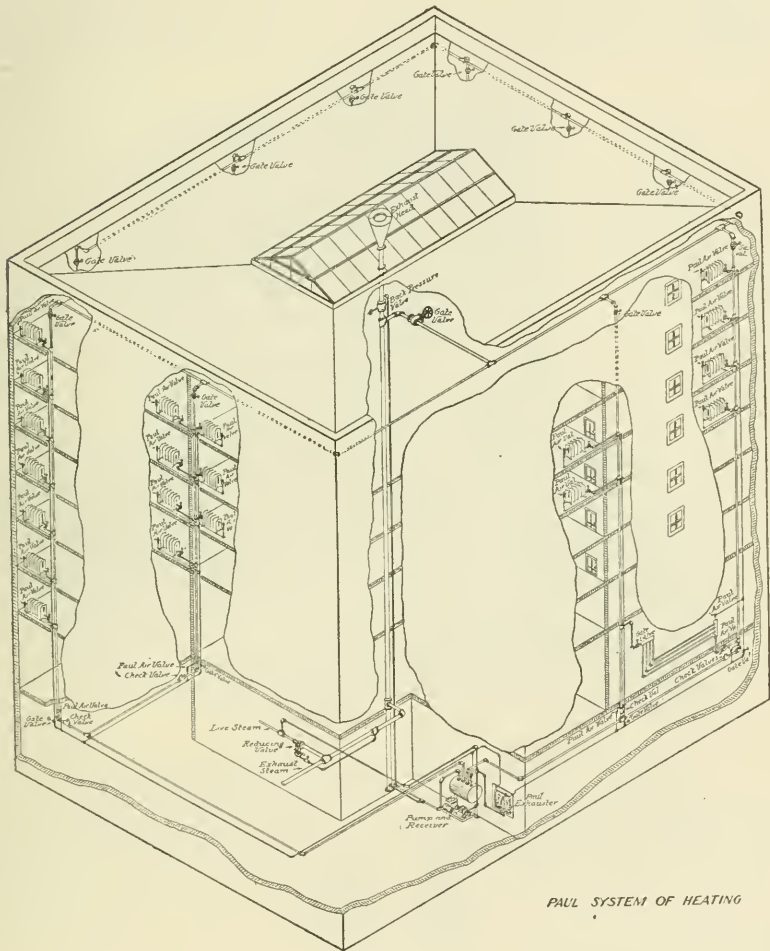

Fig. 5.

the steam. It is common practice to add from 20 to 30 per cent. to the sizes required for low pressure live steam.

FORCED BLAST.

In a system of forced circulation by means of a fan or blower the action is positive and practically constant under all usual conditions of outside temperature and wind action. This gives it a decided advantage over natural or gravity methods which are affected to a greater or less degree by changes in wind pressure,

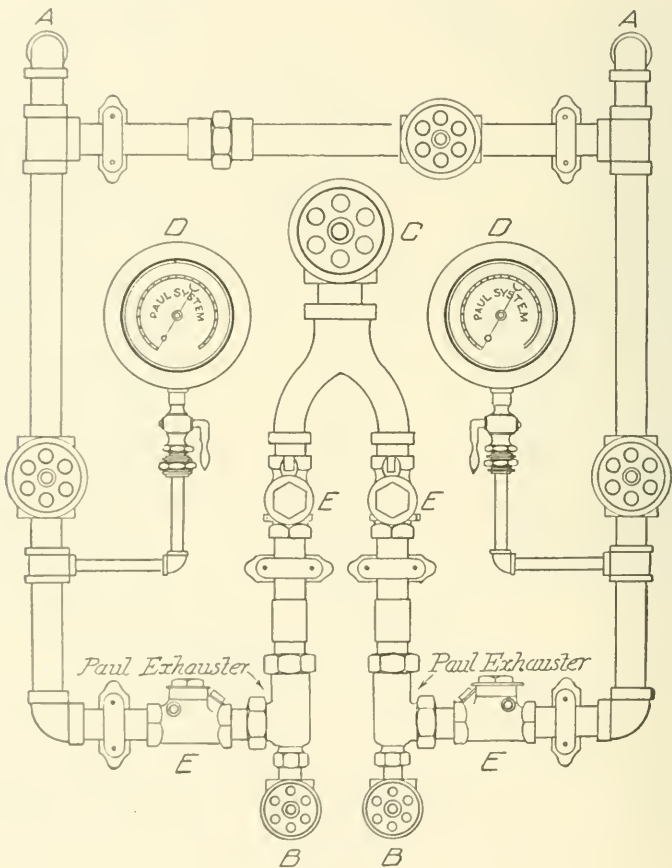

Fig. 6.

and makes it especially adapted to the ventilation and warming of large buildings such as shops, factories, schools, churches, halls, theatres, etc., where large and definite air quantities are required.

Exhaust Method. This consists in drawing the air out of a building and providing for the heat thus carried away by placing steam coils under windows or in other positions where the inward leakage is supposed to be the greatest. When this method is used a partial vacuum is created within the building or room and

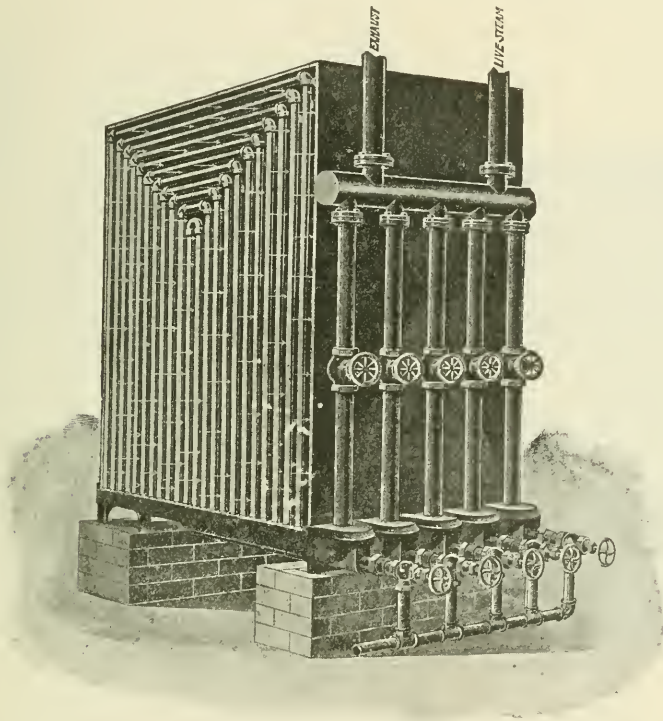

Fig. 7.

all currents and leaks are inward; there is nothing to govern definitely the quality and place of introduction of the air, and it is difficult to provide suitable means for warming it.

Plenum Method. In this case the air is forced into the building, and its quality, temperature and point of admission are completely under control. All spaces are filled with air under a slight pressure and the leakage is outward, thus preventing the drawing of foul air into the room from any outside source. But above all, ample opportunity is given for properly warming the

air by means of heaters, either in direct connection with the fan or in separate passages leading to the various rooms.

Form of Heating Surface. A common form of heater for

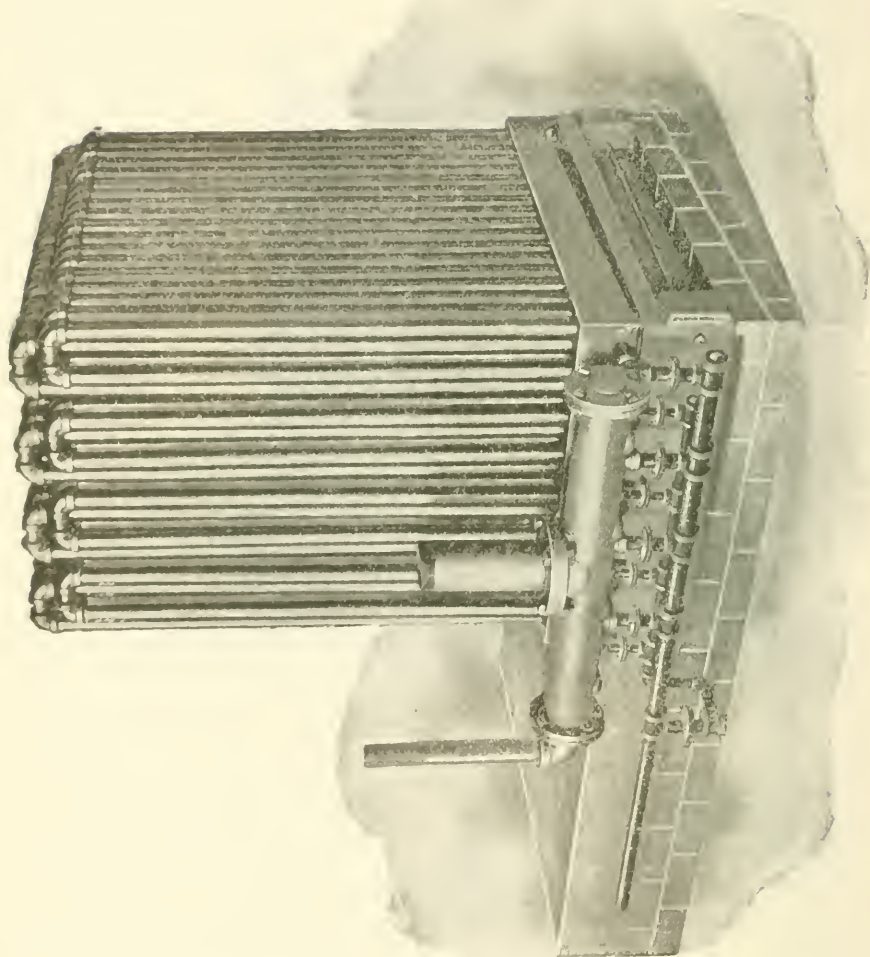

forced blast heating is shown in Fig. 16, Part I. This consists of sectional cast-iron bases with loops of wrought-iron pipe connected as shown. The steam enters the upper part of the bases or

headers and passes up one side of the loops, then across the top and down on the other side where the condensation is taken off through the return drip, which is separated from the inlet by a partition. These heaters are made up in sections of 2 and 4 rows of pipes each. The height varies from $3\frac{1}{2}$ to 9 feet and the width from 3 feet to 7 feet in the standard sizes. They are usually made up of 1-inch pipe although $1\frac{1}{4}$ inch is commonly used in the larger sizes. In Fig. 7 is shown a similar heater. This is arranged for supplying exhaust to a portion of the sections and live steam to the remainder. The division between the two sections is shown where the metal is broken away. Fig. 8 shows still

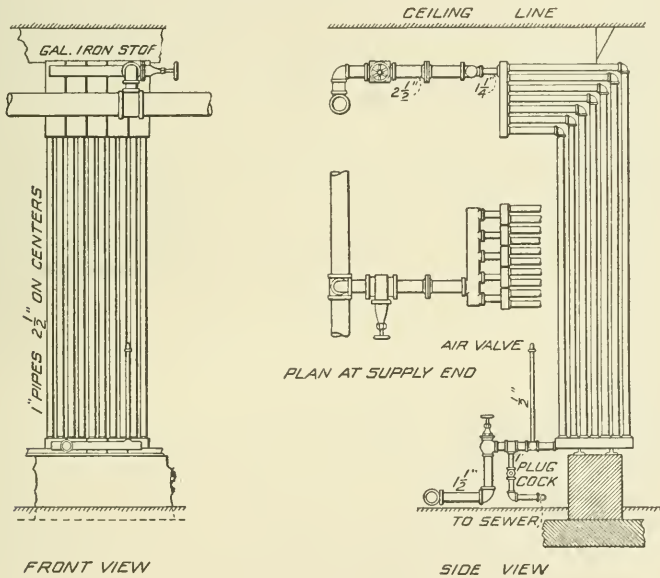

Fig. 9.

another form; in this case all of the loops are made of practically the same length by the special form of construction shown. This is claimed to prevent the short circuiting of steam through the shorter loops which causes the outer pipes to remain cold.

This form of heater is usually encased in a sheet steel housing as shown, but may be supported on a foundation between brick walls if desired.

Fig. 9 shows a special form of heater particularly adapted to ventilating work where the air does not have to be raised above

70 or 80 degrees. It is made up of 1-inch wrought-iron pipe connected with supply and return headers; each section contains 14 pipes and they are usually made up in groups of 5 sections each. These coils are supported upon tee irons resting upon a brick foundation. Heaters of this form are usually made to extend across the side of a room with brick walls at the sides instead of being encased in steel housings. Heaters made up of banks of the school-pin cast-iron radiators give excellent results for schoolhouse work. The sections should be so arranged that the free area for air flow shall not be too much restricted.

Efficiency of Heaters. The efficiency of the heaters used in connection with forced blast varies greatly, depending upon the temperature of the entering air, its velocity between the pipes, the temperature to which it is raised and the steam pressure carried in the heater. The general method in which the heater is made up is also an important factor.

In designing a heater of this kind, care must be taken that the free area between the pipes is not contracted to such an extent that an excessive velocity will be required to pass the given quantity of air through it. In ordinary work it is customary to assume a velocity of 800 to 1000 feet per minute; higher velocities call for a greater pressure on the fan which is not desirable in ventilating work.

In the heaters shown, about .4 of the total area is free for the passage of air; that is, a heater 5 feet wide and 6 feet high would have a total area of $5 \times 6 = 30$ square feet, and a free area between the pipes of $30 \times .4 = 12$ square feet. The depth or number of rows of pipe does not effect the free area although the friction is increased and additional work is thrown upon the fan. The efficiency in any given heater will be increased by increasing the velocity of the air through it, but the final temperature will be diminished, that is, a larger quantity of air will be heated to a lower temperature in the second case and while the total heat given off is greater, the air quantity increases more rapidly than the heat quantity which causes a drop in temperature.

Increasing the number of rows of pipe in a heater with a constant air quantity increases the final temperature of the air but diminishes the efficiency of the heater, because the average differ-

ence in temperature between the air and steam is less. Increasing the steam pressure in the heater (and consequently its temperature) increases both the final temperature of the air and the efficiency of the heater. Table I has been prepared from different tests and may be used as a guide in computing probable results under ordinary working conditions. In this table it is assumed that the air enters the heater at a temperature of 10 degrees below zero and passes between the pipes with a velocity of 800 feet per minute. Column 1 gives the number of rows of pipe in the heater and columns 2, 3 and 4 the final temperature of the air for different steam pressures. Columns 5, 6 and 7 give the corresponding efficiency of the heater.

For example. Air passing through a heater 10 pipes deep and carrying 20 pounds pressure will be raised to a temperature of 90 degrees and the heater will have an efficiency of 1650 B.T.U. per square foot of surface per hour. When the air is taken in at zero we may add 10 to the final temperatures given in the table, although theoretically it would be slightly less; in this case we must take the efficiency corresponding to the final temperature after the 10 degree have been added.

TABLE I.

Temp. of entering air 10° below zero.

Velocity of air between the pipes 800 feet per minute.

Rows of pipe deep.	Temp. to which the air will be raised from 10° below 0.			Efficiency of the heating surface in B. T. U., per square foot per hour.		
	Steam Pressure in Heater.			Steam Pressure in Heater.		
	5 lbs.	20 lbs.	60 lbs.	5 lbs.	20 lbs.	60 lbs.
4	30	35	45	1600	1800	2000
6	50	55	65	1600	1800	2000
8	65	70	85	1500	1650	1850
10	80	90	105	1500	1650	1850
12	95	105	125	1500	1650	1850
14	105	120	140	1400	1500	1700
16	120	130	150	1400	1500	1700
18	130	140	160	1300	1400	1600
20	140	150	170	1300	1400	1600

For a velocity of 1000 feet, multiply the *temperatures* given in the table by .95 and the *efficiencies* by 1.13.

Example. How many square feet of radiation will be required to raise 600,000 cubic feet of air per hour from 10 below zero to 80 degrees, with a velocity through the heater of 800 feet per minute and a steam pressure of 5 pounds? What must be the total area of the heater front and how many rows of pipes must it have?

Referring back to our formula for heat required for ventilation, we have

$$\frac{600,000 \times 90}{55} = 981,818 \text{ B. T. U. required.}$$

Referring to table I we find that for the above conditions a heater 10 pipes deep is required, and that an efficiency of 1500 B. T. U. will be obtained. Then $\frac{981,818}{1500} = 654$ square feet of

surface required, $\frac{600,000}{60} = 10,000$ cubic of air per minute, and

$\frac{10,000}{800} = 12.5$ square feet of free area required through the heater. If we assume .4 of the total heater front to be free for

the passage of air, then $\frac{12.5}{.4} = 31$ the required total area.

For convenience in estimating the approximate dimensions of a heater, the following table is given. The standard heaters made by different manufacturers vary somewhat, but the dimensions given below represent average practice. Column 3 gives the square feet of heating surface in a single row of pipes of the dimensions given in columns 1 and 2, and column 4 gives the free area between the pipes.

TABLE II.

Width of Section.	Height of Pipes.	Square Feet of Surface.	Free Area through Heater in Sq. Ft.
3 feet	3 ft. 6 inches	20	4.2
3 feet	4 ft. 0 inches	22	4.8
3 feet	4 ft. 6 inches	25	5.4
3 feet	5 ft. 0 inches	28	6.0
4 feet	4 ft. 6 inches	34	7.2
4 feet	5 ft. 0 inches	38	8.0
4 feet	5 ft. 6 inches	42	8.8
4 feet	6 ft. 0 inches	45	9.6
5 feet	5 ft. 6 inches	52	11.0
5 feet	6 ft. 0 inches	57	12.0
5 feet	6 ft. 6 inches	62	13.0
5 feet	7 ft. 0 inches	67	14.0
6 feet	6 ft. 6 inches	75	15.6
6 feet	7 ft. 0 inches	81	16.8
6 feet	7 ft. 6 inches	87	18.0
6 feet	8 ft. 0 inches	92	19.2
7 feet	7 ft. 6 inches	98	21.0
7 feet	8 ft. 0 inches	108	22.4
7 feet	8 ft. 6 inches	109	23.8
7 feet	9 ft. 0 inches	116	25.2

In calculating the total height of the heater add 1 foot for the base.

These sections are made up of 1-inch pipe except the last, or 7-foot sections, which are made of $1\frac{1}{4}$ -inch pipe.

Using this table in connection with the example just given we should look in the last column for a section having a free area of 12.5 square feet; here we find that a 5 feet \times 6 feet — 6 inches section has a free opening of 13 square feet and a radiating surface of 62 square feet. The conditions call for 10 rows of pipes and $10 \times 62 = 620$ square feet of radiating surface which is slightly less than called for, but which would be near enough for all practical purposes.

EXAMPLE FOR PRACTICE.

1. Compute the dimensions of a heater to warm 20,000 cubic feet of air per minute from 10 below zero to 70 degrees with 20 pounds steam pressure.

Ans. 1057 sq. feet of rad. surface 8 pipes deep.
25 sq. ft. free area through heater.

Use sixteen $5' \times 7'$ sections, side by side, which gives 28 square feet area and 1072 square feet of surface.

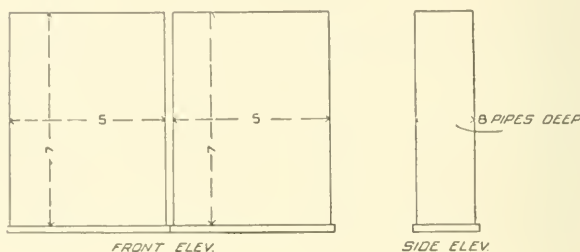

The general method of computing the size of heater for any given building is the same as in the case of indirect heating: First obtain the B.T.U. required for ventilation and to that add the heat loss through walls, etc., and divide the result by the efficiency of the heater under the given conditions.

Example.—An audience hall is to be provided with 400,000 cubic feet of air per hour. The heat loss through walls, etc., is 250,000 B.T.U. per hour in zero weather. What will be the size of heater, and how many rows of pipe deep must it be, with 20 pounds steam pressure.

$$\frac{400,000 \times 70}{55} = 509,090 \text{ B.T.U. for ventilation.}$$

Therefore $250,000 + 509,090 = 759,090$ B.T.U., total to be supplied.

We must next find to what temperature the entering air must be raised in order to bring in the required amount of heat, so that the number of rows of pipe in the heater may be obtained and its corresponding efficiency determined. We have entering the room for purposes of ventilation, 400,000 cubic feet of air every hour at a temperature of 70 degrees, and the problem now

becomes, to what temperature must this air be raised to carry in 250,000 B.T.U. additional for warming?

We have learned that 1 B.T.U. will raise 55 cubic feet of air 1 degree. Then 250,000 B.T.U. would raise $250,000 \times 55$ cubic feet of air 1 degree.

$$\frac{250,000 \times 55}{400,000} = 34 +$$

The air in this case must be raised to $70 + 34 = 104$ degrees to provide for both ventilation and warming. Referring to table I we find that a heater 12 pipes deep will be required and that the corresponding efficiency of the heater will be 1650 B.T.U.

$$\text{Then } \frac{759090}{1650} = 460 \text{ square feet of surface required.}$$

Pipe Connections. In the heater shown in Fig. 16, Part I, all of the sections take their supply from a common header; the supply pipe connecting with the top, and the return being taken from the lower division at the end, as shown.

In Fig. 7 the base is divided into two parts, one for live steam and the other for exhaust. The supply pipes connect with the upper compartments and the drips are taken off as shown. Separate traps should be provided for the two pressures.

The connections in Fig. 8 are similar to those just described except the supply and return headers, or bases, are drained through separate pipes and traps; there being a slight difference in pressure between the two which is likely to interfere with the proper drainage if brought into the same one. This heater is arranged to take exhaust steam but has a connection for feeding in live steam through a reducing valve if desired; the whole heater being under one pressure.

It is often desirable to have a heater connected up in sections so that one or more can be shut off in mild weather when the whole capacity of the heater is not required. In this case each section has separate connections with valves in supply and return. Fig. 10 shows an excellent method of making the connections for a heater using both live and exhaust steam as in this way any number of sections may be used for exhaust from one to the entire heater by a proper adjustment of the valves.

The usual connections in Fig. 9 are plainly shown. A supply header runs across the front of the heater from which valved branches are taken off to the several groups. The return pipes have cross connections with the sewer or drain for blowing out the air when steam is first turned on. Two or more groups should be connected for the use of either exhaust or live steam as shown in Fig. 10, and separate traps should be provided for the two pressures. Large and freely working automatic air valves

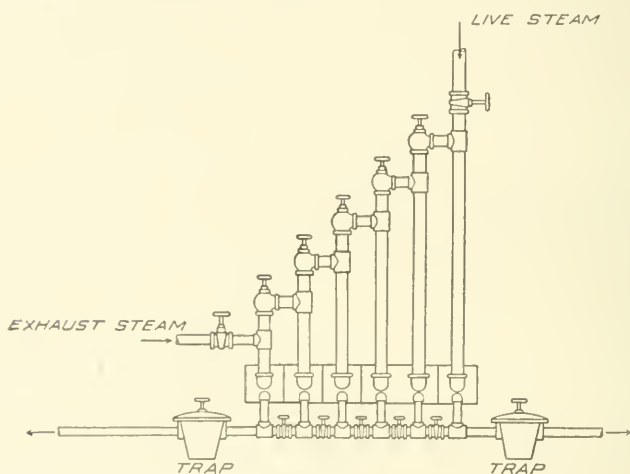

Fig. 10.

should be provided in the return header of each section or group, whatever the type of heater, and it is well also to provide hand pet cocks for opening when steam is first turned on. The form of heater shown in Fig. 9 is especially efficient and may be relied upon to give an efficiency of about 1800 B.T.U. and to raise the air from zero to 80° with a velocity of 800 feet between the pipes and a steam pressure of 20 pounds. A cast-iron sectional heater will give about 1500 B.T.U. under the same conditions.

Pipe Sizes. The pipe sizes required in this system of heating may be computed from the tables already given. The length of run from the boiler or main, the pressure carried and the allowable drop are the factors governing the size of the main supply and branches. Heaters of the pattern shown in Figs. 7 and 10

are usually tapped at the factory for high or low pressure as desired and these sizes may be followed in making the pipe connections.

The sizes marked on Fig. 9 may be used for all ordinary work where the pressure runs from 5 to 20 pounds; for pressures above that the supply connections may be reduced one size.

Fans and Blowers.

The term fan is commonly applied to any form of apparatus for moving air in which revolving blades or

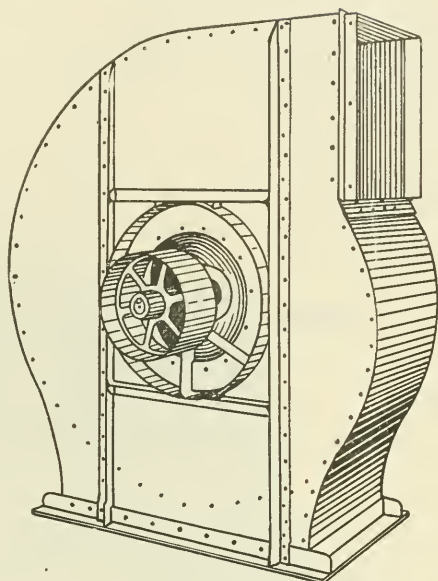

Fig. 11.

propellers are used, while the word blower is used only in those cases where the wheel or propeller is enclosed in a casing.

Referring to Part I, Fig. 17 shows the usual form of fan or wheel used in the common type of blower and Fig. 11 represents the usual form of a regular steel plate blower with full housing. Where a blower is connected with a heater having a steel plate casing it has an inlet only on one side,

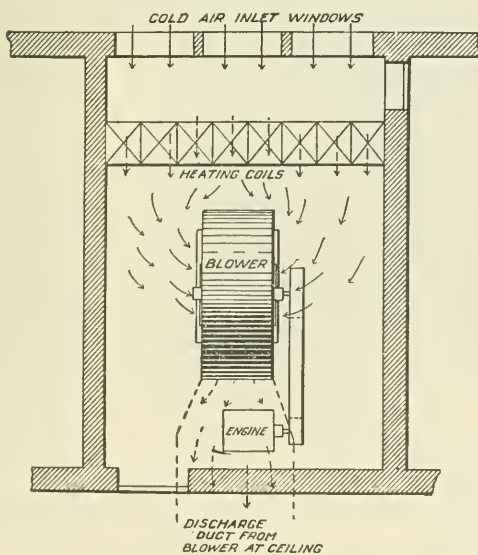

Fig. 12.

but when used in connection with a heater of the type shown in Fig. 9 it should have inlet openings upon both sides as shown in Fig. 12.

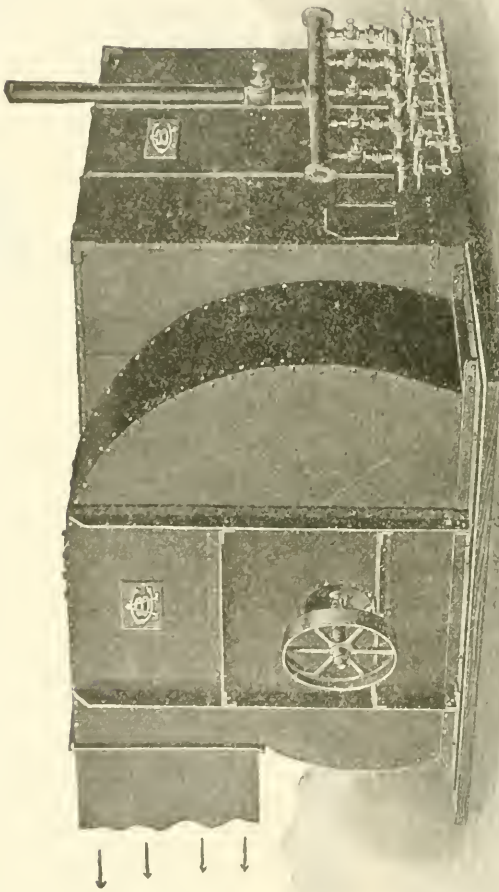

Fig. 13.

The discharge opening can be made in any position desired, either up, down, top horizontal, bottom horizontal or at any angle. Fig. 13 shows a top horizontal discharge blower connected with a heater.

Where the height of the fan room is limited, a form called the three-quarter housing may be used in which the lower part of the casing is replaced by a brick pit below the floor level. Such a construction is shown in Fig. 14 with a direct-connected engine. Another type of fan known as a disc wheel may be used where the air passages are large and the resistance to air flow is small, but for ordinary ventilating work the encased blower is to be preferred. The cone fan shown in Fig. 20, Part I, is a very efficient

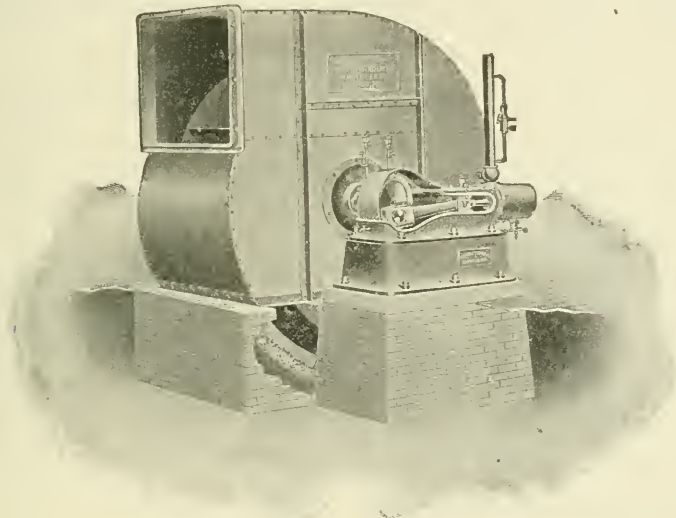

Fig. 14.

form and may be used in a wall opening as there shown or made double and enclosed in a steel plate housing.

Fan Capacity. The volume of air which a given fan will deliver depends upon the speed at which it is run and the friction or resistance through the heater and air ways. The pressure referred to in connection with a fan is that in the discharge outlet and represents the force which drives the air through the ducts and flues. The greater the pressure with a given resistance in the pipes the greater will be the volume of air delivered, and the greater the resistance, the greater the pressure required to deliver a given quantity.

Fan wheels of the same manufacture are usually made with a constant ratio between the diameter and width, although special

forms are made where this does not hold true. All practical data on the action of fans is based on the results of tests, and from these the following relations have been found to be approximately correct:

(1) The volume of air delivered varies *directly* as the speed of the fan, that is, doubling the number of revolutions doubles the volume of air delivered.

(2) The pressure varies as the *square* of the speed, for example, if the speed is doubled the pressure is increased $2 \times 2 = 4$ times, etc.

(3) The power required to run the fan varies as the *cube* of the speed; again, if the speed is doubled the power required is increased $2 \times 2 \times 2 = 8$ times.

The value of a knowledge of these relations may be illustrated by the following example.

Suppose for any reason it was desired to double the volume of air delivered by a certain fan. At first thought we might decide to use the same fan and run it twice as fast; but when we come to consider the power required we should find that this would have to be increased 8 times, and it would probably be much cheaper in the long run to put in a larger fan and run it at lower speed. In speaking of a fan as a 4 or 5-foot fan, the diameter of the propeller wheel is meant, but if we say an 80 or 100-inch fan we mean the height of casing in inches.

It has been found in practice that fans of the lower type having curved floats operate quietly and give good results when run at a speed corresponding to $\frac{1}{2}$ ounce pressure at the discharge outlet: this gives a speed of about 3600 feet per minute at the circumference of the wheel. Higher speeds are accompanied with a greater expenditure of power and are likely to produce a roaring noise or cause vibration. A much lower speed does not provide sufficient pressure to give proper control of the air distribution during strong winds. The following table gives average capacities for various sizes of fans and the corresponding horse-power of engine required. If an electric motor is used multiply the horse-power given in the table by .13.

This is done because we can never tell *exactly* what the power required will be and it is well to have an excess to meet any

emergency or unlooked-for conditions which may arise. In the case of a steam engine the steam pressure may be raised to meet any special requirements but a motor can only give out the original power for which it was designed.

TABLE III.

Nominal Size of Fan. Height of Housing in Inches.	Diameter of Fan Wheel in Inches.	Width of Housing in Inches.	Ordinary Speed Giving $\frac{1}{2}$ Ounce Pressure.	Cubic Feet of Air Delivered per Minute.	Horse-Power of Engine to Drive the Fan.
30	18	9	870	1000	$\frac{1}{3}$
40	24	12	580	1600	$\frac{1}{1}$
50	30	15	465	2600	1
60	36	18	390	4500	2
70	42	21	333	6000	$2\frac{1}{2}$
80	48	24	293	8000	$2\frac{1}{2}$
90	54	28	260	11000	$\frac{4}{4}$
100	60	32	233	12500	4
120	72	43	195	21500	7
140	84	48	167	28300	9
160	96	48	147	31800	10
	108	54	130	40400	13
	120	60	117	51000	16

Fan Engines. A simple, quiet running engine is desirable for use in connection with a fan or blower. They may be either horizontal or vertical and for schoolhouse and similar work should be provided with large cylinders so that the required power may be developed without carrying a boiler pressure much above 30 pounds. In some cases cylinders of such size are used that a boiler pressure of 12 or 15 pounds is sufficient. The quantity of steam which an engine consumes is of minor importance as the exhaust can be turned into the coils and used for heating purposes. If space allows, the engine should always be belted to the fan. Where it is direct-connected, as in Fig. 14, there is likely to be trouble from noise, as any slight looseness or pounding in the engine will be communicated to the air ducts and the sound will be carried to the rooms above. Figs. 15 and 16 show common forms of fan engines. The latter is especially adapted to this pur-

pose as all bearings are enclosed and protected from dust and grit. A horizontal engine for fan use is shown in Fig. 17.

Motors. Electric motors are especially adapted for use in

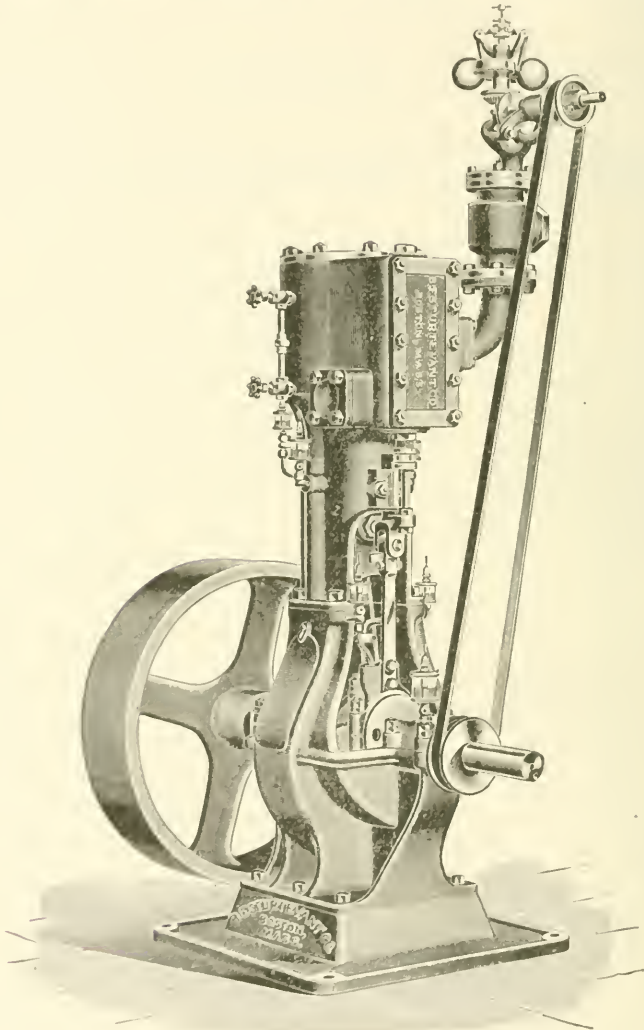

Fig. 15.

connection with fans. They are easily controlled by a switch and starting box or regulator. The motor may be directly connected

to the fan shaft or it may be belted. Fig. 18 shows a fan with direct-connected motor.

Area of Ducts and Flues. With the blower type of fan the size of the main ducts may be based on a velocity of 1200 to 1500 feet per minute, the branches on a velocity of 1000 to 1200 feet per minute, and as low as 600 to 800 feet when the pipes are small. Flue

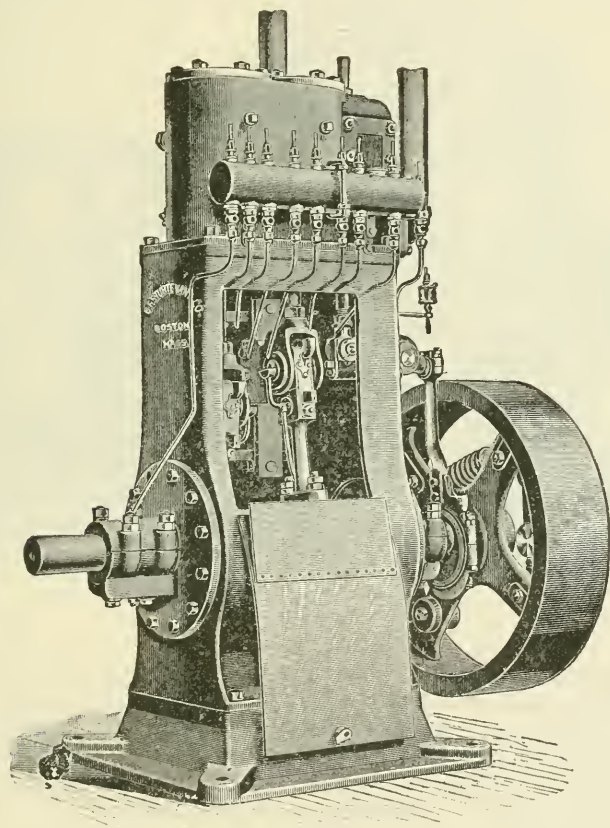

Fig. 16.

velocities of 500 to 700 feet per minute may be used although the lower velocity is preferable. The size of the inlet register should be such that the velocity of the entering air will not exceed about 300 feet per minute. The velocity between the inlet windows and the fan or heater should not exceed about 800 feet.

The air ducts and flues are usually made of galvanized iron, the ducts being run at the basement ceiling. No. 20 and 22 iron is used for the larger sizes and 24 to 28 for the smaller.

Regulating dampers should be placed in the branches leading to each flue for increasing or reducing the air supply to the different rooms. Adjustable deflectors are often placed at the fork of a pipe for the same purpose. One of these is shown in Fig. 19.

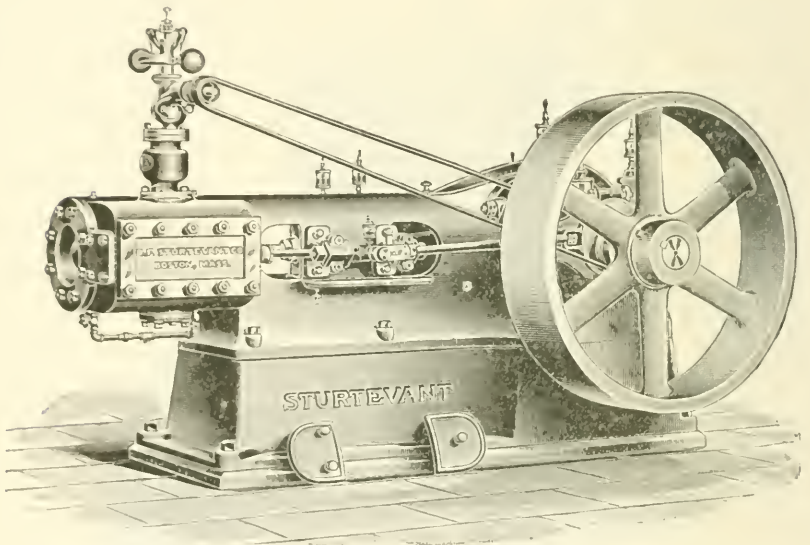

Fig. 17.

Factory Heating. The application of forced blast for the warming of factories and shops is shown in Figs. 20 and 21. The proportional heating surface in this case is generally expressed in the number of cubic feet in the building for each linear foot of 1-inch steam pipe in the heater. On this basis, in factory practice with all of the air taken from out of doors, there are generally allowed from 100 to 150 cubic feet of space per foot of pipe according as exhaust or live steam is used; live steam in this case indicating steam of about 80 pounds pressure. If practically all of the air is returned from the buildings to the heater, these figures may be raised to about 140, as a minimum and possibly 200 as a maximum, per foot of pipe. The heaters in table II may be

changed to linear feet of 1 inch pipe by multiplying the numbers in column three (square feet of surface) by three.

EXAMPLES FOR PRACTICE.

1. A machine shop 100 feet long by 50 feet wide and 3 stories, each 10 feet high, is to be warmed by forced blast using

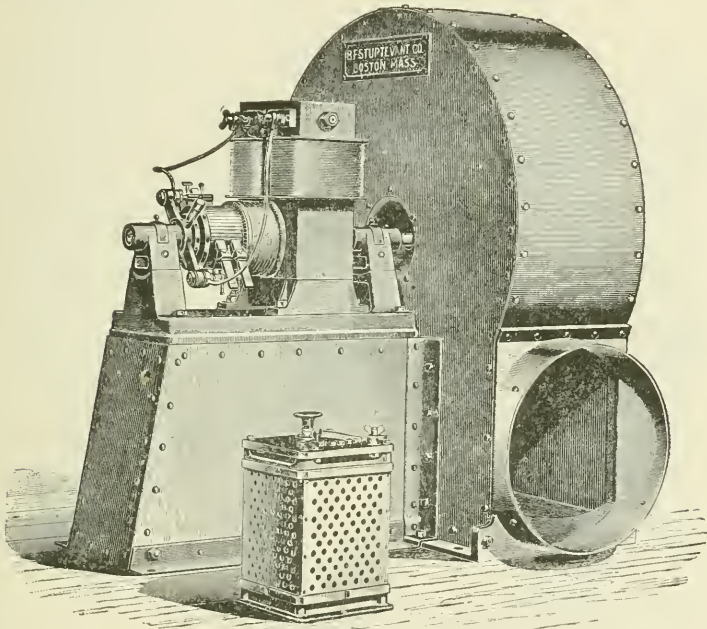

Fig. 18.

exhaust steam in the heater. The air is to be returned to the heater from the building and the whole amount contained in the building is to pass through the heater every 15 minutes, what size of blower will be required and what will be the H.P. of the engine required to run it? How many linear feet of 1 inch pipe should the heater contain?

Ans. $\left\{ \begin{array}{l} 90 \text{ inch blower.} \\ 4 \text{ H.P. engine.} \\ 1071 \text{ feet of pipe.} \end{array} \right.$

2. Find the size of blower, engine and heater for a factory 200 feet long 60 feet wide and 4 stories, each 10 feet high, using

live steam at 80 pounds pressure in the heater and changing the air every 20 minutes by taking in cold air from out of doors.

Ans. $\left\{ \begin{array}{l} 140 \text{ inch blower.} \\ 9 \text{ H.P. engine.} \\ 3200 \text{ feet of pipe.} \end{array} \right.$

In using this method of computation judgment must be used which can only come from experience. The figures given are for average conditions of construction and exposure.

Double Duct System. The varying exposures of the rooms of a school or other building similarly occupied require that more heat shall be supplied to some than to others. Rooms that are on the south side of the building and exposed to the sun may perhaps be kept perfectly comfortable with a supply of heat that will maintain a temperature of only 50 or 60 degrees in rooms on the opposite side of the building which are exposed to high winds and shut off from the warmth of the sun.

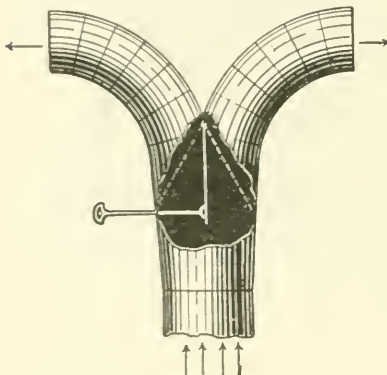

Fig. 19.

With a constant and equal air supply to each room it is evident that the temperature must be directly proportional to the cooling surfaces and exposure, and that no building of this character can be properly heated and ventilated if the temperature cannot be varied without affecting the air supply.

There are two methods of overcoming this difficulty:

The older arrangement consists in heating the air by means of a primary coil at or near the fan to about 60 degrees, or to the minimum temperature required within the building. From the coil it passes to the bases of the various flues and is there still further heated as required, by secondary or supplementary heaters placed at the base of each flue.

With the second and more recent method a single heater is employed and all of the air is heated to the maximum required to maintain the desired temperature in the most exposed rooms, while the temperature of the other rooms is regulated by mixing

with the hot air a sufficient volume of cold air at the bases of the different flues. This result is best accomplished by designing a hot blast apparatus so that the air shall be forced, rather than

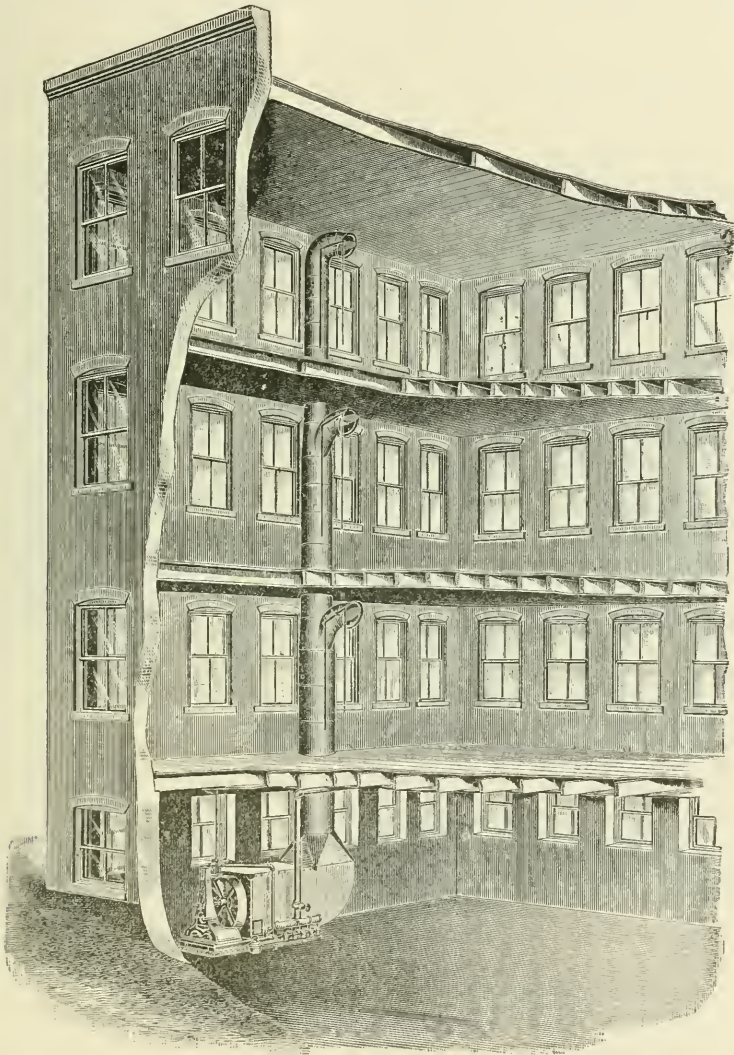

Fig. 20.

drawn through the heater, and by providing a by-pass through which it may be discharged without passing across the heated pipes. The passage for the cold air is usually made above and

separate from the heater pipes (see Fig. 19, Part I.). Extending from the apparatus is a double system of ducts, usually of galvanized iron, and suspended from the ceiling. At the base of each flue is placed a mixing damper which is controlled by a chain from the room above and so designed as to admit either a full volume of hot air, a full volume of cold air or to mix them in any



Fig. 21.

desired proportion without affecting the resulting total volume delivered to the room. A damper of this form is shown in Fig. 22.

Fig. 23 shows an arrangement of disc fan and heater where the air is first drawn through a tempering coil, then a portion of it forced through a second heater and into the warm-air pipes while the remainder is by-passed under the heater into the cold-air

pipes. Mixing dampers are placed at the bases of the flues as already described.

EXHAUST VENTILATION.

When air is to be moved against a very slight resistance, as in the case of exhaust ventilation, the disc or propeller type of wheel may be used. This is shown in different forms in Figs. 24, 25 and 26. This type of fan is light in construction, requires but little power at low speeds, and is easily erected. It may be conveniently placed in the attic or upper story of a building, where it may be driven either by a direct or belt-connected electric motor. Fig. 24 shows a fan equipped with a direct-connected motor, and Fig. 27 the general arrangement when a belted motor is used. These fans are largely used for the ventilation of toilet and smoking rooms, restaurants, etc. and are usually mounted in a wall opening, as shown in Fig. 27. A damper should always be provided for shutting off the opening when the fan is not in use.

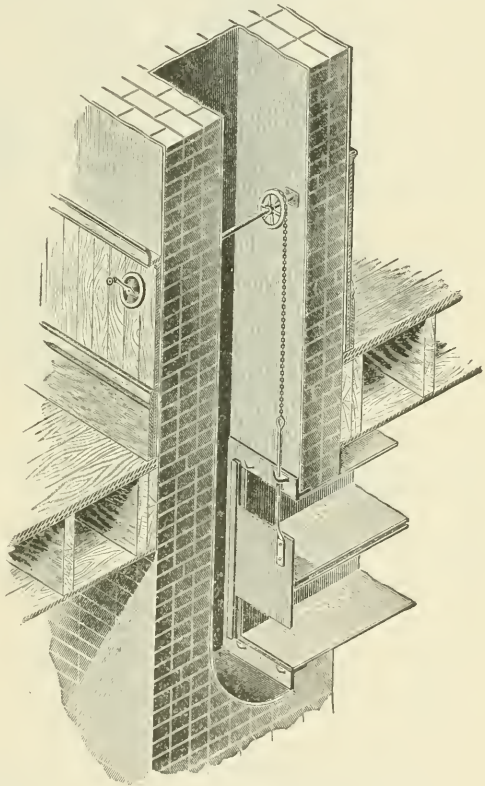

Fig. 22.

The fans shown in Figs. 25 and 26 are provided with pulleys for belt connection.

Fans of this kind are often connected with the main vent flues of large buildings, such as schools, halls, churches, theatres, etc., and are especially adapted for use in connection with

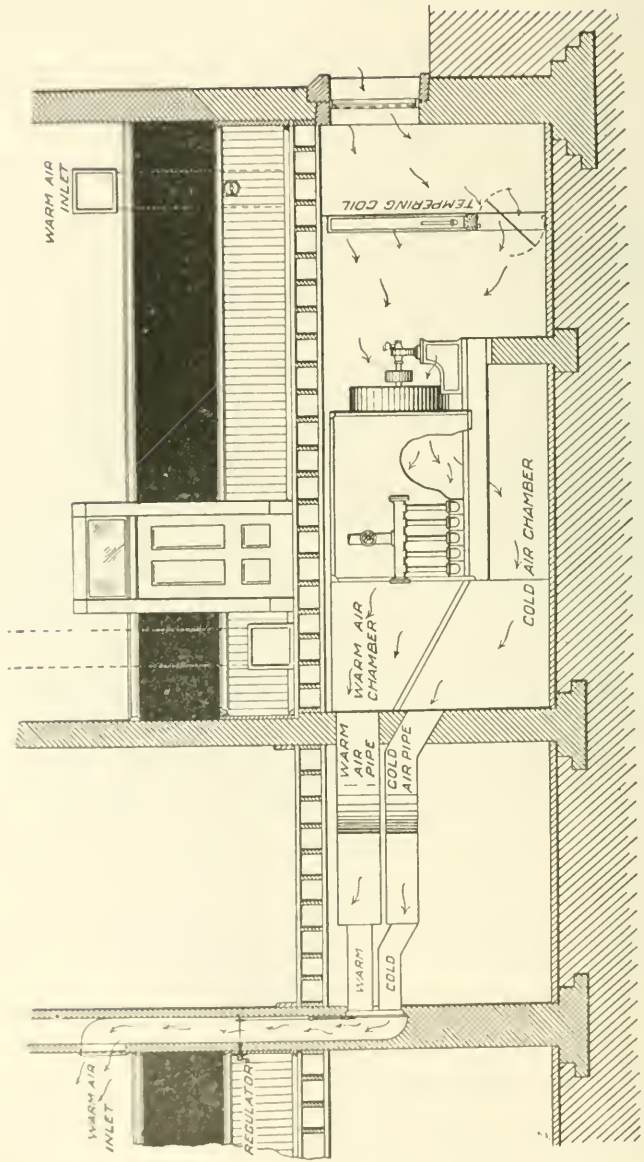

Fig. 23.

gravity heating systems. They are usually run by electric motors, and as a rule are placed in positions where an engine could

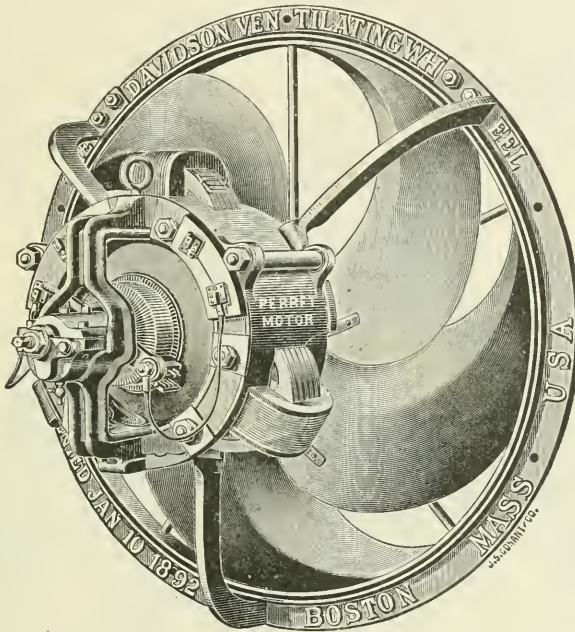

Fig. 24.

not be connected, and also in buildings where steam pressure is not available.

Table IV gives the air delivery per minute against slight resistance, and the proper size of motor for fans of the disc type.

TABLE IV.

Diameter of fan in inches.	Revolutions per minute.	Cubic feet of air delivered per minute.	H. P. of Motor.
12	1,000	600	$\frac{1}{4}$
18	800	1,500	$\frac{1}{2}$
24	500	2,300	1
30	410	3,500	1
36	380	5,700	$1\frac{1}{2}$
42	330	7,800	2
48	280	9,900	3
54	250	12,500	3
60	230	16,000	5

ELECTRIC HEATING.

Unless electricity is produced at a very low cost, it is not commercially practicable for heating residences or large buildings. The electric heater, however, has quite a wide field of application in heating small offices, bathrooms, electric cars, etc. It is a convenient method of warming rooms on cold mornings in late spring and early fall, when furnace or steam heat is not at hand. It has the especial advantage of being instantly available, and

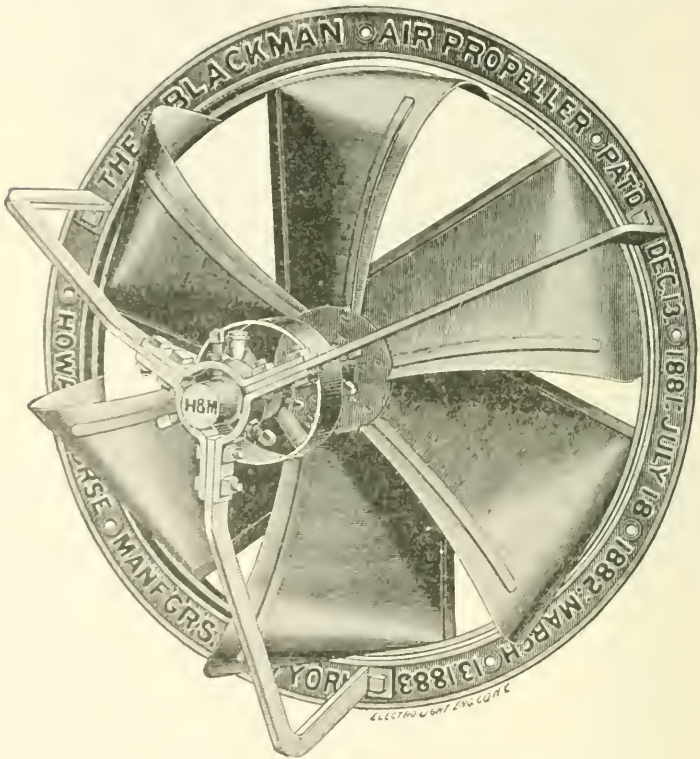

Fig. 25.

the amount of heat can be regulated at will. The heaters are perfectly clean, do not vitiate the air, and are portable.

Electric Heat and Energy. The commercial unit for electricity is one watt for one hour, and is equal to 3.41 B. T. U. Electricity is usually sold on the basis of 1,000 watt hours (called Kilowatt-hours), which is equivalent to 3,410 B. T. U. A watt,

as we have learned, is the product obtained by multiplying a current of 1 ampere by an electro-motive force of 1 volt.

From the above we see that the B. T. U. required per hour for warming, divided by 3,410, will give the Kilowatt-hours necessary for supplying the required amount of heat.

Construction of Electric Heaters. Heat is obtained from the electric current by placing a greater or less resistance in its path. Various forms of heaters have been employed. Some of the simplest consist merely of coils or loops of iron wire, arranged in parallel rows, so that the current can be passed through as many coils as are needed to provide the required amount of heat. In other

forms the heating material is surrounded with fire-clay, enamel or asbestos, and in some cases the material itself has been

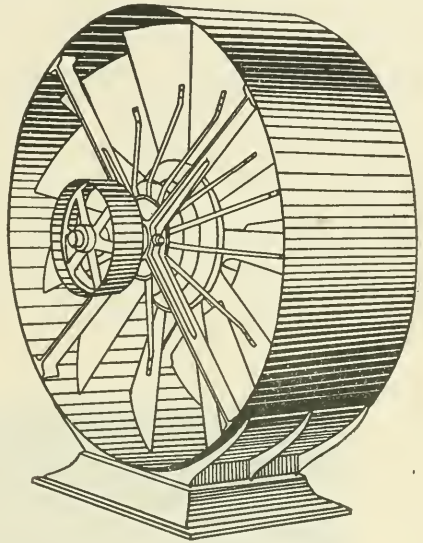

Fig. 26.

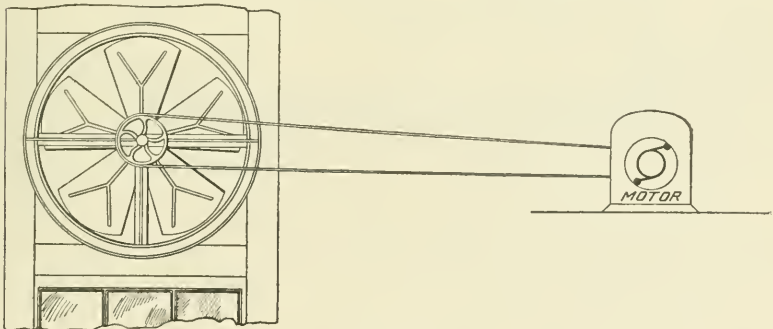

Fig. 27.

such as to give considerable resistance to the current. A form of electric car heater is shown in Fig. 28. Forms of radiators are shown in Figs. 21, 22 and 23, in Part I.

Connections for Electric Heaters. The method of wiring for electric heaters is essentially the same as for lights which require the same amount of current. A constant electro-motive force or voltage is maintained in the main wire leading to the heaters. A much less voltage is carried on the return wire, and the current in passing through the heater from the main to the return, drops in voltage or pressure. This drop provides the energy which is transformed into heat.

The principle of electric heating is much the same as that involved in the non-gravity return system of steam heating. In that system the pressure on the main steam pipes is that of the boiler, while that on the return is much less, the reduction in pressure occurring in the passage of the steam through the



Fig. 28.

radiators: the water of condensation is received into a tank and returned to the boiler by a pump.

In a system of electric heating the main wires must be sufficiently large to prevent a sensible reduction in voltage or pressure between the generator and the heater, so that the pressure in them shall be substantially that in the generator. The pressure or voltage in the main return wire is also constant, but very low, and the generator has an office similar to that of the steam pump in the system just described; that is, of raising the pressure of the return current up to that in the main. The power supplied to the generator can be considered the same as the boiler in the first case. All of the current which passes from the main to the return must flow through the heater and in so doing its pressure or voltage falls from that of the main to that of the return.

From the generator shown in Fig. 29, main and return wires

are run the same as in a two-pipe system of steam heating, and these are proportioned to carry the required current without sensible drop or loss of pressure. Between these wires are placed the various heaters, which are arranged so that when electric connection is made they draw the current from the main and discharge it into the return wire. Connections are made and broken by switches which take the place of valves on steam radiators.

Cost of Electric Heating. The expense of electric heating must in every case be great, unless the electricity can be supplied

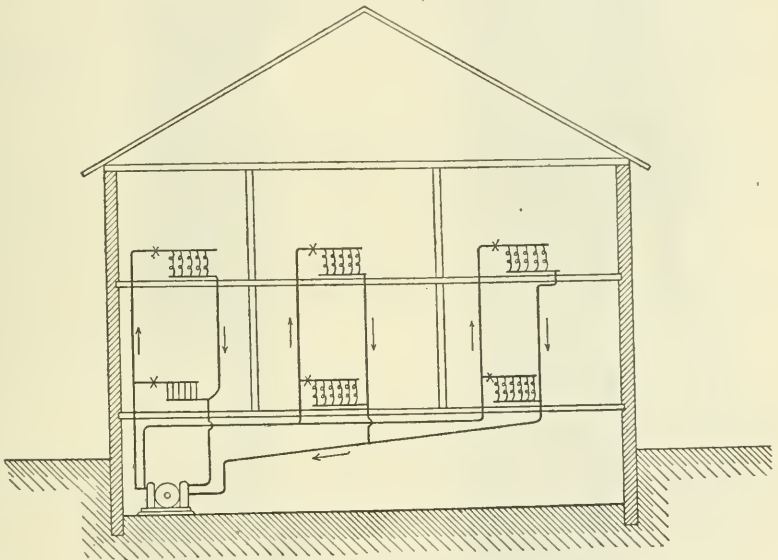

Fig. 29.

at an exceedingly low cost. Estimated on the basis of present practice, the average transformation into electricity does not account for more than 4 per cent of the energy in the fuel which is burned in the furnace; although under best conditions 15 per cent has been realized, it would not be safe to assume that in ordinary practice more than 5 per cent could be transformed into electrical energy. In heating with steam, hot water or hot air, the average amount utilized will probably be about 60 per cent,

so that the expense of electrical heating is approximately from 12 to 15 times greater than by these methods.

TEMPERATURE REGULATORS.

The principal systems of automatic temperature control

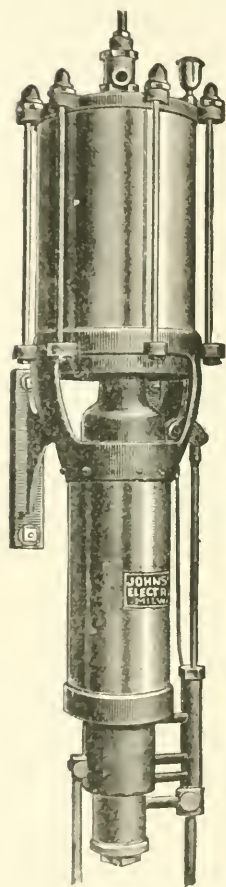

Fig. 30.

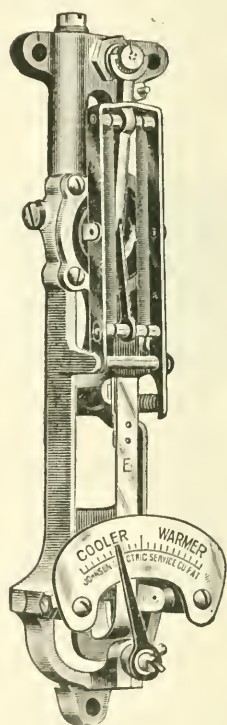

Fig. 31.

now in use consist of three essential features: First, an air compressor, reservoir and distributing pipes; second, thermostats, which are placed in the rooms to be regulated; and third, special diaphragm or pneumatic valves at the radiators.

The *air compressor* is usually operated by water pressure in

small plants and by steam in larger ones; electricity is used in some cases. Fig. 30 shows a form of water compressor. It is similar in principle to a direct-acting steam pump, in which water under pressure takes the place of steam. A piston in the upper cylinder compresses the air, which is stored in a reservoir provided for the purpose. When the pressure in the reservoir drops below a certain point, the compressor is started automatically, and continues to operate until the pressure is brought up to its working standard.

A *thermostat* is simply a mechanism for opening and closing one or more small valves, and is actuated by changes in the temperature of the air in which it is placed. Fig. 31 shows a thermostat in which the valves are operated by the expansion and contraction of the metal strip E. The degree of temperature at which it acts may be adjusted by throwing the pointer at the bottom one way or the other. Fig. 32 shows the same thermostat with its ornamental casing in place. The thermostat shown in Fig. 33 operates on a somewhat different principle. It consists of a vessel separated into two chambers by a metal diaphragm. One of these chambers is partially filled with a liquid, which will boil at a temperature below that desired in the room. The vapor of the liquid produces considerable pressure at the normal temperature

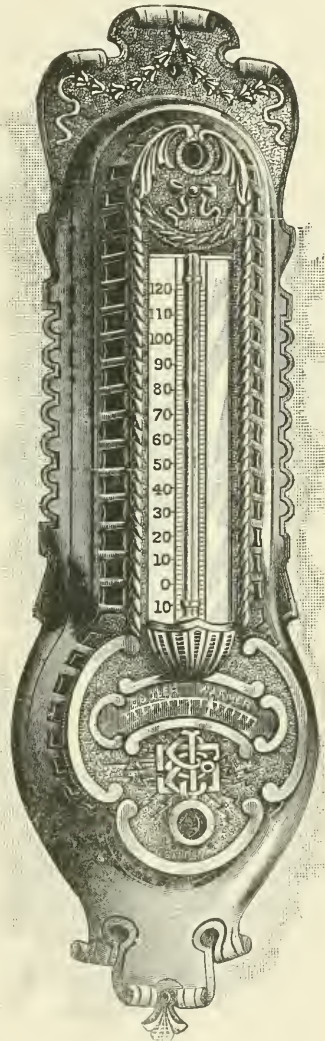

Fig. 32.

of the room, and a slight increase of heat crowds the diaphragm over and operates the small valves in a manner similar to that of the metal strip in the case just described.

The general form of a *diaphragm valve* is shown in Fig. 34. These replace the usual hand valves at the radiator. They are similar in construction to the ordinary globe or angle valve, except the stem slides up and down instead of being threaded and running in a nut. The top of the stem connects with a flat plate, which rests against a rubber diaphragm. The valve is held open by a spring, as shown, and is closed by admitting compressed air to the space above the diaphragm.

In connecting up the system, small concealed pipes are carried

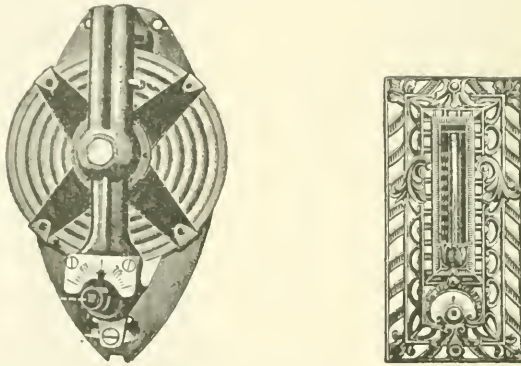

Fig. 33.

from the air reservoir to the thermostat, which is placed upon an inside wall of the room, and from there to the diaphragm valve at the radiator. When the temperature of the room reaches the maximum point for which the thermostat is set, its action opens a small valve and admits air pressure to the diaphragm, thus closing off the steam from the radiator. When the temperature falls, the thermostat acts in the opposite manner, and shuts off the air pressure from the diaphragm valve, and at the same time opens a small exhaust which allows the air above the diaphragm to escape. The pressure being removed the valve opens and again admits steam to the radiator. Thermostats and diaphragms are also used for operating mixing dampers in a similar manner.

HEATING AND VENTILATION.

Various Classes of Buildings.

The different methods used in heating and ventilation, together with the manner of computing the various proportions of the apparatus, having been taken up, the application of these systems to the different classes of buildings will now be considered briefly.

School Buildings. For school buildings of small size, the furnace system is simple, convenient and generally effective. Its use is confined as a general rule to buildings having not more

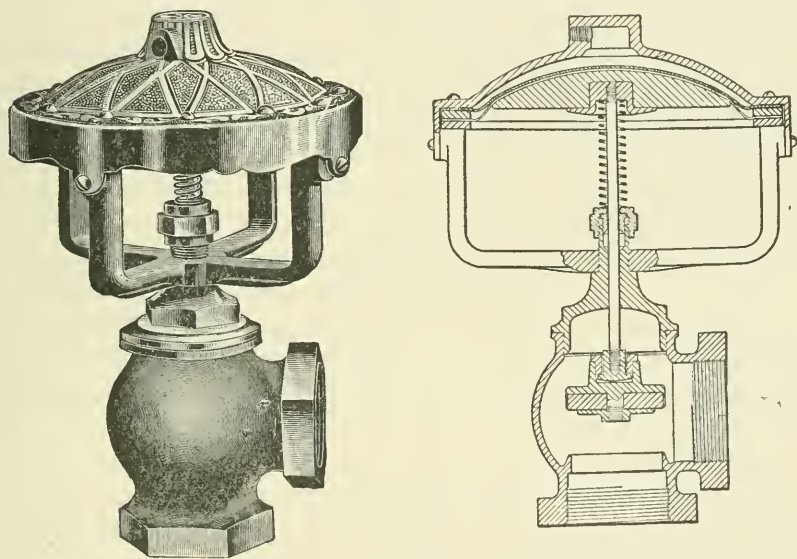

Fig. 34.

than eight rooms. For large ones this method must generally give way to some form of indirect steam system with one or more boilers, which occupy less space, and are more easily cared for than a number of furnaces scattered about in different parts of the basement. Like all systems that depend on natural circulation, the supply and removal of air is considerably affected by changes in the outside temperature and by winds.

The furnaces used are generally built of cast iron; this material being durable, and easily made to present large and

effective heating surfaces. To adapt the larger sizes of house-heating furnaces to schools a much larger space must be provided between the body and the casing, to permit a sufficient volume of air to pass to the rooms. The free area of the air passage should be sufficient to allow a velocity of about 400 feet per minute.

The size of furnace is based on the amount of heat lost by radiation and conduction through walls and windows plus that carried away by air passing up the ventilating flues. These quantities may be computed by the usual methods for "loss of heat by conduction through walls," and "heat required for ventilation." With more regular and skillful attendance, it is safe to assume a higher rate of combustion in schoolhouse heaters than in those used for warming residences. Allowing a maximum combustion of 6 pounds of coal per hour per square foot of grate, and assuming that 8,000 B. T. U. per pound are taken up by the air passing over the furnace, we have $6 \times 8,000 = 48,000$ B. T. U. furnished per hour per square foot of grate. Therefore, if we divide the total B. T. U. required for both warming and ventilation by 48,000, it will give us the necessary grate surface in square feet. It has been found in practice that a furnace with a fire-pot 32 inches in diameter, and having ample heating surface, is capable of heating two 50-pupil rooms in zero weather. The sizes of ducts and flues may be determined by rules already given under furnace and indirect steam heating.

The indirect gravity system of steam heating comes next in cost of installation. One important advantage of this system over furnace heating comes from the ability to place the heating coils at the base of the flues, thus doing away with horizontal runs of air pipe, which are required to some extent in furnace heating. The warm-air currents in the flues are less affected by variations in the direction and force of the wind where this construction is possible, and this is of much importance in exposed locations. The method of supplying cold air to the coils or heaters is important, and should be carefully worked out in the manner previously described. Mixing dampers for regulating the temperature of the rooms should be provided for each flue. The effectiveness of these dampers will depend largely upon their construction, and they should be made tight against cold-air

leakage by covering the surfaces or flanges against which they close with some form of asbestos felting. Both inlet and outlet gratings should be provided with adjustable dampers. One of the disadvantages of this system is the delivery of all the heat to the room from a single point, and this not always in a position to give the best results. The outer walls are thus left unwarmed, except as the heat is diffused throughout the room by air currents. When there is considerable glass surface, as in most of our modern schoolrooms, draughts and currents of cold air are frequently found along the outside walls.

A very satisfactory arrangement is the use of indirect heaters for warming the air needed for ventilation, and the placing of direct radiation in the rooms for heating purposes. The general construction of the indirect stacks and flues may be the same, but the heating surface can be reduced, as the air in this case must be raised only to 70 or 75 degrees in zero weather; the heat to offset that lost by conduction, etc., through walls and windows being provided by the direct surface. The mixing dampers are also omitted, and the temperature of the room is regulated by opening or closing the steam valves on the direct coils, which may be done either by hand or automatically. The direct-heating surface, which is best made up of lines of $1\frac{1}{4}$ -inch pipe, should be placed along the outer walls beneath the windows. This supplies heat where most needed, and does away with the tendency to draughts. In mild weather, during the spring and fall, the indirect heaters may prove sufficient for both ventilation and warming.

Where direct radiation is placed in the rooms, the quantity of heat supplied is not affected by varying wind conditions, as is the case in indirect heating. Although the air supply may be reduced at times, the heat quantity is not changed. Direct radiation has the disadvantage of a more or less unsightly appearance, and architects and owners often object to the running of mains or risers through the rooms of the building. Air valves should always be provided with drip connections carried to a sink or dry well in the basement.

When circulation coils are used, a good method of drainage is to carry separate returns from each coil to the basement, and place

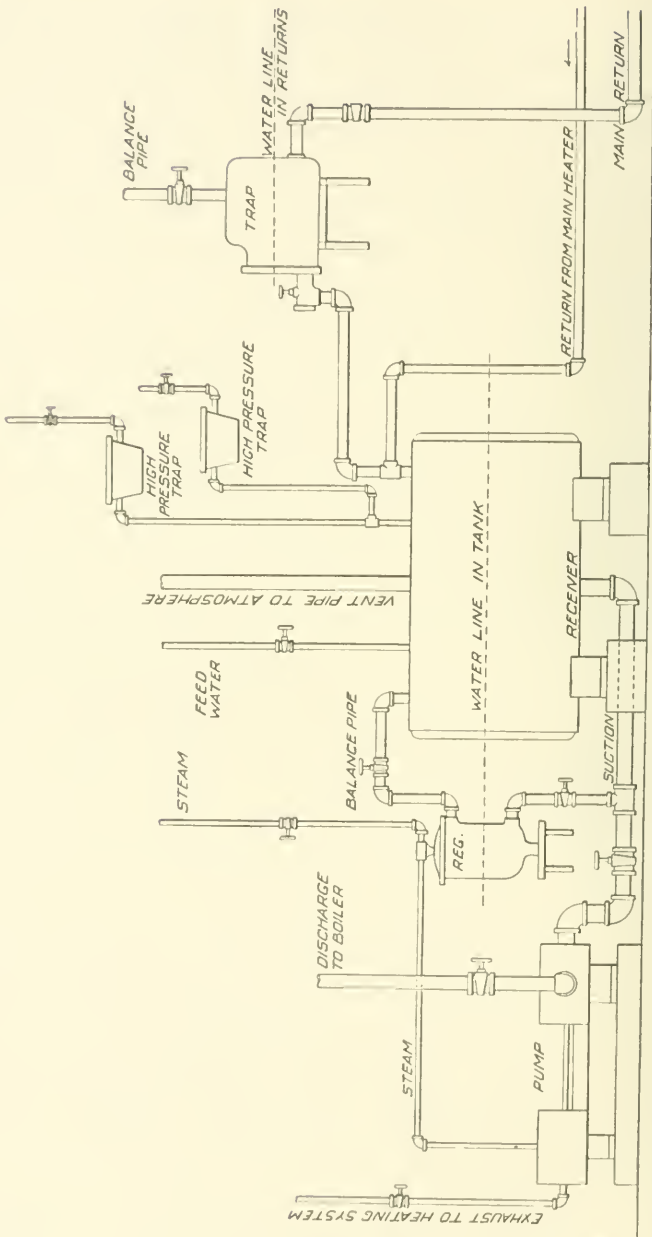

Fig. 35.

the air valves in the drops just below the basement ceiling. A check valve should be placed below the water line in each return.

The fan or blower system for ventilation with direct radiation in the rooms for warming, is considered to be one of the best possible arrangements.

In designing a plant of this kind the main heating coil should be of sufficient size to warm the total air supply to 70 or 75 degrees in the coldest weather, and the direct surface should be proportioned for heating the building independently of the indirect system. Automatic temperature regulation should be used in connection with systems of this kind by placing pneumatic valves on the direct radiation. It is customary to carry from 3 to 8 pounds pressure on the direct system and from 8 to 15 on the main coil depending upon the outside temperature. The foot-warmers, vestibule and office heaters should be placed on a separate line of piping, with separate returns and trap, so that they can be used independently of the rest of the building if desired. Where there is a large assembly hall it should be arranged so that it may be both warmed and ventilated when the rest of the building is shut off. This may be done by a proper arrangement of valves and dampers. When different parts of the system are run on different pressures the returns from each should discharge through separate traps into a receiver having connection with the atmosphere by means of a vent pipe. Fig. 35 shows a common arrangement for the return connections in a combination system of this kind. The different traps discharge into the vented receiver as shown, and the water is pumped back to the boiler automatically when it rises above a given level in the receiver, a pump governor being used to start and stop the pumps as required.

A water level or seal of suitable height is maintained in the main returns by placing the trap at the required elevation and bringing the returns into it near the bottom; a balance pipe is connected with the top for equalizing the pressure the same as in the case of a pump governor. Sometimes a fan is used with the heating coils placed at the base of the flues, instead of in the rooms. Where this is done the radiating surface may be reduced about one-half. This system is less expensive to install, but has the disadvantage

of removing the heating surface from the cold walls where it is most needed.

Churches. Churches may be warmed by furnaces, indirect steam, or by means of a fan. For small buildings the furnace is more commonly used. This apparatus is the simplest of all and is comparatively inexpensive. Heat may be generated quickly, and when the fires are no longer needed they may be allowed to go out without danger of damage to any part of the system from freezing.

It is not usually necessary that the heating apparatus be large enough to warm the entire building at one time to 70 degrees with frequent change of air. If the building is thoroughly warmed before occupancy, either by rotation or by a slow inward movement of outside air, the chapel or Sunday-school room may be shut off until near the close of the service in the auditorium, when a portion of the warm air may be turned into it. When the service ends, the switch damper is opened wide, and all of the air is discharged into the Sunday-school room. The position of the warm-air registers will depend somewhat upon the construction of the building, but it is well to keep them near the outer walls and the colder parts of the room. Large inlet registers should be placed in the floor near the entrance doors, to stop cold drafts from blowing up the aisles when the doors are opened, and also to be used as foot-warmers.

Ceiling ventilators are generally provided, but should be no larger than is necessary to remove the products of combustion from the gaslights, etc. If too large, much of the warmest and purest air will escape through them. The main vent flues should be placed in or near the floor and should be connected with a vent shaft leading outbound. This flue should be provided with a small stove or flue heater made especially for this purpose. In cold weather the natural draft will be found sufficient in most cases. The same general rules follow in the case of indirect steam as have been described for furnace heating. The stacks are placed beneath the registers or flues and mixing dampers provided. If there are large windows, flues should be arranged to open in the window sills so that a sheet of warm air may be delivered in front of the windows, to counteract the effects of cold down drafts from

the exposed glass. These flues may usually be made 3 or 4 inches in depth, and should extend the entire width of the window. Small rooms, such as vestibules, library, pastor's room, etc., are usually heated with direct radiators. Rooms which are used during the week are often connected with an independent heater so that they may be warmed without running the large boilers, as would otherwise be necessary.

When a fan is used it is desirable, if possible, to deliver the air to the auditorium through a large number of small openings. This is often done by constructing a shallow box under each pew, running its entire length, and connecting it with the distributing ducts by means of a pipe from below. The air is delivered at a low velocity through a long slot, as shown in Fig. 36.

The warm-air flues in the window sills should be retained but may be made shallower and the air forced in at a high velocity.

Halls. The treatment of a large audience hall is similar to that of a church, and is usually warmed in one of the three ways already described. Where a fan is used the air is commonly delivered through wall registers placed in part near the floor and partly at a height of 7 or 8 feet above it. They should be made of ample size, so that there will be freedom from draughts. A part of the vents should be placed in the ceiling and the remainder near the floor. All ceiling vents both in halls and churches should be provided with dampers, having means for holding them in any desired position. If indirect gravity heaters are used, it will generally be necessary to place heating coils in the vent flues for use in mild weather; but if the fresh air is supplied by means of a fan there will usually be pressure enough in the room to force the air out without the aid of other means. When the vent air ways

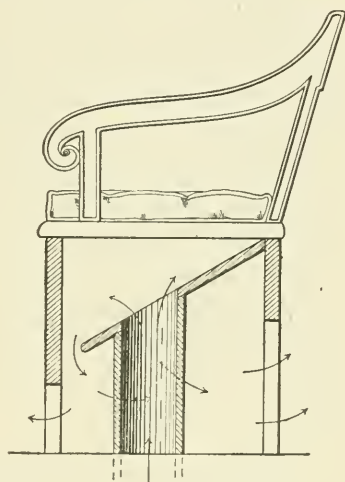

Fig. 36.

are restricted, or the air is impeded in any way, electric ventilating fans are often used. These give especially good results in warmer weather, when natural ventilation is sluggish. The temperature may be regulated either by using the double duct system or by shutting off or turning on a greater or less number of sections in the main heater. After an audience hall is once warmed and filled with people, very little heat is required to keep it comfortable, even in the coldest weather.

Theaters. In designing heating and ventilating systems for theaters, a wide experience and the greatest care are necessary to secure the best results. A theater consists of three parts: the body of the house, or auditorium; the stage and dressing-rooms; and the foyer, lobbies, corridors, stairways and offices. Theaters are usually located in cities, and surrounded with other buildings on two or more sides, thus allowing no direct connection by windows with the external air: for this reason artificial means are necessary for providing suitable ventilation, and a forced circulation by means of a fan is the only satisfactory means of accomplishing this. It is usually advisable to create a slight excess of pressure in the auditorium, in order that all openings shall allow for the discharge rather than the inward leakage of air.

The general and most approved method of air distribution is to force it into closed spaces beneath the auditorium and balcony floors, and allow it to discharge upward through small openings among the seats. One of the best methods is through chair-legs of special latticed design, which are placed over suitable openings in the floor: in this way the air is delivered to the room in small streams at a low velocity without drafts or currents. The discharge ventilation should be largely through ceiling vents, and this may be assisted if necessary by the use of ventilating fans. Vent openings should also be provided at the rear of the balconies either in the wall or ceiling, and these should be connected with an exhaust fan either in the basement or attic, as is most convenient.

The close seating of the occupants produces a large amount of animal heat, which usually increases the temperature from 6 to 10 degrees, or even more; so that in considering a theater once

filled and thoroughly warmed it becomes more of a question of cooling than one of warming to produce comfort.

Office Buildings. This class of buildings may be satisfactorily warmed by direct steam, hot water, or where ventilation is desired by the fan system. Probably direct steam is used more frequently than any other system for this purpose. Vacuum systems are well adapted to the conditions usually found in this type of building, as most modern office buildings have their own light and power plants, and the exhaust steam can be thus utilized for heating purposes. The piping may be either single or double. If the former is used it is better to carry a single main riser to the upper story and run drops to the basement, as by this means the flow of steam and water are in the same direction and much smaller pipes can be used than would be the case if risers were carried from the basement upward. Special provision must be made for the expansion of the risers or drops in tall buildings. They are usually anchored at the center and allowed to expand in both directions. The connections with the radiators must not be so rigid as to cause undue strains or lift the radiators from the floor.

It is customary in most cases to make the connections with the end farthest from the riser; this gives a length of horizontal pipe which has a certain amount of spring, and will care for any vertical movement of the riser which is likely to occur. Forced hot-water circulation is often used in connection with exhaust steam. The water is warmed by the steam in large heaters, similar to feed-water heaters, and circulated through the system by means of centrifugal pumps. This has the usual advantage of hot water over steam, inasmuch as the temperature of the radiators may be regulated to suit the conditions of outside temperature.

Apartment Houses. These are warmed by furnaces, direct steam and hot water. Furnaces are more often used in the smaller houses, as they are cheaper to install, and require a less skilful attendant to operate them. Steam is probably used more than any other system in blocks of larger size. A well-designed single pipe connection with automatic air valves dripped to the basement is probably the most satisfactory in this class of work.

People who are more or less unfamiliar with steam systems are apt to overlook one of the valves in shutting off or turning on steam, and where only one valve is used, the difficulty arising from

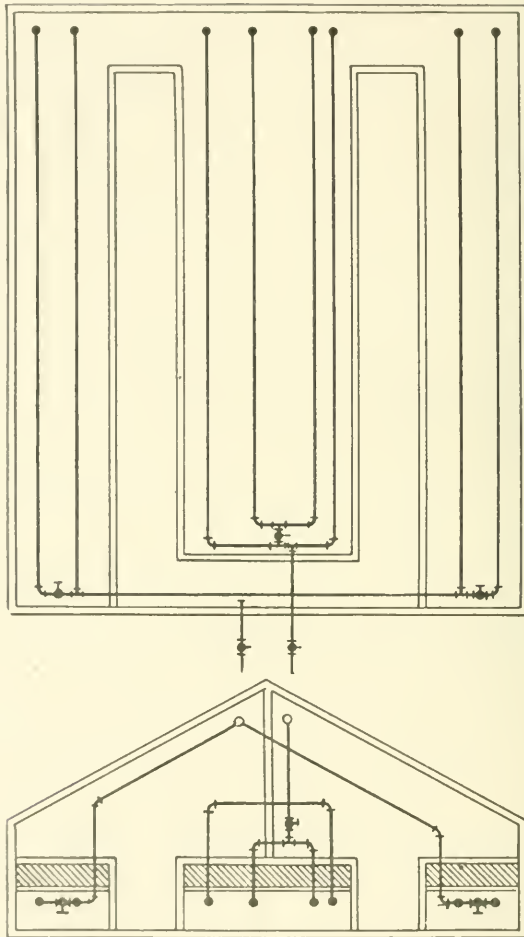

Fig. 37.

this is avoided. Where pet-cock air valves are used they are often left open through carelessness, and the automatic valves, unless dripped, are likely to give more or less trouble.

Greenhouses and conservatories are heated in some cases by

steam and in others by hot water, some florists preferring one and some the other. Either system when properly designed and constructed should give satisfaction, although hot water has its usual advantage of a variable temperature. The methods of piping are in a general way like those already described, and the pipes may be located to run underneath the beds of growing plants or above as bottom or top heat is desired. The main is generally run near the upper part of the greenhouse and to the furthest extremity in one or more branches, with a pitch upward from the heater for hot water and with a pitch downward for steam. The principal

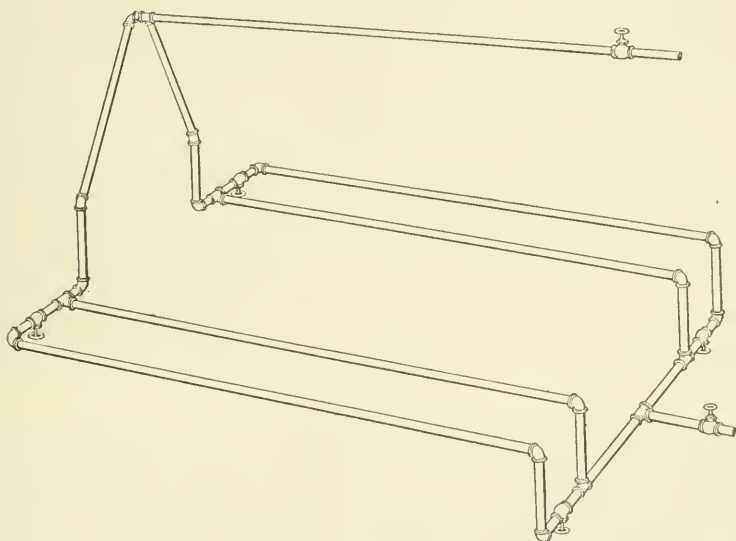

Fig. 38.

radiating surface is made of parallel lines of $1\frac{1}{2}$ inch, or larger, pipe, placed under the benches and supplied by the return current. Figs. 37, 38 and 39 show a common method of running the piping in greenhouse work. Fig. 37 shows a plan and elevation of the building with its lines of pipe, and Figs. 38 and 39 give details of the pipe connections of the outer and inner groups of pipes respectively.

Any system of piping which gives free circulation and which is adapted to the local conditions should give satisfactory results.

The radiating surface may be computed from the rules already given. As the average greenhouse is composed almost entirely of glass we may for purposes of calculation consider it such, and if we divide the total exposed surface by 4 we shall get practically the same result as if we assumed a heat loss of 85 B. T. U. per square foot of surface per hour and an efficiency of 330 B. T. U.

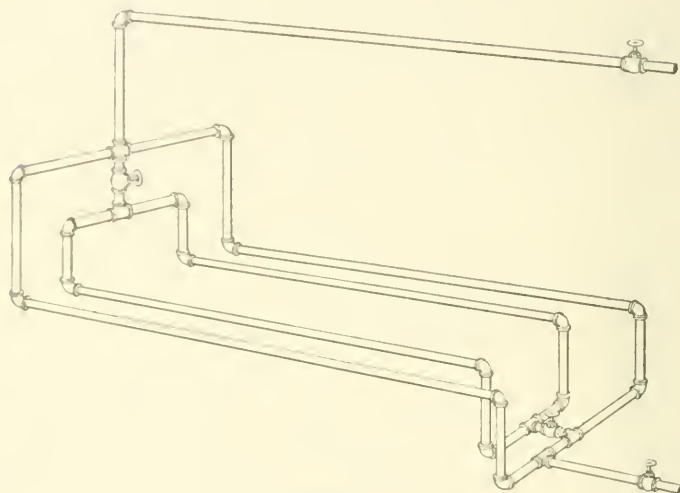

Fig. 39.

for the heating coils; so that we may say in general that the square feet of radiating surface required equals the total exposed surface divided by 4 for steam coils and by 2.5 for hot water. These results should be increased from 10 to 20 per cent for exposed locations.

CARE AND MANAGEMENT.

The care of furnaces, hot-water heaters and steam boilers has been discussed in connection with the design of these different systems of heating, and need not be repeated. The management of the heating and ventilating systems in large school buildings is a matter of much importance, especially in those using a fan system; to obtain the best results as much depends upon the skill of the operating engineer as upon that of the designer.

Beginning in the boiler room, he should exercise special care

in the management of his fires, and the instruction given in "Boiler Accessories" should be carefully followed; all flues and smoke passages should be kept clear and free from accumulations of soot and ashes by means of a brush or steam jet. Pumps and engine should be kept clean and in perfect adjustment, and extra care should be taken when they are in rooms through which the air supply is drawn, or the odor of oil will be carried to the rooms. All steam traps should be examined at regular intervals to see that they are in working order, and upon any sign of trouble they should be taken apart and carefully cleaned.

The air valves on all direct and indirect radiators should be inspected often, and upon the failure of any room to heat properly the air valve should first be looked to as a probable cause of the difficulty. Adjusting dampers should be placed in the base of each flue, so that the flow to each room may be regulated independently. In starting up a new plant the system should be put in proper balance by a suitable adjustment of these dampers, and when once adjusted they should be marked and left in these positions. The temperature of the rooms should never be regulated by closing the inlet registers. These should never be touched unless the room is to be unused for a day or more.

In designing a fan system provision should be made for "air rotation"; that is, the arrangement should be such that the same air may be taken from the building and passed through the fan and heater continuously. This is usually accomplished by closing the main vent flues and the cold-air inlet to the building, then opening the class-room doors into the corridor ways, and drawing the air down the stairwells to the basement and into the space back of the main heater through doors provided for this purpose. In warming up a building in the morning this should always be practiced until about fifteen minutes before school opens. The vent flues should then be opened, doors into corridors closed, and cold-air inlets opened wide, and the full volume of fresh air taken from out of doors.

At night time the dampers in the main vents should be closed, to prevent the warm air contained in the building from escaping. The fresh air should be delivered to the rooms at a temperature of from 70 to 75 degrees, and this temperature must

be obtained by proper use of the shut-off valves, thus running a greater or less number of sections on the main heater. A little experience will show the engineer how many sections to carry for different degrees of outside temperature. A dial thermometer should be placed in the main warm-air duct near the fan, so that the temperature of the air delivered to the rooms can be easily noted.



Fig. 40.

The exhaust steam from the engine and pumps should be turned into the main heater; this will supply a greater number of sections in mild weather than in cold, owing to the less rapid condensation.

STEAM FITTING.

In order to design a system intelligently the engineer should have some knowledge of the methods of actual construction, the tools used, etc. It is customary where a piece of work is to be done to send a supply of pipe and fittings to the building some-

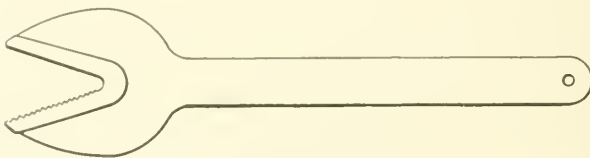

Fig. 41.

what greater than is required, and the workman after receiving the plans of construction, which show the location and sizes of the various pipes to be erected, makes his own measurements, cuts the pipes to the proper length at the building, threads them and screws them into place.

The tools belonging to this trade consist of tongs or wrenches for screwing the pipe together, cutters for cutting, taps and dies for threading the pipe, and vises for holding it in position while cutting or threading. A great variety of tongs and wrenches are

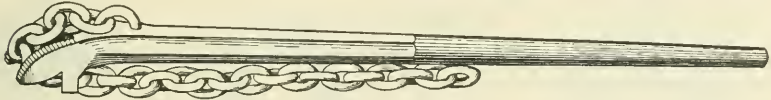

Fig. 42.

to be found on the market. For rapid work no tool is superior to the plain tongs (shown in Fig. 40), especially for the smaller sizes of pipe. The alligator wrench (shown in Fig. 41) is used in a similar manner on light work and where the pipes turn easily.

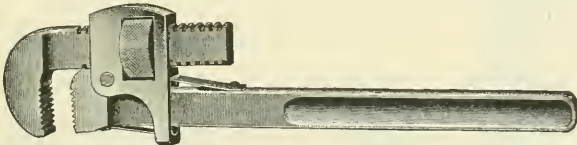

Fig. 43.

For large pipe, chain tongs of some pattern are the best, and may be used with little danger of crushing the pipe. (See Fig. 42.) A form of wrench, known as the Stilson, one form of which is shown in Fig. 43, is widely used. The wrenches or tongs which are used

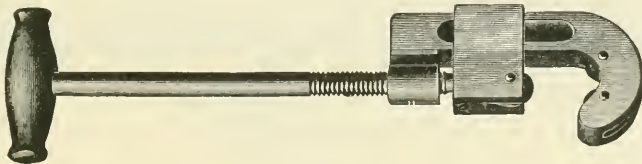

Fig. 44.

for turning the pipe, in most cases, exert more or less lateral pressure, and if too great strength is applied at the handles there is a tendency to split the pipe. The cutter ordinarily employed for small pipe consists of one or more sharp-edged steel wheels,

which are held in an adjustable frame (see Fig. 44); the cutting being performed by applying pressure and revolving it around the pipe. A section of one of the cutting wheels is shown in Fig. 45. With this tool the cutting is accomplished by simply crowding the metal to one side, and hence burrs of considerable size will be formed on the outside and inside of the pipe. Usually the outside burr must be removed by filing before the pipe can be threaded. The inside burr forms a great obstruction

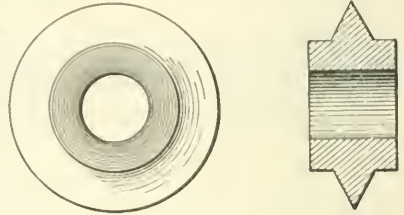

Fig. 45.

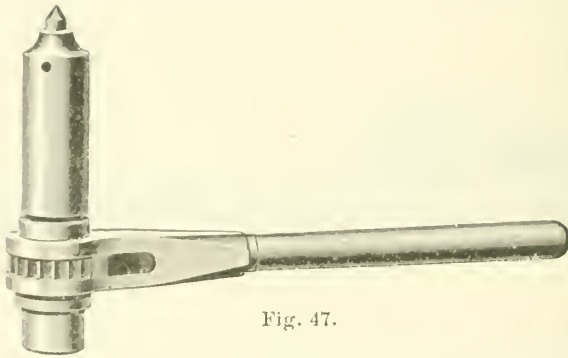

Fig. 47.

to the flow of steam or water, and should in every case be removed by the use of the reamer. There are many forms of reamers for

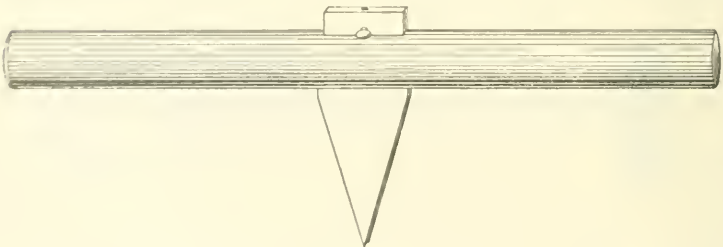

Fig. 46.

use in various cases; one of the simplest is shown in Fig. 46.

The ratchet drill is another tool often used, and is especially useful in drilling holes in pipes or fittings after the work is in

place. One of these is shown in Fig. 47. A common form of vise used for holding the pipe while cutting and threading is shown in Fig. 48. The combination vise is shown in Fig. 49.

The dies for threading the pipes are usually of a solid form, each die fitting into a stock or holder with handles. (See Fig. 50.) The cutting edges of the dies should be kept very sharp and clean, otherwise perfect threads cannot be cut. In cutting threads on wrought iron pipe, oil should always be used, which will tend to prevent heating and crumbling, and make the work easier. In erecting pipe great care should be taken to preserve the proper pitch and alignment, and to appear well the pipes should be screwed together until

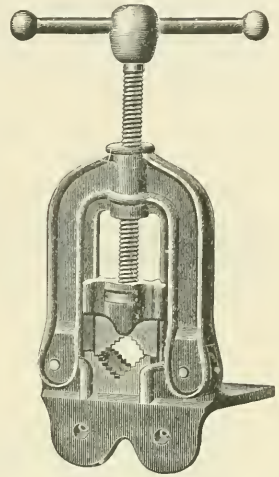

Fig. 48.

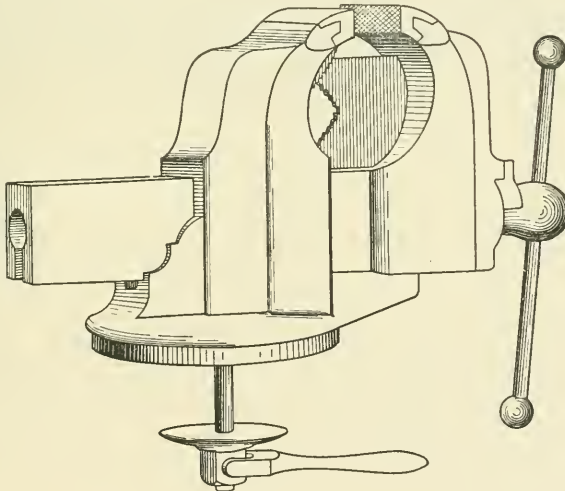

Fig. 49.

no threads are in sight. Every joint should be screwed from 6 to 8 complete turns for sizes 2 inches and under and from 8 to 12 turns for the larger sizes, otherwise there will be danger of leakage.

In screwing pipes together, red or white lead is often used.

It will generally be found that linseed or some good lubricating oil will be equally valuable. If possible, the work should be arranged so that it can be made up with right and left couplings or other fittings.

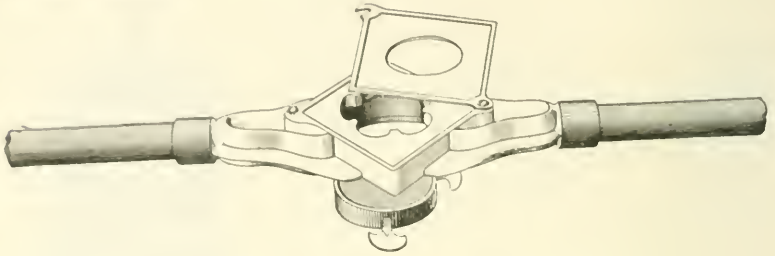

Fig. 50.

Packed joints, especially unions, are objectionable and likely to leak after use. Flange-unions with copper gaskets should be used on heavy work. Good workmanship in pipe-fitting is shown by the perfection with which small details are executed, and poor workmanship in any of the particulars mentioned may defeat the perfect operation of the best designed plant.

EXAMINATION PAPER.

HEATING AND VENTILATION
PART III.

HEATING AND VENTILATION.

Read carefully the following instructions: Place your name and full address at the head of the paper. Any cheap light paper like the sample previously sent you may be used. Do not crowd your work, but arrange it neatly and legibly. Work out in full the examples, showing each step in the work, and mark all answers plainly, "Ans." *Do not copy answers from the instruction paper; use your own words.* After completing the work add and sign the following statement:

I hereby certify that the above work is entirely my own.
(Signed)

1. A main heater contains 1,040 square feet of heating surface made up of wrought iron pipe, and is used in connection with a fan which delivers 528,000 cubic feet of air per hour. The heater is 20 pipes deep and has a free area between the pipes of 11 square feet. If air is taken at zero, to what temperature will it be raised with steam at 5 pounds pressure?

Ans. 140°.

2. A nine-foot fan running at 130 revolutions delivers 40,000 cubic feet of air per minute. If the fan is speeded up to 169 revolutions, and an electric motor substituted for the engine, what will be the rating of the required motor?

3. What precaution must be taken in connecting the radiators in tall buildings.

4. Give the size of heater from Table II, which will be required to raise 672,000 cubic feet of air per hour, from 10° below zero to 90°, with a steam pressure of 20 pounds. If the air quantity is raised to 840,000 cubic feet per hour through the same heater, what will be the resulting temperature with all other conditions the same?

Ans. 85.5°.

5. A fan running at 150 revolutions produces a pressure of $\frac{1}{2}$ ounce. If the speed is increased to 210 revolutions, what will be the resulting pressure?

6. A certain fan is delivering 12,000 cubic feet of air per minute, at a speed of 200 revolutions. It is desired to increase the amount to 18,000 cubic feet. What will be the required

speed? If the original power required to run the fan was 4 H. P., what will be the final power due to the increased speed?

7. What size fan will be required to supply a schoolhouse having 300 pupils, if each is to be provided with 3,000 cubic feet of air per hour? What speed of fan will be required, and what H. P. of engine?

8. What advantages has the plenum method of ventilation over the exhaust method?

9. A church is to be warmed and ventilated by means of a fan and heater. The air supply is to be 300,000 cubic feet per hour. The heat loss through walls and windows is 200,000 B. T. U., when it is 10° below zero. How many square feet of heating surface will be required, and how many rows of pipe deep must the heater be with steam at 5 pounds pressure?

Ans. 14 rows.

10. A schoolhouse requiring 600,000 cubic feet of air per hour is to be supplied with a cast iron sectional heater. How many square feet of radiating surface will be required to raise the air from 10° below zero to 70° above, with a steam pressure of 20 pounds?

Ans. ⁸²⁸~~582~~ square feet.

11. What velocities of air-flow in the main duct and branches are commonly used in connection with a fan system?

12. A main heater is to be designed for use in connection with a fan. How many square feet of radiation will be required to warm 1,000,000 cubic feet of air per hour, from a temperature of 10° below zero to 70° above, with a steam pressure of 20 pounds and a velocity of 800 feet per minute between the pipes of the heater? How many rows of pipe deep must the heater be?

Ans. 882 square feet.

13. State in a brief manner the essential parts of a system of automatic temperature control.

14. What advantage does an indirect steam heating system have over furnace heating in schoolhouse work?

15. The air in a restaurant kitchen is to be changed every 10 minutes by means of a disc fan. The room is $20 \times 30 \times 10$. Give size and speed of fan and H. P. of motor.

16. What forms of heating are best adapted to the warming of apartment houses?

17. Give an approximate method for finding the heating surface required for greenhouses, both for steam and hot water.

18. How does the cost of electric heating compare with that by steam and hot water?

19. Describe briefly the construction of an electric heater, and the principle upon which it works.

20. A school building of 4 rooms is to be supplied with 600,000 cubic feet of air per hour. The heat loss from the building is 300,000 B. T. U. per hour in zero weather. Give the square feet of grate surface required in the furnaces.

21. What is a double duct system as applied to forced blast heating? What are its advantages?

22. What is a thermostat? Give the principles upon which two different kinds operate.

23. Describe briefly the connections to be made in a system of electric heating. In what way do they correspond to the piping in a system of steam heating?

24. State certain points to be observed in the introduction of air for the ventilation of churches and theatres.

25. A shop 100 feet long, 50 feet wide and 5 stories, each 10 feet high, is to be warmed by forced blast using steam at 80 pounds pressure. The full amount of air passed through the heater is to be taken from out of doors, and the entire air of the building changed 3 times an hour. Give linear feet of 1 inch pipe required for heater, and size of fan and engine.

Ans. $\left\{ \begin{array}{l} 1,666 \text{ feet of pipe.} \\ 5\text{-foot fan.} \\ 4 \text{ H. P. engine.} \end{array} \right.$

26. In what cases would you use a disc fan in preference to a blower?

27. The heat loss from a room is 12,000 B. T. U. per hour. How many Kilowatt-hours will be required to furnish the necessary heat?

28. What is one of the best systems for the heating and ventilation of school buildings of large size?

29. What form of heating system would you recommend for a four-room school?

30. A factory 250 feet long by 50 feet wide has two stories, each 10 feet high. Each floor is to have a separate fan and heater, but the fans are to be driven by the same electric motor. The lower floor is to be supplied with air from out of doors and is to have a complete change of air every 20 minutes. On the upper floor the air is to be returned to the heater from the room, and the entire contents is to pass through the heater every 15 minutes. Exhaust steam is to be used in both heaters. Give sizes of fans, heaters and motor.

Ans. $\left\{ \begin{array}{l} \text{Lower floor } 3\frac{1}{2}\text{-foot fan.} \\ \text{Upper floor } 4\text{-foot fan.} \end{array} \right.$

PLUMBING

PART I.

INSTRUCTION PAPER



AMERICAN SCHOOL OF CORRESPONDENCE

[CHARTERED BY THE COMMONWEALTH OF MASSACHUSETTS]

BOSTON, MASSACHUSETTS

U. S. A.

PREPARED BY
CHARLES L. HUBBARD, M.E.,
OF
S. HOMER WOODBRIDGE COMPANY.
HEATING, VENTILATION AND SANITARY ENGINEERS.

*Copyright 1903, by
American School of Correspondence
Boston, Mass.*

PLUMBING.

PLUMBING FIXTURES.

Bath Tubs. There are many varieties of bath tubs in use at the present time, ranging from the wooden box lined with zinc or copper which was in common use a number of years ago and is still to be found in the old houses, to the finest crockery and enameled tubs which are now used in the best modern plumbing. In selecting a tub we should choose one with as little woodwork about it as possible. Those lined with zinc or copper are hard to keep clean and are liable to leak and are, therefore, undesirable from a sanitary standpoint. The plain cast iron tub, painted, is the next in cost. This makes a serviceable and satisfactory tub if

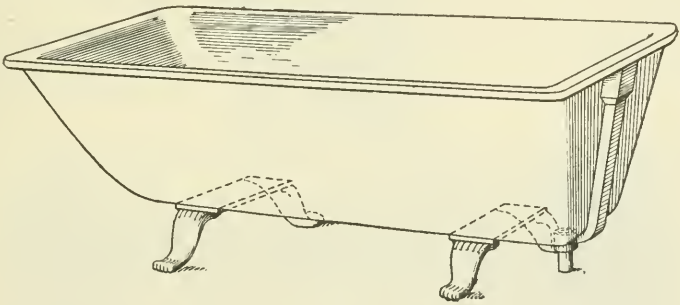

Fig. 1.

kept painted; it is used quite extensively in asylums, hospitals, etc. One of this type is shown in Fig. 1. These are sometimes galvanized instead of being painted.

The "steel-clad" tub shown in Fig. 2 is a good form for a low-priced article. This tub is formed of sheet steel and has a lining of copper. This form is light and easy to handle; it is an open fixture the same as the cast iron tub and requires no casing. It is provided with cast iron legs and a wooden cap. Probably the most common form to be found in the average house at the present time is the porcelain lined iron tub as shown in Fig. 3.

This has a smooth interior finish and is easily kept clean. It will not, however, stand the hard usage of those above described as the lining is likely to crack if struck by any hard substance.

In Fig. 4 is shown a crockery or porcelain tub arranged for needle and shower baths. This is a most sanitary article in every respect and requires no woodwork of any kind; being made of one

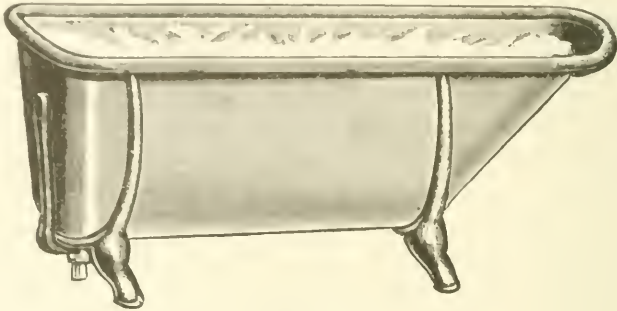

Fig. 2.

piece, there is no chance for dirt to collect. It is a heavy tub and requires great care in handling. This material is very cold to the touch until it has become thoroughly warmed by the hot water. Fig. 5 shows a seat bath and Fig. 6 a foot bath, both of which are



Fig. 3.

very convenient and should be placed in all well equipped bath rooms if the expense does not prohibit their use.

Water Closets. There is a great variety of water closets from which to choose, many operating upon the same principle but varying slightly in form and finish. The best are made of

porcelain, the bowl and trap being in one piece without corners or crevices so that they are easily kept clean. The top of the bowl is provided with a wooden rim and cover. The general arrangement of seat and flushing tank is shown in Fig. 7. A section through the bowl is shown in Fig. 8. This type is known as a

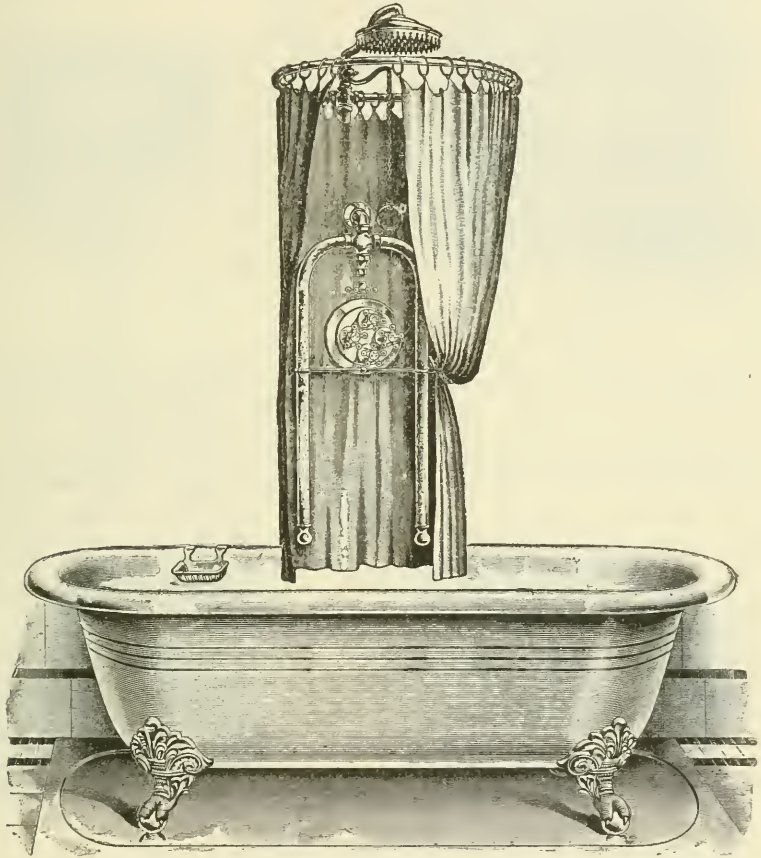

Fig. 4.

syphon closet, and those made on this principle are probably the most satisfactory of any in present use. They are made in different forms by various manufacturers but each involves the principle which gives it its name. Water stands in the bottom as shown, thus forming a seal against gases from the sewer.

When the closet is flushed, water rushes down the pipe and fills the small chamber at the rear which discharges in a jet at the bottom as shown by the arrow. The syphon action thus set up draws the entire contents of the bowl over into the soil pipe. In the meantime a part of the water from the tank fills the hollow rim of the bowl and is discharged in a thin stream around the

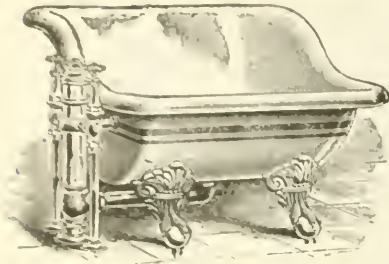

Fig. 5.

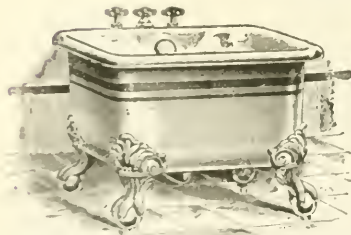

Fig. 6.

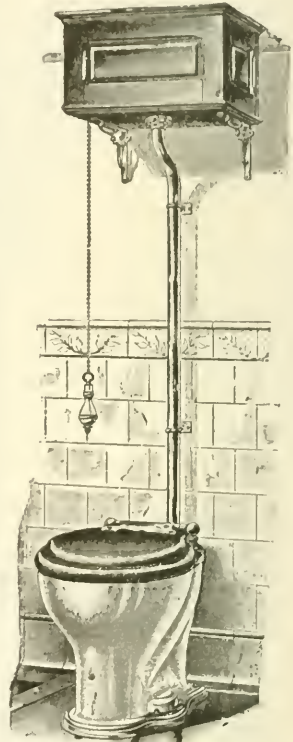

Fig. 7.

entire perimeter which thoroughly washes the inside of the bowl each time it is flushed. Fig. 9 shows a form called the "wash-out" closet. In this case the whole of the water is discharged through the flushing rim but with greater force at the rear which washes the contents of the upper bowl into the lower which overflows into the soil pipe. This is a good form of closet and is widely used. A similar form, but without the upper bowl is

shown in Fig. 10. This is known as the "wash down" closet and operates in the manner already described. The water enters the bowl through the flushing rim and discharges its contents by

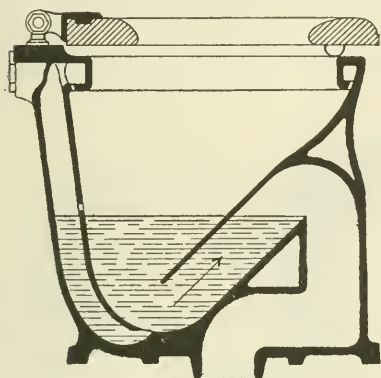

Fig. 8.

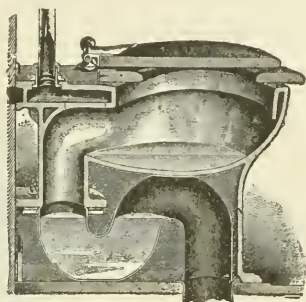

Fig. 9.

overflowing into the soil pipe. This is a simple form of closet and easily kept clean.

One of the simplest closets is the "hopper" shown in Fig. 11. This consists of a plain bowl of porcelain or cast iron tapering to

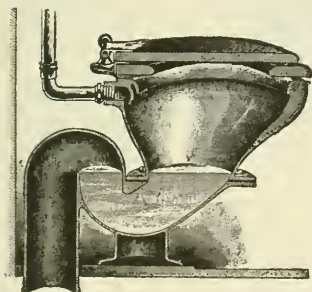

Fig. 10.



Fig. 11.

an outlet about 4" in diameter at the bottom. It is connected directly with the soil pipe as shown. The trap may be placed either above the floor or below as desired. They are provided with a flushing rim at the top similar to that already described. This type of closet is the cheapest but at the same time the least satisfactory of any of the different kinds shown.

It is sometimes desirable to place a closet in a location where there would be danger of freezing if the usual form of flushing tank was used. Fig. 12 shows an arrangement which may be used in a case of this kind. The valve and water connections are placed below the frost line and a pipe not shown in the cut is carried up to the rim of the bowl. When the rim is shut down the

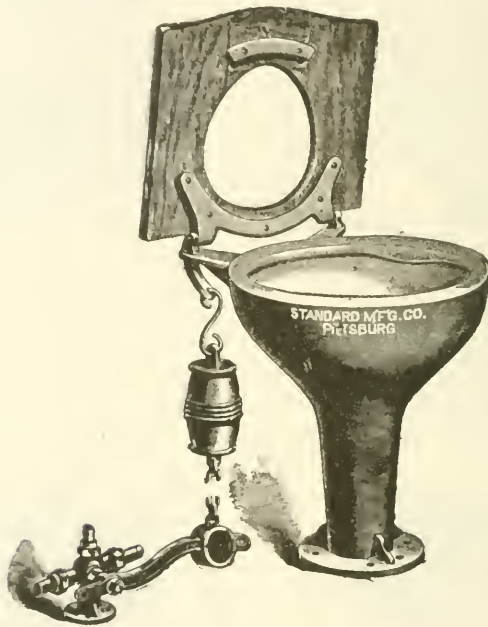

Fig. 12.

valve is opened by means of the chain attached to it and water flows through the bowl while in use. When released, the weight on the lever closes the valve and raises the wooden rim to its original position. Any water which remains in the flush pipe is drained to the soil pipe through a small drip pipe which is seen in the cut.

Urinals. A common form of urinal is shown in Fig. 13. The partitions and slab at the back are either of slate or marble and the bowl of porcelain. They may be flushed like a closet. Fig. 14 shows a section through the bowl and indicates the

manner of flushing, partly through the rim and partly at the back. The trap or seal is shown at the bottom. Another form is shown in Fig. 15. In this case the bowl remains partly filled with water which forms a seal as shown. It is flushed both through the rim and the passage at the back. In action it is the same as the syphon closet shown in Fig. 8 and the bowl is drained each

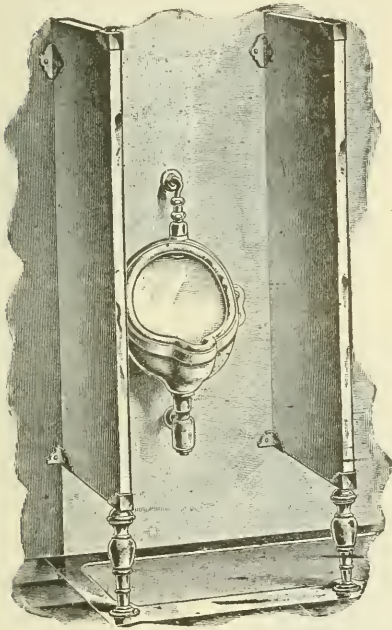

Fig. 13.

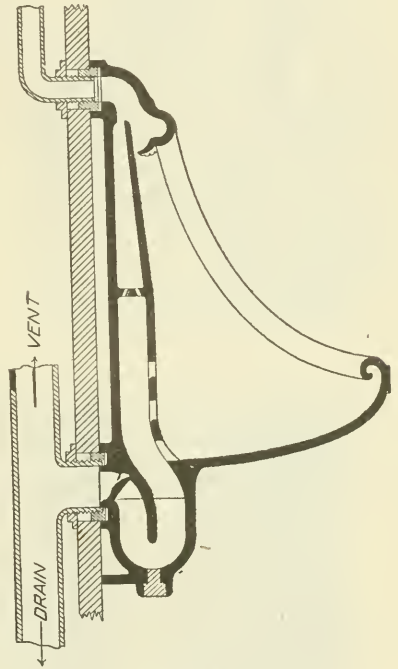

Fig. 14.

time it is flushed, but immediately fills with water to the level indicated.

An automatic flushing device is illustrated in Fig. 16. When the water line in the tank reaches a given level, the float lever releases a catch and flushes the urinal. The intervals of flushing can be regulated by adjusting the cock shown in the inlet pipe, near the bottom of the tank.

A simple form of urinal commonly used in schools and public buildings is shown in Fig. 17. This is flushed by means of

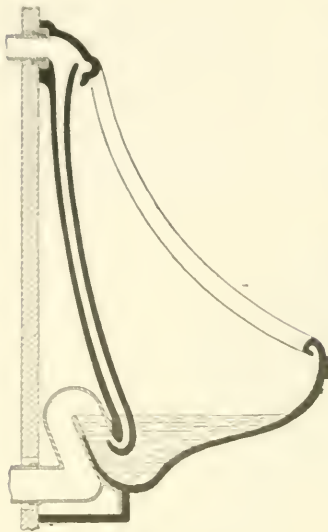

Fig. 15.

small streams of water which are discharged through the perforated pipe near the top of the slab at the back and run down in a thin sheet to the gutter at the bottom.

Lavatories. Bowls and lavatories can be had in almost any form. Fig. 18 shows a simple corner lavatory, made of porcelain and provided

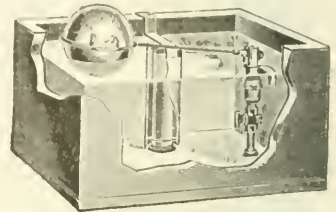

Fig. 16.

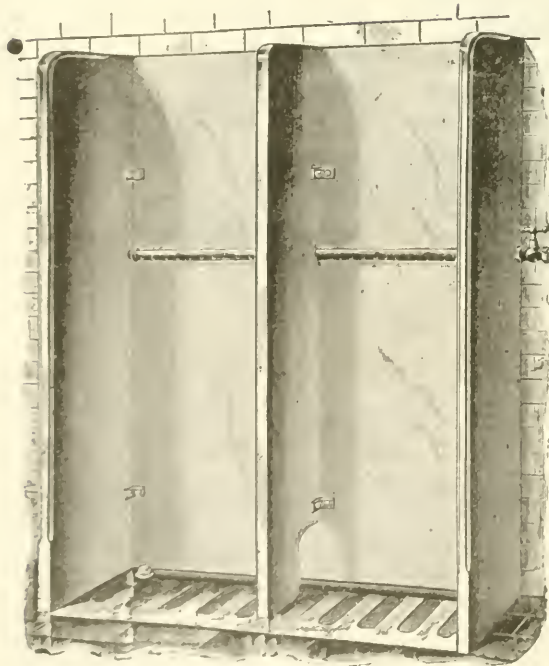

Fig. 17.

with hot and cold water faucets. It has an overflow, shown by the small openings at the back and a rubber plug for closing the drain at the bottom.

The lavatory shown in Fig. 19 is provided with marble slabs and is more expensive. Fig. 20 shows a section through the bowl. The waste pipe is at the back, which

brings the plug and chain well out of the way. A pattern still more elaborate is shown in Fig. 21, and a section through the bowl in Fig. 22. The waste pipe plug in this case is in the form of a hollow tube and acts as an overflow when closed and as a strainer when open. It is held open by means of a slot and

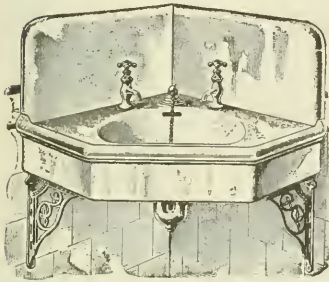

Fig. 18.

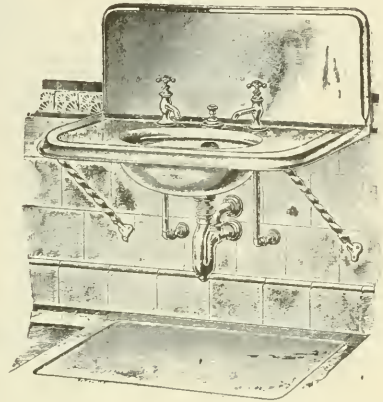

Fig. 19.

pin near the top. Fig. 23 shows a bowl so arranged that either hot, cold or tepid water may be drawn through the same opening which is placed well down in the bowl where it is out of the way.

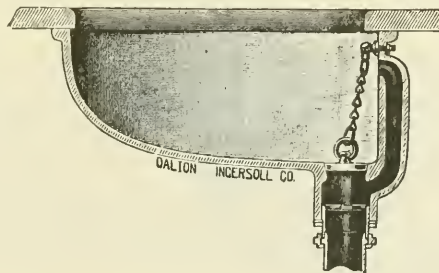

Fig. 20.

Sinks. Sinks are made of plain wood, and of wood lined with sheet metal, such as copper, zinc or galvanized iron. They are also made of sheet steel, cast iron, either plain, galvanized or enameled, and of soapstone and porcelain. Each has its advantages and disadvantages. The wooden sink is liable to leak,

and is difficult to keep thoroughly clean. The lined sink is most satisfactory when new, but holes are quite easily cut or punched through the lining and it then becomes very objectionable from a sanitary standpoint as the greasy water and vegetable matter which works through the opening causes the woodwork to decay rapidly and to give off in the process a gas which is not

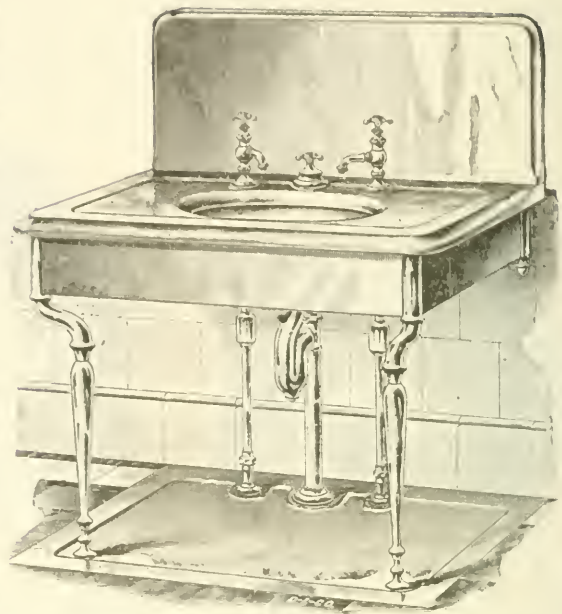

Fig. 21.

only unhealthful but tends to destroy the lining of the sink from the underside so that its destruction is rapid after a leak is once

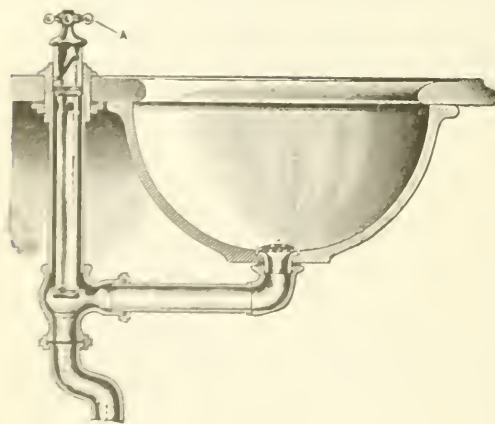

Fig. 22.

started. The cast iron sink is satisfactory. The appearance is improved by galvanizing, but this soon wears off on the inside. Enamelled sinks are easily kept clean but likely to become cracked or broken from hard usage or from extremes of hot or cold; the porcelain sink has the same defects;

they are both however well adapted to places where they will receive careful usage.

Taking all points into consideration the soapstone sink may perhaps be considered the most satisfactory for all-around use.

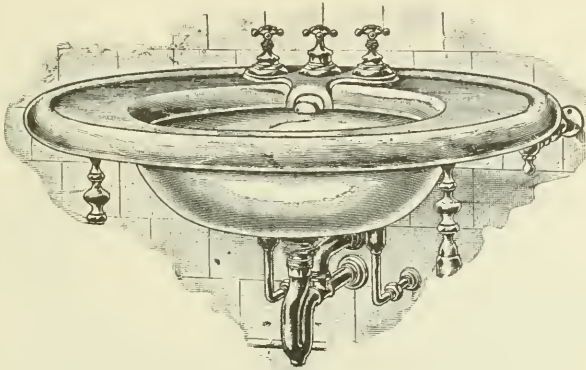

Fig. 23.

It will not absorb moisture ; is not affected by the action of acids ; oil or grease will not enter the pores and it is not injured by hot water nor liable to crack.

Fig. 24 shows the ordinary cast iron sink, made to be set in a wooden casing ; this is not to be recommended however, and it is

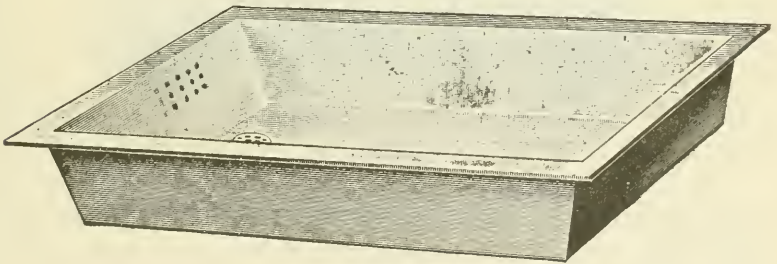

Fig. 24.

much better to support them upon iron brackets or legs. Fig. 25 shows an enameled sink mounted in this way. A porcelain sink with dish racks is shown in Fig. 26. This is a good form for a pantry sink which is used only for washing cutlery, glassware,

crockery, etc., and is not subjected to hard usage. A slop sink is shown in Fig. 27. This, as will be noticed, is provided with an extra large waste pipe and trap to prevent clogging. These sinks are made of cast iron with different finishes and of porcelain.

Set tubs for laundry use are made of soapstone, slate, cast



Fig. 25.

iron (enameled or galvanized) and of porcelain. What has been said in regard to kitchen sinks applies equally well in this case.

A set of enameled tubs is shown in Fig. 28.

Traps. A trap is a loop or water seal placed in a pipe to prevent the gases from the drain or sewer from passing up through the waste pipes of the fixtures into the rooms. A common form made up of cast iron pipe and known as a "running trap" is shown in Fig. 29. A trap of this form is placed in the main drain pipe of a

building outside of all the connections to prevent gases from the main sewer or cesspool from entering the building. A removable cover is placed on top of the trap to give access for cleaning.

The floor trap shown in section in Fig. 30 is made both of brass and of lead. It is commonly used for kitchen sinks and is placed on the floor just beneath the fixture. It is provided with a removable trap screw or clean-out for use when it is desired

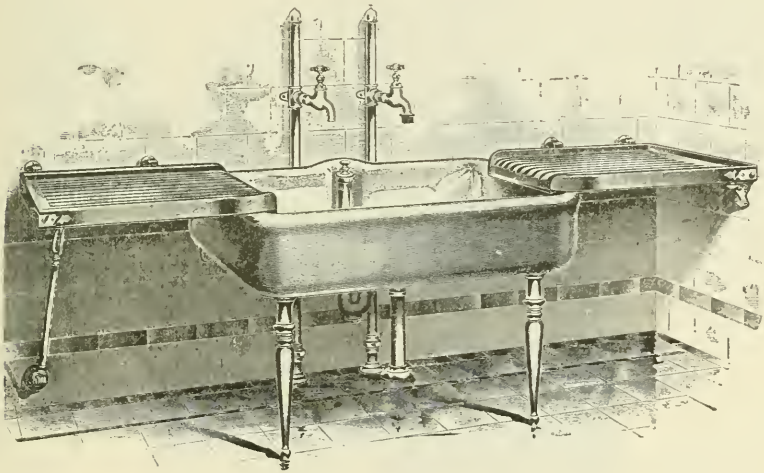

Fig. 26.

to remove grease or sediment from the interior. Fig. 31 shows a common form for lavatories, which consists simply of a loop in the waste pipe. These are usually made of brass and nickel plated when used with open fixtures. A trap for similar purposes is shown in Figs. 32 and 33.

Figs. 34 and 35 show a form known as the centrifugal trap on account of the rotary or whirling motion given to the water by the peculiar arrangement of the inlet and outlet. This motion carries all solid particles to the outside and discharges them with the water, thus keeping the trap clear of sediment. Where there is likely to be a large amount of grease in the water as in the case of waste from a hotel or restaurant it becomes necessary to use a special form of separating trap to prevent the waste pipes from becom-

ing clogged. A grease trap designed for this purpose is shown in Fig. 36. Its action is readily seen as the fatty matter will be separated, first by dropping into a large body of cold water and then being driven against the center partition before an outlet can be gained. The grease then rises to the surface where it cools and can then be easily removed as often as necessary.

Sometimes a cellar or basement is drained into a sewer which



Fig. 27.

is liable to be filled at high tide or from other causes and a special trap or check must be used to prevent the cellar from becoming flooded. Such a trap is shown in Fig. 37. When water flows in from below, the float rises, and the rubber rim pressing against the valve seat prevents any passage through the trap; the cut shows the valve closed by the action of high water.

Tanks or cisterns for flushing closets or other fixtures are usually made of wood and lined with zinc or copper. These are generally placed inside a finished casing. A common form is shown

in Fig. 38. The arrangement of valves for supplying water to the tank and for flushing the fixtures is shown in Fig. 39. The large float or ball cock regulates the flow of water into the tank from the street main or house tank. When the water in the tank

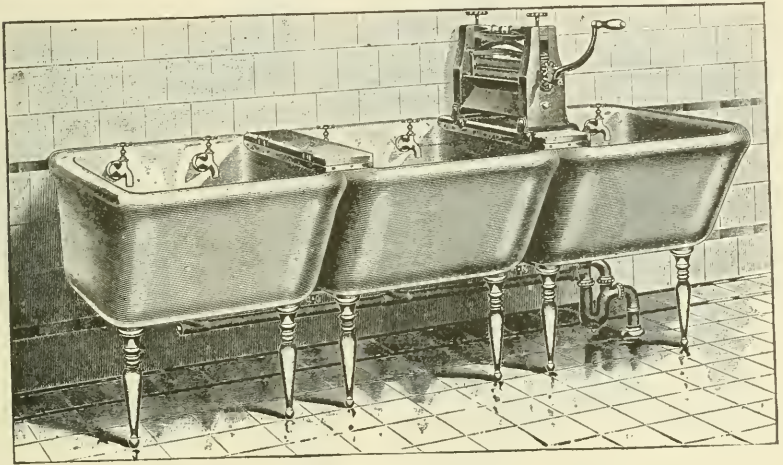

Fig. 28.

falls below a certain level the float drops and opens a valve, thus admitting more water, and closes again when the tank is filled. The closet is flushed by pulling a chain attached to the lever at the right which opens the valve in the bottom of the tank and admits water to the flushing pipe. In this form the valve remains open only while the lever is held down by the chain, the weight on the other end of the lever closing the valve as soon as the chain is released. Another form which is partially automatic is shown in Fig. 40. When the chain is pulled it raises the central valve from its seat and allows the water to flow down the flush pipe until the tank is nearly empty. When empty, the strong suction seals the valve which remains closed until the chain is again pulled. In this type of valve a single pull of the chain is sufficient to flush the closet without further attention.

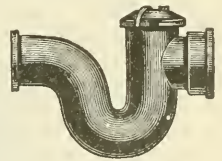

Fig. 29.

A purely automatic flushing device is shown in Fig. 41.

The chain in this case is attached to the rim of the seat so that when it is pressed down, the valve in the compartment at the bottom, connecting with the flush pipe is closed and at the same time

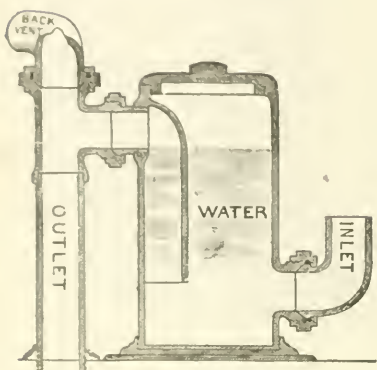

Fig. 30.

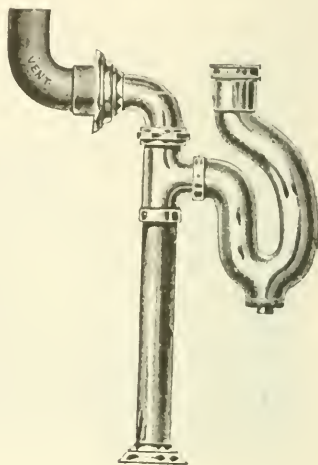

Fig. 31.

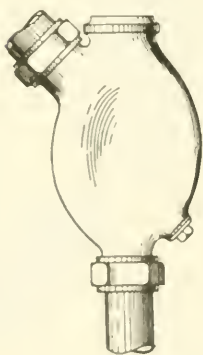

Fig. 32.

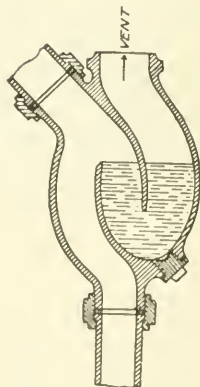

Fig. 33.

communication is opened between the two compartments. When the pull on the chain is released the valve connecting the flush pipe is opened and the opening between the compartments closed

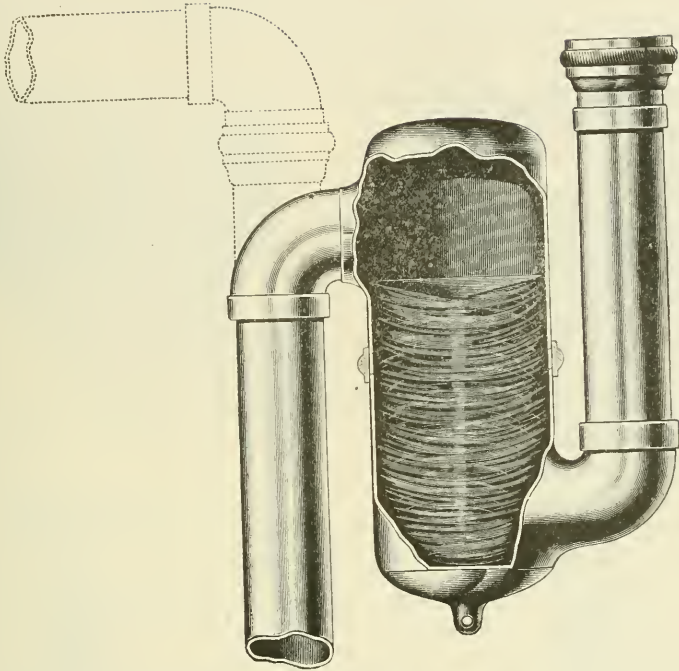

Fig. 34.

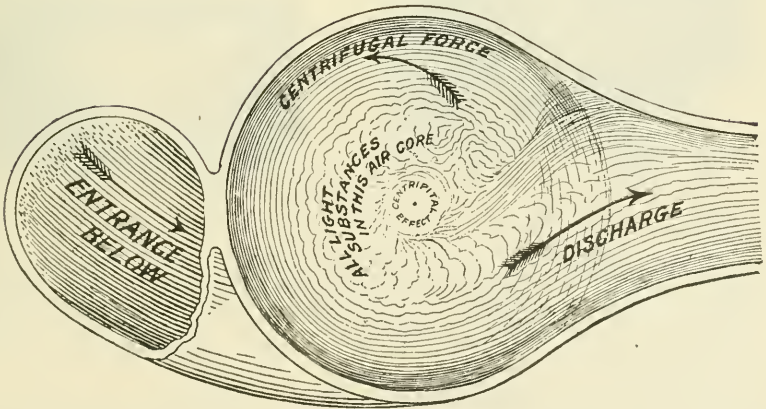

Fig. 35.

so that the water in the lower portion of the tank flows through the flush pipe into the closet automatically, and when empty no more can be admitted until the lever is again pulled down and the valve in the partition opened.

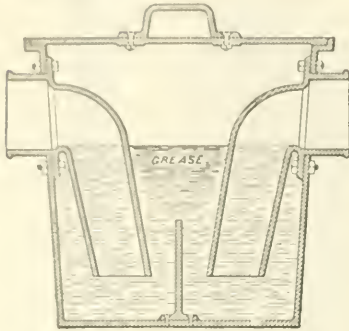

Fig. 36.

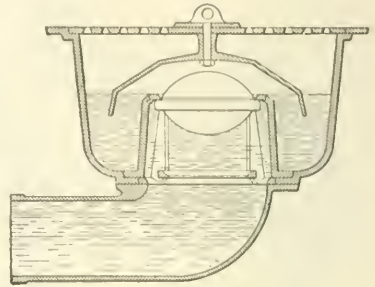

Fig. 37.

Faucets. There are many different forms of faucets in use. The most common is the compression cock shown in Fig. 42. This has a removable leather or asbestos seat which requires renewing from time to time as it becomes worn. Fig. 43 shows a similar form, in which the valve seat is free to adjust itself, being held in place by a spring. Another

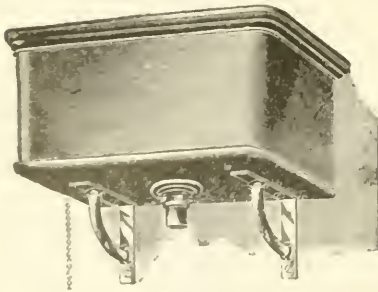

Fig. 38.

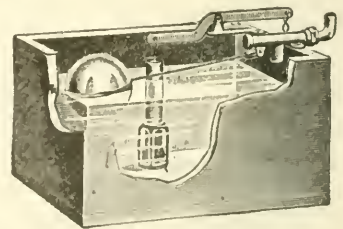

Fig. 39.

style often used in hotels and other public places is the self-closing faucet. These are fitted with springs in such a way that they remain closed except when held open. Two different forms are shown in Figs. 44 and 45.

There are various arrangements for mixing the hot and cold water for bowls and bath tubs before it is discharged. This is

accomplished by having both faucets connect with a common nozzle. Such a device for a lavatory is shown in Fig. 46.

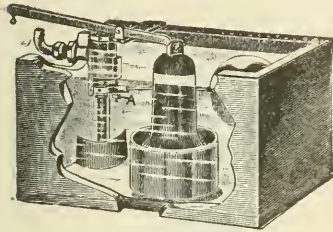

Fig. 40.

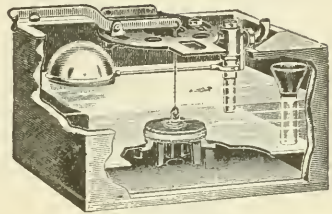

Fig. 41.

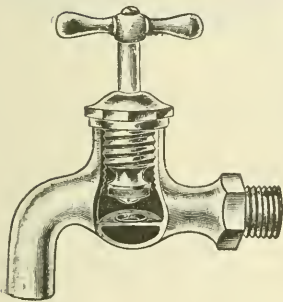

Fig. 42.

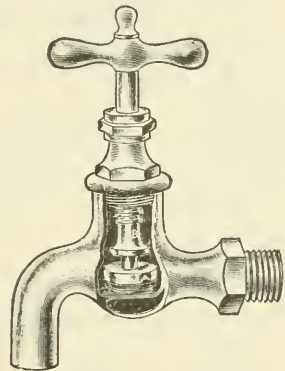

Fig. 43.

SOIL AND WASTE PIPES.

Cast-Iron Pipe. There are many different forms of soil pipes and fittings, and one can best acquaint himself with these by looking over the catalogues of different manufacturers. Figs. 47 and 48 show two lengths of soil pipe; the first is the regular pattern, having only one hub, and the second is a length of double-hub pipe; this can be used to good advantage where many short pieces are required.

Figs. 49 to 57 show some of the principal soil pipe fittings. Figs. 49, 50, 51, 52 and 53 show quarter, sixth, eighth, sixteenth

and return bends respectively, and by the use of these almost any desired angle can be obtained. Different lines of pipe may be connected by means of the Y and T-Y branches shown in Figs.

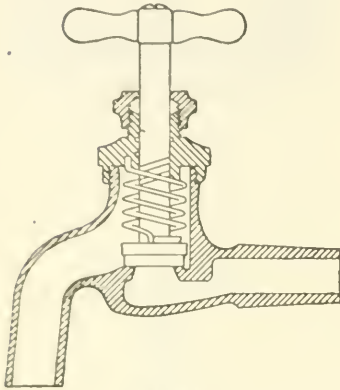

Fig. 44.

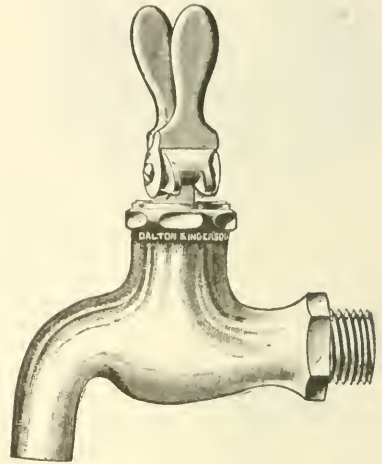

Fig. 45.

54, 55, 56 and 57. The T-Y fitting, Fig. 56, is used in place of the Y branch, Fig. 54, in cases where it is desired to connect two pipes which run perpendicular to each other.

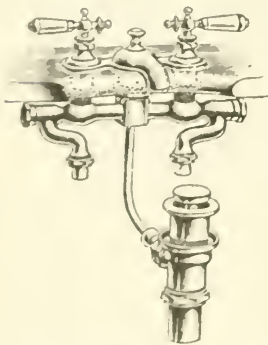

Fig. 46.

The double T-Y, Fig. 57, is convenient for use in double houses where a single soil pipe answers for two lines of closets.

Pipe Joints. Great care should be given to making up the joints in a proper manner, as serious results may follow any defective workmanship which allows sewer gas to escape into the building. In making up a joint, first place the ends of the pipes in position and fasten them rigidly, then pack the joint with the best picked oakum.

In packing the oakum around the hub, the first layer must be twisted into a small rope so that it will drive in with ease and still not pass through to the inside of the pipe where the ends join.

In a 4-inch pipe the packing should be about 1 inch in thickness and calked perfectly tight so that it will hold water of itself without the lead. Just before the packing is driven tightly into



Fig. 47.



Fig. 48.

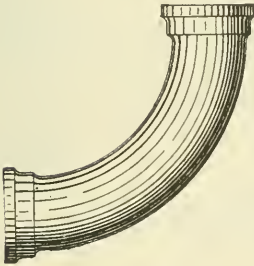

Fig. 49.

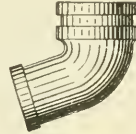

Fig. 50.

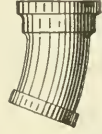

Fig. 51.



Fig. 52.

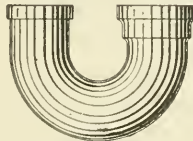

Fig. 53.

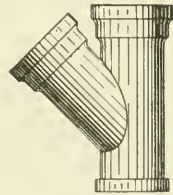

Fig. 54.

the hub, the joint should be examined to see that the space around the hub is the same, so that the lead will flow evenly and be of the same thickness at all points, as the expansion and contraction

will work an imperfect joint loose much sooner than one in which the lead is of an even thickness all the way around. Only the best of clean soft lead should be used for this purpose. In calking in the lead after it has been poured, great care must be exercised, as the pipe, if of standard grade, is easily cracked and will stand but little shock from the calking chisel and hammer.

Fig. 58 shows a section through the calked joint of a cast iron soil pipe.

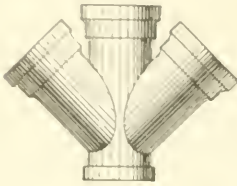

Fig. 55.

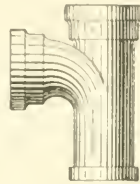

Fig. 56.

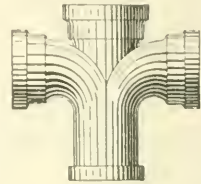

Fig. 57.

Wrought Iron Pipe. This is used but little in connection with the waste pipes except for the purpose of back venting where it may be employed with screwed joints the same as in steam work. It is sometimes used where only small drain pipes are

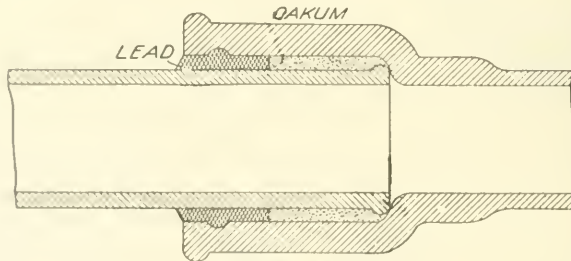

Fig. 58.

necessary, but is not desirable as it is likely to become choked with rust or to be eaten through by moisture from the outside.

Brass Pipe. Brass pipe, nickle plated, is largely used for connecting open fixtures, such as lavatories or bath tubs, with the soil pipe. It is common to use this for the exposed portions of the connections and to use lead for that part beneath the floor or in partitions. The various fittings are also made of brass and finished in a similar manner.

Lead Pipe. For sinks, bath tubs, laundry tubs, etc., nothing is better for carrying off the waste water than lead pipe, for the reason that it has a smooth interior surface which offers a small resistance to the flow of water, and does not easily collect dirt or sediment. It can also be bent in easy curves which is an advantage over fittings which make abrupt turns; this is especially important in pipes of small size.

Pipe Joints. There are two common methods of making joints in lead pipe, known as the "cup joint" and the "wipe joint." The first is suitable only on small pipes or very light pressures. This is made by flanging the end of one of the pipes and inserting the other, then filling in the flange with solder by means of a soldering iron, see Fig. 59. In making this joint great

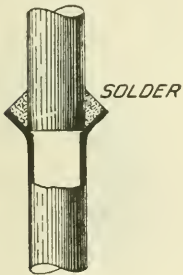

Fig. 59.

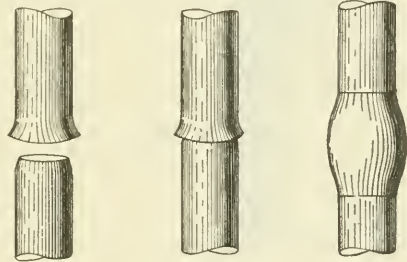

Fig. 60.

care should be taken that the ends of the pipes are round and fit closely so there will be no chance for the solder to run through inside the pipe and form obstructions for the collection of sediment.

The different stages of a wipe joint are shown in Fig. 60. The ends of the pipes are first cleaned and then fitted together as shown in the second stage. The solder is melted in a small cast iron crucible and is carefully poured on the joint or thrown on with a small stick called a "spatting stick." As the solder cools it becomes pasty and the joint can be worked into shape by means of the stick or a soft cloth, or both, depending upon the kind of joint and stage of operation. The final shape and smooth finish is given with the cloth. The ability to make a joint of this kind can be attained only by practice, and printed directions are

of little value as compared with observation and actual practice. This is the strongest and most satisfactory joint that can be made between two lead pipes or a lead and brass or copper pipe. In the latter case the brass or copper should be carefully tinned as far as the joint is to extend by means of a soldering iron.

Where lead waste pipes are to be connected with cast iron soil pipes a brass ferule should be used. Different forms of these are shown in Figs. 61 and 62. The lead pipe is wiped to the finished end of the ferule while the other end is calked into the hub of the cast iron pipe in the manner already described. The ferule should be made heavy so as not to be injured in the pro-

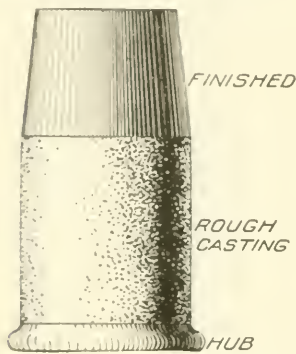

Fig. 61.

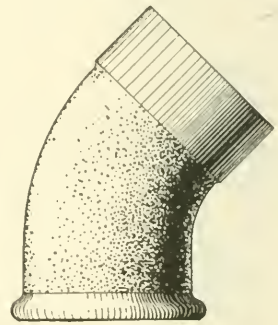

Fig. 62.

cess of calking. Cup joints should never be used for this purpose.

Tile Pipes. Nothing but metal piping should be used inside of a building, but in solid earth, starting from a point about 10 feet away from the cellar wall, we may use salt-glazed, vitrified, or terra cotta pipe for making the connection with the main sewer. This pipe is made in convenient lengths and shapes and is easily handled. Various fittings are made similar in form to those already described for cast iron. In laying tile pipe each piece should be carefully examined to see that it is smooth, round, and free from cracks. The ends should fit closely all around, and each length of pipe should fit into the next the full length of the hub. In making the joints nothing but the best hydraulic cement should be used, and great care should be taken that this is pressed well

into the space between the two pipes. All cement that works through into the interior should be carefully removed by means of a swab or brush made especially for this purpose. The earth should be filled in around a pipe of this kind before the cement is set or else the joints are likely to crack. Fine soil should be filled in around the pipe to a depth of 3 or 4 inches, and rammed down solid, and the ditch may then be filled in without regard to the pipe. No tile pipe should be used inside of a house or nearer than about 10 feet for the reason it might not stand the pressure in case a stoppage should occur in the sewer. This kind of pipe is not intended to carry a pressure and when used in this way is seldom entirely filled with water. Joints between iron and tile piping are made with cement in the manner described for two sections of tile.

Cesspools. It is often desired to install a system of plumbing in a building in the country or in a village where there is no system of sewerage with which to connect. In this case it becomes necessary to construct a cesspool. This is always undesirable, but if properly constructed and placed at a suitable distance from the house and in such a position that it cannot drain into a well or other source of water supply it may be used with comparative safety. Especial care should be taken in the construction, and when in use it should be regularly cleaned. One form of cesspool is shown in Fig. 63. This consists of two brick chambers located at some distance from the building and in a position where the ground slopes away from it if possible. The larger chamber has a clean-out opening in the top which should be provided with an air-tight cover. An ordinary cast iron cover may be made sufficiently tight by covering it over with 3 or 4 inches of earth packed solidly in place. A vent pipe should be carried from the top to such a height that all gases will be discharged at an elevation sufficient to prevent any harm.

The smaller chamber is connected with the first by means of a soil pipe as shown. This chamber is arranged for absorbing the liquids and for this purpose is provided with lengths of porous tile radiating from the bottom as shown in the plan. The house drain connects with the larger chamber, which fills to the level of the overflow, then the liquid portion of the sewage drains over

into chamber No. 2 and is absorbed through the porous tile branches. The solid part remains in chamber No. 1, and can be removed from time to time. A suitable trap should of course be placed in the house drain in the same manner as though connected with a street sewer. The safety of the cesspool will depend much upon its location, its general construction and care and the nature of the soil.

TRAPS AND VENTS.

Traps. The best method of connecting traps, and their actual value under all conditions, are matters upon which there is

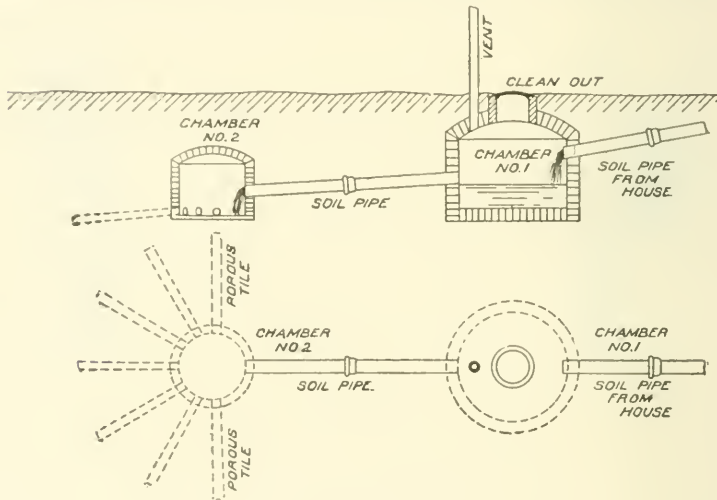

Fig. 63.

much difference of opinion. Cities also vary in their requirements to a greater or less extent, so that it will be possible to show in a general way only the various principles involved and to illustrate what is considered good practice, in the average case, at the present time.

A separate trap should in general be placed in the waste pipe from each fixture, although several of a kind, such as lavatories, etc., are often drained through a common trap, as shown in Fig. 64.

In addition to the traps at the fixtures a main or running trap is placed in the main soil pipe outside of all the connections;

this is sometimes placed in a manhole just outside the building, but more commonly in the cellar before passing through the wall; the former method is much to be preferred, as the trap may be cleaned without admitting gases or odors to the house. The running trap has been shown in Fig. 29, and is provided with a removable cap for cleaning.

The agencies which tend to destroy the water seal of traps

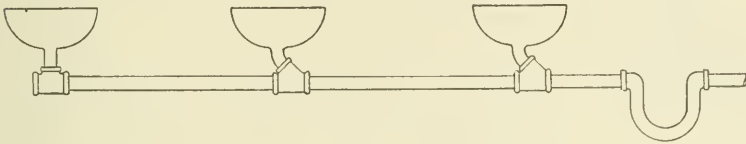

Fig. 64.

are siphonage, evaporation, back pressure, capillary action, leakage and accumulation of sediment.

Siphonage. This can best be illustrated by a few simple diagrams showing the principles involved. In Fig. 65 is shown a U tube with legs of equal length and filled with water. If we

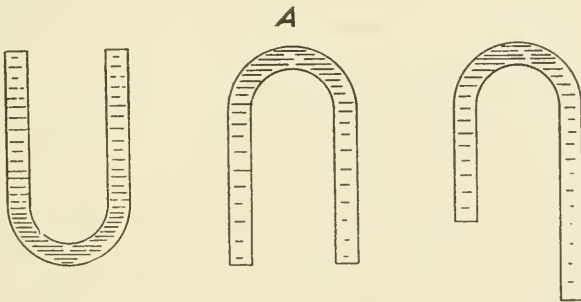

Fig. 65.

Fig. 66.

Fig. 67.

invert the tube, as shown in Fig. 66, the water will not run out, because the legs are of equal length, and contain equal weights of water, which pull downward from the top with the same force, tending to form a vacuum at the point A. If one of the legs is lengthened, as in Fig. 67, so that the column of water is heavier on one side than on the other, it will run out, while atmospheric pressure will force the water in the shorter tube up over the bend, as there

would be no pressure to resist this action should the column of water break at this point. This action is also assisted by the adhesion of the particles of water to each other. The column of water in the tube may be likened to a piece of flexible rope hanging over a pulley: when equal lengths hang over each side it

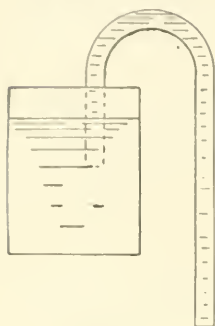

Fig. 68.

will remain stationary, but if drawn over one side slightly, so that one end is heavier than the other, the whole rope will be drawn over the pulley toward the longer and heavier end. The first cause, due to atmospheric pressure, is the principal reason for the action of siphons, but the latter assists it to some extent. If the shorter leg of the siphon be dipped in a vessel of water, as shown in Fig. 68, the atmospheric pressure, which before acted on the bottom of the water in the tube, is transferred to the surface of the

water in the vessel, and the flow through the tube will continue until the water level in the vessel falls slightly below the end of the tube and admits air pressure, which breaks the siphon action. Fig. 69 shows the same principle applied to the trap of a sink or bowl. If the bowl is well filled with water, so that when the plug is removed from the bottom, the waste pipe for some distance below the trap is filled with a solid column of water, a siphon action will be set up like the one just described, and the trap will be drained. Frequently a sufficient amount of water runs down from the fixture and sides of the pipe above the trap to partially restore the seal. This direct action of the water of a fixture in breaking its own trap seal by siphoning is called "self-siphonage."

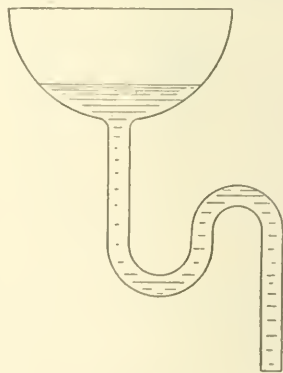

Fig. 69.

A more common form, where two or more fixtures connect with the same waste pipe, is shown in Fig. 70. In this case the seal of the lower closet is broken by the discharge of the upper. The

falling column of water leaves behind it a partial vacuum in the soil pipe, and the outer air tends to rush into the pipe through the way of least resistance, which is often through the trap seals of the fixtures below. The friction of the rough sides of a tall soil pipe, even though it be open at the roof, will sometimes cause more resistance to air flow than the trap seals of the fixtures, with the result that they are broken, and gases from the drain are free to enter the building.

Three methods have been employed to prevent the destruction of the seal by siphonage. The first method devised was what is known as "back venting," and this is largely in use at the present time, although careful experiments have shown that in many cases it is not as effective as it was at first supposed to be, and is considered by some authorities to be a useless complication. It is, however, called for in the plumbing regulations of many cities, and will be taken up briefly in connection with other methods.

Back Venting. This consists in connecting a vent pipe at or near the highest part of the trap, as shown in Fig. 71. The action of this arrangement is evident; in place of the waste pipe receiving the air necessary to fill it, through the basin, after the solid column of water has passed down, it is drawn in through the vent pipe, as shown by the arrows, and the seal remains, or should remain, unbroken. It also prevents "self-siphonage" by breaking the column of water and admitting atmospheric pressure at the highest point or crown of the trap. The vent not only prevents the seal from being broken, as described, but allows any gases which may form in the waste pipe to escape above the roof of the house. In order to be effective, the back vent should be large, but even when of the same size as the waste pipe, the flushing of a closet will oftentimes break the seal, especially if the

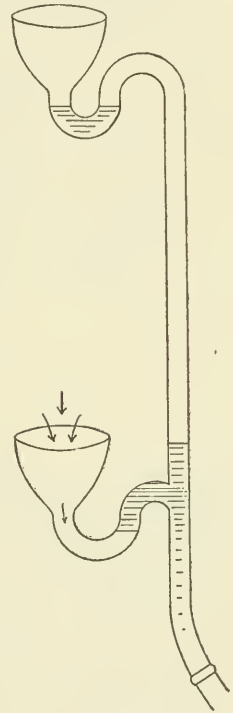

Fig. 70.

vent pipe is of considerable length. The vent often becomes choked, either with the accumulation of sediment near the trap or by frost or snow at the top; in this case its effect is of course destroyed. Another disadvantage of the back vent is the hastening of evaporation from the trap and the unsealing of fixtures which are not often used.

The second method of guarding against the loss of seal by

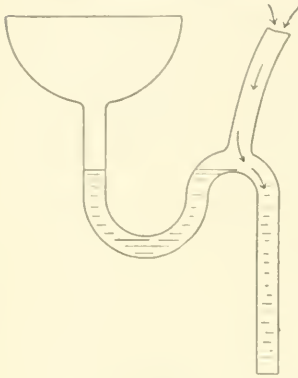

Fig. 71.

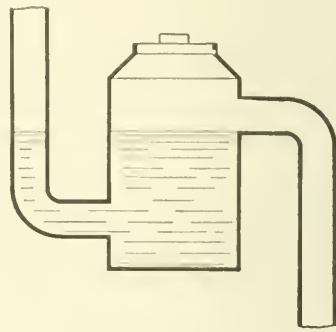

Fig. 72.

siphonage is to make the body of the trap so large that a sufficient quantity of water will always adhere to its sides after siphoning to restore a seal. The pot or cesspool trap shown in Fig. 72 is based on this principle.

The third method consists in the use of a trap of such form that it will not siphon, and will at the same time be self-cleaning. Among other types the centrifugal trap, shown in Figs. 34 and 35, is claimed to fulfil these conditions. The pot trap, while less affected by the siphoning action, is more or less objectionable on account of retaining much of the sediment and solid part of the sewage which falls into it.

Local Vents. A local vent is a pipe connected directly with a closet or urinal for carrying off any odor when in use. It has no connection with the soil pipe, unless the trap seal becomes broken, and is not provided for the purpose of carrying off gases from the sewer. A urinal provided with a local vent is shown in Fig. 73.

Sometimes a small register face back of the fixture, and con-

necting with a flue in the wall, is used in place of the regular local vent. In order for a vent flue of either form to be of any value, it must be warmed to insure a proper circulation of air through it. This is done in some cases by placing a gas-jet at the bottom of the flue, in others a steam or hot water pipe is run through a portion of the flue, and in still others the vent is carried up beside a chimney flue, from which it may receive sufficient warmth to assist the circulation to some extent.

Main or Soil Pipe Vent. It is customary to vent the main soil pipe by carrying it through the roof of the building, and leaving the end open. This is shown in Fig. 74. On gravel roofs which drain toward the center, the soil pipe is sometimes stopped on a level with the roof, and serves as a rain leader. In other cases the roof water may be led to the soil pipe in the cellar. If the latter method is used, the water should pass through a deep trap before connecting with the drain. These arrangements tend both to flush out the soil pipe and trap and prevent the accumulation of sediment.

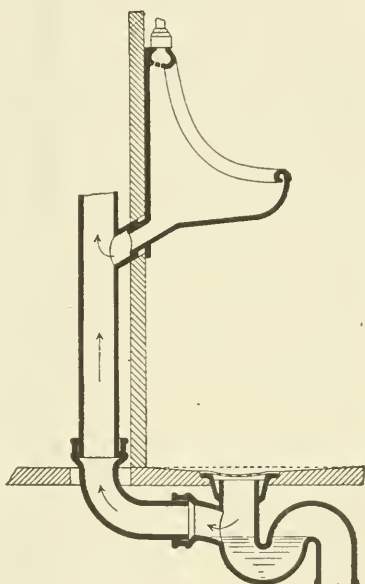

Fig. 73.

Fresh Air Inlets. The fresh air inlet shown just above the running trap Fig. 74 is to cause a circulation of air through the soil pipe, as shown by the arrows. The connection should be made just inside of the trap, so that the entire length of the drain will be swept by the current of fresh air. It is sometimes advised to extend the fresh air pipe up to the roof, because foul air may at times be driven out by heavy flushing of the drain pipe, but where this is done there is much less chance for circulation, as the inlet and outlet are nearly on a level, and the columns of air in them are more likely to be balanced. By carrying the inlet six or eight feet above the ground both objections are overcome to some extent,

unless this brings it near a window, which, of course, would not be safe. The main trap does not require a back vent, for should it be siphoned under ordinary conditions, it will always be filled

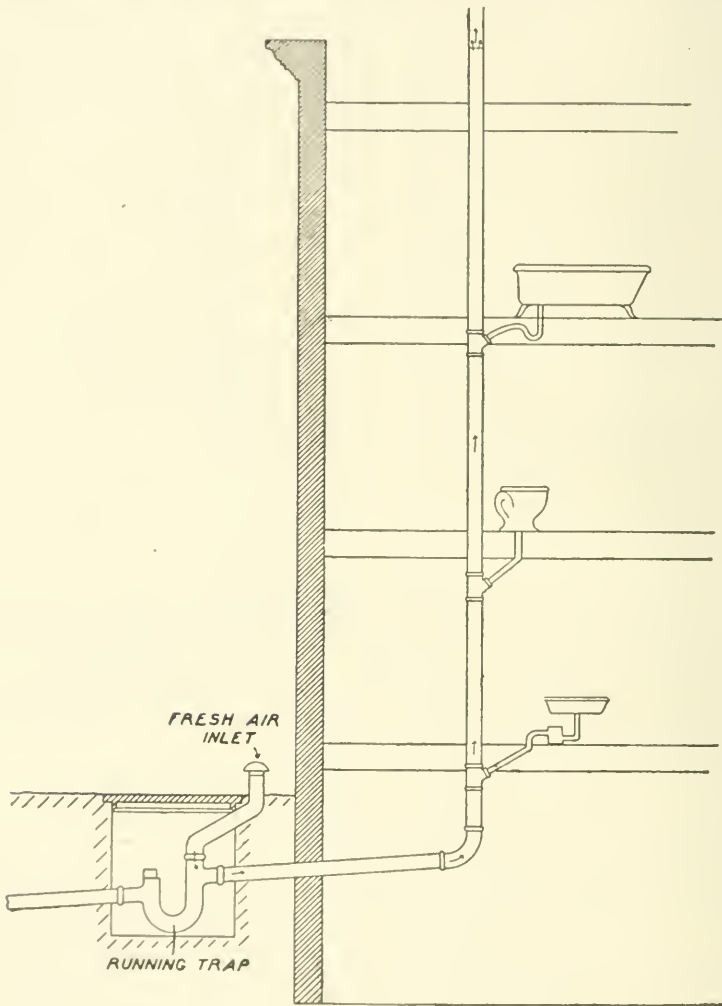

Fig. 74.

again within a few minutes; and if the main soil pipe is open at the top and all fixtures are properly tapped, no harm would come from the slight leakage of gas into the drain under these condi-

tions, and some engineers recommend the omission of the running trap.

Where a house drains into a cesspool instead of a sewer, it is far more necessary that the system should be trapped against it as it gives off a constant stream of the foulest gases. The usual form of running trap serves to protect the house, but the cesspool should have an independent vent pipe leading to some unobjectionable point and carried well up above the surface of the ground.

Disposal of Sewage. In cities and towns having a system of sewers, or where there is a large stream of running water nearby, the matter is a simple one. In the first case, the house drain is merely extended to the sewer, into which it should discharge at as high a point as possible, and at an acute angle with the direction of flow. When the drain connects with a stream it should be carried out some distance from the shore and discharge under water, an opening for ventilation being provided at the bank. Where there are neither sewers nor streams, the cesspool must be used. When the soil is sufficiently porous the method shown in Fig. 63 may be employed. Sometimes the sewage is collected in a closed cistern and discharged periodically through a flush tank into a series of small tiles laid to a gentle grade, from 8 to 12 inches below the surface. By extending these tiles over a sufficient area and allowing from 40 to 70 feet of tile for each person, a complete absorption of the sewage takes place by the action of the atmosphere and the roots.

PIPE CONNECTIONS.

The Bath Room. There are different methods of connecting up the fixtures in a bath room, depending upon the general arrangement, type, the kind of trap used, etc. Fig. 75 shows a set of fixtures connected up with vented traps. Both the soil and vent pipes are carried above the roof with open ends. No trap or fixture should be vented into a chimney, as is quite commonly done; this may work satisfactorily when the flues are warm, but in summer time, when the fires are out, there are quite likely to be down drafts, which cause the gases to be carried into the rooms through stoves or fireplaces. The vent pipe, although usually carried through the roof independently, is sometimes

connected with the soil pipe above the highest fixture; the soil pipe is often made a larger size through the attic space and above the roof in order to increase the upward flow of air through it. Fig. 76 shows a set of bath room connections in which non-siphoning traps are used without back venting; this is a simpler and less expensive method of making the connections and is especially recommended by some engineers. Its efficiency of course depends upon the proper working of the traps.

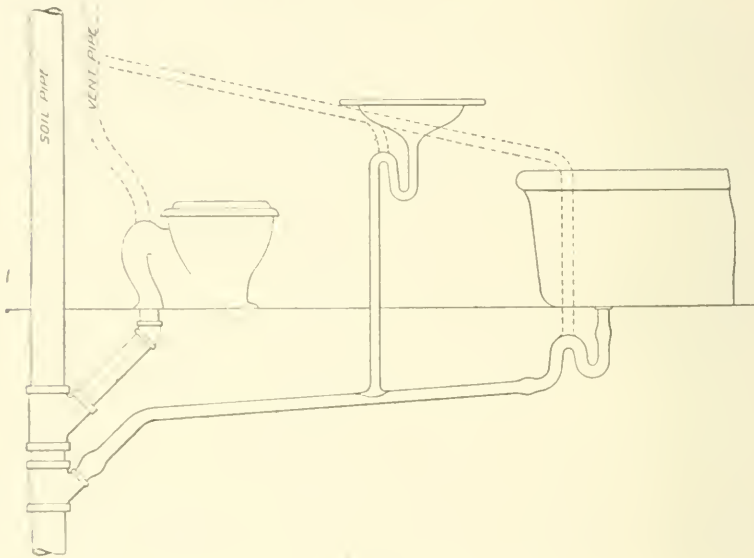

Fig. 75.

The bath room itself should be well lighted, and if possible, in a location where it will receive the sun. It should be arranged so that it may be heated to a higher temperature than other rooms in the house if desired, and it should also be thoroughly ventilated, the vent register being placed 5 or 6 feet above the floor in order that it may carry off any steam which rises from the bath tub. The walls, doors, etc., should be finished in a way to make them as nearly waterproof as possible; some form of good enamel paint answers well for this purpose. Paper should never be used on the walls, nor carpets on the floors, which should be of hard wood. Where the expense is not a matter of importance, glazed tile may be used for the floor and walls. Means should always be provided

for ventilating the bathroom without opening the door into the other rooms, and the greatest care should be taken to keep not only the fixtures, but the room itself, in the most perfect order.

Urinal Connections. The common form of urinal connection

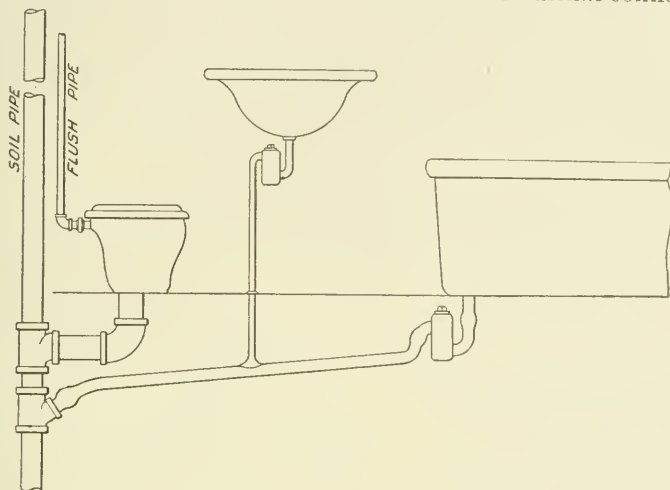

Fig. 76.

is shown in Fig. 14. The overflow from the trap ends in a tee, the lower outlet of which connects with the soil pipe and the upper with the vent pipe. Where several urinals are erected side by side it is usual to omit the individual traps, using the direct outlet connection shown in Fig. 77. These connect with a common waste pipe and drain through a single trap to the soil pipe.

Kitchen Sink Connections. Fig. 78 shows the usual method of making the connections for a kitchen sink. The waste and vent are of lead, connected with the main cast-iron soil and vent pipes by means of brass ferules and wiped joints.

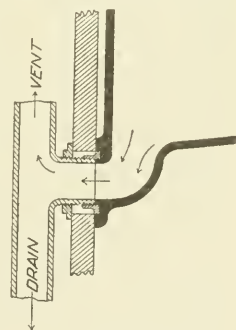

Fig. 77.

Soil and Waste Pipes. The various fixtures have been taken up, together with the different kinds of traps which are used in connection with them, and also the general methods of making the various connections for waste and vent. We will next take

up some of the points in regard to the manner of running and supporting the different pipes, together with the proper sizes to be used under different conditions.

The waste pipes of necessity contain more foul matter and therefore more harmful gases than the fixtures, so that especial care must be taken in their arrangement and construction. It is advisable to keep all piping as simple as possible, using as few connections as is consistent with the proper working of the system.

The fixtures on each floor should be arranged to come directly over each other, so as to avoid the running of horizontal pipes across or between the floor beams. The sizes of pipes commonly used require such a sharp grade that there is not sufficient space, in ordinary building construction, between the floor boards and ceiling lath below for horizontal runs of much length. One soil pipe is usually sufficient for buildings of ordinary size, and in cold climates is necessarily carried down inside the building to prevent freezing.

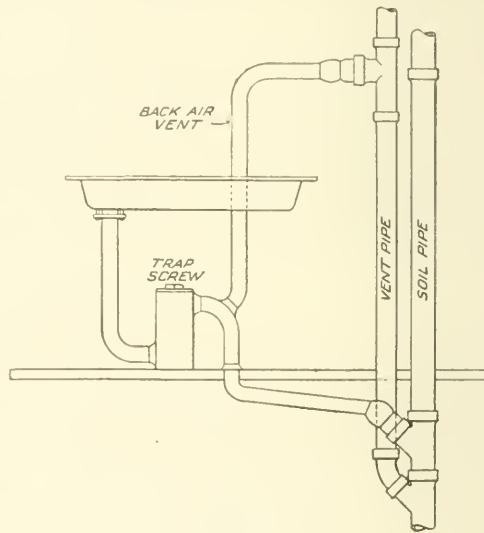

Fig. 78.

One or more waste pipes from sinks, bathtubs, etc., are usually required in addition to the soil pipe. These may be connected directly with the soil pipe (through traps), if located near it, or may be carried to the basement vertically and then joined with the main drain pipe inside the running trap. These should also be placed on the inside wall of the house, and, if necessary to conceal them, the boxing used should be put together in such a manner that it may be easily removed for inspection.

The main soil pipe should also be placed where it can be

seen, so that leaks may be easily discovered; it is commonly run along the basement wall and supported by suitable brackets or hangers. If carried beneath the cellar floor, it should run in a brick trench with removable covers. In running all lines of pipe, whether vertical or horizontal, they should be securely supported and, in the case of the latter, properly graded. Some of the various kinds of hangers and supports used are shown in Figs. 79 and 80. The grade of the pipes should be as sharp and as uniform as possible. The velocity in the pipes should be at least two feet per second to thoroughly clean them and prevent clogging. Generally speaking, the pitch of the pipes should not be in any case less than 1 foot in 50. In running lines of soil pipe, it is best to

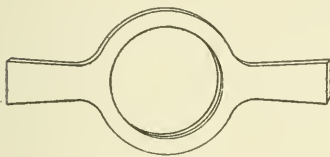

Fig. 79.



Fig. 80.

set the joints ready for calking in the exact positions they are to occupy and resting upon the supports which are intended to hold them permanently. In this way there is less liability of sagging or loosening of the joints after calking. In the running of vertical pipes, care should be taken to have them as straight as possible from the lowest fixture to the roof.

It is very necessary that the pipes be given such an alignment that the water entering them will meet with no serious obstructions. Where vertical pipes join those which are horizontal, they should be given a bend which will turn the stream gradually into the latter, thus preventing any resistance and the resulting accumulation of deposits. Horizontal pipes may be joined with vertical pipes without a bend, as the discharge will be sufficiently free without it. However, it is customary to use a Y or T branch, giving a downward direction to the flow when connecting a closet or other fixture where there is likely to be much solid matter in the sewage. Offsets should always be avoided as far as possible, as they obstruct the flow of both water and air.

Pipe Sizes. The most important requirements in the case of discharge pipes are that they carry away the waste matter as thoroughly as possible without stoppage of flow or eddying, and that they be well ventilated. In order to accomplish this they must be given such sizes as experience has shown to be the best. When water having solid matter in suspension half fills a pipe, the momentum or force for clearing the pipe will be much greater than when it forms only a shallow stream in one of a larger size, so that in proportioning the sizes of soil pipes and drains care must be taken that they are not made larger than necessary, for if the

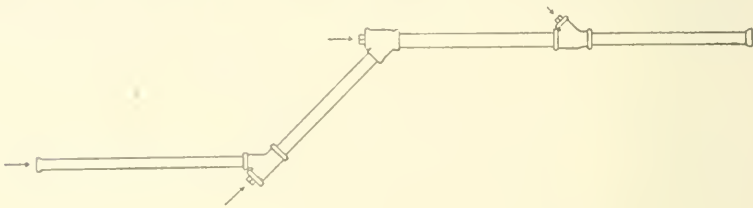

Fig. 81.

stream becomes too shallow the pipes will not be properly flushed and deposits are likely to accumulate. The amount of water used in a house of ordinary size, even when increased by the roof water from a heavy rain, will easily be cared for by a 4-inch pipe having a good pitch. While a pipe of this size would seem to be sufficient, it is found by experience that it is likely to become clogged at times by substances which through carelessness find their way into the drain, so that it seems best to use a somewhat larger size. For city buildings in general, it is recommended that the main drain should not be less than 5 or 6 inches in diameter, and in ordinary dwelling houses not less than 5 inches. The vertical soil pipes need not be larger than 4 inches, except in very high buildings.

Waste pipes may vary from $1\frac{1}{4}$ inches to 2 inches. The waste from a single bowl or lavatory should be $1\frac{1}{4}$ inches in diameter, from a bathtub, kitchen sink or laundry tub $1\frac{1}{2}$ inches, from a slop sink $1\frac{3}{4}$ inches. Smaller pipes should never be used. In laying out the lines of piping, provision should be made for clearing the pipes in case of stoppage. Fig. 81 shows how this

may be done. Clean-out plugs are left at the points indicated by the arrows, so that flexible sticks or strips of steel may be inserted to dislodge any obstruction which may occur.

The fresh-air inlet to the main drain pipe has already been referred to. This should be located away from windows, where foul air would be objectionable; in cities they may be placed at the curb line and covered with a grating. Sometimes they are arranged as shown in

Fig. 82. The opening is made in the usual way, and a hood placed over the inlet, and a pipe leading from this is carried through the roof. When the circulation of air is upward through the main soil pipe the opening acts in the usual way, that is, as a fresh-air inlet, but should there be a reversal of the current from any reason, which would discharge foul air from the sewer, it would be caught by the overhanging

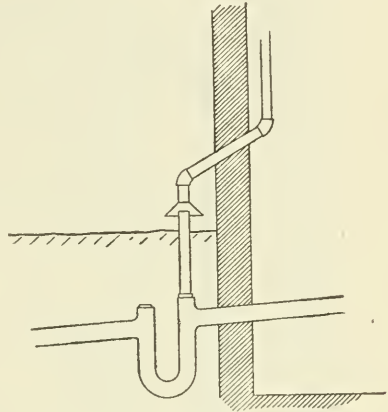

Fig. 82.

hood and carried upward through the connecting vent pipe to a point above the roof. A general layout for house drainage is shown in Fig. 83.

PLUMBING FOR VARIOUS BUILDINGS.

Dwelling Houses. The bathroom fixtures, laundry tubs and kitchen sink, with the possible addition of a slop sink, make up the usual fixtures to be provided for in the ordinary dwelling house. In houses of larger size these may be duplicated to some extent, but the general methods of connection are the same as have already been described and need not be taken up again in detail.

Apartment Houses. These are usually made up of duplicate flats, one above the other, so that the plumbing fixtures may be the same for each. It is customary to place the bathrooms in the same position on each floor, so that a single soil pipe will care for all.

Hotels. Here, as in the case just described, the bathrooms are placed one above another, so that a single soil pipe may care for each series, and the problem then becomes that of duplicating the layout for an apartment house. In addition to the private baths there is a public lavatory or toilet-room, usually on the first floor or in the basement. This is fitted up with closets,

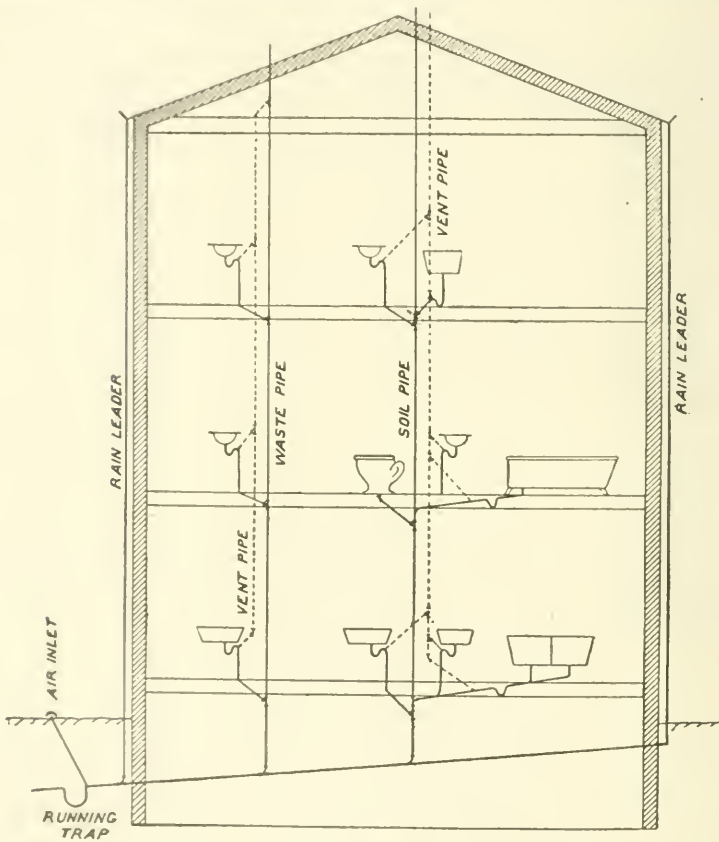

Fig. 83.

urinals and bowls. The closet seats and urinals are placed side by side, with dividing partitions, and connect with a common soil pipe running back of them and having a good pitch. Each fixture should have its own trap. The flushing of the fixtures is often made automatic, so that pressing down the wooden rim of a closet

seat will throw a lever which on being released will flush the closet. Urinals are commonly made to flush at regular intervals by some of the devices already shown. The lavatories are made up in long rows, as shown in Fig. 84.

Railroad Stations. The plumbing of a railroad station is similar to that of a hotel, although even greater care should be taken to make the fixtures self-cleansing, as the patrons are likely to include many of the lowest and most ignorant class of people. Special attention should be given to both the local ventilation of the fixtures and the general ventilation of the room.

Schoolhouses. The same general rules hold in the case of school buildings as in hotels and railroad stations. As the pupils are under the direct supervision of teachers and janitors it is not necessary to have the fixtures automatic to as great an extent as in the cases just described, and it is customary to flush the closets by means of tanks, and pull chains or rods, the same as in private dwellings. The urinals may be automatic or a small stream of water may be allowed to flow through them continuously during school hours. A good form for this class of work is shown in Fig. 85.

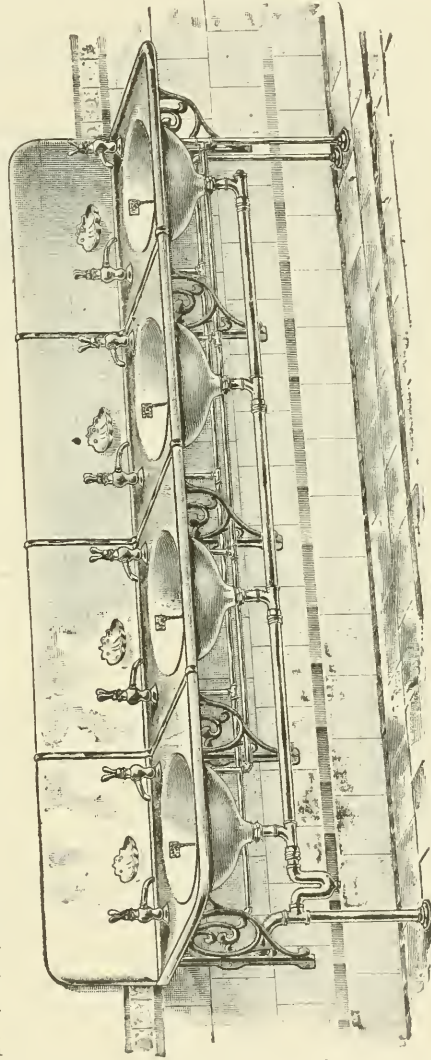

Fig. 84.

Shops and Factories. Some simple type of fixture which can be easily cared for is best in buildings of this kind.

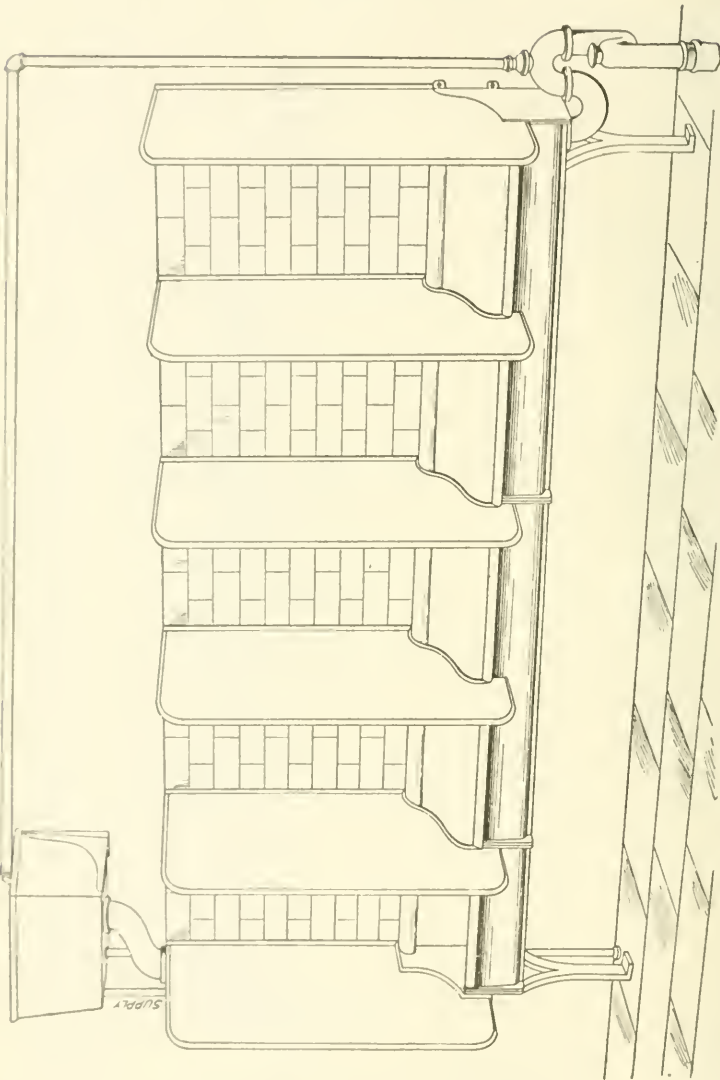

Fig. 85.

TESTING AND INSPECTION.

All plumbing work of any importance should be given two tests; the first, called the "roughing test," applies only to the

soil, waste and vent pipes, and is made before the fixtures are connected. The best method of making this test is to plug the main drain pipe just outside the running trap, and also all openings for the connections of fixtures, etc., and then fill the entire system with water. This may be done in small systems through the main vent pipe on the roof, and in larger ones by making a temporary connection with the water main. If any leaks are present they are easily detected in this way. In cold weather, when there would be danger of freezing, compressed air under a pressure of at least ten pounds per square inch may be used in place of water. Leaks in this case must be located by the sound of the issuing air. The water test is to be preferred in all cases, as it is easier to make, and small leaks are more easily detected.

The final test is made after the fixtures are in and all work is completed. There are two ways of making this test, one known as the "peppermint test," and the other as the "smoke test." In making either of these, the system should first be flushed with water, so that all traps may be sealed. If peppermint is used, 4 to 6 ounces of oil of peppermint, depending upon the size of the system, are poured down the main vent pipe, and then a quart or two of hot water to vaporize the oil. The vent pipe is then closed, and the inspector must carefully follow along the lines of piping and locate any leaks present by the odor of the escaping gas. Another and better way is to close the vent pipe and vaporize the oil in the receiver of a small air pump, and then force the gas into the system under a slight pressure. The receiver is provided with a delicate gage, so that after reaching a certain pressure (which must not be great enough to break the trap seals) the pump may be stopped and the pressure noted. If, after a short time, the pressure remains the same, it is known that the system is tight; if, however, the pressure drops, then leaks are present and must be located, as already described. Ether is sometimes used in place of peppermint for this purpose.

In making the smoke test the system is sealed, and the vent pipes closed in the same manner as for the test just described; smoke from oily waste or some similar substance is then forced into the pipes by means of a bellows. When the system is filled

with smoke, and a slight pressure produced, the fact is shown by a float, which rises and remains in this position if the joints are tight. If there are leaks, the float falls as soon as the bellows are stopped. Leaks may be detected in this way, both by the odor of the smoke and by the issuing jets from leaks of any size. Special machines are made for both the peppermint and smoke tests.

The water test is preferable for roughing in, and the smoke test for the final. Every system of plumbing should be tested at least once a year.

SEWERAGE AND SEWAGE PURIFICATION.

An abundant supply of pure water is a necessity in every town and city; and such a supply having been secured brings up the question of its disposal after being used. This is plainly the reverse of its introduction. As it was distributed through a network of conduits, diminishing in size, with its numerous branches, so it may be collected again by similar conduits, increasing in size, as one after another they unite in a common outlet.

This fouled water is called *sewage*, and the conduits which collect it constitute a sewerage system. In general, sewage is disposed of in two ways: either it must be turned into a body of water so large as to dilute it beyond all possibility of offence, and where it cannot endanger human life by polluting a public water-supply, or it must be purified in some manner.

The conduits which carry water collected from street surfaces during and after rains, or ground water collected from beneath the surface, are called drains. When one set of conduits removes sewage and another carries surface and ground water, it is said that the *separate* system of sewerage is in use. Where one system conveys both sewage and drainage water it is called the *combined* system. Various modifications of these two systems are possible, both for whole cities and for limited areas within the same town or city.

A sanitary sewerage system cannot be installed until a public water-supply has been provided. It is needed as soon as that is accomplished, for while the wells can then be abandoned the volume of waste water is greatly increased by the water-works system. Its foulness is also much increased through the introduction of water-

closets. Without sewers and with a public water-supply cesspools must be used, and with these begins a continuous pollution of the soil much more serious than that which commonly results from closets and the surface disposal of slops.

Among the data which should first be obtained in laying out a sewerage system are:

First.—The area to be served, with its topography and the general character of the soil.—A contour map of the whole town or city, showing the location of the various streets, streams, ponds or lakes, and contour lines for each 5 feet or so of change in elevation, is necessary for the best results. The general character of the soil can usually be obtained by observation and inquiry among residents or builders who have dug wells or cellars, or have observed work of this kind which was being done. The kind of soil is important as affecting the cost of trenching and its wetness or dryness, and this, together with a determination of the ground-water level, will be useful in showing the extent of underdraining necessary.

Second.—Whether the separate or combined system of sewerage, or a compromise between the two is to be adopted.—These points will depend almost wholly upon local conditions. The size and cost of combined sewers is much greater than the separate system, since the surface drainage in times of heavy rainfall is many times as great as the flow of sanitary sewage. In older towns and cities it sometimes happens that drains for removing the surface water are already provided, and in this case it is only necessary to put in the sanitary sewers; or again, the latter may be provided, leaving the matter of surface drainage for future consideration.

If the sewage must be purified, the combined system is out of the question, for the expense of treating the full flow in times of maximum rainfall would be enormous. Sometimes more or less limited areas of a town may require the combined system, while the separate system is best adapted to the remainder; and again it may be necessary to take only the roof water into the sewers. As already stated, local conditions and relative costs are the principal factors in deciding between the separate and combined systems.

Third.—Whether subsoil drainage shall be provided.—In most cases this also will depend upon local conditions. It is always an advantage to lower the ground-water level in places where it is sufficiently high to make the ground wet at or near the surface during a large part of the year. In addition to rendering the soil dry around and beneath cellars, the laying of underdrains is of such aid in sewer construction as to warrant their introduction for this purpose alone. This is the case where the trenches are so wet as to render the making and setting of cement joints difficult. The aim in all good sewer work is to reduce the infiltration of ground water into the pipes to the smallest amount; but in very wet soil, tight joints can be made only with difficulty, and never with absolute certainty. Cases have been known where fully one-half the total volume of sewage discharged consisted of ground water which had worked in through the joints.

Fourth.—The best means for the final disposal of the sewage.—Until recently it was turned into the nearest river or lake where it could be discharged with the least expense. The principal point to be observed in the disposal of sewage is that no public water-supply shall be endangered. At the present time no definite knowledge is at hand regarding the exact length of time that disease germs from the human system will live in water. The Massachusetts legislature at one time said that no sewer should discharge into a stream within 20 miles of any point where it is used for public water-supply, but it is now left largely in the hands of the State Board of Health. There may be cases where sewage disposal seems to claim preference to water supply in the use of a stream, but each case must be decided on its own merits. Knowing the amount of water and the probable quantity and character of the sewage, it is generally easy to determine whether all of the crude sewage of a city can safely be discharged into the body of water in question. Averages in this case should never be used; the water available during a hot and dry summer, when the stream or lake is at its lowest, and the banks and beds are exposed to the sun, is what must be considered. Where sewage is discharged into large bodies of water, either lakes or the ocean, it is generally necessary to make a careful study of the prevailing currents in order to determine the most available point of discharge,

in order to prevent the sewage becoming stagnant in bays, or the washing ashore of the lighter portions. Such studies are commonly made with floats, which indicate the direction of the existing currents.

Fifth.—Population, water consumption and volume of sewage for which provision should be made, together with the rainfall data, if surface drainage is to be installed.—The basis for population studies is best taken from the census reports, extending back many years. By means of these the probable growth may be estimated for a period of from 30 to 50 years. In small and rapidly growing towns it must be remembered that the rate of increase is generally less as the population becomes greater.

It is desirable to design a sewerage system large enough to serve for a number of years, 20 or 30 perhaps, although some parts of the work, such as pumping or purification works, may be made smaller and increased in size as needed.

The pipe system should be large enough at the start to serve each street and district for a long period, as the advantages to be derived from the use of city sewers are so great that all houses are almost certain to be connected with them sooner or later. It is often necessary to divide a city into districts in making estimates of the probable growth in population. Thus the residential sections occupied by the wealthiest classes will be comprised of a comparatively small population per acre, due to the large size of the lots. The population will grow more dense in the sections occupied by the less wealthy, the well-to-do and finally the tenement sections. In manufacturing districts the amount of sewage will vary somewhat, depending upon the lines of industry carried on.

The total water consumption depends mainly upon the population, but no fixed rule can be laid down for determining it beforehand. It is never safe to allow less than 60 gallons per day per capita as the average water consumption of a town if most of the people patronize the public water-supply. In general it is safer to allow 100 gallons. The total daily flow of sewage is not evenly distributed through the 24 hours. The actual amount varies widely during different hours of the day. In most towns there should be little if any sewage, if the pipes are tight enough

to prevent inward leakage, between about 10 o'clock in the evening and 4 in the morning. From $\frac{2}{3}$ to $\frac{3}{4}$ of the daily flow usually occurs in from 9 to 12 hours, the particular hours varying in different communities. This is not of importance in designing the pipe system, but only affects the disposal.

Rainfall data is usually hard to obtain except in the cities and larger towns. In cases of this kind the data of neighboring town or cities may be used if available. Monthly or weekly totals are of little value, as it is necessary to provide for the heaviest rains, as a severe shower of 15 minutes may cause more inconvenience and damage, if the sewers are not sufficiently large, than a steady rain extending over a day or two. A maximum rate of 1-inch per hour will usually cover all ordinary conditions. The proportion which will reach the sewers during a given time will depend upon local conditions, such as the slope of land, whether its surface is covered with houses and paved streets, cultivated fields or forests, etc.

Sizeth.—Extent and cost of the proposed system.—This is a matter largely dependent upon the local treasury, or the willingness of the people to pay general taxes or a special assessment for the benefits to be derived.

DESIGN AND CONSTRUCTION.

The first step is to lay out the pipe or conduit system. For this the topographical map already mentioned will be found useful. This, however, should be supplemented by a profile of all the streets in which sewers are to be laid, in order to determine the proper grades. In laying out the pipe lines, special diagrams and tables which have been prepared for this purpose may be used. In the separate system it is generally best to use 8" pipe as the smallest size to lessen the risk of stoppage, although 6" pipe is ample for the volume of sanitary sewage from an ordinary residence street of medium length. Pipe sewers are generally made of vitrified clay, with a salt-glazed surface. Cement pipe is also used in some cities. The size of pipe sewers is limited to 30 inches in diameter, owing to the difficulty and expense of making the larger pipe and the comparative ease of laying brick sewers of any size from 24 or 30 inches up. In very wet ground,

cast iron pipe with lead joints is used, either to prevent inward leakage or settling of the pipe.

The pipes should be laid to grade with great care and a good alignment should be secured. Holes should be dug for the bells of the pipe, so that they will have solid bearings their entire length. If rock is encountered in trenching, it will be necessary to provide a bed for the pipe which will not be washed into fissures by the stream of subsoil water which is likely to follow the sewer when the ground is saturated.

Underdrains. Where sewers are in wet sand or gravel, underdrains may be laid beneath or alongside the sewer. These are usually the ordinary agricultural tiles, from 3 inches in diameter upward. They have no joints, being simply hollow cylinders, and are laid with their ends a fraction of an inch apart, wrapped with a cheap muslin cloth to keep out the dirt until the matter in the trench becomes thoroughly packed about them. These drains may empty into the nearest stream, provided it is not used for a public water-supply.

Manholes. These should be placed at all changes of grade and at all junctions between streets. They are built of brick and afford access to the sewer for inspection; in addition to this they are sometimes used for flushing. They are provided with iron covers which are often pierced with holes for ventilation.

Sewer Grades. The grades of sewers should be sufficient where possible, to give them a self-clearing velocity. Practical experiments show that sewers of the usual sections will remain clear with the following minimum grades: Separate house connections, 2 per cent; (2-feet fall in each 100 feet of length) small street sewers, 1 per cent; main sewers, 0.7 per cent. These grades may be reduced slightly for sewers carrying only rain or quite pure water.

The following formula may be used for computing the minimum grade for a sewer of clear diameter equal to " d " inches and either circular or oval in section.

$$\text{Minimum grade, in per cent} = \frac{100}{5d + 50}.$$

Flushing Devices. Where very low grades are unavoidable

and at the head of branch sewers, where the volume of flow is small, flushing may be used with advantage.

In some cases water is turned into the sewer through a man-hole, from some pond or stream, or from the public water-works system. Generally, however, the water is allowed to accumulate before being discharged, by closing up the lower side of the man-hole until the water partially fills it, then suddenly releasing it and allowing the water to rush through the pipe. Instead of using clear water from outside for this purpose, it may be sufficient at some points on the system to simply back up the sewage, by closing the manhole outlet, thus flushing the sewer with the sewage itself. Where frequent and regular flushing is required, automatic devices are often used. These usually operate by means of a self-discharging siphon, although there are other devices operated by means of the weight of a tank which fills and empties itself at regular intervals.

House Connections. Provision for house connections should be made when the sewers are laid, in order to avoid breaking up the streets after the sewers are in use. Y branches should be put in at frequent intervals, say from 25 feet apart upwards, according to the character of the street. When the sewer main is deep down, quarter bends are sometimes provided, and the house connection pipe carried vertically upwards to within a few feet of the surface to avoid deep digging when connections are made. Where house connections are made with the main, or where two sewers join, the direction of flow should be as nearly in the same direction as possible, and the entering sewer should be at a little higher level in order to increase the velocity of the inflowing sewage.

Depth of Sewers Below the Surface. No general rule can be followed in this matter except to place them low enough to secure a proper grade for the house connections, which are to be made with them. They must be kept below a point where there would be trouble from freezing, but the natural depth is usually sufficient to prevent this in most cases.

Ventilation of Sewers. There is more or less difference in opinion in regard to the proper method of ventilating sewer mains. Ventilation through house soil pipes is generally approved where the sewers and house connections are properly constructed and

operated, and where the houses on a given street are of a uniform height, so that the tops of all the soil pipes will be above the highest windows. Where the houses are uneven in height, or where the sewerage system or connections are not well designed or constructed, it is recommended that main traps should be placed on all soil pipes, and that air inlets and air outlets be placed on the sewers at intervals of from 300 to 400 feet.

The Combined System. The principal differences between this and the separate system are in the greater size of conduits and the use of catch-basins or inlets for the admission of surface water. They are generally of brick, stone or concrete, or a combination of these materials, instead of vitrified pipe.

Another difference is the provision for storm overflows, by means of which the main sewers when overcharged in times of heavy rainfall may empty a part of their contents into a nearby stream. At such times the sewage is diluted by the rain-water, while the stream which receives the overflow is also of unusually large size.

Size, Shape and Material. The actual size of the sewer, and also to a large extent its shape and the material of which it is constructed, depends upon local conditions. Where the depth of flow varies greatly it is desirable to give the sewer a cross-section designed to suit all flows as fully as possible.

The best form to meet these requirements is that of an egg with its smaller end placed downward. With this form the greatest depth and velocity of flow is secured for the smallest amount of sewage, thus reducing the tendency to deposits and stoppages. Where sewers have a flow more nearly constant and equal to their full capacity the form may be changed more nearly to that of an ellipse. For the larger sewers brick is the most common material, both because of its low cost and the ease with which any form of conduit is constructed. Stone is sometimes used on steep grades, especially where there is much sand in suspension, which would tend to wear away the brick walls. Concrete is used where leakage may be expected or where the material is liable to movement, but is more commonly used as a foundation for brick construction.

A **catch-basin** is generally placed at each street corner and provided with a grated opening for giving the surface water access

to a chamber or basin beneath the sidewalk, from which a pipe leads to the sewer. Catch-basins may be provided with water traps to prevent the sewer air from reaching the street, but traps are uncertain in their action, as they are likely to become unsealed through evaporation in dry weather. To prevent the carrying of sand and dirt into the sewers, catch-basins should be provided with silt chambers of considerable depth, with overflow pipes leading to the sewer. The heavy matter which falls to the bottoms of these chambers may be removed by buckets and carted away at proper intervals.

Storm Overflows. The main point to be considered in the construction of storm overflows is to ensure a discharge into another conduit when the water reaches a certain elevation in the main sewer. This may be carried out in different ways, depending upon the available points for overflow.

Pumping Stations. The greater part of the sewerage systems in the United States operate wholly by gravity, but in some cases it is necessary to pump a part or the whole of the sewage of a city to a higher level. The lifts required are usually low, so that high-priced machinery is not required. In general the sewage should be screened before it reaches the pumps.

Where pumping is necessary, receiving or storage chambers are sometimes used to equalize the work required of the pumps, thus making it possible to shut down the plant at night. Such reservoirs should be covered, unless in very isolated localities. The force main or discharge pipe from the pumps is usually short, and is generally of cast iron put together in a manner similar to that used for water-supply systems.

Tidal Chambers. Where sewage is discharged into tide water it is often necessary to provide storage or tidal chambers, so that the sewage may be discharged only at ebb tides. These are constructed similar to other reservoirs, except that they must have ample discharge gates, so that they may be emptied in a short time. They are sometimes made to work automatically by the action of the tide.

SEWAGE PURIFICATION.

Before taking up this subject in detail it is well to consider what sewage is, from a chemical standpoint.

When fresh, it appears at the mouth of an outlet sewer as a milky-looking liquid with some large particles of matter in suspension, such as orange peels, rags, paper and various other articles not easily broken up. It often has a faint, musty odor and in general appearance is similar to the suds-water from a family laundry. Nearly all of the sewage is simply water, the total amount of solid matter not being more than 2 parts in 1,000, of which half may be organic matter. It is this 1 part in 1,000 which should be removed, or so changed in character as to render it harmless.

The two systems of purification in most common use are "chemical precipitation" and the "land treatment." Mechanical straining, sedimentation and chemical precipitation are largely removal processes, while land treatment by the slow process of infiltration, or irrigation, changes the decaying organic matter into stable mineral compounds.

Sedimentation. This is effected by allowing the suspended matter to settle in tanks. The partially clarified liquid is then drawn off leaving the solid matter, called "sludge," at the bottom for later disposal. This system requires a good deal of time and large settling tanks; therefore it is suitable only for small quantities of sewage.

Mechanical Straining. This is accomplished in different ways with varying degrees of success. Wire screens or filters of various materials may be employed. Straining of itself is of little value except as a step to further purification. Beds of coke from 6 to 8 inches in depth are often used with good results.

Chemical Precipitation. Sedimentation alone removes only such suspended matter as will sink by its own weight during the comparatively short time which can be allowed for the process.

By adding certain substances chemical action is set up, which greatly increases the rapidity with which precipitation takes place.

Some of the organic substances are brought together by the formation of new compounds, and as they fall in flaky masses they carry with them other suspended matter.

A great number and variety of chemicals have been employed for this purpose, but those which experience has shown to be most useful are lime, sulphate of alumina and some of the salts of iron.

The best chemical to use in any given case depends upon the character of the sewage and the relative cost in that locality. Lime is cheap, but the large quantity required greatly increases the amount of sludge. Sulphate of alumina is more expensive, but is often used to advantage in connection with lime. Where an acid sewage is to be treated, lime alone should be used.

The chemicals should be added to the sewage and thoroughly mixed before it reaches the settling tank; this may be effected by the use of projections or baffling plates placed in the conduit leading to the tank. The best results are obtained by means of long, narrow tanks, and they should be operated on the continuous rather than the intermittent plan. The width of the tank should be about one-fourth its length. In the continuous method the sewage is constantly flowing into one part of the tank and discharging from another. In the intermittent system a tank is filled and then the flow is turned into another, allowing the sewage in the first tank to come to rest. In the continuous plan the sewage generally flows through a set of tanks without interruption until one of the compartments needs cleaning. The clear portion is drawn off from the top, the sludge is then removed, and the tank thoroughly disinfected before being put in use again. The satisfactory disposal of the sludge is a somewhat difficult matter. The most common method is to press it into cakes, which greatly reduces its bulk and makes it more easily handled. These are sometimes burned but are more often used for fertilizing purposes. In some cases peat or other absorbent is mixed with the sludge and the whole mass removed in bulk. In other instances it is run out on the surface of coarse gravel beds and reduced by draining and drying. In wet weather little drying takes place and during the cold months the sludge accumulates in considerable quantities. This process also requires considerable manual labor, and in many cases suitable land is not available for the purpose. The required capacity of the settling tanks is the principal item in determining the cost of installing precipitation works.

In the treatment of house sewage provision must be made for about $\frac{1}{12}$ the total daily flow, and in addition to this, allowance must be made for throwing out a portion of the tanks for cleaning

and repairs. In general, the tank capacity should not be much less than $\frac{1}{3}$ the total daily flow.

In the combined system it is impossible to provide tanks for the total amount, and the excess due to storm water must discharge into natural water courses or pass by the works without treatment.

Broad Irrigation or Sewage Farming. Where sewage is applied to the surface of the ground upon which crops are raised the process is called "sewage farming." This varies but little from ordinary irrigation where clean water is used instead of sewage. The land employed for this purpose should have a rather light and porous soil, and the crops should be such as require a large amount of moisture. The application of from 5,000 to 10,000 gallons of sewage per day per acre is considered a liberal allowance. On the basis of 100 gallons of sewage per head of population this would mean that one acre would care for a population of from 50 to 100 people.

Sub-Surface Irrigation. This system is employed only upon a small scale and chiefly for private dwellings, public institutions and for small communities where for any reason surface disposal would be objectionable. The sewage is distributed through agricultural drain tiles laid with open joints and placed only a few inches below the surface. Provision should be made for changing the disposal area as often as the soil may require by turning the sewage into sub-divisions of the distributing pipes.

Intermittent Filtration. This method and the broad irrigation already described are the only purification processes in use on a large scale which can remove practically all the organic matter from sewage without being supplemented by some other method. The process is a simple one and consists in running the sewage out through distributing pipes onto beds of sand 4 or 5 feet in thickness with a system of pipes or drains below for collecting the purified liquid. In operation the sewage is first turned on one bed and then another, thus allowing an opportunity for the liquid portion to filter through. As the surface becomes clogged it is raked over or the sludge may be scraped off together with a thin layer of sand. The best filtering material consists of a clean, sharp sand with grains of uniform size such that the free space

between them will equal about one-third the total volume. When the sewage is admitted to the sand only a part of the air is driven out, so there is a store of oxygen left upon which the bacteria may draw. This is not a mere process of straining but the formation of new compounds by the action of the oxygen in the air, thus changing the organic matter into inorganic. Much depends upon the size and quality of the sand used. The grains that have been found to give the best results range from .1 to .5 of an inch in diameter. The work done by a filter is largely determined by the finer particles of sand and that used should be of fairly uniform quality, and the coarser and finer particles should be well mixed. The area and volume of sand or gravel required are so large that the transportation of material any great distance cannot be considered. Usually the beds are constructed on natural deposits, the top soil or loam being removed. The sewage should be brought into the beds so as to disturb their surface as little as possible, and should be distributed evenly over the whole bed.

The under drains should not be placed more than 50 feet apart, usually much less, and should be provided with manholes at the junctions of the pipes. Before admitting the sewage to the beds it is usually best to screen it sufficiently to take out paper, rags and other floating matter. The size of each bed should be such as to permit an even distribution of sewage over its surface.

Where the filtration area is small, it must be divided so as to permit of intermittent operation; that is, if a bed is to be in use and at rest for equal periods, then two or more beds would be necessary, the number depending on the relative periods of use and rest. Some additional area should also be provided for emergency, or for use while the beds are being scraped. If a large area is laid out, so that the size of the beds is limited only by convenience in use, then an acre may be taken as a good size.

The degree of purification depends upon various circumstances, but with the best material practically all of the organic matter can be removed from sewage by intermittent filtration at a rate of about 100,000 gallons per day.

There is often much opposition to sewage purification by those living or owning property near the plants; but experience has shown that well-conducted plants are inoffensive both within

and without their enclosures. The employees about such works are as healthy as similar classes of men in other occupations. The crops raised on sewage farms are as healthful as those of the same kind raised elsewhere, and meat and milk from sewage farms are usually as good as when produced under other conditions. Good design and construction, followed by proper methods of operation, are all that are needed to make sewage purification a success. No one system can be said to be the best for all localities. The special problems of each case must be met and solved by a selection from among the several systems and the combinations of systems, and parts chosen that are best adapted to the conditions at hand.

EXAMINATION PAPER.

PLUMBING PART I.

PLUMBING.

Read carefully : Place your name and full address at the head of the paper. Any cheap, light paper like the sample previously sent you may be used. Do not crowd your work, but arrange it neatly and legibly. *Do not copy the answers from the Instruction Paper : use your own words, so that we may be sure that you understand the subject.* After completing the work add and sign the following statement :

I hereby certify that the above work is entirely my own.
(Signed)

1. What causes a trap to "siphon," and in what three ways may it be prevented?
2. What size of soil pipe should be used for an ordinary-sized dwelling, and what pitch should be given to the horizontal portion?
3. What quantity of water per capita should be allowed in designing a sewerage system?
4. What form of cross-section of conduit gives a maximum velocity of flow to small quantities of sewage?
5. Describe the manner of making house connections with the main sewer.
6. Show by sketch the general method of running the waste and vent pipes in a dwelling house, and indicate the proper location of traps.
7. What are the two principal methods of sewage purification?
8. Describe the method of making up the joints in cast iron soil pipe.
9. In what way may the seal of a trap be broken besides siphonage?
10. What two tests are usually given to a system of plumbing? State the use of each.

11. What grade should be given to main sewers and branches?
12. Give two methods of flushing sewers.
13. Describe briefly some of the usual arrangements in the plumbing of hotels.
14. What is sewage farming? Describe the process briefly.
15. What is the difference between a "cup joint" and a "wipe joint?" State the conditions under which you would use each.
16. What is the use of a fresh-air inlet in connection with a soil pipe, and how is it connected?
17. Describe the "Smoke Test."
18. Should a trap or fixture be vented into a chimney? Give the reasons for your answer.
19. What material is commonly used for sewer pipes of different sizes?
20. When are underdrains required and how are they constructed?
21. What precautions should be taken in back venting traps?
22. What chemicals are commonly used in the precipitation of sewage?
23. How should you connect a lead pipe with a cast or wrought iron pipe?
24. Define the "separate" and "combined" systems of sewerage.
25. What is the principal point to be observed in the disposal of sewage? What precautions should be taken when it is discharged into a stream?
26. What is the sedimentation process?
27. What precautions should be taken in locating a cess-pool? Describe briefly one form of construction.
28. Name some of the most important data to be obtained before laying out a system of sewerage.
29. In designing a system of surface drains what maximum conditions should be provided for?
30. Under what conditions may sub-surface irrigation be used to advantage?

PLUMBING

PART II.

INSTRUCTION PAPER



AMERICAN SCHOOL OF CORRESPONDENCE

[CHARTERED BY THE COMMONWEALTH OF MASSACHUSETTS]

BOSTON, MASSACHUSETTS

U. S. A.

PREPARED BY
CHARLES L. HUBBARD, M.E.,
OF
S. HOMER WOODBRIDGE COMPANY,
HEATING, VENTILATION AND SANITARY ENGINEERS.

*Copyright 1902, by
American School of Correspondence
Boston, Mass.*

PLUMBING.

PART II.

DOMESTIC WATER SUPPLY.

Hydraulics of Plumbing. Although the principles of Hydraulics and Hydrostatics are discussed in "Mechanics," it will be well to review them briefly, showing their application to the various problems under the head of "Water Supply."

If several open vessels containing water are connected by pipes, the water will eventually stand at the same level in all of them, regardless of the length or the size of the connecting pipes.

The pressure exerted by a liquid at any given point is the same in all directions, and is proportional to the depth.

A column of water at 60° temperature having a sectional area of one square inch and a height of one foot, weighs .43 pound, and the pressure exerted by a liquid is usually stated in pounds per square inch, the same as in the case of steam. If a closed vessel is connected, by means of a pipe, with an open vessel at a higher level, so that it is 10 feet, for example, from the bottom of the first vessel to the surface of the water in the second, the pressure on each square inch of the entire bottom of the lower vessel will be $10 \times .43 = 4.3$ pounds, and the pressure per square inch at any given point in the vessel or connecting pipe will be equal to its distance in feet from the surface of the water in the upper vessel multiplied by .43. If a pipe is carried from a reservoir situated on the top of a hill to a point at the foot of the hill a hundred feet below the surface of the water, a pressure of $100 \times .43 = 43$ pounds per square inch will be exerted at the lower end of the pipe, provided it is closed. When the pipe is opened and the water begins to flow, the conditions are changed and the pressure in the different parts of the pipe varies with the distance from the open end.

In order for a liquid to flow through a pipe there must be a certain pressure or "head" at the inlet end. The total head causing the flow is divided into three parts, as follows: 1st, the

velocity head: the height through which a body must fall in a vacuum to acquire the velocity with which the water enters the pipe. 2d, the *entry* head: that required to overcome the resistance to entrance into the pipe. 3d, the *friction* head: due to the frictional resistance to flow within the pipe. In the case of long pipes and low heads the sum of the velocity and entry heads is so small that it may be neglected.

Table I shows the pressure of water in pounds per square inch for elevations varying in height from 1 to 135 feet.

Table II gives the drop in pressure due to friction in pipes of different diameters for varying rates of flow. The figures given are for pipes 100 feet in height. The frictional resistance in smooth pipes having a constant flow of water through them is proportional to the length of pipe. That is, if the friction causes a drop in pressure of 4.07 pounds per square inch in a $1\frac{1}{4}$ -inch pipe 100 feet long, which is discharging 20 gallons per minute, it will cause a drop of $4.07 \times 2 = 8.14$ pounds in a pipe 200 feet long; or $4.07 \div 2 = 2.03$ pounds in a pipe 50 feet long, acting under the same conditions. The factors given in the table are for pipes of smooth interior, like lead, brass or wrought iron.

Example.—A $1\frac{1}{2}$ -inch pipe 100 feet long connected with a cistern is to discharge 35 gallons per minute. At what elevation above the end of the pipe must the surface of the water in the cistern be to produce this flow?

In Table II we find the friction loss for a $1\frac{1}{2}$ -inch pipe discharging 35 gallons per minute to be 5.05 pounds. In Table I we find a pressure of 5.2 pounds corresponds to a head of 12 feet, which is approximately the elevation required.

How many gallons will be discharged through a 2-inch pipe 100 feet long where the inlet is 22 feet above the outlet? In Table I we find a head of 22 feet corresponds to a pressure of 9.53 pounds. Then looking in Table I we find in the column of Friction Loss for a 2-inch pipe that a pressure of 9.46 corresponds to a discharge of 100 gallons per minute.

Tables I and II are commonly used together in examples.

A house requiring a maximum of 10 gallons of water per minute is to be supplied from a spring which is located 600 feet distant, and at an elevation of 50 feet above the point of dis-

TABLE I.

Head in feet.	Pressure pounds per square inch.	Head in feet.	Pressure pounds per square inch.	Head in feet.	Pressure pounds per square inch.
1	.43	46	19.92	91	39.42
2	.86	47	20.35	92	39.85
3	1.30	48	20.79	93	40.28
4	1.73	49	21.22	94	40.72
5	2.16	50	21.65	95	41.15
6	2.59	51	22.09	96	41.58
7	3.03	52	22.52	97	42.01
8	3.46	53	22.95	98	42.45
9	3.89	54	23.39	99	42.88
10	4.33	55	23.82	100	43.31
11	4.76	56	24.26	101	43.75
12	5.20	57	24.69	102	44.18
13	5.63	58	25.12	103	44.61
14	6.06	59	25.55	104	45.05
15	6.49	60	25.99	105	45.48
16	6.92	61	26.42	106	45.91
17	7.36	62	26.85	107	46.34
18	7.79	63	27.29	108	46.78
19	8.22	64	27.72	109	47.21
20	8.66	65	28.15	110	47.64
21	9.09	66	28.58	111	48.08
22	9.53	67	29.02	112	48.51
23	9.96	68	29.45	113	48.94
24	10.39	69	29.88	114	49.38
25	10.82	70	30.32	115	49.81
26	11.26	71	30.75	116	50.24
27	11.69	72	31.18	117	50.68
28	12.12	73	31.62	118	51.11
29	12.55	74	32.05	119	51.54
30	12.99	75	32.48	120	51.98
31	13.42	76	32.92	121	52.41
32	13.86	77	33.35	122	52.84
33	14.29	78	33.78	123	53.28
34	14.72	79	34.21	124	53.71
35	15.16	80	34.65	125	54.15
36	15.59	81	35.08	126	54.58
37	16.02	82	35.52	127	55.01
38	16.45	83	35.95	128	55.44
39	16.89	84	36.39	129	55.88
40	17.32	85	36.82	130	56.31
41	17.75	86	37.25	131	56.74
42	18.19	87	37.68	132	57.18
43	18.62	88	38.12	133	57.61
44	19.05	89	38.55	134	58.04
45	19.49	90	38.98	135	58.48

charge. What size of pipe will be required? From Table I we find an elevation or head of 50 feet will produce a pressure of 21.65 pounds per square inch. Then if the length of the pipe were only 100 feet, we should have a pressure of 21.65 pounds available to overcome the friction in the pipe, and could follow along the line corresponding to 10 gallons in Table II until we came to the

TABLE II.

Gallons discharged per minute.	½ in.		¾ in.		1 in.		1¼ in.		1½ in.		2 in.		2½ in.		3 in.	
	Velocity in feet per second.	Friction loss in pounds.	Velocity in feet per second.	Friction loss in pounds.	Velocity in feet per second.	Friction loss in pounds.	Velocity in feet per second.	Friction loss in pounds.	Velocity in feet per second.	Friction loss in pounds.	Velocity in feet per second.	Friction loss in pounds.	Velocity in feet per second.	Friction loss in pounds.	Velocity in feet per second.	Friction loss in pounds.
5	8.17	24.6	3.63	3.3	2.04	.84	1.31	.31	.91	.12						
10	16.3	96.0	7.25	13.0	4.08	3.16	2.61	1.05	1.82	.47	1.02	.12				
15			10.9	28.7	6.13	6.98	3.92	2.38	2.73	.97	1.53	.27				
20			14.5	50.4	8.17	12.3	5.22	4.07	3.63	1.66	2.04	.42				
25			18.1	78.0	10.2	19.0	6.53	6.40	4.54	2.62	2.55	.67	1.63	.21	1.13	.10
30					12.3	27.5	7.81	9.15	5.15	3.75	3.06	.91				
35					14.3	37.0	9.14	12.04	6.36	5.05	3.57	1.25				
40					16.3	48.0	10.4	16.10	7.26	6.52	4.09	1.60				
45							11.7	20.2	8.17	8.15	4.60	2.02				
50							13.1	24.9	9.08	10.0	5.11	2.44	3.26	.81	2.27	.35
75							19.6	56.1	13.6	22.4	7.66	5.32	4.90	1.80	3.10	.74
100									18.2	39.0	10.2	9.46	6.53	3.20	4.54	1.31
125											12.8	14.9	8.16	1.89	5.67	1.99
150											15.3	21.2	9.80	7.00	6.81	2.85
175											17.1	28.1	11.4	9.46	7.91	3.85
200											20.4	37.5	13.1	12.47	9.08	5.02

friction loss corresponding most nearly to 21.65, and take the size of pipe corresponding. But as the length of the pipe is 600 feet, the friction loss will be six times that given in Table II for given sizes of pipe and rates of flow; hence we must divide 21.65 by 6 to obtain the available head to overcome friction, and look for this quantity in the table, $21.65 \div 6 = 3.61$, and Table II shows us that a 1-inch pipe will discharge 10 gallons per minute with a friction loss of 3.16 pounds, and this is the size we should use.

EXAMPLES FOR PRACTICE.

1. What size pipe will be required to discharge 40 gallons per minute, a distance of 50 feet, with a pressure head of 19 feet?

Ans. $1\frac{1}{4}$ inch.

2. What head will be required to discharge 100 gallons per minute through a $2\frac{1}{2}$ -inch pipe 700 feet long?

Ans. 52 feet.

PIPING.

Wrought iron, lead and brass are the principal materials used for water pipes. Wrought-iron pipe is the cheapest and easiest to lay, but is objectionable on account of rust and the consequent discoloration of water passing through it. When it

TABLE III.

Nominal inside diameter.	Actual outside diameter.	Thickness.	Actual inside diameter.	Internal circumference.	External circumference.	Length of pipe per square foot of inside surface.	Length of pipe per square foot of outside surface.	Internal area.	External area.	Length of pipe containing 1 cubic foot.	Weight per foot.	Number of threads per inch of screw.	Gallons per foot of length.
in.	in.	in.	in.	in.	in.	feet	feet	in.	in.	feet	pounds		
	.40	.068	.27	.85	1.27	14.1	9.44	.05	.13	2500.		27	.0006
	.54	.088	.36	1.14	1.69	10.5	7.05	.10	.23	1385.	.24	18	.0026
	.67	.091	.49	1.55	2.12	7.67	5.65	.19	.36	751.5	.42	18	.0057
	.84	.109	.62	1.95	2.65	6.13	4.50	.30	.55	472.4	.56	14	.0102
	1.05	.113	.82	2.59	3.29	4.63	3.63	.53	.86	270.0	.84	14	.0230
1	1.31	.134	1.05	3.29	4.13	3.68	2.90	.86	1.35	166.9	1.12	11½	.0408
1½	1.66	.140	1.38	4.33	5.21	2.77	2.30	1.49	2.16	96.2	1.67	11½	.0638
2	1.90	.145	1.61	5.06	5.96	2.37	2.01	2.04	2.83	70.6	2.26	11½	.0918
2½	2.37	.154	2.06	6.49	7.46	1.85	1.61	3.35	4.43	42.3	2.69	11½	.1632
3	2.87	.204	2.47	7.75	9.03	1.54	1.33	4.78	6.49	30.1	3.66	8	.2550
3½	3.50	.217	3.06	9.63	10.1	1.24	1.09	7.39	9.62	19.5	5.77	8	.3673
4	4.00	.226	3.55	11.1	12.5	1.07	.95	9.88	12.5	14.5	7.54	8	.4998
4½	4.50	.237	4.02	12.6	14.1	.95	.85	12.7	15.9	11.3	9.05	8	.6528
5	5.56	.259	5.04	15.8	17.4	.75	.63	20.0	24.3	7.2	10.7	8	.8263
6	6.62	.280	6.06	19.0	20.8	.63	.57	28.9	34.4	4.9	14.5	8	1.469
											18.7	8	1.999

is employed for this purpose it is customary to use galvanized pipe, that is, pipe which has been covered with a thin coating of zinc or zinc and tin. This prevents rust from forming where the zinc is unbroken, but at the joints where threads are cut, and at other places where the zinc becomes loosened, as by bending, the pipe is likely to be eaten away more or less rapidly, depending upon the quality of the water. Zinc, when taken into the system, is poisonous, and for this reason galvanized pipes should not ordinarily be used for drinking water.

Table III gives the various dimensions of wrought-iron pipe. In using pipe of this kind, it is well to allow something in size for possible choking by rust or sediment. While galvanized pipe does not rust, for a time at least, there is likely to be a roughness which causes an accumulation of more or less sediment.

TABLE IV.
Lead Pipe.

Internal diameter.	External diameter.	Thickness.	Weight per foot.	Mean bursting pressure (pounds per square inch).	Safe working pressure.
$\frac{3}{8}$.75	.18	1 lb. 12 oz.	1968	492
$\frac{1}{2}$.55	.087	10	1085	271
$\frac{3}{4}$	1.00	.25	3	1787	446
$\frac{1}{2}$.63	.065	10	625	156
$\frac{1}{2}$	1.10	.23	3 8	1548	387
$\frac{3}{4}$.84	.10	1 4	708	177
$\frac{1}{2}$	1.33	.29	4 14	1462	365
$\frac{1}{2}$.93	.09	1 3	505	126
1	1.60	.30	6	1230	307
1	1.18	.09	1 8	325	81
$1\frac{1}{4}$	1.80	.275	6 12	962	240
$1\frac{1}{4}$	1.44	.095	2	322	80
$1\frac{1}{2}$	2.08	.29	8	742	185
$1\frac{1}{2}$	1.74	.12	3	245	61
$1\frac{3}{4}$	2.12	.19	5	460	116
$1\frac{3}{4}$	2.0	.125	3 10	318	79
2	2.60	.30	10 11	611	152
2	2.18	.09	4	200	50

Iron pipe having a lining of tin $\frac{1}{16}$ inch or more in thickness is now manufactured, but being a comparatively new product, its wearing qualities have not yet been thoroughly tested.

Lead Pipe is the best and most widely used for domestic water supply. Although poisonous under certain conditions, as

when new and bright and when used with very pure water, it usually becomes coated with a scale which makes it practically harmless. It is more costly than iron pipe, and requires more skill in laying and making up the joints. It is less likely to burst from the action of frost, as it is a soft metal and stretches with the expansion of the ice in the pipe. When it does break under pressure it generally occurs in small holes not over an inch long, which are easily repaired without removing any part of the pipe, while in the case of iron pipe the cracks generally extend the entire length of the section in which the

TABLE V.

Tin-lined Lead Pipe.

Internal diameter.	AAA Weight per foot.		AA Weight per foot.		A Weight per foot.		B Weight per foot.		C Weight per foot.		D Weight per foot.		D light Weight per foot.		E Weight per foot.		E light Weight per foot.	
	lb.	oz.	lb.	oz.	lb.	oz.	lb.	oz.	lb.	oz.	lb.	oz.	lb.	oz.	lb.	oz.	lb.	oz.
1	1	8	1	5	1	2	1	0	0	13	0	10			0	5		
1 1/2	3	0	2	0	1	12	1	4	1	0	0	13			0	11		
2	3	8	2	12	2	8	2	0	1	12	1	8	1	4	1	4	0	9
2 1/2	4	8	3	8	3	0	3	4	2	0	1	12	1	8	1	1	0	12
3	6	0	4	12	4	0	3	4	2	8	2	0	1	8	1	4	1	0
3 1/2	6	12	5	12	4	12	3	12	3	0	3	8			3	8		
4	9	0	8	0	6	4	5	0	4	4	3	8			3	0		
4 1/2	10	12	9	0	7	0	6	0	5	4	4	0						

water is frozen, and new pipe will be required. Lead pipe is commonly made in six different thicknesses or weights, designated as AAA, AA, A, B, C and D, in which AAA is the heaviest and D the lightest. Table IV gives the principal properties of the heaviest and lightest weight for lead pipe of different diameters.

Tin-lined lead pipe is used to some extent for conveying water for domestic purposes. The principal objection to this pipe lies in the difficulty experienced in making the joints. Tin melts at a considerably lower temperature than lead, so that in making pipe joints it is likely to melt before the lead and block up the passage through the pipe. Another objection is due to the fact

that the tin lining and the outer lead covering are simply pressed together, and it often happens that in bending the pipe the lining pulls away from the lead, thus both obstructing and weakening the pipe. When used for hot water, the uneven expansion of the two metals may separate the two layers, and so cause the same difficulties already mentioned.

Table V gives some of the properties of tin-lined lead pipe.

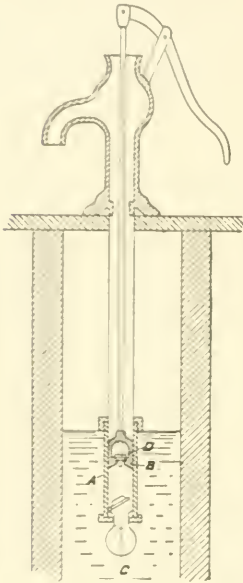

Fig. 1.

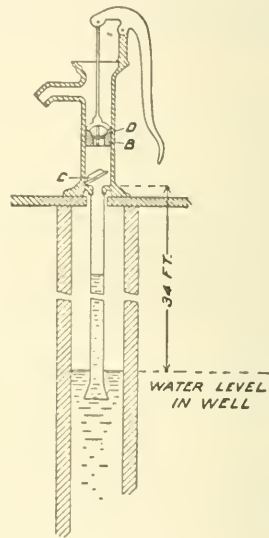

Fig. 2.

The strength of tin-lined pipe is about the same as that of lead pipe, the greater strength of the tin being offset by the lighter weight of the pipe made in this way.

Brass Pipe. Brass is one of the best materials for hot-water pipes, and should be used where the cost is not the controlling feature. It is commonly employed for connecting pumps and boilers and for the steam-heating coils inside laundry-water heaters. It is often used for the connections between the kitchen hot-water tank and range, and when nickel plated is extensively employed in connection with bathroom fixtures. The sizes and thicknesses are approximately the same as wrought-iron pipe.

PUMPS.

The principle upon which the pump operates has already been taken up in the Instruction Paper, "Mechanics." The more common forms are known as the "lift pump," the "suction pump" and a combination of the two called the "deep well pump."

Fig. 1 shows a pump of the first kind. In this pump A is the cylinder, B the plunger, C the bottom valve and D the plunger valve. When the plunger is drawn up, a vacuum is formed in the cylinder, and water flows in through C to fill it. When the plunger is forced down, valve D opens and allows the water to flow through the plunger while C remains closed. As this operation is repeated, the water is raised by the plunger at each stroke until the entire length of the pump barrel is filled, and it will then flow from the spout in an intermittent stream.

In the suction pump shown in Fig. 2, the cylinder and valves are the same, but they are placed at the top of the well and are connected with the water below by means of a pipe, as shown. When the pump is operated, a vacuum is formed in the cylinder and pipe below the plunger, and the pressure of the atmosphere upon the surface of the water forces it up the pipe and fills the chamber, after which the action becomes the same as in the case of a lift pump. The pressure of the atmosphere is approximately 15 pounds per square inch, which corresponds to the weight of a column of water 34 feet high, which is the height that the water may be raised theoretically by suction.

When the surface of the water is a greater distance than this below the point of discharge, a pump similar to that shown in Fig. 3 must be used. A is a cylinder with plunger and valves similar to those of a suction pump. The cylinder is supported in the well at some point less than 34 feet above the surface of the water; E is an air chamber connecting with the upper part of the pump cylinder, and F a discharge pipe leading from the bottom of the air chamber E. The action is as follows: water is pumped into the bottom of the air chamber, and as it rises and seals the end of the discharge pipe, the air in the upper part of the chamber is compressed, and as soon as sufficient pressure is obtained the water is forced out through the discharge pipe F. The pressure

required in the air chamber depends upon the height to which the water is raised.

The Hydraulic Ram. This is a device for automatically raising water from a lower to a higher level, the only requirements within certain limits being that the ram shall be placed at a given distance from the spring or source of supply and at a lower level, depending upon the height to which the water is to be raised and the length of the pipe through which it is to be forced. The distance from the source or spring to the ram should be at least from 25 to 50 feet, in order to secure the required velocity for proper operation. A difference in level of 2 feet, or even less, is sufficient to operate the ram; but the greater the difference, the more powerful is its operation. For ordinary purposes, where the water is to be conveyed from 50 to 60 rods, about $\frac{1}{10}$ to $\frac{1}{14}$ of the total amount used can be raised and discharged at an elevation ten times as great as the fall from the spring to the ram.

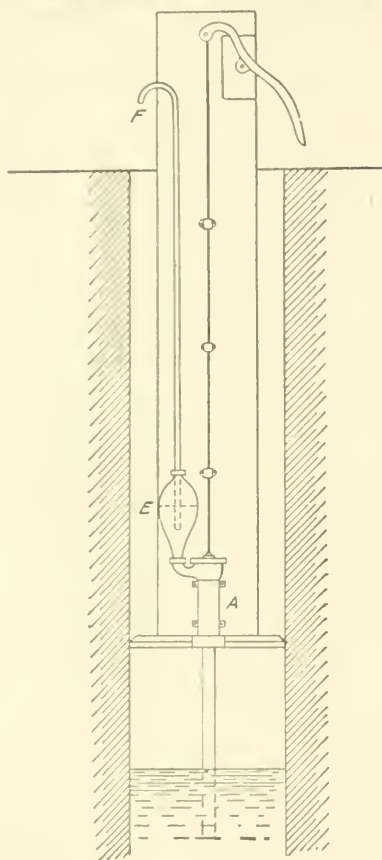

Fig. 3.

In Fig. 4, A represents the source or spring, B the supply pipe, C a valve opening upward, D an air chamber, E a valve closing when raised, and F the discharge pipe. When the water in the pipe is at rest, the valve E drops by its own weight and allows the water to flow through it. As soon as a sufficient velocity is reached by the water, its momentum or force raises the valve against its seat and closes it. The water being thus suddenly arrested in its

passage flows into the chamber D, where its sudden influx compresses the air in the top of the chamber, and this in turn forces the water upward through the discharge pipe F. As soon as the water in the pipe B becomes quiet, the valve E again opens and the operation is repeated. Bends in either the drive or discharge pipe should be avoided if possible. If elbows are necessary, the extra long turn pattern should be used in order to give as little resistance as possible. These machines are made of iron and

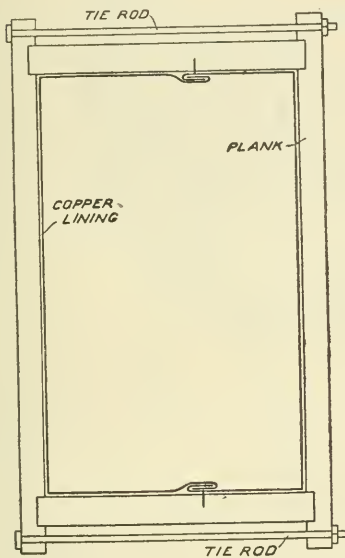

Fig. 5.

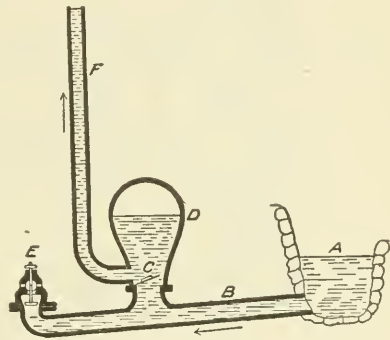

Fig. 4.

brass. The valve and stem are of bronze, on account of its wearing qualities.

Cisterns and Tanks. Water cisterns and tanks are made of various materials and in different shapes and sizes, according to

the special uses for which they are required. A durable and satisfactory tank may be made of heavy woodwork or plank bolted together with iron rods and nuts and then lined with some sheet metal, such as copper, lead or zinc. Copper or lead makes the best lining, as the zinc has a greater tendency to corrode and become leaky. If copper is used, it should be tinned on the outside. Fig. 5 shows a wooden tank in plan, with the method of locking the joints in the copper lining. All nails should be so placed as to be covered by the copper, and the joints soldered with the best quality of solder, which should be allowed to soak into the seams. If the tank is lined with lead, a good weight

should be used (about six pounds per square foot) and the joints carefully wiped by an experienced workman. If used for the storage of drinking water, this form of lining is open to the same objections as lead pipe, but if kept filled at all times, and especially if the water contains mineral matter to any extent, there is very little danger, as a coating is soon formed over the surface of the lead, protecting it from the action of the water.

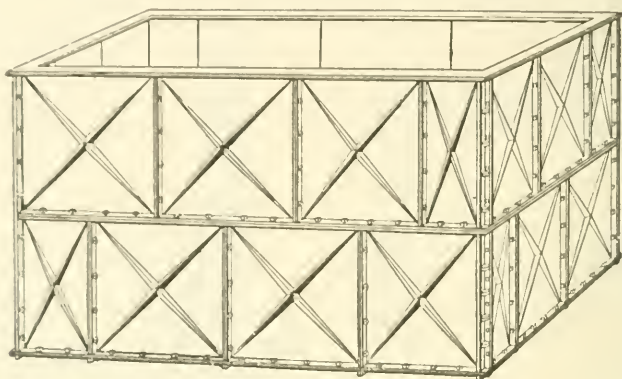

Fig. 6.

Cast-iron sectional tanks can be had in almost any size or shape. A tank of this form is shown in Fig. 6. It is made up of plates which are planed and bolted together, the joints being made tight with cement. The sections are made in convenient sizes, so that they may be handled easily and conveyed without difficulty through small openings to any part of the house. These tanks are easily set up, and are practically indestructible. Wrought-iron tanks are often used, but are not as easily handled as either of the kinds just described. Table VI will be found useful in computing the size of cylindrical tanks.

COLD-WATER SUPPLY.

Systems. There are two general methods of supplying a building with water, one known as the "direct supply" system, and the other as the "indirect" or "tank" system.

In the direct system each fixture is connected with the supply pipe and is under the same pressure as the street main,

unless a reducing valve is introduced. This system is not always desirable, as the street pressure in many places is likely to vary, especially where the water is pumped into the mains. A variable pressure is injurious to the fixtures, causing them to leak much sooner than if subjected to a steady pressure. Where the pressure in the street main exceeds 40 pounds per square inch, a reducing valve should be used if the direct system is to be employed.

TABLE VI.

Capacity of Cisterns, in Gallons, for each 10 inches in Depth.

Diameter in feet.	Gallons.	Diameter in feet.	Gallons.	Diameter in feet.	Gallons.
2.0	19.5	6.0	176.3	10	489.6
2.5	30.5	6.5	206.8	11	592.4
3.0	44.6	7.0	239.9	12	705.0
3.5	60.0	7.5	275.4	13	827.4
4.0	78.3	8.0	313.3	14	959.6
4.5	99.1	8.5	353.7	15	1101.6
5.0	122.4	9.0	396.5	20	1958.4
5.5	148.1	9.5	461.4	25	3059.4

The following factors for changing a given quantity of water from one denomination to another will often be found useful :

$$\begin{aligned} \text{Cubic feet} \times 62\frac{1}{2} &= \text{Pounds} \\ \text{Pounds} \div 62\frac{1}{2} &= \text{Cubic feet} \\ \text{Gallons} \times 8.3 &= \text{Pounds} \\ \text{Pounds} \div 8.3 &= \text{Gallons} \\ \text{Cubic feet} \times 7.2 &= \text{Gallons} \\ \text{Gallons} \div 7.2 &= \text{Cubic feet} \end{aligned}$$

For domestic purposes the indirect system is much better. In this case the connection with the street main is carried directly to a tank placed in the attic or at some point above the highest fixture, and all the water used in the house discharged into it. The supply of water is regulated by a ball-cock in the tank which shuts it off when a certain level is reached. All the plumbing fixtures are supplied from the tank, and are therefore

under a constant pressure. This pressure depends upon the distance of the fixture below the tank. The pipes and fixtures in a house supplied with the tank system will last much longer and

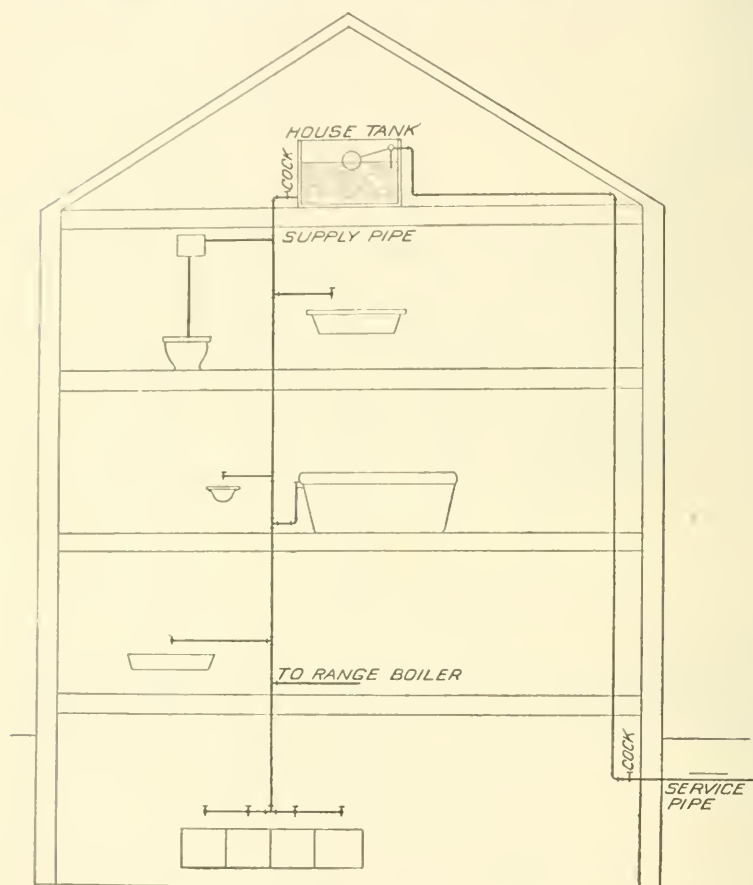

Fig. 7.

give much better results than if connected directly with the street main. The tank is also found useful for storage purposes in case of repairs to the street mains, which is often a matter of much inconvenience.

Fig. 7 shows the general arrangement of the cold-water pipes of an indirect supply system. On the right is shown the service

pipe, which is carried directly from the street to the attic, and then connected with a ball-cock located inside the house tank. A supply pipe is taken from the bottom of the tank and carried downward through the building for supplying the various fixtures. A stopcock should be placed in the supply pipe for closing off the tank connections in case of repairs to the house-piping or fixtures.

Tank Overflow Pipe. In order to prevent any possibility of overflow, every house tank should be supplied with an overflow pipe of sufficient size to carry off easily the greatest quantity of water that may be discharged into it. The overflow from a house tank should never be connected directly with a sewer or soil pipe, even if provided with traps, for the water may seldom flow

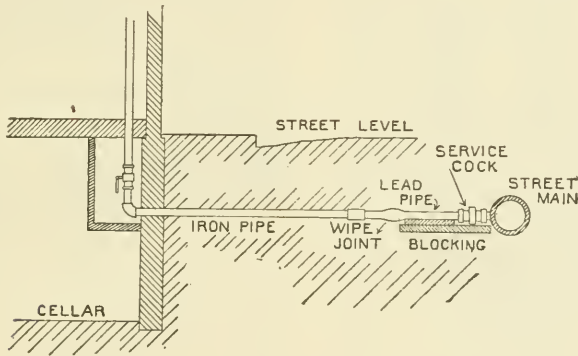

Fig. 8.

through this pipe, thus allowing the trap to become unsealed through evaporation. It is much better to let the end of the overflow pipe be open to the atmosphere or drop over some fixture which is in constant use.

Service Pipe Connections. Fig. 8 shows the usual method of connecting the service pipe with the street main. The service cock is connected directly with the main, and should be carefully blocked, so that any pressure of earth from above will not break the connection or strain the cock. To do this properly, the earth under the pipe should be rammed down solid after the connections are made, and the pipe at this point should be supported on sound

wooden blocks. If galvanized iron is used for the service pipe, it should in all cases be connected to the main service cock with a short piece of lead pipe two or three feet long, for the reason that lead will give or sag with the pressure of the earth without breaking. The remainder of the pipe should be carefully embedded in the earth, to prevent uneven strains at any particular point. Connections between the lead and iron pipes should be made by means of brass ferrules and wiped joints. A stopcock should be placed in the service pipe just inside the cellar wall, and in a position where it will be accessible in case of accident. A drip should be connected with the stopcock for draining the pipes when water is shut off.

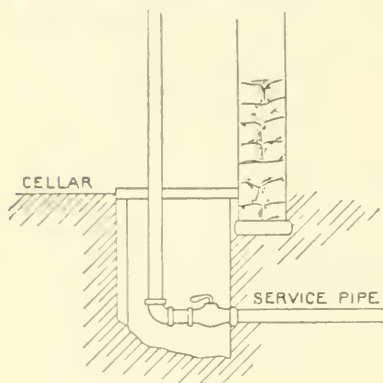

Fig. 9.

In protecting pipes against freezing it is well to pack them in hair, felt, granulated cork or dry shavings where they pass through the floor. This is shown in Fig. 8. When the service pipe comes in below the cellar floor, it may be arranged as shown in Fig. 9. The cock should be placed about 18 inches below the cellar bottom in a wooden box with hinged cover, so that it may be easily reached.

In many cities and in certain elevated situations the pressure in the mains is not sufficient to carry the water to the house tanks in the attics of the higher buildings, and it becomes necessary to use some form of automatic pump for this purpose. The screw pump shown in Fig. 10 is especially adapted to uses of this kind when equipped with an electric motor and automatic starting and stopping devices. A float in the tank operates an electric switch by means of a chain and weights, as shown. A centrifugal or rotary pump is also satisfactory for this work.

Another device which may be attached to a steam pump is shown in Fig. 11. When the water line in the tank reaches a given height, the float closes a butterfly valve in the discharge pipe, thus increasing the pressure within it; this

in pressure acts on the bottom of a piston by means of a connecting pipe, and in raising the piston, shuts off the steam supply to the pump. When the water line in the tank is lowered, the float falls

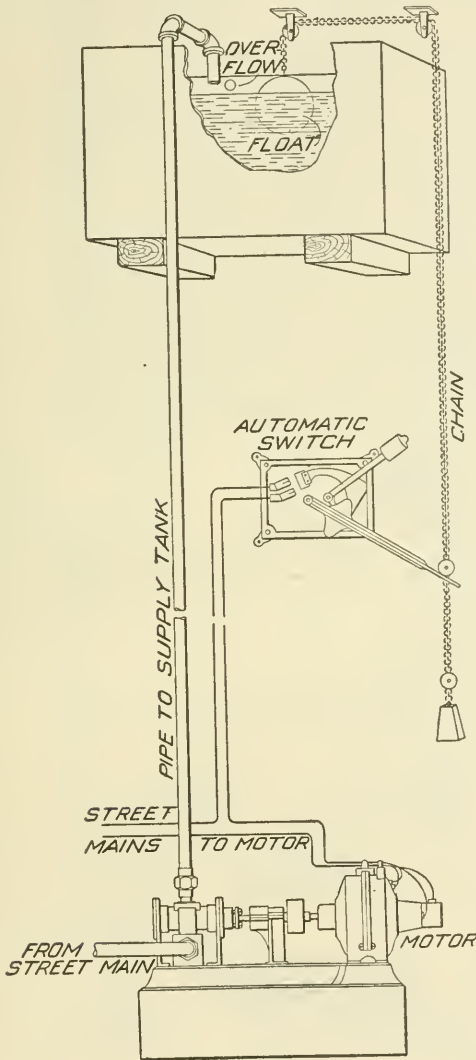

Fig. 10.

Fig. 13 shows the usual arrangement of a kitchen boiler and water-back with the necessary pipe connections. The boiler is

and the butterfly valve opens, relieving the pressure in the pipe and allowing the steam valve to open by the action of the counterweights attached to the lever arm of the valve, as shown. The automatic valve is shown in section in Fig. 12. Another means of raising water to an elevation for domestic purposes, especially in the country, is by the use of a windmill. A large storage tank is placed at a suitable height so that a sufficient supply may be pumped on windy days to last over intervening periods of calm weather.

HOT-WATER SUPPLY.

All modern systems of plumbing include a hot-water supply to the various sinks, bowls, bathtubs and laundry-tubs throughout the house.

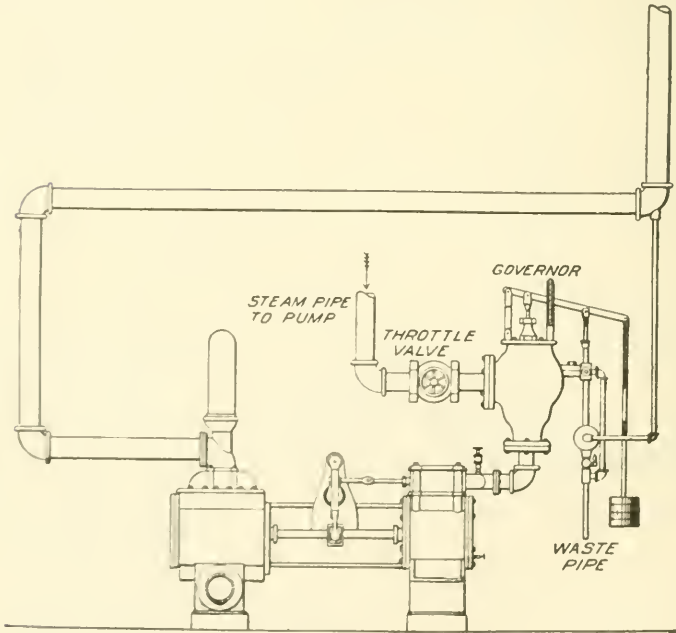
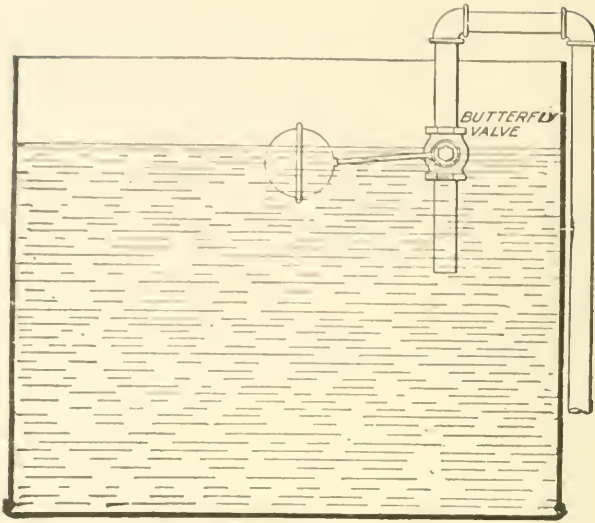

Fig. 11.

commonly made of copper and supported upon a cast-iron base. It may be located in the kitchen near the range, or may be concealed in a nearby closet. The "water-back," so called, is a special casting placed so as to form one side of the fire box in

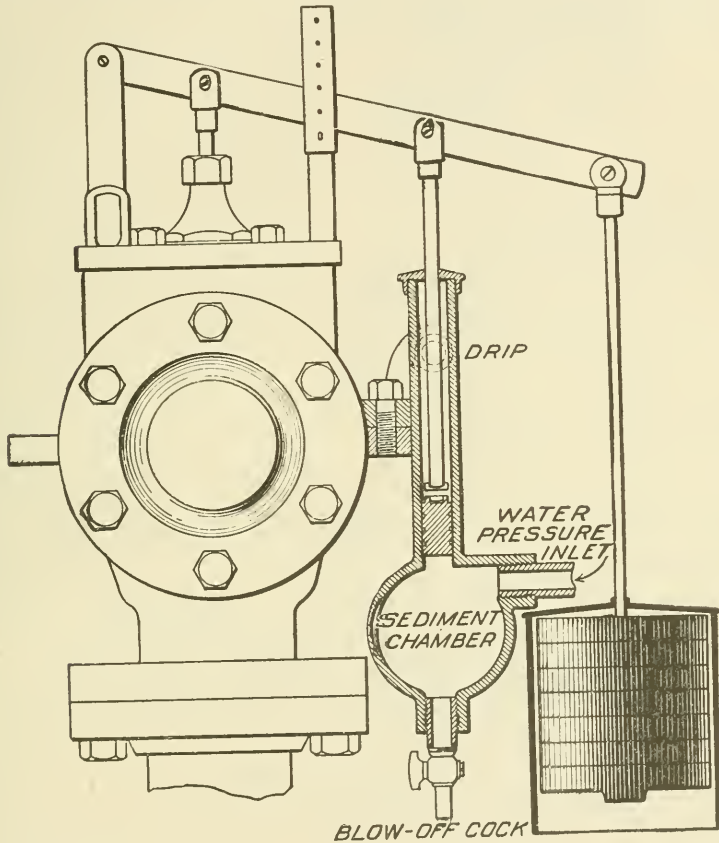

Fig. 12.

the range. The cold-water supply pipe to the boiler usually enters at the top and is carried down to a point near the bottom, as shown by the dotted lines. Connection is made between the bottom of the boiler and the lower chamber of the water-back. The upper chamber is connected at a point about one-third of the way up in the side of the boiler, as shown. The circulation of water

through the boiler and supply pipes is the same as already described for hot-water-heating systems. The range fire in contact with the water-back heats the water within it, which causes it to rise through the pipe connected with the upper chamber and

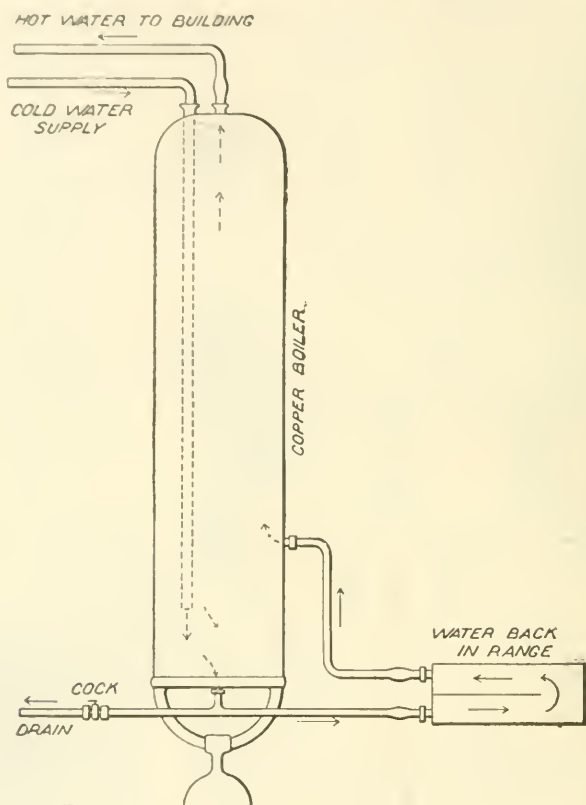

Fig. 13.

flow into the boiler or tank; in the meantime cooler water flows in at the lower connection to take its place, and the circulation thus set up is constant as long as there is a fire in the range.

The "boiler," so called, is not a heater, but only a storage tank. As the water becomes heated it rises to the top of the tank and is carried to the different fixtures in the building through a pipe or pipes connected at this point. The cold-water supply pipe is connected with the house tank so that the pressure in the boiler

is that due to the height of the tank above it. When any of the hot-water faucets are open, the pressure of the cold water in the supply pipe forces out the hot water at the top of the boilers and rushes in to take its place. There is no connection between the circulation through the water-back and the pressure in the cold-water supply pipe. The circulation is due only to the difference in temperature between the water in the pipe leading from the top of the water-back and the water in the lower part of the boiler, and difference in elevation of the connections with the boiler. The nearer the top of the boiler the discharge from the water-back is connected, the more rapid will be the circulation and the greater the quantity of water which will be heated in a given

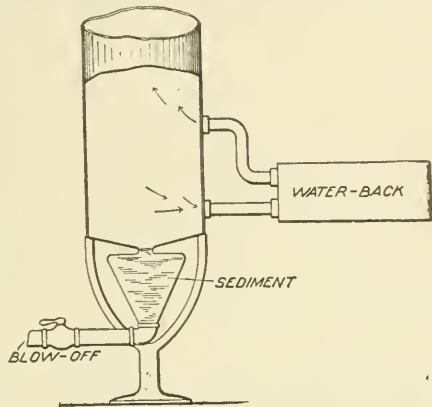

Fig. 14.

time. The cold-water supply simply furnishes a pressure to force the hot water through the pipes to the different fixtures, and replaces any water that is drawn from the boiler.

Care should always be taken to have the pipes between the water back and the boiler free from sediment or any other obstruction. If the water-back from any cause should become shut off from the boiler, an explosion would be likely to occur if there was a hot fire in the range. Freezing of the pipes is sometimes a cause of accident. The sediment which accumulates more or less rapidly should be regularly blown off through the blow-off cock provided for this purpose at the bottom of the boiler. The best time for doing this is in the morning, before the fire is started. The device shown in Fig. 14 is intended to prevent the sediment from collecting in the pipes or from being drawn into the water-back, making the water roily when a large amount is drawn off at one time. It consists of a small cylinder or chamber connected to the bottom of the boiler in such a way that the sediment will fall into it and not be disturbed by the circulation of the water through the pipes.

Double Water-back Connections. It is often desirable to connect a boiler with two water-backs, one in the kitchen range and another in a laundry stove in the cellar for summer use. Fig. 15 shows the common method of making the connections. In this case either may be used separately, or both together without any adjustment of valves. The blow-off cock at the bottom

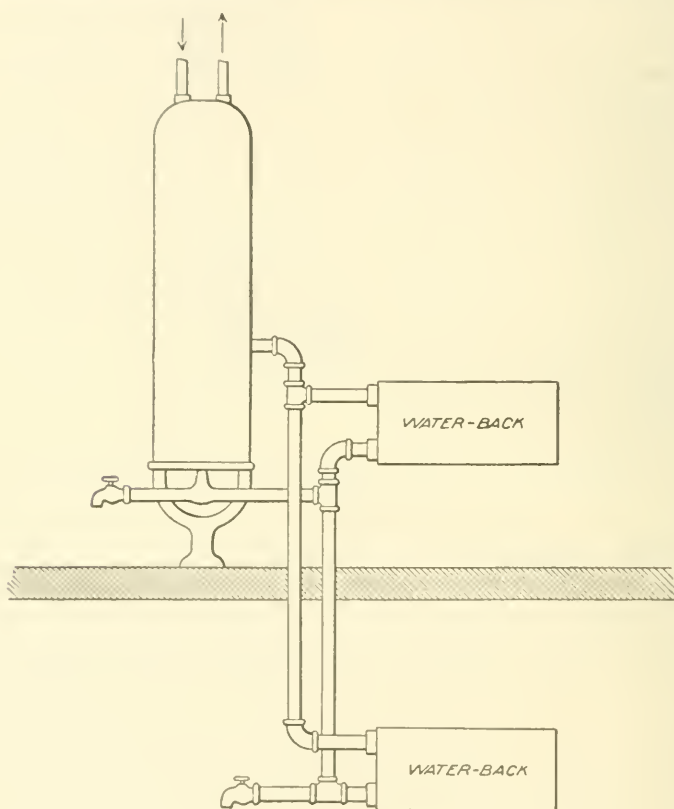

Fig. 15.

of the lower water-back should be opened quite often to clear it of sediment, as it will collect much faster at this point than at the bottom of the boiler.

Double Boiler Connections. It quite frequently happens that the kitchen boiler does not have sufficient capacity for the entire house, and it is not desirable to use a larger boiler on account

of the limited space in the kitchen. In such cases a second boiler may be connected with the laundry stove if one is provided, and the water pipes from both boilers be connected together at some point so that they may both discharge hot water into the same general supply.

Stopcocks should be placed in the pipe connections as shown, so that either boiler may be shut off for repairs without interfering with the operation of the other. Waste cocks should always be used for this purpose, so that when closed there will be a connection between the boiler and the atmosphere. This will prevent damage to the boiler in case those in charge should forget to open the cocks when starting up a fire in the stove with which the boiler is connected.

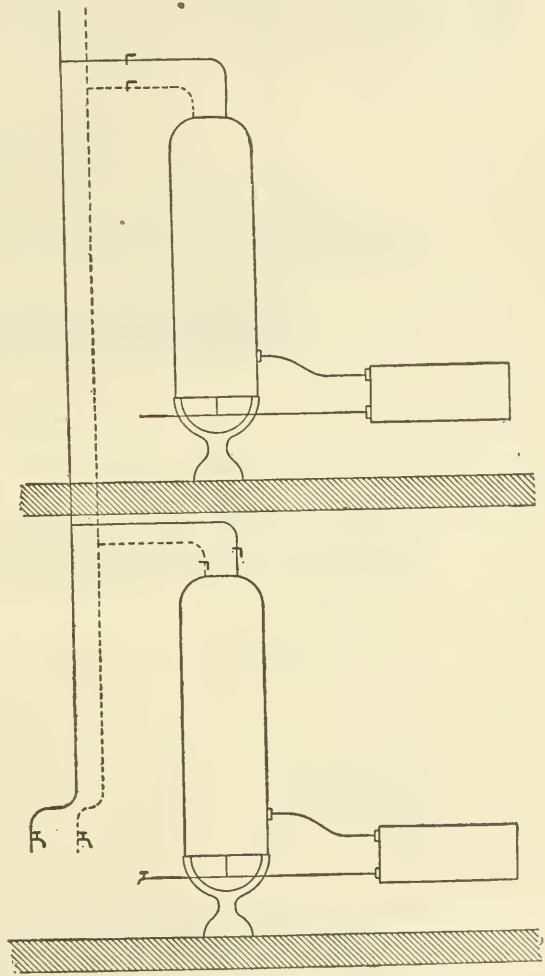

Fig. 16.

Circulation Pipes. It is often desirable to produce a continuous circulation in the distributing pipes so that hot water may be drawn from the faucets at once, without waiting for the cooler water in the pipe between the boiler and the faucet to run out.

This is accomplished by connecting a small pipe with the hot-water pipe near the faucet, and connecting it with the bottom of the boiler as shown in Fig. 17. This makes a circuit, and a constant circulation is produced by the difference in temperature of the water in the supply and circulation pipes.

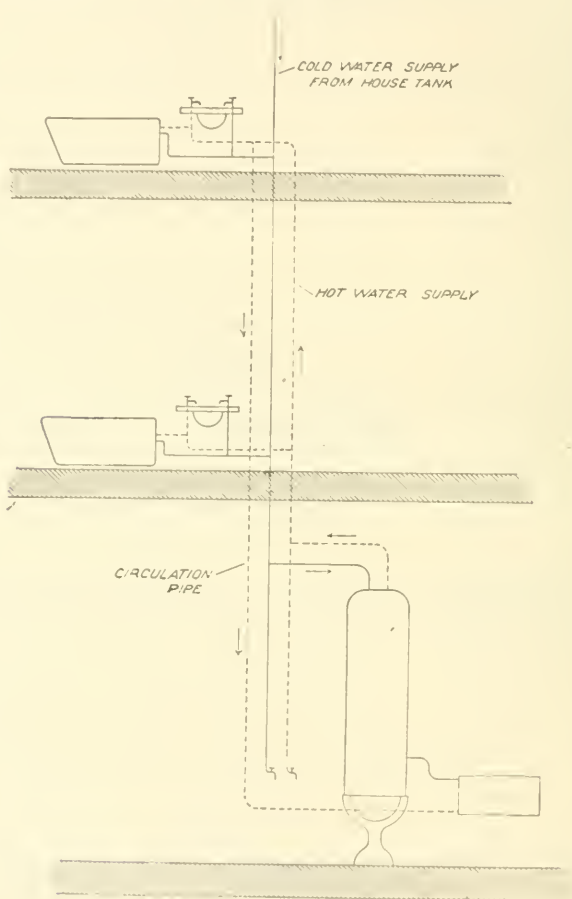

Fig. 17.

Pipe Connections. Brass or copper pipe with screwed fittings should always be used for making the connections between the boiler and water back. Where unions are used they should have ground joints without packing. Lead pipe is too soft to

stand the high temperature to which these pipes are sometimes subjected.

Laundry Boilers. In laundries, hotels, etc., where a large amount of hot water is used, it is necessary to have a larger storage tank and a heater with more heating surface than can be

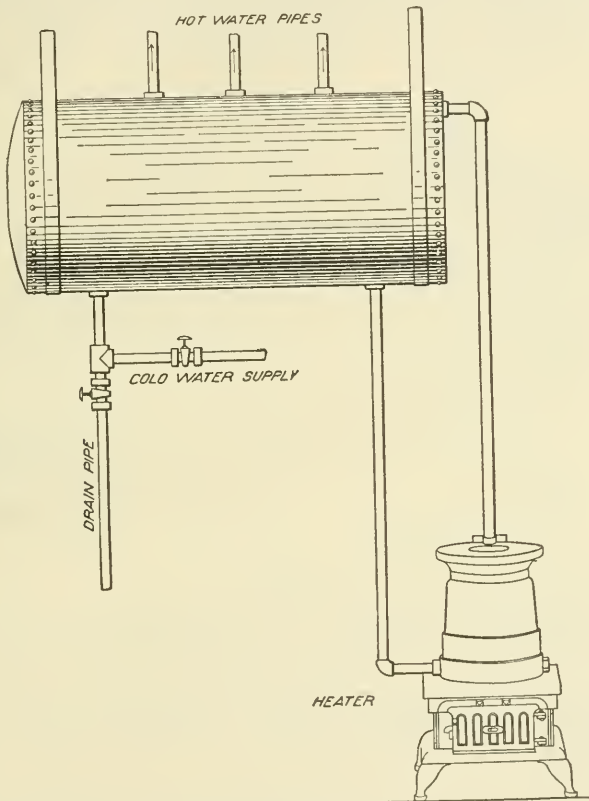

Fig. 18.

obtained in the ordinary range water-back. Fig. 18 shows an arrangement for this purpose.

The boiler may be of wrought iron or steel of any size desired, and is usually suspended from the ceiling by means of heavy strap iron. The heaters used are similar to those employed for hot water warming. The method of making the connections is indicated in the illustration.

The capacity of the heater and tank depends entirely upon the amount of water used. In some cases a large storage tank and a comparatively small heater are preferable, and in others the reverse is more desirable.

The required grate surface of the heater may be computed as follows: first determine or assume the number of gallons to be heated per hour, and the required rise in temperature. Reduce gallons

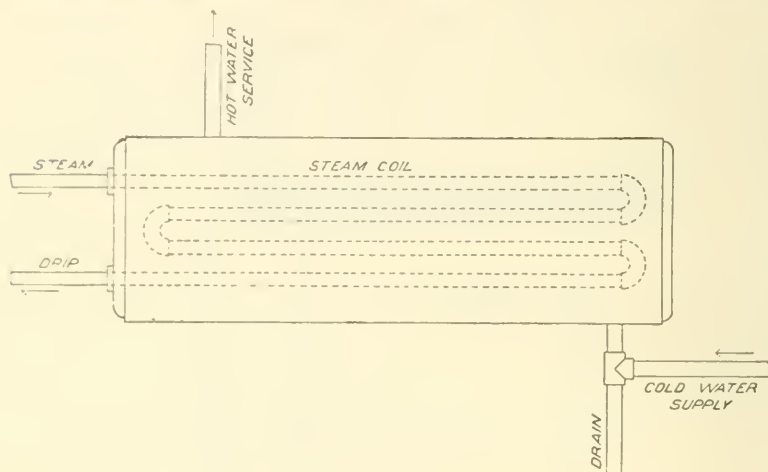

Fig. 19.

to pounds by multiplying by 8.3, and multiply the result by the rise in temperature to obtain the number of thermal units. Assuming a combustion of five pounds of coal per square foot of grate, and an efficiency of 8,000 thermal units per pound of coal, we have

$$\text{Grate Surface in sq. ft.} = \frac{\text{gal. per hour} \times 8.3 \times \text{rise in temp.}}{5 \times 8,000}$$

Example.—How many square feet of grate surface will be required to raise the temperature of 200 gallons of water per hour from 40 degrees to 180 degrees?

$$\frac{200 \times 8.3 \times (180 - 40)}{5 \times 8000} = 5.8 \text{ square feet}$$

In computing the amount of water required for bathtubs it is customary to allow from 20 to 30 gallons per tub, and to con-

sider that the tub may be used three or four times per hour as a maximum during the morning. This will vary a good deal, depending upon the character of the building. The above figures are based on apartment hotel practice.

Boilers with Steam Coils. In large buildings where steam is available, the water for domestic purposes is usually warmed by placing a steam coil of brass or copper pipe in the storage tank. This may be a trombone coil made up with brass fittings, or a spiral consisting of a single pipe. Heaters of these types are shown in Figs. 19 and 20. The former must be used in tanks which are placed horizontally, and the latter in vertical tanks. If the steam is used at boiler pressure, the condensation may return directly to the boiler by gravity; but if steam at a reduced pressure is used, it must be trapped to the receiver of a return pump or to the sewer.

The cold water is supplied near the bottom of the tank, and the service pipes are taken off at the top. A drip pipe should be connected with the bottom, for draining the tank to the sewer. Gate valves should be provided in all pipe connections for shutting off in case of repairs. Sometimes a storage tank is connected with a steam-heating system for winter use, and cross connected with a coal-burning heater for summer use where steam is not available. Such an arrangement is shown in Fig. 21.

The efficiency of a steam coil surrounded by water is much greater than when placed in the air. A brass or copper pipe will give off about 200 thermal units per square foot of surface per hour for each degree difference in temperature between the steam and the surrounding water. This is assuming that the water is

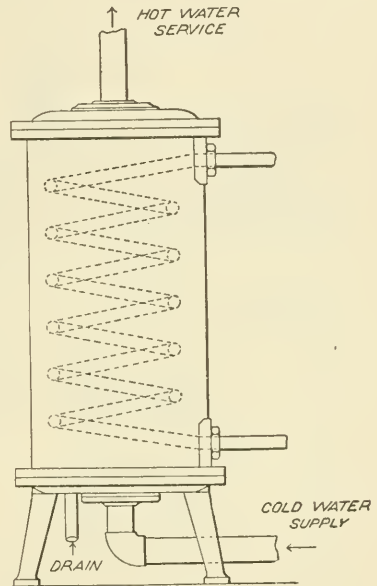

Fig. 20.

circulating through the heater so that it moves over the coil at a moderate velocity. In assuming the temperature of the water we must take the average between that at the inlet and outlet.

Example.—How many square feet of heating surface will be required in a brass coil to heat 100 gallons of water per hour from 38 degrees to 190 degrees, with steam at 5 pounds pressure?

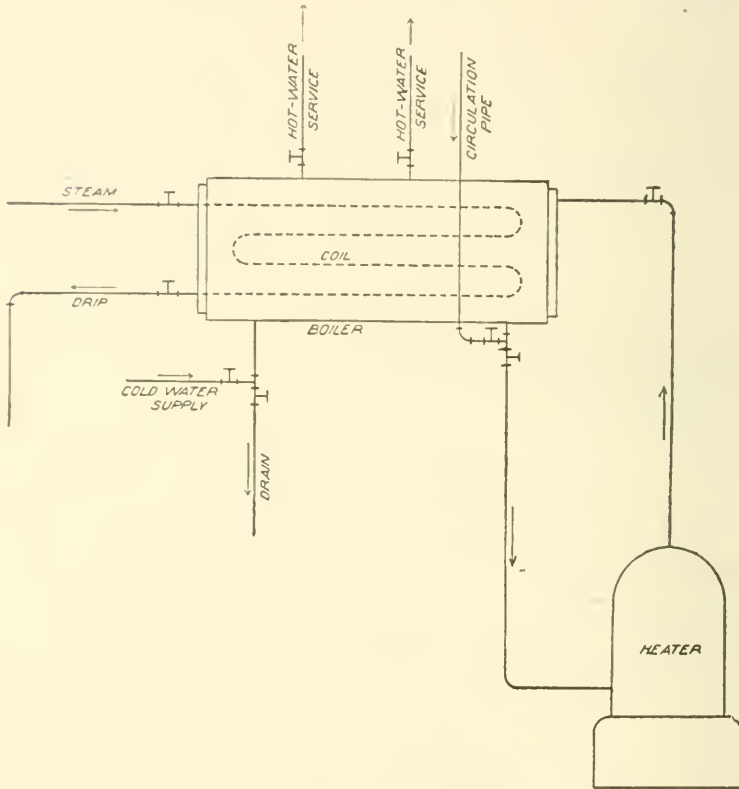

Fig. 21.

Water to be heated = $100 \times 8.3 = 830$ pounds.

Rise in temperature = $190 - 38 = 152$ degrees.

Average temperature of water in contact with the coils

$$= \frac{190 + 38}{2} = 114 \text{ degrees}$$

Temperature of steam at 5 pounds pressure = 228 degrees.

The required B. T. U. per hour = $830 \times 152 = 126,160$.

Difference between the average temperature of the water and the temperature of the steam = $228 - 114 = 114$ degrees.

B. T. U. given up to the water per square foot of surface per hour = $114 \times 200 = 22,800$, and

$$\frac{126,160}{22,800} = 5.5 \text{ square feet. Ans.}$$

EXAMPLES FOR PRACTICE.

1. How many linear feet of 1-inch brass pipe will be required to heat 150 gallons of water per hour from 40 to 200 degrees, with steam at 20 pounds pressure?

Ans. 21.3 feet.

2. How many square feet of grate surface will be required in a heater to heat 300 gallons of water per hour from 50 to 170 degrees?

Ans. 7.4 square feet.

3. A hot-water storage tank has a steam coil consisting of 30 linear feet of 1-inch brass pipe. It is desired to connect a coal-burning heater for summer use which shall have the same capacity. Steam at 5 pounds pressure is used, and the water is raised from 40 to 180 degrees. How many square feet of grate surface are required? Ans. 5.9 sq. ft.

4. A hotel has 30 bathtubs, which are used three times apiece between the hours of seven and nine in the morning. The

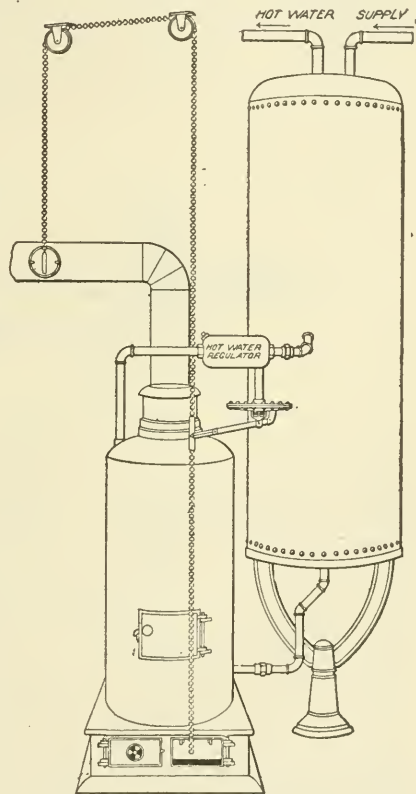

Fig. 22.

hot-water system has a storage tank of 400 gallons. Allowing 20 gallons per bath, and starting with the tank full of hot water, how many square feet of grate surface will be required to heat the additional quantity of water within the stated time, if the temperature is raised from 50 to 130 degrees? If steam at 10 pounds pressure is used instead of a heater, how many square feet of heating coil will be required?

Ans. $\left\{ \begin{array}{l} 11.6 \text{ sq. ft. grate.} \\ 15.3 \text{ sq. ft. coil.} \end{array} \right.$

Temperature Regulators. Hot-water storage tanks having special heaters or steam coils should be provided with some means for regulating the temperature of the water. Fig. 22 shows a simple form attached to a coal-burning heater. It consists of a

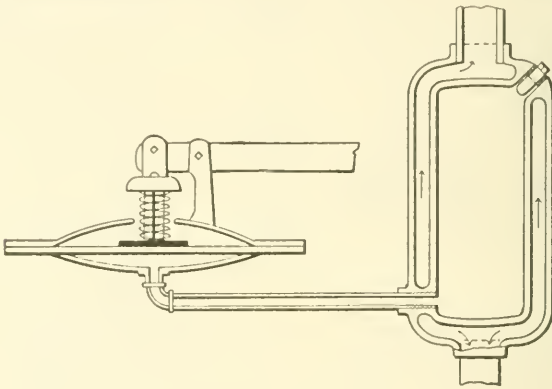

Fig. 23.

casting about nine inches long, tapped at the ends to receive a 2-inch pipe, and containing within it a second shell called the steam generator. (See Fig. 23.) The outer shell is connected with the circulation pipe as shown in Fig. 22. The generator is filled with kerosene, or a mixture of kerosene and water, depending upon the temperature at which it is wished to have the regulator operate. The inner chamber connects with the space below a flexible rubber diaphragm. The boiling point of the mixture in the generator is lower than that of water alone, and depends upon the proportion of kerosene used, so that when the temperature of the water in the outer chamber reaches this point, the mixture boils, and its vapor creates a pressure which forces down the diaphragm and closes the draft door of the heater with which it is connected.

A form of regulator for use with a steam coil is shown in Fig. 24. This consists of a rod made up of two metals having different coefficients of expansion, and so arranged that this difference in expansion will produce sufficient movement, when the water reaches a given temperature, to open a small valve. This

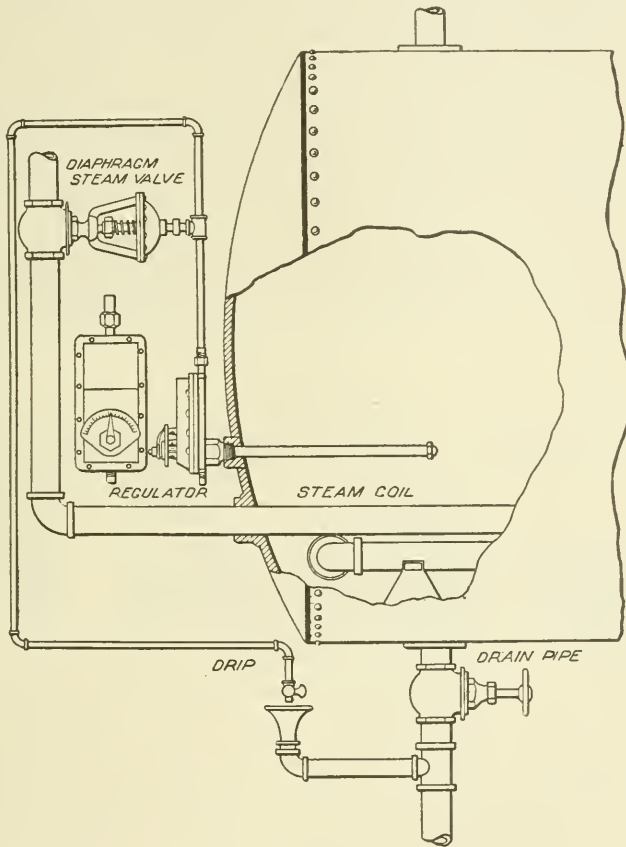

Fig. 24.

allows water pressure from the street main with which it is connected, to flow into a chamber above a rubber diaphragm, thus closing the steam supply to the coil. When the water cools, the rod contracts, and the pressure is released above the diaphragm, allowing the valve to open and thus again admit steam to the coil.

GAS FITTING.

Next to heating and ventilation and plumbing there is no part of interior house construction requiring so much attention as the gas piping and gas fitting.

Gas piping in buildings should be installed according to carefully drawn specifications, and only experienced workmen should be employed. The gas fitter should work from an accurate sketch plan showing the location of all gas service and distributing pipes in the building and the locations of the meter and shut-off cock. The plan should also indicate the exact location and size of the risers and the position of the lights in the different rooms.

Service Pipe and Meter. The service pipe by which the gas is conveyed to a building is always put in by the gas company. The size of this pipe is governed by the number of burners to be supplied, but it should never in any case, even for the smallest house, be less than 1 inch in diameter. This may be slightly larger than is necessary, but the cost is only a little more and the liability of stoppages is much less; this also allows for the future addition of more burners, which is often a matter of much convenience. Service and distributing pipes for water, or naphtha gas, should be from 15 to 20 per cent larger than for coal gas. The material for the main service pipe, from the street to the house, should be either lead or wrought iron. As a rule, wrought-iron pipe with serewed joints is preferable to lead, because it is less likely to sag in the trench, thus causing dips for the accumulation of water of condensation. Care must be observed in the use of wrought-iron pipe to protect it by coating with asphalt, or coal tar, to prevent corrosion. The pipe should also be well supported in the trench. Service pipes should preferably rise from the street gas main toward the house in order to allow all condensation to run back into the mains. This, however, cannot always be done, owing to the relative levels of the street main and the meter in the house. The latter should be placed in a cool, well-lighted position, at or below the level of the lowest burner, which is usually in the cellar. If the meter is below the gas main, the service pipe must grade toward the house and should be provided with a drip pipe, or "siphon," before connecting with the meter.

When water accumulates in the siphon, the cap is removed and the pipe drained. The gas company usually supplies and sets the meter, which should be of ample size for the number of lights burned.

A stopcock, or valve, is placed by the company in the service pipe, so that the gas may be shut off from each building separately. This is usually placed outside near the curb in the case of buildings requiring a pipe $1\frac{1}{2}$ inches in diameter, or larger. In the case of theaters or assembly halls it is often required by law as a safeguard in case of fire. The meter is connected with both the service pipe and the main house pipe by means of short connections of extra heavy lead pipe. A cock is placed near the meter, and in large buildings this is arranged so that a lock may be attached to it when the gas is shut off by the company. Gate valves are preferable for gas mains, as they give a free opening equal to the full size of the pipe.

PIPES.

Distributing Pipes. The distributing pipes inside of a house are usually of wrought iron, except where exposed in rooms, or



Fig. 25.



Fig. 26.

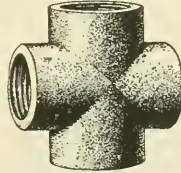

Fig. 27.

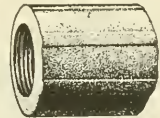

Fig. 28.

carried along walls lined with enameled brick, or tile, in which case they may be of polished brass, or copper. The chief requirements for wrought-iron distributing pipes are that they be carefully welded and perfectly circular in section. The first is important in order to avoid splitting when cutting or threading them on the pipe bench.

All gas pipes are put together with screwed joints, a thread being cut upon the outside. When the pipe is irregular in section the threading will be more or less imperfect, and as a result the joints will be defective. A good gas fitter must examine all pipe as it is delivered at the building, and observe the section

either by means of the eye or by the use of calipers. Plain wrought-iron pipe is likely to rust upon the inside, especially where the gas supplied is imperfectly purified, and for this reason it is often advisable to use rustless, or galvanized pipe, for the smaller sizes.

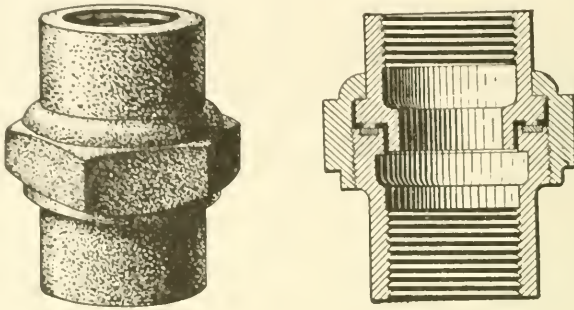

Fig. 29.

Fittings and Joints. The fittings used in gas piping are similar to those employed in steam work, such as couplings, elbows, tees, crosses, etc. (see Figs. 25, 26, 27 and 28). Other fittings not so extensively used are the union, the flange union, the running socket and right and left couplings. Fig. 29

shows a screwed union and Fig. 30 a flange. These fittings are of cast iron, or of malleable iron, the latter being preferred for the smaller sizes. Fittings may be either galvanized, or rustless, as in the

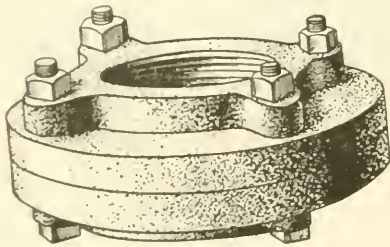

Fig. 30.

case of pipe, and it is especially necessary that they be free from sand holes. In making pipe joints the gas fitter should make use of red lead, or red and white lead mixed, to make up for any possible imperfections in the threads; this, however, should be used sparingly so that the pipe may not be choked or reduced in size. The use of gas fitters' cement should be prohibited. It is important that each length should be tightly screwed into the fitting before the next length is put on. It is always a wise precaution

to examine each length of pipe before it is put in place, to make sure it is free from imperfections of any kind.

Running Pipes and Risers. All large risers should be exposed, and it is desirable to keep all piping accessible as far as possible so that it may be easily reached for repairs. All horizontal pipes should be run with an even though slight grade toward the riser, and all sags in the pipes must be avoided to prevent the collection of water, and for this reason they should be well supported. Floor boards over all horizontal pipes should be fastened down with screws so that they may be removed for inspection of the pipes. When it becomes necessary to trap a pipe, a drip with a drain cock must be put in, but this should always be avoided under floors or in other inaccessible places. When pipes under floors run across the timbers, the latter should be cut into near the ends, or where supported upon partitions, in order to avoid weakening the timbers. All branch outlet pipes should be taken from the side or top of the running lines, and bracket pipes should be run up from below instead of dropping from above. Never drop a center pipe from the bottom of a running line; always take such an outlet from the side of the pipe. Where possible it is better to carry up a main riser near the center of the building, as the distributing pipes will be smaller than if carried up at one end. Where this is done the timbers will not require so much cutting, and the flow of gas will be more uniform throughout the system.

When a building has different heights of post it is always better to have an independent riser for each height rather than to drop a system of piping from a higher to a lower post and grading to a lower point and establishing drip pipes. Drips in a building should be avoided if possible and the whole system of piping be so arranged that any condensed gas will flow back through the system and into the service pipe. All outlet pipes should be securely fastened in position, so that there will be no possibility of their moving when the fixtures are attached. Center pipes should rest on a solid support fastened to the floor timbers near the top. The pipe should be securely fastened to the support to prevent movement sidewise. The drop must be perfectly plumb and pass through a guide fastened near the bottom of the timbers in order to hold it rigidly in position. (See arrangement, Fig. 31.)

Unless otherwise directed, outlets for brackets should be placed $5\frac{1}{2}$ feet from the floor except in the cases of hallways and bathrooms, where it is customary to place them 6 feet from the floor. Upright pipes should be plumb, so that nipples which project through the walls will be level; the nipples should not

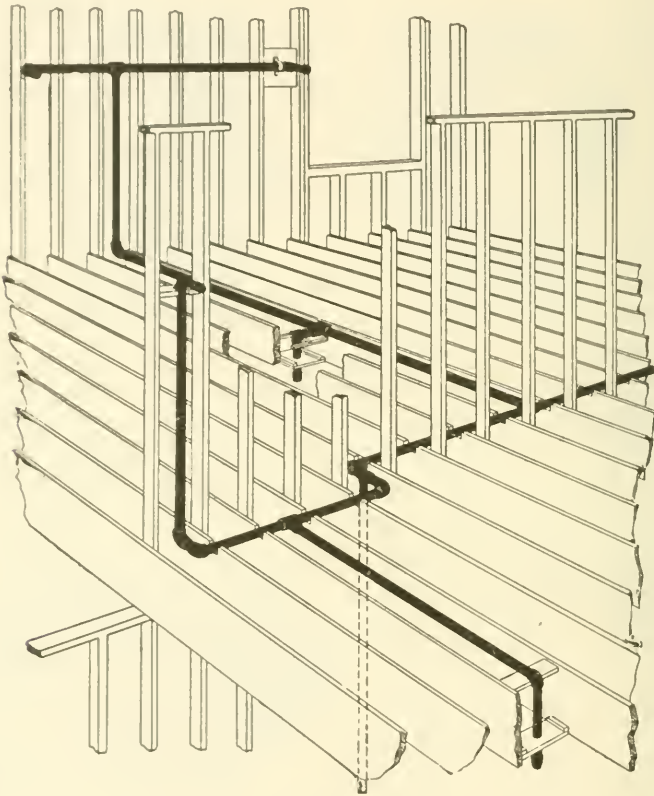

Fig. 31.

project more than $\frac{3}{4}$ inch from the face of the plastering. Lathes and plaster together are usually about $\frac{3}{4}$ inch thick, so the nipples should project about $1\frac{1}{2}$ inches from the face of the studding.

Gas pipes should never be placed on the bottoms of floor timbers that are to be lathed and plastered, because they are inaccessible in case of leakage or alterations.

Pipe Sizes. All risers and distributing pipes, and all

branches to bracket and center lights should be of sufficient size to supply the total number of burners indicated on the plans. Mains and branches should be proportioned according to the number of lights they are to supply, and not the number of outlets.

No pipe should be less than $\frac{3}{8}$ inch in diameter, and this size should not be used for more than two-bracket lights. No pipe for a chandelier should be less than $\frac{1}{2}$ inch up to four burners, and it should be at least $\frac{3}{4}$ inch for more than four burners. The following table gives sizes of supply pipes for different numbers of burners and lengths of run.

TABLE VII.

Size of Pipe. Inches.	Greatest Length of Run. Feet.	Greatest Num- ber of Burners to be Supplied.
$\frac{3}{8}$	20	2
$\frac{1}{2}$	30	4
$\frac{3}{4}$	50	15
1	70	25
$1\frac{1}{4}$	100	40
$1\frac{1}{2}$	150	70
2	200	140
$2\frac{1}{2}$	300	225
3	400	300
4	500	500

Testing Gas Pipes. As soon as the piping is completed, it should be tested by means of an air pump; a manometer or mercury gage is used to indicate the pressure. In the case of large buildings, it is better to divide the piping into sections, and test each separately. All leaks revealed must be repaired at once, and the test repeated until the whole system is air tight at a pressure of from 15 to 20 inches of mercury, or $7\frac{1}{2}$ to 10 pounds per square inch.

The final test is of great importance. This test is to provide against future troubles and dangers from leaks resulting from sand holes in the fittings, split pipe, imperfect threads, loose joints or outlets left without capping. If the building is new, a careful inspection should first be made to see that all outlets are closed, then the valve in the service pipe closed and the air pump attached to any convenient side-light. To the same outlet or an

adjacent one attach the mercury column gage used by gas fitters, and having a column from 15 to 20 inches in height. Care must be taken that there are no leaks in the gage or its connections; a tight-closing valve must be placed between the gas pipe and the temporary connections with the pump, so that it may be shut off immediately after the pump stops, thus preventing any leakage through the pump valves or hose joints. When all is ready, pump the system full of air until the mercury rises to a height of at least 12 inches in the gage; then close the intermediate valve between the pump and the piping. Should the mercury column "stand" for five minutes, it is reasonable to assume that the pipes are sufficiently tight for any pressure to which they will afterward be subjected.

If the mercury rises and falls with the strokes of the pump, it indicates a large leak or open outlet near the pump. But should there be a split pipe or an aggregation of small leaks, the mercury will run back steadily between the strokes of the pump, though more slowly than it rose. Should it rise well in the glass and sink at the rate of 1 inch in five seconds, small leaks in fittings or joints may be expected.

A leak that cannot be detected by the sound of issuing air may usually be found by applying strong soap-water with a brush over suspected joints or fittings; the leak in this case being indicated by the bubbles blown by the escaping air. Sometimes it is necessary to use ether in the pipes for locating leaks, if the pipes are in partitions or under floors. The ether is put into a bend of the connecting hose, or in a cup attached to the pump, and forced in with the air. By following the lines of the pipe, the approximate position of a leak may be determined by the odor of escaping ether.

If the house is an old one or has been finished, the meter should be taken out and the bottom of the main riser capped. Next remove all fixtures and cap the outlets. Then use ether to locate the leaks before tearing up floors or breaking partitions.

GAS FIXTURES.

Burners. Illuminating gas is a complex mixture of gases, of which various chemical compounds of carbon and hydrogen

form the principal light-giving properties. Gas always contains more or less impurities, such as carbonic oxide, carbonic acid, ammonia, sulphureted hydrogen and bisulphides of carbon. These are partly removed by purifying processes before the gas leaves the works.

When the gas-jet is lighted, the hydrogen is consumed in the lower part of the flame, producing sufficient heat to render the minute particles of carbon incandescent. The hydrogen, in the process of combustion, combines with the oxygen from the air, forming an invisible vapor of water, while the carbon unites with the oxygen, forming carbonic acid.

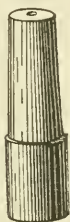

Fig. 32.

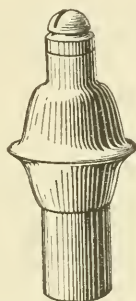

Fig. 33.

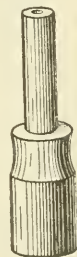

Fig. 34.

Various causes tend to render combustion incomplete: there may be excessive pressure of gas, lack of air or defective burners. An excess of pressure at the burners causes a reduction of the amount of illumination; on the other hand, if the pressure is insufficient, the heat of the flame will not raise the carbon to a white heat, and the result will be a smoky flame. It therefore follows that for every burner there is a certain pressure and corresponding flow of gas which will cause the brightest illumination.

There is a great variety of burners upon the market, among which the following are the principal types:

The single-jet burner, the bat's-wing burner, the fish-tail burner, the Argand burner, the regenerative burner and the incandescent burner.

The Single-jet burner (Fig. 32) is the simplest kind, having

only one small hole from which the gas issues. It is suitable only where a very small flame is required.

The *Bat's-wing* or slit burner (Fig. 33) has a hemispherical tip with a narrow vertical slit from which the gas spreads out in a thin, flat sheet, giving a wide and rather low flame, resembling in shape the wing of a bat, from which it is named. The common kind of slit burners are not suitable for use with globes, as the flame is likely to crack the glass.



Fig. 35.

The *Union-jet* or *Fish-tail* burner (Figs. 34 and 35) consists of a flat tip slightly depressed or concave in the center, with two small holes drilled, as shown in Fig. 35. Two jets of equal size issue from these holes, and by impinging upon each other produce a flat flame longer and narrower in shape than the bat's-wing, and not unlike the tail of a fish. Neither of these burners require a chimney, but the flames are usually encased with glass globes.

The *Argand* burner (Fig. 36) consists of a hollow ring of metal connected with the gas tube, and perforated on its upper surface with a series of fine holes, from which the gas issues, forming a round flame. This burner requires a glass chimney. As an intense heat of combustion tends to increase the brilliancy of the flame, it is desirable that the burner tips shall be of a material that will cool the flame as little as possible. On this account

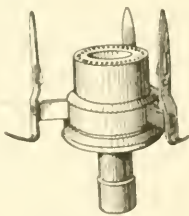

Fig. 36.



Fig. 37.



Fig. 38.

metal tips are inferior to those made of some nonconducting material, such as lava, adamant, enamel, etc. Metal tips are also objectionable because they corrode rapidly, and thus obstruct the passage of the gas. Figs. 37 and 38 show lava tips for bat's-wing and fish-tail burners. Burner tips should be cleaned occa-

sionally, but care should be taken not to enlarge the slits or holes.

In all *regenerative* burners the high temperature due to the combustion in a gas flame is used to raise the temperature of the gas before ignition, and of the air before combustion. These powerful burners are used for lighting streets, stores, halls, etc.

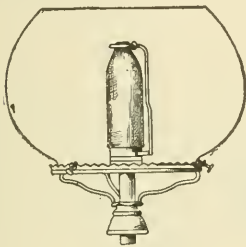

Fig. 39.

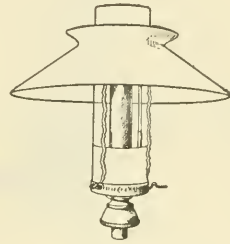

Fig. 40.

In the incandescent burner the heat of the flame is applied in raising to incandescence some foreign material, such as a basket of magnesium or platinum wires, or a funnel-shaped asbestos wick or mantel chemically treated with sulphate of zirconium and other chemical elements. A burner of this kind is shown in Fig. 39, where the mantel may be seen supported over the gas flame by a wire at the side. Fig. 40 shows another form of this burner in which a chimney and shade are used in place of a globe. Burners of this kind give a very brilliant white light when used with water gas unmixed with naphtha gases. The mantel, however, is very fragile, and is likely to lose its incandescence when exposed to an atmosphere containing much dust.

The *Bunsen* burner shown in Fig. 41 is a form much used for laboratory work. It burns with a bluish flame, and gives an intense heat without smoke or soot. The gas before ignition is mixed with a certain quantity of air, the proportions of gas and air being regulated by the thumbscrew at the bottom, and by screwing the

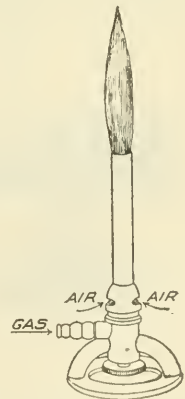

Fig. 41.

outer tube up or down, thus admitting a greater or less quantity of air at the openings indicated by the arrows. This same principle is utilized in a burner for brazing, the general form of which is shown in Fig. 42. A flame of this kind will easily melt brass in the open air.

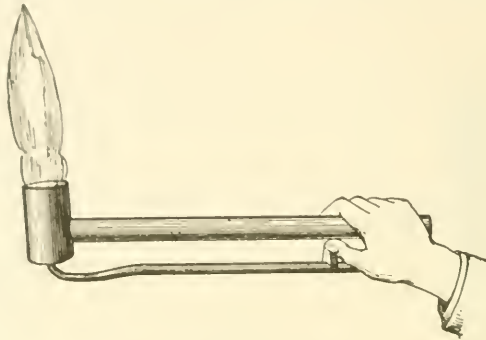

Fig. 42.

Cocks. It is of greatest importance that the stopcocks at the fixtures should be perfectly tight. It is rare to find a house piped for gas where the pressure test could be successfully applied without first removing the fixtures, as the joints of folding

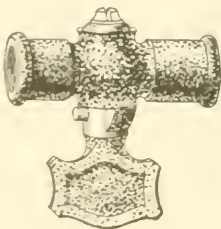

Fig. 43.

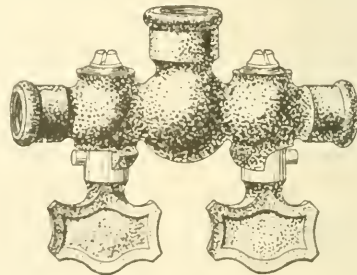

Fig. 44.

brackets, extension pendants, stopcocks, etc., are usually found to leak more than the piping. The old-fashioned, "all-around" cock should never be allowed under any conditions whatever; only those provided with stop pins should be used. Various forms of cocks with stop pins are shown in Figs. 43, 44 and 45. All

joints should be examined and tightened up occasionally to prevent their becoming loose and leaky.



Fig. 46.

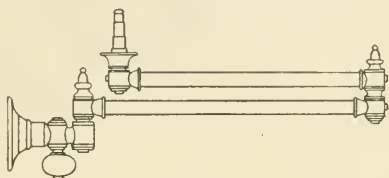

Fig. 47.

Brackets and Chandeliers. Poor illumination is frequently caused by ill-designed or poorly constructed brackets or chandeliers. Gas fixtures, almost without exception, are designed solely from an artistic standpoint, without regard to the proper conditions for obtaining the best illumination. Fixtures having too many scrolls or spirals may, in the case of imperfectly purified gas, accu-

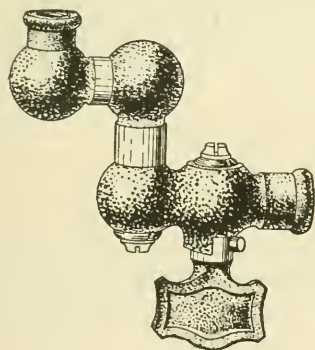

Fig. 45.

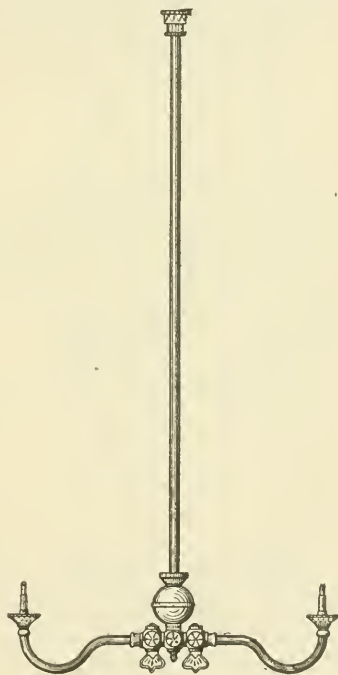

Fig. 48.

mulate a large amount of a tarry deposit which in time hardens and obstructs the passages. Another fault is the use of very small tubing for the fixtures, while a third defect consists in the many leaky stopcocks of the fixtures, caused either by defec-

tive workmanship, or by the keys becoming worn and loose. Common forms of brackets are shown in Figs. 46 and 47, the latter being an extensive bracket. There is an endless variety of chandeliers used, depending upon the kind of building, the finish of the room and the number of lights required. Figs. 48, 49 and 50 show common forms for dwelling houses, Fig. 50 being used for halls and corridors.

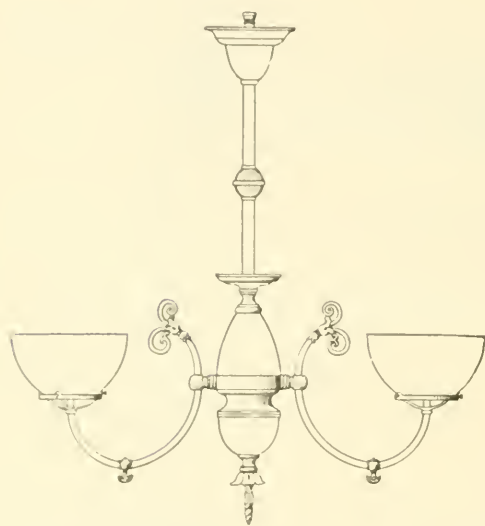

Fig. 49.

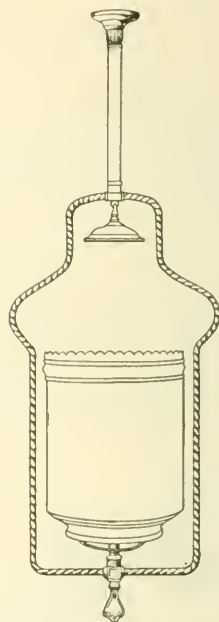

Fig. 50.

Globes and Shades. Next to the burners, the shape of the globes or shades surrounding the flame affects the illuminating power of the light. In order to obtain the best results, the flow of air to the flame must be steady and uniform. Where the supply is insufficient the flame is likely to smoke; on the other hand, too strong a current of air causes the light to flicker and become dim through cooling.

Globes with too small openings at the bottom should not be used. Four inches should be the smallest size of opening for an ordinary burner. All glass globes absorb more or less light, the

loss varying from 10 per cent for clear glass to 60 per cent or more for colored or painted globes. Clear glass is therefore much more economical, although where softness of light is especially desired the use of opal globes is made necessary.

COOKING AND HEATING BY GAS.

Cooking by gas as well as heating is now very common and there is a great variety of appliances for its use in this way. Cooking by gas is less expensive and less troublesome than by coal, oil or wood and is more healthful on account of the absence of waste heat, smoke and dust. A gas range is always ready for use and is instantly lighted by applying a match to the burner. The fire, when kindled, is at once capable

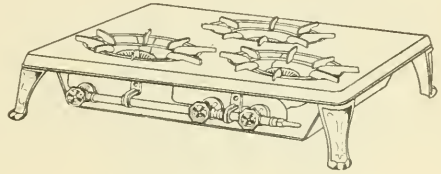

Fig. 51.

of doing its full work; it is easily regulated and can be shut off

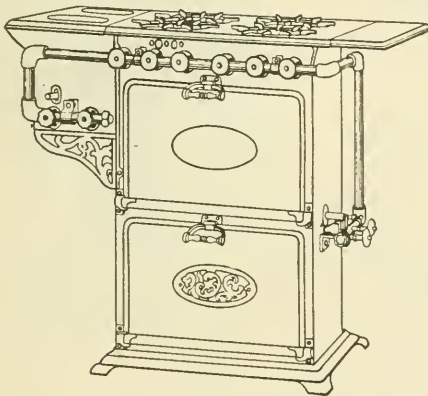

Fig. 52.

the moment it has been used, so that if properly managed there is no waste of fuel as in the case of coal or wood. The kitchen in the summertime may be kept comparatively cool and comfortable. Gas stoves are made in all sizes, from the simple form shown in Fig. 51 to the most elaborate range for hotel use. A range for family use, with ovens and water heater, is shown in Fig. 52. Figs. 53 and 54 show the forms of burners used for cooking, the former being a griddle burner and the latter an oven burner.

A broiler is shown in Fig. 55; the sides are lined with asbestos, and the gas is introduced through a large number of small

openings. The asbestos becomes heated and the effect is the same as a charcoal fire upon both sides.

Heating by Gas. Gas as a fuel has not been used to any great extent for the warming of whole buildings, its application



Fig. 54.

being usually confined to the heating of single rooms. Unlike cooking by gas, a gas fire for heating is not as cheap as a coal fire when kept burning constantly. In other ways it is effective and convenient. It is especially adapted to the warming of small apartments and single rooms where heat is only wanted occasion-

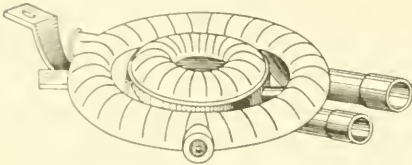

Fig. 53.

ally and for brief periods of time. In the case of bedrooms, bathrooms or dressing-rooms, a gas fire is preferable to other modes of warming and fully as economical. It may be used on cold winter days as a supplementary source of heat in houses heated by stoves or by furnaces.

Again, a gas fire may be used as a substitute for the regular heating apparatus in a house, in the spring or fall, when the fire in the furnace or boiler has not yet been started. It is often employed as the only means for heating smaller bedrooms, guest rooms, bathrooms, and for temporary heating in summer hotels where fires are required only on occasional cold days.

The most common form of heater is that shown in Fig. 56. This is easily carried from room to room and may be connected

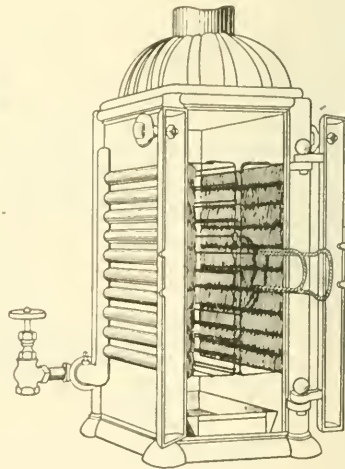

Fig. 55.

with a gas-jet, after first removing the tip, by means of rubber tubing. The heater is simply a large burner surrounded by a sheet-iron jacket or funnel. Another and more powerful form is the gas radiator, shown in Fig. 57. This is arranged with a flue for conducting the products of combustion to the chimney, as shown in the section Fig. 58. Each section of the radiator consists of an outer and an inner tube with the gas flame between the



Fig. 56.

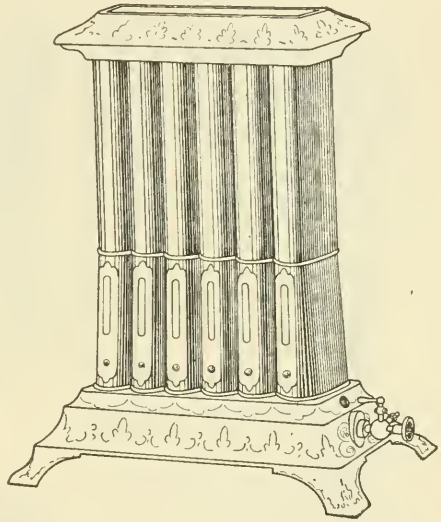

Fig. 57.

two. This space is connected with the flue, while the air to be heated is drawn up through the inner tube, as shown by the arrows.

Fig. 59 shows an asbestos incandescent grate, and Fig. 60 a grate provided with gas logs made of metal or terra-cotta and asbestos. The gas issues through small openings among the logs, and gives the appearance of an open wood fire.

Hot-water Heaters. The use of gas cooking ranges makes it necessary to provide separate means for heating water. This is accomplished in several ways. The range shown in Fig. 52 has a boiler attached which is provided with a separate burner.

Fig. 61 shows a gas heater attached to the ordinary kitchen

boiler. A section through the heater is shown in Fig. 62. This consists of a chamber surrounded by an outer jacket with an air space between. Circulation pipes, through which the water passes, are hung in the inner chamber just above a powerful gas-burner placed at the bottom of the heater.

A heater of different form for heating larger quantities of

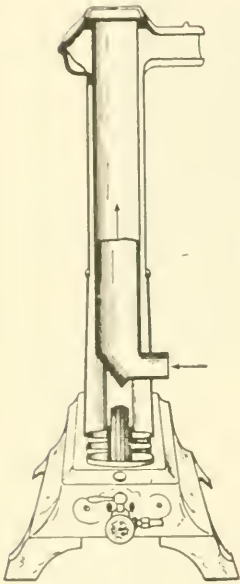

Fig. 58.

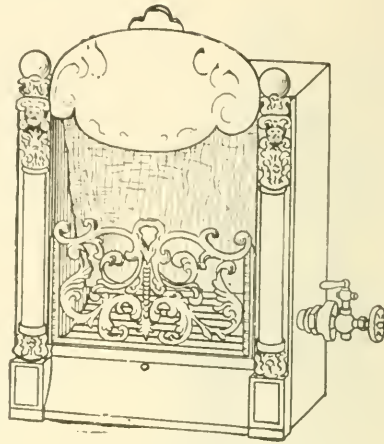

Fig. 59.

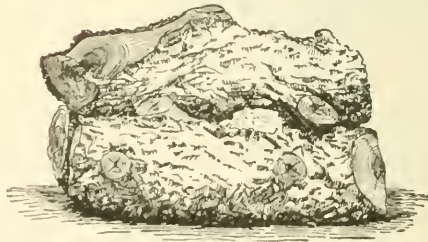

Fig. 60.

water is shown in Figs. 63 and 64. This consists, as in the case just described, of a circulation coil suspended above a series of burners. The supply of gas admitted to the burners is regulated by an automatic valve, which is opened more or less as the flow of water through the heater is increased or diminished. When no

water is being used, the gas is shut off from the burners, and only a small "pilot light," which takes its supply from above the automatic valve, is left burning. As soon as a faucet in any part of the building is opened and a flow of water started through the heater, the automatic valve opens, admitting gas to the main burn-

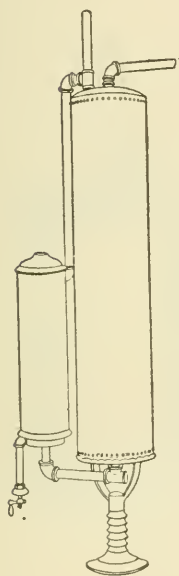

Fig. 61.

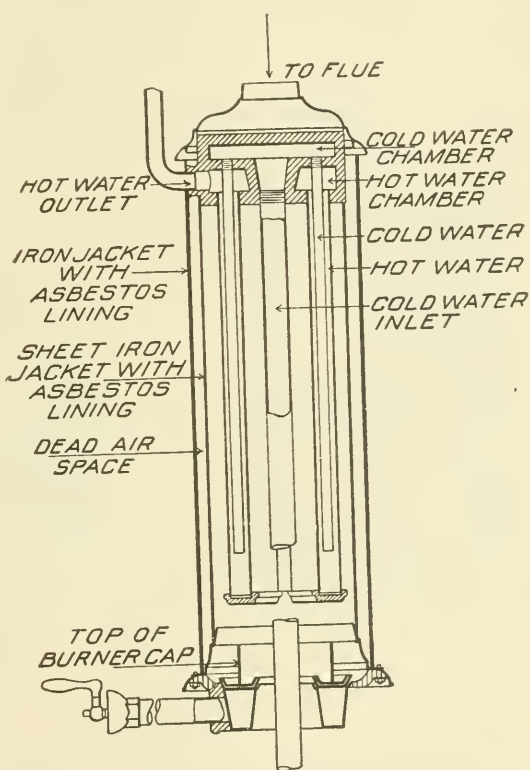

Fig. 62.

ers, which is ignited by the pilot light, and in a few moments hot water will flow from the faucet. The heater shown has a capacity of 9 gallons per minute from a temperature of 55 to 130°.

Another type is that known as the instantaneous water heater, one form of which is shown in Fig. 65. This is made especially for bathrooms, and will produce a continuous stream of hot water whenever desired. The heater is shown in section in Fig. 66, in

which A is the gas valve, B the water valve, D the pilot light, FF the burners, I a conical heating ring, J a disc to retard and spread the rising heat, K a perforated copper screen, and L a revolving water distributor. In this heater the water is exposed directly to the heated air and gases in addition to its passing over the heated surface of the ring I. The upward arrows show the path of the heat, and the downward arrows the passage of the water.

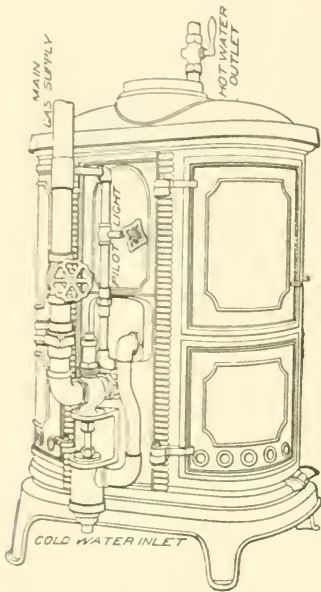

Fig. 63.

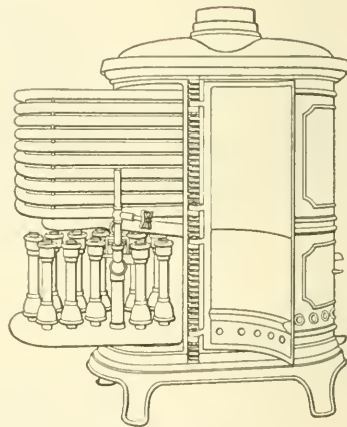

Fig. 64.

GAS METERS.

The meter should be placed in such a position that it is easily accessible and may be read without the use of an artificial light. It is connected into the system between the service pipe and main riser to the building, the connections being made as shown in Fig. 67.

Different meters vary but little in the arrangement of the dials. In large meters there are often as many as five dials, but those used for dwelling houses usually have but three. Fig. 68 shows the common form of index of a dry meter. The small index hand, D, on the upper dial is not taken into consideration when

reading the meter, but is used merely for testing. The three dials, which record the consumption of gas, are marked A, B and C, and each complete revolution of the index hand denotes 1,000, 10,000 and 100,000 cubic feet respectively. It should be noted that the index hands on the three dials do not move in the same direction ;

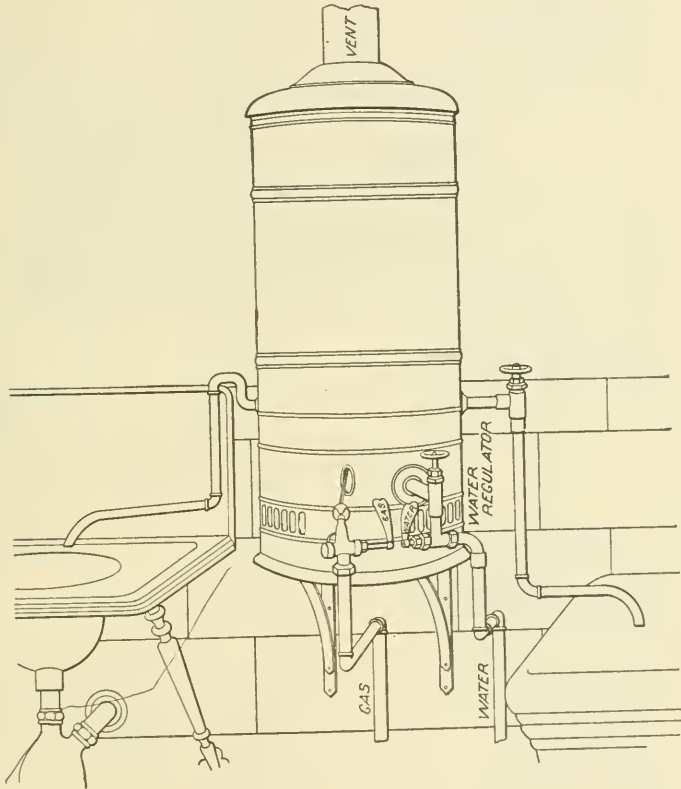

Fig. 65.

A and C move with the hands of a watch, and B in the opposite direction. The index shown in Fig. 68 should be read 48,700. Suppose after being used for a time, the hands should have the position shown in Fig. 69. This would read 64,900, and the amount of gas used during this time would equal the difference in the readings: $64,900 - 48,700 = 16,200$ cubic feet.

GAS MACHINES.

While the manufacture of gas for cities and towns is a matter beyond the scope of gas fitting, it may not be out of place to take up briefly the operation of one of the forms of gas machines

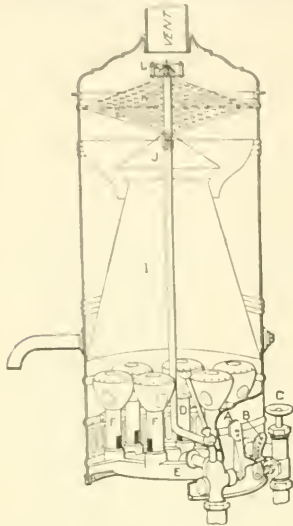

Fig. 66.

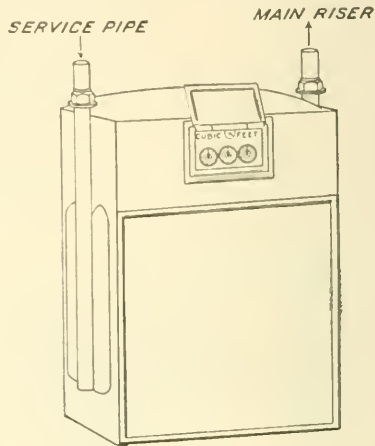

Fig. 67.

which are used for supplying private residences or manufacturing plants.

The general arrangement of the apparatus is shown in Fig.

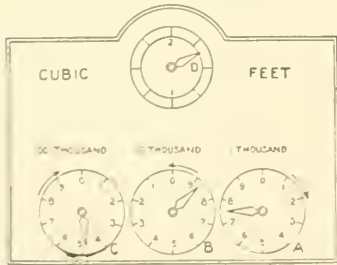

Fig. 68.

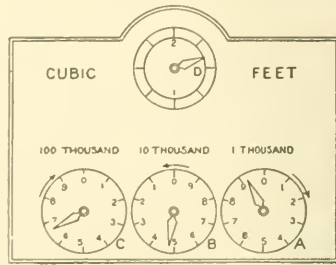

Fig. 69.

70, which consists of a generator, containing evaporating pans or chambers, and an automatic air pump, together with the necessary piping for air and gas. The gas made by these machines is com-

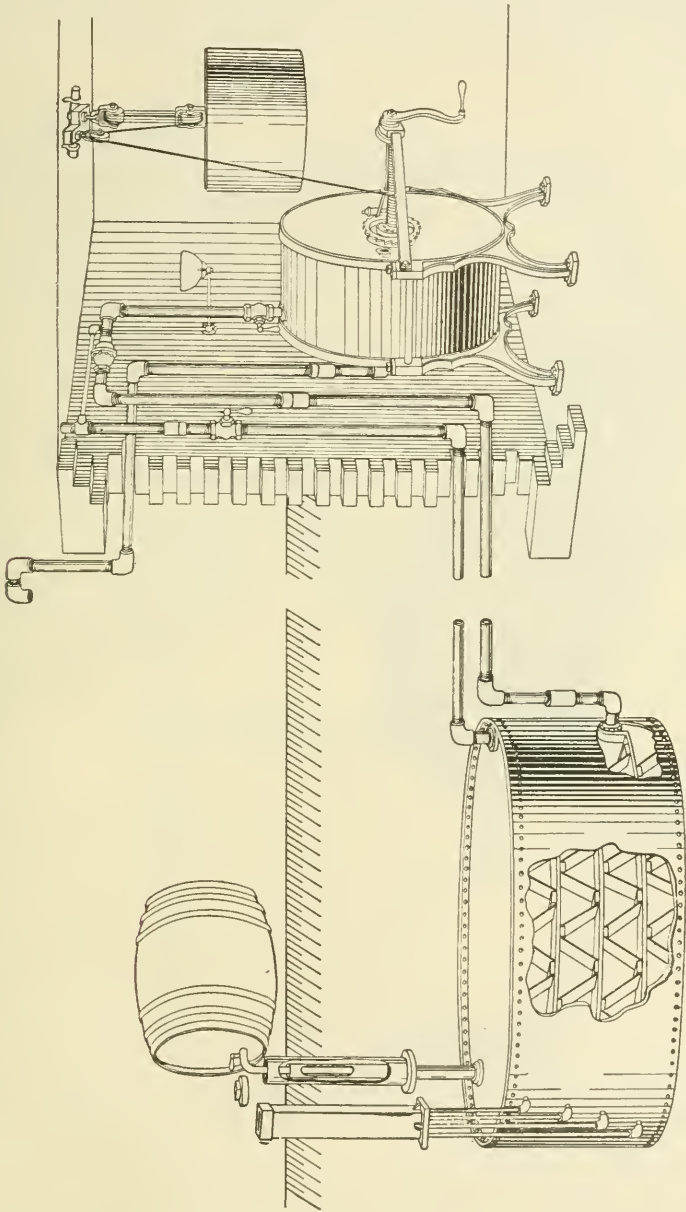

Fig. 70.

monly known as carbureted air gas, being common air impregnated with the vapors of gasoline. It burns with a rich bright flame similar to coal gas, and is conducted through pipes and fixtures in the same manner.

Referring to Fig. 70, the automatic air pump is seen in the cellar of the house, and connected to it and running underground are the air and gas pipes connecting it with the generator, which may be a hundred feet or more away if desired. When the machine is in operation, the pump

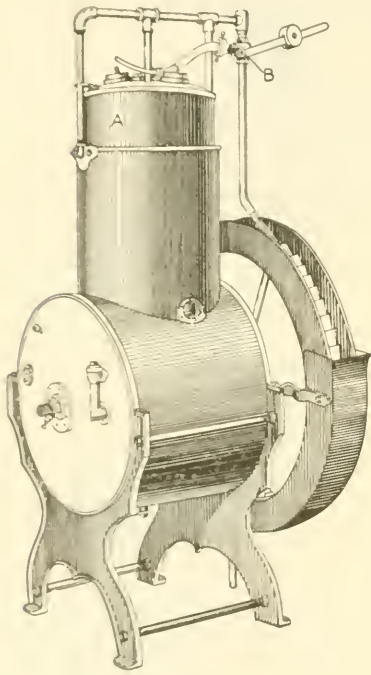

Fig. 71.

forces a current of air through the generator, where it becomes carbureted, thus forming an illuminating gas that is returned through the gas pipe to the house, where it is distributed to the fixtures in the usual way. The operation is automatic, gas being generated only as fast and in such quantities as required for immediate consumption. The process is continuous while the burners are in use, but stops as soon as the lights are extinguished. Power for running the air compressor is obtained by the weight shown at the right, which must be wound up at intervals, depending upon the amount of gas consumed. An air compressor to be run by water power is shown in Fig. 71.

The action of this machine is entirely automatic, the supply of water being controlled by the rising and falling of the holder A, which, being attached by a lever to the valve B, regulates the amount of water supplied to the wheel in exact proportion to the number of burners lighted. If all the burners are shut off, the pressure accumulating in the holder A raises it and shuts the water off. If a burner is lighted, the holder falls slightly, allow-

ing just enough water to fall upon the wheel to furnish the amount of gas required. A pump or compressor of this kind requires about two gallons of water per hour for each burner. The advan-

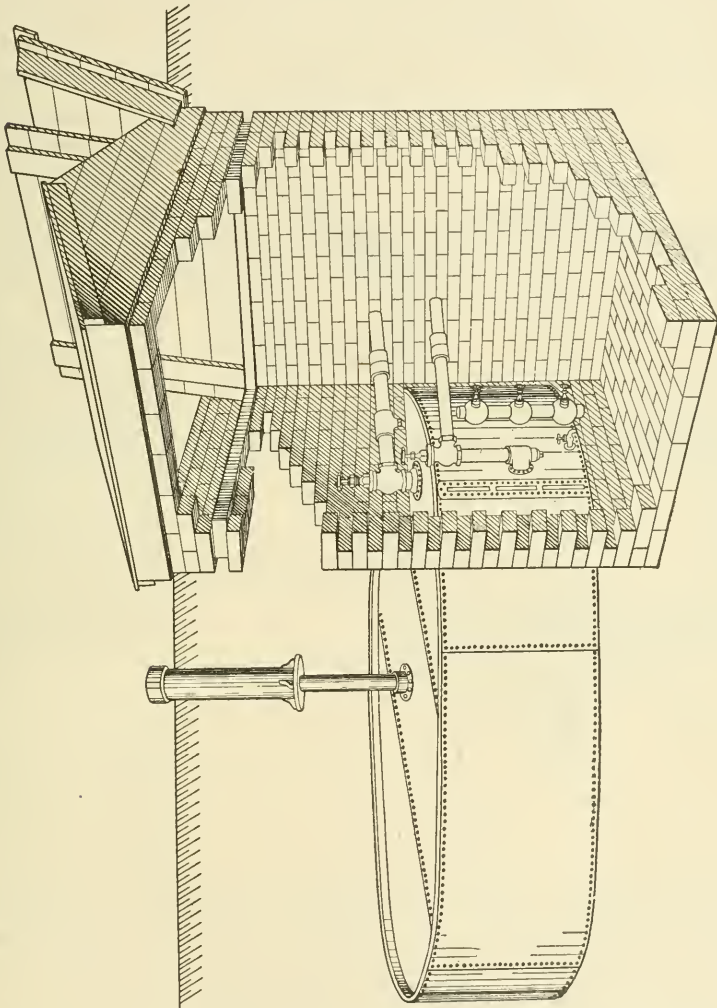

Fig. 72.

tages of a water compressor over one operated by a weight are that it requires no attention, never runs down and is ready for immediate use at all times.

The generator is made up of a number of evaporating pans or chambers placed in a cylinder one above another. These chambers

are divided by supporting frames into winding passages, which give an extended surface for evaporation. Fig. 72 shows the generator when set with a brick pit and manhole at one side. It is supplied with mica gages for showing the amount of gasoline in each pan, and with tubes and valves for distributing it to the different pans as required. In small plants the generator is usually buried without the pit being provided, but for larger plants the

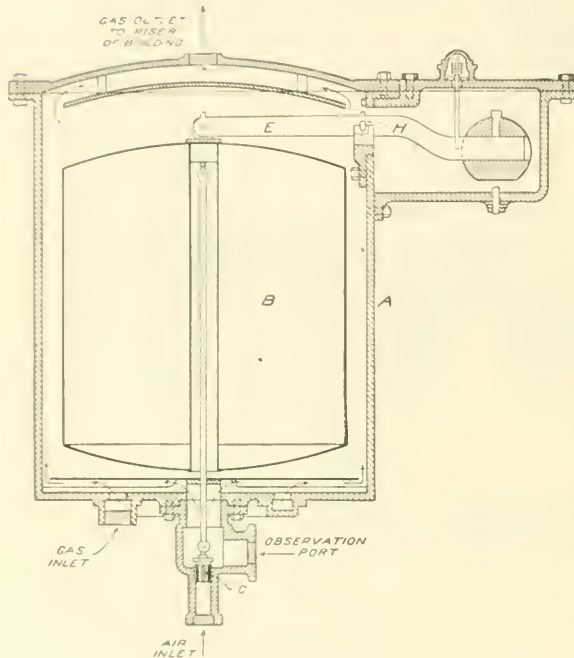

Fig. 73.

and closely sealed. The balance beam *E*, to which this is hung, is supported by the pin *H*, on agate bearings. Since the weight of the can *B* is exactly balanced by the ball on the beam *E*, movement of *B* can only be caused by a difference in the weight or density of the gas inside the chamber *A* and surrounding the can *B*. If the gas becomes too dense, *B* rises and opens the valve *C*, thus admitting more air; and if it becomes too light, *C* closes and partially or wholly shuts off the air, as may be required.

setting shown in

- Fig. 72 is recommended. Carbureted air gas of standard quality contains 15 per cent of vapor to 85 per cent of air. A regulator or mixer for supplying gas having these proportions is shown in section in Fig. 73. It consists of a cast-iron case in which is suspended a sheet-metal can, *B*, filled with air

EXAMINATION PAPER.

PLUMBING PART II.

PLUMBING.

Read carefully : Place your name and full address at the head of the paper. Any cheap light paper like the sample previously sent you may be used. Do not crowd your work, but arrange it neatly and legibly. *Do not copy the answers from the Instruction Paper : use your own words, so that we may be sure that you understand the subject.* After completing the work add and sign the following statement :

I hereby certify that the above work is entirely my own.
(Signed)

1. A hotel requires a water supply of 200 gallons of water per minute during a certain part of the day. It receives its supply from a reservoir 1,000 feet distant, and located 116 feet above the house tank, in the attic of the building. What size of wrought-iron pipe will be required to bring the water from the reservoir ?

Ans. 3 inch.

2. What is the best kind of pipe for domestic water supply under ordinary conditions? When may it be objectionable?

3. A 1-inch pipe is to discharge 40 gallons of water per minute from a cistern placed directly above it. What must be the elevation if we assume the friction in the pipe and bends to be equivalent to 100 feet?

Ans. 111 feet.

4. A house tank is situated 15 feet above a faucet upon the fifth floor of the building. If the stories are 8 feet high, what will be the difference in pressure in pounds per square inch between this faucet and one in the basement?

Ans. 17.3 pounds.

5. Describe the action of an hydraulic ram.

6. A pump has a steam cylinder 6 inches in diameter and a water cylinder 5 inches in diameter. What steam pressure will be required to raise water to an elevation of 100 feet, neglecting friction in the pipe ?

Ans. 40.3 pounds.

7. Explain the action of the ordinary kitchen boiler, together with the method of making the connections.

8. What pressure per square inch will be required to discharge 200 gallons per minute through a horizontal pipe $2\frac{1}{2}$ inches in diameter and 300 feet long? How many feet head?

$$\text{Ans. } \begin{cases} 34.4 \text{ pounds.} \\ 79 \text{ feet head.} \end{cases}$$

9. What is the difference between a "lift pump" and a "suction pump"? Describe the action of a "deep well" pump.

10. What is the greatest depth at which a suction pump will operate? Why?

11. What two systems of water supply are commonly employed?

12. A storage tank is 10 feet in diameter and 8 feet high. How many gallons will it hold?

$$\text{Ans. } 4,521.6 \text{ gallons.}$$

13. A modern cistern is 5 feet wide, 6 feet deep and 10 feet long. It is desired to replace it with a tank which shall be 8 feet in diameter. What would be the required height of the tank? What will be the weight of the water contained in the tank?

$$\text{Ans. } \begin{cases} 5.9\text{-feet.} \\ 1,8759 \text{ pounds.} \end{cases}$$

14. A 2-inch pipe is used for conducting water to a house from a spring 400 feet away. If the cistern in the house is 50 feet below the level of the spring, how many gallons of water will flow through the pipe per hour?

$$\text{Ans. } 75 \text{ gallons.}$$

15. What are the principal causes of accidents in connection with a kitchen boiler, and what precautions should be taken to prevent them?

16. A swimming tank is supplied with hot water through a hot-water heater similar to a house heater. How many square feet of grate surface will be required to raise 1,000 gallons of water per hour from a temperature of 50 to 70 degrees?

$$\text{Ans. } 4.15 \text{ square feet.}$$

17. What are circulation pipes when used in connection with a hot-water supply system, and how are they connected?

18. How many square feet of heating surface will be required in a brass coil to heat 160 gallons of water per hour from 50 degrees to 200 degrees, with steam at 5 pounds pressure?

Ans. 6.5 square feet.

19. Describe the principle and action of a gas machine. How does a regulator or mixer operate?

20. On July 1 the pointers on a gas-meter stood as shown in Fig. 1, and on Oct. 1 they had moved to the positions shown in Fig. 2. What would be the cost of gas consumed at \$1.25 per 1,000 cubic feet?



Fig. 1.



Fig. 2.

21. Describe the construction and action of one form of hot-water temperature regulator.

22. A hot-water storage boiler contains a heating coil made up of 42 linear feet of 1-inch brass pipe, and is supplied with steam at 5 pounds pressure, and the water is heated from 40 to 140 degrees. It is desired to remove the coil and substitute a coal-burning heater. How many square feet of grate surface will be required to give an equal capacity?

Ans. 9.66 square feet.

23. If a certain heating coil will heat 100 gallons of water per hour from 50 to 180 degrees with steam at 5 pounds pressure, how many gallons will the same coil heat with steam at 30 pounds pressure?

Ans. 140 gallons.

24. The following diagram represents the gas piping in a house, with the number of lights supplied by the different outlets. Make the sketch, and indicate the pipe sizes for riser, mains and branches.

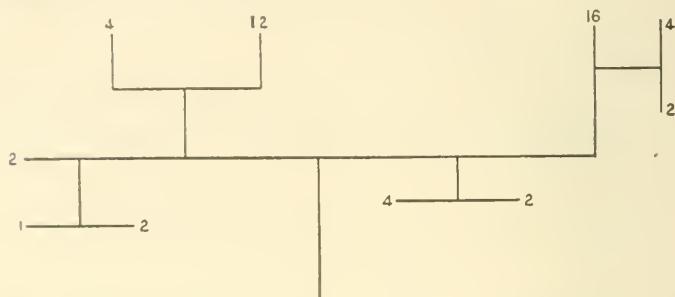

25. Describe the method of testing a new system of piping, and state how you would distinguish between different kinds of leaks.

26. A house using coal gas is supplied through a 2-inch service pipe. Another house is to be built having the same number of lights, but is to be supplied with naphtha gas. What will be the required size of service pipe?

27. How should the pipes be graded in a system of gas piping? How should branches and drops be connected with the main?

28. How does the cost of cooking and heating with gas compare with that of coal?

29. Name and describe the different types of burners. What is the best material for burner tips?

30. What is the best material for hot-water pipes? What are the common defects in pipes lined with another metal?

UCSB LIBRARY

7-63001

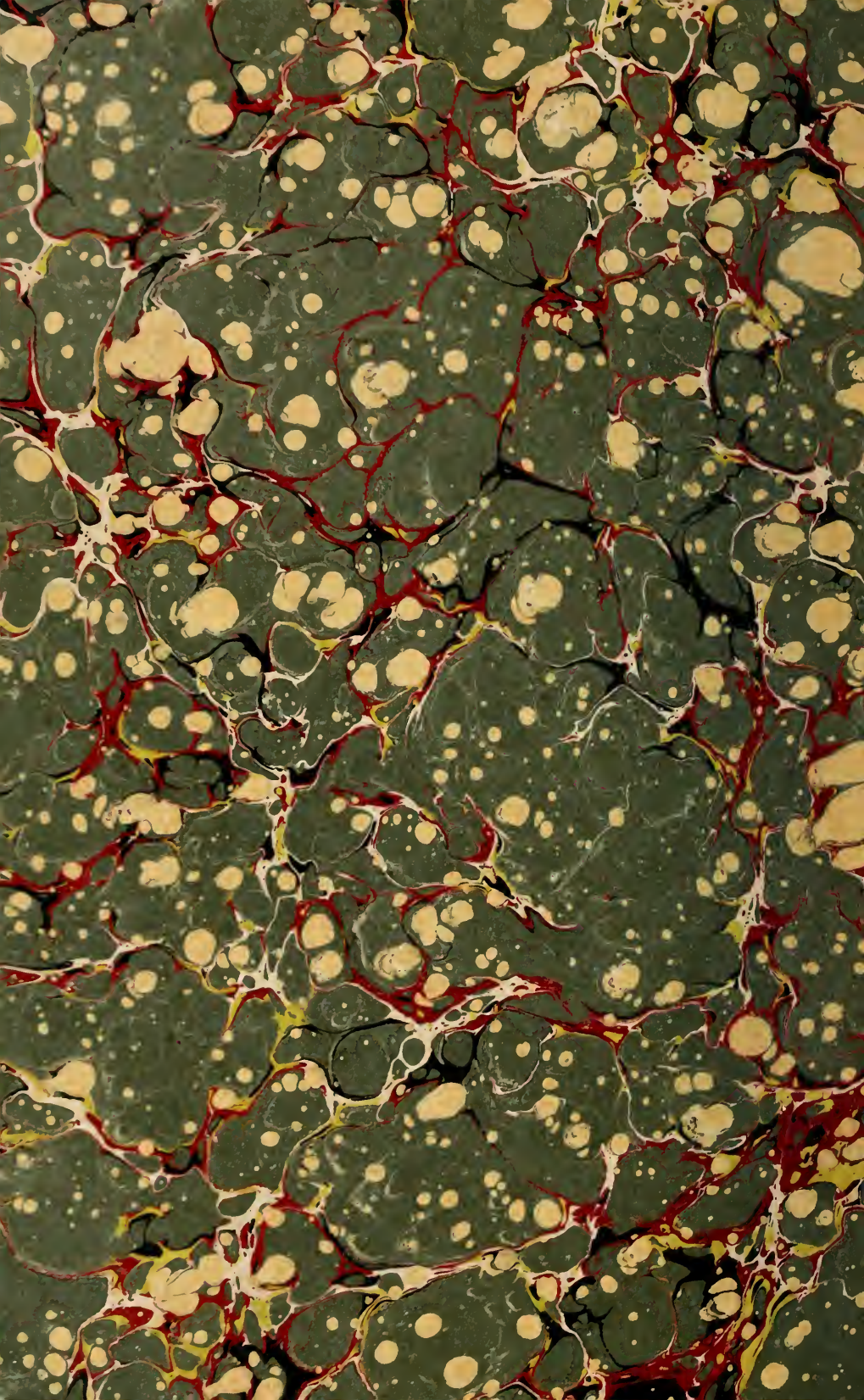



A 000 607 219 3

