

UNIVERSITY OF CALIFORNIA LIBRARY

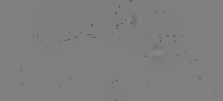

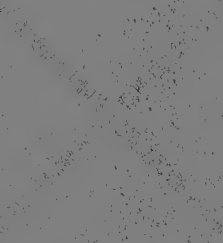
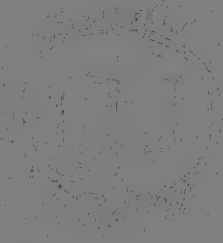
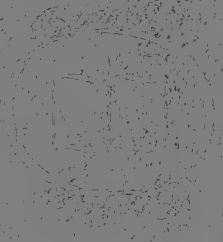
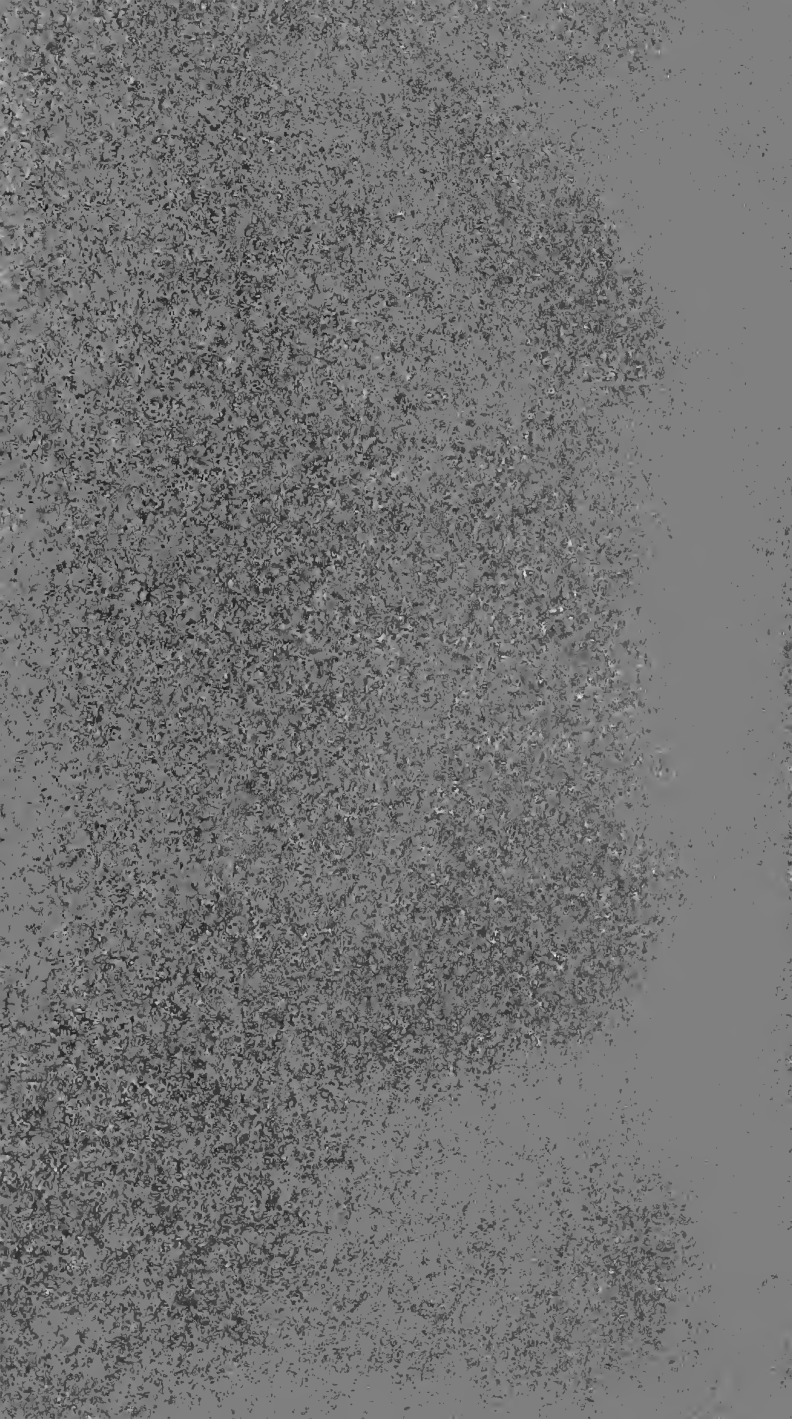

Digitized by the Internet Archive
in 2007 with funding from
Microsoft Corporation

AN HISTORICAL INTRODUCTION TO
SOCIAL ECONOMY

1
2
3
4
5
6
7
8
9
10
11
12
13
14
15
16
17
18
19
20
21
22
23
24
25
26
27
28
29
30
31
32
33
34
35
36
37
38
39
40
41
42
43
44
45
46
47
48
49
50
51
52
53
54
55
56
57
58
59
60
61
62
63
64
65
66
67
68
69
70
71
72
73
74
75
76
77
78
79
80
81
82
83
84
85
86
87
88
89
90
91
92
93
94
95
96
97
98
99
100

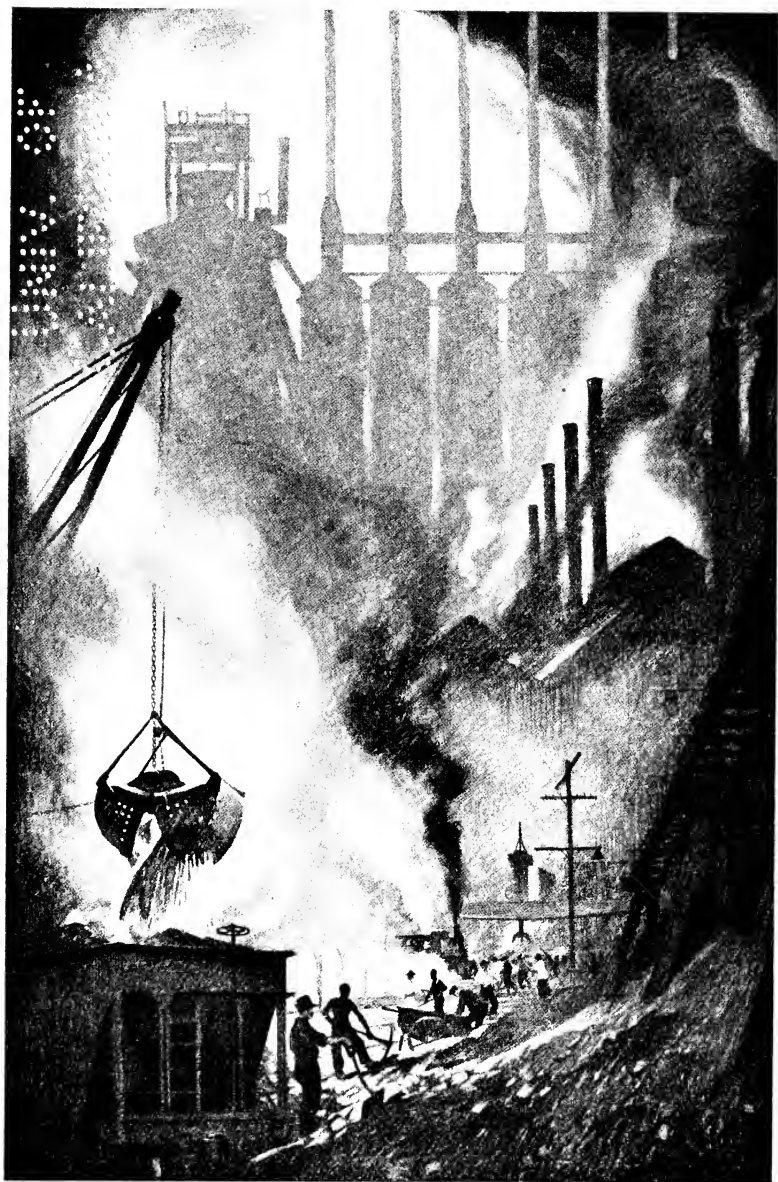

Courtesy of Thornton Oakley, the Artist

THE MILLS

AN HISTORICAL INTRODUCTION TO SOCIAL ECONOMY

BY

F. STUART CHAPIN, Ph.D.

ASSOCIATE PROFESSOR OF SOCIOLOGY AND ECONOMICS IN
SMITH COLLEGE; AUTHOR OF "AN INTRODUCTION
TO THE STUDY OF SOCIAL EVOLUTION."

"Each generation must write its own history of past events, in order to interpret them in terms corresponding to its needs. New conditions give rise to new problems, and these to new conceptions; and when we turn again to examine the past, we put to it questions never before asked."

EDWARD VANDYKE ROBINSON.

THE
CENTURY
CO.



NEW YORK
THE CENTURY CO.
1923

11-23
C4

Copyright, 1917, by
THE CENTURY Co.

Replacing 557709

TO THE
LIBRARY OF

PRINTED IN U. S. A.

DEDICATED TO
THE MEMORY OF MY MOTHER
FLORENCE A. CHAPIN
WHOSE INTELLIGENT AND SYMPATHETIC
INTEREST IN ALL THINGS HUMAN WAS
THE INSPIRATION OF MY EARLIER YEARS

M66819

PREFACE

This book is an introductory study in the history of Social Economy. It treats of certain experiences in the lives of the people in Greek, Roman, Medieval and Modern Times. It is designed for the use of the beginning student and the general reader. The author's purpose is not to write a complete history of social development or a detailed account of the evolution of industry. The book consists merely of a series of brief essays on the contrasting types of industrial organization which have existed at different historical periods, and an account of the private and public efforts made to relieve the poverty of each period. In this respect the book may well serve as an introduction to the study of industrial and social history.

Glancing back over the record of social history, one is impressed by the similarities as well as with the bold contrasts presented by the productive systems of different ages. Equally striking is the repetition of ancient errors in the practice of charity and the inevitable social reverberation of their consequences. History is said to repeat itself. But differences in natural resources, climate, racial experience and national psychology, cause history to repeat itself only inexactly.

During the period of Greek ascendancy and while Roman power lasted, we find that agrarian decline was associated with essentially similar conditions: the consolidation of small, peasant holdings into great estates,

owned by capitalists and cultivated by slave labor. In Greece, slavery never developed into the highly organized industrial system that it became in Rome, but in both periods wasteful slave labor did much to exploit the primitive fertility of the soil. In both periods, too, cereal production declined because the large slave-cultivated estates were devoted to pasturage or to the raising of luxuries. As a consequence, the food supply of the metropolis became a serious problem. Again, in both periods the inevitable competition of yeomen farmers with slaves demoralized the free, rural population, and helped bring about an exodus from the country to the city. Finally, in both periods the city populace, debased by the existing practices of public support for citizens, lost the habit of self-maintenance and degenerated into an irresponsible rabble.

The study of English economic history reveals agrarian tendencies in some respects similar to those of antiquity. Enclosure of small yeomen holdings into large capitalistic-owned estates proceeded during the fifteenth and sixteenth centuries, and was accompanied by much misery among the people. Again, in the eighteenth and nineteenth centuries, we observe a marked centralization of agricultural holding. This process, so disastrous for ancient nations, has been attended in modern times by such a remarkable expansion of manufacturing activity that the labor displaced from the soil has been rapidly absorbed, and the collapse of national economy averted.

Slavery, a basic industrial force in Greek and Roman times, hindered the development of manufacturing industry, stifling free competition by its degraded economic standards and its wasteful methods. There was consequently a tendency in antiquity, culminating in the Roman

Empire, for national consumption to exceed production. Modern nations have evaded this evil by transforming raw materials of low intrinsic value into articles of great intrinsic worth through manufacturing processes. The peoples of Greece and Rome never developed any large-scale system of manufacture like that of the great industrial nations of to-day, because slavery was a constant obstacle.

Manufacturing industry became a significant, economic activity during the later Middle Ages, when free artisans organized the craft guilds. But not until the coming of the machine and non-human motive power in modern times, did manufacturing industry attain a scale of organization commensurate with the vast commercial and agricultural activities of mankind. Indeed, the social economy of modern nations is different in this fundamental respect from that of ancient nations, for modern social organization reflects everywhere the influence of the machine. Agriculture, manufacturing industry and communication have been revolutionized, one after another, by the introduction of mechanical devices and machine power. These revolutions have been thoroughgoing and far-reaching. No intelligent understanding of modern social economy, in contrast to previous economic organization, is possible without a knowledge of these three, great, social revolutions of modern times. Their true significance once understood, however, it is possible to form an intelligent opinion upon problems of the contemporary social order.

These fundamental differences between methods of production in ancient, medieval and modern times have their counterpart in the different methods of relieving poverty, and in essentially different attitudes towards poverty. Considering the limited knowledge and the primitive

methods of the time, the poverty of Greece and Rome seems irreparable. This poverty was interwoven through the very texture of industrial life. With the institution of slavery economically necessary and morally justified, with the social ideal of a leisured life free from manual toil, it was hardly possible to develop the modern ideal of economic independence for every one through personal and productive labor. Consequently, dependence involved no stigma; if it was not actually praiseworthy, it was at least quite regular, and no one thought of alleviating or preventing poverty by constructive and rehabilitative methods.

In contrast to this rather hopeless condition of affairs, we believe that the poverty of to-day is a by-product of our industrial system, and not a necessary element in it. We do not believe with the ancients that "the poor we have always with us." By far the larger part of the poverty of the present is a product of social maladjustment, an incident in an industrial awakening and a manufacturing growth that has been more rapid than adaptation in methods of distributing wealth and sharing the costs of progress. A passing of the emphasis from the ancient alleviative to modern preventive and constructive methods of dealing with poverty exemplifies a fundamental reversal in point of view.

It is obviously impossible for the author to be a specialist in all the fields covered by this book. Consequently, he must ask the indulgence of those who have special knowledge for any errors of fact or mistakes that may have arisen through references to other historical authorities—errors which have escaped his diligent effort at accurate presentation.

In preparing the manuscript of this book, the author

was encouraged by the helpful suggestions and criticisms of Professor Edward A. Ross, whose aid is hereby gratefully acknowledged.

The author desires to acknowledge his indebtedness to A. E. Zimmern's *The Greek Commonwealth*, William Cunningham's *Essays on Western Civilization*, and John K. Ingram's *History of Slavery and Serfdom*, in writing Part I of this book; to A. H. J. Greenidge's *History of Rome*, G. Ferrero's *Greatness and Decline of Rome*, and Ingram's *History of Slavery and Serfdom*, in writing Part II; and to William Cunningham's *Growth of English Industry and Commerce*, H. de B. Gibbins' *Industry in England*, and W. J. Ashley's *An Introduction to English Economic History and Theory* in writing Parts III, IV and V.

In reading the proof of the manuscript the author was aided by his wife, his father and by Miss Charlotte B. Peck, all of whom deserve his most grateful thanks for their assistance.

F. STUART CHAPIN.

Northampton, Massachusetts, May, 1917.

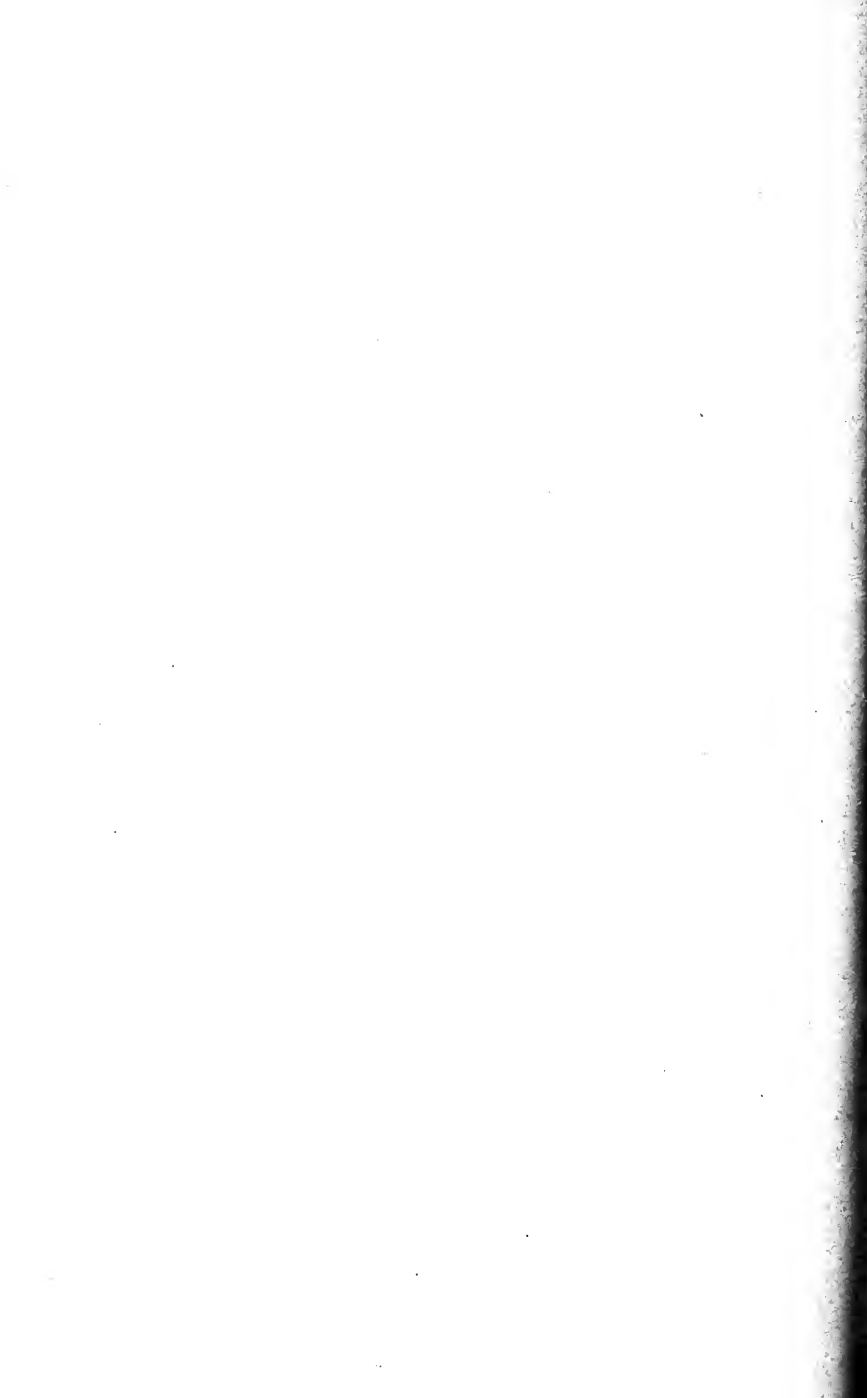

CONTENTS

	PAGE
PART I.—THE GREEK PERIOD	1- 40
CHAPTER	
I THE LAND AND THE PEOPLE	3- 11
Food Resources	5
War and Colonization	8
II SOCIAL CONDITIONS AND THE CLASS STRUGGLE	12- 25
Money Economy and Social Relations	13
Food, Money, and Debt	15
Slavery in Greece	17
Imported Grain	21
Social Unrest and the Class Struggle	22
The Social Reformers	23
III INDUSTRY AND SOCIAL ECONOMY	26- 40
The Ceramic Factory	28
The Organization of Labor	29
Charity and Social Economy	32
The Seeds of Decline	38
PART II.— THE ROMAN PERIOD	41-112
IV THE LAND AND MILITARISM	43- 47
The Common Cause and Federation	45
Militarism and Agriculture	46
V THE CLASS STRUGGLE	48- 60
Debt-slavery and Social Revolution	49
The Writing of the Laws	51
Public Land and Agrarian Reforms	54
Exploitation of the Provinces	55
The Growth of Plutocracy	56
Demoralization of the Yeoman Farmers	59
VI AGRARIAN CONDITIONS AND THE PROBLEM OF THE CITY	61- 88
Agrarian Reform of Tiberius Gracchus	62
Social Legislation of Gaius Gracchus	69
The Corn Law of Gaius Gracchus	70
Constructive Measures	73
The Gracchian Reforms in Perspective	77
Public Relief in Rome	80
Private Charity and Benevolence	84

CONTENTS

CHAPTER	PAGE
VII THE INSTITUTION OF SLAVERY	89-104
Treatment of Slaves	92
The Decline of the Slave System	94
Serfdom	96
The Recrudescence of Slavery in the New World	101
VIII THE ORGANIZATION OF LABOR	105-112
Ancient and Modern Organizations of Labor	106
The Obstacles to Industrial Progress	110
PART III.—INDUSTRIAL DEVELOPMENT AT THE END OF THE MIDDLE AGES	
113-143	
IX COMMERCE AND THE TOWNS	115-119
The Crusades	116
The Gild Merchant	118
X HANDICRAFT INDUSTRY AND THE CRAFT GILDS	120-128
The Handicraft System	120
Internal Organization of the Craft-Gilds	123
Activities of the Craft-Gilds	126
XI * THE DECLINE OF THE CRAFT-GILDS	129-137
Internal Demoralization	131
External Influences	135
XII THE RISE OF THE DOMESTIC SYSTEM	138-143
The Spread of Industry to the Country	138
The Spread of Woolen Manufacture	141
PART IV.—GREAT SOCIAL REVOLUTIONS OF MODERN TIMES	
145-260	
XIII INTRODUCTORY	147-149
XIV THE AGRICULTURAL REVOLUTION	150-169
Sheep-Raising and Enclosures for Pasturage	152
Improvements in Agriculture	157
The New Period of Enclosures and the Agrarian Revolution	159
The Decay of the Yeomanry	161
Agricultural Machinery	165
XV THE INDUSTRIAL REVOLUTION	170-214
The Inadequacy of Domestic Manufacture	172
Mechanical Inventions and Machine Power	174
The Factory System	177
Social and Economic Effects of the Factory System	182
Factory Legislation	208

CONTENTS

CHAPTER	PAGE
XVI THE REVOLUTION IN COMMUNICATION	215-260
The Great Inventions in Communication	218
The Expressiveness of the New Communication	223
Swiftness in Overcoming Space	234
The Diffusion of Intelligence	237
Permanence of Record; the Overcoming of Time	245
Social Effects of the New Communication	247
PART V. THE TRANSITION FROM REMEDIAL TO CON- STRUCTIVE CHARITY AND PREVENTIVE PHILANTHROPY	261-304
XVII MEDIEVAL CHARITY AND THE ENGLISH POOR LAW	263-279
Medieval Charity	264
The Period of Repression	269
The Poor-Law of Elizabeth	271
The Reform of the Poor-Law	273
XVIII CONSTRUCTIVE CHARITY AND PREVENTIVE PHILANTHROPY	280-304
The Hamburg-Elberfeld System of Poor Relief	281
The Charity Organization Society	286
Social Insurance	291
BIBLIOGRAPHY	305-310
INDEX	311-316

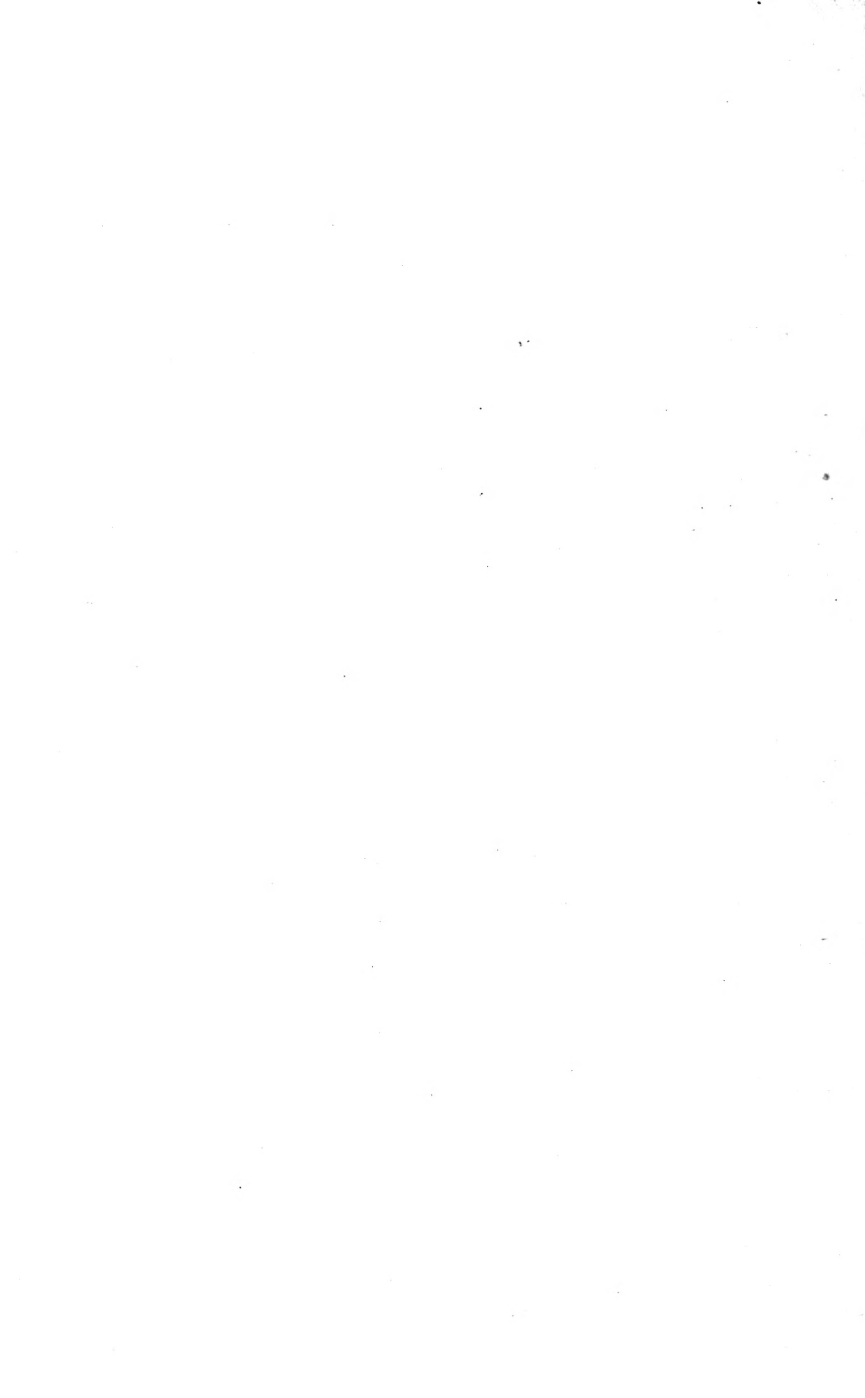

LIST OF ILLUSTRATIONS

FIG.		PAGE
	The Mills	<i>Frontispiece</i>
1	The Acropolis	35
2	The Colosseum	85
3	A blast furnace of the Middle Ages	123
4	A loom of the sixteenth century	139
5	An old Saxon plow—A. D. 1000	151
6	A Colonial plow	153
7	A steam plow at work	157
8	Plowing by automobile tractor	160
9	Gasoline motor plow	163
10	Disking and harrowing by steam	167
11	Watts' steam engine	178
12	A modern blast furnace	180
13	Tapping an open-hearth furnace	183
14	Interior of a rail mill	186
15	Han Yang iron and steel works: an industrial center of China	189
16	Assembling department of Ford Motor Company: putting on wheels, gas tank and muffler	193
17	Assembling department of Ford Motor Company: putting on dash and fenders	197
18	Diagram illustrating how labor has lost control of one step after another in the evolution of modern industry	201
19	A comparison of complex modern corporate organization of industry with the simple handicraft organization	203
20	The development of the locomotive (by F. B. Masters)	217
21	The largest locomotive	219
22	Modern types of locomotives (by F. B. Masters)	222
23	Comparison of the <i>Mauretania</i> and <i>Cleremont</i>	225
24	Evolution of the submarine: the turtle of David Bushnell	228
25	Evolution of the submarine: the <i>Nautilus</i> of Robert Fulton	229
26	Evolution of the submarine: submarine on the surface	231
27	Zeppelin over a German city	235
28	Wilbur Wright's first aëroplane trip over water by the Statue of Liberty	240
29	Morse's telegraph instrument	243
30	Telegraphing a thousand words a minute	245
31	Wireless station at Cape Cod	248
32	Telephone central exchange	250
33	Representation of spirit forms by movies	253
34	Motion-pictures of the stomach digesting food	255
35	Representation of "Twenty Thousand Leagues Under the Sea" by Movies	258



SOCIAL ECONOMY
PART I. THE GREEK PERIOD

SOCIAL ECONOMY

CHAPTER I

THE LAND AND THE PEOPLE

GREECE is located at the threshold of the Orient, readily accessible from Asia Minor and Egypt. Because of this focal location in the ancient world, Greece became the intellectual clearing-house for the eastern Mediterranean. The general information gathered here afforded material for wide comparison, and established conditions under which national growth became ordered and varied. It was a frontier region of the ancient world, where marauders, outlaws, refugees, and enterprising men from all peoples had mingled for hundreds of years, producing a hardy and fearless stock.

The shore formation is irregular and broken into many sheltered harbors and natural hiding places. Indeed, Greece is said to have the longest shore-line of any area of its size in the world. Four hundred and eighty-three islands extend in an unbroken series to the shore of Asia Minor. In early times these "stepping stones" to the East admitted the bold native inhabitants to wider maritime enterprise. On the east, the coast of Asia Minor bordering the *Ægean* abounds in small, fertile plains, and is as well supplied with harbors as is the opposite shore of Greece. Thus the *Ægean* does not separate the two coasts, but unites them in such a fash-

ion that the smallest vessels may pass across without losing sight of land.

The sense of security suggested by this advantageous shore formation is supplemented by the mild scenery of the mainland. The mountains are not lofty enough to be awe-inspiring, but are suggestive and appealing in their beauty. In general, the aspects of nature are on a small scale, comprehensible, on the measure of man himself.

Zimmern says: "The Mediterranean landscape, like the institutions of the city state, forms a permanent background to Greek life and thought. Its influence is omnipresent, but it is seldom expressed. It is left to show itself, more spontaneously and truthfully, in the chance idiom or detail that slips out as the setting of a story; in what is implied or hinted, rather than consciously stated; in the many little significant touches which, to the careful observer of nations as of men, are always the surest and happiest revelation of character."¹

From Thrace to the southern part of the Peloponnesus, the short valleys opening out to the east contain small streams, usually dry in summer. Winter converts them into roaring torrents. The entire country is so diminutive that, from almost any point inland, it is but one day's travel to the sea. The greatest length of the peninsula is about two hundred and fifty miles; its greatest breadth is about one hundred and eighty miles; its area is about equal to the State of Maine. Short valleys, with their small streams and little, alluvial plains at the mouth are separated from one another by rough, mountain masses, strewn with immense boulders. The broken relief of the country discourages travel from one valley to

¹ Zimmern, A. E.—*The Greek Commonwealth*, Oxford, 1911, p. 16.

another and interferes with intercourse between neighboring valley communities. Thus, natural conditions isolated the primitive inhabitants from their neighbors, and favored the growth of small city states in the separated valley communities. In these diminutive local groups, the people were so near to their leaders that no single chief could, for any length of time, attain the dominating power of an oppressive tyrant, and so natural conditions favored the growth of a democratic spirit. The relief of the country made the early inhabitants mountaineers. Scant living could be made for a small family group by the varied occupations of hunting, keeping stock, and small-scale tillage. The slightly remote valleys gave natural protective barriers, so that governmental protection was not essential.

FOOD RESOURCES

Although Greece lies in a border region between the semi-tropical climate and the temperate, its soil is not fertile. In general, the surface of the Greek peninsula may be divided into four divisions: the unproductive area, the forest area, the pasture area, and the cultivable area. At the present time, the unproductive area includes about one third of the entire country. This area consists mainly of bare rocks and eroded sections. Since the soil was so scanty, any considerable devastation, such as resulted, for example, during the Peloponnesian War, was a most serious catastrophe, and recovery was difficult if not impossible.²

In early times the area of Greece under forest cover was much larger than at present. But for hundreds of years the trees have been destroyed wastefully, so that

² *Ibid.*, pp. 40, 42.

at this time in eastern Greece few forests remain, although the northwestern section is still well wooded. In the vicinity of Athens, the forest furnished fuel but not timber for naval stores. Since the soil of Greece was incapable of producing a great forest, the early inhabitants of the country had to go outside in search of large lumber for their ships. As a matter of fact, the so-called forests of Greece really consist of bushes, and not of tall, standing timber.

The pasture land of Greece is that area which is too poor to be sown or cultivated. It forms the borderland on mountain slopes, below the forest belt. There are few cows because the land is so poor, but sheep and goats find sustenance where cattle cannot exist. The animals are lean and thin because they have to climb high and far in search of food. In antiquity Greece was a land of goats' milk and honey. The honey was an important staple food. It was not necessarily a luxury, but was used for all sorts of purposes for which we use sugar.

Except for the forest belt, the land which admits of cultivation is the smallest in area of the four divisions of the country. This cultivable land is found in plains and levels, flanked by rough mountain masses. These plains, watered by streams from the slopes of mountains, comprise the arable land of Greece. They form small compartments, readily protected against a hostile foe.³ Some plains are shut in by mountains, like the plain of Sparta; others end in the sea. Greek rivers are brown and muddy from the sediment which they carry and build up deltas of silt at their mouths. Since the Mediterranean is a tideless sea, this rich, alluvial soil is never washed away, and favors agricultural industry. These

³ *Ibid.*, p. 45.

natural conditions, which directly protected the small, fertile areas by rough mountains, indirectly favored the development of Greek institutions and Greek patriotism.

The products of the soil were corn, wine, and oil. Wheat or barley formed the staple food. The Greeks prepared their flour in many different ways, making wheat-bread and unbaked barley cakes. They ate two meals a day and seldom partook of meat, except at festive occasions. The corn was sown in October and harvested in May and June. Each little bit of fertile land was sown, for every Greek city tried to grow its own corn.⁴

Wine was the national drink from the earliest times. But, since the Greeks drank wine usually in proportions of three parts water to two of wine, they were not a hard drinking people. Olive oil was an important product. It was used to make butter and soap, and served as fuel for lamps. The olives were squeezed in presses several times. From the first squeezing, the eating oil was obtained; from the second, the anointing oil; from the third, the illuminating oil; the remainder was used as fuel. Since the olive groves were orchards which allowed forty feet between each tree and sixty feet between the rows, there was plenty of room to plant corn under the trees. The olive tree was not a difficult plant to cultivate, for, as Virgil tells us, all it needs is a little digging around the roots. The harvest began in the late autumn, and the olives were picked with considerable care. An important factor in olive growing was the long period which elapsed before the trees reached maturity. It was sixteen or eighteen years before they bore a full crop, and from forty to sixty years before they reached their prime. Consequently, devastation of the olive country meant not

⁴ *Ibid.*, p. 46.

merely the destruction of a year's income, but the destruction of a considerable amount of capital as well.

The ancient Greeks considered agriculture the most desirable form of livelihood. From primitive times down to the fifth century, the population had to live off the land. Among the early Greeks, since there was no trade or commerce, the chief means of support was agriculture. The Greek writers, Zenephon, Plato, and Aristotle, all eulogize the life of the farmer. Being by tradition shepherds and farmers, the Greek middle-classes were conservative. They did not live with a view to becoming rich, and did not consider whether prices were high or not. The object of life was to provide the necessities for household needs and to serve as a responsible citizen in the home community. When a Greek citizen owned a large amount of land, the community often clamored for a redistribution of land. In the time of Pericles, it is probable that one third of the corn consumed in Attica was grown on local farms. The great majority of the land holdings were cultivated by free peasants. They and their whole household worked upon the land, their sons receiving shares of the estate upon the death of the father. In 403 B.C., a proposition was made in Athens which would limit citizenship to the owners of lands or houses. Although Athens was the chief commercial city, there were only five thousand citizens who would have been excluded by this law—an indication of the prevalence of landholding among the middle-classes.⁵

WAR AND COLONIZATION

As population increased, the scanty soil of Greece became inadequate for support. About the eighth and

⁵ *Ibid.*, pp. 223, 228.

seventh centuries B.C., the point had been reached at which the law of diminishing returns in agriculture began to supplant increasing returns.

Whenever there was crop failure or lack of rainfall, the state was face to face with famine. When population presses upon the means of subsistence, there are but two immediate alternatives: to limit population or to increase food. The state must emigrate excess population, or import food. Thucydides has accepted the principle that overpopulated communities must go to war in order to obtain the necessary land for food purposes. Indeed, the chief object of early Greek warfare was to secure land and supplies. Fertile sections were occupied, and the existing population was driven off or forced to pay tribute. It was customary to make raids by land, across the borders of neighboring prosperous sections, and carry off the needed supplies. Thus war was really state-robbery, and became an established policy of the city-state.⁶ Herodotus and other ancient authors have given us descriptions of this warfare to procure the food that was so badly needed.

While war was the most direct and immediate method of securing the needed supplies, emigration of the surplus population was more difficult and less satisfactory. The need of food, therefore, stimulated policies of colonization to secure an outlet for excessive population. Great expeditions set out from the sheltered harbors of Greece to settle in Asia Minor, Italy, Sicily, and Marseilles. But Greek colonies were not established as the private ventures of enterprising merchants or associations. They were part of a carefully organized scheme of state-promoted emigration.⁷ While other ancient colonies

⁶ *Ibid.*, pp. 239, 242.

⁷ *Ibid.*, p. 247.

were frequently trading centers, the Greek colony was an agricultural community, patterned after the cities of the homeland. Zimmern says that it was only through chance that the later development of some of the colonies was in the direction of commerce. The colonists carried with them the old agricultural tradition. As a matter of fact, they were largely deposed cultivators who at home had been crying out for land. Regulations governing the establishment of the Athenian colony in Thrace show that ten land-distributers were chosen, one from each tribe. The first occupants of the new territory were to build a fortified inclosure. Each man received a site for his house within the fortification, and three quarters of an acre of land outside the city.⁸ The Greeks took great pains to select a favorable site for their colonies, and consulted the oracle of Delphi. Some of these colonial settlements grew into regular trading centers for exchange of wares. By means of their colonies in the East, the Greeks were able to establish connections with the commercial routes from Persia and the Caspian, and even with the river routes to the North, whence fur and amber came.

Communication with these different peoples and exchange of wares had a broadening influence upon the Greeks. They became acquainted with new and different customs and encountered strange institutions. The population of the Greek cities became cosmopolitan, for foreign traders came from their colonial settlements. Athens, indeed, had quite a large element of permanent foreign residents, known as "metics." At one time they numbered about ten thousand and, with their families, must have comprised fully fifty thousand people. The

⁸ *Ibid.*, pp. 247, 248.

metics paid a tax of twelve drachmas a year for the privilege of trading in Athens under the protection of the state. A drachma is eighteen cents in our coinage, but its purchasing power is much greater.

CHAPTER II

SOCIAL CONDITIONS AND THE CLASS STRUGGLE

THE commercial activities of the Greeks brought about the introduction of a money economy. Aristotle remarks that "as the benefits of commerce were more widely extended . . . the use of a currency was an indispensable device. As the necessaries of nature were not all easily portable, people agreed, for purposes of barter, mutually to give and receive some article which, while it was itself a commodity, was practically easy to handle in the business of life. Some such article, as iron or silver, was at first defined simply by size and weight, although finally they went further, and set a stamp upon every coin to relieve them from the trouble of weighing it . . ." ¹ From early times, barter had existed in the Ægean, and eventually certain articles were exchanged so often that they became a sort of commodity-money. We find the slave-unit and the ox-unit. But the disadvantage of these mediums of exchange was that slaves and oxen vary individually, and it is difficult to define the unit of value. The superior convenience of metallic money inevitably asserted itself, for equal weights and quality of metal can be easily established. Coined money seems to have been introduced about 700 B.C. With the establishment of a money economy came consequences of far-reaching

¹ *Politics*, bk. 1, ch. ix, Welldon.

importance which the English economist, William Cunningham, has outlined.²

MONEY ECONOMY AND SOCIAL RELATIONS

The intervention of money made relations of persons and the exchange of things clearer and much more orderly. In a natural economy, men were bound to one another by customary ties. Mutual obligations were discharged in service or in kind; consequently it was difficult to distinguish the physical transfer of goods by gift-making and tribute from exchange of goods by commerce. Again, it was impossible to determine whether the serf pays rental for his small holding of land in the form of service, or whether he received wages in the use of his land. In a natural economy, these concepts were not distinct. But in a money economy, gift-giving and commerce, wages and rent, were easily distinguished, and, to this extent, economic thinking was clearer and more logical.

The introduction of a money economy made for freedom of individual action, in addition to facilitating clear thinking. While the slave or the serf did his labor under compulsion, the free man worked for the sake of reward.³ The laborer enjoyed greater independence when his reward was paid in money. Under these circumstances, he decided for himself whether he would work much for a larger reward, or whether he desired to have more leisure and a smaller return. In a natural economy, payment was made in shelter or rations, and consequently the workmen's expenditure and place of habitation were

² *Western Civilization in Its Economic Aspects, (Ancient Times)*, Cambridge, 1902, pp. 73-4, 85, 94-100.

³ *Ibid.*, p. 74.

determined without regard to his own desires. When the laborer's return was in money, he might spend it as he chose. The introduction of money-payments for labor made a larger proportion of the people masters of their own time. The free man differed from the slave or serf in that the former had free time, and it became a matter of choice as to how he should occupy that time. If he chose to spare from manual tasks time to devote to affairs or self-development, he enjoyed some leisure for political life.

In addition to freedom in the disposal of his time, money economy favored freedom to migrate and to change employment. As long as the state was maintained by the personal rendering of service, men were bound to give payment in kind, and were restricted to some definite place. But with the introduction of money taxation, a man paid taxes and was free to move, "so long as his property is within reach, and can be claimed for public purposes."⁴ Industry was also affected by the change. In natural economy, the laborer must work at the traditional occupation of his family, and train his son to follow him. It was well nigh impossible for him to change his employment. But when accumulated hoards of wealth might be realized in money, the capitalist could readily embark on new enterprises by selling out his establishment and reinvesting his capital in some other enterprise. Thus, in a money economy persons who possessed even small funds of convertible wealth might change their employments, whereas in the primitive natural economy they were doomed to pass their working lives in the same old ruts as their forefathers. Hence the intervention of money opened up possibilities

⁴ *Ibid.*, pp. 94-95.

of progress and personal independence unknown to primitive economy.

In the Greek city-states, the citizens were emancipated from the constraints of the customary obligations, because money made them free to buy, sell, and bargain with one another. Making for clarity of thought, freedom of action, and personal independence, money-economy helped to separate economic and political affairs, and constituted a factor of no small importance in establishing that degree of political freedom for which the Greek cities have been justly famous.

FOOD, MONEY, AND DEBT

The food supply is a matter of utmost concern for every large community. Attica was no exception to this rule. Ordinarily, food is obtained from the neighborhood which the community inhabits. But when population increases, the law of diminishing returns at length begins to operate, and the people are forced to import larger and larger proportions of their food. In primitive times, the population of Attica was readily maintained by the food resources of the region, and peasants cultivated small plots of land. Each family group was self-sustaining. As Athens grew, these earlier conditions gave place to new problems which affected the food supply.

The introduction of a money-economy tended to disturb traditional economic relations. Accustomed to meeting his obligation to capitalist, landlord, or state, by service or payment in kind, the demand for payment in money compelled the poor farmer to revolutionize his whole plan of economic existence. To obtain money to meet the demands of a tax-collector, he must sell his produce for

money. In lean years, when prices were high and his crop was too small to secure gain, he had to compete with imported produce. In good years, the price was apt to be low, and he could not afford to set aside a surplus against poor seasons. Moreover, methods of marketing farm-produce were primitive, and it must have been difficult to sell it. As agriculture had outgrown the primitive stage in which it was pursued to supply the needs of a cultivator's household alone, and had become a trade producing for the market, the farmer needed to procure advances of money from the capitalist to enable him to purchase the seeds and materials with which to carry on his business. Thus it became customary for rich men to assist the poor peasant by making advances in silver on security of the debtor's land.⁵ Under this system, it was quite likely that, in years of large crops, the farmer could not sell at a price high enough to cover his expenses and pay the debt, so that the debt was carried over from year to year and accumulated. Finally, it often reached an amount which made redemption hopeless. The capitalist then took the land in satisfaction of the debt, or sold the poor peasant and his family into slavery. In this manner, small holdings were gradually consolidated into large estates, cultivated by debt-slaves. Competition with the larger slave estates was ruinous for the small free farmer, even if he had not incurred a large debt upon his land. The close proximity of the debt-slave population, with its inefficient working methods and low standards of living, must have had a demoralizing effect upon the free farmers who remained.

This agrarian depression made it inevitable that larger and larger numbers of yeomen should desert their small

⁵ *Plut., Solon*, 15.

country holdings and seek occupations in the city. But it still was possible to work the large estate for a profit, because slaves were used to cultivate the ground, and slaves could be cheaply maintained. Although society had adopted the money economy, the internal management of the capitalistic slave estate was still based on natural economy. It was a self-sufficing economy in that the slaves produced food for themselves and for their master's household. The land was devoted more and more to the cultivation of the most profitable crops: fruit, olives, and other products which it was permissible to export, and for which there was little competition in the Athenian market. Thus it came about that the depression of the yeomen farmer-class, and the devotion of estates to the cultivation of luxuries, discouraged the production of corn. Athens became more and more dependent upon importation of her food supply.

SLAVERY IN GREECE

Slaves increased in numbers very rapidly and were obtained from many different sources:⁶

(1) Those born slaves usually remained slaves, the condition being hereditary. In general, however, it was cheaper to buy a slave than to pay the cost of rearing him to the age of labor.

(2) Slaves were obtained by the sale of children of free parents. The sale of children, however, was not permitted in Attica, nor their exposure, except at Thebes.

(3) A third source of the slave supply was by action of the law. Up to the time of Solon, the debtor became the slave of his creditor. In Athens, freemen and metics

⁶ Ingram, J. K.—*A History of Slavery and Serfdom*, London, 1895, pp. 15-20.

were likely to be sold as slaves if they did not discharge their obligations to the state.

(4) A fourth source of slaves was by capture in war. Sometimes, even Greeks were reduced to slavery by other Greeks. After Thebes was taken by Alexander, it is said that thirty thousand women and children were sold as slaves.

(5) The fifth source of slaves was through piracy and kidnapping. Pirates descended upon the coasts and, carrying off captives, sold them as slaves. In case a victim was ransomed from the pirates, by Athenian law he became the slave of his redeemer until he had paid the purchase price in money or labor. There was also a brisk trade in carrying off children and rearing them as slaves.

(6) The final source of slaves was from commerce. A regular slave-trade developed. Syria, Pontus, Phrygia, Lydia, Galatia, Paphlagonia, and Thrace were sources of the commercial supply of slaves. Since Asiatics were most easily controlled, they were of high value. The eastern princes held Greek slaves in high esteem, especially female musicians and dancers. Athens derived revenue from the tax on the sale of slaves. Besides Athens, the principal slave-markets were at Cyprus, Samos, Ephesus, and Chios.

Slaves were sold for various prices. A Carian sold for 115 drachmas, or \$15; a Syrian could be purchased for 301 drachmas, or \$42; three Thracian women sold for from 135 to 222 drachmas, that is, \$18.75 to \$31. Slaves under the working age could be bought for as low as 153 drachmas, or \$21. The slave who was skilled at a trade was more highly valued. A courier would sell at a price of ten mines, or from \$135 to \$155. At a household auction at Athens in the year 415, the average price for men

was 166 drachmas, and for women 170.⁷ Xenophon estimated that, whereas it cost 540 drachmas (\$74) to maintain a free laborer for a year, a slave who could accomplish the same amount of labor would cost but 180 drachmas (\$26). Considering the original purchase price of the slave as 300 drachmas, the saving on slave-labor would, in fifteen months, entirely wipe out the purchase price. Thus the slave would pay for himself in fifteen months, and ever afterwards his labor, beyond the cost of maintenance, would be net gain.⁸

Since slaves were obtained from so many diverse sources, they represented many nationalities. Decrees of emancipation and burial inscriptions give us a clue to the large proportion of foreigners among the slaves. Usually, very few Greek names appeared in these decrees. From one list of 124 manumissions, there were 22 Syrians, 22 Thracians, 8 Galatians, 6 Italians, 4 Armenians, 4 Sarmatians, 4 Illyrians, not to mention Phœnicians, Jews, Egyptians, and Arabs.

We cannot give an exact account of the number of slaves. At a census taken in 309 B.C., it was estimated that there were 21,000 citizens in Athens and about 400,000 slaves in Attica. Perhaps these figures are made unduly large by the inclusion of metics. As early as the fifth century, conservative estimates put the slave population at two fifths of the population of all Greece. But slaves were not found in great numbers in the interior; they were found chiefly at commercial and manufacturing centers, and in the richer agricultural regions. M. Wallon has estimated that the number of slaves in Attica devoted

⁷ Zimmern, *op. cit.*, p. 392, note.

⁸ Zabrowski, S.—“Ancient Greece and the Slave Population,” *Annual Report of the Smithsonian Institution*, 1912, pp. 602, 605.

to domestic services was 40,000; in agriculture, 35,000; working in the mines, 10,000; and 90,000 engaged in manufactures and commerce.⁹ Cavaignac estimates that in the year 431 B.C., there were 20,000 adult, male slaves in the Athenian mines.¹⁰ The number of slaves owned by private persons was sometimes considerable. Hipponicus, a rich man, owned 600; the father of Lysias employed 120 in the workshop of his armor factory; Nicias, the general, employed 1000 in the mines.¹¹

In general, the Greeks treated their slaves well. Masters had an economic motive in kind treatment, for the varied activities of the slave made him a valued possession. Indeed, the slave often held a position of importance and responsibility in the family. Although generally excluded from sacred ceremonies and public sacrifices, slaves often participated in domestic rites. They were also allowed to enjoy a part in popular festivals. Sometimes the master of the house would even erect a monument testifying to his affection and regard for a deceased slave. The Old Oligarch speaks of the Athenian slaves as almost indistinguishable in appearance from regular citizens.¹² On the other hand, the slave laborers in the mines were chained together and worked in gangs. Under these conditions they were branded and treated as beasts. Many worked as deep as 250 feet below the surface, where the dampness made the death rate very high.

The Athenian law did not leave the slave without protection. If a master killed a slave, he might be temporarily exiled. The slave who killed his master could not

⁹ Ingram, *op. cit.*, p. 22.

¹⁰ Zimmern, *op. cit.*, p. 393, note.

¹¹ Gulick, C. B.—*Life of the Ancient Greeks*, New York, 1911, pp. 66-67.

¹² Zimmern, *op. cit.*, p. 378.

be punished by the victim's relations; they were obliged to hand over the slave to a magistrate, who dealt with him by due process of law.¹³ In some cases, however, the only recourse against the cruelty of masters was in flight. The slave who saved a sum of money by labor and economy would often be required to pay the money to his master in return for freedom. The cost of manumission varied. One hundred and sixty-two redemption prices are recorded as ranging between 300 and 500 drachmas, or \$41 to \$69. Two were as high as 2000 drachmas, or \$278; 312 women were ransomed at prices ranging from 300 to 500 drachmas.¹⁴ Thoughtful Greeks recognized that the most satisfactory way of supplying a slave with an incentive to do good work was to offer him the prospect of ultimate freedom.¹⁵

IMPORTED GRAIN

In agricultural industry the free yeoman farmer, discouraged because of the hard conditions under which he labored, was gradually driven from the field. There was a tendency for small, private holdings of land to be consolidated into large estates. Capitalists employed slaves to raise the crops, but since it was more profitable to grow fruit and olives than corn, a smaller and smaller proportion of the Athenian grain supply came from the immediate neighborhood. Athens was forced to import her grain from Pontus, Thrace, Syria, Egypt, Libia, and Sicily. To protect the course of her corn ships from interruption by enemies, Athens fortified the promontory of Sunium and provided convoys for the fleets. As merchants were inclined to inquire the range of prices at dif-

¹³ Ingram, *op. cit.*, p. 26.

¹⁵ Zimmern, *op. cit.*, p. 386.

¹⁴ Zabrowski, *op. cit.*, p. 606.

ferent ports and select the market which offered the highest prices, it was difficult to have the corn shipped to Piræus in preference to other ports. To compel the consignment of corn to this port, a law was made forbidding the loan of money on bottomry,—money loaned on the security of a ship and cargo,—to any vessel which did not bring a return cargo of grain to Athens.¹⁶ Vessels laden with corn were compelled to sell two thirds of their cargo in Athens, and only one third could be exported.¹⁷ But middlemen speculated in corn and frustrated the effort to have an abundant food supply. Athenian wholesale dealers bought up the corn upon its arrival, and held it for a rise in value until they could retail it at exorbitant prices. Laws were made with a view to controlling the anti-social operations of unscrupulous middlemen. Officials were appointed to keep account of the corn and the prices at which it was sold, in order to enforce a measure which limited the amount that each man might purchase to fifty measures (about 75 bushels). The officials also fixed a selling price which would allow only a moderate return on the sum paid. The problem was also partially met by public granaries at Athens, wherein a public stock of corn was kept and from which at intervals, as we shall see, food was sold at low prices to the poorer citizens.

SOCIAL UNREST AND THE CLASS STRUGGLE

The poorer classes in seventh- and sixth-century Attica found it hard to make a living. Although prices were higher, wages remained about the same. A few capitalists were becoming richer and richer, and the common people were growing poorer and poorer. Be-

¹⁶ Böeckh, *op. cit.*, i, 77-78.

¹⁷ Cunningham, *op. cit.*, pp. 103-104.

cause the wealth remained in comparatively few hands, the people were discontented. They wanted new laws which would grant them greater rights and help relieve them from the burden of debts. The first codification of the laws was made under Draco, in 621 B.C. Prior to this date the laws, being unwritten and known only to the nobles, were interpreted by them for their own advantage. But Draco's codification of the law failed to correct the real conditions which were responsible for so much misery among the lower classes. The nobles, in their desire to acquire all the wealth in the state, forced debtors upon their lands to become slaves. When a lord laid claim to a field or plot of land which he desired he placed upon it a boundary stone to indicate that it belonged to him.

THE SOCIAL REFORMERS

In response to growing popular discontent, the aristocrats were compelled to grant the poorer citizens greater rights in the state. Solon, a man of broad and liberal views although of aristocratic descent, was appointed to change the laws in 594 B.C. Solon first attempted to correct economic troubles by means of a broad program of social reform. He ordered the immediate removal of all boundary stones, in order that tenants might be released from payment of debt to the nobles. As he desired to secure freedom for citizens in the future, he drew up his so-called personal liberty laws. He first canceled all debts resting upon security of land. From public and private funds, he attempted to redeem Athenians who had been sold into slavery in foreign lands. He prohibited the selling of a child or a kinswoman into slavery. No one ever after should lend money on the security of the

person. Besides important agrarian reforms, Solon made certain improvements in the constitution. Among his constitutional reforms was a provision that the poorest class, as well as the others, was to be admitted to the popular supreme court. Because attendance at these meetings had long remained unpaid, only the well-to-do could afford to attend them. By admitting the *thetes* to this assembly, Solon gave them the power of protecting their own freedom and property forever.

In addition to these general legislative reforms, this sagacious statesman drew up certain special laws. He wanted to prevent famine by keeping at Athens the food produced within the country. With this in view, he forbade the exportation of all products of the soil, with the exception of olive oil. To foreigners who were willing to come to Athens with their families in order to carry on a trade, Solon gave facilities for acquiring citizenship. To encourage skilled industry, he compelled every man to teach his son a trade. Solon was wise enough to see that, since the soil was not particularly fertile and hence largely unfit for agriculture, the country could hope for prosperity only by engaging in manufacturing and commerce. To promote commerce, Solon adopted a silver coin as the money standard for his city. This was a great advantage because it insured trade with other cities and with certain prosperous colonies which used the same standard. These laws helped to develop Athens along manufacturing and commercial lines. Through intercourse with other countries, the Athenians discovered many luxuries and entered into commercial relations with Sicily, Italy, Cyprus, Egypt, and Lydia.

The rights and privileges which the people had gained under Solon's rule were so new to them that they failed

to appreciate their importance, and the class struggle within the state continued. The people were divided into three natural classes: the plainsmen, or rich landowners; the shoremen, who consisted mainly of traders living near the coasts; and the hillmen and farmers, who lived near the hills. Taking advantage of the popular discontent and commotion a certain noble named Pisistratus proclaimed himself leader of the hillmen. As the champion of their cause, he obtained enough power to rule the state. Fortunately, the machinery which Solon had invented still continued to operate, in spite of the fact that Pisistratus was the real power, for the latter was really like a political "boss," although the Greeks called him a tyrant. His most farsighted enterprise was an attempt to establish colonies on the Hellespont, in order to enlarge the trade of Athens. At his death, the people experienced two years of civil strife; then a noble named Cleisthenes, leader of the popular party, succeeded in putting an end to the class strife. Originally, the plain-, shore-, and hillmen, being united in their activities, enjoyed considerable power. Cleisthenes redivided the townships of Attica in a new fashion. He grouped small local communities into ten new tribes, so that the townships of the same tribe were not all together, some being located near the hills, others in the plains, and the remaining townships on the shore. By breaking up the old tribal communities and substituting small separated townships, the unity of each of these antagonistic classes was broken, and they ceased to give trouble.

CHAPTER III

INDUSTRY AND SOCIAL ECONOMY

SINCE industry always develops with commerce, Athens became the manufacturing, as well as the commercial, center of Greece. Of course, Athens never became a great industrial center like the factory cities of to-day, for she produced chiefly for home consumption, and most of her exports were the manufactured products of small shops. But from imported raw material, Athens manufactured shields and other metal work. She exported her surplus of wine and oil, and also clay jars, painted vases, statuettes, blocks of Pentelic marble, and the creations of her silversmiths.

Xenophon tells us of one merchant who ground only barley meal and yet, from the earnings in this business, was able to maintain not only himself and his domestics, but many pigs and cattle besides. Frequently he realized such large profits in the business that he contributed to the burden of public services. Another man lived luxuriously from the earnings of a bread factory, while others gained a good livelihood out of the cloak business and the manufacture of shawls and sleeveless tunics. A shoemaker is said to have received from the earnings of his employees two obols—about five cents per head—or \$16.50 a year. Demosthenes had an income of \$725 a year from two shops which he maintained; one, a cutlery; the other devoted to the manufacture of beds.

Most of the industrial activities of Athens appear to

have been carried on by workmen in their own shops and homes. The handicraft-domestic system seems to have quite generally prevailed.¹ Industrial workers were craftsmen, not factory hands like the workers of to-day. We must remember that in Greece agricultural work was still supreme. It was regarded as the most commendable occupation because it made those who followed it self-sufficing and independent of others; moreover, it was the traditional occupation. Industry was always subordinate to tillage. The average Greek family was approximately self-supporting. The workers made their own plows and pruning-hooks, spun and wove their garments, constructed and repaired their houses, and carried on all the necessary activities of their lives without depending upon outside help.² Nevertheless, there was some degree of specialization in industry. The lame man, who could not work in the field, became a blacksmith at the forge. In time it was recognized as undesirable for a family to make its own pots, baskets, and plows, when some specially trained craftsman could do the work far better.

In sixth-century Athens, men made a livelihood by their specialties. Solon has given us a list of some of the skilled occupations of his day: the trader, the farmer, the metal worker, the weaver, the poet, the diviner, and the doctor.³ In the fifth and fourth centuries B.C., the division of labor included: millers, grain jobbers, bakers, fullers, and dyers, manufacturers of garments, hat makers, jewelers, masons, furniture-, and cabinet-makers, potters, makers of shields, spears, bows, knives, helmets, and breast-plates. The division of labor in furniture- and cabinet-making was carried out to a considerable degree

¹ Cunningham, *op. cit.*, p. 110.

³ *Ibid.*, p. 253.

² Zimmern, *op. cit.*, p. 252.

of specialization. There were door-, bed-, chair-, and chest-makers, and turners who rounded the legs of chairs and tables.⁴

The stone contractor was himself a workman, and held a very different position from the modern contractor who simply organizes hired help. He was really a master-mason who worked by the side of his men. There appears to have been little rivalry and less competition among these simple craftsmen. In an armor manufactory inherited from his father, the orator Lysias, himself a metic, employed 120 slaves. A record of payments made by the state for the construction of the Erechtheum in 409 B.C., relates that wages were paid to 27 citizens, 40 free outlanders (metics), and 15 slaves. Other records show that various groups of workmen—freemen, foreigners, and slaves—were employed upon public works. In these activities, the slaves and non-citizens appear to have done the same tasks as the citizen workman. The three classes worked together and seem inextricably mixed.

THE CERAMIC FACTORY

A potter's workshop was a sort of primitive factory. But here, as in the stone-yard, the master worked at the same job with his apprentices, encouraging them in their efforts and superintending the handiwork. The division of labor in the ceramic factory was far less minutely specialized than with us. A considerable degree of individual skill was demanded of the workman, and he was capable of different tasks. Familiar with all details of the craft, the workman's activity was not a mechanical one. A proof of the absence of modern standardization in

⁴ Gulick, *op. cit.*, pp. 229-233.

product is seen in the fact that, of hundreds of vases discovered, none are devoid of originality, nor are any two identical. Yet there was some division of labor, for we find craftsmen engaged in working the clay, preparing the glaze, preparing the colors, painting, taking care of the ovens, and moving materials. The establishment was divided into two main parts: a workshop, where the turning, shaping, and polishing of the vases took place; and a place for the baking and drying of the pots in the furnace.⁵ In all, there must have been several buildings; a room for the vase turners and makers, a room for the painters, ovens in the court without, and a shed for storage of raw materials and for kneading and refining the clay. In addition, perhaps, there was a warehouse and a salesroom. Upon a vase from Ruvo, the studio is represented as containing four painters, and thus it may be concluded that a modest staff would amount to at least fifteen or twenty workmen. Pottier says that a potter like Douris must have had a factory of some size; and yet the investment in equipment and material could not have been large, for besides refined clay of different colors for glazing and retouching, the main materials consisted of lusters to brighten the natural color of the clay, wheels and molds, rules and compass, sharp points for sketching, and brushes of all kinds.⁶

THE ORGANIZATION OF LABOR

In this craftwork, no great investments of capital were needed. In fact, the materials were usually provided by the customer who gave the order. When you wanted a

⁵ Pottier, E.—*Douris and the Painters of Greek Vases*, London, 1909, transl. by B. Kahnweiler, p. 23.

⁶ *Ibid.*, p. 26.

pair of shoes, you took your leather to the cobbler's and had him shape it to your foot. It was not the business of a craftsman to buy his supplies. They were brought to him and he labored upon them to make them serviceable.

Our modern craftsmen select strategic situations to carry on their trade—places where they are free from competition of a fellow-worker. It was quite the reverse in Athens. Each craft had its own quarters. Thus, there might be the “street of the sculptors,” or the “street of the box-makers,” and the like. There was no competition between shops, but merely the friendly rivalry of those engaged in performing the same service and making the best article they could possibly manufacture. These arts and crafts had their own associations, but not for economic gain. Workmen did not associate to protect their own interests, but united on social and religious grounds. Since they were not looking for riches, but rather for honor and a decent livelihood, they did not raise or cut prices, but allowed the prices of their wares to be fixed by custom.

In Greece, craftsmanship covered a wider sphere of activity than with us. Every specialist was a craftsman. As such, all earned a decent living, and thus it was seldom that they worked for wages. They might with dignity receive wages from the city, since they were citizens, but as freemen, they scorned wages from their equals. Interpreting Salvioli, Zimmern says: “Such an arrangement would have put the craftsmen almost in the position of the slave. His aim in life was very different: to preserve his full personal liberty and freedom of action, to work when he felt inclined and when his duties as a citizen permitted him, to harmonize his

work with all the other occupations which filled the life of a Greek, to participate in the government, to take his seat in the courts, to join in the games and festivals, to break off his work when his friends called him out to go to the market-place or the wrestling school, or when his colleagues in the craft were holding a dinner—all of the things which were incompatible with a contract at a fixed wage.”⁷

The contemptuous attitude of the ancient Greeks toward manual labor was the result of a point of view which differs so fundamentally from our own that it is easily misunderstood. The spirit which animated the Greek worker was ordinarily one of joy in his work, for labor, as such, was not despised. But this pleasure in labor was experienced only when there was independence and freedom from restraint. Consequently, when men found it necessary to break in upon their time for political duty because of the necessity of working for self-support, such labor was regarded as demoralizing. The *thetes*, who labored by the day for a money wage, were to that extent dependent upon others, and hence held in contempt. Small traders, who sold their goods in person and led a sedentary life, making but trivial gains and reputed for their avarice and undignified haggling, were considered inferior. Artisans, who worked indoors at their trade, appeared to them as much deprived of personal liberty and free, out-of-door life as slaves. Such work was therefore contemptible, and industrial arts were called slavish. Even great painters, sculptors, and artists were in some disrepute, because they accepted money for their work. But the extensive operations of great wholesale merchants gripped the imagination of

⁷ Pp. 265, 266.

the Greek to such an extent that the activities of these large operators were not despised. The naïve idealism of this attitude toward productive labor is well explained by Tucker.⁸ He says:

. . . No people in the world ever set such a value on outward superiority of person and manners as did the classical Athenians. . . . In the first place, they did not despise work, as such, nor were they constitutionally indolent; what they disliked was the uncomely, physical effects of labor, especially of indoor labor; they detested that which made them acquire a stoop, or stunted the limbs, or misshaped the hands, or begrimed the person. In the second place, they had an intense passion for personal independence, and their ideal of personal freedom of action and speech could hardly be attained by one who had to serve and court the custom of his neighbor. In the third place, the vulgar and material concerns of the lower occupations prevent the mind from gathering the culture and refinement which come of good company and abundance of intellectual intercourse.

CHARITY AND SOCIAL ECONOMY

Since many of the citizens, although free men, derived no income from shops or properties, they eventually became objects of public support. Whereas in Crete and Sparta the citizens were wholly supported from the public treasury, the Athenian citizens were aided in various ways. We have seen how Solon tried to preserve the independence and dignity of the laboring men by canceling debts and mortgages pledged on a security of person; and we have seen how his successor, Pisistratus, tried to postpone the social decline of the people; but the methods of these legislators were not altogether successful. In order to relieve the situation, Athenians were sometimes selected from the two lowest classes and emigrated. Plu-

⁸ *Life in Ancient Athens*, London, 1911, pp. 79-80. See also Zimmern, *op. cit.*, pp. 266-7, and Gulick, *op. cit.*, pp. 188-190, 233-4, 236-8.

tarch says: "By this means he relieved the state of numerous idle agitators and assisted the necessitous." In some respects, this policy of emigration was a beneficial method, because it gave to persons who were formerly idle, the opportunity of owning property and becoming self-respecting and self-supporting. A less satisfactory method of caring for idle citizens without property was by supplying corn at reduced rates. The public granaries, which we have mentioned in another context, were erected at public expense, and provided considerable stores of grain. Since the maintenance of this large number of idle citizens depended upon the corn fleets, Athens was very much concerned about the safety of her fleets. In general, this public corn was distributed to adult citizens of 18 years of age, and others whose names appeared upon the official registers.

For those who were unable to earn a livelihood because of physical disability or infirmity, there was a system of public relief. A citizen who had property valued at not more than \$60 was qualified to receive this aid.⁹ State-pensioned cripples received an obol a day.¹⁰ The senate, when it examined the case of Socrates, awarded a bounty of one or two obols a day—about five cents. There was also a special fund for the orphans of those who had fallen in war.

During the period of Athenian commercial expansion, large fortunes were accumulated by a few persons, but after the Peloponnesian War, the wealth of the country ceased to grow. Since the people had become largely townfolk and had lost their primitive thrift, it was not possible to return them to the country for support. The main reliance for the maintenance of the governing class

⁹ Lock, *op. cit.*, p. 28.

¹⁰ Gulick, *op. cit.*, p. 249.

of citizens was therefore by emoluments. These emoluments consisted of payments to citizens for attendance at public gatherings. According to Plutarch,¹¹ the allowances for attending theaters, payments for performing public duties, and other practices which built up bad habits and changed the people from a sober, thrifty folk who maintained themselves by their own labors, to an extravagant and intemperate rabble, were initiated by Pericles. It all came about because Pericles found that Cimon, his competitor for popular leadership, was accustomed to issue invitations to dinner, give clothes to the aged, and in other ways to assist the masses, with the object of buying their support. Pericles, therefore, bought over the people to his support by moneys allowed for attendance at shows, jury duty, and other public services.

In considering these emoluments, it should always be remembered that the Athenian citizen regarded his political duties as of paramount importance. A free citizen should devote his time to public service in assemblies and law courts. If he had to support himself by his own labor, he could not be the independent political unit that he ought to be, and participate in these activities. Consequently he was not considered a dependent because he received a public allowance sufficient for his support.

Citizens over thirty years of age were elected to the Council of the Five Hundred (*boulê*), and received five obols (15 cents) a day for attendance. They also enjoyed exemption from military service. The Popular Assembly (*ecclesia*) was composed of citizens over eighteen years of age. The fee for attendance was, at first, one obol a day; in the fourth century it was two obols, and later became nine obols. Since the minimum at-

¹¹ *Pericles*, Clough's revision, 1912, vol. i, p. 234.

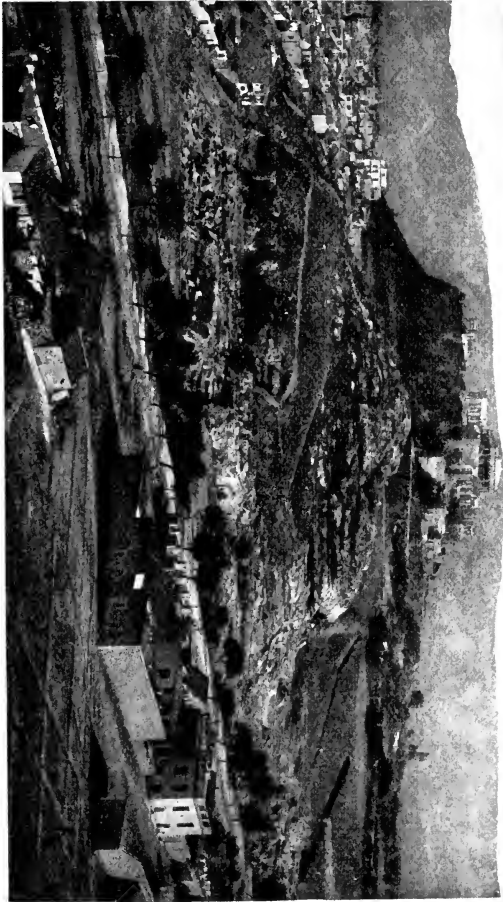

FIG. 1.—The Acropolis

tendance of 6000 citizens was necessary to transact business, a considerable number of persons must have been maintained in this way. The average size of the body of citizens composing the law courts was 6000, of whom one thousand were substitutes. The pay was two obols a day in the time of Pericles, and was increased to three obols a day by Cleon.¹² It is apparent that public emoluments reached a large proportion of the citizen body, since by 404 B.C., after the Peloponnesian War and the plague, there were only about 20,000 male citizens left.¹³ Böeckh, in his *Public Economy of Athens*,¹⁴ estimates that in 384–323 B.C., a poor family of four free persons could live on about six to nine cents a day, and this estimate includes rent. Thus, a citizen who attended an assembly or a court would receive sufficient compensation to cover the expenses of his subsistence. On the other hand, the day-laborers received about ten cents a day. At public festivals, citizens received five cents a day. In addition to these public affairs, there were religious feasts, with a free meal accompanying them. Finally, there were numerous confiscations of private property, and the poorer citizens shared in the distribution.

Besides these public forms of benevolence, there was much private liberality. Wealthy citizens considered it a part of their civic duty to share in the expense of certain public services. It is recorded that at a trial, in 425 B.C., a citizen submitted evidence to show that his father had expended more than ten thousand dollars during his life in paying the expenses of choruses, fitting out vessels for the navy, and paying an income-tax to provide for emergencies. In addition to this, he frequently helped

¹² Gulick, *op. cit.*, pp. 206–215.

¹⁴ Eng. transl., pp. 109, 117.

¹³ *Ibid.*, p. 60.

poor citizens by granting marriage portions to their daughters and sisters. He paid the funeral expenses of others, and even ransomed some.¹⁵

The effect of this extensive public aid was most unfortunate. It tended to pauperize the citizens, to discourage enterprise and thrift among the wage earners. It undermined the independence and self-respect of the workers. Aristotle observed the bad effect of indiscriminate distribution of public aid to idle citizens. He said it was like pouring water through a sieve and expressed the opinion that the state should make prosperity permanent. Many of his ideas were quite modern. For example, he thought that aid once given should be adequate, and that charity should be voluntary, rather than compulsory. To make the aid adequate, he suggested that public relief should be given in such large quantities that the poor might acquire small farms or be set up in business, and thus permanently rehabilitated.

THE SEEDS OF DECLINE

The account given of social life in Greece has included occasional reference to conditions, the persistence of which would bring about decay. The Greeks were short-sighted in their consumption of wealth. Greek statesmen drew recklessly on their mineral resources, seeming to believe that their supply of silver was inexhaustible. In time, of course, it was worked out. The soil, which may ordinarily be preserved for generations of use by proper tillage, the use of fertilizers, and crop rotation, was also exhausted by wasteful slave cultivation. The yeoman debt-slave was a reluctant worker, unskilled and inefficient, and consequently wasteful. By continued

¹⁵ Plut., *Cimon*.

cropping, the fertile sections of Greece, at best not extensive, were exploited.

Greek idealism has given us some of the most superb artistic products that have come from the hand of man, but this same idealism was accompanied by an economic misuse of capital.¹⁶ When accumulated sums of wealth and treasure are laid out in such productive works as irrigation canals, public roads, harbors, large-scale intensive agriculture, an economic return is assured, for the investment yields continuous income and thus new opportunities for further progress in wealth are offered. But when the wealth of the nation, the accumulated treasure, the skill and labor, is sunk in beautiful public buildings, there is no economic return upon the investment. During construction, these beautiful buildings afforded employment, but when completed, they served no economic purpose except that of display. They could not be utilized for the production of more wealth, nor did they act as an incentive to trade. Thus the wealth of the Greek was deliberately squandered in unproductive works; his wealth was invested in forms which did not lead to the development of natural resources or trade. The total sum spent on public works in the period 447 to 432 B.C. is estimated at \$47,000,000, a vast sum for those days.¹⁷ There was no means of withdrawing the capital so invested and turning it to other account. It is true that these beautiful architectural creations gave æsthetic income, but such an income is not expedient when the civilized community is surrounded by the menacing hostility of barbarians.

The population of the cities became a restless, pauper-

¹⁶ Cunningham, *op. cit.*, pp. 119-123.

¹⁷ Zimmern, *op. cit.*, p. 406.

ized element, maintained by low-priced public corn, private liberality, and emoluments. In this way, the thrifty habits of the people were undermined and their character demoralized. The Greeks never understood the law of diminishing returns in economic life, and, like other ancient peoples, were equally ignorant of the important sociological principle that the resources of citizenship are best conserved by maintaining those conditions which encourage a spirit of self-respect, self-reliance, independence, and habits of self-help among a people. The idealism of the Greeks was superb, but they seemed to lack a certain hard-headed practicability which takes account of the homely basis of citizenship.

PART II. THE ROMAN PERIOD

CHAPTER IV

THE LAND AND MILITARISM

Just as Greece was for many centuries the early frontier of the ancient world, so the Italian peninsula became the later frontier of the ancient world. Physical conditions were as important in the early development of Roman dominion as in the early development of Greek power. The Italian peninsula, jutting out into the middle of the Mediterranean, was strategically located for favorable development, so that from early times traders, immigrants, and adventurers came to Italy. Because of her central location, Italy was directly in the midst of the maritime life of the Mediterranean. Whether trade went east or west, north or south, Italy was so situated as to have her share in this commercial development. From the Italian peninsula it was not far to the Grecian peninsula on the east, nor far to Africa to the south. By Sicily, to the west, the way lay open to Spain through Corsica and Sardinia.

On the other hand, the exposed position of Italy had the disadvantage of offering easy access to invasion by enemies. Hence political unification was essential if the inhabiting peoples were to survive in the struggle with alien invaders, and motives of self-preservation first led Rome to policies of military expansion.

Considering the Italian peninsula itself, its area is about twice that of the State of New York, being about seven hundred miles long and averaging about one hun-

dred miles wide in the central part. Along the western coast of Italy, there are more numerous and better harbors than on the precipitous eastern coast. It was natural, therefore, for the Latin people living at Rome to spread their influence to the west, where they came in contact with the fresh, virile peoples of Spain, Gaul and western Europe. These peoples assimilated the vigorous Roman culture more readily than the peoples of the East.

The land surface of Italy was favorable to social development. To the north were the fertile, alluvial plains of the Po River. The great mountain masses of the Apennines which extend along the northwestern coast of the mainland, soon run eastward and then, turning southward, pass the center of the peninsula, thereafter running somewhat nearer to the eastern coast. The consequence is that the eastern slope is more abrupt and devoid of harbors and navigable streams, whereas the western slopes are gradual and terminate in fertile coast plains.

The Apennines do not cut Italy into isolated valleys in the way that Greece is divided, because the spurs do not run from east to west. This arrangement gives the peninsula more geographical unity, and different sections depend upon land routes rather than upon ships and the sea. Although the Alpine highlands of the north acted as a protection against enemies, they discouraged commerce. In this favorable location which combined such advantageous natural features, the early population of Italy developed frontier qualities of courage, patience, hardihood, and practical intelligence.

Since the Italian peninsula extends through several degrees of latitude, and since there are fertile plains and high mountain masses, a great variety and diversity of

climate exists. In the North and on the upper slopes of the mountains, we find a temperate climate and products of central Europe; in the South, the climate is sub-tropical, with a vegetation much like that of Africa. This diversity in natural products permitted all-round growth, and formed the natural basis for national prosperity. The natural resources of the locality consisted of such useful products as stone, copper, timber, fruit, and grains. The fertile soil and favorable climate, combined with a strategic location for commerce, favored the early accumulation of a surplus and the development of a powerful civilization.

THE COMMON CAUSE AND FEDERATION

Since the early inhabitants of Rome enjoyed no natural protective barriers like those of Greece, but were easily accessible from east, south, and west, some form of union was necessary if the community was to survive. The people of early Rome lived on an open plain, exposed to the warlike raids of the fierce mountaineers of central Italy and the aggressions of the Etruscans of the North. These Latin tribes were driven, therefore, to gain by treaty and agreement a security not afforded by natural barriers. Almost at the beginning of her career, Rome adopted a policy of alliance with her neighbors for purposes of mutual security and protection. A league of thirty cities was formed to secure immunity from hostile invasion. Rome did not at first reduce her less powerful neighbors to complete submission. By treaties she bound each community or tribe to herself, yet kept them completely isolated one from the other. In this way the danger of combination against her was reduced. Each of the separate communities enjoyed a large degree

of freedom in retaining its own customs and in enjoying commercial and social relations with Rome. In this way a secure political federation was built up, and Rome was able to maintain and extend her military supremacy unhampered by troubles at home. During this early period Roman power rested not merely on a material basis but also upon a moral basis, for she had welded together under her leadership a group of unprotected peoples. This federation was able to stand secure against outside attack, to maintain internal law and order, and yet allow a considerable degree of freedom of policy for each of the component units. Cunningham says, "These are exactly the conditions which afford the best opportunity for economic progress."¹

MILITARISM AND AGRICULTURE

Economic conditions, as well as physical surroundings and national traditions, inspired a policy of conquest and exploitation. The armies of Rome, unlike those of Carthage, were composed of citizen soldiers, not mercenaries. The consequent drain of army recruits from agricultural occupations seriously interfered with the cultivation of the soil. The military conquests of Rome brought captives of war for slavery. These slaves were utilized in such numbers to cultivate the land that their competition with the free peasant farmers became demoralizing and disastrous. Wealthy men obtained large landed estates in much the same fashion as they had in Greece. These holdings were cultivated by slave labor, chiefly utilized to produce luxuries for export. Cultivation of food crops was neglected, so that Rome was not self-supporting as regards her food, and resort was made to the im-

¹ *Op. cit.*, p. 154.

portation of grain. In the Italian cities, particularly Rome, we find a congregation of idle men and women, just as we found at Athens. The city populace of Rome was fed with the imported grain, sold at such low prices that the practice was ruinous to the yeoman farmer. He could not maintain himself and produce grain which would sell at less than the market price. Food production in the vicinity of Rome declined, and the city came to depend more and more upon an imported supply. New lands must needs be conquered to supply food by importation, in the absence of an adequate domestic supply. Thus economic conditions, connected with policies of military expansion and exploitation, completed a vicious circle, and Rome became dependent upon conquests for food. Roman colonization was not impelled by ordinary motives of migration; it was rather one of the many governmental expedients for the progress of conquest and subjugation. Roman colonies were outposts which insured the extension of Roman domain by successive advances.²

² *Ibid.*, pp. 155, 156.

CHAPTER V

THE CLASS STRUGGLE

THE Romans were mostly a peasant folk living the frugal, simple life of small farmers on the fertile plains of the Tiber. This hard life inculcated the sterner virtues of bravery, courage, initiative, and practicality. A dignified family life bound the people together with austere religious ties. Although they enjoyed a considerable degree of personal independence, the people were divided into social classes. Those of noble birth, who could trace their family ancestry through many generations, held office as senators, magistrates, or priests. The great masses of the common people (plebeians), however, although personally free, could not hold office. The patricians alone were acquainted with the laws, and the plebeians were constantly at a disadvantage in business and social dealings because of their ignorance of legal rules. But the plebeians obtained a certain degree of legal protection through the relationship of patron and client. A plebeian chose a noble as his patron; then became the client. The patron gave his client legal advice in the conduct of his business; he brought suits for him, and defended him when sued. In return for this protection, the client became dependent upon the patron; it was his duty to follow him to war and support him in public life; he made him presents and labored in his fields.

Even in early times, the distinction between the rich and poor was clearly marked. Common lands were held

by the Roman state and let out to citizens as pastureland in return for a small rental. Territory gained by conquest was let out in a similar way. Since the wealthier nobles became the governing officials, they were inclined to take advantage of their privileges and seize more than their just share of the common lands. By this means the aristocrats gradually centralized the control of wealth in their own hands, and the common people became poorer. Exploitation of the people was carried so far that in time the term "patrician" came to signify aristocracy, or a large landowner, and "plebeian," a small landowner, or landless man. But the plebeians did not submit tamely to this centralization of wealth. Through centuries of struggle they gradually gained rights of participation in determining the policies of the government. Thus internal Roman history is largely a story of class struggle.

In kingly times, the assembly of the people was consulted before war was declared or radical changes in the public policy adopted, but at length a new popular assembly developed. For some years the assembly had been organized in accordance with a military system which divided the people into classes based upon property qualifications. During the early republic, this military grouping of the people was gradually substituted as a voting assembly for the old assembly of *curiæ*. Thus it came about that the more property a man possessed, the greater was his political influence.

DEBT-SLAVERY AND SOCIAL REVOLUTION

The common people did not gain by the overthrow of the monarchy in the later period of kingship, for the kings had usually protected the people from the oppression of the powerful nobles. There was a movement

among the aristocracy to reduce their clients to a condition of slavery. The nobles looked upon unpaid rent as a debt, bearing interest. Peasants who were in arrears became deeply indebted to the nobles. Creditors frequently seized a delinquent debtor and held him as a slave until he had worked off the debt by labor. He might even be sold into real servitude to foreigners. Debtors were sometimes put into private prisons and tortured, that their friends might be influenced to redeem them. These intolerable conditions led the people to revolt. The whole plebeian army deserted the city and marched off to the sacred mount, threatening to found a new city. The governing body or senate, was left helpless without the plebeian army, with no one to make shoes, to make wine jars or to do the carpentry. This "general strike" succeeded in bringing the nobles to terms, and by an agreement drawn up on the sacred mount in 493 B.C., the common people were to have two annual officers of their own, called "tribunes," whose duty it was to protect all poor citizens unjustly treated. It was also provided that the person of the tribune was to be considered sacred, so that any one who injured a tribune or hindered him in his duties might legally be slain. The tribunes were assisted by two other officers, called *ædiles*. Under the protection of the tribunes, the common people continued their old popular assembly, and passed resolutions which were binding only upon themselves.

Jealous of the new rights of the commons, the nobles intrigued to diminish popular power and to impede the common business. Many of their clients, although landless men, had political influence. To destroy the influence of this hostile class, a law was passed through the

senate and military assemblies which provided that the plebeian assembly should vote by tribes; that is, each of the twenty-one tribes was to cast a single vote. This measure excluded landless men from the plebeian assembly, because only landowners were enrolled in the tribes, and the new assembly so formed was called a *comitia tributa*.

THE WRITING OF THE LAWS

During all this period of struggle, the laws had remained unwritten. Oral tradition was handed down from father to son in noble families who used their exclusive knowledge of the law to benefit and oppress the common people, much as the Greek nobles had done. Under these conditions, no plebeian could quote the law as a proof of the injustice he had suffered. To improve the condition of the common people, the tribunes began to urge the codification of the laws. Fortunately this reform was encouraged by one of the nobles, Appius Claudius. Under his influence, the tribunes and the senate agreed to permit a codification of the law. Upon the report of a committee sent to examine the codes of law of Greek states, the assembly of the centuries elected ten men,—*decemviri*,—empowered to write the laws. This important concession was obtained in 452 B.C., when the Roman domain was upwards of four hundred square miles, occupied by a population of not more than 150,000. Plebeians were really eligible to the new board, but the nobles, holding the power in their hands, filled it with patricians. The commission held office for one year, but failed to complete the writing of the laws. A new board was therefore elected for the following year. Upon this board the common people secured representation, for

Claudius and at least three plebeians were members. The new commission inaugurated a liberal policy during their period of governmental control. But, by their efforts to promote manufacturing and commerce, they so angered the ignorant peasants and offended the conservative patricians, that the senate refused to approve the two tables of law engraved during this second year. Nevertheless, Claudius and his colleagues, desiring to secure the ratification of their liberal measures, determined to remain in office. Thereupon their enemies and certain popular demagogues accused them of acting as tyrants, and of attempting to maintain themselves in power for life. Influenced by these demagogues, the plebeians again called a "general strike," and seceded to the sacred mount. This action gave the senate an excuse to make short work of the board of decemvirs. Some of them were thrown into prison, others were exiled from the state. The laws were finally ratified in 449 B.C. They equalized the private rights of all, and, among other things, sought to curb usury by the provision that no man should take more interest for money than one per cent. a month. If he broke the law, he was to be fined four times the sum.

The same consuls that secured the ratification of the twelve tables of the law were favorably inclined toward the lower classes, and succeeded in passing additional legislation in their favor. Prior to 449 B.C., the resolutions of the assembly of the tribes were binding only on plebeians. The consent of the senate was finally secured, so that the resolutions of the assembly of tribes were thereafter binding upon the whole people. This was a great gain for the common people, because it enabled them to share in guiding the policies of the nation.

About this time the tribunes obtained the power of veto over acts which were passed by the senate. Should the senate or magistrates ignore the veto of the tribunes, these representatives of the common people were free to obstruct the administration and enforcement of the new measure. Thus for more than a century, the class struggle persisted until, by 287 B.C., the plebeians acquired undisputed right to veto all measures of magistrates, senate, and assemblies.

For centuries intermarriage between the social classes was prohibited, but in 445 B.C., plebeians were allowed to enter into legal marriage relations with patricians. This new concession gave greater power to the wealthy and influential plebeians. Some years later (444-367 B.C.), as a consequence of the removal of this marriage restriction, the patricians admitted plebeians to hold office. In place of the consuls, two military tribunes or consular tribunes were elected for the year, and both patricians and plebeians were eligible for this office. The new law did not, however, give the plebeians the power which they sought, because the plebeians' candidates were usually defeated for office. Moreover, the shrewd noble families, who had been in power for generations, knew how to maintain themselves against strong democratic opposition by indirection and intrigue. When the danger point of any democratic wave was reached, they were always ready to divert the public mind by new and striking military successes, and constantly depended upon the power of patronage to undermine genuine popular reform.¹

¹ Ferrero, G.—*Greatness and Decline of Rome*, vol. i. *The Empire Builders*, New York, 1909, Zimmern's transl., p. 13.

PUBLIC LAND AND AGRARIAN REFORMS

The public land which Rome acquired in the course of her conquests was disposed of in various ways. Some of it was immediately granted to settlers, a second portion was leased, a third portion sold, but by far the larger part remained unsurveyed. It was customary to allow all who wished to occupy this last part of the land simply on condition that they pay to the government a tenth of the grain and a fifth of the fruit produced thereon each year. In case flocks and herds of domestic animals were pastured on these lands, the state required a share of the animals, both oxen and sheep. But the debt-oppressed plebeians were dissatisfied with this last method of disposition, since patricians and wealthy plebeians were the only ones who really occupied sections of the unsurveyed land. After occupation, these classes were accustomed to buy, sell, and bequeath the land, so that they came to regard it as their own property. More than this, a rich landowner would sometimes eject the poor peasants who were his neighbors from their small adjoining farms, and annex their lands to his estate.

To put an end to this injustice and make the poor less dissatisfied with their condition, the tribune Licinius proposed an agrarian reform bill. This bill eventually became a law in 367 B.C. The provisions of this law, which dealt more immediately with the welfare of the people and the agricultural problem, are as follows: (1) No more consular tribunes were to be elected, but one of the two consuls must ever afterwards be a plebeian; (2) All the interest that had already been paid on debts was to be deducted from the principal amount still owed, the balance of the debt to be paid in three, equal, annual in-

stalments; (3) No person must occupy more than five hundred jugera of public land (a jugerum was about two thirds the size of our acre); (4) Upon the public land, no one person should pasture more than one hundred cattle, or five hundred sheep.

As patricians had enjoyed uncontested power for so many generations, they were much averse to the first clause of this law. Consequently the Senate would not permit the first provision of the law to go into effect until the people had consented to the creation of three new patrician magistrates, a praetor, whose duty was to act as judge in civil cases, and two curule aediles to act as supervisors of streets, public buildings and public games. From this time on, the leaders of the plebs made continuous advances in their struggle to obtain office. The effect of these gains was the growth of two new political parties; the nobles and their descendants, who were office-holders; and all other citizens, who were commons. These were to take the place of the old classes, the patricians and the plebeians. Unfortunately, that clause of the Licinian law which dealt with debt proved to be but a superficial remedy for the popular distress which existed, since it was merely alleviative and did not remove the causes of poverty.

EXPLOITATION OF THE PROVINCES

Rome's early policies of expansion were not followed in the latter days of the republic, nor during the period of the empire. In the early days, it will be remembered, Rome showed the utmost consideration for the communities which she had conquered, but as she expanded over the peninsula of Italy and became a world power, the new domains did not enjoy the same privileges and im-

munities which members of the old Latin league had possessed.

The new lands known as Roman provinces enjoyed peace, but Rome always favored her own citizens at the expense of the local inhabitants. Greedy money-lenders, speculators, and traders, poured from the capital over into the provincial districts, and unjustly acquired much of the property in the subject countries. Their Roman citizenship protected them in the use of harsh methods, and they speedily reduced the people to destitution and poverty. These Roman capitalists acquired large tracts of land which were built up into vast estates cultivated by slaves. The *publicani* undertook to carry out the great government contracts for Roman roads. Money for new enterprises was borrowed from associations of money-lenders in Rome. The share-holders in these associations lived at the Imperial City. They were remote from the provinces, unfamiliar with the work and industry of these regions, and cared chiefly for the size of their dividends. They knew nothing about, or were careless of, the great abuses that existed in the mines and public works in which their money was invested.

THE GROWTH OF PLUTOCRACY

The system of taxation was most unjust because taxes were farmed out. At an auction, the privilege of collecting taxes was sold to the highest bidder. To reimburse himself and meet his contract with the government, the tax collector compelled the inhabitants of the provinces to pay many times their due. The evil of unjust taxation was, no doubt, partly due to the short term of office which the officials enjoyed. The rapid change of office without pay made it necessary for the governor of a

province to make as much money as he could while in office. It is said that he expected to make three fortunes; the first, to pay the debts which he had contracted by bribing his way to power; the second, to defend himself in case of legal prosecution on his return to Rome; and the third, to enable him to live in luxury for the remainder of his days. The courts which tried cases of extortion committed in the provinces were so corrupt that little reform could be accomplished. In fact, it may be said that thieves and plunderers sat in judgment over their fellows. In accordance with this vicious system, time brought simply an exchange of places, the judges becoming actual thieves and plunderers again, while the former culprits were elevated to the seat of justice. The provinces really had no protection from this sort of injustice. Large areas fell out of cultivation because of the rapacity of tax collectors, and even towns fell into premature decay. But exploitation and waste were not confined to the provinces. Italy also experienced a decline. The Italian communities which had aided Hannibal after the battle of Cannæ were reconquered, and their citizens reduced to slavery. From a condition of aliens, they were degraded to that of state serfs, and large tracts of their land were confiscated by Rome.

After the Second Punic War (201 B.C.), the character and ability of the noble classes declined. They kept the higher offices of the state for themselves and passed them around in rotation to members of their privileged circle, forming a sort of hereditary caste. It was customary for a young noble to enrich himself as a provincial quæstor after serving as an officer in the army. As an official, he must entertain the populace with expensive religious festivals and shows to gain their favor and se-

cure their votes for still higher offices. It was hardly necessary, under such a system as this, to resort to open bribery. At length he was advanced to the prætorship, and afterwards to the consulship. As the governor of a province, he obtained much spoil, and the autocratic powers which he possessed made him brutal and haughty. He might even be elected to the censorship if his popularity was sufficiently established among the people. These nobles were more than aristocrats; they were great capitalists who sought to hold the wealth of the world. Thus Rome was governed by a selfish plutocracy which sought to gain governmental power in order to secure more wealth.

The important body of governmental control still remained the senate, but the senate had increased its power at the expense of magistrates and popular assemblies. The members of the senate were men of considerable influence and experience; they had held high offices at home, served as commanders of the Roman armies, represented Rome as ambassadors to foreign states, and had held other important offices. Since they usually held their positions for life, they looked forward to a continuation of their power. In accordance with the constitution, all Roman citizens might rightfully attend the assemblies. Yet distance from Rome prevented many persons from attending, and these assemblies were composed chiefly of those who lived in or near the city. Although a member of the assembly could vote for or against any candidates or measures proposed by the presiding officer, new measures were initiated only by the magistrates. This state of affairs made it a simple matter for these officials to gain control of the assemblies, and the masses of the people really had very little power over legislation.

DEMORALIZATION OF THE YEOMAN FARMERS

The rural middle class suffered severe deprivations at the hands of this greedy plutocracy. After the Second Punic War, an increasing number of slaves were brought into the market and sold to capitalists, who used them to cultivate lands and tend the herds on their estates. Thus the slaves gradually took the place of freemen upon many of the old family estates, and in large country districts the free rural population became practically extinct. The small holdings of the free peasantry were thrown together into large domains (*Latifundia*) which were managed by bailiffs and worked by slaves who were often chained together in gangs. Thus, at the basis of Roman society there was a great servile population,—inefficient, wasteful, sullen, and degraded. Appian says of this condition: “The nobles became enormously rich and, while the race of slaves multiplied throughout the country, the Italians dwindled in numbers and in strength, oppressed by penury, taxes, and military service.”² The few free peasants who continued to carry on the unequal struggle in the country were subjected to the degrading example of low-grade work and low standards of living among the slaves with whom they had to compete. The demoralizing influences of slavery were not alone confined to the country; they were found also in the city. At Rome, corporations of wealthy nobles carried on industrial work based mainly upon the labor of slaves and the business ability of freemen. Slavery was a massive, brutal, industrial force. Since slaves were cheap and performed the simpler mechanical tasks, there was no economic motive for making the slave live

² *Civil Wars*, 1, 7.

long. As a rule, therefore, the master treated his slaves with great cruelty; for small offenses, they were whipped, tortured, or even crucified.

The middle class was subjected to other demoralizing influences besides slavery. We have already mentioned the unjust taxation of the provinces, which resulted in systematic exploitation of free labor. But another activity of the government was also effective in ruining the yeomen. This consisted in the artificial price regulation of grain, in order that there might be a large supply of cheap food for the idle citizens of Rome.

CHAPTER VI

AGRARIAN CONDITIONS AND THE PROBLEM OF THE CITY

THE population of Rome was largely made up of an idle and menacing element. Old soldiers returned from the wars, finding their lands confiscated by the nobles, or having lost the inclination for honest toil, became dependent for their support upon public and private charity. The ruin of agriculture throughout Italy had driven thousands of poor peasants into the city where they could find little work. Small farmers had been ejected forcibly from their lands, or had become so indebted that they gave up the unequal struggle with cheap slave labor and migrated to Rome. The urban proletariat crowded into cheaply-built, wooden lodging-houses, and were obliged to pay high rentals for even a single room. These tenements, sometimes from sixty to seventy feet high, were managed and sublet by freemen, or lessees, to laborers and small tradesmen.¹ The slums of Rome had narrow and crooked streets. Many of the tenements had tottering walls, and there was the constant danger of falling houses. Sanitation and drainage were very poor. Many of the dependents became clients of rich families, habitually looked to the beneficence of these nobles for their living, or turned from honest livelihood to begging or robbery. But it should be remembered that these people were citizens, and hence had the

¹ Ferrero, *op. cit.*, pp. 27-28.

right to vote in the great public assemblies held at Rome. By virtue of this right, they constituted a political factor. Crowds of beggar clients attended a noble and voted for him in return for the loaves of bread and food which he gave them. The expensive popular amusements which the nobles provided added to their following among the city rabble. This demoralized populace took wild delight in gladiatorial shows at which there was much rending of flesh and spilling of blood. The population was also swollen by many aliens who flocked to Rome in search of adventure, or in expectation of being supported. Thus the masses in Rome became a rabble—excitable, emotional, or sullen as the mood took them—and, while constituting an ignorant and dangerous mob which menaced the peace of the state, nevertheless, because of their votes, formed a more or less powerful political factor.

AGRARIAN REFORM OF TIBERIUS GRACCHUS

At length the condition of the masses became such a menace to the welfare of Rome that certain changes became inevitable. Reform could not well come from the senate, for, as the historian Greenidge remarks: "Social conservatism was entrenched behind a political rampart. . . ." ² At this crisis in the life of the nation, a young man of plebeian ancestry though of noble family, Tiberius Gracchus, came into political prominence. It so happened that his official duties had taken him over a portion of rural Italy in which the magnitude of exploitation wrought by unscrupulous capitalists was most evident. Tiberius was deeply moved by what he saw, and his desire to reform the evil state of affairs was

² Greenidge, A. H. J.—*History of Rome*, B. C. 133–104, London, 1905, vol. i, p. 105.

further stimulated by plaintive scraps of anonymous writing appearing on the smooth surfaces of monuments, walls, and porches,—entreaties for aid to force the public land to be given to the poor. In a public harangue, he thus described the condition of the people: “The beasts that prowl about Italy have holes and lurking-places where they may make their beds. You who fight and die for Italy enjoy but the blessings of air and light. These alone are your heritage. Homeless, unsettled, you wander to and fro with your wives and children. Our generals are in the habit of inspiring their soldiers to combat by exhorting them to repel the enemy in defense of their tombs and ancestral shrines. The appeal is idle and false. You cannot point to a paternal altar; you have no ancestral tomb. No! You fight and die to give wealth and luxury to others. You are called the masters of the world; yet there is no clod of earth you can call your own.”³ Surely a dismal picture of the change wrought in Roman society since the early period when Roman citizens had been landowning and thrifty farmers!

As tribune in the year 133 B.C., Tiberius proposed to enforce a land bill similar to the agrarian law of Licinius, which had never been seriously obeyed.⁴ The object of this new bill was to reclaim the public land from its present private occupiers and distribute it among needy citizens, so that, by one bold move, the problem of poverty would be solved, and at the same time the agrarian situation would be reformed by bringing the land under cultivation by citizens on small holdings.

All this was to be accomplished by the several provisions of the measure. In the first place, those portions of

³ Plut., *Tib. Gra.*, 9.

⁴ App., *Bell. Civ.* i, 9; Plut., *Tib. Gra.* 8.

the Licinian law which stated that no person should use more than five hundred acres of public land, or pasture more than one hundred cattle or five hundred sheep on public land, were reaffirmed. He next introduced a provision, taken from a law passed after the time of Licinius, which required that a certain portion of the laborers on any farm should be freemen. Sons of the present occupiers of the land might each hold two hundred and fifty acres of land up to a maximum of five hundred acres among all the sons of a given family. Any land not thus disposed of was to be divided among the poor in lots of about thirty acres. These latter allotments were to be heritable and granted upon perfectly secure tenure, but they were to be inalienable, and the settlers were to pay a small rental to the state for their use. Tiberius hoped to make this law effective by the provision that a commission of three, chosen annually by the people in their tribal assembly, should make the division. In these respects the bill appears to put in legislative form some of the principles Aristotle urged as fundamental guides for the remedy of poverty. Considering the bill in the light of the existing conditions, it appears to have been a bold effort to strike at the economic causes of poverty and social degeneration. It was to furnish the poor with an opportunity to earn an honest livelihood and allow them to become self-respecting and responsible citizens. The land-hunger of the capitalist was to be checked by the inalienability clause. Moreover, the army was also strengthened by the bill, for the number of citizens qualified to serve as soldiers was increased.

Such a socialistic scheme as this land redistribution plan could not have been made a law without stiff opposition from the landed interests, in spite of the provision

it contained to pay monetary compensation for the land surrendered.⁵ It must have appeared like confiscation to many who had lost the memory that their holdings had once been public land. Ancestral homes and tombs were scattered over different parts of a large owner's domain and in the redistribution, his sacred possessions would, like as not, go to strangers. The *peculia* of sons and dowries of daughters were often in land, and all these property relations would be destroyed. Capital invested in improvements by thrifty persons might go to unknown settlers. Tenure had seemed so stable a thing that it had been accepted as security for debt. Thus a variety of interests united to oppose the redivision scheme. The wealthy landlord classes had never before experienced such a danger to their accustomed habits of buying, selling, and bequeathing the land that really belonged to the Roman people.

Ferrero points out that at the time Tiberius's bill was brought forward, Italian cultivators were just beginning to adopt more efficient methods, and the land laws threatened to throw this transition stage into still greater disorder.⁶

On the other hand, the bill was supported by the peasant and small landholding classes; by clients, freemen, artisans, and a few social-minded conservatives.⁷

The opposition chose the tribune Marcus Octavius, a large landholder on the public domain, although a personal friend of Gracchus and a man of great dignity of character, to oppose the land bill. A series of spirited debates on the merits of the plan were held in the presence of the people. Yet the eloquence of Tiberius failed

⁵ Plut., *Tib. Gra.*, 9.

⁷ *Ibid.*

⁶ *Op. cit.*, vol. i, p. 55.

to prevail against the decision of Octavius, which led him to veto the bill at the close of the debates. In desperation, Gracchus tried to force the issue by an edict which practically tied up all official activity until the voting on the agrarian law should pass the measure. At this juncture, an appeal taken to the senate resulted in overwhelming criticism of the bill, and Tiberius, with mind set upon enacting his plan into law, resorted to the extreme measure of suggesting the deposition of Octavius from the tribunate. After dramatic scenes between the two representatives of the people, Octavius was removed from office and the bill became law.

In accordance with Roman law, the assembly of the people, which had just deposed a tribune during his year of office, was supreme; actually, they enjoyed little power. In the light of past practice, the aristocratic governing body of Rome,—the senate,—declared the act unconstitutional. Shortly after the bill became a law, the popular election to the land commission which was to administer it of Tiberius Gracchus, his father-in-law Appius Claudius, and his younger brother Gaius Gracchus, gave the opposition new cause for criticism, and they openly accused Tiberius of aspiring to a tyranny. As a matter of fact, the commission was really in the hands of a family clique, but as Greenidge remarks, “it was perhaps natural for the people to put faith in the family of a champion.”⁸

The senate showed its resentment by refusing to appropriate sufficient money to enforce the new law. Tiberius was thus faced with the problem of trying to benefit the poor by furnishing them land without the means of sowing, or cultivating it, or of utilizing it for pasturage. At this juncture, it so happened that the Roman people

⁸ *Ibid.*, p. 127.

became unexpected heirs to the estate of Attalus the Third, king of Pergamon. Thereupon Tiberius announced his intention to take the money left by the king, and use it to establish upon their lands the poor settlers provided for in his agrarian law.⁹ As this was a proposal which would, in its practise, usurp the financial rights of the senate, Gracchus was from this time on even more bitterly attacked by representatives of the landlord and aristocratic classes. But he sought to make good use of the short time that remained before the next election, by increasing his constituency among the urban classes. Meanwhile the opposition waxed stronger and more daring. At length election day came and, fortunately for the landed interests, it occurred at harvest time when the majority of Gracchus's rural supporters were absent. A riot was started by the hostile senators, and Tiberius Gracchus and three hundred of his followers were slain. This was the first time in the class struggle that a Roman mob had shed blood in civic discord. But the leaders of this revolution were senators, men who had grown accustomed to policies of treachery and oppression in the provinces. It was natural for them to take one step more and resort to violence, in order to crush a political foe at home. But the use of force was a dangerous precedent for the senate to establish, as these treacherous acts provoked a social revolution which was to last one hundred years.

With the death of Tiberius Gracchus, the keenness of the political opposition to his reforms vanished. The people were allowed, year after year, to perpetuate a land commission favorable to their interests. The officials carried on their work with energy. Between 131 and 125

⁹ Liv., *Ep.* lviii.

B.C., the register showed an increase of upwards of 75,000,¹⁰ a considerable proportion of whom must have been among the small landholding class, and attributable to the successful working of the new agrarian schemes.¹¹ Yet the land commission met with many difficulties. Old titles had been lost, and the right of state ownership was often difficult to prove because no historical record survived to show where the assignment had ended and the permission of occupation begun. In the effort to secure good farm land for the needy settlers, it was inevitable that some injustice should be done, and original occupiers occasionally found themselves in receipt of swamp or barren land in exchange for their former well-kept tracts.

The Latins and their allies, together with other interests that had suffered under the commission's policies of land distribution, appealed to Scipio Æmilianus for aid. Scipio was a stern soldier, one of the few surviving examples of all that was dignified and fine in ancient Roman character. He looked with disfavor upon the political activity of his late kinsman, Tiberius Gracchus, as evidence of lack of reverence for the Roman constitution. He suggested that when public and private ownership of land was in dispute, decision should be entrusted to the consuls. This idea was embodied in a new law, and the commissioners were thus shorn of their power, the land law becoming a dead letter. Immediately the feeling spread among the masses of claimants under the old land law that they had been betrayed. Scipio was charged with ingratitude and bitterly attacked in public harangues. One morning he was found dead in bed, with no marks of violence on his person. Thus ended the

¹⁰ Greenidge, *op. cit.*, pp. 145-150.

¹¹ Mommsen, *The History of Rome*, bk. iv, ch. iii.

career of an illustrious Roman, representative of all that remained good and noble in the aristocracy of the metropolis, but an unyielding conservative in social reform.

SOCIAL LEGISLATION OF GAIUS GRACCHUS

For nine years the Roman people had waited in expectation of social reform. The remedies projected by the great popular leader Tiberius Gracchus had either been nullified by the intrigues of the vested interests, or had proven inadequate to meet the complex situation. The masses needed a new champion for their cause. When things looked darkest, the younger brother of Tiberius, Gaius Gracchus, assumed the rôle of leader. Gaius had all the sincerity of purpose possessed by his brother, but combined with it greater natural gifts. He seems to have possessed extraordinary emotional and intellectual equipment for the task of social reform. He had a wide knowledge of humanity, great intellectual acumen, and convincing powers of oratory. His experience as one of the land commissioners under his brother's land law had given him practical appreciation of the interests involved and the difficulties to be met in social reform. In official service in the provinces, he had won distinction in the field and a reputation for justice in his dealings with subject peoples.

When the tribunican election of the year 123 B.C. drew near, the city swarmed with rural folk anxious to support Gaius Gracchus. In spite of the organized opposition of the conservatives, already quite aware of the young leader's rare ability and fearful of his power over the people, Gaius was elected tribune. The younger Gracchus realized the difficulties that his brother had met in his effort to reëndow 400,000 citizens of the metropolis

with a new spirit by the simple device of an agrarian reform. On the one hand, he saw a powerful and utterly unscrupulous faction in the great public landlords; on the other, a mass of citizens with entire inability to sacrifice present comforts, even temporarily, in exchange for material future gain. As Ferrero says: "The nation was by this time simply a small and exclusive oligarchy of landlords and traders, bankers and concession-hunters, artisans, adventurers, and loafers; the metropolis was peopled with a noisy, unprincipled, and self-opinionated mob, thirsting for pleasure and excitement, for easy profits and quick returns."¹² An intelligent and far-sighted reformer has, in all probability, rarely been furnished such poor working material.

THE CORN LAW OF GAIUS GRACCHUS

Gracchus soon set himself to the difficult task of creating a solid constituency out of this most heterogeneous of peoples. He had observed that his brother, while supported by the rural element, had lacked a sufficiently powerful following among the city populace. The clientele of the rich had been built up by an extravagant largess which was entirely indiscriminating in its practice. The dependence of the metropolitan proletariat upon this sort of support was utterly demoralizing. For the benefit of the rabble, the rich provided gladiatorial shows and the state provided gorgeous triumphs. Gaius conceived the idea that a reliable urban constituency, to support his efforts at social reform, could be created in this well-known way. He may not have recognized the danger of the method, or he may have considered that the end would justify the means; at any rate, there were

¹² *Op. cit.*, p. 57.

ancient precedents and apparently reasonable grounds for the plan. The Greek ideal of a class of leisured citizens supported by state payments had been put into practice, and must have been known to Gaius. For a long time the Roman government had been reaping large returns from its provinces, returns in which the proletariat had not shared. Moreover, something had already been done for the small land-owning class in which the urban population had not shared to any great extent.

Gracchus, therefore, proposed to sell corn to Roman citizens every month at half price, that is, $6\frac{1}{3}$ *asses* the *modius*.¹³ Greenidge remarks that since such important details as what proportion the monthly quantity of grain, sold at this cheap rate, bore to the total amount required for the support of a family, whether the grain was restricted to the head of each house, or granted to adult sons, whether registered citizens alone, or casual applicants received the aid, are unknown, it is futile to draw final critical conclusions.¹⁴ It is possible that a small and continuous loss on corn would be less of a drain on the treasury than the usual spasmodic attempts to put low-priced grain upon the market in times of crisis. Moreover, it is conceivable that steady purchasing on the part of the state might induce competition that would somewhat reduce the normal market price.¹⁵ From the modern point of view, the scheme may be unhesitatingly assailed because of its indiscriminate character. There was apparently no effort to inquire into the means or worthiness of recipients. This fundamental defect was, in the future, to transmute this law into the greatest, single,

¹³ Plu., *Gai. Gra.*, 5; also Appian, *B. C.*, i, 21.

¹⁴ *Op. cit.*, p. 206.

¹⁵ *Ibid.*

pauperizing influence in Roman history, for it degenerated into gratuitous distribution of corn, food, and clothing, and exhausted the state treasury. If he was unaware of the demoralizing effect of his plan, Gaius undoubtedly thought that the wholesale purchase of grain would be profitable to the landed interests, and the building of huge granaries at Rome would furnish work for contractors and laborers.¹⁶

Another reform which sought to benefit the citizen body as a whole, was a revival of Tiberius's land commission. Gaius's practical experience in the administration of the original law led him to make his new law a comprehensive statute which covered the field in considerable detail. It dealt with things as they existed rather than with new principles. There seems to be no way of estimating the effectiveness of this new law.¹⁷

To extend his constituency among the more influential classes, Gracchus proposed bills which would reduce the legal monopoly of the senators and put legal power within reach of the capitalist class. Since the legal rights of the aristocratic element had long been a thorn in the side of the newly rich, this plan was calculated to foment strife between the two factions which had formerly united to crush his brother. Another bait to the capitalists was thrown out in the form of a proposal to let out to metropolitan financiers, rather than to the provincials, the taxing of the Kingdom of Pergamus.¹⁸ Two army measures, one to furnish free clothing to soldiers, the other setting a lower limit of seventeen years as the age of enlistment, were to accomplish a much needed reform and

¹⁶ App., *B. C.*, i, 23.

¹⁷ Greenidge, *op. cit.*, p. 209.

¹⁸ Ferrero, *op. cit.*, pp. 58-59.

lay the basis for a more satisfied soldiery. All these proposals became law.

CONSTRUCTIVE MEASURES

Turning now from the legislative enactments which enabled Gaius to build up a more powerful constituency than his brother's to his constructive reforms, we find that colonization schemes occupy the foremost place. By this time the food supply of Rome had become a grave problem. The new corn law had helped attract to the city artisans, traders, adventurers, and loafers. The problem of overpopulation could best be met by colonization. Gracchus also conceived of colonization as a remedy for industrial decline. According to Greenidge, "He did not view agrarian assignation as an alternative to colonization, but recognized that the industrial spirit might be awakened by new settlements on sites favorable to commerce, just as agricultural interest had been aroused by the planting of settlers on the desolated lands."¹⁹ Gaius was the first reformer to suggest that colonization was the proper means of rehabilitating the better type of urban proletariat.²⁰ Considerable discrimination seems to have been exercised in the selection of his colonists, for the character of each applicant was investigated.²¹ Two settlements were actually established during his second tribunate, while in his first tribunate a settlement of Carthage was proposed by his colleague, Rubrius. There were to be 6000 colonists divided into a superior and inferior class, the former to receive 200 *jugera* apiece,²² with all allotments in absolute ownership. Gracchus and

¹⁹ *Op. cit.*, p. 224.

²⁰ *Ibid.*

²¹ Plut., *Gai. Gra.*, 9.

²² Mommsen, in *C. I. L.*, i, pp. 75 *et seq.*

one of his friends were named among the triumvirs to establish this colony.

This scheme of settlement rounded out the young reformer's provision for his various protégés; it cared for the more enterprising and worthy of the urban proletariat as the corn law had provided for the city dregs and the agrarian commission had helped the sturdy farmer folk. But there were insurmountable obstacles to the success of the colonization scheme. The people who were asked to support the measure, and the beneficiaries of it, had their life interests centered in the metropolis where the continual largess of the nobles and lately the corn law of Gracchus had combined to make them averse to the initial hardships of a new settlement.

To complete the revival of commercial and industrial life in Italy, Gaius outlined and carried through a great road-building enterprise. Rapid and easy communication between towns and the capital, and between hamlets and towns, was secured by a series of cross-roads between the great military thoroughfares.²³ The measure also must have helped political centralization, since the representative character of the comitia would be increased by these improved facilities for reaching Rome. The expense was probably met in part by dues taken in at toll-gates. Repairs may have been provided for by requirements made upon the time of settlers on the land allotments.

The extraordinary application of Gracchus to the execution of these varied schemes made him the busiest and most conspicuous man in Rome. Plutarch says: "The people looked with amazement at the man himself, seeing him attended by crowds of building contractors, auditors,

²³ Plut., *Gai. Gra.*, 6; App., *Bell. Civ.*, i, 23.

ambassadors, magistrates, soldiers, and learned men, to all of whom he was easy of access. While he maintained his dignity, he was affable to all, and adapted his behavior to every individual."²⁴ Gracchus had thus become a great benevolent "boss." But his very importance and consuming activity was interpreted by his enemies as evidence of a desire for greater personal power.

This power and popularity gave Gaius confidence in his own ability to carry through to successful solution a problem which had been the doom of other Roman statesmen. He proposed to grant full rights of citizenship to the Latins, and Latin rights to the other Italian allies. In support of his measure, Gaius appealed to the better nature of his followers. Yet this revolutionary plan furnished his opponents with the very opening they had waited for, and impetus was given to the forces of dissension among his heterogeneous following—forces only held in check by the political versatility of the great leader. It was suggested to the populace that enfranchisement of the Italians would crowd the urban proletariat out of the almost monopolistic position they so long had held in the enjoyment of public gatherings, games, and festivals. This cunning appeal to the selfish interests of the mob succeeded in alienating many of Gracchus's followers. The tribune Drusus threatened to impose his veto on the franchise bill, and this combination of circumstances effectively put an end to Gaius's plan. At this juncture, the opponents of social reform made use of the moderate statesman Drusus to advance a counter-colonization scheme calculated to supplant the far-sighted plan of Gracchus. From the point of view of popular support, Gaius's colonization plan was weak because it appealed

²⁴ *Gai. Gra.*, 6.

to the interests of the middle class alone; moreover, scrutiny into the personal qualifications of prospective settlers was uncomfortable. The proposal of the opposition was the foundation of twelve colonies of 3000 settlers each, where emigrants were not to be excluded because of poverty, and where no rental was required. The provisions of the new plan seemed generous, and the support it drew from Gracchus's followers was enlarged and strengthened by the senate's action to relieve all settlers on the Gracchian allotments of rent payments to the state.²⁵ Another competitive plan advanced by Drusus, with the support of the senate, was a law for the protection of the Latins. This was calculated to remove the abuses that Gaius's franchise law had proposed to overcome, but avoided the gift of franchise. These adroit policies of legal enactment effectively broke up the solidity of Gracchus's constituency.

When Gaius returned from a visit to his Carthaginian colony, during which he had personally superintended the enterprise, he found the people apathetic and cold. All his old-time eloquence failed to rouse them from their indifference—a state of mind attributable to satiety produced by the recent bounty of the senate. His last chance for a revival of power seemed to be in the creation of a solid party among the very poor. His success, however, appears to have been slight, for at the next tribunican election he was not returned to office. Thereupon his enemies sought to complete his downfall from popular power by a proposal to repeal his law for the colonization of Carthage.²⁶ After this event, matters moved rap-

²⁵ Greenidge, *op. cit.*, pp. 241-2.

²⁶ For an account of the reactionary legislation which followed the death of Gaius Gracchus, see Ferrero, *op. cit.*, pp. 68-70.

idly. The rash activity of Gracchus's followers gave the senate the opportunity it had waited for, and a riot was precipitated in which Gaius Gracchus and many of his followers were slain.

The tragic deaths of the Gracchi elevated their memories among the people to almost godlike proportions, perhaps more than did their achievements during life. "The people, though humbled and depressed for a time, soon showed how deeply they felt the loss of the Gracchi. For they had statues of the two brothers made and set up in public places, and the spots on which they fell were declared sacred ground, to which the people brought all the first fruits of the seasons, and offered sacrifices there and worshiped just as at the temples of the gods."²⁷

THE GRACCHIAN REFORMS IN PERSPECTIVE

The Gracchi lived and labored at a period in the history of Rome when social and political questions were interwoven with unusual closeness. For example, the land question had its economic, social, and political aspects. The rejuvenation of the masses could be promoted by a return to the land. Such a redistribution of population might be expected to relieve the problem of poverty of the city, stimulate agricultural industry, and at the same time build up a sturdy yeoman class whose political significance might be considerable. But the farmer is not always capable of exercising his political function of voting, for he is often far distant from the capital and seed-time and harvest duties are imperative. These last duties so signally interfered with Tiberius's political support among the country voters that his promising career came to a disastrous end, while Gaius concluded that an

²⁷ Plut., *Gai. Gra.*, 18.

urban following was the best security of a Roman reformer.

Two conditions appear to have been fatal to the small land-holder: the cheapness of slave labor, and cheap corn from the provinces. Modern economists might conceive of two remedies for these conditions: a tax on agricultural slaves, and an import duty on grain. But at the time of the Gracchi, it is doubtful whether the slave market was ever sufficiently well organized to permit discriminative taxation. The other device could not have been enforced, because it was necessary to have low-priced grain for the city populace. Already, foreign grain undersold the Italian product,²⁸ and the consequent unprofitableness of corn-growing aided the tendency toward land accumulation.

But economic conditions, however modified by social legislation, were not alone responsible for social decay. What was needed was a new spirit among the working classes. The attractions of the great metropolis exercised a constant lure, drawing population from the soil and then demoralizing it with luxuries and feverish atmosphere. The stern national psychology that feared neither hard work nor privation, a state of mind which is the product of simple dependence on nature and a continual struggle to gain the ascendancy over her rougher forces, had disappeared. Changed economic conditions and social relations, although causal factors in this transformation, could not be restored to their earlier arrangement by a spasmodic outburst of social legislation. Even had this been possible, the normal evolution of popular psychology, that secures as its end the adaptation of a people's mind to the basic factors in their national econ-

²⁸ Greenidge, *op. cit.*, p. 268.

omy, is so slow and leisurely that generations would have had to pass before the old spirit could be restored. Thus a survey of the legislative successes and failures of the Gracchi viewed in the light of social evolution only helps to deepen the conviction that preventive legislation which seeks to direct the channels of national character is preferable to remedial measures which are necessarily superficial.

The colonization scheme, probably intended to rehabilitate the commercial and industrial classes, penetrated to the very core of the social problem, for the displaced yeoman farmers did not transfer their energies to commerce and industry, but drifted into the idle habits of the metropolitan rabble. If interest in commerce and industry could have been revived by the establishment of new centers of activity, then the national ruin threatened by such a sinister combination of circumstances as agrarian depression and commercial and industrial decline might have been averted. But it was not to be, for such reforms needed the political support of the capitalistic class, whose monopolistic self-interests were directly opposed to any effort which might revive the fortunes of their competitors, the traders of moderate means.

The historical importance of the social program of Gaius Gracchus is emphasized by Greenidge when he says: "The items of reform, as embodied in his legislation, became the constant factors in every democratic program which was to be issued in the future. In these we see the demand for land, for colonial assignments, for transmarine settlements, for a renewal or extension of the corn law, perpetually recurring."²⁹

²⁹ *Op. cit.*, p. 277.

PUBLIC RELIEF IN ROME

Let us confine our study to a brief outline of later developments that followed in the wake of Gaius's *lex frumentaria*. However uncertain our knowledge of provisions for discriminate administration of this law, there is certainly no doubt of the essentially lax execution of later modifications of the law. The *lex frumentaria* was followed by the *lex Octavia*, which restricted the monthly sale to citizens settled in Rome to five *modii* (1¼ bushels). This allowance appears practically to have been a maintenance, since Polybius informs us that the support of the slave and soldier, respectively, was five and four *modii* a month. In 58 B.C. the *lex Clodia* made corn free to the *plebs urbana*. By 5 B.C. this policy of state-promoted pauperization had reached such proportions that 320,000 persons were in receipt of corn. Cæsar reduced the number to 150,000, but by Augustus's time a maximum of perhaps 320,000 had again been reached. The lists of recipients in Cæsar's time were probably settled by lot,³⁰ and the enormous figure given was, likely as not, considerably reduced by a property test and some kind of scrutiny.³¹ The distribution of grain was systematized by publishing the names of certified recipients, and by providing identification tickets. During the republic, corn or bread was distributed at the temple of Ceres, and later the practice was continued at certain steps in each of the fourteen wards of Rome. By the middle of the second century, wheaten loaves were baked for the people in state bakeries, and given out several times a week. "In Aurelian's time (A.D. 270) the flour was of the best, and the weight of the loaf (one *uncia*) was doubled. To

³⁰ Suet. *Cæs.*, 41.

³¹ Lock, *op. cit.*, p. 95.

the gifts of bread were added pork, oil, and possibly wine, clothes, also white tunics with long sleeves, were distributed. In the period after Constantine (d. 337, of Theod. *Code*, xiv, 15) three classes received bread; the palace people (*palatini*), soldiers (*militares*), and the populace (*populares*)."³²

These commodities were distributed at the proper steps of each class of recipients in the several wards. Stale loaves might be exchanged in accordance with regular provisions. Severe penalties against misappropriation were provided, designed to limit the application of the law to the needy proletariat, and aiming to discourage dependence on the part of richer classes. Only citizens could receive this relief, and the right became hereditary. At the time of the founding of Constantinople, right to relief was attached to new houses, that building operations might be encouraged. Thus attached to property, the right to relief was acquired by the purchaser (*aedes sequantur annonae*). The consequence of this indiscriminate civic bounty was the creation of a body of poor citizens who were accustomed to throw themselves flat on public charity. This dole-giving practice spread from Rome, and was introduced into Constantinople, Alexandria, and Antioch with demoralizing results.³³

The baleful results of dole-giving may be traced through the period of the empire.³⁴ A natural outgrowth of the vicious system was the obligation of the hard-working to maintain an increasing number of idlers.

³² *Ibid.*, p. 96.

³³ *Ibid.*, pp. 97-98.

³⁴ Davis, W. S.—*Influence of Wealth in Imperial Rome*, p. 195—estimates the population of Rome at the time of the fall of the republic as over one million. This seems reasonable, since other estimates vary from 870,000 to eight million.

Suetonius has given us a picture of the degree to which this practice had become entrenched by the time of Augustus. "Once at the time of a great failure of crops, when it was difficult to provide relief, Augustus ordered expulsion from the city of slaves who were exposed for sale, of schools of fencing-masters, and all foreign residents, except physicians and teachers, and, above all, of domestic slaves, so that at last the supply of corn became cheaper. At that time, he wrote that he was inclined to abolish forever the public distribution of corn, for the people had come to rely upon it and ceased to till the fields; but he had not proceeded further in the matter because he was sure that, from a desire to please the people, it would be revived at one time or another. After that time, he managed so that as much consideration was given to farmers and traders as to the multitude."³⁵

In the early years of the first century, the people raised such a complaint against the high price of corn that Tiberius (14-37 A.D.) fixed the retail price, and compensated the traders with a promise to add two *sesterces* (4 cents) on every peck sold.³⁶ Later, in 37-41 A.D., Caligula distributed 300 *sesterces*³⁷ per capita to the people at two different times. It was during a period of scarcity that the mob attacked Claudius (41-54 A.D.) and threw bread at him. To avoid a recurrence of this indignity, Claudius adopted every means to ensure the continuous importation of food throughout the winter months, and even agreed to indemnify corn merchants who suffered

³⁵ Suet., *Augustus*, 42.

³⁶ Tacitus, *Annals*, ii, 87, of xv, 18; Church and Broddrib's trans.

³⁷ Davis, *op. cit.*, p. 11, assigns the following value to Roman coins during the empire: sesterce = 4 cents; denarius = 16 cents; and talent, about \$1,000,000.

loss by storm.³⁸ Vespasian (69–79 A.D.), whose liberality to all classes of the people was extreme, was obliged to refuse a mechanical contrivance for moving immense columns into the capital because he feared that the labor-saving device would take employment from the populace, whose maintenance he had assumed. Thus the dole-giving had been carried to such lengths that inventive ability, outside the ranks of its demoralized beneficiaries, was discouraged. Lock comments upon the dole-giving thus: "In amount, the Roman dole seems to have been equivalent to the allowance provided for a slave, but the citizen received it without having to do any labor task. He received it as a statutory right. There could hardly be a more effective method for degrading his manhood and denaturalizing his family. He was also a voter, and the alms appealed to his weakness and indolence; and the fear of displeasing him and losing his vote kept him, socially, master of the situation."³⁹

Pliny⁴⁰ refers to a plan for the relief of children of citizens which developed as private charity and afterwards became imperial bounty. It evidently helped to supplement the practice of dole-giving. Nerva and Trajan made use of it. Special relief was granted to children whose names appeared on the relief tables at Rome. At Velia and Beneventum, instances of relief are recorded in inscriptions. It appears that the emperor lent money at the low rate of 2½ or 5 per cent. In the former place, the loan amounted to 1,044,000 *sesterces*. Security for the debt was provided by 51 local landowners who mortgaged holdings valued at 13 or 14 million *sesterces*.

³⁸ Suet., *Claudius*, 18, 21.

⁴⁰ *Ep.* vii, 18.

³⁹ *Op. cit.*, p. 99.

Some 300 children were aided out of the interest upon the emperor's money paid into the municipal treasury. The administration of the fund was under the local management of *quaestores alimentarii*, and high officials acted as patrons. The emperors Antonius Pius (A.D. 138), Marcus Aurelius (A.D. 160), and Severus (A.D. 192) established these funds in the names of their wives. By the third century, the system fell out of practise.⁴¹

PRIVATE CHARITY AND BENEVOLENCE

Corresponding to the dole-giving, or public charity of Rome, was the *sportula*, or private liberality. We have had occasion already to point out the fact that Gaius Gracchus, in his *lex frumentaria*, merely transferred from the numerous private sources of largess to the city, the obligation to support the poverty-stricken populace by distribution of grain. It is now important to examine the private practices of liberality, in order that we may round out our conception of Roman charity.

Between patron and client, a relation partly hospitable, partly charitable, had grown up. At rare intervals, there was an invitation to the humblest seat at the dinner-table.⁴² It was customary for presents of food to be given to clients and shabby gentlemen at the outer vestibule of the house. The recipients of this liberality carried it away in baskets (*sportulae*). Connected with this practice was considerable fraud, which the patron or his steward attempted to check by keeping a list of persons entitled to receive the aid. "The pilferer grabs the dole" became a proverb. There seems to have been little hesitation at stooping to cringing servility when receiving this insulting form of hospitality. Freedom from the

⁴¹ Lock, *op. cit.*, pp. 107-109.

⁴² Davis, *op. cit.*, pp. 269-70.

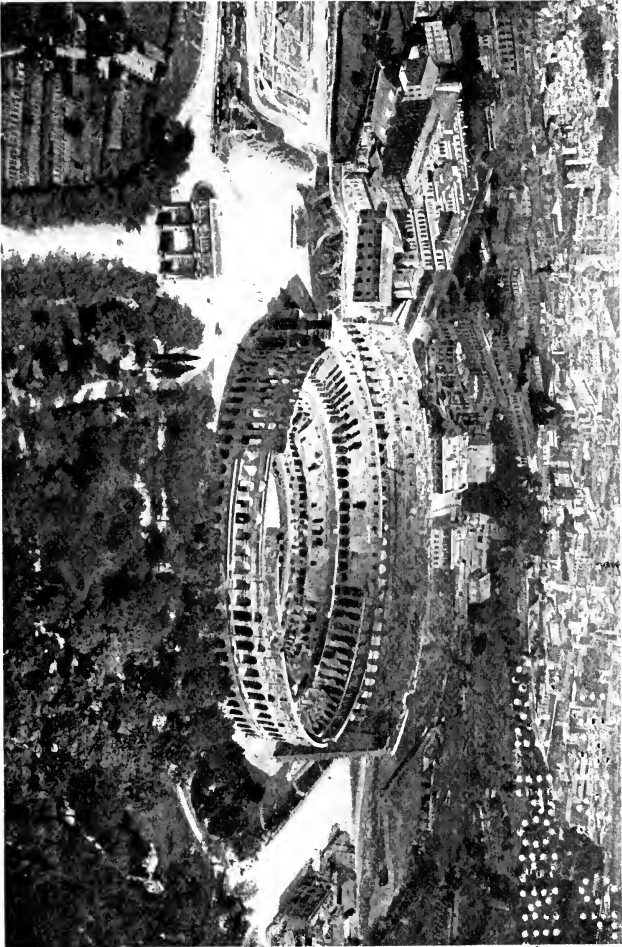

FIG. 2.—The Colosseum



necessity of labor was still the ideal, and the *sportula* provided the means for keeping the hands from toil. The *sportula* grew to be a private charity of such proportions that state regulation was attempted in 54 A.D. by Nero, who reduced it to a payment in money (about \$5.00), and in 81 A.D. by Domitian, who restored the custom of free distribution.

Private beneficence of wealthy Romans found other channels than largess to clients and political supporters. It was customary to make lavish expenditures on public improvements, games and popular amusements. Abbott says it was characteristic of ancient generosity or philanthropy "that its recipients are commonly the people of a single town, usually the donor's native town."⁴³ During his term as *edile*, or commissioner of public works, Cæsar bankrupted himself by prodigal expenditures. This ancient practice of private benefaction lost its voluntary character in time, and eventually became a legal obligation resting on public officials.⁴⁴ When the city of Urso was founded in 44 B.C., the municipal charter required that its chief magistrate should give public entertainments for four days in honor of the gods, at an expense of not less than two thousand *sesterces*.⁴⁵ This practice is the reverse of our modern custom, since our public officials are salaried. Abbott considers that these expenditures may be roughly compared with the "campaign contributions" of candidates for office in the United States⁴⁶ Besides this private provision for public amusement, statues, baths, porticos, or fountains were sometimes

⁴³ *The Common People of Ancient Rome*, 1911, pp. 185-6.

⁴⁴ *Ibid.*, p. 193.

⁴⁵ *Ibid.*, p. 194; *Corpus Inscriptionum Latinarum*, ii, 5439.

⁴⁶ *Op. cit.*, p. 195.

given. A citizen of Lanuvium, near Rome, cleansed and restored the water mains for a distance of three miles, replaced the pipes in position, and restored baths for men and women, all at his own expense.⁴⁷

Such an intolerable burden did this custom of benefaction become eventually that, as early as the first century A.D., it proved necessary to resort to ingenious devices to compel men to hold public office. A member of the town council was expected to contribute to the maintenance and support of his native city, as well as to collect the imperial taxes. Says Abbott: "As prosperity declined, he found this an increasingly difficult thing to do, and seats in the local senate were undesirable. The central government could not allow men responsible for its revenues to escape their responsibility. Consequently it interposed, and forced them to accept the honor. Some of them enlisted in the army, or even fled into the desert, but whenever they were found, they were brought back to take up their positions again. In the fourth century, service in the common council was even made a penalty imposed upon criminals. Finally it became hereditary, and it is an amusing but a pathetic thing to find that this honor, so highly prized in the early period, became in the end a form of serfdom."⁴⁸

⁴⁷ Wilmanns, *Exempla Inscriptionum Latinarum*, 1772.

⁴⁸ *Op. cit.*, p. 202.

CHAPTER VII

THE INSTITUTION OF SLAVERY

SLAVERY in Rome was a highly organized institution, far more systematized than it ever had been in Greece. It became a great industrial force underlying the economic activities of the nation. In our age of machine power, it is difficult to appreciate how essential slave labor was in ancient times. The slave performed work which is done for us by machinery. All heavy, large-scale, agricultural labor was performed by slaves. They did the hard work in factories; carried on the household drudgery, and were worked long hours in mines. When fair winds did not blow, slave-power was used to row the galleys. The extension of Roman domain necessitated the use of a larger army, and this involved the increasing absence of citizens from industrial labor. Consequently, the demand for slave labor grew apace and many slaves were obtained in the course of conquest. We have records of how captives taken at certain periods were sold as slaves. During the time of the later republic, captives were invariably reduced to slavery. After the victories of Paulus in Epirus, 150,000 captives were sold.¹ It is stated that Cæsar sold on one occasion as many as 63,000 captives.² During the Jewish war, 97,000 captives were sold as slaves.

In time, a regular commerce in slaves was established. Its systematic organization indicates a complete change

¹ Liv., xlv, 34.

² *De Bello Gall.*, iii, 16.

from the primitive methods of acquiring slaves. At Delos, pirates sold great numbers of slaves.³ Slaves were imported to Rome from Africa, Spain, and Gaul, but more generally from the Asiatic countries of Bithynia, Galatia, and from Cappadocia, and Syria. Import duties were paid on these slaves, and a tax of from two to four per cent. was levied upon their sale.⁴ But conquest was not the only source of slaves. Certain offenses were punished by reducing the guilty person to slavery. Such persons were then used in public works, either at quarries or mines. In the earlier days, the father could sell his children into slavery. The creditor could retain his debtor as a slave, and even sell him outside the city. The revolt of 493 B.C. was caused by the enslavement of creditors overwhelmed with usury that had resulted from losses by the hostile raids, or from their own absence during military service.

Besides private slaves, there were public slaves. At first free men performed the services required by the magistrates, but later the offices of couriers and attendants at the law courts, prisons, and temples were filled by slaves. Public works were carried on by slave labor, such as the construction of roads, the maintenance of aqueducts, and the cleaning of the city sewers. Slaves did the heavy work for private families. Not only in Rome, but also in rural and provincial towns, hard labor was performed by the slaves. The wealthy Roman usually bought two kinds of slaves, the *familia rustica* and the *familia urbana*. The former, the agricultural slaves, were under direction of a *villicus*, or slave-superintendent. Slaves were divided into several groups; those caring for the cattle, the flocks, and the stables, and

³ Strabo, xiv, 668.

⁴ Ingram, *op. cit.*, p. 39.

those preparing food, making clothing, making tools, and repairing buildings.

Slaves were employed to punish delinquent slaves held in the slave prisons of rural establishments. Slaves carried on the domestic work, performed the services of the toilet and the bath, waited upon table, worked in the kitchen, and, in addition, entertained the master of the house and his guests by singing, dancing, and other arts. Some acted as attendants to master and mistress when out of doors. As these were posts of honor, only those noted for their beauty or strength, and those most imposing in their appearance, were selected. The more intelligent slaves attached to a great household served as physicians, secretaries, librarians, copyists, artists, and teachers. Gladiators and circus performers were commonly slaves. Private speculators who owned troupes of gladiators frequently hired them out.

It will thus be seen that the number of slaves serving individual masters was quite large. For our knowledge of the actual number of slaves attached to the private masters of these great establishments, we must rely upon casual references by classic authors. It is said that Vettius, upon entering a revolt, armed four hundred of his own slaves.⁵ Pliny relates that a freeman living in the time of Augustus left 4116 slaves by his will.⁶ It is difficult to determine the total number of slaves at Rome or in Italy. One authority fixes the ratio of slaves to freemen during the period 146 B.C. to 235 A.D. as three to one. Thus the total number of slaves in Italy would have been about 20,832,000, and the free population about 6,944,000 during the reign of Claudius.⁷

⁵ Diod., *Fr.*, xxxvi; ii, 3.

⁷ Ingram, *op. cit.*, p. 43.

⁶ *Hist., Nat.*, xxxiii, 47.

TREATMENT OF SLAVES

Since the patriarch of the early Roman family had life and death power over all his descendants, it is not to be wondered at that the original Roman law gave the master complete power of life and death over his slaves. Whatever the slave acquired by way of property, was legally his master's, though in practice he was allowed to accumulate chance earnings or savings, known as his *peculium*. Under the law, slaves could not contract marriages. As a matter of fact, there was public sanction for their cohabitation, which practically amounted to a recognition of marriage. Penalties for crime were more severe on guilty slaves than on guilty freemen. While the punishment given under the *Lex Cornelia* for the murder of a slave or freeman was the same, the master was permitted to kill his own slave with impunity.

Although many Latin authors recommend friendliness towards one's slaves, the rapid extension of the great slave estates, or *Latifundia*, throughout the rural sections reduced each slave to the position of a mere number, and it became impossible for masters to know their slaves individually. Overseers were used as superintendents and chains were resorted to, in order that the slaves might work in groups in the fields. These chains were even worn at night while the slaves slept.⁸ This harsh treatment of the rural slaves was also found in the treatment of urban slaves.

Although the life of rural slaves was generally difficult, it is probable that the treatment accorded to the urban slaves was as little enviable. Ovid speaks of the porter as being chained in private houses. The punishments

⁸ Pliny, xviii, iv, 4, 5, and vii, 4.

which masters inflicted on their slaves varied. The milder punishments consisted in personal chastisement, and in banishment to rural labor. The more severe punishments were employment in the mines or quarries. In the time of the republic, a master might send his slave to fight wild beasts in the amphitheater. Some masters were excessively cruel and portioned out severe punishments for trivial mistakes, or even accidents. Ordinarily, his interest led a master to avoid extremely harsh treatment, but when the slave had passed the working age, his lot was likely to be a hard one.

In the period of the later republic and under the early empire, the large number of slaves was a constant menace to peace. There was a conspiracy among the slaves about 500 B.C., and another about 400 B.C. A formidable insurrection came near to breaking out in 498 B.C. Slave wars broke out in Sicily and Italy.⁹ During the reign of Nero, there were threatening movements of slaves. Even in the later stages of the empire, the danger of servile insurrection had not passed. When the Goths invaded Italy, their armies were swelled by some of their countrymen who had been slaves in Rome. Forty thousand slaves went over to Alaric when he laid siege to Rome.

The moral influence of slavery was most degrading, because the teachers of children were slaves. They tended to corrupt the youth by flattery and encouraged self-indulgence instead of disciplining their unruly charges. It is probable that the barbarous spectacle of the amphitheater was popular because of the hardening effect of the degrading system of slavery which had accustomed the people to brutality.

⁹ Plut., Sull. 9 Sall. Cat. 24, 56.

THE DECLINE OF THE SLAVE SYSTEM

In general, slaves were more easily emancipated in Rome than in Greece. There were two kinds of manumission. Under the *Justa*, or regular method, there were four modes: first, by adoption; second, by testament; third, in the time of Vespasian, by inscribing the slave's name on the roll of citizens and making presentation to the census or to the censor; fourth, the more usual form, by *vindicta*. According to this last mode, the master said "liber esto," in the presence of the same magistrate. Under the second form of manumission, the *minus Justa*, the master merely manifested good-will by some formal act before his friends, which signified his intention to liberate the slave. Of course this latter form was extralegal.

After liberation, the freeman became the client of his master. In this relation the master must protect the freeman and defend him in the courts, while on his part, the freeman took the master's name, paid him deference, and lent actual pecuniary aid. If it happened that the freeman died intestate, his patron received his property at death. Although it was not until after three full generations of freemen that the descendants of the freemen became free citizens, yet in this way the slave element in the population tended to be slowly assimilated. It is estimated that in Cicero's time the thrifty slave could save enough *peculium* in six years to purchase his freedom. About 3 A.D., we find that the law prohibited manumission, except in certain specified cases and about 7 A.D., the proportion of a man's slaves which he could liberate by testament was fixed by the law. Freemen gained steadily in influence in the time of the empire and were gradually ad-

mitted to the rank of certain magistrates of minor importance. Administrative services were frequently filled by the freemen.

The institution of slavery underwent a marked change during the second century of the Christian era. More and more, principles of liberality and humanity were applied to the slave classes. Some of the philosophers condemned the cruelty of the gladiatorial combats. As the age of conquest passed, the supply of slaves could not be increased, and each slave became of greater value. Consequently, Rome favored a policy of manumission. The emperors understood that, since warlike activities were on the wane and industrial activities on the increase, it was desirable to facilitate the work of the laboring classes. The general tendency of the law was to make the lot of the slave easier, and to facilitate manumissions. For example, an edict of Diocletian prohibited a freeman from selling himself into slavery, and a man caught stealing was punished by death. The position of the insolvent debtor was made easier after the annulment of slave sales, since the slave, his parents and family, must be returned to the seller. Thus families were saved from being broken up. In the time of Hadrian, the right of power of life and death was taken away from masters. Slaves who ran away from their masters because of excessive cruelty were brought back, and could be sold to new masters; they were not returned to their old masters. The master who killed his slave without just reason received the same punishment as if he had killed another man's slave.¹⁰

The expansion of Christianity in the Roman world favored humane treatment of the lower classes. Yet slav-

¹⁰ Ingram, *op. cit.*, p. 63.

ery was such a fundamental system in the Roman economic structure that no immediate or complete change to freedom could be hoped for. The institution of slavery was deeply rooted in Roman society, and many years had to elapse before new customs and organization could replace the old.

SERFDOM

Between the great industrial system of slavery as it existed in the ancient times, and the system of free labor to which we are accustomed to-day, there was an intermediate stage known as "serfdom." This transitional state was favored by a number of conditions enumerated by the economist Ingram.¹¹

In the first place, the Roman era of conquest having reached its completion, the supply of slaves diminished. The regular importation of slaves from conquered territories fell off. Since the diminished supply of slaves had enhanced the value of each, the effect was to improve the condition of the slave. It became of interest to each family to keep its hereditary slaves. This favored the transition of slavery into serfdom. When the external slave-trade was abolished, the internal sales were ended, and slaves became attached to the soil.

The second condition favoring the transition to serfdom was the direct rehabilitation of the free laborer. From the second century and after, this process is noticeable. In the public service, freemen were employed as subordinates to magistrates and priests. Other minor positions could be legally filled only by citizens. Corporations of free plebeians carried on the productive industries owned by the state, and under these free workmen

¹¹ Pp. 72-80.

there were public slaves. Even in private service, the better posts were often held by freemen; for example, in the higher arts of medicine, grammar, etc. Freemen appeared on the stage and in the arena. Although slave-labor was mainly employed in the factories and workshops, wealthy persons sometimes hired free laborers. The latter often united in associations to compete with these private shops. All along, free persons had been found as tenants on the great estates, and occasionally they hired themselves out as day-laborers to cultivate the land.¹²

The third condition favoring the growth of serfdom was the existence of hereditary fixity of occupation and profession. Classes who worked in administrative service must remain in this employment. They were not even permitted to marry their daughters outside of *collegia* to which they belonged. These obligations were inherited by their children. The fixity of occupations is indicated by a provision that those who abandoned their work should be sought for, and forced to return. In a few instances, substitutes could be provided, but in most cases, the worker and his family were bound to remain generation after generation in the employment of their ancestors. The sons of a soldier were bound to follow military service. The state treated the free man as its servant who might be required to furnish money or labor. This permanent fixing of a man's labor for him, by binding his descendants to remain in the same occupation, had the advantage of securing public order, enforcing industrious habits, and supplying the financial needs of the state, but individual initiative and personal independence were lost by such a semi-caste system. Yet the minute regulation

¹² *Ibid.*, p. 74.

of labor amounted to a reduction of the interval between the slave and the free man—the latter having, in some respects, almost as little mastery over himself as the slave.

A fourth condition should be mentioned in connection with the position of rural slaves. There was a tendency for the rural slave to be merged into the order of the *coloni*. Originally, the Roman *colonus* was a freeman who held land on lease, under the obligation to pay the owner a fixed annual sum, or a portion of the produce of the land. In the fourth century A.D., the *colonus* and his descendants were bound to the soil in order to check the growing tendency of *coloni* to desert the country and move to the city, that they might avoid the heavy burden of taxation which rural life entailed. Ingram concludes that the law merely met and extended a condition of things which had previously existed, when it recognized this personal and hereditary fixity of the rural laborer.¹³ Tenants by contract, who had failed to pay their rent and so remained indebted to the landlord, composed a portion of the class of *coloni*. Another section of this class was composed of foreign captives, or emigrants and fugitives from barbarian migrations, settled upon the land by the power of the state. There were also some small proprietors and poor men who voluntarily became *coloni* because they thought it would improve their condition.

These *coloni* paid the proprietors a fixed portion of the produce, and gave a certain amount of labor on that part of the domain which the master kept for his own use. The *coloni* paid taxes to the state, but the proprietor was responsible for these taxes. The position of the *colonus* was fixed permanently; he could not leave his land. If he

¹³ *Ibid.*, p. 77.

wandered away, the law required that he be brought back and punished. The person who gave him asylum must restore him and pay a penalty. This rigid regulation went so far as to prohibit marrying outside the domain. The children of the *colonus* must remain in the same status, and could not leave the land to which they were attached. In the fifth century, the law provided that a *colonus* who voluntarily came into an estate, became forever attached to it. After living there thirty years, the master of the domain could punish the *coloni*, and when they attempted to escape, could chain them. In case of sale, the lands of the *colonus* were also transferred, for they could not be separately sold. While the *colonus* could possess property of his own, he had to obtain the consent of the master before he could alienate it. In some respects, therefore, although the members of the class were personally free, they were nevertheless in a semi-servile condition. But the position of the *colonus* was not entirely degraded. It was a considerable advance upon the system of slave cultivation by the *familia rustica*. Since there was a certain similarity between the condition of the *colonus* and that of the slave, there tended to be a fusion of the two groups into a single class.¹⁴

In addition to the *coloni*, there remained a class of prædial slaves on great country estates, who worked together in groups under the direction of overseers. Now it became advantageous to settle certain slaves on other portions of the estate granting them small bits of land under conditions which approximated those of the *coloni*. These slaves had no property, and at first were entirely at the disposal of their masters. But it was to the landlord's interest to treat them with a certain amount of con-

¹⁴ *Ibid.*, p. 80.

sideration, and they continued on their holdings for such long periods of time that they really appeared to inherit them. The law tried to prohibit the sale of these slaves unless their land was sold. Yet after the invasions, the legal distinction between *coloni* and slave-tenants still continued. In practice, however, the difference was not marked, for there were frequent intermarriages between the two classes and, by the end of the seventh century, the distinction between the two classes had almost disappeared.¹⁵

Since the church favored individual emancipations, the modification of the slave system increased, for it must be remembered that adherents of the Christian doctrine were drawn from all social ranks, from freemen, serfs, and slaves.

Thus the causes which gradually undermined and broke up the slave system were within the Roman empire. The migrations of the northern barbarians exerted a minor influence in favor of freedom. Tacitus describes a situation among the Germans which, although it was not chattel slavery, was a system in which servile classes settled on definite portions of the domain and paid a fixed share of the produce to its owner. On the whole, these influences were not as important as those already enumerated. The change from slavery to serfdom, and eventually to free labor, was one of the great peaceful revolutions of history, and had a beneficial effect upon society. Now that the serf was not liable to separation from his wife and children, he was able to form a family in the true sense of the word. Since he was allowed by custom to retain a portion of his earnings, he could look forward to the time when he might purchase his complete freedom. As the

¹⁵ *Ibid.*, p. 82.

head of a separate household, he enjoyed a sort of independence. The incentive to save developed habits of industry, thrift, and self-denial. In this way the serf was securing a training which would fit him for subsequent freedom.

THE RECRUDESCENCE OF SLAVERY IN THE NEW WORLD

Although the institution of slavery in Europe passed away before the latter part of the Middle Ages, negro slavery arose in connection with capitalistic exploitation in tropical parts of the New World in the seventeenth and eighteenth centuries. During this period, there appears to have been no other means of securing the labor required to produce the great staples which Europe demanded of the New World. Slavery in the West Indies also served as a market for the products of the non-slave colonies of America.¹⁶

The nefarious colonial slave-trade in African negroes was begun in the sixteenth century by Spanish and Portuguese navigators.¹⁷ By 1619, Dutch traders had brought a shipload of Africans to Jamestown, but found their best market for slaves in the West Indies.¹⁸ Some idea of the extent of this traffic may be had from the estimate of Bryan Edwards¹⁹ that the total import of negroes into the British colonies alone of America and the West Indies from 1680 to 1786 was 2,130,000. The same authority estimates that the annual import of African negroes, about the year 1790, was 38,000 by the British, 20,000 by the

¹⁶ Callender, G. S.—*Selections from the Economic History of the United States*, 1909, Introduction to chapter xv, p. 738.

¹⁷ Ingram, *op. cit.*, p. 141.

¹⁸ Bruce, P. A.—*Economic History of Virginia in the Seventeenth Century*, 1896, vol. ii, ch. xi; and Weedon, W. B.—*Economic and Social History of New England*, 1890, vol. ii, ch. xii.

¹⁹ *History of the West Indies*, book iv, ch. ii.

French, 4000 by the Dutch, 2000 by the Danes, and 10,000 by the Portuguese—a total of 74,000.

One by one, the peoples of European nations were aroused to the iniquity of the slave-trade, and the abolition of this traffic became a matter of fact for Danish traders in 1802, for British and American in 1808, for French in 1818, for Spanish in 1820, and for Portuguese in 1836. Except for occasional violations, these dates probably mark the end of the slave-trade in African negroes.²⁰

But abolition of the colonial slave-trade did not save the United States from the incubus of negro slavery. The preservation of the slave system in America during the nineteenth century appears to have been due to the difficulty of organizing free labor in the cotton industry, the great staple industry of the South. White men were capable of cotton raising, but they would labor in the cotton fields only as independent farmers. Consequently, it was not possible to produce cotton on the large scale demanded by the textile industries of the world. The only seeming way to open capitalistic cultivation of cotton was by the use of slave labor. Thus a struggle began between the cotton planter and the independent farmer. The planter, however, was able to offer such a high price for the best lands that the farmer was persuaded to sell his small holding and take up cheaper lands farther west. The cotton industry then spread over the South, because the economies of large-scale production overbalanced the wastes of inefficient slave labor.

It should be remembered, as Callender points out,²¹ that the slave system in America had its basis in economic and social conditions. Slaves were vastly profit-

²⁰ Ingram, *op. cit.*, pp. 154-173.

²¹ *Op. cit.*, pp. 738-742.

able to their owners on the economic side because of the demand for labor in the newly opened plantations of the Southwest. As the area of new land adapted to cotton raising was gradually taken up, the value of slaves in the coastwise States first, and later even in the gulf States, came to depend upon the demand for them in the Southwest, since their labor at home was not profitable enough to maintain their value. The extension of cotton culture by slavery was fast approaching its termination when the Civil War broke out.

Cairnes has stated thus the economic reasons for the decline of slavery:²² "Because slave labor is reluctantly given, and hence needs constant oversight; because it lacks versatility, and hence is difficult to reëducate in new lines of work; and because it is unskilful, and hence unthrifty, it is an extremely wasteful mode of production. It therefore follows that its permanence and extension depends upon the existence of a supply of virgin and unoccupied soil, which may be depended upon to give rich returns in spite of inefficient and wasteful cultivation. Just as soon, however, as it becomes necessary to work the land intensively by the use of fertilizers and scientific crop rotation, slavery becomes uneconomical and must give way to intelligent individual methods of farming."

On the other hand, the social basis of slavery in the South was much stronger and more permanent than its economic basis. The danger of liberating slaves and leaving them as part of southern society was recognized, although it is doubtful whether the demoralizing economic and social effects of the continuance of the institution received much thought. It is a superficial explanation of the backwardness and poverty of the South as compared

²² *The Slave Power*, 1861, pp. 38-39, 40-45.

with the North which traces the inefficient and unenterprising character of southern industry to the stigma which slavery attaches to manual labor. For it should be noted that slavery, as the principal system of labor, at no time occupied more than a fraction of southern territory.²³ It was customary for the slaveholder to work in the fields as a farmer beside his sons and his slaves.

Economists now regard the most important injury the South sustained from negro slavery to be the checking of accumulation of capital. Southern industry was unable to secure local capital and therefore had to rely upon northern capital. Manufacturing failed to develop because of lack of capital to underwrite it. There was no serious lack of labor or enterprise. This scarcity of capital perpetuated a rude backwoods and frontier organization of society which was chiefly responsible for rendering the population shiftless and inefficient, and keeping it so.

Slavery appears to have been accountable for this lack of accumulation of capital because it discouraged the disposition to save. Employment of slave labor by planters tended to concentrate the wealth of the country in their hands, and the social conditions of class differentiation, fostered by the slave system, encouraged planters to use this wealth in extravagant living, rather than to save and accumulate capital. As a class, the planters consumed wealth and were not interested in investing it in commercial or industrial enterprises. Thus, slavery prevented the diffusion among the people of that prosperity which flowed from the economic resource of cotton, and caused all this great wealth to be absorbed chiefly by the planter class.

²³ Callender, *op. cit.*

CHAPTER VIII

THE ORGANIZATION OF LABOR ¹

BETWEEN plutocracy on the one hand and slavery on the other, the Roman middle classes were ground to pieces and their initiative strangled.² Yet in the period of the republic, there was sufficient specialization in manufacturing processes to create a considerable division of labor, and guilds of workmen and traders (*collegia*) multiplied without restraint.³ It is impossible to satisfactorily trace the growth of guilds at this time because information is lacking,⁴ but at the time of the empire our sources of information about workingmen's organizations are more abundant. Indeed, there are some twenty-five hundred inscriptions dealing with this subject. In the city of Rome alone, there were eighty different trades whose workers were organized into guilds. There were skilled and unskilled workmen, porters, and goldsmiths, and dealers in oil, wine, fish, grain, perfumes, hay, and rags, all organized into societies. We find guild inscriptions from four hundred and seventy-five towns and villages in the empire. In the Greek portion of the Roman dominion five guilds were in Tralles, Caria, six in Smyrna, one in

¹ Dill, S., *Roman Society from Nero to Marcus Aurelius*, London, 1905, pp. 251-286; Davis, *op. cit.*, ch. v; Abbott, *op. cit.*, pp. 215-234.

² Dill, S.—*Roman Society, Last Century of the Western Empire*, London, 1899, pp. 245-281.

³ Dill, *op. cit.*, p. 254.

⁴ Abbott, *op. cit.*, p. 216.

Alexandria and eleven in Hierapolis, Phrygia. At Rome, there were more than one hundred, and in other Italian cities in proportion.

ANCIENT AND MODERN ORGANIZATIONS OF LABOR

Ancient guilds, such as existed during the Roman Empire, were organizations of men working in the same trade, but here similarity to modern trade-unions ends. Their object was not to better the social and political position of the workman, or to raise wages, shorten hours, and improve working conditions, like the modern union. Nor did they seek, like the medieval guilds, to limit the number of apprentices in a trade, or to develop skill and artistic taste in a craft. Their end was to provide means of satisfying the desire of a submerged class for religion, companionship, sympathy, and help in the great natural emergencies of life.⁵ Hence the characteristic features of Roman guilds were the provisions for social gatherings, and burial. An inscription upon a tombstone of central Italy states that the deceased, "bequeathed to his guild, the rag-dealers, a thousand *sesterces*, from the income of which each year, on the festival of the *Parentalia*, not less than twelve men shall dine at his tomb."⁶ Another, from northern Italy, relates that the mother of a certain member of the rag-dealers' association gave a sum of money, from the income of which there should be provided an annual banquet in the temple.⁷ The menu of such a dinner seems to have included lamb, pork, bread, salad, onions, and wine. The expense of entertainment was about twenty-seven dollars, but in those days the

⁵ *Ibid.*, pp. 221-222.

⁶ *Corpus Inscriptionum Latinarum*, xi, 5047.

⁷ *Ibid.*, v, 7906

purchasing power of money was at least three times what it is now.⁸

The *schola* in which banquets were held was used for many purposes that the modern club-house serves. Besides these death anniversary dinners there were regular meeting times for social intercourse and banqueting. The revenues of the society were obtained from initiation fees, monthly dues, donations, and occasional fines. Every gild had its patron. He might be a high official of the empire, a magistrate, a priest, a great merchant, or a simple freeman. The finances of the *collegia* were aided by the gifts of rich patrons. These donations had two chief objects: commemoration of the dead, and provision for social enjoyment.⁹ The religious character of these gilds of workmen seems strange to us, yet each *collegia* put itself under the protection of a deity, and was associated with a cult. For example, the cabmen of the Tiber had Hercules as their guardian.

Burial provisions formed an important part of the expenditure of these societies. One epitaph states that the rag-dealers' gild contributed three hundred *denarii* to the burial expenses of a certain physician.¹⁰ The burial regulations of a gild at Lanuvium read as follows:

“It has pleased the members that whoever shall wish to join this gild shall pay an initiation fee of one hundred *sesterces*, and an amphora of good wine, as well as five *asses* a month. Voted likewise, that if any man shall not have paid his dues for six consecutive months, and if the lot common to all men has befallen him, his claim to a burial shall not be considered, even if he shall have so stipulated in his will. Voted likewise, that if any man

⁸ Abbott, *op. cit.*, p. 223.

¹⁰ *C. I. L.*, *op. cit.*, iii, 3583.

⁹ Dill, *op. cit.*, pp. 273-5, 282.

from this body of ours, having paid his dues, shall depart, there shall come to him from the treasury three hundred *sesterces*, from which sum fifty *sesterces*, which shall be divided at the funeral pyre, shall go for funeral rites. Furthermore, the obsequies shall be performed on foot.”¹¹

Abbott points out that these guilds of humble working folk provided for the natural desire of all human beings to enjoy authority over others, and to satisfy their longing for ceremony.¹² Consequently, the guilds reproduced in miniature the popular assemblies, official positions, and insignia of the Roman government,—the larger activities in which they were denied a share. Hence the Roman guilds were not economic units; they were rather social fraternities.

Several conditions conspired to crush the initiative of ancient guild-members, and to prevent their collective action to secure higher wages and improved working conditions. Manufacture, in Roman times, was carried on by artisans working singly in their own shops, and factories were comparatively small establishments in which elaborate machines were unknown. Although there was a considerable division of labor, the minute specialization characteristic of modern industrial processes did not exist, and power was supplied by human and animal energy alone. Thus there were no large groups of workmen employed in a single establishment and working under common conditions, as at present. There was a closer relation between employer and employee than with us, and the isolation of master from man had not been accomplished. All these conditions helped to keep workmen separated into small groups, and interfered with the de-

¹¹ *Ibid.*, xiv, 2112.

¹² *Op. cit.*, p. 226.

velopment of a labor-class consciousness, which encourages common action to advance class interests.

Then there was always the great servile population, sullen, individualistic, and reluctant, an utterly demoralizing competitive force. In the empire, the employer was usually able to secure a limited amount of slave labor, and this fact must have discouraged all hope of improvement. The scale of wages was fixed by the rate of slave hire, since it was customary for owners to let their slaves out by the day or job in the various occupations to which they had been trained. Wages and their purchasing power, in the year 301 A.D. or thereabouts, may be estimated by comparing the daily earnings in some forty different unskilled and skilled occupations with the prices of foods and clothing stated in Diocletian's edict.¹³

WAGES AND FOODS, 301 A.D.¹⁴

Wages per day		Common foods.	
	cents.		Cents.
Unskilled workman ...	10.8	(k) Wheat, per bushel	33.6
Bricklayer	21.6	(k) Rye, per bushel	45.
Carpenter	21.6	(k) Beans, per bushel	45.
Stone-mason	21.6	(k) Barley, per bushel	74.5
Painter	32.4	(k) Fresh pork, per lb.	7.3
Blacksmith	21.6	(k) Mutton, per lb.	4.9
Ship-builder	21 to 26	(k) Sea fish, per lb.	9 to 14
(k) receives keep also.		Cheese, per lb.	7.3
		Eggs, per doz.	5.1
		Milk, sheep's, per qt.	6.

¹³ *C. I. L.*, iii, 1926-53. This edict was an effort to deal with the pressing problem of the high cost of living. At one point it reads: "Who is of so hardened a heart and so untouched by a feeling for humanity that he can be unaware, nay, that he has not noticed, that in the sale of wares which are exchanged in the market, or dealt with in the daily business of the cities, an exorbitant tendency in prices has spread to such an extent that the unbridled desire of plundering is held in check neither by abundance nor by seasons of plenty." Translation by F. F. Abbott, *The Common People of Ancient Rome*, p. 155.

¹⁴ According to Abbott, pp. 158-165, 173-174.

Slave labor was essentially wasteful, because the great masses of slaves were unskilled and reluctant workers. These facts combined to hinder the growth of a spirit of initiative and independence among the free artisan classes of Rome.

The corrupting influence of dole-giving has already been mentioned. It effectively undermined whatever contributed to the habits of self-respect and independence the urban proletariat had acquired, and this must have contributed to the direct demoralization of the artisan, or, at the best, adversely influenced his habits of thrifty application by the depraved example set by its recipients. Even mechanical invention was discouraged. Under these circumstances, there could be little industrial progress, and consequently manufacturing stagnated.

THE OBSTACLES TO INDUSTRIAL PROGRESS

The demoralization of industry would not have entailed such serious consequences, were it not for the fact that in other respects Roman economic methods were demoralized. Under the empire the amount of gold and silver had not materially increased, because the mining of precious metals had diminished, yet at the same time gold and silver were constantly removed from circulation for use in the arts, for temple offerings, and hoarded by private persons. Added to this drain on the circulating medium, enormous sums of money were continually exported to Arabia, India, and China, to pay for silk, spices, perfumes, and many other luxuries. Moreover, the imported food supply involved the drain of money from Italy.¹⁵ The natural consequence of such a perverted

¹⁵ A suggestive treatment of the various causes of the decline of ancient civilization may be found in W. L. Westermann's article, *The Economic*

national economy was that the amount of money in circulation became smaller every year. To remedy this situation, the government tried the expedient of debasing the coinage by mixing copper with precious metals. This practice had attained such proportions by the middle of the third century A.D., that a piece which was worth forty cents at the time of Augustus came to be worth but one cent. Soon the well-known economic principle that alloyed coins drive pure coins out of circulation began to act, and all gold and silver coins were driven from circulation by the pale copper coins. An era of rising prices was experienced.

Just at this juncture in the development of Roman national economy, it was most inconvenient to have a debased currency, for the demand for money had increased rapidly. The large standing army needed its pay at regular intervals, the number of magistrates had multiplied; and the cost of operating the government had grown because of the increased expenditure and extravagance of emperors and many other high officials. Revenue to meet these large expenses was obtained by taxation, but since coins were practically worthless, money taxes failed to supply the needs of the government and resort was made to taxation in kind. The burden of the taxes fell chiefly upon poor peasant proprietors. The rich escaped the burden because their taxes were proportionately lighter and they had means of avoiding payment.

Had industry flourished, Rome might have produced sufficient value in manufactured produce to pay for the imported grain and luxuries, and hence might have been saved the economic demoralization consequent upon a de-

based currency. But consumption had exceeded production as the chief economic activity of the Roman Empire. This economic decline affected the organization of workmen adversely, and the numbers in labor organizations diminished to an alarming extent. The government had granted the *collegia* certain privileges, such as the right to receive legacies and to possess property and slaves; also exemptions from burdens which ordinary citizens bore: such as freedom from military service, municipal service, local taxes and the like. But in return for these grants, the guilds were required to perform certain public services. For example, guild officers were required to assist in collecting taxes. The burden of these obligations became so heavy that it caused a loss in membership. To stop this tendency which endangered the industrial interests of the empire, the government forbade men to withdraw from guilds. Membership in labor organizations henceforth became hereditary, and the sons of artisans were bound to follow their father's trade. An hereditary fixity of industrial occupation, as binding as the dependence of the serf upon the soil, was thus effected, and all hope of industrial progress from personal initiative and mobility of labor was, for the time being at least, lost.

PART III. INDUSTRIAL DEVELOPMENT
AT THE END OF THE MIDDLE AGES



CHAPTER IX

COMMERCE AND THE TOWNS

THE revival of town life in the second half of the Middle Ages was largely an outgrowth of the spread of commerce. A leading writer on economic history says: "Commerce had been an essential condition without which the towns of Western Christendom would not have come into being, and the development of trading intercourse in the eleventh and twelfth centuries afforded opportunities for the growth of civic wealth and power."¹

According to Giry,² it is possible to trace the tide of commercial prosperity as it flowed from south to north, first affecting the Italian Peninsula and the towns of Septimania and Provence, later reaching the Rhine lands, Flanders and northern France, and finally crossing the channel to England. But it is our purpose in this essay simply to indicate in a general way how commercial expansion was related to the early growth of towns in which, eventually, manufacturing industry was to come into its own.

Towns secured their municipal liberties by various means, and the story of this gradual emancipation from feudal restraints is exceedingly interesting. Increasing trade made the towns grow rich and powerful, and some fought for their political freedom, while others purchased it from bankrupt princes. In different ways, and on dif-

¹ Cunningham, *op. cit.*, vol. ii, p. 90.

² *Histoire Générale*, edited by Lavisé and Rambscud, ii, p. 420.

ferent occasions, freedom was obtained. The English towns of Portsmouth and Norwich, to mention two cases, gained their charters by paying part of Richard I's ransom in 1194.³

THE CRUSADES

The opening up of the East to the commerce of western Europe came from new relations established by the Crusades in the period 1095–1270 A.D. Social and economic conditions, as well as a curious complex of motives, led to the extraordinary medieval phenomena of the Crusades. Population was pressing upon the means of subsistence, and a crop failure was all that was necessary to precipitate a migratory movement among the landless and impoverished men whose condition was one of unrelieved misery. The imagination of the more intelligent was fired by tales which travelers brought from the Orient of fabulous wealth, gold and silver, beautiful women, and rich spoils awaiting the hand of the conqueror. Added to these influences, there was a religiously fanatical habit of mind which showed itself in the rapid spread of popular manias, delusions, and hallucinations. Sumner⁴ considers the Crusades as fairly typical cases of mob excitement and delusion, part of the monstrous mass-phenomena of the Middle Ages. Finally, it must be admitted that some persons were, no doubt, animated by a sincere desire to wrest the Holy Land from the infidels. But whatever the circumstances which initiated the movement and sustained the crusading spirit, there is no difficulty in understanding the important part played by the Crusades in opening up commerce.

³ Gibbins, H. deB.—*Industry in England*, 4th ed., New York, 1906, p. 91.

⁴ *Folkways*, Boston, 1907, pp. 210–14.

The transportation of large bodies of troops necessitated the organization of methods for carrying supplies, and this system, once established, was easily turned to use for regular purposes of commerce. Tastes for new luxuries, such as cotton, silks, sugar, water-melons, spices, pepper, perfumes, jewels, glassware, to mention only a few, when formed by the crusaders stimulated commercial intercourse with the East to supply these products to the West. The Italian seaports, Venice and Genoa, were large beneficiaries of this new trade. In fact, through the efforts of Venice the Fourth Crusade was a commercial enterprise. The princely leaders of the Crusades were constantly in need of funds, and corporations of Italian bankers were formed to supply certain sums of money at designated places as, for example, in all the principal cities of Cyprus, Syria, and Egypt. Cunningham says:

The impulse given to the Italian towns was communicated with more or less rapidity to other centers in Europe. The cities in the Danube valley must have profited to some extent by catering to the armies which passed along that route; while Augsburg and Nuremberg, which were in direct communication with Venice, gained with the increase of her commercial activity. . . . In the fourteenth century we can estimate the full extent of the impulse given by the Crusades. We see organized commercial communication between all parts of Western Christendom and with countries which lay outside, and we see, too, that a new development of industry followed in connection with the improvement of facilities for trading intercourse.⁵

The close of the crusading period brings us to a stage in commercial development and town growth characterized by the creation of leagues and confederations of trading towns. Augsburg and Nuremberg were leaders in the Swabian Confederacy, founded about 1300, and had com-

⁵ *Op. cit.*, pp. 128-29.

mercial relations with Venice and Genoa, as did the towns of the Confederacy of the Rhine. From the twelfth century protective alliance of Hamburg and Lübeck, there developed the Hansa League of the thirteenth century. This league comprised seventy cities, organized into four districts under the leadership of Lübeck, Cologne, Brunswick, and Danzig, respectively. It succeeded in gaining complete monopoly of the trade of the Baltic region, suppressing piracy, preserving order, and establishing factories at Novgorod, London, Bergen, and Bruges. The trade consisted largely of raw products, although such manufactured products as linen, cloth, and metal work were exchanged.⁶

Commercial expansion increased the number of merchants engaged in active trade, and this class soon obtained a dominating influence in town government. "The bankers, who acted as agents for the collection of papal revenue, were important people at many centers. At Florence, the merchants who imported cloth had a leading position; in London, the grocers, who dealt in bulky goods which were weighed by the large beam, seemed to have monopolized all city dignities for a time, though the mercers, who dealt in silk and other valuable goods weighed in a small balance, had the older organizations there. These groups of merchants, associated in companies for the wise regulation of their own trades, had practical control of the government of their city."⁷

THE GILD MERCHANT

Trading activities centered in English towns were protected and regulated by "gild merchants." These organ-

⁶ Gibbins, *op. cit.*, pp. 48-54, 60-71, 74-75.

⁷ Cunningham, *op. cit.*, p. 94.

izations were composed of all the inhabitants of a town who habitually engaged in the business of selling a great variety of articles. Unlike the ancient guilds, whose chief objects of existence were social and religious, the guild merchant was primarily an association to protect and regulate trade, and to preserve for its members a trade monopoly. Among other privileges, its members enjoyed the following: exemption from tolls; exclusive right to sell at retail; and the right to buy from another merchant at cost price.⁸ Charitable, fraternal, and religious activities were really of secondary importance, although a great part of the time of the guild merchant was spent in holding meetings and feasts.⁹

⁸ Gross, C.—*The Guild Merchant*, vol. i, pp. 38, 40, 49.

⁹ Cheney, E. P.—*An Introduction to the Industrial and Social History of England*, New York, 1908, pp. 59-64.

CHAPTER X

HANDICRAFT INDUSTRY AND THE CRAFT GILDS

THE gild merchant experienced a decline in power during the rise of the craft-gilds in twelfth and thirteenth century England. Ashley says: "The rise of the craft-gilds in the twelfth and thirteenth centuries meant the appearance in western Europe of industry as a separate economic phenomenon, as distinguished from agriculture on the one side and trade on the other."¹

The craft-gilds were composed of a body of men with whom manufacture was not a by-employment, but the main business of life. Town living had by this time so well established habits of peace and social order that growing crops and raising herds of cattle could be cared for without danger of molestation. As a consequence, the food supply increased to an extent which permitted the existence of a non-agricultural class. Moreover, the demand for manufactured articles settled down to a steady basis, and men could safely devote their entire time to supplying the need.

THE HANDICRAFT SYSTEM

The manufacture of marketable articles by artisans who were members of craft-gilds became an industrial system in itself. It was one of the really significant stages in the progress of industry, and is generally

¹ *English Economic History*, New York, 1893, vol. ii, p. 99.

known by the name of the "handicraft system." Seligman says:

Under this system the artisan is independent; he no longer works in the house of the consumer. He occupies his own house, goes to market to purchase raw materials, works up the raw material in his own home with his own tools, and sells the finished product to the consumer in his own shop. . . . Every phase of the process, down to the sale of the finished commodity, is in the hands of the workman himself. The workman or craftsman, moreover, finishes everything by hand, and it is for this reason that we speak of the "handicraft system." This does not mean that things were not previously, or even subsequently, made by hand, but calls attention to the fact that the distinguishing mark is the growing importance of industry, and the rise of an independent class of workmen who conduct business enterprises by themselves. . . .

In the Middle Ages workmen gradually banded themselves together by trades into compact organizations, known as guilds or crafts. Historically, the system has therefore come to be known as the "guild system." The guilds, however, were a result rather than a cause; and in many parts of the world we find the handicraft system without the guilds.²

Manufacture was carried on in the home-shop to supply the steady and dependable demand of a small group of customers, who lived in the town, or at least in the immediate vicinity. Only a little capital was needed. It consisted of the home-shop, a few relatively simple tools, and a small supply of raw materials. The demand for products of these small shops was a staple demand and the rapid and incalculable fluctuations of the modern market were unknown, because most of the articles were called for

² *Principles of Economics*, New York, 1908, pp. 90-91; also Ashley, *op. cit.*, pp. 218-19. In the present book Seligman is followed rather than Ashley, and the term "handicraft system" is used as a wider term which, in medieval times, embraces the guild system.

by necessity and not by fashion, and the market was strictly local. The trade was carried on in a given family and considerable manual skill attained. No new inventions or improved methods were introduced to disturb the regularity of production, and hence the regulation of prices and methods of manufacture was easy.³ Working in his own shop with his own tools upon his own material or that brought him by a customer, the artisan enjoyed a considerable degree of personal independence. The average worker procured his own raw material, then transformed it into the finished article by the labor of his own hands, and finally sold it by his own efforts at shop or market. Thus the whole process of production was in the hands of the artisan. In other cases, a customer brought the materials to the shop, and in due time returned for the article, or the artisan worked in the customer's house upon materials furnished him. But in any event, the worker was able to follow the product from its raw condition through successive stages in the process of manufacture to its finished state, and took a certain pride in its production. Here is a sharp contrast to the factory manufacturing processes of to-day, under which the average laborer performs one simple operation upon one part of an article, and may not even know the purpose of the finished product. This handiwork method made it inevitable that shops should be small, with no large class of wage-laborers like the great factories of to-day.

According to modern terminology, it seems as though the gild-craftsman was employer, employee, capitalist, and salesman, all in one, yet the terms do not accurately describe the situation. We must remember that the capital investment was small, the apprentices and journey-

³ Ashley, *op. cit.*, vol. i, pp. 92-94.

men in the shop of the master were few, and the science of salesmanship and commercial routing had not developed. The division of labor in productive processes was as yet simple, and it lacked the high specialization of contemporary times which has given the terms "employer," "employee," "capitalist," and "salesman" their significant meaning.

As early as 1130 A.D., there were guilds of weavers in London, Lincoln, and Oxford. Guilds existed among the cordwainers of Rouen, the tanners of Ghent, and the drapers of Valenciennes.⁴ It was not long before crafts other than the weavers were organized into guilds, and we find such trades as glovers, girdlers, pocket-makers, skippers, white tawyers, fletchers, bowyers, stringers, spurriers, dyers, and fishmongers, organized into independent bodies. By 1350, there were forty guilds in London alone.

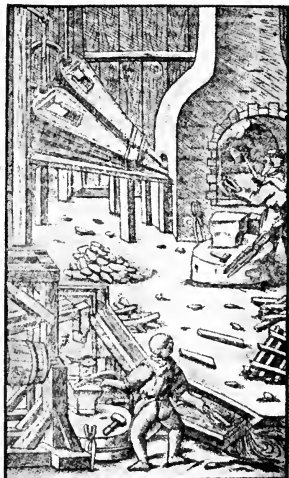

FIG. 3.—A blast furnace of the Middle Ages

INTERNAL ORGANIZATION OF THE CRAFT-GILDS

The craft-gilds "were formed primarily to regulate and preserve the monopoly of their own occupations in their own town, just as the gild merchant existed to regulate the trade of the town in general."⁵ They were usually subject to the authority of the town government, and sometimes enjoyed the special privilege of a charter from the crown. They regulated the work of all artisans in the

⁴ Cunningham, *op. cit.*, vol. ii, pp. 95-96.

⁵ Cheney, *op. cit.*, p. 65.

trade, and no one was allowed to work at a craft until he had obtained the approval of the gild's officials, and admission to the organization.

Gibbins says of the craft-gilds: "They first arose, of course, in the towns, and originally seem to have consisted of a small body of the leading men of a particular craft, to whom was confided the regulation of a particular industry, probably as soon as that industry was thought of sufficient importance to be regulated."⁶ Shops of the same trade were located in the same locality of the town, much like the grouping of artisans in Athens.

The workman attained full membership and influence in the counsels of the gild, only after he had passed through the successive grades of apprenticeship and journeyman, and had reached the position of a master. The system of each master having apprentices was designed to secure a continuous supply of competent workmen for the future. The young man entered the trade as an apprentice, and was bound to a master for a number of years, differing in different crafts, but frequently seven years. The parents of the apprentice usually signed a contract which guaranteed that clothing, food, and lodging should be provided by the master, in addition to the understanding that he should teach the apprentice all that he himself knew about the trade. The contract protected the master by stipulating that the apprentice, on his part, was bound to keep the trade secrets of his master, obey his orders, and work in his shop. It happened occasionally in French gilds that the apprentice received a small salary after the first two or three years, if the craft authorities recognized him as a capable workman. In England, this sometimes occurred after the fifth year, or a little pocket-money was given for

⁶ *Op. cit.*, p. 95.

the first few years. In general, however, the apprentice was unpaid. The craft limited the number of apprentices that a master might keep; for example, to that which a master could "keep, inform, and teach." The slaters of New Castle had a requirement that a master should not take a second apprentice until the first had served six or seven years. These regulations make it clear that the instruction given by a master was of the most approved individual nature. In the beginning, this policy of apprenticeship regulation aimed to secure thorough training, but later it was dictated by the selfish motive to crush competition. In time, the guilds strictly regulated admission to apprenticeship. Foreigners and certain stipulated classes were excluded, and in some instances even those who used husbandry until the twelfth year.⁷

At the expiration of his term of apprenticeship, the young artisan became a "journeyman" or full workman, and continued in the shop of his master as a regular wage-earner. If the journeyman was frugal, he managed to save enough money from his wages to set up an independent shop of his own, and as soon as he had produced an article of the trade which fulfilled standards set by the guild officials, he became a master workman. In this capacity he trained apprentices in his own shop, and employed journeymen at wages. Since shops were in the homes of artisans, they were of necessity small, and so few apprentices and journeymen were employed that differences in the position of the different classes of workmen were not great, thus making the relations of master and man of a very personal nature.

⁷ *Ibid.*, pp. 89-90; see also Cunningham, W.—*Growth of English Industry and Commerce*, 4th edition, 1905, pp. 336-53.

ACTIVITIES OF THE CRAFT-GILDS

Each gild had a very definite organization. There were rules and regulations providing for officials and their powers, the time and purpose of meetings, common religious observances, feast days, fines and benefits of members, the presentation of "mystery plays," and other activities.

Strict rules governing the manufacture of goods endeavored to prevent fraud and to secure the observance of certain standards of size and quality in the production of trade articles. Whenever an article was made in violation of these regulations, it was termed "false." False work was penalized by fines, one half of the fine going to the town funds, and the other half to the gild treasury. A workman who offended three or four times was expelled from the craft. Deceitful devices, such as placing better wares on the top of the bale to cover up inferior articles beneath, the moistening of groceries to make them weigh heavier when sold, and the sale of second-hand articles for new wares, were likewise punished. Persons who did these things were held in contempt. The odious terms "regrators," "forestallers," and "engrossers," were applied to those who bought low, and without adding to the value of an article, sold it at a higher price; to those who bought their supplies secretly, before they had been offered for sale in the open market; and to those who attempted to corner the supply of a necessary article. Yet such devices are all too frequently considered marks of business acumen and enterprise at the present time.

The craft authorities prohibited night work in order to prevent fraud, because the gild-wardens did not inspect work at night, and because the noise of manufacture disturbed the slumbers of the neighborhood. For example

the gild of spurriers forbade night work that no one might have the opportunity to "introduce false iron, and iron that has been cracked, for tin," and to prevent similar practices in the trade. They also observed that night work tended to encourage "wandering about all day," until the drunk and frantic artisans took to their work at night "to the annoyance of the sick and all their neighborhood as well, by reason of the broils that arise between them and the strange folk who are dwelling among them." There was also peril to the whole community from the vigorous way in which these drunken workmen blew up their fires until they blazed high and sent out showers of sparks. The gild regulations therefore conclude: "By reason thereof, it seems unto them (the gild) that working by night should be put an end to, in order to avoid false work and such perils."⁸ Thus the desire to preserve good trade standards and avoid giving offense, rather than dread of long hours on the ground of humanitarian principles, was the guiding motives in these regulations.

The social and charitable side of the gild regulations is well illustrated by the rules of the white tawyer's gild. A money-box was provided and "if by chance any of the said trade shall fall into poverty, whether through old age or because he cannot labor or work, and shall have nothing with which to keep himself, he shall have every week from the said box, seven pence for his support, if he be a man in good repute." Dependents were also provided for thus: "And after his decease, if he have a wife, a woman of good repute, she shall have weekly for her support seven pence from the said box, so long as she shall

⁸ Riley, *Memorials of London*, pp. 226 *et seq.*; trans. by Cheney, Tr. and Rp., vol. ii, no. 1.

behave herself well and keep single." A further regulation directs that "if any one of the said trade shall depart this life, and have not withal to be buried, he shall be buried at the expense of their common box."⁹ There was also the obligation upon gild members to attend the vigil of a deceased member.

The duties and powers of such gild officials as masters, wardens, or stewards, extended to supervision over the work of members, preservation of order at the craft meetings, discipline of journeymen and apprentices, settlement of disputes in the trade, administration of the gild's charities, and representation of the gild before the town authorities.

Although the economic and commercial activities of the artisan's life were the chief concern of the organized craft, the guilds did not neglect religious matters. Guilds were especially dedicated to the worship of some saint, and upon the patron saint's day, as well as at the funerals of members, common religious observances were held at which members walked in procession, dressed in common suits of their craft livery. It was customary to maintain a shrine in some neighboring church where candles, purchased with sums placed in the gild-box, were kept burning. Like the Roman *collegia*, these medieval guilds had their semireligious feast-days, when all the members gathered together to dine and enjoy social intercourse.

⁹ *Ibid.*, pp. 232 *et seq.*

CHAPTER XI

THE DECLINE OF THE CRAFT-GILDS

MEDIEVAL gilds performed a great service for the advancement of industrial and social organization. The middle-class population of Greece and Rome had been demoralized by the disproportionate growth of a class of large landholders on the one hand, and a great class of agricultural slaves or serfs on the other. It was not until the rise of medieval gilds that the middle class again appeared in the social organization of Western Europe. Within the protective shelter of the merchant and craft-gild organizations, there gradually "grew up a wide middle class of opulent traders and comfortable craftsmen," which brought about the transformation of feudal society into the modern society.¹ This middle class has been an important factor in securing the economic and social stability of our contemporary civilization. Before the rise of the gilds, there was no such class. Powerful feudal nobles, with their predatory practices, made the age one of violence and insecurity. There was no strong national government to protect the interests of individual artisans and traders. Gradually the gild organization won power with which to protect the interests of the commercial and industrial classes, and brought into being the "bourgeoisie."

The medieval period was one in which society was permeated with moral conceptions of the obligation to do

¹ Ashley, *op. cit.*, vol. ii, pp. 101, 168.

good work and the dignity of labor, conceptions quite foreign to antiquity. Ashley points out that the later Middle Ages was a time "when elementary conceptions of good and honest work needed to be driven into the general conscience by minute rules vigorously enforced; when what was required was discipline, rather than spontaneity."² Hence the craft-gild regulations governing quality and standards of production were of immense moral as well as practical value in helping to stabilize the then chaotic condition of manufacturing industries. These rules helped in considerable measure to solve the difficult problems raised by the conflict of interests of consumers and producers. Contemporary competition tends to sacrifice the welfare of the producer on the assumption that the workman can live if only articles are cheaply enough produced. As a contrast to this laissez-faire attitude, happily a passing phase of the social conscience, the ideal of the craft-gild was to combine with good quality and a fair price to the consumer, good working conditions for the producing class.

But no human institution can persist indefinitely without modifications in structure and function that permit adaptation to changing social interests and external conditions. We have seen how the gild merchant gave place to the craft-gild in the life of English towns. Now the craft-gild was similarly to be superseded by new forms of industrial organization better adapted to the new conditions which grew out of the expansion of industry to national proportions, and the extension of commerce to the New World. The craft-gild was "in its essence a system of control,"³ and its restrictions, which sought only the protection of guildsmen, inevitably worked some harm to

² *Ibid.*

³ Ashley, *op. cit.*, p. 167.

outsiders. Further than this, the protective legislation itself tended to become a restraining factor which injured the future prospects of the very system it was designed to foster. Personal initiative was crushed, and enterprise in adopting new inventions and introducing improvements was stifled. So we discover that the normal succession of the grades of apprentice, journeyman, and master craftsman, was gradually broken in upon; for not all of those who started as apprentices might hope to attain the highest industrial ranking. There was a numerically increasing class of workmen who were destined always to remain employees in the shop of some master craftsman. By the fourteenth century, a true "working-class" had arisen.⁴ The growth of this industrial proletariat was the consequence of a variety of causes not yet completely understood. But the main factors responsible for the decline of the English craft-gilds with which this phenomenon was associated were: injurious regulation of internal affairs; a change in the location of manufacturing industries; and increasing control of economic activities by the central government.⁵

INTERNAL DEMORALIZATION

The selfish desire of those who were prominent in the craft to secure a monopoly, gradually gained such ascendancy that gild regulations became injurious. Almost prohibitive fees were charged to all who desired to enter the craft and receive the privileges gild members enjoyed. In some cases the master craftsmen pursued a deliberate policy of exclusion. In 1480, there was a plea for the

⁴ Ashley, *op. cit.*, p. 102.

⁵ Cheney, *op. cit.*, pp. 147-161; see also Kramer, S.—"The English Craft Gilds and the Government," *Studies in History, Economics and Public Law*, vol. xxiii.

reduction of excessive fines assessed on apprentices who entered the mercers' guild of Shrewsbury. In 1531, Parliament limited the entrance fee to two shillings and sixpence, and the fee at completion of apprenticeship to three shillings and fourpence. The town council of Oxford enacted, in 1531, "that no occupation for crafts within the town of Oxford and the suburbs of the same shall take of any person that shall come to be brother of their crafts above the sum of 20s.; and if the same craft or occupation take any more than the same 20s., that then the same occupation or craft to forfeit to the use of the town coffers, 40s."⁶ Another irksome restraint upon individual initiative was the requirement that the term of apprenticeship be rigidly fixed at seven years. The whole situation was further complicated by the guilds' struggle with aliens, and the increasing difficulty of suppressing disorder among apprentices. There are instances in which master craftsmen required their apprentices at the time of indenture to take oath that when they completed the period of apprenticeship, they would not set up an independent establishment. This regulation was obviously designed to curb the competition which would inevitably arise if the number of independent shops should increase. Then it was not a period of great business enterprise, so that no doubt the mere lack of initiative, combined with inability to procure capital, prevented a large element from passing through the stage of journeyman and rising to master craftsmanship.

These various conditions must have helped to create a sort of class-consciousness among the wage-earning artisans, for we find the journeymen organizing themselves into "yeomen guilds," or "journeymen guilds." Be-

⁶ *Records of Oxford*, 107, quoted by Ashley, *op. cit.*, p. 105.

tween 1383 and 1696, there were such associations among the cordwainers, tailors, blacksmiths, carpenters, drapers, ironmongers, founders, fishmongers, cloth-workers, and armorers of London. We also find these organizations among the weavers in Coventry, the tailors in Exeter and Briston, and the shoemakers in Oxford.

Although there was at first natural opposition to the new societies on the part of masters,—an opposition sanctioned and supported by the town authorities,—in the course of time they received recognition and came to occupy a somewhat subordinate position in a number of different crafts. Like the older craft-gilds, they gained the right to hold meetings, have officers, possess a livery of their own, hold feasts, and administer charitable funds for their members. It was common to have written agreements which defined the relations of the yeomen gilds and the craft-gilds. For example, the craft of blacksmiths of London granted certain privileges to “the brotherhood of yeomen” in 1434. But the similarity of the journeymen gilds to the craft-gilds is confined to points of organization, for they enjoyed no general control over industry like the craft-gilds. Ashley comments upon the fact that the London ordinances give evidence of the existence of common agreements among journeymen not to work, in this respect exactly of the same nature as modern strikes.⁷ For example: “Whereas, heretofore, if there was any dispute between a master in the trade and his man (vadlett), such man has been wont to go to all the men within the city of the same trade; and then, by covin and conspiracy between them made, they would order that no one among them should work or serve his own master, until the said master and his servant man had

⁷ *Ibid.*, pp. 103-4.

come to an agreement; by reason whereof the masters in the said trade have been in great trouble, and the people left unserved; it is ordained, that from henceforth, if there be any dispute moved between any master and his man in the trade, such dispute shall be settled by the wardens of the trade. . . .”^s

While this process of class differentiation proceeded, within the old craft-gilds, to separate the master craftsmen from the journeymen, changes were also taking place within the group of master artisans themselves. Masters in the same trade came to have unequal powers and positions. The wealthier craftsmen gained a larger share in the administration of the affairs of a gild than their humbler colleagues. In the larger London companies, the more well-to-do masters possessed the means to purchase the expensive suits of livery worn by members on public occasions, and so came to be called “of the livery,” in contrast to those “not of the livery.” This distinction became an accepted sign of class or station in the company as early as the close of the fifteenth century. This aristocratic tendency is further seen in the practical administration of affairs of the wealthier companies by a smaller, exclusive group of masters, often called the “Court of Assistants.” Members of this body enjoyed greater power and privileges than the rest, and with the wardens and officials executed the important prerogatives of gild government. By the end of the sixteenth century, the old democratic organization of the gild, under which journeymen had participated in some of the minor elements of membership and looked forward to full participation when they should become masters, and according to which master craftsmen were on an equality

^s Quoted by Ashley, *ibid.*

in gild counsels, had given place to an aristocratic organization based on class-interests and wealth. The gilds had become close-corporations, controlled by and in the interest of a comparatively small group that subordinated craft-interests to the selfish desire to perpetuate itself.

EXTERNAL INFLUENCES

One evidence of the growing power of the central government in England is seen in its interference with internal economic activities. As time passed, the craft-gilds were subjected to increasing governmental interference. The exclusiveness of the later organizations, the complaints of the people, the desire to provide workmen with sufficient employment, and other influences, combined to encourage legislative control by the government.⁹

This intervention by the government in craft-gild concerns may be traced through a series of acts beginning with that of 1388, which demanded detailed information of the gild system; the act of Henry VI in 1437, which provided for registry of gilds before justices of the peace; the act of Henry VII in 1503-04, which set in authority over the craft statutes, the highest executive officials of the crown, and empowered them to settle craft disputes; the acts of Henry VIII, in 1531 and 1537 respectively, which forbade the membership fee to exceed twenty shillings, and provided penalties for masters who forced their apprentices to take oath not to set up independent establishments after their period of indenture had elapsed; the drastic act of Edward VI in 1547, which confiscated for the use of the crown all property of the purely social and religious gilds and that part of the

⁹ Cunningham, W.—*Growth of English Industry and Commerce*, pp. 506-25.

property of the craft-gilds used for religious purposes; ¹⁰ and the "Statute of Apprentices," in the year 1563 of the reign of Queen Elizabeth, which remained a law for two hundred and fifty years.¹¹

The Elizabethan statute of apprentices, while primarily a reënactment of previous statutes, extended to all industry and made general certain conditions and methods of production which had first been formulated by the craft-gilds. Certain features of the old system had improved the quality of product to such an extent that they had commended themselves to all observers, and it was but natural for the government to require their introduction into new industries which were growing up outside the sphere of craft control. This famous statute, in the first place made labor compulsory, and required justices of the peace to meet annually in each locality to fix the rate of wages for every kind of industry; in the second place, every person who engaged in any trade was required to serve a seven years' apprenticeship; in the third place, the working day was set at twelve hours in summer, and while daylight lasted in winter; and in the fourth place, except for piece-work, all engagements were to be for the term of a year, with six months' notice in case of close of contract by either party.

It is evident from this series of acts that the exclusive control of industry was gradually passing away from the craft authorities, and that the government undertook to regulate the relations of masters to journeymen and apprentices. Yet economic historians find there was no violent break in the continuity of craft activity caused

¹⁰ Gibbins, *op. cit.*, pp. 207-208.

¹¹ Kramer, *op. cit.*, pp. 40, 45, 61, 78-79, 85, and 88-123; also Cheney, *op. cit.*, pp. 154-59.

by these acts,¹² but rather a gradual transformation, due to slowly acting economic causes which have been previously mentioned and which we shall subsequently outline.

¹² Ashley, *op. cit.*, p. 155, and Kramer, *op. cit.*, p. 86.

CHAPTER XII

THE RISE OF THE DOMESTIC SYSTEM

WE have mentioned the growth of a class of wage-earners within the gild organization. Outside the pale of craft-gild control, there had always been artisans who desired to work unhindered by the requirements of gild membership, who had practised the deceitful methods condemned by the craft authorities, or who had prospered because they could adopt new methods and devices of manufacture which the conservative gild officials discouraged. There is mention of the existence of this class of workmen in ordinances of the time, and through the fifteenth and sixteenth centuries we find the efforts of gild authorities to prohibit them from setting up business in towns, unless they had the approval of craft officials, and their attempts to levy fines upon masters who engaged as journeymen newcomers who had not paid their dues, were aided by municipal and national governments. All signs point to a considerable increase in numbers of the labor class.

THE SPREAD OF INDUSTRY TO THE COUNTRY

The unorganized element of the working-class outside the gilds carried on their industry chiefly in the small market-towns and villages bordering on the larger towns of London, Norwich, and York. The fact seems to have been that industry spread from the towns, where gild regulations had been irksome, to the country, where free-

dom from these obstacles might be enjoyed. As early as the fourteenth century, weavers are found carrying on their trade in villages. About the end of the fifteenth century, the growth of this rural industry received great impetus from the introduction of home-manufactured woolens. Cloth began to be produced in accordance with a new system of industrial organization, a kind of organization which economic historians have considered distinctive enough to be characterized as a separate stage in the development of industry. Such marks of the older handicraft system as the small master artisans with their journeymen and apprentices still remained, and the work was still carried on in the artisan's shop, generally with his own tools, but raw materials were usually obtained from a middleman of some sort, and the finished product was always given over to the latter. In this way, the domestic system took from the worker all opportunity of making a profit. The "domestic system," as it is called,¹ was therefore the first step away from the handicraft system, that ideally normal stage of the workman's complete control over all steps in the process of production, and it was the first step towards the modern division of labor which culminates in the "factory system" of to-day.

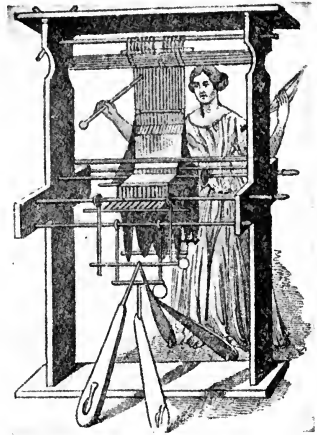

FIG. 4.—A loom of the sixteenth century

Thus there arose in woolen manufacture under the domestic system of industry, a class of merchants or

¹ Ashley, *op. cit.*, pp. 219-20; Seligman, *op. cit.*, pp. 92-3.

manufacturers who are spoken of as "clothiers," or "merchant-clothiers," in the records of the time. They purchased the raw material and gave it out to the carders or combers, spinners, weavers, fullers, and others, who worked in their home-shops in the rural hamlets. After the articles were completed, these middlemen-employers paid the master weavers or other craftsmen who had worked up the raw wool, and gathering the finished material from the countryside, disposed of the product. Gibbins says:

This wool was brought home and sorted, then sent out to the handcombers, and on being returned, was again sent out, often to long distances, to be spun. It was, for instance, sent from Yorkshire to Lancashire, and gangs of pack-horses laden with wool were always to be met plodding over the hills between these two counties. In the same way, silk was sent from London to Kendal and back. When spun, the tops, or fine wool, were entrusted to some shopkeeper to "put out" among the neighbors. Then the yarn was brought back and sorted by the manufacturer himself into hanks, according to the counts and twists. The hand-weavers would next come for their warp and weft, and in due time bring back the piece, which often was sent elsewhere to be dyed. Finally, the finished cloth was sent to be sold at the fairs, or at the local "piece halls" of such central towns as Leeds or Halifax.²

In this way, those steps in the process of production which immediately preceded actual manufacturing manipulation and immediately followed the completion of separate articles by this process, were taken from the control of the workman and appropriated by a separate class. In a few cases the small manufacturer still purchased his own materials and delivered the finished article to his customer, or took it to town on market days.

² *Op. cit.*, pp. 338-9.

Here we have a real employer class who provided the raw material, furnished much of the money capital, and undertook to sell the completed goods. Naturally, the condition of domestic manufacture varied widely in different regions. In general, the cottage workman was more independent in the northern than in the southern section of England. The capitalistic control of industry in the south involved not merely provision of raw materials by the "merchant manufacturer," but in some cases, such as in stocking and silk manufacture, went so far as to extend to the ownership of the artisan's tools. In this way the rise of the domestic system in the villages, beginning in woolen manufactures and soon extending to other trades, undermined the guild control of industry and slowly prepared the way for our modern factory system.

THE SPREAD OF WOOLEN MANUFACTURE

An important element in the domestic system was the existence of a number of small master-manufacturers, who were entirely independent and combined small farming with their industrial activities.³ Defoe has drawn for us an interesting picture of life under the domestic system as it existed near Halifax, in Yorkshire. "The land was divided into small inclosures, from two acres to six or seven each, seldom more, every three or four pieces of land having a house belonging to them; hardly a house standing out of speaking distance from another. We could see at every house a tenter, and on almost every tenter a piece of cloth or kersie or shalloon. At every considerable house there was a manufactory. Every clothier keeps one horse at least to carry his manufactures to the market; and every one generally keeps a cow

³ Toynbee, A.—*The Industrial Revolution*, London, 1902, p. 53.

or two or more for his family. By this means the small pieces of inclosed land about each house are occupied, for they scarce sow corn enough to feed their poultry. The houses are full of lusty fellows, some at the dye-vat, some at the looms, others dressing cloths; the women and children carding or spinning; being all employed, from the youngest to the oldest.”⁴

This transition stage of industry, from the more or less stable handicraft to the more or less stable factory system of to-day, is so interesting that two more quotations will not be amiss. According to one description⁵ of life in the northern counties of England:

The village combined agricultural with industrial occupation; the click of the loom was heard in the cottages; the farmyards and the fields, the cottages and the allotment gardens, made a delightful picture of rural life. The land was mainly freehold; the farmers were of the yeoman class, and not infrequently combined the calling of a clothier or master manufacturer along with that of farming. The farmer's wife, although born with a silver spoon, was industrious and thrifty; with her own hand she would churn the butter, make the cheese, cure the bacon and ham, or bake the bread; her daughters would assist in spinning the yarn, or knitting the stockings; and from the cloths woven under their supervision they would, with the assistance of the village dress-maker, make their own dresses. If you entered one of the cottages, you would find the master of the house in the “chamber,” sitting at the loom, busy throwing the shuttle, weaving a piece of cloth; his daughter would be sitting at the wheel, spinning weft; and the good wife would be busy with her domestic duties. One son would be out working on the land for the farmer; another would be working on the weaver's allotment. Down in their little allotment plot, they grow their own vegetables, and a little crop of oats which they have ground into oatmeal for making their porridge; they also keep a pig or two, and provide their

⁴ *Tour*, iii, pp. 144-6.

⁵ Illingworth, T.—*Distribution Reform*, London, 1885, p. 81.

own bacon and ham. They are on good terms with the master-manufacturer—that is, the gentleman who gives them warp and weft to weave into cloth. . . . Their chief articles of food are produced from the land immediately surrounding them. Their means of subsistence and comfort are not to be computed by the amount of their earnings in money-wages, but the produce of their bit of land, and the ease and cheapness with which they can obtain other necessities.

This simple system was pretty well diffused throughout the country-side, and the conditions of work just mentioned show that the wage-earning class enjoyed many comforts and advantages which have been denied them under the factory system. On this point Gibbins remarks :

For one thing, they still lived more or less in the country, and were not crowded together in stifling alleys and courts, or in long rows of bare, smoke-begrimed streets, in houses like so many dirty rabbit-hutches. Even if the artisan did live in a town at that time, the town was very different from the abode of smoke and dirt which now prevails in manufacturing districts. It had a more rural character. There were no tall chimneys belching out clouds of evil smoke; no huge, hot factories with their hundreds of windows blazing forth a lurid light in the darkness, and rattling with the whirr and din of ceaseless machinery by day and night. There were no gigantic blast-furnaces rising amid blackened heaps of cinders, or chemical works poisoning the fields and the trees for miles around. These were yet to come. The factory and the furnace was almost unknown. Work was carried on by the artisan in his little stone or brick house, with the workshop inside, where the wool for the weft was carded and spun by his wife and daughters, and the cloth was woven by himself and his sons. He had also, in nearly all cases, his own plot of land near the house, which provided him both with food and recreation, for he could relieve the monotony of weaving by cultivating his little patch of ground, or feeding his pigs and poultry.⁶

⁶ *Op. cit.*, pp. 327-8.



**PART IV. GREAT SOCIAL REVOLUTIONS
OF MODERN TIMES**



CHAPTER XIII

INTRODUCTORY

IN recent times there have occurred certain great transformations in human society which find their causes in three changes in economic and social relations that have come with such a degree of suddenness as to be veritable revolutions. Without an understanding of these three great revolutions, it is almost impossible to fully appreciate the meaning of the problems of the modern social order. For centuries during antiquity, and for centuries after the decline of Roman civilization, the economic basis of social relations experienced no rapid or thoroughgoing change, but almost simultaneously there came, in the later eighteenth and extending through the nineteenth and early twentieth centuries, fundamental changes in agricultural and manufacturing industries, and in transportation and communication.

It is characteristic of each of these great revolutions that their standardizing effect spread with relative rapidity throughout the populations of Western Europe and America. In this respect they differed from political revolutions which, even if their effect extends, are almost always profoundly modified by the existing and traditional political structure of each locality. There seems, thus, to be in these three great revolutions described, a massive elemental character suggestive of natural, rather than of man-made law, for before their majestic sweep, traditional ways and usages have everywhere crumbled

and given place to standardized production and exchange, and the other great uniformities of modern life.

It is as a result of these three revolutions that we are able to say that the very basis of modern social organization differs significantly from the social organization of antiquity, or even of later medieval times. The great common agent of these revolutions was and is machinery and mechanical power.

The first two revolutions modified the existing economic structure and brought a sweeping change in the ratio of man-power to agricultural and manufacturing production. It is estimated that with modern farm machinery and the new methods of agriculture, fifty men can do the work and produce the supplies that five hundred peasants without these improvements were able to produce. The four hundred and fifty men thus released from agriculture, and perhaps from rural residence, entered industry and commerce, or went to swell the populations of towns and cities.

Turning from agriculture, we find that in the manufacture of screws, as an example, the ratio of machine to hand production is 4491 to 1. That is, a man with modern machinery can produce over four thousand times as many screws in the same space as he could produce by hand labor. For the first time in the history of the world, unskilled and untrained workers can produce standardized articles of a quality equal to, and sometimes the superior of, those formerly produced by the painstaking labor of highly skilled artisans. All this has been made possible by machinery. Consequently, there has been an increasing demand for cheap labor, a growing concentration of industry in certain centers, and a redistribution of population from rural to urban conditions. These trans-

formations have involved changes which will be described in the following chapters.

The third great revolution, that which has occurred in methods of transportation and in the mechanism of communication, has profoundly affected the thought-life, as well as the economic life, of the masses by introducing artificial motor power into transportation, and by bringing into use a new and elaborate mechanism of communication. Before the standardizing influence of these changes, local prejudices, superstitions, and provincial limitations are melting away. The increased facilities for travel and personal mobility in general, combined with the remarkably efficient mechanical devices for the transmission of intelligence, constitute a long step in the direction of equality of opportunity, and supply a firm and enduring basis for democracy.

CHAPTER XIV

THE AGRICULTURAL REVOLUTION

VIEWED in its true historical background, the rapid growth of cities in recent times is not such a disturbing phenomenon as our study of Greek and Roman experience with urban increase might lead us to expect. For, parallel with it, there has been an accelerating improvement in agricultural methods. Hence, we are not in such immediate danger of experiencing an excess of consumptive activities over productive activities as were the peoples of ancient Greece and Rome. The economic and industrial foundations of the civilization of Western Europe possess far greater breadth and depth than those of ancient civilizations.

We must remember that the predominant factor in the agricultural economies of Greece and Rome, for the period we have studied, was slave cultivation. It was therefore inevitable that technique should be more or less primitive, and the results inadequate and wasteful. The primitive fertility of the soil was used up, and human, as well as natural resources, were exploited to the fullest extent. We have seen how it became impossible to provide sufficient food for the great metropolitan districts of antiquity, largely because of these same inefficient agricultural methods, and we have observed that the situation was complicated by an unwise public policy which insisted on the necessity of providing grain for the urban populace at reduced rates. Meanwhile, the

state neglected to encourage manufacturing industry, practically the only activity which might be relied upon to give stability to an unbalanced national economy, and provide means with which to pay for importations of food-stuffs. This deplorable situation was still further complicated by the traditional obstacles of preference for agricultural occupations, and the tendency to despise all those who were engaged in commerce and manufacturing.

Contrast with this state of affairs the more wholesome and rational economy of to-day. Agriculture is



FIG. 5.—An old Saxon plow—1000 A.D.

now based upon the productive labor of free men in competitive and coöperative activity. The application of capital on a large scale has permitted an intensive type of cultivation. Exact methods have been so widely applied to the whole range of agricultural economy that it has become a science in itself. Modern governments, especially the Federal Government of the United States, have used their powers to protect, encourage, and stimulate agriculture. Moreover, at the same time that agriculture has been developing a highly organized technique, the industrial activities of modern states have experienced an unprecedented expansion. The combined effect of these tendencies has made it possible for a comparatively small force of labor to obtain from the cultivation of the soil an increasingly greater supply of food-stuffs with which the growing populations of urban and industrial centers can be easily maintained. In other words, the modern growth of cities is not necessarily an unhealthy sign, for the attendant growth of manufacturing industry and agricultural activity produce the necessities

to satisfy the increasing demand in a perfectly natural manner.

From what has just been said, the reader will appreciate the importance of a brief study of modern agricultural evolution in order to gain a clear understanding of the historical background of social economy. We shall, therefore, outline rather briefly the main influences and factors in the revolution of English agriculture during the eighteenth and nineteenth centuries.

The agricultural revolution in England has been selected for study in preference to the experience of other nations because the factors responsible for its coming may be readily understood. In England the transformation of agricultural economy meant three things: the concentration of ownership and control of lands in a diminishing body of proprietors; the enclosure of common lands which had for centuries been the chief means of support of small farmers; and the consequent reduction of rural workers to the status of a wage-earning, agricultural class, along with an exodus of population from the country.¹ But before we examine the steps in this important transition, it will be well to make a brief survey of its historical backgrounds.

SHEEP-RAISING AND ENCLOSURES FOR PASTURAGE

During the early Middle Ages, the prevailing economic activity was agriculture. What little manufacture was necessary to supply the needs of the people was carried on by those who tilled the soil.² We have already had occasion to trace the rise of a separate manufacturing

¹ Ogg, F. A., *Social Progress in Contemporary Europe*, New York, 1912, p. 63.

² Ashley, *op. cit.*, p. 99.

class, but it should be remembered that agriculture was the chief occupation of the English laboring classes until after the middle of the eighteenth century. Of the three great stages which mark its evolution, agriculture had passed through the first stage, that of the old open-field husbandry of early times, and had entered upon its second stage, that of convertible husbandry. At this stage the land is used alternately during a term of years for pasture and for crops—a system which necessitates enclosure of arable land by fences or hedges. This, then, was the condition of English agriculture at the time we

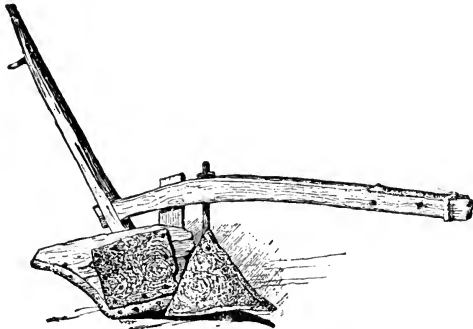

FIG. 6.—A Colonial plow

are now considering, the period which preceded the agricultural revolution.

For a century after 1272, the landowner remained also a cultivator, and lived upon his land. But this method of cultivation gradually disappeared after the Great Plague (1348). The landowner became a mere rent-receiver, although the great feature of this transformation was the growth of the practice of enclosure, according to which large tracts of farm land were turned into pasture for sheep, and fenced accordingly.

Thus it was that after the Great Plague and on through

the sixteenth century the really significant changes in agriculture were to be found in the uses to which land was put, rather than in methods of tilling the soil. We have had occasion to mention the steady growth of home manufacture of woollens. This provided a considerable home market, in addition to the existing market among the cloth manufactures of Flanders, for the products of sheep-farming. Moreover, labor had now become so costly that a use of the land in pasturage, which required comparatively little labor, was more economical than ordinary tillage. Hence, large tracts of land were taken out of cultivation and converted into pastures for sheep-raising. Yet apart from pasturage, cultivation was still carried on in the old ways.

The agrarian situation created by the system of enclosures in the sixteenth century was a serious one. It had become so profitable for landowners to go in for sheep-farming, that they turned their arable land into pastures, with small consideration for the interests of the tenant class. Small tenants were summarily evicted, so that "in this way it comes to pass that these miserable people, men, women, husbands, orphans, parents with little children, are all forced to change their seats, without knowing where to go."³ The rents of the larger tenants were raised to ruinous figures, in one recorded instance from £4 to £16 a year.⁴ Finally the large landowners took the common lands of the poor by enclosure.

The enclosures made at this time were of three kinds: the enclosing of the lord's demesne; the enclosing of certain strips of land which belonged to the lord of the

³ More, Thomas, *Utopia*, Morley's ed., p. 64.

⁴ Latimer, *First Sermon before Edward VI*, cited in Gibbins, *op. cit.*, p. 213.

manor, but which were intermixed with the strips of tenants in the open fields; and the enclosing of common fields, and even the tenant's own strips.⁵ The first and second kind of enclosures were within the right of the lord, but the latter was frequently abused, and convenient pieces of tenant's strips were sometimes taken. It was the third type of enclosure, however, that gave the most trouble and produced the greatest injustice and misery among the people.

Gibbins presents interesting evidence of the results of enclosing, taken from popular songs and parliamentary documents.⁶ In 1536, a petition complains of the new use to which land is put, which "hath not only been begun by divers gentlemen, but also by divers and many merchant adventurers, cloth-makers, goldsmiths, butchers, tanners, and other artificers, and unreasonable covetous persons which doth encroach daily many farms, more than they can occupy, in tilth of corn—ten, twelve, fourteen, or sixteen farms in one man's hands at once . . . in time past there hath been in every farm a good house kept, and in some of them three, four, five, or six plows kept and daily occupied to the great comfort and relief of your subjects, poor and rich. But now, by reason of so many farms engrossed in one man's hands, which cannot till them, the plows be decayed, and the farmhouses and other dwellings, so that when there was in a town twenty or thirty dwelling-houses, they be now decayed, plows and all the people clean gone, and the churches down, and no more parishioners in many parishes, but a neatherd and a shepherd, instead of three score or four score of

⁵ Gibbins, *op. cit.*, pp. 213-14; Ashley, *op. cit.*, pp. 285-87.

⁶ *Op. cit.*, pp. 215-18.

persons.”⁷ Sir Thomas More speaks of the increase of pasturage in England, “by which sheep may be said to devour men and to unpeople towns as well as small villages.” He proceeds to explain the terrible increase of pauperism as due to the enclosures, for the small farmers “would willingly work, but can find none that will hire them, for there is no more occasion for country labor, to which they have been bred, when there is no arable ground left.”⁸ According to Froude,⁹ “the absorption of the small farms had assumed proportions mischievous and dangerous. . . . The great cattle-owners, in order to escape the sheep statutes, held their stock in the names of their sons or servants; the highways and villages were covered, in consequence, with forlorn and outcast families, now reduced to beggary, who had been the occupiers of comfortable holdings; and thousands of dispossessed tenants made their way to London, clamoring in the midst of their starving children at the doors of the courts of law for redress which they could not obtain.” A commission, appointed in 1548, brought back a report of the distressing agrarian situation. The complaints are found voiced in ballads, such as the following:

The towns go down, the land decays,
Great men maketh now-a-days
A sheep-cote in the church.¹⁰

This depopulation of certain sections of rural England and the accompanying trend of population cityward, brings to mind the somewhat similar phenomena in

⁷ *Rolls House M.S., miscellaneous, second series* (Froude), 854.

⁸ *Op. cit.*, pp. 64-5.

⁹ *History*, iv, p. 353.

¹⁰ *Now-a-days*, a ballad (Ballad Society), lines 157-60; quoted by Gibbins, *op. cit.*, p. 216.

Greece and Rome. But the analogy is subject to the qualifications mentioned in the opening paragraphs of this chapter, for we shall see that the worst consequences of the process of land consolidation were largely offset by improvements in agricultural technic.

IMPROVEMENTS IN AGRICULTURE

Agriculture was still the greatest industrial occupation of England in the sixteenth century. Competitive rents were for the first time coming into use, and are an indication of progress. The capital invested in land was in-



From a photograph by Steele & Co.

FIG. 7.—A steam plow at work

creasing, the breeding of horses and cattle advanced, and the use of natural fertilizers became more general. New vegetables were introduced into the country by refugees from the Continent.

Enclosures presently came to be made for the purpose of carrying on improved methods of tillage, rather than for the sole sake of sheep-raising. There was a gradual

revival in arable farming, and as Gibbins says, "the special, characteristic feature of the seventeenth century is the utilization of fallow for roots, . . ." ¹¹ Writers on agricultural subjects appeared and considerable attention was paid to different kinds of manures. ¹² In the eastern counties, the fens were drained and the large districts thus reclaimed, increased agricultural prosperity. Winter roots (turnips) came into use, and in the eighteenth century there was an extension of artificial pastures and an increase in the use of clover, sainfoin, and rye-grass.

The improvements made in fodder were naturally followed by gains in the art of stock-breeding. From the fourteenth to the end of the eighteenth century, a fatted ox seldom weighed much over four hundred pounds. Compared with this the eighteenth-century fatted ox often weighed more than eight hundred pounds. ¹³ Young ¹⁴ estimates the value of stock at nearly £110,000,000 between 1700 and 1777. The increased numbers of stock involved production of larger quantities of manure, and this in turn encouraged a more intelligent use of fertilizers.

Agriculture was now carried on with a view to the market. The old practice of tillage for subsistence alone had largely given place to competitive methods. ¹⁵ Yet survivals of primitive culture were still to be seen in the common-field system which existed in sections of Hallamshire and Yorkshire. ¹⁶ "Never," says Young, "were

¹¹ P. 267.

¹² Cunningham, *Growth of English Industry and Commerce*, vol. II, p. 545.

¹³ Toyubee, A., *The Industrial Revolution*, London, 1902, pp. 43-4.

¹⁴ *Northern Tour*, iv, pp. 340-41; *Eastern Tour*, iv, p. 455.

¹⁵ Cunningham, *op. cit.*, pp. 109-10.

¹⁶ Young, A., *Northern Tour*, ii, 1.

more miserable crops seen than the spring ones in the common fields; absolutely beneath contempt.”¹⁷ It appears that there were three causes for this deficient stage of tillage: first, under the common-field system, no proper rotation of crops was possible, and consequently the same course of cropping continued year after year; second, much time was lost by laborers and cattle “in traveling to many dispersed pieces of land from one end of a parish to another;”¹⁸ and third, there were perpetual quarrels over the rights of pasture and boundaries. These reasons make clear why there was a close connection between the practice of enclosing, and improved methods of agriculture.

THE NEW PERIOD OF ENCLOSURES AND THE AGRARIAN REVOLUTION

The advent of capitalism, and the introduction of invention seem to have been the two main agencies which precipitated the agrarian revolution of the eighteenth century.¹⁹ Yet it is a highly significant fact that while these agrarian changes were making possible the support of growing town populations, and at the same time stimulating the drawing-off of surplus country population to the cities, the industrial revolution and the rise of the factory system, was encouraging the dislodgment of large numbers of people who had always lived by agriculture. It is therefore clear that the two great revolutions in methods of production interacted one upon the other, and their very conjunction in time helped to effect the consummation of the different tendencies that were at work in each group.

¹⁷ *Southern Tour*, ed. of 1772, p. 384.

¹⁸ *View of the Agriculture of Oxfordshire*, p. 100.

¹⁹ *Ogg, op. cit.*, p. 69.

Better cropping, improvements in the art of cattle-breeding, and the introduction of machinery, were important elements in the new agriculture which inevitably involved the use of capital in larger quantities than ever before, and necessitated large-scale cultivation. The tendency towards urban growth, which we have mentioned in connection with the earlier progress of industry, was

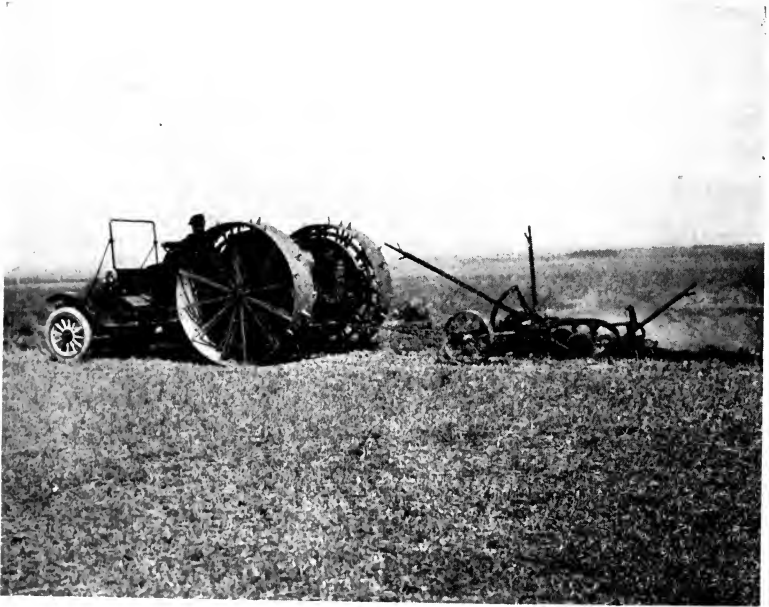

FIG. 8.—Plowing by automobile tractor

enormously accelerated by the rise of great industrial centers, in consequence of the appearance of the factory system and machine production. The farms of the older sort, cultivated for the support of local tenants, gave way before the growing urban demand for foods, and small holdings were enlarged and converted into manufactories of grain and meat. The average husbandman of the eighteenth century possessed an amount of capital and

land wholly inadequate to supply the increased demand. The imperative need for more efficient methods revived the practice of enclosures, and the small farmer lost his rights in the common lands of the parish, and was speedily reduced to the condition of a mere country wage-earner. The new agriculture, therefore, involved the virtual disappearance of the cottager class.

THE DECAY OF THE YEOMANRY

The new movement for enclosure set in early in the second half of the eighteenth century and proceeded with a rapidity and boldness that surpassed the earlier period. Between 1760 and 1843, fully seven million acres were enclosed. There were good arguments advanced for enclosure. The old subdivided and open-field system of cultivation was uneconomical. Enclosure meant redistribution of the open fields and waste-land and meadows of the parish among former possessors of land-rights in a manner that would secure to each person one continuous and enclosed tract equivalent in area to his former scattered holdings in the open fields, together with the rights in meadow and waste-land associated with his former holding.

Unfortunately, this redistribution of agricultural holdings, which had much to commend it, was accomplished in a most iniquitous manner. The process of enclosure was effected by compulsion, as well as by consent. The authorities of the parish made the change themselves, whenever it was possible to secure the unanimous consent of those who enjoyed land-rights within the parish. In practice, it was difficult to secure general consent, and the usual procedure therefore, involved procuring the assent of the possessors of four fifths the aggregate value

of the land concerned, and then the passage of a special act by Parliament which authorized the enclosure, and forced the dissenting minority to agree. Although every person deprived of his former rights received compensation either in land or money, the new arrangement usually was unfavorable to the small holder, for the enclosure measures were, as a rule, drawn up by large landholders and persons of influence in the localities concerned. Moreover, the economic situation of the person of small means was still further injured by the disappearance of the old by-employments of home-manufacture, which had contributed so much to make the lot of the farmer-domestic manufacturer a comfortable one. This situation came about because the domestic system, as we shall soon see, was giving way before the factory system.

The decay of the English yeomanry, unlike the somewhat similar decline of the Greek and Roman yeomanry which had also involved transfer of the property of one class to another, was a sudden and a silent revolution. Toynbee says: "A person ignorant of our history during the intervening period might surmise that a great exterminatory war had taken place, or a violent social revolution, which had caused a transfer of the property of one class to another. But though the surmise in this particular form would be incorrect, we are nevertheless justified in saying that a revolution of incalculable importance had taken place,—a revolution, though so silent, of as great importance as the political revolution of 1831." ²⁰

The class thus demoralized and driven from the country-side, was the small freeholders who had formed one sixth of the population of England down to the close of

²⁰ *Op. cit.*, p. 59.

the seventeenth century. "This sort of people have a certain preëminence and more estimation than laborers and the common sort of artificers, and these commonly live wealthily, keep good houses, and travel to get riches. They are also, for the most part, farmers to gentlemen, or at the leastwise, artificers; and with grazing, frequenting of markets and keeping of servants, do come to great wealth, insomuch that many of them are able to, and do,



FIG. 9.—Gasoline motor plow

buy the lands of unthrifty gentlemen, and often sending their sons to the schools, to the Universities, and to the Inns of Court, or otherwise leaving them sufficient lands whereon they may live without labor, do make them by these means to become gentlemen. These were they that in times past made all France afraid." ²¹

²¹ Harrison, *Description of England*, bk. III, ch. iv, page 13; quoted in Gibbins, *op. cit.*, pp. 276-77.

The law locks up the man or woman
Who steals the goose from off the common;
But leaves the greater villain loose
Who steals the common from the goose.

So runs a protest in current doggerel of the time. But the decay of this sturdy class of small farmers was not a result of the practice of enclosure alone; there were other influences at work. Among them Gibbins mentions the "Statute of Frauds" of 1677, according to which all holdings in land not created by deed, were treated as tenancies at will only, a law which weakened the position of the yeomen. Then the custom of primogeniture and strict settlements tended to limit the subdivision of land into tracts which small holders could afford to buy. Again, the ever-increasing poor-rates of the eighteenth and nineteenth centuries became a burden which small landholders had to bear. Farm laborers could not maintain themselves on the wages paid by large employers of agricultural labor, and so it resulted in transferring the burden of support by taxation to the shoulders of the yeoman class.²² Finally, wages were falling and rents rising.

By 1845 the agricultural revolution had run its course, and the process of readjustment had created "three great classes of men engaged in the English agriculture of later times and of to-day: (1) the landed proprietors, who let out their land in large quantities to farmers in return for as considerable a rental as they can obtain; (2) the farmers, who, possessing no proprietary interest in the soil and no direct community of interest with either the landlords or laborers, carry on agricultural operations upon these rented lands as capitalistic, profit-making enter-

²² Gibbins, *op. cit.*, pp. 276-83.

prises; (3) the agricultural laborers who neither own land nor manage it, but simply work under orders for weekly wages, as do the operatives in the factories.”²³

AGRICULTURAL MACHINERY

Although the history of English agriculture gives us a condensed picture of the agricultural revolution in so far as it has involved concentration of ownership, enclosure of lands, and the creation of a rural wage-earning class, it is to America we must turn for a view of the effects of agricultural machinery upon rural life. The vast fertile plains of the central and western parts of the United States afforded an opportunity for the application of machinery to agriculture on a scale undreamed of by English cultivators.

It was not until 1837 that the first steel plow was made. Then came the gang-plow, drawn by five horses. This invention made it possible for a man to plow five acres a day, and it seemed that the acme of progress had been attained. But at the present time a 110 horse-power machine plows a strip thirty feet wide at a rate of three or four miles an hour, and does all the harrowing at the same time. Under favorable conditions, it is possible to plant from ten to twelve acres an hour, thus performing the work ordinarily done by forty or fifty teams and as many men.²⁴

The old-fashioned harrow has undergone a remarkable evolution. To-day we have the peg-tooth, spring-tooth, disk, spader, and pulverizer harrows, drawn by horses in the wake of the plow, and capable of covering a four- to

²³ Ogg, *op. cit.*, pp. 63, 72; Cheney, *op. cit.*, pp. 222-23.

²⁴ "Farm Machinery as a Labor Saver," *Ency. of Amer. Agri.*, vol. I, pp. 208-09.

twenty-foot swath. One of the latest inventions is a harrowing machine with a 100-foot reach, which harrows thirty acres an hour.²⁵

The mowing-machine was patented in 1831, and reapers were made practicable by 1840. The first steam-thresher appeared in 1860, and five years later 250,000 machines were in use. In 1880, the United States had become the greatest wheat exporter of the world, chiefly because wheat-threshing and twine-binding were done by machinery. The cultivation of corn has been improved by the check-rower, the lister, the weeder, the riding-cultivator, and other machines.²⁶ The universal problem of motive power has finally been solved by the invention of the automobile traction-motor.

This series of brilliant inventions has had the effect of tremendously increasing agricultural output, and at the same time diminishing the need for manual labor. By modern machine-methods, the sowing of small grains is accomplished in about one fifth the time formerly required for hand-sowing. The modern harvester displaces seven men, and the modern threshing-machine has displaced from fourteen to twenty-nine farm laborers. It is estimated that the average increase in labor efficiency during the past two generations, because of the application of machinery to the nine more important crops of the United States, has been five hundred per cent.

The financial results of these improvements in farm machinery have been summarized by an authority as follows: "In 1830 it required over three hours of labor to raise a bushel of wheat; in 1896 it required but ten minutes—a saving of over fourteen cents a bushel; in 1850

²⁵ Fiske, G. W., *The Challenge of the Country*, 1912, p. 78.

²⁶ *Ibid.*, pp. 75-77.

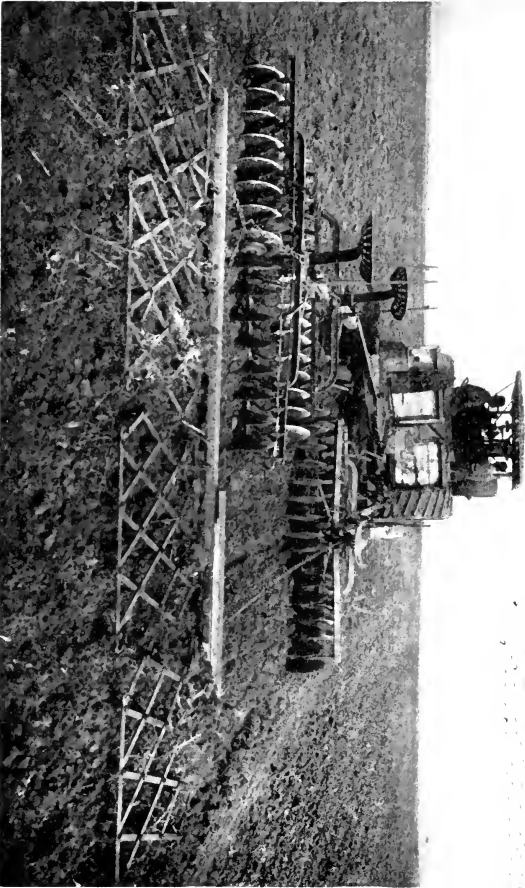

Fig. 10.—Disking and harrowing by steam



it required four and one-half hours of labor to raise a bushel of corn; in 1894 it required but forty-one minutes; in 1860 one ton of hay represented thirty-five and one-half hours of labor; in 1894 this labor was reduced to eleven and one-half hours."²⁷

Farm machinery has thus enormously increased the productivity of the land and of the farmer. It has caused a rapid increase in financial returns from crops, because the cost of production has fallen with the introduction and substitution of machine-power for manual labor. But it has meant more than the displacement of farm laborers; it has materially reduced the hard, grinding, back-breaking labor which produced such meager returns that the farm boy often grew into the hopeless and prematurely aged man, or gave up the struggle and ignominiously retired to the city. Before the conquering advance of agricultural machinery, the drudgery of farm life is gradually retreating, and now the rural population may confidently look forward to a time when the great majority of farmers will be relieved of the deadening manual routine to a degree that will permit released energies to be turned towards self-development and education.

²⁷ Gillette, J. M., *Constructive Rural Sociology*, 1916 ed., p. 150.

CHAPTER XV

THE INDUSTRIAL REVOLUTION

IN the latter part of the eighteenth century there began to take place a momentous change in industrial methods which was accomplished with comparative rapidity in England, although the full effects of the revolution came more slowly in other countries. But this industrial revolution was of far-reaching importance for the whole civilized world, since it involved a complete transformation of manufactures and an abrupt break with much that had gone before.

While many influences combined to bring the revolution in industry to England before it came to other countries, there were three conditions which appear to be of paramount importance in working the change. ¹ There was a relatively greater abundance of capital and skilled labor in England than in France or Germany in the eighteenth century. ² We have already had occasion to note the extension of woolen manufacture in England, an extension accompanied by a widened control over domestic industry by the merchant-manufacturers who provided the raw materials, often owned the tools of the trade, and paid the combers, weavers, dyers, and fullers for their labor. ³ Finally, the early appearance and rapid development of mechanical inventions in the field of textile manufacture was an essential in working the change from the old to the new. In varying degrees, then, these three

conditions favored the transformation from the domestic system to the factory system of industry.¹

The early and rapid progress of mechanical invention in England seems to have been a result of the constant expansion of commerce and the steadily increasing demand for English-manufactured goods for export, in combination with the practical turn taken by English genius in the eighteenth century. England had secured almost a monopoly of the markets of the world by her monopoly of the seas. She built up her great marine empire by certain mercantile policies of a restrictive nature. The sixteenth and seventeenth centuries witnessed an extension of national economy and state regulation which superseded town and local economy and aimed to secure increased national power and wealth. The growing importance of a regular military establishment as the basis of national power, necessitated great supplies of gold and silver with which to maintain national influence. In the absence of domestic resources in precious metals, statesmen sought to amass treasure by a "favorable balance of trade" in which the value of national exports exceeded the value of national imports. Consequently, a great system of restrictive legislation was created to secure this favorable balance of trade, and we find laws encouraging the importation of treasure, prohibiting the exportation of treasure, generally discouraging import trade, generally encouraging export trade, favoring industries which produced for export, and restricting the importation and exportation of goods to English-built and manned vessels. Although England's persistence in the enforcement of these latter "navigation acts" lost for her the monopoly of a chief

¹ Ogg, *op. cit.*, pp. 83-84; Gibbins, *op. cit.*, p. 341.

market (the American colonies), her policy of restriction made her supreme upon the seas and in the other markets of the world, so that demand for her manufactured goods became intense enough to stimulate industrial competition and arouse the inventive abilities of her workers. We shall now consider the conditions under which this burst of mechanical invention occurred.

THE INADEQUACY OF DOMESTIC MANUFACTURE

On the eve of the revolution, the increased demand for English-manufactured goods was still supplied by the antiquated methods of domestic industry. Although foreign trade had increased enormously, industrial organization remained the same as it had been for more than two centuries. Cotton and woolen cloth were still produced in the scattered cottages of domestic weavers and weaver-farmers who still used the hand-card, the old-fashioned spinning-wheel, and the cumbrous hand-loom. Primitive conveyances were used to collect the finished goods from the domestic shops in the hamlets and towns, and to deliver them at the seaports.

The extent to which the increased demand for manufactured goods pressed upon these inadequate methods of production is revealed by a study of the process of cloth-making in its details. The raw material of the textile industry, whether it be wool from sheep, the boll of the cotton, or the crushed stems of flax, is a tangled mass of fibers. The first requisite is to straighten out the threads of this fiber by combing or carding. This process was done by hand under the domestic system. The second step is spinning. This involves drawing out the fibers which the first step has separated, until they form a slender cord, meanwhile twisting the fiber-cord suf-

ficiently to cause the separate fibers to take hold upon one another, thus making a thread of greater strength. This process was done either on the old high wheel, whirled by hand and wound on the spindle, or on the old-fashioned spinning-wheel, operated by a treadle, while the material was drawn out by hand, and twisted and wound upon the flyer. The third step was weaving. For this process, it was necessary to select firmly spun threads for the "warp" of upright threads, and soft, or loosely spun threads for the "woof," or "weft." This was wrapped on a shuttle, and thrown by hand between the two diverging planes of warp-threads. The weaving process was followed by processes of finishing, fulling, shearing, and dyeing, according to the kind of cloth desired.²

In order to keep a continuous supply of materials flowing through the successive steps in these processes of manufacture, it was necessary to secure a close articulation of the various stages. It was just here that the system broke down as a means of supplying the growing commercial demand, for spinners could not keep the weavers supplied with enough thread to permit their meeting increased orders for cloth. Under the domestic organization of industry, spinning was done by women and younger children in the home with the antiquated spinning-wheel. The rate at which they could produce sufficient thread to keep the weaver constantly busy, required a ratio of about six spinners to one weaver. Naturally this proportion of labor was not always found, and it was frequently necessary to hunt up outside help to relieve the pressure on the spinners. This necessitated delays and inconveniences. The lack of adjustment between the supply of spun material and the demand for it

² Cheney, *op. cit.*, pp. 205-06.

on the part of weavers, was still further accentuated by the invention of Kay's drop-box and flying-shuttle in 1738, which permitted one man to sit still and throw the shuttle to and fro by alternately pulling two cords, thus eliminating the need for more than one person in operating the loom. No corresponding change had been introduced which would accelerate the process of spinning.

So keenly felt was this need for better spinning processes, that the Royal Society offered a prize for the invention of a machine that would spin several threads at the same time. Although this reward was never claimed, a series of brilliant mechanical inventions appeared shortly after the middle of the eighteenth century, and as soon as the manufacturing difficulties which we have enumerated were overcome, production increased by leaps and bounds.

MECHANICAL INVENTIONS AND MACHINE POWER

It is hardly possible to exaggerate the importance of these inventions, for they "explain the world in which we live, with its busy cities, its gigantic factories filled with complicated machinery, its commerce and vast fortunes, its trade-unions and labor parties, its bewildering variety of plans for bettering the lot of the great mass of the people. The story of the substitution for the distaff of the marvelous spinning-machine with its swiftly flying fingers, of the development of the locomotive and the ocean steamer which bind together the uttermost parts of the earth, of the perfected press, producing a hundred thousand newspapers an hour, of the marvels of the telegraph and the telephone,—this story of mechanical invention is in no way inferior in fascination and

importance to the more familiar history of kings, parliaments, wars, treaties, and constitutions.”³

Inventions were first introduced in cotton manufacture, and applied to the spinning process, which we have observed was already out of adjustment with the weaving process. In 1770 James Hargreaves, a Lancashire weaver, patented the “spinning-jenny,” a machine which he had completed in 1764. The device was a simple one. It consisted of a frame with a number of spindles side by side, each spinning a separate thread, and the whole row operated by a band from one hand-wheel. Thus it became possible to spin, eight, twenty, and even thirty threads at once, instead of the single thread in the old-fashioned spinning-wheel. By the use of this machine, it was now possible for spinners to easily supply the wants of weavers. But shortly afterwards, a new and more effective spinning device was brought to perfection by Richard Arkwright. This patent spinning-machine, or “water-frame,” imparted an unusual firmness to the thread by passing the carded material through successive pairs of rollers, each pair revolving more rapidly than the last, thus stretching out the thread to any required fineness and strength. Thread made by this machine was firm enough to be used for warp. Prior to the introduction of this process, linen had to be used as warp, because cotton thread had never been made strong enough, but now the practicability of all-cotton cloth was demonstrated. This machine marks another significant step in the direction of the factory system, for the cumbrousness of the mechanism made it ill-adapted for cottage industry, and practically required the use of water-power.

³ Robinson, J. H., and Beard, C., *Development of Modern Europe*, vol. II, p. 31.

Finally, in 1779, Samuel Crompton succeeded in combining the principles of the Arkwright and Hargreaves machines, and produced the "mule," which spun very fine cotton thread and made the manufacture of muslins possible. This machine drew out the raw material which had received its first twist (the roving) by an adaptation of the water-frame, and then passed it on to be finished and twisted into complete yarn by an adaptation of the spinning-jenny.⁴ The mechanism has now been improved to such an extent that twelve thousand spindles may be worked at once by one spinner. By 1811, there were more than four and a half million spindles worked by "mules" in English factories. The comparatively sudden, and remarkably powerful stimulus given to English textile industry by these inventions, was accelerated by the invention of the cotton-gin in 1792, a device which opened up for commercial uses an enormous supply of raw cotton which had hitherto been unsatisfactorily cleaned by hand methods.

It will be observed that these inventions affected the spinning process and increased the output of spun materials, yet no corresponding improvement had been made in the weaving process. Consequently the weavers now lagged behind, and were not able to utilize the greatly increased supply of thread to meet the demand for cloth goods, for Kay's shuttle had been the last advance in the weaving process. It was not until 1785 that a Kentish clergyman, Cartwright, patented his "power-loom," a machine which performed the same sort of service for the weaving process that the spinning inventions had performed for the spinning process. Although the principle

⁴ Baines, E., *History of Cotton Manufacture in Great Britain*, London, 1835, p. 198.

was right, the machine did not begin to be much used until 1813. But once adopted, this machine caused the disappearance of domestic hand-weavers, as the other inventions had abolished the hand-spinners, and soon the factory system was in full operation.

At first, water-power was used to operate these heavy-running mechanisms. But this sort of power was not always sufficient, or available, and the discovery of some other source of motive power was necessary before the revolution in manufacturing processes could be completed. This need was finally met by Watt's steam-engine, patented in 1769, but not introduced into factory manufacture until 1785. During the fifteen year period, 1788-1803, the cotton trade trebled itself, due to the introduction of these improved industrial processes.⁵ But it should be noted that mechanical inventions were first introduced into cotton manufacture, only subsequently into woollen manufacture, and then irregularly into other manufacturing processes—that is, improvements were not introduced into all fields at once. Nevertheless, the industrial revolution proceeded, on the whole, with a rapidity quite remarkable, in view of the comparative absence of innovations in industry during medieval and ancient times.

THE FACTORY SYSTEM

The introduction of mechanical inventions at first undermined, and then superseded hand methods of manufacture, transforming industrial processes from relatively simple activities which produced small quantities of goods into huge and complex organizations which produced

⁵ Toynbee, *op. cit.*, p. 90; see also Hobson, J. A., *The Evolution of Modern Capitalism*, London, 1901, 2d ed., pp. 59-60.

enormous quantities of articles. Large numbers of wage-earners were brought together in capitalistic-owned establishments in which costly and elaborate machinery was operated by artificial motive power.

An examination of the nature of machinery reveals the true causes that were at work transforming domestic industry into the factory system. The machines of Arkwright, Crompton, and Cartwright, and the improve-

ments effected thereon, were far too costly for the old cottage-weavers to buy and use. The purchase and installation of these machines furnished a new and profitable field for the investment of capital, so that we find the moneyed men from the towns drawn into

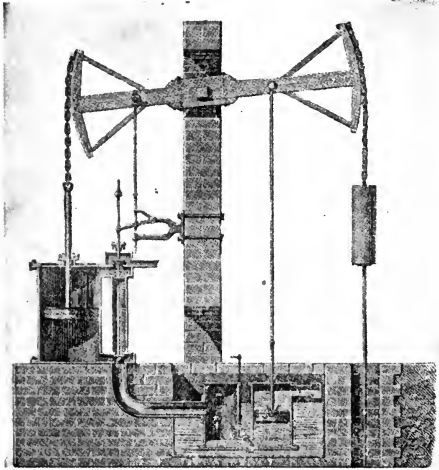

FIG. 11.—Watt's steam engine

partnership with the early machine-spinners and weavers. Besides the obstacle presented by the cost of machinery, the artisan's cottage was too small and poorly constructed to hold machinery which required space and strongly built walls.⁶ This was an added reason for abandoning home-manufacture and for erecting a special establishment to house monstrous machinery. Finally, human power was inadequate, and water or steam-power, which entailed the organization of a considerable body of laborers as well as the purchase of expensive machinery

⁶ Taylor, C., *History of the Factory System*, p. 422.

in addition to that employed directly in manufacture, could not be provided in home-manufacture. These then, are the reasons, inherent in machine-manufacture, which necessitated a new industrial organization—the factory system.

As one writer says: “What the great inventions did for the factory, was to change the relation of hand-work to mechanical assistance. The tool and the machine-tool are under government of the hand. It is the worker who supplies the force, and the tool which obeys; but after the great inventions, the position of the worker in the modern factory came to be that of assisting the machine, rather than that of supplying the energy to the hand or machine-tool. There were factories before the inventions of Watt, Crompton, and Cort, but the ‘factory system’ of the nineteenth century implies specially a subordination of the worker to the machine, which justifies us, if we look at the change over a long period, in speaking of the effect as a revolution.”⁷

Mechanical production is said to date from the middle of the eighteenth century, not because there were no machines prior to this time, but because industry then experienced a vast acceleration in the invention of complex machinery applied to industrial arts, and because there occurred for the first time the application of non-human motor-power upon an extensive scale.⁸ The earlier machines multiplied the output of processes once done by hand, while the later machines not only increased production, but combined into one continuous operation the different processes of manufacture once performed

⁷ Macgregor, D. H., *The Evolution of Industry*. London and New York, 1911, p. 40.

⁸ Hobson, *op. cit.*, pp. 45–50.

by different groups of individuals with different tools. In modern machinery the sewing-machine illustrates the latter, as the knife-cleaning machine illustrates the former. Hobson defines a machine "as a complex tool with a fixed relation of processes performed by its parts." Machinery increases the motive power at man's disposal

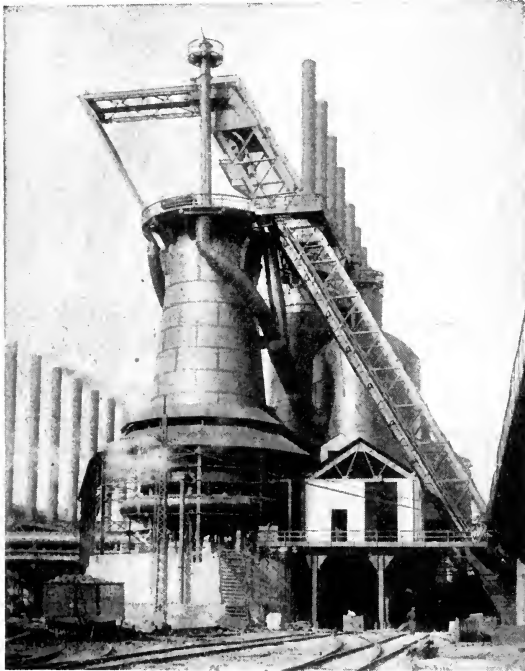

FIG. 12.—A modern blast furnace

by applying the forces of man and nature in a more effective manner through the use of various mechanical contrivances. For example, the substitution of mechanical for human power is made and also the substitution of cheaper for dearer kinds of power. Finally, the application of machinery is extended to the utilization of waste in natural and manufacturing processes.

The growth and extension of machine manufacture and the factory system from industry to industry was accomplished by four essential steps. First, the introduction of automatic machinery as a supplement to, or a substitute for, hand labor. This began in the manufacture of cotton and woolen cloth. The second step was taken when steam was applied as the motive force to drive this machinery. Manufacture was now freed from geographical restrictions set by the location of natural resources in water-power, and factories could be built at strategically situated commercial centers. But as long as methods of transportation remained slow and cumbrous, the factory system could not expand to meet the demands of distant markets. When, however, in the nineteenth century the steamship and steam railway were invented, it was possible to send manufactured products cheaply and rapidly all over the world, and the factory system soon extended to a variety of industries. The final condition determining the growth of the factory system was the enlightened encouragement of patents in the nineteenth century.

With these four conditions assured, mechanical invention was stimulated, and the factory system spread from one industry to another. This growth is marked by such important inventions as the planing-machine in 1802, the circular wood-saw, introduced in the United States in 1814, galvanized iron in 1837, vulcanized rubber in 1839, Howe's sewing-machine in 1846, watch-making by machinery in 1850, the Bessemer process of making steel in 1855, paper made from wood-pulp in 1864, the McKay shoe-sewing machine in 1861, the Siemens-Martin open-hearth steel process in 1866, and the roller-mill and middlings-purifier for making flour in 1875.

Beginning in England in the later eighteenth century, the factory system was not widely adopted in the United States until 1840, and spread to Germany only in the latter part of the nineteenth century. It has now been introduced into India, Japan, and China. The reverberation of machine-production on handicrafts is seen wherever Western civilization comes in contact with primitive economic organization, for the handicrafts are always demoralized by the enormous volume and cheapness of machine products.

SOCIAL AND ECONOMIC EFFECTS OF THE FACTORY SYSTEM

The great silent revolution in industrial processes and organization initiated by the application of mechanical contrivances and non-human motor-power to methods of production, wrought fundamental and far-reaching changes in social organization, changes which came so rapidly that adjustment to the new conditions is still imperfect, and even to-day there are many intelligent persons who fail to understand their true significance.

Perhaps the most general change resulting from the factory system has been the striking redistribution of population effected in all industrial nations, the transfer of population from rural to urban conditions. In England, the change was two-fold: population shifted from southern to northern sections of the country, and from the rural regions to the towns and cities. The growth of population in the north was chiefly due to the utilization of the coal-fields for fuel with which to turn the new machinery in the factories.⁹ The transfer of population was accompanied by a striking rapidity of growth, for the population of England, which had been 6,736,000

⁹ Gibbins, *op. cit.*, p. 349.



Photo from Underwood & Underwood.

FIG. 13.—Tapping an open-hearth furnace

10

10 20 30 40 50 60 70 80 90 100
110 120 130 140 150 160 170 180 190 200

in 1760, had risen to 12,000,236 in 1821,¹⁰ an increase of 18 per cent. for the period 1811 to 1821 alone.

By far the most important aspect of the redistribution of population, however, was the change from rural to urban living conditions. The old domestic manufacturer, half farmer, half artisan, disappeared before the competition of machine-made goods. Factory methods of production so cheapened the price that goods would bring that it was no longer profitable to carry on industry in the home. For example, spun yarn that was worth 38s. in 1786, had declined to 19s. in 1796, and to but 7s. 2d. in 1806. The wages of hand-loom weavers also declined, and we find the weavers of Bolton earning only 5s. 6d. a week in 1830, when they had received wages of 9s. in 1820, 19s. 6d. in 1810, and 25s. in 1800.¹¹ The effect of this loss of remunerative by-employment, accompanied by the agricultural changes of the enclosure system, was quite disastrous for the rural farmer-artisans. Although the desperate struggle against the new conditions was kept up for a whole generation, this sturdy class gradually died out, and there was an exodus of labor from the country with a corresponding growth of towns.

One of the serious consequences of this loss of by-employments was the change wrought in living conditions. The laborer no longer lived in a village where he could vary the monotony of his manufacturing work by a little gardening and work in the fields. The hum of the spinning-wheel grew silent in the cottage, and the weaver no longer breathed the fresh scents of hay and harvest in the country air.¹² The weaver ceased to use the product

¹⁰ *Ibid.*, and *Statistical Journal*, vol. xliii, p. 462.

¹¹ Cheney, *op. cit.*, p. 220.

¹² Gibbins, *op. cit.*, pp. 385-86.

of the spinning wheels run by his wife and children; he bought yarn from the factory. For the freedom and independence of the old life had been substituted rigid factory hours, and workers came and went at the sound of a bell. Contemporary evidence of the new order of things is contained in a description of the country around Manchester, published in 1795 by Dr. Aikin, who says of the

changes in domestic life: "The females are wholly un-instructed in knitting, sewing, and other domestic af-

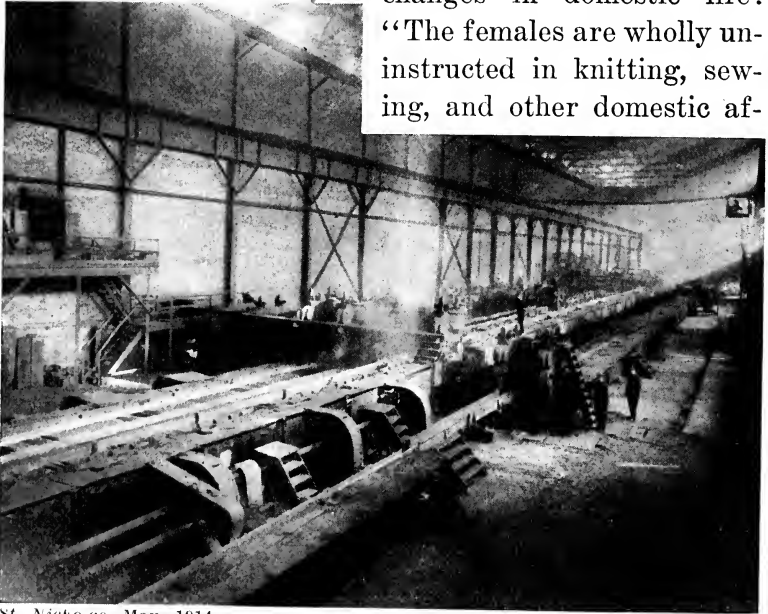

St. Nicholas, May, 1914.

FIG. 14.—Interior of rail mill

airs requisite to make them frugal wives and mothers. This is a very great misfortune to them and to the public, as is sadly proved by a comparison of the laborers in husbandry, and those in manufactures in general. In the former, we meet with neatness, cleanliness, and comfort; in the latter, with filth, rags, and poverty."¹³

¹³ Quoted in *The History of the Factory Movement*, i, p. 11, by "Alfred" (Samuel Kydd).

The laborer now lived close by the factory where he and his family worked all day long amid the smoke and the grime of great fires, and the ceaseless din of iron and steel machinery. With the introduction of steam-power, the old water-power mills in remote localities gave way to large establishments in strategically located towns and cities. It became necessary to have all the work-people close together in one large building, on account of the fact that steam could only be generated in a fixed spot, and the motive power supplied for a limited area. But there were certain economies in administration and management which such concentration afforded. For example, in cotton manufacture it was convenient to carry on the work of carders, spinners, and weavers in close proximity. In addition, there were advantages of management which accrued from nearness to markets for raw material, finished product, and labor supply, that made concentrated work economical. Thus the typical unit of production ceased to be the single family, or small group working with simple tools upon small quantities of material, but came to be a compact unit composed of hundreds, and sometimes thousands, of workmen closely associated in a coöperative activity, operating intricate machinery in large establishments, and turning out enormous quantities of goods.

The first factories were hastily constructed and without adequate provision for lighting, ventilation, or sanitation. There was a great prevalence of fevers among employees in cotton mills because of the utterly unsanitary conditions under which they worked. Although the cottages in which domestic industry had been carried on were undoubtedly small, hot, dusty, damp, and unhealthy, relief was to be had by gardening and farming; but the

prevalence of these same conditions in the mills was a much more serious matter, for men, women, and children worked regularly many more hours a day in the factories, —twelve, thirteen, and even fourteen. There were no arrangements for the preservation of health, comfort, or decency among the working classes, who were composed of men and women, adults and children. As for the children, “they slept by turns and relays in filthy beds which were never cool; for one set of children were sent to sleep in them as soon as the others had gone off to their daily or nightly toil. There was often no discrimination of sexes; and disease, misery, and vice grew as in a hot-bed of contagion.”¹⁴

Relief from the intolerable conditions under which factory labor was carried on was not to be had upon the home-coming of a tired worker; for the rapid increase in urban population had brought about congested living conditions. The “home” of the mill-hand was sometimes a damp cellar, or more frequently a small and dark tenement. Under the pressure of population crowded into such narrow limits, the old arrangements for providing water, drainage, and ventilation, broke down completely. Rents rose, and the factory towns became filthy and demoralizing centers of life.

When we examine the inherent characteristics of machine production and the factory system, we discover that the change from hand-production to machine-production has had certain subtle effects upon the organization of labor. The decay of the domestic system and the substitution of machinery for hand-labor was not, however, always accomplished in a quiet and peaceable manner. The introduction of machinery was followed by disad-

¹⁴ Gibbins, *op. cit.*, pp. 389-90.



Fig. 15.—Han Yang iron and steel works: an industrial center of China

vantages to the artisan of such an obvious and immediate nature, that riots against the installation of machinery were frequent in the early years of the industrial revolution. The gains which machine-production promised, were cheap goods at some future time, and this was not a satisfactory compensation to the laborer who lost employment through the introduction of labor-saving machinery. Hence there came fierce revolts against the new devices of manufacture. Much machinery was destroyed during riots in 1812, 1816, and 1826. Wherever the substitution of machinery for hand-labor occurred rapidly, there was great distress, but in those fields in which the change came gradually, there was much less misery. The substitution of new for old methods progressed irregularly, and it was not until 1840 that wool-combing by machinery really threatened the hand-worker, and began to drive him from the field.

These fierce outbursts against the new order of things should not blind us to the great significance of the thorough-going change that was transforming the very basis of manufacturing industry. Highly specialized routine labor, adjusted to machinery, was largely replacing the all-round skill that the apprenticeship system of hand-work had produced. Under the handicraft system of the Middle Ages, as organized in the craft guilds, the workman followed the raw material through the various stages of manufacture until it took on the form of a finished product. He knew all the steps in the process, and took pleasure and pride in his workmanship. Under the factory system, the average workman performs only one minor act in the process of production, perhaps throwing a lever back and forth, or his particular task may be to guide a machine which accomplishes some intermediate

step in the series, and so he may never see the raw material, or even know for what the finished product is to be used. A few illustrations will serve to make the matter clearer.

The manufacture of such a simple product as pins was in 1776 divided into eighteen distinct operations. It required five distinct operations, each performed by an independent workman, to draw, straighten, cut, point, and put on the head; two or three separate operations to make the head; and putting on of the head, the whitening of the pins, and the sticking of the finished pins in the paper package, were peculiar businesses in themselves.¹⁵ The manufacture of a shoe in some New England factories of to-day requires 173 different operations, each conducted by a class of laborers with a special name. In the making of a modern high-grade watch, at least 1088 different sets of workmen, aside from the operations of furnishing the power, each using a different kind of machine, are employed. In the typical cotton-mill of to-day, the division of labor embraces more than 98 different occupations. One man can operate from six to twelve machines in the manufacture of screws, and the ratio of machine to hand production is 4491 to 1. There are no less than 39 distinct processes in the manufacture of ready-made coats as now carried on in New York.¹⁶

But perhaps the most modern, as well as in some respects the most typical case of the division of labor which accompanies the factory system, is seen in the great automobile factory of Henry Ford at Detroit. John A. Fitch, writing in *The Survey*,¹⁷ thus describes the re-

¹⁵ Smith, Adam, *The Wealth of Nations*, in Macmillan's Economic Classics, p. 6, of bk. I, ch. i.

¹⁶ Seligman, *op. cit.*, p. 293.

¹⁷ February 7, 1914, pp. 545-50.

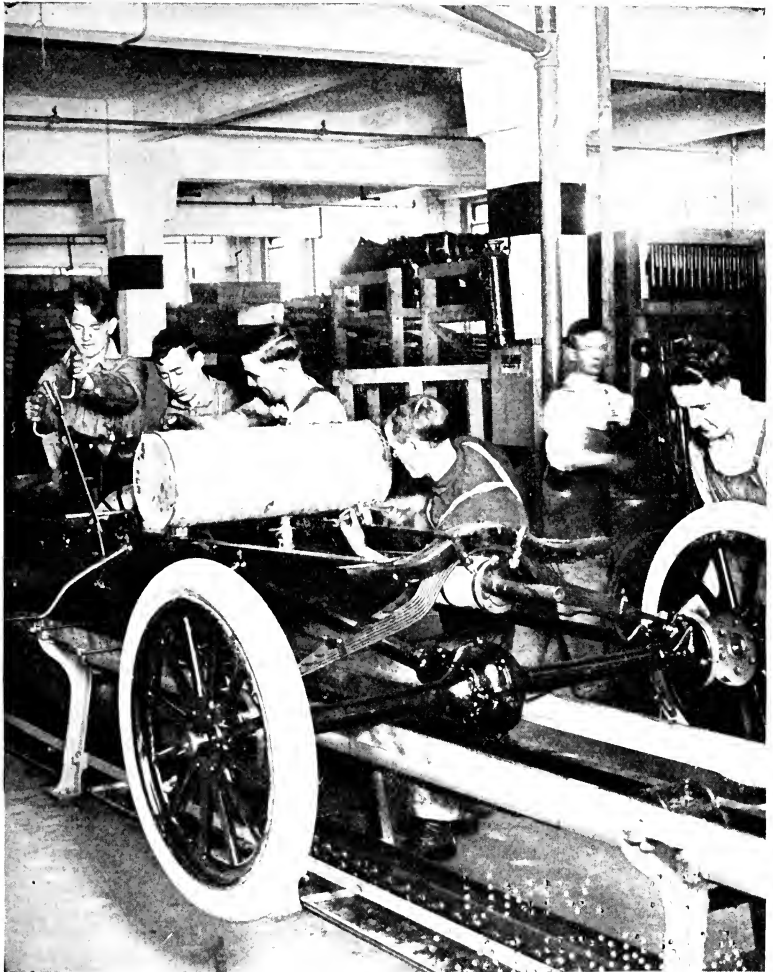

Copyright by Underwood & Underwood.

FIG. 16.—Assembling department of Ford Motor Company; putting on wheels, gas tank and muffler

1 2 3 4 5 6 7 8 9 10 11 12 13 14 15 16 17 18 19 20 21 22 23 24 25 26 27 28 29 30 31 32 33 34 35 36 37 38 39 40 41 42 43 44 45 46 47 48 49 50 51 52 53 54 55 56 57 58 59 60 61 62 63 64 65 66 67 68 69 70 71 72 73 74 75 76 77 78 79 80 81 82 83 84 85 86 87 88 89 90 91 92 93 94 95 96 97 98 99 100

markable organization of labor and machinery which permitted the production of 605 complete automobiles in four hours on January 24, 1914:

“They don’t just produce automobiles at Ford’s,” a man in another Detroit factory remarked, “they spew them out.” Fifteen thousand men work in gangs on the track system. Each gang, and each man in each gang, has just one small thing to do—and to do it over and over again. It’s push and hustle and go. The man behind may shove his work along to you at any moment—you must not hold him back; at any moment the man in front may be ready for another piece to work on—he must not be kept waiting.

Up one line and down another goes a continual stream of motor parts in process of assembling. One man fits the parts together so that the bolt holes come right. The next man slips the bolts in place. The next has a pan of nuts before him and all day long he scoops them up and with his fingers starts them on the thread of the bolts. The next man has a wrench and he gives them the final twist that makes them tight.

Over in another part of the great factory there are four or five parallel tracks. On every track are a dozen automobiles in all stages of being put together. Each is slowly moving from one end to the other, and—like a snowball rolling down-hill—gathering itself together as it travels, until with a snort and a whir it dashes out at the door on its own power.

The last of these tracks is formed by moving belts. Without a stop from start to finish the machine moves steadily forward on the belt, and, either sitting on different parts of it or walking alongside for a moment, each man adds the bolt, or gives a turn to the screw for which he is responsible. One fellow has to lie on his back underneath and hammer away at something. He has a little platform on wheels to support him and with a bent rod he “hitches on” the front axle. “Bing,” “Bang,” instantly he lets go and drops back to hitch on to the next machine.

Piled up along the way are the different parts, each to be added as the growing machine passes by. Each man does his

part, and gives it a shove. First, to a mere skeleton of a frame, two men attach the rear axle. They fasten it in haste and give it a push—some one else will tighten the bolts. Three men seize it and in a moment the front axle is in place and the four wheels put on. It 's easier to move now; a touch sends it on to another gang of three, who put on the truss-rods and tighten things up all around.

Another shove, and it goes to where a motor is dangling from chains, directly over the track. A word from some one and down comes the motor to its place, and bolts go in and on goes the machine. Then comes the steering gear, and the control levers—on again, and from overhead a hose is pulled down and a gallon of gasoline squirted into the tank. One more shove and the rear wheels drop into a slot where there are rapidly revolving pullies. The wheels begin to whirl—the motor starts—a man seats himself on the tank, grasps the wheel and cuts loose, and with a snort and a cough, out the door they go. What was, ten minutes ago, a pile of rods and gears and lifeless steels is now thrilling with power. A car came through that door every twenty-four seconds Saturday morning, January 24. . . .

This minute specialization of process permits the employment of unskilled labor, for the machine accomplishes by automatic precision the same result that human patience and skill had once attained. Under these circumstances, the old interest in producing good work disappears, for the laborer loses that intimate association with all the different stages in the process which encourages a feeling of responsibility for the quality of the product. Says Ferrero: "Machines are the barbarians of modern times, which have destroyed the fairest works of ancient civilizations."¹⁸

Another aspect of the extreme division of labor under the factory system with its specialization in productive activities, is the demoralizing effect of monotonous

¹⁸ *Ancient Rome and Modern America*. p. 6

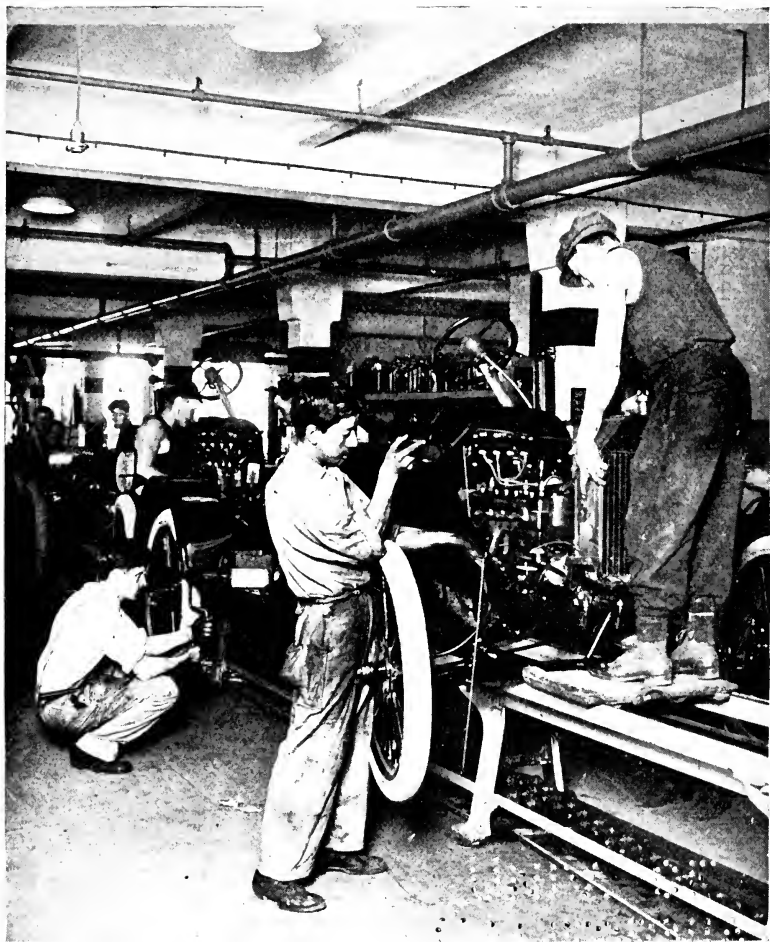

Photo from Underwood & Underwood.

FIG 17.—Assembling department of Ford Motor Company: putting on dash and fenders

CALIFORNIA
UNIV. OF

routine labor. Shoving bolts into holes, and doing nothing else all day long for a ten-hour day, is productive of dulled senses and set habits of mind and body. Specialized work in which activity is of a trivial sort, tends to destroy individual plasticity, and the workman loses his power of quick adaptation to new conditions. Under these circumstances, it is not easy for a laborer to make the change from one employment to another when he is thrown out of work by industrial depressions which result from over-production, or to adjust himself to another job when his old one has been cast aside and made useless by the introduction of new labor-saving machinery. It is the old experience of biological evolution reappearing in industrial activities, the extinction of the highly specialized. It means that the middle-aged workman who has spent his best years in some highly specialized industrial activity, is suddenly thrown upon the scrap-heap by the introduction of new machinery, at a time when his social and family obligations are heaviest. For the young and alert of limb, the minute standardization of operations permits a comparatively quick acquisition of skill, with a consequent possibility of rapid movement for workers between industries. But not so with the mature worker. The years of monotonous and uninteresting employment have deadened his initiative and ability to turn about and acquire new coördinations; and unfortunately this type of laborer represents the majority.

When the domestic system became the characteristic type of industrial organization, the workman lost control over two parts in the process of production, the purchase, or procuring of the raw material, and the selling, or disposal of the finished article. To this extent, he was less independent than under the handicraft system, although

he was still able to control the hours and conditions of labor, because he still worked in his cottage. But with the coming of the factory system, ownership of tools and place of work passed from the control of the laborer. He became a hired hand, a wage-earner, working with tools (machinery) provided by the capitalist in a specially constructed establishment (factory), upon material which he did not own and which his labor helped to turn into some finished article which he might never see. Thus the old personal relationship of the workman to the processes of production disappeared, and he was unable to regulate his hours, or the conditions under which his labor was carried on. It was a serious thing, this loss of personal freedom, this growing economic dependence of a large mass of laborers upon a small class of capitalists. It created a social situation which somewhat radical thinkers have with considerable justice called, "wage slavery." But this consideration brings us to the study of another important effect of the factory system.

A thoroughgoing differentiation of the industrial classes of capital labor was another consequence which followed the introduction of the factory system. In the days of the handicraft system in antiquity, and under the craft-gilds of the Middle Ages, the difference between employer and employee in the industrial field was not great. The master worked with his apprentices and journeymen, participating with them in the processes of production, sharing their privations and their comforts, although he possessed authority over them and paid them wages. Much the same situation existed under the domestic system. But with the factory system, came hard and fast differences between employer and employee. The ownership of materials, tools, machinery,

and factory was in the hands of those outside the class of manual laborers—the employer class—while the workmen sold naught but their labor. It was but natural that, in the absence of the old intimacy of master and man in the processes of manufacture, and in the presence of

STAGE OF PRODUCTION	Main Steps and Factors in Industrial Production			
	Provision of Raw Materials	Provision of Place of Work	Ownership of Tools of Production	Sale of Finished Product
HANDICRAFT MIDDLE AGES to 15 th CENT.	■	■	■	■
DOMESTIC 15 th , 16 th , 17 th CENTURIES	Merchant-Middleman	■	■	Middleman-Merchant
FACTORY SINCE 18 th CENTURY	Producer of Raw Materials Merchant-Middleman	Capitalistic Factory Production	Capitalistic Machine Production	Wholesaler Middleman Retailer
■ This step in the process of production controlled by Labor.				

FIG. 18.—Diagram illustrating how labor has lost control of one step after another in the evolution of modern industry. (The dates are only approximations and merely serve to indicate when the particular type of industry was most prevalent.)

marked differentiation of function, the interests of the two should grow apart. Under this type of industrial organization, it was comparatively easy for the capitalist to appropriate nearly all the wealth produced by the labor of the mill-hands, leaving the employees a scant living share. “Hence,” says Gibbins, “it may be said that

capital in this case was the result of abstinence, though the abstinence was on the part of the workman and not of his employer. . . .”¹⁹

It is profitable to dwell at length upon the differentiation of classes and the growth of hostile class-interests which came as a consequence of the new organization of industry, for an understanding of these facts helps to explain many of the complex problems of the present day. In place of the old personal tie between employer and employee, we have a simple wage-paying-labor-giving relation, sometimes described as a “cash-nexus.” To the large employer of labor, the average employee becomes a mere number. The human relation has disappeared. Large-scale production, the organization of great masses of labor and intricate machinery for enormous output, has apparently increased and enhanced the separation of the productive classes, and made inevitable a feeling of irresponsibility on the part of those in control for the lives of the manual workers. Compare the system of production as it existed when the master craftsman worked in the same room and handled the same tools as his apprentice or employee, with the usual organization of the modern corporation. In the former, the relations of employer and employee were personal and direct; there were no intermediate authorities. In the latter, between the manual laborer and the ultimate owner—the stockholder—there is a whole hierarchy of officials and authorities, represented by the factory superintendent, the general manager, the president of the corporation, the executive committee of the board of directors, and the board of directors itself. How easy it is for responsibility for industrial accident, inadequate wages, or un-

¹⁹ *Op. cit.*, p. 381.

healthful working conditions, to be lost somewhere between the beginning and the end of this series! Thus there are structural facts inherent in the factory organization of industry which make for irresponsibility and hostile class-interests.

Unfortunately, the evil effects of these structural traits that promoted class misunderstandings and antagonisms,

MODERN CORPORATE ORGANIZATION OF INDUSTRY

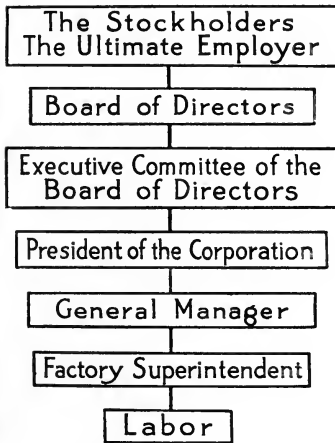

THE HANDICRAFT ORGANIZATION OF INDUSTRY

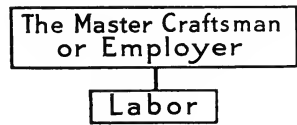

FIG. 19.—A comparison of complex modern corporate organization of industry with the simple handicraft organization

have been increased by a mistaken economic philosophy. Policies of commercial and industrial restriction which had their inception in the era of national aggrandizement at the close of the Middle Ages, tended to stifle legitimate economic expansion in the new-world economy, and the reaction against these fetters was first voiced by seventeenth-century English economic writers and by the contemporary French school of the "Physiocrats."²⁰ But

²⁰ Haney, L. H., *History of Economic Thought*, 1911, pp. 133-90.

like most social revulsions, this change from restrictive policies went too far, and there was an unwise reduction in governmental control over economic activities. The prevailing desire for personal liberty and freedom from outside restraint led people to think of government regulation as an interference with their natural liberty. It was felt that the evils of the existing social order were due, in large measure, to the artificial restraints of man-made laws. If only these legal and customary obstacles could be removed, man would speedily get back to a "state of nature," and freed from unwise and selfish restrictions, could work out his destiny in accordance with beneficent, natural law. The economic writers Adam Smith, Malthus, Ricardo, and others, attempted to explain why it was that all interference with free competition was interference with natural law, and hence ineffectual and foredoomed to failure.

This social and economic philosophy was therefore quite opposed to the extension, or even the continuance of control by the government over matters affecting labor, wages, hours of work, industrial conditions and organization, commerce, agriculture, or any other kinds of economic activity. The idea of the survival of the biologically fit through the agency of a rigorous struggle for existence, appears to have had its counterpart in this economic doctrine that free and unhampered competition was the sole guaranty of social and industrial progress. An enlightened self-interest was relied upon to ensure justice to all, and to perfect the structure of social and economic relations in the interest of general human welfare. Consequently, we find that there was a gradual cessation of government regulation. The state should let things alone; *laissez-faire* became the prevailing

theory of the functions of government. The growth of this let-alone policy is seen in the parliamentary acts of 1803 and 1809, which modified the old Statute of Apprentices and permitted greater individual freedom, in the subsequent amendment of 1813, which did away with the wage clauses, and in the eventual repeal of the act in 1814, as against the natural rights of the people. The old restrictions which had forbidden laborers to combine to settle wages and hours, were repealed in 1824. The Navigation Acts were abolished in 1849. In 1845, duties on over four hundred articles were removed, and four years later, protective duties on corn were abandoned. Thus England reversed her traditional policy of regulation, and became the greatest national exponent of "free trade" in modern times.

Combined with the inherent structural tendencies of the modern capitalistic system, this philosophy of *laissez-faire*, or letting things alone, inevitably worked to the disadvantage of the labor class. The new ideal of free competition justified the most thoughtless and inhuman treatment of employees as much as it opposed government interference to protect them from exploitation. Reduced to a state of dependence, and prevented from exercising control over working conditions to protect themselves, the wage-earners, as a class, fell an easy victim to capitalists unscrupulous or thoughtless enough to rigidly apply the principle of *laissez-faire*. On the assumption that laborers were guided by self-interest, enjoyed personal freedom in employing themselves, and would avoid unfavorable terms or working conditions, the employer was freed of responsibility for their welfare. Let us see how this worked out.

The weaker classes of the wage-earning population

were ruthlessly exploited. Women and children were in great demand as mill-hands. They could readily do the work formerly performed by strong men, for strength was not required to operate the powerful machines driven by water- or steam-power; they were more easily managed than men, being less insistent upon their rights and less pugnacious; finally, they were cheap, for they could be obtained at lower wages than would satisfy a strong adult man. Of 31,632 employees in worsted mills in the year 1839, 18,416 were under eighteen years of age, and 10,192 of the remaining adults were women. This leaves only 3024 adult men among a group of more than 30,000 mill-hands. At a flax-spinning mill near Leeds in 1832, there were 829 employees below eighteen out of a total force of 1200.²¹

One serious aspect of the employment of women and children in such large numbers was that the normal relations of the home were reversed. The man often ceased to be the breadwinner, and the women and children were driven from the home to the factory. Parents came to depend upon the earnings of their children and remained shiftlessly at home, the children going forth to work before daylight and returning home after dark. This horrible state of affairs brought its hideous crop of sickly, stunted, and degenerate persons among those individuals who survived childhood and grew to adult years.

Perhaps the most vicious aspect of the employment of children is seen in the apprentice slavery of workhouse children. The insatiable demand for labor led manufacturers to secure pauper and orphan children from overseers of the poor in the different parishes of England, under the flimsy disguise of pretending to apprentice

²¹ Cheney, *op. cit.*, p. 237.

them to the new employments just introduced. Days were regularly set for inspection of the children, and a systematic traffic was developed according to which the children were conveyed by canal-boats or wagons to the factory; or they were kept in some dark cellar of the factory district until they could be sold to a manufacturer in need of labor. This last transaction was carried on exactly as the slave-dealers of the American markets sold their blacks, the children being examined for height, strength, and bodily capacity. Although nominally apprentices to the master, the unfortunate children were really slaves "who got no wages, and whom it was not worth while even to feed or clothe properly, because they were so cheap, and their places could be so easily supplied. . . . The hours of their labor were limited only by exhaustion, after many modes of torture had been unavailingly applied to force continued work. Illness was no excuse; no child was accounted ill till it was positively impossible to force him or her to continue to labor, in spite of all the cruelty which the ingenuity of a tormentor could suggest."²² The horror and pathos of it all is well expressed by Alfred:²³ "In stench, in heated rooms, amid the constant whirling of a thousand wheels, little fingers and little feet were kept in ceaseless action, forced into unnatural activity by blows from the heavy hands and feet of the merciless overlooker, and the infliction of bodily pain by instruments of punishment, invented by the sharpened ingenuity of insatiable selfishness." Many of the children committed suicide, and many children who fell under the influence of the ghastly system were buried secretly at night in some desolate

²² Gibbins, *op. cit.*, pp. 388-90; Taylor, *op. cit.*, p. 192.

²³ *History of the Factory Movement*, i, 21, 22.

spot, lest people should remark at the number of graves.

It should always be remembered that this unexampled suffering of the weaker industrial classes occurred in enlightened England at the very time when British philanthropists were agitating for the relief of negro slaves in other countries. It is well also to recall in this connection the treatment accorded industrial slaves in Greek and Roman times, for one has a right to expect more humanity in the relations of employers and employees, of master and man, as industrial evolution proceeds.

The children were sent from London and other large cities to work in the factories of the north. "Apprentice houses" were constructed near the factories, and superintendents and matrons provided. During rush periods, the children often worked in twelve-hour shifts. Only the coarsest and cheapest food was provided, and they were frequently forced to eat this while operating the machinery. Sunday, far from being a day of rest, was spent in cleaning machinery. The children worked at mills in remote places where the horrible conditions of their labor would remain unknown to the general public, and directed by petty masters, or small foremen, so that the absentee mill-owners were frequently ignorant of the real state of affairs.

FACTORY LEGISLATION

One of the first efforts to remedy this evil was the passage of the "The Health and Morals Act to regulate the Labor of Bound Children in Cotton Factories," under the influence of Sir Robert Peel, a large employer of child-labor. This act of 1802 set an age-limit of nine years, below which children might not be bound out for

factory labor; night work was forbidden, and working hours were restricted to twelve a day. Direct health provisions required whitewashed walls and adequate ventilation. In addition, the welfare of the children was still further guarded by insisting upon sufficient clothing and some religious opportunities, as well as instruction in English. But perhaps more effective than this act in ameliorating the abuses of this apprentice system, was an industrial change that occurred about the same time. The application of steam-power to textile manufacture caused a transfer to the towns of many of the factories that had previously been located in rural districts where water-power could be obtained. In these towns the children of families there resident could be employed, and the practice of using pauper children was largely discontinued.

But the substitution of these town children for the workhouse apprentices was not a satisfactory solution of the problem, for the evil of child labor still continued. The same early working age, the same long hours and night work, and the same unsanitary factory conditions, persisted. From 1800 to as late as 1840, the results of the evil may be seen in the early deaths of many working children, and in the stunted and distorted forms of those who survived. Meanwhile the act of 1802 had not been enforced, and the old conditions had largely returned.

Gradually, with painful slowness, the attention of the public became fixed upon the sad lives of these abused and much neglected little waifs, and reform legislation was enacted. It was not until 1830 that a young abolitionist, Richard Oastler, was aroused to the fact that actual slavery existed in England. Although he at once started agitation against this "wage-slavery," he met

with many disappointments, for even indisputable facts failed to convince the respectable and self-satisfied classes of the existence of the terrible system in their midst.

As early as 1816, a select committee of the House of Commons had been appointed to collect evidence upon the conditions of child-labor. The committee secured evidence of terrible abuse and overwork, yet the greed of capitalists was so great that it was not until 1819 that the second "Factory Act" was passed, and their objections overcome. Between the ages of nine and sixteen, nine being the legal minimum for employment, the hours of labor were restricted to twelve. The actual working hours were from twelve and a half to fourteen a day. The factories began work at 6 A. M. and continued till noon. After a half-hour interval for dinner, sometimes used for eating while attending the machinery, work began again, and continued till 7:30 or 8:30 in the evening. It was a period of unexampled demand for manufactured goods, and every nerve was strained to supply the need and make large profits.

Arguments against the system were based on the feeling that in wealthy and humane England, such grinding conditions of work, with their consequent hardships and loss of normal recreation, were unendurable. Moreover, the moral and intellectual education of the children was sacrificed, and they grew up to be immoral and illiterate adults, undesirable citizens. Finally, the system, if persisted in, would bring about the physical degeneration of the industrial population, making diseased and deformed adults. On these grounds the factory acts were urged as necessary reform and preventive legislation. But the established interests advanced arguments against the

enactment of factory laws on the ground that these acts constituted unjust and unnecessary interference with the freedom of manufacturers, who, as a class, were responsible for the prosperity of the nation and the employment of the laboring classes. Again, it was pointed out that the factory system was being introduced into France, Belgium, and the United States, where no legal restrictions on work conditions prevailed, and that the inevitable result would be that English manufacturers, hampered by the factory acts, would lose out in the world competition, to the great embarrassment of the nation. Lastly, the policy of government regulation had been tried for hundreds of years and abandoned as a failure, because any artificial interference with the natural laws which controlled wages, employment, and profits, was inherently injurious.

Strangely enough, the economists were defeated on ground which seemed peculiarly to belong to them, for the philanthropists won their fight for the protection of women and children in the factories and mines of England. In 1831 an act forbade night work in factories for persons between nine and twenty-one years of age, and fixed the working day at twelve hours, with a nine-hour day on Saturday for all under eighteen. Step by step the long struggle against factory slavery was won. The Act of 1833 extended the application of restrictive legislation to woolen and other operatives, prohibiting night work to persons under eighteen, fixing the weekly hours of labor at forty-eight for children from nine to thirteen, and at sixty-eight for young persons from thirteen to eighteen. Factory inspectors were to be appointed, and there was to be provision for education. The best evidence of the diminished employment of children, caused

by these acts, is seen in the great increase of improved machines and mechanical labor-saving devices. The "Children's Half-time Act" was passed in 1844. This law provided protective devices and safety rules for the operation of dangerous machinery, and restricted the labor of children to half a day, the other half to be spent in attendance at school. In addition, previous principles of factory legislation were extended to cover the work of all women, under the rules originally laid down for young persons. Three years later, in 1847, the famous "Ten-hour Act" was passed. By this law the labor of women and young persons was reduced to ten hours a day, and the legal day set at between 5:30 A. M. and 8:30 P. M. It is estimated that the act applied to 360,000 persons. This meant that "at least three fourths of all persons employed in textile industries had their hours and some other conditions of labor directly regulated by law."²⁴

Other acts followed, and many much needed extensions of their provisions have been made, as well as legislative enactments on other matters affecting the welfare of the laboring classes. The modern tendency has therefore been in the direction of greater government regulation, and, in opposition to the teachings of the superficial philosophy of *laissez-faire*, there is a trend towards state paternalism.

Modern government regulation, however, does not stop with the protection of labor, but extends to the safeguarding of the consumer and investor. This expansion of the activities of the state was made necessary by the spread of the corporate form of organization in large-scale production. The introduction of the machine and of the factory system of manufacture called for the employment

²⁴ Cheney, *op. cit.*, p. 256.

of aggregates of capital far beyond the means of the old-fashioned partnership, and the corporate form of enterprise was adopted to meet the need. Although the commercial corporation existed long before the industrial revolution, and the joint-stock principle had been applied in the sixteenth century, it was not until industrial capital, as distinct from commercial capital, assumed dominant importance in the nineteenth century, that an immense expansion of corporate enterprise took place.

Possessing the advantages of joint-stock ownership, limited liability, and perpetual life, the corporation supplied the necessary machinery for the successful capitalistic organization of production on a large scale. In proportion to his investment, every stockholder has a voice in the enterprise, and the number of such investors can be increased indefinitely because of the device of corporate security, thus rendering possible vast accumulations and wide dissemination of capital. Although the shareholders die and disappear, the shares remain, and the corporation enjoys a continuity of existence. Thus the corporation possesses advantages of permanence and stability, and provides for scope in planning ahead that never fails to attract high ability.

But the corporation has shortcomings which require correction, if the consumer is to be protected and the investor safeguarded from its predatory tendencies. From the early form of agreement to fix prices, modern corporate enterprise has passed through various stages of agreements to divide the field between competitors, pool arrangements by which output rather than price or field is restricted by agreement, selling bureau agreements to fix prices and output, and to manage selling, ordering, and distributing, the "trust" stage, in which constituent

enterprises turned over their business to a central board of trustees, and the stage of the holding corporation. These developments of business units into larger and larger combinations in possession of greater and greater power, have made it necessary for the government of the modern industrial nation to regulate corporate enterprise in the interest of the innocent investor by enforcing responsibility and requiring publicity, and to interfere with monopoly prices in the interest of the consumer by supplementing competitive checks with legislative restrictions. So it has happened that, in contemporary times, the sphere of government regulation has widened to include activities which seek to protect the consumer and investor, as well as to safeguard labor.

CHAPTER XVI

THE REVOLUTION IN COMMUNICATION

THE industrial revolution perfected the mechanism of manufacturing production and made possible the enormous output of goods which flow through the markets of to-day. But the mechanism for distributing the vast wealth so created is still antiquated and far from being adapted to requirements of the present social order. What we now need is a revolution in distribution, in order that the inequalities of income may be reduced to such an extent that the masses of the working people may obtain a larger share of the annual production of wealth.

Popular government seems to be the chief hope of those who desire to see this change affected. But the poverty and the destitution, the class separation and antagonisms, which came as the inevitable result of the rapid progress of the industrial revolution, have threatened the very basis of democracy. The gap between the capitalist and the working classes prevents the latter from communicating their needs and desires in a way which can secure the essential changes.

Fortunately for the future of popular government as an instrument for the amelioration of social evils, a revolution has come to pass in the means of communication, a transformation so thoroughgoing and formidable that it is quite comparable in importance and meaning with the great revolutions in agriculture and manufacturing industry just described. The revolution in communica-

tion completes the trio of great peaceful revolutions that have transformed modern society and marked off contemporary times from all the past history of mankind. The new communication furnishes the mechanism through which the abuses of the modern social order may be corrected, because it injects new life into popular government by supplying a medium for the diffusion in vivid terms of truthful information about social relations. With this highly perfected instrument of communication at its disposal, democracy should be able to devise a means of social control of wealth distribution that will more and more guarantee an equable sharing of the annual production of wealth. It is not the purpose of this book to consider the development and perfecting of a new order of distribution. All that will here be attempted is a demonstration of the great significance of the new communication for the expression of the popular will and the strengthening of democracy.

Considering the means of transportation and communication of two centuries ago, men of the eighteenth century were about as much circumscribed in thought and limited in action by material and physical barriers as were men of antiquity. Vast oceans, arid stretches of desert region, and lofty and impassable mountain ranges, set definite limits upon the freedom of movement of all but a negligible few. The customs and prejudices of each little locality enslaved the intelligence of the masses, and encouraged a narrow and provincial outlook upon life. Travel was the luxury of a small minority, and communication was largely direct or by word of mouth. Then came the burst of scientific discovery and mechanical invention in the field of transportation and communication that, beginning in the late eighteenth century, in

THE DEVELOPMENT OF THE LOCOMOTIVE

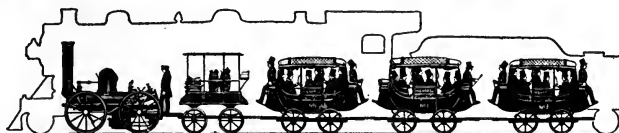

1831
FROM AN
OLD TIME
ENGRAVING

FRAMED
BY A
PACIFIC
THE
STANDARD
PASSENGER
ENGINE
OF 1915

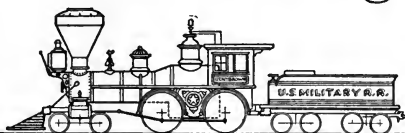

1862



1848
FROM
AN OLD
DRAWING

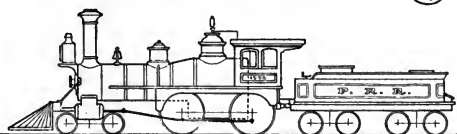

1876

FIREBOX 1876
BETWEEN AXLES 1893
OVER AXLES 1915
OVERTRAILERS

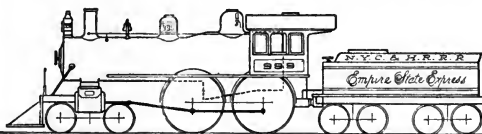
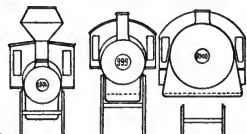

AMERICAN 1895

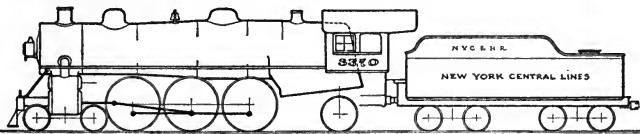

PACIFIC 1915

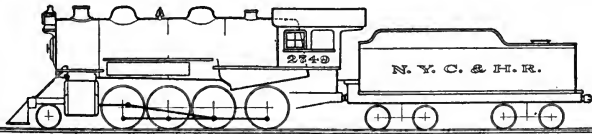

CONSOLIDATION FREIGHT 1905

Drawings by F. B. MASTERS

By F. B. Masters.

FIG. 20.—The development of the locomotive

creased in volume and importance during the nineteenth and twentieth centuries, until at the beginning of the second decade of the twentieth century, it seems as though the mechanism of communication had been largely perfected.

In the widest sense of the word, transportation is communication, for it involves the transfer of material, or physical objects, which themselves may be the agents or means of communication.¹ Messages, mails, letters, persons, and physical bodies are conveyed from place to place by the modern transportation system. It is, therefore, as a means, or an agent of communication that transportation will be considered in this chapter.

THE GREAT INVENTIONS IN COMMUNICATION

The modern transportation system began with the application of steam-power to motor vehicles in the early part of the nineteenth century. The earliest railway vehicle in the United States was used at Boston in 1807. George Stephenson built his first engine and operated it on the Killingsworth railroad in 1814, and traffic began on the Stockton and Darlington railroad in 1825. The first practicable electric railway was built in 1884, when an overhead trolley-line began operation in Kansas City.

It was not long before steam-power was applied to water transportation. Robert Fulton's sidewheel steamer *Clermont* began to navigate in 1807. As early as 1801, Fulton had constructed and operated, with more or less success, a model submarine. But it was not until the twentieth century that under-water transportation attained any degree of practical value, even for military

¹ Cooley, C. H., *The Theory of Transportation*, *Pub. Amer. Economic Association*, vol. IX (1894), pp. 262-94.

and naval purposes. On July 9, 1916, the great commercial submarine *Deutschland* arrived at Baltimore, having eluded the Allied blockade of German ports and crossed the Atlantic ocean by means of her own power and fuel.

Although transportation by automobile is of recent development, a steam-carriage was proposed by Newton in 1680, and a model steam-carriage was constructed by Nathan Read in 1790. In 1802, a steam-carriage was driven ninety miles, and during the period from 1824 to 1836 steam-carriages were constructed in numbers. The



FIG. 21.—The largest locomotive

period of modern development of the automobile began in 1894. It is true that a gas-engine was constructed in 1886, but the successful internal combustion engine was not constructed until George B. Sheldon of Rochester, New York, patented his device in 1895.

Early efforts to conquer the air began in 1783, when Pilâtre de Rozier and Marquis d'Arlandes rose 3000 feet and traveled nearly two miles by balloon. There were fifty-two balloon ascents in 1784. The first notable distance record was made in 1859 by two American aëronauts who traveled 1150 miles at a rate of about a mile a minute. Colonel Renard traveled twenty-three miles in a dirigible balloon driven by a motor screw in the year 1884. By 1910 Count Zeppelin opened the first regular airship passenger-service with the great dirigible *Deutschland*. In 1913, Zeppelins carried a total of 12,382

passengers for trips as long as five hours at a time. Following the earlier experiments of Langley and Maxim, Orville and Wilbur Wright of Dayton, Ohio, were the first to solve the problem of aviation. They flew twenty-four and one-half miles with a heavier-than-air machine in 1906. During the last decade, the number of different aeroplane models has increased, until to-day there are almost as many different aeroplane as automobile models and the conquest of the air seems practically completed. Thus, in the course of about one century, man has perfected the mechanism of transportation in three elements—on the earth, on and under the water, and through the air.

Even more startling than the rapid progress of invention in transportation, has been the discovery and invention of new methods of direct communication. Photography appears to have had its beginning with the investigations of K. W. Scheele in 1777 as to the darkening action of sunlight on silver chloride. The experiment was repeated by J. Senebier in 1782. The first real photograph was produced in 1802 by an Englishman, Thomas Wedgwood. The daguerreotype of L. J. M. Daguerre and Niepce was perfected in 1839. Dry plates were invented in 1862. The first "kodak," using films, was invented in 1888. Frederick E. Ives of Philadelphia invented the three-color process of color-photography, based upon the combination of three primary colors, red, green, and blue, in the year 1878, and further perfected the process in 1885.² Lithography, begun in 1798, became a regularly established trade at Munich by 1806.

The motion-picture was invented by Dr. Coleman Sel-

² "The Invention and Development of Photography," in *The Scientific American Supplement*, vol. 112, pp. 530, 560-66.

lers of Philadelphia, who patented the "kinematoscope" in 1861. The first motion-picture exhibit was given by Henry Heyl of Philadelphia before an audience of 1500 persons in 1870. The standardization of the motion-picture film and apparatus is now complete, and the Smith-Urban kinemacolor process, and the Gaumont three-color process have recently been introduced. New developments have appeared in the form of a talking-motion-picture, known as the "kenetophone" (invented by Edison in 1913), in which there is a synchronization of screen pictures and the spoken word. Since the inventions of M. Gaumont of Paris, in 1902 and 1912, motion-pictures in natural colors have been possible in connection with the kenetophone.³

One of the most extraordinary, as well as useful inventions of new communication is the phonograph. Thomas Young, in 1807, described a method of recording the vibrations of a tuning-fork on the surface of a drum. The "phonautograph" of Leon Scott, used in 1857 to record the vibration of a membrane, seems to have been the real precursor of the phonograph. But it was Thomas A. Edison who first accomplished the reproduction of vibrations of sounds on moving surfaces. Edison patented his device in 1877. Other sound-recording machines soon followed. Alexander Graham Bell and S. Tanier patented the graphophone in 1885, while Emile Berliner patented the gramophone in 1887.

The first practical use of the principles of Volta's battery and Sturgeon's electro-magnet was made by Joseph Henry of Washington, D. C., in 1831. Samuel F. B. Morse invented the commercially practicable system of telegraphy in 1837. After preliminary experimental work

³ *Ibid.*, vol. 108, p. 539.

PASSENGER AND FREIGHT GIANTS OF TO-DAY

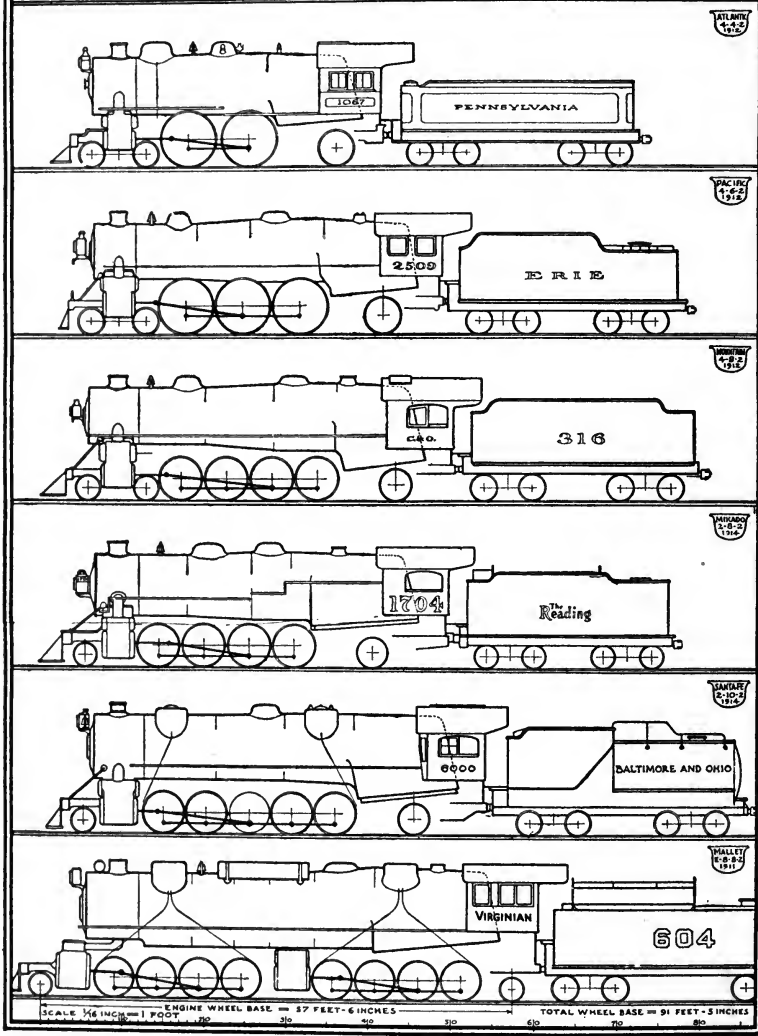

By F. B. Masters.

FIG 22.—Modern types of locomotive

between 1845 and 1888, the first practical application of electric-wave wireless-telegraphy was made by Guglielmo Marconi in 1896. In 1851, the first successful submarine cable was laid, and in 1857 and 1865 Trans-Atlantic cables were put down. The most recent developments in the field of telegraphy is facsimile-telegraphy and photo-telegraphy. Alexander Bain invented a copying machine in 1843, and transmitted handwriting by telegraphy in 1847. From 1898 to 1909 telautography was used in connection with the wireless system.

Alexander Graham Bell established the first commercially practicable telephone system during the period 1875 to 1877, having patented his invention in 1875. Bell's work was the outgrowth of experimentation which had begun as early as 1831.

Somewhat less spectacular and startling than these remarkable single inventions and their combinations, has been the appearance and wide use of the cheap newspaper (since the 1830's), low-priced magazines, and inexpensive books. Yet these changes, as well as improvements introduced by the linotype machine and the typewriter in the last quarter of the nineteenth century, have had a profound influence in creating the new communication.

THE EXPRESSIVENESS OF THE NEW COMMUNICATION

If we attempt to analyze and describe the characteristics of the new communication, four factors may be distinguished which, according to Professor Cooley,⁴ have mainly contributed to its efficiency. These aspects of the new mechanism of communication are: expressiveness, or the range of ideas and feelings it is competent to carry; permanence of record, or the overcoming of time; swift-

⁴ *Social Organization*, 1912, p. 80.

ness, or the overcoming of space; and diffusion, or its access to all classes of men. This classification is about as significant and comprehensive as any, and we may now examine the sociological importance of the new communication in the light of it.

Through the medium of the photograph in its half-tone and color processes, by means of the motion-picture and the phonograph, and their synchronization in the kenetophone, through the channel of the telephone and the large-scale printing of penny newspapers, cheap magazines, and inexpensive books, the range of ideas and feelings which the modern mechanism of communication is competent to express has been extended to cover all aspects of modern social life. These inventions in communication make it possible for society to be more and more organized on a basis of the higher faculties of intelligence and sympathy, and less and less dependent on the crude unifying influences of authority, caste, and routine.

The postal system furnishes the material means by which personal communications, newspapers, and magazines may be sent to the uttermost corners of the earth, and intelligence about world events radiates from metropolitan centers to remote rural localities.

The American one-cent newspaper provides a European news service of remarkable fullness, a lavish amount of information about local, state, and national politics, educational news of schools, colleges, and societies, religious and church news, women's clubs and suffrage news, articles and news about music, drama, new books, social service, and innumerable agencies of civic activity. Then there is considerable space devoted to such sports as baseball, foot-ball, racing, tennis, hockey, golf, skating, and aquatics. The commercial section embraces in-

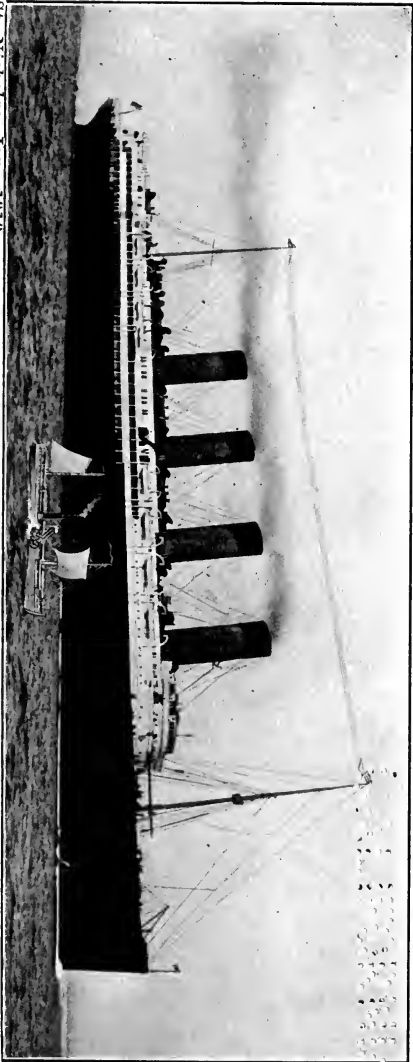

St. Nicholas, Jan., 1910.

FIG. 23.—Comparison of *Mauretania* and *Clermont*

formation about all markets and trades, and devotes much space to real estate. The Sunday supplements publish excellent photographic reproductions illustrating specially significant or interesting occurrences at home and abroad. The "funny sheet," or comic page, has apparently become one of the established institutions of the American press.

Magazines are of all sorts. They may be classified on the basis of the human activity or field of thought which they endeavor to express. There are a multitude of scientific, religious, artistic, trade, business, agricultural, and manufacturing periodicals, in addition to the few high-grade literary publications, and the many cheap and frothy magazines.

Photography has enormously increased our capacity of expression. Great paintings, beautiful architecture, natural wonders of forest, stream, mountain, plain, and sea, as well as the varied aspects of the human face, are faithfully reproduced in soft half-tones and striking contrasts. The unsanitary tenement with its rickety stairs, dark halls, filthy plumbing, and cracked walls is just as graphically shown as the marble stairways and rich hangings of the palace. Public sympathy is aroused in support of reform legislation to remedy bad housing, tuberculosis, "sweating," child-labor, and uncompensated industrial accidents by vivid photographic representations of the trail of misery and squalor that follows these evil conditions. Stereoscopic views of foreign countries realistically portray the charm of their natural scenery and architecture. In art books, in popular magazines, and on post-cards, views of all sorts are printed in natural colors.

Moving-pictures seem unusually real because they express the motion and action that earlier photography

failed to catch. The rushing torrent, the magnificent waterfall, the splashing surf, the even flight of a bird, the speed of an express-train, the course of a sailing vessel, the surging of a crowd, the rhythmical march of line upon line of troops, and the facial expressions of mirth, laughter, sorrow, weeping, fear, and joy,—all are reproduced with impressive fidelity.

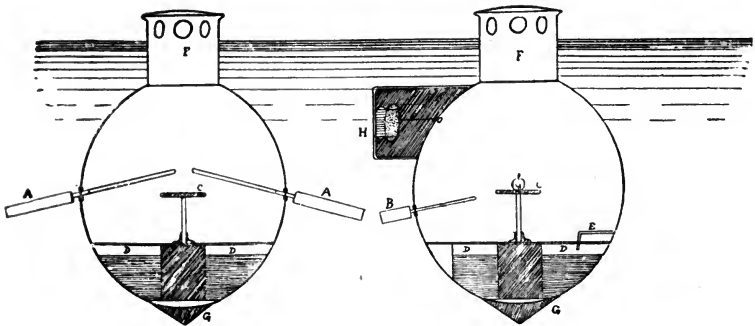

FIG. 24.—Evolution of the submarine: the *Turtle* of David Bushnell

Yet the motion-picture does more than represent external and objective things. It is capable of expressing the subtler mental processes far more forcibly than the ordinary photograph. Emotion, feeling, and imagination may be interpreted upon the screen by a fleeting glimpse of past events aroused in memory. The phantom of a dead loved one appears to stay the hand of the murderer. Thus by a clever deception of photography the audience is enabled to visualize images that pass through the hero's mind in quick succession and explain his hidden motives, moods, and action better than any words or facial expression alone. Professor Münsterberg has said: "It is the only visual art in which the whole richness of our inner life, our perceptions, our memory, and our imagination, our expectation, and our at-

tention can be made living in the outer expressions themselves.”⁵ Indeed, so insinuating are the suggestions of motion-picture plays that it has seemed necessary to exercise a degree of social control over the type of “reel” exhibited to the public by means of a voluntary board of censorship.

The extraordinary range of expression and usefulness of the motion-picture has found application in the educa-

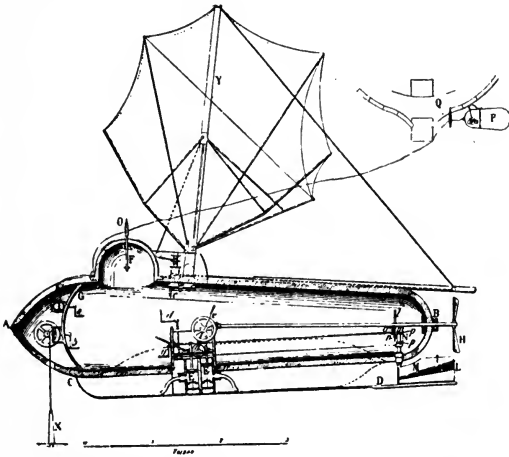

FIG. 25.—Evolution of the submarine: the *Nautilus* of Robert Fulton

tional field. The authorities of Vienna and Dusseldorf teach their citizens how to get on and off street-cars safely by means of motion-pictures. A group of manufacturers have equipped an “industrial betterment special” which uses motion-pictures to teach workmen how to avoid accidents and care for machinery. A Pacific Coast railroad has a “reel” which shows trainmen the rules of the road and the consequences of carelessness. The United States Department of Agriculture has an up-to-date motion-pic-

⁵ *The Cosmopolitan Magazine*, December, 1915.

ture laboratory where the germination of seeds and the growth of flowers are photographed. During the summer of 1914 ten thousand feet of reel, showing forest-fires, ranger's life, and the use of national forests for recreation purposes, was exhibited throughout the West.⁶ "Rube theaters" were sent to the rural sections, educating farmers to the importance of good roads, giving complete courses in poultry-farming that covered such details as raising hens, packing and sorting eggs, marketing, routes, and so forth, and showing how wheat grows from the planting of the seed, through its stages of growth to the final processes of harvesting and shipping. Automobile companies and manufacturing concerns utilize motion-pictures to instruct their salesmen.⁷

In the field of medicine and science, there have been remarkable applications. In France, by use of motion-pictures, deaf-mutes are taught to talk. The nature, prevention, and cure of disease may be successfully shown. Diagnosis of nervous diseases characterized by quick movements, tremors, peculiar gaits, convulsions, and spasms, is assisted by use of the motion-picture. Motion-pictures are also useful in the study of diseases of the eye, whooping-cough, meningitis, the right and wrong methods of bathing and dressing a child, the movement and growth of bacilli, and in obstetrical surgery and epilepsy. Motion-pictures have been used to illustrate modern methods in social work. The National Association for the Prevention of Tuberculosis uses a scenario to show the cure of tuberculosis. Screen-pictures of *Les Misér-*

⁶ *Outlook*, vol. 109, pp. 749-50.

⁷ Lanier, H. W., "The Educational Future of the Motion Picture," *Review of Reviews*, vol. 50, pp. 725-29; and Mason, G., "Teaching by Movies," *Outlook*, vol. 107, pp. 963-70.



FIG. 26.—Evolution of the submarine: submarine on the surface

ables have been shown in reformatory institutions to convey a moral lesson. Dr. Alexis Carrel of the Rockefeller Institute and Dr. Doyen of Paris have spread information of unusual feats of surgery by means of the motion-picture. It is planned to aid country physicians by sending out "reels" which show the master surgeon in action. Motion-pictures show microbes at work. X-ray motion-pictures show the stomach and muscles performing their functions, and the palpitating heart. By film, it is possible to produce in three minutes, a ten-day period of growth in a horse-chestnut. Slow motions can be hastened to observe the total effect in truer perspective. It is equally possible to retard, and so analyze quick movements like the flight of insects, the course of a projectile and its effect on armor plate, and the falling of a body.

Some of the direct uses of motion-pictures for educational purposes are worthy of note. Films have been employed to assist a pupil to make a choice of vocation. School children now study geography in Ontario, Canada, by means of the "movies." Greece has four thousand machines for use in government schools. The University of Wisconsin has a film library which is circulated throughout the state, and many other colleges and universities in the United States use motion-pictures. Superintendent Hyatt of California has said: "The time is at hand when moving-pictures will be as much an adjunct of any properly equipped school as text-books." Dr. Wallin says: "It represents the most highly evolved education instrument which the present century has bequeathed."⁸

But the new communication has passed beyond the stage of mute appeal by photograph and motion-picture; it has

⁸ Lanier, *op. cit.*

made notable conquests in the realm of sound. By telephone, the finest graduations of tone, and the subtler qualities of the human voice are faithfully transmitted and reproduced over great distances, so that a person's state of feeling, whether of joy, sorrow, anger, pleasure, depression, or exaltation may be correctly expressed. The music of the human voice, and of full orchestral instruments, is recorded upon a wax disk, and reproduced with great fidelity to details. Thus the whole gamut of human passion, feeling, emotion, and sentiment is made increasingly communicable and recordable. George Bernard Shaw says he will not be surprised if the cinematograph and the phonograph turn out to be the most revolutionary inventions in communication since the discovery of writing and printing.

SWIFTNESS IN OVERCOMING SPACE

James Bryce has expressed the opinion that the Great War might have been averted had it not been for the speed with which the cable, telegraph, and telephone flashed news between the capitals of Europe during those dramatic closing days of July, 1914. If news had spread less rapidly, perhaps the slower processes of diplomacy might have been given opportunity to work,—at least, the statesmen of Europe would have been saved the necessity of making tremendously important decisions at short notice.

It takes but an instant to transmit the human voice by telephone to a far distant point. By telegraph, news radiates from central places, and flashes across oceans and over continents in an incredibly short space of time. On Oct. 4, 1915, Mr. Theodore N. Vail in New York, picked up his desk-telephone and conversed easily with San Fran-

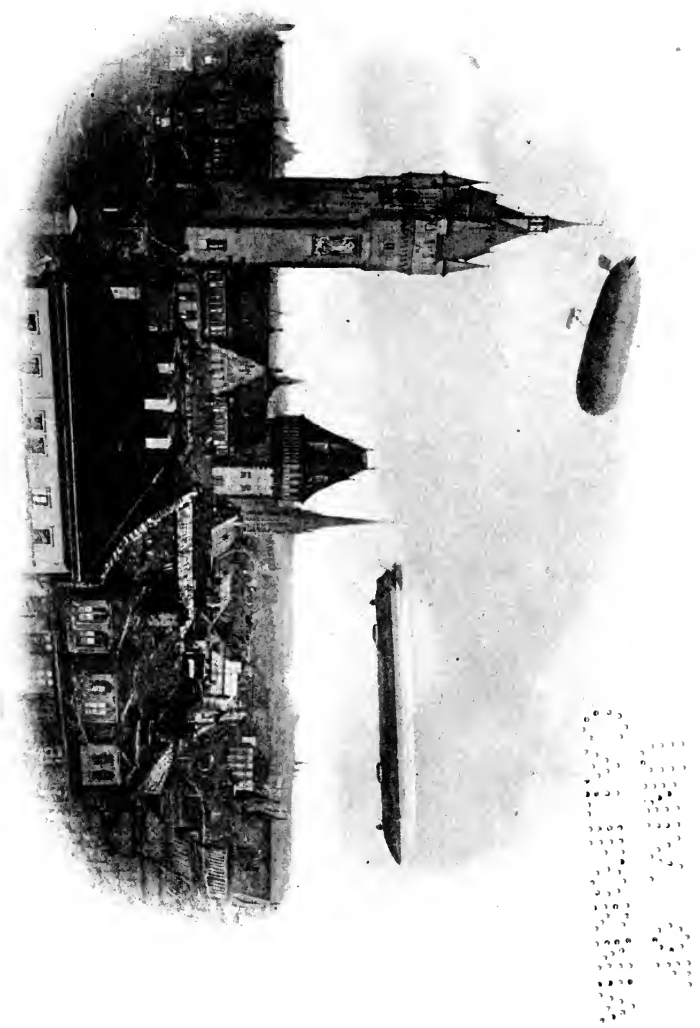
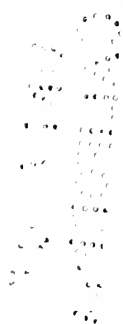

FIG. 27.—Zeppelin over a German city



cisco. Thus the human voice, hardly audible at a hundred yards, was carried more than 3000 miles, and 2500 miles of this distance was by wireless. The same conversation was overheard by a wireless operator in Hawaii, 4800 miles distant. Suitable receiving stations at Petrograd, Timbuktu, Rio de Janeiro, or the North Pole could have heard the same conversation. The fast express-train carries the morning newspaper, printed in the metropolis, to towns and villages that lie two hundred miles distant. The Atlantic ocean may be crossed in less than five days. The automobile and the aëroplane complete man's emancipation from the ancient disadvantage of remote location and inaccessibility.

THE DIFFUSION OF INTELLIGENCE

The aggregate railroad mileage of the world in 1913 was estimated at 690,133 miles, of which 257,823 miles were in the United States. Nearly two billion and one-half cars were operated on the trackage of the United States during the same year. Some idea of the diffusion of intelligence made possible by the railroad systems of this country may be gained from the fact that the total passenger movement in 1910 was 32,388,870,444 miles, involving the transportation of 998,735,432 persons. Over one billion passengers were carried in 1913. But the real significance for communication of this vast rail movement is seen in its relation to the mail service. In 1915, there were 56,380 post-offices and mail routes, with a total mileage of 433,334. During the one week of October 12th to 19th, 1907, the total of all classes of mail despatched was 246,020,347 pieces, of which 133,035,673 were first class.

The amount of printed matter in the form of personal communications transmitted by railroad and other mail

service is incalculable, but it is possible to gain an idea of the diffusion of information by means of the daily newspaper circulated in urban regions and radiated into the surrounding country. In New York City alone, the average daily circulation of newspapers was 3,883,499, among 1,020,827 families and 4,766,833 individuals, in 1914. The largest newspaper press in use in 1911 had a capacity of 96,000 sixteen-page papers per hour, folded to half size and counted. From 1850 to 1909, the per capita circulation of periodicals increased from 18 to 129, which means that the average American now receives more than seven times as many periodicals as in 1850. During this period, the number of different periodicals published increased more than eightfold. Finally, reference to the increasing volume of printed matter would not be complete without mention of the eight thousand public libraries of the United States, whose millions of volumes, circulated each year, represent radiant points of intelligence power of which it is hard to overestimate.

This new communication has wrought its greatest benefits in rural communities. Isolation from the vast currents of men and ideas that move along the more accessible river-valleys and over the fertile alluvial plains where great cities have arisen, is the great curse of the country. The influences that have revolutionized the life of country folk are found within the limits of the new communication.

About twenty million country people received mail daily over the forty thousand odd rural mail routes during 1909. The distribution of metropolitan dailies brings to the remote village news of the throbbing life of the city, and serves as a constant stimulus to thought and action. The farmer and his boys are now able to intelligently dis-

cuss the great interests of humanity. This broadens and enriches their lives to an incalculable degree, and prevents mental stagnation. Fiske⁹ mentions one rural route upon which the number of daily newspapers delivered increased in three years from 13 to 113. The number of rural free delivery carriers in 1915 was 43,710, and the daily mileage, 1,073,099.

Although the steam railroad has opened up whole sections for settlement, and served as an important artery of communication for the continuous influx of fresh thought and world standards, it is the interurban trolley that has, in recent years, contributed most to the enlargement of rural life and possibilities. For the electric railway does what the steam railroad cannot do: it provides frequent service and stops, at a small fare. Its passenger-rates vary from three quarters to one and one-half cents a mile, compared with two to three cents on steam roads. Cheap construction, low expense for power, low maintenance, and equipment costs, make these rates possible. The frequent stops and small charge for fare facilitate visiting and travel. Says Dr. Roads: "No king one hundred years ago could have had a coach, warmed in winter, lighted to read at night, running smoothly with scarcely a jolt, and more swiftly than the fastest horses."¹⁰

The final step in transportation which has emancipated rural life from its agelong inaccessibility and stagnation, is the inexpensive automobile. Its low running-cost makes the automobile as much of a necessity for the farmer as agricultural machinery. It annihilates distance, makes isolation a myth, and as a means of communication outstrips all but the telephone. A consider-

⁹ *The Challenge of the Country*, 1912.

¹⁰ *Rural Christendom*, p. 84.

able proportion of the two million automobiles in the United States in 1915 were owned by farmers.

With the coming of the rural telephone, distant neigh-



St. Nicholas, Jan., 1910.

FIG. 28.—Wilbur Wright's first aëroplane trip over water by the Statue of Liberty

hors are brought nearer, and the family circle is widened. The dreary winter months are not as monotonous as formerly, for association by the distinctly personal element

of the human voice is now possible without actual visiting. Advice, information, and gossip are freely exchanged, and many needless trips over weary miles of country road are saved. Fiske estimates that there were at least 266,969 rural telephones in 1902.

Telephone service now extends over the whole globe. In 1911, there were 11,235,987 telephone stations in the world, sending messages over 26,644,367 miles of wire. In 1915, the Bell Telephone Company's system in the United States alone contained over nine million telephone stations. Since 1895, the number of daily messages and conversations has increased over tenfold. This means that at the present time one person out of every four, as compared with but one person out of every twenty seven in 1895, converses daily over the telephone.

Communication by photography is now within the reach of practically all classes in America. The "Brownie" camera costs but a small sum, and its films, developing and printing, are also inexpensive. Small "Ping-pong" pictures are within the means of the poorest workingman. The penny post-card, colored with great realism, is a cheap and wonderfully satisfactory means of communicating by mail.

Perhaps the most democratic of the new arts of photographic communication is the low-priced motion-picture show. During 1915, it is estimated that daily attendance at the "movies" averaged from four to ten million persons. When eighty per cent. of the wage-earning population of the United States earns less than \$750 a year,¹¹ it is clear that the ordinary theater, with its dollar and two dollar seats, fails to supply the popular need. At the

¹¹ Nearing, S., "The Adequacy of American Wages," *Annals of the Amer. Acad. of Pol. & Soc. Science*, May, 1915.

“movies,” a man and his family of children may spend the evening, see such a variety of “reels” that all tastes are pleased, and then, if disappointed, feel little sense of loss. Perhaps the patronage of the wage-earners of the nation, who have lived perpetually close to the sterner realities of life, supplies an element which the drama needs.¹² But the truly democratic character of the motion-picture is seen in its extraordinary diffusion as a means of entertainment. Bernard Shaw suggests that the “movies” will make it possible for our young people to grow up in healthy remoteness from the crowded masses and slums of big cities, without also growing up as savages.¹³ It reaches the Russian *mujik*, the Chinaman, the Peruvian, as well as the New Yorker—in fact, all nations and ages, and both sexes. It has entered the daily stream of thought of the masses, for while the technique of the theater was a subject for scholars and professionals, the crowd is quite capable of intelligently discussing the “movies.” The common people know how the films are made, what the costs are, and the names of the leading actors. *The Nation* says that the producers of moving-pictures “have converted their entire audience into first nighters.”¹⁴ The masses are more than mere critics; they are authors. Everybody is writing moving-picture scenarios.

Under the caption, *The Future Home Theater*,¹⁵ Mr. S. C. Gilfillan has anticipated the social effects of the “talking-motion-picture” in a somewhat prophetic article. He believes that the talking-motion-picture and the electric-

¹² Eaton, W. P., “Class Consciousness and the Movies,” *Atlantic Monthly*, vol. 115, pp. 48-56.

¹³ *Metropolitan Magazine*, 1915.

¹⁴ Vol. 97, p. 193.

¹⁵ *The Independent*, vol. 73, pp. 886-91.

vision apparatus connected with the telephone will eventually become so inexpensive that the apparatus will be installed in every house, like the country telephone, so that one may go to the theater and the opera without leaving home. This "home theater" will be a combination of the kenetoscope, phonograph, and telephone. When color-photography and stereoscopy are added, the scenes will

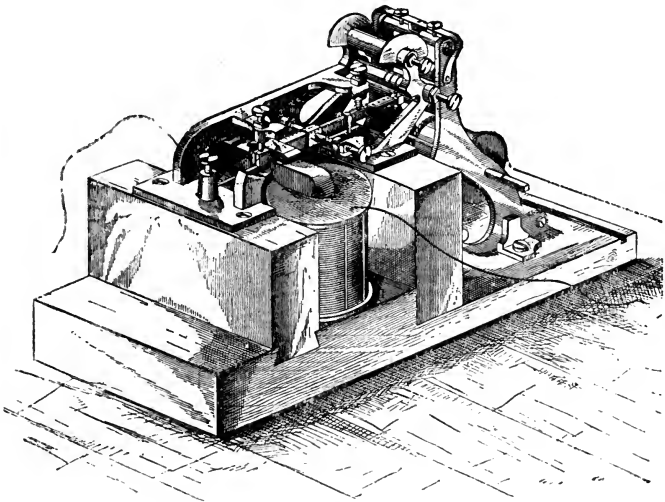

FIG. 29.—Morse's telegraph instrument

be three-dimensional; not flat pictures, but vistas of reality. The device will send sight and sound from a central stage to millions of homes by using telephone wires as communicating means. The sound may be increased by use of the microphone, and thus made distinctly audible all over the room. The theater is completed by moving-colored-stereoscopic-pictures thrown upon the wall.

Mr. Gilfillan holds that the electric form of the "home theater" will be used to publish the more timely and popular productions, while the disk and film apparatus will be

utilized to show past occurrences. He maintains that a better art will be produced, since the artists will be inspired by accessible records of masters of the past; that the moral tone will be better than that of the present theater, because the electric form will be supported by family audiences; and that the disks and films distributed from public libraries can be easily censored at the point of distribution. Such a synchronous device would have great educational value, and it is possible that every large apartment-house would have connections. Finally, it will tend powerfully to preserve the home. This forecast is no idle prophecy. The City of Budapest, Hungary, has had a "Telephone Herald" service for fifteen years, which distributes hourly news, editorials, speeches, language lessons, music of all sorts, and the audible parts of the best plays. Yet, however advantageous the "home theater" principle may prove, it is certain that public gatherings at theaters and motion-picture shows will continue, for the simple reason that the imperious call of man's gregarious instinct and sociable dispositions will ever lead him to bathe his being in the stimulating atmosphere that overhangs and permeates every crowd.

Although the "home theater" as a means of diffusion of information and intelligence is as yet a thing of the future, the disk phonograph is very much a thing of the present. The family of small means may now sit comfortably at home and listen to the clear notes of Farrar and Caruso emanating from the talking machine. They may teach their children appreciation of good music without the necessity of lavish expenditure for opera seats. The washerwoman in her tenement, the wood-chopper in his cabin, and the cowboy of the prairie, may hear good music, if they choose, from the cheap phonograph.

PERMANENCE OF RECORD—THE OVERCOMING OF TIME

The historian of the future will find a wealth of material in newspaper files, current magazines, and books,



St. Nicholas, Mar., 1910.

FIG. 30.—Telegraphing a thousand words a minute

which the earlier scholar could never have consulted. It is not hard to forecast the tremendous scientific importance for latter-day historians and sociologists of the

great mass of material about common-place events and happenings that is described with considerable accuracy in the news columns of papers and magazines of to-day.

This rich mine of printed verbal description is made vivid, accurate, and realistic as no former manuscript ever was, by photographic reproductions of the actual events. There is no escape from the evidence of a photograph and lithograph, and future scholars will be in a position of great vantage in studying the past.

By means of the motion-picture, the true movements of extinct animals and obsolete industrial processes will be preserved for coming generations. It will be possible to compare contemporary methods and scientific technic with those of the past. The motion-picture films of the Great War will be of incalculable value to future students of military science. Realistic information about sports, games, and folk-dances can be indefinitely preserved. The peculiar grace of movement, the personal charm of facial expression of great actors, can be reproduced for the admiring observation of coming generations of lovers of the drama. Edison has said: "The next generation of 'stars' will not die with their artistic death. The phonograph and the motion-picture will preserve them."

Old books which described savage life depicted the natives in Europeanized appearance. All this was changed by photographic representation. Similarly, old hand-books on the music of primitive peoples contained Europeanized versions. The phonograph has remedied this error. Ethnological museums now contain collections of photographs of primitive peoples and primitive life, and also phonographic cylinders and gramophone disk-records of primitive music and languages. The great facility with which sound-records can be duplicated renders

exchange easy, so that these precious records have wide distribution and may be preserved indefinitely. Tone-pictures should be taken of every rare and passing dialect, and of all old ballads, so that future students of mankind may have access to first-hand records of the past. The English language is changing. There was, in 1911, but one clergyman who could conduct divine service in Wendish. It was some time ago that the last man to speak the Cornish language died. The Mecklenburg dialect, in which Fritz Reuter wrote his *Onkel Bräsig*, is already obsolete. Many of the queer costumes of peasantry have already vanished, and folk-songs, country dances, and turns of rural speech appear to be fast following them.¹⁶

SOCIAL EFFECTS OF THE NEW COMMUNICATION

The disappearance of dialects and localisms before the standardizing sweep of universal ideas as carried by the new mechanism of communication, is a phenomenon of general observation. Some consider this a serious menace to individuality, and see in it an ultimate dead level of uniformity in human thought and aspiration. De Toqueville, whose name has been associated with this doctrine, fears that the peculiar characteristics of each individual will soon be entirely submerged and lost in the general aspect of the world.¹⁷ The naturalist, John Burroughs, maintains that our separate personalities are likely to be worn down and smoothed off by the constant intercommunication and friction of travel, streets, books, and newspapers, until we shall become like pebbles upon the same shore, and all alike.¹⁸

¹⁶ Kelley, E. S., "A Library of Living Melody," *Outlook*, vol. 99, pp. 283-7

¹⁷ *Democracy in America*, vol. 2, bk. 4, ch. 7.

¹⁸ "Nature's Way," *Harper's Magazine*, July, 1904.

Cooley¹⁹ finds encouragement and a key to this perplexity in the distinction that there are two different kinds of individuality, one produced by isolation, and the other produced by choice. The new communication fosters the latter and effaces the former. Modern conditions of communication are conducive to rational and free living, rather than of mere local and accidental existence. They enlarge and intensify the competition of ideas, so that

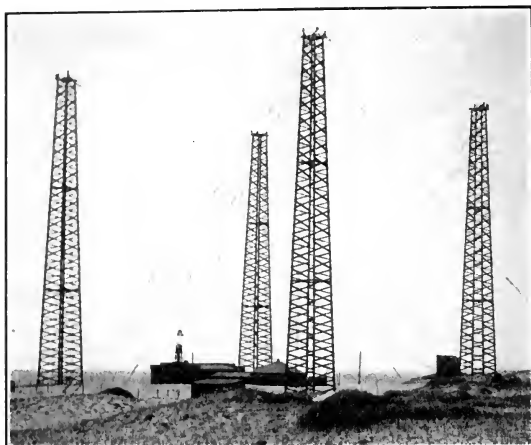

St. Nicholas, Jan., 1914.

FIG. 31.—Wireless station at Cape Cod

the selective process is speeded up, and whatever persists because it has never been tested, is likely to go, whereas that which is endowed with elements of universal truth, is sure to survive and be increased. Any one who has penetrated into remote mountain communities is impressed with the local flavor of conversation and fashion of dress; and all persons who have spent a portion of their lives in great metropolitan centers where the modern mechanism of communication is most highly developed,

¹⁹ *Op. cit.*, pp. 93-4.

have observed the uniformity of style and the tendency of individuals with like interests, although separated by many miles of street, to get together in congenial clubs and groups. It would therefore seem that Professor Cooley's distinction is an adequate explanation of the situation.

This sociologist predicts the likelihood of diminution in local peculiarities of speech and manner, and in other curious and involuntary evidences of individuality. The example that suggests itself is the gradual disappearance of those diversities in dress, language, and culture which were developed in Europe during medieval times. It is hardly possible that we shall ever see the development of small isolated communities with peculiar traditions, like the little baronies that formerly developed in the midst of large populations. It is improbable that modern cities will ever evolve the sort of architectural individuality we find in Italy, where each village was built as a distinct political and social unit. This will mean a loss of local color and of picturesque social types.

But compensation will be found in the creation of a more vital individuality. Special groups who cultivate peculiar phases of knowledge, art, conduct, or of any human interest, are already on the increase, and will probably become more numerous. Cooley believes that we will have uniformity only in those matters wherein conformity is cheap and convenient, but that in all activities wherein men care to assert themselves, to put themselves into their work, something distinctive will be produced. Thus the vital individuality of special interest displaces the accidental individuality of isolation.

Dr. Delos F. Wilcox, an authority on municipal problems, in recognizing that modern means of transportation

and communication are reorganizing society according to interests rather than according to place,²⁰ notes that the principles of this reorganization run counter to political forms and habits. Our one-time practical interest in local institutions has suffered a good deal by the development of railways, steamships, telegraphs, and telephones, which have given men a certain obvious, although in some respects a quite superficial independence of locality.

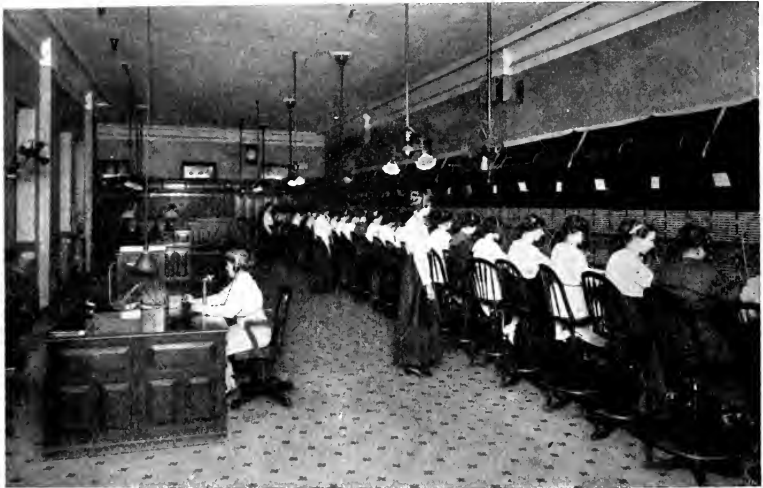

FIG 32.—Telephone central exchange

Business interests and modern concentrated industrial organization lead men to work in offices, stores, or factories located in one part of the city, and dwell in houses, apartments, or tenements in a distant section, or even a suburb. In such cases “political boundary lines are practically powerless, and men readily abandon their citizenship in ward, city, or even commonwealth, at the dictation of non-political interests.”

²⁰ *The American City*, 1911, pp. 6-7.

It is common among business and professional classes for a man's friends and business associates to be scattered over the whole city, while he rarely knows his next door neighbor's face or name. Since the majority of city men carry on their day's work away from their dwelling, the only time left to spend with their wives and children is in the evenings and on Sundays. Thus it happens that there is another strong motive to keep men from going down town after the evening meal.²¹

Yet in spite of these obstacles to the exercise of democracy based on locality, the city really emphasizes locality, and provides unusual opportunity for collective action and coöperation. It is possible for people to gather in mass-meetings at short notice. The press furnishes a medium for the immediate expression of public opinion. Officials can be made to feel the weight of personal pressure without delay. The fault seems to be that the natural primary units of local democratic organization—the home and the neighborhood—have been weakened and in many cases almost destroyed by the increased facility of transportation and communication. Yet the new communication contains within itself the remedy for these temporary evils occasioned by the movement towards centralization. Public opinion has been aroused against the evils of decayed neighborhood life and the isolation of the home from civic affairs by means of magazine articles, novels, sociological books, press stories, "movies," photographs, and the movement for equal suffrage.

Professor Ross calls attention to the fact that the public mind is more open and responsive to readable accounts of contemporary oppression or political corruption than ever before. This comes about because competition of

²¹ *Ibid.*, p. 234.

ideas has thrust out much gossip and trashy fiction, and so made room for a presentation of things as they are. Often this is more enthralling than fiction, and yet is quite true. The "muck-rakers," despite their sensationalism, have roused the public to a realization of contemporary wrongs and abuses. The spread of social enlightenment has been followed by active efforts to remedy social evils. An aroused public has turned the new instruments of intelligence to account in a very practical way, and has thrown the search-light of social inquiry upon dark practices in convict camps, mill centers, coal fields, and copper districts.²²

The perfected mechanism of the new communication lies ready to our hand, if we will but invoke its power of expression and diffusion in favor of those legitimate and local democratic interests which have suffered incidentally in the evolution towards higher centralization. A wider use of the school plant in every neighborhood, the introduction into the common school of the modern inventions of communication, and a more liberal education in every-day interests, suggest themselves as possible remedies for the loss of neighborhood autonomy.

Thomas Edison is one of the first creators of the new communication to make a systematic effort to realize its promise for education. As now organized, common school education is quite as likely to repel and discourage the pupil as to stimulate his curiosity for learning. Mr. Edison brings movement into the field of formal education by introducing the motion-picture. As early as 1912, he had worked out between seven hundred and a thousand subjects for scenarios, each prepared by a specialist. He

²² "Free Communication and the Struggle for Right," *Pub. Amer. Sociological Society*, vol. 9, p. 2, Dec. 28, 1914.

claims that he is ready to elucidate by motion-picture such subjects as bacteriology, astronomy, botany, chemistry, entomology, zoölogy, forestry, geography, geology, horticulture, history, mechanics and mechanism, physics, and the technique of industrial arts and trades. Mr. Edison says that the time to make good moral citizens out of



FIG. 33.—Representation of spirit forms by Movies

children is between eleven and twelve years of age, when they are interested to learn about everything. With their mind awake and eager to gain knowledge, you can mold them any way you please. If, on the other hand, you wait till they are fifteen years old, it is too late, for their habits are set. He believes, therefore, that education

by "movies" has great promise, if it can begin at a relatively early age.

But the introduction of the motion-picture as a new educational device is not without its dangers. Democracy is successful both as it is the political expression of people who think for themselves, and the means of educating individuals in the same habit. Mere seeing is not necessarily knowing and understanding, and our use of the motion-picture for elucidating difficult points must not blind us to this fact. The only sort of education that counts is the kind that trains the individual to think for himself, clearly, independently, and critically. There is already far too much of the sort of education that consists in ladling out information. The motion-picture in education should avoid the danger of merely presenting predigested information poured into a receptive mind. Yet according to Dr. Leonard P. Ayres,²³ the dangers of the motion-picture as an educational tool, although real, are not necessarily inherent or unavoidable, because they can go beyond the mere imparting of facts, and be employed to organize, illustrate, clarify, and summarize knowledge which children have acquired by their own effort under intelligent guidance.

Aside from its uses in formal education, the motion-picture exerts considerable educational influence over its audience. But since the film is vastly more appealing and rousing in its effect than the printed word can be, and since it reaches and excites the non-reading classes, illiterates, and children, it has become necessary to exercise over motion-pictures a censorship which has been abandoned as regards the printed word. The National

²³ "Edison vs. Euclid, a Moving Stairway to Learning, with a Symposium," *Survey*, vol. 30, p. 687.

Board of Censorship, a voluntary unpaid body composed of representatives of Young Men's Christian Associa-

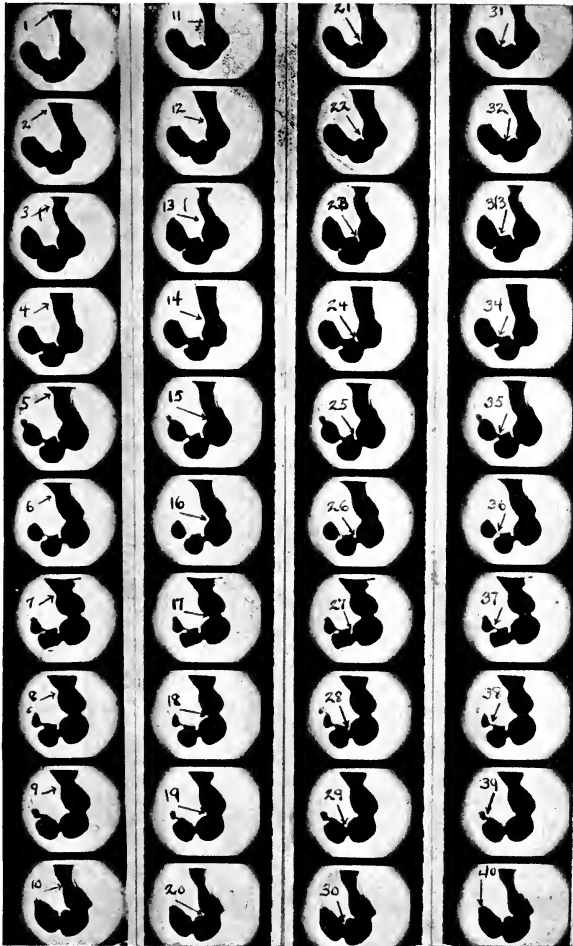

By permission of the "American Quarterly of Roentgenology."

FIG. 34.—Motion-picture of the stomach digesting food

tions, charity societies, children's aid associations, churches, social settlements, women's clubs and similar organizations, works in coöperation with certain film pro-

ducers to maintain standards of decency, and to exclude from the screen, examples of immorality, vulgarity, and violence.²⁴ There are over three hundred and fifty organizations and individuals in active coöperation with the national board, who bring pressure to bear against proprietors that show condemned films. In 1913, the board condemned fifty-three film subjects, and eliminated parts from 401 others. It is estimated that ninety-five per cent. of the film industry is covered by this censorship and by the bulletin which goes to four hundred cities.

The new communication is, then, not in danger of reducing us all to a dead level of uniformity in thought and aspiration, since it encourages an individuality based on choice, rather than an accidental individuality that results from isolation. Yet just because it magnifies the importance of choice, and multiplies the occasions for the exercise of rational selection beyond anything before experienced in the history of human society, it adds the element of mental strain. In this new social order, it costs the individual more by way of brain-work to live, than it did in the old order. He has a broader outlook, which means that he must think about a wider range of matters; he is required also to have a more thorough mastery of his particular specialty.²⁵

Nordau finds in this greater complexity of modern life, with its inevitable wear and tear of nerve material, a cause of degeneration. It appears probable that the prime minister of a petty, or second-rate state of a century ago, had a more limited geographical horizon and less extensive intellectual interests than the average vil-

²⁴ *The Survey*, vol. 26. pp. 469-70; vol. 32, pp. 337-8; and *Review of Reviews*, vol. 50, p. 730.

²⁵ Cooley, *op. cit.*, p. 98.

lage inhabitant of to-day. The average "drummer" travels more, and sees more towns and cities, than did the reigning prince of earlier times. A petty tradesman, or a cook send and receive more letters than the average university professor did formerly. No matter how simple these activities are, every one of them involves an effort of the nervous system, and a wearing out of tissue. Our sensory nerves and brain centers are set in ceaseless activity by the countless stimuli that pour in upon our minds with every conversation, every scene perceived through the window of a street-car or a railway train, and every ring of the door-bell or telephone. There are many little shocks of railway and street-car travel, often unperceived by consciousness but which, combined with the perpetual undercurrent of noise in a large town and with our constant state of suspense pending the occurrence of progressing events, increase the volume of stimuli that costs our brain the wear and tear of effort at continual attention. Nordau further maintains that in fifty years the sum of a man's labors has increased tenfold, while population has not doubled, and that every civilized man now furnishes as much work as twenty-five men did half a century ago.²⁶

Thus the very volume and complexity of intellectual stimuli that falls upon the individual mind from all quarters, produce strain as the price of sustained animation, and superficiality as the cost of versatility. We may be becoming broad-minded, but it is at some expense to truth and depth. Cooley points out that as there is an increase in self-consciousness and choice, there is a corresponding increase in the burden put upon intelligence, because opportunities for the exercise of will have been

²⁶ *Degeneration*, p. 39.

vastly multiplied, and the responsibilities of character have become more complex. If the individual is to avoid being swamped by the flood of urgent suggestions that pour in upon him, he must constantly make choices and decisions.



FIG. 35.—Representation of "Twenty Thousand Leagues Under the Sea," by movies

We discover, therefore, from an analysis of the character and effects of the new communication, that it holds forth both promise of good and evil. The same characteristics that have made modern communication the device for the spread of democracy—its great dispersive

power from central sources of information—make it amenable to centralized control by arbitrary interests. Mr. George W. Perkins has said :

Did any man in this room ever hear of a political leader, or a so-called statesman, delivering a speech in a state legislature or the National Congress, calling the attention of the people to the mighty changes that have taken place in the methods of intercommunication during the past twenty years and pointing out that, as intercommunication is the first requisite for doing business, these mighty changes are entirely responsible for the centralization of business?

On the contrary, speech after speech has been made, haranguing our people with the grossly misleading statement that the trusts exist because of the tariff and the greed and avarice of a small group of men. A more pernicious and misleading statement has never been thrust on the attention of our people. . . . *The tariff never made a trust, and free trade never will destroy one. It requires only a little serious, intelligent thought to reach the inevitable conclusion that, if we were given free trade in this country to-morrow, not a single so-called trust would dissolve;* on the other hand, even though our tariff were put as high as the mountains, if that strange force that we call electricity were suddenly withdrawn from our use, and the telephone and the telegraph went out of existence, not a single so-called trust could continue for twenty-four hours. In all the hours and years of debate on the question of corporations and big business I doubt if a single speech has ever been made, calling attention to *the great fundamental fact that a volcanic upheaval has taken place in methods of intercommunication; that the ox-team, the stage-coach, the sailing vessel and the horse or car have been buried deep in the ashes of the past, and in their place have arisen steam, electricity, and the wireless.* While this great change has come suddenly, it has come so naturally that we have scarcely stopped to realize that it has shaken the very foundations of our economics; for with the disappearance of old methods of intercommunication has disappeared the old

school of economics, and with the advent of new methods of intercommunication has arisen a new school of economics.²⁷ . . .

The remarkably complete military censorship during the Great War is an example of this control. Even in peaceful times, the obscurity which covers dissemination of news by the Associated Press brings irresponsibility and distress. Yet the tremendous power of enlightenment possessed by this new tool supplies the self-regulatory element needed to correct its abuse by selfish interests. It may take some time for a proper equilibrium to be reached, but the powerful impetus given by modern communication to the whole educational process is the bright promise of the future.

²⁷ "The Outlook for Prosperity; Economics New Versus Economics Old," address before Economic Club of New York, Feb. 10, 1915. (Italics introduced by the author.)

PART V. THE TRANSITION FROM RE-
MEDIAL TO CONSTRUCTIVE
CHARITY AND PREVEN-
TIVE PHILANTHROPY

CHAPTER XVII

MEDIEVAL CHARITY AND THE ENGLISH POOR LAW

THE Roman attitude towards charity is best expressed by the words *liberalitas*, *beneficentia*, and *pietas*. The first two terms emphasize the mood of the free and independent giver, as well as the deed and its purpose, while the last introduces the religious notes of piety and pity.¹ Contrasted with this attitude towards charity is the theory of medieval times, represented by three lines of thought. St. Bernard (1091-1153) helped to shape the idea that poverty was not as much a social state as a spiritual one. Thus, the poor were those who had taken vows of poverty. This doctrine invigorated the monastic movement and tended to make the monastery the center of charitable relief. St. Francis (1182-1226) revived the conception of charity as an ideal of personal service which should lead men to live among the poor and share their privations and misfortunes. St. Thomas Aquinas (1225-1274) associated charity with definite groups of good works, and thus established the basis in popular thought for the stereotyped form of aid which made the giver over-conscious of ultimate reward accruing to himself in an after-life. This last doctrine destroyed the simplicity and spontaneity of the deed, and falsifying it at the outset, gave charity the stamp of "otherworldliness."

¹ Lock, *op. cit.*, pp. 80-81.

MEDIEVAL CHARITY

Transition from the public relief of Rome to the monastery as a center of charitable aid was accomplished by various stages. To mention merely one in passing, it is sufficient to cite the establishment of the "church fund" during the second century. This fund was supported by voluntary gifts, and was used to assist the poor, provide burial, help destitute and orphaned children, and relieve other dependents. Around this charitable center, the parochial system developed.²

Throughout the Middle Ages, ecclesiastical theory regarded the collection of sums of money for the relief of poor members as the primary obligation of those who administered church property. In the sixth century, it was customary to divide the revenues of the Church into four portions, one for the bishop, one for the rest of the clergy, one for the maintenance of the church fabric, and one for the poor.³ Originally in the hands of the bishop, church revenues were eventually allotted to the several parishes. It was only one more step to assign to parish priests the duty of relieving the poor. This reorganization of the ecclesiastical system, originating first on the Continent, was copied by English lawmakers in the eighth century.

When the parochial system of relief gave way, monasteries, guilds, and private almsgiving continued the work of aiding the poor. After the twelfth century, the use of the tithe appears to have ceased as an element in charity. The almsgiving of church dignitaries assumed the aspect

² *Ibid.*, p. 211.

³ Ulhorn, *Christian Charity in the Early Church*, 1883, p. 266; and Ashley, vol. II, *op. cit.*, p. 307

of "gracious outpouring of their own charity," rather than ecclesiastical obligation. Such parochial poor-relief as did exist at the close of the Middle Ages appears to have been furnished from a sort of "church fund."

The monasteries carried on the work that the parochial clergy did not perform. Without organization or any centralized system of poor-relief, the alms given by every monastery was entirely without relation to any other; consequently aid was given to all strangers who chose to apply, as well as to cases of local need. Under these circumstances relief was indiscriminate, and soon a professional beggary grew up and overran the land. The pauperizing effect of such almsgiving was due more to lack of unity in the administration of poor-relief than to church doctrine encouraging indiscriminate giving. In fact, Basil cautioned against giving without distinction to every beggar that asks. But this wise counsel, as well as that of others, appears to have passed unheeded.

Each monastery was a center of relief, with its almonry usually near the church of the monastery. The almoner's duty was to give alms to the needy, and to aid with especial liberality travelers, palmers, chaplains, mendicants (professional beggars), and the leprous (the sick). Outdoor relief was given to the old and infirm and to the lame and the blind who were confined to their beds. Rooms for the sick were frequently provided in the almonry. The almoner distributed to widows, orphans, and poor clerks, the remnants of meals, and the old clothes of the monks. He was thus a local visitor, as well as the agent who provided indoor relief for the sick. Ashley says of this method of poor relief:

There are, . . . very strong reasons for believing that, for a couple of centuries at least before the Reformation, the English

monasteries had done little for the relief of honest poverty; and that their almsgiving tended rather to foster the growth of a class of professional beggars.⁴

Besides monasteries, the relief of distress was provided for by another class of institutions known as hospitals. These were charitable foundations for the care of the sick and the sheltering of destitute and enfeebled old age. They were a sort of a combination of the modern hospital and almshouse in a primitive stage of development. There were hundreds of these institutions scattered over Western Europe. These hospitals were under the administrative charge of a master or warden, several priests who assisted in the performance of religious offices, and a number of lay and religious brethren.

For a time these foundations did their work well, and grew rich and powerful from the continuous stream of fresh endowments left by the wills of wealthy persons. In time, however, they came to be regarded by their administrators as a source of income, and their attendants wasted their revenues in idleness and dissipation. Admission of the sick and needy was refused, and the heads of these houses used the property for their own advantage. But misappropriation of revenue was by no means the only abuse to which these hospitals were submitted. Scandalous methods of begging contributions were resorted to by their agents. Moreover, it was customary for the larger hospitals to offer food and lodging to all applicants irrespective of need or worthiness. "Vagabonds who lived by begging went 'from spital to spital, prowling and poaching for lumps of bread and meat.' Around the gates of Saint Bartholomew and other great foundations gathered swarms of the miserably shiftless

⁴ *Op. cit.*, vol. II, p. 312.

and idle, decrepit, halt, and maimed, covered with rags and filth, like those still to be seen around the entrance to many a Continental cathedral.”⁵

Crafts and fraternities furnished relief to their own members. Although many of the religious guilds did not profess to relieve bodily distress, the majority of them were accustomed to give occasional aid to needy members. Some guilds provided a weekly pension for indigent members sufficient to cover mere maintenance. These payments were not considered as something the members could claim in return for their own dues, like a sick-benefit, but were quite frankly regarded as a form of almsgiving that was chiefly valuable from the point of view of spiritual benefit to the giver, rather than as so much aid for the assistance of members in distress.

As the industrial and trading population increased, craft associations began to provide lodging for destitute members, and some proceeded to erect almshouses which were managed in much the same fashion as the endowed hospitals. Beginning with the religious guilds, the practice spread to the crafts, where further bequests enabled these almshouses to provide for inmates a regular weekly allowance in addition to shelter. In the case of smaller fraternities, the weekly doles appear to have been obtained by contributions furnished for each particular case, and not from endowments.

Private charity of the Middle Ages was chiefly indiscriminate almsgiving. The almsgiving of great prelates and nobles assumed such dimensions that it rivaled, and sometimes actually exceeded that of the monasteries and hospitals. Food was frequently provided for scores, and even hundreds of individuals. Double and triple doles

⁵ *Ashley*, pp. 323-24.

were dealt out on festival days. It was customary to distribute doles to all who applied at the gates. While bequests were sometimes made by wealthy landlords for the benefit of their poor tenants, and occasionally money was left for the education of poor children, or the marriage portion of a poor girl, it was far more usual to find that a bequest was left to be distributed to the poor without any restriction. Sometimes alms were offered to all who cared to come for them.

In making charitable bequests, the dominant motive was the spiritual gain that accrued to the testator in the next world. It was thought that the prayers of the recipients would be added to the sum of the benefactor's good works, thus laying up for him a greater heavenly reward.

In our brief survey of the poor-relief and charity of the Middle Ages, we have discovered that the work was entirely in the hands of the church, or under the influence of religious motives acting upon the minds of individuals. There was no attempt by the church to organize poor-relief according to a systematic plan, and the state and secular authorities made no such effort. Almsgiving by monasteries, hospitals, guilds, private persons, and by ecclesiastical and lay magnates, was the form taken by the bulk of poor-relief. This indiscriminate distribution of relief exercised a pauperizing influence, and rendered it easy for shiftless persons to get a living without work. A horde of professional beggars was created, who wandered from place to place, going the regular rounds of monastery, hospital, and festival, supported year in and year out by reckless and unintelligent giving, and increasing in numbers and boldness. Meanwhile, there were hardworking people of honest habits, and deserving poor,

who found no assistance because they were too proud or afraid to go out with these shameless vagabonds.

THE PERIOD OF REPRESSION

The first step in governmental interference in the relief of the poor appeared under the guise of that section of the first Statute of Laborers in 1349, which attempted to prevent vagrancy by repressing it. The law sought to secure an adequate supply of labor at the rate of wages current before the "Black Death," but also declared that all persons who gave alms to "sturdy beggars" should be punished by imprisonment. It was expected that idleness would cease as soon as almsgiving to able-bodied beggars was discontinued. Throughout the fourteenth and fifteenth centuries, England enacted statutes in an effort to solve the problem of vagrancy by repression.⁶

There were successive enactments in 1360, 1376, 1388, and during the fifteenth century. The dissolution of the monasteries during the reign of Henry VIII transferred from the control of the church to the hands of the nobles one fifth of the lands of England. As a result, many of the poorer tenants were ruined and reduced to poverty, because the nobles were chiefly intent upon quick money-returns, and consequently sold off the farm-stock and often evicted the tenants. The suppression of the monasteries suddenly brought to an end the lavish almsgiving on which the class of professional beggars had grown to depend, and without perhaps actually increasing the absolute amount of vagrancy, immensely aggravated the seriousness of the problem.

Earlier than this, however, the problem of poverty had assumed dimensions of gravity, because of the agrarian

⁶ Nicholl, G., *History of the English Poor Law*, 1899.

difficulties connected with the first period of inclosures. It was the inadequacy of the ecclesiastical system of poor-relief, or rather the lack of system, in dealing with this problem, that made it necessary to incorporate into the legislation against vagabondage and vagrancy some provision for the relief of the impotent poor.⁷ The Act of 1530 directed justices of the peace to license such impotent poor as could go begging, provided they did not beg outside certain set limits. If caught outside these limits, they were to be punished by imprisonment in stocks, and by whipping. All able-bodied persons caught begging were to receive punishment by whipping, and were to be returned to their place of birth, or where they had lived for the past three years. The punishments for second and third offenses were severe.

Although designed to check begging by attempting to correct the deficiencies of the first enactment, the Act of 1536 provided positive measures for the relief of the poor. The mayor of every town, and the churchwardens of every parish, were directed to collect alms on Sundays and holidays for the aid of poor, impotent, sick, and diseased persons. Account of expenditures must be kept by the parish priest, and all idle children over five years of age were to be taught husbandry or craftsmanship. Able-bodied men were to be set at work. "Sturdy vagabonds" were to receive harsh punishment, and even put to death as felons. The revenues for this poor relief were the voluntary gifts of the people, but the giving of private alms by individuals was forbidden, and the punishment was forfeiture of ten times the amount given.⁸

⁷ Ellwood, C. A., "Public Relief and Private Charity in England," *The University of Missouri Studies*, 1903, vol. II, no. 2, p. 5.

⁸ Nicholl, *op. cit.*, vol. I, pp. 121-25.

This act marks a transition from ecclesiastical to secular poor-relief. It is the first instance in which the state directed how funds for poor-relief should be raised, and how they should be administered. While secular power intervened in this way, it was not to secularize relief, but rather to revitalize and organize the system of ecclesiastical relief.

In 1547, measures repressive of vagrancy were made more cruel, yet the Act of 1551 marked an amelioration in the laws relating to the helpless poor. By this act it was provided that two or more collectors of alms were to be appointed in each parish, who were to make lists of the impotent, the feeble, and the very poor, for the purpose of admonishing parishioners to contribute. Persons not contributing according to their means, were to be exhorted and reproved by the bishop of the diocese.

THE POOR-LAW OF ELIZABETH

An approach to a compulsory poor-rate levied by civil authorities was made early in the reign of Elizabeth. In 1562, it was enacted that bishops should bind over all who refused to pay the amounts assessed by parish collectors to appear before justices empowered to assess them such sums as they thought reasonable.

By a gradual process of successive enactment, the whole system of poor-relief, which had worked so badly under church control, was transferred to civil authorities. The Act of 1572 provided for parish collectors and overseers of the poor, who should tax inhabitants for support of the poor. In 1576, stocks of raw materials were kept in each town to provide work for the poor. Able-bodied persons who refused to work were sent to the house of correction. Among other enactments, that of 1597 stands out as char-

acteristic of the new spirit in the administration of poor-relief. Overseers of the poor were appointed in each parish to assume charge of relief, as well as to raise by taxation whatever amount of money was necessary to purchase material for labor, and to provide relief.

All the essential principles of the Act of 1597, as well as the machinery for administering relief worked out in the experience of the past generation, were incorporated in the famous Statute of 1601, the so-called "Poor Law of Elizabeth." The admirable characteristics of this law may be traced to the fact that it was the culmination of long experience, and therefore inevitably rested upon certain principles of universal validity.

By this law, recipients of poor relief were divided into three classes: able-bodied persons, those unable to work, and children. Work was to be provided for the first class upon such raw materials as flax, hemp, wool, iron, and other materials to be supplied by overseers of the poor. If any able-bodied person refused to work, he was to be punished by being put in stocks, or by imprisonment. Overseers were directed to provide necessary relief for those unable to work. For this purpose, maintenance in almshouses was commended. Emphasis was laid upon the responsibility of those near of kin; consequently children, parents, and grandparents were made liable for the support of relatives unable to work. For the third class, dependent children, provision was to be made for their apprenticeship in some craft—boys till the age of twenty-four, and girls till the age of twenty-one, or until married.

Overseers were directed to levy a tax to raise the funds required for this poor-relief. These taxes were to be collected weekly, or otherwise, and were levied chiefly upon the occupiers of real estate. When a poor parish was

overburdened by its rate, aid was to be secured from other parishes in the "hundred," or county.⁹

The parish still remained the unit of poor-relief administration, for justices of the peace were directed to nominate in Easter week two or more overseers of the poor, to assume charge of the administration. Justices of the peace were vested with powers of supervision.

In spite of the admirable principles of the poor-law, in practice its operation was not satisfactory. One difficulty appears to have been that overseers of the poor neglected their duty to provide stocks of raw materials and work for able-bodied persons. The training of children by apprenticeship in certain crafts led to their ill-treatment, and the plan of providing relief from the rates led to considerable abuses. That clause of the law which secured assistance for parishes not rich enough to maintain their own poor entirely, by supplementing these rates from the rest of the "hundred," was abused by converting it into an instrument whereby unscrupulous employers reduced wages in their own parish for the purpose of obtaining this "rate in aid."¹⁰

THE REFORM OF THE POOR-LAW

In spite of these shortcomings, the Elizabethan Poor-Law continued in operation as the basis of English poor-relief for several centuries. But between 1601 and the Poor-Law Amendment, or reform of 1834, the state continued legislative experiments in the field of poor-relief. The history of this experimentation may be conveniently divided into three parts: the period 1660 to 1760, characterized by heavy poor-rates and settlement laws of more

⁹ Lonsdale, S., *The English Poor Laws*, London, 1901.

¹⁰ Gibbins, *op. cit.*, pp. 261-63.

or less severity; the period 1760 to 1800, marked by lower poor-rates and a change in the spirit of poor-relief; and the period 1800 to 1834, or that of oppressive rates and increasing demoralization.

The Settlement Act of 1662 restricted the obligation of the parish to relieve destitution to persons who had legal settlement within its borders. Legal domicile, or settlement, was acquired by birth, proprietorship, sojourn, service, or apprenticeship. Upon complaint of the overseers, justices might order a person who had lived forty days or less within a parish to remove to his own place of settlement. It was expected that this act would remove from parishes the burden of those who were already dependent or likely to become so, and put responsibility where it belonged—upon the community where the indigent person had settlement. But the effect was to destroy the mobility of labor and bind the working classes to the soil. The act was used by poor and rich parishes alike in the selfish endeavor to prevent an influx of poor from other parishes. These vicious practices checked the natural mobility of labor, industry consequently declined, and impoverished by lack of employment, the laboring classes became more and more a heavy charge upon the poor-rates. Instead of correcting these abuses, subsequent legislation made the acquisition of settlement even more difficult, and thus aggravated the problem. Substantial amelioration of these harsh and unwise settlement restrictions did not come until 1795, when it was enacted that expulsion from a parish could not be made unless the person concerned was actually dependent, not merely a possible future dependent.

Since overseers of the poor had often been careless in their administration of funds, and had abused their pow-

ers, it was provided in 1791 that supreme power in relief administration should be vested in justices. This act required a careful registration of all paupers in each parish, a certain degree of publicity with reference to the amount of relief given, and ordered that no name should be added to this list except by authority of the justices. Instead of improving the administration of poor relief, this act had the opposite effect, and made the system more lax than ever.

Increase of expenditure encouraged people to look for a more economical method of caring for the poor. Hence the idea of building poorhouses became popular. It was thought that paupers could be put at remunerative work and thus contribute to their support. By an act of Parliament, a workhouse was erected at Bristol in 1697. Other places followed this example until, in 1722, it was enacted that parishes might combine into unions of two or more, or might singly erect, buy, or rent workhouses. A "work test" was provided by the ruling that "no poor who refused to be lodged and kept in such houses should be entitled to ask for parochial relief." Wherever adopted, the system caused an immediate decrease in the expenditure for poor-relief. Unfortunately, another provision of this act authorized parishes to "farm out" their poor by permitting them to contract with persons for the lodging, maintenance, and employment of the poor. Grave abuses resulted. The helpless inmates of these poorhouses and workhouses were cruelly treated by inhuman contractors.

The farming out of the poor was abolished by Gilbert's Act of 1782. Adjacent parishes were given the right to unify their administration of relief, as well as to unite for a common poorhouse. Indoor and outdoor relief was to

be administered by paid "guardians" who were appointed by justices. The duties of overseers were reduced to the mere assessment and collection of funds. Visitors were also to be appointed by the justices, and, in association with these honorary officials, justices exercised supervision over the administration of poor-relief. But since the adoption of this system was optional and not mandatory, the reforms did not become widespread.

An unfortunate departure from sound principles was contained in Gilbert's Act by the stipulation that while only the old and infirm poor, mothers of illegitimate children, and children too young to work, should be maintained in the poorhouse, guardians should find work for the able-bodied poor near their own homes and collect their wages for them, applying the same towards their maintenance, and supplementing low wages by a subsidy from the relief funds. This was the beginning of the vicious allowance system by which relief in aid of low wages was granted. This practice pauperized many of England's laborers and demoralized the working classes. It reached its culmination in 1795 when the magistrates of Berkshire established the custom of aiding all poor families who were industrious, but whose incomes were considered insufficient. Relief from the poor funds was made to such families, in consideration of the price of wheat and the size of the family.¹¹ This example was followed by the whole country, and Parliament soon legalized (1796) outdoor relief to able-bodied persons by rescinding the Act of 1722 with its salutary principle of the "workhouse test," and legalizing wage subsidies. Thus indiscriminate relief was legalized, and the demoralization of the laboring classes encouraged.

¹¹ Fowle, *op. cit.*, pp. 65-6.

Meanwhile the enormous increase of pauperism in England, which took place between 1780 and 1820, attracted the attention of economists. Malthus, who investigated the actual conditions at the time, maintained that the principal cause of this increase was the indiscriminate relief of the poor. Certainly this system of lavish poor-relief was instituted at a time when the economic situation of England's working classes could not have been less opportune. England was gradually aroused to the menace of the situation by the repeated attacks of her economists, and feeble efforts at reform began to be made. Parliament appointed a committee for the investigation of the poor-laws in 1817. Although the report of this committee was enlightening, very little was done to correct the existing abuses, until in 1832 a second royal commission was appointed to investigate the practical workings of the poor-law.

In 1834, this commission made a report that contained most sensational disclosures of abuses connected with the entire system of poor-relief. An almost unbelievable state of corruption existed among administrators and recipients alike. Parliament was aroused, and passed the famous "Poor Law Amendment Act." No new principles of relief were advocated, but emphasis was laid upon the principle "that the condition of the pauper ought to be, on the whole, less eligible than that of the independent laborer."

The fundamental provisions of this new law may be examined under three heads:

(1) Administration of poor-relief was centralized by the creation of a board of three poor-law commissioners with extensive powers over local authorities. This board had power to issue orders and enforce them. It exer-

cised supervision over local administration through inspectors who visited workhouses and investigated complaints. It exercised supervision over finances through auditors who examined the accounts of all local officials twice a year.

(2) The board was directed to divide the country into districts, or poor-law unions, to form the administrative units of the system. Local responsibility was to be encouraged by a provision that each union should have a board of guardians, locally elected, who were to be responsible in the administration of relief. Boards of guardians were to carry on their executive work through salaried relief officers.

(3) Guardians were required to erect a workhouse, or workhouses, for each union. The "workhouse test" was reestablished by directing that no relief should be given to able-bodied persons.

Changes in the poor-law were made in 1847, when the board of poor-law commissioners was transformed into a ministerial department responsible to Parliament; and again in 1871, when the local government board was established with supervision over poor-relief as one among its many duties. The powers and functions of the central board have been enlarged from time to time and the local administration of relief democratized by the Local Government Act of 1894. By this act, equal franchise in the election of boards of guardians was granted to all adult persons who resided in the union for at least a year. Many women, as well as laboring men, have been elected guardians. In some unions there has been a considerable increase in outdoor relief, always, however, subject to the check of the central board.¹²

¹² Ellwood, *op. cit.*, pp. 19-21.

In the belief that a recasting of the relief system might be advisable, a public commission of eighteen members was appointed in 1908, to inquire into the operation of the existing law with special reference to the problem of unemployment. Two elaborate reports were submitted in 1909. One of these, that of the minority, recommended drastic reforms in poor-relief administration; the other, that of the majority, recommended certain modifications in the existing law. Both reports favored the abolition of workhouses where the able-bodied were gathered, and both agreed in recommending that the existing local boards of guardians be abolished, although there was some disagreement as to what should be substituted.¹³

The English poor-law has never given much satisfaction. Indeed, the majority of statutes connected with the administration of poor-relief have created new evils and aggravated the very ones which they were intended to prevent. Recently, however, radically new methods of dealing with the vexatious problem of poverty have been introduced, and matters have taken a more hopeful turn. But adequate consideration of modern constructive charity and preventive philanthropy requires separate treatment, so that we shall deal with these subjects in the following chapter.

¹³ Webb, S. and B., *The Break-up of the Poor Law: being Part One of the Minority Report of the Poor Law Commission*, London, 1909; also *The English Poor Law Policy*, London, 1910, and *The Prevention of Destitution*, London and New York, 1911.

CHAPTER XVIII

CONSTRUCTIVE CHARITY AND PREVENTIVE PHILANTHROPY

So extensive is the subject of modern constructive and preventive philanthropy, and so varied are the experiments, that a thorough treatment of the entire field would consume more space than is at our disposal in an introductory work of this kind. Hence, all that will be here attempted is a brief outline of three characteristic systems.

At one time men thought the institution of slavery an abiding element in human society. Although it persisted for centuries, slavery gradually passed away from civil society because it was incompatible with progress in industrial and social organization. The condition of poverty for great masses of people is inconsistent with a healthy and well-balanced economic organization, and this condition, it is believed, will also gradually pass away, in large measure at least, not so much of its own accord as because of intelligent efforts to abolish its causes. Hence the emphasis on constructive and preventive methods.

Professor Simon N. Patten has expressed the following view:

Our children's children may learn with amazement how we thought it a natural social phenomenon that men should die in their prime, leaving wives and children in terror of want; that accidents should make an army of maimed dependents; that there should not be enough houses for workers; and that epi-

demies should sweep away multitudes as autumn frost sweeps away summer insects. They will wonder that the universal sadness of such a world should have appealed to our transient sympathies, but did not absorb our widest interests. They will ask why there was some hope of succor for those whose miseries passed for a moment before the eyes of the tender-hearted, but none for the dwellers beyond the narrow horizon within which pity moves. And they will be unable to put themselves in our places, because the new social philosophy, which we are this moment framing, will have so molded their minds that they cannot return to the philosophy that molds ours.

THE HAMBURG-ELBERFELD SYSTEM OF POOR RELIEF

One of the earliest constructive efforts at dealing with paupers and poverty-stricken people was made in Hamburg at the close of the eighteenth century. The system consisted of a central bureau, with the city divided into districts under the direction of overseers. Almsgiving at the door was prohibited, work was supplied the unemployed so that the helpless might learn to help themselves, an industrial school was provided for the children, and there were hospitals for the sick. So complete was the provision for all classes in need of assistance or discipline, that the system worked a revolution in Hamburg. Beggars, who had formerly lined the streets to the annoyance of the passerby, were either put at work or driven out. Destitute children, who had heretofore begun the struggle of life under a terrible handicap, were relieved and educated to industry and self-support. The poverty-stricken sick were cared for, or restored to health.¹

The Elberfeld system of public relief, adopted in 1852 as a modification of the Hamburg system, represents one of the most remarkable of the earlier experiments in con-

¹ Henderson, C. R., *Modern Methods of Charity*, 1904, pp. 4-14.

structive charity. Its fundamental principles are a thorough examination of each individual dependent, continued careful guardianship during the period of dependence, and a constant effort to help him regain economic independence. In practice, a large number of unpaid citizens are relied upon to carry on this work.

For purposes of administration, the city is divided into 564 precincts, each of which contain from four to six poor families out of a population of three hundred. A citizen visitor, or *Armenpfleger*, is placed in charge of each precinct. Appointed for three years of compulsory service on pain of loss of franchise and increased taxes, the *Armenpfleger* is a responsible person whose services the city may count upon. The office is not limited to the wealthy classes; indeed, a special effort is made to secure tradesmen and mechanics. Considerable prestige attaches to the office, which is considered the first round on the ladder of municipal honor offices.

Applications for aid come directly to the *Armenpfleger*, whose duty it is to inquire carefully into all the circumstances of the case. When he is convinced that the family is really in need, he gives the relief himself. At least once every two weeks he visits each poor family, and keeps himself informed of any change in their circumstances. The law sets a minimum amount for relief, and any income received by the family is deducted from this minimum. By this means it is possible to keep the aid within an amount necessary to supply the bare necessities of life, and thus discourage dependence on public assistance. As an adviser, or a "friendly visitor," the *Armenpfleger* assists any persons or families whose circumstances indicate the possibility of future dependence. Thus he finds work for the unemployed, provides medical aid for

the sick, advises the improvident, and reports the incorrigible for prosecution and discipline.

Fourteen precincts are grouped into a district organization. The reports of the *Armenpfleger* are made to the overseer of the district at regular fortnightly meetings where all cases are thoroughly discussed and a minute book prepared for the central committee. This committee meets fortnightly, following the district meetings. It has control over the work of the district workers, reviews the district decisions in regard to amount, kind, and duration of relief in particular cases, and prepares measures of a general nature. While relief to the poor in their own homes is administered and decided by the district meetings of visitors, subject to supervision and review by the central committee, it is the latter authority alone, acting upon recommendation of the visitors, which has the power to order relief in an institution.

The success of the system is indicated by the fact that although Elberfeld increased from fifty thousand in 1852 to one hundred and sixty-two thousand in 1904, the proportion of the population in receipt of temporary or permanent relief diminished by over forty per cent.; that is, from 8 to 4.7 per cent. The per capita cost also diminished. The secret of its success seems to be found in the efficient service secured by the personal and intimate touch resulting from first-hand contact. When each relief agent has but four or six cases to look after, it is possible to individualize them, and to show true neighborliness. The bane of much charitable effort has been the custom of treating the poor as a homogeneous class, wholly without individual differences. Besides this personal element, the relief is made constructive, because a competent and kindly person, the *Armenpfleger*, acts as a

connecting link between the discouraged or inefficient individual and organized society. Aid thus becomes more than a mere doling out of material assistance by a formal public relief bureau; it becomes the instrumentality for that regeneration which grows out of the effort towards self-help.

With modifications, this Elberfeld system has spread to many other German cities. In 1892, the Hamburg system was reorganized by adapting some of the principles of the Elberfeld system to the special needs of a city of six hundred thousand. The original relief system of the city had broken down under the strain put upon it by increased population. It was obviously impossible for a visitor to look after the welfare of from twenty to eighty cases in a thorough manner. As a consequence, relief had become a matter of receiving applications, making a more or less careful examination at the time the aid was granted, and continuing the same from year to year without renewed investigation. Inquiry showed that about fifty per cent. of the cases were not in need of the aid granted them. Under these circumstances the visitor ceased to be a friend and adviser, and the chief advantage of the original system was lost.

In the absence of records kept at a central office, there was no means provided for preventing an indigent pauper from receiving support the year round. As reorganized, the system was arranged with superintendents at the head of each district. Applications for aid were made to these officials, who in turn assigned cases to the visitors best fitted to deal with them. This plan prevented overburdening busy visitors, and permitted the selection of visitors who were especially capable of treating certain types of cases. In spite of the appointment of this re-

sponsible official in charge of the district work, administration of relief was really not as strictly centralized as it had been before, since the districts were given the right of nomination for office of superintendents and new visitors, as well as considerable power to vote aid. Another reform consisted of an extension of the period for which relief was granted. Under the Elberfeld system, aid was given for two weeks. Under the new system, dependents were divided into several classes. The aged, sick, and disabled were granted an allowance for six months, younger persons, like widows with dependent children, received aid for not more than three months, and all other cases were granted relief from one session of the council to another, usually for a month at a time. Another distinguishing mark of the reorganized Hamburg plan was the insertion of circuit councils, composed of district superintendents, between the district and the central administrative board. The circuit council discusses matters of interest to all districts, hears complaints against district decisions, and grants hospital and institutional relief.

The central board is the court of last appeal for complaints. It fixes the rules of administration, and determines upon more general remedial measures and agencies. Finally, the business management is the agency which centralizes and organizes the work by providing a registry of information of all cases from all districts, thus making it easy to detect duplication of relief. The active corps of this admirable relief system consists of twenty members of the central board, over one hundred district chairmen, about sixteen hundred helpers, and nearly one hundred clerks. Professor Henderson said of this system in 1904:

The distinction between the function of the honor offices and those held by professional or salaried officials may be briefly stated thus: the former foster the spirit of the work; the latter have the care of the forms; each is supplemented and modified by the other, so that neither arbitrariness, disorder, and looseness, on the one hand, nor, on the other, stiff formality and excessive writing may hamper the work. This aim has thus far been realized in a very satisfactory manner.²

In fact, so well has the system worked in Hamburg, that it has been adopted with success in several other large German cities.

THE CHARITY ORGANIZATION SOCIETY

A second system of charity, characteristic of modern methods and forming a distinct contrast to the relief methods of antiquity and medieval times, is the Charity Organization Society, a private charity. The reform movement in public charitable administration, initiated by the successful Hamburg-Elberfeld system, spread to England where, in 1869, the Charity Organization Society of London was formed. This society aimed at organizing the existing charities of the city, public and private, in order that the work of relief might be carried on in a spirit of harmonious coöperation. It tried to check the evil of overlapping relief, and to repress and prevent pauperism by means of investigation, follow-up work, and restoration of the destitute to independence by self-help.

Since 1877, when Buffalo established the first Charity Organization Society in the United States, the system has spread to the chief cities of this country. The first step towards the organization of private relief was the

² *Ibid.*, p. 15

establishment of Relief Societies to take the place of indiscriminate almsgiving by individuals. Then came the period of Associations for Improving the Condition of the Poor. These associations attempted the permanent elevation of those in need, but failing to keep in view this desirable end, degenerated into the practice of giving indiscriminate relief. They were not educational, provided no adequate safeguards against deception, and neglected the supervision of recipients of aid. Finally, comes the Charity Organization Movement.

Four principles form the fundamental working-plan of these private organizations. There must be careful and intelligent investigation of all cases of application for aid. This inquiry is not solely to thwart impostors, or to prevent the waste that comes from duplicate relief: it is rather a social diagnosis of the factors involved in the particular case, and becomes an instrument for intelligent treatment of distress. Investigation really expedites relief, since it throws light upon the complex causes that have been at work to produce the misery of each case. On the basis of facts so discovered, it is possible to determine the kind of treatment most needed, whether it be hospital, institutional, personal advice, shelter, food, clothing, or other material relief. Because it employs trained investigators, the Charity Organization Society, or Associated Charities as it is frequently called, is able to do more effective and thoroughgoing work than the Elberfeld system, where investigation is made by untrained citizen-visitors. Moreover, another defect of the German system, the practice of visitors giving relief themselves, is overcome, for the Charity Organization Society specifically avoids almsgiving itself, seeking to obtain aid peculiarly adapted to the needs of

each case from the appropriate relief agency. It is only in emergency that the society itself gives aid.

The second important principle is central registration of relief. An alphabetical list of all cases that have received aid from any reporting relief agency or any co-operating social organization, as well as any cases that have been investigated by its agents, is kept at a central office. This card-catalogue, or "confidential exchange," is the clearing-house of information about needy persons in the community. In large cities, this list comprises tens of thousands of different cases. It is a repository of important information, and by providing a common source of knowledge, assists the numerous charitable organizations of a large city to avoid duplication of aid, and overlapping.³

Specifically implied in the principle of central registration is the principle of coöperation between relief agencies. It is here that the society aims to bring order out of confusion. For every case a plan is worked out, and each agency is assigned its particular division of the work. For example, an agreement as to division of work might be reached whereby a relief society might consent to supply the necessary money or groceries, a dispensary furnish the needed medical attendance, a church-club furnish clothes, and a children's aid society help provide temporarily for the children. In this way the various charitable resources of the community are united in an effort to work out the salvation of a concrete case. In so far as harmonious activity results, the special case treated is tided over a temporary adversity, quite probably started on the road to regain economic

³ The "Social Service Exchange" of the New York Charity Organization Society is used by 190 coöperating charitable agencies.

independence, and more than this, becomes the means of better understanding of mutual sociological effort, instead of a bone of contention between competing charities. Last, but by no means least, is the effort made to secure the willing coöperation of the needy individual himself in the plan for his relief and restoration. The total result of successful coöperation is to make the rehabilitation of needy persons as smooth and natural a process as possible.

But the successful consummation of the special plan of relief involves careful and painstaking after-care and guardianship, or "follow-up work." A destitute family cannot be left to shift for itself after simply giving it aid and planning out its problems. There must be periodic visits by responsible individuals with a personal interest in the peculiar problems of the case. Friendly visits, accompanied by sympathetic but not sentimental advice, assist the needy family to utilize its own resources to better advantage, and render far more constructive service than mere almsgiving, which fails to teach people to invent methods of meeting difficulties as they arise.

The principles of relief just enunciated are carried out by a plan of work which divides the city into districts, each of which is equipped with a salaried professional agent and an office, assisted by volunteer workers or visitors of the immediate locality. Weekly conferences of the chairman, agent, and visitors are held to discuss cases and decide upon a plan of treatment. By the organization of district committees, local interest in the work is aroused, and the great city is broken up into manageable portions of the whole vast territory which, in its aggregate, is a bewildering problem. Over these local district committees and their trained superintendents or

agents, is a general secretary, a well-paid and experienced social worker, and a board of directors. The organization is completed by a central office with its registration records.

The general policy of the society in dealing with an application for relief is to investigate all the circumstances of the case, in order to discover the real need and the special resources available to meet the situation. The aim is always to restore to ultimate self-support, as far as economic independence is practicable. To this end, emphasis is laid upon securing employment, providing right and useful educational training, and on the building up of health and moral habits. If resources for self-help are insufficient to supply a sound basis for the reconstruction of character or economic rehabilitation, aid is first secured from those naturally concerned. Relatives, friends, former employers, church societies, and labor or professional organizations, are appealed to for help. When these sources of aid are unavailing, relief is obtained from appropriate charitable agencies. Whatever the case, it is regarded as of utmost importance to give adequate relief in each instance, rather than superficial relief in many cases.

Although, in the beginning, the Charity Organization Society tended to avoid giving relief from its own funds, spending all its revenues on administrative expenses, many societies now provide aid from their own funds for cases that cannot be assisted through ordinary charitable channels. Warner⁴ maintained that the society never should have a relief fund because "such a fund at once saps the energy and ingenuity of agents and visitors in treating cases and securing coöperation." Professor

⁴ *American Charities*, 1908 ed., p. 450.

Devine has pointed out that one reason why these societies have kept free from the dangers inherent in almsgiving, is because they have not, as a general thing, directly disbursed relief from a fund previously accumulated, but have had to secure relief, case by case as the need arose, and were compelled constantly to justify their decisions and their methods to others in order to secure the necessary approval and coöperation.⁵ It is the practice of the New York Charity Organization Society to send its expert "home economist" to make a careful budget-study of each case, considering the size of the family, the ages of its members, and so on, and upon the basis of this study, a scientific budget and dietary are drawn up. Relief funds to aid the case may then be obtained by direct personal appeal to some individual giver in the neighborhood of the needy family. The society thereafter makes reports to the donor of the way in which his money is being spent.

SOCIAL INSURANCE

The Hamburg-Elberfeld system of public relief as well as the Charity Organization Society exemplify great progress towards efficiency in the giving of relief, but their work is largely concerned with restoring to self-support and economic independence those whom misfortune or wilfulness has reduced to destitution. However constructive the methods pursued by these excellent systems, they do not immediately strike at and eradicate the causes of fresh misery. For an example of preventive philanthropy we must turn to the great social insurance schemes of modern industrial nations. Social insurance provides the minimum of prompt and adequate relief con-

⁵ *Principles of Relief*, p. 351.

sistent with a complex and elastic system for the prevention of misery and poverty resulting from the occurrence of sickness, industrial accident, unemployment, and old age.

It is now quite generally recognized that under the contemporary organization of industry which has resulted from the industrial revolution, the great masses of working people of industrial nations receive inadequate wages, as tested by the necessity of meeting the unescapable hazards of accident, sickness, death, and old age. A knowledge of this fact, as well as a variety of separate contributory influences, foremost among which was several years' experience with sick benefits among labor organizations, led the German government to formulate a plan for three branches of insurance—insurance against sickness, against industrial accident, and against old age and invalidity. These respective bills of the year 1881, became laws in 1883, 1884, and in 1889. Under them, millions of German working people have been insured, and have received protection which they could not have secured by individual assumption of the risks. Benefits granted under the law are considered payments of legal obligation, and not public charity. The success of this vast experiment seems to be shown by its continuance as a settled policy during a period of great industrial and commercial expansion, and by its recent imitation on the part of Germany's great competitor, England. It is claimed by Germans that no small part of their country's remarkable national unity in the Great War is due to the strengthening effects of thirty years of social insurance among the masses of the people.

Systems of compensation for industrial accident have been established practically throughout Europe, in many

British colonies, and in thirty-five states and territories of the United States. Altogether, several score million workmen in industrial and other employments are affected. The German practice is compulsory insurance of employees by all employers in accident insurance associations under the supervision of an imperial insurance department. In Great Britain, compensation is compulsory, but not insurance in special associations like the German method. In the United States, there is considerable variety in the arrangements that guarantee payment of compensation awards. In some states, employers maintain their own insurance fund, subject to the approval of an accident board; in others, they insure in a mutual association authorized to insure compensation liability; in still others, they insure in a state insurance fund managed by the accident board upon the same principles and under the same general requirements as those which govern mutual insurance associations; and in yet others, they insure in private stock companies subjected to the most rigid regulation of rates to be charged, agent's commission to be paid, and methods of compensation used.⁶

The justification for systems of workmen's compensation for industrial accident, according to which payment is automatically made to injured workmen instead of delayed payment after litigation, is found in the fact that the old common-law principles of employer's liability are not adapted to the conditions of modern industry. Before the time of the factory system, the master workman or employer was in close touch with the workman. There was a natural personal relation, because

⁶ "Standards for Workmen's Compensation Laws," *American Association for Labor Legislation*, October, 1916.

the two did their work in the same room and shop. Out of this more or less intimate relation grew up the common-law principle of liability of an employer for injury caused to an employee when occupied. This principle of liability secured sufficient protection for the worker under all ordinary circumstances, or until the industrial revolution brought the factory system of manufacture. Then the simple relation of master and man was supplanted by a more complex and much less personal relation of the corporation and stock company. The old intimate ties vanished, responsibility became divided, and the employee was at the mercy of a "soulless" corporation. Yet the antiquated employer's liability law still remained. According to this principle, the injured workman could not recover damages unless it could be proven that the employer was at fault. The courts recognized that an employer must take reasonable care for the safety of his employees, and in their effort to define what reasonable meant, evolved certain principles out of successive decisions. These principles seriously weakened the employer's responsibility, because they were based upon a theory of personal negligence and responsibility, assumptions not tenable under the modern organization of industry, and of little meaning when most accidents result from non-personal causes, and when the organization of production divides responsibility.⁷

On the assumption that industry should bear the whole loss from industrial accident to workmen, just as it has always borne the cost of accidental damage to machinery and plant by the device of passing on the burden to society in the form of a higher price for the product, work-

⁷ Seager, H. R., *Social Insurance*, 1910, pp. 53-67; and Rubinow, I. M., *Social Insurance*, 1913, pp. 86-99.

men's compensation systems are not contributory, but paid for by the employer. Hence it follows that, since premium rates are always a delicate measure of the hazard of the occupation, employers are induced to adopt adequate contrivances to insure the safety of their employees from dangerous machinery and other perils of occupation. Thus, in so far as compensation systems encourage the introduction of safety devices, industrial accident is prevented, and its consequent trail of misery and poverty checked at the source. But this is only one aspect of the preventive character of social insurance.

The benefit features of compensation systems exemplify a combination of the principles of immediate relief and preventive method that is comparatively new in social experience. After injury from industrial accident has occurred, a period of three days in the German and Swiss laws, and an interval of seven days in the British law, elapses before relief from accident funds is given to the workman. All of these systems furnish medical assistance, medicines, doctor's and nurse's attention, and hospital treatment to the injured man. Under the German system, medical assistance is provided for the first thirteen weeks from sickness insurance funds, and thereafter from accident insurance funds. American states provide "reasonable" or "necessary" medical aid at once, or after a period of from three to fourteen days has elapsed, depending upon the particular state law under consideration. In addition to medical assistance, practically all compensation systems pay the workmen a percentage of his weekly or annual earnings during the period of disability; and in case of death, all pay a small sum of money to cover burial expenses. The German workman receives payments up to a maximum of two

thirds of his annual earnings. The British workman receives payments of one half his wages.⁸ The practices of American states in this respect differ, but the amount paid an injured workman is frequently two thirds of his wages, which payment continues during total disability, or for a limited period of one or two years as the case may be. In the event of partial disability, a certain percentage is paid, sometimes $66\frac{2}{3}$ per cent. of the difference between his wages before injury and his wage-earning capacity after injury. Besides compensation for death in the form of funeral expenses, state laws provide compensation for dependent widows, widowers, widows or widowers with children, orphaned children of the victim, dependent parents, brothers, sisters, grandchildren or grandparents, and even alien non-resident dependents. Such compensation is based upon a certain percentage of the original wage.

When one considers the destitution and poverty which ordinarily result to the wife and family of a workman killed by industrial accident, it is clear that the benefits provided by compensation systems go a long way towards preventing poverty that would follow if accidents in occupation were not compensated. Moreover, the giving of such timely aid, in the dignified form of a regular wage-payment, checks the vicious tendency of poverty to cumulate from one generation to another by establishing miserable conditions that handicap the lives of unborn generations.

Health insurance and unemployment insurance are parts of social insurance that give, perhaps, the greatest promise of preventive and constructive usefulness. Germany since 1883, and Great Britain since 1911, have in-

⁸ Seager, *op. cit.*, pp. 67-75; and Rubinow, *op. cit.*, pp. 100-202.

sured their working classes against sickness by compulsory contributory systems.

The state insurance of Germany did not destroy any existing sick-benefit societies in carrying its national plan of insurance into effect. It recognized the local sick-funds, establishment funds, building trades' funds, miners' funds, gild funds, mutual aid funds, and communal sick-insurance, and merely added the principles of state compulsion, regulation, and control. In this way the existing social resources were utilized to the fullest extent, and local opposition to a national scheme checked. Two thirds of the cost of the system is borne by the employee or insured person, and one third by the employer, or one half as much as the employee's payment. In the event of sickness, medical aid of an appropriate sort is granted, and usually fifty per cent. of the wages is paid for periods of from 26 to 52 weeks.⁹ Burial money to the sum of not less than twenty nor more than forty times the average day's wages, is paid in the event of death from sickness. The German system of sickness-insurance is compulsory upon all working people with an income of less than \$476 a year.

Compulsory sickness-insurance under the British National Insurance Act of 1911 affects millions of working people whose income is less than \$800 a year, and many more who have insured voluntarily under the plan. Unlike the German and some other continental systems, the British system applies only to cases of sickness apart from industrial accident. The cost of insurance is met by contributions from employer, employee, and state. A sort of sliding scale of premium payments is arranged for cases of workers whose daily earnings are very small,

⁹ *Ibid.*, pp. 265, 272.

according to which the dues diminish until, at a wage of 37½ cents a day or less, the employee contributes nothing at all, the entire cost being borne by the employer and the state. For most people, however, there are uniform dues; eight cents for men and six cents for women, the employers contributing six cents and the state four cents in each case. This means that the workman pays one quarter or even less of the cost, the employer and state paying the balance. Benefits consist of free medical treatment and supplies, payment of \$2.44 a week for men and \$1.80 a week for women for a period of twenty-six weeks, and maternity insurance benefits of \$7.50, in addition to the normal sick-benefits of four weeks. The British act provides no funeral benefits for death from sickness.

By providing immediate and specific medical assistance, sickness-insurance prevents the ill-health in after-life which inevitably follows upon neglected ailments. In this way also poverty is prevented, and the span of useful lives lengthened. The weekly cash benefit makes up, in some measure, for the loss of income due to sickness and absence from work. The moral degeneration and listlessness that frequently come as a natural consequence of unattended sickness¹⁰ are prevented by sickness-insurance. Moreover, the contributory feature provides training in foresight and responsibility that is educational for the masses of people insured. A consciousness that one is making provision for circumstances in the future cannot fail to give a wholesome feeling of safety and self-respect.

¹⁰ The Rochester Survey of the Metropolitan Life Insurance Company showed that 39 per cent. of cases of illness did not have a physician in attendance; see Fisher, I—"The Need for Health Insurance," *Amer. Labor Leg. Review*, March, 1917, p. 14.

Unemployment insurance is compulsory in Great Britain upon several million workers in the building trades. The British system makes use of the existing provision for out-of-work benefits among trade-unions. It strengthens these local funds, provides unemployment insurance for workers they do not reach, and nationalizes the whole principle of out-of-work benefits by connecting it with the network of public labor exchanges that cover the country. Continental experience with public provision for unemployment insurance, especially in Ghent, has demonstrated the value of administering the system through local and national labor-unions. The government coöperates with trade-unions by refunding three quarters of the amount of benefit paid out, provided the union pays a benefit at least one third the size of the state benefit, and on condition that the claims are paid directly through the public labor exchanges. Up to July, 1913, one hundred and five associations, with an aggregate enrolment of 539,775 members, had entered into these arrangements. A similar subsidy arrangement is made with unions outside the trades which carry compulsory insurance, to encourage them to join in the plan for unemployment insurance.

The benefit features of the British system are most cleverly arranged to provide assistance without encouraging unemployment or irregularity of employment. The fund is raised by payments of five cents each by employer and employee, the state contributing a sum equal to one third the aggregate contribution of employer and workman. Payments are made by the employer when the wage is paid. He deducts the workman's share and adds his own, pasting insurance stamps to the correct amount in each employee's book. Benefits

consist of weekly payments to the workman, while unemployed, of \$1.75, up to a maximum of fifteen weeks in any twelve months. No benefit is paid for the first week of unemployment, for it is considered good policy to allow one week of unemployment in which the workman should seek a new position, either on his own initiative or through the regular employment exchanges. To secure the benefit, a worker must have been employed in an insured trade for twenty-six weeks during the preceding five years, and must have paid his share of the premium during this period.

In order that the system may not work to the disadvantage of the steady workman who pays his premium year after year, and to the advantage of the more casual type who is employed just long enough to get the unemployment benefit, there is a clever provision that after a man has paid in five hundred weekly contributions, has been insured under the system for at least ten years, and has reached the age of sixty, he may then withdraw in cash all that he has paid in (less benefits paid to him), with compound interest at $2\frac{1}{2}$ per cent. For the steady-going and trustworthy workman, therefore, the system provides a small savings fund, available after the age of sixty. Besides this feature which tends to encourage regular employment on the part of the workman, the plan provides employers an inducement to keep their employees continuously at work, week after week, by allowing a claim for a refund at the end of the year of one third the employer's contribution on each workman regularly employed during the year. These ingenious provisions assist in regularizing employment.

The preventive features of the British unemployment act are not difficult to discover. By providing a regular,

although small benefit to the unemployed workman, he is tided over the slack season and kept from abject want, without having been paid enough to encourage indolence. In this way the dismal period of unemployment is relieved of the terror of starvation, health and hope are maintained, and moral degeneration averted. A feeling of independence and self-reliance is fostered by the knowledge that provision against misfortune is being built up by one's own weekly contributions. Thus does unemployment insurance not only prevent poverty that results from loss of wages during an out-of-work period, but also forestalls the subtle moral degeneration that grows out of shiftlessness and discouragement.¹¹

The social insurance system is completed by provision for old-age insurance. The need for some sort of state provision for the aged members of the working classes is a natural consequence of the modern industrial organization of society. Prior to the industrial revolution, when the population lived largely under rural conditions, it was possible for the aged to find work to do until well-advanced in years. But in the modern nation of cities, with its crowded tenement houses and insatiable demand of industry for the young and the quick of movement, there is little work that an aged person can find to do. Since changing economic conditions have rendered the dependence of old people upon their descendants increasingly precarious, and since old age is a risk to which all are liable, but which many never survive to experience, the proper method of safeguarding old age is by some insurance plan.

Germany established a compulsory old-age insurance

¹¹ For a discussion of unemployment insurance see Rubinow, *op. cit.*, and *Amer. Labor Leg. Review*, May, 1914.

system in 1889, and by 1910 about one quarter of her people were insured. At sixteen years of age, all wage-earners whose earnings aggregate less than \$476 a year must begin old-age insurance. The cost is met by equal contributions from employer and employee. To this amount the state adds a subsidy of \$11.90. At seventy years of age, the workman receives a pension of from \$26.18 to \$54.64 a year. The average pension has steadily risen until, in 1913, it amounted to more than ten cents a day.¹² While the sum seems deplorably inadequate, according to American standards, it should be remembered that it goes farther in Germany, and in reality does help to lighten the burden of aged dependents upon their children.

Just how solid a front against the encroachments of such misfortunes as industrial accident, sickness, unemployment, and dependent old age, social insurance throws about the "average" workman may be shown if we will but follow an insured workman through the various vicissitudes of his life-history.

It is probable that the early years of work will be quite free from misfortunes such as sickness and accident, but since industrial depression is no respecter of youthful and agile persons, our workman will be likely to experience the loss of his job. We will assume that he has spent the week in diligent search for work, but without avail. Yet his failure to find a new job does not consign him to a discouraging period of privation, for he begins to draw unemployment benefits after the first week. This payment continues for fifteen weeks, if necessary. It is practically certain that long before the maximum period is up, he will have found a new position. Indeed,

¹² Rubinow, *op. cit.*, pp. 358-9.

experience has shown that ninety-nine per cent. of the beneficiaries of unemployment insurance secure work before the expiration of fifteen weeks. Thus, social insurance has tided him over a crisis which the ordinary experience of workmen makes large with possibilities for evil, and has permitted his reestablishment as a self-supporting citizen.

As the years go by, sickness is sure to come, with its consequent suffering, incapacity, and loss of income. At this point sickness-insurance steps in and provides medical attention and supplies which the wage-earner's small savings and uncertain income could not obtain. Moreover, the loss of income due to absence from work is made up in considerable measure by the payment of a weekly benefit of two thirds of his wages. When invalidity follows, a pension is paid, and the burden of dependence upon the family made bearable, or at least considerably reduced. In cases of death, there is this pension for the wage-earner's dependents, besides funeral money. Again our workman has been tided over misfortune, saved from sinking into dependence, and restored to economic independence, by adequate provision for an economic and moral, as well as physical recovery.

Then, perhaps, the misfortune of industrial accident occurs. There is a class of injury to the workman which results in complete or partial incapacity for a considerable length of time. Once more social insurance, this time in the form of compensation for industrial accident, or perhaps sickness-insurance, wards off the worst physical, moral, and economic effects of the misfortune, by providing medical attendance and two thirds of his wages. The period of privation and suffering is lightened, permanent disability, if it occurs, is relieved by a

pension, or in a case of death, the dependents are assisted by a pension payment adapted to their peculiar needs. Thus, for a third time, social insurance has stepped in and helped solve the problems of a life's vicissitudes.

Finally, when our worker is no longer adaptable in mind and body, social insurance provides a modest annuity sufficient to diminish the burden of aged dependence upon the self-supporting children. This small pension is increased by whatever private savings the workman had been able to gather together in his period of greatest productivity, and by the fund he may have accumulated under unemployment insurance because of his unusual regularity at work. Thus all the ordinary risks of life that workmen are unable individually to assume, because of inadequate wages, are covered by a socialized form of insurance which becomes a preventer of poverty, as well as a constructor of citizenship.

BIBLIOGRAPHY



PARTIAL BIBLIOGRAPHY

This list of references is adapted to the use of the student or the general reader who desires more intensive knowledge of the historical developments outlined in the text.

PART I. THE GREEK PERIOD

- Bury, J. B.—A History of Greece, London, 1913.
Cunningham, Wm.—Western Civilization in Its Economic Aspects (Ancient Times), Cambridge, 1902.
Gulick, C. B.—Life of the Ancient Greeks, New York, 1911.
Ingram, J. K.—A History of Slavery and Serfdom, London, 1895.
Lock, C. S.—Charity and Social Life, London, 1910.
Plutarch's Lives.
Pottier, E.—Douris and the Painters of Greek Vases, London, 1909.
Tucker, T. G.—Life in Ancient Athens, London, 1911.
Zimmern, A. E.—The Greek Commonwealth, Oxford, 1911.

PART II. THE ROMAN PERIOD

- Abbott, F. F.—The Common People of Ancient Rome, New York, 1911.
Buckland, W. W.—The Roman Law of Slavery, Cambridge, 1908.
Cunningham, Wm.—Western Civilization in Its Economic Aspects.
Davis, W. S.—The Influence of Wealth in Imperial Rome, New York, 1910.
Dill, S.—Roman Society from Nero to Marcus Aurelius, London, 1905.
—Roman Society in the Last Century of the Western Empire, London, 1899.
Ferrero, G.—Greatness and Decline of Rome, Empire Builders, transl. by A. E. Zimmern, New York, 1909.

- Greenidge, A. H. J.—History of Rome, Vol. I, London, 1905.
 Johnson, H. W.—The Private Life of the Romans, 1903.
 Lock, C. S.—Charity and Social Life.
 Ingram, J. K.—A History of Slavery and Serfdom.
 Mommsen, T.—History of Rome, New York, 1875.
 Plutarch's Lives.

PART III. THE MEDIEVAL PERIOD

- Ashley, W. J.—English Economic History, New York, 1893.
 Cheney, E. P.—An Introduction to the Industrial and Social History of England, New York, 1908.
 Cunningham, Wm.—The Growth of English Industry and Commerce, Cambridge, 4th ed., 1905.
 Gibbins, H. de B.—Industry in England, 4th ed., New York, 1906.
 —History of Commerce in Europe, London, 1909, 2nd ed.
 Gross, C.—The Gild Merchant, Oxford, 1890.
 Kramer, S.—The English Craft Guilds and the Government, in *Studies in History, Economics and Public Law*, Columbia University, Vol. XXIII.

PART IV. GREAT SOCIAL REVOLUTIONS OF MODERN TIMES

- Ashley, W. J.—English Economic History.
 Baines, E.—History of Cotton Manufacture in Great Britain, London, 1835.
 Bücher, C.—Industrial Evolution, Wickett transl., New York, 1901.
 Callender, G. S.—Selections from the Economic History of the United States, Boston, 1909.
 Cheney, E. P.—Industrial and Social History of England.
 Cooley, C. H.—Social Organization, New York, 1912.
 Cunningham, Wm.—The Growth of English Industry and Commerce.
 —Outlines of English Industrial History, New York, 1895.
 Fiske, G. W.—The Challenge of the Country, New York, 1912.
 Gillette, J. M.—Constructive Rural Sociology, New York, 1916 ed.
 Hobson, J. A.—The Evolution of Modern Capitalism, London, 1906, rev. ed.

- Lincoln, J. T.—The Factory, Boston, 1912.
- Macgregor, D. H.—The Evolution of Industry, London and New York, 1911.
- Ogg, F. A.—Social Progress in Contemporary Europe, New York, 1912.
- Plunkett, H.—The Rural Life Problem of the United States, New York, 1911.
- Robinson, J. H. and Beard, C.—The Development of Modern Europe, Boston, 1908.
- Taylor, C.—A History of the Factory System.
- Tickner, F. W.—Social and Industrial History of England, New York, 1915.
- Toynbee, A.—The Industrial Revolution, London, 1902 ed.

PART V—THE TRANSITION FROM REMEDIAL TO CONSTRUCTIVE CHARITY AND PREVENTIVE PHILANTHROPY.

- Ashley, J. W.—English Economic History.
- Dawson, W. H.—Social Insurance in Germany, London, 1912.
- Devine, E. T.—Principles of Relief, New York, 1905.
- The Practice of Charity, New York, 1901.
- Ellwood, C. A.—Public Relief and Private Charity in England, University of Missouri Studies, 1903, Vol. II, No. 2.
- Frankel, L. K. and Dawson, M. M.—Workingmen's Insurance in Europe, New York, 1910.
- Henderson, C. R.—Modern Methods of Charity, New York, 1904.
- Industrial Insurance in the United States, Chicago, 1909.
- Citizens in Industry, New York, 1914.
- Lee, J.—Constructive Philanthropy, New York, 1906.
- Lewis, F. W.—State Insurance, Boston, 1909.
- Lonsdale, S.—The English Poor Laws, London, 1901.
- Nicholl, G.—History of the English Poor Law, London, 1899.
- Parmelee, M.—Poverty and Social Progress, New York, 1916.
- Pigou, A. C.—Unemployment, New York, 1914.
- Richmond, M. E.—Social Diagnosis, New York, 1917.
- Rubinow, I. M.—Social Insurance, New York, 1913.
- Schloss, D. F.—Insurance Against Unemployment, London, 1909.
- Seager, H. R.—Social Insurance, New York, 1910.
- Webb, S.—The Prevention of Destitution, London, 1911.

Webb, S. and B.—The Break-up of the Poor Law; being Part One of the Minority Report of the Poor Law Commission, London, 1909.

—The English Poor Law Policy, London, 1910.

INDEX

- Abbott, F. F., cited, 105, 106, 107; quoted, 87, 88, 109.
- Acre, 10, 55, 64.
- Acropolis, 35.
- Aeroplane, 237, 240.
- Agrarian conditions, 16, 23-4, 46-7, 54-5, 62-9, 74, 154-69, 269.
- Airship, 219.
- Alfred, quoted, 207.
- Agriculture, 6, 9, 10, 16, 27, 46, 54, 65, 73, 77, 102, 185, 204, 229, 239; machinery, 165-9; revolution in, 147, 148, 150-69.
- Almsgiving, 264-9, 281.
- Almshouse, 266.
- Appian, cited, 63, 71, 72; quoted, 59.
- Apprentice, 124, 125, 131, 132, 134, 139, 206, 208, 265-6, 266-7; statute of, 136, 205.
- Aristotle, 8, 12, 38, 64.
- Arkwright, R., 175, 176, 178.
- Armenpfleger*, 282-3.
- Ashley, W. J., cited, 121, 122, 131, 133, 137, 139, 152, 155; quoted, 120, 129, 130, 132, 134, 265-6, 266-7.
- Assemblies, popular, *boulé*, 34; *eclesia*, 34; *curiae*, 49.
- Associated charities, 287.
- Athens, 6, 8, 10, 11, 15, 17-22, 25, 26, 30, 124.
- Automobile, 160, 166, 195, 219, 230, 237, 239, 240.
- Aviation, 220.
- Ayres, L. P., 254.
- Bain, A., 223.
- Baines, C., 176.
- Balloon, 219.
- Beard, C., quoted, 174-5.
- Beggars, 62, 156, 265, 268, 269, 281.
- Bell, A. G., 221, 223.
- Berliner, E., 221.
- Black death, 269.
- Blast furnace, medieval, 123; modern, 180.
- Böeckh, 22.
- Bottomry, 22.
- Boulé, 34.
- Bourgeoisie, 129.
- British National Insurance Act, 297.
- Bruce, P. A., 101.
- Bryce, J., 234.
- Burroughs, J., 247.
- Bushnell, D., 228.
- Cairnes, quoted, 103.
- Callender, G. S., 101, 102, 104.
- Capital and capitalism, 15, 16, 21, 39, 56, 59, 62, 65, 72, 79, 101, 102, 121, 122, 157, 164, 170, 200, 201, 205, 213, 215.
- Capitalistic estates in England, 164.
- Capitalistic slave estates, in Greece, 17; in Rome, 59.
- Carrel, A., 223.
- Cartwright, 176, 178.
- Cattle, 6, 55, 64, 157.
- Cavaignac, 20.
- Censorship of movies, 255-6.
- Charity of guilds, 128; in Greece, 32-8; medieval, 264-73; modern, 263-304; in Rome, 61, 84-8; private, in Greece, 37; in Middle Ages, 264, 266, 267, 268; in modern times, 286-91; in Rome, 84-8.
- Charity Organization Society, 286-91.

- Cheney, E. P., cited, 119, 131, 165, 173, 185, 212; quoted, 123, 127, 129.
- Christianity and slavery, 95.
- Church, 264, 265, 269, 270, 271.
- Cities, problem of, 150-1.
- Class struggle, in England, 152-61; in Greece, 22, 25; in Rome, 48-60, 67.
- Cleisthenes, 25.
- Climate, 5, 44-5.
- Collegia, 97, 105, 107, 112, 128.
- Colonization, 9, 47, 73, 75.
- Colonus, 98, 99, 100.
- Colosseum, 85.
- Commerce, 10, 13, 24, 33, 43, 45, 52, 74, 79, 89, 115-19, 128, 151, 203, 204.
- Communication, revolution in, 147, 149, 215-60.
- Compensation for industrial accident, 292-6.
- Competition, in Greece, 28, 30; Middle Ages, 130; modern, 214; Rome, 71.
- Cooley, C. H., 218, 223, 248, 249, 256, 257.
- Constructive charity, coöperation, 228; follow-up, 289; investigation, 287; registration, 288.
- Corporation, 202, 213-14.
- Crafts, 28-30, 106, 207, 269.
- Craft guilds, 120-37, 138, 200.
- Crompton, S., 176, 178.
- Crusades, 116-18.
- Cunningham, W., cited, 13, 14, 22, 27, 39, 47, 123, 125, 135, 158; quoted, 46, 115, 117, 118.
- Daguerre, L. J. M., 220.
- Davis, W. S., cited, 81, 84.
- Debt slavery, in Greece, 15, 16, 23; in Rome, 49, 50, 54.
- Defoe, D., quoted, 141-2.
- Democracy, 5, 149, 216, 258.
- Demosthenes, 26.
- Dependents, in Greece, 33; in Middle Ages, 127; modern, 274; in Rome, 61.
- Detoqueville, 247.
- Devine, E. T., 291.
- Dill, S., 105, 107.
- Division of labor, 27, 28, 29, 108, 123.
- Dole-giving, 81, 83, 110, 267.
- Domestic system, 27, 138-43, 188, 199, 200.
- Drachma, 11, 18, 19.
- Draco, 23.
- Eaton, W. P., 242.
- Edison, T., cited, 221, 252, 253; quoted, 246.
- Education, 252-4.
- Edwards, B., 101.
- Elberfeld system of public poor-relief, 281-6, 287.
- Ellwood, C. A., 270, 278.
- Emigration, 9, 32, 73, 75.
- Emoluments, 34, 40.
- Enclosures of agricultural land, 152, 154, 155, 157, 161, 185.
- Endowments of charity, 267.
- Employers' liability, 293-4.
- Factory, 26, 27, 28, 29, 89, 122, 142, 165, 176; acts, 208-12, 293; system, 139, 141, 142, 160, 177-214.
- Farmer, 16, 46, 63, 77, 82, 163, 164, 169, 185, 230, 238.
- Ferrero, G., cited, 53, 61, 65, 72, 76; quoted, 70, 196.
- Fiske, G. W., 166, 239, 241.
- Fisher, I., 298.
- Fitch, J. A., quoted, 195-6.
- Food supply in Athens, 15, 17, 24; Rome, 47, 60, 62, 73, 82.
- Fowle, cited, 276.
- Friendly visiting, 282, 289.
- Froude, cited, 156.
- Fulton, R., 218, 229.
- Gaumont, M., 221.

- Gibbins, H. de B., cited, 116, 118, 125, 136, 155, 164, 171, 182, 185, 273; quoted, 124, 140, 143, 158, 182, 202, 207.
- Gilfillan, S. C., 242, 243.
- Gillette, J. M., 169.
- Gilds, craft, 120-37; in Greece, 30; journeymen's, 132-3; medieval, 118-39; merchant, 118-19; yeomen, 132-3.
- Giry, 115.
- Government control and regulation, of factory conditions, 204, 208-14; of medieval guilds, 135-6; poor relief, 269-77; prices of grain in Greece, 22, 33; in Rome, 71, 84.
- Gracchus, G., 69, 71, 72, 73, 74, 79; colonization law, 73-4; corn law, 71, 84; death, 77; franchise law, 76.
- Gracchus, T., 62, 64, 65, 66, 67, 72; death, 67, 77; land law, 64-6, 68, 72; quoted, 63.
- Grain supply in Athens, 22; in Rome, 47, 48; distribution in Athens, 33; Rome, 71-2, 80.
- Gramophone, 221.
- Graphophone, 221.
- Greece, 3-40, 129, 150, 157, 162, 208.
- Greenidge, A. H. J., cited, 68, 71, 72, 76, 78; quoted, 62, 66, 73, 79.
- Gross, C., 119.
- Gulick, C. B., 28, 32, 33, 37.
- Hamburg-Elberfeld system of poor-relief, 281-6, 291.
- Handicraft system, 27, 120-22, 139, 142, 200, 203.
- Haney, L. H., 203.
- Hansa League, 118.
- Hargreaves, J., 175, 176.
- Harrison, quoted by Gibbins, 163.
- Health insurance, 296-8.
- Henderson, C. R., cited, 281; quoted, 285-6.
- Henry, J., 221.
- Herodotus, 9.
- Heyl, H., 221.
- Hobson, J. A., cited, 177, 179; quoted, 180.
- Hospitals, medieval, 266, 267, 268.
- Husbandry, convertible, 153.
- Hyatt, Supt., quoted, 233.
- Illingsworth, T., quoted, 142.
- Industry, 14, 24, 26, 27, 31, 59, 73, 74, 79, 102, 104, 108, 110, 111, 129, 130, 131, 136, 139, 147, 148, 160, 170-214, 250.
- Ingram, J. K., 17, 21, 90, 91, 95, 96, 97, 98, 100, 101, 102.
- Interurban trolley, 239.
- Inventions, 83, 110, 131; in agriculture, 165-9; in communication, 216, 218-23, 252; manufacturing industry, 174-7.
- Insurance, against industrial accident, 291-6; health, 296-8; against sickness, 296-8; social, 291-304; against unemployment, 299-304.
- Italy, 9, 19, 55, 57, 62, 91, 106; physical aspects, 43-4.
- Ines, F. E., 220.
- Journeymen, 124, 125, 131, 132, 134, 136, 138; guilds, 132-3.
- Kay's shuttle, 174, 176.
- Kelley, E. S., 247.
- Kenetophone, 221, 224.
- Kinematoscope, 221, 243.
- Kramer, S., 131, 136, 137.
- Kydd, S., quoted, 186.
- Labor, 29, 31, 60, 102, 105, 112, 130, 151, 153, 170, 274; attitude of Greeks toward, 31, 32; statute of, 269.
- Laissez-faire, 130, 204, 205, 212.
- Land holding, in England, 153-

- 65; in Greece, 16, 23-4; in Rome, 46-7, 54-5, 63-9.
- Langley, 220.
- Lanier, H. W., 230.
- Latifundia, 59, 92.
- Latimer, cited, 154.
- Laws, colonization law of Gracchus, 73-4; corn law of Gracchus, 71; factory acts, 208-12; Licinian, 54, 63, 64; poor-laws, 271-3; writing of, in Greece, 23; in Rome, 51-2.
- Licinian law, 54, 63, 64.
- Linotype, 223.
- Lithography, 220.
- Livy, cited, 67.
- Lock, C. S., cited, 33, 80, 84, 263-4; quoted, 80-1, 83.
- Locomotive, 217, 219, 222.
- Loom, 139, 142.
- Lonsdale, S., 273.
- Macgregor, D. H., 179.
- Machinery, 89, 148, 160, 199, 200, 202, 206, 208, 212, 239; agricultural, 165-9; textile manufacture, 174-82, 188-92.
- Magazine, 223, 224, 227, 245, 246.
- Mail, 218, 237-8.
- Malthus, T. R., 204.
- Manufactures, in Greece, 24, 26, 27, 28; in Middle Ages, 104, 108, 110, 115, 121, 122, 126, 130, 131, 139, 140, 143, 147, 151; in Rome, 52; textile, 170-214.
- Manumission, in Greece, 21; in Rome, 94-5.
- Marconi, G., 223.
- Market and markets, 16, 101, 121, 138, 141, 158.
- Mason, G., 230.
- Master workman, 28, 124, 125, 131, 132, 134, 136, 293.
- Maxim, H., 220.
- Mechanical power, 148.
- Metics of Athens, 10, 17, 28.
- Middle Ages, 116, 121, 191, 200, 203, 264, 265, 267, 268.
- Middle class, 8, 59, 60, 105, 129.
- Middlemen, 22, 139.
- Mommsen, T., 68, 73.
- Monasteries, 264, 265, 266, 268, 269.
- Money, 12-17, 22, 23, 56, 97, 101, 110, 124.
- More, T., quoted, 154, 156.
- Morse, S. F. B., 221, 243.
- Motion-pictures, 221, 227-33, 241-4, 246, 251-6, 258.
- Münsterberg, L., quoted, 228-9.
- National Insurance Act, British, 297.
- Navigation Acts, 171, 205.
- Nearing, S., 241.
- Newspaper, 223, 224, 238, 239, 245.
- Nicholl, C., 269, 270.
- Nordau, M., 256, 257.
- Ogg, F. A., cited, 152, 159, 171; quoted, 165.
- Overseers of the Poor, 272.
- Ovid, cited, 92.
- Patrician, 48, 49, 53, 54, 55.
- Patten, S. N., quoted, 280-1.
- Peasant, 16, 46, 50, 59, 65.
- Peloponnesian war, 5, 33, 37.
- Pensions, 33, 301-2.
- Perkins, G. W., quoted, 259-60.
- Pericles, 8, 34, 37.
- Philanthropy, 280.
- Phonograph, 221.
- Phonograph, 221, 234, 243, 244, 246.
- Photography, 220, 224, 227, 228, 233, 241, 251.
- Pisistratus, 25, 32.
- Plebeian, 48, 49, 51, 53, 54, 62, 96.
- Pliny, 83, 91.
- Plow, 151, 155; colonial, 153; motor, 163, 165; steam, 157.
- Plutarch, cited, 16, 34, 38, 73, 93; quoted, 33, 63, 74-5, 77.

- Plutoeracy, 56-8.
- Polybius, 80.
- Poor, the, and poverty, in Greece, 15, 16, 22, 40; medieval and modern times, 156, 206, 215, 263, 277, 296; in Rome, 50, 54, 59, 64, 66, 76, 80-7.
- Poor-law amendment, 277-8.
- Poor-law of Elizabeth, 271-3.
- Poor relief, 268, 270, 271, 273, 274, 275, 278, 279, 281-6, 287-91.
- Population, 9, 15, 19, 51, 59, 61, 62, 77, 78, 91, 104, 116, 148, 151, 156, 159, 182-5, 267.
- Popular government, 215-16.
- Pottier, E., 29.
- Preventive philanthropy, 280-304.
- Prices, 16, 19, 22, 30, 82, 109, 111, 126.
- Private charity, in Greece, 37; medieval, 264, 266-8; modern, 286-91; Rome, 84-8.
- Property, 33, 37, 54, 56, 80, 81, 266.
- Publicani*, 56.
- Public relief in Greece, 34, 37; modern, 281-6; Rome, 80-4.
- Railroad mileage, 237.
- Relief of the poor, private in Greece, 37; medieval, 264, 266-8; modern, 286-91; Rome, 80-4; public in Greece, 34, 37; modern, 271-79; Rome, 80-4; indoor, 275, 283; outdoor, 275, 276, 278.
- Revolution, in agriculture, 148, 150-69; communication, 147, 149, 215-60; industrial, 159, 170-214; social, in modern times, 147-9; in Rome, 67.
- Ricardo, 203.
- Roads, Dr., quoted, 239.
- Robinson, J. H., quoted, 174-5.
- Roman provinces, 55-6, 60.
- Rome, 42-112, 129, 147, 157, 162, 208.
- Ross, E. A., 251, 252.
- Rubinow, I., 294, 296, 297, 302.
- Saint Thomas Aquinas, 263.
- St. Bernard, 263.
- St Bartholomew, 266.
- St. Francis, 263.
- Salvioli, 30
- Scheele, K. W., 220.
- Scott, L., 221.
- Seager, H. R., 294, 296.
- Sellers, C., 221.
- Seligman, E. R. A., cited, 139, 192; quoted, 121.
- Senate, Roman, 50, 52, 55, 58, 66, 67.
- Senebier, J., 220.
- Serf, 13, 14, 57, 96-101.
- Sesterce, 82, 83, 87, 106.
- Settlement Act, 274.
- Sheldon, G. B., 219.
- Shaw, G. B., 234.
- Sickness insurance, 296-8.
- Smith, A., 192, 204.
- Slave, 13, 14, 16, 18, 28, 59, 78, 82, 129, 150, 208; *familia rustica* and *familia urbana*, 90; manumission, in Greece, 21; in Rome, 94-5; numbers, in America, 101-2; in Greece, 19-20; in Rome, 89-91; praedial, in Rome, 99; prices of, in Greece, 19; punishments of, in Rome, 93; sources of, in America, 101-2; in Greece, 17-18; in Rome, 89-90; treatment of, in Greece, 20; in Rome, 92-3.
- Slave estates, in Greece, 17; in Rome, 59.
- Slavery, in America, 101-4; decline of, 96-101; in Greece, 17-21, 23; in Rome, 46, 59, 89-101; wage slavery in England, 200, 206-7, 209.
- Statute of Apprentices, 136, 205.
- Statute of Labors, 269.
- Strabo, cited, 90.
- Suetonius, cited, 80, 83; quoted, 82.

- Submarine, 218, 219, 228, 229, 231.
 Sumner, W. G., 116.
 Swabian confederacy, 117.
- Tacitus, 82, 100.
 Tanier, S., 221.
 Taylor, C., 178, 207.
 Taxes, 14, 56, 57, 59, 111, 112, 271, 272, 282.
 Telegraph, 221, 223, 234, 245, 259.
 Telautography, 223.
 Telephone, 223, 224, 234, 240, 241, 243, 257, 259.
 Tenements, 61, 188, 227.
 Textile manufacture, 172-8.
 Thetes, 24, 31.
 Thucydides, 9.
 Toynbee, A., cited 141, 158, 171; quoted, 162.
 Tractor, 166.
 Trade union, 106.
 Transportation, 149, 216, 218, 250, 251.
 Tribune, Roman, 50, 53, 54, 69, 75; Consular, 54.
 Trolley car, 218, 239.
 Tucker, T. G., quoted, 32.
 Typewriter, 223.
- Ulhom, cited, 264.
 Unemployment, 229-304.
- Vail, T., 234.
 Virgil, cited, 7.
- Wages, 13, 22, 30, 31, 108, 109, 125, 136, 164, 185, 200, 202, 206, 207, 276.
 Wallin, W., quoted, 233.
 Warner, A. G., 290.
 Weaving, 173, 175, 185.
 Webb, S. and B., 279.
 Wedgwood, T., 220.
 Weedon, W. P., 101.
 Westermann, W. L., 110.
 Wilcox, D. F., cited, 249; quoted, 250.
 Wilmanns, cited, 88.
 Wireless telegraph and telephone, 223, 237, 248, 259.
 Work test, 275, 276, 278.
 Workhouse, 206, 209, 275, 276, 278.
 Working class, 131, 215.
 Workmen, 13, 28, 105, 108, 121, 124, 187, 191; compensation for industrial accident, 292-6.
 Wright, O. and W., 220.
- Xenophon 8, 19, 26.
- Yeomen, 16, 77, 132, 161-5.
 Young, A., cited 158; quoted, 159.
 Young, T., 221.
- Zabrowski, S., 19, 21.
 Zeppelin, 219, 235.
 Zimmern, A. E., cited, 4, 5, 6, 7, 8, 9, 10, 19, 20, 21, 27, 32, 39; quoted, 30.

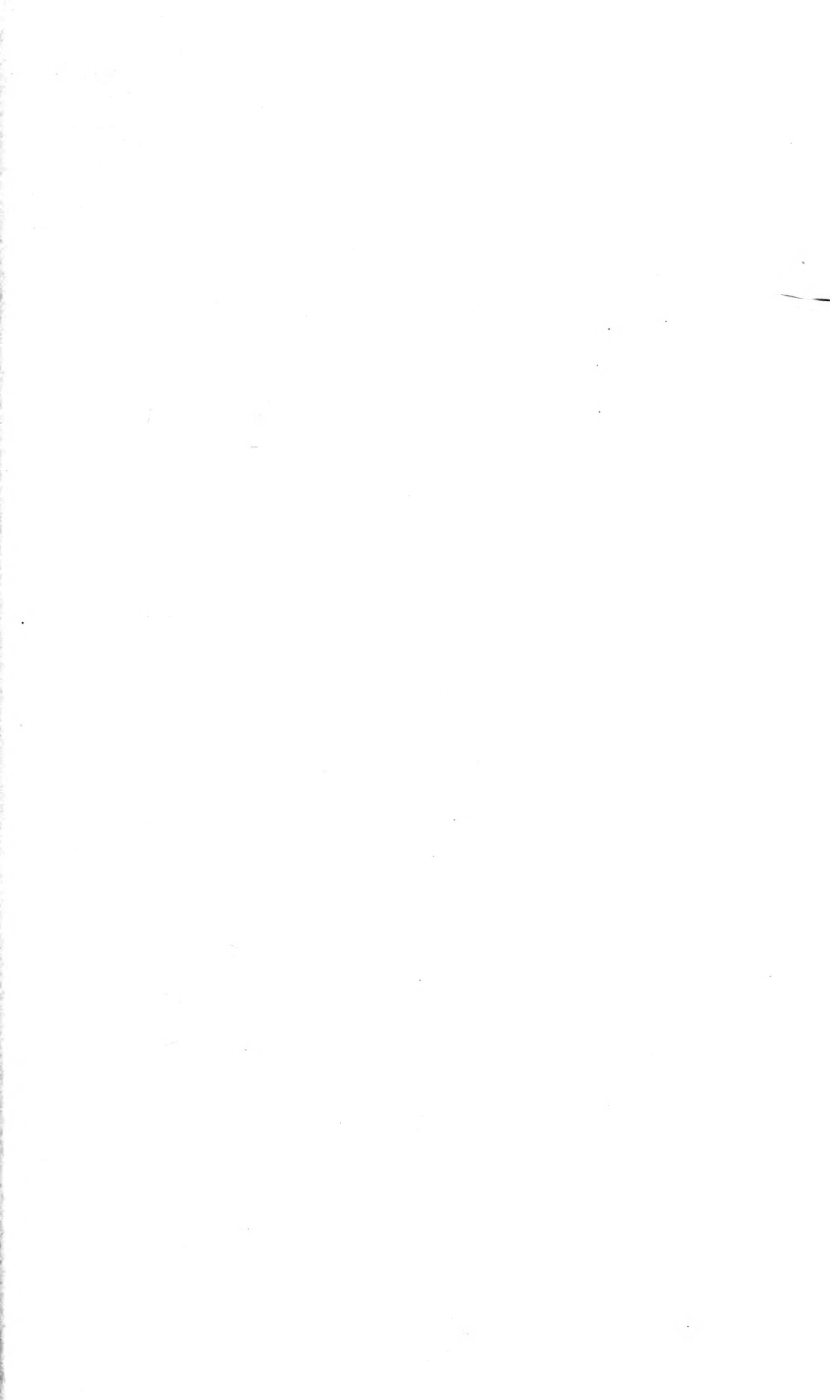



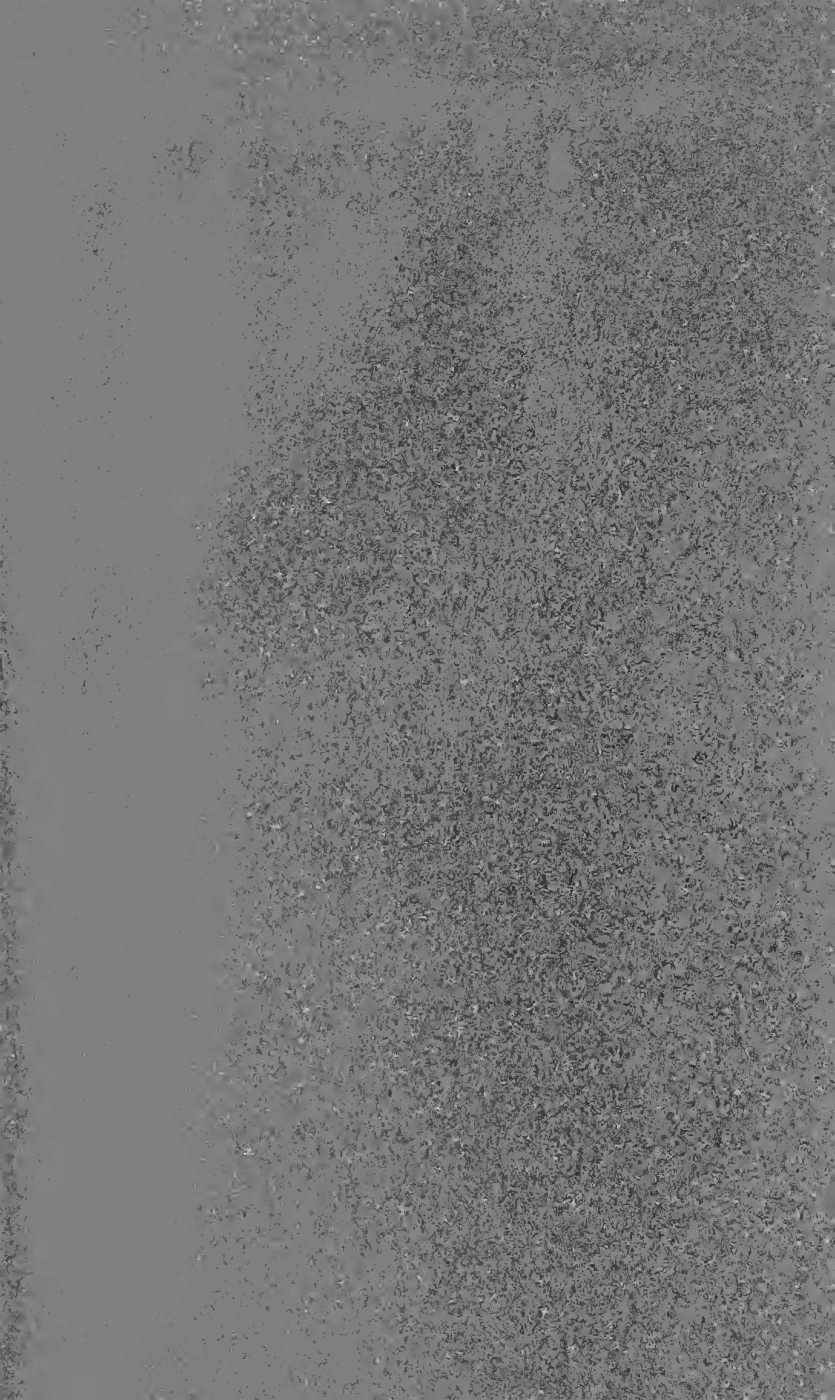

14 DAY USE
RETURN TO DESK FROM WHICH BORROWED
LOAN DEPT.

This book is due on the last date stamped below, or
on the date to which renewed.
Renewed books are subject to immediate recall.

	MAY 17 1969 0 ^X
JUL 25 1967 11	
REC'D	MAY 16 '69 -9 PM
JUL 15 '67 -1 PM	LOAN DEPT.
LOAN DEPT.	
AUG 30 1967 34	
JUL 16 '67 -1 PM	
JUN 4 1968 5	
REC'D	
MAY 22 '68 -10 PM	

LD 21A-60m-2,'67
(H241s10)476B

General Library
University of California
Berkeley

LOAN DEPT.

